Ground Vibration Test Results of a JetStar Airplane Using Impulsive Sine Excitation

Michael W. Kehoe and David F. Voracek

February 1989



National Aeronautics and
Space Administration

Ground Vibration Test Results of a JetStar Airplane Using Impulsive Sine Excitation

Michael W. Kehoe and David F. Voracek
Ames Research Center, Dryden Flight Research Facility, Edwards, California

1989



National Aeronautics and
Space Administration

Ames Research Center

Dryden Flight Research Facility
Edwards, California 93523-5000

GROUND VIBRATION TEST RESULTS OF A JETSTAR AIRPLANE USING IMPULSIVE SINE EXCITATION

Michael W. Kehoe
David F. Voracek
Ames Research Center
Dryden Flight Research Facility
Edwards, California, U.S.A.

ABSTRACT

Structural excitation is important for both ground vibration and flight flutter testing. The structural responses caused by this excitation are analyzed to determine frequency, damping, and mode shape information. Many excitation waveforms have been used throughout the years. The use of impulsive sine $(\sin \omega t)/\omega t$ as an excitation waveform for ground vibration testing and the advantages of using this waveform for flight flutter testing are discussed. The ground vibration test results of a modified JetStar airplane using impulsive sine as an excitation waveform are compared with the test results of the same airplane using multiple-input random excitation. The results indicated that the structure was sufficiently excited using the impulsive sine waveform. Comparisons of input force spectrums, mode shape plots, and frequency and damping values for the two methods of excitation are presented in this paper.

INTRODUCTION

To obtain aircraft structural response data that have a high signal-to-noise ratio for both ground and in-flight applications, the test structure must be adequately and properly excited. The structural responses that are measured from this excitation are analyzed to determine the frequency, damping, and mode shape for each structural mode of vibration.

Many excitation waveforms have been used for both ground vibration and flight flutter testing. These have included sine dwell, sine sweep, impact, and single and multiple-input random excitation^(1,2,3) for ground vibration testing. In-flight excitation has consisted

mainly of impact, from bonkers⁽⁴⁾ or control surface pulses,⁽⁵⁾ and sine sweeps using either wingtip oscillating aerodynamic vanes,⁽⁶⁾ or existing control surfaces,⁽⁷⁾ or oscillating masses,⁽⁸⁾ or rotating eccentric weights.⁽⁹⁾

Ideally, a waveform that excites all structural modes simultaneously and in a short duration is desired for in-flight applications because of the high cost of flight testing. One such waveform is impulsive sine $(\sin \omega t)/\omega t$.⁽¹⁰⁾ The capability of this waveform to excite all of the structural modes of interest on an aircraft structure was investigated by conducting a ground vibration test on a modified JetStar airplane. This test was considered a necessary first step to determine if this waveform would be effective for in-flight applications.

This paper contains the results of a ground vibration test (GVT) on a modified JetStar airplane using impulsive sine as an excitation waveform. These results are compared with the results of a GVT previously conducted on the same airplane using multiple-input random excitation.⁽²⁾ Data are presented in the form of reciprocity plots, mode shape plots, input force spectrums, and frequency and damping comparisons.

IN-FLIGHT EXCITERS

In-flight structural excitation is essential for safe and efficient flight flutter testing. Flutter testing is conducted on aircraft to verify that the vehicle's flight envelope is free of aeroelastic instabilities. Since flutter can result in sudden catastrophic failure of the structure, it is imperative that the stability of the structural modes of interest be determined in-flight. This can be accomplished by analysis of high signal-to-noise ra-

This paper is declared a work of the U.S. Government and is not subject to copyright protection in the United States.

tio structural response data over the frequency range of interest.

Theoretically, the impulsive sine function can excite all of the modes of interest equally from 0 Hz up to the assigned frequency of the function. This is possible since the Fourier transform of the function is a box car function equal in amplitude from 0 Hz up to the assigned frequency.

The magnitude of force for simple sinusoidal oscillating mass exciters is proportional to the oscillation amplitude and the square of the excitation frequency. The effectiveness decreases rapidly at lower frequencies where large displacements or very large masses are required for high force levels. By using the impulsive sine function, an oscillating mass shaker with a relatively small mass could be operated at high frequencies (low displacement) and yet produce high force levels evenly over the entire frequency spectrum. It was interesting in this potential benefit that led to the ground vibration test to research the impulsive sine waveform.

IMPULSIVE SINE FUNCTION

The $(\sin \omega t)/\omega t$ (impulsive sine) time history function yields a flat power spectrum when transformed into the frequency domain via the Fourier transform. The time and frequency domain representations are shown in Fig. 1. The function has a constant frequency in the time domain but varying amplitude. The width of the central lobe is inversely proportional to the width in the frequency domain. Thus, as the frequency approaches infinity, the function approaches the Dirac delta function.

The amplitude remains constant in the frequency domain from 0 Hz to the assigned frequency. It is interesting to note that increasing the frequency of the function with a constant input level in the time domain results in an overall power decrease for each discrete frequency in the frequency domain.

AIRPLANE CONFIGURATION

The Lockheed JetStar airplane used for the ground vibration test has been extensively modified. Wing modifications included removal of the external fuel slipper tanks and installation of leading-edge laminar flow test sections on each wing. Upper and lower wing fairing devices completed each test section. The gap in the wing trailing edge left by the tank removal was closed by spanwise extension of the flaps. Figure 2 shows the location from which the external fuel tanks were

removed and indicates the trailing-edge and leading-edge modifications.

The airplane was supported on its landing gear during the test. The nitrogen contained within the landing gear struts was bled to eliminate potential nonlinear oscillations of the oleo strut. The tires were deflated to 100 psi (approximately one-half the normal pressure) to provide a soft support. The wing internal fuel tanks were empty for the test.

TEST PROCEDURE

Impulsive Sine

The impulsive sine time history was generated by a polynomial waveform synthesizer. Since only one of these units was available at the time of the test, dual, uncorrelated inputs could not be injected into two electrodynamic shakers simultaneously. As a result, single input excitation was used to excite the elastic modes of the airplane. The shaker was attached to the aft wing spar at the tip by means of a telescoping thrust rod, a mechanical fuse (stinger) and a force link. The force link was attached to a locking ball nut joint that was mounted directly to the structure by a threaded stud.

The programmable waveform synthesizer was used to generate a $(\sin \omega t)/\omega t$ time history at a frequency of 20 Hz. This signal was amplified to drive a single electrodynamic shaker. Time histories of input force and the forward left wing tip accelerometer response are shown in Fig. 3. The waveform synthesizer was programmed to generate the impulsive sine function 2 sec after the 16 sec of data acquisition had begun. This arrangement allowed the structural response to completely decay before data acquisition was complete. This makes the measurement periodic within the data acquisition window which eliminates leakage and distortion caused by weighting windows.

Data were acquired at each of the 93 locations shown in Fig. 4. (Points not shown are 45-46, 55, 83-90, 60-61, 72 and 74 which mirror points 9-10, 19, 75-82, 24-25, 34 and 36, respectively, on the right side.) Data were sampled at 51.2 samples per sec using a data blocksize of 1024 samples by a minicomputer-based structural analysis system.⁽²⁾ The antialiasing filters were set at 20 Hz. Fifty averages were used to calculate each frequency response function.

The modal parameters (frequency, damping, phase, and amplitude) were estimated using the complex exponential technique,⁽¹²⁾ since the structure was excited at only one location. Mode shape coefficients for each

mode were calculated at all points by using the amplitude and phase of the measured response at the selected resonant frequency. Animated mode shapes were then displayed to identify each mode.

Multiple Input Random

Two electrodynamic shakers were used to excite the airplane elastic modes. The shakers were attached to each wing rear spar at the tip with the same hardware used in the impulsive sine test.

Burst random excitation⁽¹¹⁾ was used for this test. Uncorrelated, random signals were routed into the electrodynamic shakers. A switching mechanism was used to start the excitation 1 sec after data acquisition began. The excitation was terminated 6 sec before data acquisition was completed to allow the structural response to completely decay.

Data acquisition was performed using the same sampling rate, blocksize, antialiasing filter setting, and number of averages as was used for the impulsive sine test. Data were also acquired at the same 93 aircraft locations.

Once data acquisition was completed for the entire airplane, frequency, damping, phase and amplitude were estimated for each mode using the polyreference parameter estimation technique.⁽¹²⁾ This technique uses multiple response functions from up to three input force locations simultaneously to obtain global least squares estimates of the modal parameters.

After an acceptable estimation of modal parameters was completed, the modal coefficients for each mode shape were calculated by using a multiple degree of freedom technique. Animated mode shapes were then displayed to identify each mode.

RESULTS AND CONCLUSIONS

Input Force Spectrum Comparison

The input force spectrum for multiple-input random and impulsive sine excitation is shown in Fig. 5. The random forcing function was shaped to be flat from 20 to 4 Hz. The amplitude then was rolled off below 4 Hz at -48 dB per octave to attenuate excitation of the aircraft rigid body modes.

The spectrum for the impulsive sine excitation, which was generated with the frequency set at 20 Hz in the $(\sin \omega t)/\omega t$ function, generally exhibits a flat spectrum from 1 to 20 Hz. There is a very slight rolloff in amplitude from 2 to 1 Hz. In addition, there were some

slight irregularities in amplitude at approximately 5 and 16 Hz where wing structural modes exist. This may be due to the force link sensing the decaying motion of the wing structural mode after it was excited with the central lobe of the $(\sin \omega t)/\omega t$ waveform.

The central lobe force of the impulsive sine waveform was 40 lb. This level was the maximum achievable from a 150-lb force-rated shaker because of the amplifier peak current requirements necessary for the generation of the impulse sine waveform. This resulted in a low overall force level for the impulsive sine excitation. The multiple-input random excitation amplitude was an order of magnitude greater than the impulsive sine excitation amplitude (Fig. 5). For the shaker equipment used, the multiple-input random excitation force level could have been increased even further.

A lower overall force level, as shown by the impulsive sine function, results in less energy to excite the structural modes of the airplane. This can result in modes not being sufficiently excited or not being excited at all, and a low response data signal-to-noise ratio.

Reciprocity Comparisons

The average quality of the reciprocity for multiple-input random excitation is better than that for impulsive sine. A reciprocity comparison of multiple-input random and impulsive sine excitation is shown in Figs. 6 and 7. The reference and response locations listed on each figure refer to the location where the input force and structural response, respectively were measured on the airplane. These locations are shown in Fig. 4.

The reciprocity for impulsive sine (Fig. 7), shows a shift in frequency for the rigid body mode at approximately 2 Hz and a shift in amplitude for most of the elastic modes when compared to the multiple input random reciprocity shown in Fig. 6. The frequency shift and amplitude changes may be caused by nonlinearities and also from using a shaker at a single location. These cause the impulsive sine reciprocity to be rather poor for most modes which generally makes data analysis more difficult and less accurate.

Modal Parameter Comparison

The modal assurance criterion (MAC),^(12,13) which can be used as an approximation of an orthogonality check, was used to compare the mode shapes from the multiple-input random and impulsive sine methods. MAC values above 0.90 indicate a high degree of correlation between mode shapes.

A comparison of the MAC values obtained from the tests is shown in Table 1. All of the MAC values for these two tests are 0.90 or greater. However, the MAC values tend to decrease as the frequency of the modes increased. This is most likely due to using single point excitation for impulsive sine which results in an uneven energy distribution to the airplane. A comparison of mode shapes for multiple-input random and impulsive sine excitation is shown in Figs. 8 through 16. The mode shape data indicated that the airplane was responding asymmetrically. The symmetric first wing bending mode shape (Fig. 8) shows motion on the vertical stabilizer which is an indication of asymmetries. Additionally, the symmetric stabilizer and wing bending mode shape (Fig. 13) and the antisymmetric first wing bending mode shape (Fig. 14) data each indicate that the wing and horizontal surfaces have different symmetry.

A comparison of modal frequencies (Table 1) indicates that the impulsive sine frequencies were within 2 percent of those measured with multiple-input random excitation. In general, the impulsive sine measured frequencies were slightly higher in value with the exception of the second symmetric wing bending frequency which was lower in value and antisymmetric wing bending which was equal in value. These frequencies may have been higher because of the differences in force distribution caused by single and multiple-input excitation. In general, a better force distribution and higher force levels tend to cause a decrease in the resonant frequency.⁽⁷⁾

The estimated damping values (Table 1) for impulsive excitation are lower than those estimated for multiple-input random with the exception of the first and second symmetric wing bending modes. Variations in estimated damping values may be caused by data scatter or may be a result of using different estimation algorithms for each type of excitation. The complex exponential technique, which was used for impulsive sine, operates on a single response function. The polyreference technique, which was used for multiple-input random excitation, obtains a least square estimate using several frequency response functions simultaneously from several different forcing points.

The test results obtained using impulsive sine as excitation have compared favorably with those obtained from multiple-input random. The test results have shown that this technique is viable for ground vibration testing. Improvements in test results could be ob-

tained by using multiple shakers and by increasing the force levels.

Application to In-Flight Exciters

According to data from this ground vibration test, implementation of an in-flight excitation system using impulsive sine looks promising but several areas need to be addressed before this waveform can be used. First, significantly higher force levels than those used for the GVT will be required for in-flight excitation in order to overcome the aerodynamic forces acting on the airplane. In addition, the power requirements to obtain those force levels may be so high that implementation of this waveform would be impractical.

SUMMARY

A ground vibration test was conducted on a modified JetStar airplane to investigate the feasibility of using the impulsive sine function $(\sin wt)/wt$ as an excitation waveform for flight test applications.

The results indicated that impulsive sine is viable for ground vibration testing. The modal parameters (frequency, damping, and mode shape) that the authors estimated using impulsive sine excitation were compared to those estimated using multiple-input random excitation. The impulsive sine frequency values were within 2 percent of the frequencies measured with multiple-input random excitation. The damping values estimated for impulsive sine excitation were generally lower in value than those estimated for multiple-input random excitation. In general, the mode shapes compared well for the two methods of excitation.

This test also illustrated that the extension of impulsive sine to in-flight applications would require higher force levels than those used for this ground vibration test to overcome the effect of the aerodynamic forces acting on the airplane in flight. In addition, the power requirements may be excessive to obtain these necessary force levels. Further research is needed to determine if this waveform can be used for in-flight excitation.

REFERENCES

- ¹Olsen, Norm, "Excitation Functions for Structural Frequency Response Measurements," Proceedings of the Second International Modal Analysis Conference, Orlando, Florida, pp. 894-902, Feb. 1984.
- ²Kehoe, Michael W., "Aircraft Ground Vibration Testing at NASA Ames-Dryden Flight Research Facility," NASA TM-88272, 1987.

³Kehoe, Michael W., Cazier, F.W., Jr., and Ellison, Joseph F., "Ground Vibration Test of the Laminar Flow Control JetStar Airplane," NASA TM-86398, 1985.

⁴Larue, Pierre, Millet, Maurice, and Piazzoli, Gerard, "Pyrotechnic Bonkers for Structural Tests in Flight," Office National d'Étude et de Recherches Aérospatiales TP 1389, 1974.

⁵Kehoe, Michael W., "KC-135A Winglet Flight Flutter Test Program," AFFTC-TR-81-4, Air Force Flight Test Center, Edwards Air Force Base, California, June 1981.

⁶Zimmermann, Helmut, "Flight Flutter Testing With Emphasis on the Tip Vane Method," Office National d'Étude et de Recherches Aérospatiales TP 1982-109, 1982.

⁷Kehoe, Michael W., "F-15A/B Nestable Fuel Tank Ground Vibration, Flight Flutter and Loads Demonstration Test Program," AFFTC-TR-79-14, Air Force

Flight Test Center, Edwards Air Force Base, California, May 1979.

⁸Dobbs, S.K., and Hodson, C.H., "Determination of Subcritical Frequency and Damping From B-1 Flight Flutter Test Data," NASA CR-3152, 1979.

⁹Kehoe, Michael W., and Rivera, Joseph A., "Flutter and Aeroservoelastic Clearance of the X-29A Forward-Swept Wing Airplane," NASA TM-100447, 1988.

¹⁰Houbolt, John C., "Subcritical Flutter Testing and System Identification," NASA CR-132480, 1974.

¹¹Olsen, Norm, "Burst Random Excitation," Sound and Vibration, Nov. 1983, pp. 20-23.

¹²"User Manual for Modal Analysis 8.0," General Electric CAE International, 1983.

¹³Ewins, D.J., "Modal Testing: Theory and Practice," John Wiley and Sons Inc., New York, 1984.

TABLE 1. MULTIPLE INPUT RANDOM AND IMPULSIVE SINE MODAL PARAMETER COMPARISON

Mode Description	Multiple-input random		Impulsive sine		Modal assurance criterion
	Frequency, Hz	Damping, G	Frequency, Hz	Damping, G	
Symmetric wing bending	4.92	0.011	4.94	0.021	0.96
Empennage roll, fuselage torsion	5.13	0.017	5.20	0.012	0.978
Empennage roll, fuselage torsion, engine pylon bending	5.87	0.017	5.95	0.014	0.991
Engine pylon bending, wing and stabilizer bending	7.43	0.020	7.49	0.016	0.979
Vertical fin bending	9.14	0.024	9.22	0.013	0.963
Stabilizer and fuselage bending	10.47	0.032	10.64	0.018	0.902
Antisymmetric wing bending	10.96	0.052	10.96	0.024	0.923
Symmetric stabilizer bending	13.55	0.026	13.65	0.014	0.911
Symmetric second wing bending	16.22	0.056	16.00	0.088	0.935

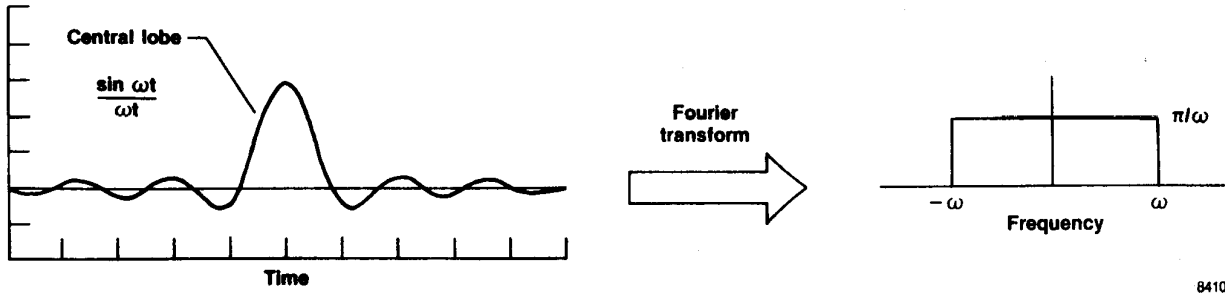

Fig. 1 The $\sin \omega t / \omega t$ function and its Fourier transform.

8410

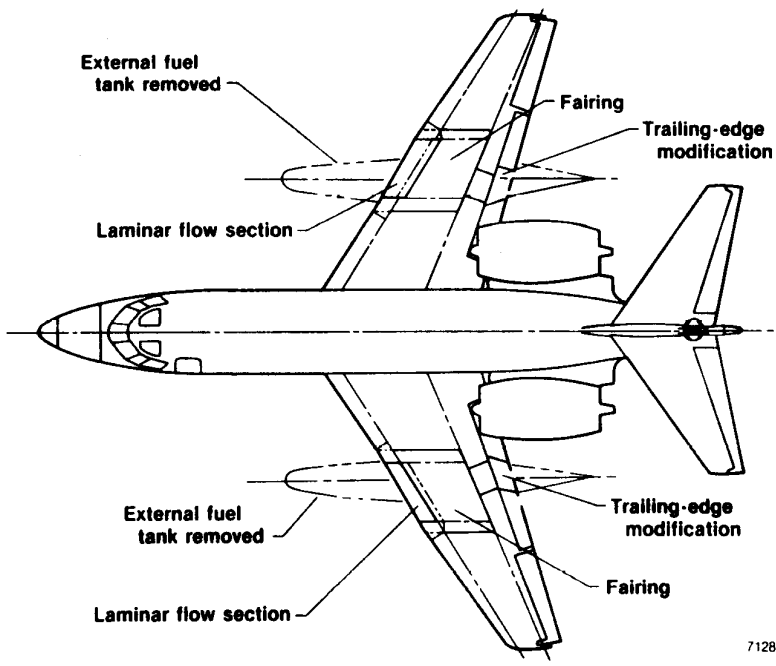

Fig. 2 JetStar airplane modifications.

7128

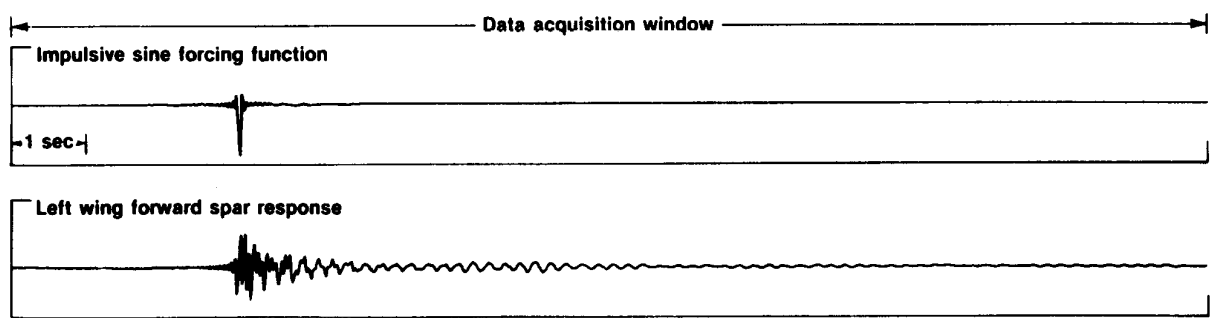

Fig. 3 Impulsive sine time history function.

8411

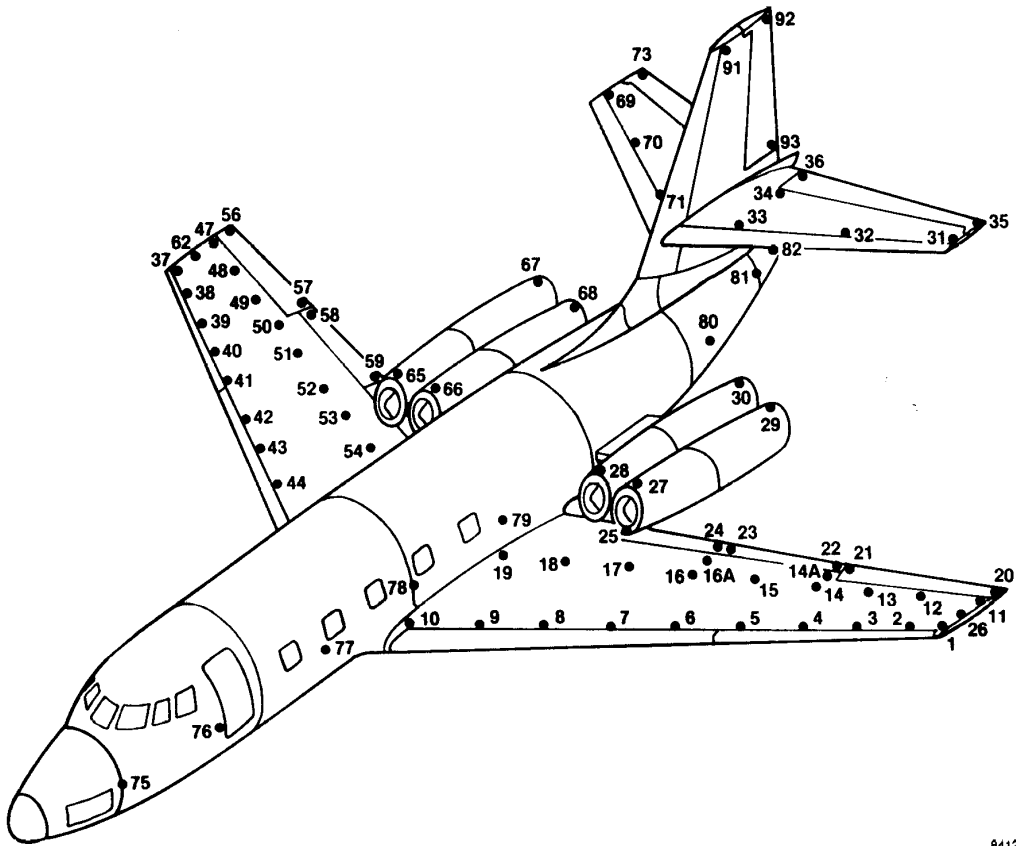
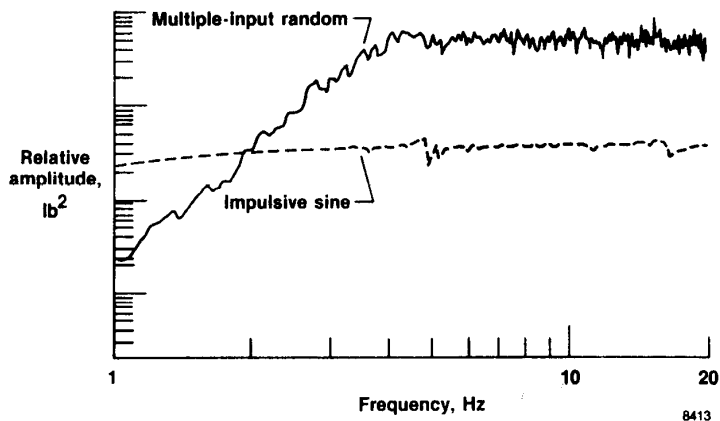

Fig. 4 Accelerometer locations for mode-shape measurements.

8412



8413

Fig. 5 Comparison of impulsive sine and multiple-input random excitation input force spectrums.

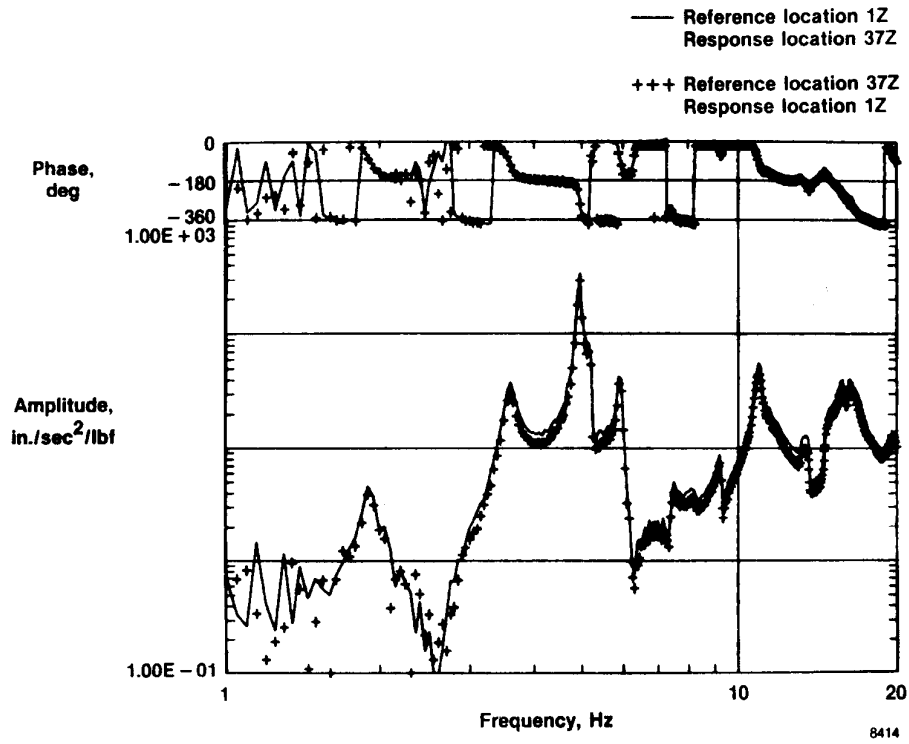

Fig. 6 Multiple-input random reciprocity comparison.

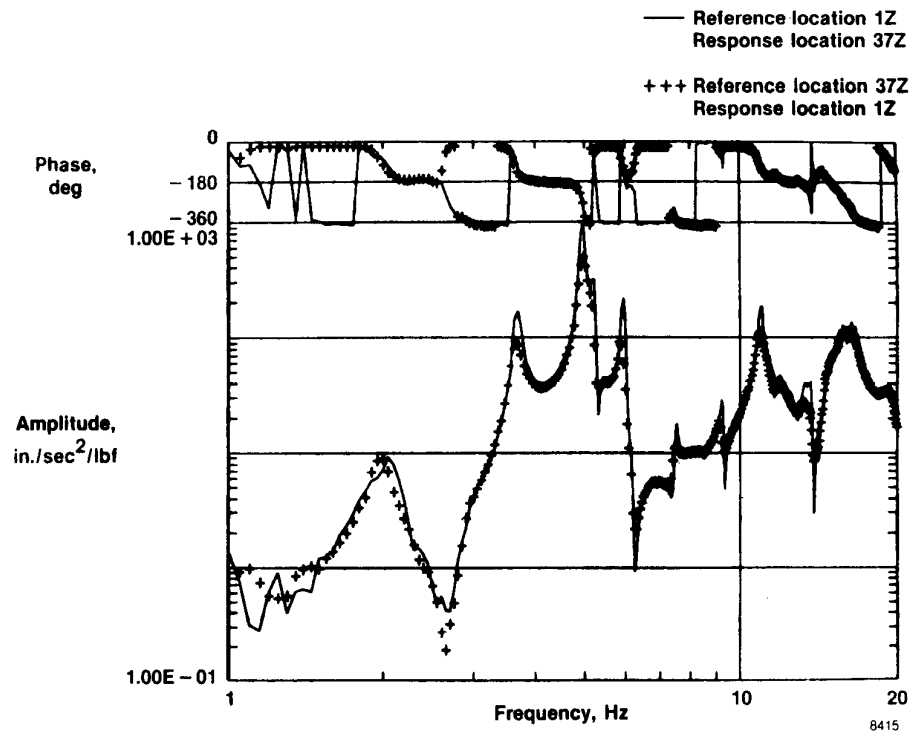
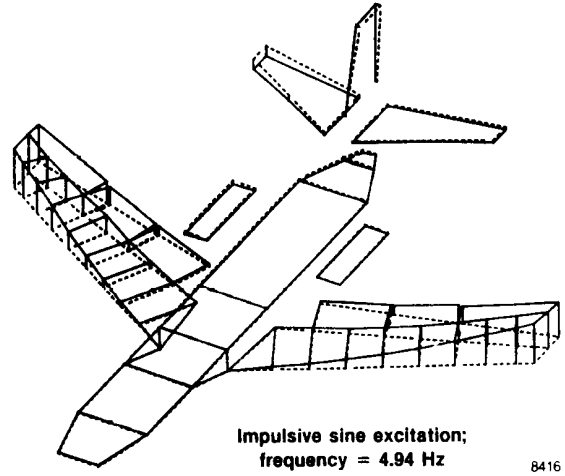
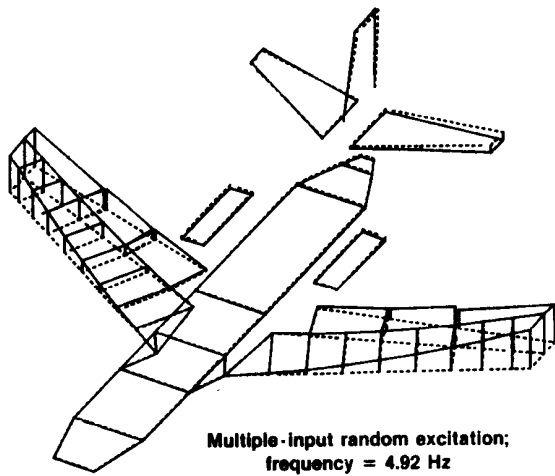
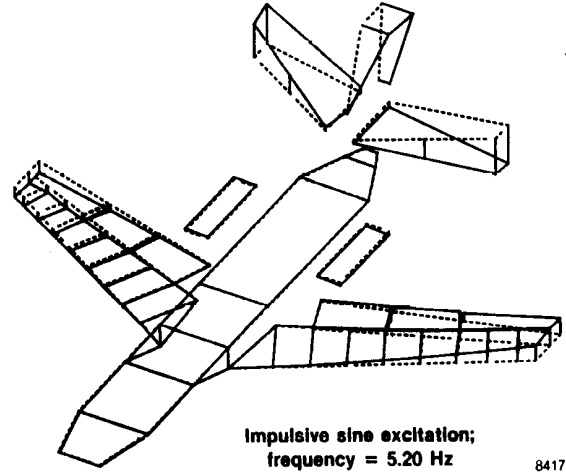
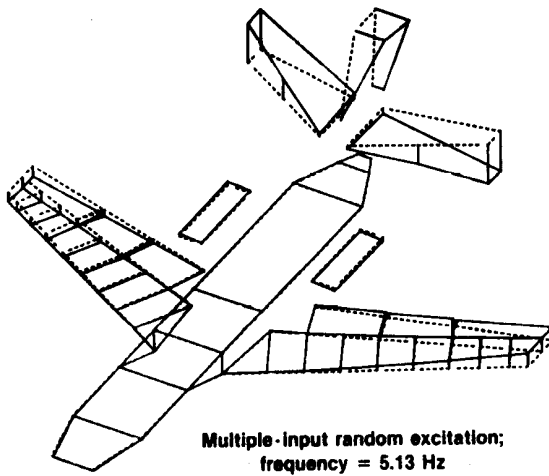

Fig. 7 Impulsive sine reciprocity comparison.



8416

Fig. 8 Symmetric first wing bending mode shape.



8417

Fig. 9 Empennage roll and fuselage torsion mode shape.

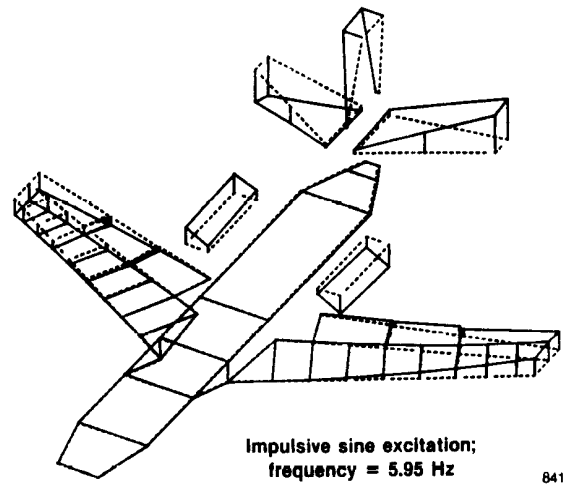
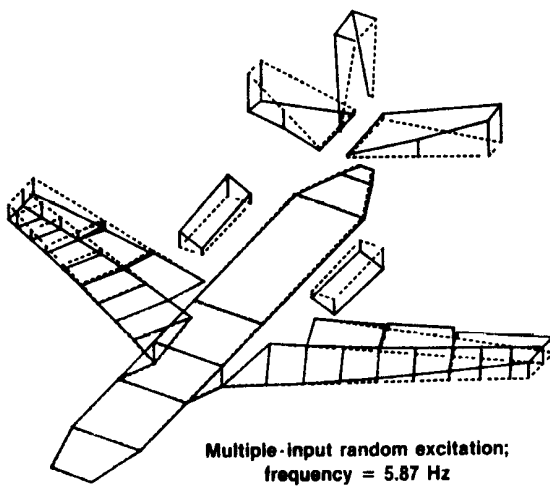

8418

Fig. 10 Empennage roll, fuselage torsion, and engine pylon bending mode shape.

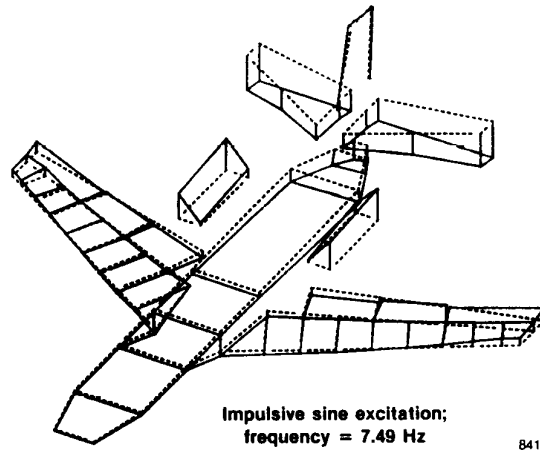
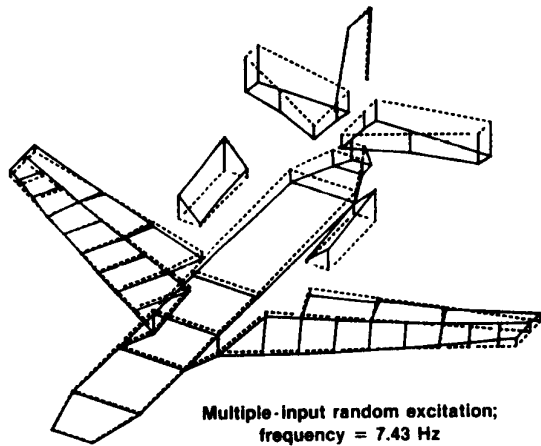

8419

Fig. 11 Symmetric nacelle, wing, and stabilizer bending mode shape.

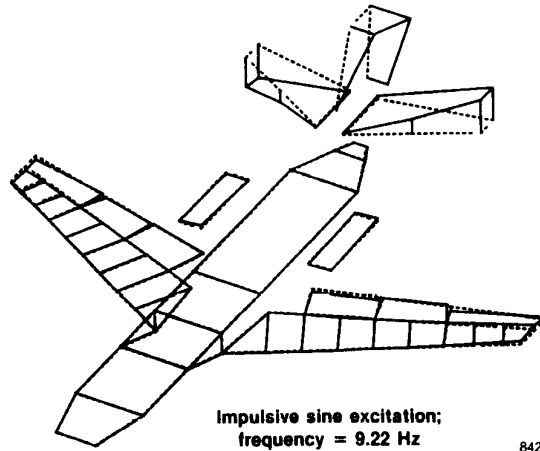
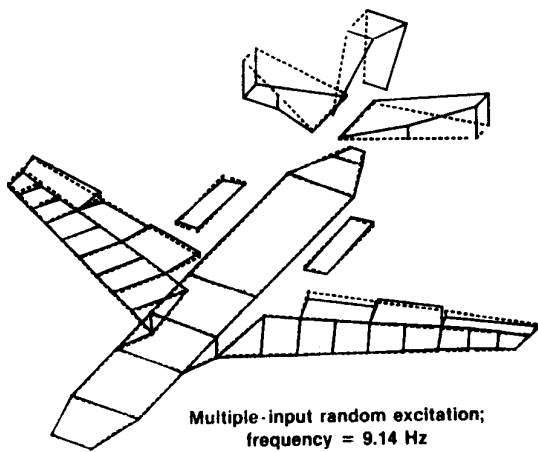

8420

Fig. 12 Vertical fin bending mode shape.

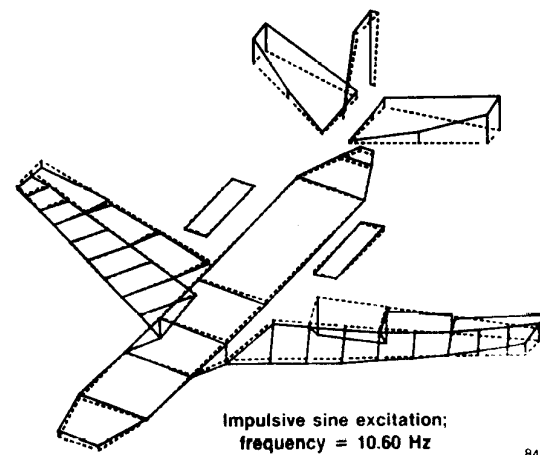
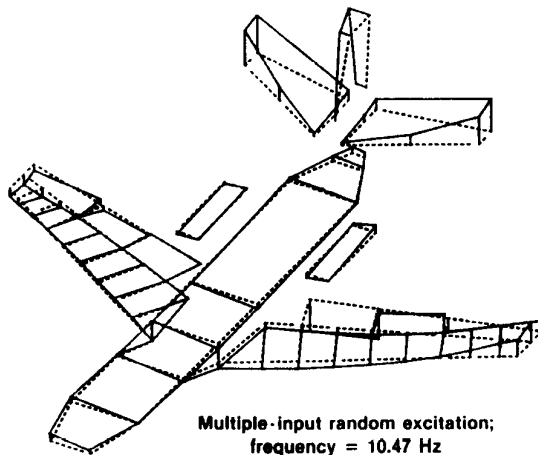

8421

Fig. 13 Symmetric stabilizer and wing bending mode shape.

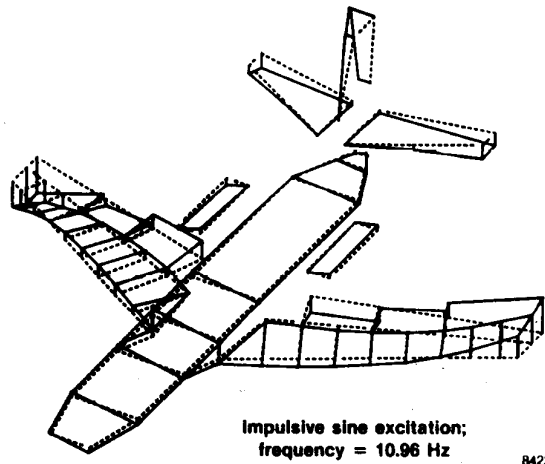
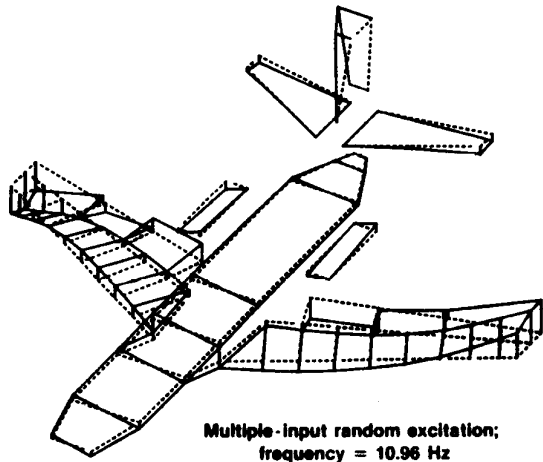

8422

Fig. 14 Antisymmetric first wing bending mode shape.

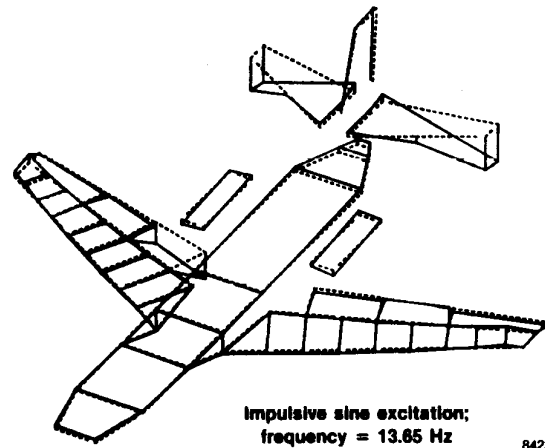
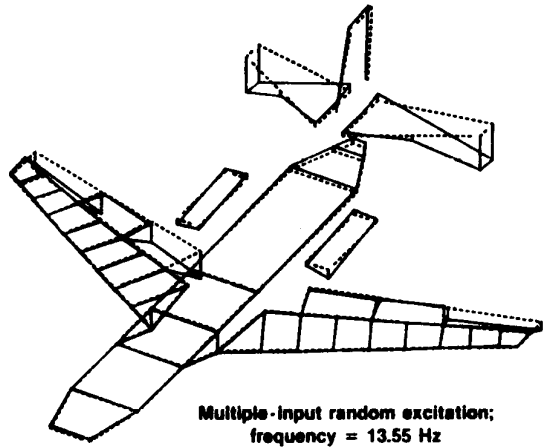

8423

Fig. 15 Symmetric stabilizer mode shape.

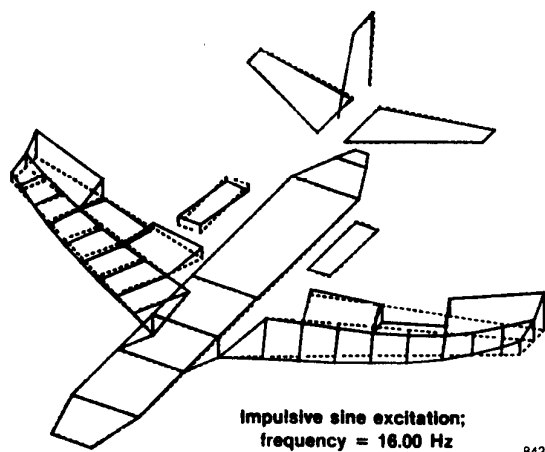
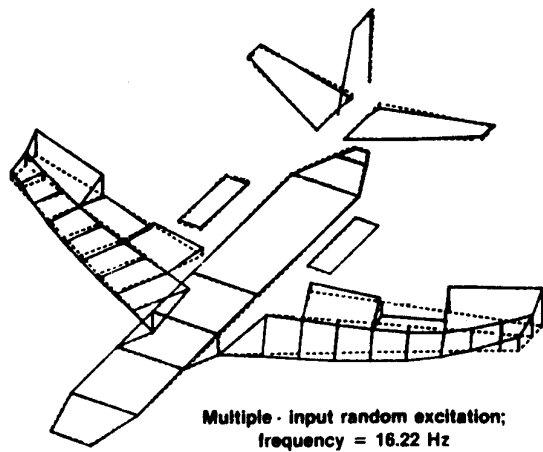

8424

Fig. 16 Symmetric second wing bending mode shape.



Report Documentation Page

1. Report No. NASA TM-100448	2. Government Accession No.	3. Recipient's Catalog No.	
4. Title and Subtitle Ground Vibration Test Results of a JetStar Airplane Using Impulsive Sine Excitation		5. Report Date February 1989	
		6. Performing Organization Code	
7. Author(s) Michael W. Kehoe and David F. Voracek		8. Performing Organization Report No. H-1504	
		10. Work Unit No. RTOP 505-63-21	
9. Performing Organization Name and Address NASA Ames Research Center Dryden Flight Research Facility P.O. Box 273, Edwards, CA 93523-5000		11. Contract or Grant No.	
		13. Type of Report and Period Covered Technical Memorandum	
12. Sponsoring Agency Name and Address National Aeronautics and Space Administration Washington, DC 20546		14. Sponsoring Agency Code	
		15. Supplementary Notes Prepared for presentation at the 7th International Modal Analysis Conference, January 30–February 2, 1989, at Las Vegas.	
16. Abstract Structural excitation is important for both ground vibration and flight flutter testing. The structural responses caused by this excitation are analyzed to determine frequency, damping, and mode shape information. Many excitation waveforms have been used throughout the years. The use of impulsive sine $(\sin \omega t)/\omega t$ as an excitation waveform for ground vibration testing and the advantages of using this waveform for flight flutter testing are discussed. The ground vibration test results of a modified JetStar airplane using impulsive sine as an excitation waveform are compared with the test results of the same airplane using multiple-input random excitation. The results indicated that the structure was sufficiently excited using the impulsive sine waveform. Comparisons of input force spectrums, mode shape plots, and frequency and damping values for the two methods of excitation are presented in this paper.			
17. Key Words (Suggested by Author(s)) Ground vibration test Modal analysis		18. Distribution Statement Unclassified — Unlimited Subject category 05	
19. Security Classif. (of this report) Unclassified	20. Security Classif. (of this page) Unclassified	21. No. of pages 14	22. Price A02