

HYD 84

HYD 84

MASTER  
FILE COPY

BUREAU OF RECLAMATION  
HYDRAULIC LABORATORY  
NOT TO BE REPRODUCED WITHOUT PERMISSION

\*\*\*\*\*

UNITED STATES  
DEPARTMENT OF THE INTERIOR  
BUREAU OF RECLAMATION

-----

HYDRAULIC LABORATORY REPORT NO. 84

-----

HYDRAULIC MODEL STUDIES  
OF THE CONTROLLING WORKS FOR THE  
SHOSHONE CANYON CONDUIT  
SHOSHONE PROJECT

By  
H. G. Dewey, Jr.

-----

Denver, Colorado

June 24, 1940

\*\*\*\*\*

Denver, Colorado, June 24, 1940.

MEMORANDUM TO CHIEF DESIGNING ENGINEER

(H. G. Dewey, Jr.)

Subject: Hydraulic model study of the controlling works for the Shoshone Canyon conduit, Shoshone project, Wyoming.

1. Introduction. The Shoshone Dam, located in northern Wyoming, eight miles southwest of Cody on the Shoshone River, was built by the Bureau of Reclamation from 1905 to 1910. This construction has supplied electric power and irrigation to the area northeast of Cody, with the irrigation being limited, somewhat, to the less elevated lands adjacent to the Shoshone River (figures 1 and 2). In more recent years it has been considered desirable to furnish water to the higher country north and east of Cody. This will be made possible by the present construction of the Shoshone Canyon conduit which will deliver water from the Shoshone Reservoir to the Heart Mountain canal (figure 1). A division works at the end of the Shoshone Canyon conduit will divide the water between the Heart Mountain canal and the Oregon Basin supply canal, the latter being a future development to extend to the south of Cody (figure 2).

In order to regulate the supply of water to the Shoshone Canyon conduit, there will be provided underground near the right abutment of the dam, a controlling works with a maximum discharge of 1,200 second-feet under a head of approximately 150 feet. The recommended design of the controlling works has its inlet in the steep bank of the reservoir, with the flow proceeding from this point to the controlling works proper in a 10-foot diameter concrete-lined tunnel (section A-A, figure 3). At the entrance to the bottom of the controlling works a transition is made to a short length of rectangular section, 6'-0" by 7'-6", provided with an auxiliary slide gate at the downstream end. The flow then enters a type of scroll case divided into six passages (figure 4) and passes into a gate chamber. The flow from the scroll case is regulated in the gate chamber by a 10-foot diameter cylinder gate (section A-A, figure 3; figures 5 and 6). As the flow leaves the scroll case, it passes under and upwards through the cylinder gate and enters a 16- by 21-foot chamber provided with two concrete baffles developed from the model study (section A-A, figure 3). At the top

of this chamber the flow enters a transition and finally proceeds into the Shoshone Canyon conduit.

When it is considered that the high velocity jets issuing from the scroll case impinge on each other, it is evident that considerable turbulence will occur. This turbulence, furthermore, must be prevented from continuing to the top of the stilling chamber, since it is required that the water surface and the flow be free from turbulence and waves as it enters the Shoshone Canyon conduit. To accomplish this, it is evident that some means must be provided for dissipating a large part of the energy of flow as it rises in the stilling chamber. Since it was not possible during the design of the controlling works to accurately predict the flow behavior or to determine what should be placed in the stilling chamber for dissipating the energy of the flow, it was necessary to solve the problem by means of a hydraulic model study. Accordingly, this report treats the study made of the controlling works with particular reference to the stilling chamber, cylinder gate, and transition to the Shoshone Canyon conduit.

The design of the Shoshone Canyon conduit, controlling works, and tunnels was made under the general supervision of H. R. McBirney, senior engineer, and C. P. Vetter, engineer. The cylinder gate and its appurtenances were designed under the general direction of W. C. Beatty, senior engineer, and P. A. Kinzie, engineer.

2. Similitude between model and prototype. In most model studies of hydraulic structures the gravitational (weight) forces are of more importance than the viscous or surface tension forces. Because of this the relation between the flow characteristics of a model and prototype may be determined by Froude's criterion,  $\frac{V^2}{a}$ , where  $V$  = velocity;  $a$  = any linear dimension; and  $g$  = acceleration due to gravity which is considered to be the same for model and prototype.

From Froude's criterion we can develop the fundamental relations between model and prototype velocity, discharge, and other characteristics which form the basis of similitude in hydraulic model studies. For example, if we denote the prototype terms by the subscript, p, and the model terms by the subscript, m, it is possible to write:

$$\frac{v_p^2/a_p}{\epsilon_p} = \frac{v_m^2/a_m}{\epsilon_m} \dots\dots\dots (1)$$

and since we may consider  $\epsilon_p = \epsilon_m$ , we obtain:

$$\frac{v_p^2}{v_m^2} = \frac{a_p}{a_m} \dots \dots \dots (2)$$

Now let the ratio  $\frac{a_p}{a_m}$  in equation (2) be the ratio of linear dimensions (scale ratio) between model and prototype, then:

$$n = \frac{a_p}{a_m} \dots \dots \dots (3)$$

hence from equation (2):

$$\frac{v_p^2}{v_m^2} = n$$

or  $v_p = (n)^{1/2} \cdot v_m \dots \dots \dots (4)$

Equation (4) represents the fundamental relation between model and prototype velocities based on the Froude criterion, which takes into consideration only the gravitational forces and is independent of the fluid used in the model. In a similar manner it can be shown from equation (1) and the relation  $Q = A \cdot V$ , that the discharge of the model and prototype are related as follows:

$$Q_p = (n)^{5/2} \cdot Q_m \dots \dots \dots (5)$$

Although only gravitational forces are usually considered to be the important forces in a model study of a hydraulic structure, consideration must sometimes be given to the effect of viscous forces. This requires that a definite relation be maintained between the kinematic viscosity of the model and prototype fluids. The kinematic viscosity is defined as  $\nu = \frac{\mu}{\rho}$ , where  $\mu$  is the absolute viscosity (coefficient of viscosity)<sup>P</sup>, and  $\rho$  is the density of the fluid. In the MLT system the kinematic viscosity has the dimension  $\frac{L^2}{T}$ , so it can be written in model and prototype terms that:

$$\nu_m = \frac{L^2}{T_m} \dots \dots \dots (6)$$

and 
$$v_p = \frac{L_p^2}{T_p} \dots\dots\dots (7)$$

Now from equations (3) and (4):

$$L_p = n \cdot L_m \dots\dots\dots (8)$$

and 
$$T_p = (n)^{1/2} \cdot T_m \dots\dots\dots (9)$$

Dividing equation (7) by equation (6) and substituting equations (8) and (9), we obtain:

$$\frac{v_p}{v_m} = \frac{L_p^2}{T_p} \cdot \frac{T_m}{L_m^2} = \frac{n^2 \cdot L_m}{(n)^{1/2} \cdot T_m} \cdot \frac{T_m}{L_m^2} = (n)^{3/2}$$

$$\therefore \frac{v_p}{v_m} = (n)^{3/2} \dots\dots\dots (10)$$

Equation (10) is the fundamental relation between the kinematic viscosities of the model and prototype fluids. It is immediately apparent that if the two fluids are the same the scale ratio  $n$  becomes unity, thus making it impossible to have exact similitude if a reduced scale model is used. Therefore, if a model study is made in which the fluid of the model and the prototype are the same, it is impossible to take into consideration both gravitational and viscous forces: rigorous similitude is lacking.

Since the model study of the controlling works was made with a 1:12 scale ratio in which the model and prototype fluids were both water, it is quite evident that similitude relative to viscous forces will be impossible. This is unfortunate because any design of stilling chamber obtained from the model must be based on effective energy dissipation, which, in turn, is related to fluid turbulence and therefore to viscosity.

Consider, then, the relation established in equation (10), and since the prototype fluid can only be water, consider what the model fluid shall have been in the tests on the controlling works to permit similitude. Assume the water in the prototype to be at 15° C. and at sea level; then the kinematic viscosity is  $v_p = 0.01145$  stokes. For a scale ratio of 1:12, we obtain from equation (10):

$$v_m = \frac{0.01145}{(12)^{3/2}} = 0.000275 \text{ stokes}$$

Obviously, any model fluid having this viscosity, even if available, would not be a practical one for model tests.

As a matter of interest it can also be shown what the prototype fluid should be if the model and prototype performance is to be similar. From equation (10) considering the model fluid to be water, we obtain:

$$v_p = 0.01145 (12)^{3/2} = 4.76 \text{ stokes.}$$

Glycerine at 26.5° C. has a kinematic viscosity  $\nu = 3.92$ ; hence, the prototype fluid should be highly viscous, but this condition is obviously impossible to satisfy.

From this brief analysis it may be seen that for the model study of the controlling works it is impossible to have exact similitude relative to viscosity between model and prototype. Gravitational and viscous forces cannot be considered together, and only the flow characteristics due to gravitational forces based on Froude's criterion can be maintained in rigorous similitude. It may also be evident that since the model fluid was water, the prototype fluid should be a highly viscous one if the prototype is to perform in a manner similar to the model. Because of this there is reason to believe that the turbulence in the prototype may be more severe than the turbulence observed in the model. As a result the water surface at the top of the prototype stilling chamber may be rougher than that indicated by the model.

On the other hand, there are reasons to believe that the prototype will operate satisfactorily regardless of the lack of complete similitude. It is thought, for example, that when a given volume of turbulent flow in the model is increased to the prototype volume, the eddies will be necessarily more developed and more intense, enabling greater dissipation of energy to occur. If this should be true, it is reasonable to assume that the smoothness of the prototype water surface at the top of the stilling chamber will be nearly similar to that of the model.

The hydraulic jump is also a phenomenon based on energy dissipation by turbulence and eddies; and it is known by comparison that hydraulic jump stilling pools designed from model studies operate satisfactorily in the prototype. Since the model and prototype

agreement is good in this case, except for spray in the prototype, it is reasonable to assume that other turbulent phenomena will show good agreement if the gravity forces and not the viscous forces play the most important part.

Relative to similitude and the role of viscosity in energy dissipation, Professor Escande, Assistant Director of the Electro-Technical Institute and of the Fluid Mechanics Institute of Toulouse, France, stated on page 429 in an article in *Le Genie Civil*<sup>1</sup>:

"We are acquainted with the role played in hydraulic installations of energy dissipation, the use of which requires that there be dissipated, at once, in turbulence and eddies in a limited space as possible, the excess energy of a liquid flowing at a high velocity or gushing from a system under pressure."

"The engineer can scarcely establish the theoretical elements for the determination of this phenomenon. Accordingly, the study by models constitutes the method most generally used for determining the dimensions and in foreseeing the functioning of it. In this regard, it was interesting to M. Camichel and to us, in comparing research made on an industrial installation to a model specially constructed for the purpose, to see if this method is justified; and, in particular, to see if the application of the laws of similitude furnish quantitative results sufficiently approached."

#### Similitude applicable to energy dissipation.

"The dissipation occurs, in most cases, in a stilling basin having a free surface in contact with the atmosphere. The laws of hydrodynamic similitude of incompressible fluids indicate that, under these conditions, if the viscosity interferes in an appreciable way, its influence makes the existence of a rigorous similitude impossible. Furthermore, these laws of similitude concern incompressible fluids and they do not take into account the phenomenon of air entrainment and the formation of air-water emulsions, which almost always accompany the functioning of energy dissipation installations. Two elements exist, therefore, the viscosity of the water and the entrainment of air which are capable of disturbing the similitude."

---

<sup>1</sup>"L'Etude Sur Modèle Réduit Des Ouvrages De Rupture De Charge. Experiences de l'usine du Carcanet." (Model Study of Energy Dissipation. Experiments on an industrial plant at Carcanet) by L. Escande; *Le Genie Civil*; Dec. 16, 1939; pp. 429-433.

### Role of viscosity.

"Actually the viscosity effect is not to be feared, because the tumultuous character of the flow corresponds to an agitation of extreme turbulence, putting into play the energy losses by impact and changes of kinetic energy; on the other hand, the simple slipping of liquid particles one on another plays an entirely negligible role. As we and M. Camichel have shown in previous studies, the losses of head vary as the square of the velocity and are practically independent of the proper viscosity of the liquid, entirely concealed by the fictitious viscosity of turbulence."

In any event, it is necessary to depend on the best model arrangement and assume that arrangement will be the best one for the prototype. As a necessary precaution, moreover, the model was tested for heads in excess of the design head.

3. The model. The model of the original design of the controlling works was built to a scale of 1:12 (figure 7). The conduit leading to the controlling works was made of sheet metal, with piezometers being installed just upstream from the transition to the scroll case to measure the head on the model. The scroll case at the bottom of the stilling chamber was cut into a large block of cypress, made into two sections, with the joint occurring at the center line of the scroll (section D-D, figure 7; upper block shown on figure 9A). The cylinder gate, which fits into the gate chamber of the scroll case, was made of light-gage galvaneal with a lifting mechanism attached (side elevation figure 7). This enabled the cylinder gate to be moved up and down past the parts of the scroll case to regulate the discharge. The side walls of the stilling chamber were made of pyralin to permit observation of the flow. At the top of the stilling chamber a sheet-metal transition was installed and a sufficient length of tunnel, open at the top for observation purposes, was added to represent the Shoshone Canyon conduit.

The dimensions given on most of the model drawings are in feet and inches in terms of the model. Prototype dimensions are readily obtained from these, since one inch on the model equals one foot on the prototype.

4. Performance of original design. The model of the original design clearly demonstrated that little energy dissipation occurred, resulting in excessive turbulence extending to the top of the stilling chamber. For the maximum discharge and for various heads, the water shot upwards in the model stilling chamber in large spouts



and spilled over the top of the stilling chamber walls. This condition was due to the extreme turbulence developed just above the gate chamber of the scroll case as the issuing jets impinged on each other; and, with only an open chamber above, this turbulence continued undiminished to the top of the chamber. This prevailed for all operating conditions: full gate opening and various discharges up to the maximum of 1,200 second-feet, or for partial gate opening and various discharges.

Careful observations were not made of the other parts of the controlling works; that is, the scroll case proper, the cylinder gate, and transition, until the unfavorable flow conditions in the stilling chamber had been rectified.

5. Tests on scroll case gate chamber. From the study of the model of the original design, it was evident that the extreme disturbance in and immediately above the gate chamber of the scroll case should be prevented from reaching the top of the stilling chamber. Since there was nothing to prevent this disturbance from continuing upward, it was thought that if the gate chamber of the scroll case were deepened, the added space would permit more energy dissipation. At the same time, it was believed that if part of the flow could be forced downward into this chamber and then allowed to pass through holes placed in the scroll case piers, the turbulence would be distributed over a greater area instead of being concentrated in and above the gate chamber. Accordingly, a perforated plate was placed at the top of the gate chamber and a metal pot with adjustable depth was added below the chamber (figure 8A). In addition, holes were drilled through the piers of the scroll case into the pot below.

This design did not prove successful because the high-velocity jets flowing through the holes in the perforated plate and in the scroll case piers shot upward to the surface of the stilling chamber and caused nearly as much disturbance as originally obtained. No improvement was noted with an increase in the depth of gate chamber. It was noticed, particularly, that for all operating conditions the head to pass a given discharge was greatly increased. If more holes could have been placed in the scroll case piers this design might have operated better, but additional holes were impossible because of structural limitations.

6. Baffle study. When changes to the gate chamber did not produce satisfactory results, the most apparent procedure to follow was to place perforated horizontal baffles in the stilling chamber. Forcing the flow to pass through many holes would evidently reduce the excessive turbulence arising from the gate chamber

and would also cause energy dissipation. This expedient proved successful, and extensive studies were made to determine a satisfactory arrangement of baffles.

The procedure in testing the baffles consisted of placing a baffle at various elevations above the gate chamber (figure 8B), and observing the flow conditions at the surface for various heads and discharges. Because the flow distribution was exceedingly unbalanced, many types of baffles were tried (figure 8D) in order to spread uniformly the boiling at the water surface of the stilling chamber. All baffles were tested for heads in excess of those anticipated in the prototype, due to the aforementioned lack of exact similitude. There was little difference, however, in the performance of a given baffle between normal and excess head. In fact, more turbulence was noted at the top of the stilling chamber for full gate opening and lower heads than for other combinations of partial opening and excess head.

After a baffle had been satisfactorily developed on the model of the original design to eliminate excessive boiling at the water surface of the stilling chamber, it was specified that in order to allow the cylinder gate to be removed in sections for repairs, a hole 4'-6" by 4'-0" should be placed in the baffle at the upstream wall of the stilling chamber. When this gate passage was added, part of it extended over the gate chamber. As a result, a majority of the turbulent flow escaped through this opening and upset the previously established smooth surface conditions. To eliminate this unfavorable condition and to provide additional space for energy dissipation, the stilling chamber was increased to 16 by 21 feet in plan and deepened by 21 feet. This change (figure 8C) removed the gate opening in the baffle from directly above the gate chamber and furnished additional space for testing the baffles. The increase in the depth of the stilling chamber, in addition to furnishing a larger volume for energy dissipation, simplified the underground excavation by bringing the bottom of the excavation and the access tunnel more nearly to the same elevation (section A-A, figure 3).

The larger stilling chamber containing a baffle, operated more satisfactorily than the smaller chamber with a baffle. This is somewhat analogous to a jet of water flowing downward into a shallow vessel, such as a drinking glass. In this case the flow spills out of the glass with excessive disturbance; but if the same jet were to flow downward into a much larger vessel, such as a pot, the turbulence would be greatly reduced.

The baffle developed in the smaller stilling chamber of the original design was adopted for use in the larger chamber. More holes had to be added and their arrangement changed to produce the desired smoothness of water surface. In addition, the gate opening in the baffle, although removed from over the gate chamber, had to be partially plugged by adding cross pieces. These were required because the flow still escaped up the back wall and created excessive boiling at the water surface.

Although only one baffle had been studied at different positions in the stilling chamber of the original design, the larger chamber allowed space for two baffles, one above the other (figures 8C and 9B). This was tried and proved to give even better surface conditions. Extensive tests were made until the proper size and spacing of holes and position of baffles provided a minimum surface disturbance. With two baffles, it was only necessary to place cross pieces in the gate opening of the upper baffle (section G-G, figure 11). Figure 10 shows the model of the recommended design with two baffles in the stilling chamber. It will be noted that the flow conditions are nearly identical for full and partial gate opening.

Recalling again that exact similitude was not possible in this study, and considering that the flow distribution in the stilling chambers of the model and prototype may not be exactly similar, the design using two baffles was accepted, not only because of its good performance but because it offered a factor of safety.

After a satisfactory baffle arrangement had been developed, piezometers were installed to determine the pressures on the bottom of the baffles. The pressures obtained in the model for maximum operating conditions, converted to prototype, varied from 2,347 to 6,172 pounds per square foot on the lower baffle and from 1,515 to 1,882 pounds per square foot on the upper baffle. These pressures required the lower baffle to be 4'-0" thick (in the prototype), and the upper baffle to be 2'-10" thick. Pressures were also measured on the back wall of the stilling chamber between the baffles and under the lower baffle. These pressures varied from 1,700 to 2,700 pounds per square foot. The baffles in the model were then rebuilt using the correct thickness. Heretofore they had been three-fourths of an inch thick (9 inches prototype) to expedite construction. The added thickness affected the performance of the baffles, requiring further study of their arrangement and location of holes. A combination was finally obtained which gave the desired surface conditions and which allowed the cylinder gate stems to pass through openings of the baffles (figure 11). This final combination of baffles was again checked for pressures and their thickness was found to be ample.

Although the holes or openings cut in the baffles in this study were square or rectangular (in plan), there is no reason to believe that these shapes are the best. Circular holes would probably work equally as well, although their formwork would be more involved. The holes in the baffles could also be made with the opening diverging upwards. In fact, a baffle of this type was tried and it worked nearly as well as two baffles together. This type of opening, however, is not an energy dissipator since, theoretically, head is regained; but its good performance in the model is best explained by the reduction in velocity occurring between the lower and the upper side of a baffle. Unfortunately, time did not permit a further study of this baffle, but it was believed that even if one baffle would operate satisfactorily, two baffles would furnish a desired factor of safety, as previously mentioned. Regardless of the type of openings used, sharp edges at the entrance were desirable to induce losses in addition to the losses obtained by the successive enlargements and contractions as the flow rises through the baffles.

7. Change in scroll case passages and cylinder gate. After the baffles had been determined, it was noticed and expected that the head required to pass the maximum discharge of 1,200 second-feet was greater than could possibly be obtained in the prototype. To reduce the head to that which could be obtained, the passages and ports of the scroll case were increased to 2'-6" by 3'-4" (figures 4 and 11). Previously the size was 2'-3" by 3'-4" (figure 7), and a reduction in the size of the ports had been made (profile along Y-2, figure 7) which was also eliminated.

At this point in the study the cylinder gate and the shape of gate chamber also changed (figure 11). At the start of the studies the design of the gate had not been fully completed, and the one used in the original model (figure 7) represented the design available at the time. The change of cylinder gate did not affect the performance of the baffles. See paragraph 9 for a discussion of tests on the cylinder gate.

8. Transition study. Upon completion of the baffle study, the smoothness of the water surface at the top of the stilling chamber permitted a study to be made of the transition to the Shoshone Canyon conduit. The original transition was intended to produce a nearly horizontal water surface, which was made possible by placing a weir in the floor of the transition to maintain a constant area (figure 7). This design, however, did not perform as desired because the relatively high velocities entering the transition from the stilling chamber, together with the shortness of the transition, produced a standing wave in the tunnel downstream.

from the end of the transition. This caused a series of waves in the tunnel downstream which, if they extended to the crown, would entrap air and cause "gulping."

A new transition was then designed to produce a longitudinal parabolic water surface (figure 11). In this transition a length of 40 feet was chosen to eliminate an abrupt break at the end of the transition and the start of the tunnel proper (section C-C, figure 11). By assuming a water surface for the maximum discharge and knowing the elevation of the energy gradient at each end of the transition, it was then possible, at various sections, to determine the velocity head, velocity, and finally the area to produce the desired water surface. This transition operated satisfactorily with only small waves developing in the tunnel, which would be too small to seal against the crown and cause "gulping."

9. Pressures on cylinder gate. During the tests of the model of the controlling works and after the cylinder gate and scroll case had been changed (paragraph 7), a rattling sound was heard in the region of the gate chamber. This sound was particularly prominent when the model was operated under the higher heads and smaller gate openings. The resemblance of this sound to the severe rattling obtained in pipe flow developing cavitation caused some concern and led to a study of the pressures on the cylinder gate.

Test 1, figure 12, shows the cylinder gate installed in the model after the scroll case had been changed. Because the lip on the bottom of this gate diverged five degrees from the bottom shoulder of the gate chamber (section A-A, figure 12), it was believed that cavitation would develop in a diverging section of this type, especially at small gate openings. Accordingly, piezometers were installed in the gate opposite the center line of the ports of the scroll case on one side of the scroll. The piezometers were placed in the outside surface of the gate (section B-B, figure 12); in the lip of the gate (detail A, figure 12); and in the inside surface of the gate just above the edge of the lip (section C-C, figure 12). The most important ones were those on the lip, so the pressures indicated at these points were carefully investigated in deciding the best design. Pressures were recorded for a discharge of 1,200 second-feet for two gate openings: 20 and 40 percent. For the 20-percent gate opening the head exceeded the head obtainable in the prototype, but all the pressures, relative to atmospheric pressure, were positive (see table, test 1, figure 12). The pressures were also positive for the 40-percent gate opening. It was believed, therefore, that since the pressures were positive for extreme operating conditions, even though the rattling noise prevailed,

no cavitation would occur for normal heads and gate openings. On the other hand, concern was felt over the pressures that might be developed when the gate is raised but one or two inches. In this regard, it would have been difficult to make accurate tests on the model for such small gate openings. Further tests were then continued for 20- and 40-percent gate openings in the belief that the best design so obtained would also be satisfactory for smaller gate openings.

To eliminate the tendency for cavitation to occur at small gate openings, the divergence of the bottom lip with the bottom shoulder of the gate chamber was decreased to one degree (test 2, figure 12). Again the pressures were all positive although somewhat greater than the pressures on the gate in test 1 (see table, test 2). This was probably due to the lip being rotated downward into the flow to reduce the divergence.

Test 3 was then made to see what effect there would be on the pressures if a surface in the diverging section were removed. This was accomplished by removing the bottom shoulder of the gate chamber (test 3, figure 12). The pressures obtained were all positive and were greater than those of the preceding tests (see table, test 3). This design would probably have developed higher pressures for gate openings of six inches or less, but it was objected to because of structural limitations requiring a bottom shoulder in the gate chamber, which had been removed in this test.

From these tests it was evident that no negative pressures would occur for normal operating conditions, whether the divergence was five degrees (test 1, figure 12) or whether it was only one degree (test 2, figure 12); but to eliminate any tendency for cavitation to occur at very small gate openings, the divergence between the lip of the gate and the bottom shoulder of the gate chamber was reduced to one degree. In the model, the angle of the lip was placed at 29 degrees (test 2, figure 12) and the slope of the bottom shoulder of the gate chamber was placed at 30 degrees. By some misunderstanding, the final design of the gate was made with the angle of the lip at 25 degrees and the shoulder of the gate chamber was changed to 26 degrees (figure 5). The divergence of one degree was the same in both cases, however, and it is not believed that this difference will cause any undesirable results.

The decision to use a divergence of one degree was made after the model had been removed from the laboratory, so the final design of the model shows the cylinder gate to have a divergence of five degrees (figure 11). In this regard, the calibration of the cylinder gate will apply only approximately to the prototype (paragraph 10).

Another problem of importance in the design of the cylinder gate was to keep the projected area of the lip of the gate upstream from the point of seat to a minimum. If this area is large the full head acting on this area produces a large uplift which must be taken care of in the design of the gate stems. Test 4 was therefore made on a gate designed to reduce this uplift. This design was unsatisfactory because some negative pressures developed on the lip of the model gate for 20-percent gate opening (see table, test 4). In general, the pressures were lower on the lip and higher elsewhere than pressures obtained on the preceding gates. This was probably due to the increase in divergence to  $2^{\circ} 30'$ , and also to the extension of the bottom of the port to the inside edge of the gate which reduced the discharge area (section F-F, test 4, figure 12). This allowed the issuing jets to immediately impinge on each other without being first deflected downward, as accomplished by the other gates tested.

Test 5, using a gate with a horizontal lip and reducing the uplift, but replacing a 30-degree bottom shoulder in the gate chamber, was made to increase the discharge area under the lip of the gate. Since the divergence was greatly increased in this design, some of the pressures on the lip of the gate were negative, as anticipated (see table, test 5). However, the head to pass the maximum discharge for each gate opening tested was greatly reduced.

Since tests 4 and 5 showed tendencies for negative pressures to develop for 20- and 40-percent gate openings, and since the uplift on the gate selected (figure 5) was not excessively large, no additional tests were made on the cylinder gate.

A study of these tests on the cylinder gate reveals the following general conclusions:

- (1) The jets issuing from the ports of the scroll case should be given a downward direction at the bottom of the gate. Horizontal impingement may increase the head required to pass a given discharge;
- (2) The divergence between the bottom of the gate and the sloping shoulder in the gate chamber should be kept to a minimum;
- (3) The gate seat should be close to the outside surface of the gate to reduce uplift;
- (4) The lip at the bottom of the cylinder gate should slope downward into the flow to eliminate any tendency for negative pressures to develop;

(5) The pressure due to the flow is greater on the outside than on the inside surface of the gate;

(6) The general reduction of pressure on the gate surfaces opposite the different ports around the gate chamber indicates unequal flow distribution in the passages of the scroll case;

(7) Pressures on the inside surface of the gate just above the lip are, in general, slightly less than the static head above this point.

10. Calibration of model. The model was calibrated with the cylinder gate shown on figure 11 and figure 12, test 1 in the scroll-case gate chamber. As explained in paragraph 9, the final design of the prototype gate, which was made after the model had been removed from the laboratory, had an angle of divergence at the lip of the gate of one degree (figure 5); whereas, the final design of the gate in the model had a divergence of five degrees (figure 11). As a result of this difference, the calibration curves shown on figure 13 will apply only approximately to the prototype.

Figure 13A gives, for various gate openings, the discharge through the controlling works versus the pressure-head in feet of water at station 1+99.69 (side elevation, figure 11). Figure 13B gives approximate reservoir elevations versus pressure-heads at station 1+99.69, the reservoir elevations being approximate because of the necessity in obtaining them to assume losses from station 1+99.69 to the reservoir.

11. Summary of tests and the final design. To create effective energy dissipation and to reduce the excessive turbulence in the stilling chamber of the controlling works, the stilling chamber was enlarged and two baffles were placed in it above the cylinder gate chamber. The model of the original design, shown on figure 7, was developed from the designs given on figure 8 to the final design as shown on figure 11. Figure 9 shows the model in the laboratory, and the effectiveness of the final design of the stilling chamber may be seen on figure 10. When the stilling chamber had been satisfactorily evolved, improvements were made on the transition between the top of the stilling chamber and Shoshone Canyon conduit. By changing the length and shape of the transition, standing waves were eliminated in the tunnel downstream (compare figures 7 and 11).

Pressures were measured on the cylinder gate to determine if there would be any tendency for negative pressures to develop on



the bottom lip, and to establish the optimum divergence between the lip and the bottom shoulder of the gate chamber. The results of these tests may be seen on figure 12, with general conclusions from these tests outlined in paragraph 9. The final design of the cylinder gate is shown on figure 5, and the prototype scroll case and cylinder gate as assembled in the fabricating shops may be seen in figure 6. Other prototype details are shown on figures 3, 4, and 5, with additional information given in specifications No. 798, "Shoshone Canyon Conduit Controlling Works and Tunnels."

A calibration was made in the model of the cylinder gate shown on figure 11 and on figure 12, test 1. As stated in paragraph 10, this gate represented one different from the gate of the final design, so that this calibration (figure 13) will apply only approximately.

12. Conclusions. Although it was necessary to solve certain hydraulic problems pertaining to the design of the controlling works with the aid of a model study, it may be true that the prototype behavior will be different from that indicated by the model. When only gravitational forces are important, it is reasonably certain that the model and prototype behavior will be similar. In this study, however, viscous forces also play a part, and, as discussed in paragraph 2, if the same fluid is used in the model and the prototype, and if gravitational and viscous forces are considered together, exact similitude is impossible. Nevertheless, for the reasons previously discussed in paragraph 2, there is reasonable assurance that the prototype will operate satisfactorily.

It is believed that this type of controlling works is unique in its use of a type of scroll case, cylinder gate, and baffled stilling chamber to conduct water under a high head into a tunnel. Perhaps the stilling chamber would have operated satisfactorily without baffles if the chamber were much deeper, but this depth would have been excessive, judging from the manner in which the water shot upwards in the stilling chamber of the original design. The effectiveness of the final design depends, therefore, on the baffles.

The problems in the design of the cylinder gate were much more difficult in the selection of metal to be used and the method of fabrication than were the hydraulic problems. The problem of gate vibration is believed to be solved by the use of rubber backing on the gate slides. Cavitation of the bottom lip is not expected because of the use of a minimum angle of divergence between the lip of the gate and the sloping shoulder at the bottom of the gate chamber.

FILE

DEPARTMENT OF THE INTERIOR  
 BUREAU OF RECLAMATION  
 SHOSHONE PROJECT-WYOMING  
 HEART MOUNTAIN DIVISION

**SHOSHONE CANYON CONDUIT  
 CONTROLLING WORKS-TUNNELS  
 LOCATION MAP**

DRAWN: S.W.F.  
 TRACED: W.P.  
 CHECKED: W.P.

SUBMITTED: *J. G. Williams*  
 RECOMMENDED: *J. G. Williams*  
 APPROVED: *G. S. Waller*

ENGINEER: COLEMAN, JULY 17, 1934

26-D-710

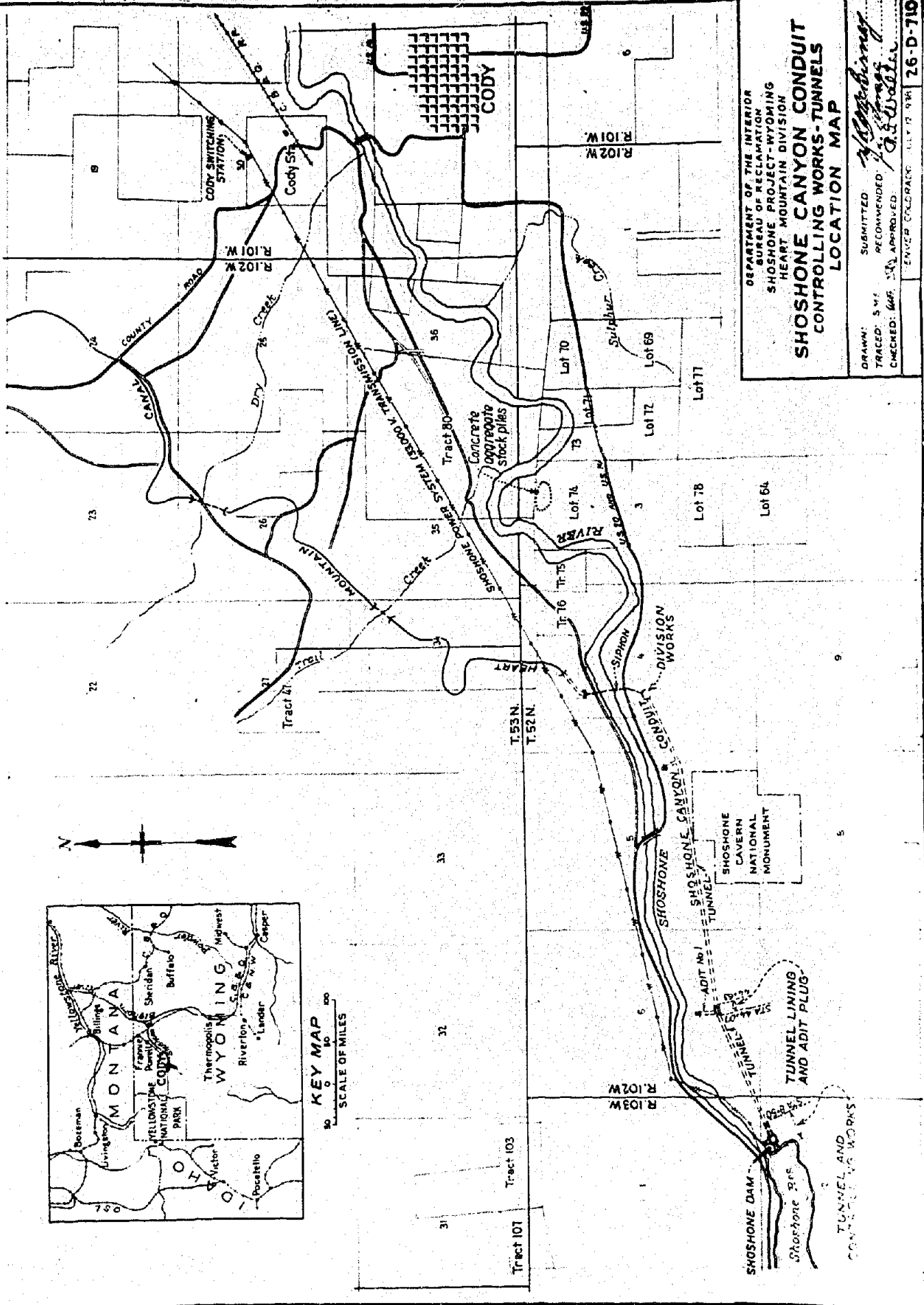
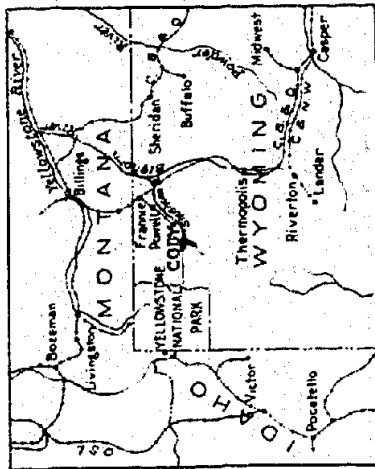

UNITED STATES  
DEPARTMENT OF THE INTERIOR  
BUREAU OF RECLAMATION  
SHOSHONE IRRIGATION PROJECT  
WYOMING - MONTANA

L. J. Wells, Acting Superintendent  
Map No. 20-120  
Prepared in the Washington Office  
A. M. Smith, Acting Chief Draftsman  
1920

EXPLANATION

- Canal constructed, U.S. R.
- Canal constructed, private
- Canal proposed, U.S. R.
- Telephone line, U.S. R.
- Telephone line, private
- Highway (all surface)
- Highway (improved)
- Trail
- Power transmission line (22,000 volts)
- Land under U.S. R. control, irrigable from works completed or under construction
- Land irrigable under proposed but not yet authorized works
- Boundary of Shoshone Irrigation district
- Boundary of Goshute Irrigation district
- Boundary of Shoshone National Forest

THE CANALS AND RESERVOIR SHOWN ON THIS MAP AS PROPOSED SHOULD NOT BE CONSIDERED NEARLY LOCATED AS THEY ARE SUBJECT TO CHANGE OR ABANDONMENT UPON FURTHER INVESTIGATION.

SCALE OF FEET

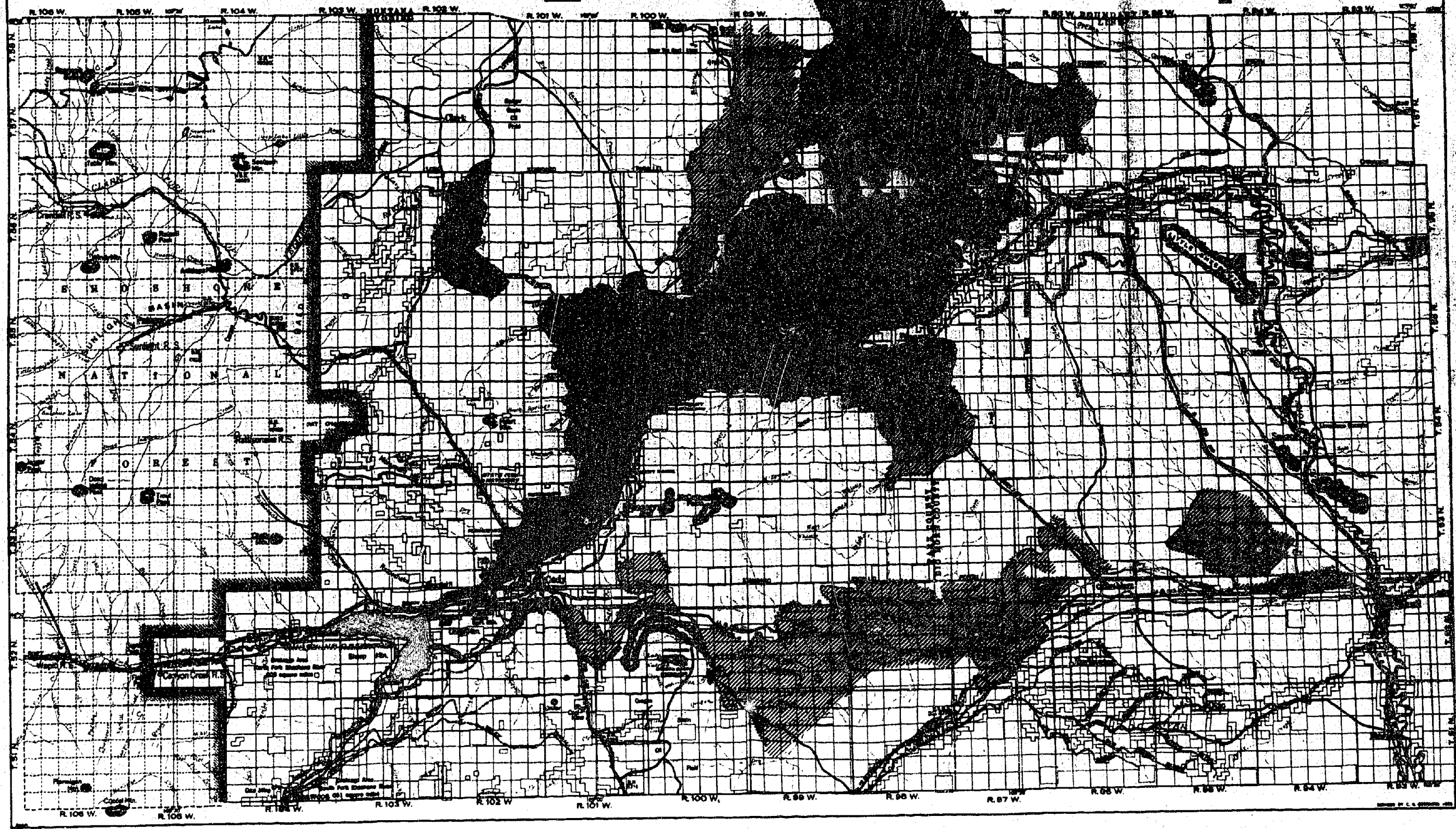

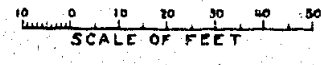
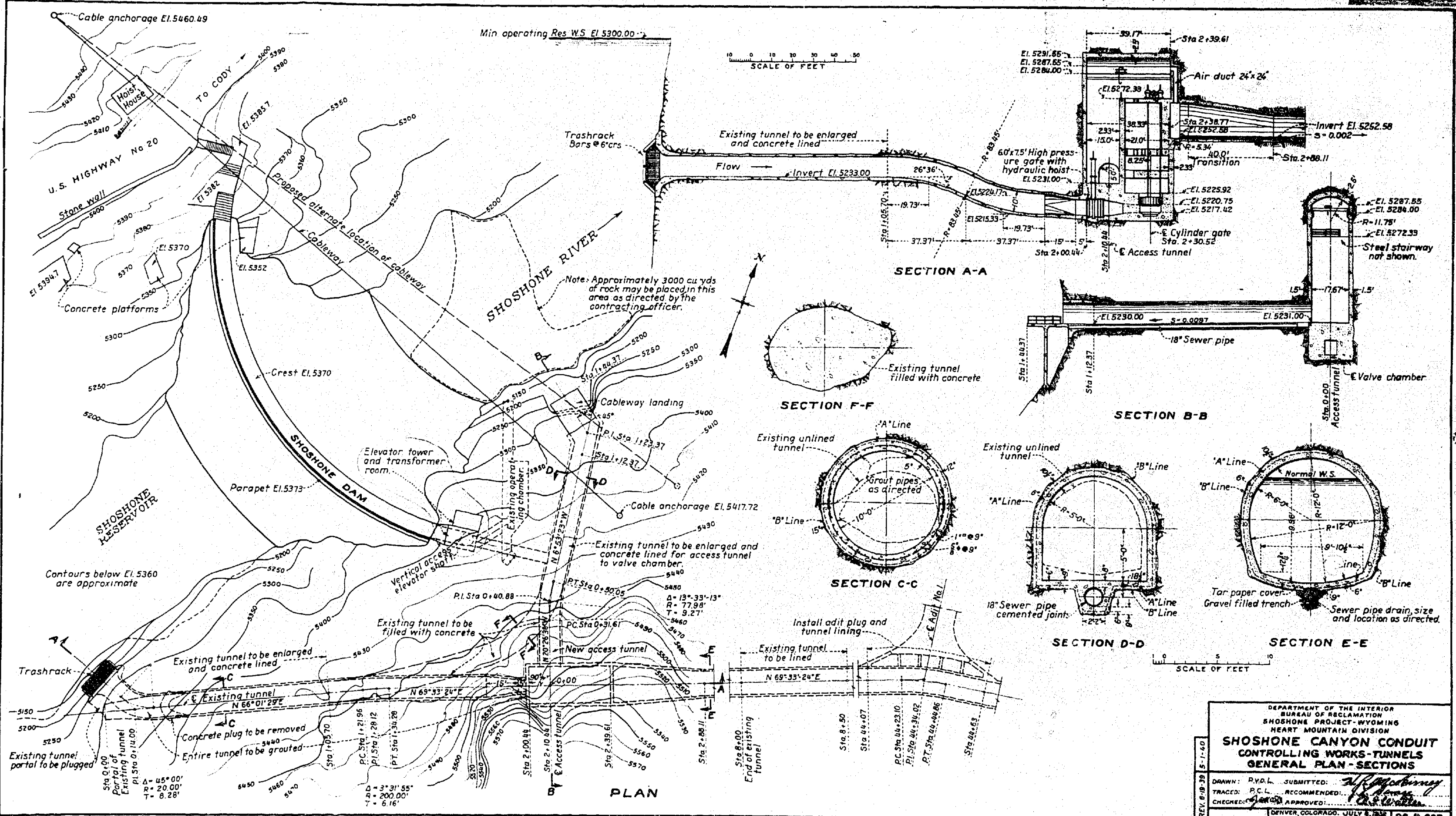

SECTION A-A

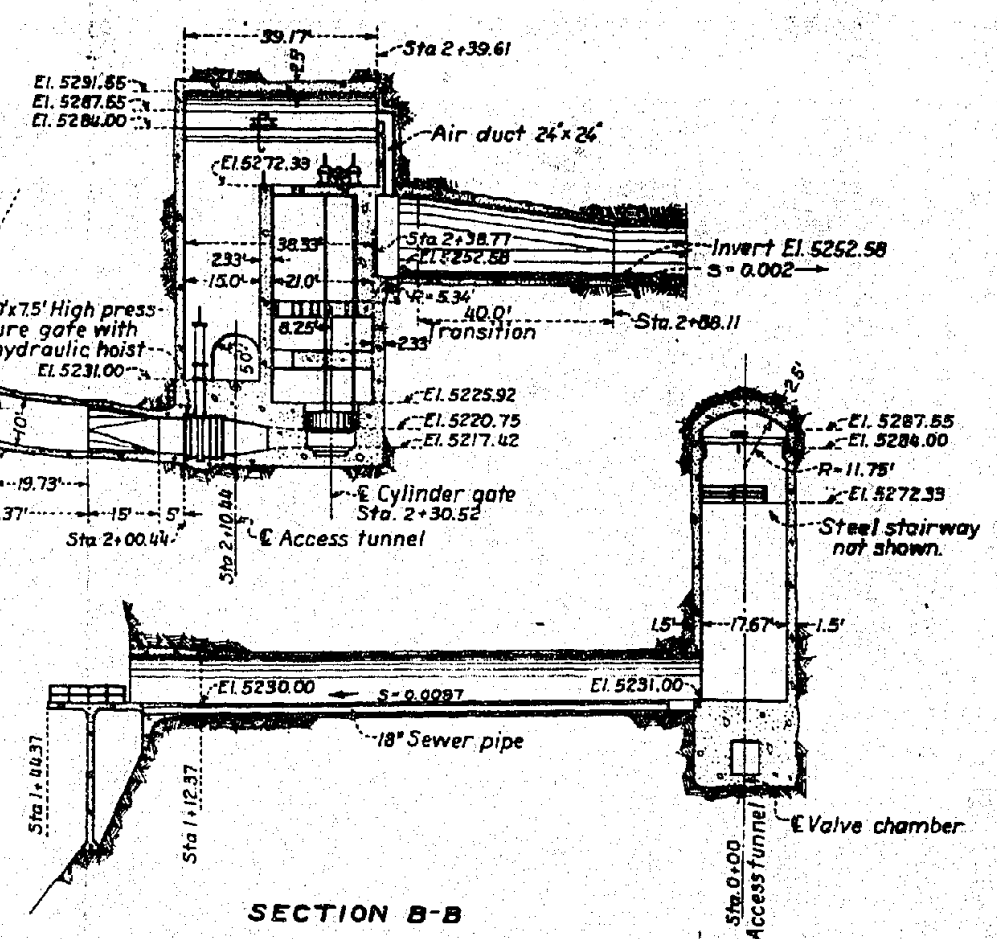

SECTION F-F

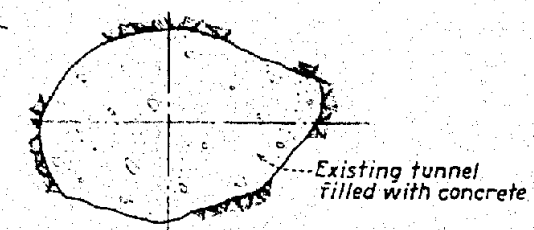

SECTION B-B

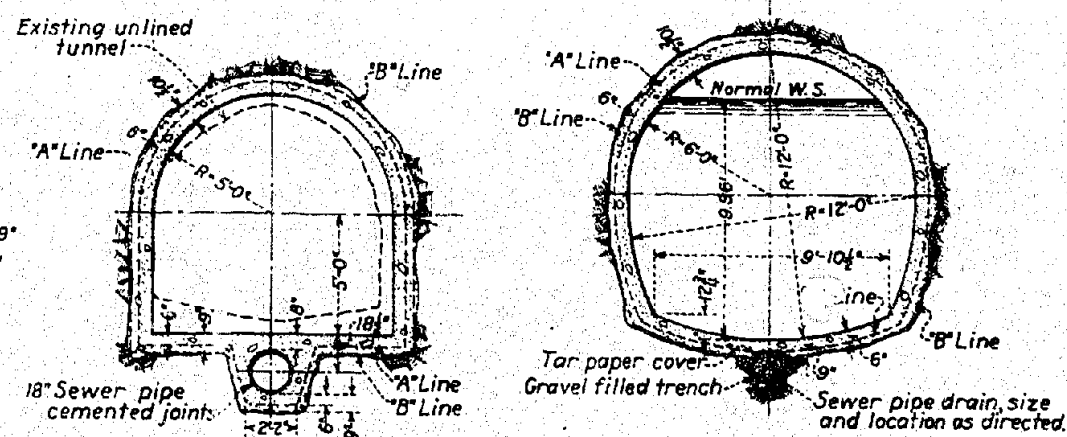

SECTION C-C

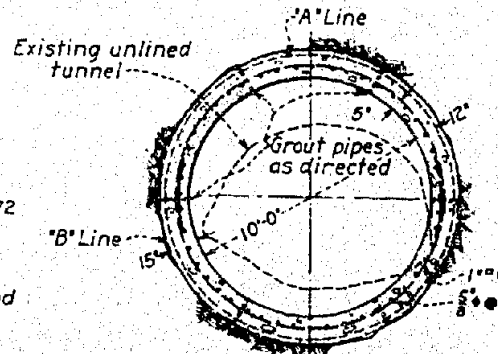

SECTION D-D

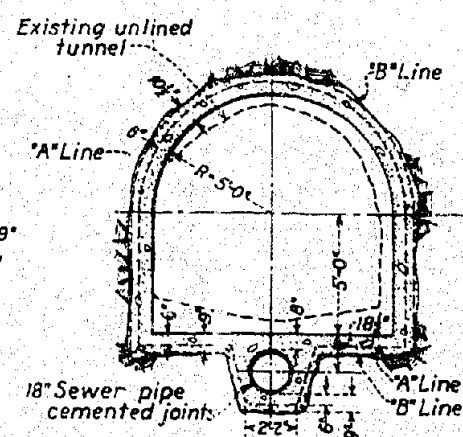

SECTION E-E

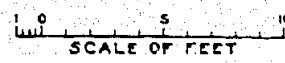
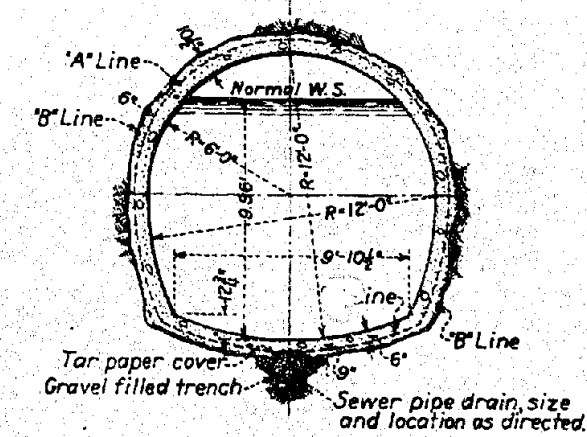

PLAN

DEPARTMENT OF THE INTERIOR  
BUREAU OF RECLAMATION  
SHOSHONE PROJECT-WYOMING  
HEART MOUNTAIN DIVISION

**SHOSHONE CANYON CONDUIT  
CONTROLLING WORKS-TUNNELS  
GENERAL PLAN-SECTIONS**

DRAWN: R.Y.D.L. SUBMITTED: *J.P. Robinson*  
TRACED: P.C.L. RECOMMENDED: *J.P. Robinson*  
CHECKED: *J.P. Robinson* APPROVED: *J.P. Robinson*

REV. 8-19-39 5-1-40  
DENVER, COLORADO, JULY 8, 1938 26-D-667



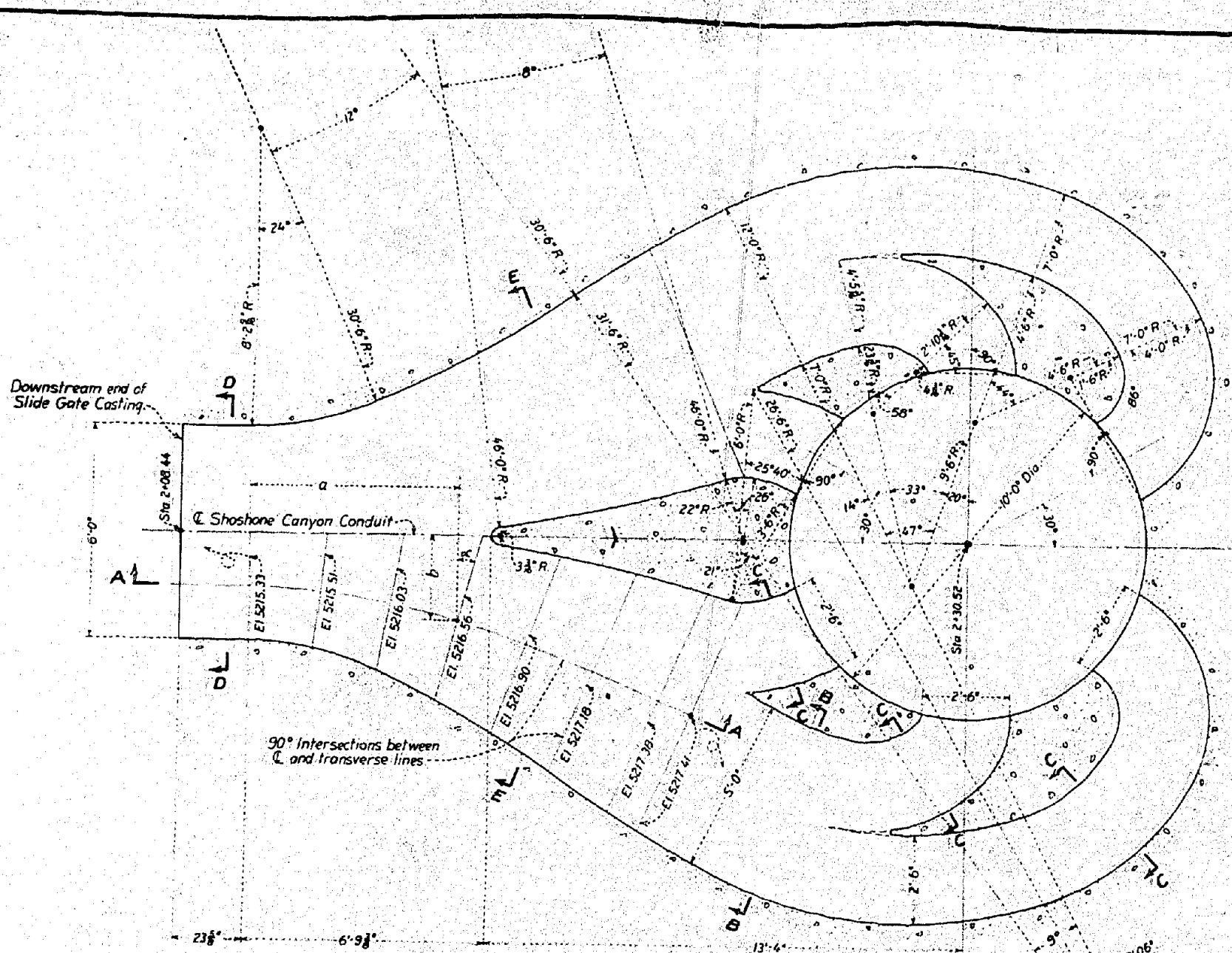

PLAN  
Symmetrical about CL

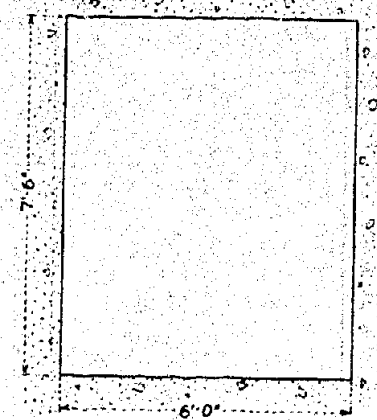
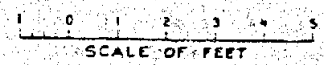

SECTION D-D

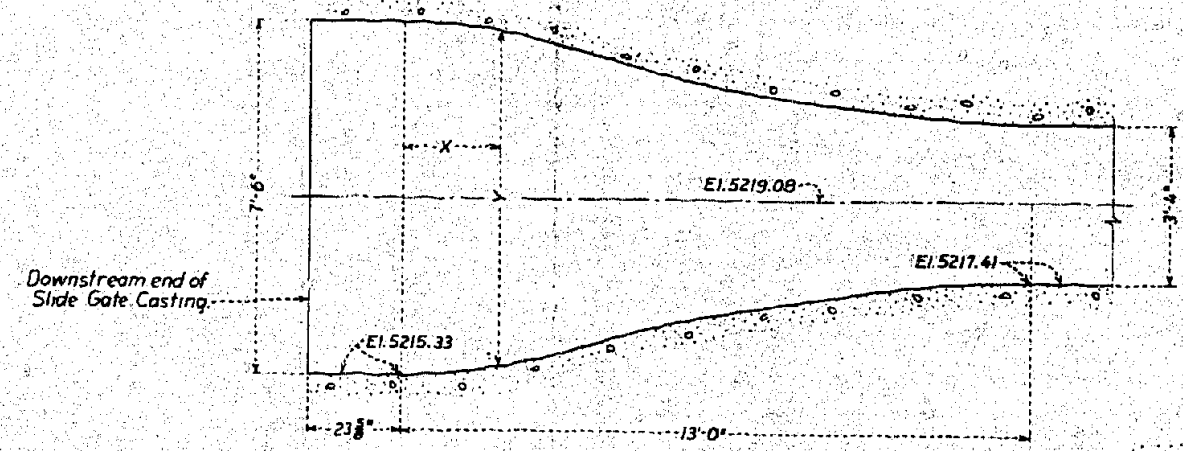

SECTION A-A (Developed)  
Symmetrical about CL

TABLE OF OFFSETS AND ELEVATIONS

X	Y	Bottom El.	a Dist.	b Offset	Angle α
0'	7'-6"	5215.33	0	1.50	0
1'	7'-5"	5215.37	0.99	1.54	3° 15'
2'	7'-1 1/2"	5215.51	1.98	1.61	6° 15'
3'	6'-8"	5215.75	2.96	1.74	9° 15'
4'	6'-1 1/2"	5216.03	3.94	1.90	12° 00'
5'	5'-6 1/2"	5216.31	4.91	2.12	16° 30'
6'	5'-0 1/2"	5216.56	5.88	2.40	18° 00'
7'	4'-8 1/2"	5216.74	6.83	2.70	19° 30'
8'	4'-4 1/2"	5216.90	7.78	3.04	21° 00'
9'	4'-0 1/2"	5217.06	8.72	3.40	22° 45'
10'	3'-9 1/2"	5217.18	9.65	3.78	24° 15'
11'	3'-6 1/2"	5217.31	10.57	4.18	25° 15'
12'	3'-4 1/2"	5217.38	11.48	4.60	25° 00'
13'	3'-6"	5217.41	12.38	5.02	24° 30'

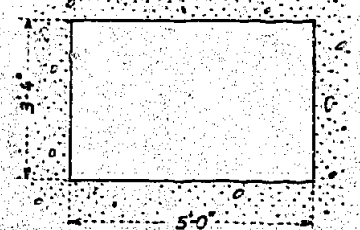

SECTION B-B

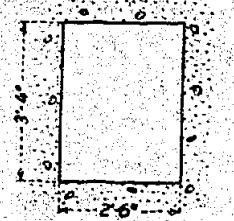

SECTION C-C

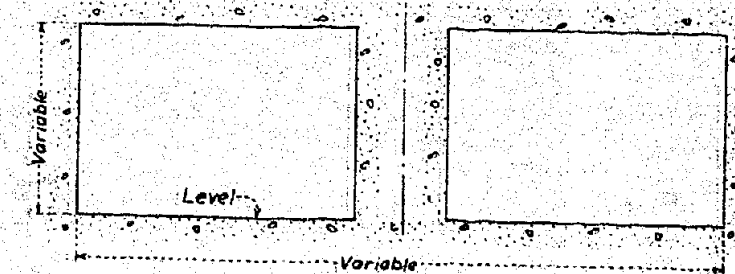

SECTION E-E  
(Developed)

NOTE  
Steel lining plates not shown.

DEPARTMENT OF THE INTERIOR  
BUREAU OF RECLAMATION  
SHOSHONE PROJECT-WYOMING  
HEART MOUNTAIN DIVISION

**SHOSHONE CANYON CONDUIT  
CONTROLLING WORKS-TUNNELS  
10' CYLINDER GATE-SCROLL CASE  
DIMENSIONAL DRAWING**

DRAWN: C.M.J. SUBMITTED: [Signature]  
TRACED: D.T.W. RECOMMENDED: [Signature]  
CHECKED: [Signature] APPROVED: [Signature]

DRIVER, COLORADO, JULY 1954

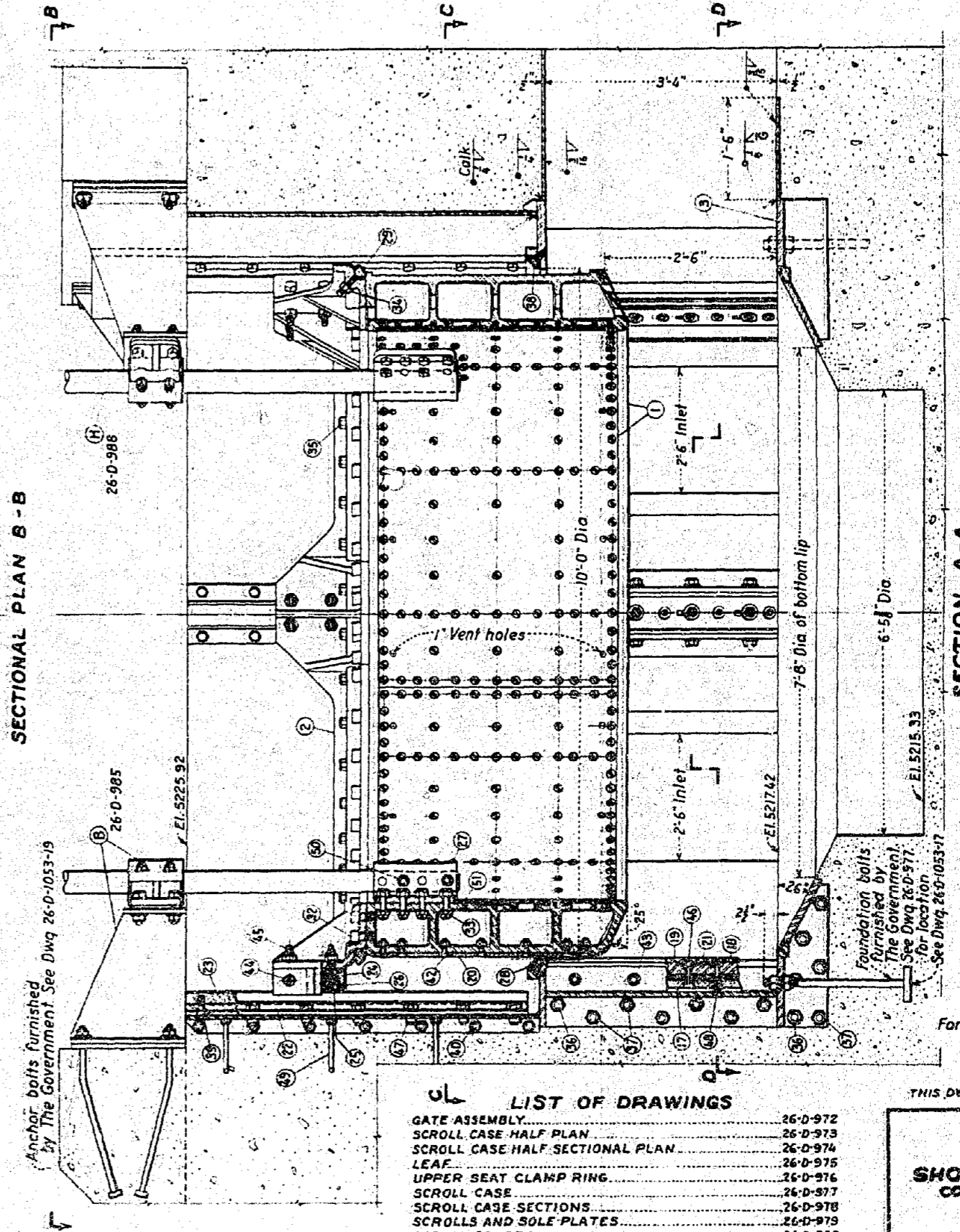
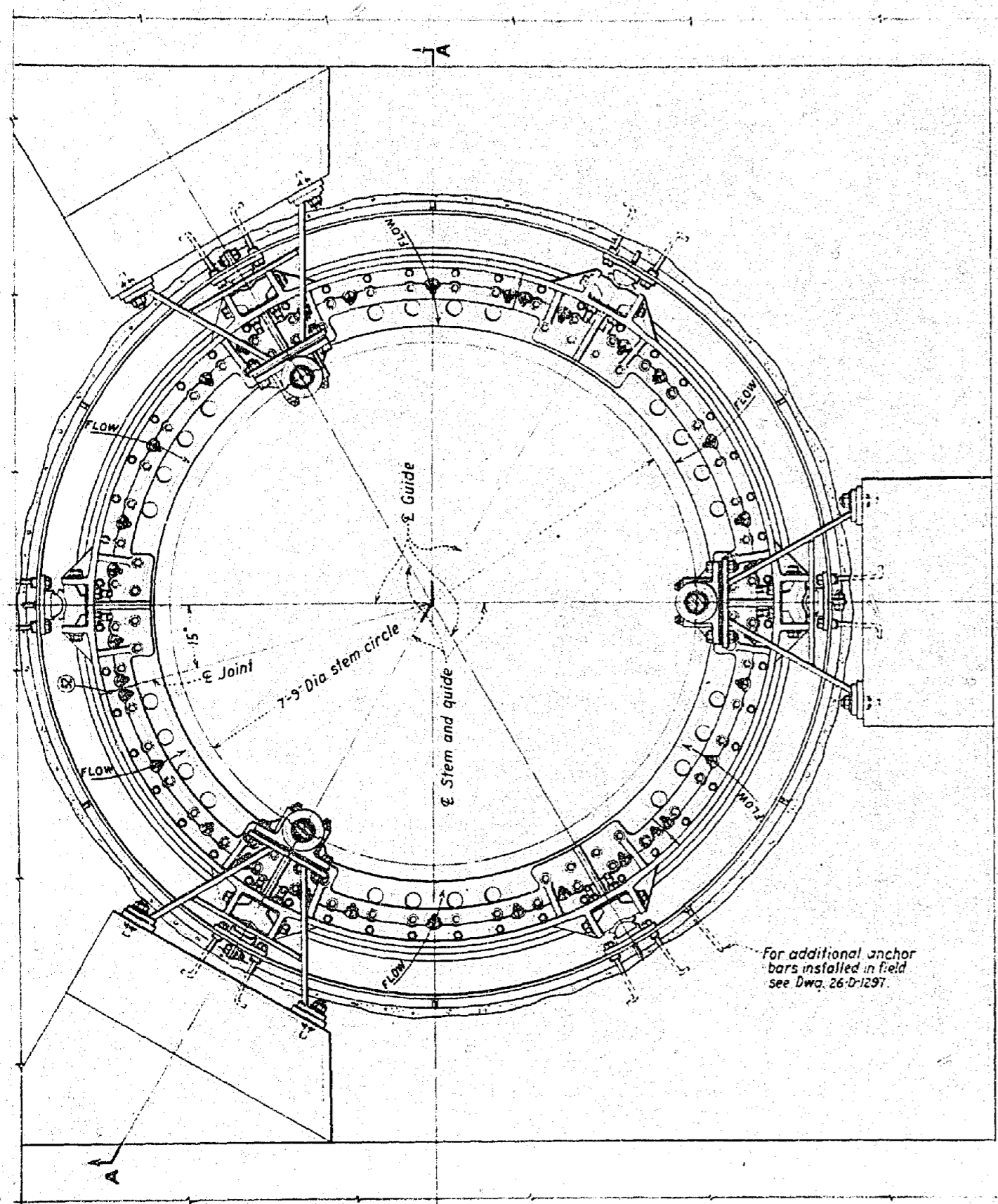

SECTIONAL PLAN B - B

SECTION A - A

REFERENCE DRAWING  
10' CYLINDER GATE AND MOIST  
INSTALLATION ASSEMBLY.....27-D-971

NOTE  
For sections see dwgs. 26-D-973 and 974

LIST OF DRAWINGS

GATE ASSEMBLY.....	26-D-972
SCROLL CASE HALF PLAN.....	26-D-973
SCROLL CASE HALF SECTIONAL PLAN.....	26-D-974
LEAF.....	26-D-975
UPPER SEAT CLAMP RING.....	26-D-976
SCROLL CASE.....	26-D-977
SCROLL CASE SECTIONS.....	26-D-978
SCROLLS AND SOLE PLATES.....	26-D-979
SCROLL COVERS.....	26-D-980
LOWER GUIDE PARTS-ASSEMBLY.....	26-D-981
STEM BRACKET-UPPER GUIDE PARTS-ASSEMBLY.....	26-D-982
UPPER SEAT RINGS-ASSEMBLY.....	26-D-983
BOLTS-LIST OF PARTS-MATERIALS.....	26-D-984

THIS DWG. SUPERSEDES DWG. 26-D-716

UNITED STATES  
DEPARTMENT OF THE INTERIOR  
BUREAU OF RECLAMATION  
SHOSHONE PROJECT-WYOMING  
HEART MOUNTAIN DIVISION

**SHOSHONE CANYON CONDUIT  
CONTROLLING WORKS-TUNNELS  
10' CYLINDER GATE  
GATE ASSEMBLY**

REV. 5/10/40  
DRAWN R.S.C.G.M. SUBMITTED [Signature]  
TRACER L.L.S. RECOMMENDED [Signature]  
CHECKED [Signature] APPROVED [Signature]  
ENGINEER [Signature] JUN 25 1940  
DWG. NO. 26-D-972

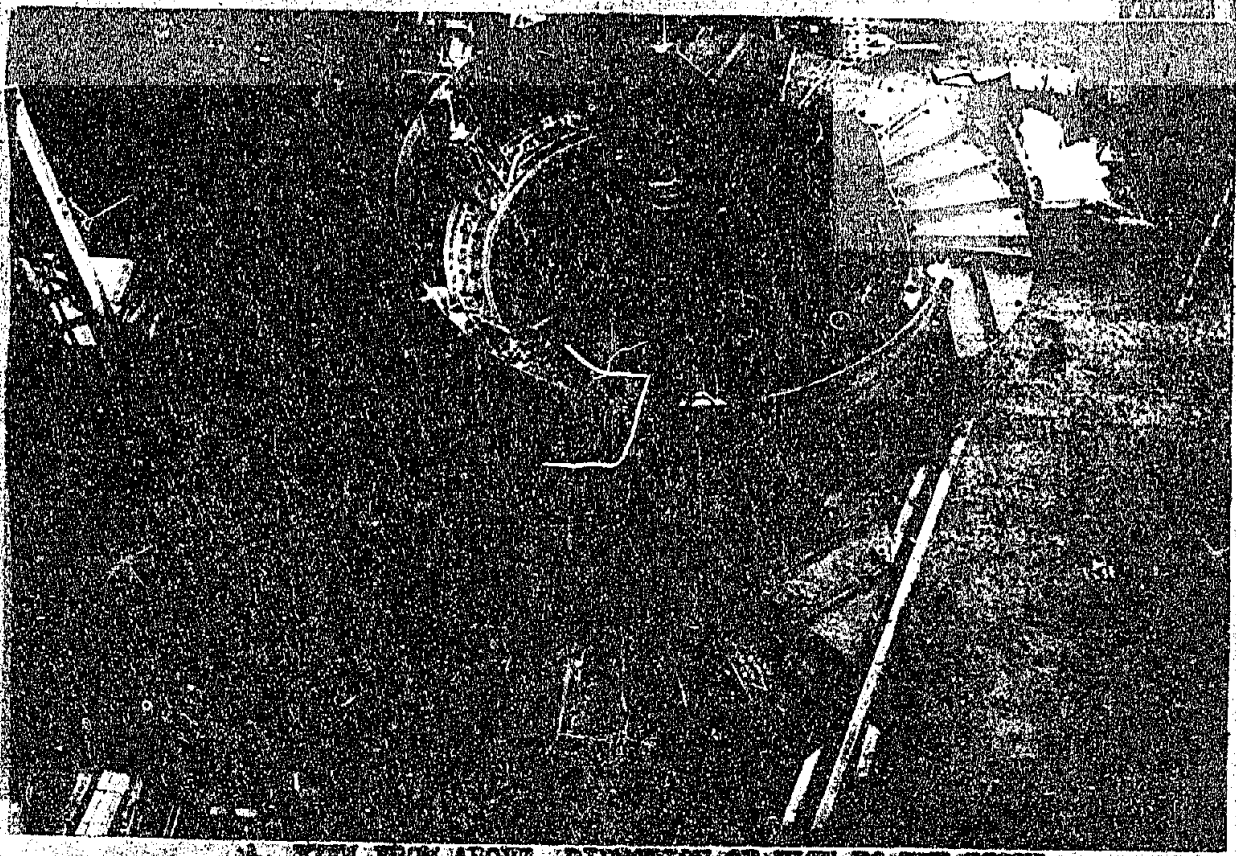

A. VIEW FROM ABOVE. DIRECTION OF FLOW TO THE RIGHT.

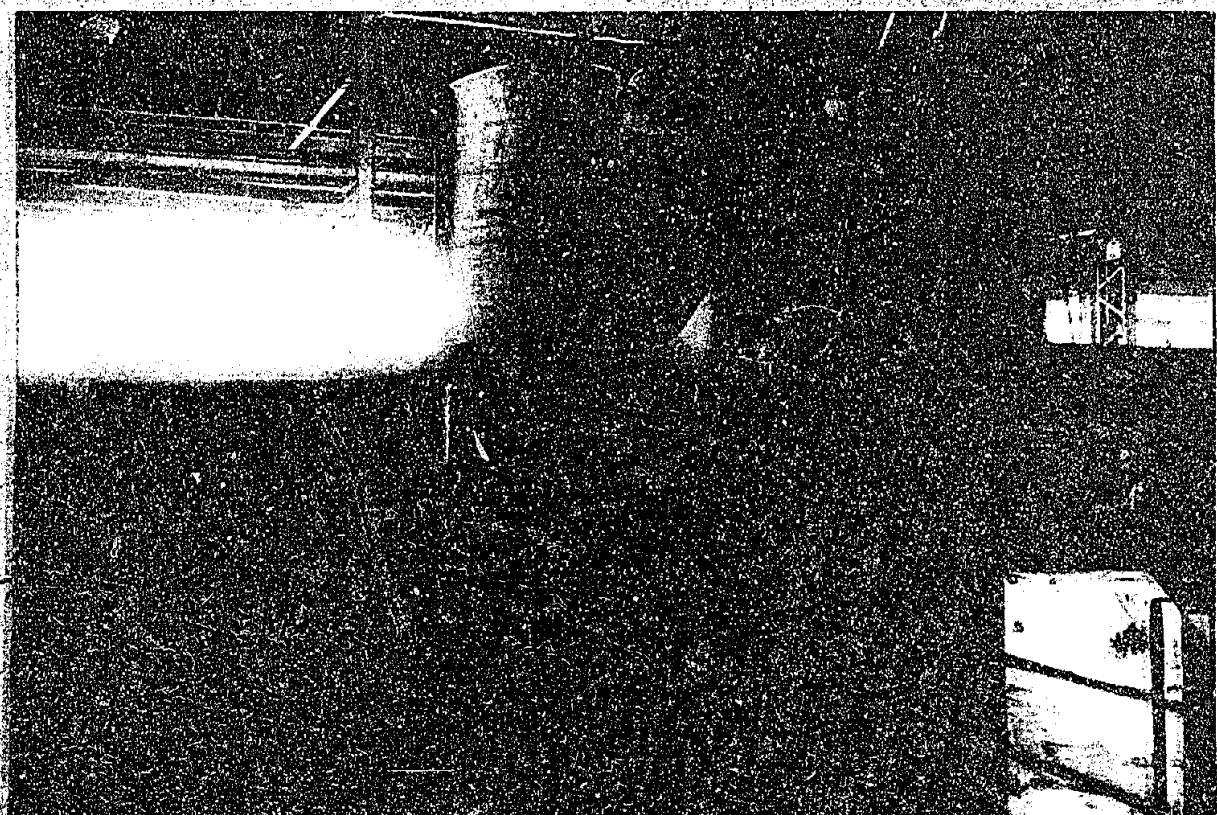

B. VIEW LOOKING DOWNSTREAM INTO SCROLL CASE. NOTE BOTTOM OF CYLINDER GATE NEAR TOP OF PORTS.

PROTOTYPE SCROLL CASE AND GATE ASSEMBLY





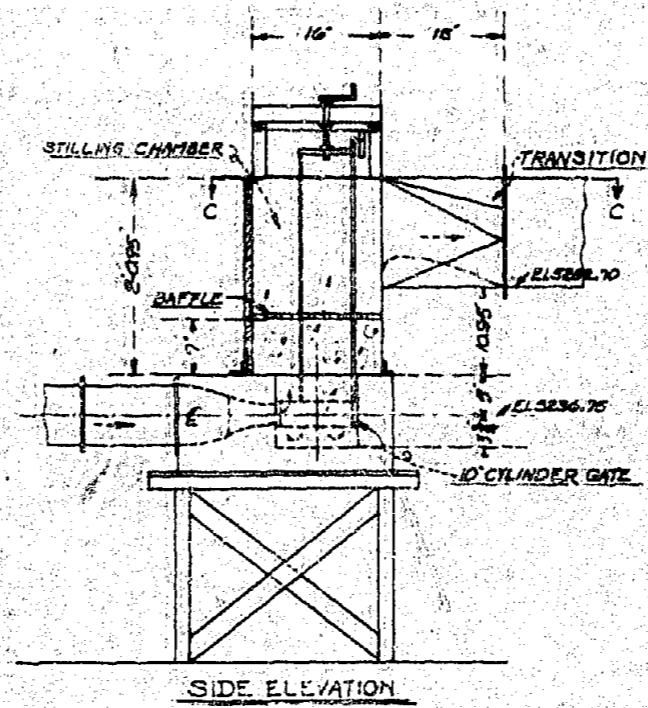
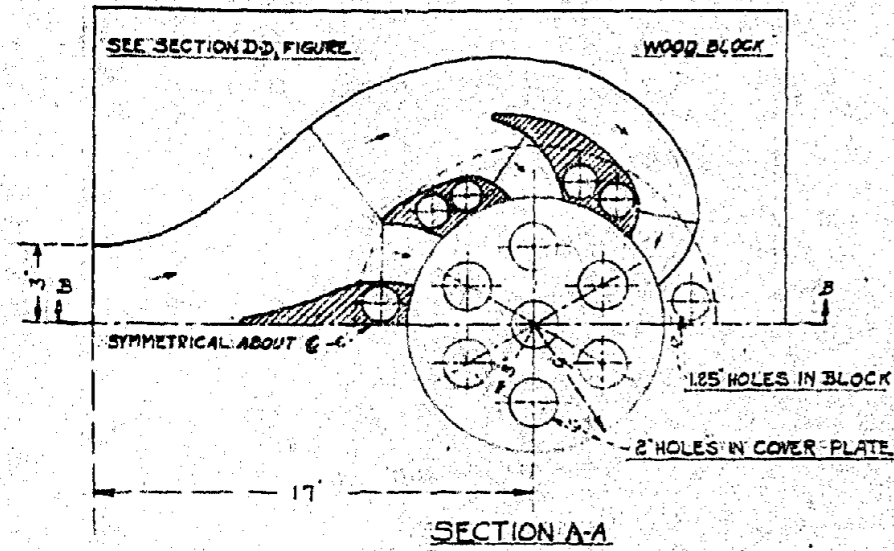

B. BAFFLE STUDY-ORIGINAL MODEL

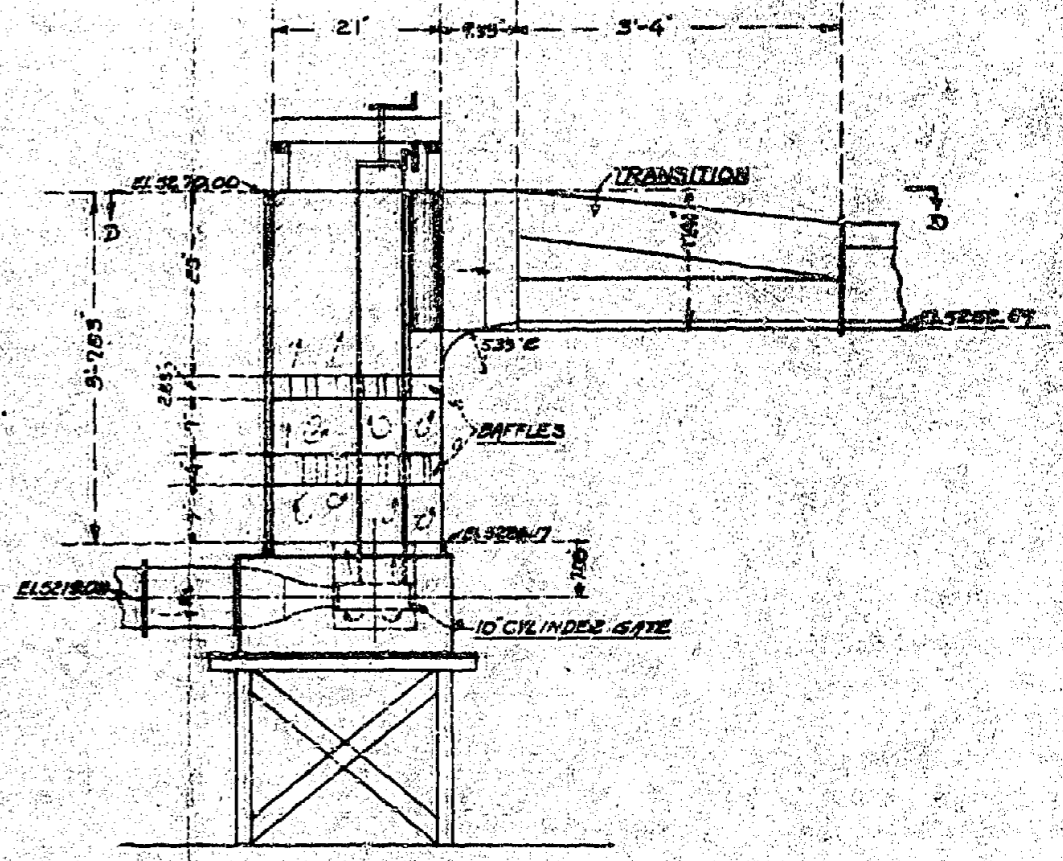

C. STILLING CHAMBER INCREASED

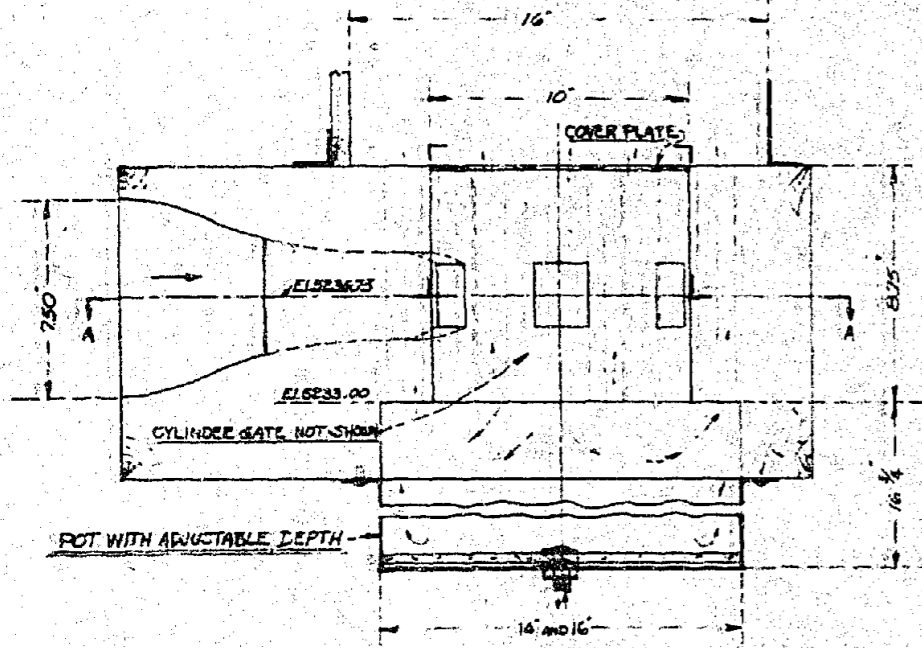

A. ADDITIONS TO SCROLL CASE GATE CHAMBER

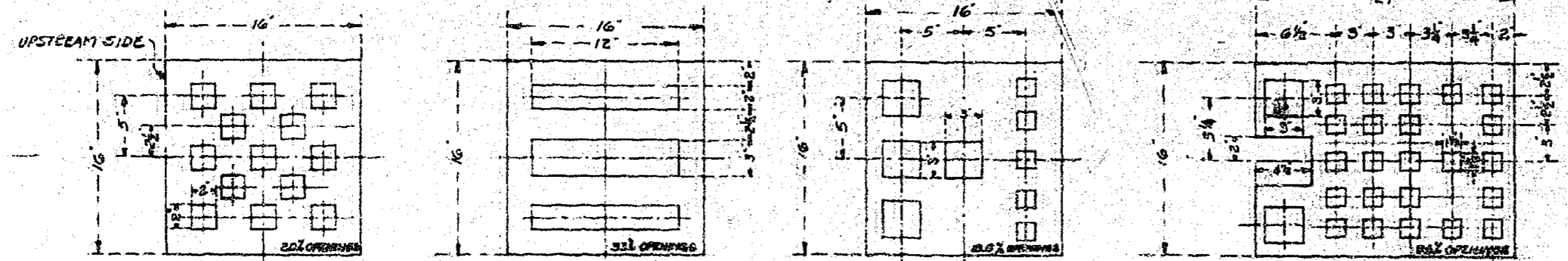
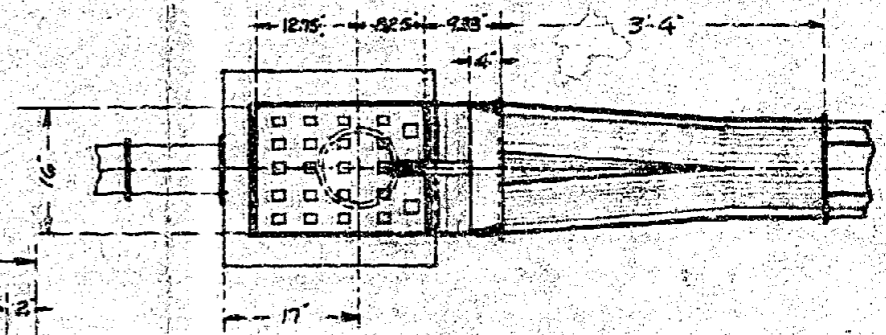
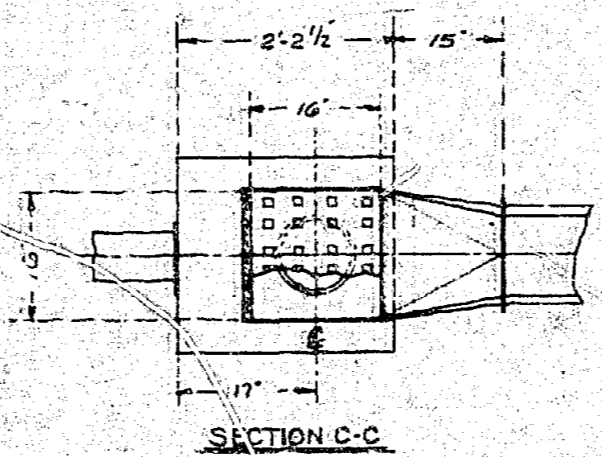

D. EXAMPLES OF BAFFLES TESTED

SEE ALSO FIGURE

SHOSHONE CANYON CONDUIT  
 HYDRAULIC MODEL STUDY  
 DESIGNS TESTED IN MODEL FOR DETERMINING  
 STILLING ACTION IN GATE CHAMBER

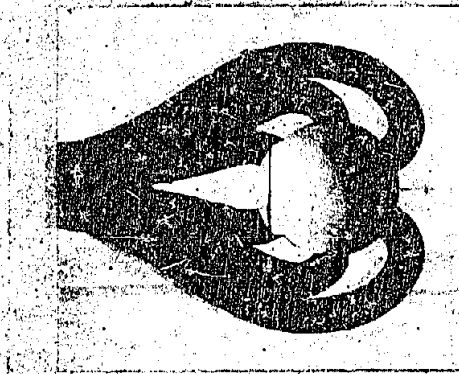

A. HOLE CUT IN WOOD BLOCK.

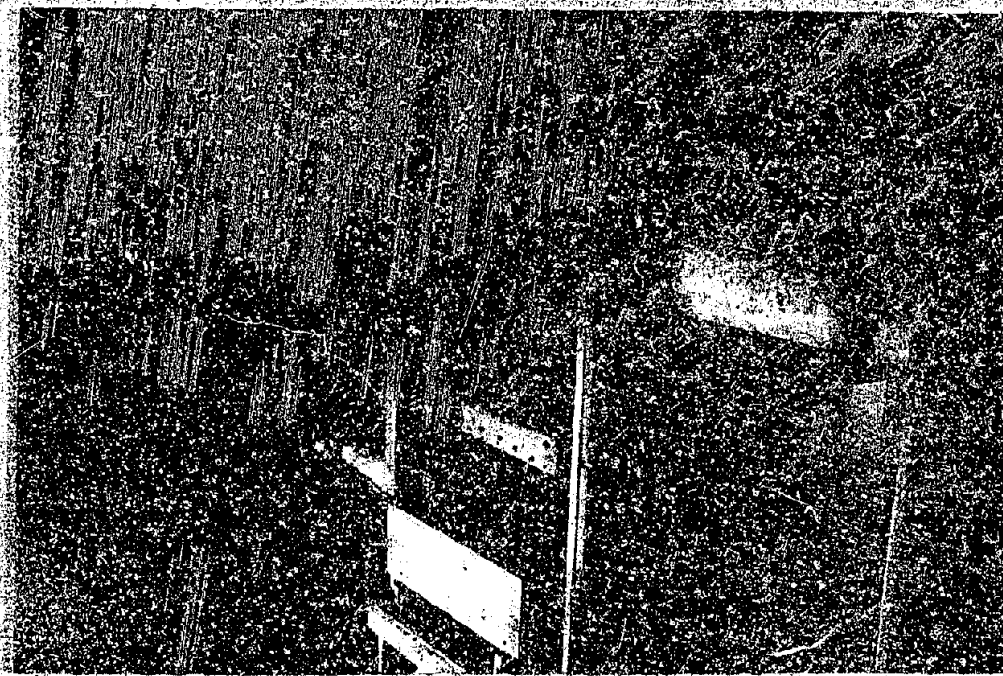

B. WOOD ASSEMBLY. VIEW LOOKING UPSTREAM.

RECOMMENDED DESIGN

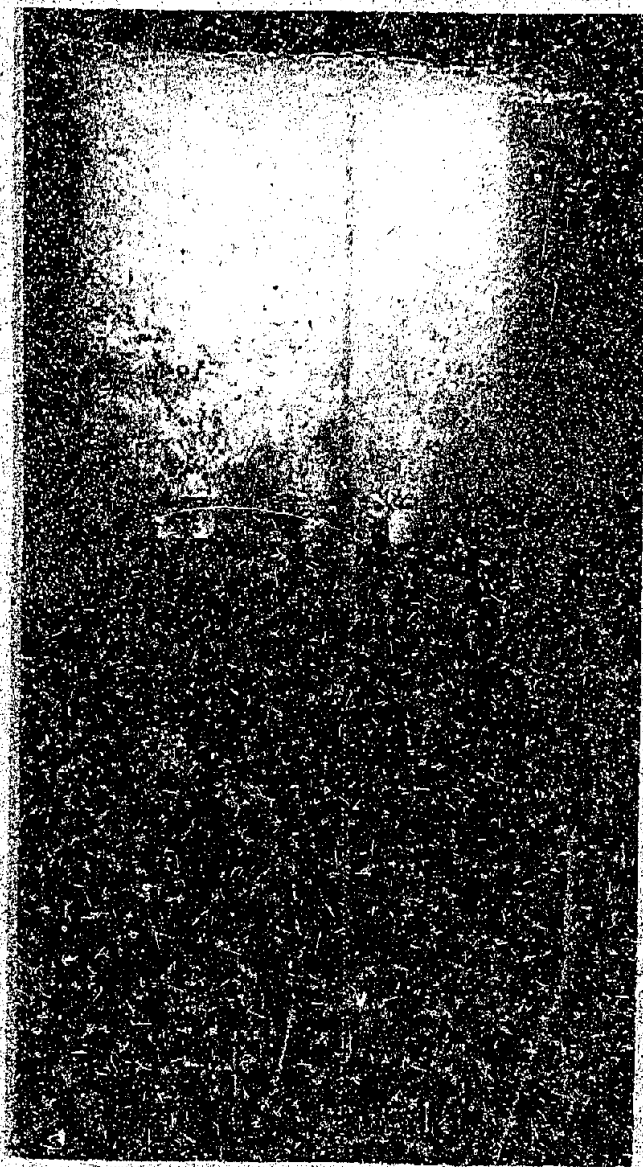

A. GATE OPEN 100 PER CENT.  
DISCHARGE 1200 SECOND-FEET.  
VIEW THROUGH RIGHT SIDE.

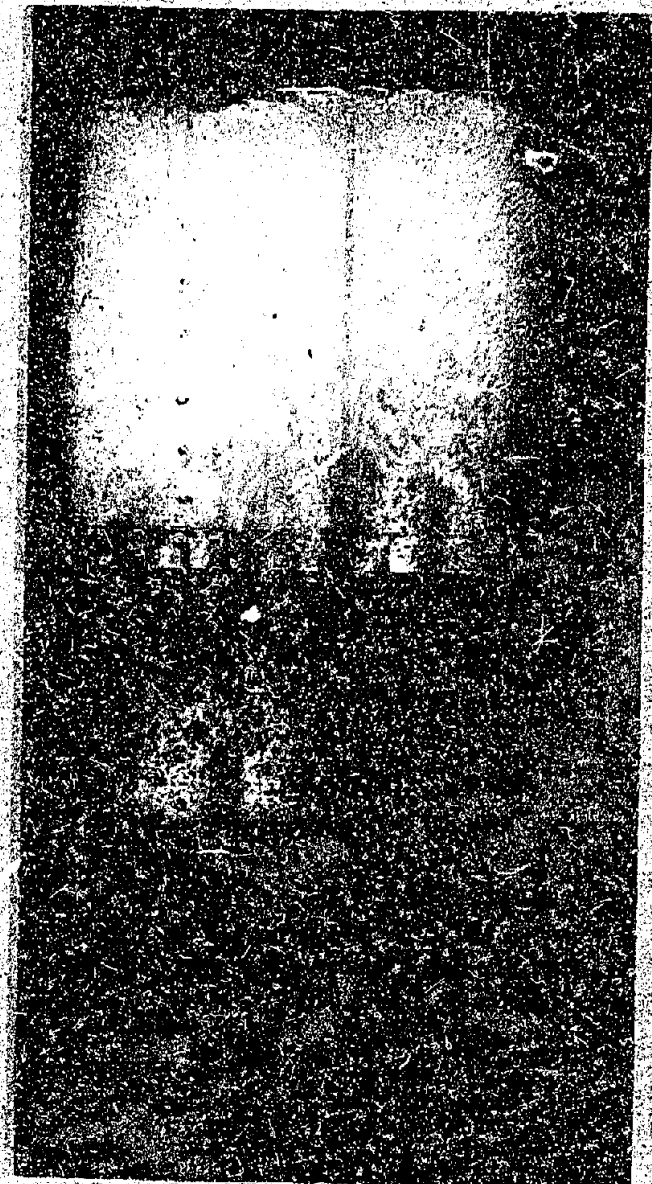

B. GATE OPEN 100 PER CENT.  
DISCHARGE 1500 SECOND-FEET.  
VIEW THROUGH RIGHT SIDE.

AIR INTRODUCED IN FLOW TO SHOW POSITION OF  
EDDIES AND FLOW THROUGH RAFFLES.



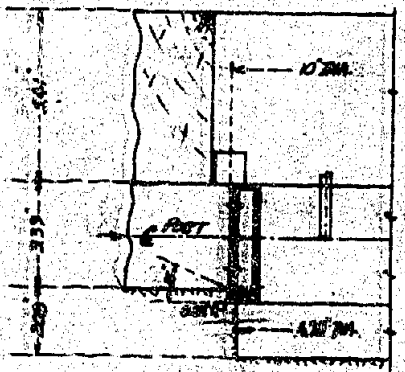
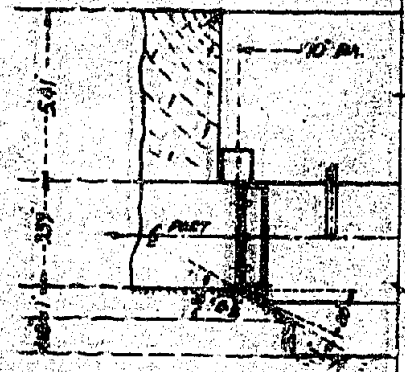
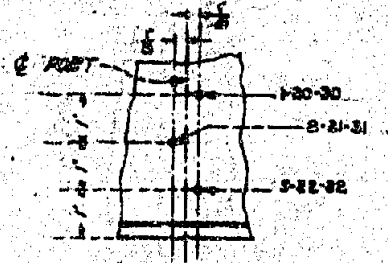
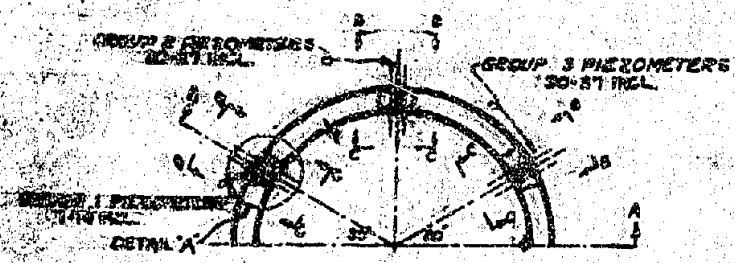

TEST 1 TEST 2

PROTOTYPE PRESSURE HEAD ON CYLINDER GATE

PIEZOMETER NO.	TEST 1	TEST 2	TEST 3	TEST 4	TEST 5
1					
2					
3					
4					
5					
6					
7					
8					
9					
10					
11					
12					
13					
14					
15					
16					
17					
18					
19					
20					
21					
22					
23					
24					
25					
26					
27					
28					
29					
30					
31					
32					
33					
34					
35					
36					
37					
38					
39					
40					
41					
42					
43					
44					
45					
46					
47					
48					
49					
50					
51					
52					
53					
54					
55					
56					
57					
58					
59					
60					
61					
62					
63					
64					
65					
66					
67					
68					
69					
70					
71					
72					
73					
74					
75					
76					
77					
78					
79					
80					
81					
82					
83					
84					
85					
86					
87					
88					
89					
90					
91					
92					
93					
94					
95					
96					
97					
98					
99					
100					

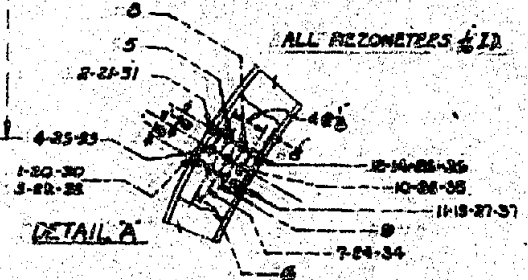
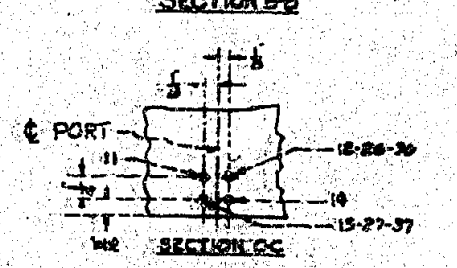
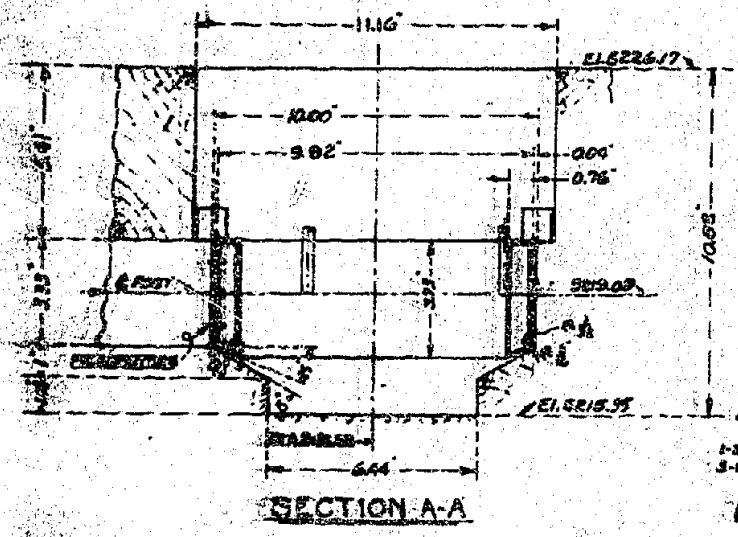

TEST 1

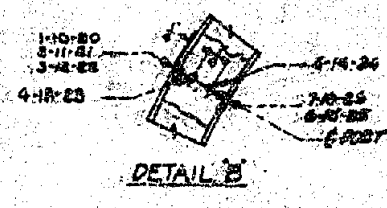
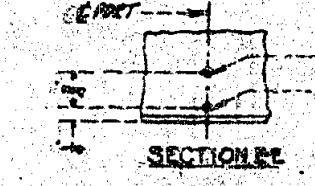
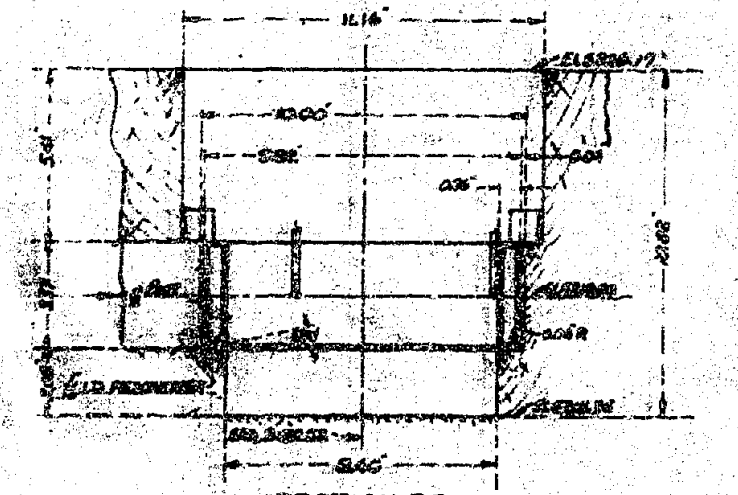
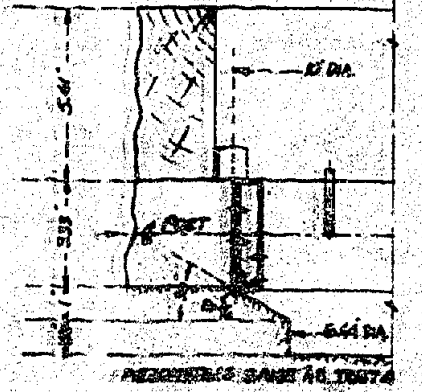
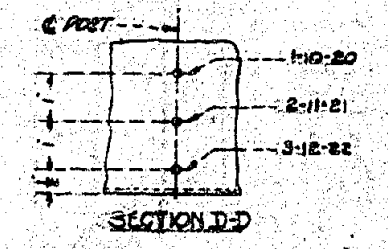
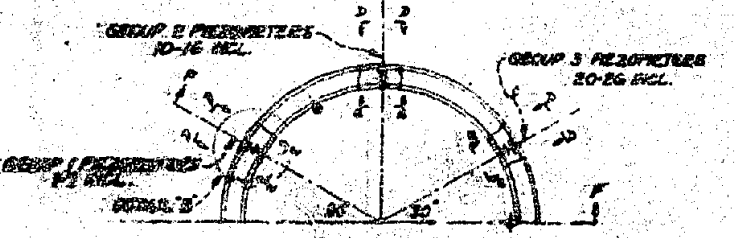

SECTION B-B

TEST 4

TEST 4 TEST 5

PIEZOMETER NUMBER	TEST 4		TEST 5	
	NOT OPEN	OPEN	NOT OPEN	OPEN
1				
2				
3				
4				
5				
6				
7				
8				
9				
10				
11				
12				
13				
14				
15				
16				
17				
18				
19				
20				
21				
22				
23				
24				
25				
26				
27				
28				
29				
30				
31				
32				
33				
34				
35				
36				
37				
38				
39				
40				
41				
42				
43				
44				
45				
46				
47				
48				
49				
50				
51				
52				
53				
54				
55				
56				
57				
58				
59				
60				
61				
62				
63				
64				
65				
66				
67				
68				
69				
70				
71				
72				
73				
74				
75				
76				
77				
78				
79				
80				
81				
82				
83				
84				
85				
86				
87				
88				
89				
90				
91				
92				
93				
94				
95				
96				
97				
98				
99				
100				

PROTOTYPE PRESSURE HEAD ON CYLINDER GATE

SEE FINISH FOR COMPLETE GATE ASSEMBLY

SHOSHONE CHEMICAL COMPANY  
HYDRAULIC  
PRESSURE

NOTE: SEE FIGURE 11 FOR MODEL DURING CALIBRATION

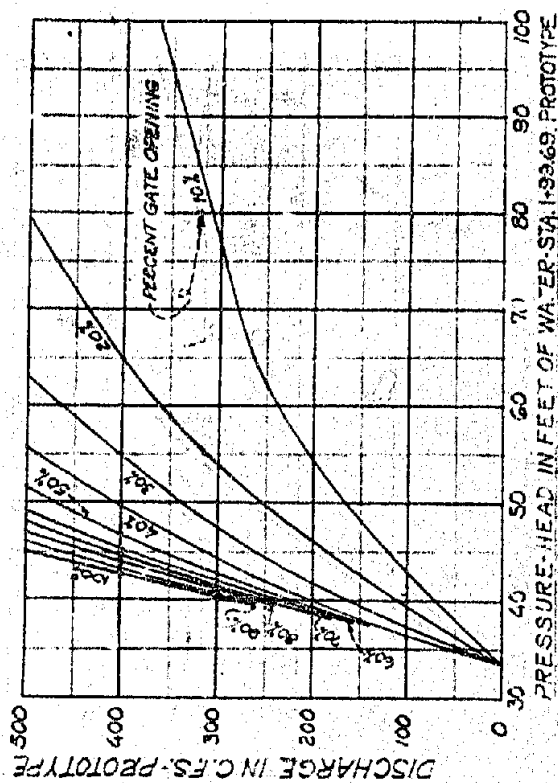
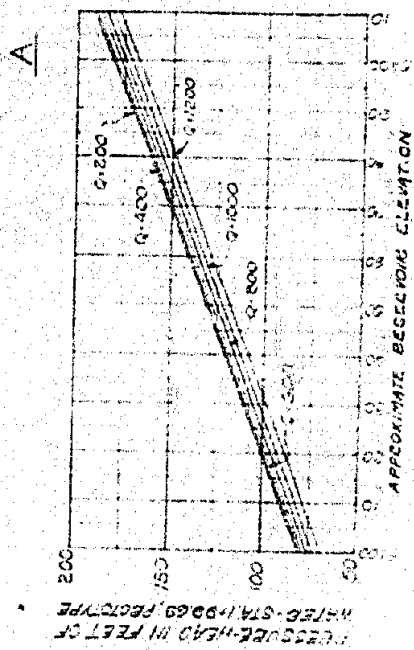
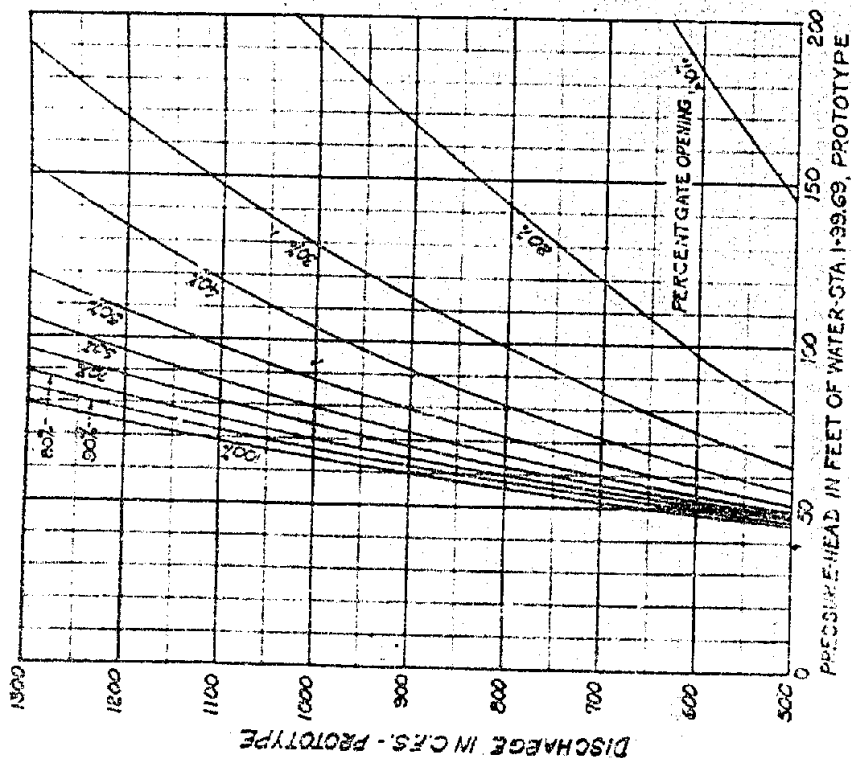

UNITED STATES  
DEPARTMENT OF THE INTERIOR  
BUREAU OF RECLAMATION  
SHOSHOE PROJECT - WYOMING  
HEART MOUNTAIN DIVISION

SHOSHOE CANYON CONDUIT  
HYDRAULIC MODEL STUDIES-INDICARE  
CALIBRATION OF COMPLETE GATE

ICR-45-D-20

FIGURE 13