

TEST REPORT

REPORT NUMBER: I08GE6338-FCC-EMC

ON

Type of Equipment: GSM/GPRS/EDGE Mobile phone(Quad Band
GSM850 /900/1800/1900 handheld Cellular
phone)
Type of Designation: MEGA4E
Manufacturer: Ezze Mobile Tech

ACCORDING TO

**FCC CFR Part 2, FREQUENCY ALLOCATIONS AND RADIO
TREATY MATTERS; GENERAL RULES AND REGULATIONS;
e-CFR, March 23, 2006**

PART 22, PUBLIC MOBILE SERVICES (Oct 1, 02 Edition)

**PART 24, PERSONAL COMMUNICATIONS SERVICES (Oct 1, 97
Edition)**

China Telecommunication Technology Labs.

Month date, year
Sep, 23, 2008

Signature

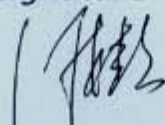

He Guili
Director

FCC ID: RV2MEGA4E

Report Date: 2008-9-23

Test Firm Name: China Telecommunication Technology Labs

Registration Number: 840587

Statement

The measurements shown in this report were made in accordance with the procedures described on test pages. All reported tests were carried out on a sample equipment to demonstrate limited compliance with FCC CFR 47 Parts 2, 22, and 24. The sample tested was found to comply with the requirements defined in the applied rules.

CONTENTS

1 GENERAL INFORMATION	4
1.1 NOTES	4
1.2 TESTERS	5
1.3 TESTING LABORATORY INFORMATION	6
1.4 DETAILS OF APPLICANT OR MANUFACTURER	7
2 TEST ITEM	8
2.1 GENERAL INFORMATION	8
2.2 OUTLINE OF EUT	8
2.3 MODIFICATIONS INCORPORATED IN EUT	8
2.4 EQUIPMENT CONFIGURATION	8
2.5 OTHER INFORMATION	9
3 SUMMARY OF TEST RESULTS	10
4 TEST RESULTS OF MODE	12
4.1 RADIATED SPURIOUS EMISSION	12
4.2 RADIATED RF POWER OUTPUT AND ERP	26
4.3 OCCUPIED BANDWIDTH	29
4.4 FREQUENCY STABILITY OVER TEMPERATURE VARIATION	41
4.5 FREQUENCY STABILITY OVER VOLTAGE VARIATION	45
4.6 CONDUCTED RF POWER OUTPUT	47
4.7 CONDUCTED SPURIOUS EMISSION	50
4.8 BAND EDGE	57
ANNEX A EXTERNAL PHOTOS	66
ANNEX B INTERNAL PHOTOS.....	69
ANNEX C DEVIATIONS FROM PRESCRIBED TEST METHODS.....	71

1 General Information

1.1 Notes

All reported tests were carried out on a sample equipment to demonstrate limited compliance with FCC CFR 47 Parts 2, 22 and 24.

The test results of this test report relate exclusively to the item(s) tested as specified in section 2.

The following deviation from, additions to, or exclusions from the test specifications have been made. See Annex C.

China Telecommunication Technology Labs.(CTTL) authorizes the applicant or manufacturer (see section 1.4) to reproduce this report provided, and the test report may only be reproduced or published in full. Reproduction or publication of extracts from the report requires the prior written approval of CTTL Mr. He Guili.

Any use which a third party makes of this report, or any reliance on or decisions to be made based on it, are the responsibility of such third parties. CTTL accepts no responsibility for damages, if any, suffered by any third party as a result of decisions made or actions based on this report.

FCC Parts 2, 22, 24
Equipment: MEGA4E

REPORT NO.: I08GE6338-FCC-EMC

1.2 Testers

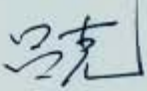
Name: Lv Ke
Position: Engineer
Department: Department of EMC test
Signature: 

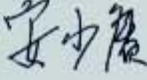
Name: An Shaogeng
Position: Engineer
Department: Department of EMC test
Signature: 

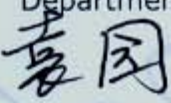
Name: Yuan Yuan
Position: Engineer
Department: Department of EMC test
Signature: 

Editor of this test report:
Name: Yuan Yuan
Position: Engineer
Department: Department of EMC test
Date: 2008-9-23
Signature: 

Technical responsibility for area of testing:
Name: Zhang Xia
Position: Manager
Department: Department of EMC test
Date: 2008-9-23
Signature: 

1.3 Testing Laboratory information

1.3.1 Location

Name: China Telecommunication Technology Labs.
Address: No. 11, Yue Tan Nan Jie, Xi Cheng District
BEIJING
P. R. CHINA, 100083
Tel: +86 10 68094053
Fax: +86 10 68011404
Email: emc@chinattl.com

1.3.2 Details of accreditation status

Accredited by: China National Accreditation Service for Conformity
Assessment (CNAS)
Registration number: CNAS Registration No. CNAS L0570
Standard: ISO/IEC 17025:2005

1.3.3 Test location, where different from section 1.3.1

Name: -----
Street: -----
City: -----
Country: -----
Telephone: -----
Fax: -----
Postcode: -----

1.4 Details of applicant or manufacturer

1.4.1 Applicant

Name: Ezze Mobile Tech
Address: 1F, Bubmusa Bldg., 151-31,
Nonhyun-dong, Kangnam-ku, Seoul
Country: Korea
Telephone: 82-2-519-7805
Fax: 82-2-519-7882
Contact: Anny
Telephone: 82-10-9265-2189
Email: eosahn@ezzemobile.com

1.4.2 Manufacturer (if different from applicant in section 1.4.1)

Name: --
Address: --

1.4.3 Manufactory (if different from applicant in section 1.4.1)

Name: Ezze Mobile Tech
Address: Rm. 204, Anyang Megavalley, 799,
Guanyang-dong, Dongan-gu, Anyang-city,
Gyeonggi-do, Korea, 431-767

2 Test Item

2.1 General Information

Manufacturer: Ezze Mobile Tech
 Name: GSM/GPRS/EDGE Mobile phone(Quad Band GSM850 /900/1800/1900 handheld Cellular phone)
 Model Number: MEGA4E
 Serial Number: --
 Production Status: Production
 Receipt date of test item: 2008-9-2

2.2 Outline of EUT

E.U.T. is a GSM/GPRS/EDGE Mobile phone(Quad Band GSM850 /900/1800/1900 handheld Cellular phone)

2.3 Modifications Incorporated in EUT

The EUT has not been modified from what is described by the brand name and unique type identification stated above.

2.4 Equipment Configuration

Equipment configuration list:

Item	Generic Description	Manufacturer	Type	Serial No.	Remarks
A	handset	Ezze Mobile Tech	MEGA4E	--	None
B	adapter	Yu Feng	USB Type	--	None
C	battery	Zhi-in	Li-ion	--	None
D	Earphone	Rich star	Wire Type(stereo)	--	None

Cables:

Item	Cable Type	Manufacturer	Length	Shield	Quantity	Remarks
1	DC cable on Adapter	Unknown	1.0 m	No	1	None

2.5 Other Information

- (a) Modulation is GMSK.
- (b) Emission Designator is 252KGXW.
- (c) Version of hardware and software
 - HW Version: V 0.1
 - SW Version: V 0.1
- (d) Adaptor information:
 - Input: 100-240VAC 50/60Hz
 - Output: 5.0VDC 1A
- (e) Battery information:
 - 3.7VDC 750mAh

CITL Test Report

3 Summary of Test Results

A brief summary of the tests carried out is shown as following.

GSM mode:		
Specification Clause	Name of Test	Result
2.1051, 24.238, 2.1053,22.917	Radiated Spurious Emission	Pass
2.1046,24.232	Radiated RF Power Output	Pass
22.913(a)	Effective Radiated Power (ERP)	Pass
2.1049,22.917(b), 24.238(b)	Occupied Bandwidth	*Note 1
2.1055,22.355, 24.235	Frequency Stability over Temperature Variation	Pass
2.1055,22.355, 24.235	Frequency Stability over Voltage Variation	Pass
2.1046,22.913(a), 24.232(c)	Conducted RF Power Output	Pass
2.1051,22.917,24. 238	Conducted spurious emissions	Pass
Note 1: No applicable performance criteria.		

GPRS mode:		
2.1051, 24.238, 2.1053,22.917	Radiated Spurious Emission	Pass
2.1046,24.232	Radiated RF Power Output	Pass
22.913(a)	Effective Radiated Power (ERP)	Pass
2.1049,22.917(b), 24.238(b)	Occupied Bandwidth	*Note 2
2.1055,22.355, 24.235	Frequency Stability over Temperature Variation	Pass
2.1055,22.355, 24.235	Frequency Stability over Voltage Variation	Pass
2.1046,22.913(a), 24.232(c)	Conducted RF Power Output	Pass
2.1051,22.917,24. 238	Conducted spurious emissions	Pass
Note 2: No applicable performance criteria.		

EGPRS mode:		
2.1051, 24.238, 2.1053,22.917	Radiated Spurious Emission	Pass
2.1046,24.232	Radiated RF Power Output	Pass
22.913(a)	Effective Radiated Power (ERP)	Pass
2.1049,22.917(b), 24.238(b)	Occupied Bandwidth	*Note 2
2.1055,22.355, 24.235	Frequency Stability over Temperature Variation	Pass
2.1055,22.355, 24.235	Frequency Stability over Voltage Variation	Pass
2.1046,22.913(a), 24.232(c)	Conducted RF Power Output	Pass
2.1051,22.917,24. 238	Conducted spurious emissions	Pass
Note 2: No applicable performance criteria.		

TTL Test Report

4 Test Results of mode

4.1 Radiated Spurious Emission

Specifications:	2.1051, 24.238, 2.1053, 22.917					
Date of Tests	2008-9-8,2008-9-18,2008-9-19					
Test conditions:	Ambient Temperature: 15°C-35°C Relative Humidity: 30%-60% Air pressure: 86-106kPa					
Operation Mode	TX on, channel 190 and 661 for GSM and GPRS mode					
Test Results:	Pass					
Test equipment Used:						
Asset Number	Description	Manufacturer	Model Number	Serial Number	Cal Due	State
7805	EMI Test Receiver	R/S	ESI26	100211	2009-01-03	Normal
7330	Ultra Broadband Antenna	SCHWARZBECK	VULB 9160	--	2010-10-26	Normal
7330	Double-Ridged Horn Antenna	R/S	HF906	100037	2009-01-14	Normal
713	Fully-Anechoic Chamber	ETS	11.8m×6.5m×6.3 m	--	2010-11-17	Normal
023	Wireless Communications Test Set	Agilent	8960(E5515C)	GB41450323	2009-06-13	Normal
111835	Wireless Communications Test Set	R&S	CMU200	1100000802	--	Normal

Limit Level Construction:

According to Part 24.238 (a), i.e., Out of band emissions. The power of any emission outside of the authorized operating frequency ranges must be attenuated below the transmitting power (P) by a factor of at least $43 + 10 \log(P)$ dB, so the limit level is:
 $P(\text{dBm}) - (43 + 10 \log(P)) \text{ dB} = -13\text{dBm}$

Limits for Radiated spurious emissions(UE)

Frequency range	Limit Level /Resolution Bandwidth
30 MHz to 20000 MHz	-13dBm/1MHz

Test Setup:

The EUT was placed in an anechoic chamber, see figure SP. The Wireless Communications Test Set was used to set the TX channel and power level and modulate the TX signal with different bit patterns. The test was done using an automated test system, where all test equipments were controlled by a computer.

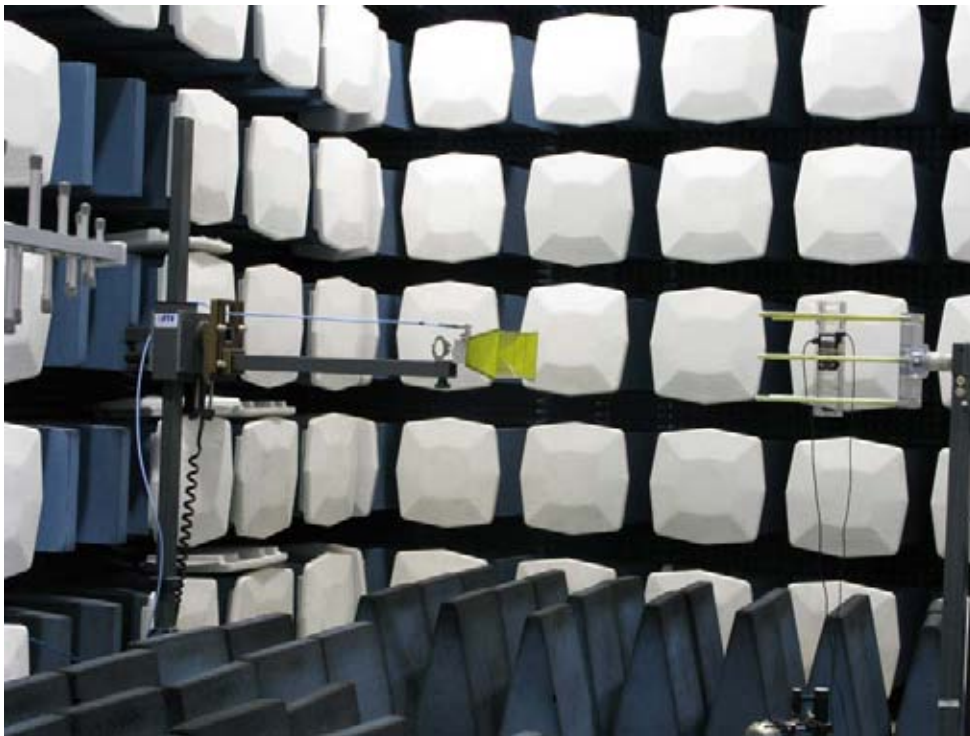

Figure SP

Test Method:

The measurement was performed accordance with section 2.2.12 of ANSI/TIA-603-B-2002: *Land Mobile FM or PM Communications Equipment Measurement and Performance Standards*.

1 The maximum spurious emissions were searched by turning the azimuth of the turntable, shifting the polarization of the measuring antenna and changing the pose of the EUT.

2 Levels of EUT's transmitter harmonics and suspicious signals were recorded.

3 The recorded levels were corrected in the automated test system with the correction factors given by a substitution calibration made before the measurement. The calibration was made separately for vertical and horizontal polarization and the system uses different correction factors depending on the measuring antenna polarization.

4 The corrected values of radiated spurious emissions indicated as EIRP are reported.

Note:

1 The investigated ARFCNs are 190 (836.6 MHz) and 661 (1880.0 MHz).

2 The investigated frequency range is 30 MHz ~ 18 GHz.

Test Results for GSM mode:

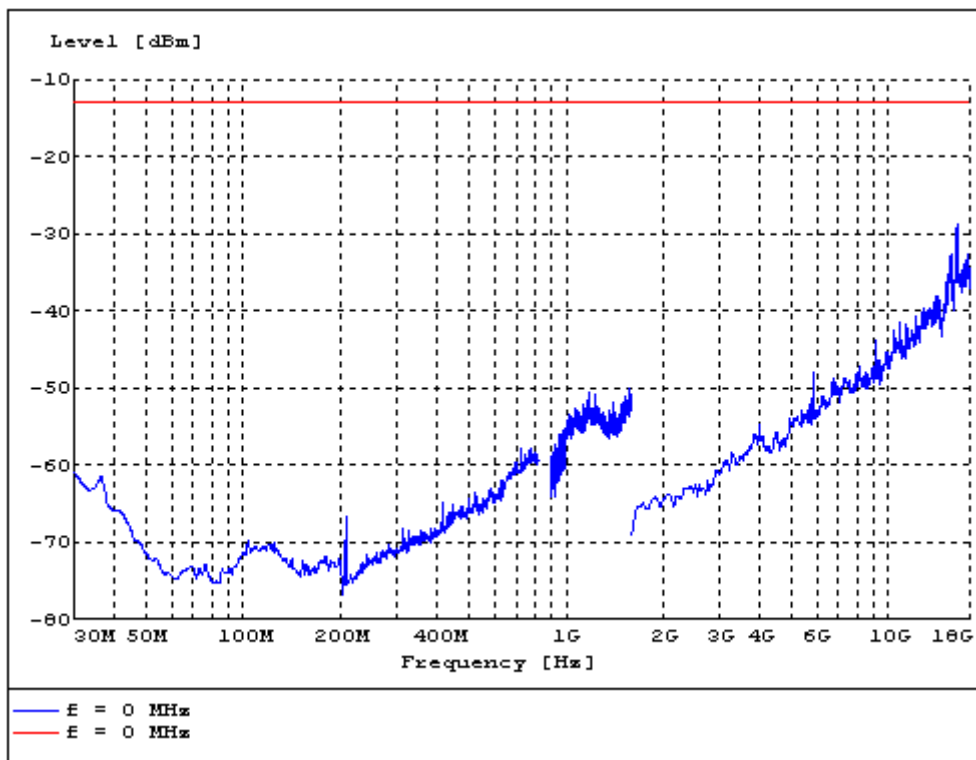

S190VF for GSM mode

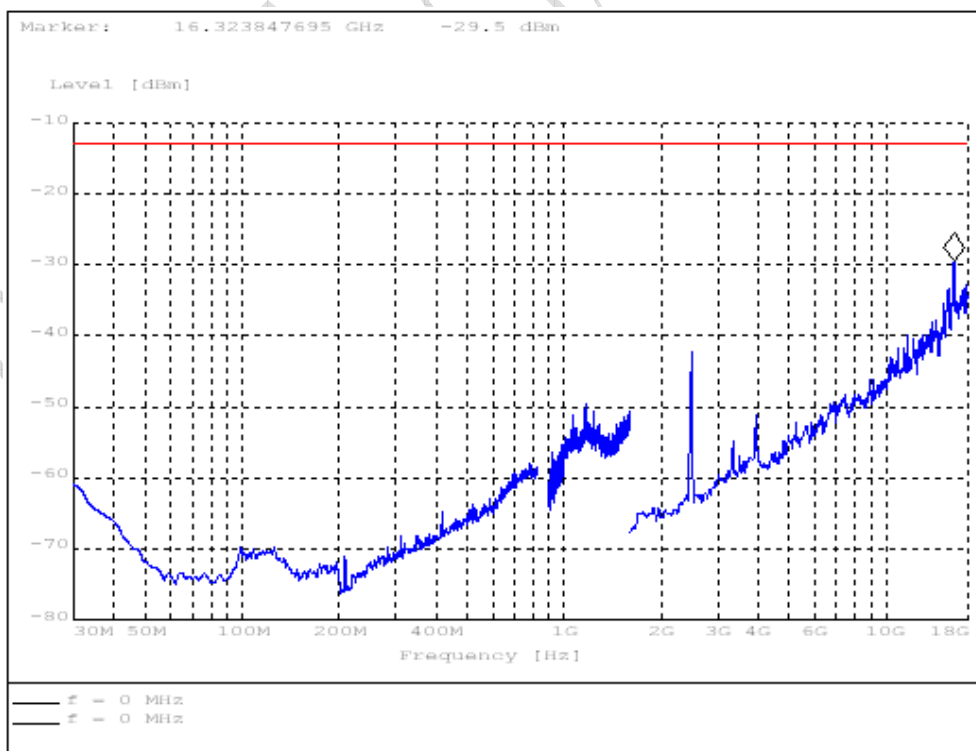

S190HF for GSM mode

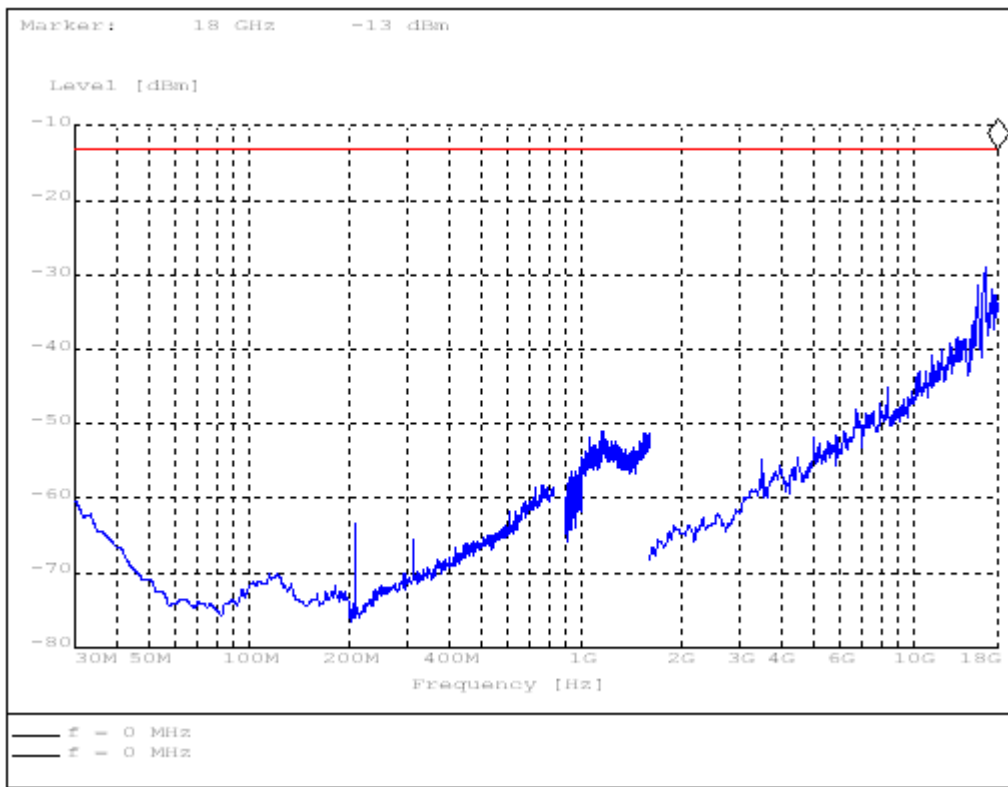

S190VT for GSM mode

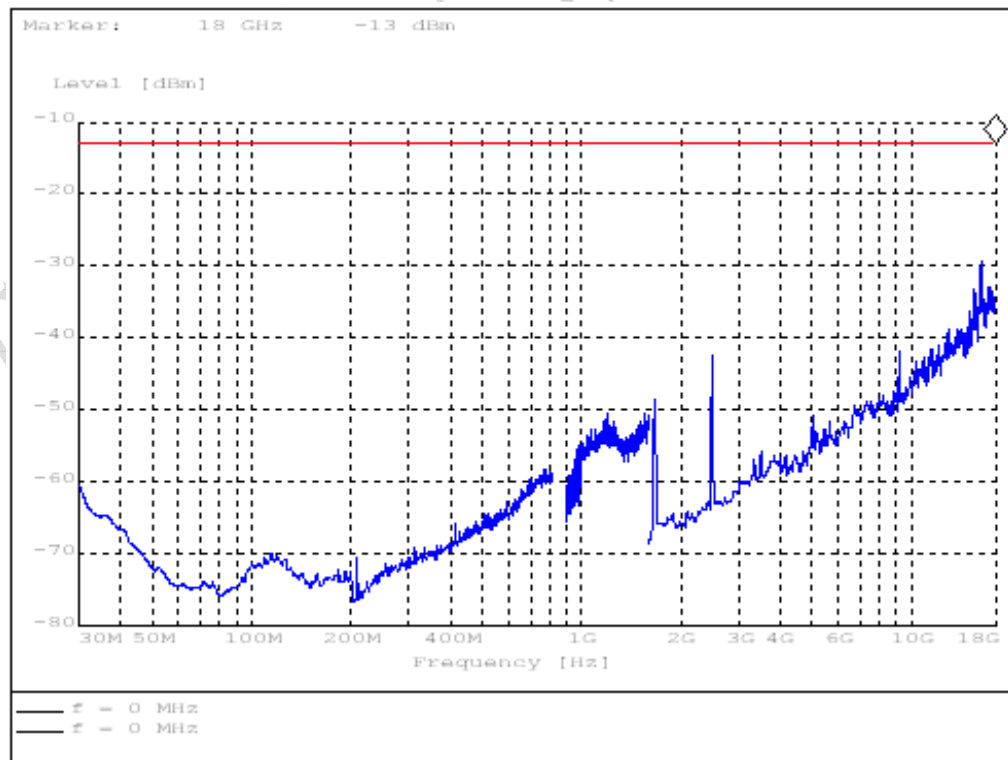

S190HT for GSM mode

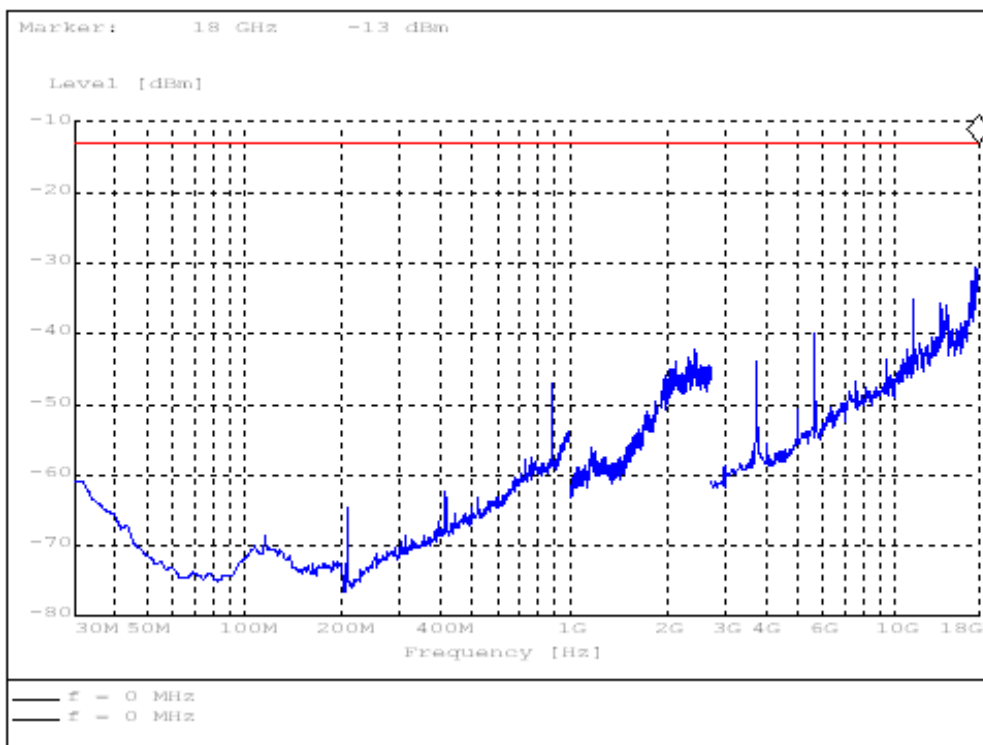

S661VF for GSM mode

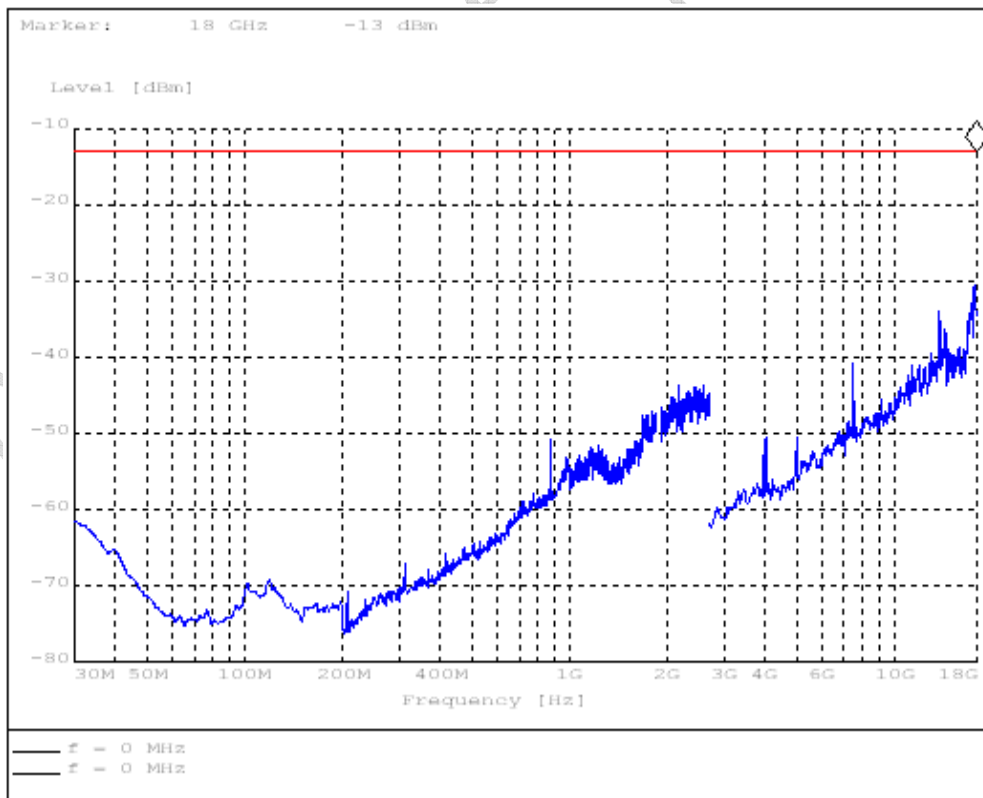

S661HF for GSM mode

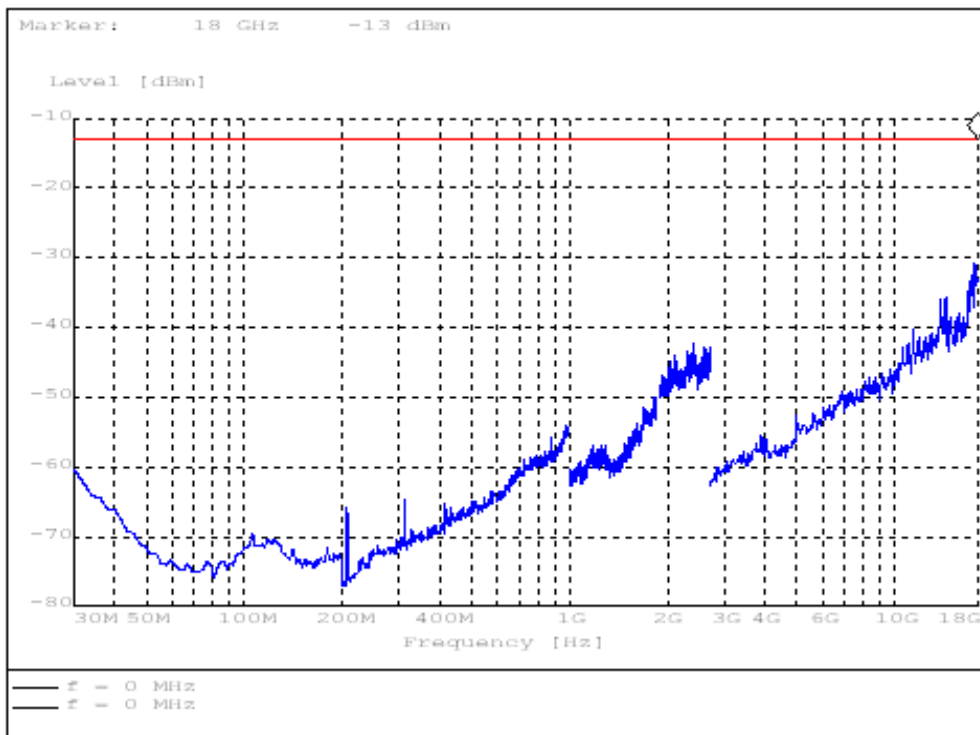

S661VT for GSM mode

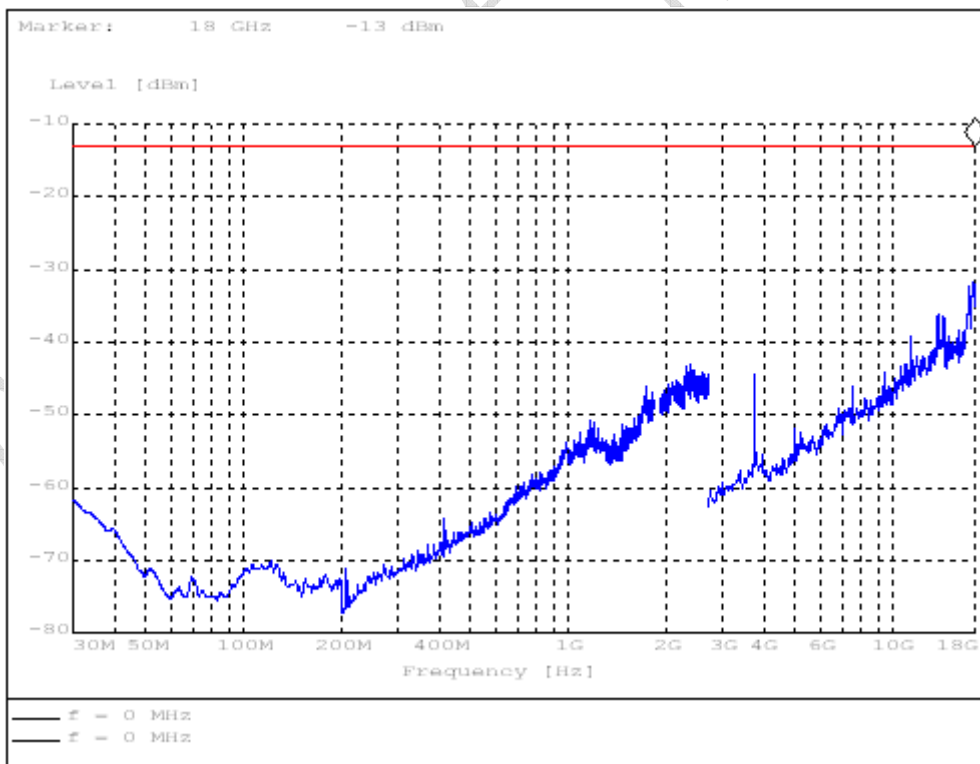

S661HT for GSM mode

Test Results for GPRS mode:

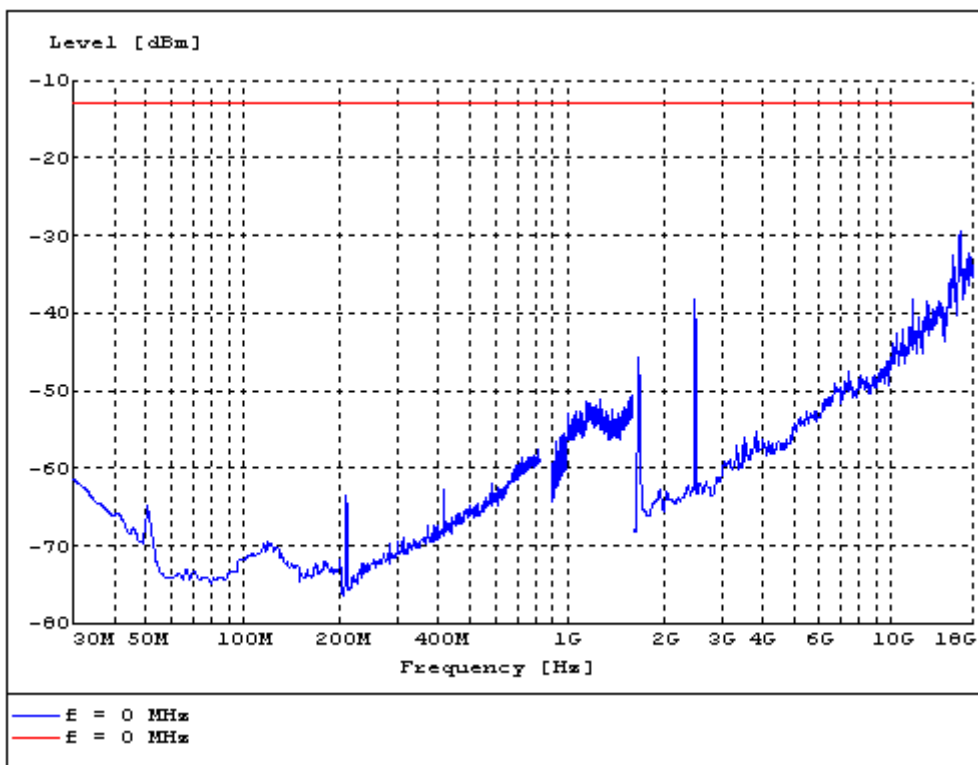

S190VF for GPRS mode

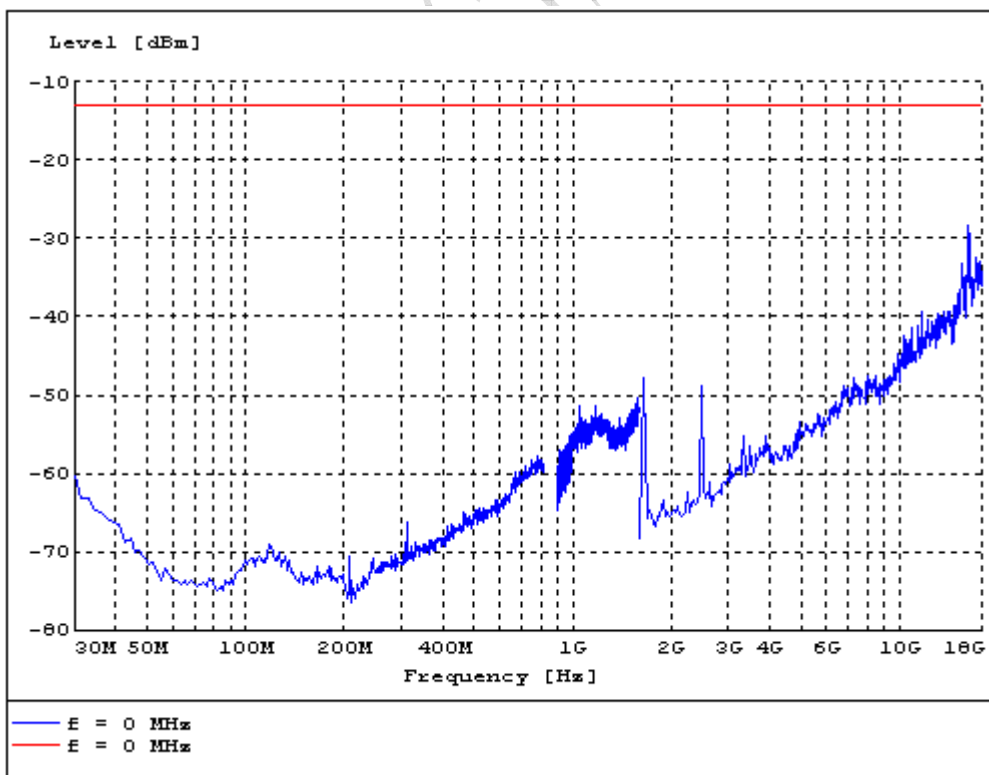

S190HF for GPRS mode

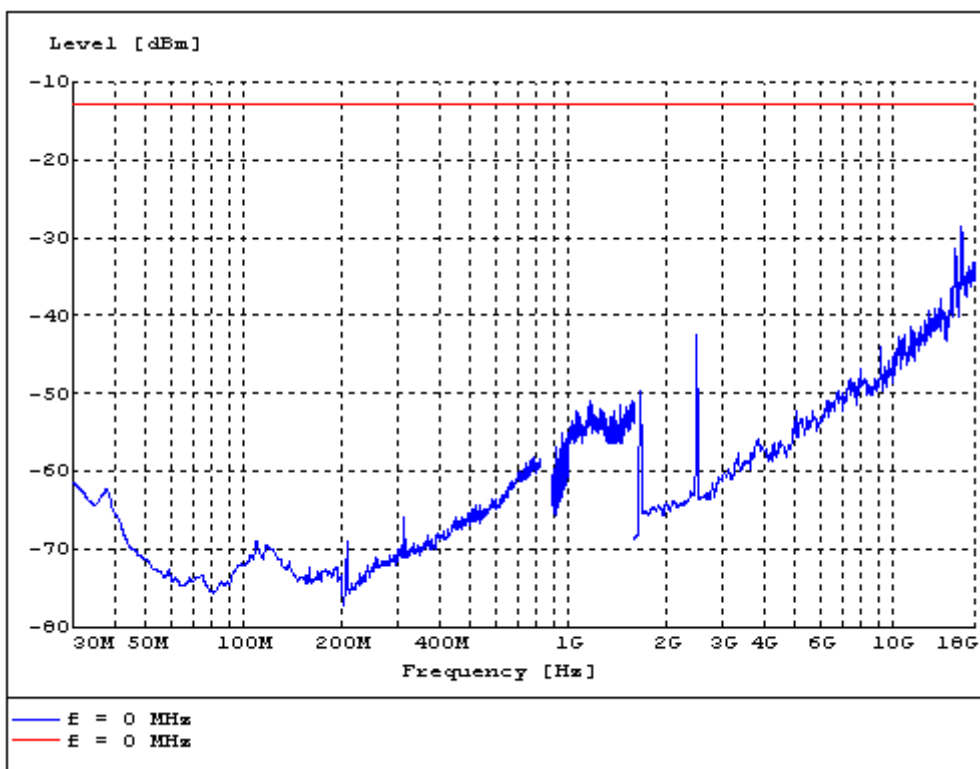

S190VT for GPRS mode

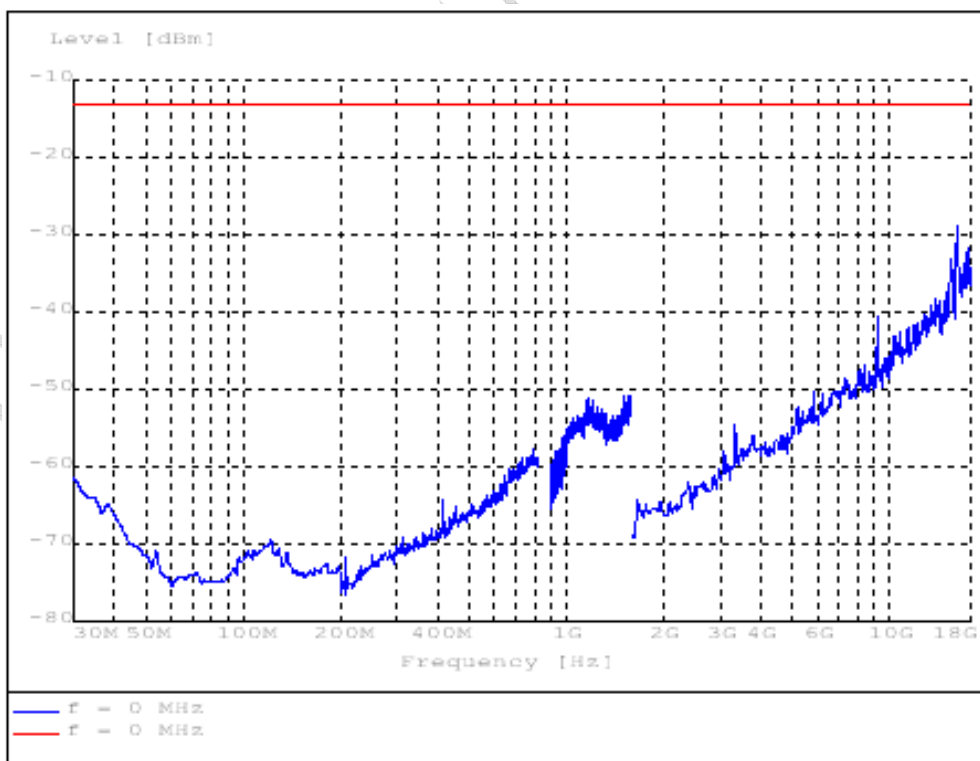

S190HT for GPRS mode

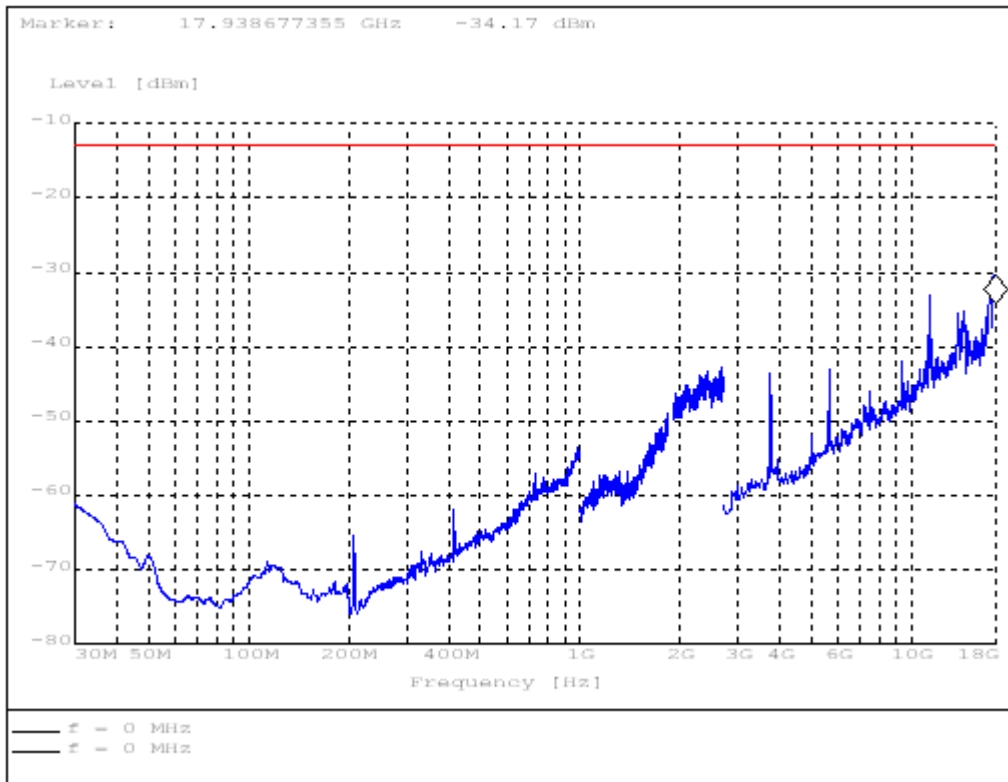

S661VF for GPRS mode

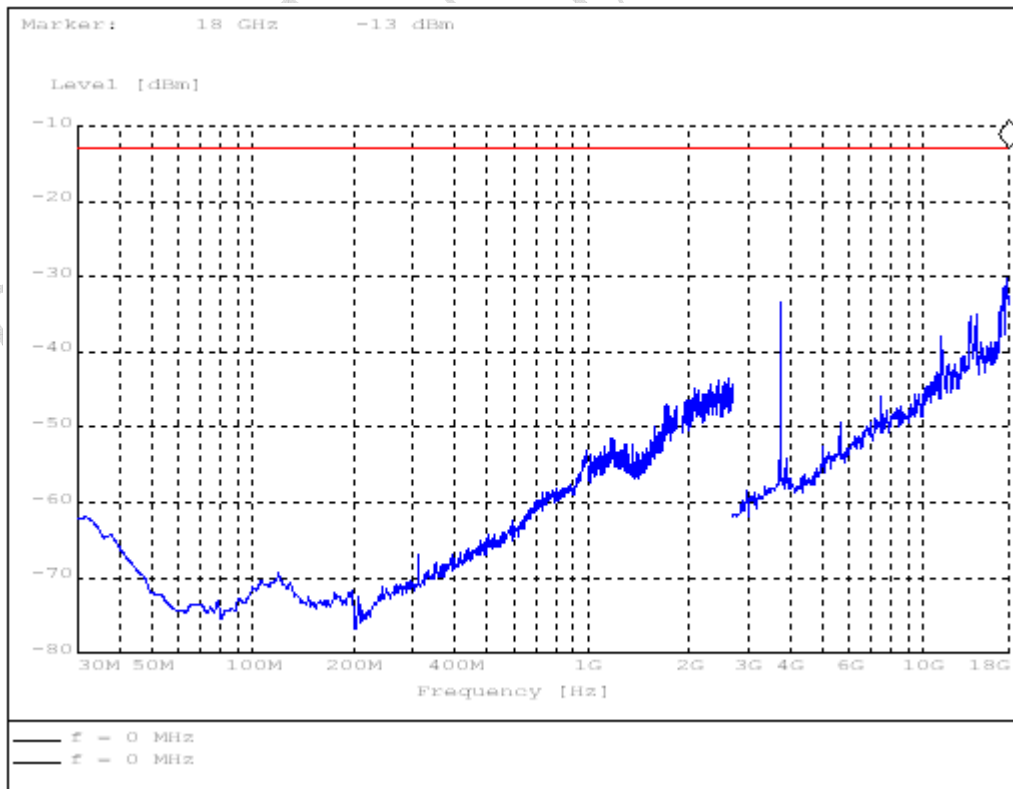

S661HF for GPRS mode

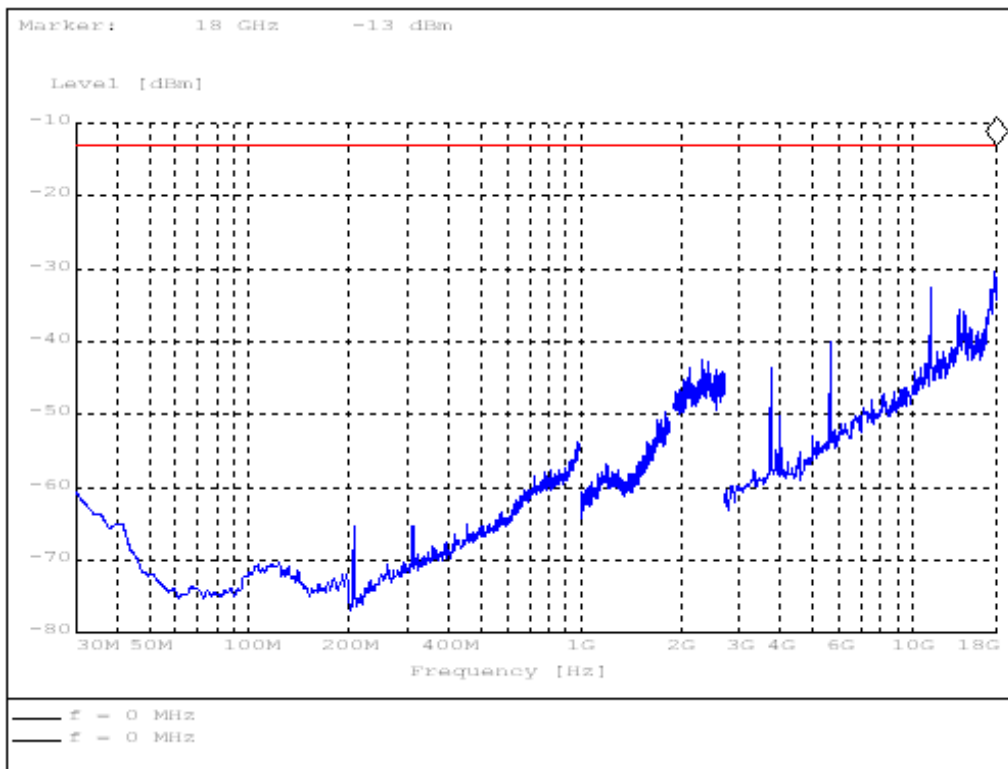

S661VT for GPRS mode

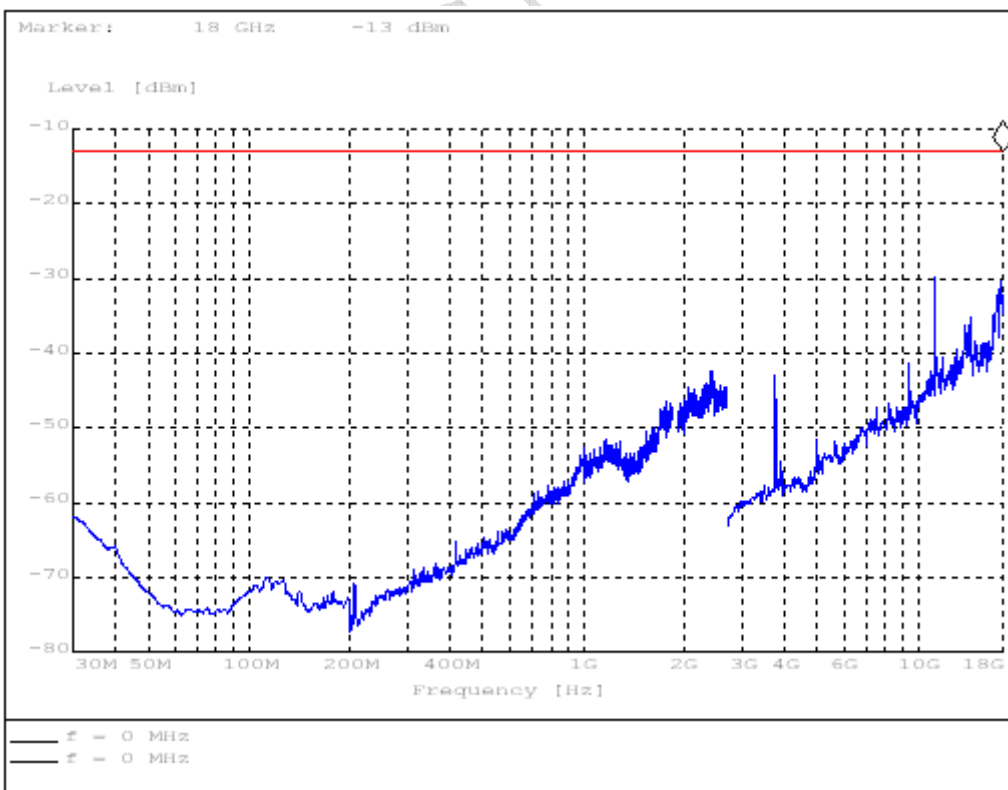

S661HT for GPRS mode

Test Results for EPRS mode:

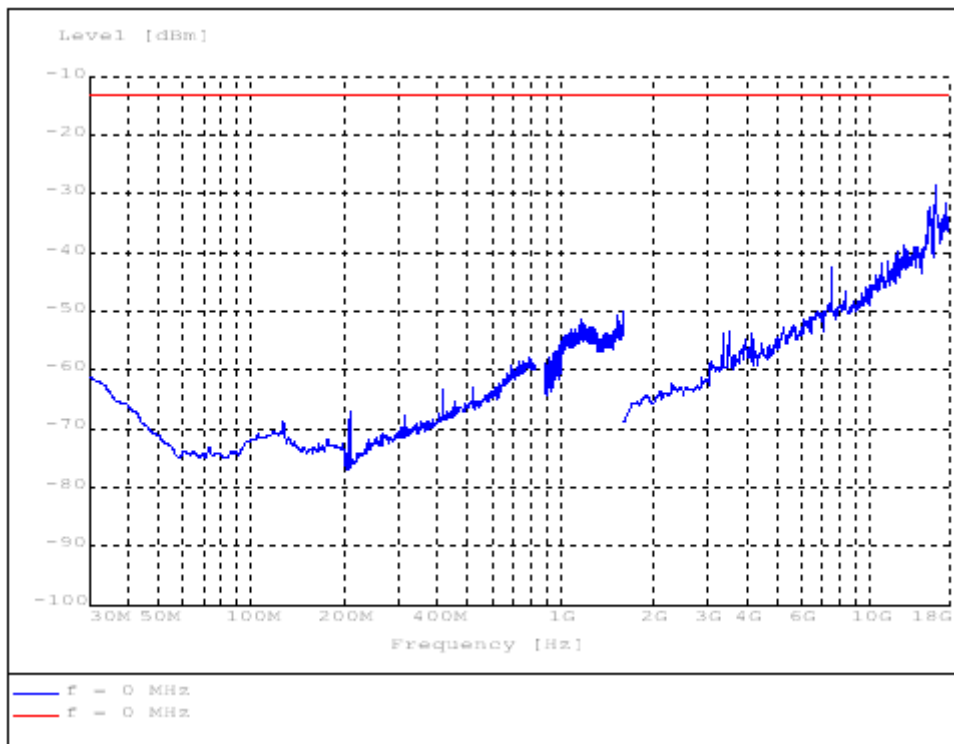

S190VF for EPRS mode

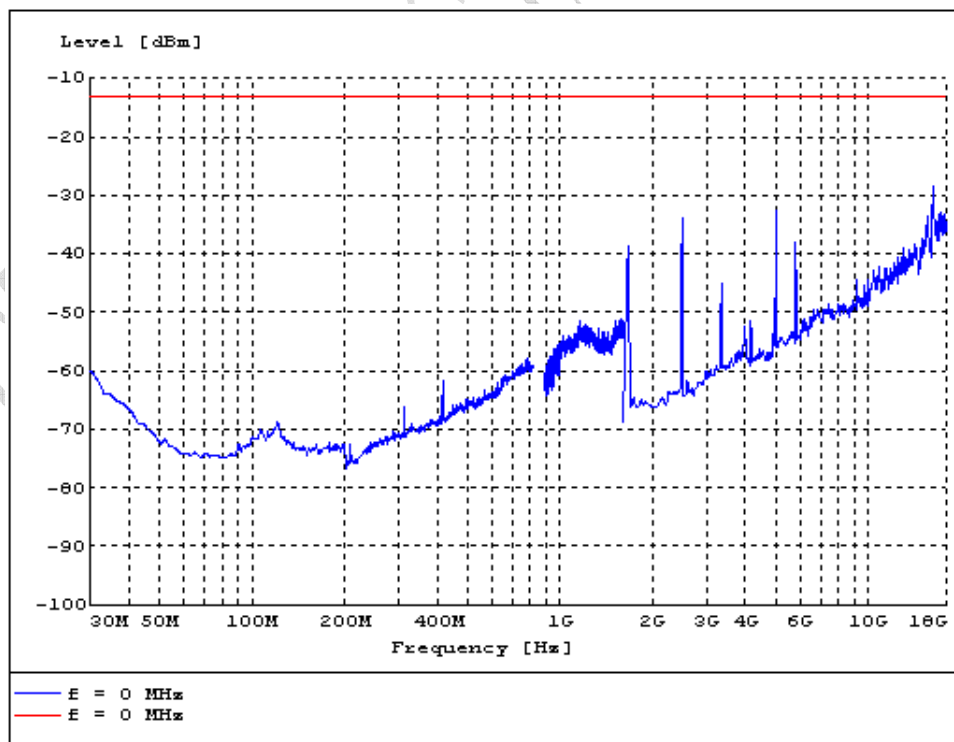

S190HF for EPRS mode

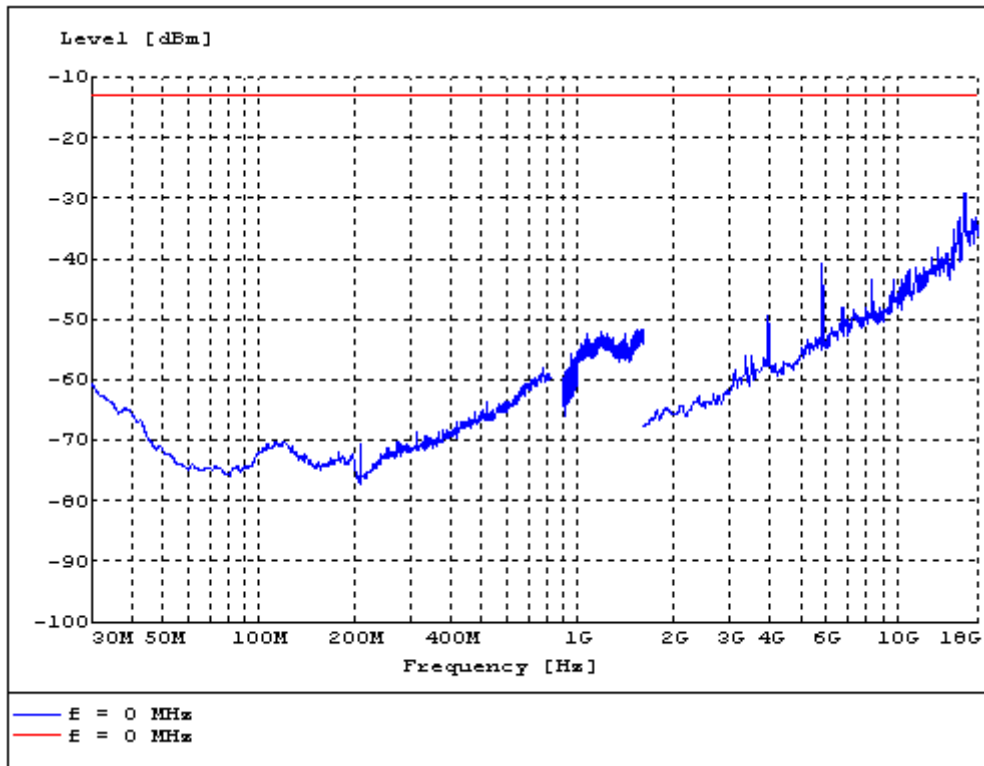

S190VT for EPRS mode

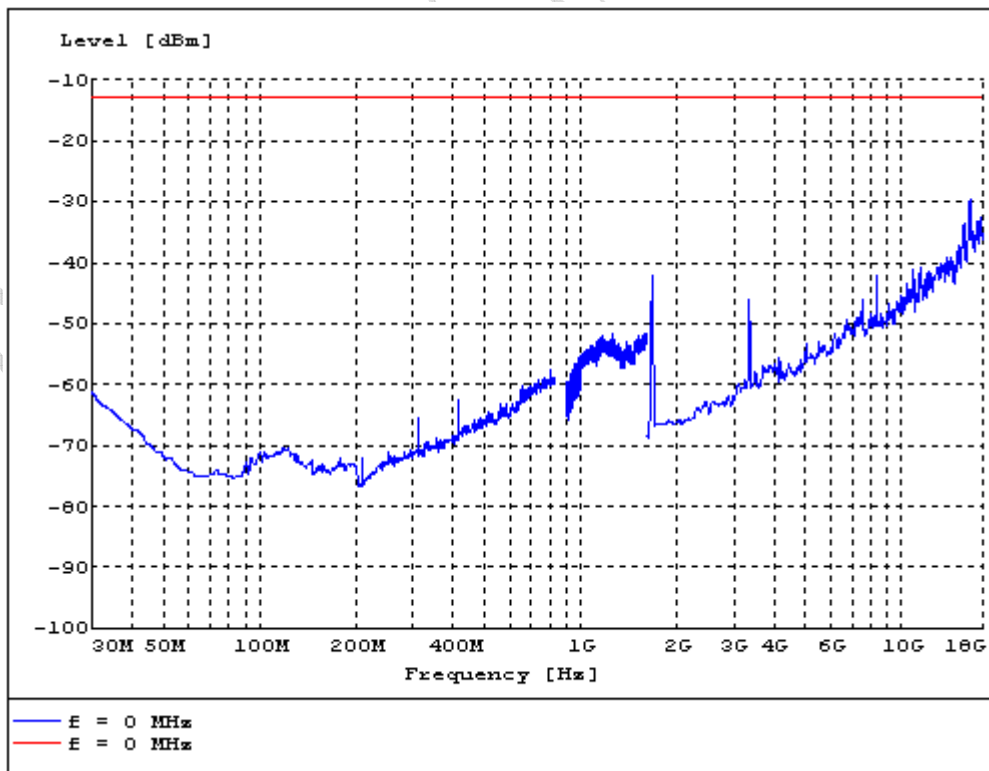

S190HT for EPRS mode

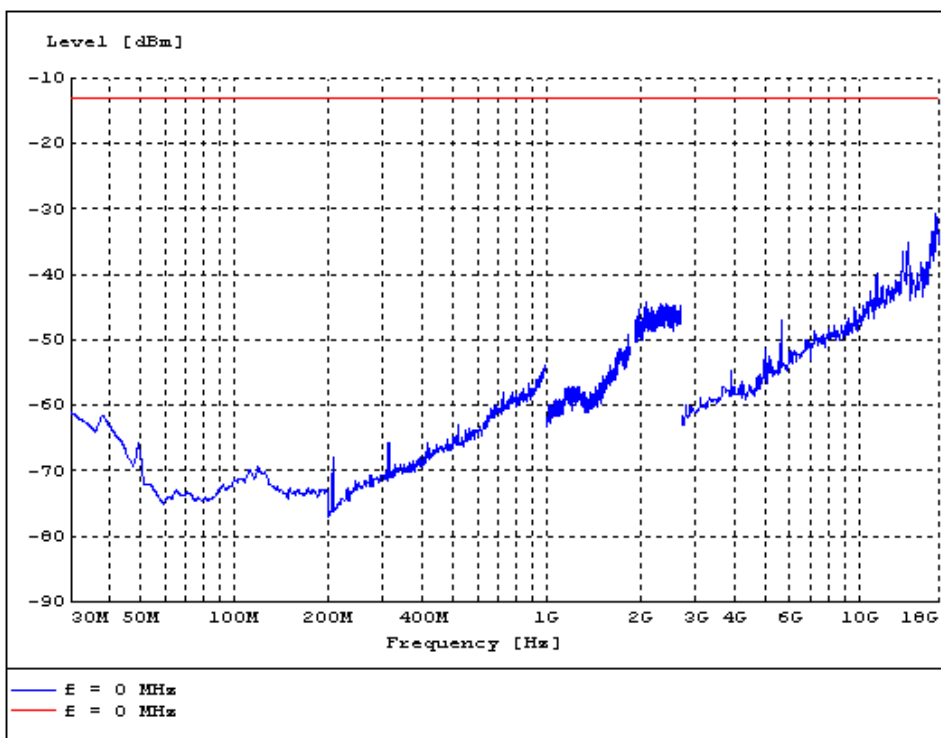

S661VF for EPRS mode

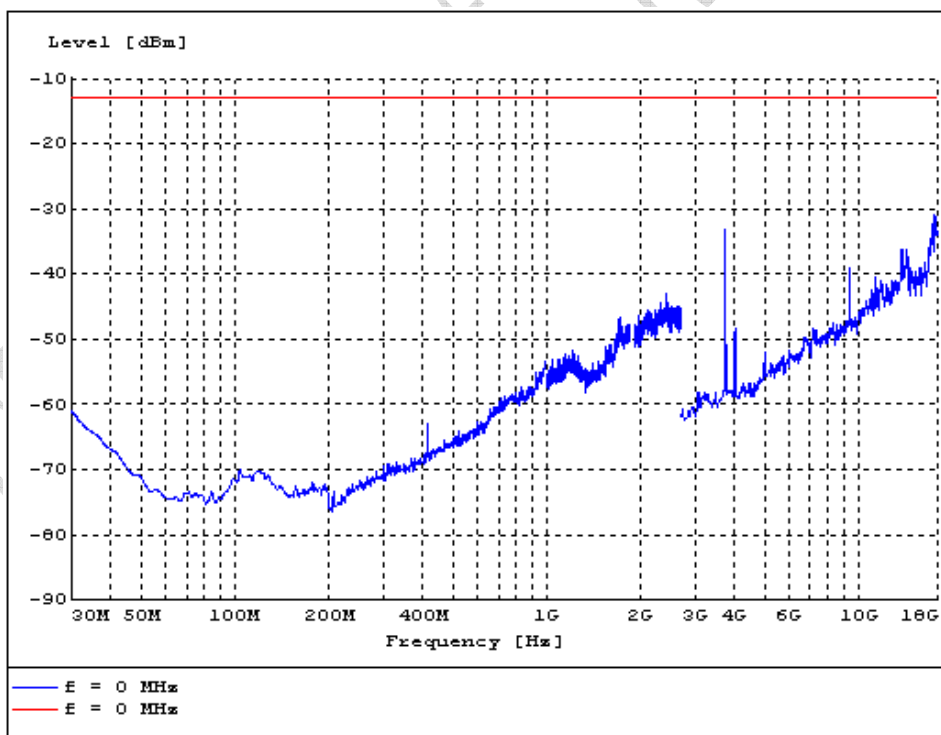

S661HF for EPRS mode

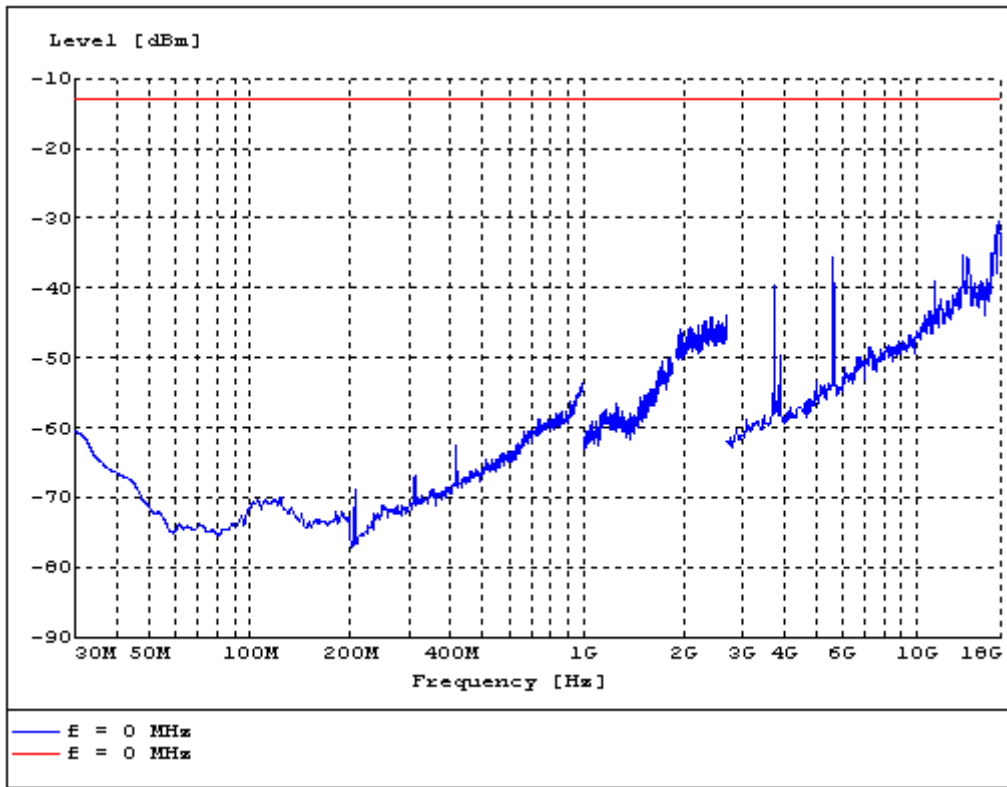

S661VT for EPRS mode

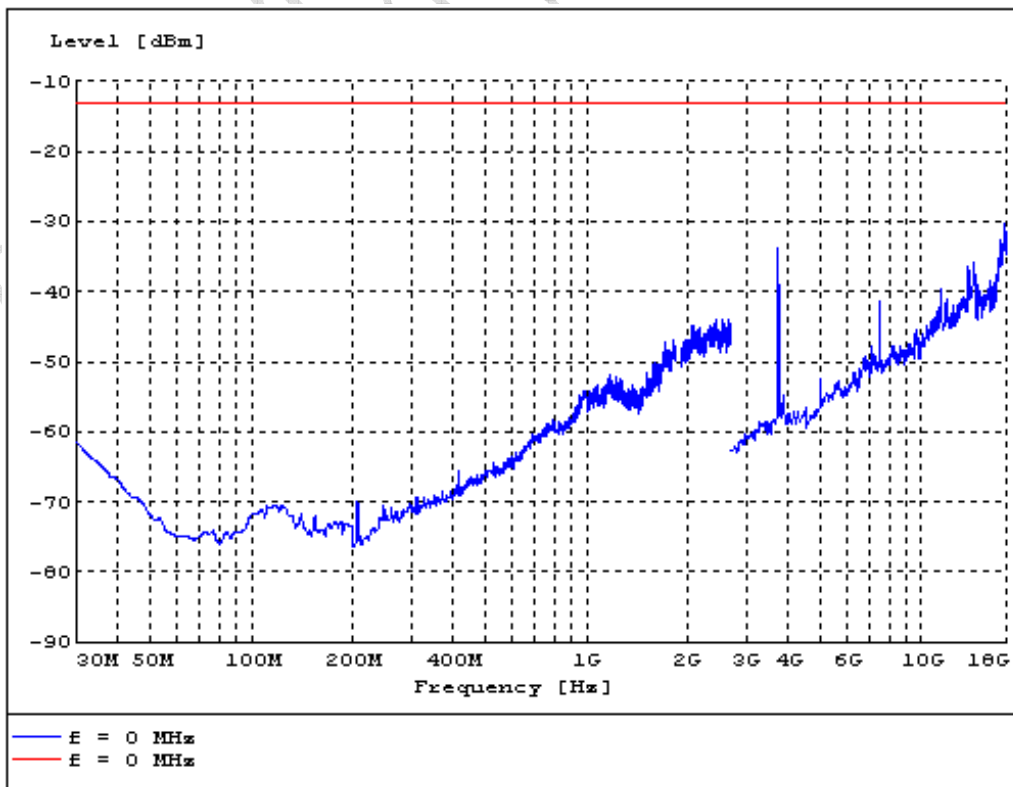

S661HT for EPRS mode

4.2 Radiated RF Power Output and ERP

Specifications:	2.1046,24.232,22.913(a)					
Date of Tests	2008-9-8,2008-9-18					
Test conditions:	Ambient Temperature: 15°C-35°C Relative Humidity: 30%-60% Air pressure: 86-106kPa					
Operation Mode	TX on, channel 128, 190, 251, 512, 661 and 810					
Test Results:	Pass					
Test equipment Used:						
Asset Number	Description	Manufacturer	Model Number	Serial Number	Cal Due	State
7805	EMI Test Receiver	R/S	ESI26	100211	2009-01-04	Normal
7330	Ultra Broadband Antenna	SCHWARZBECK	VULB 9160	--	2010-10-26	Normal
7330	Double-Ridged Horn Antenna	R/S	HF906	100037	2009-01-14	Normal
713	Fully-Anechoic Chamber	ETS	11.8m×6.5m×6.3m	--	2010-11-17	Normal
023	Wireless Communications Test Set	Agilent	8960(E5515C)	GB41450323	2009-06-13	Normal
111835	Wireless Communications Test Set	R&S	CMU200	1100000802	--	Normal

Limit Level Construction:

(a) Radiated RF Power Output
According to Part 24.232(b), i.e., Mobile/portable stations are limited to 2 watts EIRP peak power and the equipment must employ means to limit the power to the minimum necessary for successful communications, so the limit level is 2 W or 33 dBm.

(b) ERP
According to Part 22.913(a), the ERP of mobile transmitters and auxiliary test transmitters must not exceed 7 Watts.

Limits for Radiated RF Power Output	
Frequency range	Limit Level (EIRP)/Resolution Bandwidth
TX channel	33dBm/1MHz
Limits for ERP	
Frequency range	Limit Level (ERP)
TX channel	7W

Test Setup:

The EUT was set in an anechoic chamber, which is connected to the Wireless Communications Test Set located outside the chamber over the air. The test was done using an automated test system, where all test equipments were controlled by a computer.

Test Method

The measurement was performed accordance with section 2.2.17 of ANSI/TIA-603-B-2002: *Land Mobile FM or PM Communications Equipment Measurement and Performance Standards*.

1 The maximum power was searched by turning the azimuth of the turntable, shifting the polarization of the measuring antenna and changing the pose of the EUT.

2 The measured levels are EIRP values corrected in the automated test system with the correction factors given by a substitution calibration made before the measurement. The calibration is made separately for vertical and horizontal polarization and the system uses different correction factors depending on the measuring antenna polarization.

3 The corrected maximum levels were reported for EIRP values, and ERP values can be calculated from EIRP values.

Note:

ERP dBm = EIRP dBm – 2.15dB.

ERP Value for GSM 850 band mode:

ARFCN	Frequency [MHz]	ERP [dBm]
128	824.128257	18.99
190	836.653307	18.15
251	848.877756	19.56

EIRP Value for GSM 1900 band mode:

ARFCN	Frequency [MHz]	EIRP [dBm]
512	1850.100200	23.03
661	1879.919840	22.11
810	1909.899800	20.17

ERP Value for GPRS 850 band mode:

ARFCN	Frequency [MHz]	ERP [dBm]
512	824.128257	19.10
661	836.553106	18.94
810	848.877756	19.57

EIRP Value for GPRS 1900 band mode:

ARFCN	Frequency [MHz]	EIRP [dBm]
128	1850.100200	22.40
190	1880.080160	21.95
251	1909.899800	19.42

ERP Value for EGPRS 850 band mode:

ARFCN	Frequency [MHz]	ERP [dBm]
512	824.228457	20.07
661	836.553106	20.01
810	848.877000	18.71

EIRP Value for EGPRS 1900 band mode:

ARFCN	Frequency [MHz]	EIRP [dBm]
128	1850.100200	24.67
190	1879.920000	24.51
251	1909.900000	24.04

4.3 Occupied bandwidth

Specifications:	2.1049,22.917(b),24.238(b)					
Date of Test	2008-9-7					
Test conditions:	Ambient Temperature: 15°C-35°C Relative Humidity: 30%-60% Air pressure: 86-106kPa					
Operation Mode	TX on, channel 128, 190, 251, 512, 661 and 810					
Test Results:	--					
Test equipment Used:						
Asset Number	Description	Manufacturer	Model Number	Serial Number	Cal Due	State
7805	EMI Test Receiver	R/S	ESI26	100211	2009-01-03	Normal
7330	Ultra Broadband Antenna	SCHWARZBECK	VULB 9160	--	2010-10-26	Normal
7330	Double-Ridged Horn Antenna	R/S	HF906	100037	2009-01-14	Normal
713	Fully-Anechoic Chamber	ETS	11.8m×6.5m×6.3m	--	2010-11-17	Normal
023	Wireless Communications Test Set	Agilent	8960(E5515C)	GB41450323	2009-06-13	Normal
111835	Wireless Communications Test Set	R&S	CMU200	1100000802	--	Normal

Test Setup

The situation under which maximum EIRP values were found in the measurement of the radiated RF power output was used to determine the 99% occupied bandwidth. The Wireless Communications Test Set was used to set the TX channel, power level and modulation.

Test Method

The 99% occupied bandwidth was calculated from the spectrum analyzer. Markers in the spectrum analyzer were then placed between the calculated frequencies to show the calculated 99% power band.

Note: --

Results data of GSM mode:

EUT channel	99% occupied bandwidth [kHz]
128	248
190	248
251	248
512	250
661	248
810	252

Graphical results for GSM mode:

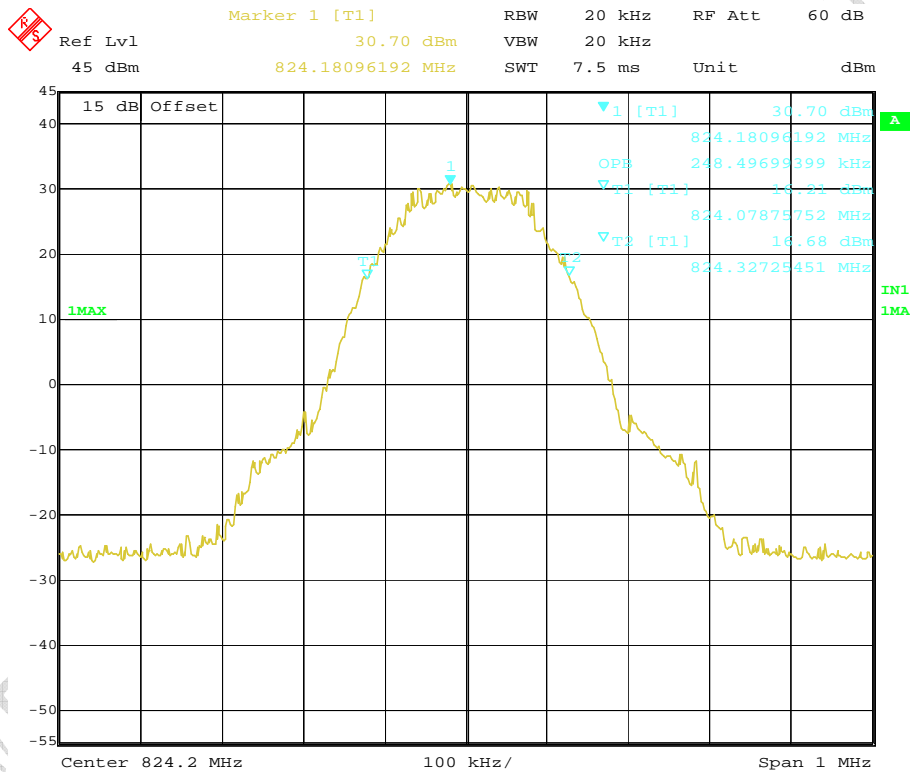

Channel 128

FCC Parts 2, 22, 24
Equipment: MEGA4E

REPORT NO.: I08GE6338-FCC-EMC

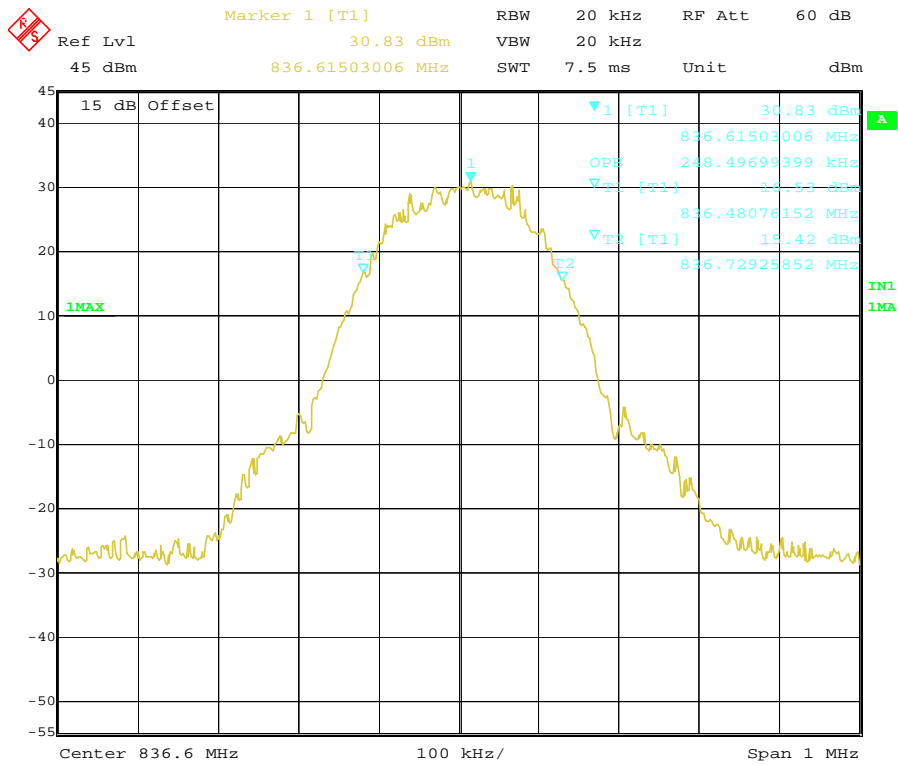

Date: 7.SEP.2008 13:10:48

Channel 190

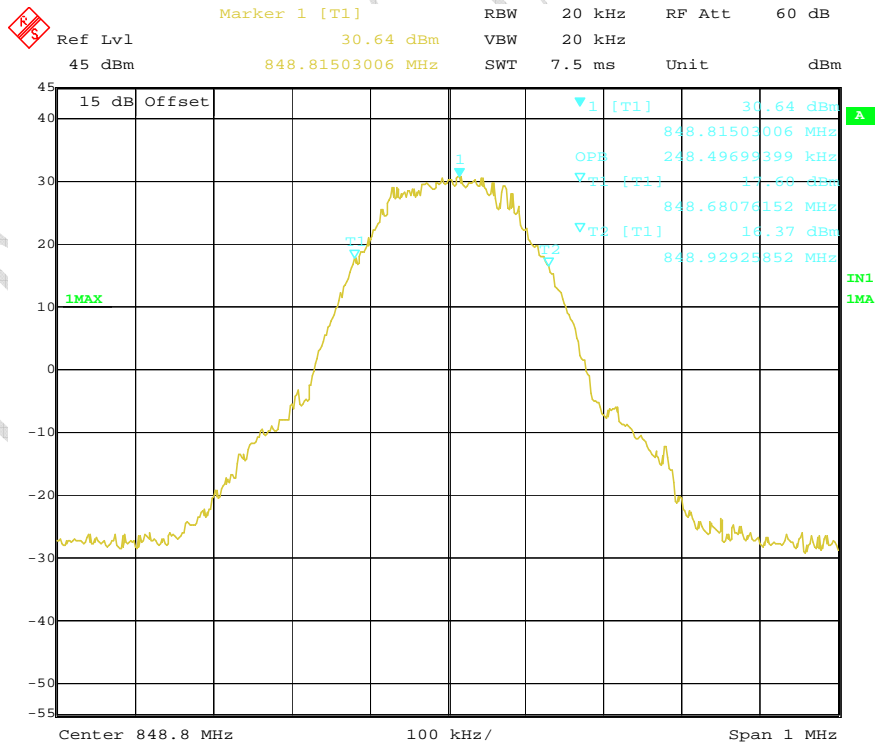

Date: 7.SEP.2008 13:11:51

Channel 251

FCC Parts 2, 22, 24
Equipment: MEGA4E

REPORT NO.: I08GE6338-FCC-EMC

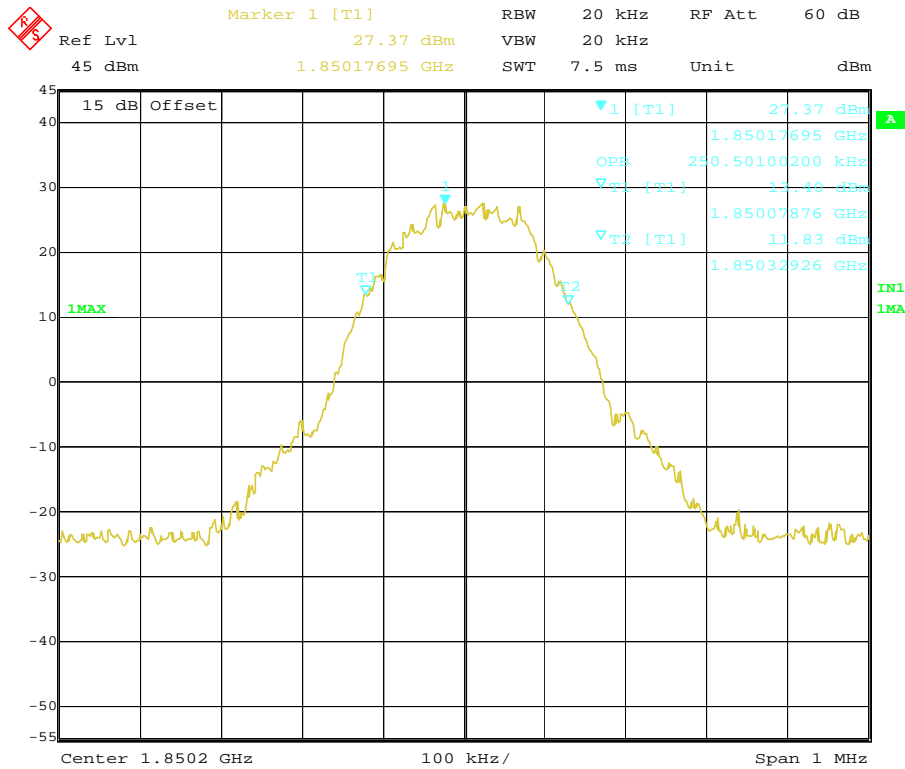

Date: 7.SEP.2008 13:15:04

Channel 512

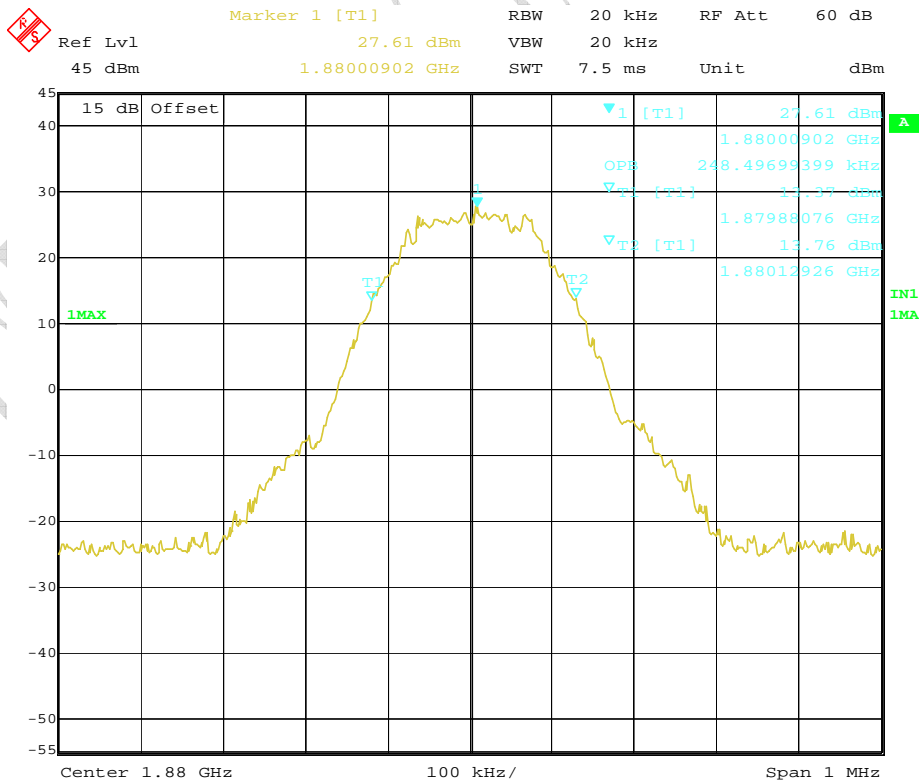

Date: 7.SEP.2008 13:13:58

Channel 661

FCC Parts 2, 22, 24
Equipment: MEGA4E

REPORT NO.: I08GE6338-FCC-EMC

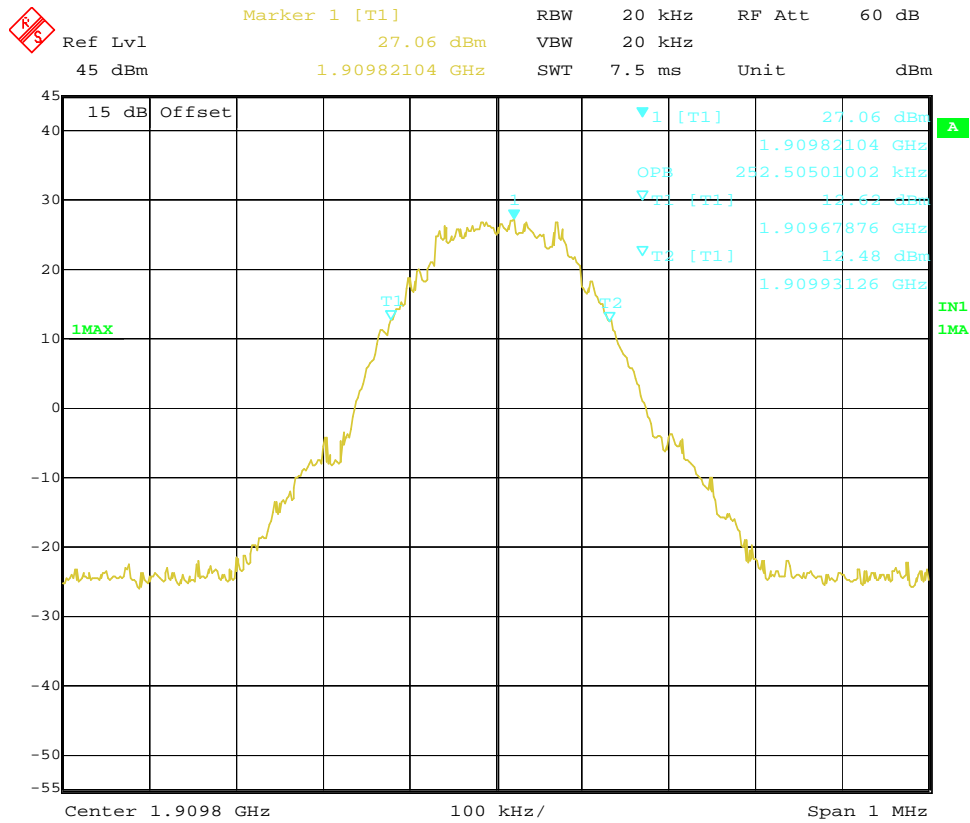

Date: 7.SEP.2008 13:16:10

Channel 810

Results data of GPRS mode:

EUT channel	99% occupied bandwidth [kHz]
128	248
190	245
251	245
512	247
661	247
810	250

Graphical results for GPRS mode:

FCC Parts 2, 22, 24
Equipment: MEGA4E

REPORT NO.: I08GE6338-FCC-EMC

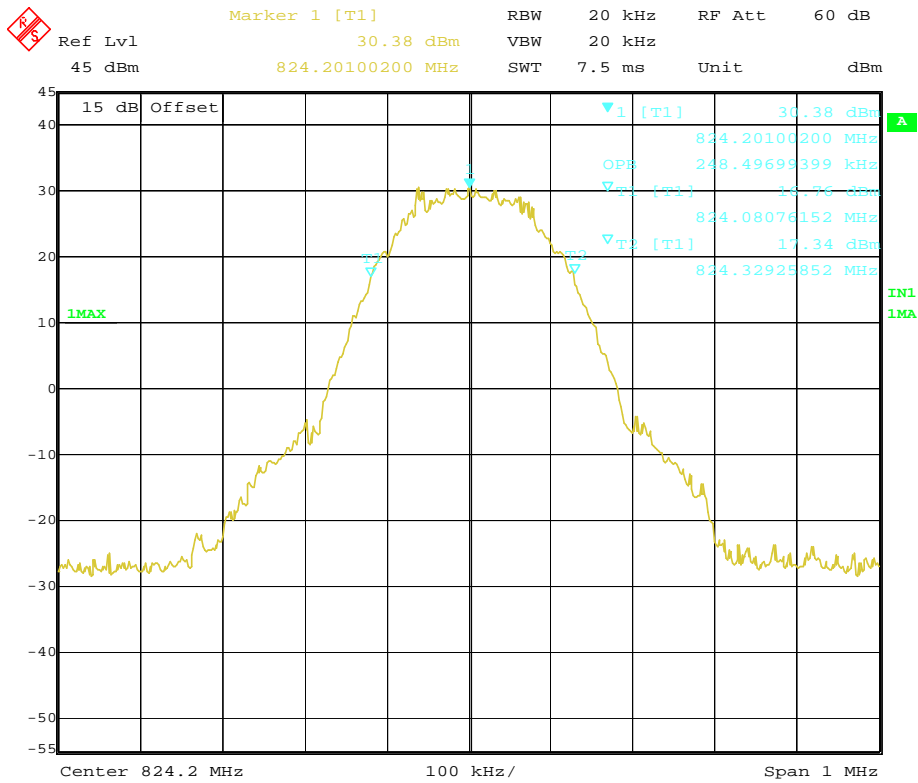

Date: 7.SEP.2008 13:29:21

Channel 128

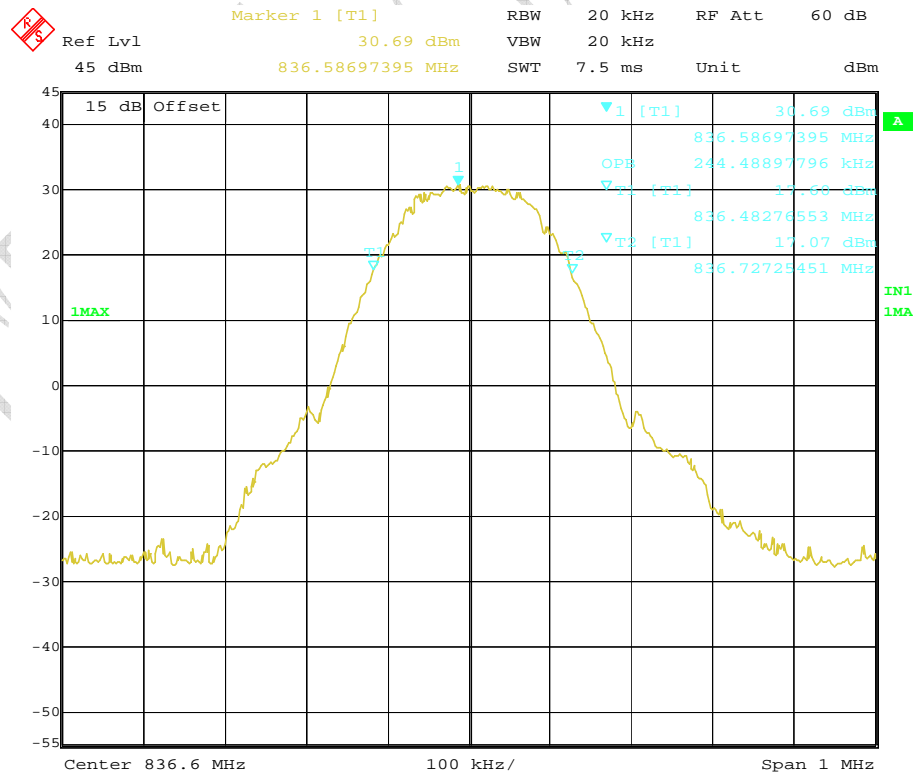

Date: 7.SEP.2008 13:28:21

Channel 190

FCC Parts 2, 22, 24
Equipment: MEGA4E

REPORT NO.: I08GE6338-FCC-EMC

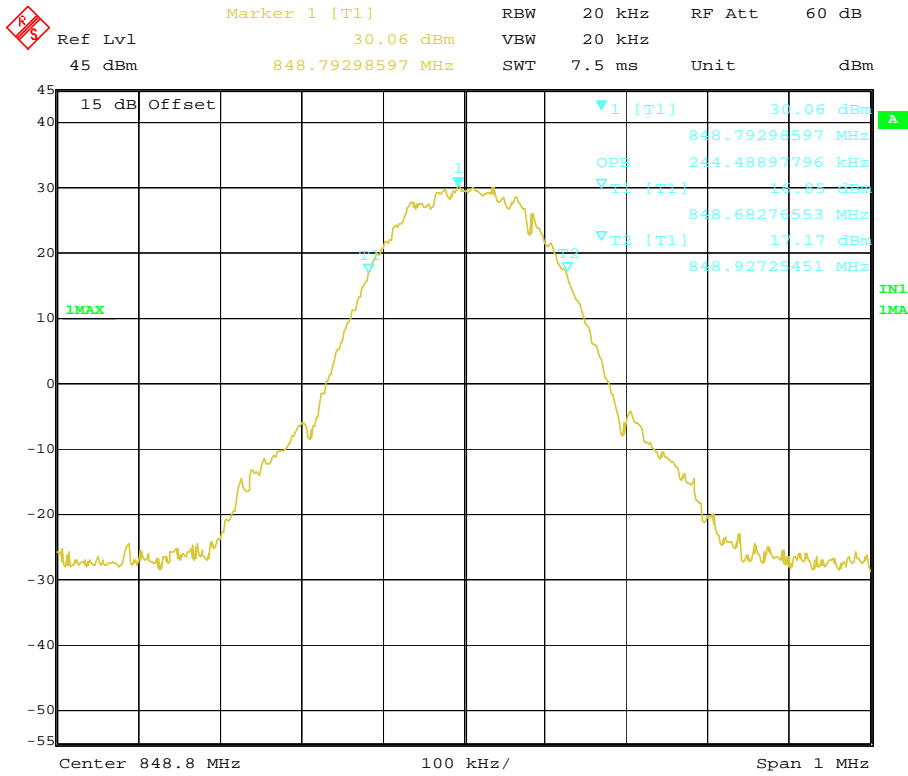

Channel 251

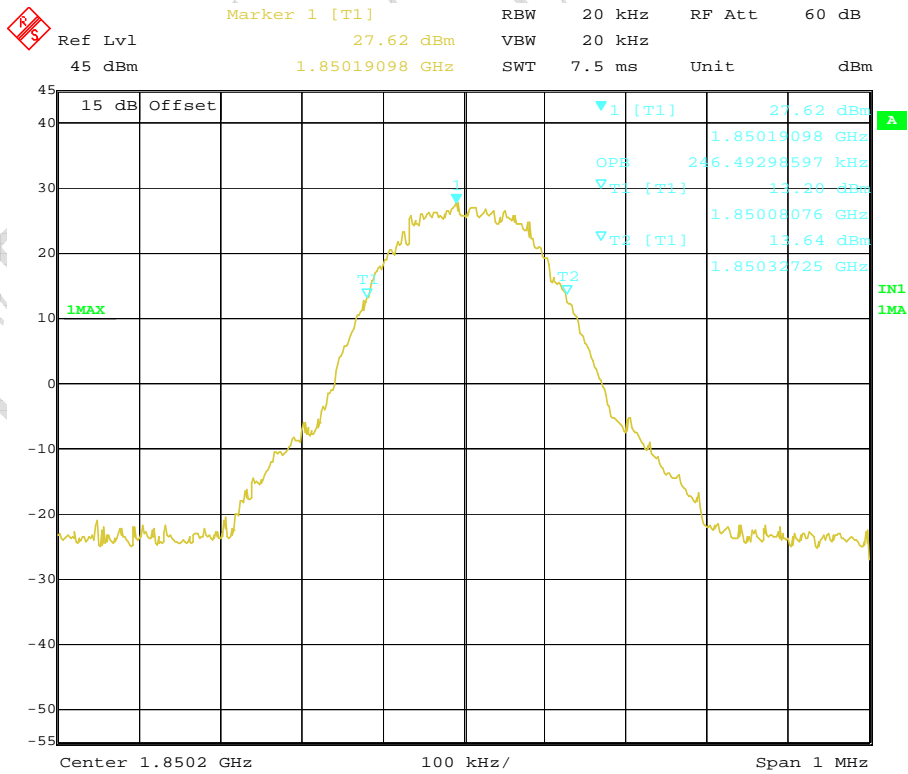

Channel 512

FCC Parts 2, 22, 24
Equipment: MEGA4E

REPORT NO.: I08GE6338-FCC-EMC

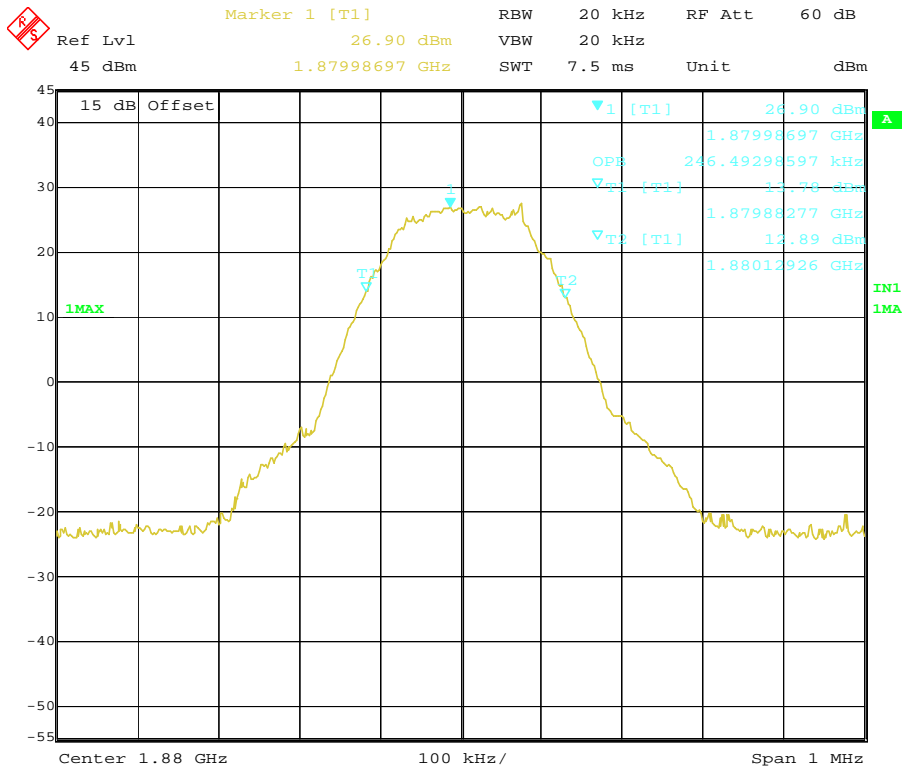

Date: 7.SEP.2008 13:37:34

Channel 661

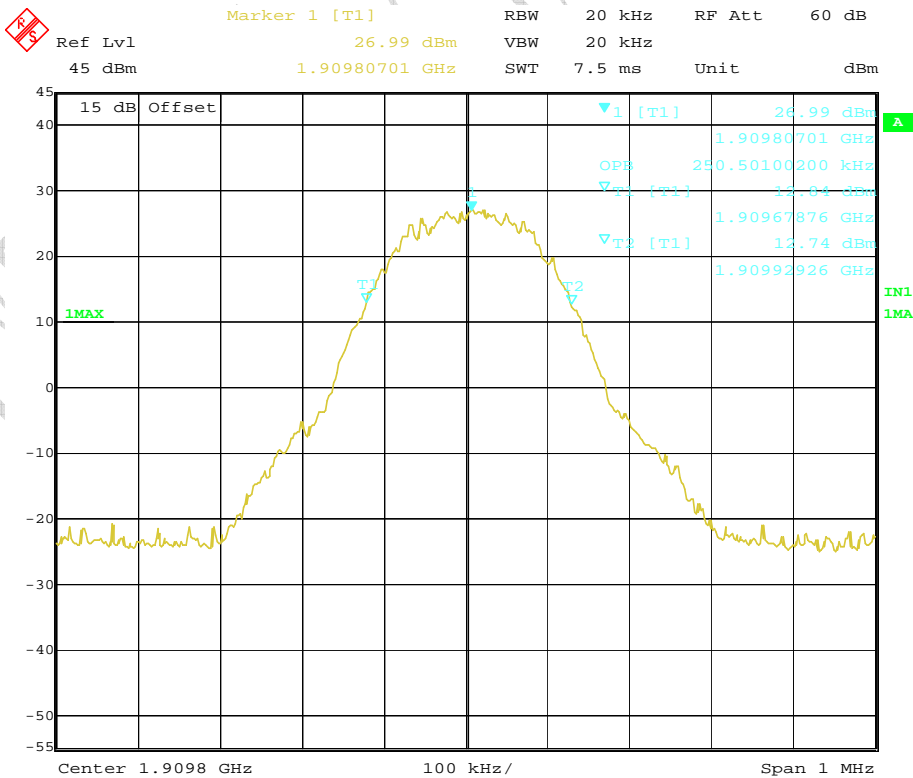

Date: 7.SEP.2008 13:42:01

Channel 810

Results data of EGPRS mode:

EUT channel	99% occupied bandwidth [kHz]
128	248
190	245
251	248
512	250
661	246
810	246

Graphical results for GPRS mode:

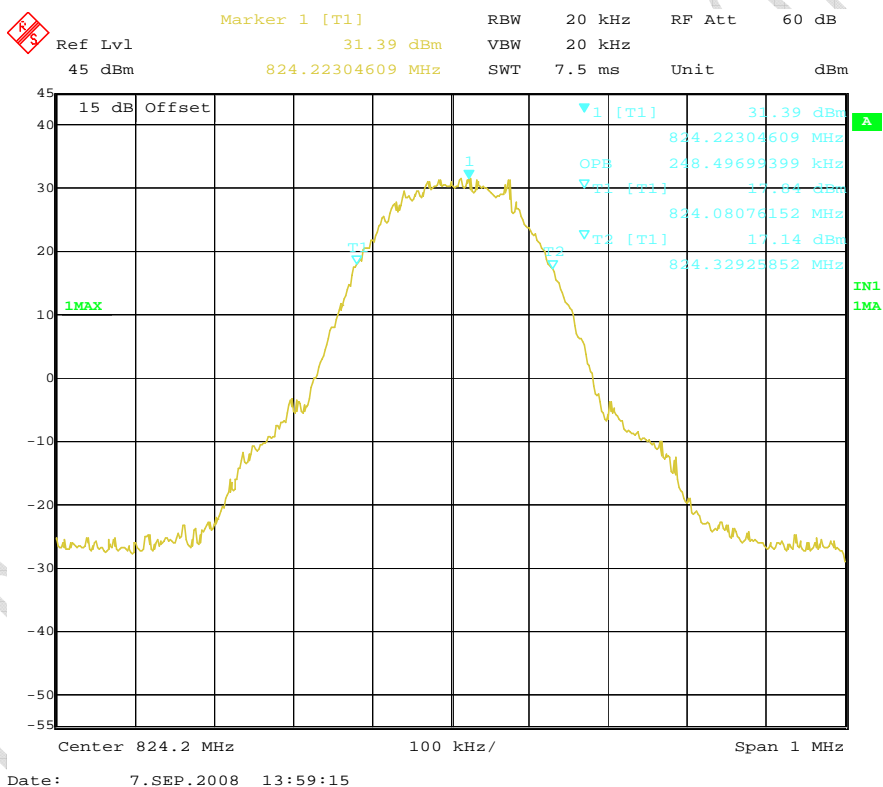

Channel 128

FCC Parts 2, 22, 24
Equipment: MEGA4E

REPORT NO.: I08GE6338-FCC-EMC

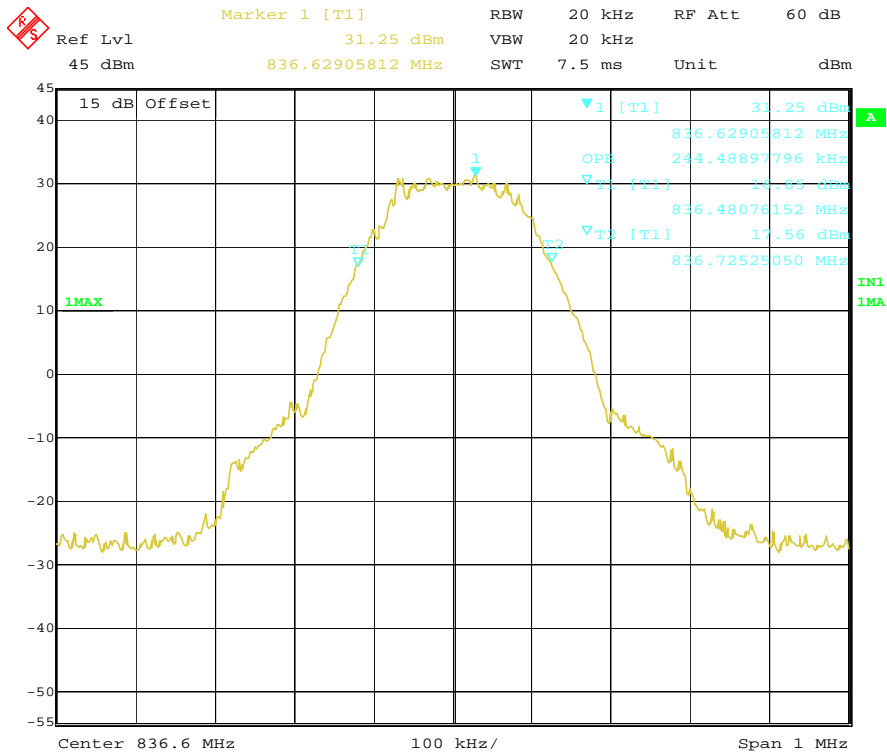

Channel 190

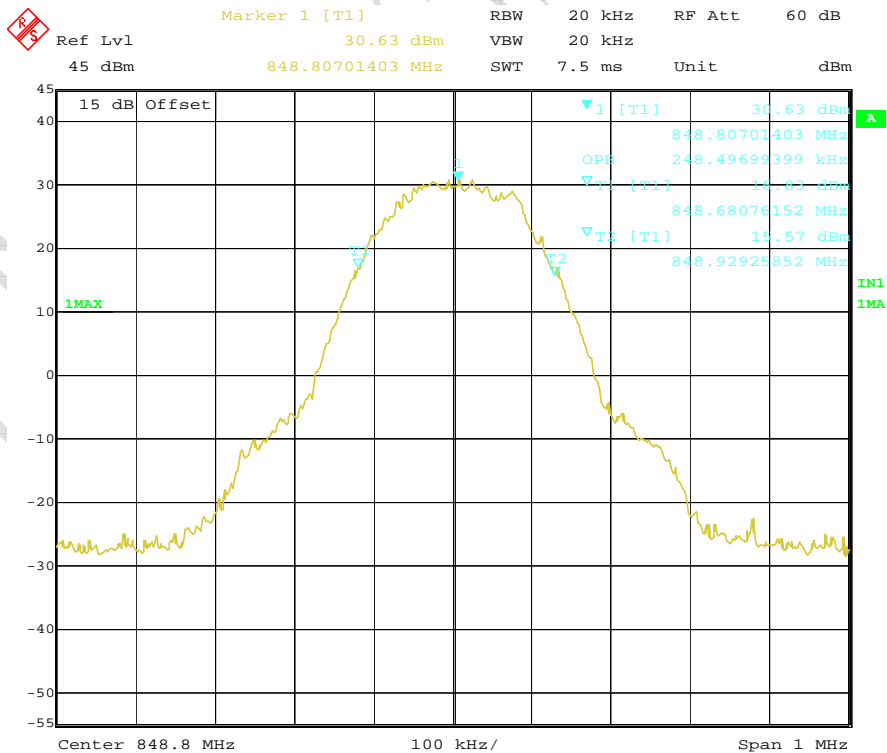

Channel 251

FCC Parts 2, 22, 24
Equipment: MEGA4E

REPORT NO.: I08GE6338-FCC-EMC

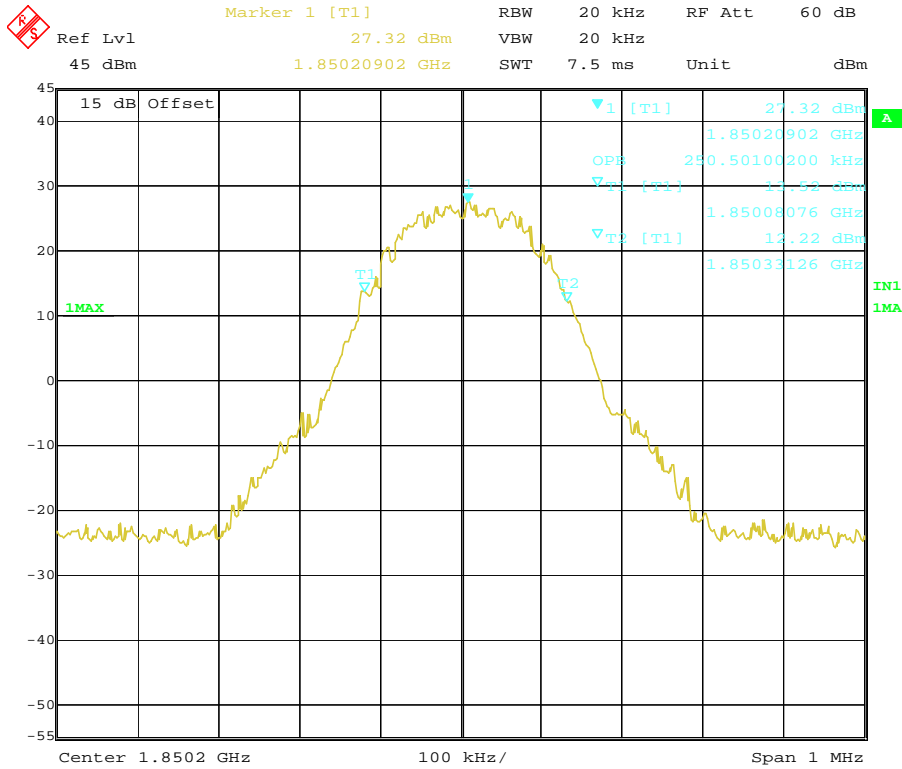

Date: 7.SEP.2008 14:05:29

Channel 512

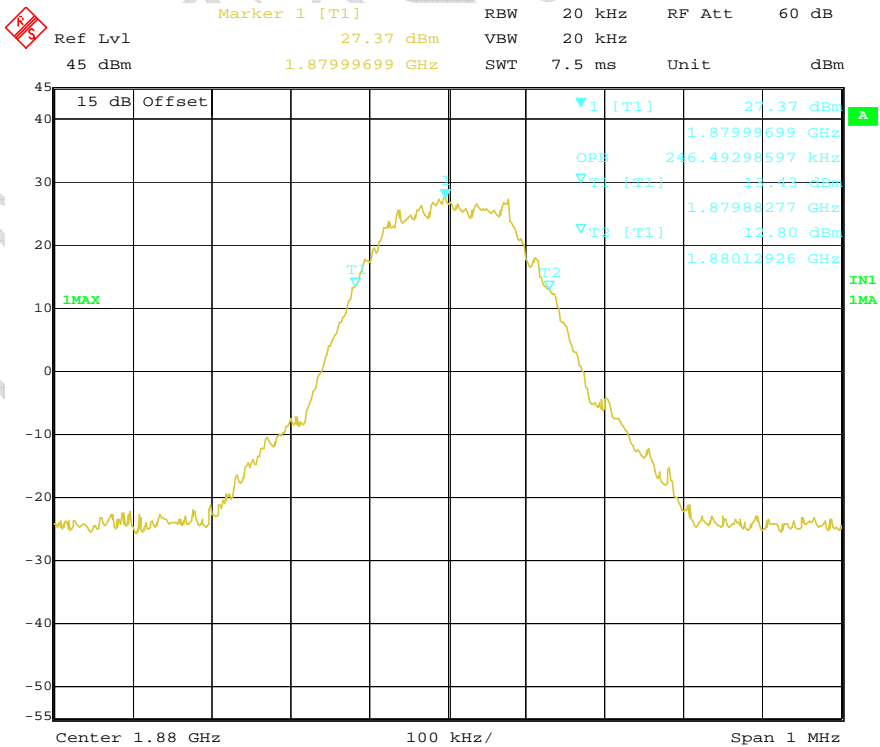

Date: 7.SEP.2008 14:07:05

Channel 661

FCC Parts 2, 22, 24
Equipment: MEGA4E

REPORT NO.: I08GE6338-FCC-EMC

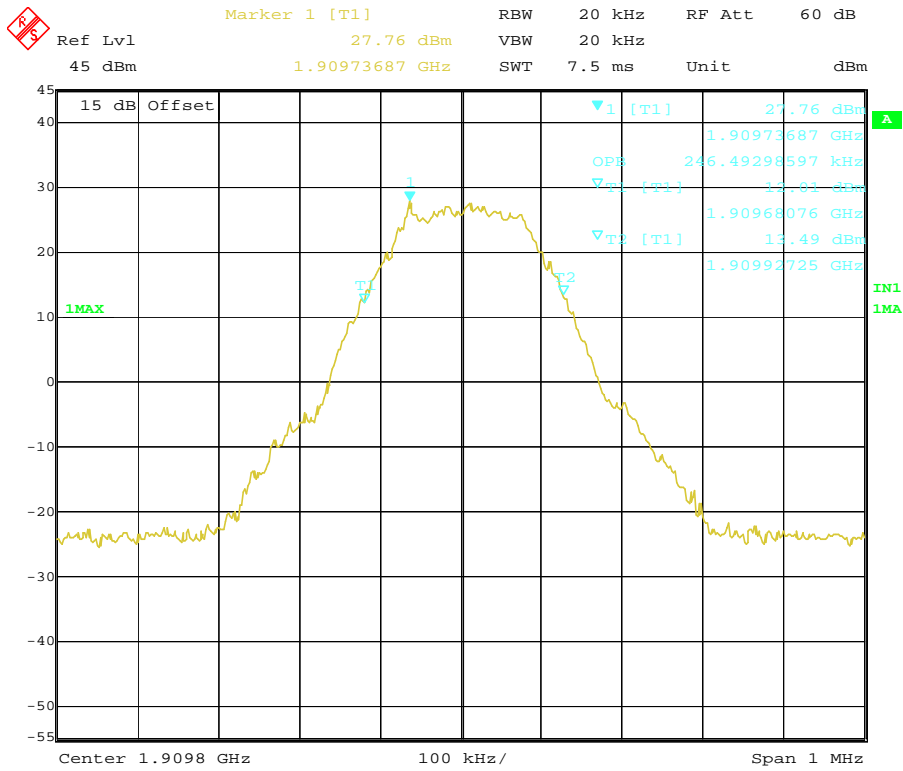

Date: 7.SEP.2008 14:08:49

Channel 810

CITL TEST

4.4 Frequency Stability over Temperature Variation

Specifications:	2.1055,22.355,24.235					
Date of Test	2008-9-7					
Test conditions:	Ambient Temperature: -30°C-50°C Relative Humidity: 30%-60% Air pressure: 86-106kPa					
Operation Mode	TX on, channel 190 and 661					
Test Results:	Pass					
Test equipment Used:						
Asset Number	Description	Manufacturer	Model Number	Serial Number	Cal Due	State
023	Wireless Communications Test Set	Agilent	8960(E5515C)	GB41450323	2009-06-13	Normal
561	Temperature Chamber	Terchy Environmental Technology LTD.	MHU-800SR	84121202	2009-05-06	Normal
111835	Wireless Communications Test Set	R&S	CMU200	1100000802	--	Normal
Limit						
Frequency deviation [ppm]		±2.5				

Test Setup

The EUT was placed in a temperature chamber, demonstrated as figure T. The wireless communications test set (test simulator) was used to set the TX channel and power levels, modulate the TX signal with different bit patterns and measure the frequency of TX.

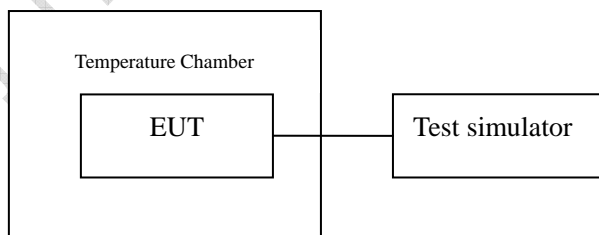

Figure T: setup for measurement of frequency stability over temperature variation

Test Method

1. The EUT was turned off and placed in the temperature chamber.
2. The temperature of the chamber was set to -30°C and allowed to stabilize.
3. The EUT temperature was allowed to stabilize for 45 minutes.
4. The EUT was turned on and set to transmit with 8960.
5. The maximum transmit frequency deviation during one minute period was measured by Wireless Communications Test Set.
6. The steps 3-5 were repeated for -20°C, -10°C, 0°C, 10°C, 20°C, 30°C, 40°C and 50°C.

Test results data for GSM mode:

Channel 190:

Temperature[°C]	Deviation[Hz]	Deviation[ppm]	Remarks
-30	-18	-0.0215	Pass
-20	-13	-0.0155	Pass
-10	-9	-0.0107	Pass
0	-20	-0.0239	Pass
10	11	0.0131	Pass
20	-15	-0.0179	Pass
30	20	0.0239	Pass
40	10	0.0119	Pass
50	15	0.0179	Pass

Channel 661:

Temperature[°C]	Deviation[Hz]	Deviation[ppm]	Remarks
-30	-32	-0.0170	Pass
-20	-36	-0.0191	Pass
-10	45	0.0239	Pass
0	29	0.0154	Pass
10	45	0.0239	Pass
20	38	0.0202	Pass
30	32	0.0170	Pass
40	20	0.0106	Pass
50	25	0.0133	Pass

Test results data for GPRS mode:

Channel 190:

Temperature[°C]	Deviation[Hz]	Deviation[ppm]	Remarks
-30	24	0.0287	Pass
-20	27	0.0323	Pass
-10	25	0.0299	Pass
0	26	0.0311	Pass
10	34	0.0406	Pass
20	28	0.0335	Pass
30	27	0.0323	Pass
40	24	0.0287	Pass
50	26	0.0311	Pass

Channel 661:

Temperature[°C]	Deviation[Hz]	Deviation[ppm]	Remarks
-30	31	0.0165	Pass
-20	27	0.0144	Pass
-10	29	0.0154	Pass
0	35	0.0186	Pass
10	42	0.0223	Pass
20	40	0.0213	Pass
30	37	0.0197	Pass
40	38	0.0202	Pass
50	42	0.0223	Pass

Test results data for EGPRS mode:

Channel 190:

Temperature[°C]	Deviation[Hz]	Deviation[ppm]	Remarks
-30	23	0.0275	Pass
-20	26	0.0311	Pass
-10	24	0.0287	Pass
0	25	0.0299	Pass
10	30	0.0359	Pass
20	29	0.0347	Pass
30	28	0.0335	Pass
40	31	0.0371	Pass
50	36	0.0430	Pass

Channel 661:

Temperature[°C]	Deviation[Hz]	Deviation[ppm]	Remarks
-30	37	0.0197	Pass
-20	39	0.0207	Pass
-10	33	0.0176	Pass
0	36	0.0191	Pass
10	45	0.0239	Pass
20	50	0.0266	Pass
30	53	0.0282	Pass
40	48	0.0255	Pass
50	46	0.0245	Pass

4.5 Frequency Stability over Voltage Variation

Specifications:	2.1055,22.355,24.235					
Date of Test	2008-9-7					
Test conditions:	Ambient Temperature: 15°C -35°C Relative Humidity: 30%-60% Air pressure: 86-106kPa					
Operation Mode	TX on, channel 190 and 661					
Test Results:	Pass					
Test equipment Used:						
Asset Number	Description	Manufacturer	Model Number	Serial Number	Cal Due	State
023	Wireless Communications Test Set	Agilent	8960(E5515C)	GB41450323	2009-06-13	Normal
111835	Wireless Communications Test Set	R&S	CMU200	1100000802	--	Normal
7982	DC Power Source	4NIC	DH1715A-3	004224	--	Normal
Limit						
Frequency deviation [ppm]	±2.5					

Test Setup

The EUT was placed in a shielding chamber and powered by the dummy battery which is connected to a DC power source, demonstrated as figure V. The wireless communications test set was used to set the TX channel and power level, modulate the TX signal with different bit patterns and measure the frequency of TX.

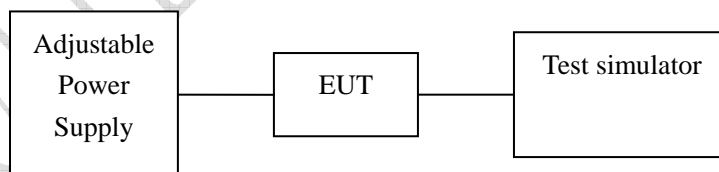

Figure V: test setup for measurement of frequency stability over voltage variation

Test Results data for GSM mode:

Channel 190:

Level	Voltage[V]	Deviation[Hz]	Deviation[ppm]	Remarks
Nominal	3.7	-43	-0.0514	Pass
Cut-off point	3.3	-41	-0.0490	Pass

Channel 661:

Level	Voltage[V]	Deviation[Hz]	Deviation[ppm]	Remarks
Nominal	3.7	23	0.0122	Pass
Cut-off point	3.4	27	0.0144	Pass

Test Results data for GPRS mode:

Channel 190:

Level	Voltage[V]	Deviation[Hz]	Deviation[ppm]	Remarks
Nominal	3.7	-43	-0.0514	Pass
Cut-off point	3.4	-45	-0.0538	Pass

Channel 661:

Level	Voltage[V]	Deviation[Hz]	Deviation[ppm]	Remarks
Nominal	3.7	-11	-0.0059	Pass
Cut-off point	3.4	-13	-0.0069	Pass

Test Results data for EGPRS mode:

Channel 190:

Level	Voltage[V]	Deviation[Hz]	Deviation[ppm]	Remarks
Nominal	3.7	-41	-0.0490	Pass
Cut-off point	3.4	-43	-0.0514	Pass

Channel 661:

Level	Voltage[V]	Deviation[Hz]	Deviation[ppm]	Remarks
Nominal	3.7	-23	-0.0122	Pass
Cut-off point	3.4	-25	-0.0133	Pass

4.6 Conducted RF Power Output

Specifications:	2.1046,22.913(a),24.232(c)					
Date of Tests	2008-9-3					
Test conditions:	Ambient Temperature: 15°C-35°C Relative Humidity: 30%-60% Air pressure: 86-106kPa					
Operation Mode	TX on, channel 128, 190, 251, 512, 661 and 810					
Test Results:	Pass					
Test equipment Used:						
Asset Number	Description	Manufacturer	Model Number	Serial Number	Cal Due	State
7805	EMI Test Receiver	R/S	ESI26	100211	2009-01-04	Normal
023	Wireless Communications Test Set	Agilent	8960(E5515C)	GB41450323	2009-06-13	Normal
---	Power splitter	Jie sai	---	1000132	2009-01-04	Normal
111835	Wireless Communications Test Set	R&S	CMU200	1100000802	--	Normal

Limits for Radiated RF Power Output	
Frequency range	Limit Level (EIRP)/Resolution Bandwidth
TX channel	33dBm/1MHz
Limits for ERP	
Frequency range	Limit Level (ERP)
TX channel	7W

Test Setup:

During the process of testing, the EUT was controlled via the Wireless Communications Test Set to ensure max power transmission and proper modulation and measured by Rhode & Schwarz EMI test receiver (ESI26).

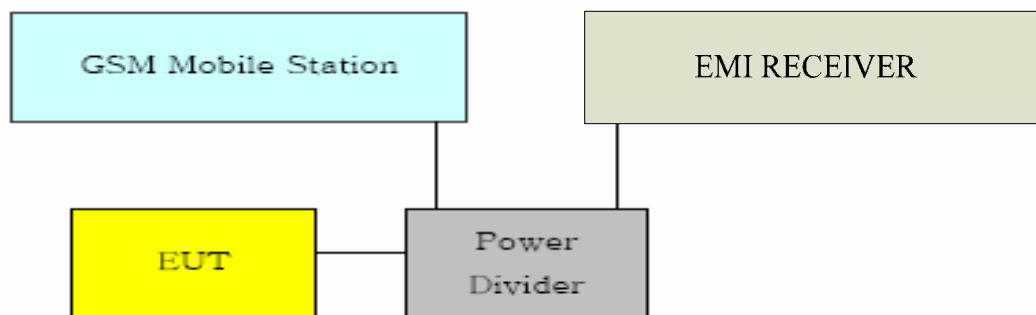

Test Method

- 1) The EUT was coupled to the EMI test receiver analyzer mode and the base station simulator through a power divider. The radio frequency load attached to the EUT antenna terminal was 50 Ohm. The lost of the cables the test system is calibrated to correct the readings.
- 2) The spectrum analyzer was set to Maxpeak Detector function and Maximum hold mode.
- 3) The resolution bandwidth of the spectrum analyzer was comparable to the emission bandwidth.

Note: --

Test Results for GSM mode:

ERP Value for GSM 850 band:

ARFCN	Peak output power [dBm]
128	28.94
190	29.46
251	28.60

EIRP Value for GSM 1900 band:

ARFCN	Peak output power [dBm]
512	28.23
661	28.02
810	27.66

Test Results for GPRS mode:

ERP Value for GPRS 850 band:

ARFCN	Peak output power [dBm]
128	28.75
190	28.65
251	27.94

EIRP Value for GPRS 1900 band:

ARFCN	Peak output power [dBm]
512	28.18
661	27.22
810	26.10

Test Results for EGPRS mode:

ERP Value for GPRS 850 band:

ARFCN	Peak output power [dBm]
128	28.13
190	28.33
251	27.87

EIRP Value for GPRS 1900 band:

ARFCN	Peak output power [dBm]
512	19.71
661	18.95
810	17.59

4.7 Conducted Spurious Emission

Specifications:	2.1051,22.917,24.238					
Date of Tests	2008-9-3					
Test conditions:	Ambient Temperature: 15°C-35°C Relative Humidity: 30%-60% Air pressure: 86-106kPa					
Operation Mode	TX on, channel 190 and 661					
Test Results:	Pass					
Test equipment Used:						
Asset Number	Description	Manufacturer	Model Number	Serial Number	Cal Due	State
7805	EMI Test Receiver	R/S	ES126	100211	2009-01-04	Normal
023	Wireless Communications Test Set	Agilent	8960(E5515C)	GB41450323	2009-06-13	Normal
---	Power splitter	Jie sai	---	1000132	2009-01-04	Normal
111835	Wireless Communications Test Set	R&S	CMU200	1100000802	--	Normal

Limit Level Construction:

According to Part 24.238 (a), i.e., Out of band emissions. The power of any emission outside of the authorized operating frequency ranges must be attenuated below the transmitting power (P) by a factor of at least 43 + 10 log(P) dB, so the limit level is:
 $P(\text{dBm}) - (43 + 10 \log(P)) \text{ dB} = -13\text{dBm}$

Limits for Radiated spurious emissions(UE)

Frequency range	Limit Level /Resolution Bandwidth
30 MHz to 20000 MHz	-13dBm/1MHz

Test Setup:

During the process of testing, the EUT was controlled via Wireless Communications Test Set to ensure max power transmission and proper modulation and measured by Rhode & Schwarz EMI test receiver (ES126)

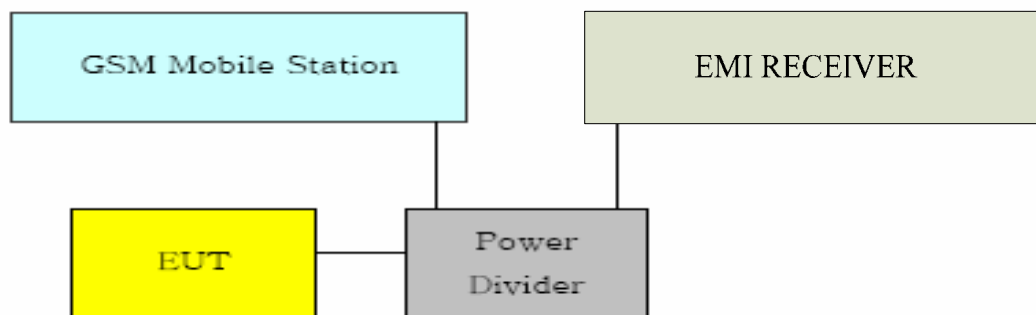

Test Method

The measurement was performed accordance with section 2.2.13 of ANSI/TIA-603-B-2002: *Land Mobile FM or PM Communications Equipment Measurement and Performance Standards*.

The following steps outline the procedure used to measure the conducted emissions from the EUT.

1. Determine frequency range for measurements: From CFR 2.1057 the spectrum should be investigated from the lowest radio frequency generated in the equipment up to at least the 10th harmonic of the carrier frequency. For the equipment under test, this equates to a frequency range of 30 MHz to 19.1 GHz, data taken from 30 MHz to 20 GHz.
2. Determine EUT transmit frequencies: below outlines the band edge frequencies pertinent to conducted emissions testing.

Note: --

Test Results for GSM mode:

Out of band emission	
Frequency [MHz]	Level (dBm)
--	--

Graphical results for GSM mode:

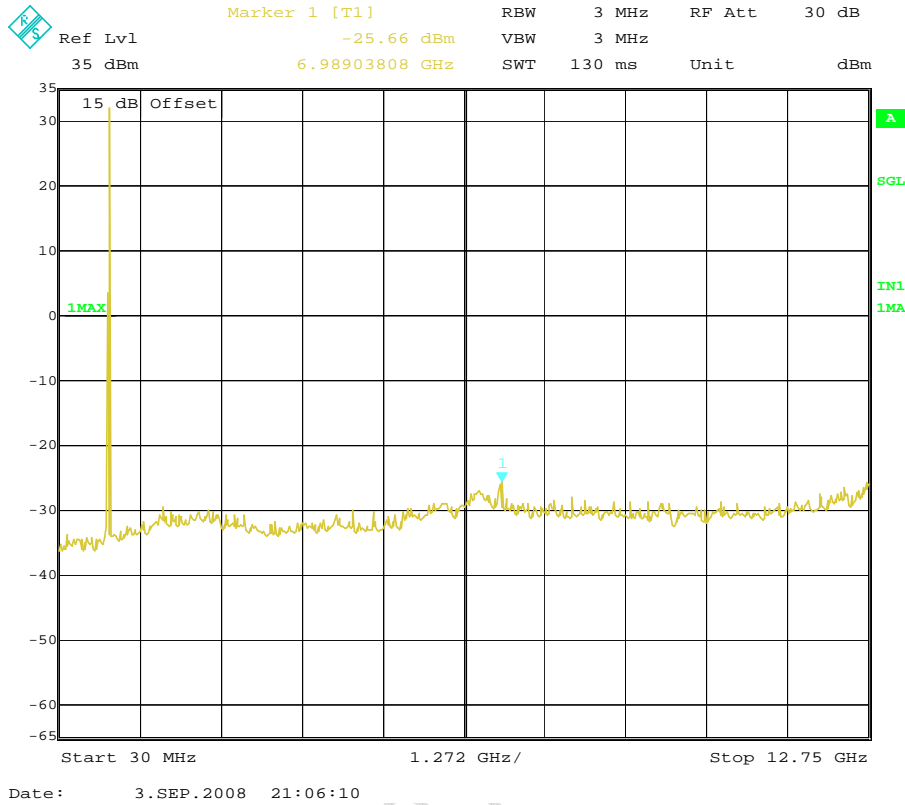

Channel 190

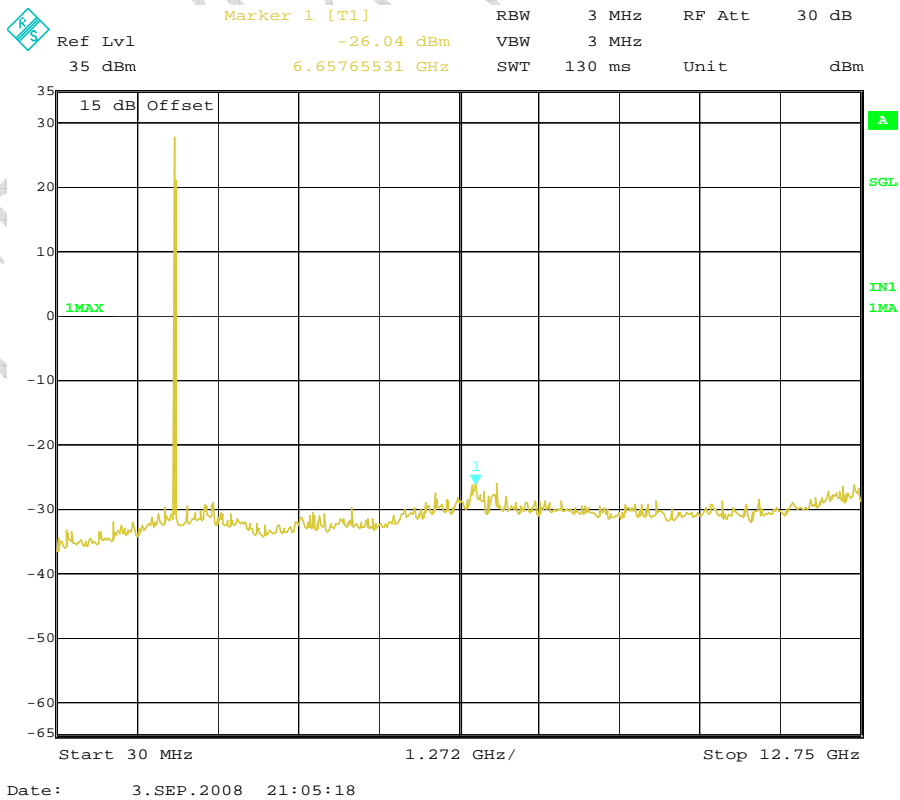

Channel 661

Test Results for GPRS mode:

Out of band emission	
Frequency [MHz]	Level (dBm)
--	--

Graphical results for GPRS mode:

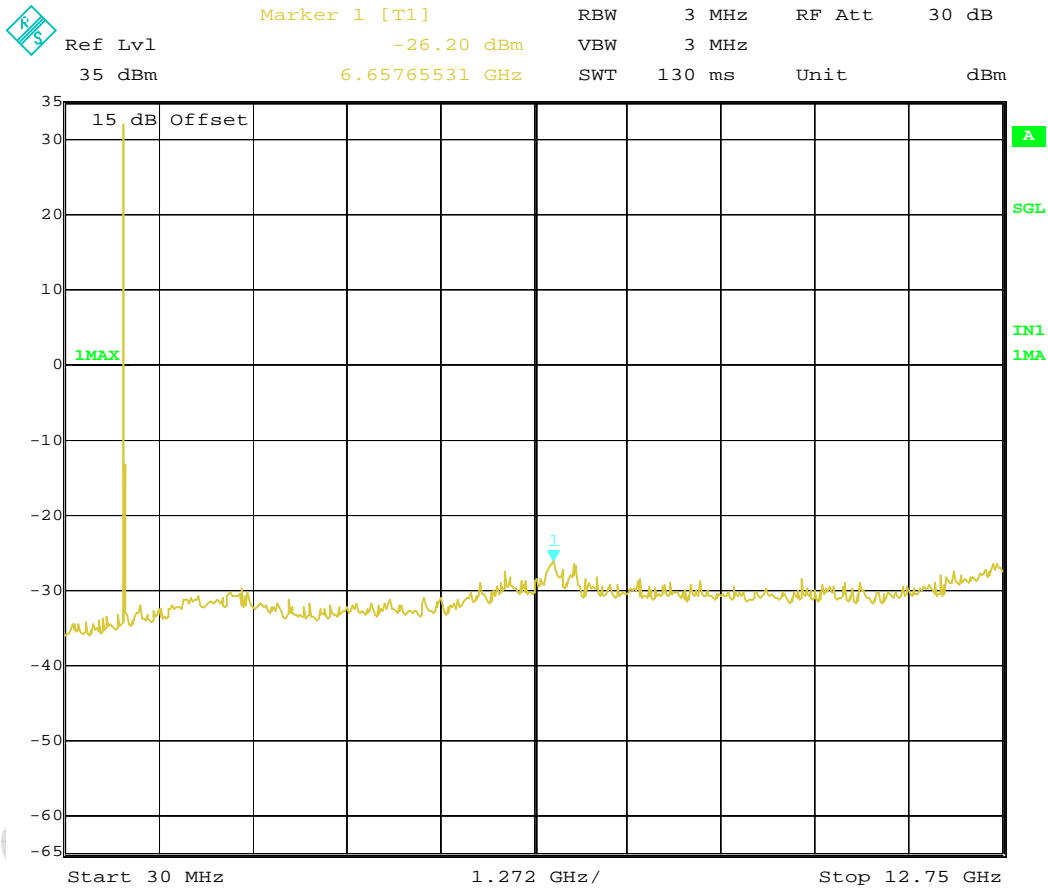

Date: 3.SEP.2008 21:28:42

Channel 190

FCC Parts 2, 22, 24
Equipment: MEGA4E

REPORT NO.: I08GE6338-FCC-EMC

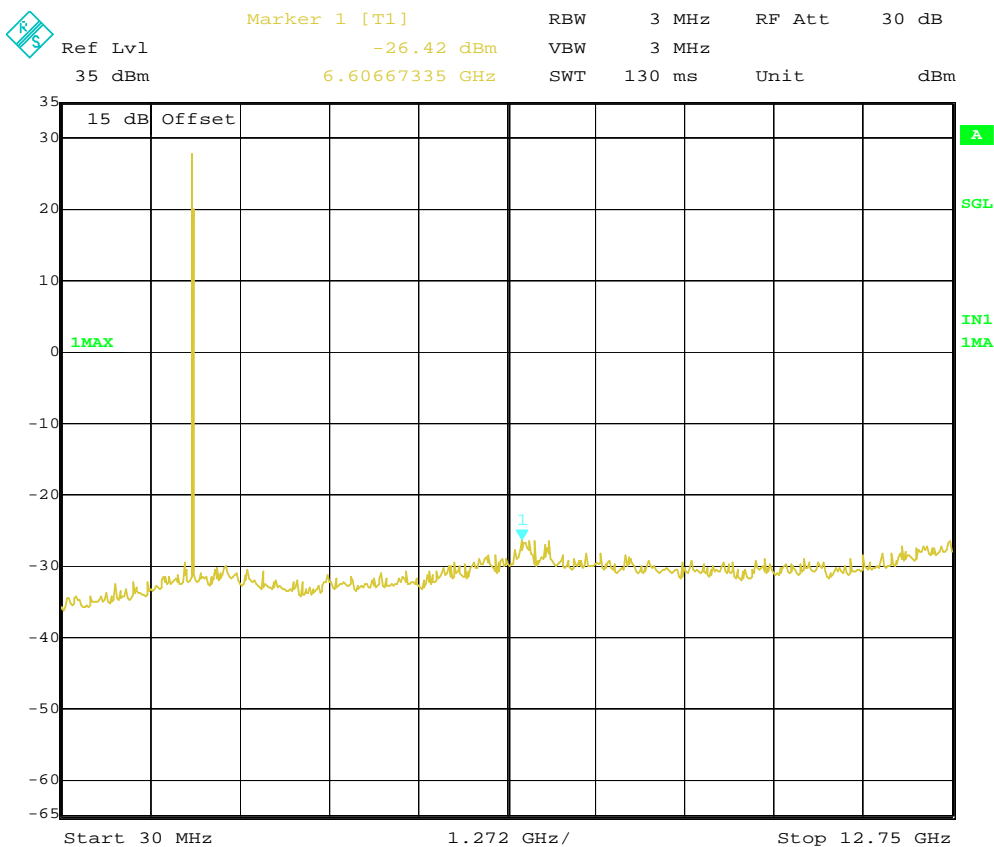

Date: 3.SEP.2008 21:27:46

Channel 661

China Telecommunication Technology Labs.

Test Results for EGPRS mode:

Out of band emission	
Frequency [MHz]	Level (dBm)
1661.422850	-26.31

Graphical results for EGPRS mode:

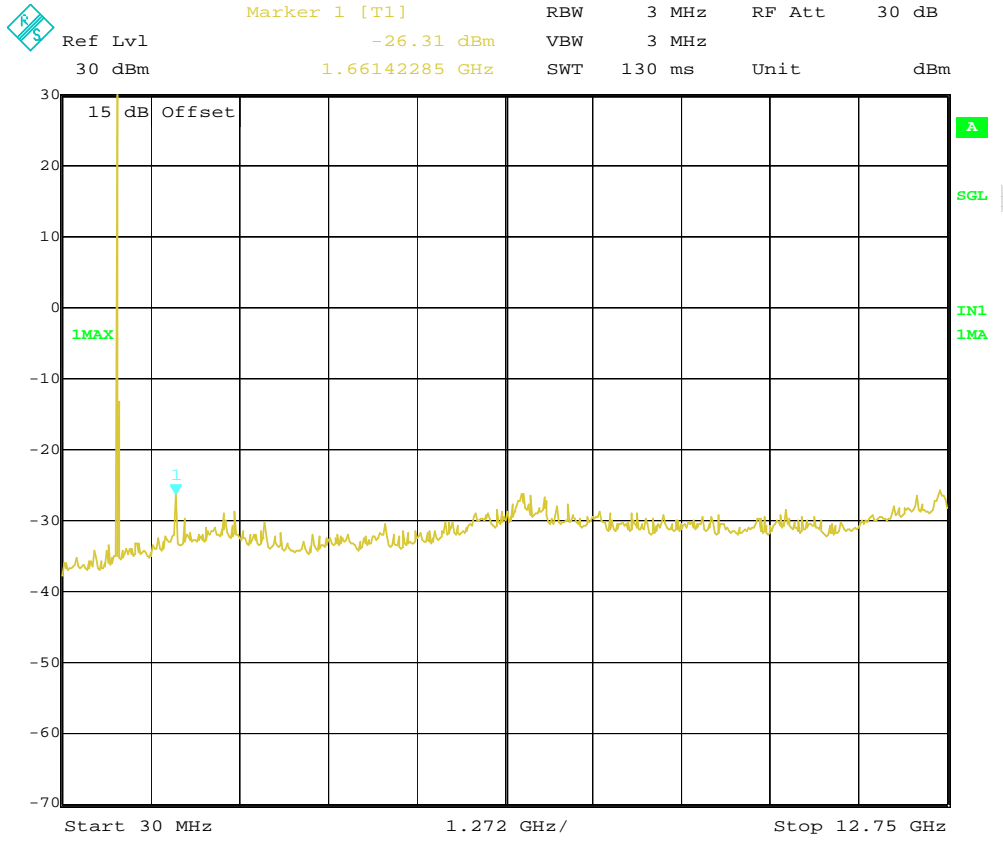

Date: 3.SEP.2008 22:03:16

Channel 190

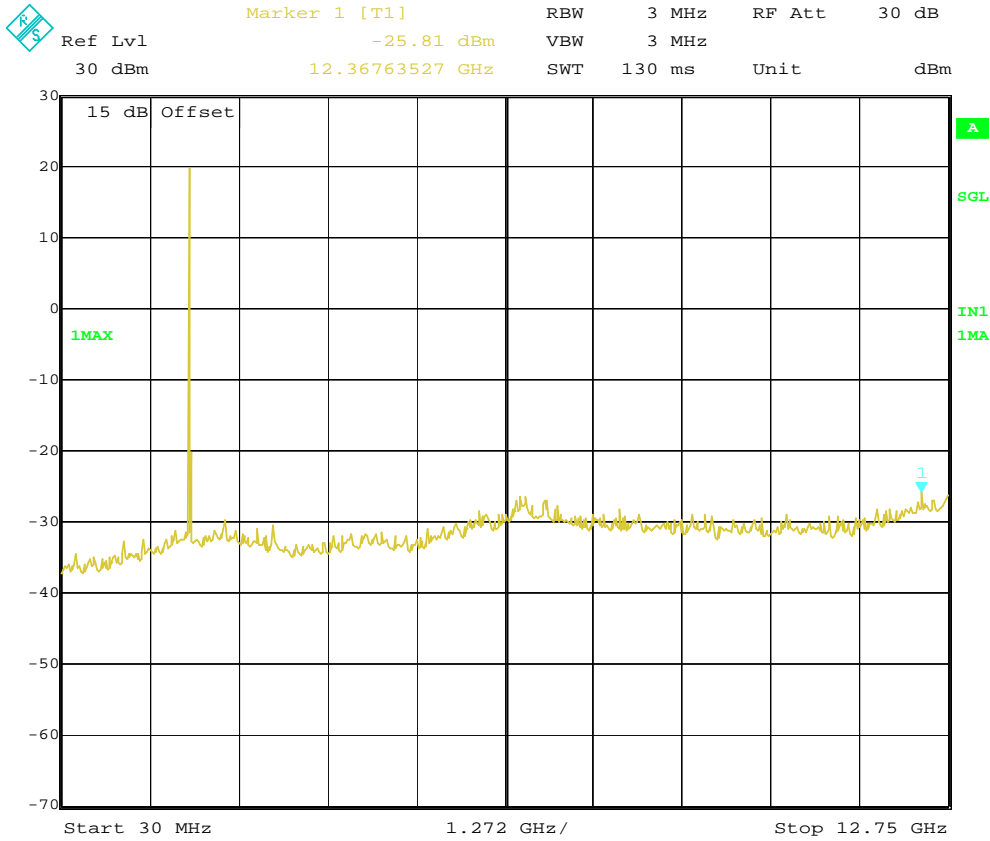

Date: 3.SEP.2008 22:02:27

Channel 661

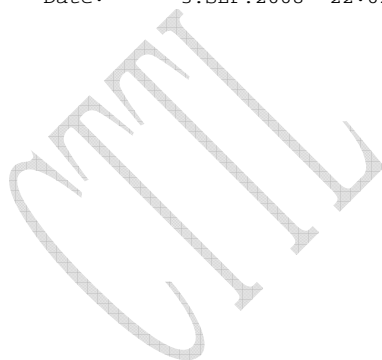

4.8 Band Edge

Specifications:	2.1051, 24.238, 2.1053, 22.917					
Date of Tests	2008-9-3					
Test conditions:	Ambient Temperature: 15°C-35°C Relative Humidity: 30%-60% Air pressure: 86-106kPa					
Operation Mode	TX on, channel 128, 251, 512 and 810					
Test Results:	Pass					
Test equipment Used:						
Asset Number	Description	Manufacturer	Model Number	Serial Number	Cal Due	State
7805	EMI Test Receiver	R/S	ESI26	100211	2009-01-04	Normal
023	Wireless Communications Test Set	Agilent	8960(E5515C)	GB41450323	2009-06-13	Normal
---	Power splitter	Jie sai	---	1000132	2009-01-04	Normal
111835	Wireless Communications Test Set	R&S	CMU200	1100000802	--	Normal

Limit Level Construction:

According to Part 24.238 (a), i.e., Out of band emissions. The power of any emission outside of the authorized operating frequency ranges must be attenuated below the transmitting power (P) by a factor of at least 43 + 10 log(P) dB, so the limit level is:

$$P(\text{dBm}) - (43 + 10 \log(P)) \text{ dB} = -13\text{dBm}$$

Limits for Radiated spurious emissions(UE)

Frequency range	Limit Level /Resolution Bandwidth
30 MHz to 20000 MHz	-13dBm/1MHz

Test Setup:

During the process of testing, the EUT was controlled via the Wireless Communications Test Set to ensure max power transmission and proper modulation and measured by Rhode & Schwarz EMI test receiver (ESI26).

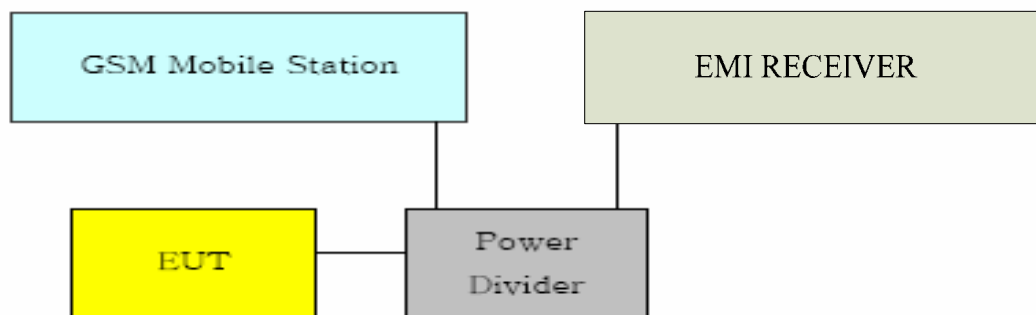

Test Method

- 1) The EUT was coupled to the EMI test receiver analyzer mode and the base station simulator through a power divider. The radio frequency load attached to the EUT antenna terminal was 50 Ohm. The loss of the cables the test system is calibrated to correct the readings.
- 2) The spectrum analyzer was set to Maxpeak Detector function and Maximum hold mode.
- 3) The resolution bandwidth of the spectrum analyzer was comparable to the emission bandwidth.

Note: --

Test Results:

GSM mode:

Band-edge emission		
EUT Channel	Frequency [MHz]	Level [dBm]
128 Left band edge	823.995891	-17.54
251 Right band edge	849.004949	-21.35
512 Left band edge	1850.000000	-21.36
810 Right band edge	1909.986470	-21.37

GPRS mode:

Band-edge emission		
EUT Channel	Frequency [MHz]	Level [dBm]
128 Left band edge	823.996312	-18.23
251 Right band edge	849.007474	-20.39
512 Left band edge	1850.008500	-30.65
810 Right band edge	1909.998220	-32.56

EGPRS mode:

Band-edge emission		
EUT Channel	Frequency [MHz]	Level [dBm]
128 Left band edge	823.995853	-17.97
251 Right band edge	849.002424	-21.13
512 Left band edge	1850.006930	-30.94
810 Right band edge	1909.998700	-31.63

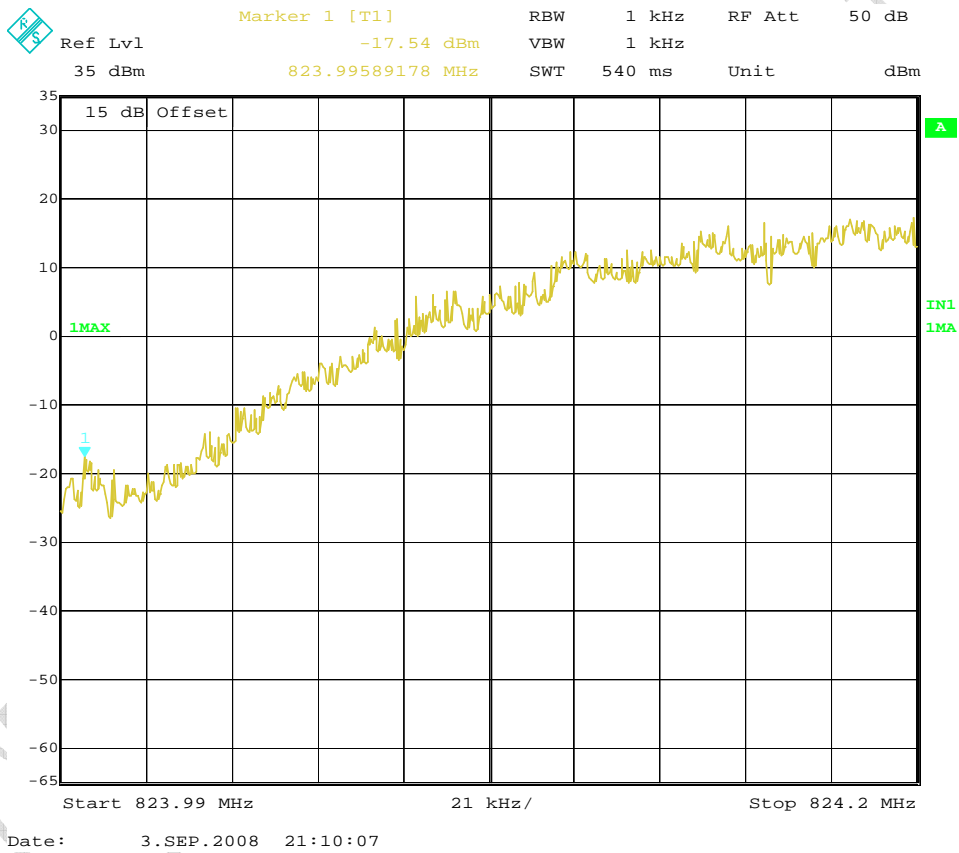

GSM channel 128 Left band edge

FCC Parts 2, 22, 24
Equipment: MEGA4E

REPORT NO.: I08GE6338-FCC-EMC

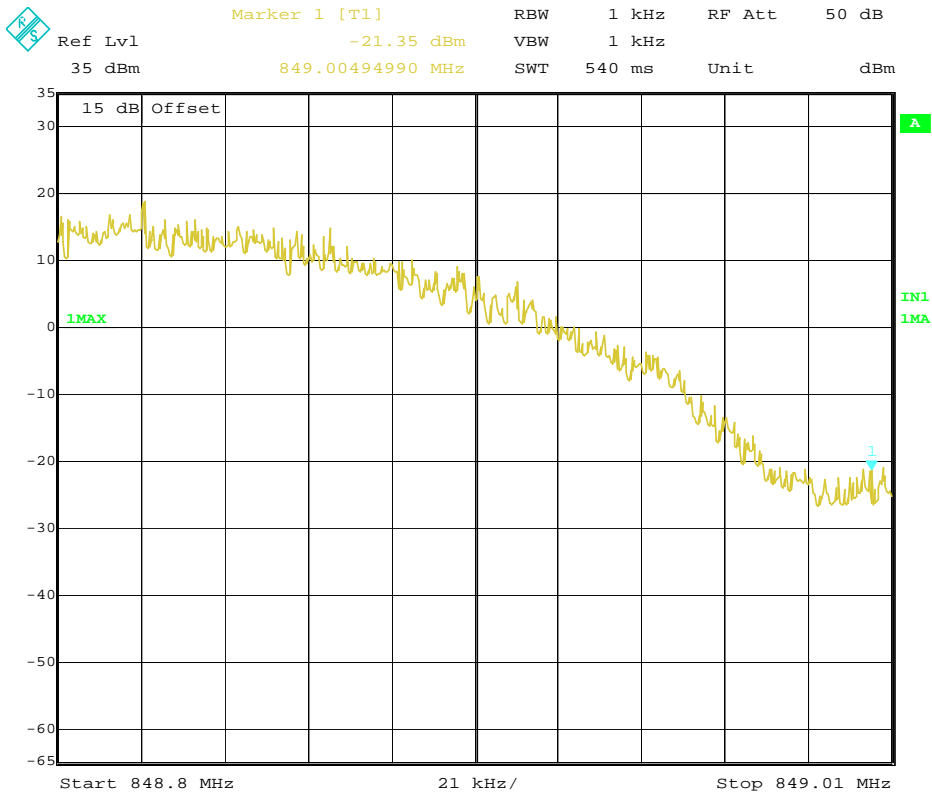

Date: 3.SEP.2008 21:11:20

GSM channel 251 Right band edge

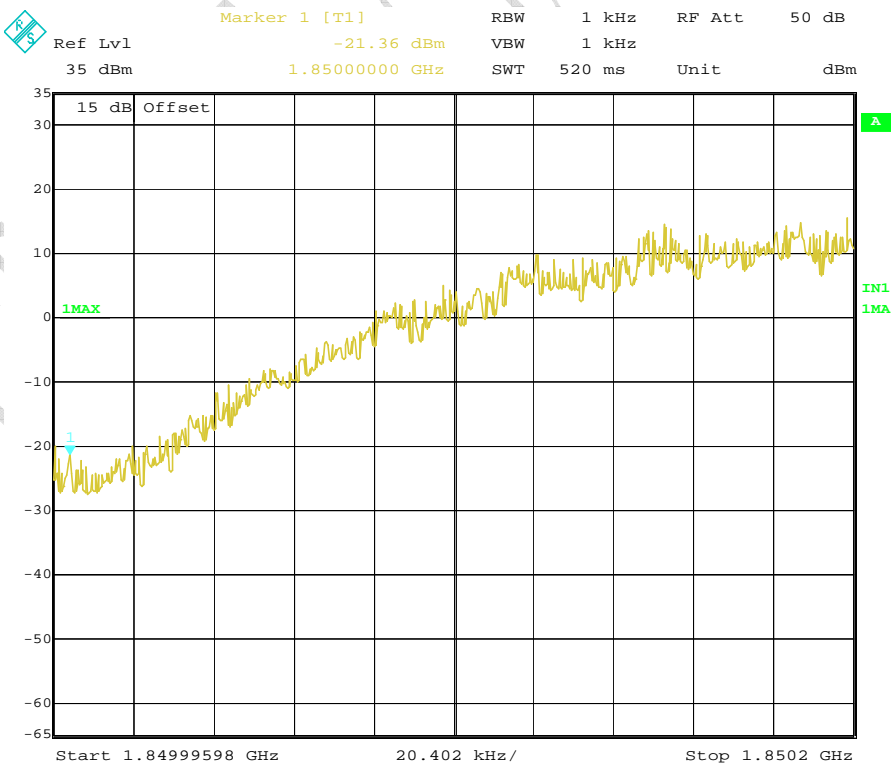

Date: 3.SEP.2008 21:13:35

GSM channel 512 Left band edge

FCC Parts 2, 22, 24
Equipment: MEGA4E

REPORT NO.: I08GE6338-FCC-EMC

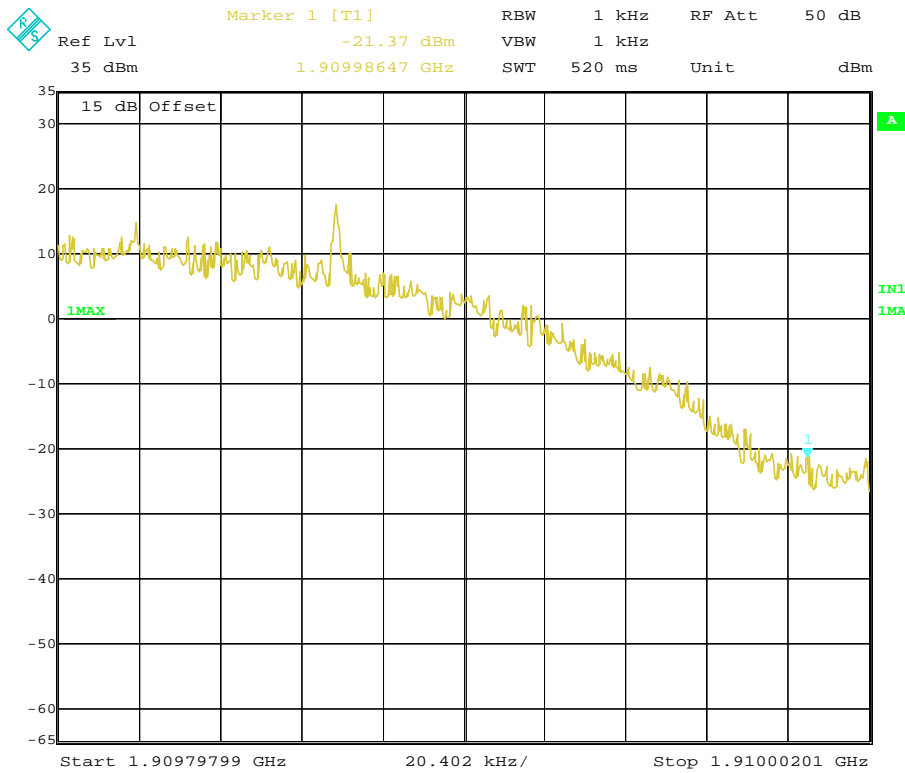

Date: 3.SEP.2008 21:15:06

GSM channel 810 Right band edge

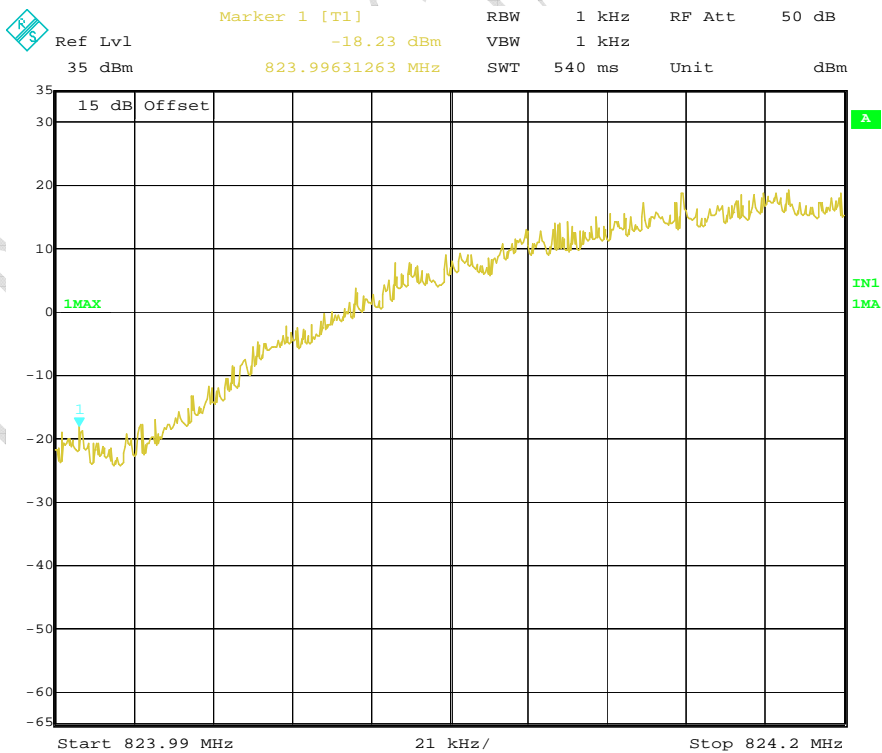

Date: 3.SEP.2008 21:31:57

GPRS channel 128 Left band edge

FCC Parts 2, 22, 24
Equipment: MEGA4E

REPORT NO.: I08GE6338-FCC-EMC

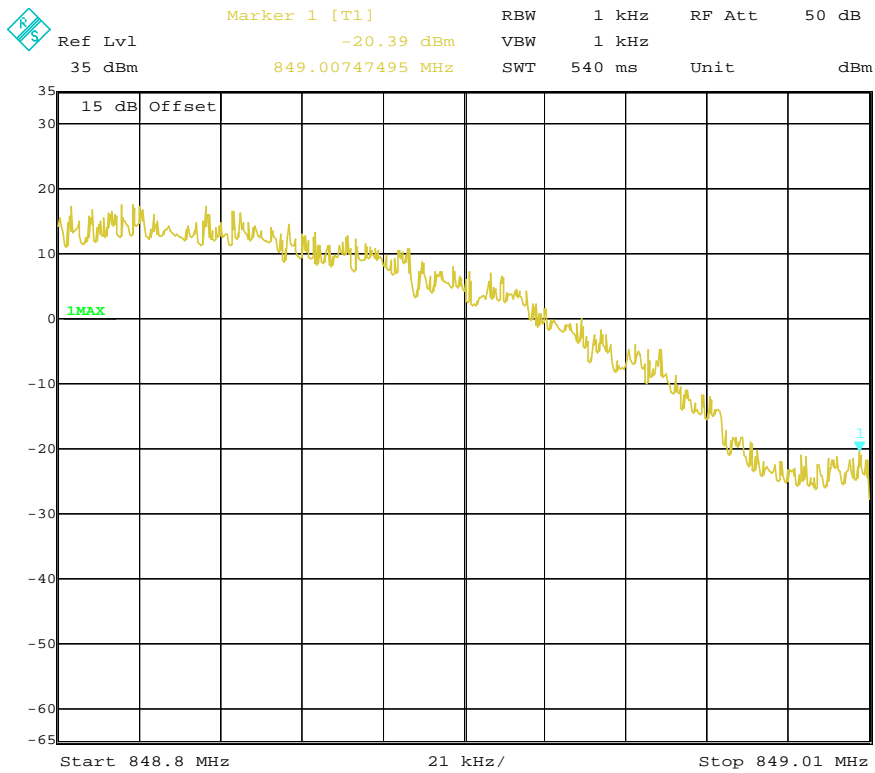

Date: 3.SEP.2008 21:33:10

GPRS channel 251 Right band edge

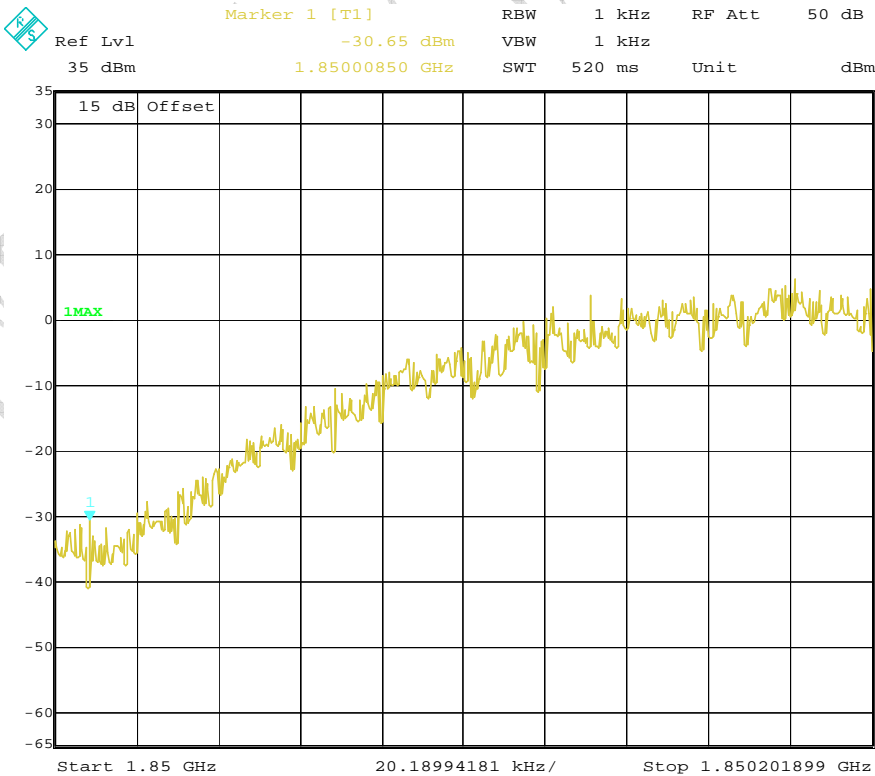

Date: 3.SEP.2008 21:34:38

GPRS channel 512 Left band edge

FCC Parts 2, 22, 24
Equipment: MEGA4E

REPORT NO.: I08GE6338-FCC-EMC

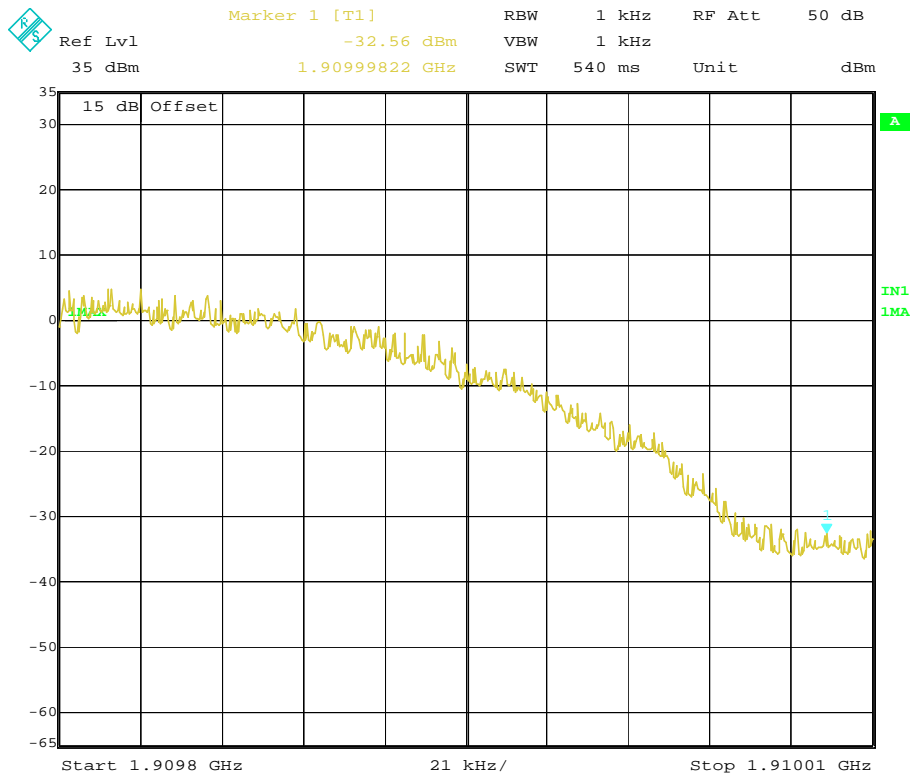

Date: 3.SEP.2008 21:36:09

GPRS channel 810 Right band edge

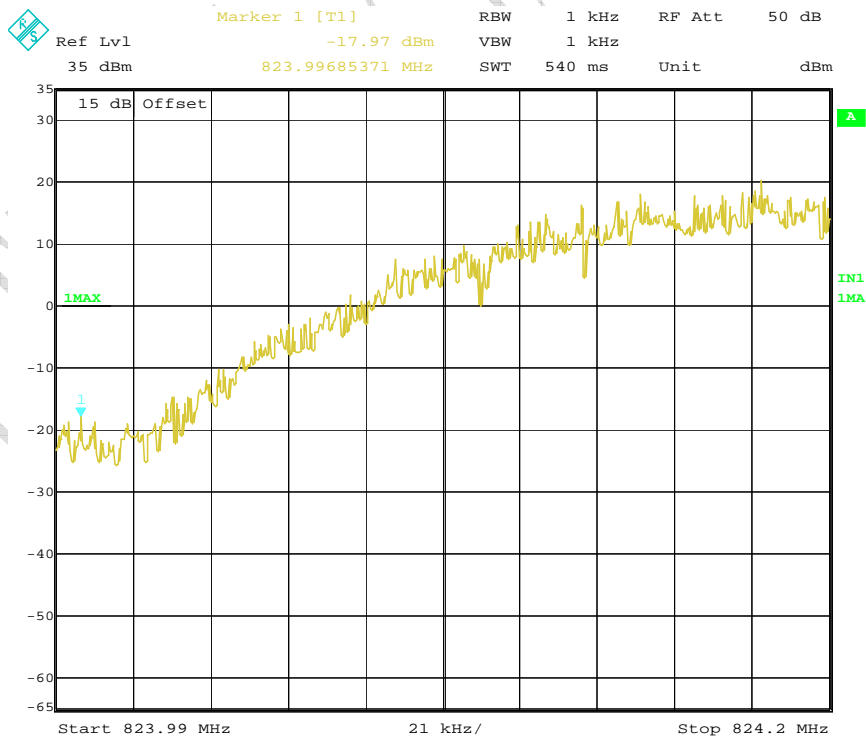

Date: 3.SEP.2008 21:44:32

EGPRS channel 128 Left band edge

FCC Parts 2, 22, 24
Equipment: MEGA4E

REPORT NO.: I08GE6338-FCC-EMC

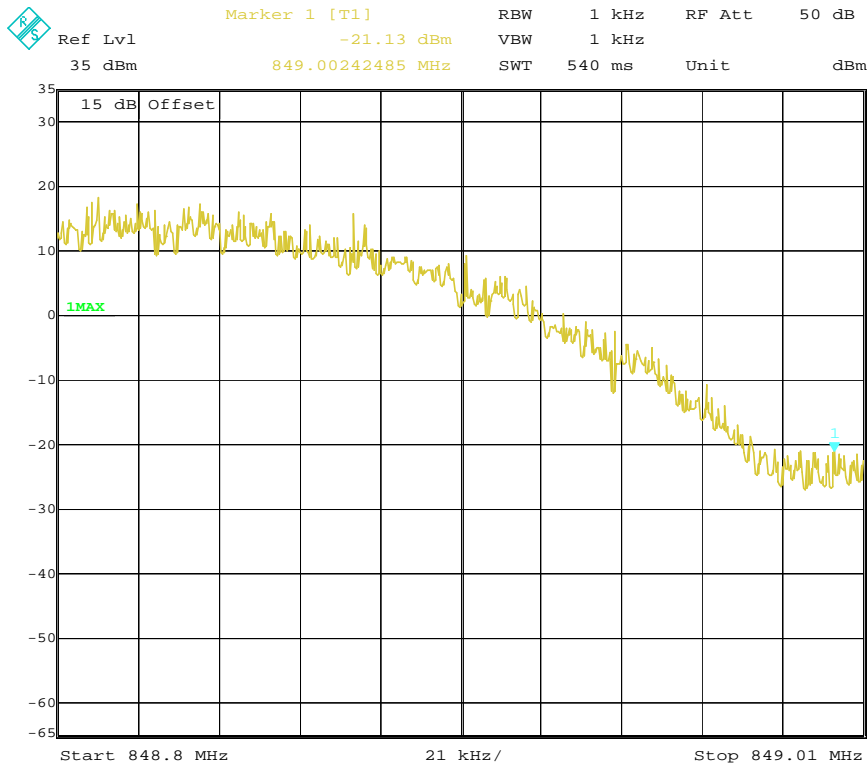

Date: 3.SEP.2008 21:47:25

EGPRS channel 251 Right band edge

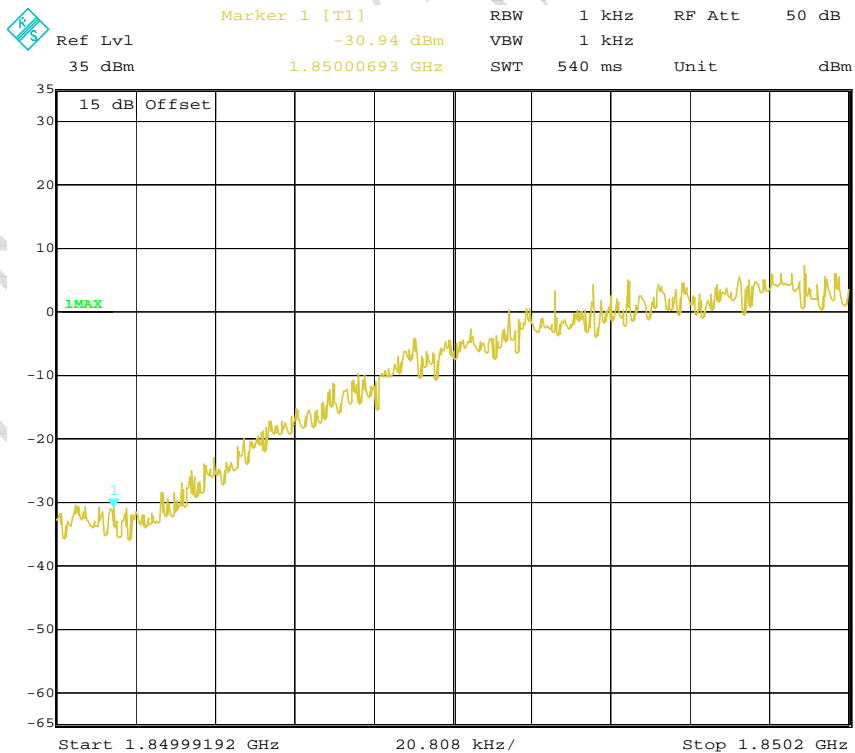

Date: 3.SEP.2008 21:54:21

EGPRS channel 512 Left band edge

FCC Parts 2, 22, 24
Equipment: MEGA4E

REPORT NO.: I08GE6338-FCC-EMC

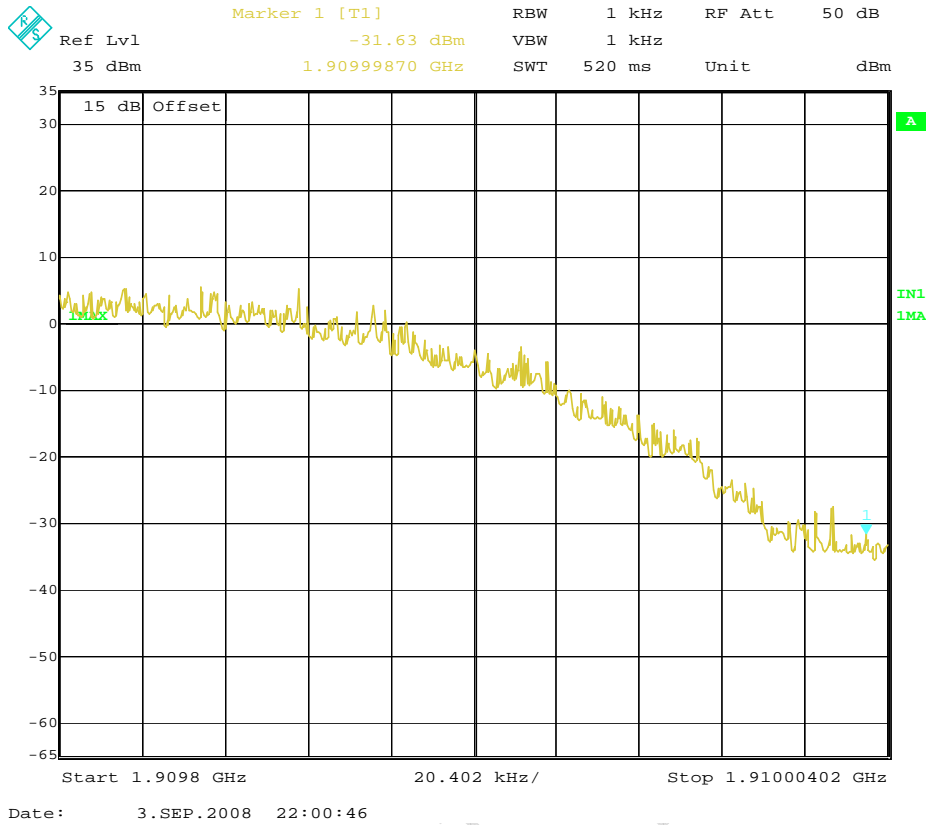

EGPRS channel 810 Right band edge

CHINA TELECOMMUNICATION TECHNOLOGY LABS

Annex A External Photos



Front view



Back view



Adaptor and Cable

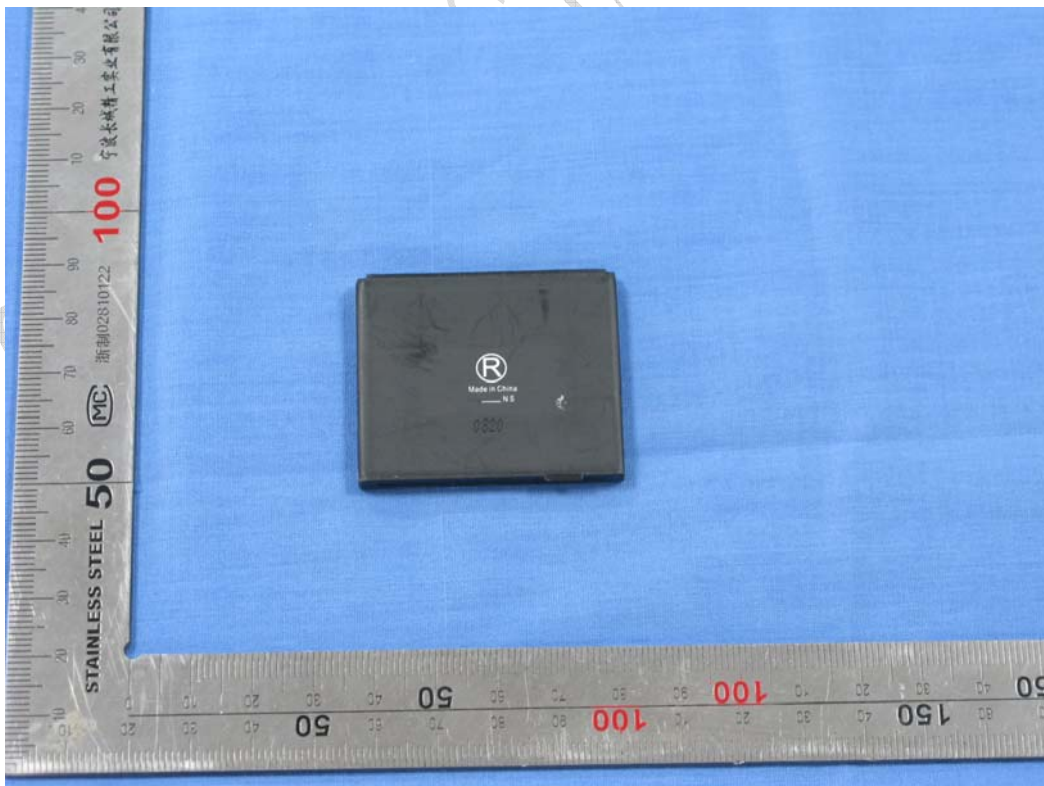

battery



Earphone

China Test

Annex B Internal Photos

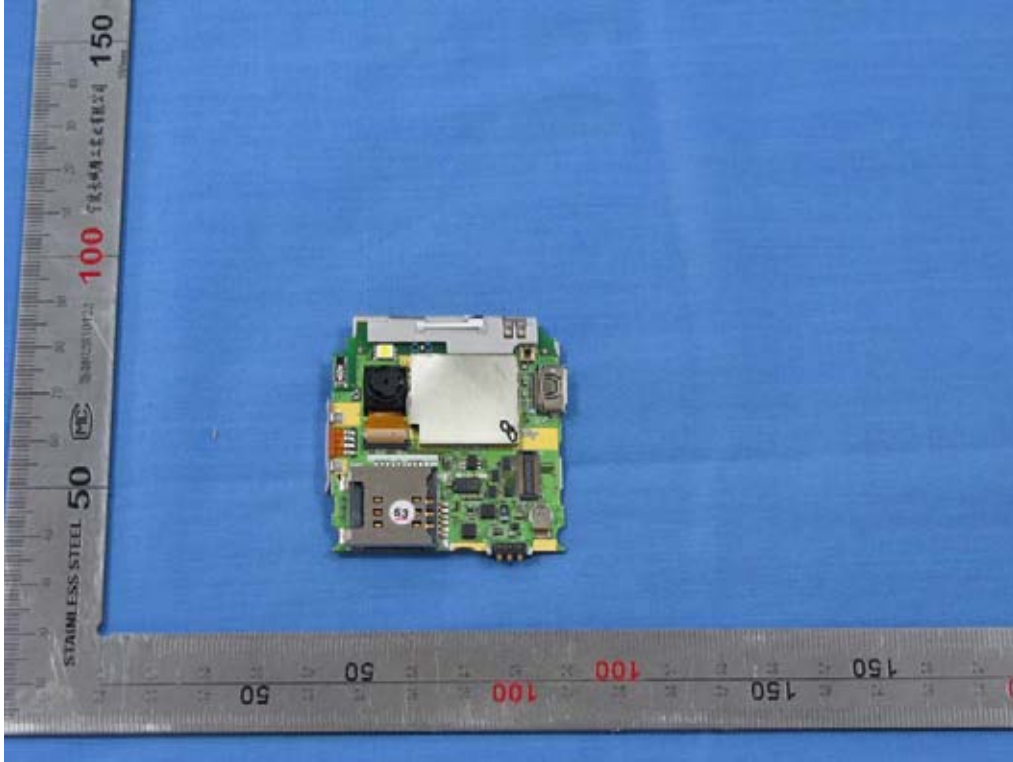

Main board (face)

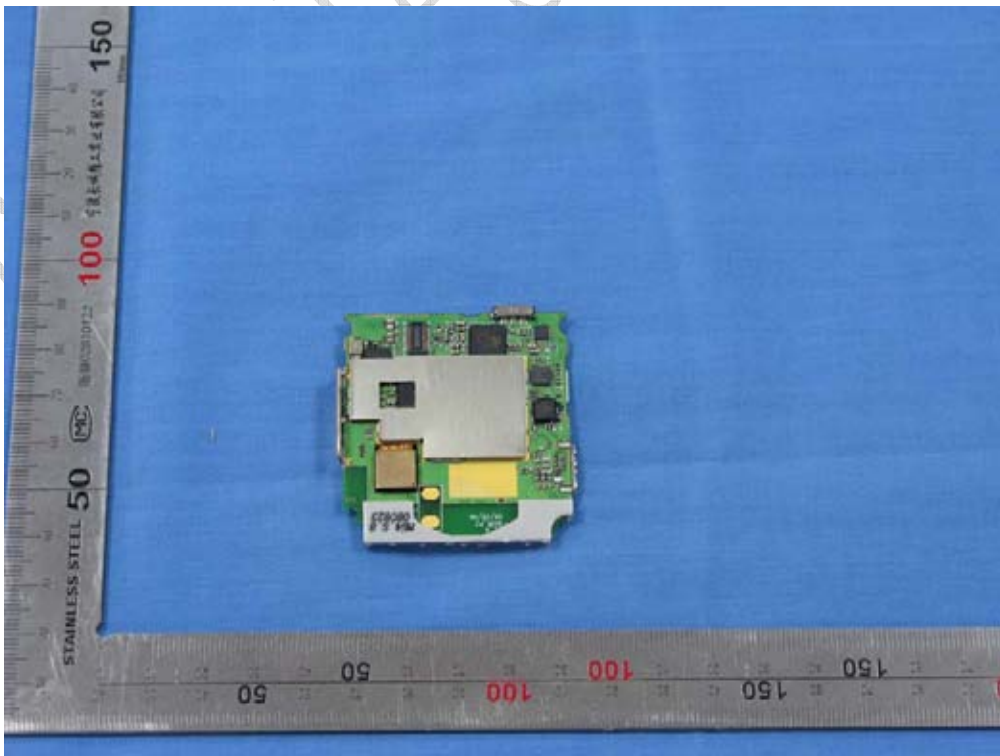

Main board (back)

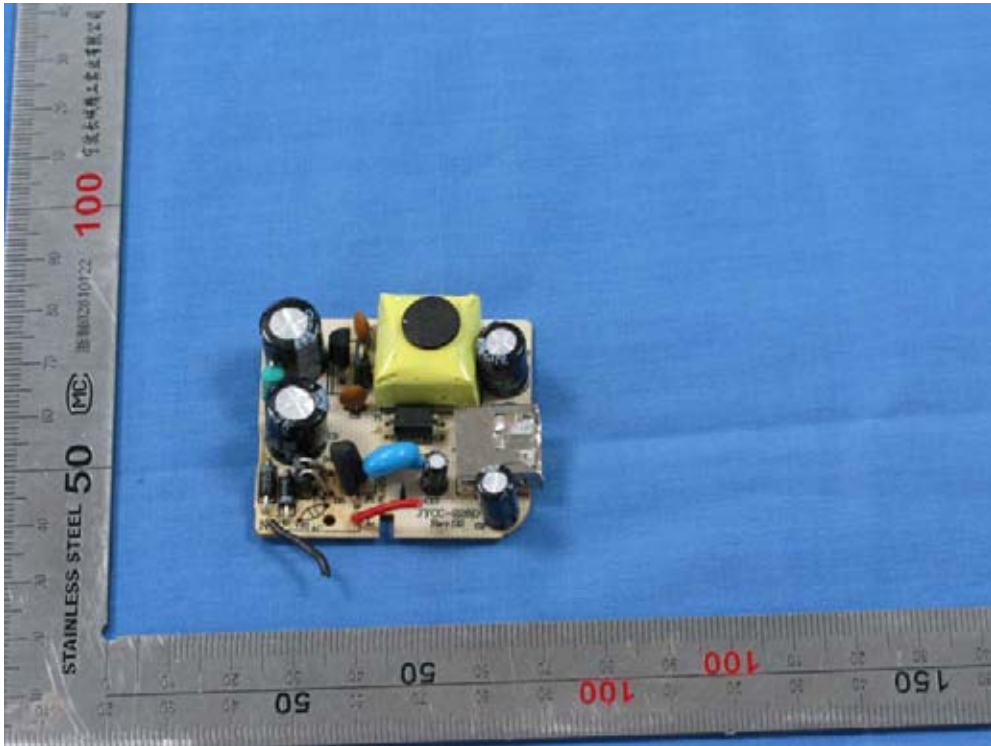

Adaptor face

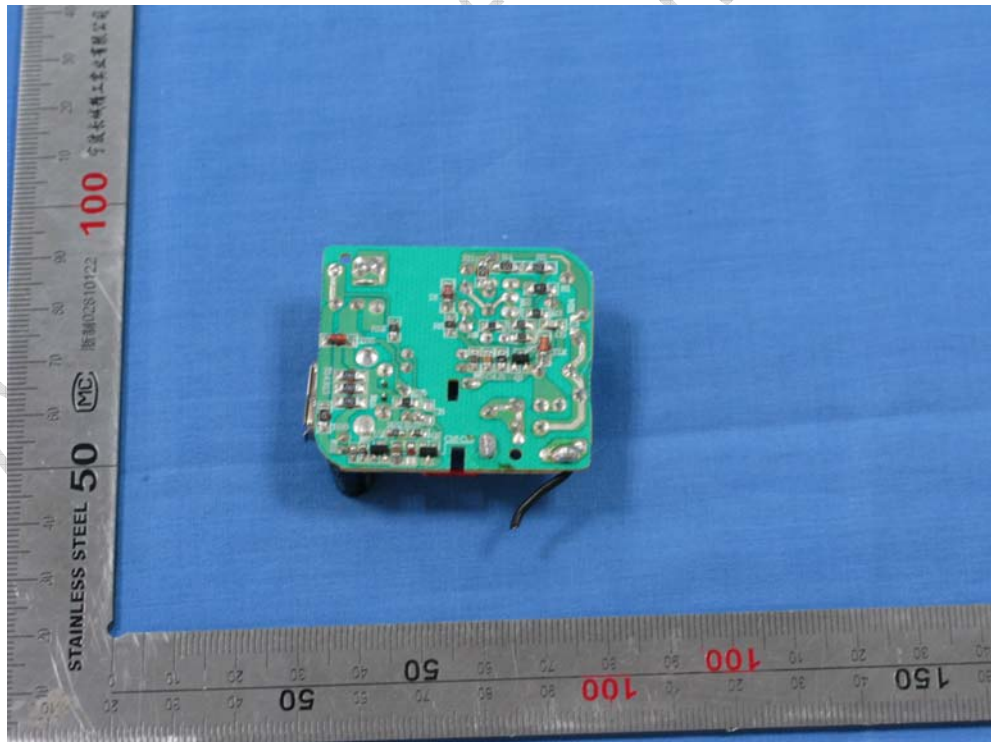

Adaptor back

ANNEX C Deviations from Prescribed Test Methods

No deviation from Prescribed Test Methods.

————— **The End of this Report** —————

CITL Test Report