



**Series PMC464, APC464, AcPC464
64 Digital I/O and Counter Timer Board**

USER'S MANUAL

**ACROMAG INCORPORATED
30765 South Wixom Road
P.O. BOX 437
Wixom, MI 48393-7037 U.S.A.**

**Tel: (248) 624-1541
Fax: (248) 624-9234**

**Copyright 2003, Acromag, Inc., Printed in the USA.
Data and specifications are subject to change without notice.**

8500-708-C05G011

TABLE OF CONTENTS

The information of this manual may change without notice. Acromag makes no warranty of any kind with regard to this material, including, but not limited to, the implied warranties of merchantability and fitness for a particular purpose. Further, Acromag assumes no responsibility for any errors that may appear in this manual and makes no commitment to update, or keep current, the information contained in this manual. No part of this manual may be copied or reproduced in any form without the prior written consent of Acromag, Inc.

IMPORTANT SAFETY CONSIDERATIONS

You must consider the possible negative effects of power, wiring, component, sensor, or software failure in the design of any type of control or monitoring system. This is very important where property loss or human life is involved. It is important that you perform satisfactory overall system design and it is agreed between you and Acromag, that this is your responsibility.

1.0 General Information

KEY 464 FEATURES	4
PCI INTERFACE FEATURES	6
SIGNAL INTERFACE PRODUCTS	6
Board DLL Control Software	7
Board VxWORKS Software	7
Board QNX Software	7

2.0 PREPARATION FOR USE

UNPACKING AND INSPECTION	8
CARD CAGE CONSIDERATIONS	8
BOARD CONFIGURATION	8
Default Hardware Jumper Configuration.....	8
Front Panel I/O.....	9
Rear J4 Field I/O Connector (PMC Only).....	10
Non-Isolation Considerations.....	10

3.0 PROGRAMMING INFORMATION

PCI CONFIGURATION ADDRESS SPACE	11
Configuration registers.....	11
MEMORY MAP	12
Interrupt Register.....	14
Interrupt Status/Clear Counter/Timer.....	15
Interrupt Status/Clear Digital I/O.....	15
Digital Input/Output Registers.....	16
Direction Control Register.....	16
Interrupt Enable Registers.....	17
Interrupt Type Configuration Registers.....	17
Interrupt Polarity Registers.....	17
Debounce Duration Select & Enable.....	18
Counter Trigger Register.....	19
Counter Stop Register.....	19
Counter Readback Registers.....	20
Counter Constant A Registers.....	20
Counter Constant B Registers.....	20
Counter Control Registers.....	21
Pulse Width Modulation.....	22
Watchdog Timer Operation.....	24
Event Counting Operation.....	26
Frequency Measurement Operation.....	28
Input Pulse Width Measurement.....	30
Input Period Measurement.....	32

TABLE OF CONTENTS

One-Shot Pulse Mode.....	34
PROGRAMMING EXAMPLES	36
Pulse Width Modulation Example.....	36
Watchdog Timer Operation Example.....	37
Event Counting Operation Example.....	38
Frequency Measurement Operation Example.	40
Input Pulse Width Measurement Example.....	41
Input Period Measurement Example.....	43
One-Shot Pulse Mode Example.....	44
4.0 THEORY OF OPERATION	
LOGIC/POWER INTERFACE.....	47
PCI INTERFACE LOGIC.....	47
DIGITAL INPUT/OUTPUT LOGIC.....	47
COUNTER TIMER CONTROL LOGIC.....	47
5.0 SERVICE AND REPAIR	
SERVICE AND REPAIR ASSISTANCE.....	48
PRELIMINARY SERVICE PROCEDURE.....	48
WHERE TO GET HELP.....	48
6.0 SPECIFICATIONS	
PHYSICAL.....	49
ENVIRONMENTAL.....	49
DIGITAL INPUT/OUTPUT.....	50
BOARD CRYSTAL OSCILLATOR.....	52
PCI LOCAL BUS INTERFACE.....	52
APPENDIX	
CABLE: MODEL 5028-432.....	53
TERMINATION PANEL: MODEL 5025-288.....	53
DRAWINGS	
4501-957 464 BLOCK DIAGRAM.....	54
4501-958 464 RESISTOR LOCATION.....	55
4501-919 CABLE 5028-432 (SHIELDED).....	56
4501-920 TERMINATION PANEL 5025-288.....	57

Trademarks are the property of their respective owners.

1.0 GENERAL INFORMATION

The 464 board has 64 digital input/output channels. In addition, four 16-bit multifunction counter/timers are provided.

Sixteen digital input/output channels can be programmed for input or output on a channel basis and are used for counter timer control. The remaining 48 digital input/output channels are programmed for input or output on a 8-bit port basis. All input channels can be enabled for change of state, low, or high level transition interrupts.

Four 16-bit multifunction counters/timers can be configured for pulse width modulated output, watchdog timer, event counter, frequency measurement, pulse width measurement, period measurement, or one shot pulse output. The four 16-bit counters can also be configured into two 32-bit counter/timers.

Signal input noise spikes can be filtered with use of the debounce logic provided on each of the 64 channels.

Table 1.1: The 464 boards are available in standard and extended temperature ranges

MODEL	Board Form Factor	16-bit Counters	I/O Type	OPERATING TEMPERATURE RANGE
PMC464	PCI Mezzanine Card	Four	64 TTL	0°C to +70°C
PMC464R	PCI Mezzanine Card (Rear I/O)	Four	63 TTL	0°C to +70°C
APC464	Short PCI	Four	64 TTL	0°C to +70°C
AcPC464	3U CompactPCI	Four	64 TTL	0°C to +70°C
PMC464E	PCI Mezzanine Card	Four	64 TTL	-40°C to +85°C
PMC464RE	PCI Mezzanine Card (Rear I/O)	Four	63 TTL	-40°C to +85°C
APC464E	Short PCI	Four	64 TTL	-40°C to +85°C
AcPC464E	3U CompactPCI	Four	64 TTL	-40°C to +85°C

Note: PMC464R and PMC464RE are rear field I/O models, only. All other models have front I/O.

KEY 464 FEATURES

- **16 Digital Input/Output Channels** – Interface with up to 16 input/output channels (15 Rear I/O channels for PMCxxxR models) which can be configured for input or output on an individual channel basis. Four of these signals are used for each enabled counter/timer.
- **48 Digital Input/Output Channels** – Interface with up to 48 input/output channels which can be configured for input or output on a 8-bit port basis.
- **Programmable Change of State/Level Interrupts** – Interrupts are software programmable for any bit Change-Of-State or level on all 64 channels.
- **Input Signal Filtering Debounce Logic** – Input signals can be filtered from noise spikes. Four programmable debounce filter durations from 1.6µs to 3.2ms can be selected.

KEY 464 FEATURES

- **Pulse Width Modulation** – Each counter can be programmed for pulse width modulation. The duration of the logic high and low levels of the output signal can be independently controlled. An external gate signal can also be used to start/stop generation of the output signal.
- **Watchdog Timer** – Each counter can be configured as a countdown timer for implementation as a watchdog timer. A gate-off signal is available for use to stop the count down operation. Interrupt generation upon a countdown to zero condition is available.
- **Event Counter** – Each counter can be configured to count input pulses or events. A gate-off signal is provided to control count-up or count down with each event. Interrupt generation upon programmed count condition is available.
- **Frequency Measurement** – Each counter can be configured to count how many active edges are received during a period defined by an external count enable signal. An interrupt can be generated upon measurement complete.
- **Pulse-Width or Period Measurement** – Each counter can be configured to measure pulse-width or waveform period. In addition, an interrupt can be generated upon measurement complete.
- **One-Shot and Repetitive One-Shot** – A one-shot pulse waveform may also be generated by each counter. The duration of the pulse and the delay until the pulse goes active is user programmable. A repetitive one-shot can be initiated with repetitive trigger pulses.
- **TTL Compatible Thresholds** – Input and output signal thresholds are at TTL levels.
- **Power Up and System Reset is Failsafe** – For safety, the digital channels are configured for input upon power-up.

PCI INTERFACE FEATURES

- **High density** - Target board.
- **Field Connections** – All counter/timer, digital I/O, and power connections are made through a single 68-pin SCSI front panel I/O connector. Models PMC464R and PMC464RE, only use a 64 pin rear I/O connector.
- **32, 16, 8-bit I/O** - Register Read/Write is performed through data transfer cycles in the PCI memory space. All registers can be accessed via 32, 16, or 8-bit data transfers.
- **Compatibility** – Complies to PCI Local Bus Specification Revision 2.2. Provides one multifunction interrupt. Board is 5V signaling compliant and 3.3V signaling tolerant.

SIGNAL INTERFACE PRODUCTS

The following signal interface products are for front I/O models, which are accessed via a 68 pin SCSI-3 front panel connector.

Cables and a termination panel are also available to interface with this board.

Cable:

Model 5028-432: A 2-meter, round 68 conductor shielded cable with a male SCSI-3 connector at both ends and 34 twisted pairs. The cable is used for connecting the board to Model 5025-288 termination panels. For optimum performance, use the shortest possible length of shielded input cable.

Termination Panel:

Model 5025-288: DIN-rail mountable panel provides 68 screw terminals for universal field I/O termination. Connects to Acromag board, via SCSI-3 to twisted pair cable described above.

See the Appendix for further information on these products.

Acromag provides a software product (sold separately) to facilitate the development of Windows (98/Me/NT4/2000/XP®) applications accessing Acromag PMC I/O board products, PCI I/O Cards, and CompactPCI I/O Cards. This software (Model PCISW-API-WIN) consists of low-level drivers and Windows 32 Dynamic Link Libraries (DLLs) that are compatible with a number of programming environments including Visual C++™, Visual Basic®, Borland C++ Builder® and others. The DLL functions provide a high-level interface to boards eliminating the need to perform low-level reads/writes of registers, and the writing of interrupt handlers.

BOARD DLL CONTROL SOFTWARE

Acromag provides a software product (sold separately) consisting of board VxWorks® software. This software (Model PMCSW-API-VXW) is composed of VxWorks® (real time operating system) libraries for all Acromag PMC I/O board products, PCI I/O Cards, and CompactPCI I/O Cards. The software is implemented as a library of "C" functions which link with existing user code to make possible simple control of all Acromag PMC boards.

BOARD VxWORKS SOFTWARE

Acromag provides a software product (sold separately) consisting of board QNX® software. This software (Model PCISW-API-QNX) is composed of QNX® (real time operating system) libraries for all Acromag PMC I/O board products, PCI I/O Cards, and CompactPCI I/O Cards. The software is implemented as a library of "C" functions which link with existing user code to make possible simple control of all Acromag PMC boards.

BOARD QNX SOFTWARE

2.0 PREPARATION FOR USE

UNPACKING AND INSPECTION



WARNING: This board utilizes static sensitive components and should only be handled at a static-safe workstation.

CARD CAGE CONSIDERATIONS

IMPORTANT: Adequate air circulation must be provided to prevent a temperature rise above the maximum operating temperature.

BOARD CONFIGURATION

Default Hardware Jumper Configuration

Upon receipt of this product, inspect the shipping carton for evidence of mishandling during transit. If the shipping carton is badly damaged or water stained, request that the carrier's agent be present when the carton is opened. If the carrier's agent is absent when the carton is opened and the contents of the carton are damaged, keep the carton and packing material for the agent's inspection.

For repairs to a product damaged in shipment, refer to the Acromag Service Policy to obtain return instructions. It is suggested that salvageable shipping cartons and packing material be saved for future use in the event the product must be shipped.

This board is physically protected with packing material and electrically protected with an anti-static bag during shipment. However, it is recommended that the board be visually inspected for evidence of mishandling prior to applying power.

Refer to the specifications for loading and power requirements. Be sure that the system power supplies are able to accommodate the power requirements of the system boards, plus the installed Acromag board, within the voltage tolerances specified.

Adequate air circulation must be provided to prevent a temperature rise above the maximum operating temperature and to prolong the life of the electronics. If the installation is in an industrial environment and the board is exposed to environmental air, careful consideration should be given to air-filtering.

Remove power from the system before installing board, cables, termination panels, and field wiring.

The board may be configured differently, depending on the application. When the board is shipped from the factory, it is configured as follows:

- J3 is open. Plus 3.3 volts is provided from an on board regulator.
- The default configuration of the programmable software control register bits at power-up are described in section 3.
- The control registers must be programmed to the desired configuration before starting data input or output operation.

The front panel connector provides the field I/O interface connections. It is a SCSI-3 68-pin female connector (AMP 787082-7 or equivalent) employing latch blocks and 30 micron gold in the mating area (per MIL-G-45204, Type II, Grade C). Connects to Acromag termination panel 5025-288 from the front panel via round shielded cable (Model 5028-432).

Digital channels 0 to 47 are control on an 8-bit port basis. Digital channels 48 to 63 are controlled on an individual bit basis. The counter/timer input and output control signals share Digital I/O channels 48 to 63. Each counter uses three input signals and one output signal. An enabled counter/timer has its required input and output signals automatically dedicated via the field connector. If the counter is not used then the ports are available for independent channel digital I/O.

Front Panel Field I/O Connector

Pin Description	Pin	Pin Description	Pin
Digital CH0	1	COMMON	35
Digital CH1	2	COMMON	36
Digital CH2	3	Digital CH24	37
Digital CH3	4	Digital CH25	38
Digital CH4	5	Digital CH26	39
Digital CH5	6	Digital CH27	40
Digital CH6	7	Digital CH28	41
Digital CH7	8	Digital CH29	42
Digital CH8	9	Digital CH30	43
Digital CH9	10	Digital CH31	44
Digital CH10	11	Digital CH32	45
Digital CH11	12	Digital CH33	46
Digital CH12	13	Digital CH34	47
Digital CH13	14	Digital CH35	48
Digital CH14	15	Digital CH36	49
Digital CH15	16	Digital CH37	50
COMMON	17	Digital CH38	51
COMMON	18	Digital CH39	52
Digital CH16	19	Digital CH40	53
Digital CH17	20	Digital CH41	54
Digital CH18	21	Digital CH42	55
Digital CH19	22	Digital CH43	56
Digital CH20	23	Digital CH44	57
Digital CH21	24	Digital CH45	58
Digital CH22	25	Digital CH46	59
Digital CH23	26	Digital CH47	60
Digital CH48/Counter 1A	27	Digital CH56/Counter 3A	61
Digital CH49/Counter 1B	28	Digital CH57/Counter 3B	62
Digital CH50/Counter 1C	29	Digital CH58/Counter 3C	63
Digital CH51/Counter 1OUT	30	Digital CH59/Counter 3 OUT	64
Digital CH52/Counter 2A	31	Digital CH60/Counter 4A	65
Digital CH53/Counter 2B	32	Digital CH61/Counter 4B	66
Digital CH54/Counter 2C	33	Digital CH62/Counter 4C	67
Digital CH55/Counter 2 OUT	34	Digital CH63/Counter 4 OUT	68

Table 2.1: Board Field I/O Pin Connections

The board has four 16-bit counters available. Two 16-bit counters can be configured as one 32-bit counter. If counters 1 and 2 were configured as a 32-bit counter, then the input and output corresponding to Counter 1 are used. Similarly, counters 3 and 4 can also be configured as 32-bit counters. The signals corresponding to the first counter in the pair will be used.

Rear J4 Field I/O Connector

On models with rear I/O, the J4 PMC connector provides the field I/O interface connections. This connector is a 64-pin female receptacle header (AMP 120527-1 or equivalent) which mates to the male connector on the carrier/CPU board (AMP 120521-1 or equivalent).

Table 2.2: Board Rear Field I/O Pin Connections

The board has four 16-bit counters available. Two 16-bit counters can be configured as one 32-bit counter. If counters 1 and 2 were configured as a 32-bit counter, then the input and output corresponding to Counter 1 are used. Similarly, counters 3 and 4 can also be configured as 32-bit counters. The signals corresponding to the first counter in the pair will be used.

Pin Description	Pin	Pin Description	Pin
Digital CH0	1	Digital CH24	33
Digital CH1	2	Digital CH25	34
Digital CH2	3	Digital CH26	35
Digital CH3	4	Digital CH27	36
Digital CH4	5	Digital CH28	37
Digital CH5	6	Digital CH29	38
Digital CH6	7	Digital CH30	39
Digital CH7	8	Digital CH31	40
Digital CH8	9	Digital CH32	41
Digital CH9	10	Digital CH33	42
Digital CH10	11	Digital CH34	43
Digital CH11	12	Digital CH35	44
Digital CH12	13	Digital CH36	45
Digital CH13	14	Digital CH37	46
Digital CH14	15	Digital CH38	47
Digital CH15	16	Digital CH39	48
Digital CH16	17	Digital CH40	49
Digital CH17	18	Digital CH41	50
Digital CH18	19	Digital CH42	51
Digital CH19	20	Digital CH43	52
Digital CH20	21	Digital CH44	53
Digital CH21	22	Digital CH45	54
Digital CH22	23	Digital CH46	55
Digital CH23	24	Digital CH47	56
Digital CH48/Counter 1A	25	Digital CH56/Counter 3A	57
Digital CH49/Counter 1B	26	Digital CH57/Counter 3B	58
Digital CH50/Counter 1C	27	Digital CH58/Counter 3C	59
Digital CH51/Counter 1OUT	28	Digital CH59/Counter 3 OUT	60
Digital CH52/Counter 2A	29	Digital CH60/Counter 4A	61
Digital CH53/Counter 2B	30	Digital CH61/Counter 4B	62
Digital CH54/Counter 2C	31	Digital CH62/Counter 4C	63
Digital CH55/Counter 2 OUT	32	COMMON	64

Note: On rear I/O models, Counter 4 Output is not connected to J4.

Non-Isolation Considerations

The board is non-isolated, since there is electrical continuity between the logic and field I/O grounds. As such, the field I/O connections are not isolated from the system. Care should be taken in designing installations without isolation to avoid noise pickup and ground loops caused by multiple ground connections. This is particularly important for analog inputs and outputs when a high level of accuracy/resolution is needed.

This Section provides the specific information necessary to program and operate the board.

This board is a PCI Specification version 2.2 compliant PCI bus target only board.

The PCI bus is defined to address three distinct address spaces: I/O, memory, and configuration space. This board can be accessed via the PCI bus memory space and configuration spaces, only.

The card's configuration registers are initialized by system software at power-up to configure the card. The board is a Plug-and-Play PCI card. As a Plug-and-Play card the board's base address and system interrupt request line are not selected via jumpers but are assigned by system software upon power-up via the configuration registers. A PCI bus configuration access is used to read/write the PCI card's configuration registers.

When the computer is first powered-up, the computer's system configuration software scans the PCI bus to determine what PCI devices are present. The software also determines the configuration requirements of the PCI card.

The system software accesses the configuration registers to determine how many blocks of memory space the carrier requires. It then programs the board's configuration registers with the unique memory base address.

The configuration registers are also used to indicate that the board requires an interrupt request line. The system software then programs the configuration registers with the interrupt request line assigned to the board.

Since this board is relocatable and not fixed in address space, its device driver must use the mapping information stored in the board's Configuration Space registers to determine where the board is mapped in memory space and which interrupt line will be used.

The PCI specification requires software driven initialization and configuration via the Configuration Address space. This board provides 256 bytes of configuration registers for this purpose. It contains the configuration registers, shown in Table 3.1, to facilitate Plug-and-Play compatibility.

The Configuration Registers are accessed via the Configuration Address and Data Ports. The most important Configuration Registers are the Base Address Registers and the Interrupt Line Register which must be read to determine the base address assigned to the board and the interrupt request line that goes active on a board interrupt request.

3.0 PROGRAMMING INFORMATION

PCI Configuration Address Space

CONFIGURATION REGISTERS

Table 3.1 Configuration Registers

Reg. Num.	D31	D24	D23	D16	D15	D8	D7	D0
0	Device ID=4248				Vendor ID= 16D5			
1	Status				Command			
2	Class Code=118000						Rev ID=00	
3	BIST		Header		Latency		Cache	
4	32-bit Memory Base Address for 4K-Byte Block							
5 : 10	Not Used							
11	Subsystem ID=0000				Subsystem Vendor ID=0000			
12	Not Used							
13,14	Reserved							
15	Max_Lat		Min_Gnt		Inter. Pin		Inter. Line	

MEMORY MAP

This board is allocated a 4K byte block of memory that is addressable in the PCI bus memory space to control the boards multiple functions. Three types of information are stored in the memory space: control, status, and data.

The memory space address map for the board is shown in Table 3.2. Note that the base address for the board in memory space must be added to the addresses shown to properly access the board registers. Register accesses as 32, 16, and 8-bit in memory space are permitted.

Table 3.2: Memory Map

Base Addr+	D31	D16	D15	D00	Base Addr+
14 ³ 03	Not Used ¹		Interrupt Register		00
15 07	Not Used ¹		Counters 1 to 4 Interrupt Status/Clear Reg.		04
15 0B	Interrupt Status/Clear 31-16 Digital I/O		Interrupt Status/Clear 15-0 Digital I/O		08
15 0F	Interrupt Status/Clear 63-48 Digital I/O.		Interrupt Status/Clear 47-32 Digital I/O		0C
16 13	31-16 Digital I/O Register		15-0 Digital I/O Register		10
16 17	63-48 Digital I/O Register		47-32 Digital I/O Register		14
16 1B	Direction Register Digital Channels 63-48		Direction Register Digital Channels 47-0		18
17 1F	Interrupt Enable Digital Channels 31-16		Interrupt Enable Digital Channels 15-0		1C
17 23	Interrupt Enable Digital Channels 63-48		Interrupt Enable Digital Channels 47-32		20
17 27	Interrupt Type Digital Channels 31-16		Interrupt Type Digital Channels 15-0		24
17 2B	Interrupt Type Digital Channels 63-48		Interrupt Type Digital Channels 47-32		28
17 2F	Interrupt Polarity Digital Channels 31-16		Interrupt Polarity Digital Channels 15-0		2C
17 33	Interrupt Polarity Digital Channels 63-48		Interrupt Polarity Digital Channels 47-32		30
19 37	Counter Stop Register		Counter Trigger Register		34

1. The board will return 0 for all addresses that are "Not Used".

2. The board has 4 TTL 16-bit counters available. Via counter 1 control register, 16-bit counters 1 and 2 can be configured as one 32-bit counter. This is also an option for counter pairs 3 and 4.

3. The numbers in the left most column represent the User Manual page containing a description of the corresponding register.

21	3B	Counter 1 Control Register (32-bit Counter Control Register) ²		38
21	3F	Counter 2 Control Register		3C
21	43	Counter 3 Control Register (32-bit Counter Control Register) ²		40
21	47	Counter 4 Control Register		44
20	4B	Counter 2 Read Back Register	Counter 1 Read Back Register	48
20	4F	Counter 4 Read Back Register	Counter 3 Read Back Register	4C
20 ³	53	Counter 2 Constant A Register	Counter 1 Constant A Register	50
20	57	Counter 4 Constant A Register	Counter 3 Constant A Register	54
20	5B	Counter 2 Constant B Register	Counter 1 Constant B Register	58
20	5F	Counter 4 Constant B Register	Counter 3 Constant B Register	5C
18	63	Debounce Duration Select and Enable Channels 0 to 7		60
18	67	Debounce Duration Select and Enable Channels 8 to 15		64
18	6B	Debounce Duration Select and Enable Channels 16 to 23		68
18	6F	Debounce Duration Select and Enable Channels 24 to 31		6C
18	73	Debounce Duration Select and Enable Channels 32 to 39		70
18	77	Debounce Duration Select and Enable Channels 40 to 47		74
18	7B	Debounce Duration Select and Enable Channels 48 to 55		78
18	7F	Debounce Duration Select and Enable Channels 56 to 63		7C
		Not Used ¹		
		↓		
	FFF	Not Used ¹		FFC

MEMORY MAP

When a 32-bit counter is enabled, the readback and constant registers of the two 16-bit counters that make the 32-bit counter become 32-bit register values.

3. The numbers in the left most column represent the User Manual page containing a description of the corresponding register.

This memory map reflects byte accesses using the "Little Endian" byte ordering format. Little Endian uses even-byte addresses to store the low-order byte. The Intel x86 family of microprocessors uses "Little Endian" byte ordering. Big Endian is the convention used in the Motorola 68000 microprocessor family and is the VMEbus convention. In Big Endian, the lower-order byte is stored at odd-byte addresses.

INTERRUPT REGISTERS

Interrupt Register (Read/Write) – (Base + 00H)

This read/write register is used to enable board interrupt operation, determine the pending status of interrupts, and release pending interrupts.

The function of each of the interrupt register bits is described in Table 3.3. This register can be read or written with either 8-bit, 16-bit, or 32-bit data transfers. A power-up or system reset sets all interrupt register bits to 0.

Table 3.3: *Interrupt Register*

BIT	FUNCTION
0	Board Interrupt Enable Bit. (Read/Write Bit) 0 = Disable Interrupt 1 = Enable Interrupt If enabled via this bit an interrupt request from the board will be issued to the system upon any of its interrupt conditions. The interrupt request will remain active until the interrupt release bit is set, or by disabling interrupts via this bit.
1	Board Interrupt Pending Status Bit. (Read Only Bit) 0 = Interrupt Not Pending 1 = Interrupt Pending This bit can be read to determine the interrupt pending status of the board. When this bit is logic "1" an interrupt is pending and will cause an interrupt request if bit-0 of the register is set. When this bit is a logic "0" an interrupt is not being requested. Once the bit is in the pending status it will remain until the pending interrupt is removed via the source of the interrupt. This bit will remain active even if interrupts are disabled via bit-0. When this bit is set the pending interrupt can originate from any of the counter timers or the 64 digital I/O channels. To identify the source of the pending interrupt base address plus 04H is read to identify a Counter/Timer Interrupt, while base address plus 08H and 0CH are read to identify Digital input Interrupts.
2 to 13	Not Used ¹
14	Software Reset: The board is reset.
15	Not Used ¹

1. All bits labeled "Not Used" will return logic "0" when read.

Interrupt Status/Clear Counter/Timer Register (Read/Write) – (Base + 04H)

INTERRUPT REGISTERS

This read/write register is used to determine the pending status of Counter/Timer interrupts, and release pending Counter/Timer interrupts.

The Counter/Timer interrupt status/clear bits 0 to 3 reflect the status of each of the Counter/Timers. **Read** of this bit reflects the interrupt pending status. Read of a “1” indicates that an interrupt is pending for the corresponding counter/timer. **Write** of a logic “1” to this bit to release a counter timer pending interrupt. Writing “0” to a bit location has no effect, a pending interrupt will remain pending. The Counter/Timer and its corresponding interrupt Pending/Clear bits are as shown in Table 3.4.

BIT	FUNCTION
0	Counter/Timer 1 Interrupt Pending/Clear
1	Counter/Timer 2 Interrupt Pending/Clear
2	Counter/Timer 3 Interrupt Pending/Clear
3	Counter/Timer 4 Interrupt Pending/Clear
4-31	Not Used ¹

Table 3.4: Board Counter/Timer Interrupt Status/Clear

1. All bits labeled “Not Used” will return logic “0” when read.

The board has 4 TTL 16-bit counters available. Two 16-bit counters can be configured as one 32-bit counter. For example, counter 1 and 2 can be combined to form a 32-bit counter. A counter configured as a 32-bit counter has its interrupt status/clear function controlled via the odd counter. For example, counter 3 and 4 when combined have their interrupt status/clear function controlled via bit-2.

Interrupt Status/Clear Digital I/O (Read/Write) – (Base + 08H & 0CH)

These read/write register is used to determine the pending status of Digital I/O interrupts, and release pending Digital I/O interrupts.

The Digital I/O interrupt status/clear registers reflect the status of each of the Digital I/O channels. **Read** of this bit reflects the interrupt pending status. Read of a “1” indicates that an interrupt is pending for the corresponding digital channel. **Write** of a logic “1” to this bit to release the corresponding digital channel’s pending interrupt. Writing “0” to a bit location has no effect, a pending interrupt will remain pending.

Digital I/O channel 0 interrupt status is identified via data bit-0 while Digital I/O channel 31 status is identified via data bit-31 at base address plus 08H. Digital I/O channel 32 interrupt status is identified via data bit-0 while Digital I/O channel 63 status is identified via data bit-31 at base address plus 0CH.

Reg. Num.	D31	D24	D23	D16	D15	D8	D7	D0
08H	31-0 Digital I/O Interrupt Status/Clear Bits							
0CH	63-32 Digital I/O Interrupt Status/Clear Bits							

DIGITAL INPUT/OUTPUT REGISTERS

Digital Input/Output Registers (Read/Write) – (Base + 10H and 14H)

Sixty-four possible input/output channels numbered 0 through 63 may be individually accessed via these registers. Channels 31 to 0 are accessed at the carrier base address +10H via data bits 31 to 0. Channels 63 to 32 are accessed at the carrier base address +14H via data bits 31 to 0. Channel input signal levels are determined by reading this register. Likewise, channel output signal levels are set by writing to this register. Note the data direction, input or output, must first be set via the Direction register at base address plus 18H.

Channel read/write operations use 8-bit, 16-bit, or 32-bit data transfers with the lower ordered bits corresponding to the lower-numbered channels for the register of interest. All input/output channels are configured as inputs on a power-on or software reset.

Direction Control Register (Read/Write) - (Base + 18H)

The data direction (input or output) of the 64 digital channels is selected via this register. The data direction of channels 0 to 47 is controlled on a port basis. Channels 0 to 47 are set/controlled via bits 0 to 5 as shown below. The data direction of channels 48 to 63 is controlled on an individual channel basis. Channels 48 to 63 are set/controlled via bits 16 to 31 as shown below. Setting a bit low configures the corresponding channel data direction for input. Setting the control bit high configures the corresponding channel data direction for output.

The counter/timer input and output control signals share Digital I/O channels 48 to 63. Each counter uses three input signals and one output signal. An enabled counter/timer has its required input and output signals automatically set by hardware and control via this register is disabled. If the counter is not used, then the ports are available for independent channel digital I/O.

Channels and Corresponding Register Bits					
Ch47 - 40	Ch39 - 32	Ch31 - 24	Ch23 - 16	Ch15 - 8	Ch7 - 0
D5	D4	D3	D2	D1	D0

Ch 55	Ch 54	Ch 53	Ch 52	Ch 51	Ch 50	Ch 49	Ch 48
D23	D22	D21	D20	D19	D18	D17	D16

Ch 63	Ch 62	Ch 61	Ch 60	Ch 59	Ch 58	Ch 57	Ch 56
D31	D30	D29	D28	D27	D26	D25	D24

The default power-up state of these registers is logic low. Thus, all channels are configured as inputs on system reset or power-up. Register bits D6 to D15 of this register are "Not Used" and will always read low (0's). Reading or writing to this register is possible via 32-bit, 16-bit or 8-bit data transfers.

Interrupt Enable Registers (Read/Write) – (Base + 1CH and 20H)

DIGITAL INTERRUPT REGISTERS

The Interrupt Enable Registers provide a mask bit for each of the 64 channels. A “0” bit will prevent the corresponding input channel from generating an external interrupt. A “1” bit will allow the corresponding channel to generate an interrupt.

The Interrupt Enable register at the base address + offset 1CH is used to control channels 0 through 31 via data bits 0 to 31. Channels 63 to 32 are accessed at the carrier base address +20H via data bits 31 to 0.

All channel interrupts are disabled (set to “0”) following a power-on or software reset. Reading or writing to this register is possible via 32-bit, 16-bit or 8-bit data transfers.

Interrupt Type (COS or H/L) Configuration Registers (Read/Write) - (Base + 24H and 28H)

The Interrupt Type Configuration Registers determine the type of input channel transition that will generate an interrupt for each of the 64 possible interrupting channels. A “0” bit selects interrupt on level. An interrupt will be generated when the input channel level specified by the Interrupt Polarity Register occurs (i.e. Low or High level transition interrupt). A “1” bit means the interrupt will occur when a Change-Of-State (COS) occurs at the corresponding input channel (i.e. any state transition, low to high or high to low).

The Interrupt Type Configuration register at base address + offset 24H is used to control channels 0 through 31. For example, channel 0 is controlled via data bit-0. Channels 63 to 32 are accessed at the carrier base address +28H via data bits 31 to 0. For example, channel 32 is controlled via data bit-0.

All bits are set to “0” following a reset which means that, if enabled, the inputs will cause interrupts for the levels specified by the digital input channel Interrupt Polarity Register.

Channel read or write operations use 8-bit, 16-bit, or 32-bit data transfers. Note that no interrupts will occur unless they are enabled by the Interrupt Enable Register.

Interrupt Polarity Registers (Read/Write) – (Base + 2CH and 30H)

The Interrupt Polarity Register determines the level that will cause a channel interrupt to occur for each of the channels enabled for level interrupts. A “0” bit specifies that an interrupt will occur when the corresponding input channel is low (i.e. a “0” in the digital input channel data register). A “1” bit means that an interrupt will occur when the input channel is high (i.e. a “1” in the digital input channel data register). Note that no interrupts will occur unless they are enabled by the Interrupt Enable Register. Further, the Interrupt Polarity Register will have no effect if the

DIGITAL INTERRUPT REGISTERS

Change-of-State (COS) interrupt type is configured by the Interrupt Type Configuration Register.

The Interrupt Polarity register at the carrier's base address + offset 2CH is used to control channels 0 through 31. Channels 63 to 32 are accessed at the carrier base address +30H via data bits 31 to 0. For example, channel 32 is controlled via data bit-0.

All bits are set to "0" following a reset which means that the inputs will cause interrupts when they are below TTL threshold (provided they are enabled for interrupt on level).

DEBOUNCE DURATION REGISTERS

Debounce Duration Select and Enable Registers (Read/Write) – (Base + 60H to 7CH)

This register controls debounce enable and duration selection for each of the 64 digital channels. Debounce, when enabled, will filter noise present on a channel's input line. All noise spikes with a duration less than the debounce time, selected via Table 3.5, are ignored when present on the input signal/channel.

Table 3.5a: Debounce Duration Select

Not Used Bits: 3, 7, 11, 15, 19, 23, 27, and 31 will return logic "0" when read.

Channels and Corresponding Register Bits								
Reg. Bits	Offset Address							
	60H	64H	68H	6CH	70H	74H	78H	7CH
2,1,0	Ch0	Ch8	Ch16	Ch24	Ch32	Ch40	Ch48	Ch56
6,5,4	Ch1	Ch9	Ch17	Ch25	Ch33	Ch41	Ch49	Ch57
10,9,8	Ch2	Ch10	Ch18	Ch26	Ch34	Ch42	Ch50	Ch58
14,13,12	Ch3	Ch11	Ch19	Ch27	Ch35	Ch43	Ch51	Ch59
18,17,16	Ch4	Ch12	Ch20	Ch28	Ch36	Ch44	Ch52	Ch60
22,21,20	Ch5	Ch13	Ch21	Ch29	Ch37	Ch45	Ch53	Ch61
26,25,24	Ch6	Ch14	Ch22	Ch30	Ch38	Ch46	Ch54	Ch62
30,29,28	Ch7	Ch15	Ch23	Ch31	Ch39	Ch47	Ch55	Ch63

The bits listed in the Register Bits column above must be set as shown in the Debounce Duration Select Table 3.5b.

Table 3.5b: Debounce Duration Select

LOGIC LEVEL OF BITS	FUNCTION
000	Debounce Disabled
001	1.6µs
010	10.4µs
011	408.8µs
100	3.276ms
101, 110, 111	Reserved

For example, to enable channel 33 and channel 37 for a debounce level of 10.4µs, and 3.276ms respectively, the value 400020H must be written to base address plus 70H. Notice bits 3, 7, 11, 15, 19, 23, 27, and 31 are don't care bits and are represented by an "X" in the following table. Note that writing 400020 Hex, to base address plus 70H, also disables debounce for channels 32, 34, 35, 36, 38, and 39.

Ch39	Ch38	Ch37	Ch36	Ch35	Ch34	Ch33	Ch32
Bits 31 down to 16				Bits 15 down to 0			
X000	X000	X100	X000	X000	X000	X010	X000
0	0	4	0	0	0	2	0
Disable	Disable	3.27ms	Disable	Disable	Disable	10.4µs	Disable

DEBOUNCE DURATION REGISTERS

The Debounce Duration Select and Enable register bits are set to “0” following reset. Thus, on reset and power-up debounce will be disabled by default. These registers are read/write registers that can be accessed with 8-bit, 16-bit, or 32-bit data transfers.

Counter Trigger Register (Write) - (Base + 34H)

This register is used to implement software triggering for all counter timers. Writing a 1 to the counter’s corresponding trigger bit of this register will cause the counter function to be triggered. Table 3.6 identifies the trigger bit location corresponding to each of the counters. The contents of this register are not stored and merely act to trigger the corresponding counters.

BIT	FUNCTION
0	Counter 1 Trigger (32-bit Counter Trigger)
1	Counter 2 Trigger
2	Counter 3 Trigger (32-bit Counter Trigger)
3	Counter 4 Trigger
4-15	Not Used ¹

COUNTER REGISTERS

Table 3.6: Board Counter Trigger Register

1. All bits will return logic “0” when read

Triggering may be used to initiate pulse width modulation, watchdog timer (initiates countdown), event counting, frequency measurement, pulse-width measurement, period measurement, or one-shot.

Writing to this register is possible via 32-bit, 16-bit or 8-bit data transfers.

Counter Stop Register (Read/Write) - (Base + 36H)

This register is used to stop one or a group of Counter/Timers. Writing a “1” to the counter’s corresponding stop bit of this register will cause the counter to be disabled. That is, bits 2, 1, and 0 of the counter control register are cleared to “000”, thus disabling and stopping the counter. Table 3.7 identifies the stop bit location corresponding to each of the counters. The bits of this register are not stored and merely act to stop the corresponding counter when set to logic high.

Writing to this register is possible via 32-bit, 16-bit or 8-bit data transfers.

BIT	FUNCTION
16	Counter 1 Stop (32-bit Counter Stop)
17	Counter 2 Stop
18	Counter 3 Stop (32-bit Counter Stop)
19	Counter 4 Stop
20-31	Not Used ¹

Table 3.7: Board Counter Stop Register

1. All bits will return logic “0” when read

COUNTER REGISTERS**Counter Readback Registers (Read Only) –
(Base + 48H and 4CH)**

The Counter Readback register is a dynamic function register that returns the current value held in the counter. It is updated with the value stored in the internal counter, each time it is read.

The internal counter is generally initialized with the value in the Counter Constant Register, and its value is incremented or decremented according to the application.

The Counter Readback register at base address + offset 48H corresponds to counters 1 and 2. Counters' 3 and 4 Readback registers are accessed at the carrier base address +4CH.

This register must be read using 32-bit long-word accesses for 32-bit enabled counters, but it may be read using 16-bit accesses for 16-bit enabled counters.

Note that the Counter Constant Registers are cleared (set to 0) following a system or software reset.

**Counter Constant A Registers (Write Only) –
(Base + 50H and 54H)**

This write-only register is used to store the counter/timer constant A value (initial value) for the various counting modes. Accesses to this register are allowed on a 16-bit or 32-bit long-word basis, only. It is necessary to load the constant value into the counter in one clock cycle. Thus, for a 16-bit counter a 16-bit or 32-bit write access is required, while a 32-bit write access is required for a 32-bit counter.

Base address + offset 50H corresponds to the Counter Constant A register for counters 1 and 2. Base address + offset 54H corresponds to the Counter Constant A register for counters 3 and 4.

**Counter Constant B Registers (Read/Write) –
(Base + 58H and 5CH)**

This read/write register is used to store the counter/timer constant B value. It is necessary to load the constant value into the counter in one clock cycle. Thus, for a 16-bit counter a 16-bit or 32-bit write access is required, while a 32-bit write access is required for a 32-bit counter.

Base address + offset 58H corresponds to the Counter Constant B register for counters 1 and 2. Base address + offset 5CH corresponds to the Counter Constant B register for counters 3 and 4.

**Counter Control Registers (Read/Write) –
(Base + 38H, 3CH, 40H, 44H)****COUNTER CONTROL
REGISTERS**

This register is used to configure counter/timer functionality. It defines the counter mode, output polarity, input polarity, clock source, counter size, and interrupt enable.

The memory map addresses corresponding to the control registers are given in Table 3.2. The Counter Control Register is cleared (set to 0) following a reset, thus disabling the counter/timer. Reading or writing to this register is possible via 32-bit, 16-bit, or 8-bit data transfers.

The board has four 16-bit Counter/Timers. A pair of counters can be grouped to form a 32-bit counter. Control register bit-14 when set high enables 32-bit counter mode. When a 32-bit counter is enabled it must be selected via control register 1 for counters 1 and 2. Likewise, control register 3 is used when counters 3 and 4 are enabled as a 32-bit counter.

The counter timer functions of the board provide seven modes of operation: pulse width modulation, watchdog timer, event counting, frequency measurement, pulse width measurement, period measurement, and one-shot pulse mode. The following sections describe the features of each method of operation and how to best use them.

COUNTER CONTROL REGISTERS

Pulse Width Modulation

Pulse width modulated waveforms may be generated at the counter timer output. The pulse width modulated waveform is generated continuously. Pulse Width Modulation generation is selected by setting Counter Control Register bits 2 to 0 to logic "010".

Counter Constant A value controls the time until the pulse goes active. The duration of the pulse is set via the Counter Constant B register. Note that a high pulse will be generated if active high output is selected while a low pulse will be generated if active low output is selected.

The counter goes through a countdown sequence for each Counter Constant value. When the 0 count is detected, the output toggles to the opposite state. Then the second Counter Constant value is loaded into the counter, and countdown resumes, decrementing by one for each rising edge of the clock selected via Control Register bits 12, 11, and 10. For example, a counter constant value of 3 will provide a pulse duration of 3 clock cycles of the selected clock. Note, when the internal 20MHz clock is selected, a delay of one extra clock cycle will be added to the counter constant value.

InA can be used as a Gate-Off signal to stop and start the counter and thus the pulse-width modulated output. When InA is enabled via bits 5 and 4 of the control register for active low Gate-Off input, a logic low input will enable pulse-width modulation counting while a logic high will stop PWM counting. When InA is enabled for active high Gate-Off operation, a logic high will enable PWM counting while a logic low will stop PWM counting.

InB can be used to input an external clock for use in PWM. Bits 7 and 6 must be set to either logic "01" or "10". Additionally, the clock source bits 12, 11, and 10 must be set to logic "101" to enable external clock input. PWM can alternatively be clocked via an internal 1.25MHz, 2.5MHz, 5MHz, 10MHz, or 20MHz clock as selected via control register bits 12, 11, and 10.

InC can be used to externally trigger Pulse Width Modulation generation. Additionally PWM can be triggered internally via the Counter Trigger Register at the base address + offset 34H. An initial trigger, software or external, causes the pulse width modulated signal to be generated. After an initial trigger, do not issue additional triggers. Triggers issued while running will cause the Constant A and B values to load at the wrong time. In addition, changing the Control register setting while running can also cause the Constant A and B values to load at the wrong time.

If the Interrupt Enable bit of the Counter Control Register is set (bit 15) and bit-0 of the Interrupt register is set, an interrupt is generated when the output pulse transitions from low to high and also for transitions from high to low. Thus, an interrupt is generated at each pulse transition.

Bit(s)	FUNCTION
2,1,0	Specifies the Counter Mode:
	010 Pulse Width Modulation
3	Output Polarity (Output Pin ACTIVE Level):
	0 Active LOW (Default)
	1 Active HIGH
5, 4	InA Polarity / Gate-Off Polarity
	00 Disabled (Default)
	01 Active LOW In A=0; Counter is Enabled In A=1; Counter is Disabled
	10 Active HIGH In A=0 Counter is Enabled In A=1 Counter is Disabled
	11 Disabled
7, 6	InB Polarity / External Clock Input
	00 Disabled (Default)
	01 External Clock Enabled
	10 External Clock Enabled
	11 Disabled
9,8	InC Polarity / External Trigger
	00 Disabled (Default)
	01 Active LOW External Trigger
	10 Active HIGH External Trigger
	11 Disabled
12,11,10	Clock Source
	000 Internal @ 1.25MHz (Default)
	001 Internal @ 2.5MHz
	010 Internal @ 5MHz
	011 Internal @ 10MHz
	100 Internal @ 20MHz
	101 External Clock (Up to 8MHz)
13	Not Used (bit is read as logic "0")
14	Counter Size:
	0 16-bit Counter (Default) ¹
	1 32-bit Counter
15	Interrupt Enable
	0 Disable Interrupt Service (Default)
	1 Enable Interrupt Service

COUNTER CONTROL REGISTERS

Pulse Width Modulation

Table 3.8: Counter Control Register (Pulse Width Modulation)

1. When two 16-bit counters are selected to implement a 32-bit counter the control register corresponding to the first 16-bit counter is used for control of the 32 bit counter.

COUNTER CONTROL REGISTERS

Watchdog Timer Operation

The watchdog operation counts down from a programmed (Counter Constant A) value until it reaches 0. While counting, the counter output will be in its active state (the output polarity is programmable). Upon time-out, the counter output will return to its inactive state, and an optional interrupt may be generated. Watchdog operation is selected by setting Counter Control Register bits 2 to 0 to logic "011".

A timed-out watchdog timer will not re-cycle until it is reloaded and then followed with a new trigger. Failure to cause a reload would generate an automatic time-out upon re-triggering, since the counter register will contain the 0 it previously counted down to.

InA input can be used to reload the counter with the Constant A register value. InA reload input is enabled via Control register bits 5 and 4. The counter can also be reloaded via a software write to the Counter Constant A register. Writing to the Counter Constant A register will load the value directly into the counter even if watchdog counting is active.

InB can be used to input an external clock for watchdog timing. Bits 7 and 6 must be set to either logic "01" or "10". Additionally, the clock source bits 12, 11, and 10 must be set to logic "101" to enable external clock input. The timer can alternatively be clocked via an internal 1.25MHz, 2.5MHz, 5MHz, 10MHz, or 20MHz clock as selected via control register bits 12, 11, and 10.

InC can be used to either continue/stop watchdog counting or as an external trigger input. When control register bits 9 and 8 are set to logic "11", InC functions as a Continue/Stop signal. When the Continue/Stop signal is high the counter continues counting (when low the counter stops counting). Alternately, when control register bits 9 and 8 are set to logic "01" or "10", the InC input functions as an external trigger input. The watchdog timer may also be internally triggered (via the Trigger Control Register at the base address + offset 34H).

When triggered, the counter/timer contents are decremented by one for each clock cycle, until it reaches 0, upon which a watchdog timer time-out occurs. For example, a counter constant value of 30 will provide a time-out delay of 30 clock cycles of the selected clock. However, due to the asynchronous relationship between the trigger and the selected clock, one clock cycle of error can be expected. The counter can be read from the Counter Readback register at any time during watchdog operation.

Upon time-out, the counter output pin returns to its inactive state. The board will also issue an interrupt upon detection of a count value equal to 0, if enabled via bit-15 of the Counter Control Register and bit-0 of the Interrupt register. This could be useful for alerting the host that a watchdog timer time-out has occurred and may need to be reinitialized. The interrupt will remain pending until the watchdog timer is reinitialized and the interrupt is released by setting the required bit of the Counter/Timer Interrupt Status/Clear register.

COUNTER CONTROL REGISTERS

Watchdog Timer Operation

Table 3.9: Counter Control Register (Watchdog Timer)

Bit(s)	FUNCTION
2,1,0	Specifies the Counter Mode:
	011 Watchdog Function
3	Output Polarity (Output Pin ACTIVE Level):
	0 Active LOW (Default)
	1 Active HIGH
5, 4	InA Polarity / Counter Reload
	00 Disabled (Default)
	01 Active LOW In A=0 Counter Reinitialized In A=1 Inactive State
	10 Active HIGH In A=0 Inactive State In A=1 Counter Reinitialized
	11 Disabled
7, 6	InB Polarity / External Clock Input
	00 Disabled (Default)
	01 External Clock Enabled
	10 External Clock Enabled
	11 Disabled
9,8	InC Polarity / External Trigger
	00 Disabled (Default)
	01 Active LOW Trigger
	10 Active HIGH Trigger
	11 Gate-Off (Continue when high/Stop when low)
12,11,10	Clock Source
	000 Internal @ 1.25MHz (Default)
	001 Internal @ 2.5MHz
	010 Internal @ 5MHz
	011 Internal @ 10MHz
	100 Internal @ 20MHz
	101 External Clock (Up to 8MHz)
13	Not Used (bit is read as logic "0")
14	Counter Size:
	0 16-bit Counter (Default) ¹
	1 32-bit Counter
15	Interrupt Enable
	0 Disable Interrupt Service (Default)
	1 Enable Interrupt Service

1. When two 16-bit counters are selected to implement a 32-bit counter the control register corresponding to the first 16-bit counter is used for control of the 32 bit counter.

COUNTER CONTROL REGISTERS

Event Counting Operation

Positive or negative polarity events can be counted. Event Counting is selected by setting Counter Control Register bits 2 to 0 to logic "100" and setting bits 12 to 10 to logic "000".

Input pulses or events occurring at the input InB of the counter will increment the counter until it reaches the Counter Constant A value. Upon reaching the count limit, an output pulse of 1.6 μ s will be generated at the counter output pin, and an optional interrupt may be generated. Additionally, the internal event counter is cleared. The counter will continue counting, again from 0, until it reaches the Counter Constant A value. Once triggered, event counting will continue until disabled via Control register bits 2 to 0.

InA can be used as a Gate-Off signal to stop and start event counting. When InA is enabled via bits 5 and 4 of the control register for active low Gate-Off input, a logic low input will enable event counting while a logic high will stop event counting. When InA is enabled for active high Gate-Off operation, a logic high will enable event counting while a logic low will stop event counting.

InB is used as the event input signal. Active high or low input events can be selected via Control register bits 7 and 6. A minimum event pulse width (InB) of 100ns is required for correct pulse detection with input debounce disabled. Programmable clock selection is not available in event counter mode.

InC can be used to either control up/down counting or as an external trigger input. When control register bits 9 and 8 are set to logic "11", InC functions as an Up/Down signal. When the Up/Down signal is high the counter is in the count down mode (when low the counter counts up). The counter will not count down below a count of zero. Alternately, when control register bits 9 and 8 are set to logic "01" or "10", the InC input functions as an external trigger input. Event counting may also be internally triggered (via the Trigger Control Register at the base address + offset 34H).

The Counter Constant A Register holds the count-to value (constant). Reading the Counter Readback Register will return the current count (variable). **The Counter Constant A value must not be left as 0.** The counter upon trigger starts counting from 0 and since the counter would match the count-to value the counter resets and starts counting from zero again.

If the Interrupt Enable bit of the Counter Control Register is set (bit 15) and bit-0 of the Interrupt register is set, an interrupt is generated when the number of input pulse events is equal to the Counter Constant A register value. The internal counter is then cleared and will continue counting events until the counter constant A value is again reached and a new interrupt generated. An interrupt will remain pending until released by setting the required bit of the Counters Interrupt Status/Clear register at the base address + offset 04H. A pending interrupt can also be cleared, by setting Control register bit-15 to logic low.

Bit(s)	FUNCTION	
2,1,0	Specifies the Counter Mode:	
	100 Event Counting	
3	Output Polarity (Output Pin ACTIVE Level):	
	0 Active LOW (Default)	
	1 Active HIGH	
5, 4	InA Polarity / Gate-Off	
	00 Disabled (Default)	
	01	Active LOW In A=0: Continue Counting In A=1: Stop Counting
		Active HIGH In A=0: Stop Counting In A=1: Continue Counting
	11	Disabled
7, 6	InB Polarity / Event Input	
	00 Disabled (Default)	
	01 Active LOW Events	
	10 Active HIGH Events	
	11 Disabled	
9,8	InC Polarity / External Trigger	
	00 Disabled (Default)	
	01 Active LOW Trigger	
	10 Active HIGH Trigger	
	11 Up when logic low /Down when logic high	
12,11,10	Specifies the Counter Mode:	
	000 Event Counting	
13	Not Used (bit is read as logic "0")	
14	Counter Size:	
	0 16-bit Counter (Default) ¹	
	1 32-bit Counter	
15	Interrupt Enable	
	0 Disable Interrupt Service (Default)	
	1 Enable Interrupt Service	

COUNTER CONTROL REGISTERS

Event Counting Operation

Table 3.10: Counter Control Register (Event Counting)

1. When two 16-bit counters are selected to implement a 32-bit counter the control register corresponding to the first 16-bit counter is used for control of the 32 bit counter.

COUNTER CONTROL REGISTERS

Frequency Measurement Operation

Frequency Measurement is selected by setting Counter Control Register bits 2 to 0 to logic "100" and setting bits 12 to 10 to logic "111". The counter counts how many InB edges (low to high or high to low) are received during the InA enable interval. The frequency is the number of counts divided by the duration of the InA enable signal.

InA is used as an enable signal to start frequency measurement. The InA signal must be a pulse of known width. When InA is configured (via bits 5 and 4 of the control register) as an active low enable input, a logic low input will enable frequency measurement while a logic high will stop frequency measurement. When InA is configured as an active high enable signal, a logic high will enable frequency measurement while a logic low will stop frequency measurement.

InB is used to input the signal whose frequency is to be measured. Input pulses occurring at input InB of the counter are counted while the enable signal present on InA is active. When the InA signal goes inactive, the counter output will generate a 1.6 μ s output pulse and an optional interrupt.

InC can be used as an external trigger input. When control register bits 9 and 8 are set to logic "01" or "10", the InC input functions as an external trigger input. Frequency measurement may also be internally triggered (via the Trigger Control Register at the base address + offset 34H). An initial trigger, software or external, starts frequency measurement upon the active edge of the InA enable signal. Retrigger is required for a new frequency measurement.

The Counter Constant A Register is not used for frequency measurement. Do not write to this register while the counter is actively counting since this will cause the counter to be loaded with the Constant A value.

Reading the Counter Readback Register will return the current count (variable). A minimum event pulse width (InB) of 100ns is required for correct pulse detection with input debounce disabled. Programmable clock selection is not available for frequency measurement.

If the Interrupt Enable bit-15 of the Counter Control Register is set and bit-0 of the Interrupt register is set, an interrupt is generated when the input InA enable pulse goes inactive. An interrupt will remain pending until released by setting the required bit of the Counters Interrupt Status/Clear register at the base address + offset 04H. A pending interrupt can also be cleared, by setting the Counter Control register bit-15 to logic low.

COUNTER CONTROL REGISTERS

Frequency Measurement Operation

Table 3.11: Counter Control Register (Frequency Measurement)

Bit(s)	FUNCTION
2,1,0	Specifies the Counter Mode:
	100 Frequency Measurement
3	Output Polarity (Output Pin ACTIVE Level):
	0 Active LOW (Default)
	1 Active HIGH
5, 4	InA Polarity / Enable Pulse of Known Width
	00 Disabled (Default)
	01 Active LOW Pulse
	10 Active HIGH Pulse
	11 Disabled
7, 6	InB Polarity / Signal Measured/Counted
	00 Disabled (Default)
	01 Active LOW Pulse Counted
	10 Active HIGH Pulse Counted
	11 Disabled
9,8	InC Polarity / External Trigger
	00 Disabled (Default)
	01 Active LOW Trigger
	10 Active HIGH Trigger
	11 Disabled (Default)
12,11,10	Specifies the Counter Mode:
	111 Frequency Measurement
13	Not Used (bit is read as logic "0")
14	Counter Size:
	0 16-bit Counter (Default) ¹
	1 32-bit Counter
15	Interrupt Enable
	0 Disable Interrupt Service (Default)
	1 Enable Interrupt Service

1. When two 16-bit counters are selected to implement a 32-bit counter the control register corresponding to the first 16-bit counter is used for control of the 32 bit counter.

COUNTER CONTROL REGISTERS

Input Pulse Width Measurement

Setting bits 2 to 0 of the Counter Control Register to logic "101" configures the counter for pulse-width measurement. After pulse-width measurement is triggered, the first input pulse is measured.

InA is used to input the pulse to be measured. An active low or high pulse can be measured.

InB can be used to input an external clock for Pulse-Width Measurement. Bits 7 and 6 must be set to either logic "01" or "10". Additionally, the clock source bits 12, 11, and 10 must be set to logic "101" to enable external clock input. Pulse Width Measurement can alternatively be clocked via an internal 1.25MHz, 2.5MHz, 5MHz, 10MHz, or 20MHz clock as selected via control register bits 12, 11, and 10.

InC can be used to externally trigger Pulse Width Measurement. Additionally, Pulse Width Measurement can be triggered internally via the Counter Trigger Register at the base address + offset 34H. An initial trigger, software or external, starts pulse width measurement at the beginning of the next active pulse.

For pulse-width measurement, the pulse-width being measured serves as an enable control for an up-counter whose value can be read from the Counter Readback Register. When triggered, the counter is reset and then increments by one for each clock pulse while the input signal level remains in the active state (high or low according to the programmed polarity of input InA). The resultant pulse-width is equivalent to the count value read from the Counter Readback Register, multiplied by the clock period. An output pulse will be generated at the counter output pin to signal the completion of a given measurement. Note that the measured pulse may be in error by ± 1 clock cycle.

A counter value of 0xFFFF hex for a 16-bit counter or 0xFFFFFFFF for a 32-bit counter indicates that the pulse duration is longer than the current counter size and clock frequency can measure. Upon read of this overflow value you must select a slower clock frequency and re-measure.

An interrupt can be generated upon completion of a given pulse width measurement (the pulse has returned to the opposite polarity), if enabled via the interrupt enable bit of the Counter Control Register (bit 15) and bit-0 of the Interrupt register. The interrupt will remain pending until released by setting the required bit of the Counter's Interrupt Status/Clear register at the base address + offset 04H. A pending interrupt can also be cleared, by setting the Counter Control register bit-15 to logic low.

**COUNTER CONTROL
REGISTERS**

**Input Pulse Width
Measurement**

Table 3.12: Counter Control Register (Input Pulse Width Measurement)

Bit(s)	FUNCTION
2,1,0	Specifies the Counter Mode:
	101 Pulse-Width Measurement
3	Output Polarity (Output Pin ACTIVE Level):
	0 Active LOW (Default)
	1 Active HIGH
5, 4	InA Polarity / Pulse Polarity to be Measured
	00 Disabled (Default)
	01 Active LOW Pulse is Measured
	10 Active HIGH Pulse is Measured
	11 Disabled
7, 6	InB Polarity / External Clock Input
	00 Disabled (Default)
	01 External Clock Enabled
	10 External Clock Enabled
	11 Disabled
9,8	InC Polarity / External Trigger
	00 Disabled (Default)
	01 Active LOW Trigger
	10 Active HIGH Trigger
	11 Disabled
12,11,10	Clock Source
	000 Internal @ 1.25MHz (Default)
	001 Internal @ 2.5MHz
	010 Internal @ 5MHz
	011 Internal @ 10MHz
	100 Internal @ 20MHz
	101 External Clock (Up to 8MHz)
13	Not Used (bit is read as logic "0")
14	Counter Size:
	0 16-bit Counter (Default) ¹
	1 32-bit Counter
15	Interrupt Enable
	0 Disable Interrupt Service (Default)
	1 Enable Interrupt Service

1. When two 16-bit counters are selected to implement a 32-bit counter the control register corresponding to the first 16-bit counter is used for control of the 32 bit counter.

COUNTER CONTROL REGISTERS

Input Period Measurement

The counter/timer may be used to measure the period of an input signal at the counter input InA. Setting bits 2 to 0 of the Counter Control Register to logic "110" configures the counter for period measurement. The first input cycle after period measurement is triggered will be measured.

InA is used to input the signal to be measured. Period measurement can be initiated on the active low or high portion of the waveform. The period of signal is the time the signal is low added to the time the signal is high, before it repeats.

InB can be used to input an external clock for period measurement. Bits 7 and 6 must be set to either logic "01" or "10". Additionally, the clock source bits 12, 11, and 10 must be set to logic "101" to enable external clock input. Period measurement can alternatively be clocked via an internal 1.25MHz, 2.5MHz, 5MHz, 10MHz, or 20MHz clock as selected via control register bits 12, 11, and 10.

InC can be used to externally trigger period measurement. Additionally, Period Measurement can be triggered internally via the Counter Trigger Register at the base address + offset 34H. An initial trigger, software or external, starts period measurement at the beginning of the next active period.

The period being measured serves as an enable control for an up-counter whose value can be read from the Counter Readback Register. When triggered the counter is reset. Then, the active polarity of InA starts period measurement. The counter increments by one for each clock pulse during the input signal period (InA). The resultant period is equivalent to the count value read from the Counter Readback Register, multiplied by the clock period. A 1.6 μ s output pulse will be generated at the counter output pin to signal the completion of a given measurement. Note that the measured period may be in error by ± 1 clock cycle.

A counter value of 0xFFFF hex for a 16-bit counter or 0xFFFFFFFF for a 32-bit counter indicates that the period duration is longer than the current counter size and clock frequency can measure. Upon read of this overflow value you must select a slower clock frequency and re-measure.

An interrupt can be generated upon completion of a given period measurement, if enabled via the interrupt enable bit of the Counter Control Register (bit 15) and bit-0 of the Interrupt register. The interrupt will be generated upon completion of the first complete waveform cycle after the counter is triggered. The interrupt will occur even if an external clock is selected but no clock signal is provided on InB. The count value will be zero in this case. The interrupt, once driven active, will remain pending until released by setting the required bit of the Interrupt Status/Clear register at the base address + offset 04H. A pending interrupt can also be cleared, by setting Counter Control register bit-15 to logic low.

Bit(s)	FUNCTION
2,1,0	Specifies the Counter Mode:
	110 Period Measurement
3	Output Polarity (Output Pin ACTIVE Level):
	0 Active LOW (Default)
	1 Active HIGH
5, 4	InA Polarity / Signal Measured
	00 Disabled (Default)
	01 Active LOW portion of the signal starts period measurement.
	10 Active HIGH portion of the signal starts period measurement.
7, 6	InB Polarity / External Clock Input
	00 Disabled (Default)
	01 External Clock Enabled
	10 External Clock Enabled
9,8	InC Polarity / External Trigger
	00 Disabled (Default)
	01 Active LOW Trigger
	10 Active HIGH Trigger
12,11,10	Clock Source
	000 Internal @ 1.25MHz (Default)
	001 Internal @ 2.5MHz
	010 Internal @ 5MHz
	011 Internal @ 10MHz
	100 Internal @ 20MHz
	101 External Clock (Up to 8MHz)
13	Not Used (bit is read as logic "0")
14	Counter Size:
	0 16-bit Counter (Default) ¹
	1 32-bit Counter
15	Interrupt Enable
	0 Disable Interrupt Service (Default)
	1 Enable Interrupt Service

COUNTER CONTROL REGISTERS

Input Period Measurement

Table 3.13: Counter Control Register (Input Period Measurement)

1. When two 16-bit counters are selected to implement a 32-bit counter the control register corresponding to the first 16-bit counter is used for control of the 32 bit counter.

COUNTER CONTROL REGISTERS

One-Shot Pulse Mode

One-Shot pulse mode provides an output pulse that is asserted one time or repeated each time it is re-triggered. One-Shot generation is selected by setting Counter Control Register bits 2 to 0 to logic "111".

The Counter Constant A value controls the time until the pulse goes active. The duration of the pulse high or low is set via the Counter Constant B value. Note that the Constant B value defines the logic high pulse width, if active high output is selected, and a low pulse if active low output is selected.

The counter goes through a full countdown sequence for each Counter Constant value. When the 0 count is detected, on the next rising-edge of the clock, the output toggles to the opposite state, and the Counter Constant B value is loaded into the counter and countdown resumes, decrementing by one each clock cycle. For example, a counter constant value of 7 will provide a pulse duration of 7 clock cycles of the selected clock, then 50ns will be added for the count detection of 0.

InA can be used as a Gate-Off signal to stop and start the counter and, thus output. When InA is enabled via bits 5 and 4 of the control register for active low Gate-Off input, a logic low input will enable the one-shot counter while a logic high will stop the one-shot counter. When InA is enabled for active high Gate-Off operation, a logic high will enable the one-shot counter while a logic low will stop the one-shot counter.

InB can be used to input an external clock for use in one-shot. Bits 7 and 6 must be set to either logic "01" or "10". Additionally, the clock source bits 12, 11, and 10 must be set to logic "101" to enable external clock input.

InC can be used to externally trigger One-Shot pulse mode. Additionally, a one-shot pulse can be triggered internally via the Counter Trigger Register at the base address + offset 34H. An initial trigger, software or external, causes the one-shot signal to be generated with no additional triggers required. Additional triggers must not be input until the one shot pulse has completed count down of the Constant B value.

If the Interrupt Enable bit-15 of the Counter Control Register is set, and bit-0 of the Interrupt register is set, an interrupt is generated when the pulse transitions from low to high and also when the pulse transitions from high to low. The interrupt will remain pending until released by setting the required bit of the Counters Interrupt Status/Clear register at the base address + offset 04H. A pending interrupt can also be cleared, by setting the Counter Control register bit-15 to logic low.

Bit(s)	FUNCTION
2,1,0	Specifies the Counter Mode:
	111 One-Shot Generation
3	Output Polarity (Output Pin ACTIVE Level):
	0 Active LOW (Default)
	1 Active HIGH
5, 4	InA Polarity / Gate-Off Polarity
	00 Disabled (Default)
	01 Active LOW In A=0 Output Enabled In A=1 Output Disabled
	10 Active HIGH In A=0 Output Disabled In A=1 Output Enabled
	11 Disabled
7, 6	InB Polarity / External Clock Input
	00 Disabled (Default)
	01 External Clock Enabled
	10 External Clock Enabled
	11 Disabled
9,8	InC Polarity / External Trigger
	00 Disabled (Default)
	01 Active LOW Trigger
	10 Active HIGH Trigger
	11 Disabled
12,11,10	Clock Source
	000 Internal @ 1.25MHz (Default)
	001 Internal @ 2.5MHz
	010 Internal @ 5MHz
	011 Internal @ 10MHz
	100 Internal @ 20MHz
	101 External Clock (Up to 8MHz)
13	Not Used (bit is read as logic "0")
14	Counter Size:
	0 16-bit Counter (Default) ¹
	1 32-bit Counter
15	Interrupt Enable
	0 Disable Interrupt Service (Default)
	1 Enable Interrupt Service

COUNTER CONTROL REGISTERS

One-Shot Pulse Mode

Table 3.14: Counter Control Register (One-Shot Pulse)

1. When two 16-bit counters are selected to implement a 32-bit counter the control register corresponding to the first 16-bit counter is used for control of the 32 bit counter.

PROGRAMMING EXAMPLES

The following section provides sample applications for each of the counter modes of operation. This includes I/O pin assignments, register settings, required calculations, and waveform diagrams.

Pulse Width Modulation Example

The objective for this example is to create a pulse width modulated with an active high pulse of 2 μ s and a low pulse of 6 μ s using 16-bit Counter 3. The counter has an external active high gate-off, trigger, and clock signals. The output is active high. Assume the external clock has a frequency of 500KHz. The Gate-Off signal will become active after 2 PWM cycles. Additionally, interrupts are enabled.

1. Connect the inputs/output to the following pins (unpowered):

Table 3.17: PWM Pin Assignments for Counter 3

Pin #	Connection	Description
61	In3_A(+)	Gate-Off
62	In3_B(+)	Ext. Clock
63	In3_C(+)	Ext. Trigger
64	Out3(+)	Output

Note: Make sure all inputs and outputs are properly grounded.

2. Write the following information, 966AH, to Counter 3 Control Register located at base address plus an offset of 40H.

Table 3.18: PWM Counter Control Register 3 Settings

Bits	Logic	Operation
2,1,0	010	Sets the counter to Pulse Width Modulation mode.
3	1	Sets the output to active high.
5,4	10	Enable the Gate-Off input (InA) to active high.
7,6	01	Enables the external clock input (InB).
9,8	10	Enables the external Trigger Input (InC) to active high.
12,11,10	101	Sets the clock to an external source.
13	0	Not Used
14	0	Select a 16-bit counter size for use.
15	1	Enables interrupts. ¹

1. Make sure that bit 0 at base address plus an offset 0H is set to enable interrupts.

3. Write the 16-bit value 3H to Counter 3 Constant A Register located at base address plus an offset 54H for the non-active portion of the pulse, and 1H to Counter 3 Constant B Register located at base address plus an offset 5CH for the active portion of the pulse.

In order to determine the necessary Counter Constant values first calculate the period of the selected clock (internal or external). The period is calculated by taking the inverse of the clock frequency. In this case, 1/500KHz is equal to 2 μ s. Then take the total time for the low portion of the pulse and divide it by the clock period. For this example, 6 μ s/2 μ s is equal to 3. Convert this value to Hex and the result is the total count that is placed in the appropriate Counter Constant Register. Since it has been stipulated that the pulse is active high, 3H is written to Counter 3 Constant A Register, which contains the value for the non-active (low) portion of the pulse. The same procedure is used to calculate the Constant B value. Take the total period of the high portion of the pulse and divide it by the period of the clock.

Here $2\mu\text{s}/2\mu\text{s}$ is equal to 1. Converting to hex, 1H is written to Counter 3 Constant B Register since it contains the active (high) portion of the pulse.

4. The following is a waveform diagram of this example.

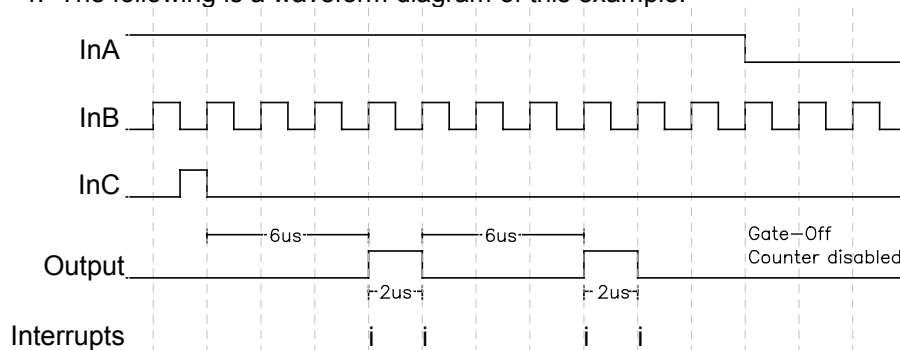

PROGRAMMING EXAMPLES

Figure 3.3: PWM waveform

In the figure an “i” represents an interrupt

Note that the InA and InC inputs run off the internal 20MHz clock. Those signals may not be synchronous with an external clock. The delay after the trigger on InC to the Output pulse going active can vary by one clock period. With the 500KHz clock of this example the variance will be $2\mu\text{s}$. That means the delay from InC trigger to Output signal going active can be between $6\mu\text{s}-2\mu\text{s}$ ($4\mu\text{s}$) and $6\mu\text{s}$.

Watchdog Timer Operation Example

The objective for this example is to create a Watchdog Timer with a countdown length of $10\mu\text{s}$ using 32-bit Counter 1 with an external active high counter reload, clock, and active low trigger signals. The output is active high. Assume the external clock has a frequency of 500KHz. The counter reload and trigger signals are periodic. Additionally, interrupts are enabled.

Since Counter 1 is a 32-bit counter, Counter 2 cannot be used.

1. Connect the inputs/output to the following pins (unpowered):

Pin #	Connection	Description
27	In1_A(+)	Reload
28	In1_B(+)	Ext. Clock
29	In1_C(+)	Ext. Trigger
30	Out1(+)	Output

Table 3.19: Watchdog Pin Assignments for Counter 1

Note: Make sure all inputs and outputs are properly grounded.

2. Write the following information, D56BH, to Counter 1 Control Register located at base address plus an offset of 38H.

Bits	Logic	Operation
2,1,0	011	Sets the counter to Watchdog mode.
3	1	Sets the output to active high.
5,4	10	Enable the Counter Reload input (InA) to active high.
7,6	01	Enables the external clock input (InB).
9,8	01	Enables the external Trigger Input (InC) to active low.
12,11,10	101	Sets the clock to an external source.
13	0	Not Used
14	1	Select a 32-bit counter size for use.
15	1	Enables interrupts. ¹

Table 3.20: Watchdog Counter Control Register 1 Settings

1. Make sure that bit 0 at base address plus an offset 0H is set to enable interrupts.

PROGRAMMING EXAMPLES

Counter Constant B Register is not used in Watchdog mode.

Figure 3.4: Watchdog waveform

3. Write the 32-bit value 5H to Counter 1 Constant A Register located at the base address plus an offset of 50H.

In order to determine the correct Constant A Register value, first calculate the period of the selected clock. The period is calculated by taking the inverse of the clock frequency. In this case, 1/500KHz is equal to 2µs. Then take the total duration of the watchdog timer and divide it by the clock period. For this example, 10µs/2µs is equal to five. Converted to Hex, this is the number to write to the Counter 1 Constant A Register.

4. The following is a waveform diagram of this example.

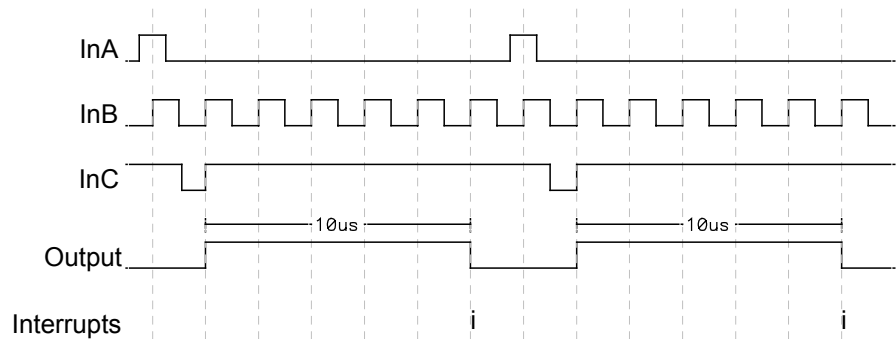

In the figure each “i” represents an interrupt

In Watchdog mode, the counter must be loaded (InA) and then triggered (InC) for each cycle. The counter can be loaded internally or externally.

Note that the InA and InC inputs run off the internal 20MHz clock. Those signals may not be synchronous with an external clock. The delay after the trigger on InC to the Output pulse going low can vary by one clock period. With the 500KHz clock of this example the variance will be 2µs. That means the delay from InC trigger to Output signal going low can be between 10µs-2µs (8µs) and 10µs.

Event Counting Operation Example

The objective for this example is to create an Event Counter that will count the number of active high events on InB using 32-bit Counter 3. The output is active low. Additionally the counter has an active low Gate-Off and an active low External Trigger. After every five events, the event counter interrupts.

1. Connect the inputs/output to the following pins (unpowered):

Pin #	Connection	Description
61	In3_A(+)	Gate-Off
62	In3_B(+)	Event Input
63	In3_C(+)	Ext. Trigger
64	Out3(+)	Output

2. Write the following information, C194H, to Counter 3 Control Register located at base address plus an offset of 40H.

Since Counter 3 is a 32-bit counter, Counter 4 cannot be used.

Table 3.21: Event Counting Pin Settings for Counter 3

Note: Make sure all inputs and outputs are properly grounded.

Bits	Logic	Operation
2,1,0	100	Sets the counter to Event Counting mode.
3	0	Sets the output to active low.
5,4	01	Enable the Gate-Off input (InA) to active low.
7,6	10	Enables the Event input (InB) to active high.
9,8	01	Enables the external Trigger Input (InC) to active low.
12,11,10	000	Sets the counter to Event Counting mode.
13	0	Not Used
14	1	Select a 32-bit counter size for use.
15	1	Enables interrupts. ¹

PROGRAMMING EXAMPLES

Table 3.22: Event Counter Control Register 3 Settings

1. Make sure that bit 0 at base address plus an offset 0H is set to enable interrupts.

3. Write the 32-bit value 5H to Counter 3 Constant A Register located at the base address plus an offset of 54H.

In Event Counting, when the Constant A Register is equal to the value in the Read Back Register, in this case located at base address plus an offset of 4CH, there is an output pulse and an interrupt. Furthermore, when this condition occurs, the counter resets to zero and starts incrementing again. For this example, an interrupt and output pulse will occur every five events. Therefore 5H is written to the Counter 3 Constant A Register. Note that all values are stored and read in Hex.

Counter Constant B Register is not used in Event Counting mode.

4. The following is a waveform diagram of this example.

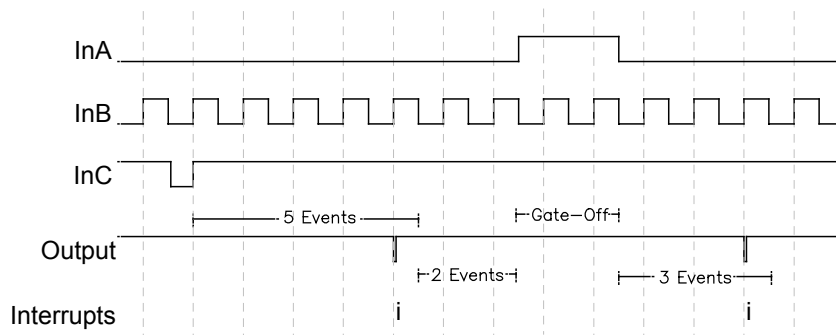

Figure 3.5: Event Counting waveform

In the figure each "i" represents an interrupt

The Gate-Off signal is used in this example to pause the counter. While the Gate-Off signal is non-active (logic high), the counter and output will remain constant. Additionally, the output pulse is active for 1.6µs upon the detection of the final event. For further information, see the Event Counting Operation description.

PROGRAMMING EXAMPLES

Since Counter 1 is a 32-bit counter, Counter 2 cannot be used.

Table 3.23: Frequency Measurement Pin Assignments for Counter 1

Frequency Measurement Operation Example

The objective for this example is to use the Frequency Measurement Operation using 32-bit Counter 1. The enable signal and the signal measured are active high. Additionally, the counter has an active low External Trigger. The output of the counter is active low and interrupts are enabled. Assume the enable pulse has a duration of 50µs.

1. Connect the inputs/output to the following pins (unpowered):

Pin #	Connection	Description
27	In1_A(+)	Enable Input
28	In1_B(+)	Signal Input
29	In1_C(+)	Ext. Trigger
30	Out1(+)	Output

Note: Make sure all inputs and outputs are properly grounded.

2. Write the following information, DDA4H, to Counter 1 Control Register located at base address plus an offset of 38H.

Table 3.24: Frequency Measurement Control Register 1 Settings

Bits	Logic	Operation
2,1,0	100	Sets the counter to Frequency Measurement.
3	0	Sets the output to active low.
5,4	10	Sets the Enable Pulse input (InA) to active high.
7,6	10	Enables the Signal input (InB) to active high.
9,8	01	Enables the external Trigger Input (InC) to active low.
12,11,10	111	Sets the counter to Frequency Measurement mode.
13	0	Not Used
14	1	Select a 32-bit counter size for use.
15	1	Enables interrupts. ¹

1. Make sure that bit 0 at base address plus an offset 0H is set to enable interrupts.

3. Do not write to either of the Counter 1 Constant Registers. They are not required for frequency measurement and writing to them can cause errors.

4. The following is a waveform diagram of this example.

Figure 3.6: Frequency Measurement waveform

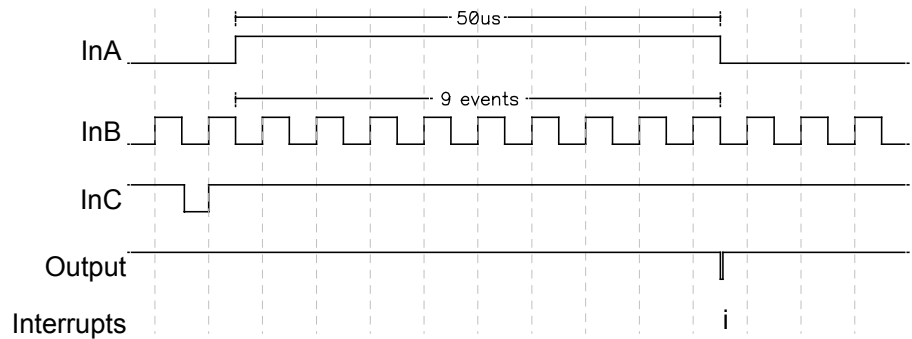

In the figure each "i" represents an interrupt

The frequency of the signal is calculated by dividing the value in the Counter 1 Read Back Register, located at base address plus an offset of 48H, by the duration of the InA enable signal. Note that the value in the Read Back Register is stored in Hex and requires conversion to decimal for calculations. In this case the pulse length is 50µs. The value in the Read Back Register is 9, since there were nine high pulses during the enable signal. Therefore, the frequency is 9/50µs, which is equal to 180KHz.

Note that the counter must be re-triggered before the next frequency measurement can take place. Additionally, the output pulse is active for 1.6µs. For further information, see the Frequency Measurement Operation description.

PROGRAMMING EXAMPLES

Input Pulse-Width Measurement Example

The objective for this example is to use the Pulse-Width Measurement Operation using 32-bit Counter 3. The pulse to be measured is active low. Additionally the counter has an external clock and an active low External Trigger. The output of the counter is active high and interrupts are enabled. Assume the external clock has a frequency of 100KHz.

Since Counter 3 is a 32-bit counter, Counter 4 cannot be used.

1. Connect the inputs/output to the following pins (unpowered):

Pin #	Connection	Description
61	In3_A(+)	Pulse Input
62	In3_B(+)	Ext. Clock
63	In3_C(+)	Ext. Trigger
64	Out3(+)	Output

Table 3.25: Pulse-Width Measurement Pin Assignments for Counter 3

Note: Make sure all inputs and outputs are properly grounded.

2. Write the following information, D59DH, to Counter 3 Control Register located at base address plus an offset of 40H.

Bits	Logic	Operation
2,1,0	101	Sets the counter to Pulse-Width Measurement.
3	1	Sets the output to active high.
5,4	01	Sets the Pulse input (InA) to active low.
7,6	10	Enables the external clock input (InB).
9,8	01	Enables the external Trigger Input (InC) to active low.
12,11,10	101	Sets the clock to an external source.
13	0	Not Used
14	1	Select a 32-bit counter size for use.
15	1	Enables interrupts. ¹

Table 3.26: Pulse-Width Measurement Control Register 3 Settings

1. Make sure that bit 0 at base address plus an offset 0H is set to enable interrupts.

3. Do *not* write to either of the Counter 3 Constant Registers. They are not required for pulse-width measurement and writing to them can cause errors.

PROGRAMMING EXAMPLES

Figure 3.7: Pulse-Width
Measurement waveform

In the figure each "i"
represents an interrupt

4. The following is a waveform diagram of this example.

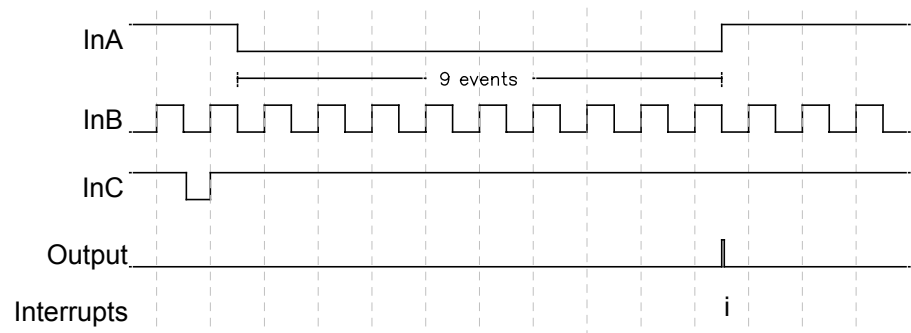

The length of the low portion of the InA pulse is calculated by multiplying the number in the Counter 3 Read Back Register, located at base address plus an offset of 4CH, by the period of the selected clock. Note that the value in the Read Back Register is stored in Hex and requires conversion to decimal for calculations. In this case the value in the Read Back Register is 9, since there were nine high pulses during the active InA signal. The period of the clock is calculated by taking the inverse of the frequency of the clock. For this example, the frequency was 100KHz. Therefore the clock period is $1/100\text{KHz}$, which is equal to $10\mu\text{s}$. The clock period multiplied by the Read Back Register $10\mu\text{s} \times 9$, is equal to $90\mu\text{s}$, the duration of the active low InA pulse. This value may be in error by ± 1 clock period.

Note that the InA and InC inputs run off the internal 20MHz clock. Those signals may not be synchronous with the selected clock. The output pulse is active for $1.6\mu\text{s}$. Additionally, the counter must be re-triggered before any further measurements take place. For more information, see the Pulse-Width Measurement description.

Input Period Measurement Example

The objective for this example is to use the Input Period Measurement operation using 32-bit Counter 3. The high-to-low transition of the input signal will begin measurement. Additionally, the counter has an external clock and an active high External Trigger. The output of the counter is active high and interrupts are enabled. Assume the external clock has a frequency of 250KHz.

1. Connect the inputs/output to the following pins (unpowered):

Pin #	Connection	Description
61	In3_A(+)	Period Input
62	In3_B(+)	Ext. Clock
63	In3_C(+)	Ext. Trigger
64	Out3(+)	Output

2. Write the following information, D65EH, to Counter 3 Control Register located at base address plus an offset of 40H.

Bits	Logic	Operation
2,1,0	110	Sets the counter to Input Period Measurement.
3	1	Sets the output to active high.
5,4	01	Sets the Period input (InA) to active low.
7,6	01	Enables the external clock input (InB).
9,8	10	Enables the external Trigger Input (InC) to active high.
12,11,10	101	Sets the clock to an external source.
13	0	Not Used
14	1	Select a 32-bit counter size for use.
15	1	Enables interrupts. ¹

3. Do *not* write to either of the Counter 3 Constant Registers. They are not required for input period measurement and writing to them can cause errors.

4. The following is a waveform diagram of this example.

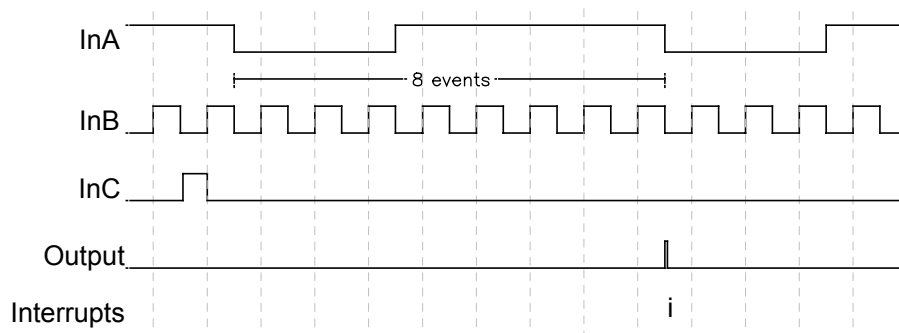

PROGRAMMING EXAMPLES

Since Counter 3 is a 32-bit counter, Counter 4 cannot be used.

Table 3.27: Input Period Measurement Pin Assignments for Counter 3

Note: Make sure all inputs and outputs are properly grounded.

Table 3.28: Input Period Measurement Control Register 3 Settings

1. Make sure that bit 0 at base address plus an offset 0H is set to enable interrupts.

Figure 3.8: Input Period Measurement waveform

In the figure each “i” represents an interrupt

PROGRAMMING EXAMPLES

The period of one cycle of the InA waveform is calculated by multiplying the number in the Counter 3 Read Back Register, located at the base address plus an offset of 4CH, by the period of the selected clock. Note that the value in the Read Back Register is stored in Hex and requires conversion to decimal for calculations. In this case the value in the Counter 3 Read Back Register is 8, since there were eight high pulses during one InA period. The period of the clock is calculated by taking the inverse of the frequency of the clock. For this example, the frequency was 250KHz. Therefore, the clock period is 1/250KHz, which is equal to 4 μ s. The clock period multiplied by the Read Back Register 4 μ s x 8, is equal to 32 μ s (the period of the InA waveform). This value may be in error by ± 1 clock period.

Note that the InA and InC inputs run off the internal 20MHz clock. Those signals may not be synchronous with the selected clock. The output pulse is active for 1.6 μ s. Additionally, the counter must be re-triggered before any further measurements take place. For more information, see the Input Period Measurement description.

One-Shot Pulse Mode Example

The objective for this example is to use the One-Shot Pulse mode using 32-bit Counter 1. The output pulse is active high with the low portion 20 μ s long and the high portion 5 μ s long. Additionally, the counter has an external clock, an active high Gate-off signal, and an active high External Trigger. Interrupts are enabled. Assume the external clock has a frequency of 200KHz.

1. Connect the inputs/output to the following pins (unpowered):

Pin #	Connection	Description
27	In1_A(+)	Gate-Off
28	In1_B(+)	Ext. Clock
29	In1_C(+)	Ext. Trigger
30	Out1(+)	Output

2. Write the following information, D66FH, to Counter 1 Control Register located at base address plus an offset of 38H.

Bits	Logic	Operation
2,1,0	111	Sets the counter to One-Shot Pulse generation mode.
3	1	Sets the output to active high.
5,4	10	Sets the Gate-Off input (InA) to active high.
7,6	01	Enables the external clock input (InB).
9,8	10	Enables the external Trigger Input (InC) to active high.
12,11,10	101	Sets the clock to an external source.
13	0	Not Used
14	1	Select a 32-bit counter size for use.
15	1	Enables interrupts. ¹

Since Counter 1 is a 32-bit counter, Counter 2 cannot be used.

Table 3.29: One-Shot Pulse Pin Assignments for Counter 9

Note: Make sure all inputs and outputs are properly grounded.

Table 3.30: One-Shot Pulse Control Register 1 Settings

1. Make sure that bit 0 at base address plus an offset 0H is set to enable interrupts.

**PROGRAMMING
EXAMPLES**

3. Write the 32-bit value 4H to Counter 1 Constant A Register located at base address plus an offset 50H for the non-active portion of the pulse, and 1H to Counter 1 Constant B Register located at base address plus an offset 58H for the active portion of the pulse.

In order to determine the necessary Counter Constant values first calculate the period of the selected clock (internal or external). The period is calculated by taking the inverse of the clock frequency. In this case, 1/200KHz is equal to 5µs. Then take the total time for the low portion of the pulse and divide it by the clock period. For this example, 20µs/5µs is equal to 4. Convert this value to Hex and the result is the total count that is placed in the appropriate Counter Constant Register. Since it has been stipulated that the pulse is active high, 4H is written to the Counter 1 Constant A Register, which contains the value for the non-active (low) portion of the pulse. The same procedure is used to calculate the Constant B value. Take the total period of the high portion of the pulse and divide it by the period of the clock. For this example 5µs/5µs is equal to 1. Converting to hex, 1H is written to Counter 1 Constant B Register since it contains the active (high) portion of the pulse.

4. The following is a waveform diagram of this example.

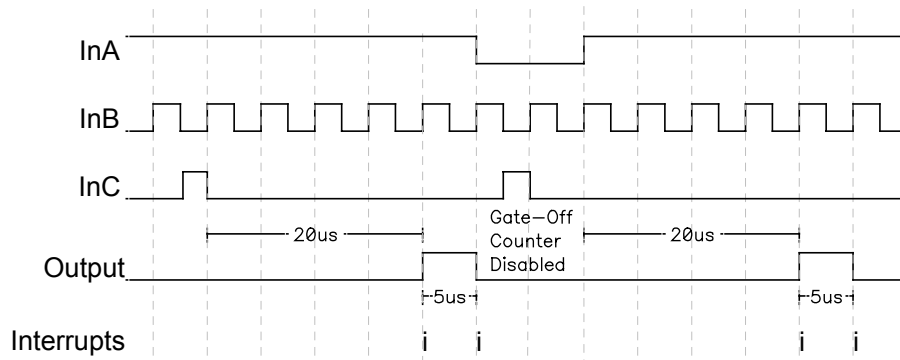

Figure 3.9: One-Shot Pulse waveform

In the figure each “i” represents an interrupt

The Gate-Off signal (InA) is used as a pause mechanism. The counter register and output remain constant while the Gate-Off signal is active. In this example, this occurs when InA is logic low.

Note that the InA and InC inputs run off the internal 20MHz clock. Those signals may not be synchronous with an external clock (InB). The delay after the trigger on InC to the Output pulse going low can vary by one clock period. With the 200KHz clock of this example, the variance will be 5µs. That means, the delay from InC trigger to Output signal going low can be between 20µs–5µs (15µs) and 20µs.

Table 3.15: Counter Timer Modes Overview

Function Description	Pulse Width Modulation/ One-Shot	Watchdog	Event Counting	Frequency Measure	Pulse Measure	Period Measure
InA Input	Gate-Off for start/stop control	Counter Reload	Gate-Off for start/stop control	Enable Frequency Measurement for Set Duration	Next complete pulse after trigger is measured.	Next complete period after trigger is measured.
InB Input	External Clock	External Clock	Event Input	Signal Measured/ Counted	External Clock	External Clock
InC Input	External Trigger	External Trigger or Gate-Off for start/stop control	External Trigger or Up/Down Count Control	External Trigger	External Trigger	External Trigger
Internal Software Trig	Starts Waveform Generation	Starts Count Down	Start Event Counting	Start Frequency Measurement on next active edge of InA signal.	Next complete pulse after trigger is measured.	Next complete period after trigger is measured.
Counter Timer Output	Output Waveform	Output is active from trigger until terminal count.	1.6 μ s pulse is output upon reaching the count limit	1.6 μ s pulse is output upon end of frequency measurement	1.6 μ s pulse is output upon end of pulse measurement	1.6 μ s pulse is output upon end of period measurement
Constant A Reg	Count down from value loaded. Defines duration until active pulse	Counts down from value loaded. Must always load before trigger. Note that InA input can be used to reload.	Count Limit. Input events are counted up to the count limit.			
Constant B Reg	Count down from value loaded. Defines duration of active pulse					
Counter Readback Reg		Gives the Count value at the time of the read.	Gives the Count value at the time read.	Gives count value reflecting measurement	Gives count value reflecting pulse measured	Gives count value reflecting period measured
Interrupt	On Edge Transitions	On Terminal Count of 0	Upon reach of count limit	Upon end of enable pulse	Upon end of pulse measurement	Upon end of period measurement

This section contains information regarding the hardware of the board. A description of the basic functionality of the circuitry used on the board is also provided. Refer to the Block Diagram shown in Drawing 4501-957 as you review this material.

A Field Programmable Gate-Array (FPGA) installed on the board provides an interface to the carrier/CPU board per PCI Local Bus Specification 2.2. The interface to the carrier/CPU board allows complete control of all board functions.

This is a target only board, with the PCI bus interface logic imbedded within the FPGA. This logic includes support for PCI commands, including: configuration read/write, and memory read/write. In addition, the PCI target interface performs parity error detection, uses a single 4K base address register, and implements target abort, retry, and disconnect. The logic also implements interrupt requests via interrupt line INTA#.

The digital field I/O interface to the board is provided through Field I/O Connector (refer to Table 2.1). *Field I/O points are NON-ISOLATED.* This means that the field return and logic common have a direct electrical connection to each other. As such, care must be taken to avoid ground loops. Ignoring this effect may cause operation errors, and with extreme abuse, possible circuit damage.

Digital input/output signals to the FPGA are buffered using buffered line drivers. Field inputs to these buffers include transient protection devices on each line and a 4.7K pullup resistor to +5V. Output operation is considered 'Fail-safe'. That is, the Digital Input/Output signals are always configured as input upon power-up reset or software reset. This is done for safety reasons to ensure reliable control under all conditions.

Digital channels of this model can be configured to generate interrupts for Change-Of-State (COS) and input level (polarity) match conditions on all channels (channels 0-63). The interrupt is released via a write to the corresponding bit of the Interrupt Status/Clear register.

Debounce logic is available to filter noise present on individual input signals. Debounce filters of 1.6 μ s, 10.4 μ s, 408.8 μ s, and 3.276ms can be individually enabled for each input signal. For example if the 10.4 μ s debounce duration is enabled, noise spikes less than 10.4 μ s in duration are removed from the input signal by the internal FPGA logic.

The counter/timer input and output control signals are TTL logic level and are available on Digital I/O channels 48 to 63. Each counter uses three input signals and one output signal. An enabled counter/timer has its required input and output signals automatically dedicated via the field connector. See Table 2.1 for the list of these signals and their corresponding pin assignments.

4.0 THEORY OF OPERATION

PCI INTERFACE LOGIC

DIGITAL INPUT/OUTPUT LOGIC

COUNTER TIMER CONTROL LOGIC

5.0 SERVICE AND REPAIR

SERVICE AND REPAIR ASSISTANCE

Surface-Mounted Technology (SMT) boards are generally difficult to repair. It is highly recommended that a non-functioning board be returned to Acromag for repair. The board can be easily damaged unless special SMT repair and service tools are used. Further, Acromag has automated test equipment that thoroughly checks the performance of each board. When a board is first produced and when any repair is made, it is tested, placed in a burn-in room at elevated temperature, and retested before shipment.

Please refer to Acromag's Service Policy Bulletin or contact Acromag for complete details on how to obtain parts and repair.

PRELIMINARY SERVICE PROCEDURE

CAUTION: POWER MUST BE TURNED OFF BEFORE REMOVING OR INSERTING BOARDS

Before beginning repair, be sure that all of the procedures in Section 2, Preparation For Use, have been followed. Also, refer to the documentation of your carrier/CPU board to verify that it is correctly configured. Replacement of the board with one that is known to work correctly is a good technique to isolate a faulty board.

WHERE TO GET HELP

If you continue to have problems, your next step should be to visit the Acromag worldwide web site at <http://www.acromag.com>. Our web site contains the most up-to-date product and software information.

www.acromag.com

Go to the "Support" tab to access:

- Application Notes
- Frequently Asked Questions (FAQ's)
- Product Knowledge Base
- Tutorials
- Software Updates/Drivers

An email question can also be submitted from within the Knowledge Base or directly from the "Contact Us" tab.

Acromag's application engineers can also be contacted directly for technical assistance via telephone or FAX through the numbers listed at the bottom of this page. When needed, complete repair services are also available.

Single PMC Board

Height	13.5 mm (0.531 in)
Stacking Height	10.0 mm (0.394 in)
Depth	149.0 mm (5.866 in)
Width	74.0 mm (2.913 in)
Board Thickness	1.59 mm (0.062 in)

Short PCI Board

Height	106.68 mm (4.2 in)
Depth	167.64 mm (6.6 in)
Board Thickness	1.59 mm (0.062 in)
Max Component Height	14.48 mm (0.57 in)
Card Spacing	20.32 mm (0.8 in)

3UCompactPCI Board

Height	100.0 mm (3.937 in)
Depth	160.0 mm (6.299 in)
Board Thickness	1.59 mm (0.062 in)
Max Component Height	13.97 mm (0.55 in)
Card Spacing	20.32 mm (0.8 in)

- **PMC424:** PCI Local Bus Interface: Two 64-pin female receptacle header (AMP 120527-1 or equivalent).
- **AcPC424:** PCI Local Bus Interface: Type "A" right angle female connector, 110 contacts with upper shield. A 5 volt coding key is inserted into J1 connector to allow this card to be plugged into a 5 volt backplane system only.
- **APC424:** 3.3 V and 5V card "finger" edge spacing.
- Field I/O: 68-pin, SCSI-3, female receptacle header (AMP 787082-7 or equivalent).

6.0 SPECIFICATIONS

PHYSICAL

Connectors

Power Requirements		PMC464, APC464, AcPC464
5V (±5%)	Typical	160mA
	Max.	200mA
+/-12V (±5%)	Not used	

Table 6.1: Power Requirements

5V Maximum rise time of 100m seconds

Operating Temperature: 0 to +70°C. -40°C to +85°C (E Version).

Relative Humidity: 5-95% Non-Condensing.

Storage Temperature: -55°C to 125°C (-55°C to 105°C for PMC Models).

Non-Isolated: Logic and field commons have a direct electrical connection.

ENVIRONMENTAL

CE Mark: All models are designed to comply with EMC Directive 89/336/EEC per **European Standard EN 61000-6-1:2001** Electromagnetic compatibility (EMC) – Part 6-1: Generic standards - Immunity for residential, commercial and light-industrial environments and **European Standard EN 61000-6-3:2001** Electromagnetic compatibility (EMC) – Part 6-3: Generic standards - Emission standard for residential, commercial and light-industrial environments.

CE MARK

Note: Only the APC Models have the CE Mark.

ENVIRONMENTAL**FCC**

FCC: Only the APC Models are compliant to standard FCC PART 15, Subpart.

NOTE: This equipment has been tested and found to comply with the limits for a Class B digital device, pursuant to part 15 of the FCC Rules. These limits are designed to provide reasonable protection against harmful interference in a residential installation. This equipment generates, uses, and can radiate radio frequency energy and, if not installed and used in accordance with the instruction manual, may cause harmful interference to radio communications. However, there is no guarantee that interference will not occur in a particular installation. If this installation does cause harmful interference to the radio or television reception, which can be determined by turning the equipment off and on, the user is encouraged to try to correct the interference by one or more of the following measures:

- Reorient or relocate the receiving antenna.
- Increase the separation between the equipment and receiver.
- Connect the equipment into an outlet on a circuit different from that to which the receiver is connected.
- Consult the dealer or experienced radio/TV technician for help.

Reliability Prediction

Mean Time Between Failure: MTBF = 1,750,590 hours @ 25°C, Using MIL-HDBK-217F, Notice 2.

Digital Input/Output

Channel Configuration: 48 Bi-directional TTL Transceivers Direction controlled on a port basis (Channels 0 to 47)
16 Bi-directional TTL Transceivers Direction controlled as 16 independent channels (Channels 48-63)

Reset/Power Up Condition: All Digital Channels Default to Input.

Pull-up Resistors: 4.7K Ω pull-up resistor networks are installed in sockets. eight networks of 8 resistors each are utilized for the Digital I/O.

- R21 for Digital I/O (0 to 7)
- R24 for Digital I/O (8 to 15)
- R22 for Digital I/O (16 to 23)
- R23 for Digital I/O (24 to 31)
- R25 for Digital I/O (32 to 39)
- R26 for Digital I/O (40 to 47)
- R28 for Digital I/O (48 to 55)
- R27 for Digital I/O (56 to 63)

- V_{OH} : 2.4V minimum
- V_{OL} : 0.55V maximum
- I_{OH} : -15.0mA
- I_{OL} : 64mA
- V_{IH} : 2.0V minimum
- V_{IL} : 0.8V maximum

SPECIFICATIONS

Digital I/O DC Electrical Characteristics Channels 0 to 47

- Driver/Receiver Input to Output Delay = 20ns Typical

Propagation Delay Channels 0 to 47

- Digital I/O DC Electrical Characteristics

Digital I/O DC Electrical Characteristics Channels 48 to 63

- V_{OH} : 3.8V minimum
- V_{OL} : 0.55V maximum
- I_{OH} : -32.0mA
- I_{OL} : 32mA
- V_{IH} : 3.5V minimum
- V_{IL} : 1.5V maximum

- Driver/Receiver Input to Output Delay = 20ns Typical

Propagation Delay Channels 48 to 63

Counter Functions: Pulse Width Modulation, Watchdog Timer, Event Counting, Frequency Measurement, Period Measurement, Pulse-Width Measurement, and One Shot/Repetitive

16 or 32-Bit Counters

Four 16-Bit counters: - A pair of 16-bit counters can be configured into a 32-bit counter. A total of two 32-bit counters can be enabled.

Configuration

Each Counter has an InA, InB, and InC input port. These TTL input signals are used to control Start/Stop, Reload, Event Input, External Clock, Trigger, and Up/Down operations.

Counter Input

Each Counter has one Output Signal. The TTL output signal is used for waveform output, watchdog active indicator, or 1.6µs pulse upon counter function completion. Counter output is programmable as active high or low.

Counter Output

Programmable Debounce Intervals:

Programmable Debounce

- 1.6µs, 10.4µs, 408.8µs, and 3.276ms
Controlled via Debounce Duration Select and Enable Register

Selectable Counter Clock Frequencies: 20MHz, 10MHz, 5MHz, 2.5MHz, 1.25MHz or External up to 8MHz

Counter Clock Frequencies

- Minimum I/P Event:** 100ns (debounce disabled)
- Minimum Pulse Measurement:** 100ns (debounce disabled)
- Minimum Period Measurement:** 200ns (debounce disabled)
- Minimum Gate/Trigger Pulse:** 100ns (debounce disabled)

SPECIFICATIONS

Board Crystal Oscillator

Board Crystal Oscillator: 20MHz

Frequency Stability: 25ppm. This is $\pm 1.25\text{ps}$ for each clock cycle. For example, if you were to measure a pulse with a half second duration, using the counter measurement function, your accuracy would be $\pm 12.5\mu\text{s}$.

PCI Local Bus Interface

PMC464 Compatibility: Conforms to PCI Bus Specification, Revision 2.2 and PMC Specification, P1386.1

APC464 Compatibility: Conforms to PCI Bus Specification, Revision 2.2

AcPC464 Compatibility: Conforms to PCI Bus Specification, Revision 2.2 and CompactPCI Specification PICMG 2.0 R2.1

PCI Target: Implemented by Altera FPGA

4K Memory Space Required: One Base Address Register

PCI commands Supported: Configuration Read/Write memory Read/Write, 32, 16, and 8-bit data transfer types supported.

Signaling: 5V Compliant, 3.3V Tolerant

INTA#: Interrupt A is used to request an interrupt. Source of interrupt can be from the Digital I/O, or Counter/Timer Functions.

Access Times: 8 PCI Clock Cycles for all register accesses.

APPENDIX

Type: Round shielded cable, 68-wires (SCSI-3 male connector at both ends). The cable length is 2 meters (6.56 feet). This shielded cable is recommended for all I/O applications (both digital I/O and precision analog I/O).

Application: Used to connect Model 5025-288 termination panel to the board.

Length: Standard length is 2 meters (6.56 feet). Consult factory for other lengths. It is recommended that this length be kept to a minimum to reduce noise and power loss.

Cable: 68 conductors, 28 AWG on 0.050 inch centers (permits mass termination for IDC connectors), foil/braided shield inside a PVC jacket.

Connectors: SCSI-3, 68-pin male connector with backshell.

Keying: The SCSI-3 connector has a "D Shell".

Schematic and Physical Attributes: See Drawing 4501-919.

Electrical Specifications: 30 VAC per UL and CSA (SCSI-3 connector spec.'s). 1 Amp maximum at 50% energized (SCSI-3 connector spec.'s).

Operating Temperature: -30°C to +80°C.

Storage Temperature: -40°C to +85°C.

Shipping Weight: 1.0 pound (0.5Kg), packed.

CABLE: MODEL 5028-432 (SCSI-3 to Round, Shielded)

Type: Termination Panel For 68 Pin SCSI-3 Cable Connection

Application: To connect field I/O signals to the board. *Termination Panel:* Acromag Part 4001-066. The 5025-288 termination panel facilitates the connection of up to 68 field I/O signals and connects to the board (connectors only) via a round shielded cable (Model 5028-432). Field signals are accessed via screw terminal strips. The terminal strip markings on the termination panel (1-68) correspond to field I/O (pins 1-68) on the board. Each board has its own unique pin assignments. Refer to the board manual for correct wiring connections to the termination panel.

Schematic and Physical Attributes: See Drawing 4501-920.

Field Wiring: 68-position terminal blocks with screw clamps. Wire range 12 to 26 AWG.

Mounting: Termination panel is snapped on the DIN mounting rail.

Printed Circuit Board: Military grade FR-4 epoxy glass circuit board, 0.063 inches thick.

Operating Temperature: -40°C to +100°C.

Storage Temperature: -40°C to +100°C.

Shipping Weight: 1.0 pounds (0.5kg) packaged.

**TERINATION PANEL:
MODEL 5025-288**

DRAWINGS

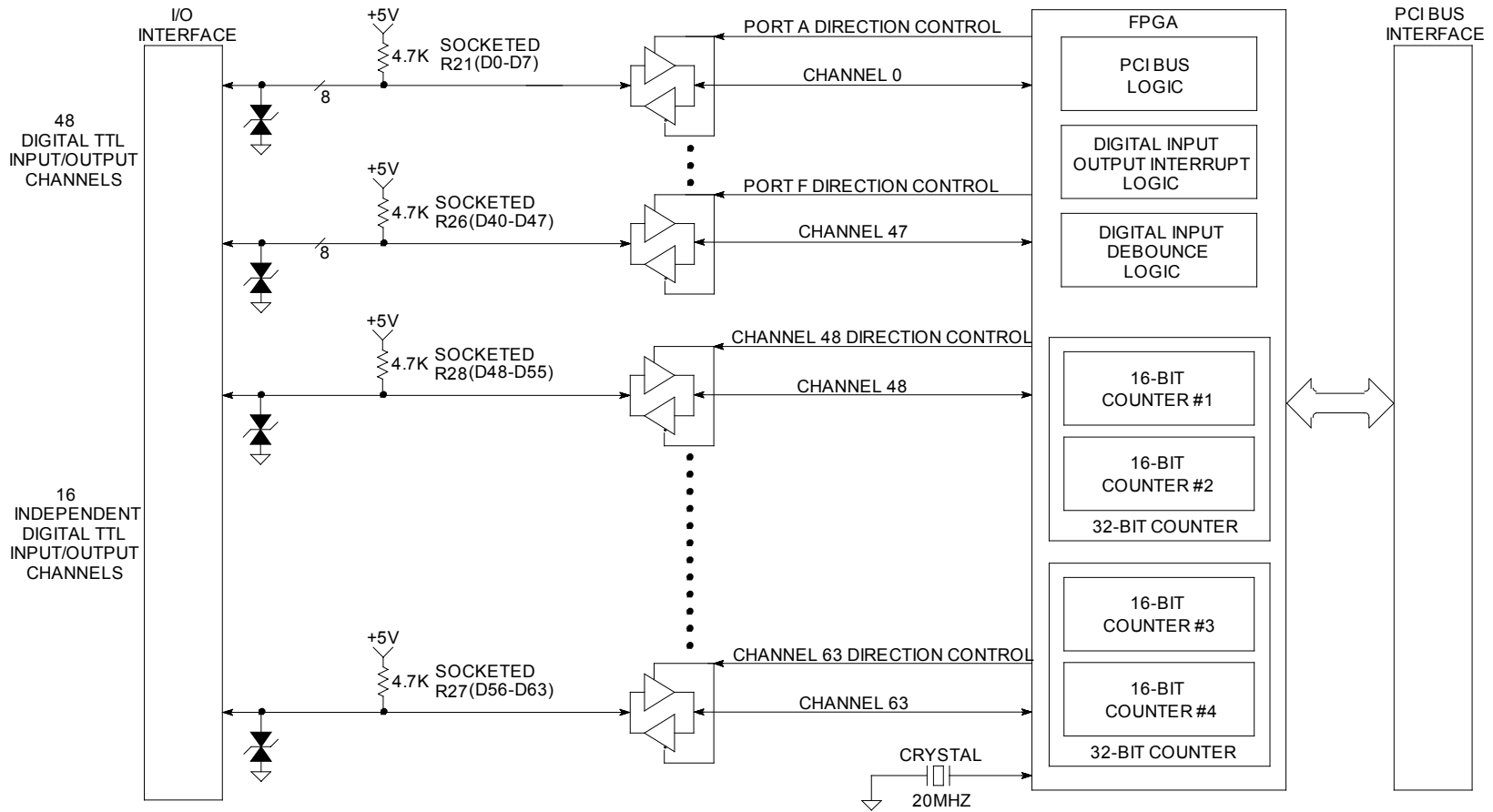

PMC, APC, AcPC464 BLOCK DIAGRAM

4501-957

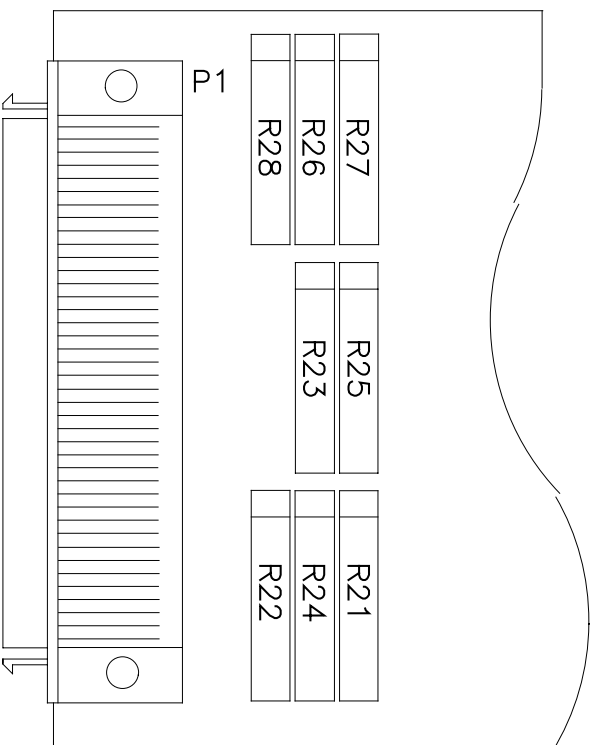

FIELD
I/O
INTERFACE

PMC, APC, AcPC464 RESISTOR LOCATIONS

4501-958

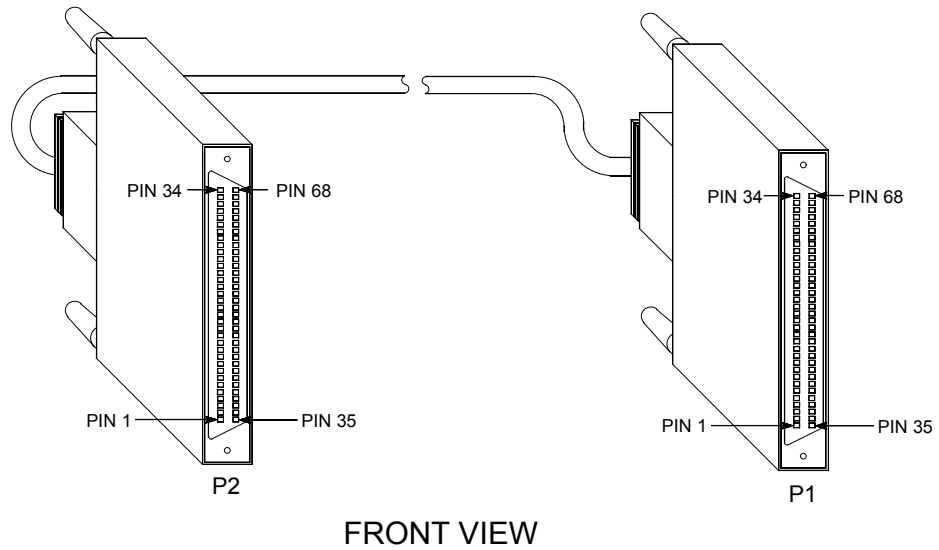
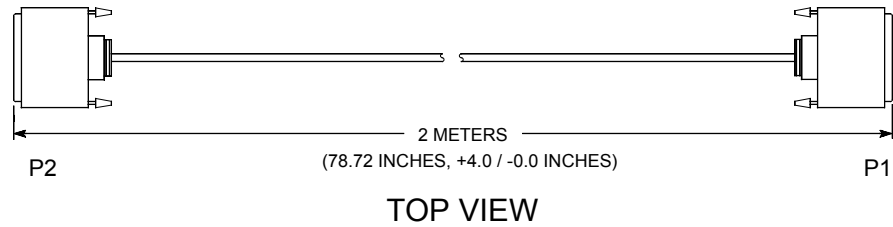
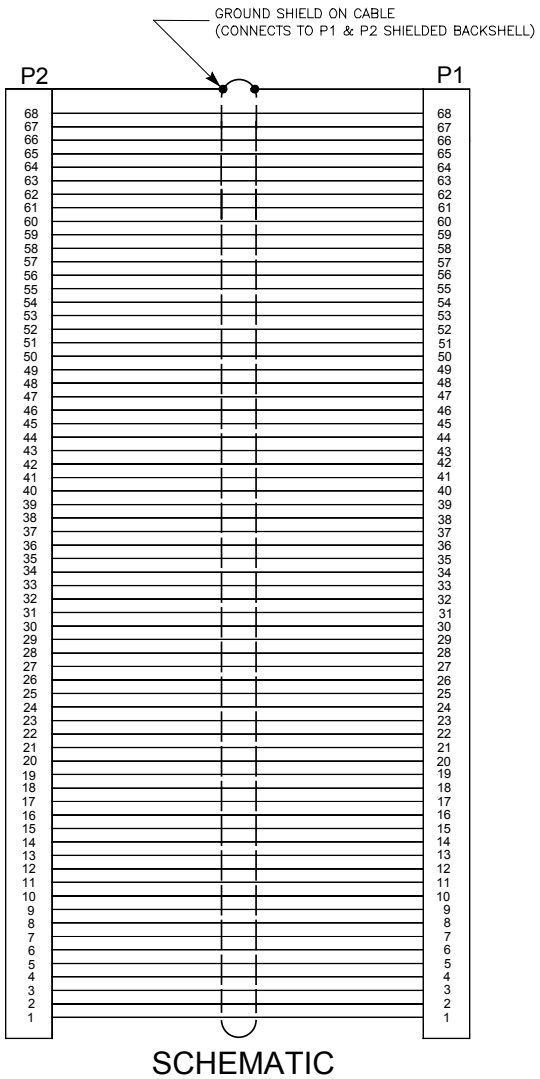

MODEL 5028-432
SCSI-3 68 PIN CABLE ASSEMBLY, SHIELDED

4501-919C

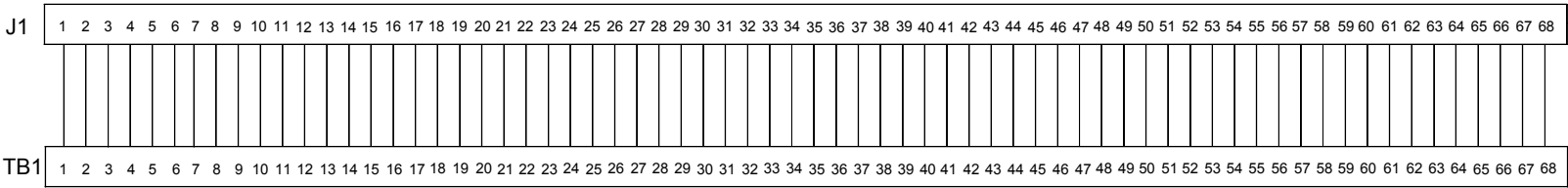

MODEL 5025-288 TERMINATION PANEL SCHEMATIC

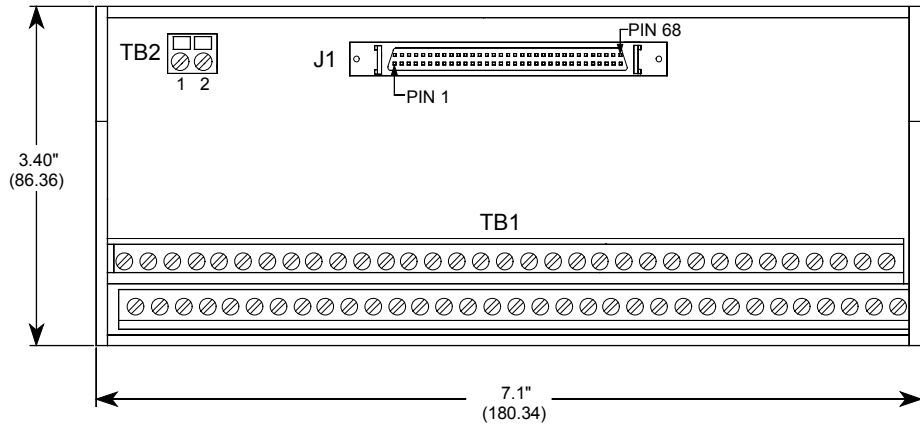

TOP VIEW

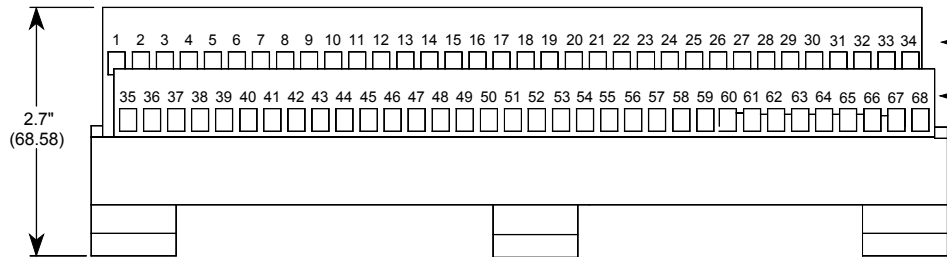

FRONT VIEW

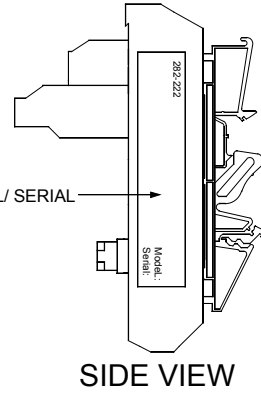

SIDE VIEW

TB2 PINS 1 & 2 ARE TIED TO J1 METAL HOUSING

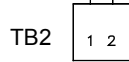

NOTE: DIMENSIONS ARE IN INCHES. (MILLIMETERS)

4501-920B