



Test Report

Product Name : GSM Mobile Phone

Model No : T201

FCC ID : QIST201

Applicant : Huawei Technologies Co.,Ltd

Address : Huawei Base BanTian Longgang Shenzhen 51829 P.R.C

Date of Receipt : 2007/09/19

Issued Date : 2007/10/09

Report No. : 079240R-HP-US-P07V01

The test results relate only to the samples tested.

The test report shall not be reproduced except in full without the written approval of Quietek Corporation.

This report must not be used to claim product endorsement by NVLAP any agency of the U.S. Government

Test Report Certification

Issued Date : 2007/10/09

Report No.: 079240R-HP-US-P07V01



Accredited by NIST (NVLAP)
NVLAP Lab Code: 200533-0

Product Name : GSM Mobile Phone
Applicant : Huawei Technologies Co.,Ltd
Address : Huawei Base BanTian Longgang Shenzhen 51829 P.R.C
Manufacturer : Huawei Technologies Co.,Ltd
Model No. : T201
Rated Voltage : AC 120V/60Hz
EUT Voltage : DC 3.7V (Battery)
Measurement Standard : FCC CFR Title 47 Part 2 22 24
Measurement Reference : TIA/EIA 603-A
Test Result : Complied

Test results relate only to the samples tested.

The test report shall not be reproduced except in full without the written approval of Quietek Corporation.

This report must not be used to claim product endorsement by NVLAP any agency of the U.S. Government

Documented By : 
(Engineering Adm.
Assistant / Nicole
Huang)

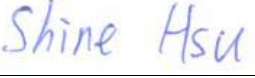
Tested By : 
(Senior Engineer /
Shine Hsu)

Approved By : 
(Deputy Manager
/ Vincent Lin)

TABLE OF CONTENTS

Description	Page
1. GENERAL INFORMATION	4
1.1. EUT Description	4
1.2. Operational Description.....	4
1.3. Configuration of tested System	5
1.4. EUT Setup Procedures	5
1.5. Test Facility	6
1.6. Type of Emission	6
1.7. DC voltages and DC currents	6
2. Peak Power Output	7
2.1. Test Equipment.....	7
2.2. Test Setup	7
2.3. Limits	8
2.4. Test Procedure.....	8
2.5. Test Specification	8
2.6. Test Result of Peak Power Output	9
3. Modulation Characteristics	13
3.1. Test Equipment.....	13
3.2. Test Setup	13
3.3. Modulation Description.....	13
3.4. Test Specification	14
3.5. Test Result of Modulation	15
4. Occupied Bandwidth.....	16
4.1. Test Equipment.....	16
4.2. Test Setup	16
4.3. Test Procedure.....	16
4.4. Test Specification	17
4.5. Test Result of Occupied Bandwidth	18
5. Spurious Emission At Antenna Terminals (+/-1MHz)	22
5.1. Test Equipment.....	22
5.2. Setup	22
5.3. Limits	23
5.4. Test Procedure.....	23
5.5. Test Specification	23
5.6. Test Result of Spurious Emission At Antenna Terminals (+/-1MHz).....	24
6. Spurious Emission	26
6.1. Test Equipment.....	26
6.2. Test Setup	26
6.3. Limits	27
6.4. Test Procedure.....	27
6.5. Test Specification	28
6.6. Test Result of Spurious Emission	29
7. Frequency Stability Under Temperature & Voltage Variations	36
7.1. Test Equipment.....	36
7.2. Test Setup	36
7.3. Limits	36
7.4. Test Procedure.....	37
7.5. Test Specification	37
7.6. Test Result of Frequency Stability Under Temperature Variations	38
8. EMI Reduction Method During Compliance Testing	40
Attachment 1: EUT Test Photographs	
Attachment 2: EUT Detailed Photographs	

1. GENERAL INFORMATION

1.1. EUT Description

Product Name	GSM Mobile Phone
Model No.	T201
IMEI No.	011399000000101
Antenna Type	Internal
TX Frequency	824MHz~849MHz(GSM 850) 1850MHz ~ 1910MHz(PCS 1900)
Rx Frequency	869MHz~894MHz(GSM 850) 1930MHz ~ 1990MHz(PCS 1900)
Hardware version	Ver.C
Software version	T201CZ.P12.I33.06.00
Battery Pack	DC 3.7V (Battery), 750mAh

1.2. Operational Description

The information contained within this report is intended to show verification of compliance of the 850/1900MHz Mobile Phone to the requirements of 47CFR2, 22 and 24.

The EUT operates from a 120Vac/60Hz adapter where GSM 850/PCS 1900 is Power Class 4/Class 1, operating with a maximum output power of 2watt/1watt.

Quietek has verified the construction and function in typical operation. All the test modes were carried out with the EUT in normal operation, which was shown in this test report and defined as:

Test Mode:	GSM 850
	PCS 1900

1.3. Configuration of tested System

(a) Configuration of Radiated measurement

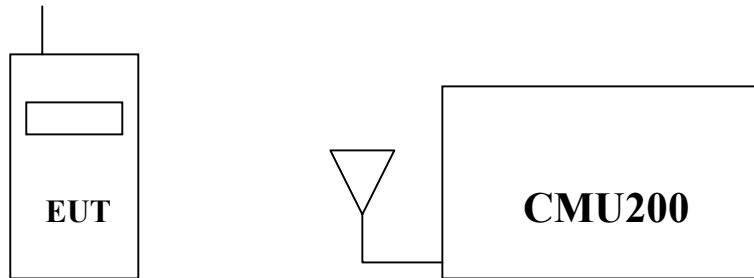

(b) Configuration of Conducted measurement

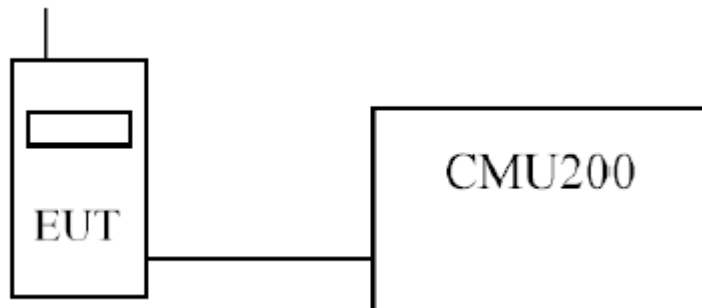

1.4. EUT Setup Procedures

- (1) Setup the EUT and simulators as shown on 1.3
- (2) Turn on the power of all equipments.
- (3) The EUT was set to communicate with CMU200.
- (4) Repeat the above procedure (3).

1.5. Test Facility

Ambient conditions in the laboratory:

Items	Required (IEC 68-1)	Actual
Temperature (°C)	15-35	20-35
Humidity (%RH)	25-75	50-65
Barometric pressure (mbar)	860-1060	950-1000

Site Description: June 22, 2001 File on
 Federal Communications Commission
 FCC Engineering Laboratory
 7435 Oakland Mills Road
 Columbia, MD 21046
 Reference 31040/SIT1300F2



0914

July 03, 2001 Accreditation on NVLAP
 NVLAP Lab Code: 200533-0

Site Name: Quietek Corporation

Site Address: No. 5-22, Ruei-Shu Valley, Ruei-Ping Tsuen,
 Lin-Kou Shiang, Taipei,
 Taiwan, R.O.C.
 TEL: 886-2-8601-3788 / FAX: 886-2-8601-3789
 E-Mail: service@quietek.com

1.6. Type of Emission

300KGXW

1.7. DC voltages and DC currents

GSM 850

EUT Transmitting (in maximum power) :
 DC voltage : 3.7V , DC current : 0.3A

EUT Standby :
 DC voltage : 3.7V , DC current : 0.08A

GSM 1900

EUT Transmitting (in maximum power) :
 DC voltage : 3.7V , DC current : 0.21A

EUT Standby :
 DC voltage : 3.7V , DC current : 0.08A

2. Peak Power Output

2.1. Test Equipment

The following test equipments are used during the radiated emission test:

Test Site	Equipment	Manufacturer	Model No./Serial No.	Last Cal.
☒OATS 3	Test Receiver	R & S	ESCS 30 / 100122	Feb., 2007
	Universal Radio Communication Tester	R & S	CMU200 / 104846	Apr., 2007
	Spectrum Analyzer	Advantest	R3162 / 120300652	Feb., 2007
	Pre-Amplifier	QTK	QTK-AMP-03 / 0003	May, 2007
	Bilog Antenna	SCHAFFNER	CBL6112B / 2697	May, 2007
	Horn Antenna	ETS	3115 / 0005-6160	Jul., 2007
	Pre-Amplifier	QTK	QTK-AMP-01 / 0001	Jul., 2007

- Note: 1. All equipments that need to be calibrated are with calibration period of 1 year.
 2. Mark "X" test instruments are used to measure the final test results.

2.2. Test Setup

Radiated Power Measurement

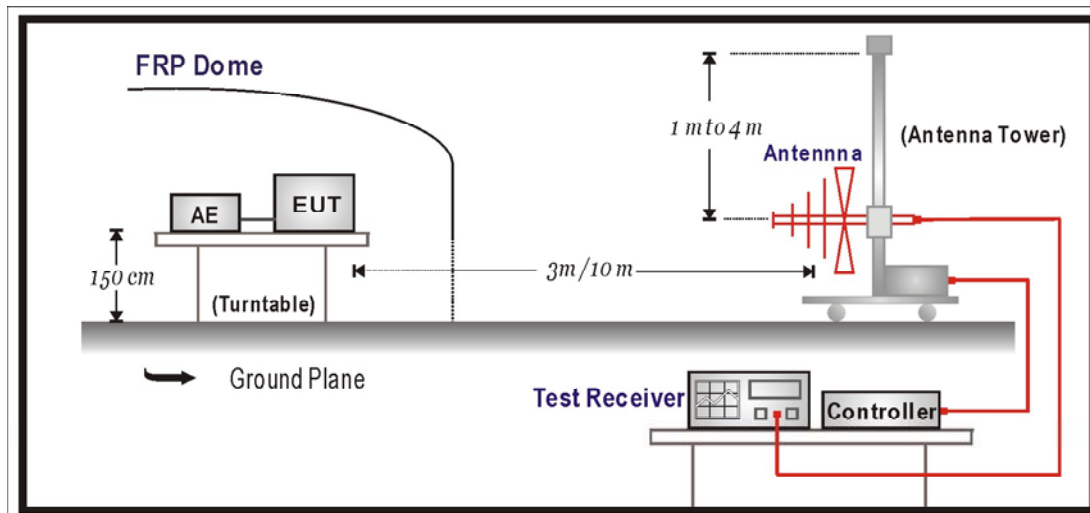

Conducted Power Measurement

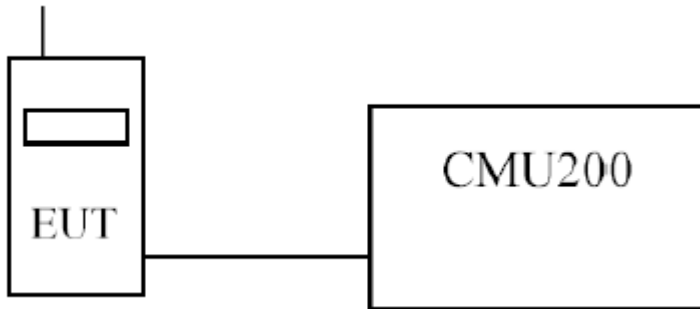

2.3. Limits

GSM850	<7W
PCS1900	<2W or +33dBm

2.4. Test Procedure

➤RF Out Power (Radiated)

The Spectrum Analyzer was tuned to the test frequency. The device was put into Transmit mode then rotated through 360 degrees until the highest power level was observed in both horizontal and vertical polarization. The device was then replaced with a substitution antenna, which input signal was adjusted until the received level matched that of the previously detected emission. The resolution bandwidth was 1MHz.

➤RF Out Power (Conducted)

Using a spectrum analyser and attenuator(s), the output power of the EUT was measured at the antenna terminals. The EUT only support GSM. The device is class 4(GSM850) and class1(PCS1900) module. The carrier was modulated by it's normal GMSK modulation and measurements performed with Timeslot 3(TS3) active.

2.5. Test Specification

According to Part 2.1046, 22.913,24.232.

2.6. Test Result of Peak Power Output

Product	GSM Mobile Phone		
Test Mode	RF Output Power (Conducted)		
Date of Test	2007/10/08	Test Site	CB5
Test Condition	GSM 850		

Maximum Power-GSM 850

Frequency (MHz)	Output Power (dBm)	Path Loss (dB)	Result (dBm)	Result (W)
824.2	31.04	0.4	31.44	1.39
836.4	31.23	0.4	31.63	1.46
848.8	31.32	0.4	31.72	1.49

Note:

1. EUT complies with CFR 47.2.1046 and 22.913(a). The EUT does not exceed 7W at the measured frequencies.

Product	GSM Mobile Phone		
Test Mode	RF Output Power (Conducted)		
Date of Test	2007/10/08	Test Site	CB5
Test Condition	PCS1900		

Maximum Power-PCS 1900

Frequency (MHz)	Output Power (dBm)	Path Loss (dB)	Result (dBm)	Result (W)
1850.2	27.58	0.7	28.28	0.67
1880	27.70	0.7	28.30	0.68
1909.8	27.7	0.7	28.30	0.68

Note:

1. EUT complies with CFR 47.2.1046 and 24.232(b). The EUT does not exceed 2W or +33dBm at the measured frequencies.

Product	GSM Mobile Phone		
Test Mode	RF Output Power (Radiated)		
Date of Test	2007/10/08	Test Site	OATS 3
Test Condition	GSM 850		

Maximum Power-GSM 850

Frequency (MHz)	Reading Level (dBm)	Substitution Level (dBm)	Substitution Antenna Gain (dBd)	Cable Loss (dB)	Result EIRP (dBm)	Result EIRP (W)
824.2	16.38	18.62	4.45	0.51	22.56	0.18
836.4	17.51	19.75	4.45	0.51	23.69	0.23
848.8	18.27	20.54	4.45	0.51	24.48	0.28

Note:

1. The EUT meets the requirements of FCC CFR 47: Part 22, Section 22.913(a) for Effective Radiated Power.
2. Receiver setting (Peak Detector) : RBW:1MHz; VBW:3MHz
3. Result EIRP = Substitution Level + Substitution Antenna Gain - Cable Loss

Product	GSM Mobile Phone		
Test Mode	RF Output Power (Radiated)		
Date of Test	2007/10/08	Test Site	OATS 3
Test Condition	PCS 1900		

Maximum Power-PCS 1900

Frequency (MHz)	Reading Level (dBm)	Substitution Level (dBm)	Substitution Antenna Gain (dBi)	Cable Loss (dB)	Result EIRP (dBm)	Result EIRP (W)
1850.2	16.29	17.59	10.4	1.02	26.97	0.50
1880.0	15.84	17.12	10.4	1.02	26.5	0.45
1909.8	13.91	15.11	10.4	1.02	24.49	0.28

Note:

1. The EUT meets the requirements of FCC CFR 47: Part 24, Section 24.232(b) for Effective Radiated Power.
2. Receiver setting (Peak Detector) : RBW:1MHz; VBW:3MHz
3. Result EIRP = Substitution Level + Substitution Antenna Gain - Cable Loss

3. Modulation Characteristics

3.1. Test Equipment

The following test equipment are used during the modulation characteristics test:

Equipment	Manufacturer	Model No./Serial No.	Last Cal.
Spectrum Analyzer	Advantest	R3182 / 100803470	May, 2007
Universal Radio Communication Tester	R & S	CMU200 / 104846	Apr., 2007
Directional couple	Agilent	87300C / 3239A01864	N/A

Note: All equipments that need to be calibrated are with calibration period of 1 year.

3.2. Test Setup

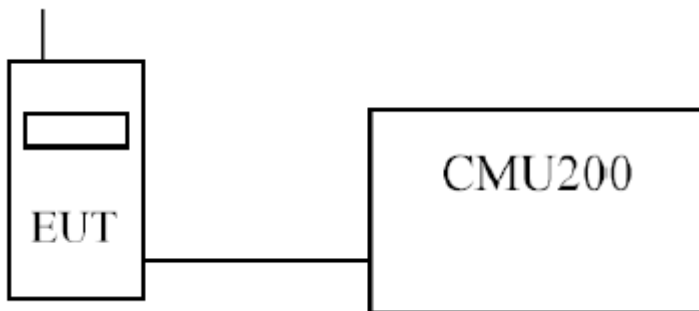

3.3. Modulation Description

GMSK is a form of binary signaling schemes which represent digital states as a shift between discrete sinusoidal frequencies called Frequency Shift Keying (FSK). Minimum Shift Keying (MSK) is continuous phase FSK with the smallest possible modulation index h . Modulation index is defined as:

$$h = 2 \cdot F \cdot T_b$$

where F = Peak frequency deviation in Hz and T_b = Bit period in seconds

Two discrete frequencies, representing two distinct digital states, with equal phases at switch time $t = 0$ requires a minimum value of $h = 0.5$. The Gaussian part of GMSK describes the fact that the digital pulses are filtered in the time domain. This results in bits which are sinusoidal rather than square. The effective spectrum is then compressed with the average carrier frequency in the center of the passband. This is a great advantage because of the significantly reduced bandwidth. GMSK is utilized because of these bandwidth conservation properties.

The bandwidth for GSM850 is a 25MHz up-link at 824-849Mhz and down-link at 869-894MHz. The PCS1900 is a 60MHz up-link at 1850-1910 MHz and down-link at 1930-1990 MHz. The 65 MHz is divided into 299 channels, each of which is 200 kHz wide. Slight spectral spillage is allowed into neighboring channels (which is minimized by GMSK). This separated transmit/receive frequencies scheme under GSM enables easier duplex filtering.

Within the bandwidth, individual channels are subdivided into multiframes (made of 26 frames), frames (made of 8 time slots), and time slots (made of 8 fields). The time slots are 0.57 ms long allowing 156.25 bits of information including overhead.

The modulation used in GPRS is the same used in GSM. A GSM channel contains eight timeslots, each timeslot is dedicated to one circuit switched call. For GPRS the timeslots are assigned on an as needed basis, and more than one timeslot can be assigned for a particular transmission depending on the network and the device.

3.4. Test Specification

According to Part 2.1047(d)

3.5. Test Result of Modulation

Product	GSM Mobile Phone		
Test Mode	Modulation		
Date of Test	2007/10/08	Test Site	CB5
Test Condition	GSM 850 PCS1900		

Circuit Switched (GSM 850)

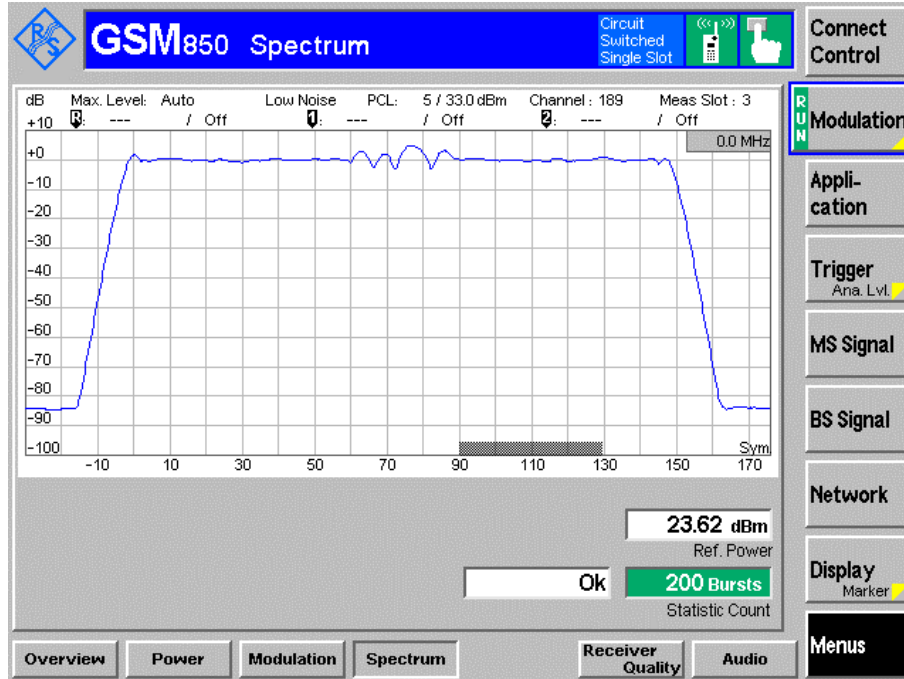

Circuit Switched (PCS 1900)

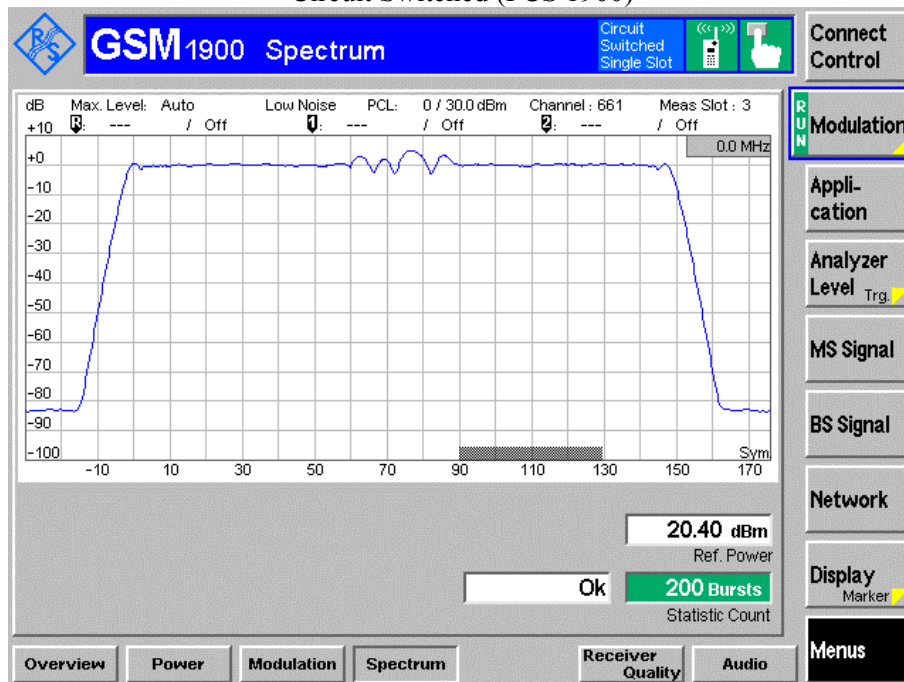

4. Occupied Bandwidth

4.1. Test Equipment

The following test equipments are used during the occupied bandwidth tests:

Equipment	Manufacturer	Model No./Serial No.	Last Cal.
Spectrum Analyzer	Advantest	R3182 / 100803470	May, 2007
Universal Radio Communication Tester	R & S	CMU200 / 104846	Apr., 2007
Directional coupler	Agilent	87300C / 3239A01864	N/A

Note: All equipments upon which need to be calibrated are with calibration period of 1 year.

4.2. Test Setup

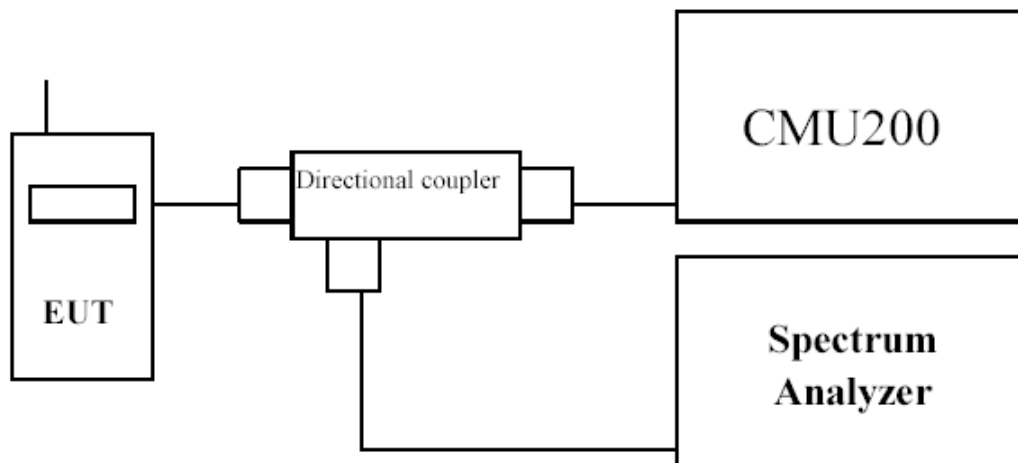

4.3. Test Procedure

➤ GSM

The EUT was set to transmit on maximum power and measurements were made on Timeslot 3.

➤ GPRS

The EUT was set to transmit on maximum power, (timeslots 3 and 4 active), and measurements were made on Timeslot 3.

Using a resolution bandwidth of 3kHz and a video bandwidth of 10kHz, the -26dBc points were established and the emission bandwidth determined.

The plots below show the resultant display from the Spectrum Analyzer.

4.4. Test Specification

According to Part 2.1049, 22.917(b), 24.238(b).

4.5. Test Result of Occupied Bandwidth

Product	GSM Mobile Phone		
Test Mode	Occupied Bandwidth		
Date of Test	2007/10/08	Test Site	CB5
Test Condition	GSM 850		

Circuit Switched (GSM Mode CH 128)

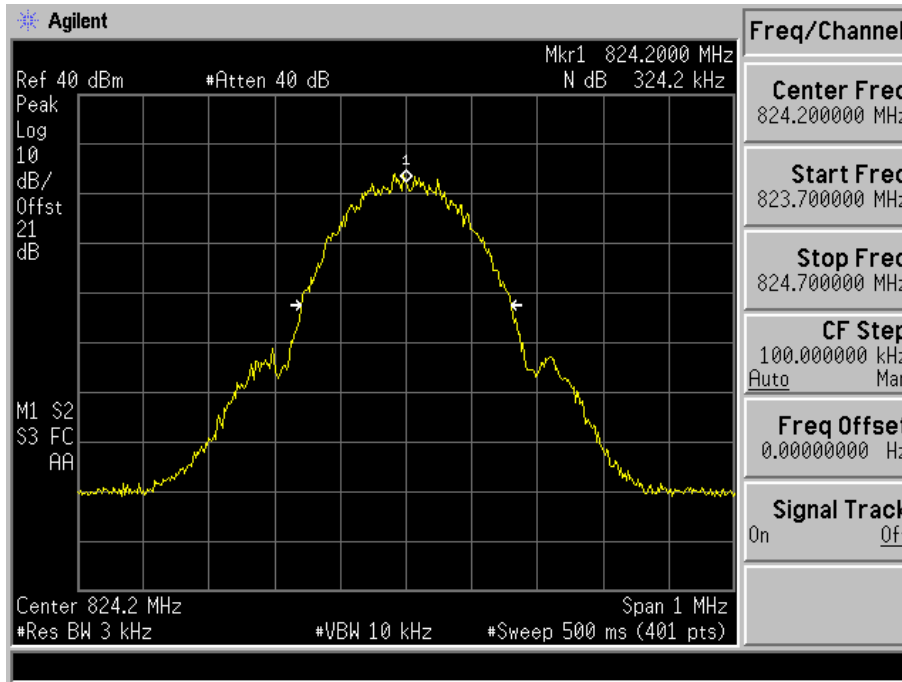

Circuit Switched (GSM Mode CH189)

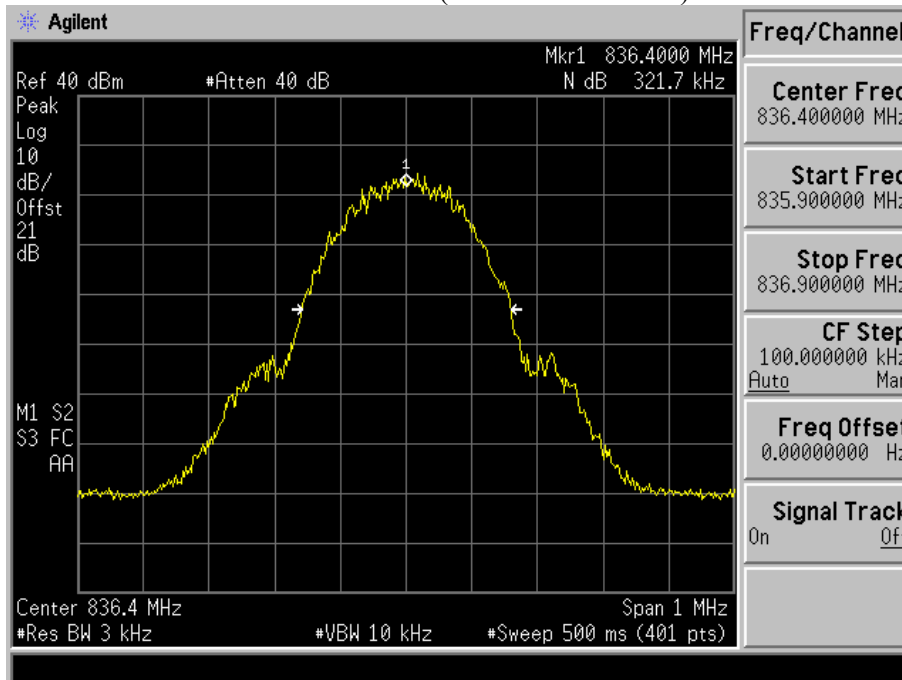

Product	GSM Mobile Phone		
Test Mode	Occupied Bandwidth		
Date of Test	2007/10/08	Test Site	CB5
Test Condition	GSM 850		

Circuit Switched (GSM Mode CH 251)

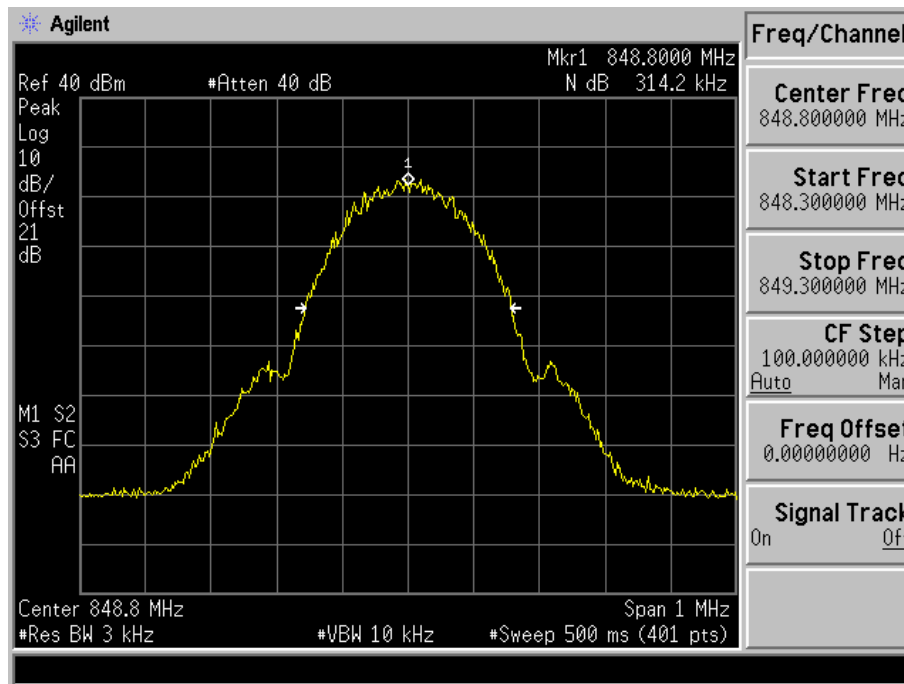

Product	GSM Mobile Phone		
Test Mode	Occupied Bandwidth		
Date of Test	2007/10/08	Test Site	CB5
Test Condition	PCS1900		

Circuit Switched (PCS Mode CH 512)

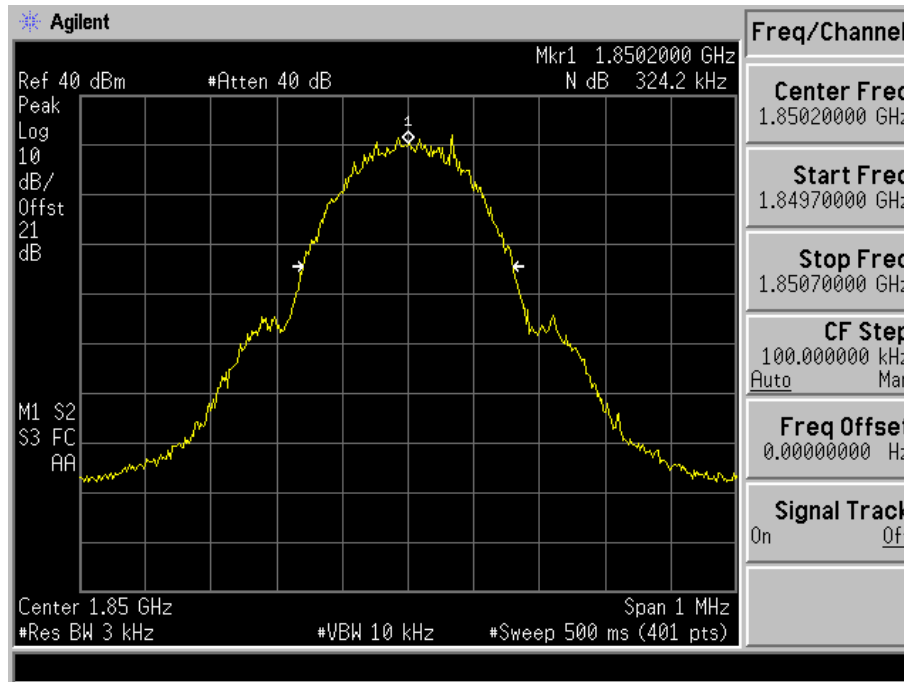

Circuit Switched (PCS Mode CH661)

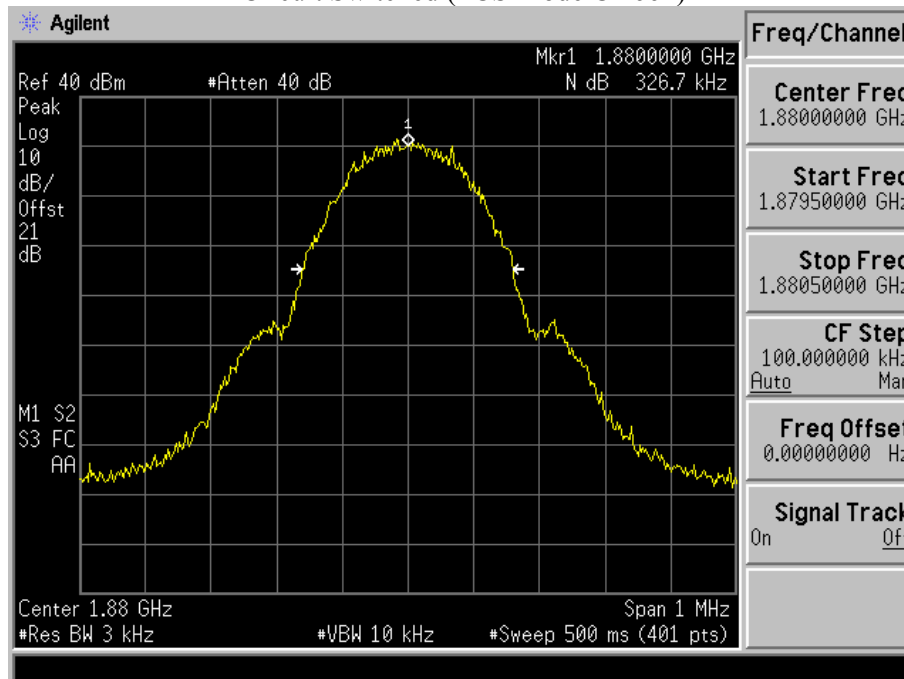

Product	GSM Mobile Phone		
Test Mode	Occupied Bandwidth		
Date of Test	2007/10/08	Test Site	CB5
Test Condition	PCS1900		

Circuit Switched (PCS Mode CH 810)

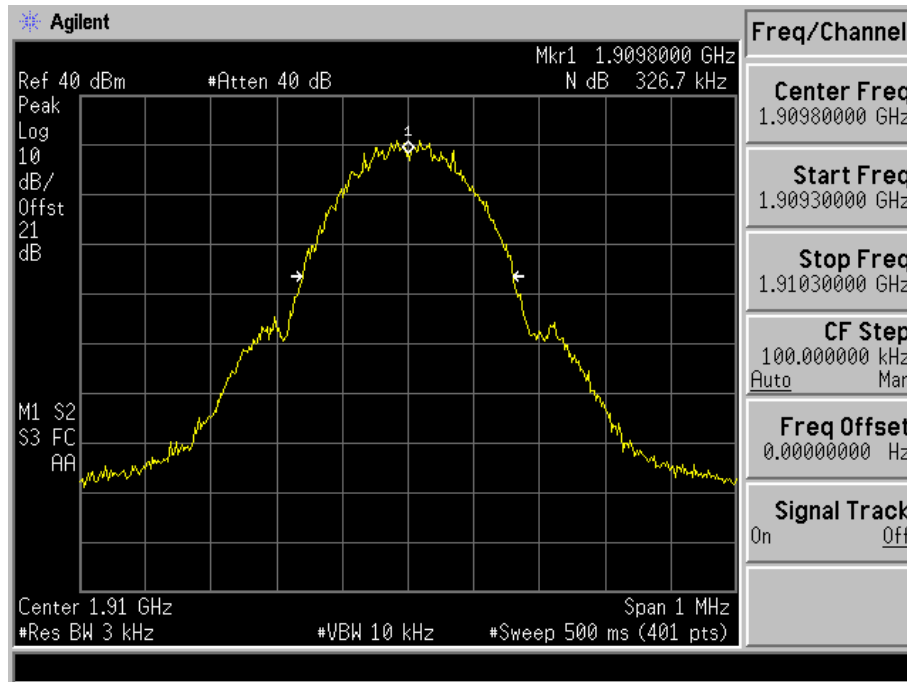

5. Spurious Emission At Antenna Terminals (+/-1MHz)

5.1. Test Equipment

The following test equipments are used during the spurious emission test

Equipment	Manufacturer	Model No./Serial No.	Last Cal.
Spectrum Analyzer	Advantest	R3182 / 100803470	May, 2007
Universal Radio Communication Tester	R & S	CMU200 / 104846	Apr., 2007
Directional coupler	Agilent	87300C / 3239A01864	N/A

Note: All equipments upon which need to be calibrated are with calibration period of 1 year.

5.2. Setup

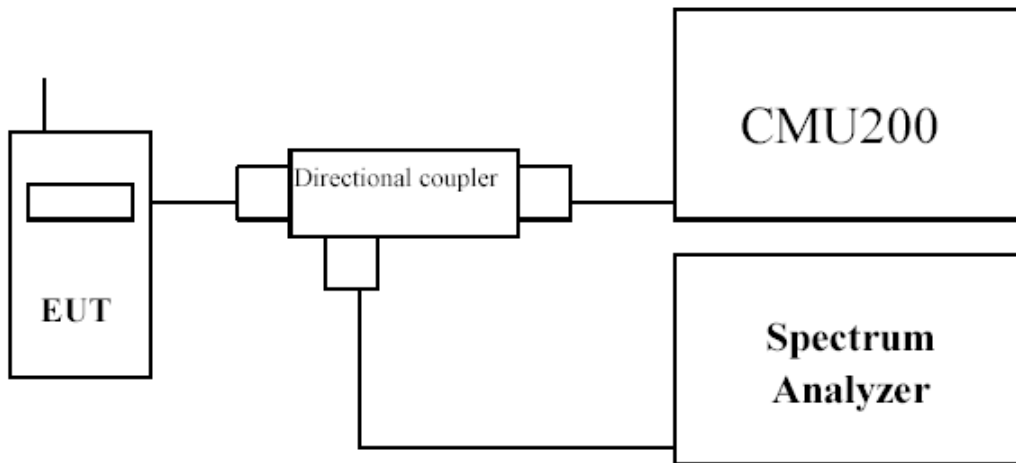

5.3. Limits

GSM850 Transmitter limits for narrowband spurious emission

Lower Block Edge Test Frequencies	Upper Block Edge Test Frequencies
Block A Channel : 128 Frequency : 824.2 MHz	Block B Channel : 251 Frequency : 848.2 MHz

PCS 1900 Transmitter limits for narrowband spurious emission

Lower Block Edge Test Channels/Frequencies	Upper Block Edge Test Channels/Frequencies
Block A Channel : 512 Frequency : 1850.2 MHz	Block C Channel : 810 Frequency : 1909.8 MHz

5.4. Test Procedure

In accordance with Part 22.917 and 24.238, at least 1% of the emission bandwidth was used for the resolution and video bandwidths up to 1MHz away from the Block Edge. At greater than 1MHz, the resolution and video bandwidth were increased to 1MHz.

The reference power and path losses of all channels used for testing in each frequency block were measured.

5.5. Test Specification

According to Part 2.1049, 22.917,24.238.

5.6. Test Result of Spurious Emission At Antenna Terminals (+/-1MHz)

Product	GSM Mobile Phone		
Test Mode	Spurious Emission At Antenna Terminals (+/-1MHz)		
Date of Test	2007/10/08	Test Site	CB5
Test Condition	Block Edge Test (GSM 850)		

GSM 850 Lower Channel 128 (824.2MHz)

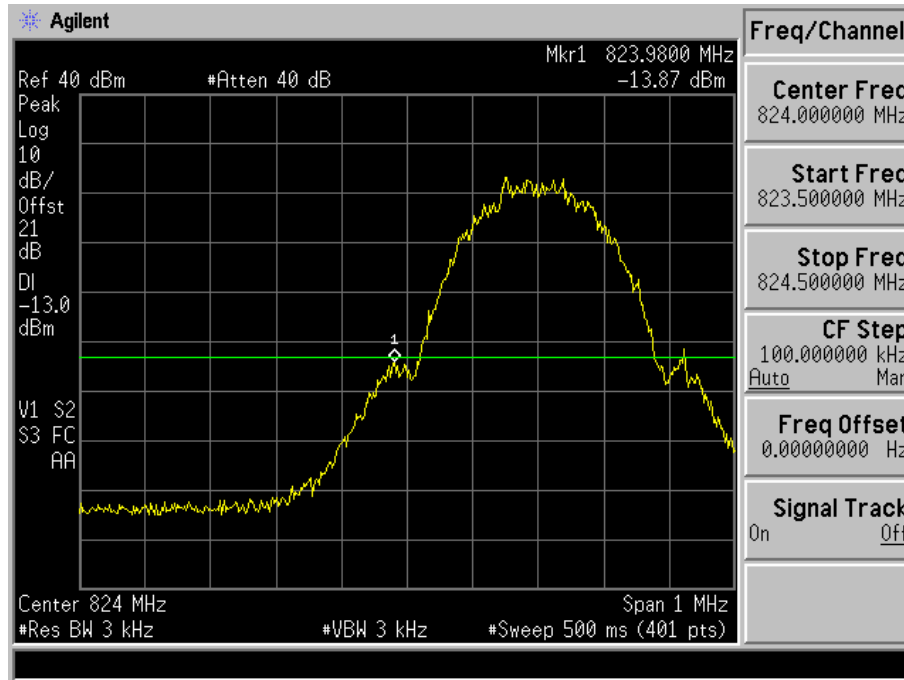

GSM 850 Upper Channel 251(848.8MHz)

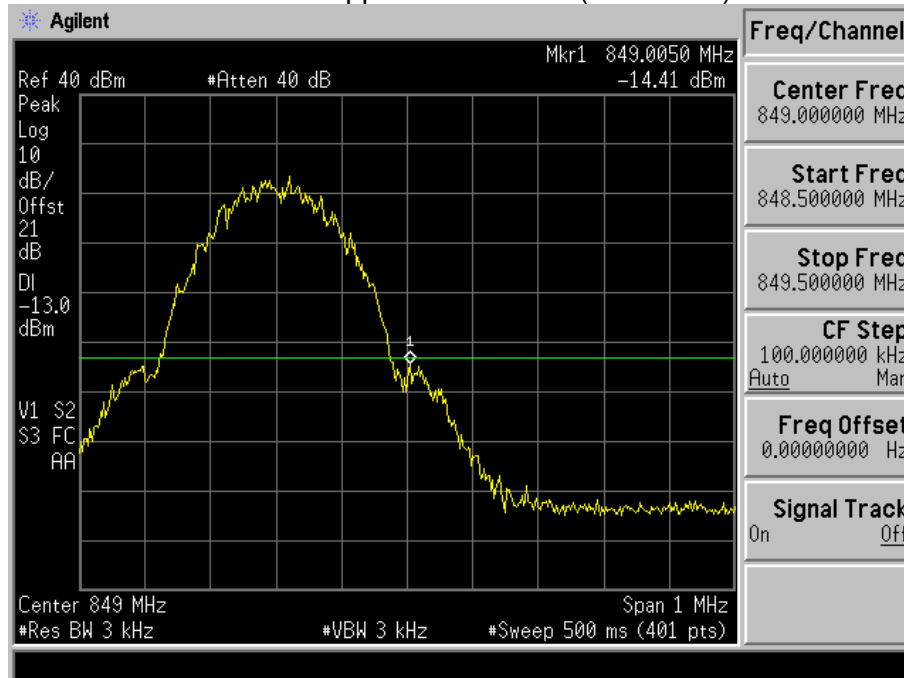

Product	GSM Mobile Phone		
Test Mode	Spurious Emission At Antenna Terminals (+/-1MHz)		
Date of Test	2007/10/08	Test Site	CB5
Test Condition	Block Edge Test (PCS 1900)		

PCS 1900 Lower Channel 512 (1850.2MHz)

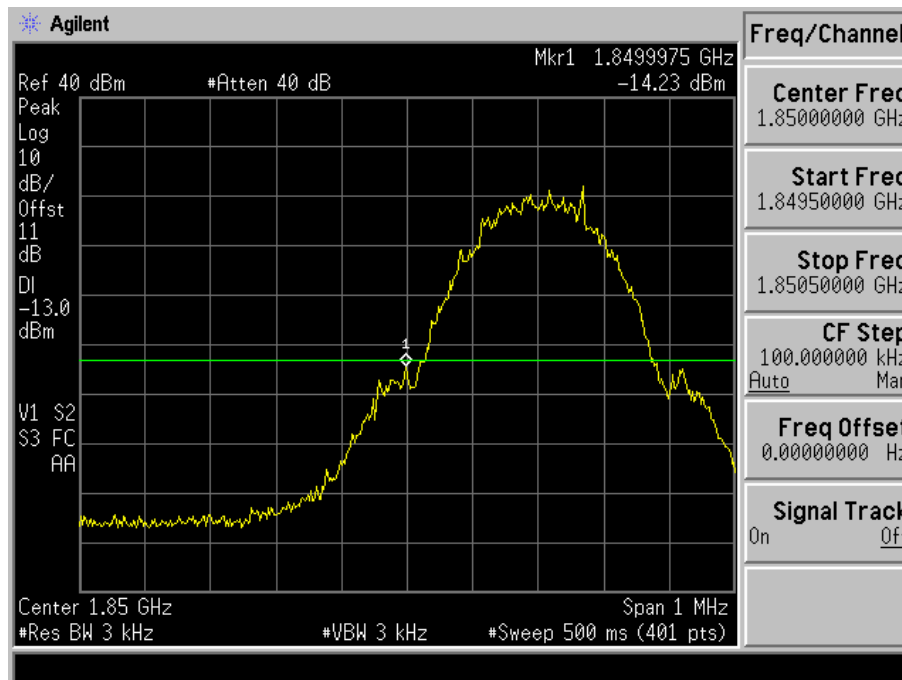

PCS 1900 Upper Channel 810(1910.0MHz)

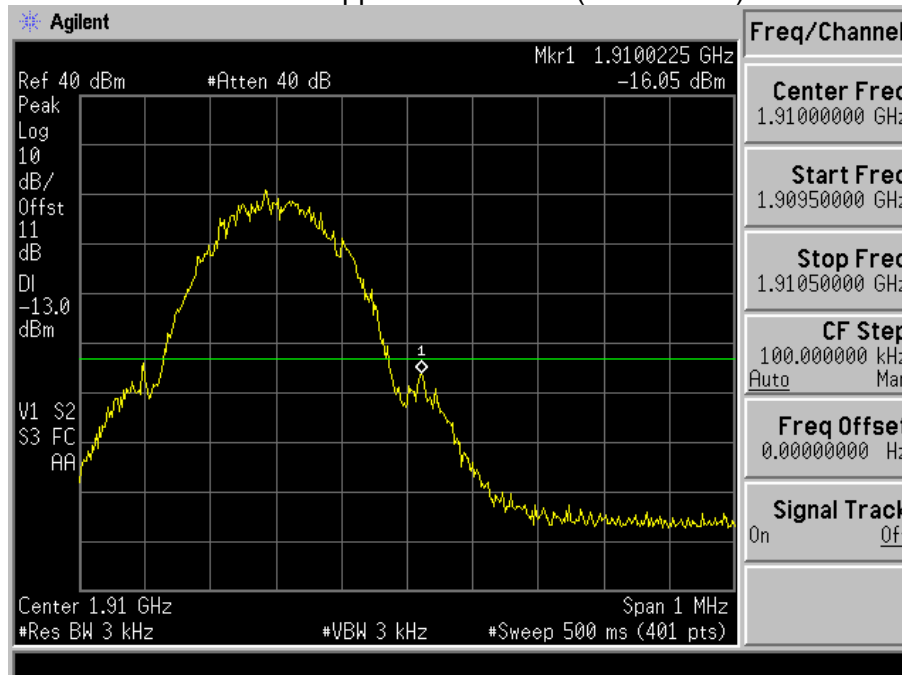

6. Spurious Emission

6.1. Test Equipment

The following test equipments are used during the radiated emission test:

Test Site	Equipment	Manufacturer	Model No./Serial No.	Last Cal.
☒OATS 3	Test Receiver	R & S	ESCS 30 / 100122	Feb., 2007
	Universal Radio Communication Tester	R & S	CMU200 / 104846	Apr., 2007
	Spectrum Analyzer	Advantest	R3162 / 120300652	Feb., 2007
	Pre-Amplifier	QTK	QTK-AMP-03 / 0003	May, 2007
	Bilog Antenna	SCHAFFNER	CBL6112B / 2697	May, 2007
	Horn Antenna	ETS	3115 / 0005-6160	Jul., 2007
	Pre-Amplifier	QTK	QTK-AMP-01 / 0001	Jul., 2007

Note: 1. All equipments that need to be calibrated are with calibration period of 1 year.
 2. Mark "X" test instruments are used to measure the final test results.

6.2. Test Setup

(a) Spurious emissions at antenna terminals.

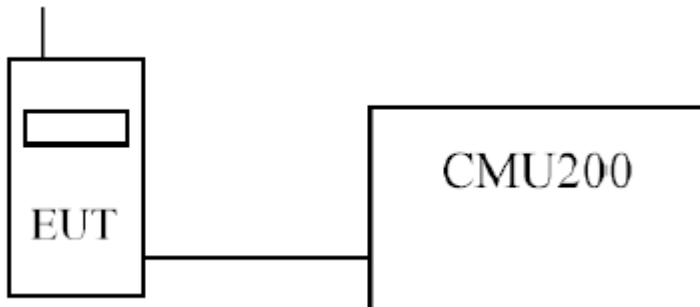

(b) **Field strength of spurious radiation.**

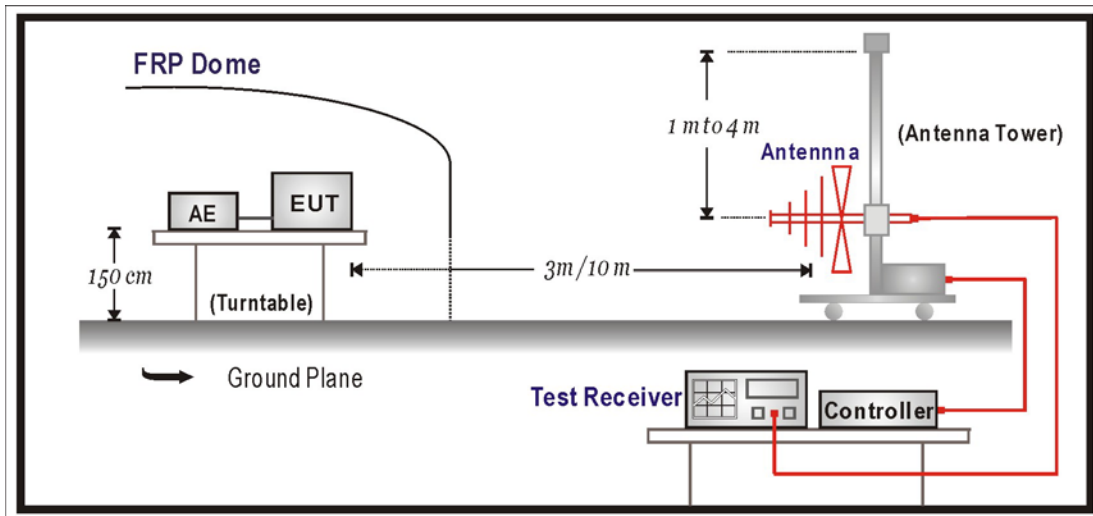

6.3. Limits

Limit	<-13dBm
--------------	-------------------

43 + 10Log(P) down on the carrier where P is the power in Watts.

6.4. Test Procedure

In accordance with Part 2.1051, the spurious emissions from the antenna terminal were measured. The transmitter output power was attenuated using a combination of filters and attenuators and the frequency spectrum investigated from 9kHz to 20GHz. The EUT was set to transmit on full power. The EUT was tested on bottom, middle and top channels for both power levels. The resolution and video bandwidth was set to 1MHz in accordance with Part 24.238. The spectrum analyzer detector was set to Max Hold.

In addition, measurements were made up to the 10th harmonic of the fundamental.

The EUT is placed on a turn table which is 1.5 meter above ground. The turn table can rotate 360 degrees to determine the position of the maximum emission level. The EUT was positioned such that the distance from antenna to the EUT was 3 meters.

The antenna can move up and down between 1 meter and 4 meters to find out the maximum emission level.

Both horizontal and vertical polarization of the antenna are set on measurement. In order to find the maximum emission, all of the interface cables must be manipulated according to TIA/EIA 603-A on radiated measurement.

6.5. Test Specification

According to Part 2.1051, 2.1053, 22.917(a), 24.238(b).

6.6. Test Result of Spurious Emission

Product	GSM Mobile Phone		
Test Mode	Spurious Emission (Conducted)		
Date of Test	2007/10/08	Test Site	CB5
Test Condition	GSM 850	Test Range	9KHz~10GHz

GSM850 Mid-Channel 189

Frequency (MHz)	Reading Level (dBm)	Path Loss (dB)	Emission Level (dBm)	Limit (dBm)
1670	-33.53	0.58	-32.95	-13
2509.2	-31.62	0.7	-30.92	-13
3345.6	-34.63	1.01	-33.62	-13
4182	-52.3	1.18	-51.12	-13
5018.4	-51.09	1.23	-49.86	-13
5854.8	-58.33	1.45	-56.88	-13
6691.2	-55.73	1.56	-54.17	-13
7527.6	-54.7	1.59	-53.11	-13
8364	-55.8	1.82	-53.98	-13

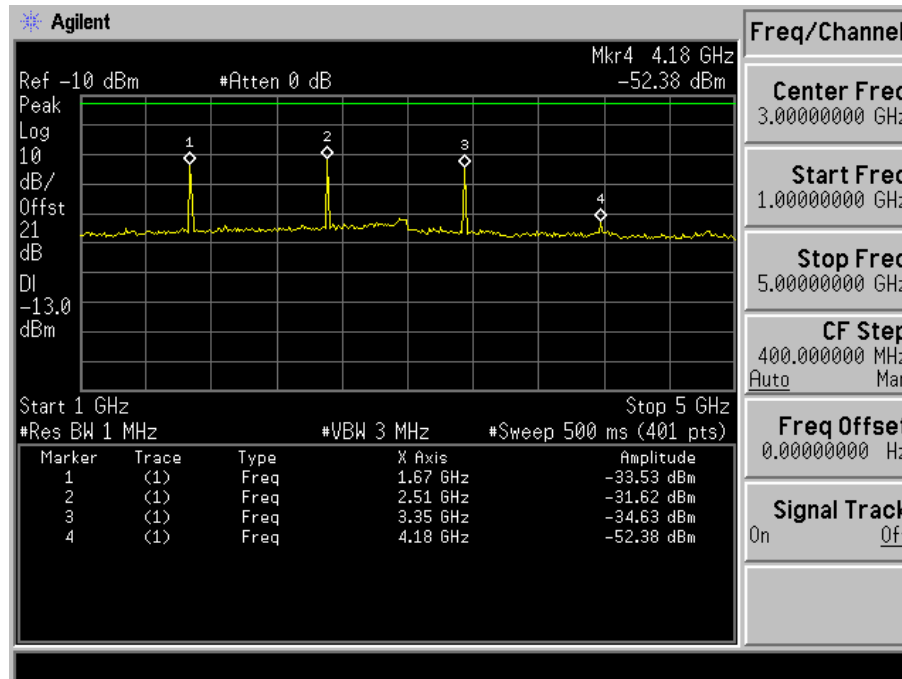

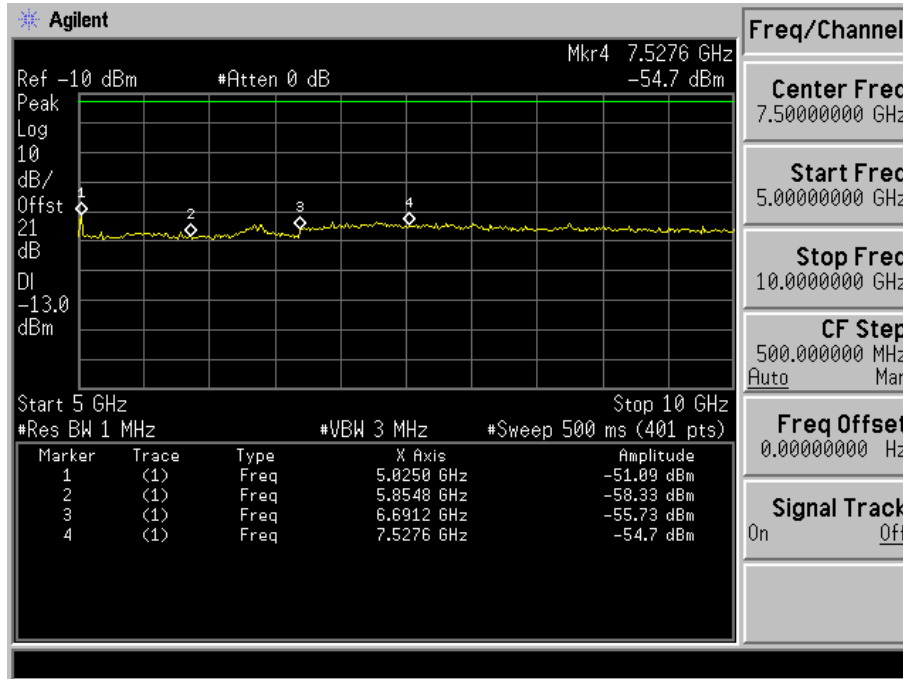

Freq/Channel

Center Freq
7.50000000 GHz

Start Freq
5.00000000 GHz

Stop Freq
10.00000000 GHz

CF Step
500.000000 MHz
Auto Man

Freq Offset
0.00000000 Hz

Signal Track
On Off

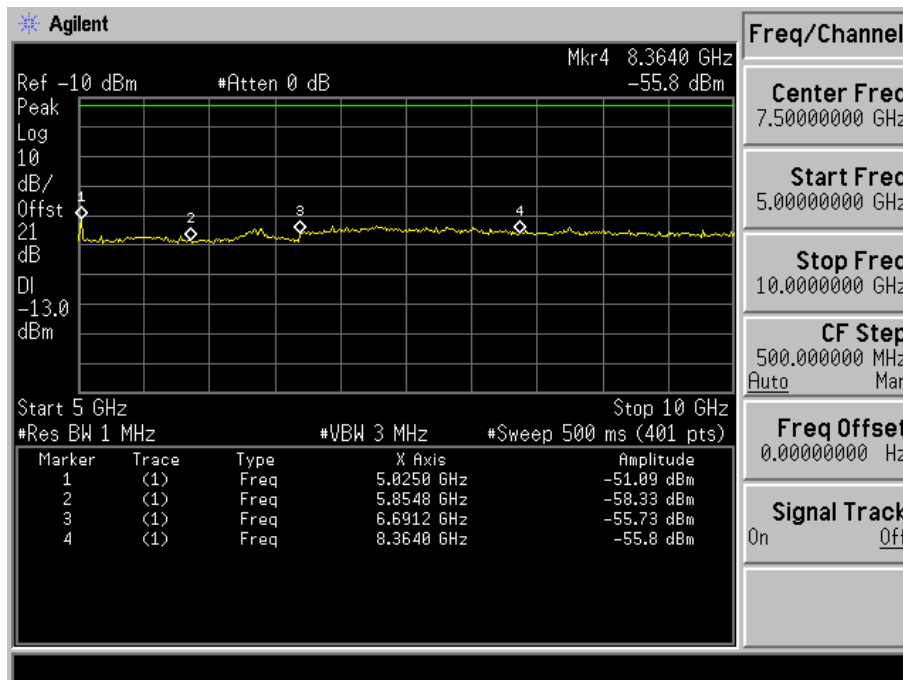

Freq/Channel

Center Freq
7.50000000 GHz

Start Freq
5.00000000 GHz

Stop Freq
10.00000000 GHz

CF Step
500.000000 MHz
Auto Man

Freq Offset
0.00000000 Hz

Signal Track
On Off

Product	GSM Mobile Phone		
Test Mode	Spurious Emission (Conducted)		
Date of Test	2007/10/08	Test Site	CB5
Test Condition	PCS 1900	Test Range	9KHz~20GHz

PCS1900 Mid-Channel 661

Frequency (MHz)	Reading Level (dBm)	Path Loss (dB)	Emission Level (dBm)	Limit (dBm)
3760	-54.78	1.1	-53.68	-13
5640	-65.87	1.23	-64.64	-13
7520	-61.99	1.59	-60.4	-13
9400	-56.68	1.89	-54.79	-13
112800	-57.12	2.07	-55.05	-13
131600	-63.29	2.26	-61.03	-13
162800	-62.87	2.64	-60.23	-13
181600	-64.93	3.5	-61.43	-13

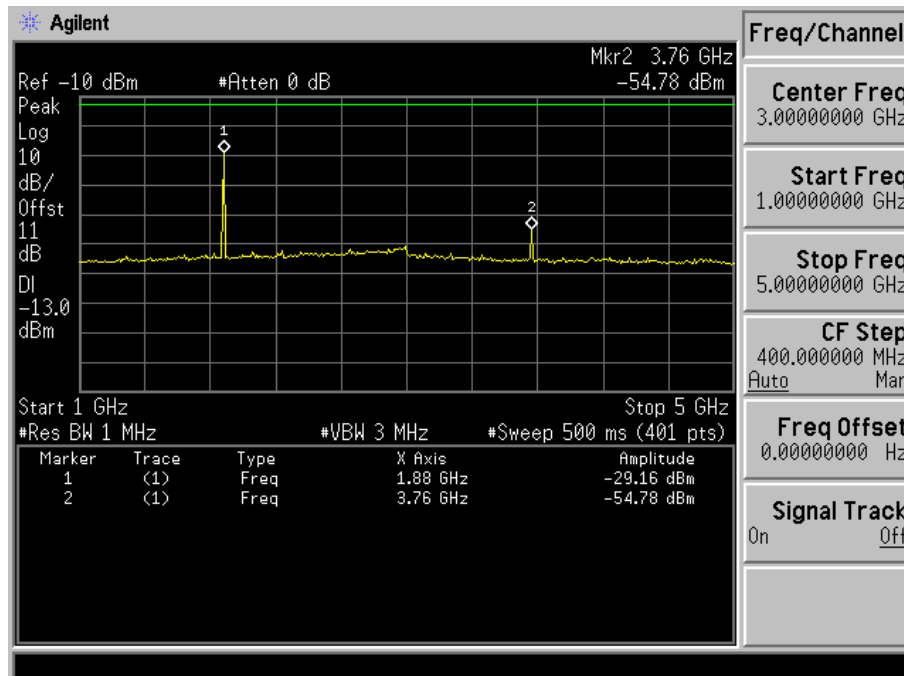

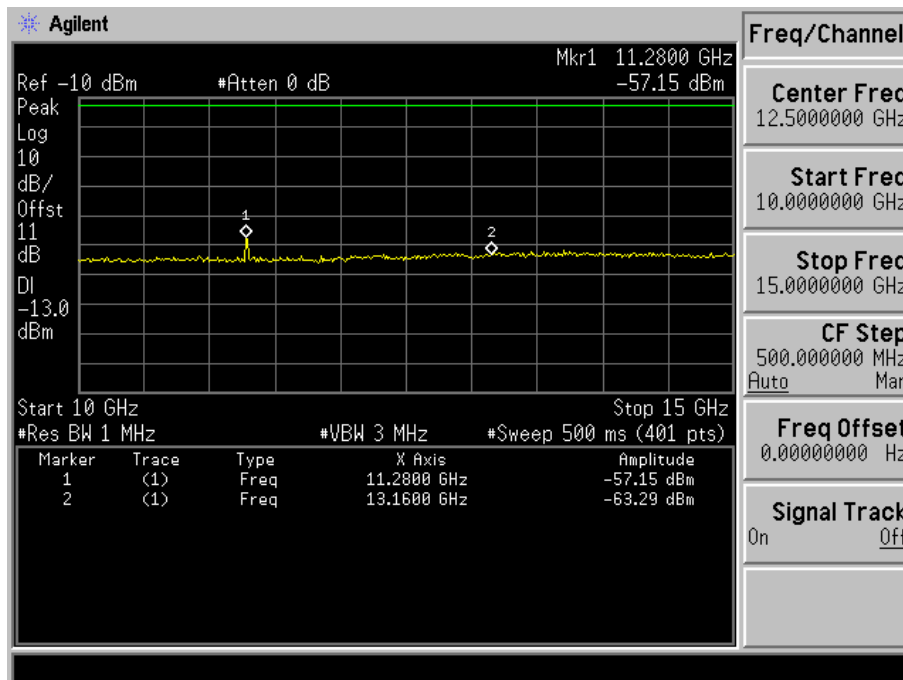
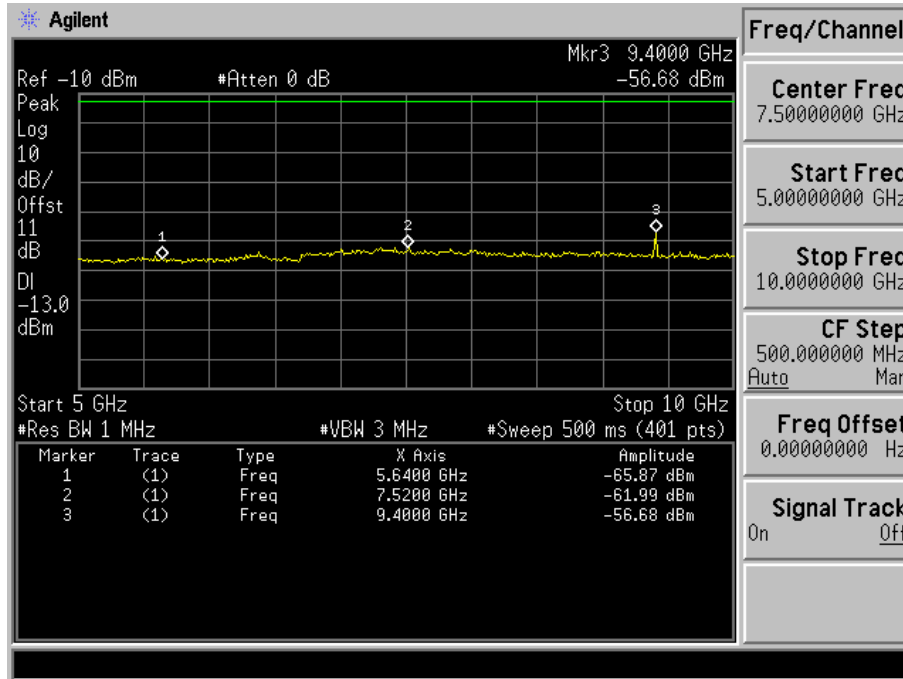

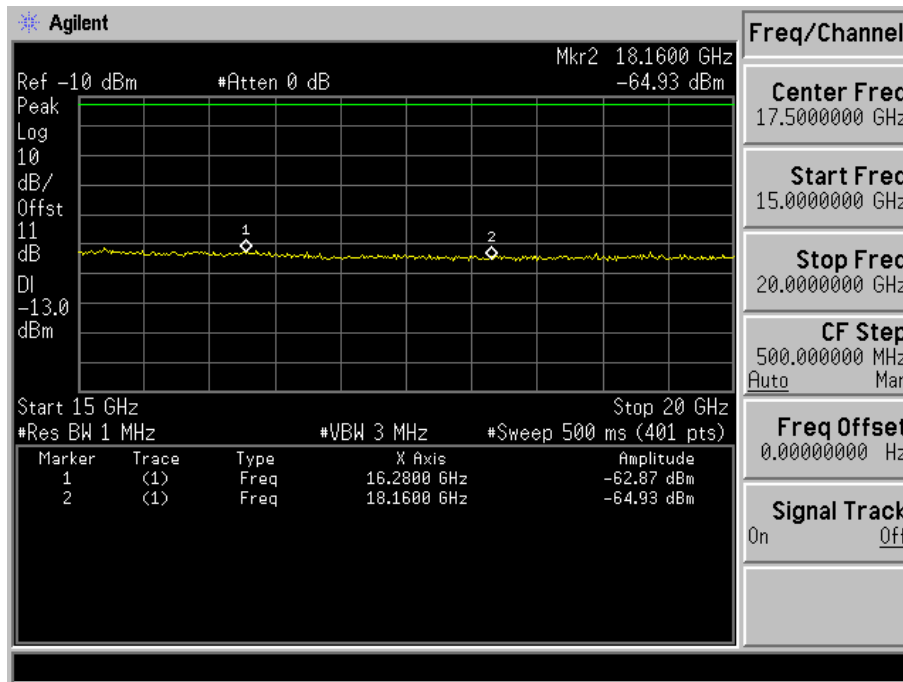

Product	GSM Mobile Phone		
Test Mode	Spurious Emission (Radiated)		
Date of Test	2007/10/08	Test Site	OATS 3
Test Condition	Channel 189 (GSM 850)	Test Range	9KHz ~20GHz

Frequency	Reading Level	Signal Generator Level	Cable Loss	Antenna Gain	ERP Value	Limit
(GHz)	(dBm)	(dBm)	(dB)	(dBd)	(dBm)	(dBm)

Horizontal Emissions

1670	-51.85	-46.85	12.6	1.41	-35.66	-13
2509.2	-47.48	-33.72	13.1	1.56	-22.18	-13
3345.6	-62.07	-54.05	11.5	2.01	-44.56	-13
4182	-62.6	-57.29	12	2.74	-48.03	-13
5018.4	-65.33	-65.00	12	2.64	-55.64	-13
5854.8	-64.79	-61.16	13.3	2.36	-50.22	-13
6691.2	-64.17	-57.88	13.7	3.16	-47.34	-13
7527.6	-63.09	-54.08	15.3	3.3	-42.08	-13
8364	-62.53	-32.93	8.9	3.16	-27.19	-13

Vertical Emissions

1670	-50.86	-47.32	12.6	1.41	-36.13	-13
2509.2	-50.13	-34.58	13.1	1.56	-23.04	-13
3345.6	-63.09	-53.22	11.5	2.01	-43.73	-13
4182	-62.8	-54.88	12	2.74	-45.62	-13
5018.4	-64.75	-64.48	12	2.64	-55.12	-13
5854.8	-64.51	-58.50	13.3	2.36	-47.56	-13
6691.2	-64.13	-56.84	13.7	3.16	-46.30	-13
7527.6	-62.86	-55.02	15.3	3.3	-43.02	-13

Note:

1. Receiver setting (Peak Detector) : RBW:1MHz; VBW:3MHz
2. ERP Value = Signal Generator Level + Antenna Gain - Cable Loss
3. Spurious emissions past 6 GHz are not shown, due to the magnitude of spurious emissions attenuated more than 20 dB below the limit.

Product	GSM Mobile Phone		
Test Mode	Spurious Emission (Radiated)		
Date of Test	2007/10/08	Test Site	OATS 3
Test Condition	Channel 661 (PCS1900)	Test Range	9KHz ~20GHz

Frequency	Reading Level	Signal Generator Level	Cable Loss	Antenna Gain	EIRP Value	Limit
(GHz)	(dBm)	(dBm)	(dB)	(dBi)	(dBm)	(dBm)

Horizontal Emissions

3760	-58.35	-56.37	12.6	1.41	-45.18	-13
5640	-63.04	-59.07	13.1	1.56	-47.53	-13
7520	-62.87	-56.49	11.5	2.01	-47.00	-13
9400	-61.88	-55.49	12	2.74	-46.23	-13
112800	-63.76	-59.35	12	2.64	-49.99	-13
131600	-63.98	-58.16	13.3	2.36	-47.22	-13
150400	-63.68	-55.00	13.7	3.16	-44.46	-13
162800	-63.15	-54.43	15.3	3.3	-42.43	-13
181600	-62.48	-32.41	8.9	3.16	-45.18	-13

Vertical Emissions

3760	-61.32	-61.77	12.6	1.41	-50.58	-13
5640	-63.89	-60.13	13.1	1.56	-48.59	-13
7520	-63.31	-57.44	11.5	2.01	-47.95	-13
9400	-64.12	-58.83	12	2.74	-49.57	-13
112800	-63.92	-57.72	12	2.64	-48.36	-13
131600	-64.65	-58.24	13.3	2.36	-47.30	-13
150400	-63.64	-55.73	13.7	3.16	-45.19	-13
162800	-63.07	-54.94	15.3	3.3	-42.94	-13

Note:

1. Receiver setting (Peak Detector) : RBW:1MHz; VBW:3MHz
2. EIRP Value = Signal Generator Level + Antenna Gain - Cable Loss
3. Spurious emissions past 12GHz are not shown, due to the magnitude of spurious emissions attenuated more than 20 dB below the limit.

7. Frequency Stability Under Temperature & Voltage Variations

7.1. Test Equipment

The following test equipments are used during the frequency stability test:

Equipment	Manufacturer	Model No./Serial No.	Last Cal.
Universal Radio Communication Tester	R & S	CMU200 / 104846	Apr., 2007
Standard Temperature & Humidity Chamber	WIT	TH-1S-B / 108210	Aug., 2007
DC Power Supply	Topward	6303D / 670302	N/A

Note: All equipments upon which need to be calibrated are with calibration period of 1 year

7.2. Test Setup

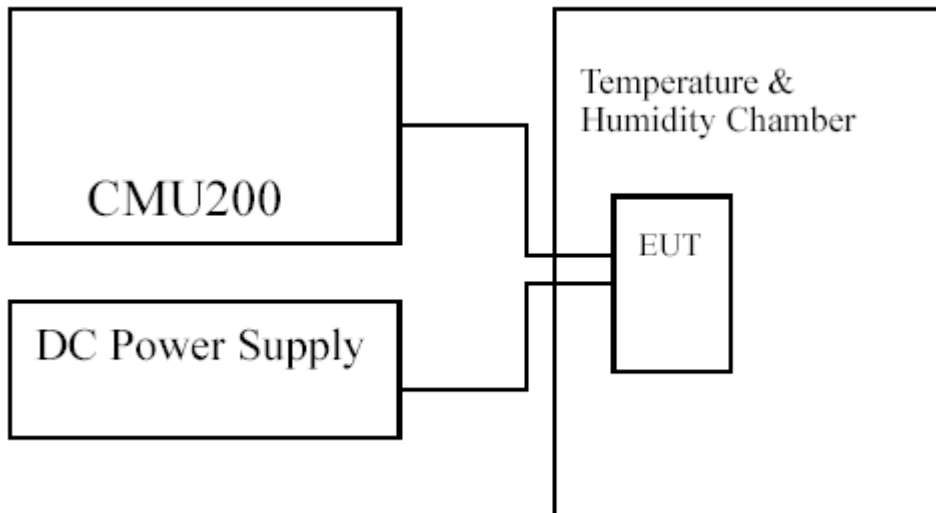

7.3. Limits

Limit	$\leq \pm 1 \text{ ppm}$
-------	--------------------------

7.4. Test Procedure

GSM

The EUT was set to transmit on maximum power and measurements were made on Timeslot3. Universal Radio Communication Tester, (CMU200), was used to measure The Frequency Error. The maximum result of measurements made over 200 bursts was recorded.

GPRS

The EUT was set to transmit on maximum power, (timeslots 3 and 4 active), and measurements performed on Timeslot 3. A Universal Radio Communication Tester, (CMU200), was used to measure the frequency error. The maximum result of measurements made over 200 bursts was recorded.

7.5. Test Specification

According to Part 2.1055, 24.235

7.6. Test Result of Frequency Stability Under Temperature Variations

Product	GSM Mobile Phone		
Test Mode	Frequency Stability Under Temperature Variations & Voltage Variations		
Date of Test	2007/10/08	Test Site	CB4
Test Condition	GSM 850 / Channel 189	Test Range	-30°C ~+50°C

GSM-Circuit Switched

Temperature Interval(°C)	Test Frequency (GHz)	Deviation (Hz)	Limit (KHz)
-30	0.836	-13	0.836
-20	0.836	-15	0.836
-10	0.836	-14	0.836
0	0.836	-14	0.836
10	0.836	-15	0.836
20	0.836	-14	0.836
30	0.836	-17	0.836
40	0.836	-16	0.836
50	0.836	-16	0.836

GSM-Circuit Switched

DC Voltage (V)	Test Frequency (GHz)	Deviation (Hz)	Limit (KHz)
3.31	0.836	-26	0.836
3.7	0.836	19	0.836
4.255	0.836	-18	0.836

Product	GSM Mobile Phone		
Test Mode	Frequency Stability Under Temperature Variations & Voltage Variations		
Date of Test	2007/10/08	Test Site	CB4
Test Condition	PCS 1900 / Channel 661	Test Range	-30°C ~+50°C

GSM-Circuit Switched

Temperature Interval(°C)	Test Frequency (GHz)	Deviation (Hz)	Limit (KHz)
-30	1.88	40	1.88
-20	1.88	39	1.88
-10	1.88	42	1.88
0	1.88	37	1.88
10	1.88	35	1.88
20	1.88	32	1.88
30	1.88	33	1.88
40	1.88	31	1.88
50	1.88	36	1.88

GSM-Circuit Switched

DC Voltage (V)	Test Frequency (GHz)	Deviation (Hz)	Limit (KHz)
3.31	1.88	40	1.88
3.7	1.88	54	1.88
4.255	1.88	41	1.88

8. EMI Reduction Method During Compliance Testing

No modification was made during testing.