



FCC TEST REPORT (FOR BLUETOOTH)

REPORT NO.: RF960621L09

MODEL NO.: VOGU100

RECEIVED: Jun. 21, 2007

TESTED: Jun. 21 ~ Jun. 29, 2007

ISSUED: Jul. 03, 2007

APPLICANT: High Tech Computer Corp.

ADDRESS: 23, Hsin-Hua Rd., Taoyuan, 330, Taiwan, R.O.C.

ISSUED BY: Advance Data Technology Corporation

LAB ADDRESS: No. 47, 14th Ling, Chia Pau Tsuen, Lin Kou Hsiang
244, Taipei Hsien, Taiwan, R.O.C.

TEST LOCATION: No. 19, Hwa Ya 2nd Rd., Wen Hwa Tsuen, Kwei
Shan Hsiang, Taoyuan Hsien 333, Taiwan, R.O.C.

This test report consists of 79 pages in total. It may be duplicated completely for legal use with the approval of the applicant. It should not be reproduced except in full, without the written approval of our laboratory. The client should not use it to claim product endorsement by TAF, A2LA or any government agencies. The test results in the report only apply to the tested sample.





TABLE OF CONTENTS

1.	CERTIFICATION	4
2.	SUMMARY OF TEST RESULTS.....	5
2.1	MEASUREMENT UNCERTAINTY	5
3.	GENERAL INFORMATION	6
3.1	GENERAL DESCRIPTION OF EUT	6
3.2	DESCRIPTION OF TEST MODES	8
3.2.1	CONFIGURATION OF SYSTEM UNDER TEST.....	9
3.2.2	TEST MODE APPLICABILITY AND TESTED CHANNEL DETAIL	10
3.3.3	GENERAL DESCRIPTION OF APPLIED STANDARDS.....	13
3.3.4	DESCRIPTION OF SUPPORT UNITS.....	13
4.	TEST TYPES AND RESULTS.....	14
4.1	CONDUCTED EMISSION MEASUREMENT.....	14
4.1.1	LIMITS OF CONDUCTED EMISSION MEASUREMENT	14
4.1.2	TEST INSTRUMENTS	14
4.1.3	TEST PROCEDURES.....	15
4.1.4	DEVIATION FROM TEST STANDARD	15
4.1.5	TEST SETUP	16
4.1.6	EUT OPERATING CONDITIONS.....	16
4.1.7	TEST RESULTS.....	17
4.2	RADIATED EMISSION MEASUREMENT.....	23
4.2.1	LIMITS OF RADIATED EMISSION MEASUREMENT	23
4.2.2	TEST INSTRUMENTS	24
4.2.3	TEST PROCEDURES.....	25
4.2.4	DEVIATION FROM TEST STANDARD	25
4.2.5	TEST SETUP	26
4.2.6	EUT OPERATING CONDITIONS.....	26
4.2.7	TEST RESULTS.....	27
4.3	NUMBER OF HOPPING FREQUENCY USED	39
4.3.1	LIMIT OF HOPPING FREQUENCY USED	39
4.3.2	TEST INSTRUMENTS	39
4.3.3	TEST PROCEDURES.....	39
4.3.4	DEVIATION FROM TEST STANDARD	40
4.3.5	TEST SETUP	40
4.3.6	TEST RESULTS.....	40
4.4	DWELL TIME ON EACH CHANNEL.....	43
4.4.1	LIMIT OF DWELL TIME USED	43
4.4.2	TEST INSTRUMENTS	43
4.4.3	TEST PROCEDURES.....	43
4.4.4	DEVIATION FROM TEST STANDARD	43
4.4.5	TEST SETUP	43
4.4.6	TEST RESULTS.....	44
4.5	CHANNEL BANDWIDTH	52
4.5.1	LIMITS OF CHANNEL BANDWIDTH.....	52
4.5.2	TEST INSTRUMENTS	52
4.5.3	TEST PROCEDURE	52
4.5.4	DEVIATION FROM TEST STANDARD	52
4.5.5	TEST SETUP	53
4.5.6	EUT OPERATING CONDITION	53



4.5.7	TEST RESULTS.....	53
4.6	HOPPING CHANNEL SEPARATION.....	58
4.6.1	LIMIT OF HOPPING CHANNEL SEPARATION.....	58
4.6.2	TEST INSTRUMENTS.....	58
4.6.3	TEST PROCEDURES.....	58
4.6.4	DEVIATION FROM TEST STANDARD.....	58
4.6.5	TEST SETUP.....	58
4.6.6	TEST RESULTS.....	59
4.7	MAXIMUM PEAK OUTPUT POWER.....	63
4.7.1	LIMITS OF MAXIMUM PEAK OUTPUT POWER MEASUREMENT.....	63
4.7.2	TEST INSTRUMENTS.....	63
4.7.3	TEST PROCEDURES.....	63
4.7.4	DEVIATION FROM TEST STANDARD.....	63
4.7.5	TEST SETUP.....	64
4.7.6	EUT OPERATING CONDITION.....	64
4.7.7	TEST RESULTS.....	64
4.8	BAND EDGES MEASUREMENT.....	69
4.8.1	LIMITS OF BAND EDGES MEASUREMENT.....	69
4.8.2	TEST INSTRUMENTS.....	69
4.8.3	TEST PROCEDURE.....	69
4.8.4	DEVIATION FROM TEST STANDARD.....	69
4.8.5	EUT OPERATING CONDITION.....	69
4.8.6	TEST RESULTS.....	70
4.9	ANTENNA REQUIREMENT.....	76
4.9.1	STANDARD APPLICABLE.....	76
4.9.2	ANTENNA CONNECTED CONSTRUCTION.....	76
5.	PHOTOGRAPHS OF THE TEST CONFIGURATION.....	77
6.	INFORMATION ON THE TESTING LABORATORIES.....	78
7.	APPENDIX A – MODIFICATIONS RECORDERS FOR ENGINEERING CHANGES TO THE EUT BY THE LAB.....	79



1. CERTIFICATION

PRODUCT: Pocket PC phone

MODEL: VOGU100

APPLICANT: High Tech Computer Corp.

TESTED: Jun. 21 ~ Jun. 29, 2007

TEST SAMPLE: ENGINEERING SAMPLE

STANDARDS: FCC Part 15, Subpart C (Section 15.247)

ANSI C63.4-2003

The above equipment (model: VOGU100) have been tested by **Advance Data Technology Corporation**, and found compliance with the requirement of the above standards. The test record, data evaluation & Equipment Under Test (EUT) configurations represented herein are true and accurate accounts of the measurements of the sample's EMC characteristics under the conditions specified in this report.

PREPARED BY : Andrea Hsia , **DATE:** Jul. 03, 2007
Andrea Hsia / Specialist

TECHNICAL ACCEPTANCE : Long Chen , **DATE:** Jul. 03, 2007
Responsible for RF Long Chen / Senior Engineer

APPROVED BY : Gary Chang , **DATE:** Jul. 03, 2007
Gary Chang / Supervisor

2. SUMMARY OF TEST RESULTS

The EUT has been tested according to the following specifications:

APPLIED STANDARD: FCC Part 15, Subpart C			
STANDARD SECTION	TEST TYPE AND LIMIT	RESULT	REMARK
15.207	AC Power Conducted Emission	PASS	Meet the requirement of limit Minimum passing margin is -9.09dB at 2.676MHz.
15.247(a)(1)(iii)	Number of Hopping Frequency Used Spec.: At least 15 channels	PASS	Meet the requirement of limit
15.247(a)(1)(iii)	Dwell Time on Each Channel Spec.: Max. 0.4 second within 31.6 second	PASS	Meet the requirement of limit
15.247(a)(1)	1. Hopping Channel Separation Spec. : Min. 25 kHz or 2/3*20 dB bandwidth, whichever is greater (see Note) 2. Spectrum Bandwidth of a Frequency Hopping Sequence Spread Spectrum System	PASS	Meet the requirement of limit.
15.247(b)	Maximum Peak Output Power Spec.: max. 21dBm (see Note)	PASS	Meet the requirement of limit.
15.247(d)	Transmitter Radiated Emissions Spec.: Table 15.209	PASS	Meet the requirement of limit Minimum passing margin is -3.72dB at 904.83MHz.
15.247(d)	Band Edge Measurement	PASS	Meet the requirement of limit

NOTE: If The Frequency Hopping System operating in 2400-2483.5MHz band and the output power less than 125mW. The hopping channel carrier frequencies separated by a minimum of 25kHz or two-thirds of the 20dB bandwidth of hopping channel whichever is greater.

2.1 MEASUREMENT UNCERTAINTY

Where relevant, the following measurement uncertainty levels have been estimated for tests performed on the EUT as specified in CISPR 16-4-2:

MEASUREMENT	FREQUENCY	UNCERTAINTY
Conducted emissions	9kHz~30MHz	2.44 dB
Radiated emissions	30MHz ~ 200MHz	3.34 dB
	200MHz ~1000MHz	3.35 dB
	1GHz ~ 18GHz	2.26 dB
	18GHz ~ 40GHz	1.94 dB

This uncertainty represents an expanded uncertainty expressed at approximately the 95% confidence level using a coverage factor of k=2.

3. GENERAL INFORMATION

3.1 GENERAL DESCRIPTION OF EUT

PRODUCT	Pocket PC phone
MODEL NO.	VOGU100
FCC ID	NM8VOGU100
POWER SUPPLY	3.7Vdc from rechargeable lithium battery 5.0Vdc from power adapter 5.0Vdc from host equipment
MODULATION TYPE	GFSK, $\pi/4$ -DQPSK, 8DPSK
MODULATION TECHNOLOGY	FHSS
TRANSFER RATE	1/2/3Mbps
FREQUENCY RANGE	2400 ~ 2483.5 MHz
NUMBER OF CHANNEL	79
OUTPUT POWER	1.581mW
ANTENNA TYPE	PIFA antenna with 0dBi gain
DATA CABLE	1.6m USB shielded cable without core
I/O PORTS	Refer to user's manual
ACCESSORY DEVICE	Refer to NOTE 2 as below

NOTE:

- The EUT is a CDMA2000 (850/1900) + 1xEVDO/ 1xRTT/ IS-95A/B Pocket PC phone with bluetooth V2.0 w EDR + AGPS functions. This report is only covered the functions of Bluetooth. The mobile phone function is covered in another two test reports, which standards used are FCC Part 22 and FCC Part 24 (Report No.: RF960621L09-1, RF960621L09-2).
- The EUT has following accessories.

ACCESSORY	BRAND	MODEL	SUPPORTER	REMARKS
Belt Clip	HTC	PO S292	NEWTECH	
Carrying Case	HTC	PO S290	NEWTECH	
Earphone	HTC	HS S190	Merry	1.6m cable
Splitter (1)	HTC	YC A130	MEC	10.5cm (earphone with audio interface)
Splitter (2)	HTC	YC A100	Acon	9.7cm (earphone with USB interface)

- The EUT have two lithium batteries listed as below:

STANDARD BATTERY 1:	
MANUFACTURER:	TWS
MODEL:	ELF0160
RATING:	3.7Vdc, 1100mAh

STANDARD BATTERY 2:	
MANUFACTURER:	SAMSUNG
MODEL:	ELF0160
RATING:	3.7Vdc, 1100mAh

**After pre-tested both batteries, found battery A is worse, therefore all the test results came out from this.

4. The EUT were operated with following power adapters:

ADAPTER 1:	
BRAND:	DELTA ELECTRONIC, INC.
MODEL:	ADP-5FH B
INPUT:	100-240Vac, 50-60Hz, 0.2A
OUTPUT:	5Vdc, 1A
POWER LINE:	1.8m non-shielded cable without core

ADAPTER 2:	
BRAND:	htc
MODEL:	PSAA05A-050
INPUT:	100-240Vac, 50-60Hz, 200mA
OUTPUT:	5.0Vdc, 1A
POWER LINE:	1.8m non-shielded cable without core

5. The above EUT information was declared by manufacturer and for more detailed features description, please refer to the manufacturer's specifications or User's Manual.

3.2 DESCRIPTION OF TEST MODES

79 channels are provided to this EUT for Bluetooth function:

CHANNEL	FREQ. (MHz)	CHANNEL	FREQ. (MHz)	CHANNEL	FREQ. (MHz)	CHANNEL	FREQ. (MHz)
0	2402	20	2422	40	2442	60	2462
1	2403	21	2423	41	2443	61	2463
2	2404	22	2424	42	2444	62	2464
3	2405	23	2425	43	2445	63	2465
4	2406	24	2426	44	2446	64	2466
5	2407	25	2427	45	2447	65	2467
6	2408	26	2428	46	2448	66	2468
7	2409	27	2429	47	2449	67	2469
8	2410	28	2430	48	2450	68	2470
9	2411	29	2431	49	2451	69	2471
10	2412	30	2431	50	2452	70	2472
11	2413	31	2433	51	2453	71	2473
12	2414	32	2434	52	2454	72	2474
13	2415	33	2435	53	2455	73	2475
14	2416	34	2436	54	2456	74	2476
15	2417	35	2437	55	2457	75	2477
16	2418	36	2438	56	2458	76	2478
17	2419	37	2439	57	2459	77	2479
18	2420	38	2440	58	2460	78	2480
19	2421	39	2441	59	2461		

3.2.1 CONFIGURATION OF SYSTEM UNDER TEST

TEST MODE A, B, C & D

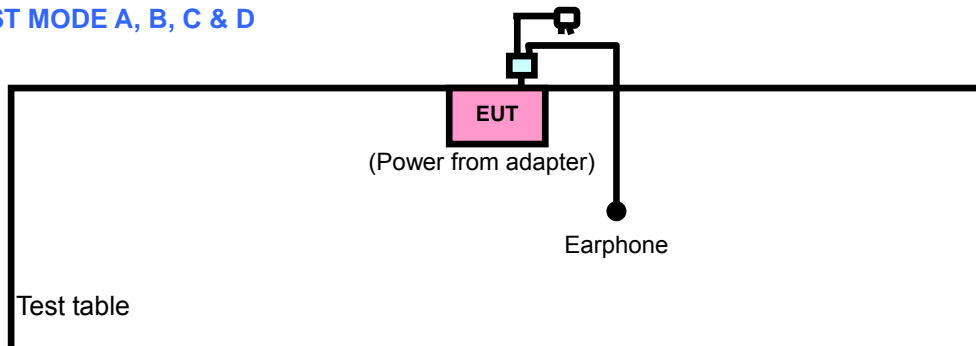

TEST MODE E & F

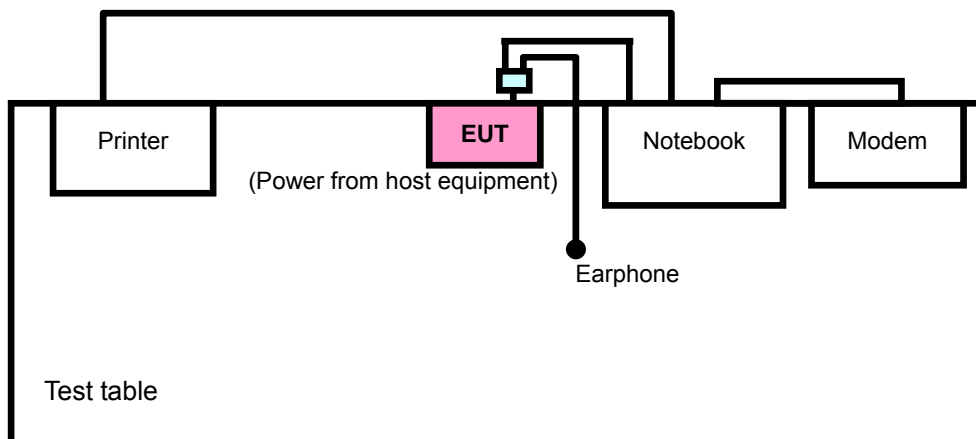

3.2.2 TEST MODE APPLICABILITY AND TESTED CHANNEL DETAIL

EUT CONFIGURE MODE	APPLICABLE TO				DESCRIPTION
	PLC	RE<1G	RE≥1G	APCM	
A	-	√	-	-	The EUT + Earphone with Splitter (2) and powered by adapter 1
B	-	√	-	-	The EUT + Earphone with Splitter (1) and powered by adapter 1
C	-	√	-	-	The EUT + Earphone with Splitter (2) and powered by adapter 2
D	√	√	√	√	The EUT + Earphone with Splitter (1) and powered by adapter2
E	-	√	-	-	The EUT + Earphone with Splitter (2) and powered by host equipment
F	-	√	-	-	The EUT + Earphone with Splitter (1) and powered by host equipment

Where **PLC**: Power Line Conducted Emission
RE≥1G: Radiated Emission above 1GHz

RE<1G: Radiated Emission below 1GHz
APCM: Antenna Port Conducted Measurement

NOTE: “-“ means no effect.

POWER LINE CONDUCTED EMISSION TEST:

- Pre-Scan has been conducted to determine the worst-case mode from all possible combinations between available modulations, antenna ports (if EUT with antenna diversity architecture), and packet types.
- Following channel(s) was (were) selected for the final test as listed below.

EUT CONFIGURE MODE	AVAILABLE CHANNEL	TESTED CHANNEL	MODULATION TECHNOLOGY	MODULATION TYPE	PACKET TYPE
D	0 to 78	0, 39, 78	FHSS	GFSK	DH5

RADIATED EMISSION TEST (BELOW 1 GHz):

- Pre-Scan has been conducted to determine the worst-case mode from all possible combinations between available modulations, data rates, antenna ports (if EUT with antenna diversity architecture), X, Y, Z Axis, and packet type.
- Following channel(s) was (were) selected for the final test as listed below.

EUT CONFIGURE MODE	AVAILABLE CHANNEL	TESTED CHANNEL	MODULATION TECHNOLOGY	MODULATION TYPE	PACKET TYPE	AXIS
A	0 to 78	78	FHSS	GFSK	DH5	Y
B	0 to 78	78	FHSS	GFSK	DH5	Y
C	0 to 78	78	FHSS	GFSK	DH5	Y
D	0 to 78	78	FHSS	GFSK	DH5	Y
E	0 to 78	78	FHSS	GFSK	DH5	Y
F	0 to 78	78	FHSS	GFSK	DH5	Y

RADIATED EMISSION TEST (ABOVE 1 GHz):

- Pre-Scan has been conducted to determine the worst-case mode from all possible combinations between available modulations, data rates, antenna ports (if EUT with antenna diversity architecture), X, Y, Z Axis, and packet type.
- Following channel(s) was (were) selected for the final test as listed below.

EUT CONFIGURE MODE	AVAILABLE CHANNEL	TESTED CHANNEL	MODULATION TECHNOLOGY	MODULATION TYPE	PACKET TYPE	DATE RATE	AXIS
D	0 to 78	0, 39, 78	FHSS	GFSK	DH5	1	Y
D	0 to 78	0, 39, 78	FHSS	8DPSK	DH5	3	Y

BANDEDGE MEASUREMENT:

- Pre-Scan has been conducted to determine the worst-case mode from all possible combinations between available modulations, antenna ports (if EUT with antenna diversity architecture), and packet types.
- Following channel(s) was (were) selected for the final test as listed below.

EUT CONFIGURE MODE	AVAILABLE CHANNEL	TESTED CHANNEL	MODULATION TECHNOLOGY	MODULATION TYPE	PACKET TYPE	DATE RATE
D	0 to 78	0, 78	FHSS	GFSK	DH5	1
D	0 to 78	0, 78	FHSS	8DPSK	DH5	3



ANTENNA PORT CONDUCTED MEASUREMENT:

- Pre-Scan has been conducted to determine the worst-case mode from all possible combinations between available modulations, antenna ports (if EUT with antenna diversity architecture), and packet types.
- Following channel(s) was (were) selected for the final test as listed below.

EUT CONFIGURE MODE	AVAILABLE CHANNEL	TESTED CHANNEL	MODULATION TECHNOLOGY	MODULATION TYPE	PACKET TYPE	DATE RATE
D	0 to 78	0, 39, 78	FHSS	GFSK	DH5	1
D	0 to 78	0, 39, 78	FHSS	8DPSK	DH5	3



3.3.3 GENERAL DESCRIPTION OF APPLIED STANDARDS

The EUT is a RF Product. According to the specifications of the manufacturer, it must comply with the requirements of the following standards:

FCC Part 15, Subpart C. (15.247)

ANSI C63.4- 2003

All test items have been performed and recorded as per the above standards.

NOTE: The EUT is also considered as a kind of computer peripheral, because the connection to computer is necessary for typical use. It has been verified to comply with the requirements of FCC Part 15, Subpart B, Class B (DoC). The test report has been issued separately.

3.3.4 DESCRIPTION OF SUPPORT UNITS

The EUT has been tested as an independent unit together with other necessary accessories or support units. The following support units or accessories were used to form a representative test configuration during the tests.

NO.	PRODUCT	BRAND	MODEL NO.	SERIAL NO.	FCC ID
1	NOTEBOOK COMPUTER	DELL	PP05L	16484462992	E2K24CLNS
2	MODEM	ACEEX	1414V/3	0401008253	IFAXDM1414
3	PRINTER	EPSON	LQ-300+	DCGY054011	FCC DoC Approved
4	EARPHONE	SANYO	MDR-P033	NA	NA

NO.	SIGNAL CABLE DESCRIPTION OF THE ABOVE SUPPORT UNITS
1	NA
2	1.2 m shielded cable
3	1.2m shielded cable
4	2.5m shielded cable

NOTE: All power cords of the above support units are non shielded (1.8m).

4. TEST TYPES AND RESULTS

4.1 CONDUCTED EMISSION MEASUREMENT

4.1.1 LIMITS OF CONDUCTED EMISSION MEASUREMENT

FREQUENCY OF EMISSION (MHz)	CONDUCTED LIMIT (dB μ V)	
	Quasi-peak	Average
0.15 ~ 0.5	66 to 56	56 to 46
0.5 ~ 5	56	46
5 ~ 30	60	50

- NOTE:**
1. The lower limit shall apply at the transition frequencies.
 2. The limit decreases in line with the logarithm of the frequency in the range of 0.15 to 0.50 MHz.
 3. All emanations from a class A/B digital device or system, including any network of conductors and apparatus connected thereto, shall not exceed the level of field strengths specified above.

4.1.2 TEST INSTRUMENTS

DESCRIPTION & MANUFACTURER	MODEL NO.	SERIAL NO.	CALIBRATED UNTIL
Test Receiver ROHDE & SCHWARZ	ESCS30	100289	Dec. 07, 2007
RF signal cable Woken	5D-FB	Cable-HYC01-01	Jan. 06, 2008
LISN ROHDE & SCHWARZ	ESH3-Z5	100312	Feb. 13, 2008
LISN ROHDE & SCHWARZ	ESH2-Z5	100104	Sep. 14, 2007
Software ADT	ADT_Cond_V3	NA	NA

- NOTE:**
1. The calibration interval of the above test instruments is 12 months and the calibrations are traceable to NML/ROC and NIST/USA.
 2. The test was performed in HwaYa Shielded Room 1.
 3. The VCCI Site Registration No. is C-2040.

4.1.3 TEST PROCEDURES

- a. The EUT was placed 0.4 meters from the conducting wall of the shielded room with EUT being connected to the power mains through a line impedance stabilization network (LISN). Other support units were connected to the power mains through another LISN. The two LISNs provide 50 ohm/ 50uH of coupling impedance for the measuring instrument.
- b. Both lines of the power mains connected to the EUT were checked for maximum conducted interference.
- c. The frequency range from 150kHz to 30MHz was searched. Emission levels under (Limit - 20dB) was not recorded.

4.1.4 DEVIATION FROM TEST STANDARD

No deviation

4.1.5 TEST SETUP

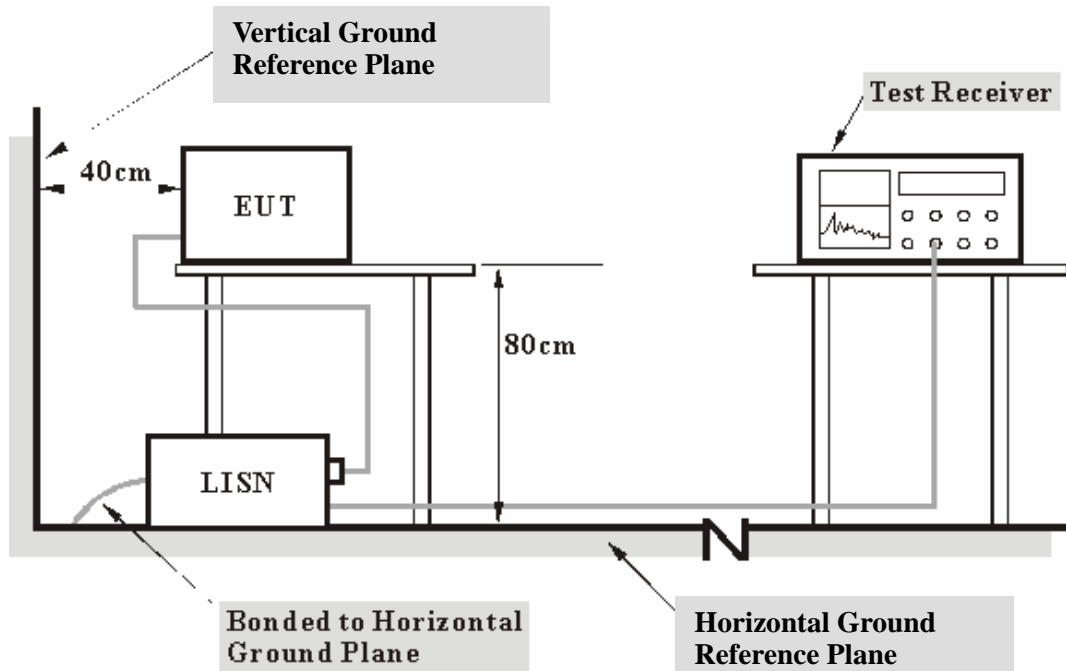

- Note:** 1. Support units were connected to second LISN.
 2. Both of LISNs (AMN) 80 cm from EUT and at the least 80 cm from other units and other metal planes support units.

For the actual test configuration, please refer to the attached file (Test Setup Photo).

4.1.6 EUT OPERATING CONDITIONS

TEST MODE A, B, C & D:

- a. Placed the EUT on a testing table.
- b. Set the EUT under transmission condition continuously at specific channel frequency.

TEST MODE E & F:

- a. Connected the EUT to notebook via USB cable and placed on a testing table.
- b. The notebook ran a test program (provided by manufacturer) to enable EUT under transmission condition continuously at specific channel frequency.
- c. The necessary accessories enable the system in full functions.

4.1.7 TEST RESULTS

CONDUCTED WORST CASE DATA

EUT TEST CONDITION		MEASUREMENT DETAIL	
CHANNEL	Channel 0	PHASE	Line 1
MODULATION TYPE	GFSK	6dB BANDWIDTH	9 kHz
ENVIRONMENTAL CONDITIONS	20deg. C, 60%RH, 991hPa	INPUT POWER (SYSTEM)	120Vac, 60 Hz
TEST MODE	D	TESTED BY	Match Tsui

No	Freq. [MHz]	Corr. Factor (dB)	Reading Value [dB (uV)]		Emission Level [dB (uV)]		Limit [dB (uV)]		Margin (dB)	
			Q.P.	AV.	Q.P.	AV.	Q.P.	AV.	Q.P.	AV.
			1	0.189	0.21	37.92	-	38.13	-	64.08
2	0.537	0.22	36.96	-	37.18	-	56.00	46.00	-18.82	-
3	1.152	0.24	39.68	-	39.92	-	56.00	46.00	-16.08	-
4	1.828	0.26	42.20	-	42.46	-	56.00	46.00	-13.54	-
5	2.699	0.31	43.35	-	43.66	-	56.00	46.00	-12.34	-
6	8.410	0.50	38.62	-	39.12	-	60.00	50.00	-20.88	-

- REMARKS:**
1. Q.P. and AV. are abbreviations of quasi-peak and average individually.
 2. "-": The Quasi-peak reading value also meets average limit and measurement with the average detector is unnecessary.
 3. The emission levels of other frequencies were very low against the limit.
 4. Margin value = Emission level - Limit value
 5. Correction factor = Insertion loss + Cable loss
 6. Emission Level = Correction Factor + Reading Value.

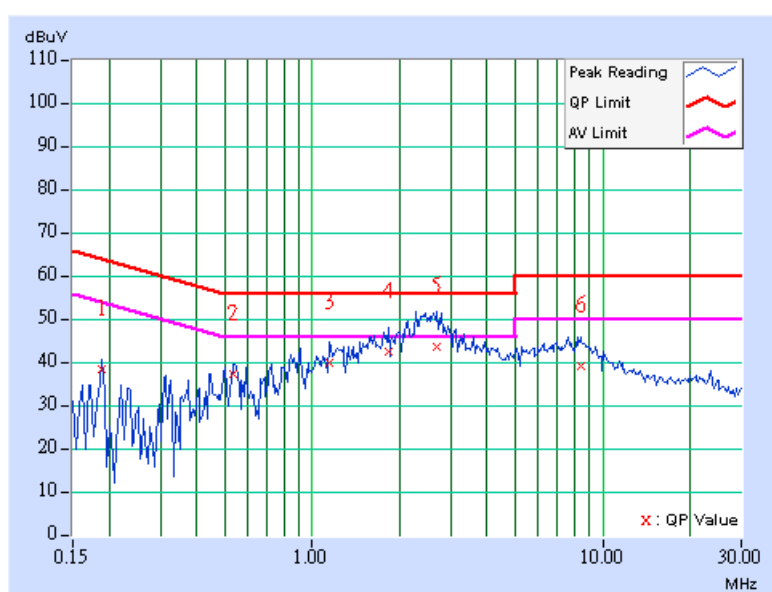

EUT TEST CONDITION		MEASUREMENT DETAIL	
CHANNEL	Channel 0	PHASE	Line 2
MODULATION TYPE	GFSK	6dB BANDWIDTH	9 kHz
ENVIRONMENTAL CONDITIONS	20deg. C, 60%RH, 991hPa	INPUT POWER (SYSTEM)	120Vac, 60 Hz
TEST MODE	D	TESTED BY	Match Tsui

No	Freq. [MHz]	Corr. Factor (dB)	Reading Value [dB (uV)]		Emission Level [dB (uV)]		Limit [dB (uV)]		Margin (dB)	
			Q.P.	AV.	Q.P.	AV.	Q.P.	AV.	Q.P.	AV.
1	0.189	0.21	39.22	-	39.43	-	64.08	54.08	-24.65	-
2	0.548	0.22	33.67	-	33.89	-	56.00	46.00	-22.11	-
3	0.852	0.23	38.48	-	38.71	-	56.00	46.00	-17.29	-
4	1.449	0.25	38.29	-	38.54	-	56.00	46.00	-17.46	-
5	2.641	0.30	41.89	-	42.19	-	56.00	46.00	-13.81	-
6	8.535	0.50	34.53	-	35.03	-	60.00	50.00	-24.97	-

- REMARKS:**
1. Q.P. and AV. are abbreviations of quasi-peak and average individually.
 2. "-": The Quasi-peak reading value also meets average limit and measurement with the average detector is unnecessary.
 3. The emission levels of other frequencies were very low against the limit.
 4. Margin value = Emission level - Limit value
 5. Correction factor = Insertion loss + Cable loss
 6. Emission Level = Correction Factor + Reading Value.

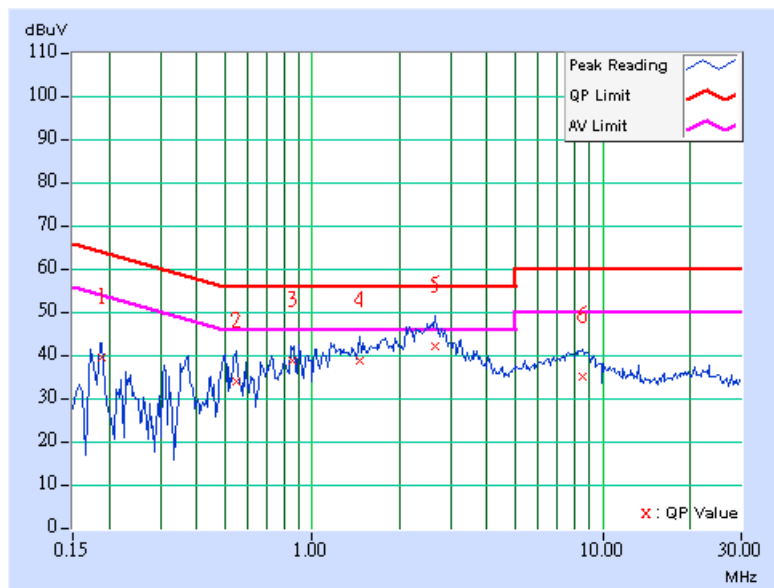

EUT TEST CONDITION		MEASUREMENT DETAIL	
CHANNEL	Channel 39	PHASE	Line 1
MODULATION TYPE	GFSK	6dB BANDWIDTH	9 kHz
ENVIRONMENTAL CONDITIONS	20deg. C, 60%RH, 991hPa	INPUT POWER (SYSTEM)	120Vac, 60 Hz
TEST MODE	D	TESTED BY	Match Tsui

No	Freq. [MHz]	Corr. Factor (dB)	Reading Value [dB (uV)]		Emission Level [dB (uV)]		Limit [dB (uV)]		Margin (dB)	
			Q.P.	AV.	Q.P.	AV.	Q.P.	AV.	Q.P.	AV.
1	0.184	0.21	40.42	-	40.63	-	64.32	54.32	-23.69	-
2	0.509	0.22	36.30	-	36.52	-	56.00	46.00	-19.48	-
3	0.908	0.24	40.04	-	40.28	-	56.00	46.00	-15.72	-
4	1.766	0.26	43.01	-	43.27	-	56.00	46.00	-12.73	-
5	2.676	0.30	46.61	35.81	46.91	36.11	56.00	46.00	-9.09	-9.89
6	8.242	0.50	39.79	-	40.29	-	60.00	50.00	-19.71	-

- REMARKS:**
1. Q.P. and AV. are abbreviations of quasi-peak and average individually.
 2. "-": The Quasi-peak reading value also meets average limit and measurement with the average detector is unnecessary.
 3. The emission levels of other frequencies were very low against the limit.
 4. Margin value = Emission level - Limit value
 5. Correction factor = Insertion loss + Cable loss
 6. Emission Level = Correction Factor + Reading Value.

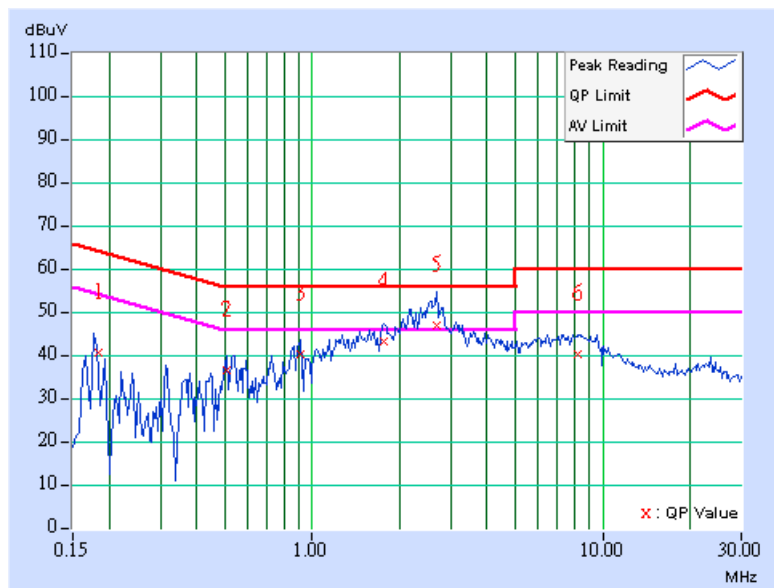

EUT TEST CONDITION		MEASUREMENT DETAIL	
CHANNEL	Channel 39	PHASE	Line 2
MODULATION TYPE	GFSK	6dB BANDWIDTH	9 kHz
ENVIRONMENTAL CONDITIONS	20deg. C, 60%RH, 991hPa	INPUT POWER (SYSTEM)	120Vac, 60 Hz
TEST MODE	D	TESTED BY	Match Tsui

No	Freq. [MHz]	Corr. Factor (dB)	Reading Value [dB (uV)]		Emission Level [dB (uV)]		Limit [dB (uV)]		Margin (dB)	
			Q.P.	AV.	Q.P.	AV.	Q.P.	AV.	Q.P.	AV.
1	0.181	0.21	40.40	-	40.61	-	64.43	54.43	-23.82	-
2	0.545	0.22	34.55	-	34.77	-	56.00	46.00	-21.23	-
3	0.904	0.24	37.89	-	38.13	-	56.00	46.00	-17.87	-
4	1.816	0.26	37.30	-	37.56	-	56.00	46.00	-18.44	-
5	2.480	0.29	41.77	-	42.06	-	56.00	46.00	-13.94	-
6	8.348	0.50	34.61	-	35.11	-	60.00	50.00	-24.89	-

- REMARKS:**
1. Q.P. and AV. are abbreviations of quasi-peak and average individually.
 2. "-": The Quasi-peak reading value also meets average limit and measurement with the average detector is unnecessary.
 3. The emission levels of other frequencies were very low against the limit.
 4. Margin value = Emission level - Limit value
 5. Correction factor = Insertion loss + Cable loss
 6. Emission Level = Correction Factor + Reading Value.

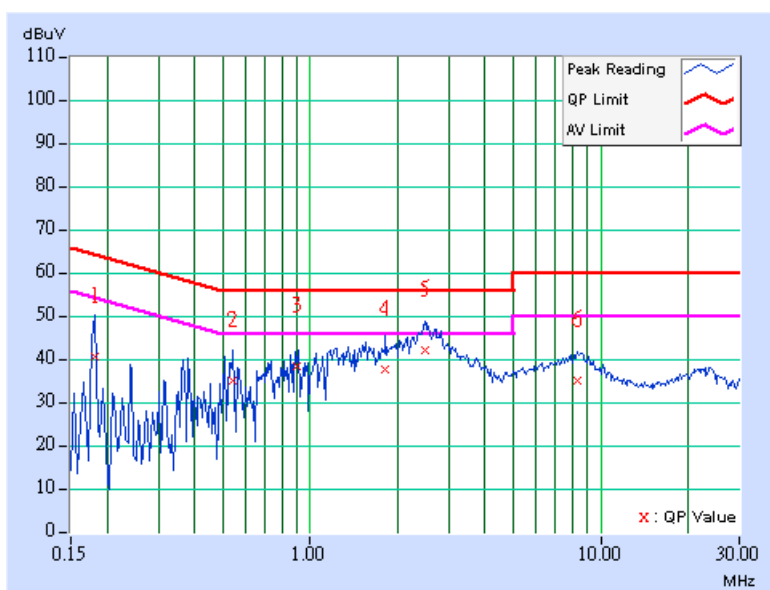

EUT TEST CONDITION		MEASUREMENT DETAIL	
CHANNEL	Channel 78	PHASE	Line 1
MODULATION TYPE	GFSK	6dB BANDWIDTH	9 kHz
ENVIRONMENTAL CONDITIONS	20deg. C, 60%RH, 991hPa	INPUT POWER (SYSTEM)	120Vac, 60 Hz
TEST MODE	D	TESTED BY	Match Tsui

No	Freq. [MHz]	Corr. Factor (dB)	Reading Value [dB (uV)]		Emission Level [dB (uV)]		Limit [dB (uV)]		Margin (dB)	
			Q.P.	AV.	Q.P.	AV.	Q.P.	AV.	Q.P.	AV.
1	0.185	0.21	38.29	-	38.50	-	64.25	54.25	-25.75	-
2	0.537	0.22	37.52	-	37.74	-	56.00	46.00	-18.26	-
3	0.908	0.24	40.46	-	40.70	-	56.00	46.00	-15.30	-
4	1.766	0.26	40.63	-	40.89	-	56.00	46.00	-15.11	-
5	2.582	0.30	43.91	-	44.21	-	56.00	46.00	-11.79	-
6	8.332	0.50	37.94	-	38.44	-	60.00	50.00	-21.56	-

- REMARKS:**
1. Q.P. and AV. are abbreviations of quasi-peak and average individually.
 2. "-": The Quasi-peak reading value also meets average limit and measurement with the average detector is unnecessary.
 3. The emission levels of other frequencies were very low against the limit.
 4. Margin value = Emission level - Limit value
 5. Correction factor = Insertion loss + Cable loss
 6. Emission Level = Correction Factor + Reading Value.

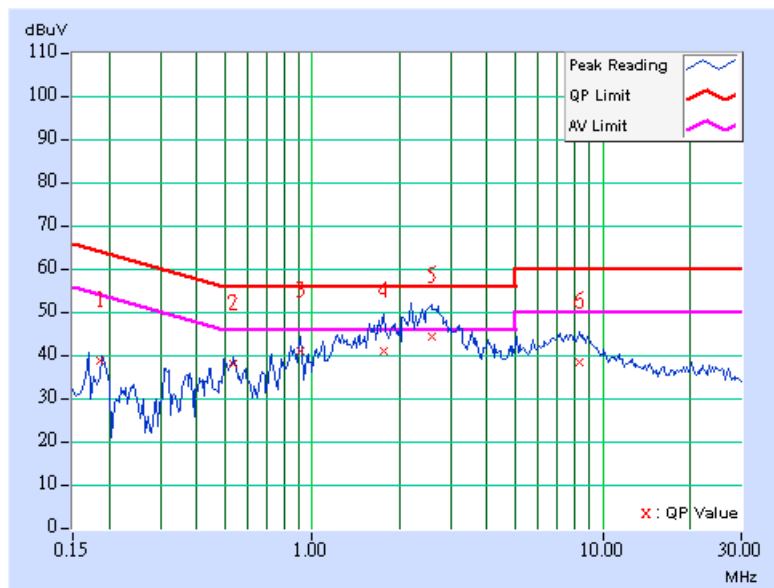

EUT TEST CONDITION		MEASUREMENT DETAIL	
CHANNEL	Channel 78	PHASE	Line 2
MODULATION TYPE	GFSK	6dB BANDWIDTH	9 kHz
ENVIRONMENTAL CONDITIONS	20deg. C, 60%RH, 991hPa	INPUT POWER (SYSTEM)	120Vac, 60 Hz
TEST MODE	D	TESTED BY	Match Tsui

No	Freq. [MHz]	Corr. Factor (dB)	Reading Value [dB (uV)]		Emission Level [dB (uV)]		Limit [dB (uV)]		Margin (dB)	
			Q.P.	AV.	Q.P.	AV.	Q.P.	AV.	Q.P.	AV.
1	0.173	0.21	35.07	-	35.28	-	64.79	54.79	-29.52	-
2	0.545	0.22	33.75	-	33.97	-	56.00	46.00	-22.03	-
3	1.238	0.24	36.82	-	37.06	-	56.00	46.00	-18.94	-
4	1.754	0.26	36.74	-	37.00	-	56.00	46.00	-19.00	-
5	2.668	0.30	39.53	-	39.83	-	56.00	46.00	-16.17	-
6	8.910	0.51	32.78	-	33.29	-	60.00	50.00	-26.71	-

- REMARKS:**
1. Q.P. and AV. are abbreviations of quasi-peak and average individually.
 2. "-": The Quasi-peak reading value also meets average limit and measurement with the average detector is unnecessary.
 3. The emission levels of other frequencies were very low against the limit.
 4. Margin value = Emission level - Limit value
 5. Correction factor = Insertion loss + Cable loss
 6. Emission Level = Correction Factor + Reading Value.

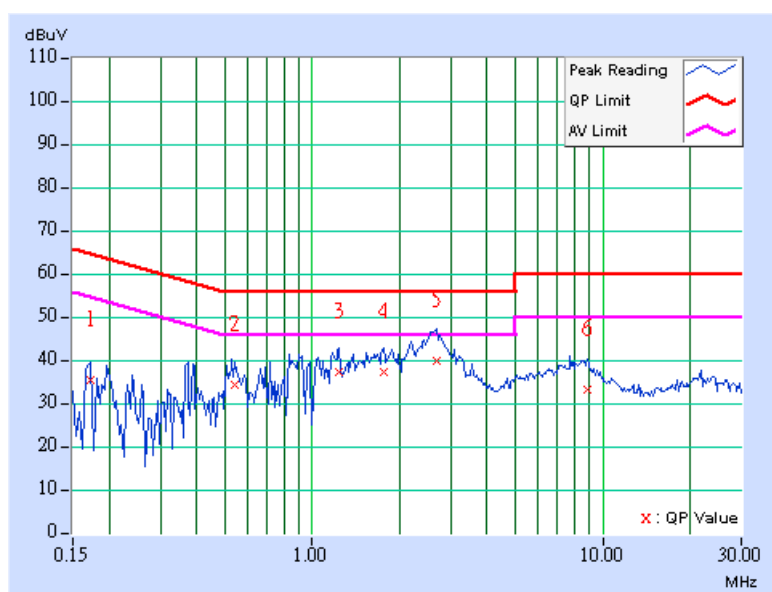

4.2 RADIATED EMISSION MEASUREMENT

4.2.1 LIMITS OF RADIATED EMISSION MEASUREMENT

Emissions radiated outside of the specified bands, shall be according to the general radiated limits in 15.209 as following:

FREQUENCIES (MHz)	FIELD STRENGTH (microvolts/meter)	MEASUREMENT DISTANCE (meters)
0.009-0.490	2400/F(kHz)	300
0.490-1.705	24000/F(kHz)	30
1.705-30.0	30	30
30-88	100	3
88-216	150	3
216-960	200	3
Above 960	500	3

NOTE:

1. The lower limit shall apply at the transition frequencies.
2. Emission level (dBuV/m) = 20 log Emission level (uV/m).
3. As shown in 15.35(b), for frequencies above 1000MHz, the field strength limits are based on average detector, however, the peak field strength of any emission shall not exceed the maximum permitted average limits, specified above by more than 20dB under any condition of modulation.

4.2.2 TEST INSTRUMENTS

DESCRIPTION & MANUFACTURER	MODEL NO.	SERIAL NO.	CALIBRATED UNTIL
Test Receiver ROHDE & SCHWARZ	ESCI	100424	Aug 04, 2007
Spectrum Analyzer ROHDE & SCHWARZ	FSP40	100025	Oct. 05, 2007
BILOG Antenna SCHWARZBECK	VULB9168	9168-160	May 31, 2008
HORN Antenna SCHWARZBECK	9120D	9120D-209	Jun. 28, 2008
HORN Antenna SCHWARZBECK	BBHA 9170	BBHA9170243	Dec. 28, 2007
Preamplifier Agilent	8447D	2944A10633	Oct. 26, 2007
Preamplifier Agilent	8449B	3008A01964	Oct. 26, 2007
RF signal cable HUBER+SUHNNER	SUCOFLEX 104	238137/4	Dec. 11, 2007
RF signal cable HUBER+SUHNNER	SUCOFLEX 104	233233/4	Nov. 14, 2007
Software ADT.	ADT_Radiated_V7.6	NA	NA
Antenna Tower inn-co GmbH	MA 4000	013303	NA
Antenna Tower Controller inn-co GmbH	CO2000	017303	NA
Turn Table ADT.	TT100.	TT93021703	NA
Turn Table Controller ADT.	SC100.	SC93021703	NA

- NOTE:**
1. The calibration interval of the above test instruments is 12 months and the calibrations are traceable to NML/ROC and NIST/USA.
 2. The test was performed in HwaYa Chamber 3.
 3. The horn antenna and HP preamplifier (model: 8449B) are used only for the measurement of emission frequency above 1GHz if tested.
 4. The VCCI Site Registration No. is R-237.
 5. The IC Site Registration No. is IC3789B-3.

4.2.3 TEST PROCEDURES

- a. The EUT was placed on the top of a rotating table 0.8 meters above the ground at a 3 meter semi-anechoic chamber. The table was rotated 360 degrees to determine the position of the highest radiation.
- b. The EUT was set 3 meters away from the interference-receiving antenna, which was mounted on the top of a variable-height antenna tower.
- c. The antenna is a broadband antenna, and its height is varied from one meter to four meters above the ground to determine the maximum value of the field strength. Both horizontal and vertical polarizations of the antenna are set to make the measurement.
- d. For each suspected emission, the EUT was arranged to its worst case and then the antenna was tuned to heights from 1 meter to 4 meters and the rotatable table was turned from 0 degrees to 360 degrees to find the maximum reading.
- e. The test-receiver system was set to Peak Detect Function and Specified Bandwidth with Maximum Hold Mode.
- f. If the emission level of the EUT in peak mode was lower than the limit specified, then testing could be stopped and the peak values of the EUT would be reported. Otherwise the emissions would be re-tested one by one using peak, quasi-peak or average method as specified and then reported in a data sheet.

NOTE:

1. The resolution bandwidth and video bandwidth of test receiver/spectrum analyzer is 120kHz for Quasi-peak detection at frequency below 1GHz.
2. The resolution bandwidth of test receiver/spectrum analyzer is 1 MHz and video bandwidth is 3MHz for Peak detection at frequency above 1GHz.

4.2.4 DEVIATION FROM TEST STANDARD

No deviation

4.2.5 TEST SETUP

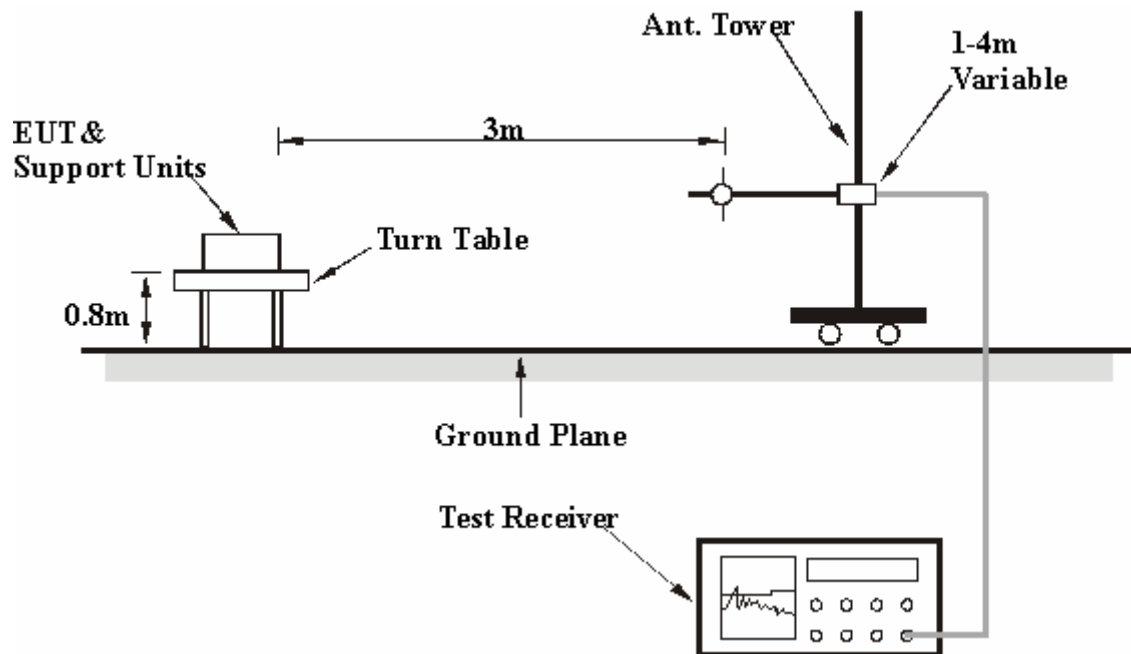

For the actual test configuration, please refer to the attached file (Test Setup Photo).

4.2.6 EUT OPERATING CONDITIONS

Same as 4.1.6

4.2.7 TEST RESULTS

RADIATED BELOW 1GHz TEST DATA

EUT TEST CONDITION		MEASUREMENT DETAIL	
CHANNEL	Channel 78	FREQUENCY RANGE	Below 1000MHz
MODULATION TYPE	GFSK	DETECTOR FUNCTION	Quasi-Peak
ENVIRONMENTAL CONDITIONS	26deg. C, 68%RH, 991hPa	INPUT POWER (SYSTEM)	120Vac, 60 Hz
TEST MODE	A	TESTED BY	Match Tsui

ANTENNA POLARITY & TEST DISTANCE: HORIZONTAL AT 3 M								
No.	Freq. (MHz)	Emission Level (dBuV/m)	Limit (dBuV/m)	Margin (dB)	Antenna Height (m)	Table Angle (Degree)	Raw Value (dBuV)	Correction Factor (dB/m)
1	749.29	25.22 QP	46.00	-20.78	1.00 H	331	-0.41	25.63
2	778.45	25.25 QP	46.00	-20.75	1.50 H	217	-0.53	25.78
3	805.67	25.90 QP	46.00	-20.10	2.00 H	223	-0.11	26.01
4	844.56	26.40 QP	46.00	-19.60	2.00 H	100	-0.44	26.84
5	871.78	27.21 QP	46.00	-18.79	2.00 H	115	-0.03	27.24
6	881.50	27.10 QP	46.00	-18.90	1.00 H	232	-0.26	27.36
7	932.05	27.62 QP	46.00	-18.38	2.00 H	265	-0.44	28.06
8	957.33	28.98 QP	46.00	-17.02	1.50 H	277	0.61	28.37

ANTENNA POLARITY & TEST DISTANCE: VERTICAL AT 3 M								
No.	Freq. (MHz)	Emission Level (dBuV/m)	Limit (dBuV/m)	Margin (dB)	Antenna Height (m)	Table Angle (Degree)	Raw Value (dBuV)	Correction Factor (dB/m)
1	51.29	27.70 QP	40.00	-12.30	1.00 V	106	12.91	14.79
2	745.40	25.16 QP	46.00	-20.84	2.00 V	241	-0.36	25.52
3	753.18	25.35 QP	46.00	-20.65	1.00 V	196	-0.32	25.66
4	801.78	25.63 QP	46.00	-20.37	1.50 V	4	-0.29	25.92
5	825.11	30.98 QP	46.00	-15.02	2.00 V	256	4.56	26.42
6	875.67	27.10 QP	46.00	-18.90	1.50 V	97	-0.19	27.29
7	893.16	27.79 QP	46.00	-18.21	2.00 V	283	0.28	27.51
8	924.27	27.45 QP	46.00	-18.55	1.00 V	70	-0.50	27.95
9	955.38	28.52 QP	46.00	-17.48	1.50 V	58	0.17	28.36

- REMARKS:**
1. Emission level (dBuV/m) = Raw Value (dBuV) + Correction Factor (dB/m).
 2. Correction Factor (dB/m) = Antenna Factor (dB/m) + Cable Factor (dB).
 3. The other emission levels were very low against the limit.
 4. Margin value = Emission level – Limit value.

EUT TEST CONDITION		MEASUREMENT DETAIL	
CHANNEL	Channel 78	FREQUENCY RANGE	Below 1000MHz
MODULATION TYPE	GFSK	DETECTOR FUNCTION	Quasi-Peak
ENVIRONMENTAL CONDITIONS	26deg. C, 68%RH, 991hPa	INPUT POWER (SYSTEM)	120Vac, 60 Hz
TEST MODE	B	TESTED BY	Match Tsui

ANTENNA POLARITY & TEST DISTANCE: HORIZONTAL AT 3 M								
No.	Freq. (MHz)	Emission Level (dBuV/m)	Limit (dBuV/m)	Margin (dB)	Antenna Height (m)	Table Angle (Degree)	Raw Value (dBuV)	Correction Factor (dB/m)
1	204.89	23.40 QP	43.50	-20.10	1.00 H	280	11.93	11.48
2	755.12	25.52 QP	46.00	-20.48	1.50 H	337	-0.15	25.67
3	807.62	26.56 QP	46.00	-19.44	1.00 H	262	0.51	26.05
4	825.11	28.74 QP	46.00	-17.26	1.50 H	10	2.32	26.42
5	852.33	27.05 QP	46.00	-18.95	2.00 H	115	0.06	26.99
6	885.39	27.40 QP	46.00	-18.60	1.00 H	4	-0.02	27.41
7	935.94	27.48 QP	46.00	-18.52	1.50 H	7	-0.64	28.12
8	959.27	28.59 QP	46.00	-17.41	1.50 H	1	0.20	28.38

ANTENNA POLARITY & TEST DISTANCE: VERTICAL AT 3 M								
No.	Freq. (MHz)	Emission Level (dBuV/m)	Limit (dBuV/m)	Margin (dB)	Antenna Height (m)	Table Angle (Degree)	Raw Value (dBuV)	Correction Factor (dB/m)
1	53.23	29.27 QP	40.00	-10.73	1.00 V	130	14.66	14.61
2	809.56	26.83 QP	46.00	-19.17	1.50 V	235	0.74	26.09
3	825.11	33.23 QP	46.00	-12.77	1.00 V	4	6.81	26.42
4	873.72	27.45 QP	46.00	-18.55	2.50 V	178	0.19	27.26
5	904.83	42.28 QP	46.00	-3.72	2.00 V	121	14.61	27.67
6	910.66	41.12 QP	46.00	-4.88	2.00 V	85	13.36	27.75

- REMARKS:**
- 1 Emission level (dBuV/m) = Raw Value (dBuV) + Correction Factor (dB/m).
 2. Correction Factor (dB/m) = Antenna Factor (dB/m) + Cable Factor (dB).
 3. The other emission levels were very low against the limit.
 4. Margin value = Emission level – Limit value.

EUT TEST CONDITION		MEASUREMENT DETAIL	
CHANNEL	Channel 78	FREQUENCY RANGE	Below 1000MHz
MODULATION TYPE	GFSK	DETECTOR FUNCTION	Quasi-Peak
ENVIRONMENTAL CONDITIONS	26deg. C, 68%RH, 991hPa	INPUT POWER (SYSTEM)	120Vac, 60 Hz
TEST MODE	C	TESTED BY	Match Tsui

ANTENNA POLARITY & TEST DISTANCE: HORIZONTAL AT 3 M								
No.	Freq. (MHz)	Emission Level (dBuV/m)	Limit (dBuV/m)	Margin (dB)	Antenna Height (m)	Table Angle (Degree)	Raw Value (dBuV)	Correction Factor (dB/m)
1	33.79	20.65 QP	40.00	-19.35	1.50 H	241	6.92	13.73
2	671.52	24.93 QP	46.00	-21.07	2.00 H	259	1.08	23.85
3	710.40	24.28 QP	46.00	-21.72	1.00 H	355	-0.22	24.50
4	739.57	25.38 QP	46.00	-20.62	1.50 H	208	0.04	25.35
5	770.67	24.99 QP	46.00	-21.01	1.50 H	250	-0.76	25.75
6	811.50	25.99 QP	46.00	-20.01	1.00 H	109	-0.14	26.13
7	836.78	29.35 QP	46.00	-16.65	1.50 H	100	2.68	26.67
8	873.72	26.81 QP	46.00	-19.19	1.00 H	100	-0.45	27.26
9	877.61	27.27 QP	46.00	-18.73	2.00 H	313	-0.05	27.31
10	937.88	28.19 QP	46.00	-17.81	1.00 H	43	0.04	28.14
11	943.72	28.74 QP	46.00	-17.26	1.00 H	115	0.51	28.23

ANTENNA POLARITY & TEST DISTANCE: VERTICAL AT 3 M								
No.	Freq. (MHz)	Emission Level (dBuV/m)	Limit (dBuV/m)	Margin (dB)	Antenna Height (m)	Table Angle (Degree)	Raw Value (dBuV)	Correction Factor (dB/m)
1	113.50	24.58 QP	43.50	-18.92	1.00 V	343	12.74	11.84
2	129.06	21.63 QP	43.50	-21.87	1.00 V	10	8.49	13.14
3	191.28	22.29 QP	43.50	-21.21	1.50 V	100	10.27	12.02
4	714.29	25.03 QP	46.00	-20.97	1.00 V	280	0.42	24.61
5	737.62	25.67 QP	46.00	-20.33	1.00 V	157	0.38	25.29
6	757.06	25.44 QP	46.00	-20.56	2.00 V	79	-0.24	25.68
7	813.45	26.38 QP	46.00	-19.62	1.00 V	16	0.21	26.17
8	836.78	37.36 QP	46.00	-8.64	1.50 V	22	10.68	26.67
9	850.39	27.04 QP	46.00	-18.96	2.00 V	49	0.08	26.96
10	904.83	41.58 QP	46.00	-4.42	1.50 V	307	13.91	27.67
11	945.66	28.52 QP	46.00	-17.48	1.00 V	10	0.26	28.26

- REMARKS:**
1. Emission level (dBuV/m) = Raw Value (dBuV) + Correction Factor (dB/m).
 2. Correction Factor (dB/m) = Antenna Factor (dB/m) + Cable Factor (dB).
 3. The other emission levels were very low against the limit.
 4. Margin value = Emission level – Limit value.

EUT TEST CONDITION		MEASUREMENT DETAIL	
CHANNEL	Channel 78	FREQUENCY RANGE	Below 1000MHz
MODULATION TYPE	GFSK	DETECTOR FUNCTION	Quasi-Peak
ENVIRONMENTAL CONDITIONS	26deg. C, 68%RH, 991hPa	INPUT POWER (SYSTEM)	120Vac, 60 Hz
TEST MODE	D	TESTED BY	Match Tsui

ANTENNA POLARITY & TEST DISTANCE: HORIZONTAL AT 3 M								
No.	Freq. (MHz)	Emission Level (dBuV/m)	Limit (dBuV/m)	Margin (dB)	Antenna Height (m)	Table Angle (Degree)	Raw Value (dBuV)	Correction Factor (dB/m)
1	84.34	22.46 QP	40.00	-17.54	2.00 H	337	12.62	9.84
2	512.08	26.72 QP	46.00	-19.28	2.50 H	343	6.20	20.52
3	755.12	25.57 QP	46.00	-20.43	1.00 H	94	-0.11	25.67
4	813.45	25.38 QP	46.00	-20.62	1.50 H	34	-0.80	26.17
5	825.11	29.19 QP	46.00	-16.81	2.00 H	304	2.77	26.42
6	864.00	27.54 QP	46.00	-18.46	1.50 H	43	0.40	27.14
7	902.89	27.51 QP	46.00	-18.49	1.00 H	265	-0.13	27.64
8	928.16	28.03 QP	46.00	-17.97	1.00 H	34	0.03	28.00
9	949.55	28.26 QP	46.00	-17.74	2.00 H	7	-0.05	28.31

ANTENNA POLARITY & TEST DISTANCE: VERTICAL AT 3 M								
No.	Freq. (MHz)	Emission Level (dBuV/m)	Limit (dBuV/m)	Margin (dB)	Antenna Height (m)	Table Angle (Degree)	Raw Value (dBuV)	Correction Factor (dB/m)
1	39.62	26.62 QP	40.00	-13.38	1.50 V	118	11.99	14.63
2	82.40	20.44 QP	40.00	-19.56	2.50 V	238	10.28	10.16
3	119.34	22.83 QP	43.50	-20.67	1.50 V	181	10.27	12.56
4	751.23	26.55 QP	46.00	-19.45	1.50 V	64	0.89	25.65
5	776.51	25.73 QP	46.00	-20.27	1.00 V	118	-0.04	25.77
6	811.50	25.64 QP	46.00	-20.36	1.50 V	220	-0.50	26.13
7	825.11	28.22 QP	46.00	-17.78	2.00 V	7	1.80	26.42
8	871.78	26.91 QP	46.00	-19.09	2.00 V	85	-0.33	27.24
9	893.16	27.48 QP	46.00	-18.52	1.50 V	73	-0.03	27.51
10	935.94	27.90 QP	46.00	-18.10	1.00 V	49	-0.21	28.12
11	955.38	29.21 QP	46.00	-16.79	1.50 V	136	0.86	28.36

- REMARKS:**
1. Emission level (dBuV/m) = Raw Value (dBuV) + Correction Factor (dB/m).
 2. Correction Factor (dB/m) = Antenna Factor (dB/m) + Cable Factor (dB).
 3. The other emission levels were very low against the limit.
 4. Margin value = Emission level – Limit value.

EUT TEST CONDITION		MEASUREMENT DETAIL	
CHANNEL	Channel 78	FREQUENCY RANGE	Below 1000MHz
MODULATION TYPE	GFSK	DETECTOR FUNCTION	Quasi-Peak
ENVIRONMENTAL CONDITIONS	26deg. C, 68%RH, 991hPa	INPUT POWER (SYSTEM)	120Vac, 60 Hz
TEST MODE	E	TESTED BY	Match Tsui

ANTENNA POLARITY & TEST DISTANCE: HORIZONTAL AT 3 M								
No.	Freq. (MHz)	Emission Level (dBuV/m)	Limit (dBuV/m)	Margin (dB)	Antenna Height (m)	Table Angle (Degree)	Raw Value (dBuV)	Correction Factor (dB/m)
1	162.11	30.70 QP	43.50	-12.80	1.50 H	79	16.35	14.35
2	199.05	30.17 QP	43.50	-13.33	1.00 H	55	18.83	11.34
3	356.54	31.45 QP	46.00	-14.55	1.00 H	97	14.82	16.62
4	368.21	32.65 QP	46.00	-13.35	1.00 H	100	15.75	16.90
5	395.43	35.51 QP	46.00	-10.49	2.00 H	49	17.97	17.53
6	681.24	32.10 QP	46.00	-13.90	1.00 H	43	8.13	23.97

ANTENNA POLARITY & TEST DISTANCE: VERTICAL AT 3 M								
No.	Freq. (MHz)	Emission Level (dBuV/m)	Limit (dBuV/m)	Margin (dB)	Antenna Height (m)	Table Angle (Degree)	Raw Value (dBuV)	Correction Factor (dB/m)
1	49.34	34.90 QP	40.00	-5.10	1.00 V	55	20.09	14.81
2	76.56	31.06 QP	40.00	-8.94	2.00 V	253	19.77	11.29
3	115.45	33.01 QP	43.50	-10.49	1.00 V	10	20.93	12.08
4	162.11	34.37 QP	43.50	-9.13	1.00 V	127	20.02	14.35
5	455.70	32.05 QP	46.00	-13.95	1.00 V	331	12.55	19.50
6	591.80	35.90 QP	46.00	-10.10	1.00 V	178	13.64	22.26
7	665.68	32.05 QP	46.00	-13.95	1.00 V	220	8.26	23.78

- REMARKS:**
1. Emission level(dBuV/m)=Raw Value(dBuV) + Correction Factor(dB/m)
 2. Correction Factor(dB/m) = Antenna Factor (dB/m) + Cable Factor (dB)
 3. The other emission levels were very low against the limit.
 4. Margin value = Emission level – Limit value.

EUT TEST CONDITION		MEASUREMENT DETAIL	
CHANNEL	Channel 78	FREQUENCY RANGE	Below 1000MHz
MODULATION TYPE	GFSK	DETECTOR FUNCTION	Quasi-Peak
ENVIRONMENTAL CONDITIONS	26deg. C, 68%RH, 991hPa	INPUT POWER (SYSTEM)	120Vac, 60 Hz
TEST MODE	F	TESTED BY	Match Tsui

ANTENNA POLARITY & TEST DISTANCE: HORIZONTAL AT 3 M								
No.	Freq. (MHz)	Emission Level (dBuV/m)	Limit (dBuV/m)	Margin (dB)	Antenna Height (m)	Table Angle (Degree)	Raw Value (dBuV)	Correction Factor (dB/m)
1	53.23	26.51 QP	40.00	-13.49	2.50 H	313	11.90	14.61
2	94.06	34.62 QP	43.50	-8.88	2.00 H	319	25.19	9.44
3	101.84	35.25 QP	43.50	-8.25	2.00 H	307	24.84	10.42
4	158.22	31.13 QP	43.50	-12.37	2.00 H	64	16.69	14.44
5	162.11	34.31 QP	43.50	-9.19	1.50 H	91	19.96	14.35
6	199.05	35.90 QP	43.50	-7.60	1.00 H	10	24.56	11.34
7	385.70	32.79 QP	46.00	-13.21	2.50 H	58	15.48	17.31
8	665.68	32.93 QP	46.00	-13.07	1.00 H	10	9.15	23.78

ANTENNA POLARITY & TEST DISTANCE: VERTICAL AT 3 M								
No.	Freq. (MHz)	Emission Level (dBuV/m)	Limit (dBuV/m)	Margin (dB)	Antenna Height (m)	Table Angle (Degree)	Raw Value (dBuV)	Correction Factor (dB/m)
1	47.40	33.59 QP	40.00	-6.41	2.00 V	4	19.07	14.52
2	82.40	30.72 QP	40.00	-9.28	1.00 V	274	20.56	10.16
3	113.50	33.84 QP	43.50	-9.66	1.00 V	190	22.00	11.84
4	152.39	32.71 QP	43.50	-10.79	1.00 V	109	18.49	14.22
5	167.94	35.56 QP	43.50	-7.94	1.50 V	310	21.65	13.91
6	455.70	31.42 QP	46.00	-14.58	1.00 V	328	11.92	19.50
7	599.58	31.64 QP	46.00	-14.36	1.00 V	178	9.19	22.45
8	848.45	34.45 QP	46.00	-11.55	1.50 V	355	7.53	26.92

- REMARKS:**
1. Emission level (dBuV/m) = Raw Value (dBuV) + Correction Factor (dB/m).
 2. Correction Factor (dB/m) = Antenna Factor (dB/m) + Cable Factor (dB).
 3. The other emission levels were very low against the limit.
 4. Margin value = Emission level – Limit value.

**RADIATED ABOVE 1GHz WORST-CASE DATA
FOR GFSK MODULATION**

EUT TEST CONDITION		MEASUREMENT DETAIL	
CHANNEL	Channel 0	FREQUENCY RANGE	1 ~ 25GHz
MODULATION TYPE	GFSK	DETECTOR FUNCTION	Peak (PK) Average (AV)
INPUT POWER (SYSTEM)	120Vac, 60 Hz	ENVIRONMENTAL CONDITIONS	27deg. C, 65%RH, 991hPa
TEST MODE	D	TESTED BY	Morgan Chen

ANTENNA POLARITY & TEST DISTANCE: HORIZONTAL AT 3 M								
No.	Freq. (MHz)	Emission Level (dBuV/m)	Limit (dBuV/m)	Margin (dB)	Antenna Height (m)	Table Angle (Degree)	Raw Value (dBuV)	Correction Factor (dB/m)
1	2390.00	53.59 PK	74.00	-20.41	1.05 H	315	23.00	30.59
2	2390.00	48.46 AV	54.00	-5.54	1.05 H	315	17.87	30.59
3	*2402.00	94.90 PK			1.02 H	313	64.26	30.64
4	*2402.00	64.80 AV			1.02 H	313	34.16	30.64
5	4804.00	57.32 PK	74.00	-16.68	1.08 H	345	21.16	36.16
6	4804.00	27.22 AV	54.00	-26.78	1.08 H	345	-8.94	36.16

ANTENNA POLARITY & TEST DISTANCE: VERTICAL AT 3 M								
No.	Freq. (MHz)	Emission Level (dBuV/m)	Limit (dBuV/m)	Margin (dB)	Antenna Height (m)	Table Angle (Degree)	Raw Value (dBuV)	Correction Factor (dB/m)
1	2390.00	45.35 PK	74.00	-28.65	1.08 V	325	14.76	30.59
2	2390.00	40.57 AV	54.00	-13.43	1.08 V	325	9.98	30.59
3	*2402.00	85.96 PK			1.00 V	352	55.32	30.64
4	*2402.00	55.86 AV			1.00 V	352	25.22	30.64
5	4804.00	55.55 PK	74.00	-18.45	1.03 V	341	19.39	36.16
6	4804.00	25.45 AV	54.00	-28.55	1.03 V	341	-10.71	36.16

- REMARKS:**
1. Emission level (dBuV/m) = Raw Value (dBuV) + Correction Factor (dB/m).
 2. Correction Factor(dB/m) = Antenna Factor(dB/m) + Cable Factor(dB)
 3. Margin value = Emission level - Limit value
 4. " * " : Fundamental Frequency.
 5. The other emission levels were very low against the limit
 6. The DH5 packet was the worse case duty cycle for a transmit dwell time on a channel, based upon bluetooth theory the transmitter is on 0.625*5 per 296.25 ms per channel. Therefore, the duty cycle correction factor be equal to: $20\log(3.125/100) = -30.1 \text{ dB}$
 7. Average value = peak reading + $20\log(\text{duty cycle})$

EUT TEST CONDITION		MEASUREMENT DETAIL	
CHANNEL	Channel 39	FREQUENCY RANGE	1 ~ 25GHz
MODULATION TYPE	GFSK	DETECTOR FUNCTION	Peak (PK) Average (AV)
INPUT POWER (SYSTEM)	120Vac, 60 Hz	ENVIRONMENTAL CONDITIONS	27deg. C, 65%RH, 991hPa
TEST MODE	D	TESTED BY	Morgan Chen

ANTENNA POLARITY & TEST DISTANCE: HORIZONTAL AT 3 M								
No.	Freq. (MHz)	Emission Level (dBuV/m)	Limit (dBuV/m)	Margin (dB)	Antenna Height (m)	Table Angle (Degree)	Raw Value (dBuV)	Correction Factor (dB/m)
1	*2441.00	94.98 PK			1.05 H	325	64.21	30.77
2	*2441.00	64.88 AV			1.05 H	325	34.11	30.77
3	4882.00	57.98 PK	74.00	-16.02	1.11 H	338	21.66	36.32
4	4882.00	27.88 AV	54.00	-26.12	1.11 H	338	-8.44	36.32

ANTENNA POLARITY & TEST DISTANCE: VERTICAL AT 3 M								
No.	Freq. (MHz)	Emission Level (dBuV/m)	Limit (dBuV/m)	Margin (dB)	Antenna Height (m)	Table Angle (Degree)	Raw Value (dBuV)	Correction Factor (dB/m)
1	*2441.00	86.11 PK			1.00 V	345	55.34	30.77
2	*2441.00	56.01 AV			1.00 V	345	25.24	30.77
3	4882.00	55.85 PK	74.00	-18.15	1.05 V	355	19.53	36.32
4	4882.00	25.75 AV	54.00	-28.25	1.05 V	355	-10.57	36.32

- REMARKS:**
1. Emission level (dBuV/m) = Raw Value (dBuV) + Correction Factor (dB/m).
 2. Correction Factor(dB/m) = Antenna Factor(dB/m) + Cable Factor(dB)
 3. Margin value = Emission level - Limit value
 4. " * " : Fundamental Frequency.
 5. The other emission levels were very low against the limit
 6. The DH5 packet was the worse case duty cycle for a transmit dwell time on a channel, based upon bluetooth theory the transmitter is on 0.625*5 per 296.25 ms per channel. Therefore, the duty cycle correction factor be equal to: $20\log(3.125/100) = -30.1 \text{ dB}$
 7. Average value = peak reading + $20\log(\text{duty cycle})$

EUT TEST CONDITION		MEASUREMENT DETAIL	
CHANNEL	Channel 78	FREQUENCY RANGE	1 ~ 25GHz
MODULATION TYPE	GFSK	DETECTOR FUNCTION	Peak (PK) Average (AV)
INPUT POWER (SYSTEM)	120Vac, 60 Hz	ENVIRONMENTAL CONDITIONS	27deg. C, 65%RH, 991hPa
TEST MODE	D	TESTED BY	Morgan Chen

ANTENNA POLARITY & TEST DISTANCE: HORIZONTAL AT 3 M								
No.	Freq. (MHz)	Emission Level (dBuV/m)	Limit (dBuV/m)	Margin (dB)	Antenna Height (m)	Table Angle (Degree)	Raw Value (dBuV)	Correction Factor (dB/m)
1	*2480.00	95.12 PK			1.05 H	325	64.23	30.89
2	*2480.00	65.02 AV			1.05 H	325	34.13	30.89
3	2483.50	54.85 PK	74.00	-19.15	1.02 H	325	23.94	30.91
4	2483.50	49.35 AV	54.00	-4.65	1.02 H	325	18.44	30.91
5	4960.00	58.23 PK	74.00	-15.77	1.11 H	322	21.74	36.49
6	4960.00	28.13 AV	54.00	-25.87	1.11 H	322	-8.36	36.49

ANTENNA POLARITY & TEST DISTANCE: VERTICAL AT 3 M								
No.	Freq. (MHz)	Emission Level (dBuV/m)	Limit (dBuV/m)	Margin (dB)	Antenna Height (m)	Table Angle (Degree)	Raw Value (dBuV)	Correction Factor (dB/m)
1	*2480.00	86.23 PK			1.00 V	345	55.34	30.89
2	*2480.00	56.13 AV			1.00 V	345	25.24	30.89
3	2483.50	46.35 PK	74.00	-27.65	1.05 V	316	15.44	30.91
4	2483.50	41.23 AV	54.00	-12.77	1.05 V	316	10.32	30.91
5	4960.00	55.85 PK	74.00	-18.15	1.05 V	336	19.36	36.49
6	4960.00	25.75 AV	54.00	-28.25	1.05 V	336	-10.74	36.49

- REMARKS:**
1. Emission level (dBuV/m) = Raw Value (dBuV) + Correction Factor (dB/m).
 2. Correction Factor(dB/m) = Antenna Factor(dB/m) + Cable Factor(dB)
 3. Margin value = Emission level - Limit value
 4. " * " : Fundamental Frequency.
 5. The other emission levels were very low against the limit
 6. The DH5 packet was the worse case duty cycle for a transmit dwell time on a channel, based upon bluetooth theory the transmitter is on 0.625*5 per 296.25 ms per channel. Therefore, the duty cycle correction factor be equal to: $20\log(3.125/100) = -30.1 \text{ dB}$
 7. Average value = peak reading + $20\log(\text{duty cycle})$

FOR 8DPSK MODULATION

EUT TEST CONDITION		MEASUREMENT DETAIL	
CHANNEL	Channel 0	FREQUENCY RANGE	1 ~ 25GHz
MODULATION TYPE	8DPSK	DETECTOR FUNCTION	Peak (PK) Average (AV)
INPUT POWER (SYSTEM)	120Vac, 60 Hz	ENVIRONMENTAL CONDITIONS	27deg. C, 65%RH, 991hPa
TEST MODE	D	TESTED BY	Morgan Chen

ANTENNA POLARITY & TEST DISTANCE: HORIZONTAL AT 3 M								
No.	Freq. (MHz)	Emission Level (dBuV/m)	Limit (dBuV/m)	Margin (dB)	Antenna Height (m)	Table Angle (Degree)	Raw Value (dBuV)	Correction Factor (dB/m)
1	2390.00	52.65 PK	74.00	-21.35	1.35 H	11	20.42	32.23
2	2390.00	47.58 AV	54.00	-6.42	1.35 H	11	15.35	32.23
3	*2402.00	91.34 PK			1.35 H	11	59.06	32.28
4	*2402.00	61.24 AV			1.35 H	11	28.96	32.28
5	4804.00	55.15 PK	74.00	-18.85	1.28 H	22	16.74	38.41
6	4804.00	25.05 AV	54.00	-28.95	1.28 H	22	-13.36	38.41

ANTENNA POLARITY & TEST DISTANCE: VERTICAL AT 3 M								
No.	Freq. (MHz)	Emission Level (dBuV/m)	Limit (dBuV/m)	Margin (dB)	Antenna Height (m)	Table Angle (Degree)	Raw Value (dBuV)	Correction Factor (dB/m)
1	2390.00	43.58 PK	74.00	-30.42	1.05 V	315	11.35	32.23
2	2390.00	38.75 AV	54.00	-15.25	1.05 V	315	6.52	32.23
3	*2402.00	82.87 PK			1.00 V	342	50.59	32.28
4	*2402.00	52.77 AV			1.00 V	342	20.49	32.28
5	4804.00	54.89 PK	74.00	-19.11	1.08 V	354	16.48	38.41
6	4804.00	24.79 AV	54.00	-29.21	1.08 V	354	-13.62	38.41

- REMARKS:**
1. Emission level (dBuV/m) = Raw Value (dBuV) + Correction Factor (dB/m).
 2. Correction Factor(dB/m) = Antenna Factor(dB/m) + Cable Factor(dB)
 3. Margin value = Emission level - Limit value
 4. " * " : Fundamental Frequency.
 5. The other emission levels were very low against the limit
 6. The DH5 packet was the worse case duty cycle for a transmit dwell time on a channel, based upon bluetooth theory the transmitter is on 0.625*5 per 296.25 ms per channel. Therefore, the duty cycle correction factor be equal to: $20\log(3.125/100) = -30.1$ dB
 7. Average value = peak reading + $20\log$ (duty cycle)

EUT TEST CONDITION		MEASUREMENT DETAIL	
CHANNEL	Channel 39	FREQUENCY RANGE	1 ~ 25GHz
MODULATION TYPE	8DPSK	DETECTOR FUNCTION	Peak (PK) Average (AV)
INPUT POWER (SYSTEM)	120Vac, 60 Hz	ENVIRONMENTAL CONDITIONS	27deg. C, 65%RH, 991hPa
TEST MODE	D	TESTED BY	Morgan Chen

ANTENNA POLARITY & TEST DISTANCE: HORIZONTAL AT 3 M								
No.	Freq. (MHz)	Emission Level (dBuV/m)	Limit (dBuV/m)	Margin (dB)	Antenna Height (m)	Table Angle (Degree)	Raw Value (dBuV)	Correction Factor (dB/m)
1	*2441.00	91.56 PK			1.38 H	25	59.13	32.43
2	*2441.00	61.46 AV			1.38 H	25	29.03	32.43
3	4882.00	55.58 PK	74.00	-18.42	1.33 H	36	16.85	38.73
4	4882.00	25.48 AV	54.00	-28.52	1.33 H	36	-13.25	38.73

ANTENNA POLARITY & TEST DISTANCE: VERTICAL AT 3 M								
No.	Freq. (MHz)	Emission Level (dBuV/m)	Limit (dBuV/m)	Margin (dB)	Antenna Height (m)	Table Angle (Degree)	Raw Value (dBuV)	Correction Factor (dB/m)
1	*2441.00	83.35 PK			1.00 V	335	50.92	32.43
2	*2441.00	53.25 AV			1.00 V	335	20.82	32.43
3	4882.00	55.13 PK	74.00	-18.87	1.05 V	346	16.40	38.73
4	4882.00	25.03 AV	54.00	-28.97	1.05 V	346	-13.70	38.73

- REMARKS:**
1. Emission level (dBuV/m) = Raw Value (dBuV) + Correction Factor (dB/m).
 2. Correction Factor(dB/m) = Antenna Factor(dB/m) + Cable Factor(dB)
 3. Margin value = Emission level - Limit value
 4. “ * “ : Fundamental Frequency.
 5. The other emission levels were very low against the limit
 6. The DH5 packet was the worse case duty cycle for a transmit dwell time on a channel, based upon bluetooth theory the transmitter is on 0.625*5 per 296.25 ms per channel. Therefore, the duty cycle correction factor be equal to: $20\log(3.125/100) = -30.1 \text{ dB}$
 7. Average value = peak reading + $20\log(\text{duty cycle})$

EUT TEST CONDITION		MEASUREMENT DETAIL	
CHANNEL	Channel 78	FREQUENCY RANGE	1 ~ 25GHz
MODULATION TYPE	8DPSK	DETECTOR FUNCTION	Peak (PK) Average (AV)
INPUT POWER (SYSTEM)	120Vac, 60 Hz	ENVIRONMENTAL CONDITIONS	27deg. C, 65%RH, 991hPa
TEST MODE	D	TESTED BY	Morgan Chen

ANTENNA POLARITY & TEST DISTANCE: HORIZONTAL AT 3 M								
No.	Freq. (MHz)	Emission Level (dBuV/m)	Limit (dBuV/m)	Margin (dB)	Antenna Height (m)	Table Angle (Degree)	Raw Value (dBuV)	Correction Factor (dB/m)
1	*2480.00	91.46 PK			1.06 H	312	58.89	32.57
2	*2480.00	61.36 AV			1.06 H	312	28.79	32.57
3	2483.50	52.98 PK	74.00	-21.02	1.00 H	35	20.39	32.59
4	2483.50	47.76 AV	54.00	-6.24	1.00 H	35	15.17	32.59
5	4960.00	55.83 PK	74.00	-18.17	1.33 H	32	16.92	38.91
6	4960.00	25.73 AV	54.00	-28.27	1.33 H	32	-13.18	38.91

ANTENNA POLARITY & TEST DISTANCE: VERTICAL AT 3 M								
No.	Freq. (MHz)	Emission Level (dBuV/m)	Limit (dBuV/m)	Margin (dB)	Antenna Height (m)	Table Angle (Degree)	Raw Value (dBuV)	Correction Factor (dB/m)
1	*2480.00	82.99 PK			1.03 V	336	50.42	32.57
2	*2480.00	52.89 AV			1.03 V	336	20.32	32.57
3	2483.50	43.98 PK	74.00	-30.02	1.08 V	305	11.39	32.59
4	2483.50	38.76 AV	54.00	-15.24	1.08 V	305	6.17	32.59
5	4960.00	55.03 PK	74.00	-18.97	1.18 V	330	16.12	38.91
6	4960.00	25.03 AV	54.00	-28.97	1.18 V	330	-13.88	38.91

- REMARKS:**
1. Emission level (dBuV/m) = Raw Value (dBuV) + Correction Factor (dB/m).
 2. Correction Factor(dB/m) = Antenna Factor(dB/m) + Cable Factor(dB)
 3. Margin value = Emission level - Limit value
 4. " * " : Fundamental Frequency.
 5. The other emission levels were very low against the limit
 6. The DH5 packet was the worse case duty cycle for a transmit dwell time on a channel, based upon bluetooth theory the transmitter is on 0.625*5 per 296.25 ms per channel. Therefore, the duty cycle correction factor be equal to: $20\log(3.125/100) = -30.1 \text{ dB}$
 7. Average value = peak reading + $20\log(\text{duty cycle})$



4.3 NUMBER OF HOPPING FREQUENCY USED

4.3.1 LIMIT OF HOPPING FREQUENCY USED

At least 15 channels frequencies, and should be equally spaced.

4.3.2 TEST INSTRUMENTS

DESCRIPTION & MANUFACTURER	MODEL NO.	SERIAL NO.	CALIBRATED UNTIL
SPECTRUM ANALYZER	FSP40	100040	Jun. 28, 2008

NOTE: The calibration interval of the above test instruments is 12 months. And the calibrations are traceable to NML/ROC and NIST/USA.

4.3.3 TEST PROCEDURES

- a. Check the calibration of the measuring instrument (SA) using either an internal calibrator or a known signal from an external generator.
- b. Turn on the EUT and connect its antenna terminal to measurement via a low loss cable. Then set it to any one measured frequency within its operating range and make sure the instrument is operated in its linear range.
- c. Set the SA on MaxHold Mode, and then keep the EUT in hopping mode. Record all the signals from each channel until each one has been recorded.
- d. Set the SA on View mode and then plot the result on SA screen.
- e. Repeat above procedures until all frequencies measured were complete.

4.3.4 DEVIATION FROM TEST STANDARD

No deviation.

4.3.5 TEST SETUP

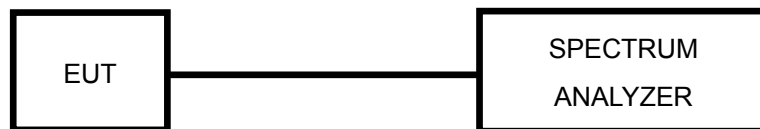

4.3.6 TEST RESULTS

There are 79 hopping frequencies in the hopping mode. Please refer to next page for the test result. On the plots, it shows that the hopping frequencies are equally spaced.



FOR GFSK MODULATION

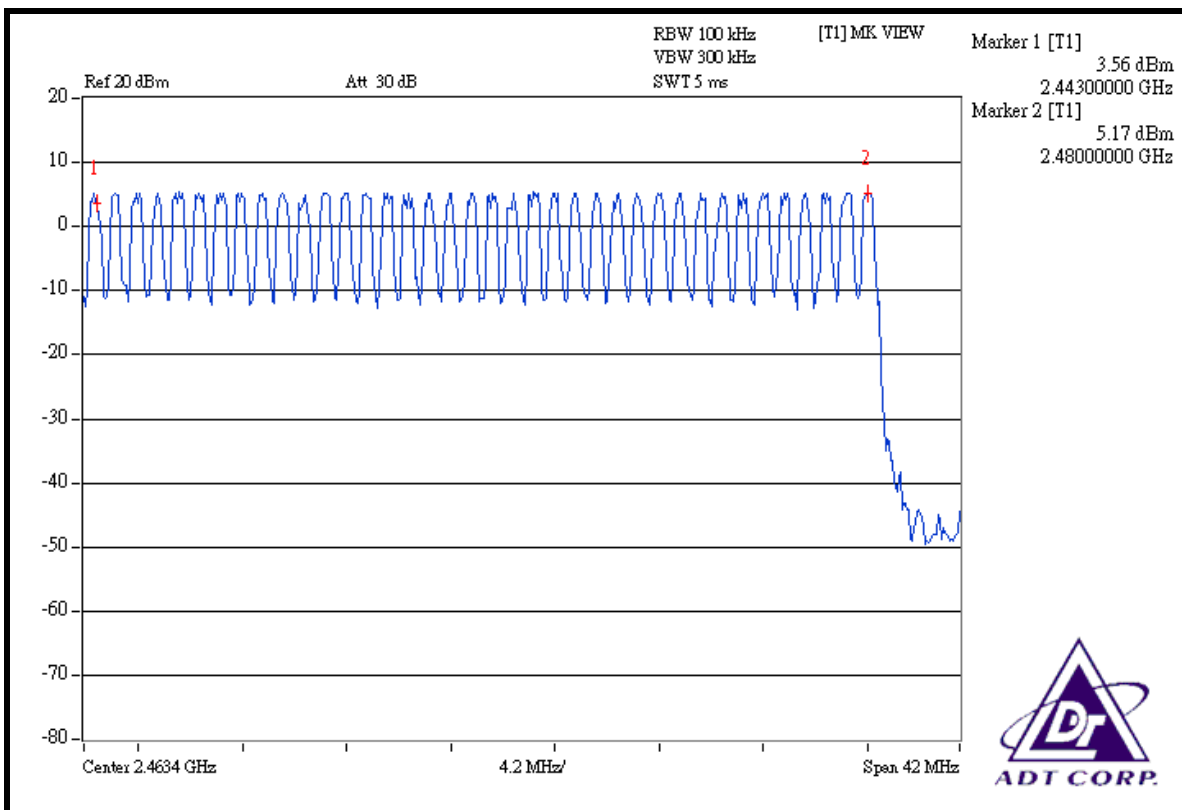
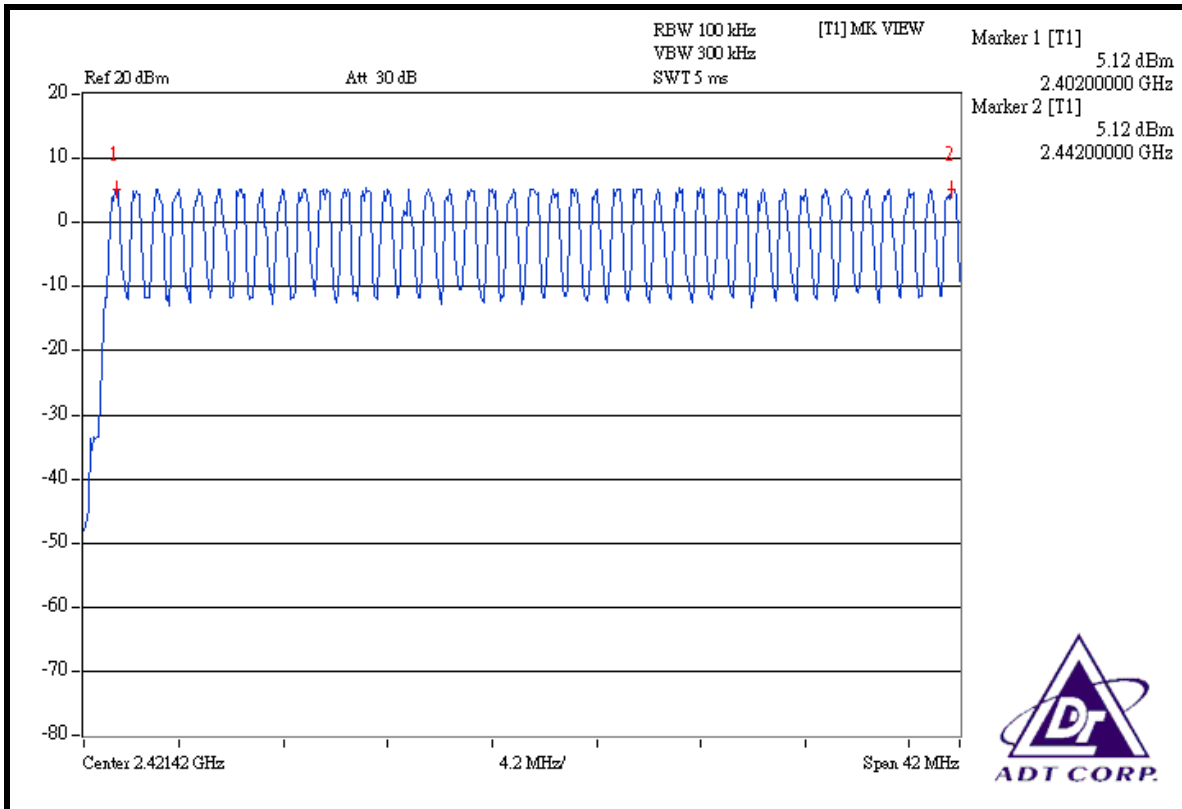



FOR 8DPSK MODULATION

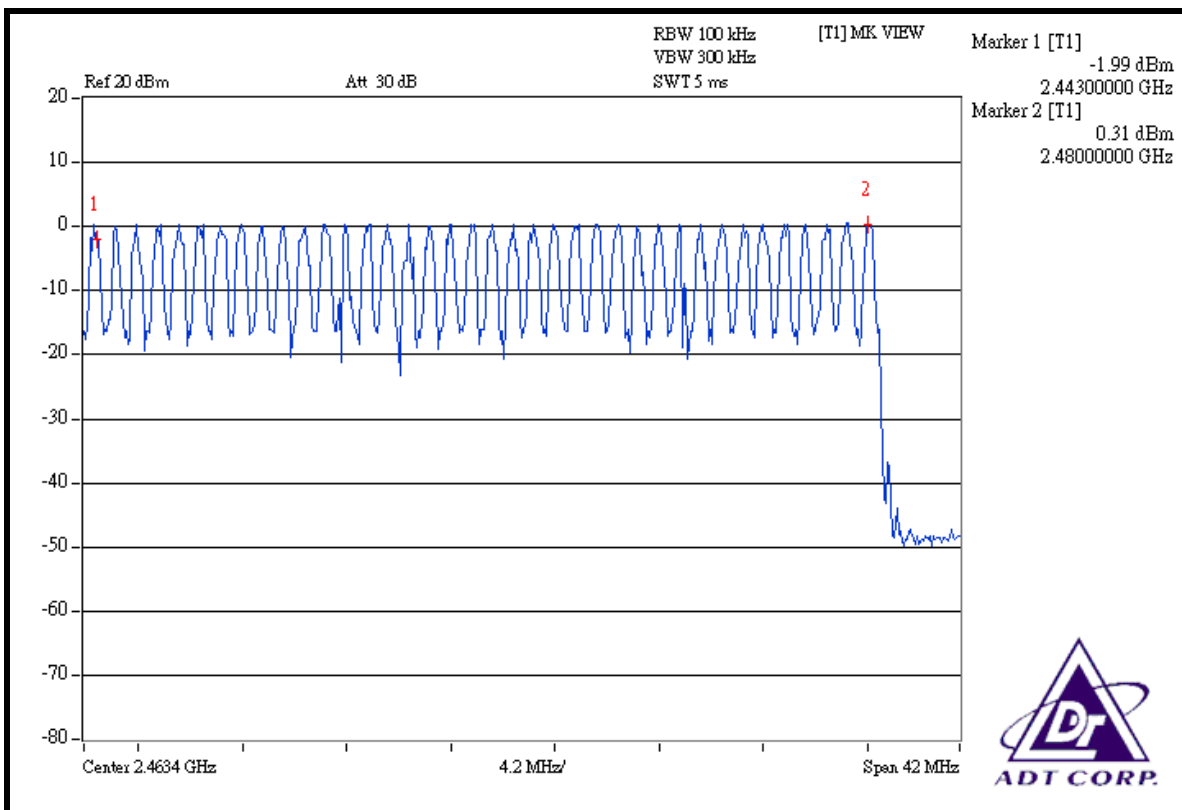
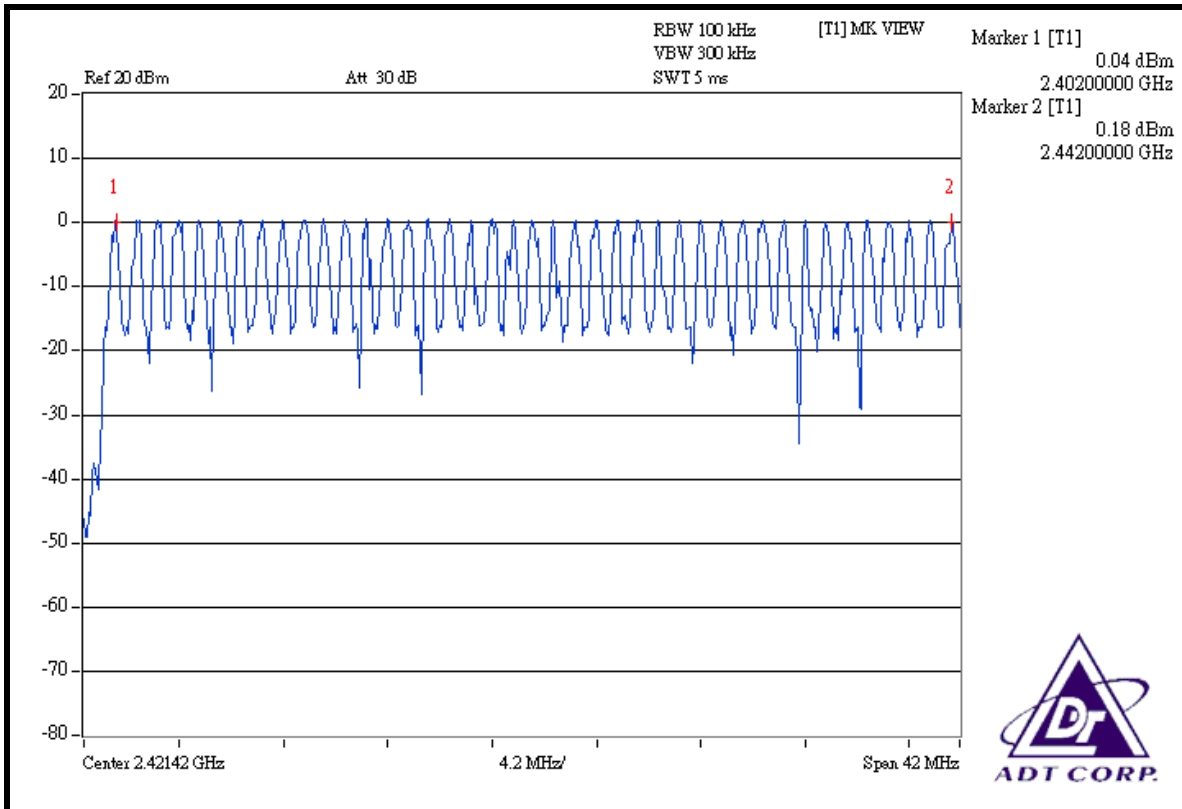



4.4 DWELL TIME ON EACH CHANNEL

4.4.1 LIMIT OF DWELL TIME USED

The average time of occupancy on any channel shall not be greater than 0.4 seconds within a period of 0.4 seconds multiplied by the number of hopping channels employed.

4.4.2 TEST INSTRUMENTS

DESCRIPTION & MANUFACTURER	MODEL NO.	SERIAL NO.	CALIBRATED UNTIL
SPECTRUM ANALYZER	FSP40	100040	Jun. 28, 2008

NOTES: The calibration interval of the above test instruments is 12 months. And the calibrations are traceable to NML/ROC and NIST/USA.

4.4.3 TEST PROCEDURES

- a. Check the calibration of the measuring instrument (SA) using either an internal calibrator or a known signal from an external generator.
- b. Turn on the EUT and connect its antenna terminal to measurement via a low loss cable. Then set it to any one measured frequency within its operating range and make sure the instrument is operated in its linear range.
- c. Adjust the center frequency of SA on any frequency be measured and set SA to zero span mode. And then, set RBW and VBW of spectrum analyzer to proper value.
- d. Measure the time duration of one transmission on the measured frequency. And then plot the result with time difference of this time duration.
- e. Repeat above procedures until all different time-slot modes have been completed.

4.4.4 DEVIATION FROM TEST STANDARD

No deviation.

4.4.5 TEST SETUP

Same as 4.3.5

4.4.6 TEST RESULTS

FOR GFSK MODULATION

Mode	Number of transmission in a 31.6 (79Hopping*0.4)	Length of transmission time (msec)	Result (msec)	Limit (msec)
DH1	50 (times / 5 sec) *6.32=316.00 times	0.462	145.992	400
DH3	27 (times / 5 sec) *6.32=170.64 times	1.746	297.937	400
DH5	18 (times / 5 sec) *6.32=113.76 times	3.010	342.418	400

NOTE: Test plots of the transmitting time slot are shown on next 3 pages.

DH1

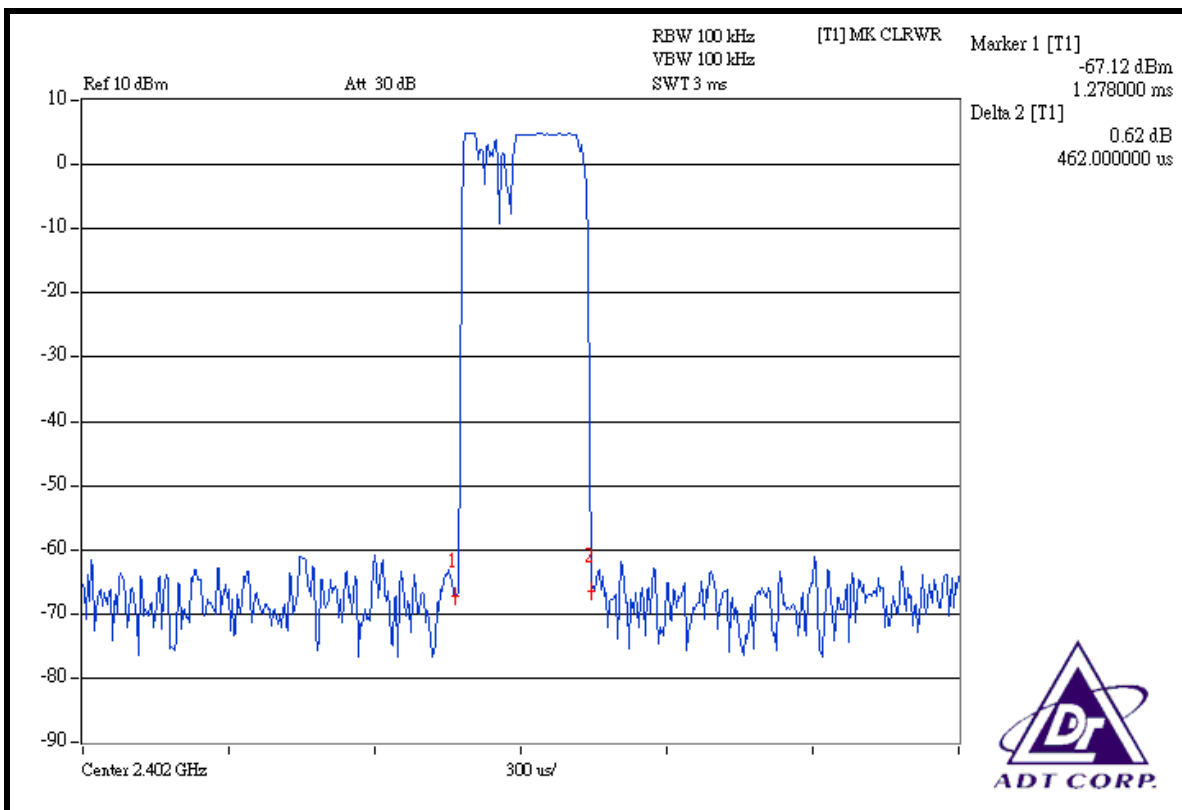
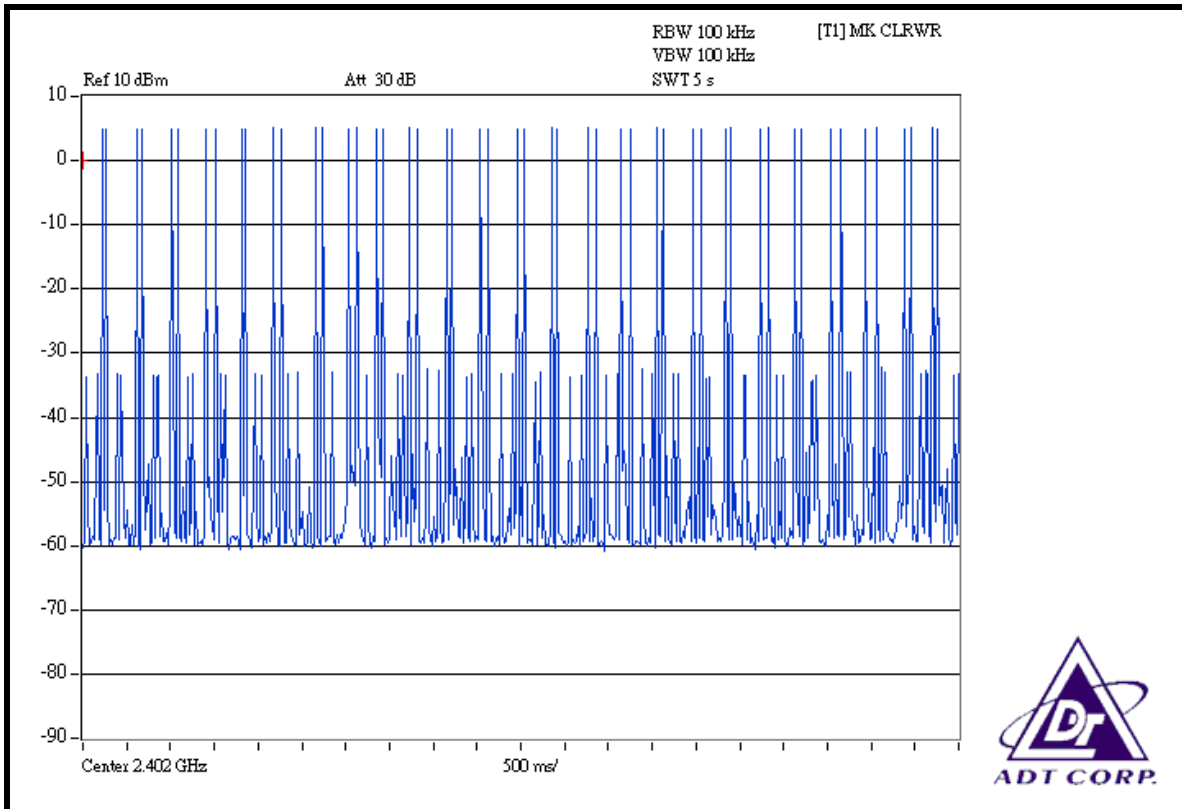

DH3

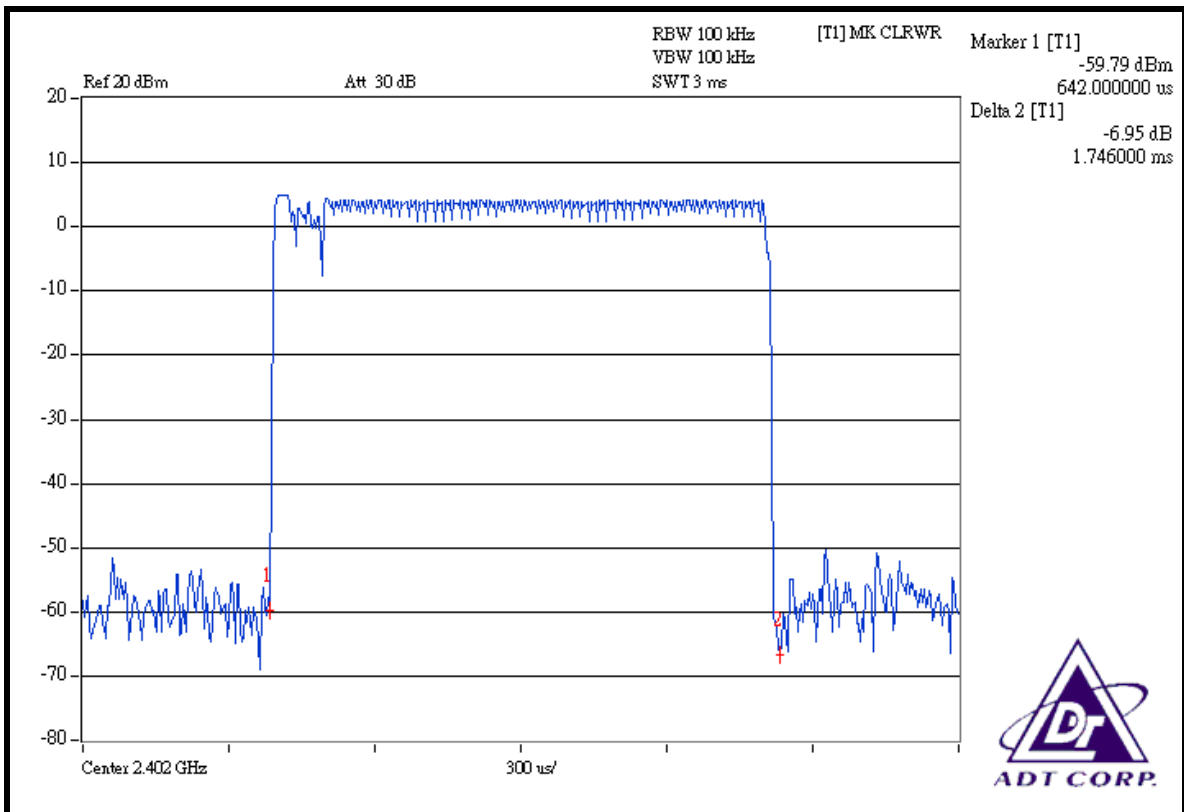
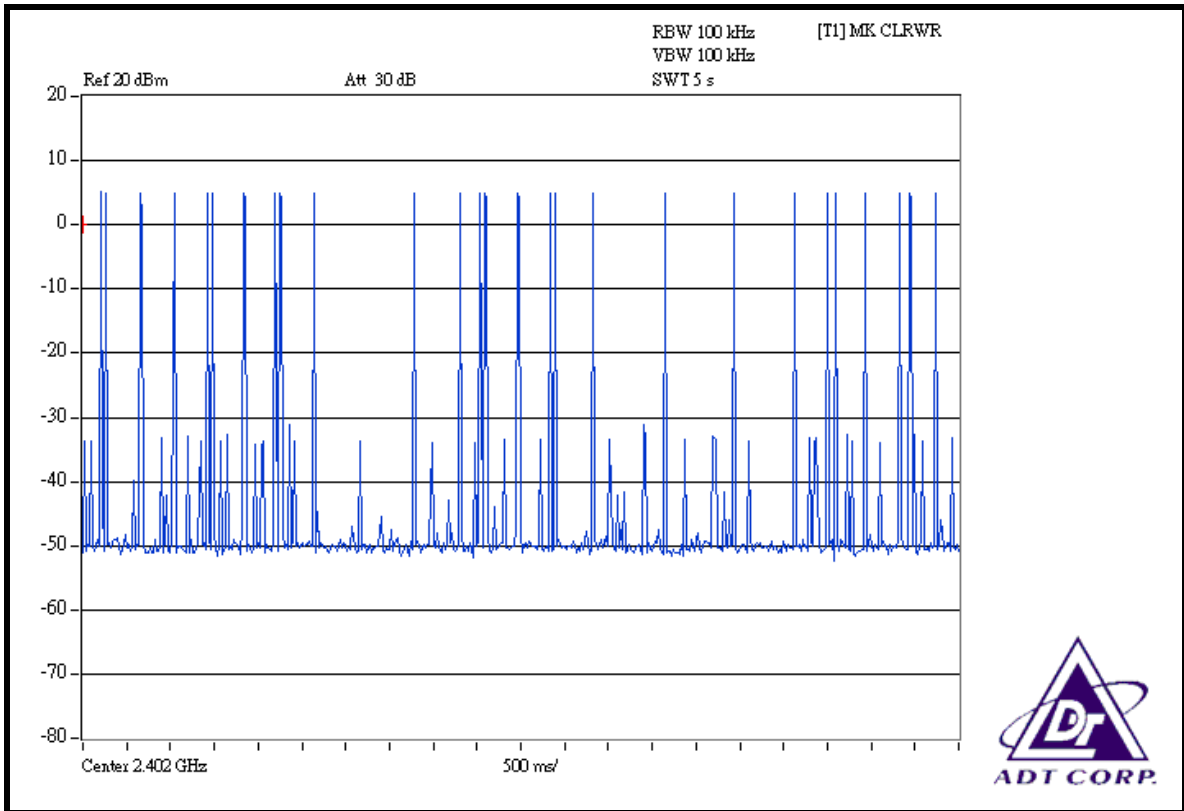

DH5

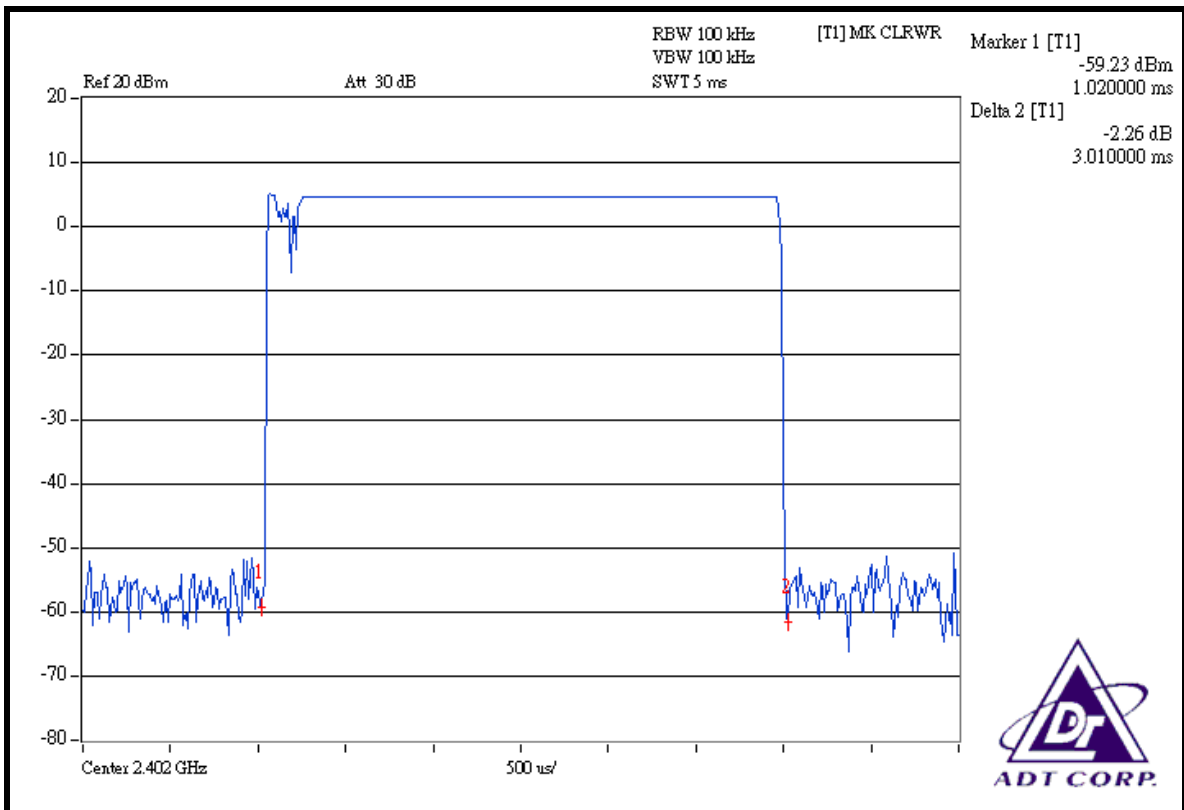
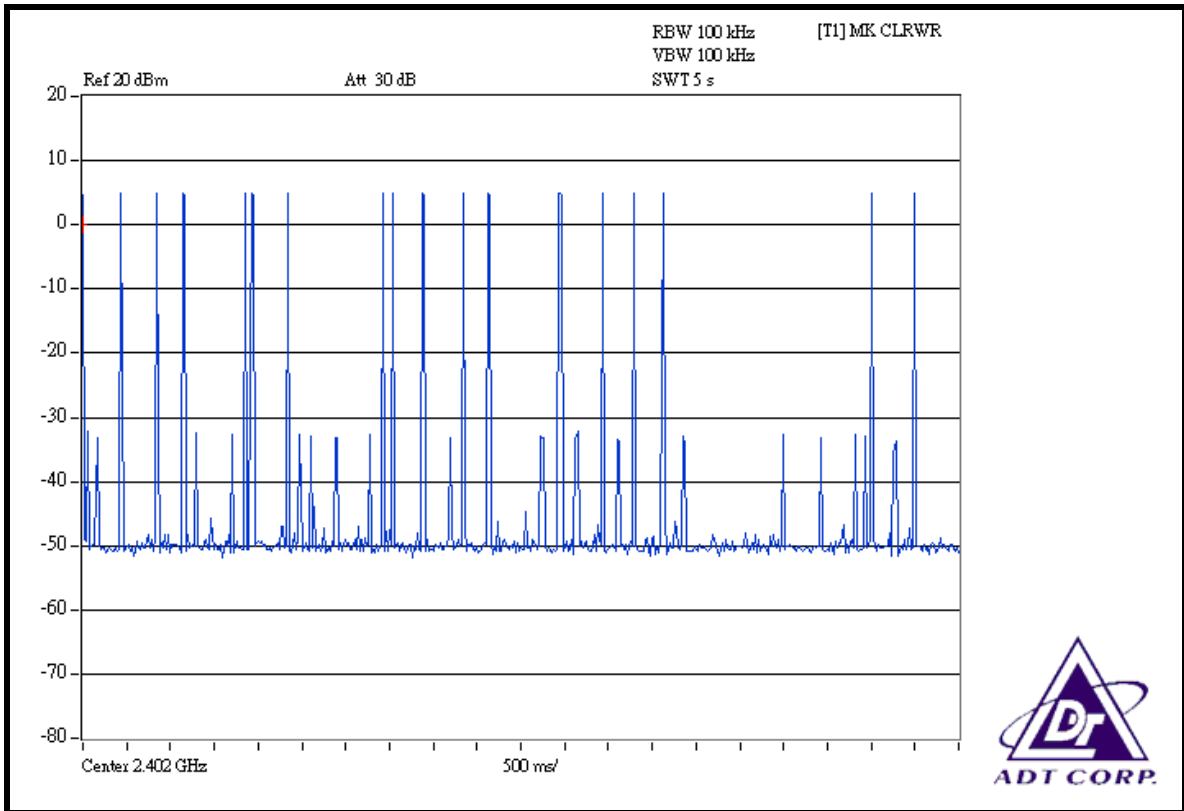

FOR 8DPSK

Mode	Number of transmission in a 31.6 (79Hopping*0.4)	Length of transmission time (msec)	Result (msec)	Limit (msec)
DH1	52 (times / 5 sec) *6.32=328.64 times	0.326	107.137	400
DH3	27 (times / 5 sec) *6.32=170.64 times	0.743	126.786	400
DH5	17 (times / 5 sec) *6.32=107.44 times	1.164	125.060	400

NOTE: Test plots of the transmitting time slot are shown on next 3 pages.

DH1

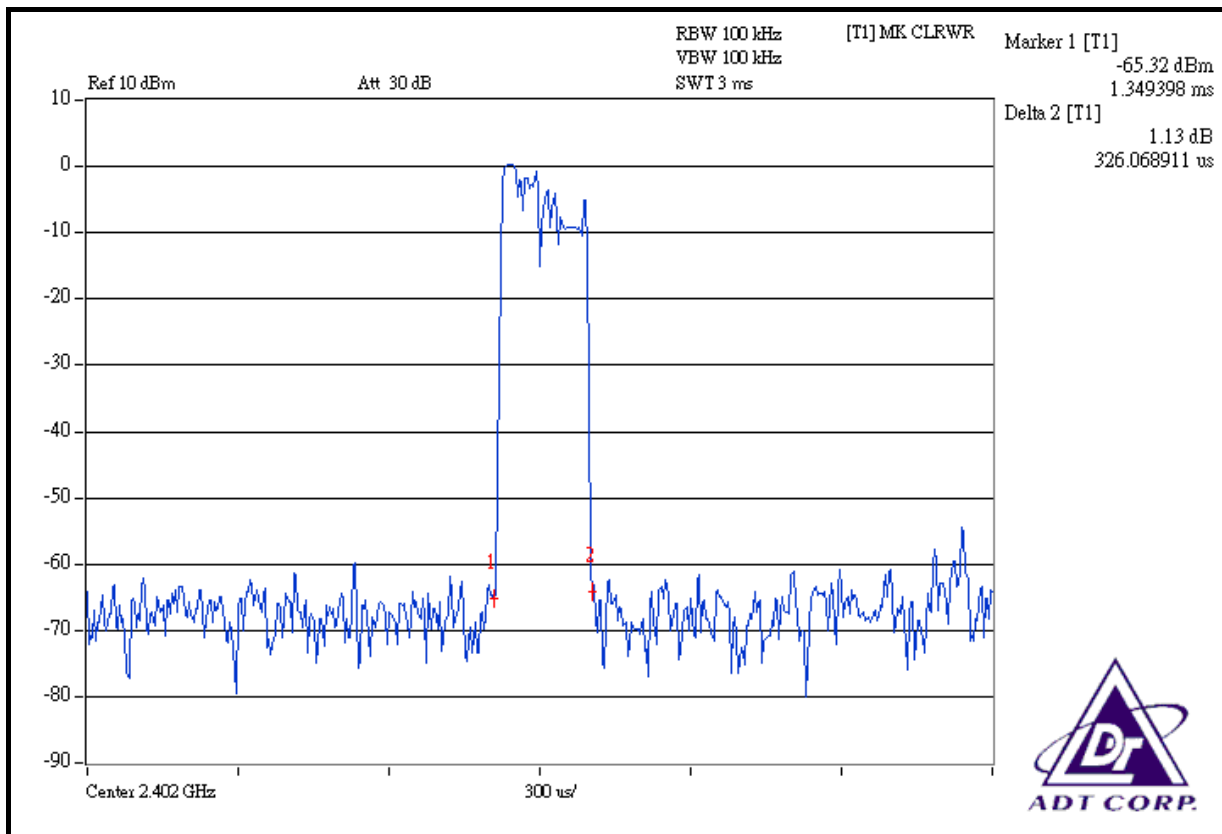
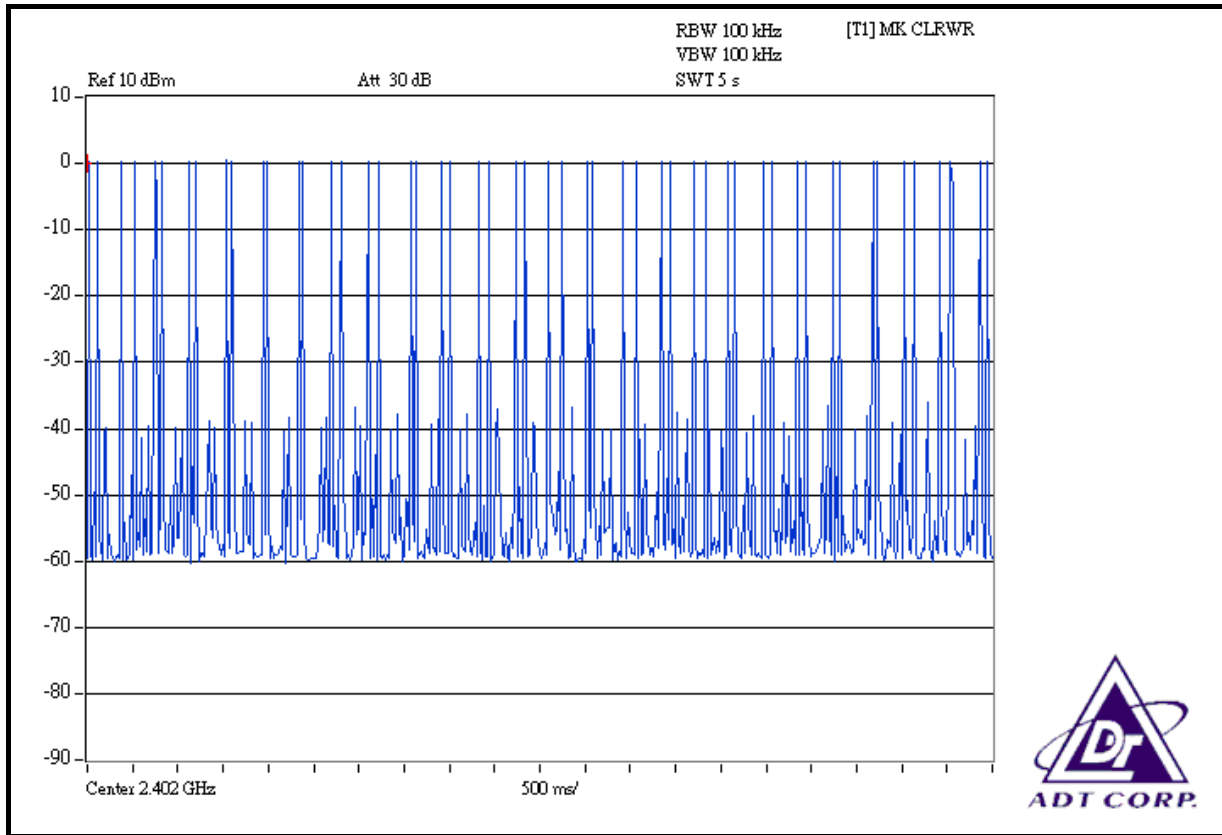

DH3

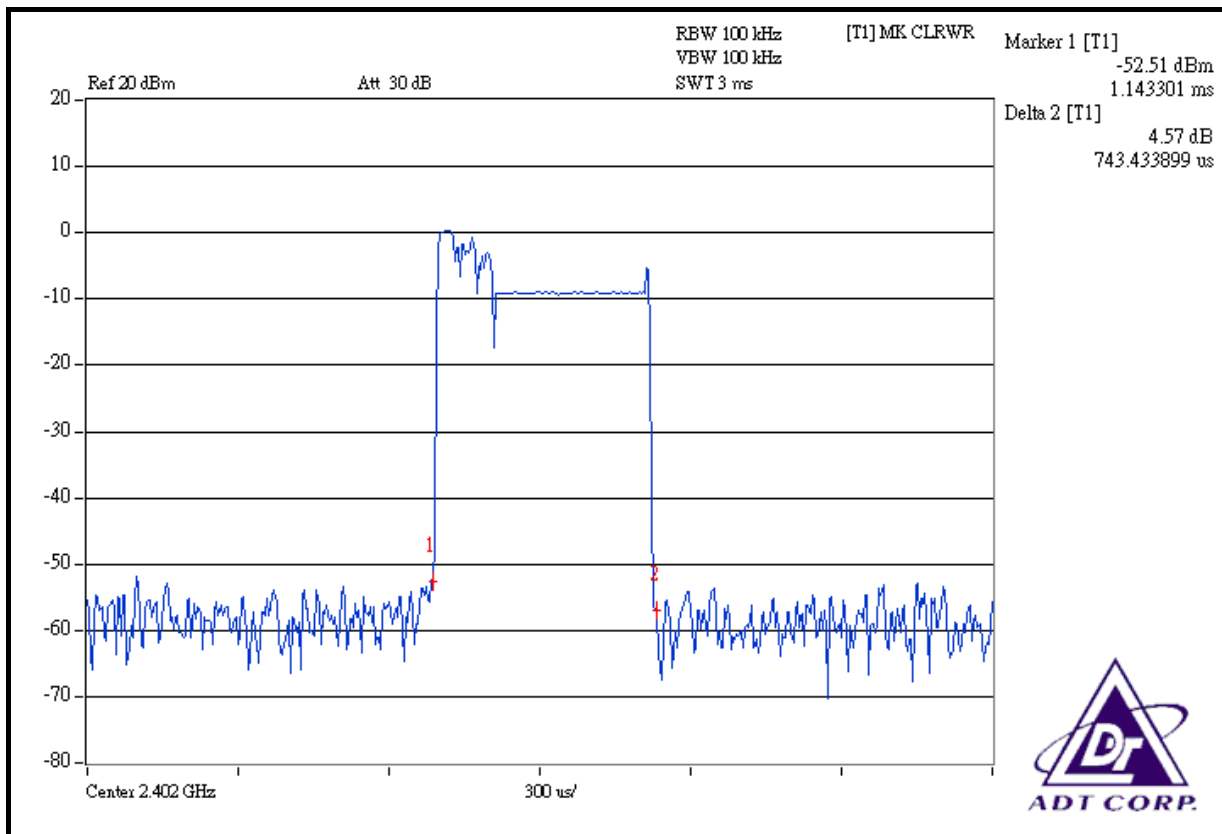
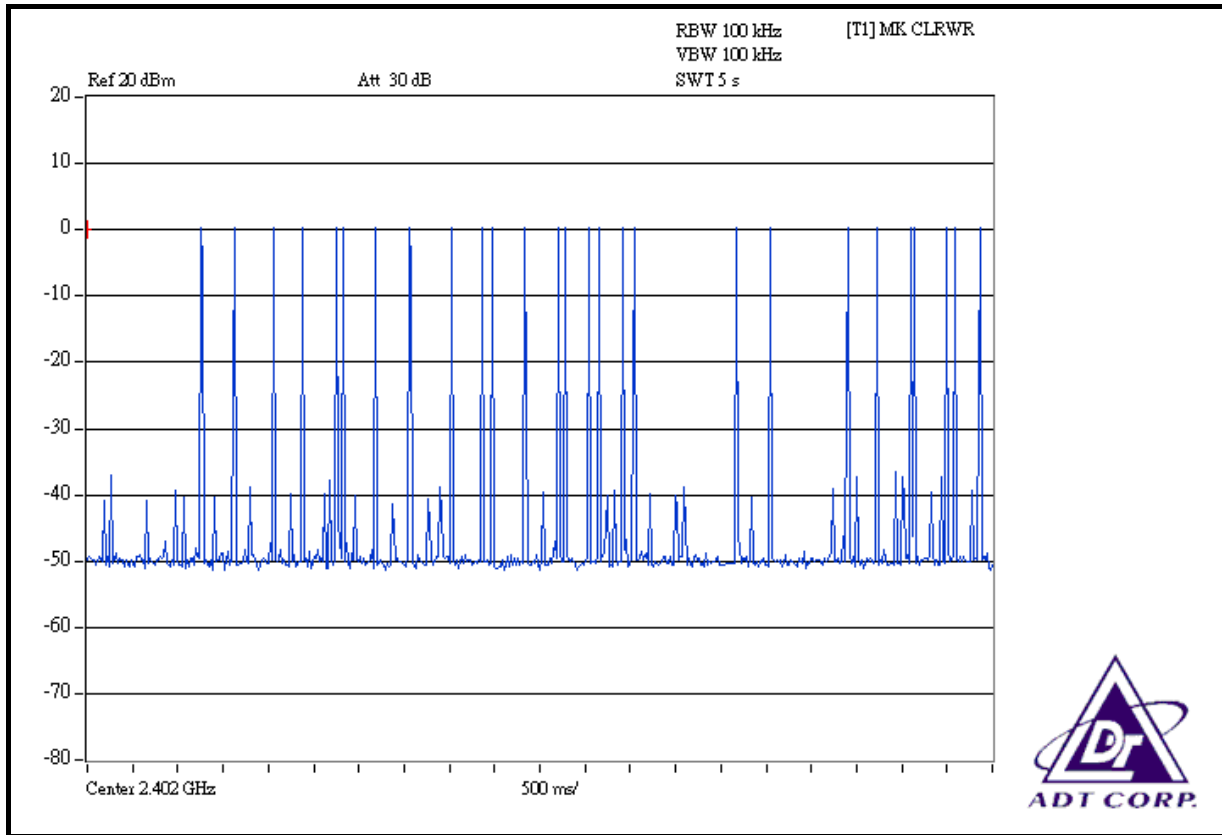



DH5

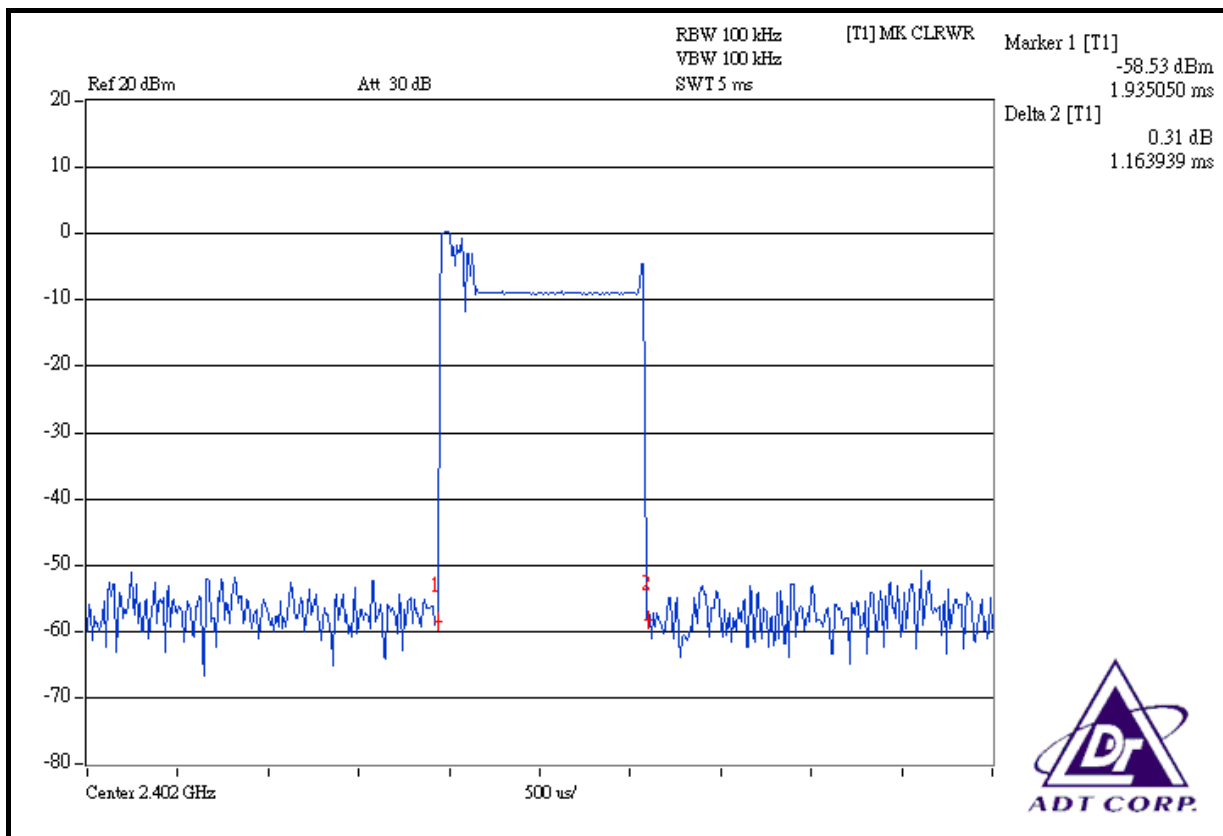
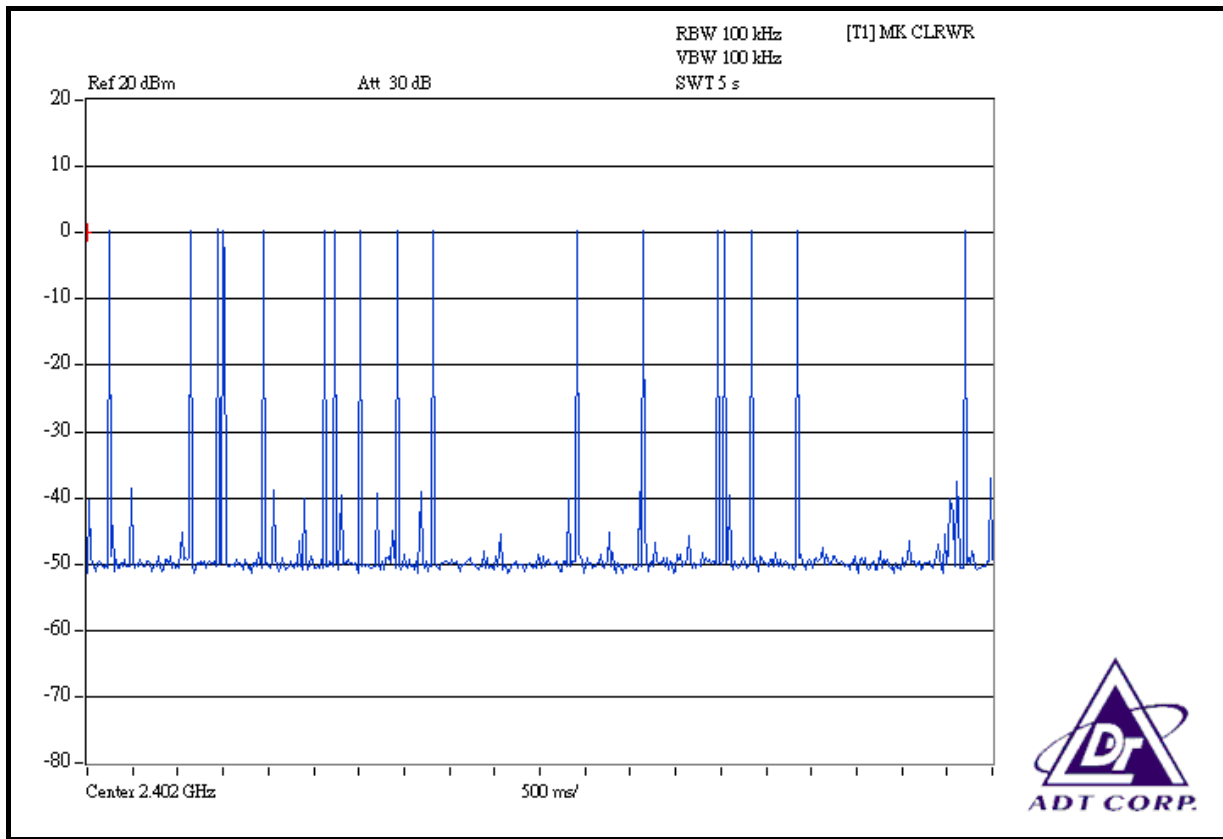



4.5 CHANNEL BANDWIDTH

4.5.1 LIMITS OF CHANNEL BANDWIDTH

For frequency hopping system operating in the 2400-2483.5MHz, If the 20dB bandwidth of hopping channel is greater than 25kHz, two-thirds 20dB bandwidth of hopping channel shall be a minimum limit for the hopping channel separation.

4.5.2 TEST INSTRUMENTS

DESCRIPTION & MANUFACTURER	MODEL NO.	SERIAL NO.	CALIBRATED UNTIL
SPECTRUM ANALYZER	FSP40	100040	Jun. 28, 2008

NOTE: The calibration interval of the above test instruments is 12 months. And the calibrations are traceable to NML/ROC and NIST/USA.

4.5.3 TEST PROCEDURE

- a. Check the calibration of the measuring instrument using either an internal calibrator or a known signal from an external generator.
- b. Turn on the EUT and connect it to measurement instrument. Then set it to any one convenient frequency within its operating range. Set a reference level on the measuring instrument equal to the highest peak value.
- c. Measure the frequency difference of two frequencies that were attenuated 20dB from the reference level. Record the frequency difference as the emission bandwidth.
- d. Repeat above procedures until all frequencies measured were complete.

4.5.4 DEVIATION FROM TEST STANDARD

No deviation.



4.5.5 TEST SETUP

Same as 4.3.5

4.5.6 EUT OPERATING CONDITION

The software provided by client enabled the EUT to transmit and receive data at lowest, middle and highest channel frequencies individually.

4.5.7 TEST RESULTS

FOR GFSK MODULATION

MODULATION TYPE	GFSK	ENVIRONMENTAL CONDITIONS	25deg. C, 68%RH, 991hPa
INPUT POWER (SYSTEM)	120Vac, 60 Hz	TESTED BY	Morgan Chen

CHANNEL	CHANNEL FREQUENCY (MHz)	20dB BANDWIDTH (MHz)
0	2402	0.955
39	2441	0.955
78	2480	0.955



CH 0

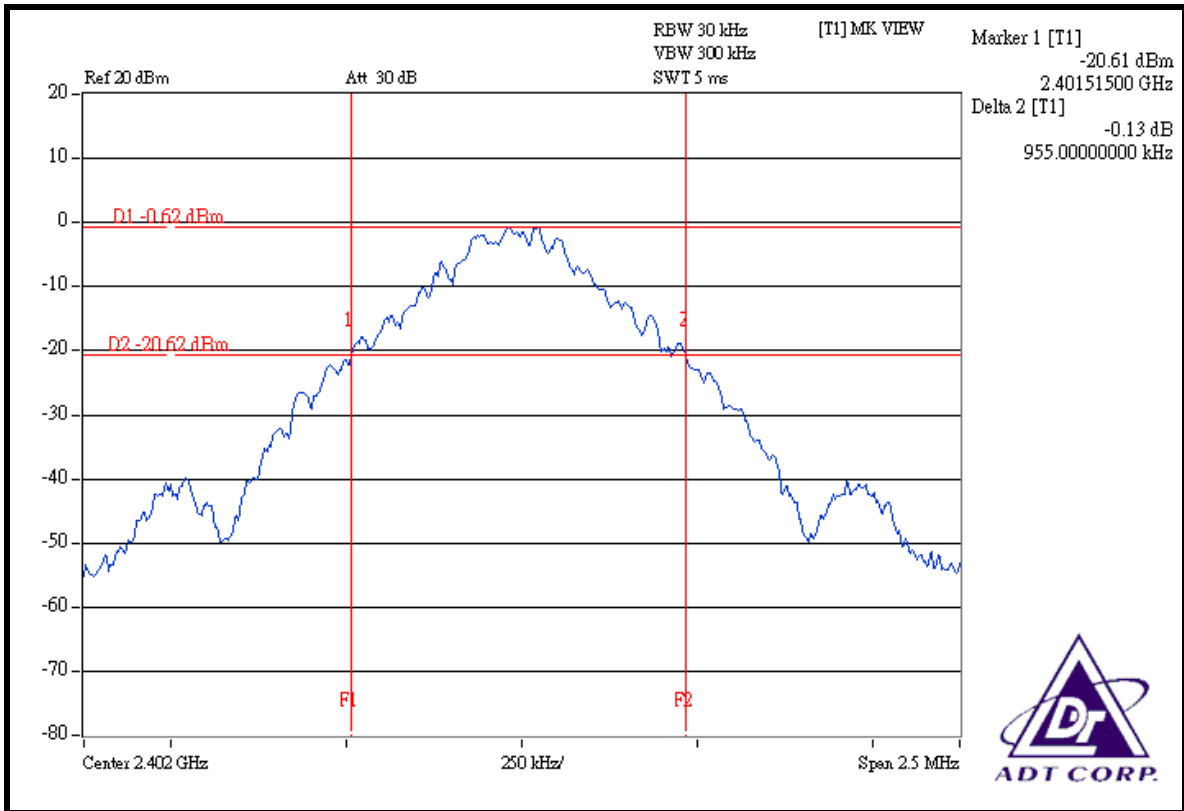

CH 39

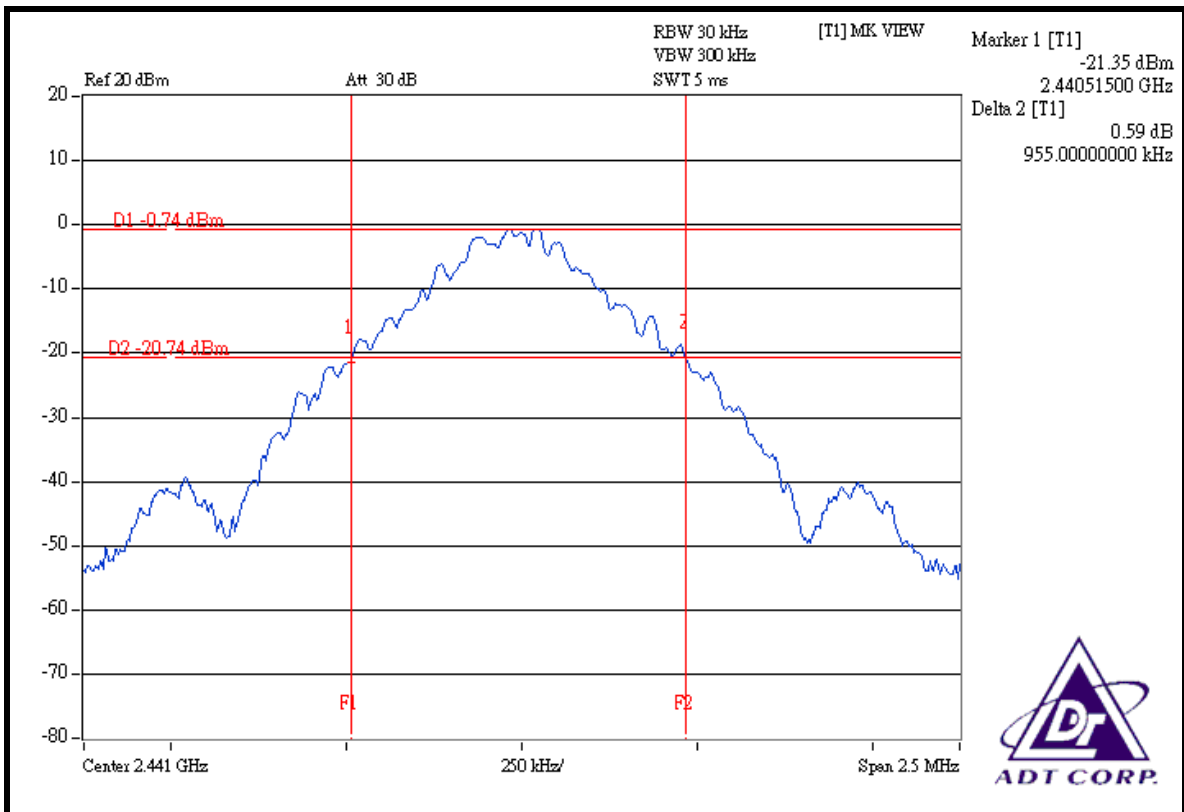

CH 78

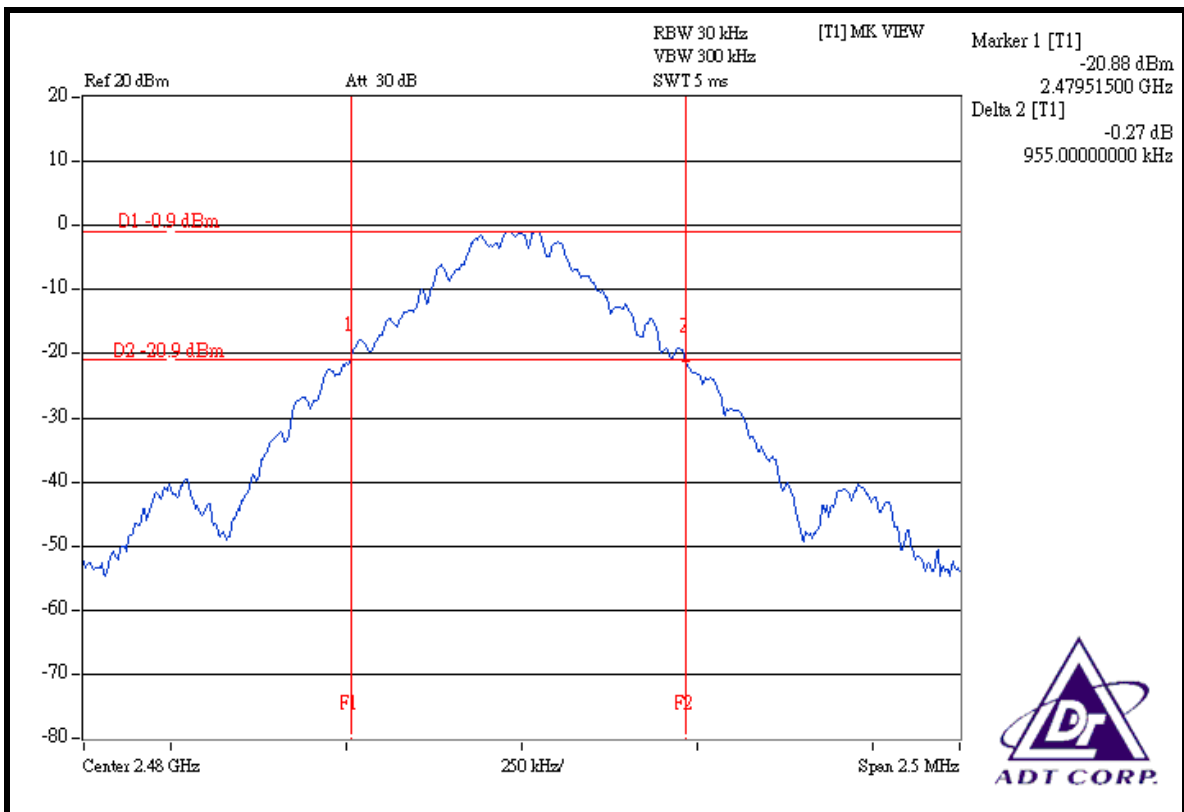



FOR 8DPSK MODULATION

MODULATION TYPE	8DPSK	ENVIRONMENTAL CONDITIONS	25deg. C, 68%RH, 1004.9hPa
INPUT POWER (SYSTEM)	120Vac, 60 Hz	TESTED BY	Morgan Chen

CHANNEL	CHANNEL FREQUENCY (MHz)	20dB BANDWIDTH (MHz)
0	2402	1.375
39	2441	1.375
78	2480	1.375

CH 0

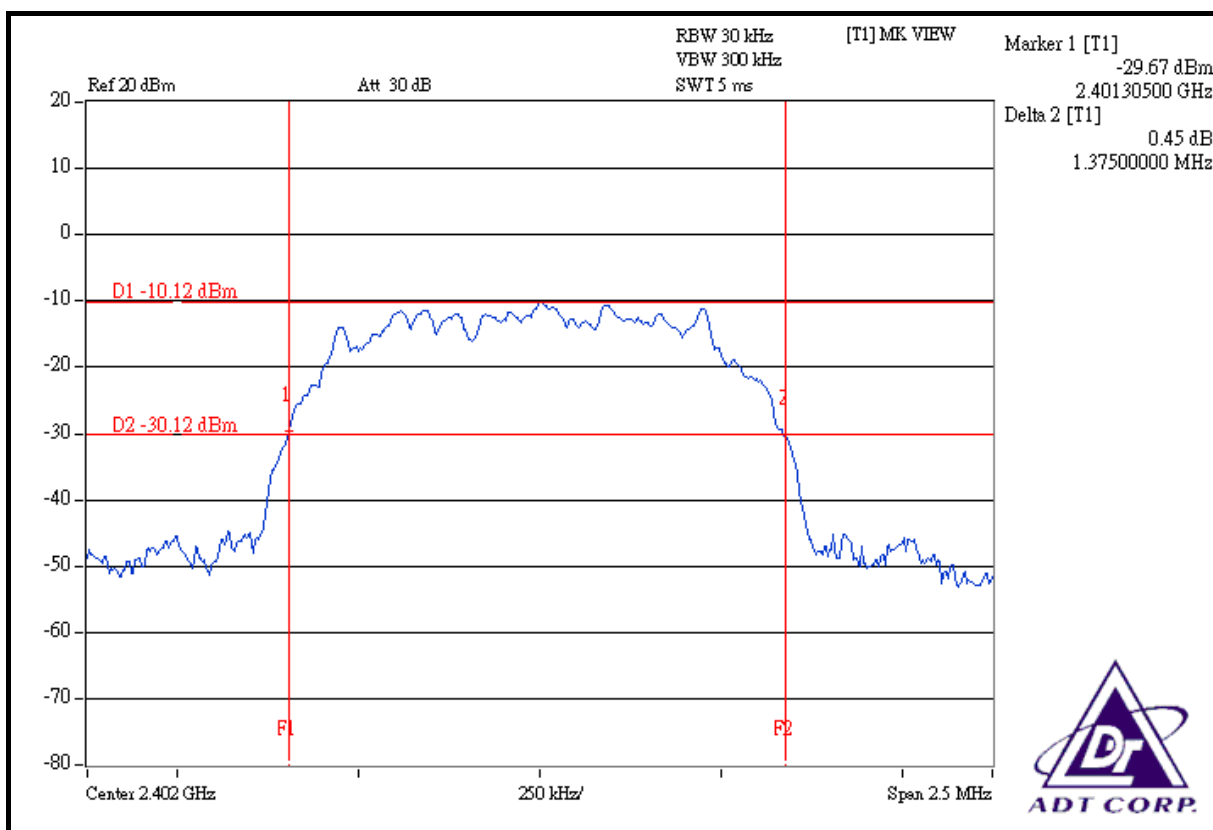



CH 39

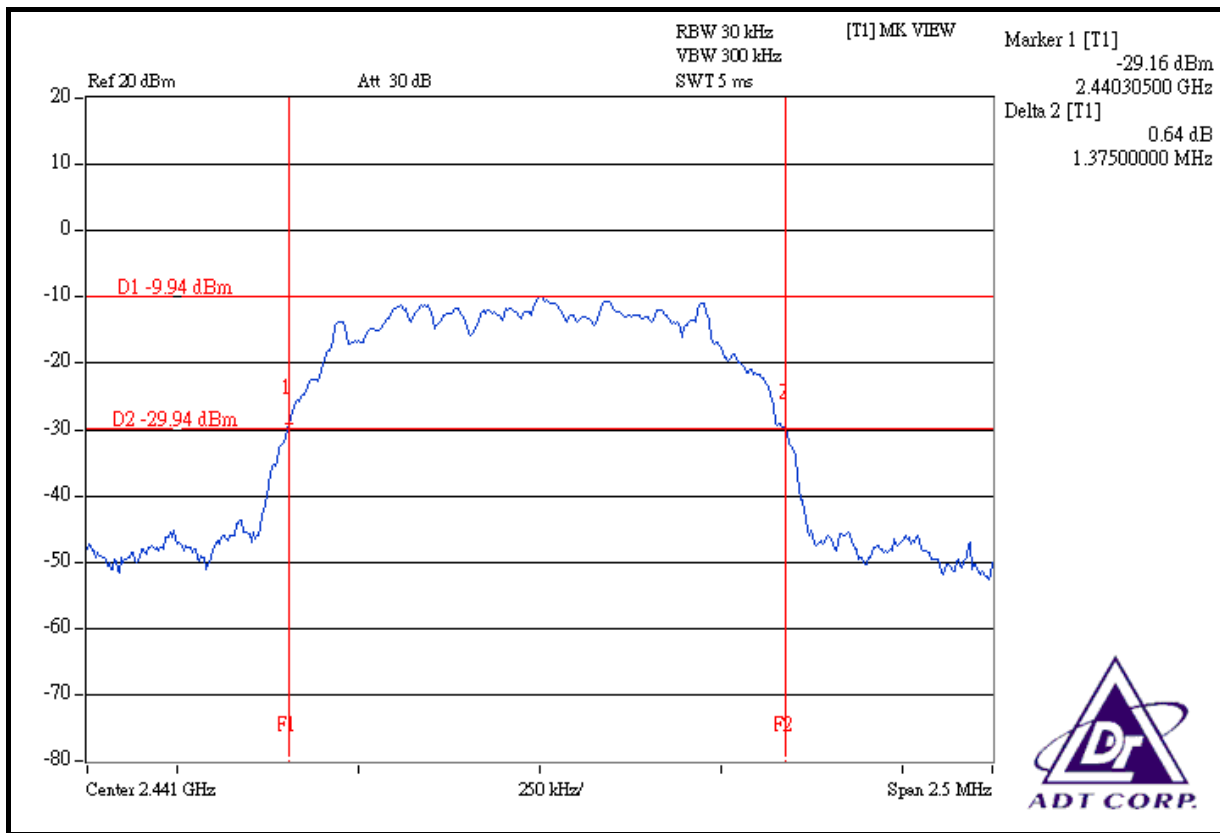

CH 78

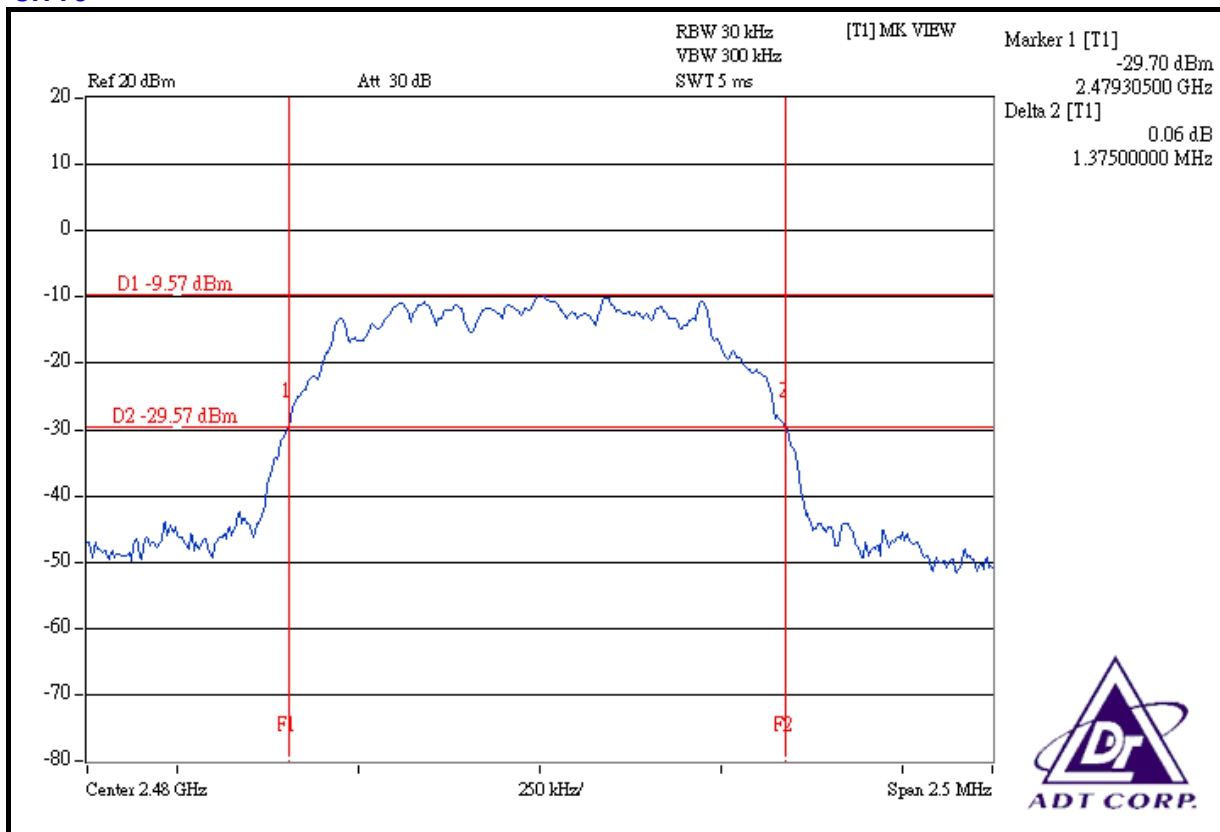



4.6 HOPPING CHANNEL SEPARATION

4.6.1 LIMIT OF HOPPING CHANNEL SEPARATION

At least 25kHz or two-third of 20dB hopping channel bandwidth (whichever is greater).

4.6.2 TEST INSTRUMENTS

DESCRIPTION & MANUFACTURER	MODEL NO.	SERIAL NO.	CALIBRATED UNTIL
SPECTRUM ANALYZER	FSP40	100040	Jun. 28, 2008

NOTES: The calibration interval of the above test instruments is 12 months. And the calibrations are traceable to NML/ROC and NIST/USA.

4.6.3 TEST PROCEDURES

- a. Check the calibration of the measuring instrument using either an internal calibrator or a known signal from an external generator.
- b. Turn on the EUT and connect it to measurement instrument. Then set it to any one convenient frequency within its operating range.
- c. By using the MaxHold function record the separation of two adjacent channels.
- d. Measure the frequency difference of these two adjacent channels by SA MARK function. And then plot the result on SA screen.
- e. Repeat above procedures until all frequencies measured were complete.

4.6.4 DEVIATION FROM TEST STANDARD

No deviation

4.6.5 TEST SETUP

Same as 4.3.5



4.6.6 TEST RESULTS

FOR GFSK MODULATION

MODULATION TYPE	GFSK	ENVIRONMENTAL CONDITIONS	25deg. C, 68%RH, 1004.9hPa
INPUT POWER (SYSTEM)	120Vac, 60 Hz	TESTED BY	Morgan Chen

CHANNEL	FREQUENCY (MHz)	ADJACENT CHANNEL SEPARATION (MHz)	20dB BANDWIDTH (MHz)	MINIMUM LIMIT (MHz)	PASS / FAIL
0	2402	1.002	0.955	0.637	PASS
39	2441	1.006	0.955	0.637	PASS
78	2480	1.008	0.955	0.637	PASS

NOTE: The minimum limit is two-third 20dB bandwidth. Test results please refer to next two pages.

CH 0

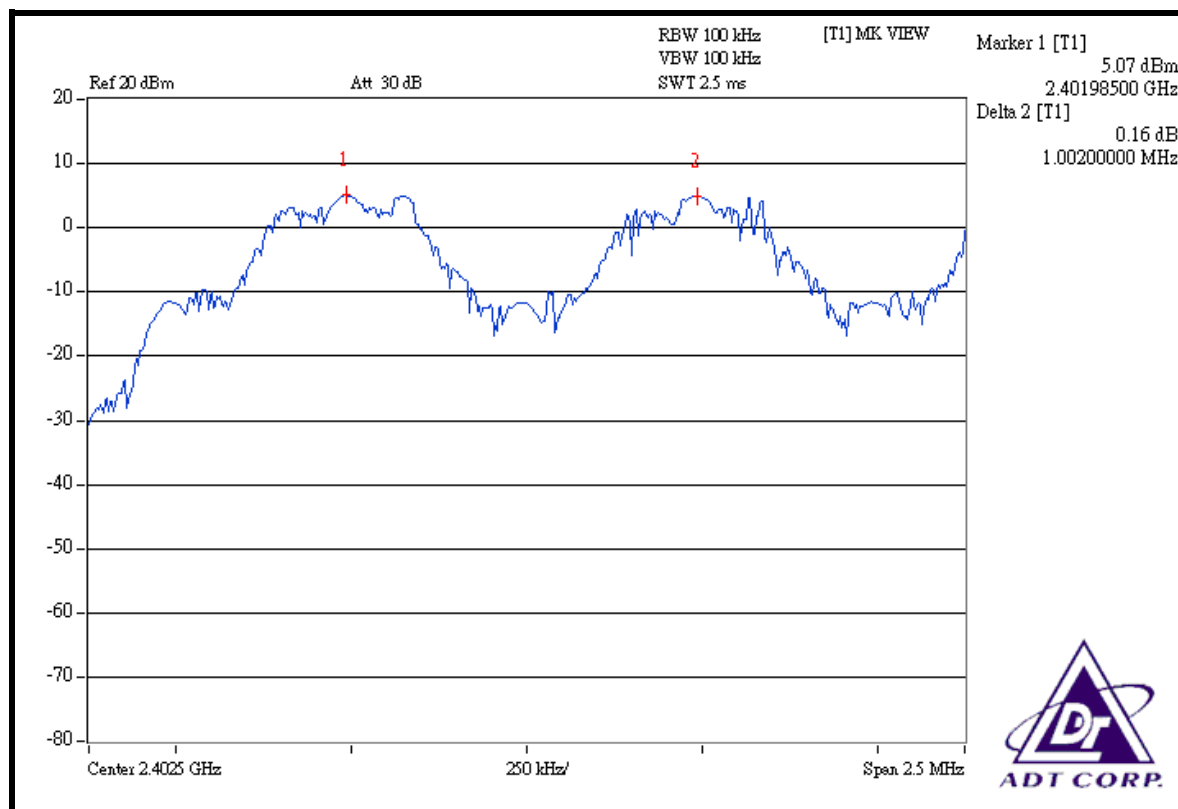



CH 39

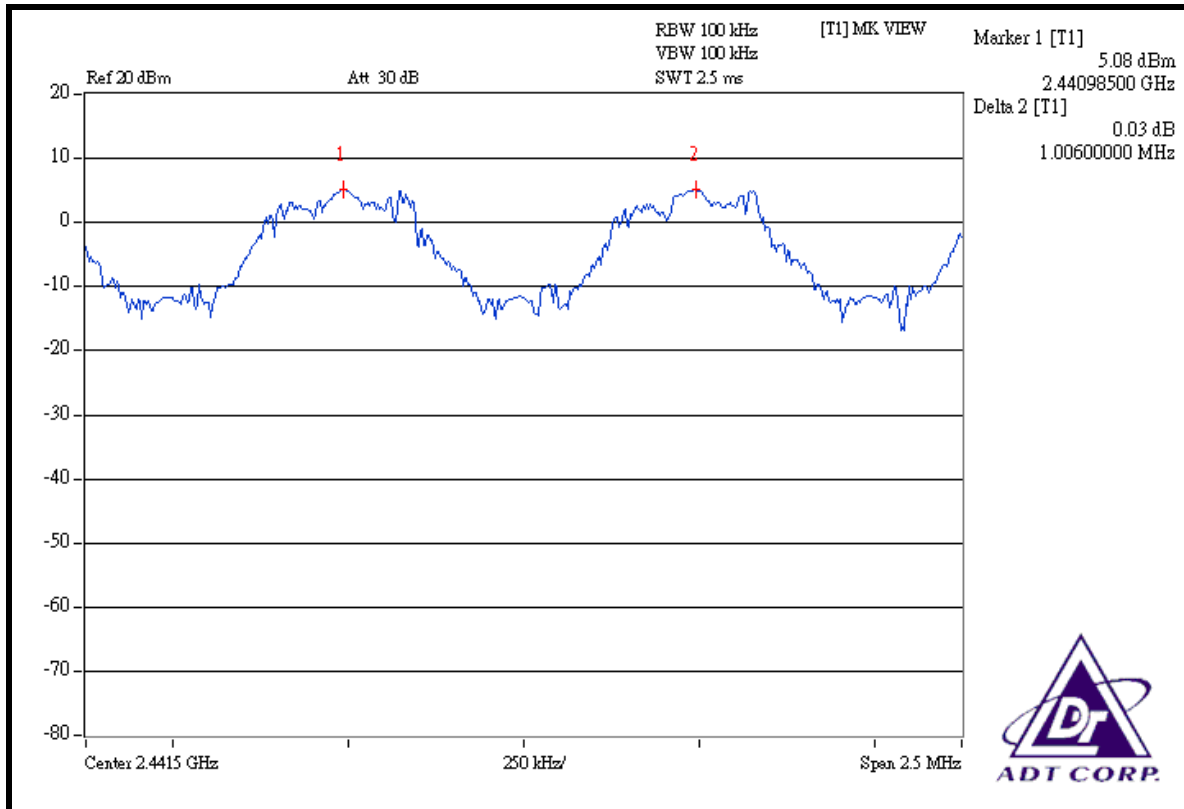

CH 78

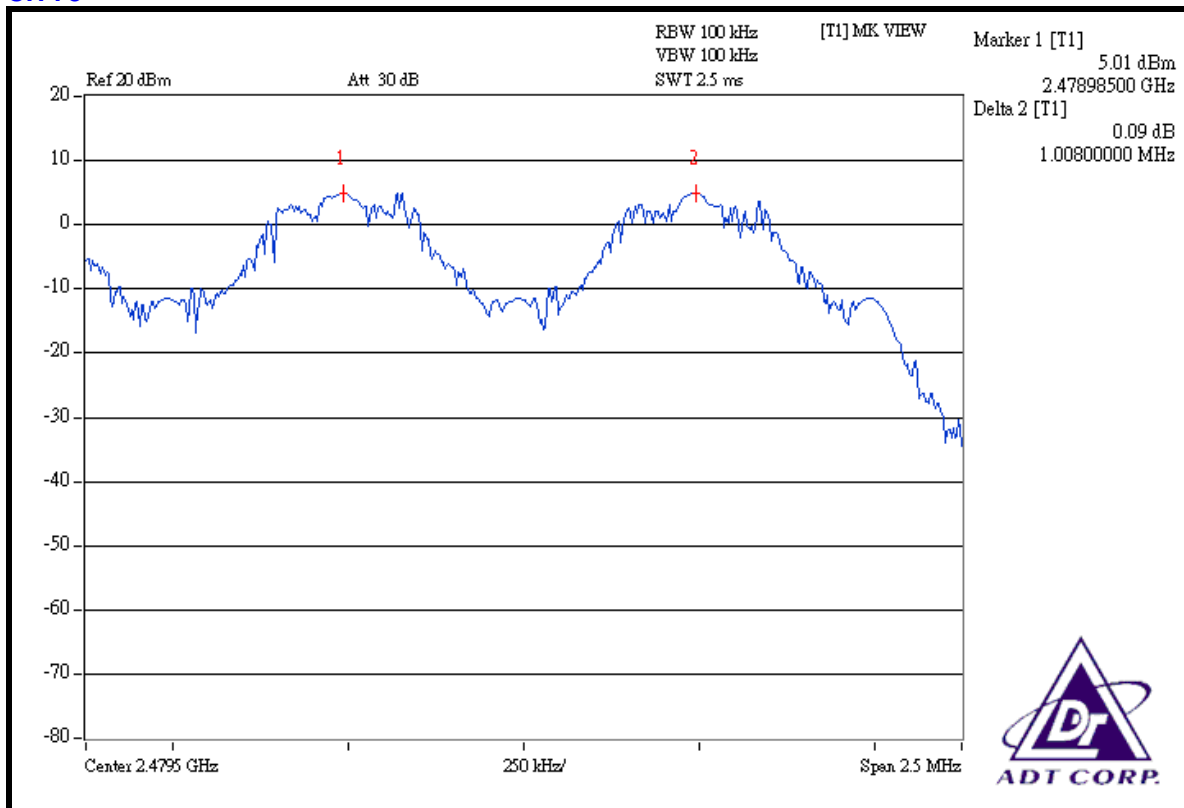



FOR 8DPSK MODULATION

MODULATION TYPE	8DPSK	ENVIRONMENTAL CONDITIONS	25deg. C, 68%RH, 1004.9hPa
INPUT POWER (SYSTEM)	120Vac, 60 Hz	TESTED BY	Morgan Chen

CHANNEL	FREQUENCY (MHz)	ADJACENT CHANNEL SEPARATION (MHz)	20dB BANDWIDTH (MHz)	MINIMUM LIMIT (MHz)	PASS / FAIL
0	2402	1.001	1.375	0.917	PASS
39	2441	1.001	1.375	0.917	PASS
78	2480	1.005	1.375	0.917	PASS

NOTE: The minimum limit is two-third 20dB bandwidth. Test results please refer to next two pages.

CH 0

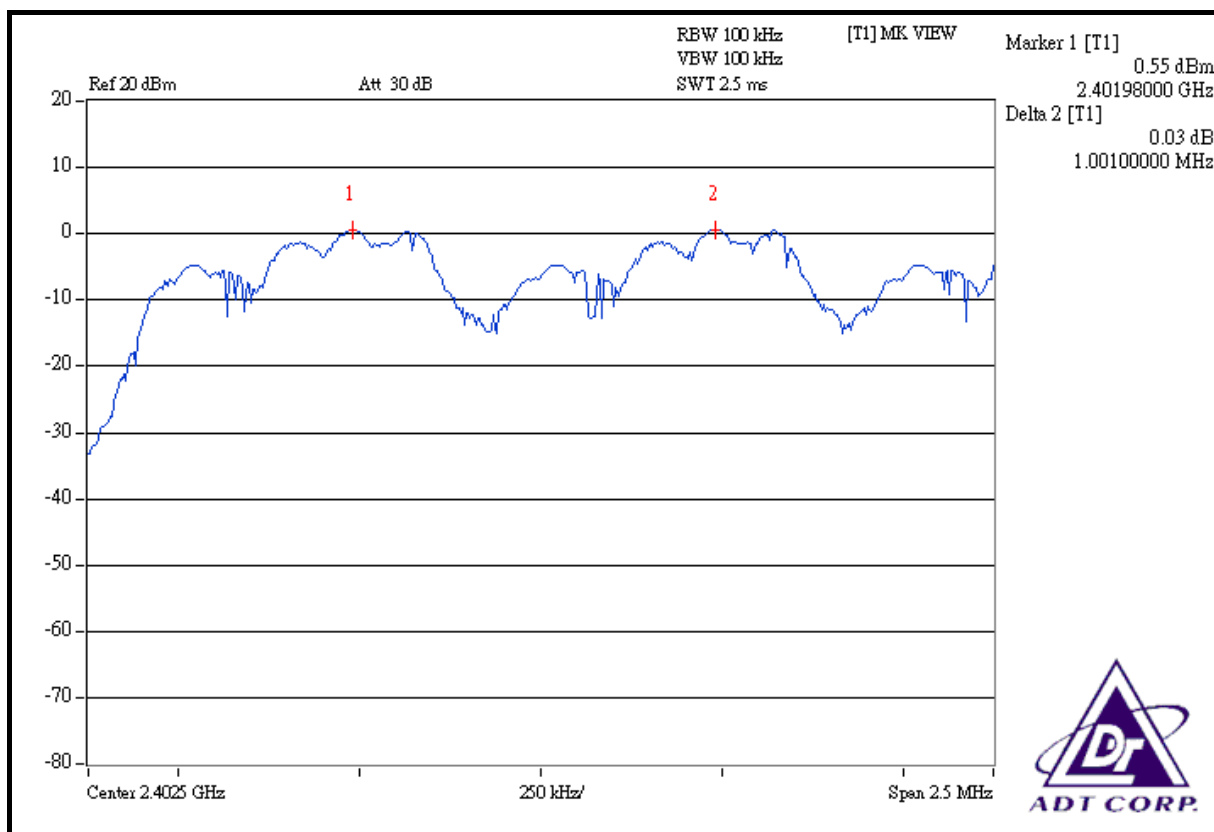



CH 39

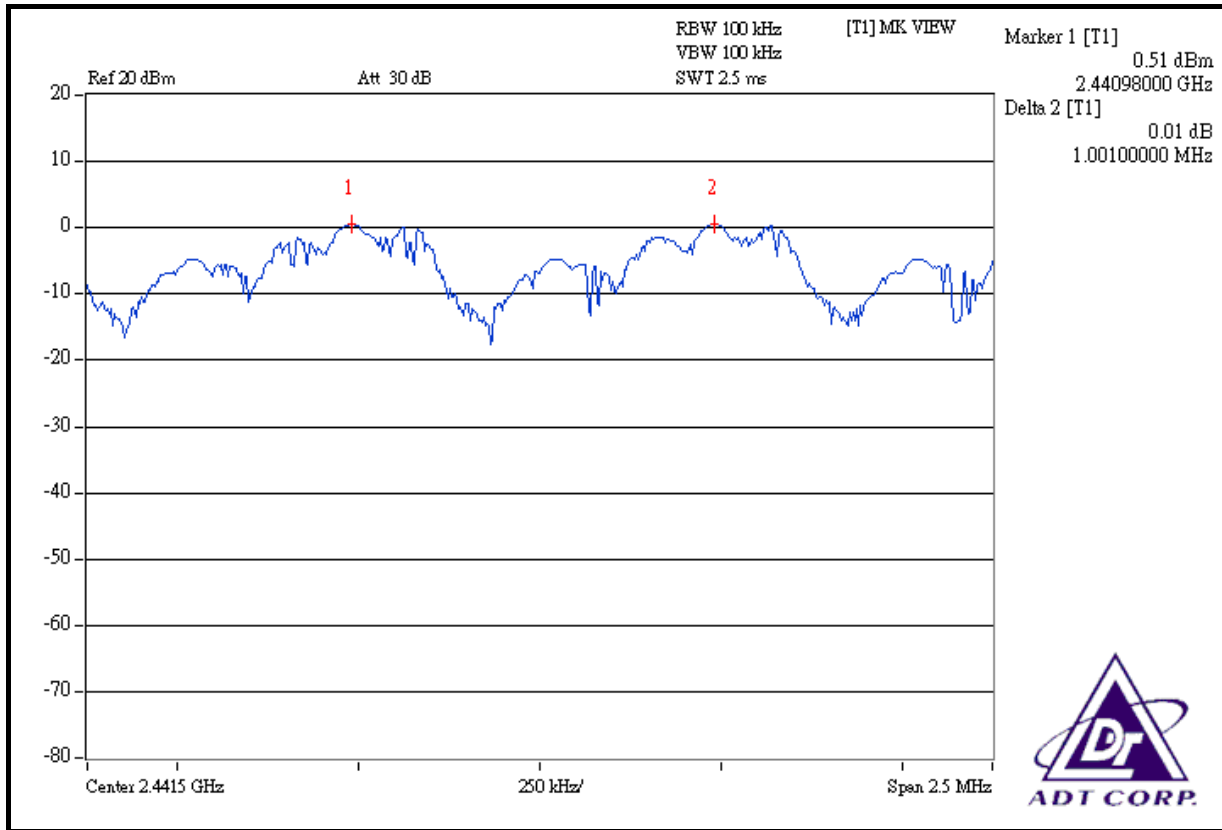

CH 78

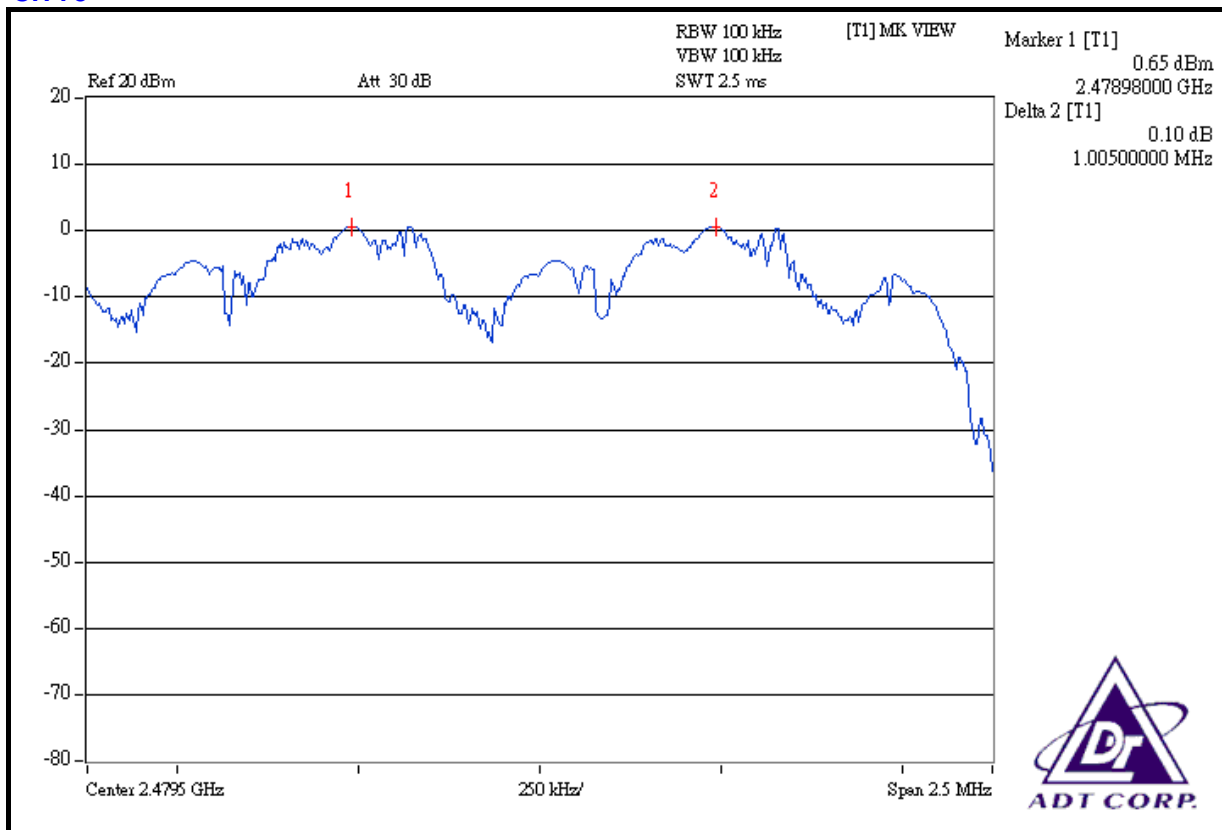



4.7 MAXIMUM PEAK OUTPUT POWER

4.7.1 LIMITS OF MAXIMUM PEAK OUTPUT POWER MEASUREMENT

The Maximum Peak Output Power Measurement is 21dBm or 125mW.

4.7.2 TEST INSTRUMENTS

DESCRIPTION & MANUFACTURER	MODEL NO.	SERIAL NO.	CALIBRATED UNTIL
SPECTRUM ANALYZER	FSP40	100040	Jun. 28, 2008

NOTE: The calibration interval of the above test instruments is 12 months and the calibrations are traceable to NML/ROC and NIST/USA.

4.7.3 TEST PROCEDURES

- a. Check the calibration of the measuring instrument using either an internal calibrator or a known signal from an external generator.
- b. Turn on the EUT and connect it to measurement instrument. Then set it to any one convenient frequency within its operating range. Set a reference level on the measuring instrument equal to the highest peak value.
- c. The center frequency of the spectrum analyzer is set to the fundamental frequency and using 1 MHz RBW and 3 MHz VBW.
- d. Measure the captured power within the band and recording the plot.
- e. Repeat above procedures until all frequencies required were complete.

4.7.4 DEVIATION FROM TEST STANDARD

No deviation



4.7.5 TEST SETUP

Same as 4.3.5

4.7.6 EUT OPERATING CONDITION

The software provided by client enabled the EUT to transmit and receive data at lowest, middle and highest channel frequencies individually.

4.7.7 TEST RESULTS

FOR GFSK

MODULATION TYPE	GFSK	ENVIRONMENTAL CONDITIONS	25deg. C, 68%RH, 1004.9hPa
INPUT POWER (SYSTEM)	120Vac, 60 Hz	TESTED BY	Morgan Chen

CHANNEL	CHANNEL FREQUENCY (MHz)	PEAK POWER OUTPUT (mW)	PEAK POWER OUTPUT (dBm)	PEAK POWER LIMIT (mW)	PASS/FAIL
0	2402	1.581	1.99	125	PASS
39	2441	1.581	1.99	125	PASS
78	2480	1.560	1.93	125	PASS



CH 0

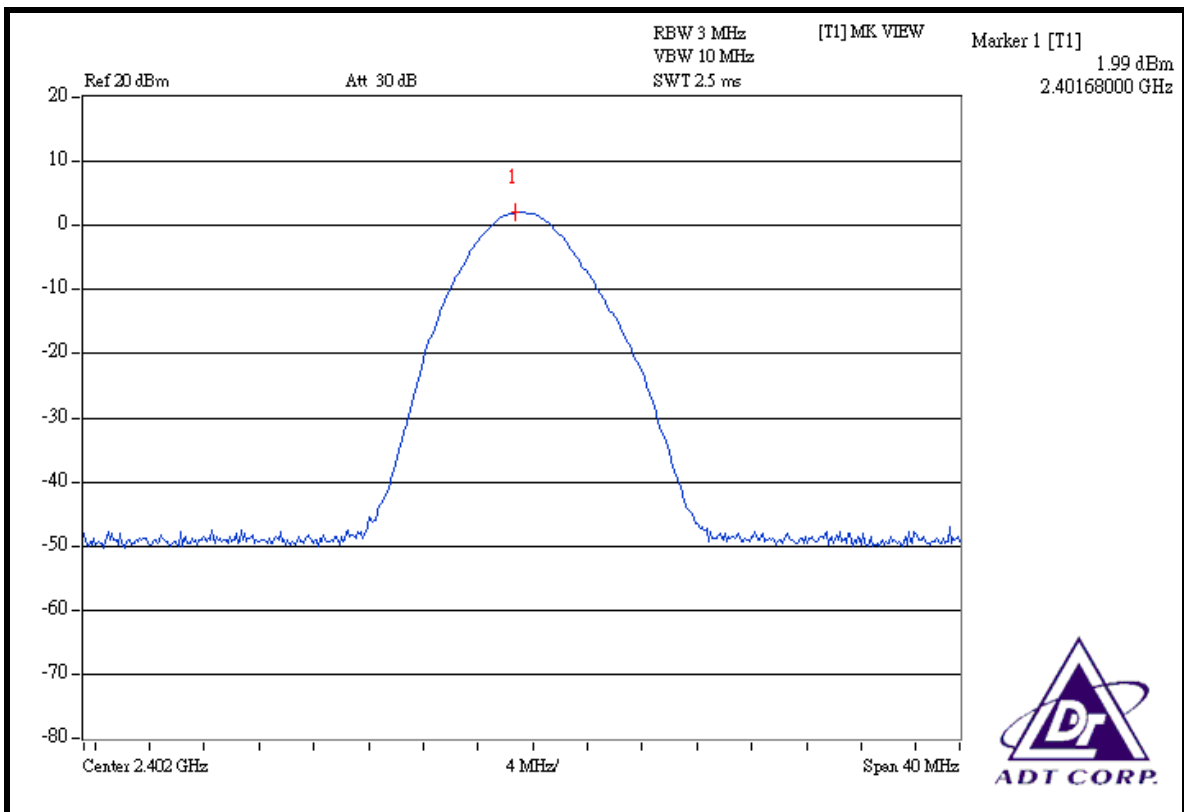

CH 39

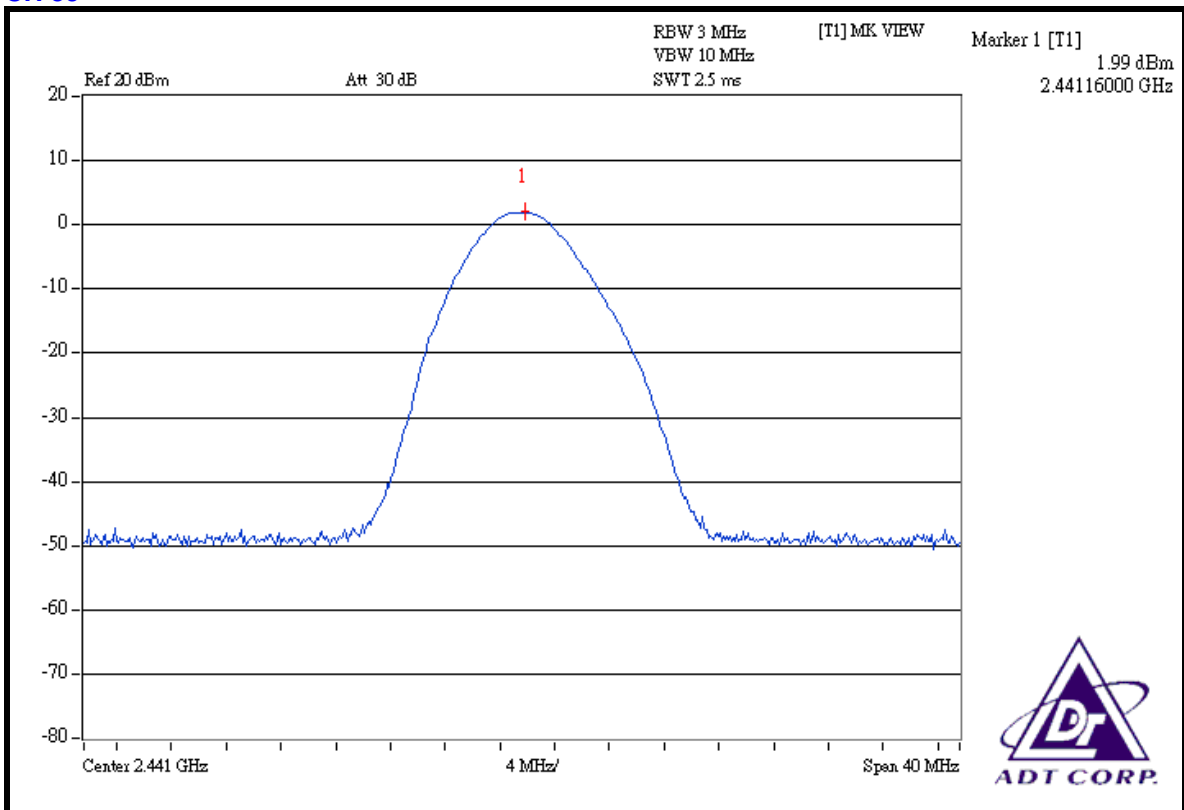



CH 78

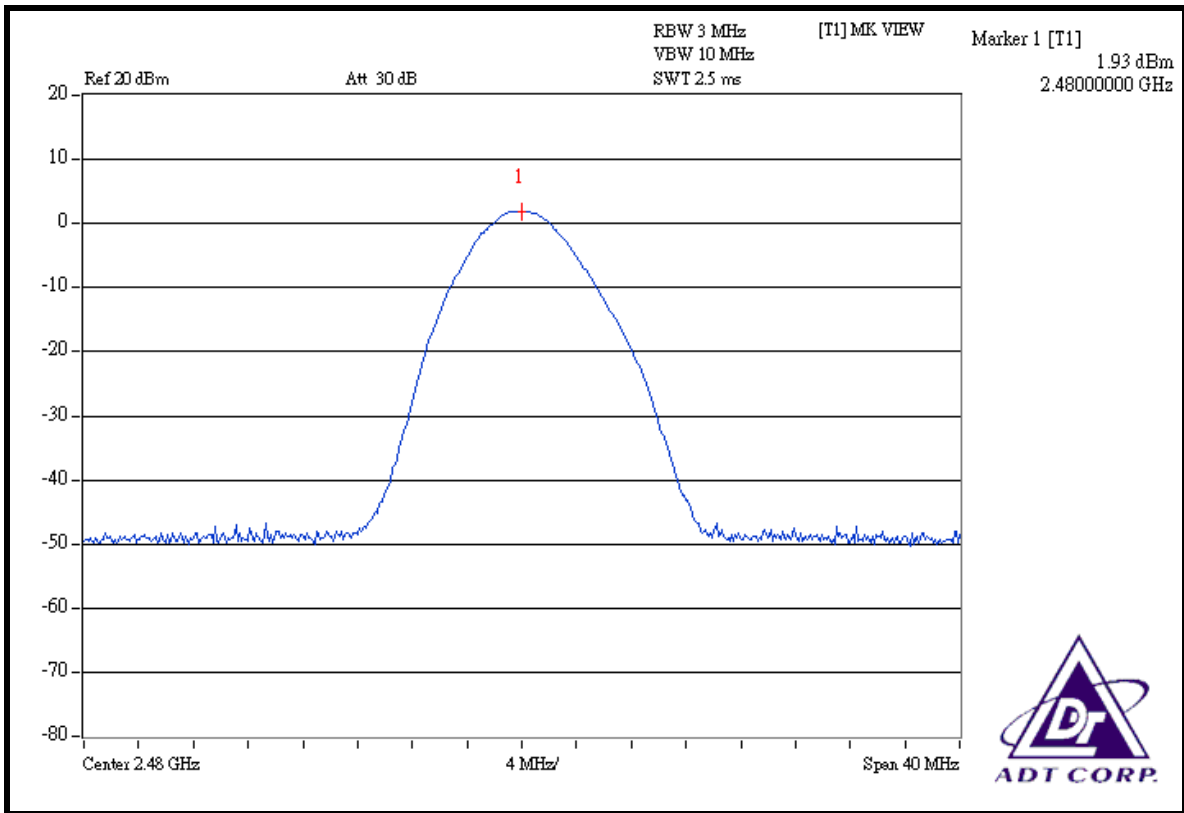



FOR 8DPSK MODULATION

MODULATION TYPE	8DPSK	ENVIRONMENTAL CONDITIONS	25deg. C, 68%RH, 1004.9hPa
INPUT POWER (SYSTEM)	120Vac, 60 Hz	TESTED BY	Morgan Chen

CHANNEL	CHANNEL FREQUENCY (MHz)	PEAK POWER OUTPUT (mW)	PEAK POWER OUTPUT (dBm)	PEAK POWER LIMIT (mW)	PASS/FAIL
0	2402	0.805	-0.94	125	PASS
39	2441	0.836	-0.78	125	PASS
78	2480	0.895	-0.48	125	PASS

CH 0

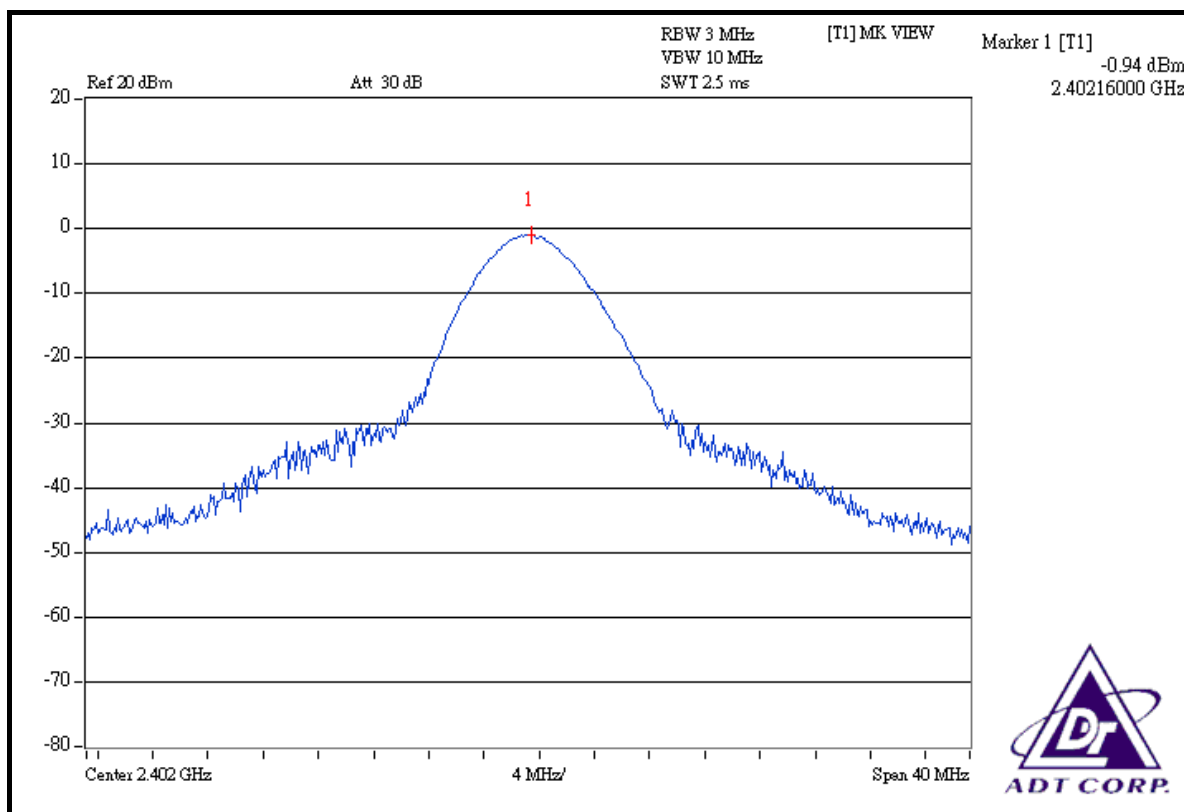



CH 39

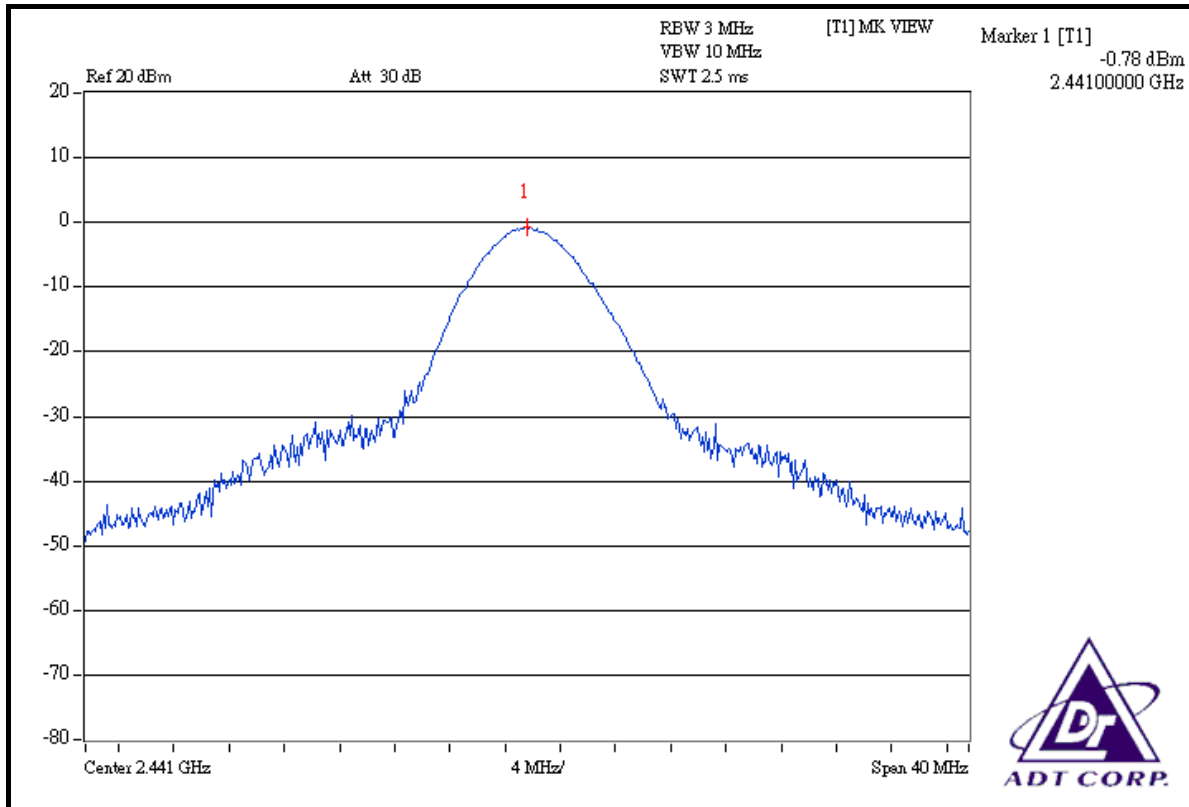

CH 78

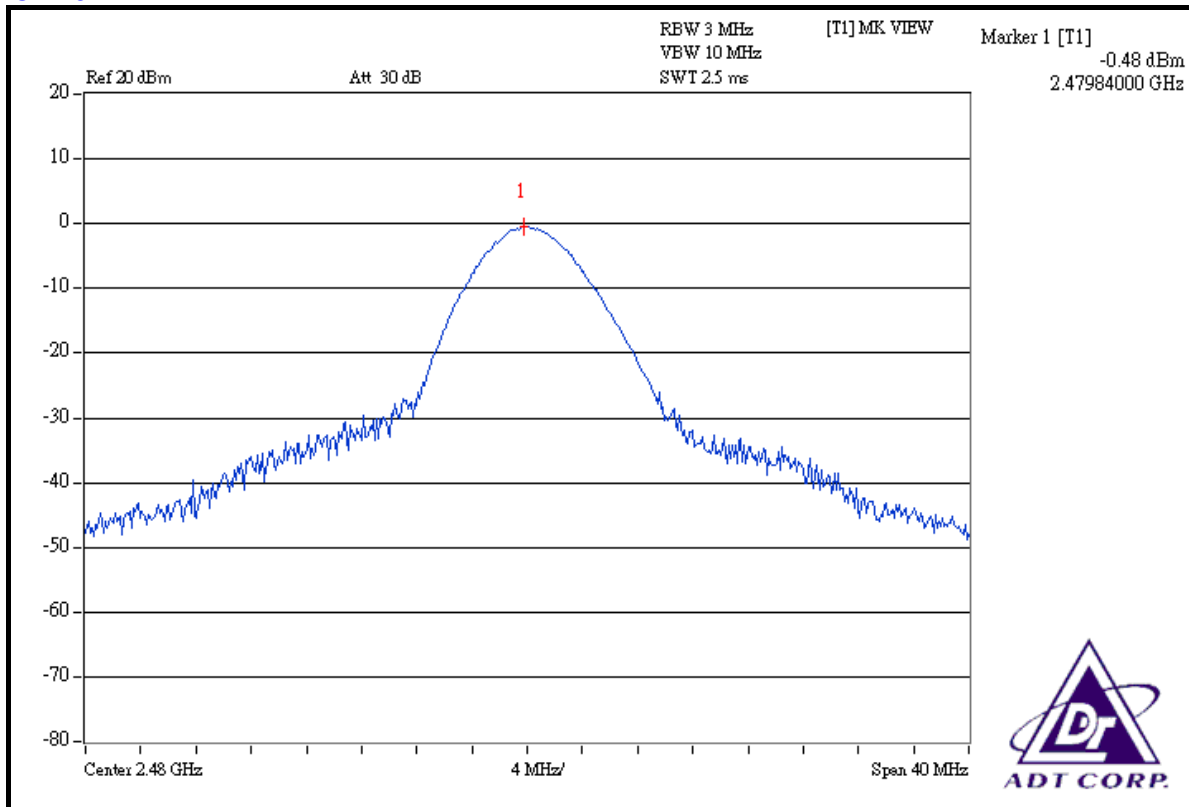



4.8 BAND EDGES MEASUREMENT

4.8.1 LIMITS OF BAND EDGES MEASUREMENT

Below -20dB of the highest emission level of operating band (in 100kHz RBW).

4.8.2 TEST INSTRUMENTS

DESCRIPTION & MANUFACTURER	MODEL NO.	SERIAL NO.	CALIBRATED UNTIL
SPECTRUM ANALYZER	FSP40	100040	Jun. 28, 2008

NOTES: The calibration interval of the above test instruments is 12 months. And the calibrations are traceable to NML/ROC and NIST/USA.

4.8.3 TEST PROCEDURE

The transmitter output was connected to the spectrum analyzer via a low lose cable. Set both RBW and VBW of spectrum analyzer to 100 kHz with suitable frequency span including 100 MHz bandwidth from band edge. The band edges was measured and recorded.

4.8.4 DEVIATION FROM TEST STANDARD

No deviation.

4.8.5 EUT OPERATING CONDITION

The software provided by client enabled the EUT to transmit and receive data at lowest, and highest channel frequencies individually.

4.8.6 TEST RESULTS

The spectrum plots are attached on the following 4 images. D1 line indicates the highest level, D2 line indicates the 20dB offset below D1. It shows compliance with the requirement in part 15.247(d).

FOR GFSK

NOTE 1:

The band edge emission plot on the next page shows 49.69dBc between carrier maximum power and local maximum emission in restrict band (2.3658GHz). The emission of carrier strength list in the test result of channel 0 at the item 4.2.7 is 94.90dBuV/m (Peak), so the maximum field strength in restrict band is $94.90 - 49.69 = 45.21$ dBuV/m, which is under 74dBuV/m limit.

Average value = $45.21 - 30.10 = 15.11$ dBuV/m, which is under 54dBuV/m limit.

*The DH5 packet was the worse case duty cycle for a transmit dwell time on a channel, based upon bluetooth theory the transmitter is on $0.625 * 5$ per 296.25 ms per channel. Therefore, the duty cycle be equal to: $20\log(3.125/100) = -30.10$ dB.

Average value = peak reading -30.10 .

NOTE 2:

The band edge emission plot on the next second page shows 51.24dBc between carrier maximum power and local maximum emission in restrict band (2.4938GHz). The emission of carrier strength list in the test result of channel 78 at the item 4.2.7 is 95.12dBuV/m (Peak), so the maximum field strength in restrict band is $95.12 - 51.24 = 43.88$ dBuV/m, which is under 74dBuV/m limit.

Average value = $43.88 - 30.10 = 13.78$ dBuV/m, which is under 54dBuV/m limit.

*The DH5 packet was the worse case duty cycle for a transmit dwell time on a channel, based upon bluetooth theory the transmitter is on $0.625 * 5$ per 296.25 ms per channel. Therefore, the duty cycle be equal to: $20\log(3.125/100) = -30.10$ dB.

Average value = peak reading -30.10 .

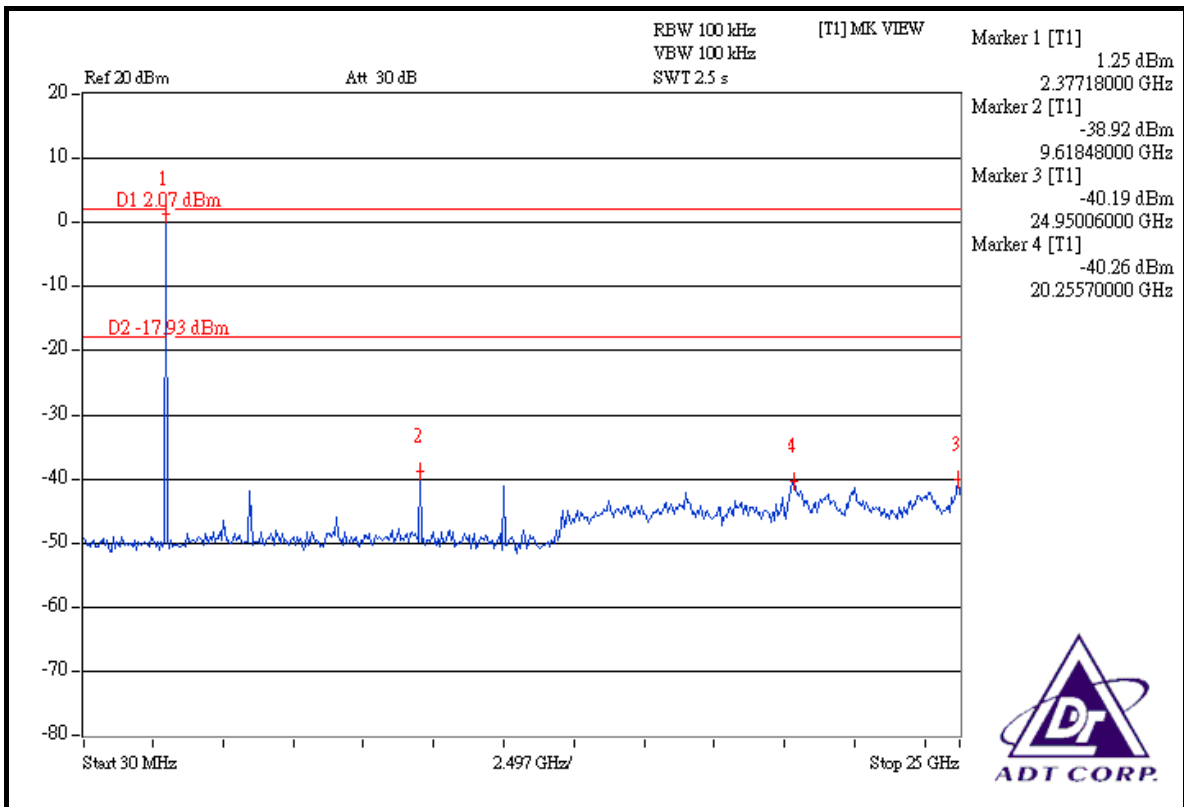
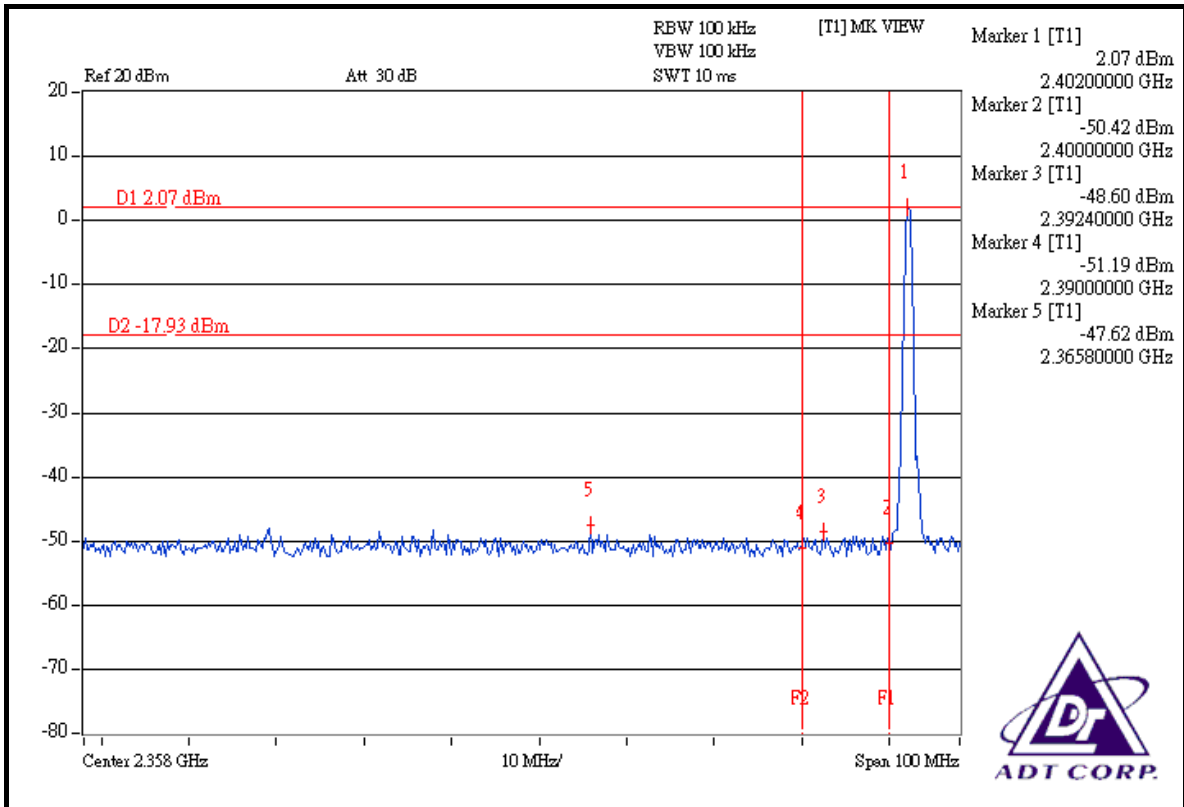

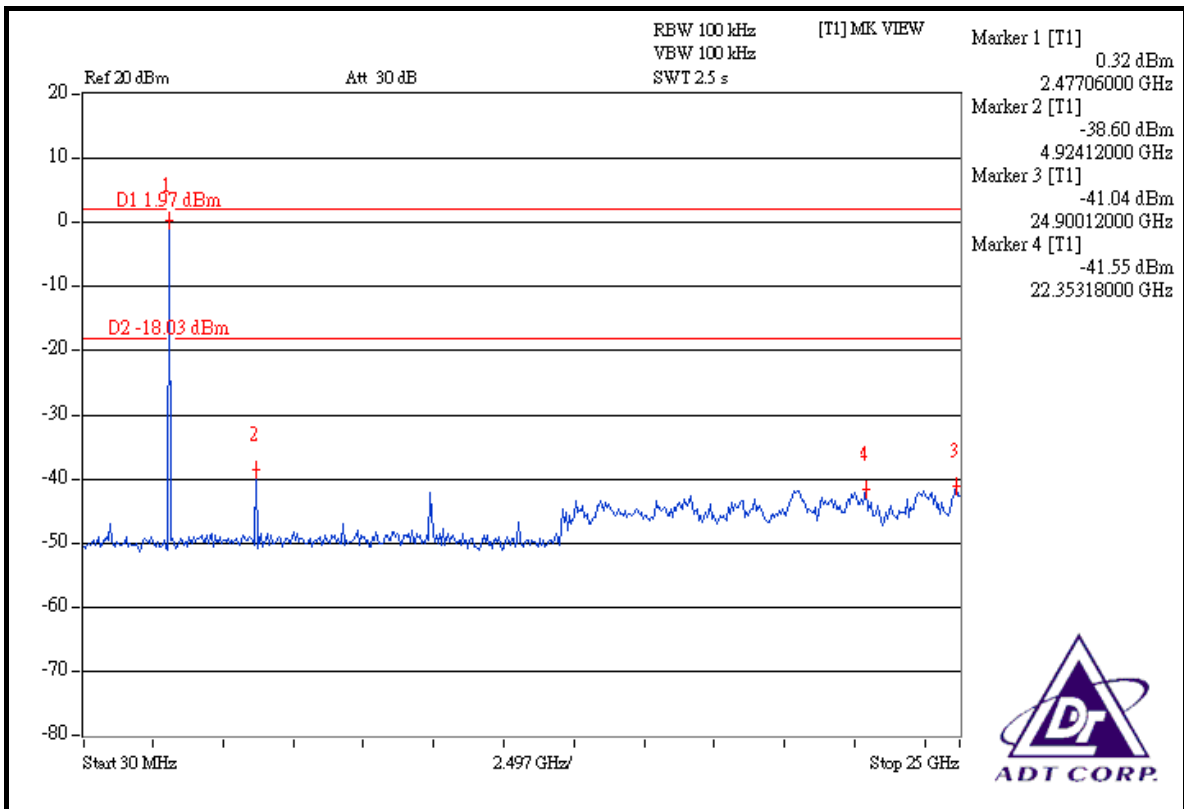
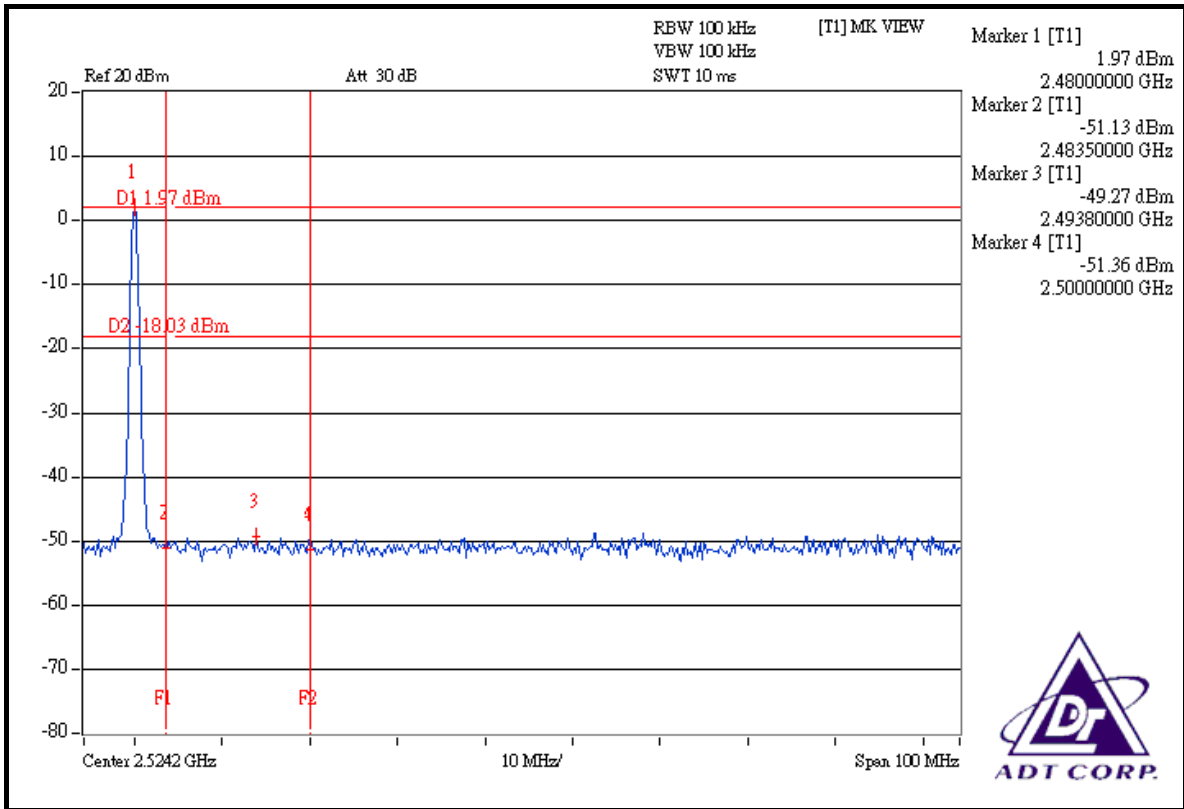



FOR 8DPSK MODULATION

NOTE 1:

The band edge emission plot on the next page shows 42.59dBc between carrier maximum power and local maximum emission in restrict band (2.3170GHz). The emission of carrier strength list in the test result of channel 0 at the item 4.2.7 is 91.34dBuV/m (Peak), so the maximum field strength in restrict band is $91.34 - 42.59 = 48.75$ dBuV/m, which is under 74 dBuV/m limit.

Average value = $48.75 - 30.10 = 18.65$ dBuV/m, which is under 54dBuV/m limit.

*The DH5 packet was the worse case duty cycle for a transmit dwell time on a channel, based upon bluetooth theory the transmitter is on $0.625 * 5$ per 296.25 ms per channel. Therefore, the duty cycle be equal to: $20\log(3.125/100) = -30.10$ dB.

Average value = peak reading -30.10 .

NOTE 2:

The band edge emission plot on the next second page shows 43.98dBc between carrier maximum power and local maximum emission in restrict band (2.4864GHz). The emission of carrier strength list in the test result of channel 78 at the item 4.2.7 is 91.46dBuV/m (Peak), so the maximum field strength in restrict band is $91.46 - 43.98 = 47.48$ dBuV/m, which is under 74 dBuV/m limit.

Average value = $47.48 - 30.10 = 17.38$ dBuV/m, which is under 54dBuV/m limit.

*The DH5 packet was the worse case duty cycle for a transmit dwell time on a channel, based upon bluetooth theory the transmitter is on $0.625 * 5$ per 296.25 ms per channel. Therefore, the duty cycle be equal to: $20\log(3.125/100) = -30.10$ dB.

Average value = peak reading -30.10 .

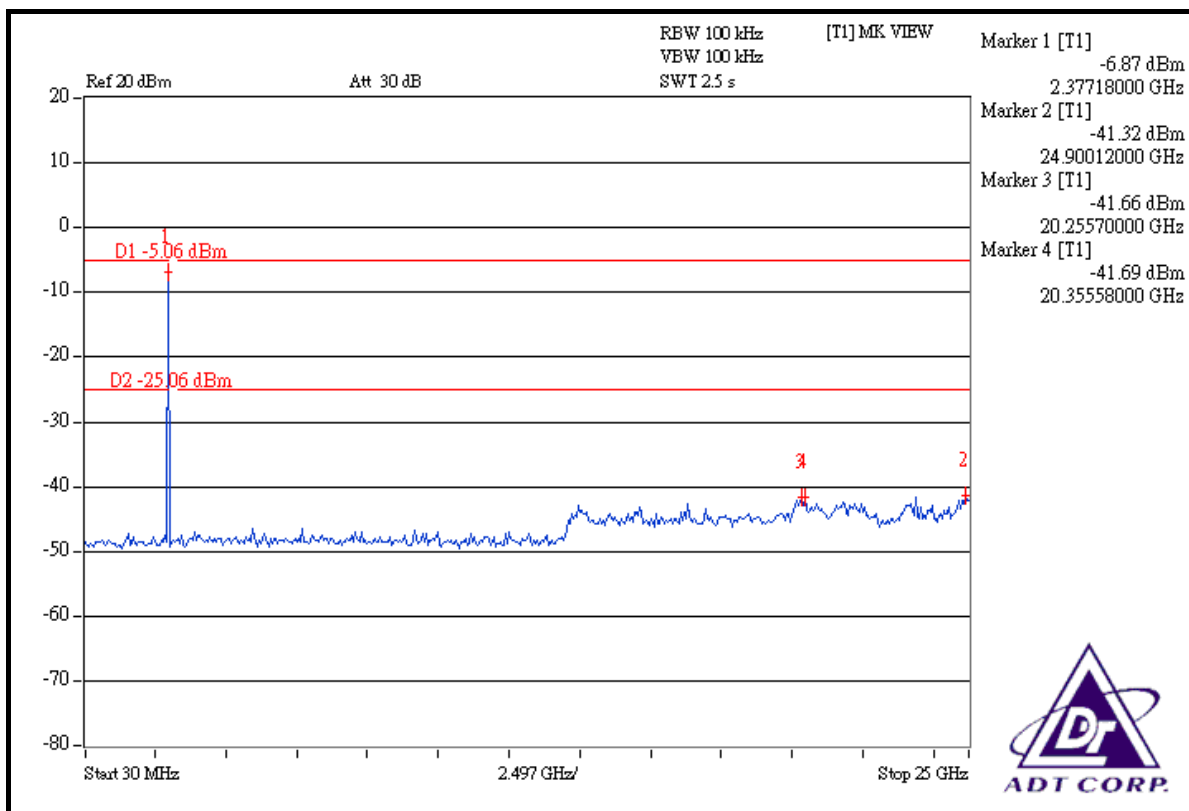
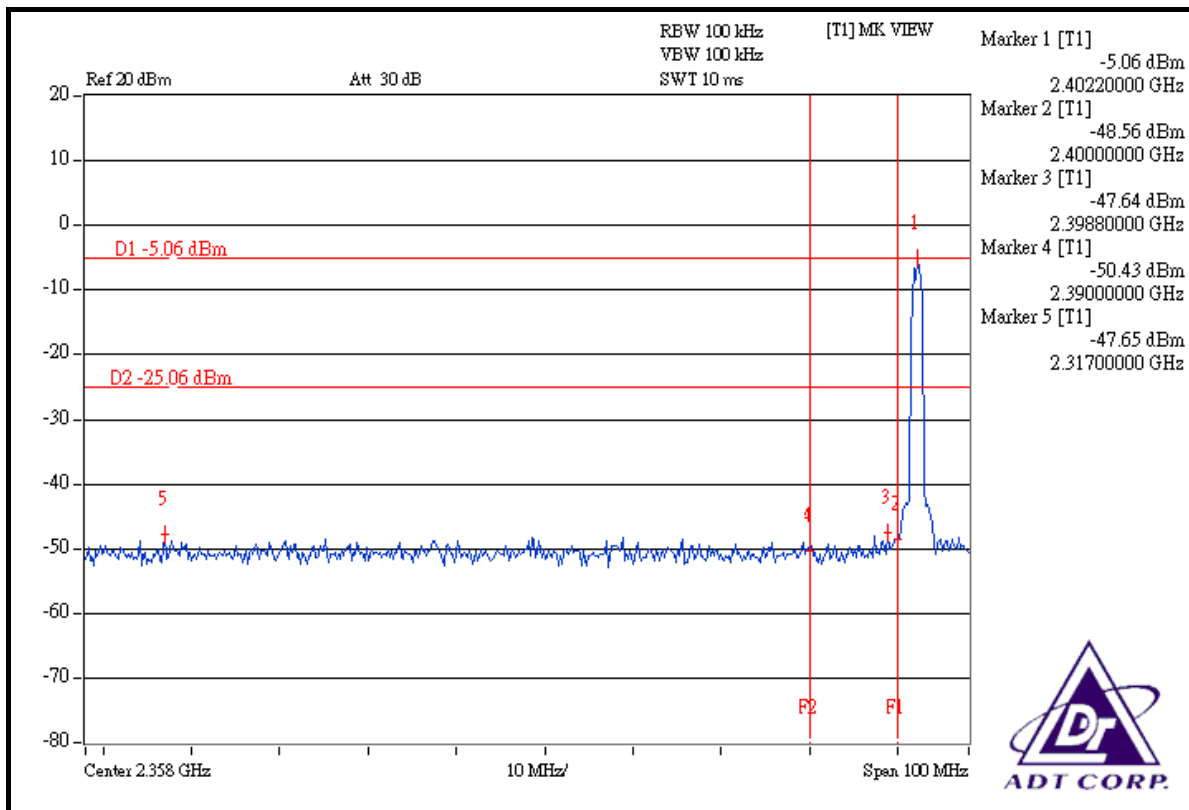

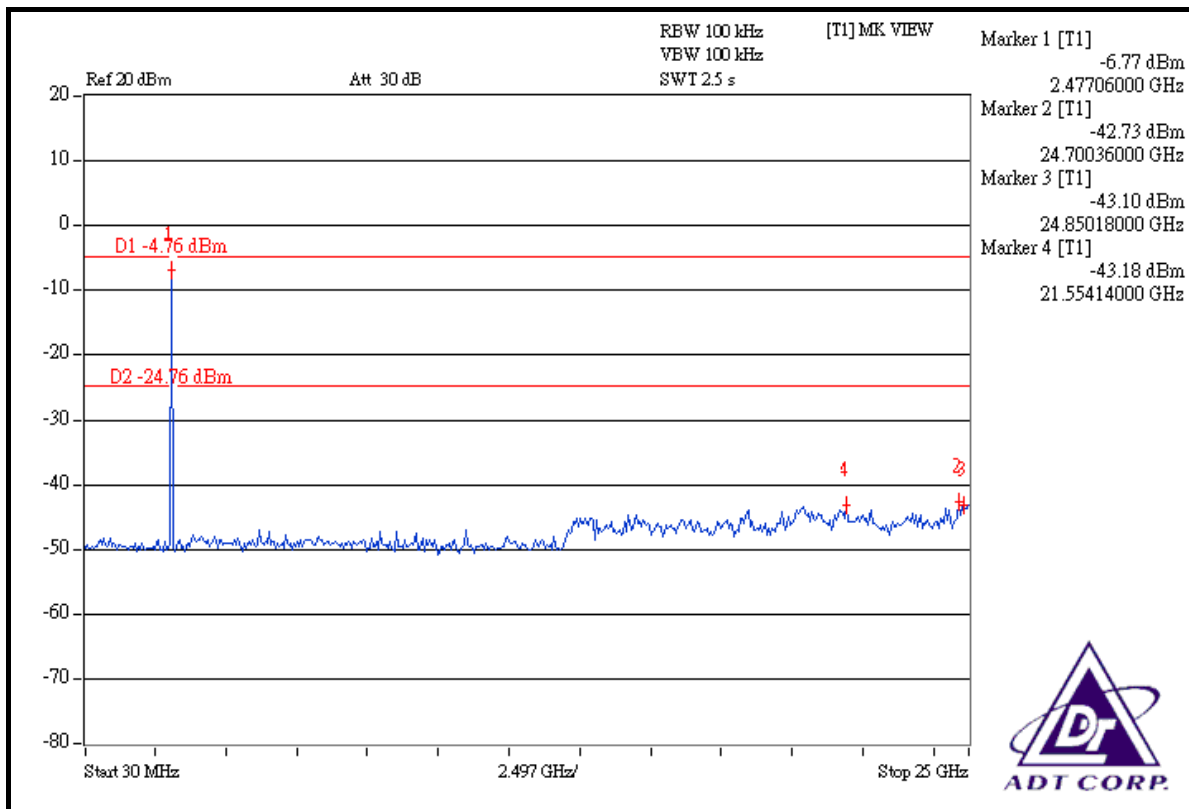
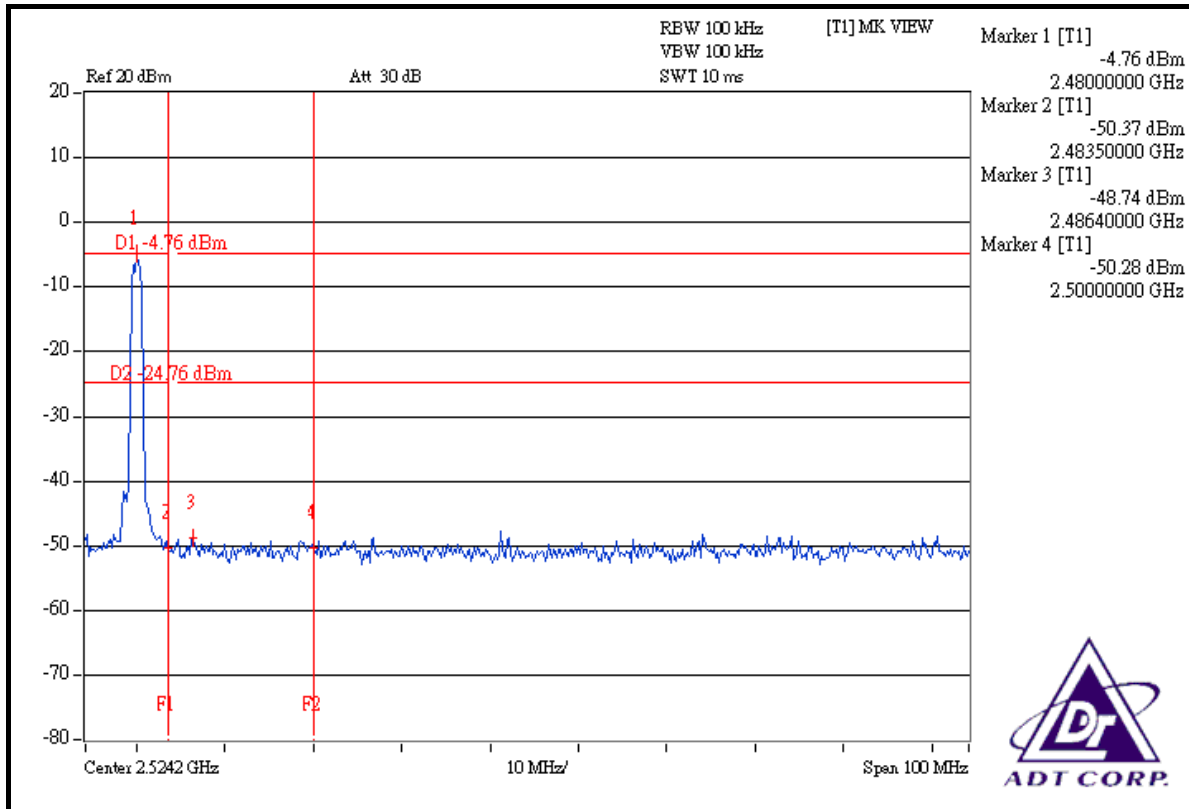



4.9 ANTENNA REQUIREMENT

4.9.1 STANDARD APPLICABLE

For intentional device, according to FCC 47 CFR Section 15.203, an intentional radiator shall be designed to ensure that no antenna other than that furnished by the responsible party shall be used with the device.

And according to FCC 47 CFR Section 15.247 (b), if transmitting antennas of directional gain greater than 6dBi are used, the power shall be reduced by the amount in dB that the directional gain of the antenna exceeds 6dBi.

4.9.2 ANTENNA CONNECTED CONSTRUCTION

The antenna used in this product is PIFA antenna without antenna connector. The maximum gain of this antenna is 0dBi.



5. PHOTOGRAPHS OF THE TEST CONFIGURATION

Please refer to the attached file (Test Setup Photo).



6. INFORMATION ON THE TESTING LABORATORIES

We, ADT Corp., were founded in 1988 to provide our best service in EMC, Radio, Telecom and Safety consultation. Our laboratories are accredited and approved by the following approval agencies according to ISO/IEC 17025.

USA	FCC, UL, A2LA
GERMANY	TUV Rheinland
JAPAN	VCCI
NORWAY	NEMKO
CANADA	INDUSTRY CANADA , CSA
R.O.C.	TAF, BSMI, NCC
NETHERLANDS	Telefication
SINGAPORE	PSB , GOST-ASIA (MOU)
RUSSIA	CERTIS (MOU)

Copies of accreditation certificates of our laboratories obtained from approval agencies can be downloaded from our web site: www.adt.com.tw/index.5/phtml.
If you have any comments, please feel free to contact us at the following:

Linko EMC/RF Lab:
Tel: 886-2-26052180
Fax: 886-2-26051924

Hsin Chu EMC/RF Lab:
Tel: 886-3-5935343
Fax: 886-3-5935342

Hwa Ya EMC/RF/Safety Telecom Lab:
Tel: 886-3-3183232
Fax: 886-3-3185050

Web Site: www.adt.com.tw

The address and road map of all our labs can be found in our web site also.



7. APPENDIX A – MODIFICATIONS RECORDERS FOR ENGINEERING CHANGES TO THE EUT BY THE LAB

No any modifications are made to the EUT by the lab during the test.