

EMC TEST Report

Issued Date : Oct. 22, 2007

Project No. : 0710C061

Equipment : Dual Band GSM Mobile Phone

Model Name : Bird S700

Applicant : NINGBO BIRD CO.,LTD

Address : No.999 Dacheng East Road,Fenghua
City, Zhejiang

Tested by:

Neutron Engineering Inc. EMC Laboratory

Date of Test:

Oct. 09, 2007 ~ Oct. 12, 2007

Testing Engineer :

(Jeff Yang)

Technical Manager :

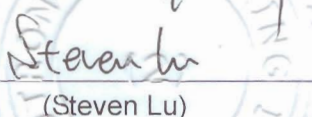
(Steven Lu)

Authorized Signatory :

(Andy Chiu)

NEUTRON ENGINEERING INC.

No. 132-1, Lane 329, Sec. 2, Palain Rd.,
Shijr City, Taipei, Taiwan
TEL : (02) 2646-5426 FAX : (02) 2646-6815



Declaration

Neutron represents to the client that testing is done in accordance with standard procedures as applicable and that test instruments used has been calibrated with the standards traceable to National Measurement Laboratory (**NML**) of **R.O.C.**, or National Institute of Standards and Technology (**NIST**) of **U.S.A.**

Neutron's reports apply only to the specific samples tested under conditions. It is manufacture's responsibility to ensure that additional production units of this model are manufactured with the identical electrical and mechanical components. **Neutron** shall have no liability for any declarations, inferences or generalizations drawn by the client or others from **Neutron** issued reports.

Neutron's reports must not be used by the client to claim product endorsement by the authorities or any agency of the Government.

This report is the confidential property of the client. As a mutual protection to the clients, the public and **Neutron-self**, extracts from the test report shall not be reproduced except in full with **Neutron's** authorized written approval.

Neutron's laboratory quality assurance procedures are in compliance with the **ISO Guide 17025** requirements, and accredited by the conformity assessment authorities listed in this test report.

Limitation

For the use of the authority's logo is limited unless the Test Standard(s)/Scope(s)/Item(s) mentioned in this test report is (are) included in the conformity assessment authorities acceptance respective.

Table of Contents	Page
1 . CERTIFICATION	4
2 . SUMMARY OF TEST RESULTS	5
2.1 TEST FACILITY	6
2.2 MEASUREMENT UNCERTAINTY	6
3 . GENERAL INFORMATION	7
3.1 GENERAL DESCRIPTION OF EUT	7
3.2 DESCRIPTION OF TEST MODES	8
3.3 BLOCK DIAGRAM SHOWING THE CONFIGURATION OF SYSTEM TESTED	9
3.4 DESCRIPTION OF SUPPORT UNITS	11
4 . EMC EMISSION TEST	12
4.1 CONDUCTED EMISSION MEASUREMENT	12
4.1.1 POWER LINE CONDUCTED EMISSION	12
4.1.2 MEASUREMENT INSTRUMENTS LIST	12
4.1.3 TEST PROCEDURE	13
4.1.4 DEVIATION FROM TEST STANDARD	13
4.1.5 TEST SETUP	13
4.1.6 EUT OPERATING CONDITIONS	14
4.1.7 TEST RESULTS	15
4.2 RADIATED EMISSION MEASUREMENT	19
4.2.1 LIMITS OF RADIATED EMISSION MEASUREMENT	19
4.2.2 MEASUREMENT INSTRUMENTS LIST	20
4.2.3 TEST PROCEDURE	20
4.2.4 DEVIATION FROM TEST STANDARD	20
4.2.5 TEST SETUP	21
4.2.6 EUT OPERATING CONDITIONS	21
4.2.7 TEST RESULTS	22
5 . EUT TEST PHOTO	28
Conducted Measurement Photos	28

1. CERTIFICATION

Equipment : Dual Band GSM Mobile Phone
Trade Name : BiRD
Model Name : Bird S700
Applicant : NINGBO BIRD CO.,LTD
Date of Test : Oct. 09, 2007 ~ Oct. 12, 2007
Test Item : ENGINEERING SAMPLE
Standards : FCC Part 15, Subpart B, Class B
 CISPR 22: 1997+A1: 2000, Class B
 ICES-003: 2004, Class B
 ANSI C63.4-2003

The above equipment has been tested and found compliance with the requirement of the relative standards by Neutron Engineering Inc. EMC Laboratory.

The test data, data evaluation, and equipment configuration contained in our test report (Ref No. NEI-FCCE-1-0710C061) were obtained utilizing the test procedures, test instruments, test sites that has been accredited by the Authority of NVLAP and TAF according to the ISO-17025 quality assessment standard and technical standard(s).

2. SUMMARY OF TEST RESULTS

Test procedures according to the technical standards:

EMC Emission				
Standard	Test Item	Limit	Judgment	Remark
FCC Part15, Subpart B CISPR 22:1997+A1: 2000 ICES-003: 2004	Conducted Emission	Class B	PASS	
	Radiated Emission	Class B	PASS	

NOTE:

(1) "N/A" denotes test is not applicable in this Test Report

2.1 TEST FACILITY

The test facilities used to collect the test data in this report is **C01/OS02** at the location of No.132-1, Lane 329, Sec. 2, Palain Road, Shijr City, Taipei, Taiwan.

2.2 MEASUREMENT UNCERTAINTY

The reported uncertainty of measurement $y \pm U$, where expended uncertainty **U** is based on a standard uncertainty multiplied by a coverage factor of **k=2**, providing a level of confidence of approximately **95 %**.

A. Conducted Measurement :

Test Site	Method	Measurement Frequency Range	U , (dB)	NOTE
C01	ANSI	150 KHz ~ 30MHz	1.94	

B. Radiated Measurement :

Test Site	Method	Measurement Frequency Range	Ant. H / V	U , (dB)	NOTE
OS-01	ANSI	30MHz ~ 200MHz	V	3.82	
		30MHz ~ 200MHz	H	3.60	
		200MHz ~ 1,000MHz	V	3.86	
		200MHz ~ 1,000MHz	H	3.94	
OS-02	ANSI	30MHz ~ 200MHz	V	2.48	
		30MHz ~ 200MHz	H	2.16	
		200MHz ~ 1,000MHz	V	2.50	
		200MHz ~ 1,000MHz	H	2.66	

3. GENERAL INFORMATION

3.1 GENERAL DESCRIPTION OF EUT

Equipment	Dual Band GSM Mobile Phone
Trade Name	BiRD
Model Name	Bird S700
OEM Brand/Model Name	N/A
Model Difference	N/A
Product Description	The EUT is a Dual Band GSM Mobile Phone. Based on the application, features, or specification exhibited in User's Manual, the EUT is considered as an ITE/Computing Device. More details of EUT technical specification, please refer to the User's Manual.
Power Source	DC Supplied from AC/DC Adapter/Li-ion Battery Brand: BiRD Model:TCK4535/BD-L4B
Power Rating	Adapter I/P:100~240V 50/60Hz 100mA O/P:4.5V/350mA Li-ion Battery: 3.7V 650mAh
Connecting I/O Port(s)	Please refer to the User's Manual
Products Covered	N/A

Note:

1. For a more detailed features description, please refer to the manufacturer's specifications or the User's Manual.

3.2 DESCRIPTION OF TEST MODES

To investigate the maximum EMI emission characteristics generated from EUT, the test system was pre-scanning tested base on the consideration of following EUT operation mode or test configuration mode which possible have effect on EMI emission level. Each of these EUT operation mode(s) or test configuration mode(s) mentioned above was evaluated respectively.

Pretest Mode	Description
MODE1	ADAPTER MODE
MODE2	USB MODE
MODE3	BATTERY ONLY WITH EARPHONE

For Conducted Test	
Final Test Mode	Description
MODE1	ADAPTER MODE
MODE2	USB MODE

For Radiated Test	
Final Test Mode	Description
MODE1	ADAPTER MODE
MODE2	USB MODE
MODE3	BATTERY ONLY WITH EARPHONE

3.3 BLOCK DIAGRAM SHOWING THE CONFIGURATION OF SYSTEM TESTED

MODE 1: ADAPTER MODE

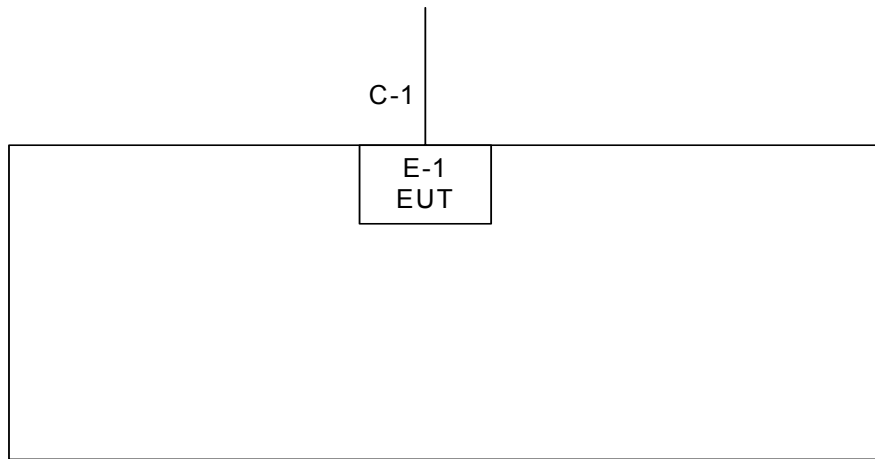

C-1: POWER LINE

MODE 2: USB MODE

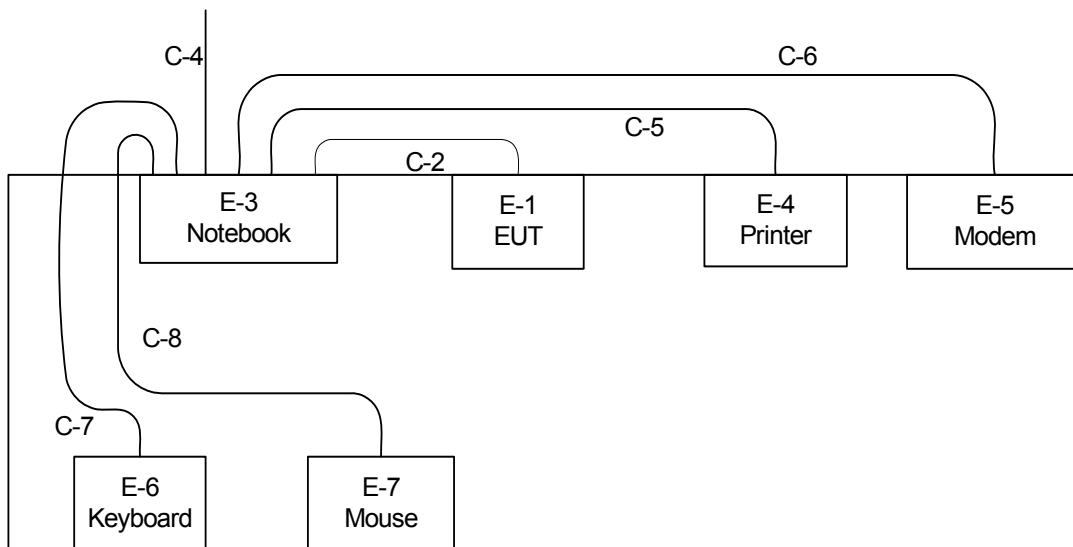

- C-2 USB LINE
- C-4 POWER LINE
- C-5 LPT LINE
- C-6 RS-232 LINE
- C-7 USB LINE
- C-8 USB LINE

MODE 3: BATTERY ONLY WITH EARPHONE

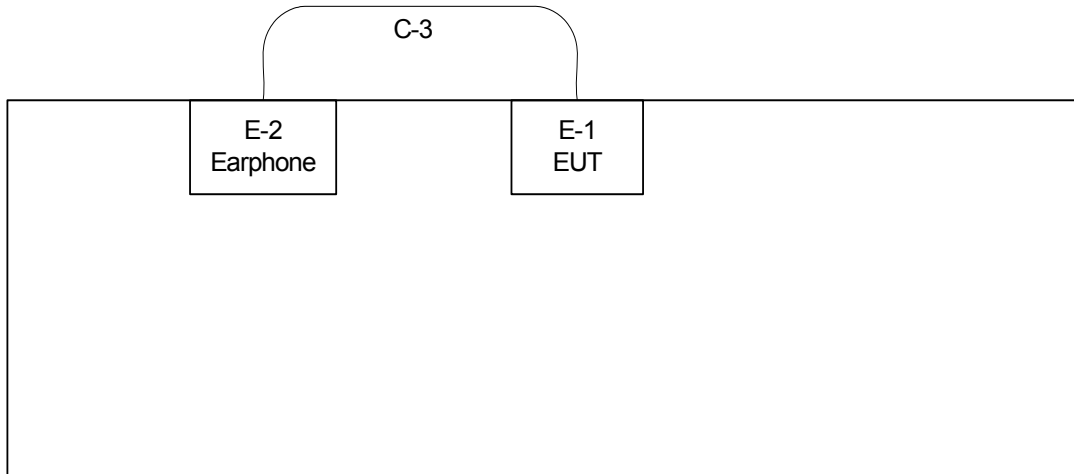

C-3: AUDIO LINE

3.1 DESCRIPTION OF SUPPORT UNITS

The EUT has been tested as an independent unit together with other necessary accessories or support units. The following support units or accessories were used to form a representative test configuration during the tests.

Item	Equipment	Mfr/Brand	Model/Type No.	FCC ID	Series No.	Note
E-1	Dual Band GSM Mobile Phone	BiRD	Bird S700	DOC	N/A	EUT
E-2	Earphone	N/A	N/A	N/A	N/A	
E-3	Notebook PC	DELL	D600	DOC	7T390 A03	
E-4	Printer	SII	DPU-414	DOC	1045105A	
E-5	Modem	ACEEX	DM-1414V	DOC	8041708	
E-6	USB K/B	DELL	SK-8115	DOC	MY-0DJ325-71619-77N-1526	
E-7	USB Mouse	IBM	MO28UO	DOC	23-271883	

Item	Shielded Type	Ferrite Core	Length	Note
C-1	NO	NO	1.8M	
C-2	YES	NO	1.2M	
C-3	NO	NO	1.3M	
C-4	NO	YES	1.8M	
C-5	YES	NO	1.8M	
C-6	YES	NO	1.8M	
C-7	YES	NO	1.8M	
C-8	YES	NO	1.8M	

Note:

- (1) The support equipment was authorized by Declaration of Conformity.
- (2) For detachable type I/O cable should be specified the length in cm in 『Length』 column.

4. EMC EMISSION TEST

4.1 CONDUCTED EMISSION MEASUREMENT

4.1.1 POWER LINE CONDUCTED EMISSION (Frequency Range 150KHz-30MHz)

FREQUENCY (MHz)	Class A (dBUV)		Class B (dBUV)	
	Quasi-peak	Average	Quasi-peak	Average
0.15 -0.5	79.00	66.00	66 - 56 *	56 - 46 *
0.50 -5.0	73.00	60.00	56.00	46.00
5.0 -30.0	73.00	60.00	60.00	50.00

Note:

- (1) The tighter limit applies at the band edges.
- (2) The limit of " * " marked band means the limitation decreases linearly with the logarithm of the frequency in the range.

4.1.2 MEASUREMENT INSTRUMENTS LIST

Item	Kind of Equipment	Manufacturer	Type No.	Serial No.	Calibrated until
1	LISN	EMCO	3816/2	00042991	Jan. 25, 2008
2	LISN	EMCO	3816/2	00042990	Jan. 25, 2008
3	Pulse Limiter	Electro-Metrics	EM-7600	112644	Nov. 28, 2007
4	50Ω Terminator	N/A	N/A	N/A	May.13, 2009
5	Test Cable	N/A	C01	N/A	Nov. 28, 2007
6	EMI Test Receiver	R&S	ESCI	100082	Mar. 08, 2008

Remark: " N/A" denotes No Model No. , Serial No. or No Calibration specified.

The following table is the setting of the receiver

Receiver Parameters	Setting
Attenuation	10 dB
Start Frequency	0.15 MHz
Stop Frequency	30 MHz
IF Bandwidth	9 kHz

4.1.3 TEST PROCEDURE

- a. The EUT was placed 0.4 meters from the horizontal ground plane with EUT being connected to the power mains through a line impedance stabilization network (LISN). All other support equipments powered from additional LISN(s). The LISN provide 50 Ohm/ 50uH of coupling impedance for the measuring instrument.
- b. Interconnecting cables that hang closer than 40 cm to the ground plane shall be folded back and forth in the center forming a bundle 30 to 40 cm long.
- c. I/O cables that are not connected to a peripheral shall be bundled in the center. The end of the cable may be terminated, if required, using the correct terminating impedance. The overall length shall not exceed 1 m.
- d. LISN at least 80 cm from nearest part of EUT chassis.
- e. For the actual test configuration, please refer to the related Item –EUT Test Photos.

4.1.4 DEVIATION FROM TEST STANDARD

No deviation

4.1.5 TEST SETUP

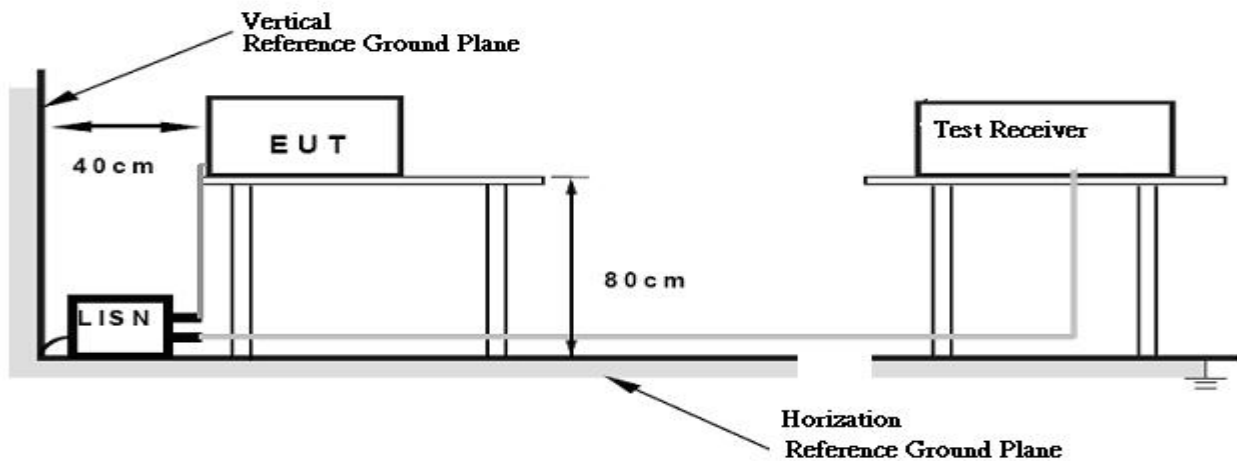

4.1.6 EUT OPERATING CONDITIONS

The EUT exercise program (EMC.exe) used during radiated and/or conducted emission measurement was designed to exercise the various system components in a manner similar to a typical use. The program contained on a PC hard disk and is auto-starting on power-up. Once loaded, the program sequentially exercises each system component in turn. The sequence used is:

1. Read (write) from (to) mass storage device (Disk).
2. Send "H" pattern to video port device (Monitor).
3. Send " H " pattern to parallel port device (Printer).
4. Send " H " pattern to serial port device (Modem).
5. Repeated from 2 to 4 continuously.

As the keyboard and mouse are strictly input devices, no data is transmitted to (from) them during test. They are, however, continuously scanned for data input activity.

4.1.7 TEST RESULTS

EUT :	Dual Band GSM Mobile Phone	Model Name :	Bird S700
Temperature :	25 °C	Relative Humidity :	60 %
Pressure :	1010 hPa	Test Power :	AC 120V/60Hz
Test Mode :	ADAPTER MODE		

Freq. (MHz)	Terminal L/N	Measured(dBuV)		Limits(dBuV)		Margin (dB)	Note
		QP-Mode	AV-Mode	QP-Mode	AV-Mode		
0.43	Line	48.04	40.06	57.35	47.35	-7.29	(AV)
0.47	Line	51.44	44.47	56.51	46.51	-2.04	(AV)
0.52	Line	54.04	43.48	56.00	46.00	-1.96	(QP)
0.73	Line	48.88	37.59	56.00	46.00	-7.12	(QP)
1.05	Line	48.29	36.38	56.00	46.00	-7.71	(QP)
1.42	Line	48.35	38.12	56.00	46.00	-7.65	(QP)
1.95	Line	49.62	39.16	56.00	46.00	-6.38	(QP)
2.83	Line	54.60	42.20	56.00	46.00	-1.40	(QP)

Remark

- (1) All readings are QP Mode value unless otherwise stated AVG in column of Note. If the QP Mode Measured value compliance with the QP Limits and lower than AVG Limits, the EUT shall be deemed to meet both QP & AVG Limits and then only QP Mode was measured, but AVG Mode didn't perform. In this case, a " * " marked in AVG Mode column of Interference Voltage Measured.
- (2) Measuring frequency range from 150KHz to 30MHz.

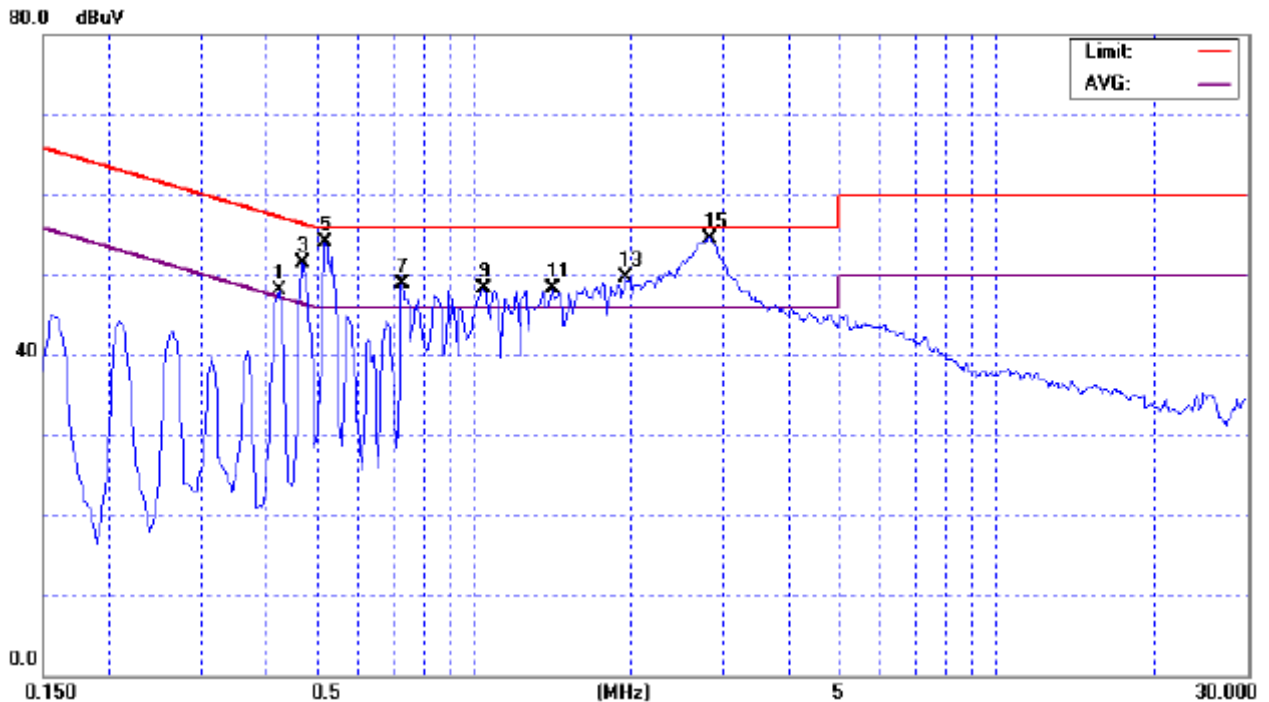

EUT :	Dual Band GSM Mobile Phone	Model Name :	Bird S700
Temperature :	25 °C	Relative Humidity :	60 %
Pressure :	1010 hPa	Test Power :	AC 120V/60Hz
Test Mode :	ADAPTER MODE		

Freq. (MHz)	Terminal L/N	Measured(dBuV)		Limits(dBuV)		Margin (dB)	Note
		QP-Mode	AV-Mode	QP-Mode	AV-Mode		
0.47	Neutral	49.24	42.55	56.51	46.51	-3.96	(AV)
0.53	Neutral	51.26	42.56	56.00	46.00	-3.44	(AV)
0.89	Neutral	46.66	37.97	56.00	46.00	-8.03	(AV)
1.26	Neutral	46.97	37.49	56.00	46.00	-8.51	(AV)
1.63	Neutral	47.34	42.11	56.00	46.00	-3.89	(AV)
2.20	Neutral	48.45	30.17	56.00	46.00	-7.55	(QP)
2.73	Neutral	53.69	40.39	56.00	46.00	-2.31	(QP)

Remark

- (1) All readings are QP Mode value unless otherwise stated AVG in column of Note. If the QP Mode Measured value compliance with the QP Limits and lower than AVG Limits, the EUT shall be deemed to meet both QP & AVG Limits and then only QP Mode was measured, but AVG Mode didn't perform. In this case, a " * " marked in AVG Mode column of Interference Voltage Measured.
- (2) Measuring frequency range from 150KHz to 30MHz.

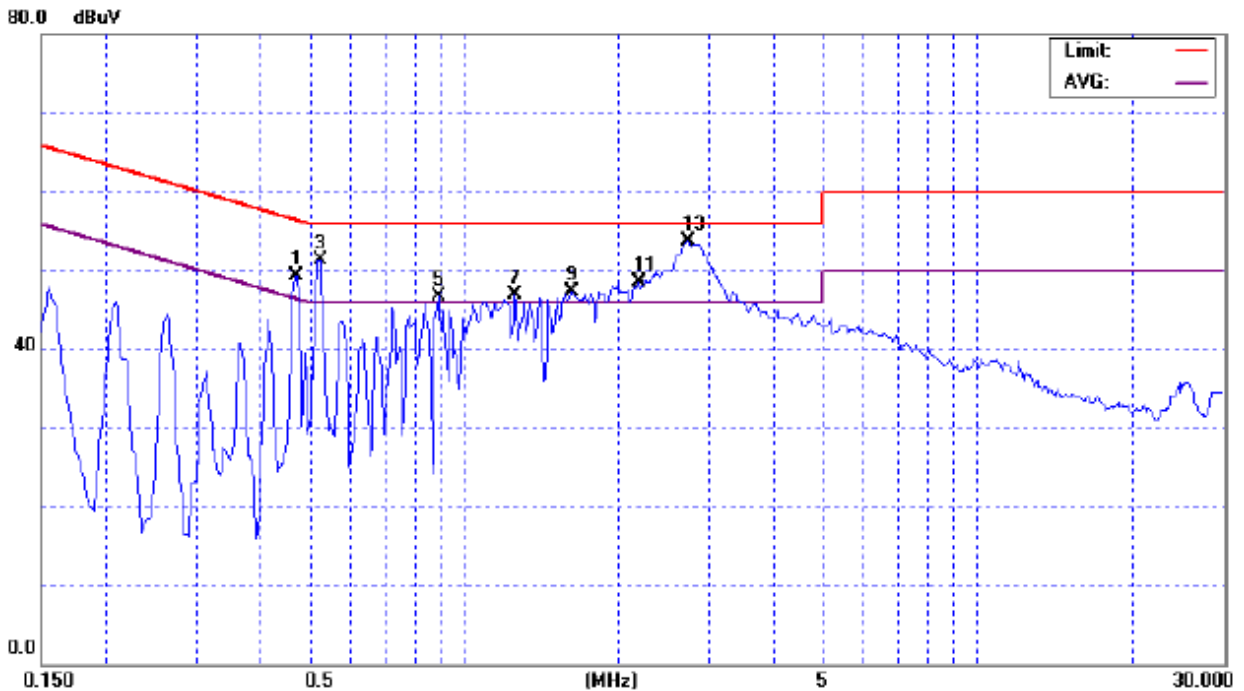

EUT :	Dual Band GSM Mobile Phone	Model Name :	Bird S700
Temperature :	25 °C	Relative Humidity :	60 %
Pressure :	1010 hPa	Test Power :	AC 120V/60Hz
Test Mode :	USB MODE		

Freq. (MHz)	Terminal L/N	Measured(dBuV)		Limits(dBuV)		Margin (dB)	Note
		QP-Mode	AV-Mode	QP-Mode	AV-Mode		
0.24	Line	41.18	*	62.10	52.10	-20.92	(QP)
0.36	Line	35.50	*	58.84	48.84	-23.34	(QP)
0.69	Line	35.96	*	56.00	46.00	-20.04	(QP)
6.15	Line	32.50	*	60.00	50.00	-27.50	(QP)
12.28	Line	45.75	*	60.00	50.00	-14.25	(QP)
19.13	Line	45.55	*	60.00	50.00	-14.45	(QP)

Remark

- (1) All readings are QP Mode value unless otherwise stated AVG in column of Note. If the QP Mode Measured value compliance with the QP Limits and lower than AVG Limits, the EUT shall be deemed to meet both QP & AVG Limits and then only QP Mode was measured, but AVG Mode didn't perform. In this case, a "*" marked in AVG Mode column of Interference Voltage Measured.
- (2) Measuring frequency range from 150KHz to 30MHz.

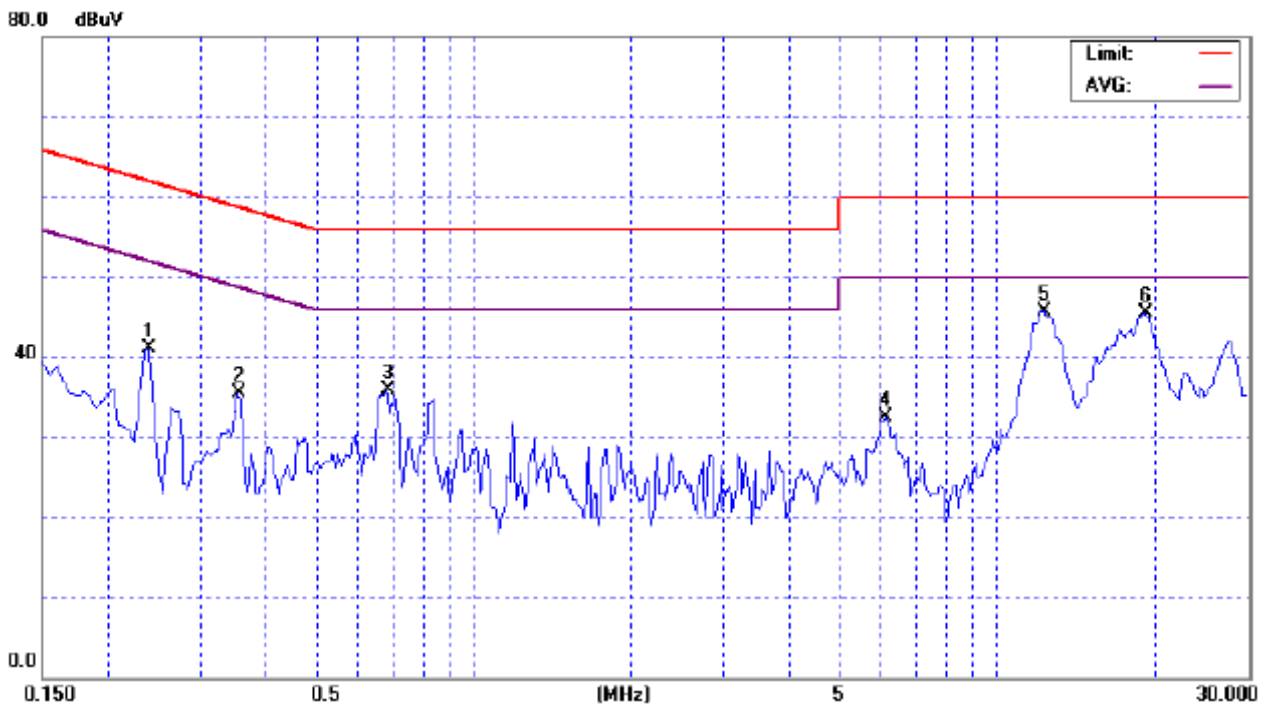

EUT :	Dual Band GSM Mobile Phone	Model Name :	Bird S700
Temperature :	25 °C	Relative Humidity :	60 %
Pressure :	1010 hPa	Test Power :	AC 120V/60Hz
Test Mode :	USB MODE		

Freq. (MHz)	Terminal L/N	Measured(dBuV)		Limits(dBuV)		Margin (dB)	Note
		QP-Mode	AV-Mode	QP-Mode	AV-Mode		
0.24	Neutral	36.52	*	62.10	52.10	-25.58	(QP)
0.67	Neutral	35.76	*	56.00	46.00	-20.24	(QP)
1.80	Neutral	32.39	*	56.00	46.00	-23.61	(QP)
6.11	Neutral	34.88	*	60.00	50.00	-25.12	(QP)
12.23	Neutral	44.34	*	60.00	50.00	-15.66	(QP)
18.72	Neutral	50.97	34.83	60.00	50.00	-9.03	(QP)

Remark

- (1) All readings are QP Mode value unless otherwise stated AVG in column of Note. If the QP Mode Measured value compliance with the QP Limits and lower than AVG Limits, the EUT shall be deemed to meet both QP & AVG Limits and then only QP Mode was measured, but AVG Mode didn't perform. In this case, a "*" marked in AVG Mode column of Interference Voltage Measured.
- (2) Measuring frequency range from 150KHz to 30MHz.

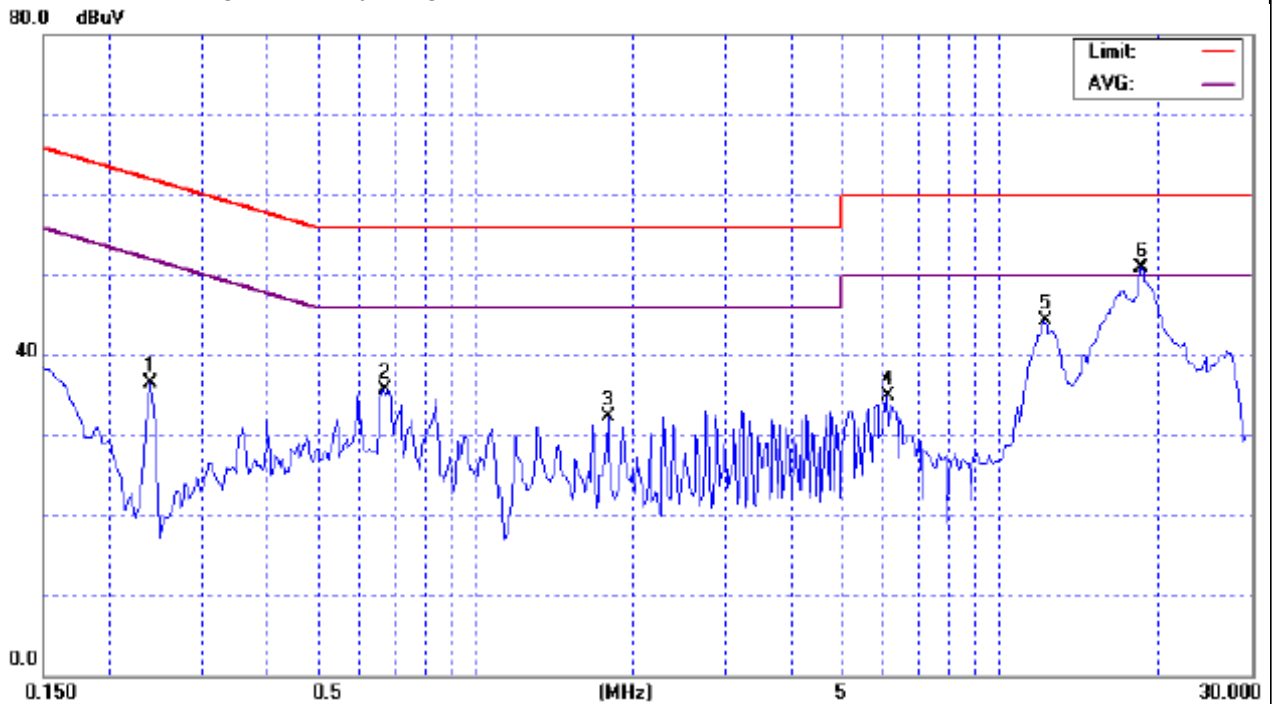

4.2 RADIATED EMISSION MEASUREMENT

4.2.1 LIMITS OF RADIATED EMISSION MEASUREMENT (Below 1000MHz)

FREQUENCY (MHz)	Class A (at 10m)	Class B (at 10m)
	dBuV/m	dBuV/m
30 – 230	40	30
230 – 1000	47	37

Notes:

- (1) The limit for radiated test was performed according to as following:
CISPR 22/ FCC PART 15B /ICES-003.
- (2) The tighter limit applies at the band edges.
- (3) Emission level (dBuV/m)=20log Emission level (uV/m).

FREQUENCY RANGE OF RADIATED MEASUREMENT (For unintentional radiators)

Highest frequency generated or Upper frequency of measurement used in the device or on which the device operates or tunes (MHz)	Range (MHz)
Below 1.705	30
1.705 – 108	1000
108 – 500	2000
500 – 1000	5000
Above 1000	5 th harmonic of the highest frequency or 40 GHz, whichever is lower

4.2.2 MEASUREMENT INSTRUMENTS LIST

Item	Kind of Equipment	Manufacturer	Type No.	Serial No.	Calibrated until
1	Test Cable	N/A	SR03_C	N/A	Aug. 20, 2008
2	Log-Bicon Antenna	Schwarzbeck	VULB 9160	3058	Mar. 20, 2008
3	Test Cable	N/A	10M_OS01	N/A	Nov. 28, 2007
4	Pre-Amplifier	Anritsu	MH648A(OS01)	M09961	Nov. 28, 2007
5	Spectrum Analyzer	HP	8591EM	3536A00681010	Feb. 18, 2008
6	Test Receiver	MEB	SMV41	130	Jun. 21, 2008
7	Horn Antenna	Schwarzbeck	BBHA9120D	9120D-325	Dec. 13, 2007
8	Antenna Mast	Chance Most	CMTB-1.5	N/A	N/A
9	Turn Table	Chance Most	CMTB-1.5	N/A	N/A
10	Loop Ant	EMCO	6502	00042960	Jan. 13, 2008

Remark: " N/A" denotes No Model No. / Serial No. and No Calibration specified.

4.2.3 TEST PROCEDURE

- The measuring distance of at 10 m shall be used for measurements at frequency up to 1GHz. For frequencies above 1GHz, any suitable measuring distance may be used.
- The EUT was placed on the top of a rotating table 0.8 meters above the ground at a 10 meter open area test site. The table was rotated 360 degrees to determine the position of the highest radiation.
- The height of the equipment or of the substitution antenna shall be 0.8 m; the height of the test antenna shall vary between 1 m to 4 m. Both horizontal and vertical polarizations of the antenna are set to make the measurement.
- The initial step in collecting radiated emission data is a spectrum analyzer peak detector mode pre-scanning the measurement frequency range. Significant peaks are then marked and then Quasi Peak detector mode re-measured.
- If the Peak Mode measured value compliance with and lower than Quasi Peak Mode Limit, the EUT shall be deemed to meet QP Limits and then no additional QP Mode measurement performed.
- For the actual test configuration, please refer to the related Item –EUT Test Photos.

4.2.4 DEVIATION FROM TEST STANDARD

No deviation

4.2.5 TEST SETUP

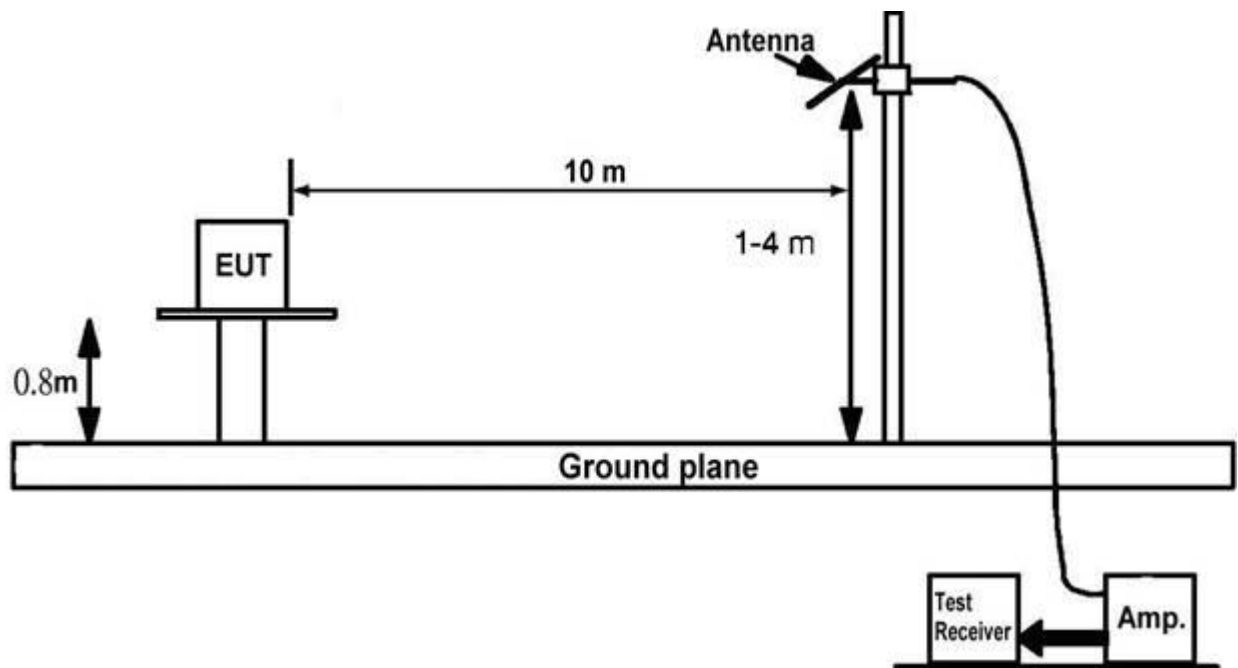

4.2.6 EUT OPERATING CONDITIONS

The EUT tested system was configured as the statements of 4.1.6 Unless otherwise a special operating condition is specified in the follows during the testing.

4.2.7 TEST RESULTS

EUT :	Dual Band GSM Mobile Phone	Model Name :	Bird S700
Temperature :	26 °C	Relative Humidity :	66%
Pressure :	1003 hPa	Test Power :	AC 120V/60Hz
Test Mode :	ADAPTER MODE		

Freq. (MHz)	Ant. H/V	Reading(RA) (dBuV)	Corr.Factor(CF) (dB)	Measured(FS) (dBuV/m)	Limits(QP) (dBuV/m)	Margin (dB)	Note
159.98	V	26.06	-5.54	20.52	30.00	- 9.48	
192.96	V	25.07	-8.25	16.82	30.00	- 13.18	
598.42	V	18.55	2.52	21.07	37.00	- 15.93	
699.30	V	16.70	4.16	20.86	37.00	- 16.14	
815.70	V	16.36	6.02	22.38	37.00	- 14.62	
862.26	V	16.62	6.71	23.33	37.00	- 13.67	

Remark :

- (1) Reading in which marked as QP or Peak means measurements by using are Quasi-Peak Mode or Peak Mode with Detector BW=120KHz ; SPA setting in RBW=120KHz, VBW =120KHz, Swp. Time = 0.3 sec./MHz ◦
- (2) All readings are Peak unless otherwise stated QP in column of 『 Note 』 . Peak denotes that the Peak reading compliance with the QP Limits and then QP Mode measurement didn't perform ◦
- (3) Measuring frequency range from 30MHz to 1000MHz ◦
- (4) If the peak scan value lower limit more than 20dB, then this signal data does not show in table ◦

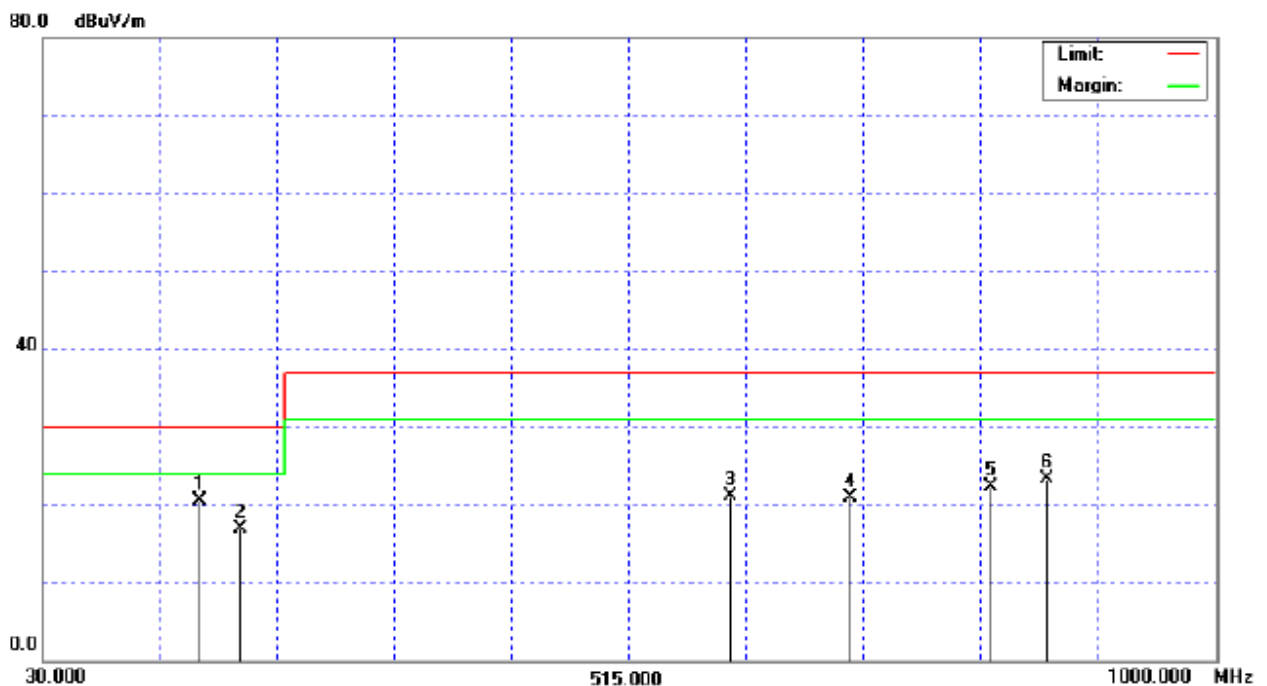

EUT :	Dual Band GSM Mobile Phone	Model Name :	Bird S700
Temperature :	26 °C	Relative Humidity :	66%
Pressure :	1003 hPa	Test Power :	AC 120V/60Hz
Test Mode :	ADAPTER MODE		

Freq. (MHz)	Ant. H/V	Reading(RA) (dBuV)	Corr.Factor(CF) (dB)	Measured(FS) (dBuV/m)	Limits(QP) (dBuV/m)	Margin (dB)	Note
152.22	H	19.86	-5.92	13.94	30.00	- 16.06	
526.64	H	19.00	0.85	19.85	37.00	- 17.15	
596.48	H	19.80	2.47	22.27	37.00	- 14.73	
773.02	H	16.80	5.34	22.14	37.00	- 14.86	
875.84	H	15.14	6.89	22.03	37.00	- 14.97	
984.48	H	13.71	8.57	22.28	37.00	- 14.72	

Remark :

- (1) Reading in which marked as QP or Peak means measurements by using are Quasi-Peak Mode or Peak Mode with Detector BW=120KHz ; SPA setting in RBW=120KHz, VBW =120KHz, Swp. Time = 0.3 sec./MHz .
- (2) All readings are Peak unless otherwise stated QP in column of 『 Note 』 . Peak denotes that the Peak reading compliance with the QP Limits and then QP Mode measurement didn't perform .
- (3) Measuring frequency range from 30MHz to 1000MHz .
- (4) If the peak scan value lower limit more than 20dB, then this signal data does not show in table .

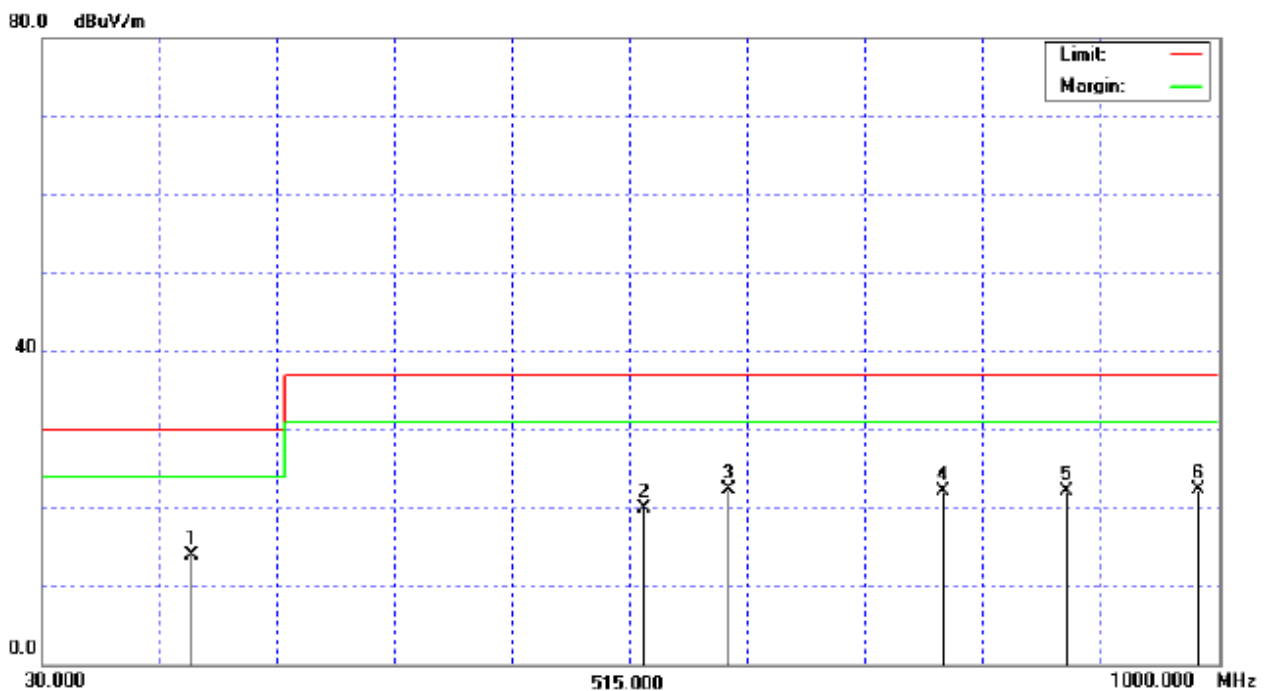

EUT :	Dual Band GSM Mobile Phone	Model Name :	Bird S700
Temperature :	26 °C	Relative Humidity :	66%
Pressure :	1003 hPa	Test Power :	AC 120V/60Hz
Test Mode :	USB MODE		

Freq. (MHz)	Ant. H/V	Reading(RA) (dBuV)	Corr.Factor(CF) (dB)	Measured(FS) (dBuV/m)	Limits(QP) (dBuV/m)	Margin (dB)	Note
159.98	V	24.19	-5.54	18.65	30.00	- 11.35	
191.02	V	24.75	-8.10	16.65	30.00	- 13.35	
639.16	V	18.19	3.07	21.26	37.00	- 15.74	
769.14	V	16.40	5.28	21.68	37.00	- 15.32	
848.68	V	16.81	6.53	23.34	37.00	- 13.66	
982.54	V	15.35	8.54	23.89	37.00	- 13.11	

Remark :

- (1) Reading in which marked as QP or Peak means measurements by using are Quasi-Peak Mode or Peak Mode with Detector BW=120KHz ; SPA setting in RBW=120KHz, VBW =120KHz, Swp. Time = 0.3 sec./MHz ◦
- (2) All readings are Peak unless otherwise stated QP in column of 『 Note 』 . Peak denotes that the Peak reading compliance with the QP Limits and then QP Mode measurement didn't perform ◦
- (3) Measuring frequency range from 30MHz to 1000MHz ◦
- (4) If the peak scan value lower limit more than 20dB, then this signal data does not show in table ◦

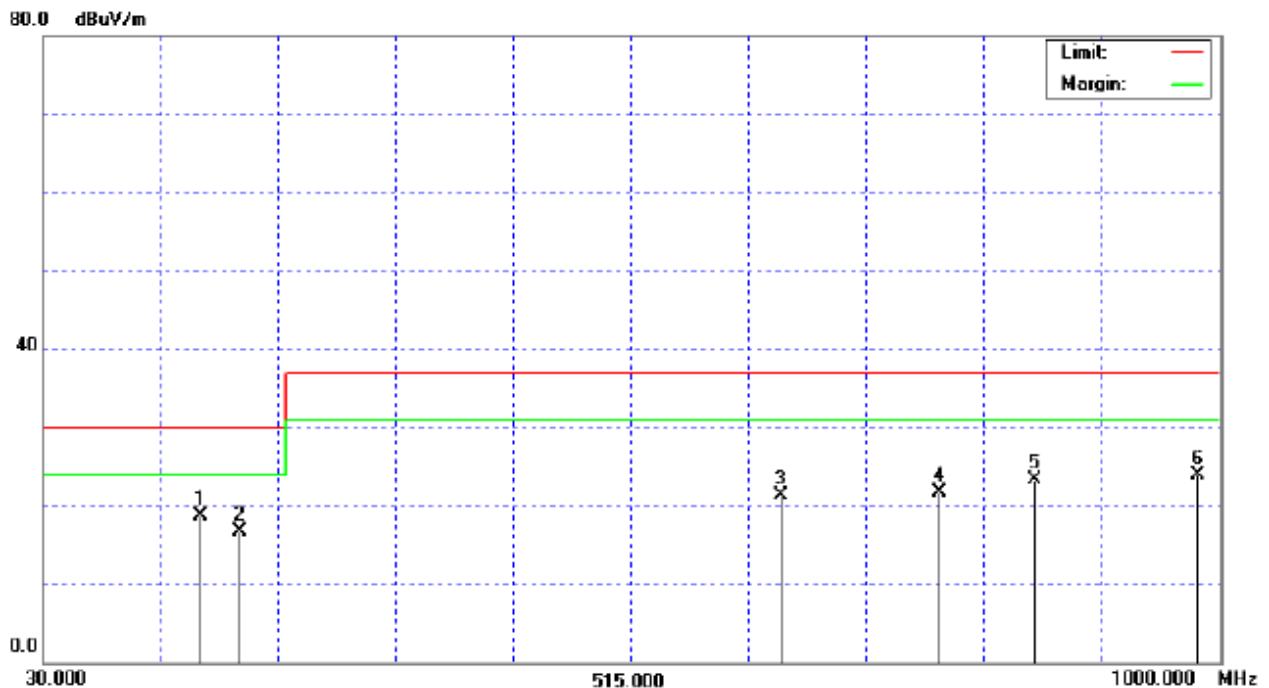

EUT :	Dual Band GSM Mobile Phone	Model Name :	Bird S700
Temperature :	26 °C	Relative Humidity :	66%
Pressure :	1003 hPa	Test Power :	AC 120V/60Hz
Test Mode :	USB MODE		

Freq. (MHz)	Ant. H/V	Reading(RA) (dBuV)	Corr.Factor(CF) (dB)	Measured(FS) (dBuV/m)	Limits(QP) (dBuV/m)	Margin (dB)	Note
159.98	H	24.98	-5.54	19.44	30.00	- 10.56	
598.42	H	17.64	2.52	20.16	37.00	- 16.84	
637.22	H	17.60	3.04	20.64	37.00	- 16.36	
743.92	H	17.80	4.87	22.67	37.00	- 14.33	
837.04	H	17.27	6.35	23.62	37.00	- 13.38	
996.12	H	11.94	8.76	20.70	37.00	- 16.30	

Remark :

- (1) Reading in which marked as QP or Peak means measurements by using are Quasi-Peak Mode or Peak Mode with Detector BW=120KHz ; SPA setting in RBW=120KHz, VBW =120KHz, Swp. Time = 0.3 sec./MHz ◦
- (2) All readings are Peak unless otherwise stated QP in column of 『 Note 』 . Peak denotes that the Peak reading compliance with the QP Limits and then QP Mode measurement didn't perform ◦
- (3) Measuring frequency range from 30MHz to 1000MHz ◦
- (4) If the peak scan value lower limit more than 20dB, then this signal data does not show in table ◦

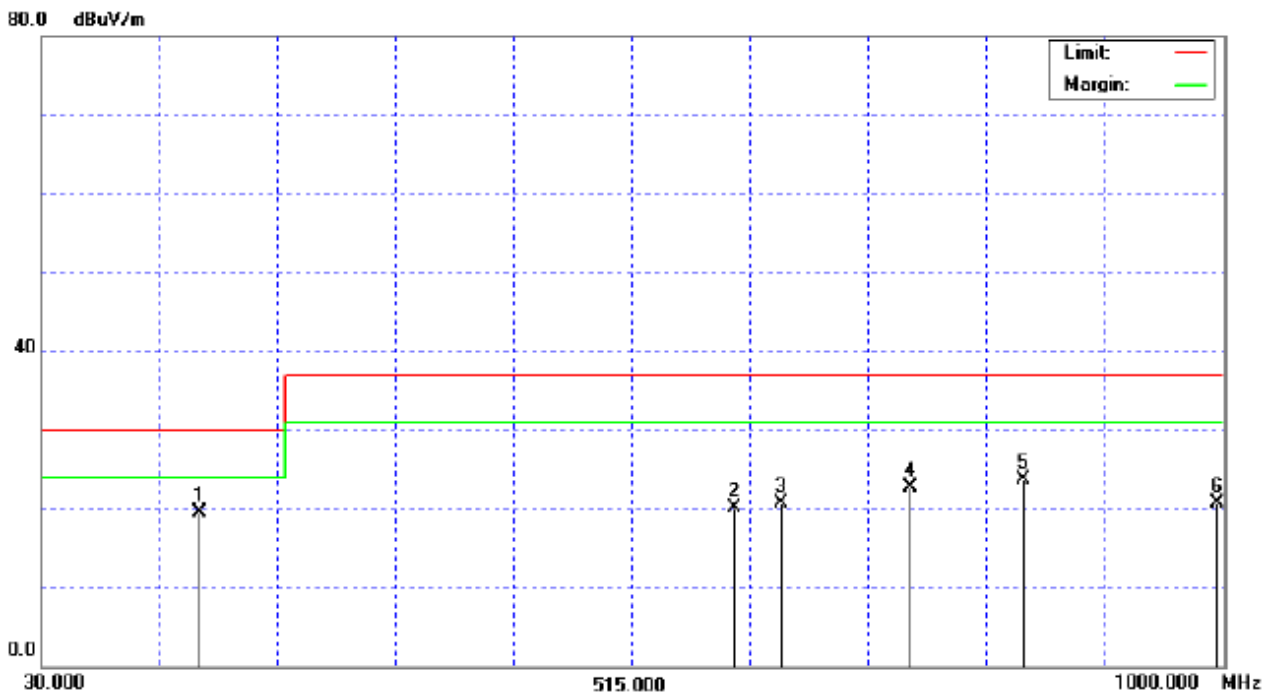

EUT :	Dual Band GSM Mobile Phone	Model Name :	Bird S700
Temperature :	26 °C	Relative Humidity :	66%
Pressure :	1003 hPa	Test Power :	Li-ion battery 3.7Vdc
Test Mode :	BATTERY ONLY WITH EARPHONE		

Freq. (MHz)	Ant. H/V	Reading(RA) (dBuV)	Corr.Factor(CF) (dB)	Measured(FS) (dBuV/m)	Limits(QP) (dBuV/m)	Margin (dB)	Note
365.62	V	24.28	-3.17	21.11	37.00	- 15.89	
499.48	V	26.34	0.17	26.51	37.00	- 10.49	
528.58	V	27.67	0.89	28.56	37.00	- 8.44	
666.32	V	23.05	3.52	26.57	37.00	- 10.43	
699.30	V	26.08	4.16	30.24	37.00	- 6.76	
965.08	V	19.87	8.26	28.13	37.00	- 8.87	

Remark :

- (1) Reading in which marked as QP or Peak means measurements by using are Quasi-Peak Mode or Peak Mode with Detector BW=120KHz ; SPA setting in RBW=120KHz, VBW =120KHz, Swp. Time = 0.3 sec./MHz ◦
- (2) All readings are Peak unless otherwise stated QP in column of 『 Note 』 . Peak denotes that the Peak reading compliance with the QP Limits and then QP Mode measurement didn't perform ◦
- (3) Measuring frequency range from 30MHz to 1000MHz ◦
- (4) If the peak scan value lower limit more than 20dB, then this signal data does not show in table ◦

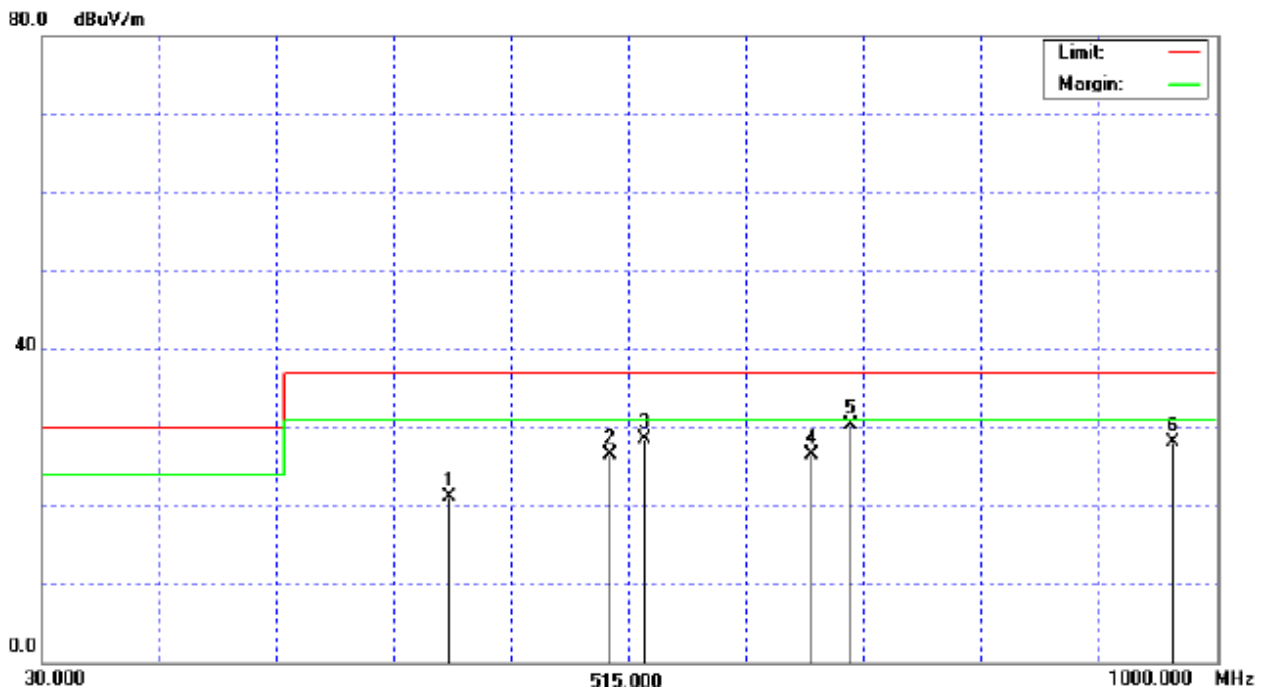

EUT :	Dual Band GSM Mobile Phone	Model Name :	Bird S700
Temperature :	26 °C	Relative Humidity :	66%
Pressure :	1003 hPa	Test Power :	Li-ion battery 3.7Vdc
Test Mode :	BATTERY ONLY WITH EARPHONE		

Freq. (MHz)	Ant. H/V	Reading(RA) (dBuV)	Corr.Factor(CF) (dB)	Measured(FS) (dBuV/m)	Limits(QP) (dBuV/m)	Margin (dB)	Note
165.80	H	26.14	-5.96	20.18	30.00	- 9.82	
336.52	H	26.07	-3.95	22.12	37.00	- 14.88	
499.48	H	30.95	0.17	31.12	37.00	- 5.88	
528.58	H	27.69	0.89	28.58	37.00	- 8.42	
666.32	H	21.88	3.52	25.40	37.00	- 11.60	
699.30	H	22.36	4.16	26.52	37.00	- 10.48	

Remark :

- (1) Reading in which marked as QP or Peak means measurements by using are Quasi-Peak Mode or Peak Mode with Detector BW=120KHz ; SPA setting in RBW=120KHz, VBW =120KHz, Swp. Time = 0.3 sec./MHz ◦
- (2) All readings are Peak unless otherwise stated QP in column of 『 Note 』 . Peak denotes that the Peak reading compliance with the QP Limits and then QP Mode measurement didn't perform ◦
- (3) Measuring frequency range from 30MHz to 1000MHz ◦
- (4) If the peak scan value lower limit more than 20dB, then this signal data does not show in table ◦

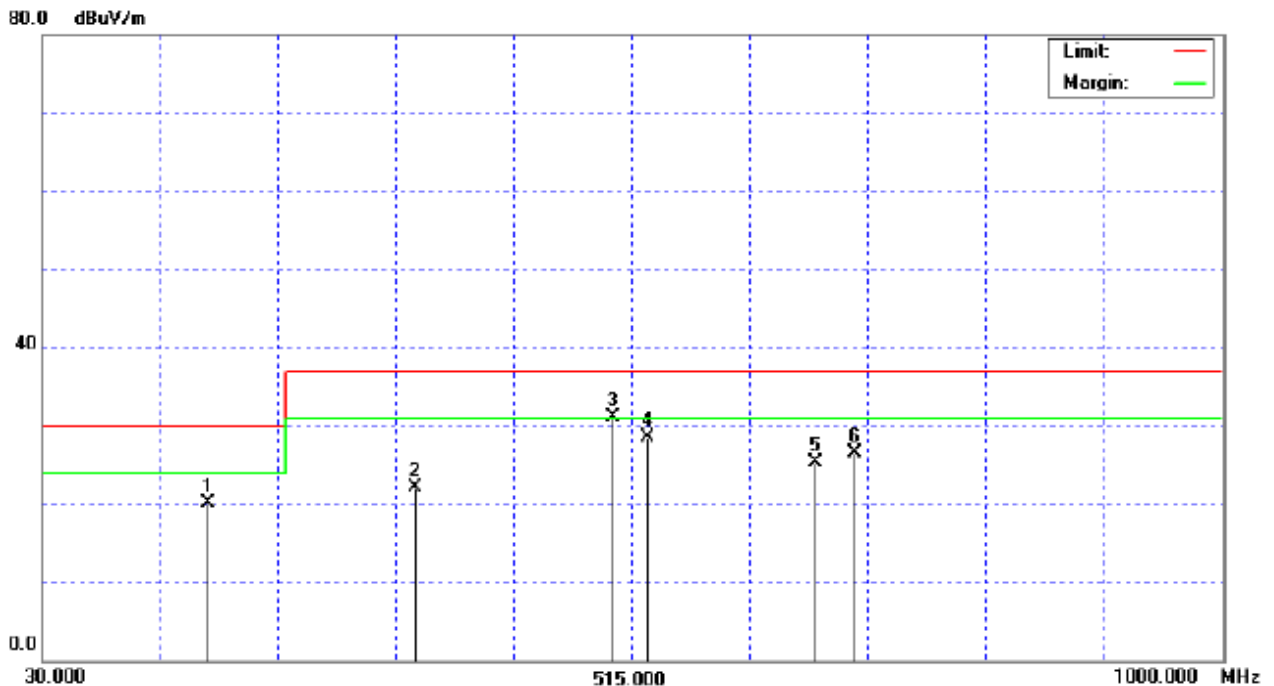

5. EUT TEST PHOTO

**Conducted Measurement Photos
ADAPTER MODE**



**Radiated Measurement Photos
ADAPTER MODE**



**Conducted Measurement Photos
USB MODE**



**Radiated Measurement Photos
USB MODE**

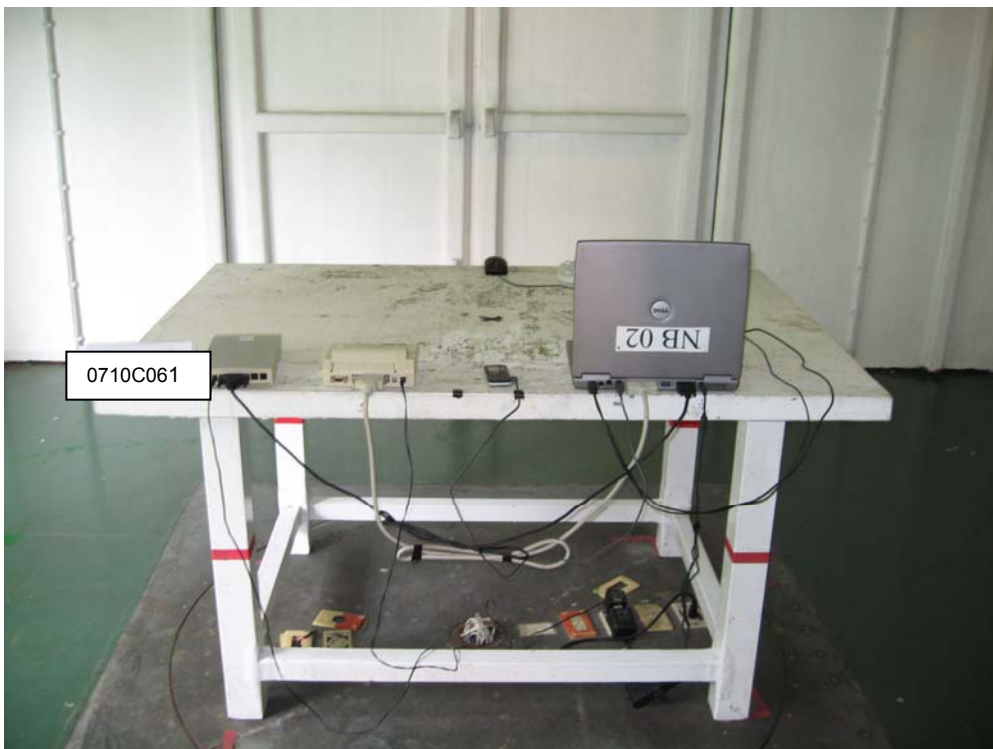

**Radiated Measurement Photos
Battery Only With Earphone**

