



**FCC 47 CFR PART 22 SUBPART H AND PART 24 SUBPART E**

**TEST REPORT**

**For**

**PDA phone**

**Model: JADE100**

**Trade Name: HTC**

*Issued to*

**HTC Corporation**  
**No.23, Xinghua Rd., Taoyuan City,**  
**Taiwan County, 330 R.O.C.**

*Issued by*

**Compliance Certification Services Inc.**  
**No. 11, Wu-Gong 6<sup>th</sup> Rd., Wugu Industrial Park,**  
**Taipei Hsien 248, Taiwan (R.O.C.)**  
**<http://www.ccsemc.com.tw>**  
**[service@tw.ccsemc.com](mailto:service@tw.ccsemc.com)**



---

***Note:** This report shall not be reproduced except in full, without the written approval of Compliance Certification Services Inc. This document may be altered or revised by Compliance Certification Services Inc. personnel only, and shall be noted in the revision section of the document.*



# TABLE OF CONTENTS

- 1. TEST RESULT CERTIFICATION..... 3**
- 2. EUT DESCRIPTION ..... 4**
- 3. TEST METHODOLOGY ..... 5**
  - 3.1 EUT CONFIGURATION ..... 5
  - 3.2 EUT EXERCISE ..... 5
  - 3.3 GENERAL TEST PROCEDURES ..... 5
  - 3.4 DESCRIPTION OF TEST MODES ..... 6
- 4. INSTRUMENT CALIBRATION..... 7**
  - 4.1 MEASURING INSTRUMENT CALIBRATION ..... 7
  - 4.2 MEASUREMENT EQUIPMENT USED ..... 7
- 5. FACILITIES AND ACCREDITATIONS ..... 9**
  - 5.1 FACILITIES ..... 9
  - 5.2 EQUIPMENT ..... 9
  - 5.3 TABLE OF ACCREDITATIONS AND LISTINGS ..... 10
- 6. SETUP OF EQUIPMENT UNDER TEST ..... 11**
  - 6.1 SETUP CONFIGURATION OF EUT ..... 11
  - 6.2 SUPPORT EQUIPMENT ..... 11
- 7. FCC PART 22 & 24 REQUIREMENTS ..... 12**
  - 7.1 AVERAGE POWER ..... 12
  - 7.2 ERP & EIRP MEASUREMENT ..... 14
  - 7.3 OCCUPIED BANDWIDTH MEASUREMENT ..... 19
  - 7.4 OUT OF BAND EMISSION AT ANTENNA TERMINALS ..... 30
  - 7.5 FIELD STRENGTH OF SPURIOUS RADIATION MEASUREMENT ..... 48
  - 7.6 FREQUENCY STABILITY V.S. TEMPERATURE MEASUREMENT ..... 86
  - 7.7 FREQUENCY STABILITY V.S. VOLTAGE MEASUREMENT ..... 90
  - 7.8 POWERLINE CONDUCTED EMISSIONS ..... 94
- APPENDIX I PHOTOGRAPHS OF TEST SETUP ..... 97**



# 1. TEST RESULT CERTIFICATION

**Applicant:** HTC Corporation  
 No.23, Xinghua Rd., Taoyuan City,  
 Tamshui Taipei Hsien, Taiwan, R.O.C.

**Equipment Under Test:** PDA phone

**Trade Name:** HTC

**Model Number:** JADE100

**Date of Test:** July 16 ~ 18, 2008

APPLICABLE STANDARDS	
STANDARD	TEST RESULT
FCC 47 CFR PART 22 SUBPART H AND PART 24 SUBPART E	No non-compliance noted

### We hereby certify that:

The above equipment was tested by Compliance Certification Services Inc. The test data, data evaluation, test procedures, and equipment configurations shown in this report were made in accordance with the procedures given in ANSI/TIA/EIA-603-A-2001 and the energy emitted by the sample EUT tested as described in this report is in compliance with conducted and radiated emission limits of FCC Rule FCC PART 22 Subpart H and PART 24 Subpart E.

The test results of this report relate only to the tested sample identified in this report.

*Approved by:*

*Reviewed by:*

---

Rex Lai  
 Section Manager  
 Compliance Certification Services Inc.

---

Amanda Wu  
 Section Manager  
 Compliance Certification Services Inc.



## 2. EUT DESCRIPTION

<b>Product</b>	PDA phone
<b>Trade Name</b>	HTC
<b>Model Number</b>	JADE100
<b>Model Discrepancy</b>	N/A
<b>Power Supply</b>	<p>1. Power Adapter:  Manufacturer: PHIHONG  Model: PSAI05R-050Q  I/P: 100-240VAC, 50-60Hz, 0.3A  O/P: 5V, 1.0A</p> <p>2. Rechargeable Lithium Battery:  Manufacturer: Total Wireless Solutions(TWS)  Model: JADE160  Rating: 3.7VDC, 1100mAh</p> <p>3. Powered from Host device via USB cable.</p>
<b>Accessories</b>	<p>1. Earphone: MEC (model name: HS S200), Unshielded, 1.7m</p> <p>2. Earphone: COTRON (model name: HS S200), Unshielded, 1.7m</p> <p>3. USB cable: MEC (model name: DC U200) Unshielded, 2.1m</p> <p>4. Pouch: NEWTECH (model name: PO S340)</p>
<b>Frequency Range</b>	<p>TX: 824 ~ 849 MHz / 1850 ~ 1910 MHz</p> <p>RX: 869 ~ 894 MHz / 1930 ~ 1989.8 MHz</p>
<b>Transmit Power (ERP &amp; EIRP Power)</b>	<p>GSM 850: 27.74dBm  GPRS 850: 28.45 dBm  GSM 1900: 22.39 dBm  GPRS 1900: 22.57 dBm  EGPRS 850: 27.12 dBm  EGPRS 1900: 18.41 dBm</p>
<b>Cellular Phone Protocol</b>	<p>GSM 850, GSM1900: Class B  GPRS 850, GPRS1900: Class 10  EGPRS 850, EGPRS 1900: Class 10</p>
<b>Type of Emission</b>	<p>GSM 850 MHz: 245KGXW---  GPRS 850 MHz: 247KGXW---  GSM 1900 MHz: 246KGXW---  GPRS 1900 MHz: 245KGXW---  EGPRS 850 MHz: 247KG7W---  EGPRS 1900 MHz: 251KG7W---</p>
<b>Modulation Technique</b>	<p>GSM: GMSK  GPRS: GMSK  EGPRS: 8PSK</p>
<b>Antenna Gain</b>	<p>850 MHz: -2.0 dBi  1900 MHz: 1.0 dBi</p>
<b>Antenna Type</b>	PIFA Antenna

### Remark:

1. The sample selected for test was engineering sample that approximated to production product and was provided by manufacturer.
2. This submittal(s) (test report) is intended for FCC ID: NM8JDV filing to comply with Part 22 and Part 24 of the FCC 47 CFR Rules.



### **3. TEST METHODOLOGY**

Both conducted and radiated testing were performed according to the procedures document on chapter 13 of ANSI C63.4 and FCC CFR 47, 2.1046, 2.1047, 2.1049, 2.1051, 2.1053, 2.1055 and 2.1057.

#### **3.1 EUT CONFIGURATION**

The EUT configuration for testing is installed on RF field strength measurement to meet the Commissions requirement and operating in a manner that intends to maximize its emission characteristics in a continuous normal application.

#### **3.2 EUT EXERCISE**

The EUT was operated in the engineering mode to fix the TX frequency that was for the purpose of the measurements.

#### **3.3 GENERAL TEST PROCEDURES**

##### **Conducted Emissions**

The EUT is placed on the turntable, which is 0.8 m above ground plane. According to the requirements in Section 13.1.4.1 of ANSI C63.4. Conducted emissions from the EUT measured in the frequency range between 0.15 MHz and 30MHz using CISPR Quasi-peak and average detector modes.

##### **Radiated Emissions**

The EUT is placed on a turn table, which is 0.8 m above ground plane. The turntable shall rotate 360 degrees to determine the position of maximum emission level. EUT is set 3m away from the receiving antenna, which varied from 1m to 4m to find out the highest emission. And also, each emission was to be maximized by changing the polarization of receiving antenna both horizontal and vertical. In order to find out the maximum emissions, exploratory radiated emission measurements were made according to the requirements in Section 13.1.4.1 of ANSI C63.4.



### **3.4 DESCRIPTION OF TEST MODES**

The EUT (model: JADE100) had been tested under operating condition.

EUT staying in continuous transmitting mode was programmed.

GSM / GPRS / EGPRS 850:

Channel Low (CH128), Channel Mid (CH190) and Channel High (CH251) were chosen for full testing.

GSM / GPRS / EGPRS 1900:

Channel Low (CH512), Channel Mid (CH661) and Channel High (CH810) were chosen for full testing.

After verification, all tests were carried out with the worst case test modes as shown below except radiated spurious emission below 1GHz and power line conducted emissions below 30MHz, which worst case was in normal link mode only.

The field strength of spurious emission was measured in the following position: EUT stand-up position (Z axis), lie-down position (X, Y axis). The worst emission was found in lie-down position (X axis) for power line conducted emission testing and the worst case was recorded.

Based on the above results from the different modulations, GSM 850 / GPRS 850 / GSM 1900 / GPRS1900 / EGPRS 850 / EGPRS 1900 were determined to be the worst-case scenario for all tests.

The worst emission was found:

in lie-down (X axis) for GSM 1900 / GPRS 850 / GPRS1900 / EGPRS 850 / EGPRS 1900, and in lie-down (Y axis) for GSM 850.



## 4. INSTRUMENT CALIBRATION

### 4.1 MEASURING INSTRUMENT CALIBRATION

The measuring equipment, which was utilized in performing the tests documented herein, has been calibrated in accordance with the manufacturer's recommendations for utilizing calibration equipment, which is traceable to recognized national standards.

### 4.2 MEASUREMENT EQUIPMENT USED

#### Equipment Used for Emissions Measurement

*Remark: Each piece of equipment is scheduled for calibration once a year.*

Conducted Emissions Test Site				
Name of Equipment	Manufacturer	Model	Serial Number	Calibration Due
Spectrum Analyzer	Agilent	E4446A	MY43360131	02/24/2009
Power Meter	Agilent	E4416A	GB41291611	04/06/2009
Power Sensor	Agilent	E9327A	US40441097	06/19/2009
Temp. / Humidity Chamber	Terchy	MHG-150LF	930619	08/07/2009
DC Power Source	Agilent	E3640A	MY40001774	01/10/2009

3M Semi Anechoic Chamber				
Name of Equipment	Manufacturer	Model	Serial Number	Calibration Due
Spectrum Analyzer	Agilent	E4446A	US42510252	09/11/2008
Test Receiver	Rohde & Schwarz	ESCI	100064	11/12/2008
Switch Controller	TRC	Switch Controller	SC94050010	05/02/2009
4 Port Switch	TRC	4 Port Switch	SC94050020	05/02/2009
Horn-Antenna	TRC	HA-0502	06	06/04/2009
Horn-Antenna	TRC	HA-0801	04	06/19/2009
Bilog- Antenna	Sunol Sciences	JB3	A030205	03/28/2009
Loop Antenna	EMCO	6502	8905/2356	05/29/2009
Turn Table	Max-Full	MFT-120S	T120S940302	N.C.R.
Antenna Tower	Max-Full	MFA-430	A440940302	N.C.R.
Controller	Max-Full	MF-CM886	CC-C-1F-13	N.C.R.
Site NSA	N/A	FCC: 965860 IC: IC 6106	09/25/2008	09/25/2008
Reject Filter	Micro-Tronics	HPM13194	003	04/24/2009
S.G.	HP	83630B	3844A01022	04/17/2009
Substituted Dipole	Schwazbeck	VHAP/UHAP	998 +999/ 981+982	06/09/2009
Substituted Horn	EMCO	3115	00022257	12/16/2008
Test S/W	LABVIEW (V 6.1)			

*Remark: The measurement uncertainty is less than +/-3.7046dB (30MHz ~ 1GHz), +/-3.0958dB (Above 1GHz) which is evaluated as per the NAMAS NIS 81 and CISPR/A/291/CDV.*



Powerline Conducted Emissions Test Site				
Name of Equipment	Manufacturer	Model	Serial Number	Calibration Due
EMI Test Receiver 9kHz-30MHz	Rohde & Schwarz	ESHS30	828144/003	11/18/2009
Two-Line V-Network 9kHz-30MHz	Schaffner	NNB41	03/10013	06/11/2009
LISN 10kHz-100MHz	EMCO	3825/2	9106-1809	04/09/2009
Test S/W	LABVIEW (V 6.1)			

**Remark:** The measurement uncertainty is less than +/- 2.81dB, which is evaluated as per the NAMAS NIS 81 and CISPR/A/291/CDV.





## **5. FACILITIES AND ACCREDITATIONS**

### **5.1 FACILITIES**

No.11, Wugong 6th Rd., Wugu Industrial Park, Taipei Hsien 248, Taiwan

Tel: 886-2-2299-9720 / Fax: 886-2-2298-4045

The sites are constructed in conformance with the requirements of ANSI C63.7, ANSI C63.4 and CISPR Publication 22.

### **5.2 EQUIPMENT**



Radiated emissions are measured with one or more of the following types of linearly polarized antennas: tuned dipole, biconical, log periodic, bi-log, and/or ridged waveguide, horn. Spectrum analyzers with pre-selectors and quasi-peak detectors are used to perform radiated measurements.

Conducted emissions are measured with Line Impedance Stabilization Networks and EMI Test Receivers.

Calibrated wideband preamplifiers, coaxial cables, and coaxial attenuators are also used for making measurements.

All receiving equipment conforms to CISPR Publication 16-1, "Radio Interference Measuring Apparatus and Measurement Methods."

### 5.3 TABLE OF ACCREDITATIONS AND LISTINGS

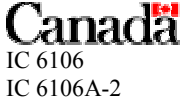
Country	Agency	Scope of Accreditation	Logo
USA	A2LA	EN 55011, EN 55014-1/2, CISPR 11, CISPR 14-1/2, EN 55022, EN 55015, CISPR 22, CISPR 15, AS/NZS 3548, VCCI V3 (2001), CFR 47, FCC Part 15/18, CNS 13783-1, CNS 13439, CNS 13438, CNS 13803, CNS 14115, EN 55024, IEC 801-2, IEC 801-3, IEC 801-4, IEC/EN 61000-3-2, EIC/EN 61000-3-3, IEC/EN 61000-4-2/3/4/5/6/8/11, EN 50081-1/ EN 61000-6-3, EN 50081-2/EN 61000-6-4, EN 50081-2/EN 61000-6-1: 2001	
USA	FCC	3M Semi Anechoic Chamber (965860 and 898658) to perform FCC Part 15/18 measurements	
Taiwan	TAF	LP0002, RTTE01, FCC Method-47 CFR Part 15 Subpart C, D, E, RSS-210, RSS-310 IDA TS SRD, AS/NZS 4268, AS/NZS 4771, TS 12.1 & 12.2, ETSI EN 300 440-1, ETSI EN 300 440-2, ETSI EN 300 328, ETSI EN 300 220-1, ETSI EN 300 220-2, ETSI EN 301 893, ETSI EN 301 489-1/3/7/17 FCC OET Bulletin 65 + Supplement C, EN 50360, EN 50361, EN 50371, RSS 102, EN 50383, EN 50385, EN 50392, IEC 62209, CNS 14958-1, CNS 14959 FCC Method -47 CFR Part 15 Subpart B IEC / EN 61000-3-2, IEC / EN 61000-3-3, IEC / EN 61000-4-2/3/4/5/6/8/11	
Canada	Industry Canada	3M Semi Anechoic Chamber (IC 6106 & IC 6106A-2) to perform RSS 212 Issue 1	

*\* No part of this report may be used to claim or imply product endorsement by A2LA or any agency of the US Government.*



## 6. SETUP OF EQUIPMENT UNDER TEST

### 6.1 SETUP CONFIGURATION OF EUT

See test photographs attached in Appendix I for the actual connections between EUT and support equipment.

### 6.2 SUPPORT EQUIPMENT

No.	Device Type	Brand	Model	FCC ID	Series No.	Data Cable	Power Cord
1.	Notebook PC	DELL	PP05L	7T390 A03	E2K5HCKT	N/A	AC I/P: Unshielded, 1.8m DC O/P: Unshielded, 1.8m with a core
2.	Universal Radio Communication Tester (Remote)	R&S	CMU200	1100.000.8.02	N/A	N/A	Unshielded, 1.8m

**Remark:**

1. All the equipment/cables were placed in the worst-case configuration to maximize the emission during the test.
2. Grounding was established in accordance with the manufacturer's requirements and conditions for the intended use.



## 7. FCC PART 22 & 24 REQUIREMENTS

### 7.1 AVERAGE POWER

#### LIMIT

According to FCC §2.1046.

#### Test Configuration

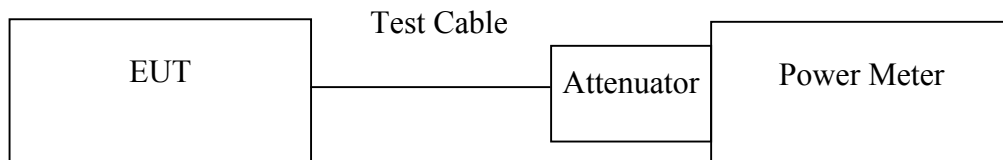

*Remark: Measurement setup for testing on Antenna connector*

#### TEST PROCEDURE

The transmitter output was connected to a calibrated attenuator, the other end of which was connected to a power meter. Transmitter output was read off the power meter in dBm. The power output at the transmitter antenna port was determined by adding the value of the attenuator to the power meter reading.



### TEST RESULTS

*No non-compliance noted.*

#### Test Data

Test Mode	CH	Frequency (MHz)	Power Meter Reading (dBm)	Attenuator (dB)	Average Power (dBm)
GSM 850 (Class B)	128	824.20	2.07	32.0	34.07
	190	836.60	2.02		34.02
	251	848.80	2.01		34.01
GPRS 850 (Class 10)	128	824.20	2.08		34.08
	190	836.60	2.06		34.06
	251	848.80	1.99		33.99
EGPRS 850 (Class 10)	128	824.20	-2.00		30.00
	190	836.60	-1.96		30.04
	251	848.80	-1.81		30.19

Test Mode	CH	Frequency (MHz)	Power Meter Reading (dBm)	Attenuator (dB)	Average Power (dBm)
GSM 1900 (Class B)	512	1850.20	-2.38	32.0	29.62
	661	1880.00	-2.25		29.75
	810	1909.80	-1.92		30.08
GPRS 1900 (Class 10)	512	1850.20	-2.48		29.52
	661	1880.00	-2.16		29.84
	810	1909.80	-2.07		29.93
EGPRS 1900 (Class 10)	512	1850.20	-6.39	32.5	26.11
	661	1880.00	-6.33		26.17
	810	1909.80	-5.85		26.65

**Remark:** *The value of factor includes both the loss of cable and external attenuator*

## 7.2 ERP & EIRP MEASUREMENT

### LIMIT

According to FCC §2.1046

FCC 22.913(a): The Effective Radiated Power (ERP) of mobile transmitters must not exceed 7 Watts.

FCC 24.232(b): The equivalent Isotropic Radiated Power (EIRP) must not exceed 2 Watts.

### Test Configuration

#### Below 1 GHz

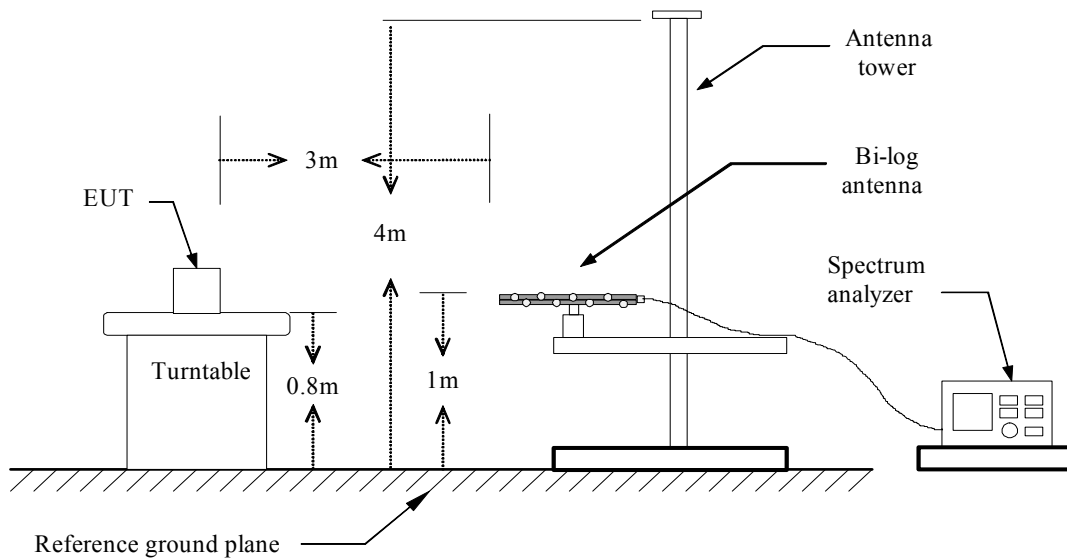

#### Above 1 GHz

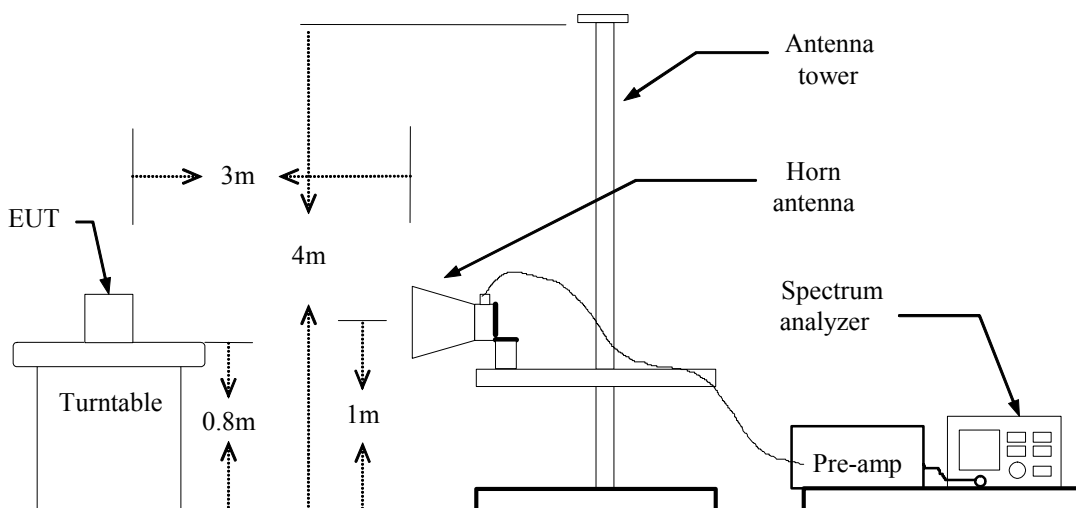

**For Substituted Method Test Set-UP**

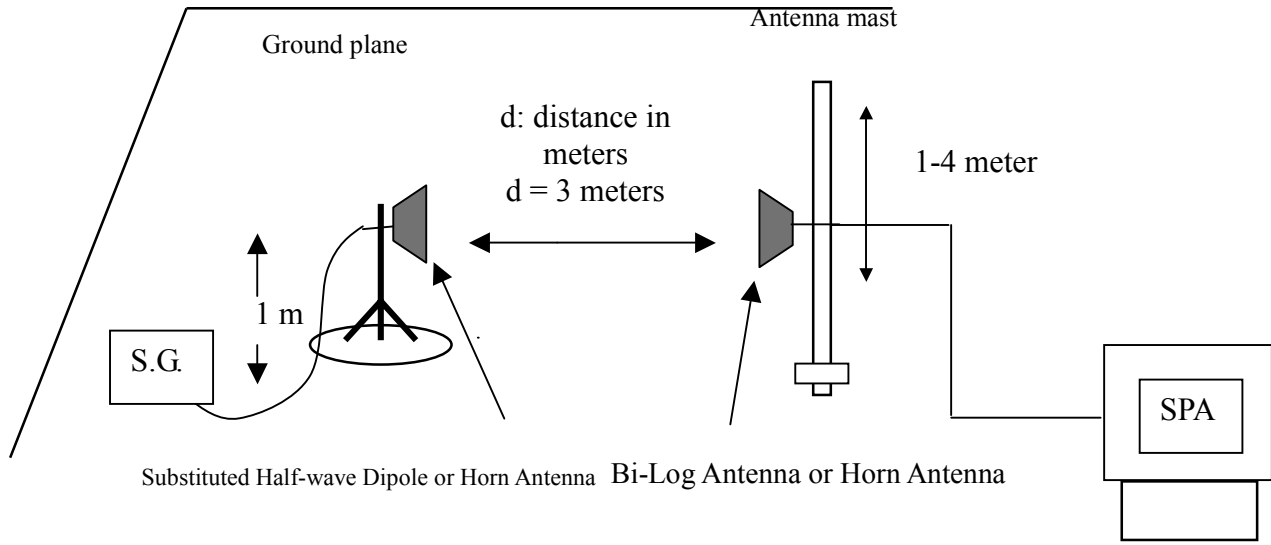

**TEST PROCEDURE**

The EUT was placed on a non-conductive turntable using a non-conductive support. The radiated emission at the fundamental frequency was measured at 3 m with a test antenna and EMI spectrum analyzer.

During the measurement of the EUT, the resolution bandwidth was set to 3MHz and the average bandwidth was set to 3MHz. The highest emission was recorded with the rotation of the turntable and the lowering of the test antenna. The reading was recorded and the field strength (E in dBuV/m) was calculated.

ERP in frequency band 824-849MHz, and EIRP in frequency band 1851.25 –1910MHz were measured using a substitution method. The EUT was replaced by half-wave dipole (824-849MHz) or horn antenna (1851.25-1910MHz) connected to a signal generator. The spectrum analyzer reading was recorded and ERP/EIRP was calculated as follows:

$$ERP = \text{S.G. output (dBm)} + \text{Antenna Gain (dBd)} - \text{Cable (dB)}$$

$$EIRP = \text{S.G. output (dBm)} + \text{Antenna Gain (dBi)} - \text{Cable (dB)}$$

**TEST RESULTS**

*No non-compliance noted.*

**TEST RESULTS***No non-compliance noted.***GSM 850 Test Data (Class B)**

EUT Pol.	Channel	Frequency (MHz)	Antenna Pol.	Reading level (dBuV)	Correction Factor (dB)	Emission level (dBm)	Limit (dBm)	Margin (dB)
X	128	824.20	V	-21.87	36.22	14.35	38.50	-24.15
		824.20	H	-13.46	36.08	22.63	38.50	-15.87
	190	836.60	V	-18.66	36.31	17.65	38.50	-20.85
		836.60	H	-11.41	36.20	24.78	38.50	-13.72
	251	848.80	V	-14.91	36.37	21.46	38.50	-17.04
		848.80	H	-8.62	36.35	27.73	38.50	-10.77
Y	128	824.20	V	-22.77	36.22	13.46	38.50	-25.04
		824.20	H	-13.12	36.08	22.96	38.50	-15.54
	190	836.60	V	-20.32	36.31	16.00	38.50	-22.50
		836.60	H	-11.01	36.20	25.19	38.50	-13.31
	251	848.80	V	-18.50	36.37	17.87	38.50	-20.63
		848.80	H	-8.60	36.34	<b>27.74</b>	38.50	-10.76
Z	128	824.20	V	-15.89	36.22	20.33	38.50	-18.17
		824.20	H	-20.63	36.08	15.45	38.50	-23.05
	190	836.60	V	-13.40	36.31	22.91	38.50	-15.59
		836.60	H	-18.12	36.20	18.08	38.50	-20.42
	251	848.80	V	-10.73	36.37	25.64	38.50	-12.86
		848.80	H	-15.94	36.35	20.41	38.50	-18.09

**GPRS 850 Test Data (Class 10)**

EUT Pol.	Channel	Frequency (MHz)	Antenna Pol.	Reading level (dBuV)	Correction Factor (dB)	Emission level (dBm)	Limit (dBm)	Margin (dB)
X	128	824.20	V	-22.02	36.22	14.21	38.50	-24.29
		824.20	H	-13.23	36.08	22.85	38.50	-15.65
	190	836.60	V	-18.60	36.31	17.71	38.50	-20.79
		836.60	H	-10.60	36.19	25.59	38.50	-12.91
	251	848.80	V	-14.78	36.37	21.59	38.50	-16.91
		848.80	H	-7.89	36.34	<b>28.45</b>	38.50	-10.05
Y	128	824.20	V	-25.19	36.22	11.03	38.50	-27.47
		824.20	H	-14.07	36.08	22.01	38.50	-16.49
	190	836.60	V	-21.01	36.31	15.30	38.50	-23.20
		836.60	H	-10.99	36.19	25.20	38.50	-13.30
	251	848.80	V	-18.29	36.37	18.08	38.50	-20.42
		848.80	H	-8.56	36.35	27.79	38.50	-10.71
Z	128	824.20	V	-15.83	36.22	20.39	38.50	-18.11
		824.20	H	-20.18	36.08	15.90	38.50	-22.60
	190	836.60	V	-13.49	36.31	22.82	38.50	-15.68
		836.60	H	-17.84	36.19	18.35	38.50	-20.15
	251	848.80	V	-11.30	36.37	25.07	38.50	-13.43
		848.80	H	-15.75	36.34	20.60	38.50	-17.90



**GSM 1900 Test Data (Class B)**

EUT Pol.	Channel	Frequency (MHz)	Antenna Pol.	Reading level (dBuV)	Correction Factor (dB)	Emission level (dBm)	Limit (dBm)	Margin (dB)
X	512	1850.20	V	-23.90	35.17	11.26	33.00	-21.74
		1850.20	H	-13.19	35.17	21.98	33.00	-11.02
	661	1880.00	V	-23.48	35.01	11.53	33.00	-21.47
		1880.00	H	-12.63	35.02	<b>22.39</b>	33.00	-10.61
	810	1909.80	V	-24.68	34.87	10.19	33.00	-22.81
		1909.80	H	-12.87	34.88	22.00	33.00	-11.00
Y	512	1850.20	V	-13.96	35.16	21.21	33.00	-11.79
		1850.20	H	-15.89	35.17	19.29	33.00	-13.71
	661	1880.00	V	-14.65	35.01	20.37	33.00	-12.63
		1880.00	H	-16.00	35.02	19.02	33.00	-13.98
	810	1909.80	V	-15.27	34.86	19.60	33.00	-13.40
		1909.80	H	-17.10	34.88	17.77	33.00	-15.23
Z	512	1850.20	V	-18.39	35.16	16.78	33.00	-16.22
		1850.20	H	-14.22	35.17	20.96	33.00	-12.04
	661	1880.00	V	-17.57	35.01	17.45	33.00	-15.55
		1880.00	H	-15.01	35.02	20.02	33.00	-12.98
	810	1909.80	V	-17.27	34.87	17.60	33.00	-15.40
		1909.80	H	-15.93	34.88	18.94	33.00	-14.06

**GPRS 1900 Test Data (Class 10)**

EUT Pol.	Channel	Frequency (MHz)	Antenna Pol.	Reading level (dBuV)	Correction Factor (dB)	Emission level (dBm)	Limit (dBm)	Margin (dB)
X	512	1850.20	V	-22.88	35.16	12.28	33.00	-20.72
		1850.20	H	-12.60	35.17	<b>22.57</b>	33.00	-10.43
	661	1880.00	V	-22.29	35.01	12.72	33.00	-20.28
		1880.00	H	-12.68	35.02	22.34	33.00	-10.66
	810	1909.80	V	-22.85	34.87	12.02	33.00	-20.98
		1909.80	H	-12.86	34.88	22.02	33.00	-10.98
Y	512	1850.20	V	-13.93	35.16	21.23	33.00	-11.77
		1850.20	H	-15.63	35.17	19.55	33.00	-13.45
	661	1880.00	V	-14.43	35.02	20.59	33.00	-12.41
		1880.00	H	-15.91	35.02	19.12	33.00	-13.88
	810	1909.80	V	-15.19	34.87	19.68	33.00	-13.32
		1909.80	H	-17.18	34.88	17.70	33.00	-15.30
Z	512	1850.20	V	-18.08	35.16	17.08	33.00	-15.92
		1850.20	H	-14.44	35.17	20.74	33.00	-12.26
	661	1880.00	V	-17.58	35.02	17.43	33.00	-15.57
		1880.00	H	-15.18	35.03	19.85	33.00	-13.15
	810	1909.80	V	-17.45	34.87	17.41	33.00	-15.59
		1909.80	H	-16.58	34.88	18.29	33.00	-14.71

**EGPRS 850 Test Data (Class 10)**

EUT Pol.	Channel	Frequency (MHz)	Antenna Pol.	Reading level (dBuV)	Correction Factor (dB)	Emission level (dBm)	Limit (dBm)	Margin (dB)
X	128	824.20	V	-21.84	36.22	14.38	38.50	-24.12
		824.20	H	-15.01	36.08	21.07	38.50	-17.43
	190	836.60	V	-18.61	36.31	17.69	38.50	-20.81
		836.60	H	-17.84	36.19	18.35	38.50	-20.15
	251	848.80	V	-14.41	36.37	21.97	38.50	-16.53
		848.80	H	-13.62	36.34	22.72	38.50	-15.78
Y	128	824.20	V	-31.67	36.22	4.55	38.50	-33.95
		824.20	H	-19.91	36.08	16.17	38.50	-22.33
	190	836.60	V	-29.89	36.31	6.43	38.50	-32.07
		836.60	H	-17.38	36.20	18.81	38.50	-19.69
	251	848.80	V	-17.64	36.37	18.73	38.50	-19.77
		848.80	H	-9.22	36.34	<b>27.12</b>	38.50	-11.38
Z	128	824.20	V	-14.96	36.22	21.27	38.50	-17.23
		824.20	H	-26.59	36.08	9.49	38.50	-29.01
	190	836.60	V	-13.46	36.31	22.85	38.50	-15.65
		836.60	H	-19.71	36.20	16.49	38.50	-22.01
	251	848.80	V	-11.16	36.37	25.21	38.50	-13.29
		848.80	H	-21.70	36.34	14.64	38.50	-23.86

**EGPRS 1900 Test Data (Class 10)**

EUT Pol.	Channel	Frequency (MHz)	Antenna Pol.	Reading level (dBuV)	Correction Factor (dB)	Emission level (dBm)	Limit (dBm)	Margin (dB)
X	512	1850.20	V	-27.41	35.17	7.76	33.00	-25.24
		1850.20	H	-16.77	35.17	<b>18.41</b>	33.00	-14.59
	661	1880.00	V	-26.61	35.02	8.40	33.00	-24.60
		1880.00	H	-16.92	35.03	18.10	33.00	-14.90
	810	1909.80	V	-26.61	34.87	8.26	33.00	-24.74
		1909.80	H	-16.83	34.88	18.05	33.00	-14.95
Y	512	1850.20	V	-18.58	35.16	16.58	33.00	-16.42
		1850.20	H	-20.00	35.17	15.17	33.00	-17.83
	661	1880.00	V	-18.33	35.01	16.69	33.00	-16.31
		1880.00	H	-20.91	35.02	14.12	33.00	-18.88
	810	1909.80	V	-18.35	34.87	16.52	33.00	-16.48
		1909.80	H	-21.28	34.88	13.60	33.00	-19.40
Z	512	1850.20	V	-21.90	35.16	13.27	33.00	-19.73
		1850.20	H	-18.46	35.17	16.72	33.00	-16.28
	661	1880.00	V	-21.59	35.01	13.42	33.00	-19.58
		1880.00	H	-18.21	35.03	16.81	33.00	-16.19
	810	1909.80	V	-21.13	34.87	13.73	33.00	-19.27
		1909.80	H	-18.45	34.88	16.43	33.00	-16.57

## 7.3 OCCUPIED BANDWIDTH MEASUREMENT

### LIMIT

According to §FCC 2.1049.

### Test Configuration

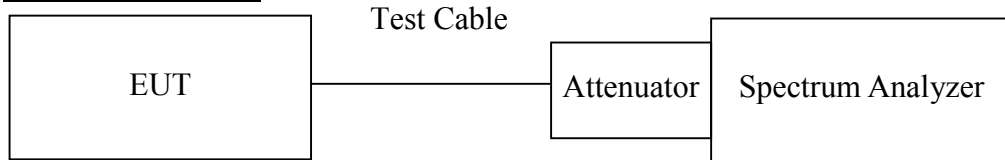

*Remark: Measurement setup for testing on Antenna connector*

### TEST PROCEDURE

The EUT's output RF connector was connected with a short cable to the spectrum analyzer, RBW was set to about 1% of emission BW, VBW is set to 3 times the RBW, -26dBc display line was placed on the screen (or 99% bandwidth), the occupied bandwidth is the delta frequency between the two points where the display line intersects the signal trace.

### TEST RESULTS

*No non-compliance noted*



**Test Data**

Test Mode	CH	Frequency (MHz)	99% Bandwidth (kHz)
GSM 850 (Class B)	128	824.20	243.6846
	190	836.60	239.9712
	251	848.80	245.5247
GPRS 850 (Class 10)	128	824.20	246.8389
	190	836.60	247.1702
	251	848.80	239.8100
EGPRS 850 (Class 10)	128	824.20	247.7452
	190	836.60	239.8095
	251	848.80	240.3591

Test Mode	CH	Frequency (MHz)	99% Bandwidth (kHz)
GSM 1900 (Class B)	512	1850.20	246.4050
	661	1880.00	246.4424
	810	1909.80	245.6683
GPRS 1900 (Class 10)	512	1850.20	245.7146
	661	1880.00	244.1803
	810	1909.80	240.9542
EGPRS 1900 (Class 10)	512	1850.20	240.4353
	661	1880.00	251.6850
	810	1909.80	247.2478



Test Plot

GSM 850 (CH Low)

Agilent 16:43:42 Jul 16, 2008

R T

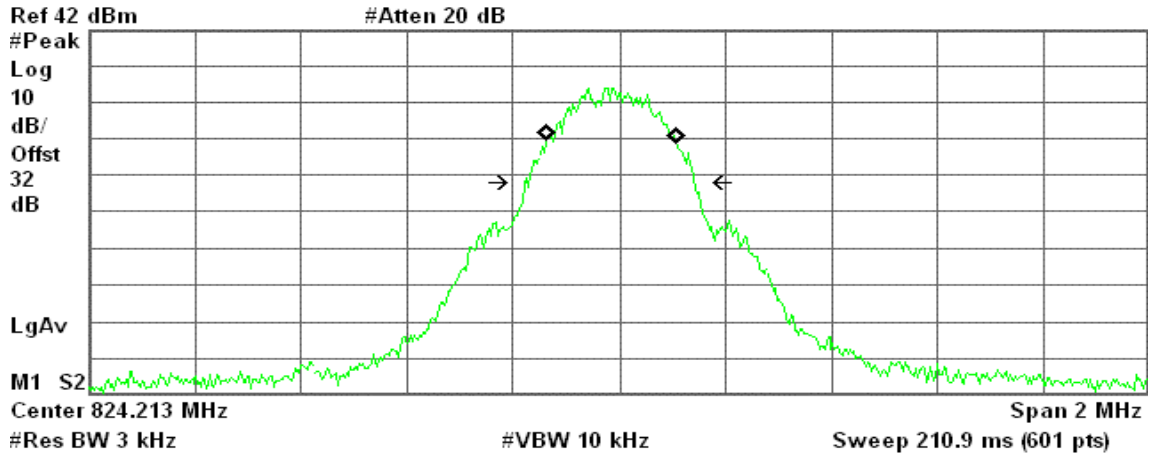

Occupied Bandwidth  
243.6846 kHz

Occ BW % Pwr 99.00 %  
x dB -26.00 dB

Transmit Freq Error -13.837 kHz  
x dB Bandwidth 318.468 kHz

GSM 850 (CH Mid)

Agilent 16:44:06 Jul 16, 2008

R T

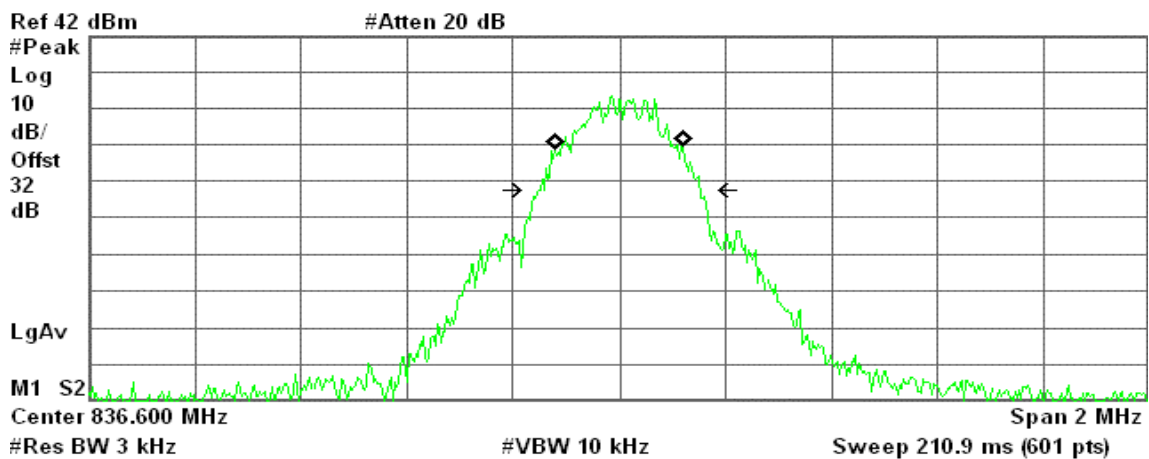

Occupied Bandwidth  
239.9712 kHz

Occ BW % Pwr 99.00 %  
x dB -26.00 dB

Transmit Freq Error 352.516 Hz  
x dB Bandwidth 303.352 kHz



### GSM 850 (CH High)

Agilent 16:44:26 Jul 16, 2008

R T

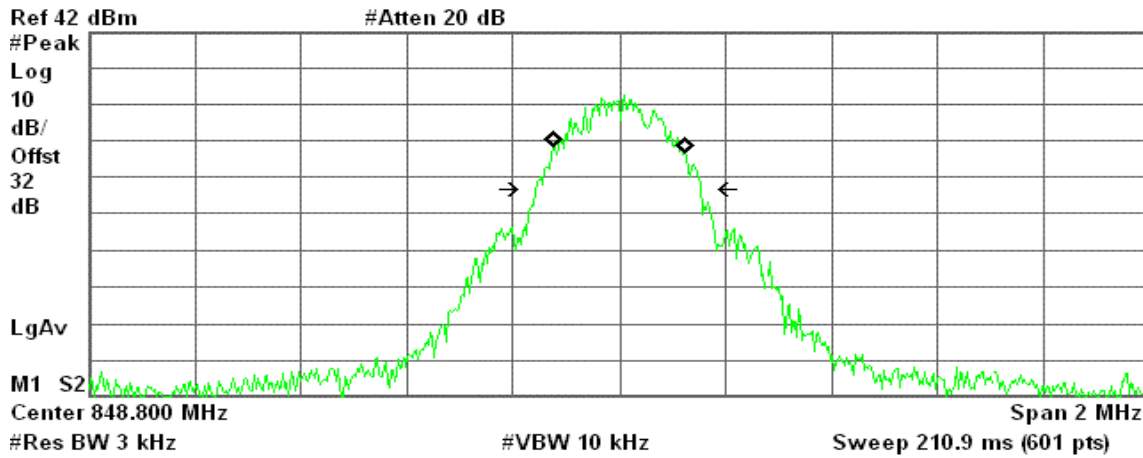

Occupied Bandwidth  
245.5247 kHz

Occ BW % Pwr 99.00 %  
x dB -26.00 dB

Transmit Freq Error -45.056 Hz  
x dB Bandwidth 310.612 kHz

### GPRS 850 (CH Low)

Agilent 17:23:53 Jul 16, 2008

R T

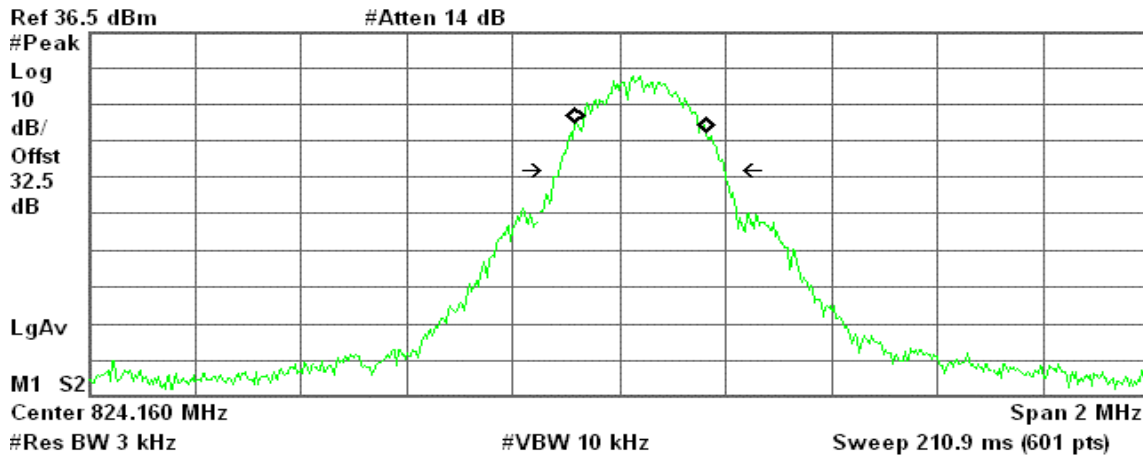

Occupied Bandwidth  
246.8389 kHz

Occ BW % Pwr 99.00 %  
x dB -26.00 dB

Transmit Freq Error 39.782 kHz  
x dB Bandwidth 310.121 kHz



### GPRS 850 (CH Mid)

Agilent 17:24:25 Jul 16, 2008

R T

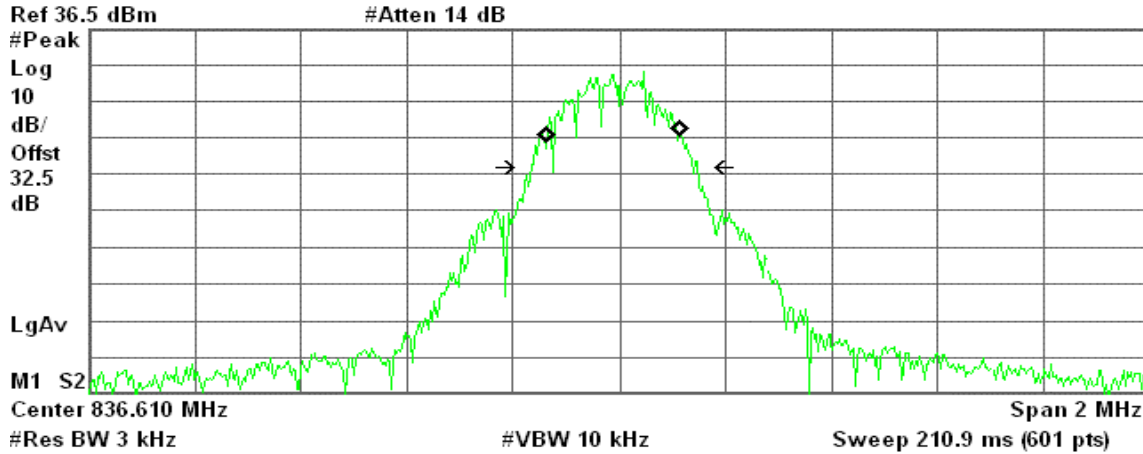

Occupied Bandwidth  
247.1702 kHz

Occ BW % Pwr 99.00 %  
x dB -26.00 dB

Transmit Freq Error -11.579 kHz  
x dB Bandwidth 312.220 kHz

### GPRS 850(CH High)

Agilent 17:25:29 Jul 16, 2008

R T

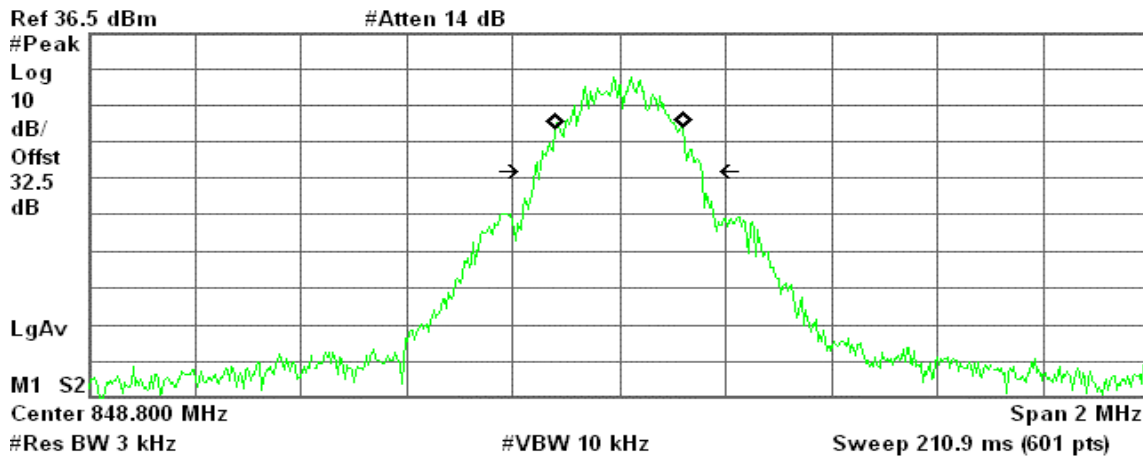

Occupied Bandwidth  
239.8100 kHz

Occ BW % Pwr 99.00 %  
x dB -26.00 dB

Transmit Freq Error -329.241 Hz  
x dB Bandwidth 313.440 kHz



### GSM 1900 (CH Low)

Agilent 16:56:47 Jul 16, 2008

R L

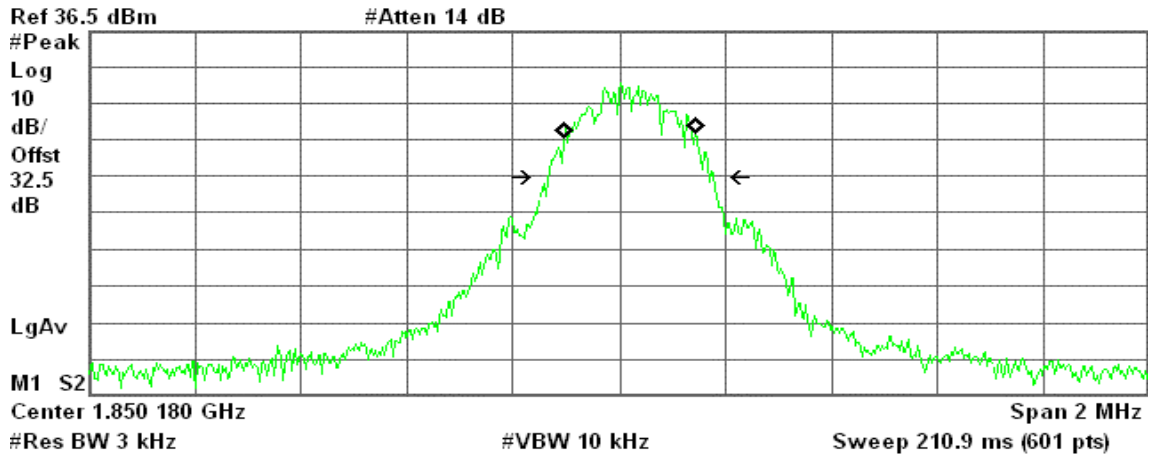

Occupied Bandwidth  
246.4050 kHz

Occ BW % Pwr 99.00 %  
x dB -26.00 dB

Transmit Freq Error 20.847 kHz  
x dB Bandwidth 311.002 kHz

### GSM 1900 (CH Mid)

Agilent 16:57:07 Jul 16, 2008

R T

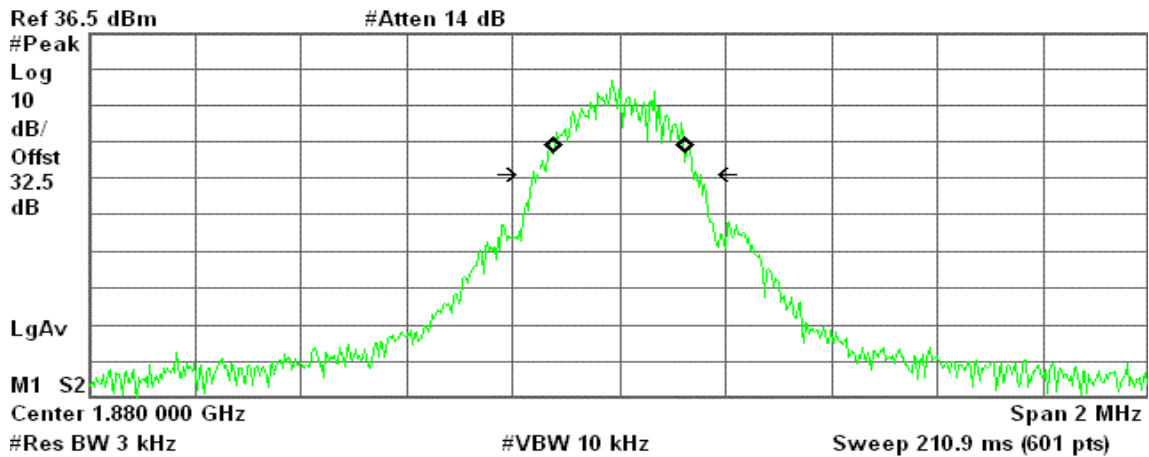

Occupied Bandwidth  
246.4424 kHz

Occ BW % Pwr 99.00 %  
x dB -26.00 dB

Transmit Freq Error -1.115 kHz  
x dB Bandwidth 314.639 kHz





### GSM 1900 (CH High)

Agilent 16:57:47 Jul 16, 2008

R T

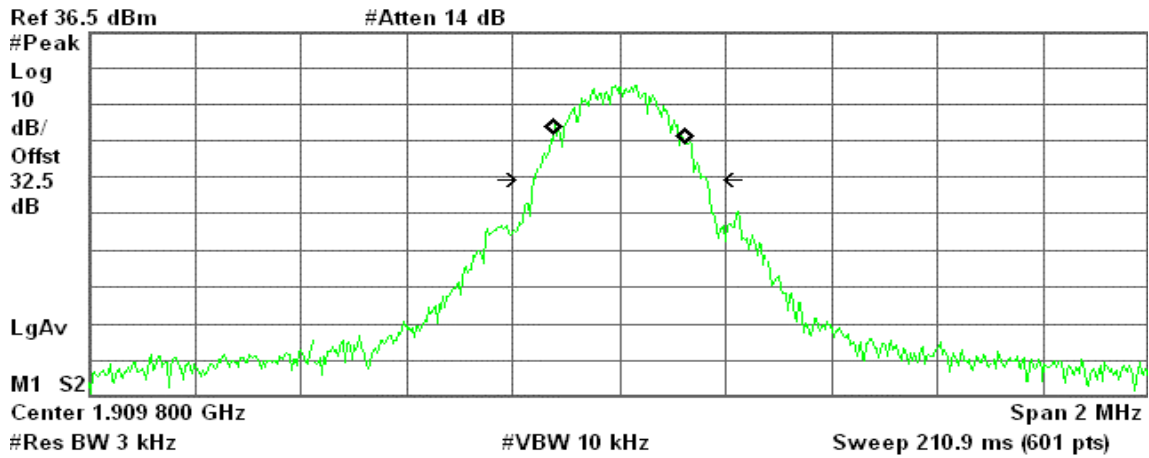

Occupied Bandwidth  
245.6683 kHz

Occ BW % Pwr 99.00 %  
x dB -26.00 dB

Transmit Freq Error 852.639 Hz  
x dB Bandwidth 325.259 kHz

### GPRS 1900 (CH Low)

Agilent 17:05:06 Jul 16, 2008

R T

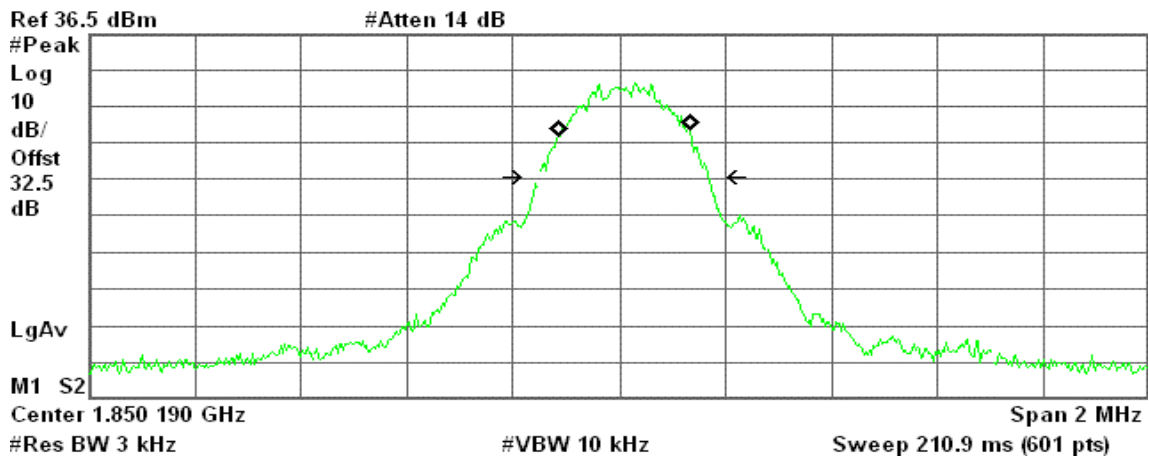

Occupied Bandwidth  
245.7146 kHz

Occ BW % Pwr 99.00 %  
x dB -26.00 dB

Transmit Freq Error 9.748 kHz  
x dB Bandwidth 317.331 kHz



### GPRS 1900 (CH Mid)

Agilent 17:06:18 Jul 16, 2008

R T

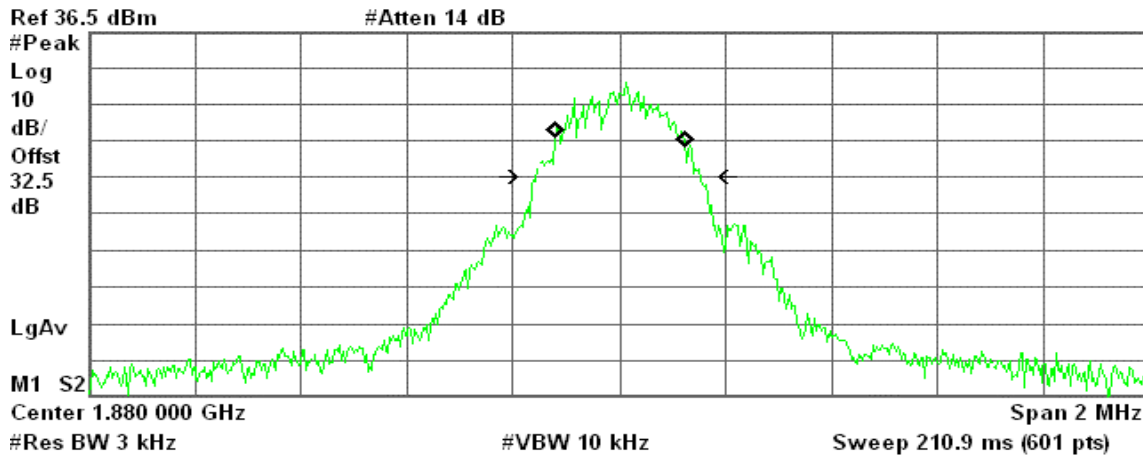

Occupied Bandwidth  
244.1803 kHz

Occ BW % Pwr 99.00 %  
x dB -26.00 dB

Transmit Freq Error 2.280 kHz  
x dB Bandwidth 308.776 kHz

### GPRS 1900 (CH High)

Agilent 17:06:49 Jul 16, 2008

R T

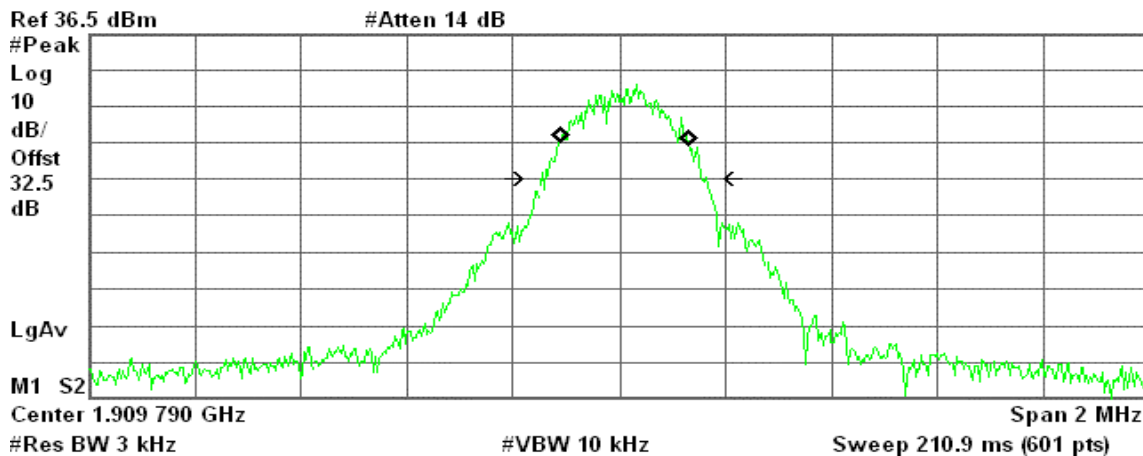

Occupied Bandwidth  
240.9542 kHz

Occ BW % Pwr 99.00 %  
x dB -26.00 dB

Transmit Freq Error 10.372 kHz  
x dB Bandwidth 309.568 kHz



**EGPRS**

**EGPRS 850 (CH Low)**

Agilent 10:09:27 Jul 17, 2008

R T

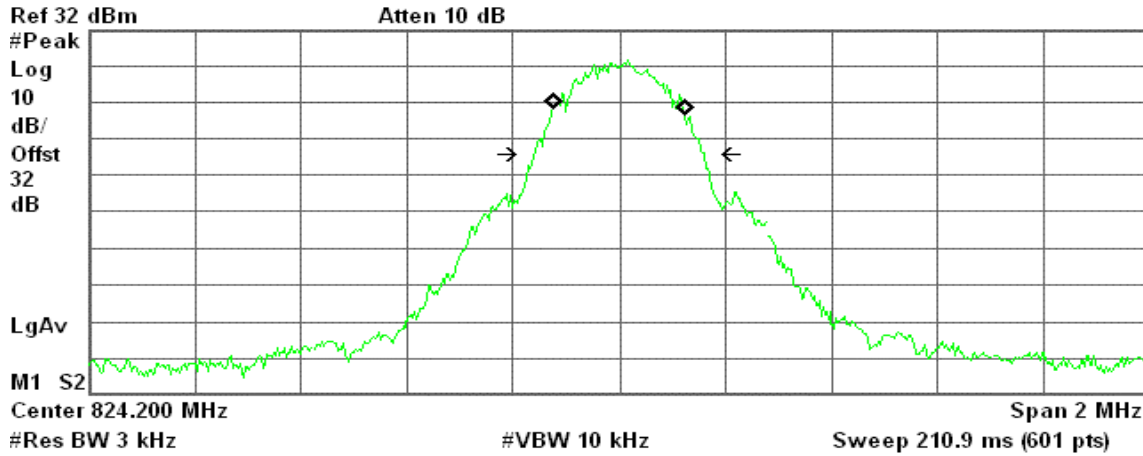

Occupied Bandwidth  
247.7452 kHz

Occ BW % Pwr 99.00 %  
x dB -26.00 dB

Transmit Freq Error -394.178 Hz  
x dB Bandwidth 318.561 kHz

**EGPRS 850 (CH Mid)**

Agilent 10:10:05 Jul 17, 2008

R T

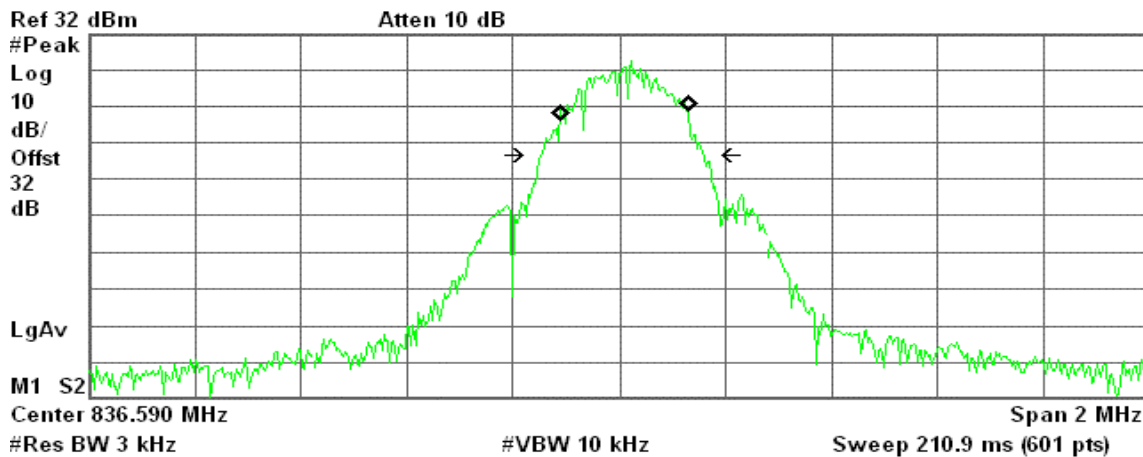

Occupied Bandwidth  
239.8095 kHz

Occ BW % Pwr 99.00 %  
x dB -26.00 dB

Transmit Freq Error 8.806 kHz  
x dB Bandwidth 305.716 kHz



### EGPRS 850 (CH High)

Agilent 10:11:00 Jul 17, 2008

R T

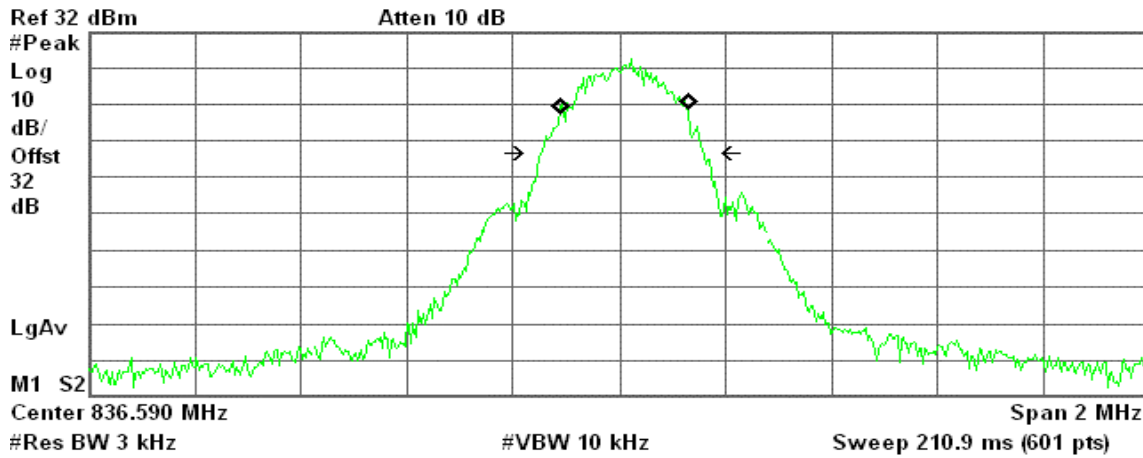

Occupied Bandwidth  
240.3591 kHz

Occ BW % Pwr 99.00 %  
x dB -26.00 dB

Transmit Freq Error 8.968 kHz  
x dB Bandwidth 305.716 kHz

### EGPRS 1900 (CH Low)

Agilent 10:32:16 Jul 17, 2008

R T

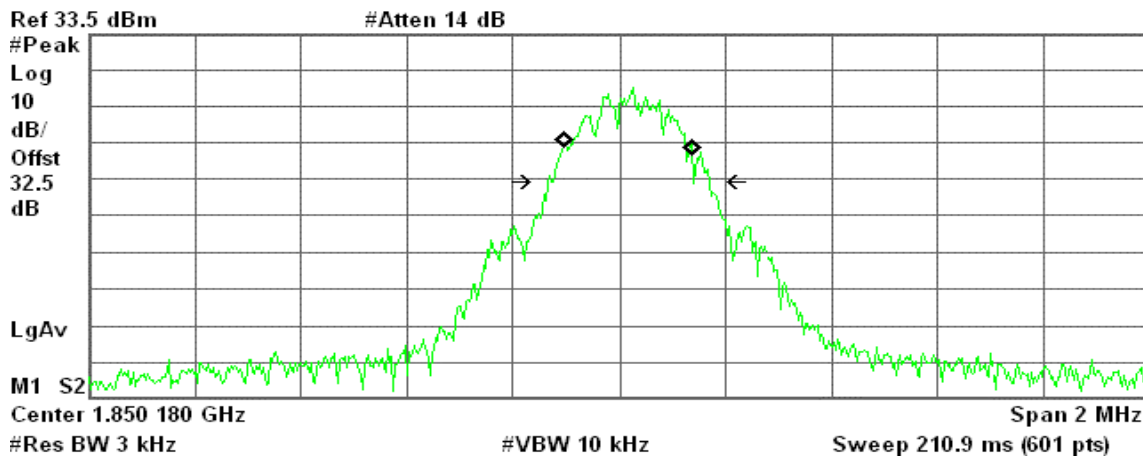

Occupied Bandwidth  
240.4353 kHz

Occ BW % Pwr 99.00 %  
x dB -26.00 dB

Transmit Freq Error 17.418 kHz  
x dB Bandwidth 302.247 kHz



### EGPRS 1900 (CH Mid)

Agilent 10:32:40 Jul 17, 2008

R T

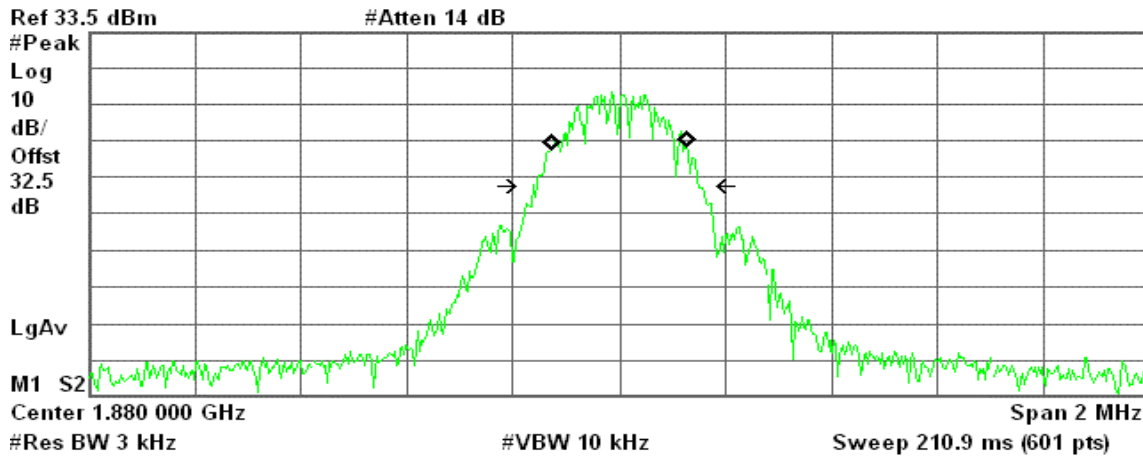

Occupied Bandwidth  
251.6850 kHz

Occ BW % Pwr 99.00 %  
x dB -26.00 dB

Transmit Freq Error -252.313 Hz  
x dB Bandwidth 310.025 kHz

### EGPRS 1900 (CH High)

Agilent 10:33:14 Jul 17, 2008

R T

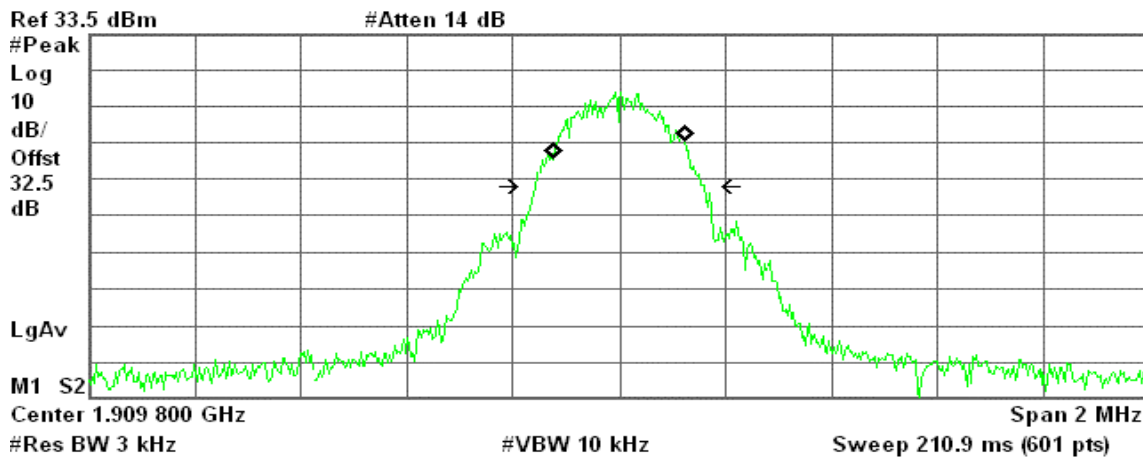

Occupied Bandwidth  
247.2478 kHz

Occ BW % Pwr 99.00 %  
x dB -26.00 dB

Transmit Freq Error 401.436 Hz  
x dB Bandwidth 316.506 kHz



## 7.4 OUT OF BAND EMISSION AT ANTENNA TERMINALS

### LIMIT

According to FCC §2.1051, FCC §22.917, FCC §24.238(a).

**Out of Band Emissions:** The mean power of emission must be attenuated below the mean power of the non-modulated carrier (P) on any frequency twice or more than twice the fundamental frequency by at least  $43 + 10 \log P$  dB.

**Mobile Emissions in Base Frequency Range:** The mean power of any emissions appearing in the base station frequency range from cellular mobile transmitters operated must be attenuated to a level not exceed  $-80$  dBm at the transmit antenna connector.

**Band Edge Requirements:** In the 1MHz bands immediately outside and adjacent to the frequency block, a resolution bandwidth of at least 1% of the emission bandwidth of the fundamental emission of the transmitter may be employed to measure the Out of band Emission

### Test Configuration

**Out of band emission at antenna terminals:**

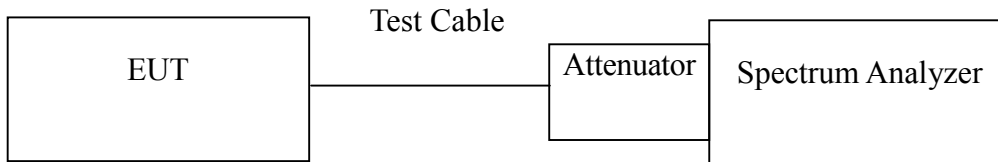

### TEST PROCEDURE

The RF output of the transceiver was connected to a spectrum analyzer through appropriate attenuation. The resolution bandwidth of the spectrum analyzer was set at 1MHz, sufficient scans were taken to show the out of band Emissions if any up to 10th harmonic.

For the out of band: Set the RBW, VBW = 1MHz, Start=30MHz, Stop= 10 th harmonic. Limit = -13dBm

Band Edge Requirements (824 MHz and 849 MHz /1850MHz and 1910MHz): In the 1 MHz bands immediately outside and adjacent to the frequency block, a resolution bandwidth of at least 1 percent of the emission bandwidth of the fundamental emission of the transmitter may be employed to measure the out of band Emissions. Limit, -13dBm.

### TEST RESULTS

*No non-compliance noted.*



**Test Data**

Mode	CH	Location	Description
GSM 850 (Class B)	128	Figure 7-1	Conducted spurious emissions, 30MHz - 20GHz
	190	Figure 7-2	Conducted spurious emissions, 30MHz - 20GHz
	251	Figure 7-3	Conducted spurious emissions, 30MHz - 20GHz
GPRS 850 (Class 10)	128	Figure 7-4	Conducted spurious emissions, 30MHz - 20GHz
	190	Figure 7-5	Conducted spurious emissions, 30MHz - 20GHz
	251	Figure 7-6	Conducted spurious emissions, 30MHz - 20GHz

Mode	CH	Location	Description
GSM 1900 (Class B)	512	Figure 8-1	Conducted spurious emissions, 30MHz - 20GHz
	661	Figure 8-2	Conducted spurious emissions, 30MHz - 20GHz
	810	Figure 8-3	Conducted spurious emissions, 30MHz - 20GHz
GPRS 1900 (Class 10)	512	Figure 8-4	Conducted spurious emissions, 30MHz - 20GHz
	661	Figure 8-5	Conducted spurious emissions, 30MHz - 20GHz
	810	Figure 8-6	Conducted spurious emissions, 30MHz - 20GHz

Mode	CH	Location	Description
GSM 850 (Class B)	128	Figure 9-1	Band Edge emissions
	251	Figure 9-2	Band Edge emissions
GPRS 850 (Class 10)	128	Figure 9-3	Band Edge emissions
	251	Figure 9-4	Band Edge emissions

Mode	CH	Location	Description
GSM 1900 (Class B)	512	Figure 10-1	Band Edge emissions
	810	Figure 10-2	Band Edge emissions
GPRS 1900 (Class 10)	512	Figure 10-3	Band Edge emissions
	810	Figure 10-4	Band Edge emissions



Mode	CH	Location	Description
EGPRS 850 (Class 10)	128	Figure 11-1	Conducted spurious emissions, 30MHz - 20GHz
	190	Figure 11-2	Conducted spurious emissions, 30MHz - 20GHz
	251	Figure 11-3	Conducted spurious emissions, 30MHz - 20GHz
EGPRS 1900 (Class 10)	512	Figure 11-4	Conducted spurious emissions, 30MHz - 20GHz
	661	Figure 11-5	Conducted spurious emissions, 30MHz - 20GHz
	810	Figure 11-6	Conducted spurious emissions, 30MHz - 20GHz

Mode	CH	Location	Description
EGPRS 850 (Class 10)	128	Figure 12-1	Band Edge emissions
	251	Figure 12-2	Band Edge emissions
EGPRS 1900 (Class 10)	512	Figure 12-3	Band Edge emissions
	810	Figure 12-4	Band Edge emissions





Test Plot

GSM 850

Figure 7-1: Out of Band emission at antenna terminals – GSM CH Low

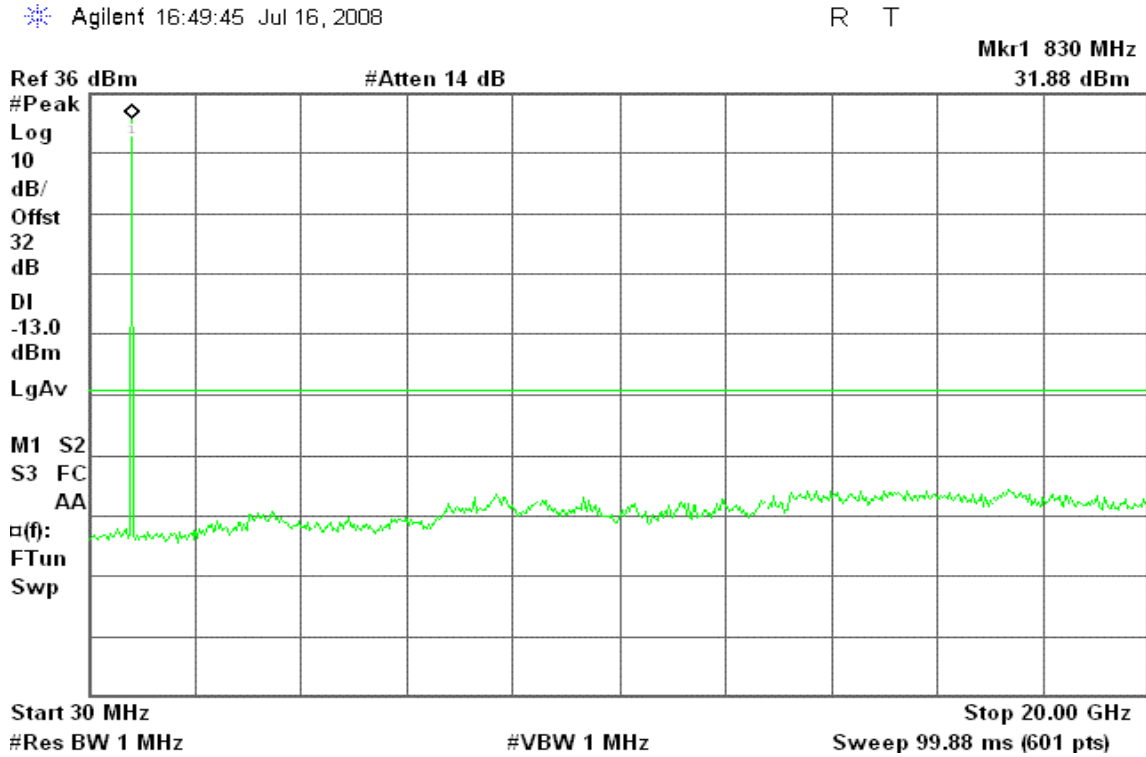

Figure 7-2: Out of Band emission at antenna terminals – GSM CH Mid

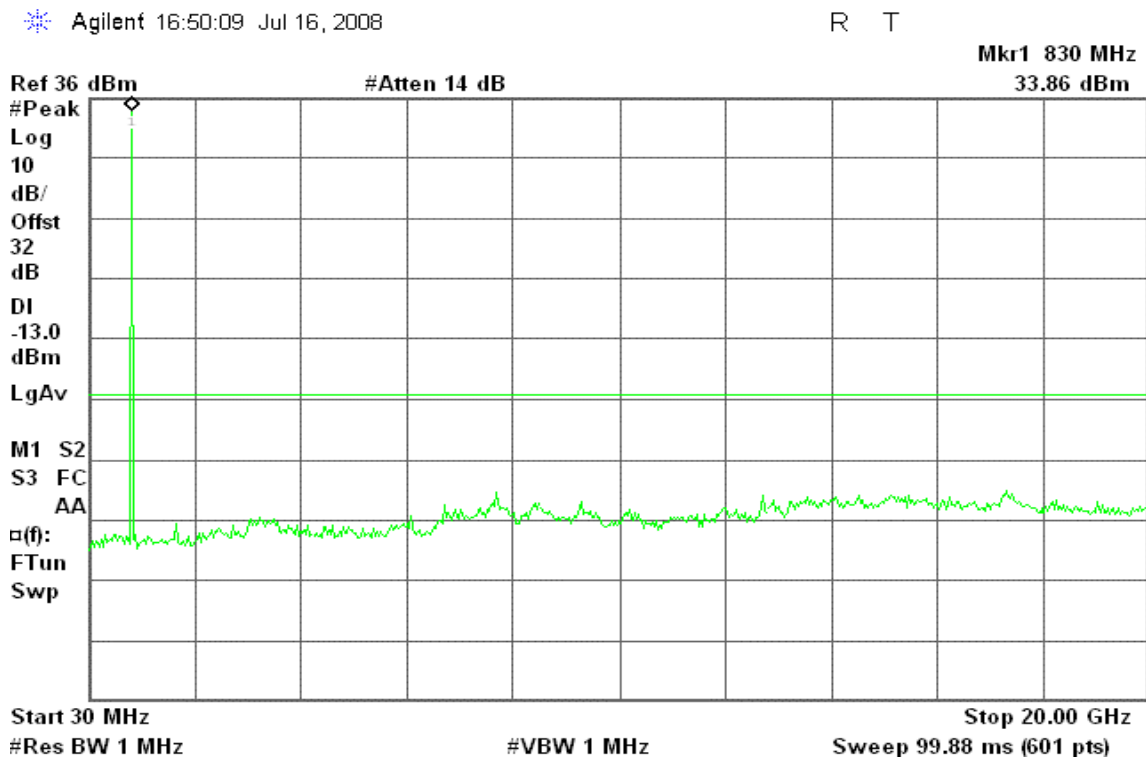
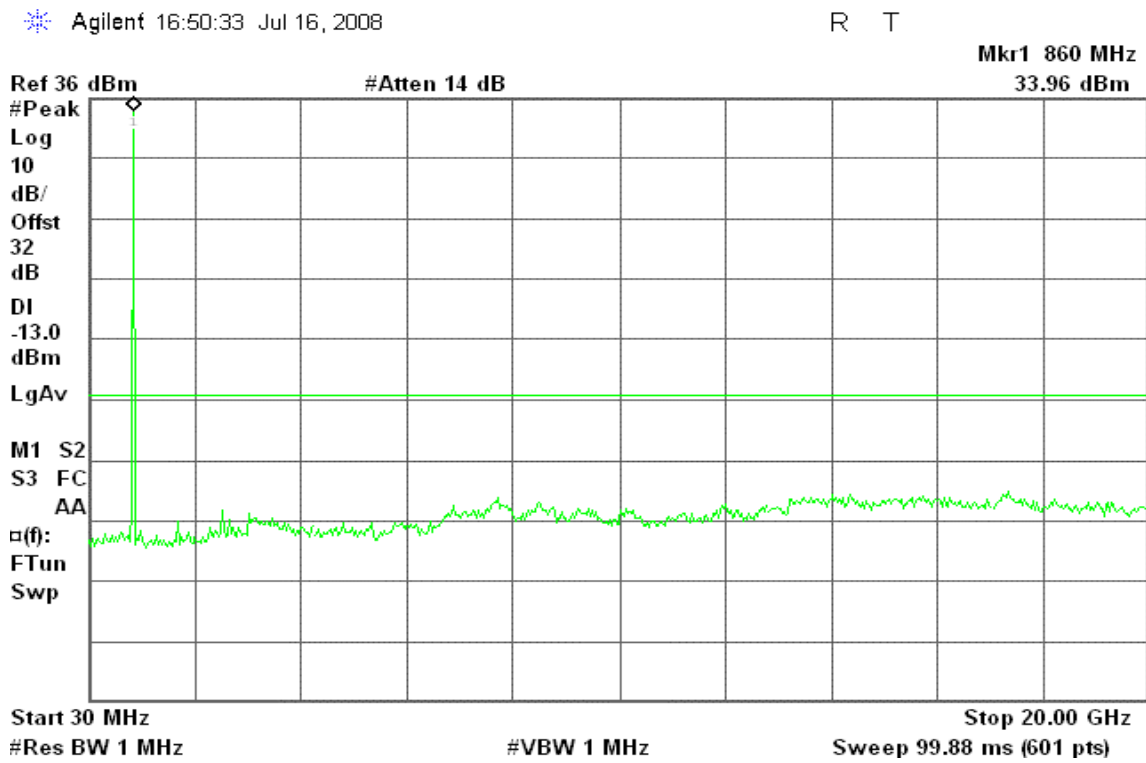



Figure 7-3: Out of Band emission at antenna terminals – GSM CH High



### GPRS 850

Figure 7-4: Out of Band emission at antenna terminals – GPRS CH Low

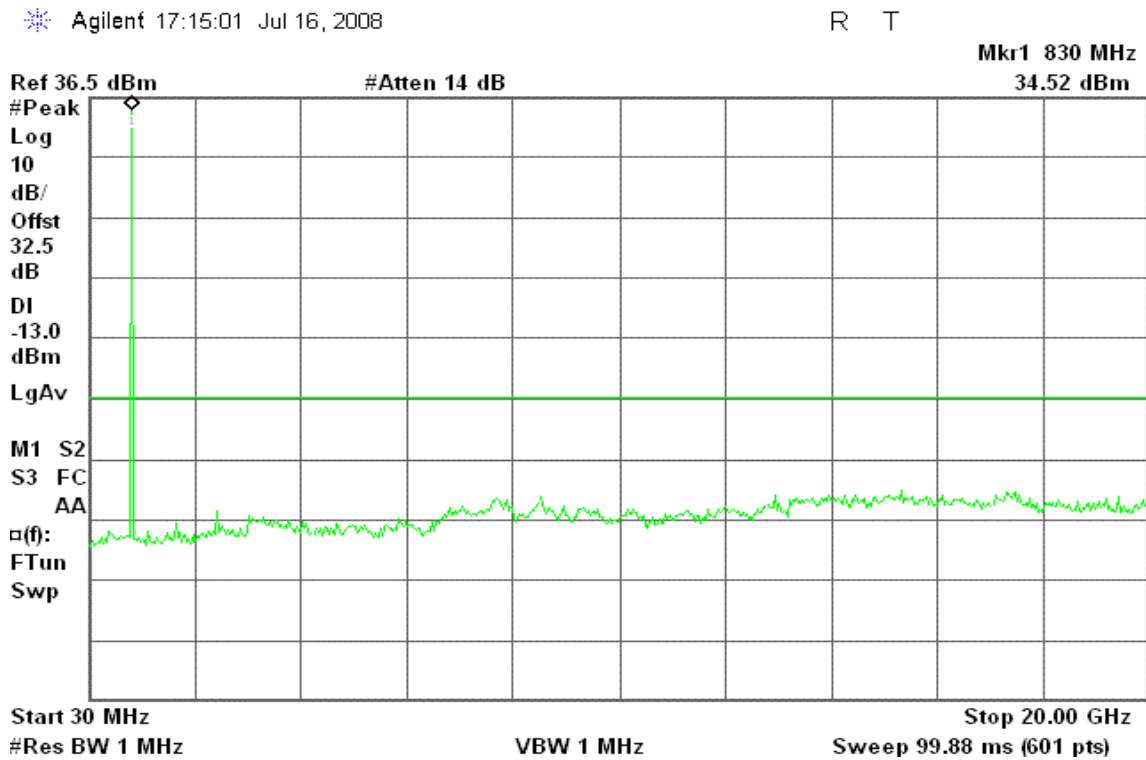



Figure 7-5: Out of Band emission at antenna terminals – GPRS CH Mid

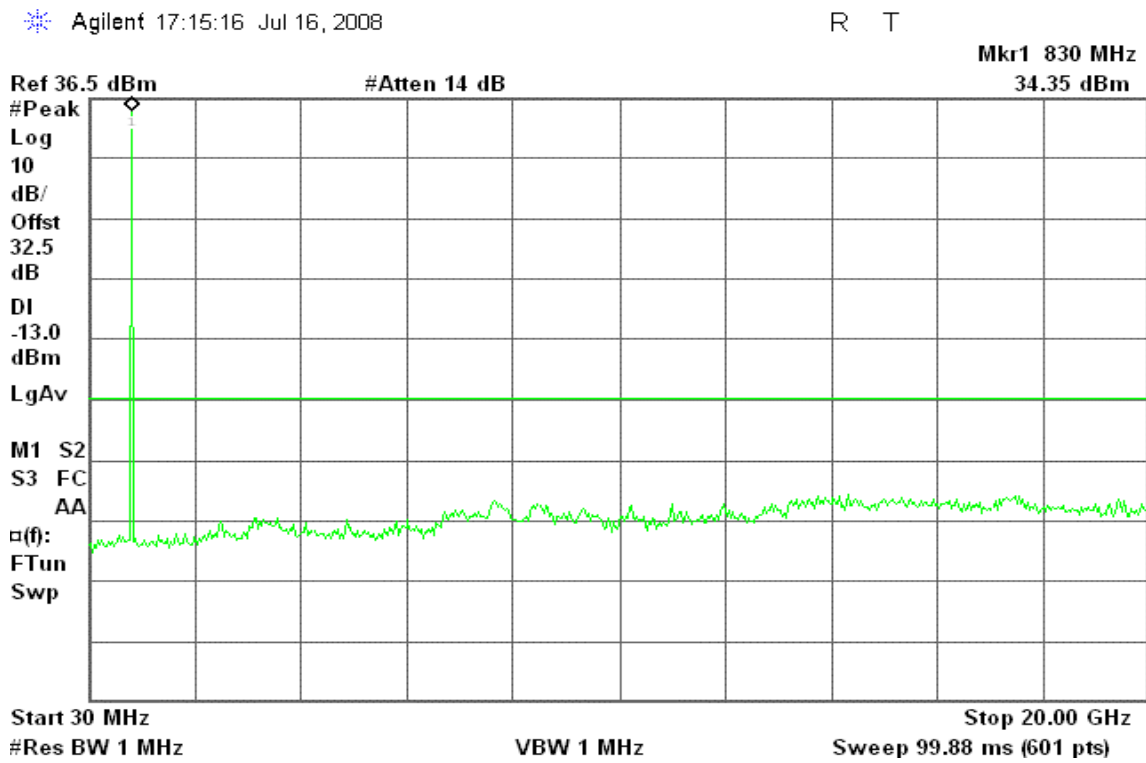
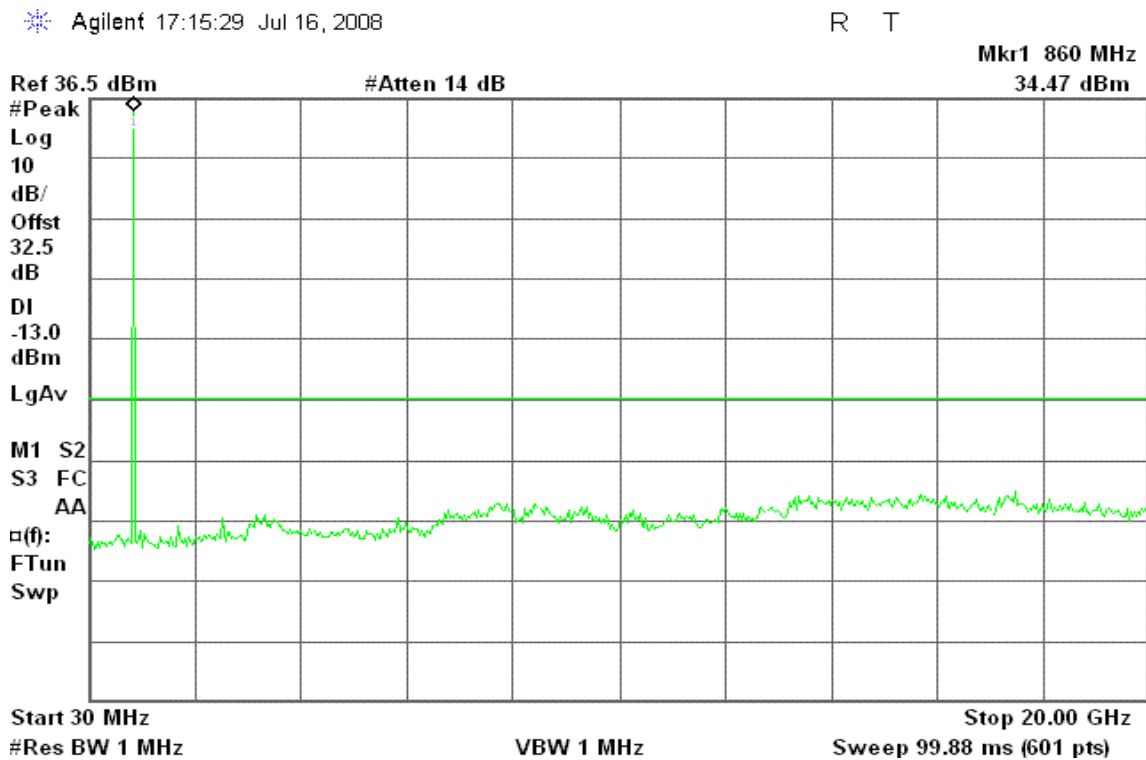

Figure 7-6: Out of Band emission at antenna terminals – GPRS CH High





### GSM 1900

Figure 8-1: Out of Band emission at antenna terminals – GSM CH Low

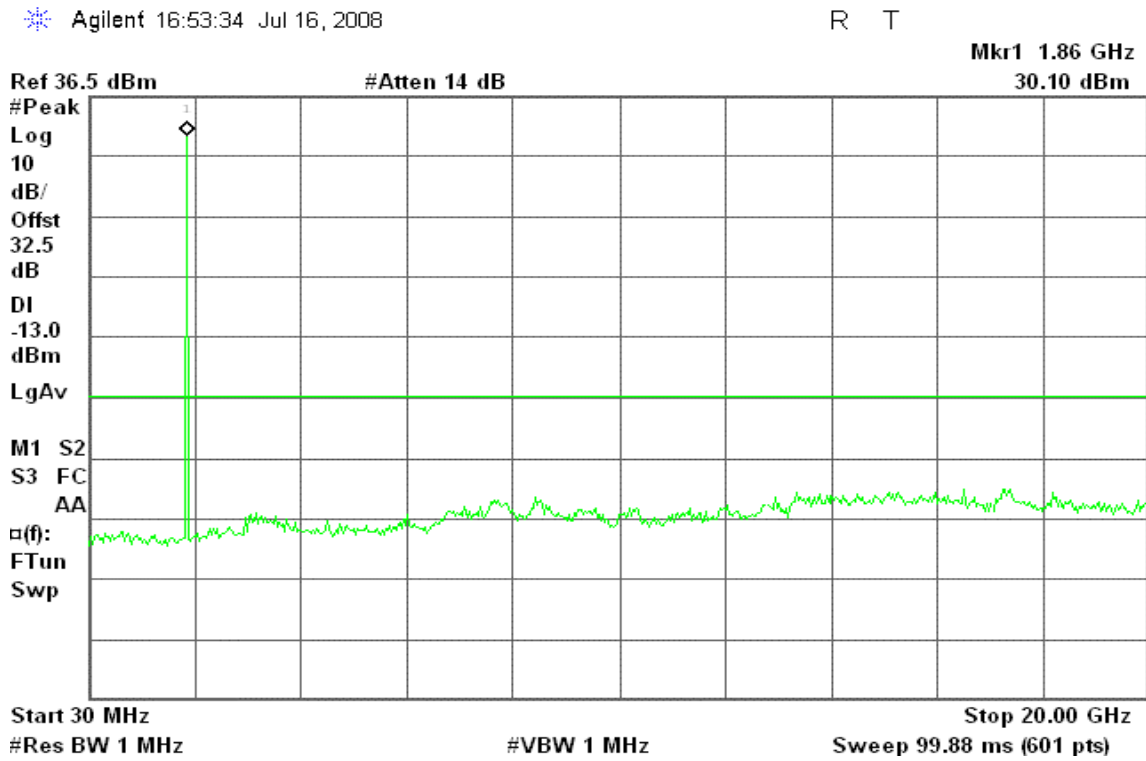

Figure 8-2: Out of Band emission at antenna terminals – GSM CH Mid

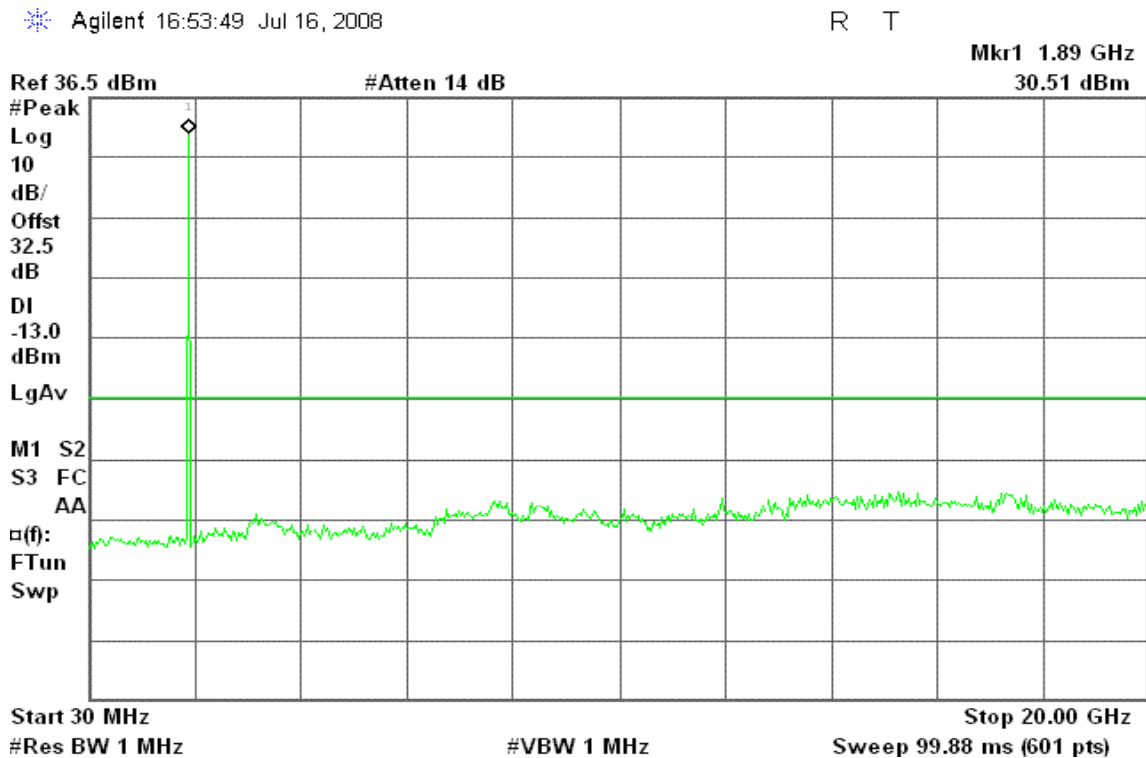
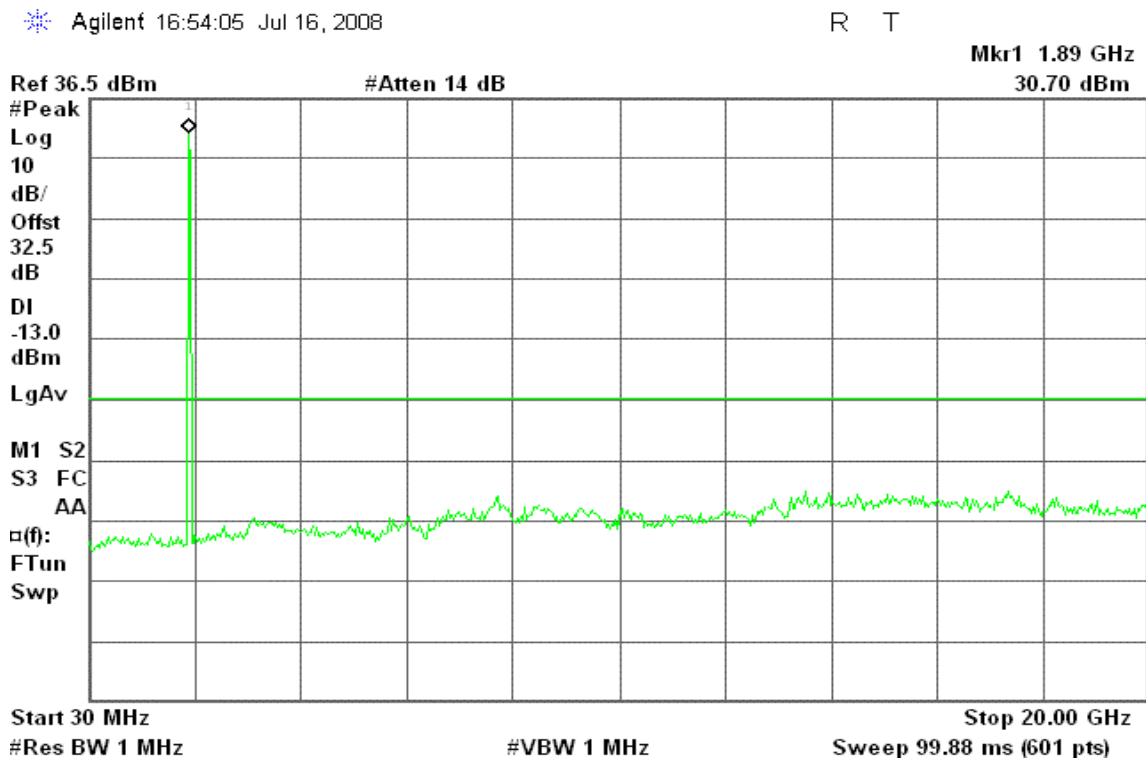



Figure 8-3: Out of Band emission at antenna terminals – GSM CH High



### GPRS 1900

Figure 8-4: Out of Band emission at antenna terminals – GPRS CH Low

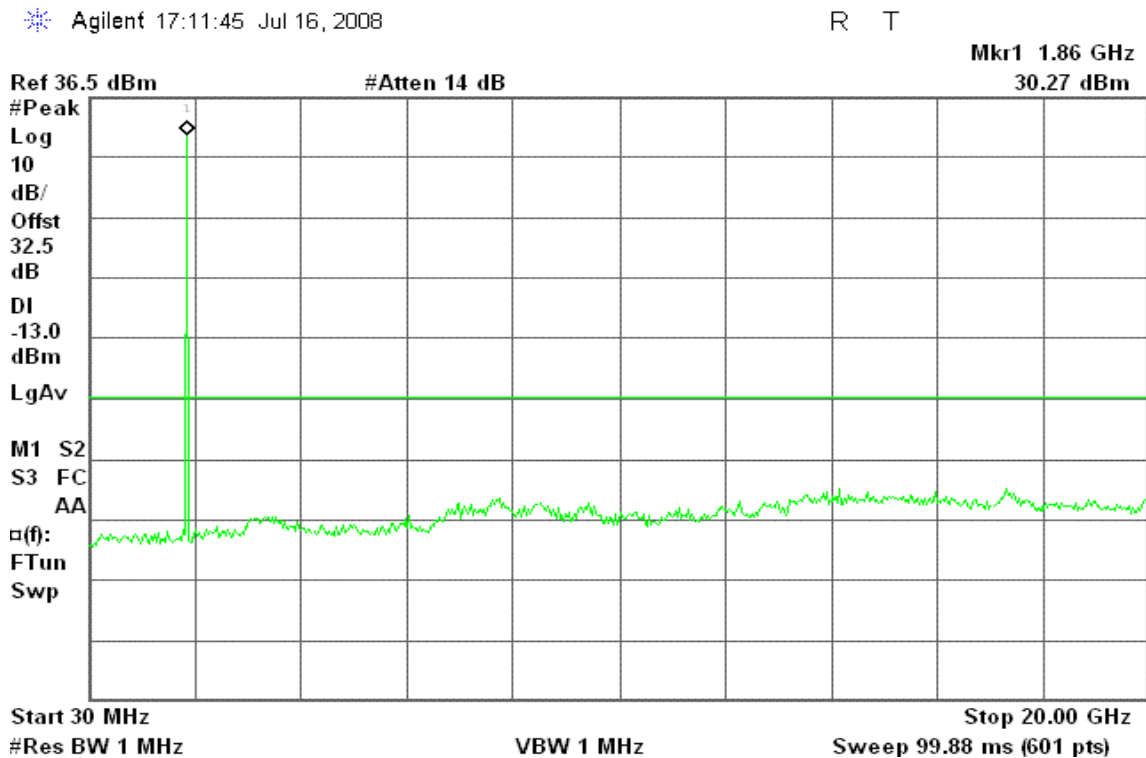



Figure 8-5: Out of Band emission at antenna terminals – GPRS CH Mid

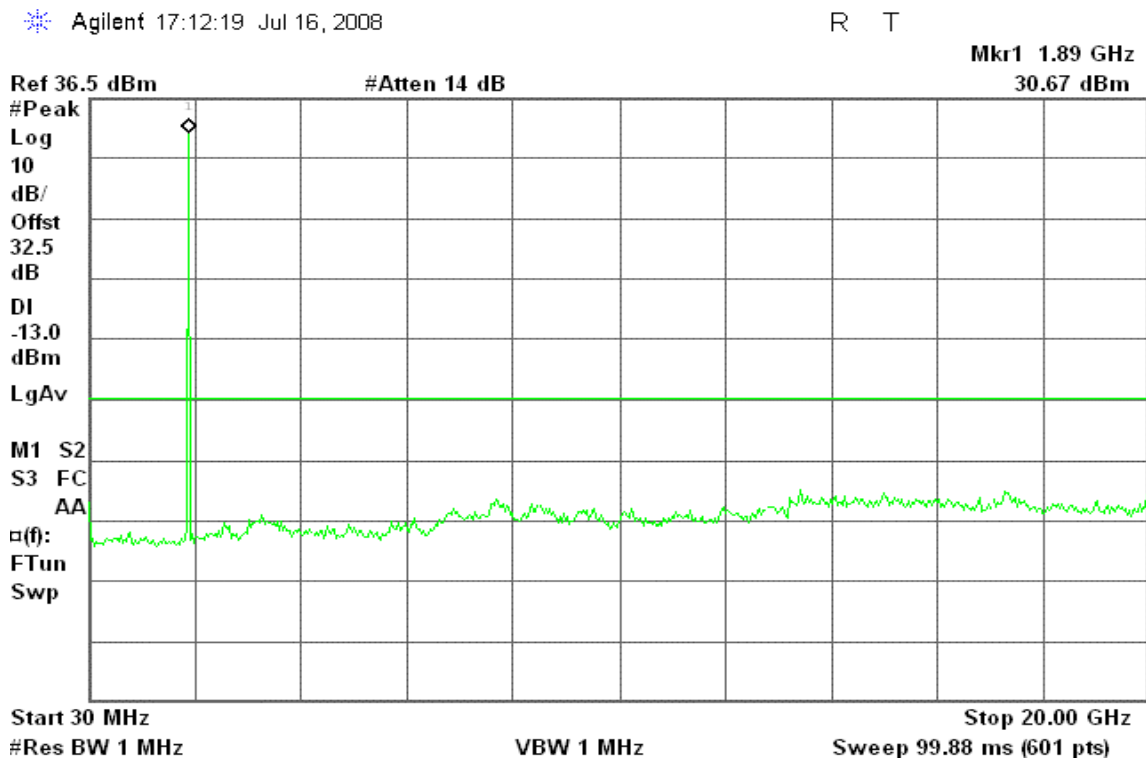

Figure 8-6: Out of Band emission at antenna terminals – GPRS CH High





### GSM 850

Figure 9-1: Band Edge emissions – GSM CH Low

Agilent 16:47:57 Jul 16, 2008

R T

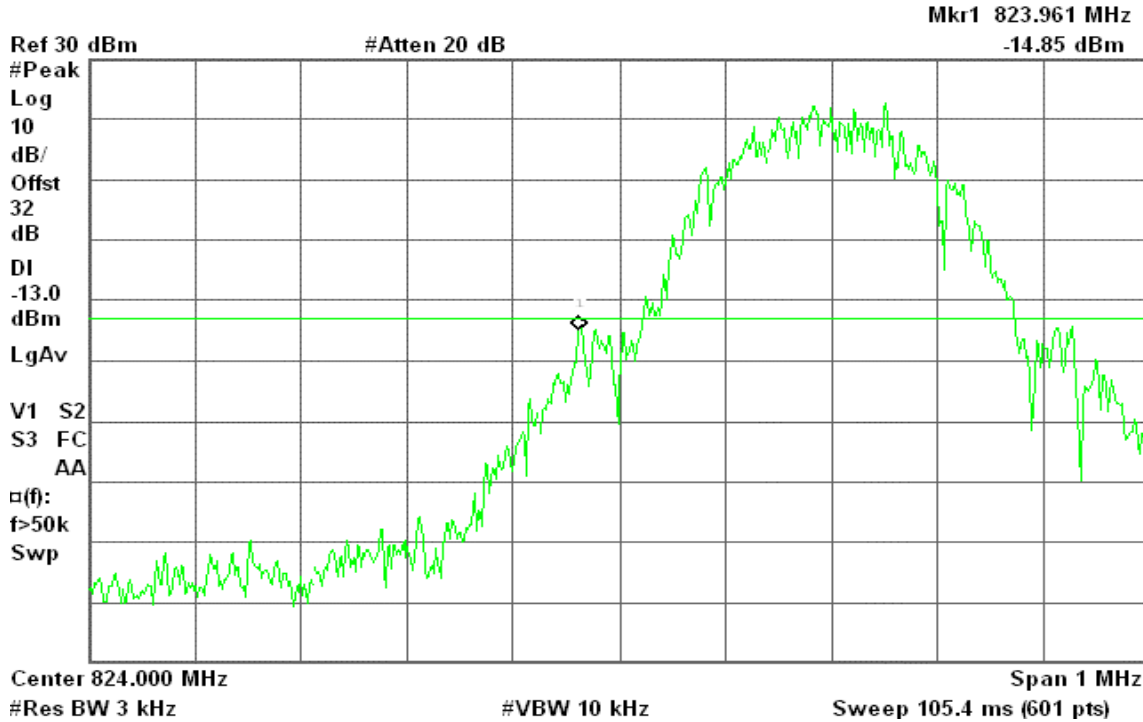
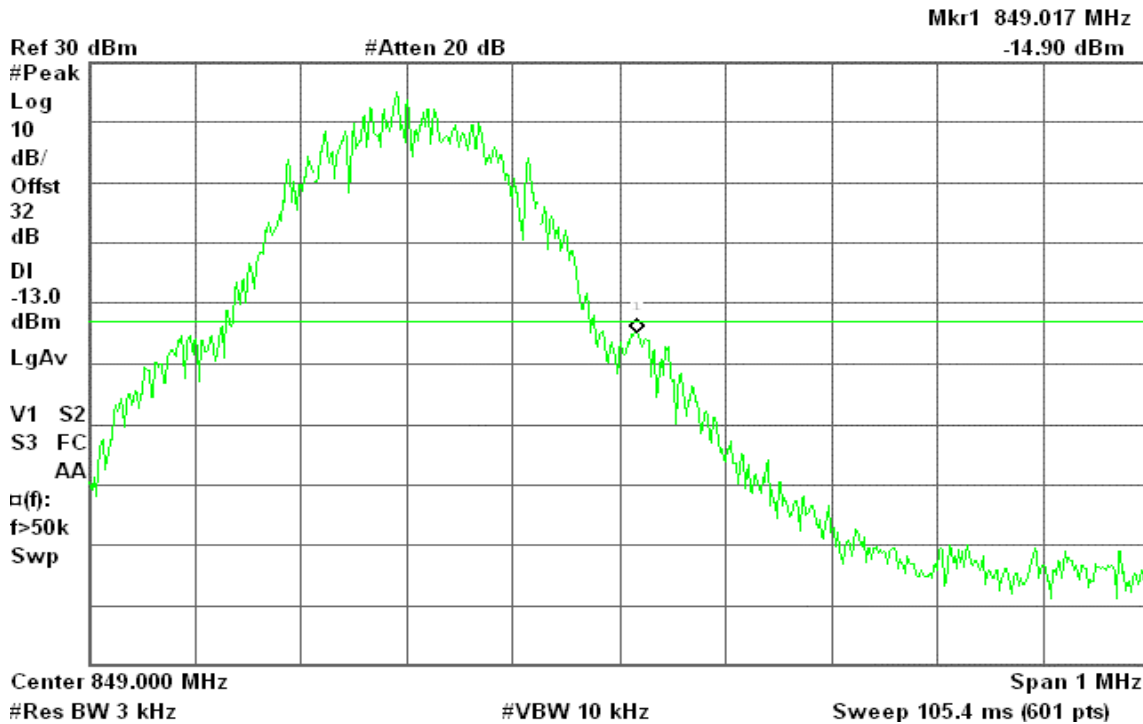

Figure 9-2: Band Edge emissions – GSM CH High

Agilent 16:47:23 Jul 16, 2008

R T





### GPRS 850

Figure 9-3: Band Edge emissions – GPRS CH Low

Agilent 17:21:45 Jul 16, 2008

R T

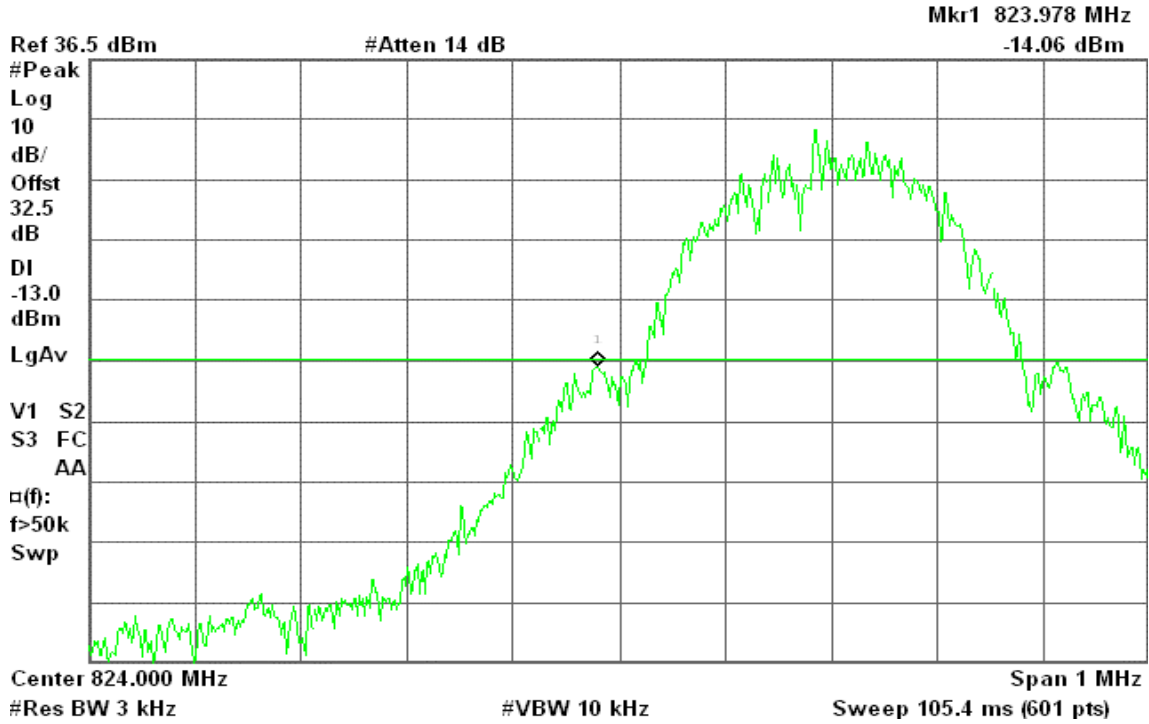
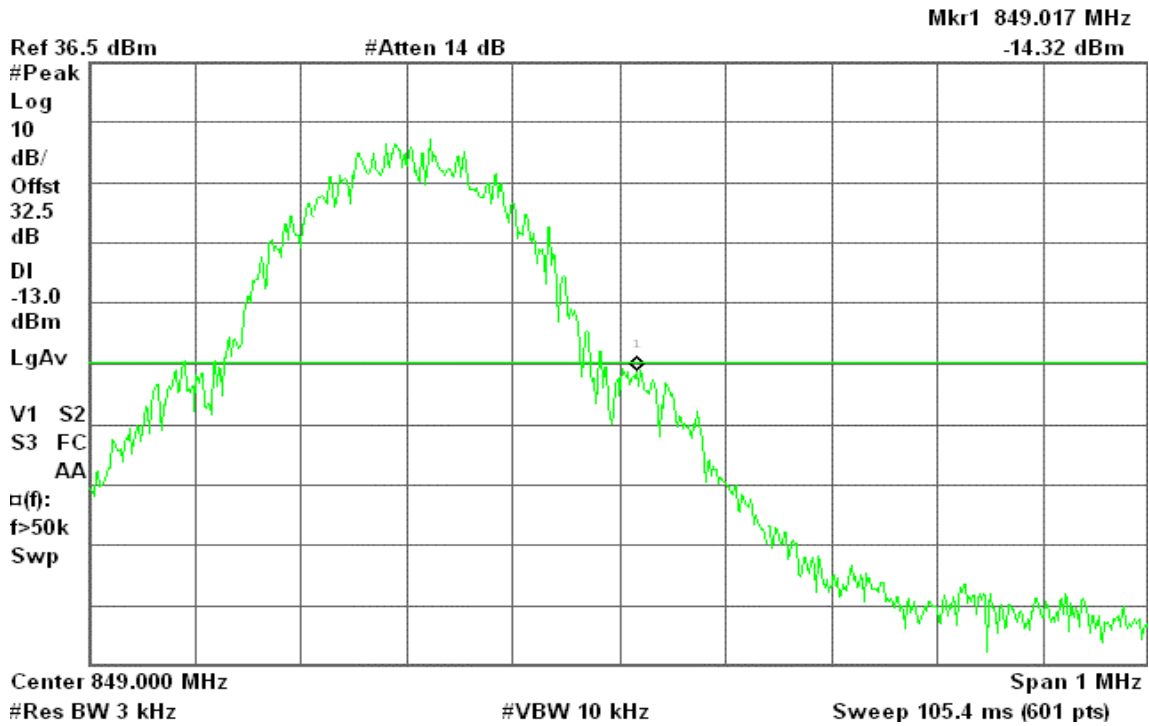

Figure 9-4: Band Edge emissions –GPRS CH High

Agilent 17:16:43 Jul 16, 2008

R T







### GSM 1900

Figure 10-1: Band Edge emissions – GSM CH Low

Agilent 16:55:56 Jul 16, 2008

R T

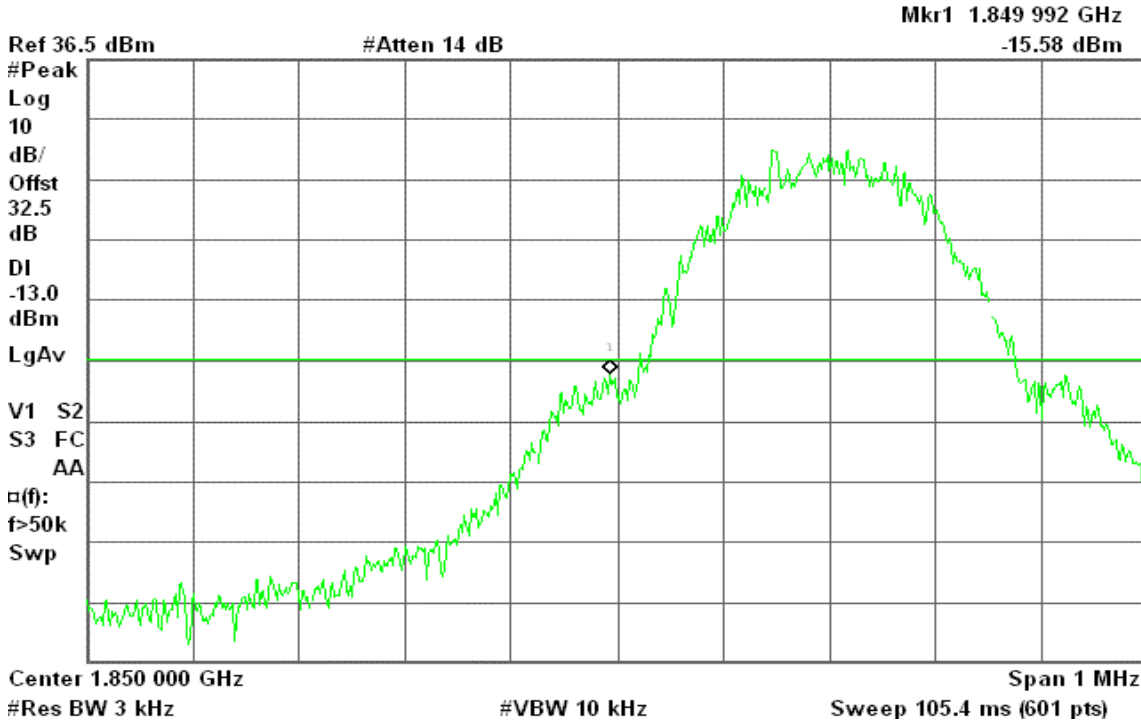
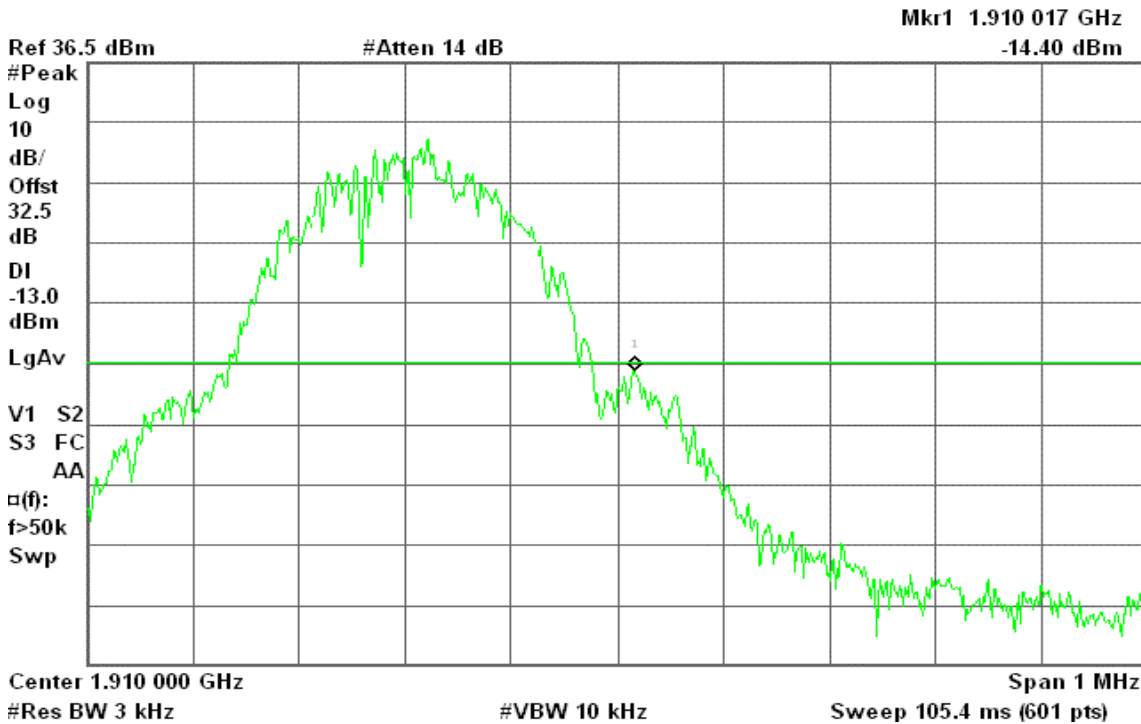

Figure 10-2: Band Edge emissions – GSM CH High

Agilent 16:55:21 Jul 16, 2008

R T





### GPRS 1900

Figure 10-3: Band Edge emissions – GPRS CH Low

Agilent 17:08:29 Jul 16, 2008

R T

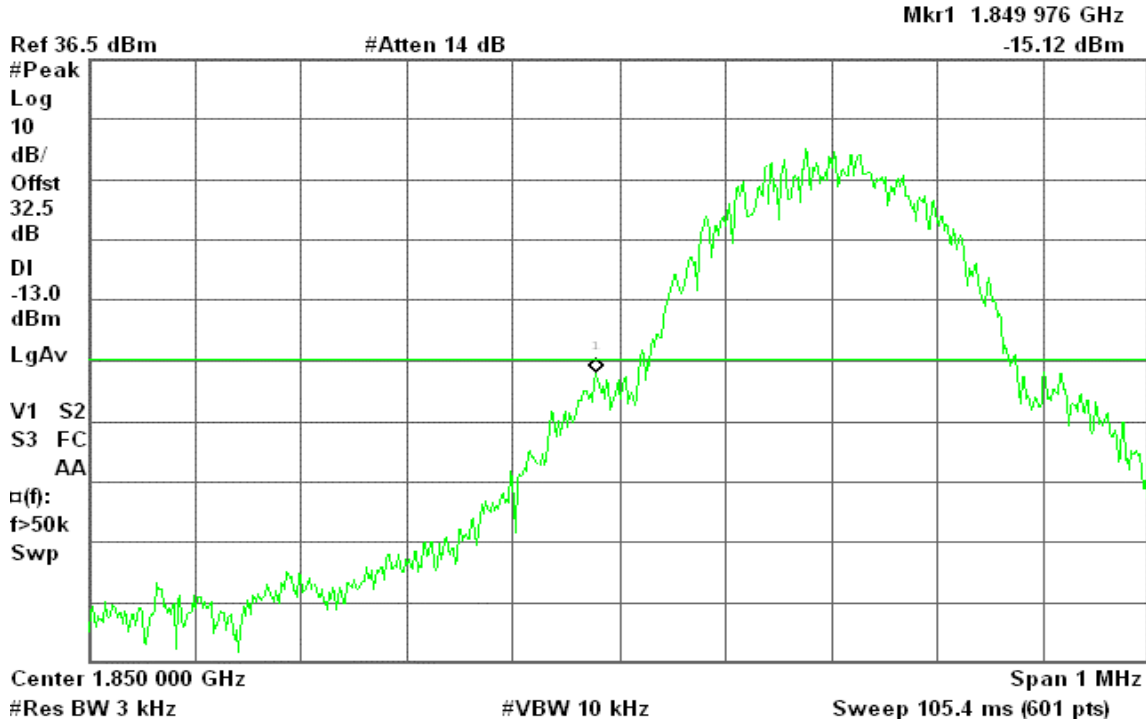
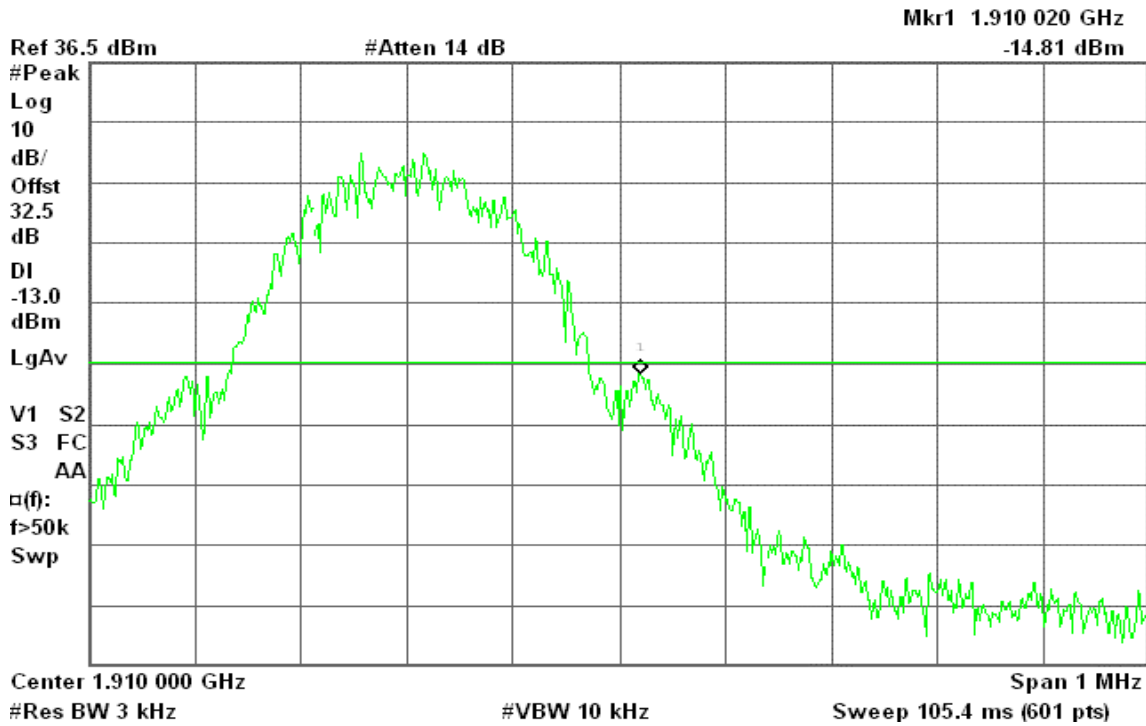

Figure 10-4: Band Edge emissions – GPRS CH High

Agilent 17:08:03 Jul 16, 2008

R T





### EGPRS 850

Figure 11-1: Out of Band emission at antenna terminals –EGPRS CH Low

Agilent 10:18:03 Jul 17, 2008

R T

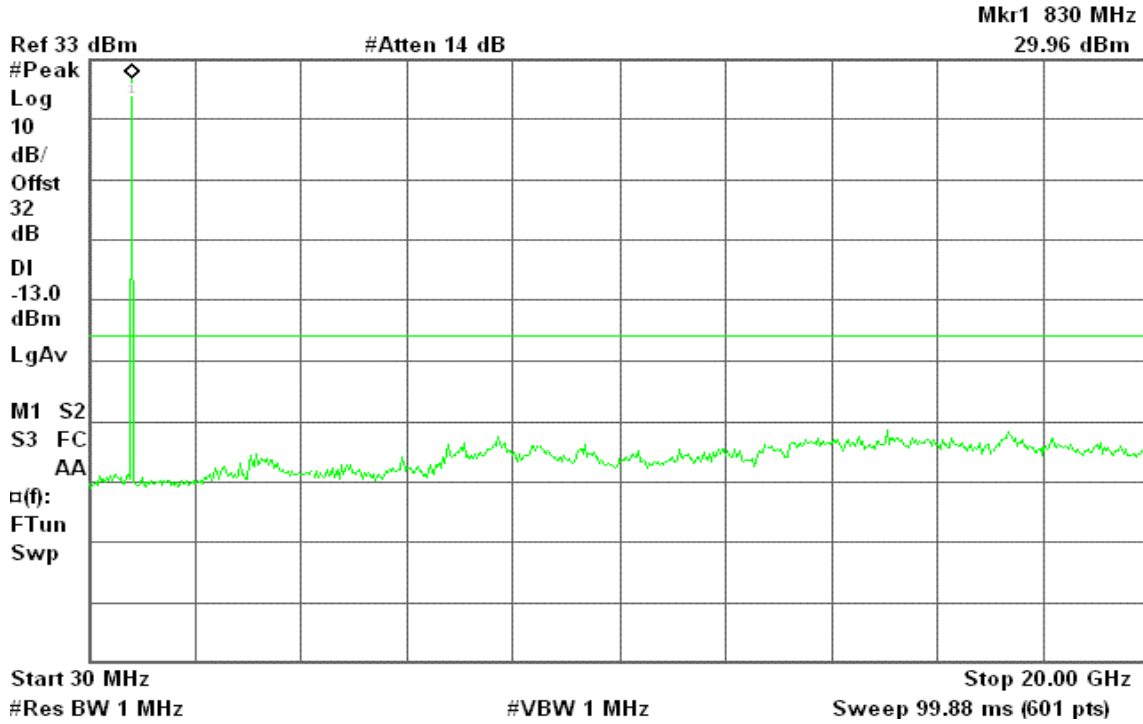

Figure 11-2: Out of Band emission at antenna terminals –EGPRS CH Mid

Agilent 10:21:03 Jul 17, 2008

R T

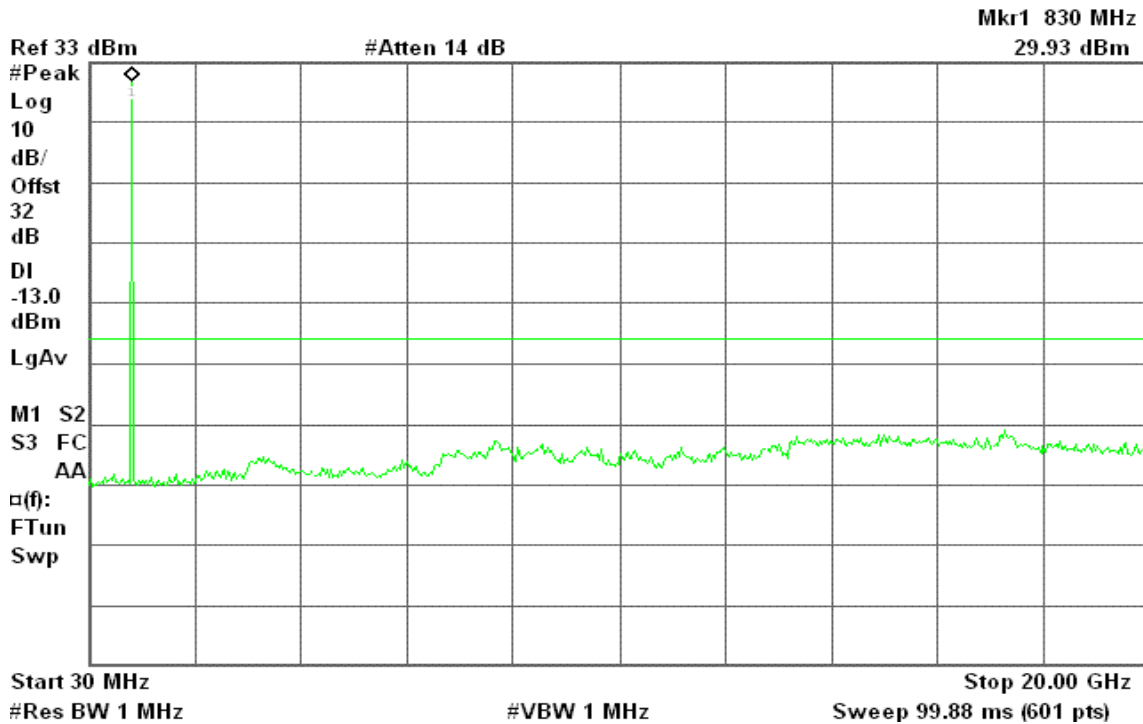
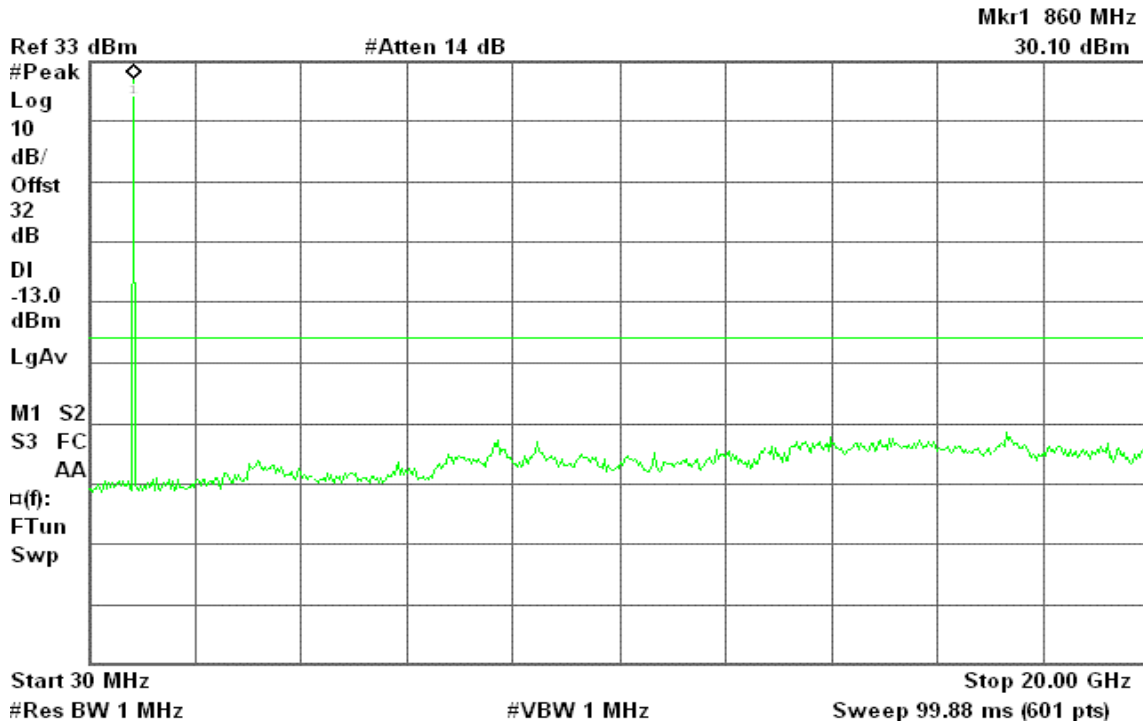



Figure 11-3: Out of Band emission at antenna terminals –EGPRS CH High

Agilent 10:21:30 Jul 17, 2008

R T



### EGPRS 1900

Figure 11-4: Out of Band emission at antenna terminals –EGPRS CH Low

Agilent 10:25:36 Jul 17, 2008

R T

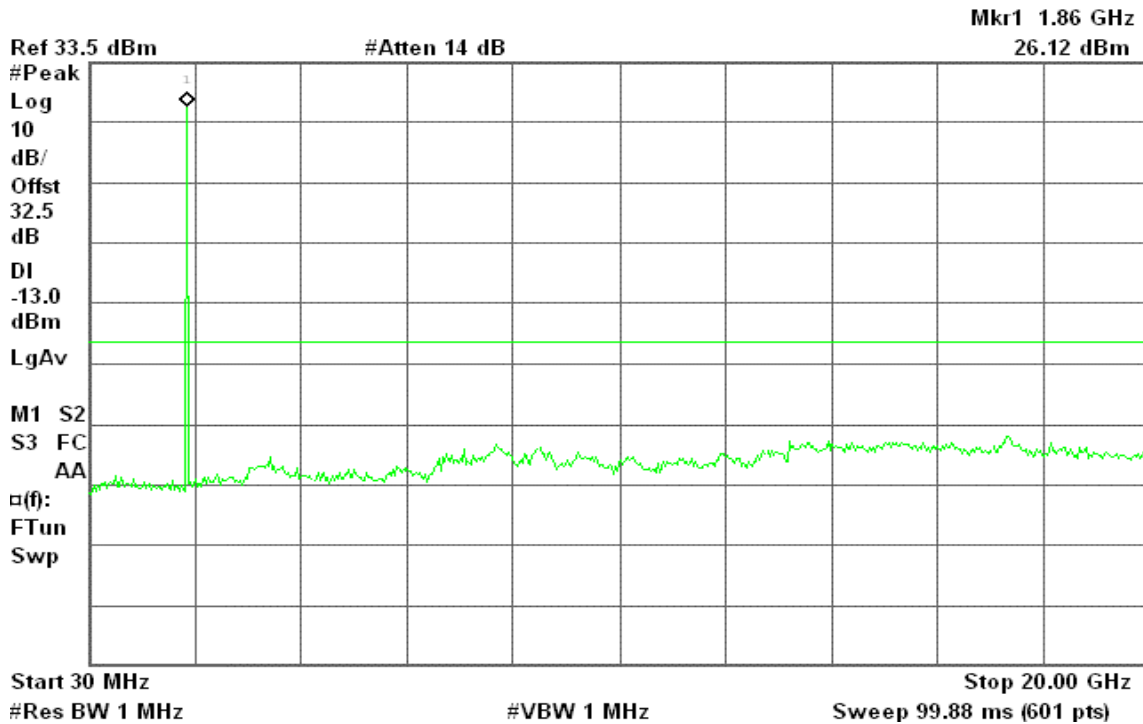



Figure 11-5: Out of Band emission at antenna terminals –EGPRS CH Mid

Agilent 10:25:53 Jul 17, 2008

R T

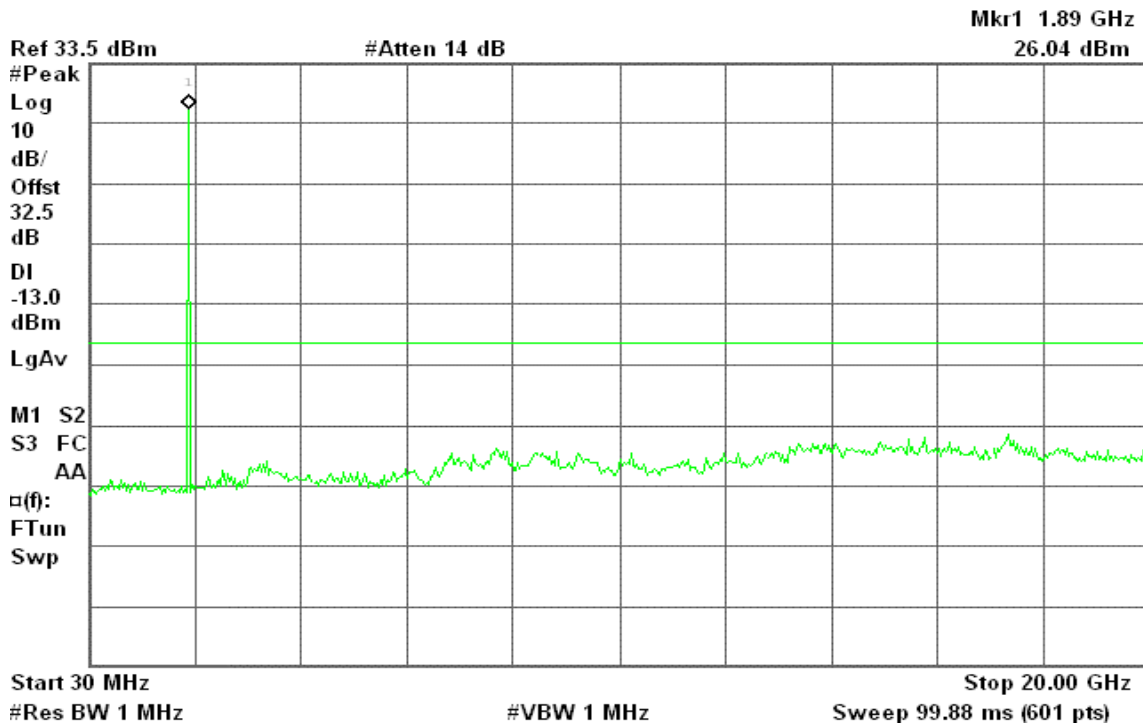
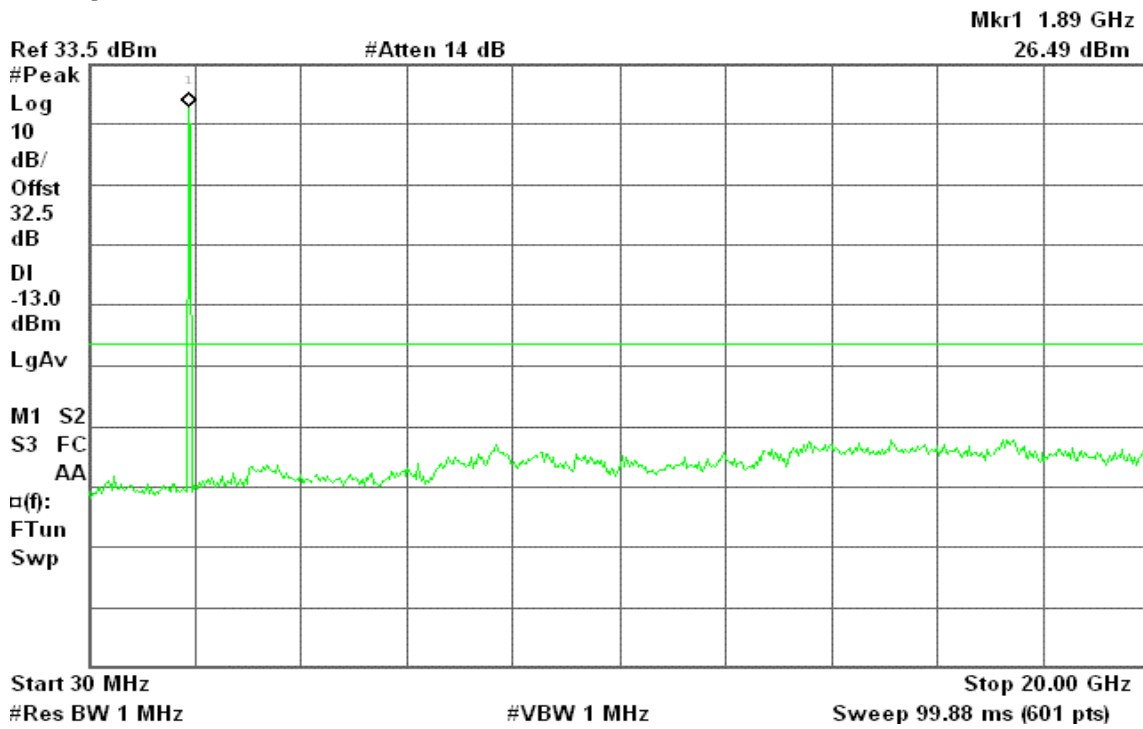

Figure 11-6: Out of Band emission at antenna terminals –EGPRS CH High

Agilent 10:26:14 Jul 17, 2008

R T





### EGPRS 850

Figure 12-1: Band Edge emissions – EGPRS CH Low

Agilent 10:15:31 Jul 17, 2008

R T

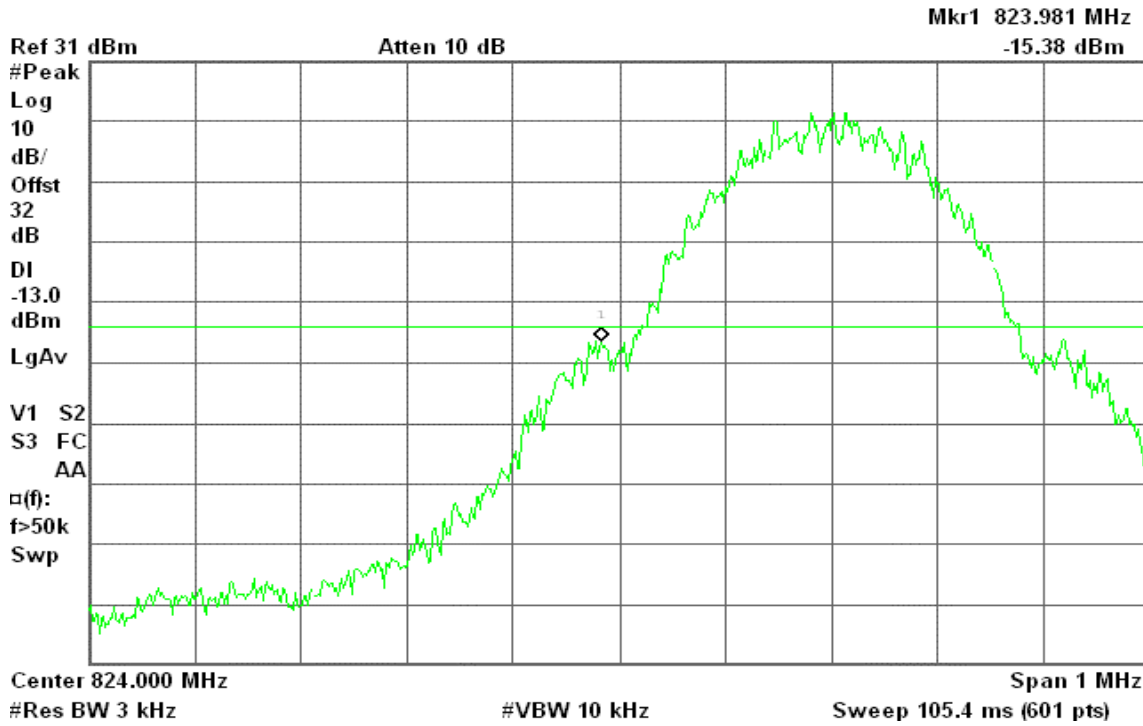
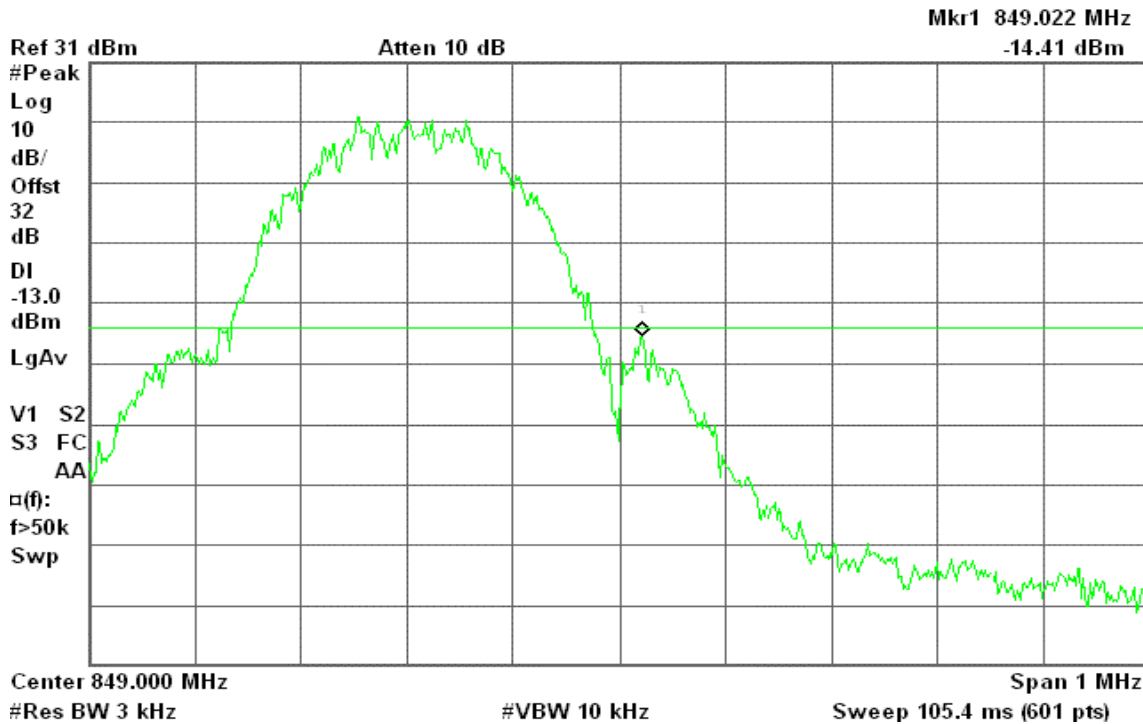

Figure 12-2: Band Edge emissions – EGPRS CH High

Agilent 10:14:35 Jul 17, 2008

R T





### EGPRS 1900

Figure 12-3: Band Edge emissions – EGPRS CH Low

Agilent 10:31:36 Jul 17, 2008

R T

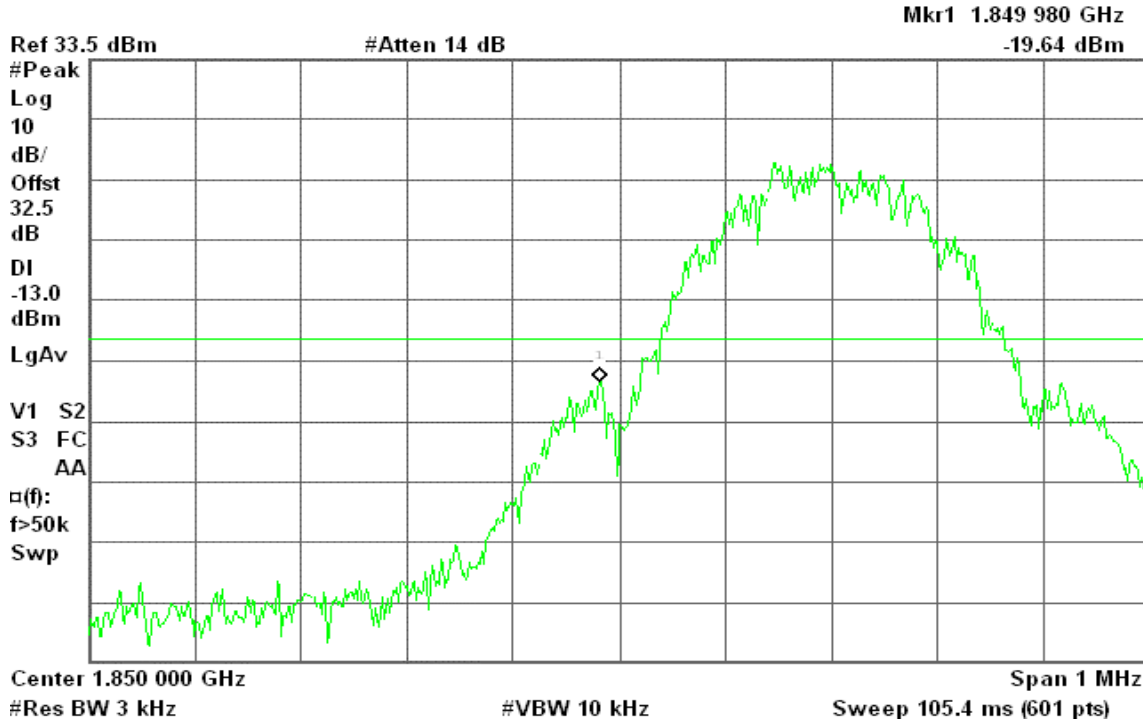
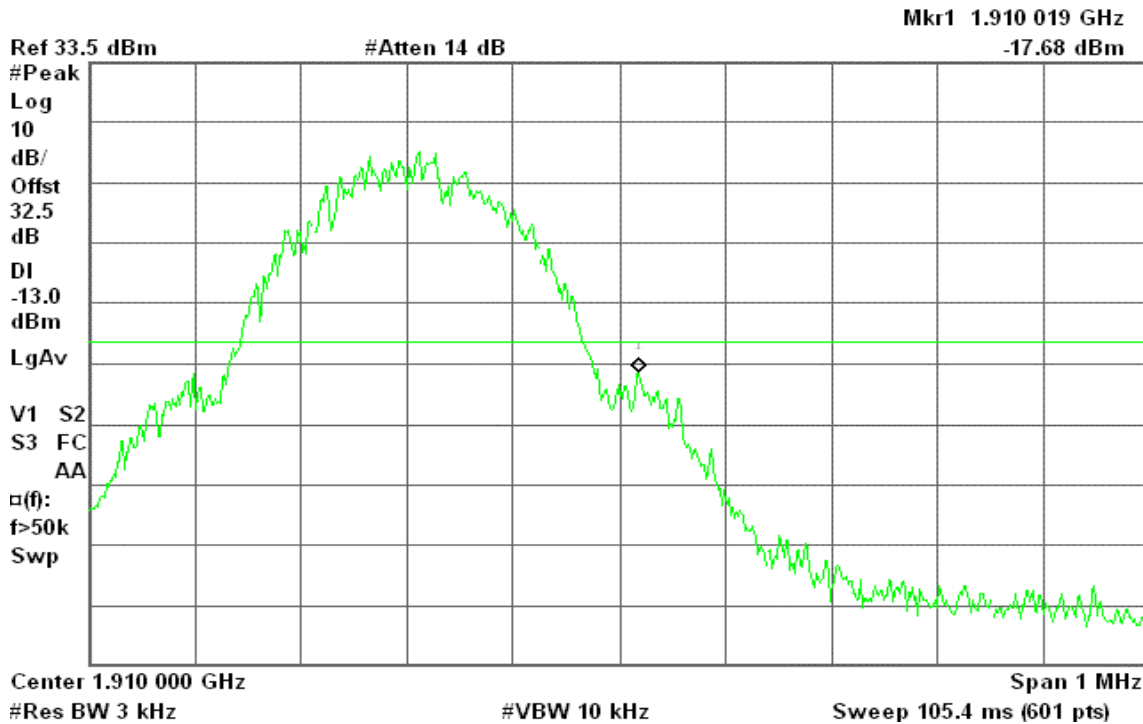

Figure 12-4: Band Edge emissions – EGPRS CH High

Agilent 10:27:30 Jul 17, 2008

R T



## 7.5 FIELD STRENGTH OF SPURIOUS RADIATION MEASUREMENT

### LIMIT

According to FCC §2.1053

### Test Configuration

#### Below 1 GHz

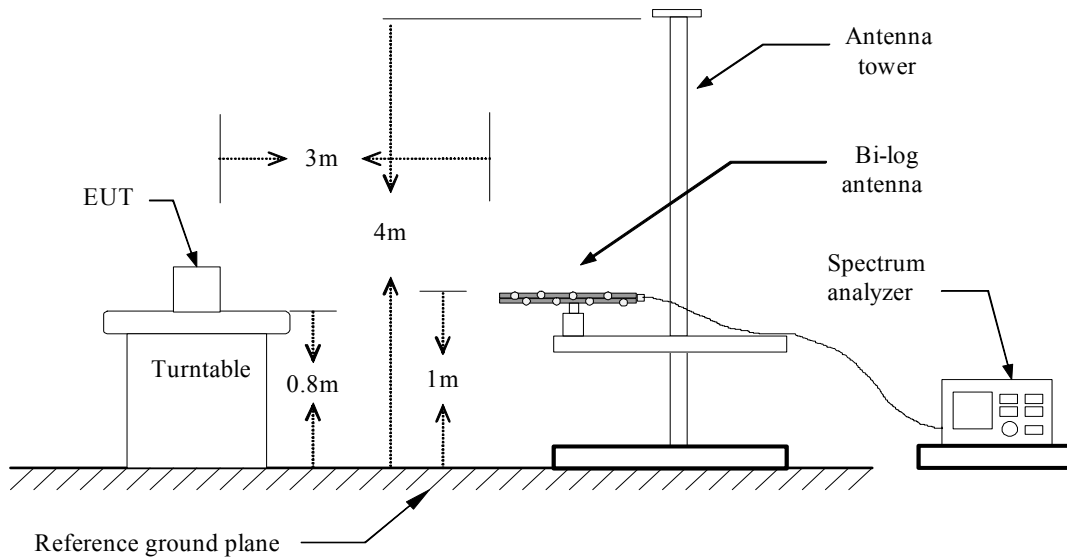

#### Above 1 GHz

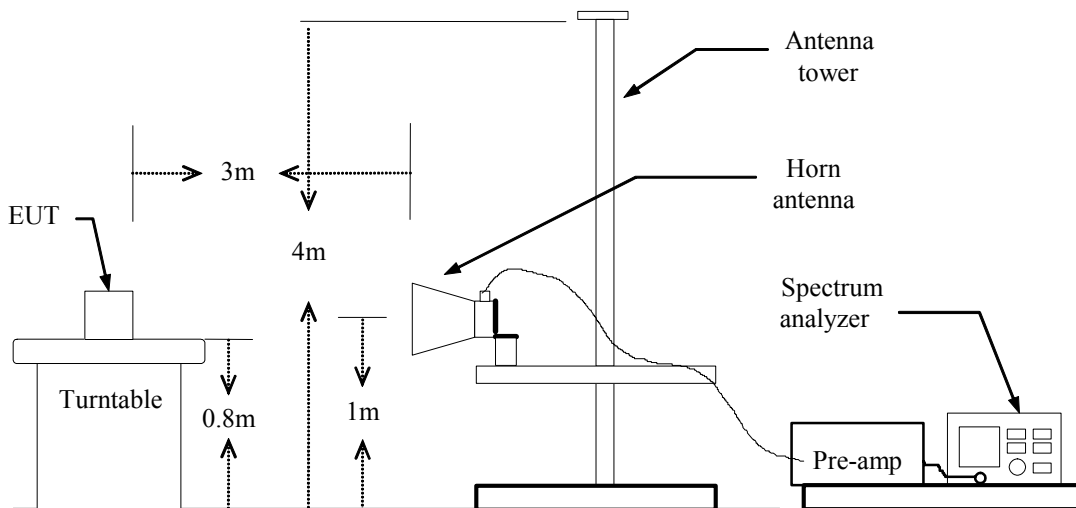



**Substituted Method Test Set-up**

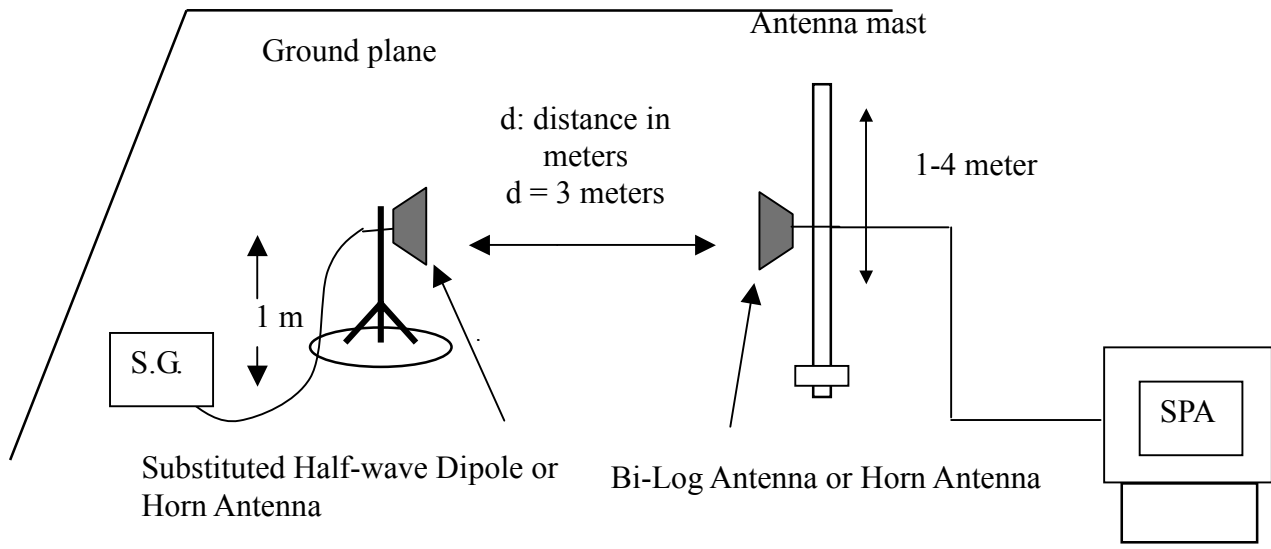

**TEST PROCEDURE**

The EUT was placed on a non-conductive, the measurement antenna was placed at a distance of 3 meters from the EUT. During the tests, the antenna height and the EUT azimuth were varied in order to identify the maximum level of emissions from the EUT. This maximization process was repeated with the EUT positioned in each of its three orthogonal orientations.

The frequency range up to tenth harmonic was investigated for each of three fundamental frequency (low, middle and high channels). Once spurious emission were identified, the power of the emission was determined using the substitution method.

The spurious emissions attenuation was calculated as the difference between radiated power at the fundamental frequency and the spurious emissions frequency.

$$ERP = \text{S.G. output (dBm)} + \text{Antenna Gain (dBd)} - \text{Cable (dB)}$$

$$EIRP = \text{S.G. output (dBm)} + \text{Antenna Gain (dBi)} - \text{Cable (dB)}$$

**TEST RESULTS**

*Refer to the attached tabular data sheets.*

**Radiated Spurious Emission Measurement Result****Below 1GHz****Operation Mode:** GSM 850 / TX / CH 128**Test Date:** July 17, 2008**Temperature:** 25°C**Tested by:** Mark Yang**Humidity:** 50 % RH**Polarity:** Ver. / Hor.

Frequency (MHz)	Antenna Polarization (V/H)	Reading (dBm)	Correction Factor (dB)	Emission level (dBm)	Limit (dBm)	Margin (dB)
50.37	V	-54.22	-16.44	-70.66	-13.00	-57.66
86.26	V	-48.70	-20.68	-69.38	-13.00	-56.38
150.28	V	-66.66	-12.22	-78.88	-13.00	-65.88
196.84	V	-64.85	-13.85	-78.70	-13.00	-65.70
368.53	V	-66.19	-12.13	-78.32	-13.00	-65.32
512.09	V	-65.55	-7.90	-73.44	-13.00	-60.44
99.84	H	-47.71	-18.98	-66.69	-13.00	-53.69
368.53	H	-59.95	-12.02	-71.98	-13.00	-58.98
408.30	H	-57.78	-10.42	-68.19	-13.00	-55.19
512.09	H	-62.05	-7.96	-70.01	-13.00	-57.01
681.84	H	-63.17	-6.18	-69.35	-13.00	-56.35
924.34	H	-67.84	-3.16	-71.00	-13.00	-58.00

***Remark:***

- 1. The emission behaviour belongs to narrowband spurious emission.*
- 2. Measurements above show only up to 6 maximum emissions noted, or would be lesser; with " N/A " remark, if no specific emissions from the EUT are recorded (ie: margin > 20dB from the applicable limit) and considered that's already beyond the background noise floor.*



Operation Mode: GSM 850 / TX / CH 190

Test Date: July 17, 2008

Temperature: 25°C

Tested by: Mark Yang

Humidity: 50 % RH

Polarity: Ver. / Hor.

Frequency (MHz)	Antenna Polarization (V/H)	Reading (dBm)	Correction Factor (dB)	Emission level (dBm)	Limit (dBm)	Margin (dB)
50.37	V	-54.01	-16.44	-70.45	-13.00	-57.45
86.26	V	-50.30	-20.68	-70.98	-13.00	-57.98
119.24	V	-64.68	-14.38	-79.06	-13.00	-66.06
146.40	V	-67.20	-12.19	-79.39	-13.00	-66.39
195.87	V	-66.93	-14.00	-80.93	-13.00	-67.93
287.05	V	-67.29	-12.27	-79.56	-13.00	-66.56
130.88	H	-50.46	-14.72	-65.18	-13.00	-52.18
368.53	H	-63.76	-12.02	-75.78	-13.00	-62.78
409.27	H	-65.58	-10.38	-75.96	-13.00	-62.96
453.89	H	-61.65	-9.16	-70.81	-13.00	-57.81
523.73	H	-67.41	-7.98	-75.39	-13.00	-62.39
967.02	H	-61.56	-2.88	-64.44	-13.00	-51.44

**Remark:**

1. The emission behaviour belongs to narrowband spurious emission.
2. Measurements above show only up to 6 maximum emissions noted, or would be lesser, with " N/A " remark, if no specific emissions from the EUT are recorded (ie: margin > 20dB from the applicable limit) and considered that's already beyond the background noise floor.



Operation Mode: GSM 850 / TX / CH 251

Test Date: July 17, 2008

Temperature: 25°C

Tested by: Mark Yang

Humidity: 50 % RH

Polarity: Ver. / Hor.

Frequency (MHz)	Antenna Polarization (V/H)	Reading (dBm)	Correction Factor (dB)	Emission level (dBm)	Limit (dBm)	Margin (dB)
50.37	V	-54.46	-16.44	-70.90	-13.00	-57.90
86.26	V	-50.33	-20.68	-71.01	-13.00	-58.01
150.28	V	-66.74	-12.22	-78.96	-13.00	-65.96
206.54	V	-62.36	-14.74	-77.10	-13.00	-64.10
368.53	V	-66.66	-12.13	-78.79	-13.00	-65.79
409.27	V	-67.40	-10.34	-77.74	-13.00	-64.74
86.26	H	-51.00	-21.73	-72.73	-13.00	-59.73
116.33	H	-63.07	-15.10	-78.16	-13.00	-65.16
149.31	H	-66.74	-13.29	-80.02	-13.00	-67.02
368.53	H	-63.43	-12.02	-75.46	-13.00	-62.46
409.27	H	-65.89	-10.38	-76.27	-13.00	-63.27
452.92	H	-68.34	-9.18	-77.52	-13.00	-64.52

**Remark:**

1. The emission behaviour belongs to narrowband spurious emission.
2. Measurements above show only up to 6 maximum emissions noted, or would be lesser, with " N/A " remark, if no specific emissions from the EUT are recorded (ie: margin > 20dB from the applicable limit) and considered that's already beyond the background noise floor.



Operation Mode: GPRS 850 / TX / CH 128

Test Date: July 17, 2008

Temperature: 25°C

Tested by: Mark Yang

Humidity: 50 % RH

Polarity: Ver. / Hor.

Frequency (MHz)	Antenna Polarization (V/H)	Reading (dBm)	Correction Factor (dB)	Emission level (dBm)	Limit (dBm)	Margin (dB)
66.86	V	-48.91	-15.47	-64.38	-13.00	-51.38
86.26	V	-41.72	-20.68	-62.40	-13.00	-49.40
171.62	V	-56.08	-13.91	-69.99	-13.00	-56.99
226.91	V	-56.23	-14.52	-70.75	-13.00	-57.75
326.82	V	-57.97	-12.96	-70.92	-13.00	-57.92
452.92	V	-58.93	-9.22	-68.15	-13.00	-55.15
86.26	H	-42.01	-21.73	-63.74	-13.00	-50.74
99.84	H	-46.96	-18.98	-65.95	-13.00	-52.95
384.05	H	-60.06	-11.43	-71.48	-13.00	-58.48
408.30	H	-56.17	-10.42	-66.59	-13.00	-53.59
512.09	H	-60.27	-7.96	-68.22	-13.00	-55.22
682.81	H	-62.52	-6.17	-68.70	-13.00	-55.70

**Remark:**

1. The emission behaviour belongs to narrowband spurious emission.
2. Measurements above show only up to 6 maximum emissions noted, or would be lesser, with " N/A " remark, if no specific emissions from the EUT are recorded (ie: margin > 20dB from the applicable limit) and considered that's already beyond the background noise floor.



Operation Mode: GPRS 850 / TX / CH 190

Test Date: July 17, 2008

Temperature: 25°C

Tested by: Mark Yang

Humidity: 50 % RH

Polarity: Ver. / Hor.

Frequency (MHz)	Antenna Polarization (V/H)	Reading (dBm)	Correction Factor (dB)	Emission level (dBm)	Limit (dBm)	Margin (dB)
66.86	V	-48.88	-15.47	-64.34	-13.00	-51.34
86.26	V	-42.64	-20.68	-63.33	-13.00	-50.33
171.62	V	-56.55	-13.91	-70.46	-13.00	-57.46
226.91	V	-56.00	-14.52	-70.52	-13.00	-57.52
326.82	V	-57.85	-12.96	-70.81	-13.00	-57.81
452.92	V	-59.31	-9.22	-68.53	-13.00	-55.53
86.26	H	-40.74	-21.73	-62.47	-13.00	-49.47
130.88	H	-51.38	-14.72	-66.10	-13.00	-53.10
200.72	H	-60.98	-12.25	-73.22	-13.00	-60.22
368.53	H	-60.29	-12.02	-72.32	-13.00	-59.32
427.70	H	-59.75	-9.74	-69.49	-13.00	-56.49
967.99	H	-61.23	-2.86	-64.09	-13.00	-51.09

**Remark:**

1. The emission behaviour belongs to narrowband spurious emission.
2. Measurements above show only up to 6 maximum emissions noted, or would be lesser, with " N/A " remark, if no specific emissions from the EUT are recorded (ie: margin > 20dB from the applicable limit) and considered that's already beyond the background noise floor.



**Operation Mode:** GPRS 850 / TX / CH 251

**Test Date:** July 17, 2008

**Temperature:** 25°C

**Tested by:** Mark Yang

**Humidity:** 50 % RH

**Polarity:** Ver. / Hor.

Frequency (MHz)	Antenna Polarization (V/H)	Reading (dBm)	Correction Factor (dB)	Emission level (dBm)	Limit (dBm)	Margin (dB)
50.37	V	-53.78	-16.44	-70.22	-13.00	-57.22
86.26	V	-50.63	-20.68	-71.31	-13.00	-58.31
148.34	V	-61.57	-12.18	-73.76	-13.00	-60.76
193.93	V	-64.90	-14.30	-79.20	-13.00	-66.20
254.07	V	-63.72	-14.14	-77.87	-13.00	-64.87
452.92	V	-69.01	-9.22	-78.23	-13.00	-65.23
86.26	H	-41.00	-21.73	-62.73	-13.00	-49.73
116.33	H	-60.88	-15.10	-75.98	-13.00	-62.98
162.89	H	-60.30	-13.47	-73.77	-13.00	-60.77
191.02	H	-63.74	-13.64	-77.39	-13.00	-64.39
288.02	H	-65.64	-12.63	-78.27	-13.00	-65.27
368.53	H	-62.41	-12.02	-74.44	-13.00	-61.44

**Remark:**

1. *The emission behaviour belongs to narrowband spurious emission.*
2. *Measurements above show only up to 6 maximum emissions noted, or would be lesser, with " N/A " remark, if no specific emissions from the EUT are recorded (ie: margin>20dB from the applicable limit) and considered that's already beyond the background noise floor.*



Operation Mode: GSM 1900 / TX / CH 512

Test Date: July 17, 2008

Temperature: 25°C

Tested by: Mark Yang

Humidity: 50 % RH

Polarity: Ver. / Hor.

Frequency (MHz)	Antenna Polarization (V/H)	Reading (dBm)	Correction Factor (dB)	Emission level (dBm)	Limit (dBm)	Margin (dB)
45.52	V	-41.45	-13.23	-54.69	-13.00	-41.69
77.53	V	-41.66	-18.36	-60.02	-13.00	-47.02
148.34	V	-44.35	-12.18	-56.53	-13.00	-43.53
196.84	V	-51.25	-13.85	-65.10	-13.00	-52.10
256.98	V	-51.72	-14.10	-65.82	-13.00	-52.82
440.31	V	-58.90	-9.48	-68.39	-13.00	-55.39
45.52	H	-47.51	-12.15	-59.66	-13.00	-46.66
77.53	H	-44.48	-20.20	-64.68	-13.00	-51.68
119.24	H	-51.87	-14.56	-66.43	-13.00	-53.43
152.22	H	-44.26	-13.32	-57.57	-13.00	-44.57
218.18	H	-54.27	-14.49	-68.76	-13.00	-55.76
262.80	H	-53.84	-13.98	-67.82	-13.00	-54.82

**Remark:**

1. *Measuring frequencies from 1 GHz to the 10th harmonic of highest fundamental frequency.*
2. *Measurements above show only up to 6 maximum emissions noted, or would be lesser, with " N/A " remark, if no specific emissions from the EUT are recorded (ie: margin > 20dB from the applicable limit) and considered that's already beyond the background noise floor.*





Operation Mode: GSM 1900 / TX / CH 661

Test Date: July 17, 2008

Temperature: 25°C

Tested by: Mark Yang

Humidity: 50 % RH

Polarity: Ver. / Hor.

Frequency (MHz)	Antenna Polarization (V/H)	Reading (dBm)	Correction Factor (dB)	Emission level (dBm)	Limit (dBm)	Margin (dB)
44.55	V	-42.67	-12.93	-55.61	-13.00	-42.61
76.56	V	-42.76	-17.96	-60.72	-13.00	-47.72
118.27	V	-50.19	-14.55	-64.74	-13.00	-51.74
152.22	V	-44.73	-12.49	-57.23	-13.00	-44.23
222.06	V	-50.50	-14.86	-65.36	-13.00	-52.36
255.04	V	-50.91	-14.13	-65.04	-13.00	-52.04
44.55	H	-48.23	-11.83	-60.06	-13.00	-47.06
75.59	H	-43.62	-19.62	-63.24	-13.00	-50.24
118.27	H	-52.56	-14.74	-67.30	-13.00	-54.30
151.25	H	-43.89	-13.26	-57.15	-13.00	-44.15
270.56	H	-53.75	-13.13	-66.88	-13.00	-53.88
293.84	H	-53.58	-12.70	-66.28	-13.00	-53.28

**Remark:**

1. Measuring frequencies from 1 GHz to the 10th harmonic of highest fundamental frequency.
2. Measurements above show only up to 6 maximum emissions noted, or would be lesser; with " N/A " remark, if no specific emissions from the EUT are recorded (ie: margin > 20dB from the applicable limit) and considered that's already beyond the background noise floor.



Operation Mode: GSM 1900 / TX / CH 810

Test Date: July 17, 2008

Temperature: 25°C

Tested by: Mark Yang

Humidity: 50 % RH

Polarity: Ver. / Hor.

Frequency (MHz)	Antenna Polarization (V/H)	Reading (dBm)	Correction Factor (dB)	Emission level (dBm)	Limit (dBm)	Margin (dB)
44.55	V	-42.17	-12.93	-55.10	-13.00	-42.10
76.56	V	-41.58	-17.96	-59.54	-13.00	-46.54
118.27	V	-49.38	-14.55	-63.94	-13.00	-50.94
149.31	V	-43.79	-12.18	-55.98	-13.00	-42.98
195.87	V	-52.11	-14.00	-66.11	-13.00	-53.11
257.95	V	-51.83	-14.08	-65.91	-13.00	-52.91
44.55	H	-47.75	-11.83	-59.58	-13.00	-46.58
76.56	H	-44.40	-19.91	-64.31	-13.00	-51.31
137.67	H	-47.88	-14.53	-62.41	-13.00	-49.41
151.25	H	-44.34	-13.26	-57.61	-13.00	-44.61
166.77	H	-48.51	-13.13	-61.64	-13.00	-48.64
268.62	H	-55.21	-13.29	-68.50	-13.00	-55.50

**Remark:**

1. *Measuring frequencies from 1 GHz to the 10th harmonic of highest fundamental frequency.*
2. *Measurements above show only up to 6 maximum emissions noted, or would be lesser, with " N/A " remark, if no specific emissions from the EUT are recorded (ie: margin > 20dB from the applicable limit) and considered that's already beyond the background noise floor.*



Operation Mode: GPRS 1900 / TX / CH 512

Test Date: July 17, 2008

Temperature: 25°C

Tested by: Mark Yang

Humidity: 50 % RH

Polarity: Ver. / Hor.

Frequency (MHz)	Antenna Polarization (V/H)	Reading (dBm)	Correction Factor (dB)	Emission level (dBm)	Limit (dBm)	Margin (dB)
45.52	V	-43.20	-13.23	-56.44	-13.00	-43.44
76.56	V	-43.05	-17.96	-61.01	-13.00	-48.01
151.25	V	-48.38	-12.36	-60.74	-13.00	-47.74
225.94	V	-50.84	-14.59	-65.43	-13.00	-52.43
256.01	V	-50.06	-14.11	-64.17	-13.00	-51.17
414.12	V	-58.66	-10.11	-68.77	-13.00	-55.77
44.55	H	-49.37	-11.83	-61.20	-13.00	-48.20
78.50	H	-43.81	-20.49	-64.30	-13.00	-51.30
150.28	H	-46.02	-13.21	-59.24	-13.00	-46.24
169.68	H	-50.65	-12.88	-63.53	-13.00	-50.53
262.80	H	-54.38	-13.98	-68.36	-13.00	-55.36
290.93	H	-56.35	-12.54	-68.89	-13.00	-55.89

**Remark:**

1. *Measuring frequencies from 1 GHz to the 10th harmonic of highest fundamental frequency.*
2. *Measurements above show only up to 6 maximum emissions noted, or would be lesser, with " N/A " remark, if no specific emissions from the EUT are recorded (ie: margin > 20dB from the applicable limit) and considered that's already beyond the background noise floor.*



Operation Mode: GPRS 1900 / TX / CH 661

Test Date: July 17, 2008

Temperature: 25°C

Tested by: Mark Yang

Humidity: 50 % RH

Polarity: Ver. / Hor.

Frequency (MHz)	Antenna Polarization (V/H)	Reading (dBm)	Correction Factor (dB)	Emission level (dBm)	Limit (dBm)	Margin (dB)
44.55	V	-42.01	-12.93	-54.94	-13.00	-41.94
78.50	V	-42.80	-18.76	-61.56	-13.00	-48.56
117.30	V	-50.48	-14.73	-65.21	-13.00	-52.21
148.34	V	-46.21	-12.18	-58.40	-13.00	-45.40
201.69	V	-49.35	-13.72	-63.07	-13.00	-50.07
260.86	V	-50.19	-13.93	-64.12	-13.00	-51.12
45.52	H	-48.51	-12.15	-60.66	-13.00	-47.66
78.50	H	-43.85	-20.49	-64.33	-13.00	-51.33
150.28	H	-45.91	-13.21	-59.12	-13.00	-46.12
192.96	H	-53.95	-13.30	-67.26	-13.00	-54.26
265.71	H	-53.59	-13.64	-67.23	-13.00	-54.23
327.79	H	-56.75	-13.35	-70.11	-13.00	-57.11

**Remark:**

1. *Measuring frequencies from 1 GHz to the 10th harmonic of highest fundamental frequency.*
2. *Measurements above show only up to 6 maximum emissions noted, or would be lesser, with " N/A " remark, if no specific emissions from the EUT are recorded (ie: margin > 20dB from the applicable limit) and considered that's already beyond the background noise floor.*



Operation Mode: GPRS 1900 / TX / CH 810

Test Date: July 17, 2008

Temperature: 25°C

Tested by: Mark Yang

Humidity: 50 % RH

Polarity: Ver. / Hor.

Frequency (MHz)	Antenna Polarization (V/H)	Reading (dBm)	Correction Factor (dB)	Emission level (dBm)	Limit (dBm)	Margin (dB)
45.52	V	-41.46	-13.23	-54.69	-13.00	-41.69
75.59	V	-43.83	-17.56	-61.39	-13.00	-48.39
117.30	V	-49.72	-14.73	-64.44	-13.00	-51.44
150.28	V	-45.21	-12.22	-57.43	-13.00	-44.43
203.63	V	-51.21	-14.13	-65.34	-13.00	-52.34
253.10	V	-50.55	-14.16	-64.71	-13.00	-51.71
45.52	H	-48.10	-12.15	-60.24	-13.00	-47.24
77.53	H	-44.54	-20.20	-64.74	-13.00	-51.74
150.28	H	-46.19	-13.21	-59.41	-13.00	-46.41
198.78	H	-54.86	-12.29	-67.16	-13.00	-54.16
273.47	H	-54.59	-13.15	-67.74	-13.00	-54.74
478.14	H	-59.26	-8.57	-67.83	-13.00	-54.83

**Remark:**

1. *Measuring frequencies from 1 GHz to the 10th harmonic of highest fundamental frequency.*
2. *Measurements above show only up to 6 maximum emissions noted, or would be lesser, with " N/A " remark, if no specific emissions from the EUT are recorded (ie: margin>20dB from the applicable limit) and considered that's already beyond the background noise floor.*



Operation Mode: EGPRS 850 / TX / CH 128

Test Date: July 17, 2008

Temperature: 25°C

Tested by: Mark Yang

Humidity: 50 % RH

Polarity: Ver. / Hor.

Frequency (MHz)	Antenna Polarization (V/H)	Reading (dBm)	Correction Factor (dB)	Emission level (dBm)	Limit (dBm)	Margin (dB)
50.37	V	-51.73	-16.44	-68.17	-13.00	-55.17
86.26	V	-48.35	-20.68	-69.03	-13.00	-56.03
120.21	V	-61.89	-14.22	-76.11	-13.00	-63.11
143.49	V	-65.29	-12.19	-77.48	-13.00	-64.48
199.75	V	-64.96	-13.41	-78.37	-13.00	-65.37
280.26	V	-65.48	-12.69	-78.17	-13.00	-65.17
99.84	H	-46.94	-18.98	-65.93	-13.00	-52.93
132.82	H	-61.10	-14.67	-75.77	-13.00	-62.77
368.53	H	-61.80	-12.02	-73.83	-13.00	-60.83
398.60	H	-55.55	-10.80	-66.35	-13.00	-53.35
512.09	H	-60.11	-7.96	-68.07	-13.00	-55.07
681.84	H	-62.76	-6.18	-68.94	-13.00	-55.94

**Remark:**

1. *Measuring frequencies from 1 GHz to the 10th harmonic of highest fundamental frequency.*
2. *Measurements above show only up to 6 maximum emissions noted, or would be lesser, with " N/A " remark, if no specific emissions from the EUT are recorded (ie: margin>20dB from the applicable limit) and considered that's already beyond the background noise floor.*



Operation Mode: EGPRS 850 / TX / CH 190

Test Date: July 17, 2008

Temperature: 25°C

Tested by: Mark Yang

Humidity: 50 % RH

Polarity: Ver. / Hor.

Frequency (MHz)	Antenna Polarization (V/H)	Reading (dBm)	Correction Factor (dB)	Emission level (dBm)	Limit (dBm)	Margin (dB)
66.86	V	-49.50	-15.47	-64.97	-13.00	-51.97
86.26	V	-44.41	-20.68	-65.09	-13.00	-52.09
171.62	V	-55.15	-13.91	-69.06	-13.00	-56.06
226.91	V	-54.73	-14.52	-69.25	-13.00	-56.25
326.82	V	-56.20	-12.96	-69.15	-13.00	-56.15
452.92	V	-59.31	-9.22	-68.53	-13.00	-55.53
57.16	H	-47.00	-15.62	-62.62	-13.00	-49.62
86.26	H	-39.05	-21.73	-60.77	-13.00	-47.77
130.88	H	-52.38	-14.72	-67.11	-13.00	-54.11
200.72	H	-55.82	-12.25	-68.07	-13.00	-55.07
368.53	H	-59.98	-12.02	-72.01	-13.00	-59.01
967.99	H	-60.99	-2.86	-63.85	-13.00	-50.85

**Remark:**

1. Measuring frequencies from 1 GHz to the 10th harmonic of highest fundamental frequency.
2. Measurements above show only up to 6 maximum emissions noted, or would be lesser; with " N/A " remark, if no specific emissions from the EUT are recorded (ie: margin > 20dB from the applicable limit) and considered that's already beyond the background noise floor.



Operation Mode: EGPRS 850 / TX / CH 251

Test Date: July 17, 2008

Temperature: 25°C

Tested by: Mark Yang

Humidity: 50 % RH

Polarity: Ver. / Hor.

Frequency (MHz)	Antenna Polarization (V/H)	Reading (dBm)	Correction Factor (dB)	Emission level (dBm)	Limit (dBm)	Margin (dB)
50.37	V	-49.40	-16.44	-65.84	-13.00	-52.84
86.26	V	-47.51	-20.68	-68.19	-13.00	-55.19
119.24	V	-59.95	-14.38	-74.33	-13.00	-61.33
194.90	V	-61.57	-14.15	-75.72	-13.00	-62.72
259.89	V	-63.15	-14.05	-77.20	-13.00	-64.20
452.92	V	-63.69	-9.22	-72.91	-13.00	-59.91
86.26	H	-49.94	-21.73	-71.66	-13.00	-58.66
116.33	H	-59.21	-15.10	-74.31	-13.00	-61.31
179.38	H	-62.70	-12.89	-75.59	-13.00	-62.59
280.26	H	-64.29	-13.17	-77.46	-13.00	-64.46
368.53	H	-60.99	-12.02	-73.02	-13.00	-60.02
452.92	H	-65.08	-9.18	-74.25	-13.00	-61.25

**Remark:**

1. Measuring frequencies from 1 GHz to the 10th harmonic of highest fundamental frequency.
2. Measurements above show only up to 6 maximum emissions noted, or would be lesser; with " N/A " remark, if no specific emissions from the EUT are recorded (ie: margin > 20dB from the applicable limit) and considered that's already beyond the background noise floor.





Operation Mode: EGPRS 1900 / TX / CH 512

Test Date: July 17, 2008

Temperature: 25°C

Tested by: Mark Yang

Humidity: 50 % RH

Polarity: Ver. / Hor.

Frequency (MHz)	Antenna Polarization (V/H)	Reading (dBm)	Correction Factor (dB)	Emission level (dBm)	Limit (dBm)	Margin (dB)
44.55	V	-44.73	-12.93	-57.66	-13.00	-44.66
77.53	V	-42.44	-18.36	-60.80	-13.00	-47.80
151.25	V	-48.68	-12.36	-61.04	-13.00	-48.04
206.54	V	-49.90	-14.74	-64.65	-13.00	-51.65
260.86	V	-50.80	-13.93	-64.73	-13.00	-51.73
324.88	V	-57.10	-12.97	-70.07	-13.00	-57.07
43.58	H	-49.49	-11.83	-61.32	-13.00	-48.32
77.53	H	-43.15	-20.20	-63.34	-13.00	-50.34
137.67	H	-50.62	-14.53	-65.15	-13.00	-52.15
163.86	H	-48.28	-13.38	-61.66	-13.00	-48.66
294.81	H	-54.95	-12.75	-67.70	-13.00	-54.70
415.09	H	-58.08	-10.15	-68.23	-13.00	-55.23

**Remark:**

1. Measuring frequencies from 1 GHz to the 10th harmonic of highest fundamental frequency.
2. Measurements above show only up to 6 maximum emissions noted, or would be lesser; with " N/A " remark, if no specific emissions from the EUT are recorded (ie: margin > 20dB from the applicable limit) and considered that's already beyond the background noise floor.



Operation Mode: EGPRS 1900 / TX / CH 661

Test Date: July 17, 2008

Temperature: 25°C

Tested by: Mark Yang

Humidity: 50 % RH

Polarity: Ver. / Hor.

Frequency (MHz)	Antenna Polarization (V/H)	Reading (dBm)	Correction Factor (dB)	Emission level (dBm)	Limit (dBm)	Margin (dB)
45.52	V	-45.04	-13.23	-58.27	-13.00	-45.27
77.53	V	-42.04	-18.36	-60.40	-13.00	-47.40
153.19	V	-49.72	-12.63	-62.35	-13.00	-49.35
198.78	V	-51.27	-13.56	-64.82	-13.00	-51.82
260.86	V	-50.50	-13.93	-64.43	-13.00	-51.43
288.02	V	-55.36	-12.20	-67.56	-13.00	-54.56
45.52	H	-49.74	-12.15	-61.89	-13.00	-48.89
78.50	H	-43.80	-20.49	-64.29	-13.00	-51.29
160.95	H	-46.69	-13.64	-60.33	-13.00	-47.33
206.54	H	-54.29	-13.61	-67.90	-13.00	-54.90
265.71	H	-54.80	-13.64	-68.44	-13.00	-55.44
638.19	H	-59.62	-6.09	-65.71	-13.00	-52.71

**Remark:**

1. Measuring frequencies from 1 GHz to the 10th harmonic of highest fundamental frequency.
2. Measurements above show only up to 6 maximum emissions noted, or would be lesser; with " N/A " remark, if no specific emissions from the EUT are recorded (ie: margin > 20dB from the applicable limit) and considered that's already beyond the background noise floor.



Operation Mode: EGPRS 1900 / TX / CH 810

Test Date: July 17, 2008

Temperature: 25°C

Tested by: Mark Yang

Humidity: 50 % RH

Polarity: Ver. / Hor.

Frequency (MHz)	Antenna Polarization (V/H)	Reading (dBm)	Correction Factor (dB)	Emission level (dBm)	Limit (dBm)	Margin (dB)
45.52	V	-44.51	-13.23	-57.74	-13.00	-44.74
78.50	V	-42.29	-18.76	-61.05	-13.00	-48.05
151.25	V	-48.80	-12.36	-61.16	-13.00	-48.16
199.75	V	-51.66	-13.41	-65.07	-13.00	-52.07
260.86	V	-50.33	-13.93	-64.26	-13.00	-51.26
414.12	V	-59.10	-10.11	-69.21	-13.00	-56.21
44.55	H	-49.78	-11.83	-61.61	-13.00	-48.61
77.53	H	-43.60	-20.20	-63.80	-13.00	-50.80
163.86	H	-47.85	-13.38	-61.24	-13.00	-48.24
183.26	H	-53.24	-13.19	-66.44	-13.00	-53.44
262.80	H	-53.70	-13.98	-67.68	-13.00	-54.68
425.76	H	-58.26	-9.79	-68.05	-13.00	-55.05

**Remark:**

1. Measuring frequencies from 1 GHz to the 10th harmonic of highest fundamental frequency.
2. Measurements above show only up to 6 maximum emissions noted, or would be lesser; with " N/A " remark, if no specific emissions from the EUT are recorded (ie: margin > 20dB from the applicable limit) and considered that's already beyond the background noise floor.



**Above 1GHz**

**Operation Mode:** GSM 850 / TX / CH 128

**Test Date:** July 17, 2008

**Temperature:** 25°C

**Tested by:** Mark Yang

**Humidity:** 50 % RH

**Polarity:** Ver. / Hor.

Frequency (MHz)	Antenna Polarization	Reading level (dBuV)	Correction Factor (dB)	Emission level (dBm)	Limit (dBm)	Margin (dB)
1651.00	V	-55.28	1.63	-53.65	-13.00	-40.65
2470.00	V	-56.36	4.75	-51.61	-13.00	-38.61
3296.00	V	-59.29	6.32	-52.97	-13.00	-39.97
4913.00	V	-52.71	8.78	-43.93	-13.00	-30.93
N/A						
1651.00	H	-55.56	1.63	-53.92	-13.00	-40.92
2470.00	H	-59.01	4.74	-54.26	-13.00	-41.26
4122.00	H	-60.45	7.47	-52.97	-13.00	-39.97
N/A						

**Remark:**

1. Measuring frequencies from 1 GHz to the 10th harmonic of highest fundamental frequency.
2. Measurements above show only up to 6 maximum emissions noted, or would be lesser, with " N/A " remark, if no specific emissions from the EUT are recorded (ie: margin>20dB from the applicable limit) and considered that's already beyond the background noise floor.



Operation Mode: GSM 850 / TX / CH 190

Test Date: July 17, 2008

Temperature: 25°C

Tested by: Mark Yang

Humidity: 50 % RH

Polarity: Ver. / Hor.

Frequency (MHz)	Antenna Polarization	Reading level (dBuV)	Correction Factor (dB)	Emission level (dBm)	Limit (dBm)	Margin (dB)
1672.00	V	-54.10	1.64	-52.47	-13.00	-39.47
2512.00	V	-55.62	4.96	-50.66	-13.00	-37.66
3345.00	V	-60.23	6.41	-53.82	-13.00	-40.82
N/A						
1672.00	H	-54.14	1.66	-52.48	-13.00	-39.48
2512.00	H	-60.03	4.94	-55.09	-13.00	-42.09
N/A						

**Remark:**

1. Measuring frequencies from 1 GHz to the 10th harmonic of highest fundamental frequency.
2. Measurements above show only up to 6 maximum emissions noted, or would be lesser, with " N/A " remark, if no specific emissions from the EUT are recorded (ie: margin > 20dB from the applicable limit) and considered that's already beyond the background noise floor.



Operation Mode: GSM 850 / TX / CH 251

Test Date: July 17, 2008

Temperature: 25°C

Tested by: Mark Yang

Humidity: 50 % RH

Polarity: Ver. / Hor.

Frequency (MHz)	Antenna Polarization	Reading level (dBuV)	Correction Factor (dB)	Emission level (dBm)	Limit (dBm)	Margin (dB)
1700.00	V	-51.46	1.65	-49.81	-13.00	-36.81
2547.00	V	-51.56	5.02	-46.55	-13.00	-33.55
N/A						
1700.00	H	-51.93	1.68	-50.24	-13.00	-37.24
2547.00	H	-55.30	4.98	-50.32	-13.00	-37.32
N/A						

**Remark:**

1. Measuring frequencies from 1 GHz to the 10th harmonic of highest fundamental frequency.
2. Measurements above show only up to 6 maximum emissions noted, or would be lesser, with "N/A" remark, if no specific emissions from the EUT are recorded (ie: margin > 20dB from the applicable limit) and considered that's already beyond the background noise floor.



Operation Mode: GPRS 850 / TX / CH 128

Test Date: July 17, 2008

Temperature: 25°C

Tested by: Mark Yang

Humidity: 50 % RH

Polarity: Ver. / Hor.

Frequency (MHz)	Antenna Polarization	Reading level (dBuV)	Correction Factor (dB)	Emission level (dBm)	Limit (dBm)	Margin (dB)
1651.00	V	-55.68	1.63	-54.05	-13.00	-41.05
2470.00	V	-55.12	4.75	-50.37	-13.00	-37.37
3296.00	V	-59.05	6.32	-52.74	-13.00	-39.74
N/A						
1651.00	H	-55.25	1.63	-53.62	-13.00	-40.62
2470.00	H	-58.22	4.74	-53.48	-13.00	-40.48
N/A						

**Remark:**

1. Measuring frequencies from 1 GHz to the 10th harmonic of highest fundamental frequency.
2. Measurements above show only up to 6 maximum emissions noted, or would be lesser, with "N/A" remark, if no specific emissions from the EUT are recorded (ie: margin > 20dB from the applicable limit) and considered that's already beyond the background noise floor.



Operation Mode: GPRS 850 / TX / CH 190

Test Date: July 17, 2008

Temperature: 25°C

Tested by: Mark Yang

Humidity: 50 % RH

Polarity: Ver. / Hor.

Frequency (MHz)	Antenna Polarization	Reading level (dBuV)	Correction Factor (dB)	Emission level (dBm)	Limit (dBm)	Margin (dB)
1672.00	V	-54.85	1.64	-53.22	-13.00	-40.22
2512.00	V	-58.21	4.96	-53.25	-13.00	-40.25
3345.00	V	-59.91	6.41	-53.51	-13.00	-40.51
N/A						
1672.00	H	-52.78	1.66	-51.13	-13.00	-38.13
2512.00	H	-59.19	4.94	-54.26	-13.00	-41.26
N/A						

**Remark:**

1. Measuring frequencies from 1 GHz to the 10th harmonic of highest fundamental frequency.
2. Measurements above show only up to 6 maximum emissions noted, or would be lesser, with "N/A" remark, if no specific emissions from the EUT are recorded (ie: margin > 20dB from the applicable limit) and considered that's already beyond the background noise floor.





Operation Mode: GPRS 850 / TX / CH 251

Test Date: July 17, 2008

Temperature: 25°C

Tested by: Mark Yang

Humidity: 50 % RH

Polarity: Ver. / Hor.

Frequency (MHz)	Antenna Polarization	Reading level (dBuV)	Correction Factor (dB)	Emission level (dBm)	Limit (dBm)	Margin (dB)
1700.00	V	-52.29	1.65	-50.64	-13.00	-37.64
2547.00	V	-54.06	5.02	-49.04	-13.00	-36.04
N/A						
1700.00	H	-52.06	1.68	-50.37	-13.00	-37.37
N/A						

**Remark:**

1. Measuring frequencies from 1 GHz to the 10th harmonic of highest fundamental frequency.
2. Measurements above show only up to 6 maximum emissions noted, or would be lesser, with "N/A" remark, if no specific emissions from the EUT are recorded (ie: margin > 20dB from the applicable limit) and considered that's already beyond the background noise floor.



Operation Mode: GSM 1900 / TX / CH 512

Test Date: July 18, 2008

Temperature: 25°C

Tested by: Mark Yang

Humidity: 50 % RH

Polarity: Ver. / Hor.

Frequency (MHz)	Antenna Polarization (V/H)	Reading (dBm)	Correction Factor (dB)	Emission level (dBm)	Limit (dBm)	Margin (dB)
3702.00	V	-57.71	7.57	-50.14	-13.00	-37.14
N/A						
3702.00	H	-51.48	6.71	-44.76	-13.00	-31.76
N/A						

**Remark:**

1. Measuring frequencies from 1 GHz to the 10th harmonic of highest fundamental frequency.
2. Measurements above show only up to 6 maximum emissions noted, or would be lesser, with " N/A " remark, if no specific emissions from the EUT are recorded (ie: margin>20dB from the applicable limit) and considered that's already beyond the background noise floor.



Operation Mode: GSM 1900 / TX / CH 661

Test Date: July 18, 2008

Temperature: 25°C

Tested by: Mark Yang

Humidity: 50 % RH

Polarity: Ver. / Hor.

Frequency (MHz)	Antenna Polarization (V/H)	Reading (dBm)	Correction Factor (dB)	Emission level (dBm)	Limit (dBm)	Margin (dB)
2540.00	V	-59.33	5.01	-54.32	-13.00	-41.32
3758.00	V	-55.56	7.81	-47.75	-13.00	-34.75
N/A						
3758.00	H	-50.55	6.83	-43.73	-13.00	-30.73
5641.00	H	-58.56	9.93	-48.63	-13.00	-35.63
N/A						

**Remark:**

1. Measuring frequencies from 1 GHz to the 10th harmonic of highest fundamental frequency.
2. Measurements above show only up to 6 maximum emissions noted, or would be lesser; with " N/A " remark, if no specific emissions from the EUT are recorded (ie: margin > 20dB from the applicable limit) and considered that's already beyond the background noise floor.



Operation Mode: GSM 1900 / TX / CH 810

Test Date: July 18, 2008

Temperature: 25°C

Tested by: Mark Yang

Humidity: 50 % RH

Polarity: Ver. / Hor.

Frequency (MHz)	Antenna Polarization (V/H)	Reading (dBm)	Correction Factor (dB)	Emission level (dBm)	Limit (dBm)	Margin (dB)
3821.00	V	-56.26	8.09	-48.17	-13.00	-35.17
N/A						
3821.00	H	-52.56	6.95	-45.61	-13.00	-32.61
5732.00	H	-60.17	9.65	-50.52	-13.00	-37.52
N/A						

**Remark:**

1. Measuring frequencies from 1 GHz to the 10th harmonic of highest fundamental frequency.
2. Measurements above show only up to 6 maximum emissions noted, or would be lesser, with " N/A " remark, if no specific emissions from the EUT are recorded (ie: margin > 20dB from the applicable limit) and considered that's already beyond the background noise floor.



Operation Mode: GPRS 1900 / TX / CH 512

Test Date: July 18, 2008

Temperature: 25°C

Tested by: Mark Yang

Humidity: 50 % RH

Polarity: Ver. / Hor.

Frequency (MHz)	Antenna Polarization (V/H)	Reading (dBm)	Correction Factor (dB)	Emission level (dBm)	Limit (dBm)	Margin (dB)
3702.00	V	-49.41	7.57	-41.84	-13.00	-28.84
N/A						
3702.00	H	-53.74	6.71	-47.03	-13.00	-34.03
N/A						

**Remark:**

1. Measuring frequencies from 1 GHz to the 10th harmonic of highest fundamental frequency.
2. Measurements above show only up to 6 maximum emissions noted, or would be lesser, with " N/A " remark, if no specific emissions from the EUT are recorded (ie: margin > 20dB from the applicable limit) and considered that's already beyond the background noise floor.



Operation Mode: GPRS 1900 / TX / CH 661

Test Date: July 18, 2008

Temperature: 25°C

Tested by: Mark Yang

Humidity: 50 % RH

Polarity: Ver. / Hor.

Frequency (MHz)	Antenna Polarization (V/H)	Reading (dBm)	Correction Factor (dB)	Emission level (dBm)	Limit (dBm)	Margin (dB)
3758.00	V	-50.51	7.81	-42.70	-13.00	-29.70
N/A						
3758.00	H	-54.20	6.83	-47.38	-13.00	-34.38
N/A						

**Remark:**

1. Measuring frequencies from 1 GHz to the 10th harmonic of highest fundamental frequency.
2. Measurements above show only up to 6 maximum emissions noted, or would be lesser, with " N/A " remark, if no specific emissions from the EUT are recorded (ie: margin > 20dB from the applicable limit) and considered that's already beyond the background noise floor.



Operation Mode: GPRS 1900 / TX / CH 810

Test Date: July 18, 2008

Temperature: 25°C

Tested by: Mark Yang

Humidity: 50 % RH

Polarity: Ver. / Hor.

Frequency (MHz)	Antenna Polarization (V/H)	Reading (dBm)	Correction Factor (dB)	Emission level (dBm)	Limit (dBm)	Margin (dB)
3821.00	V	-52.16	8.09	-44.07	-13.00	-31.07
N/A						
3821.00	H	-55.19	6.95	-48.23	-13.00	-35.23
N/A						

**Remark:**

1. Measuring frequencies from 1 GHz to the 10th harmonic of highest fundamental frequency.
2. Measurements above show only up to 6 maximum emissions noted, or would be lesser, with " N/A " remark, if no specific emissions from the EUT are recorded (ie: margin>20dB from the applicable limit) and considered that's already beyond the background noise floor.



Operation Mode: EGPRS 850 / TX / CH 128

Test Date: July 18, 2008

Temperature: 25°C

Tested by: Mark Yang

Humidity: 50 % RH

Polarity: Ver. / Hor.

Frequency (MHz)	Antenna Polarization (V/H)	Reading (dBm)	Correction Factor (dB)	Emission level (dBm)	Limit (dBm)	Margin (dB)
1651.00	V	-59.24	1.63	-57.61	-13.00	-44.61
N/A						
1651.00	H	-60.28	1.63	-58.65	-13.00	-45.65
N/A						

**Remark:**

1. Measuring frequencies from 1 GHz to the 10th harmonic of highest fundamental frequency.
2. Measurements above show only up to 6 maximum emissions noted, or would be lesser; with " N/A " remark, if no specific emissions from the EUT are recorded (ie: margin > 20dB from the applicable limit) and considered that's already beyond the background noise floor.





Operation Mode: EGPRS 850 / TX / CH 190

Test Date: July 17, 2008

Temperature: 25°C

Tested by: Mark Yang

Humidity: 50 % RH

Polarity: Ver. / Hor.

Frequency (MHz)	Antenna Polarization (V/H)	Reading (dBm)	Correction Factor (dB)	Emission level (dBm)	Limit (dBm)	Margin (dB)
1672.00	V	-58.66	1.64	-57.03	-13.00	-44.03
N/A						
1672.00	H	-59.01	1.66	-57.35	-13.00	-44.35
N/A						

**Remark:**

1. Measuring frequencies from 1 GHz to the 10th harmonic of highest fundamental frequency.
2. Measurements above show only up to 6 maximum emissions noted, or would be lesser, with " N/A " remark, if no specific emissions from the EUT are recorded (ie: margin > 20dB from the applicable limit) and considered that's already beyond the background noise floor.



Operation Mode: EGPRS 850 / TX / CH 251

Test Date: July 17, 2008

Temperature: 25°C

Tested by: Mark Yang

Humidity: 50 % RH

Polarity: Ver. / Hor.

Frequency (MHz)	Antenna Polarization (V/H)	Reading (dBm)	Correction Factor (dB)	Emission level (dBm)	Limit (dBm)	Margin (dB)
1700.00	V	-52.96	1.65	-51.31	-13.00	-38.31
2547.00	V	-56.74	5.02	-51.72	-13.00	-38.72
N/A						
1700.00	H	-58.38	1.68	-56.70	-13.00	-43.70
2547.00	H	-57.72	4.98	-52.74	-13.00	-39.74
N/A						

**Remark:**

1. Measuring frequencies from 1 GHz to the 10th harmonic of highest fundamental frequency.
2. Measurements above show only up to 6 maximum emissions noted, or would be lesser; with " N/A " remark, if no specific emissions from the EUT are recorded (ie: margin > 20dB from the applicable limit) and considered that's already beyond the background noise floor.



Operation Mode: EGPRS 1900 / TX / CH 512

Test Date: July 18, 2008

Temperature: 25°C

Tested by: Mark Yang

Humidity: 50 % RH

Polarity: Ver. / Hor.

Frequency (MHz)	Antenna Polarization (V/H)	Reading (dBm)	Correction Factor (dB)	Emission level (dBm)	Limit (dBm)	Margin (dB)
3702.00	V	-50.56	7.57	-42.99	-13.00	-29.99
N/A						
3702.00	H	-54.01	6.71	-47.30	-13.00	-34.30
N/A						

**Remark:**

1. Measuring frequencies from 1 GHz to the 10th harmonic of highest fundamental frequency.
2. Measurements above show only up to 6 maximum emissions noted, or would be lesser; with " N/A " remark, if no specific emissions from the EUT are recorded (ie: margin > 20dB from the applicable limit) and considered that's already beyond the background noise floor.



Operation Mode: EGPRS 1900 / TX / CH 661

Test Date: July 17, 2008

Temperature: 25°C

Tested by: Mark Yang

Humidity: 50 % RH

Polarity: Ver. / Hor.

Frequency (MHz)	Antenna Polarization (V/H)	Reading (dBm)	Correction Factor (dB)	Emission level (dBm)	Limit (dBm)	Margin (dB)
3758.00	V	-51.28	7.81	-43.47	-13.00	-30.47
N/A						
3758.00	H	-54.90	6.83	-48.07	-13.00	-35.07
N/A						

**Remark:**

1. Measuring frequencies from 1 GHz to the 10th harmonic of highest fundamental frequency.
2. Measurements above show only up to 6 maximum emissions noted, or would be lesser; with " N/A " remark, if no specific emissions from the EUT are recorded (ie: margin > 20dB from the applicable limit) and considered that's already beyond the background noise floor.



Operation Mode: EGPRS 1900 / TX / CH 810

Test Date: July 18, 2008

Temperature: 25°C

Tested by: Mark Yang

Humidity: 50 % RH

Polarity: Ver. / Hor.

Frequency (MHz)	Antenna Polarization (V/H)	Reading (dBm)	Correction Factor (dB)	Emission level (dBm)	Limit (dBm)	Margin (dB)
3821.00	V	-53.63	8.09	-45.54	-13.00	-32.54
N/A						
3821.00	H	-56.71	6.95	-49.76	-13.00	-36.76
N/A						

**Remark:**

1. Measuring frequencies from 1 GHz to the 10th harmonic of highest fundamental frequency.
2. Measurements above show only up to 6 maximum emissions noted, or would be lesser; with " N/A " remark, if no specific emissions from the EUT are recorded (ie: margin > 20dB from the applicable limit) and considered that's already beyond the background noise floor.

## 7.6 FREQUENCY STABILITY V.S. TEMPERATURE MEASUREMENT

### LIMIT

According to FCC §2.1055, FCC §24.235.

Frequency Tolerance: 2.5 ppm

### Test Configuration

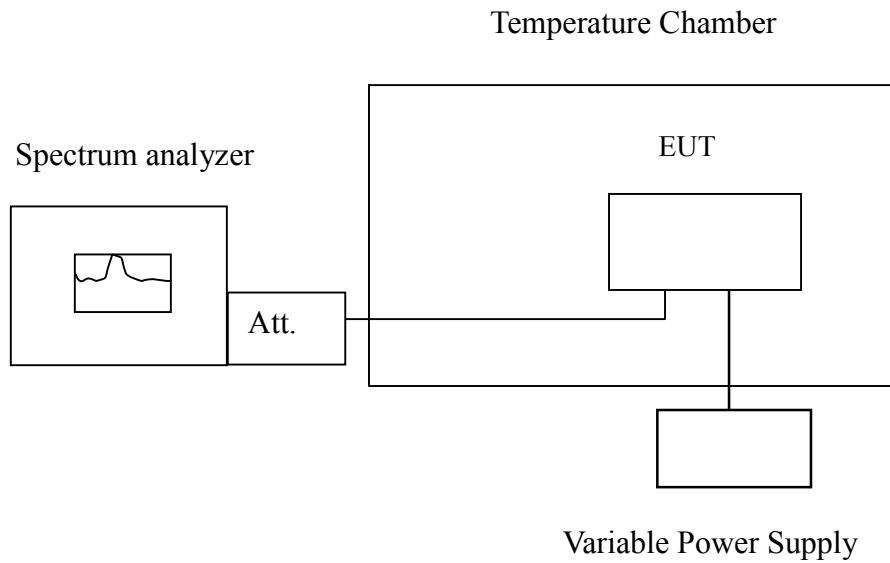

*Remark: Measurement setup for testing on Antenna connector*



### TEST PROCEDURE

The equipment under test was connected to an external AC or DC power supply and input rated voltage. RF output was connected to a frequency counter or spectrum analyzer via feed through attenuators. The EUT was placed inside the temperature chamber. Set the spectrum analyzer RBW low enough to obtain the desired frequency resolution and measure EUT 20°C operating frequency as reference frequency. Turn EUT off and set the chamber temperature to -30°C. After the temperature stabilized for approximately 30 minutes recorded the frequency. Repeat step measure with 10°C increased per stage until the highest temperature of +50°C reached.

### TEST RESULTS

No non-compliance noted.

Reference Frequency: GSM Mid Channel 836.6 MHz @ 20°C				
Limit: ± 2.5 ppm = 2090 Hz				
Power Supply Vdc	Environment Temperature (°C)	Frequency (Hz)	Delta (Hz)	Limit (Hz)
3.7	50	83600005	10	2090
	40	83600001	6	
	30	83599998	3	
	20	83599995	0	
	10	83599989	-6	
	0	83599987	-8	
	-10	83599992	-3	
	-20	83599995	0	
	-30	83599994	-1	

Reference Frequency: GSM Mid Channel 1880 MHz @ 20°C				
Limit: ± 2.5 ppm = 90 Hz				
Power Supply Vdc	Environment Temperature (°C)	Frequency (Hz)	Delta (Hz)	Limit (Hz)
3.7	50	188000011	17	90
	40	187999998	4	
	30	187999999	5	
	20	187999994	0	
	10	187999997	3	
	0	187999995	1	
	-10	188000002	8	
	-20	188000003	9	
	-30	187999996	2	



Reference Frequency: GPRS Mid Channel 836.6 MHz @ 20°C				
Limit: +/- 2.5 ppm = 2090 Hz				
Power Supply Vdc	Environment Temperature (°C)	Frequency (Hz)	Delta (Hz)	Limit (Hz)
3.7	50	83600007	11	2090
	40	83600002	6	
	30	83600016	20	
	20	83599996	0	
	10	83599988	-8	
	0	83599999	3	
	-10	83599998	2	
	-20	83599997	1	
	-30	83599995	-1	

Reference Frequency: GPRS Mid Channel 1880 MHz @ 20°C				
Limit: ± 2.5 ppm = 90 Hz				
Power Supply Vdc	Environment Temperature (°C)	Frequency (Hz)	Delta (Hz)	Limit (Hz)
3.7	50	1880000002	15	90
	40	1879999999	12	
	30	1879999997	10	
	20	1879999987	0	
	10	1880000004	17	
	0	1880000008	21	
	-10	1880000002	15	
	-20	1880000011	24	
	-30	1880000007	20	





Reference Frequency: EGPRS Mid Channel 836.6 MHz @ 20°C				
Limit: +/- 2.5 ppm = 2090 Hz				
Power Supply Vdc	Environment Temperature (°C)	Frequency (Hz)	Delta (Hz)	Limit (Hz)
3.7	50	83599999	-6	2090
	40	83599997	-8	
	30	83599994	-11	
	20	83600005	0	
	10	83599989	-16	
	0	83599985	-20	
	-10	83599990	-15	
	-20	83599987	-18	
	-30	83599992	-13	

Reference Frequency: EGPRS Mid Channel 1880 MHz @ 20°C				
Limit: ± 2.5 ppm = 90 Hz				
Power Supply Vdc	Environment Temperature (°C)	Frequency (Hz)	Delta (Hz)	Limit (Hz)
3.7	50	1880000047	59	90
	40	1880000043	55	
	30	1880000040	52	
	20	1879999988	0	
	10	1880000048	60	
	0	1880000051	63	
	-10	1880000056	68	
	-20	1880000055	67	
	-30	1880000060	72	

## 7.7 FREQUENCY STABILITY V.S. VOLTAGE MEASUREMENT

### LIMIT

According to FCC §2.1055, FCC §24.235,

Frequency Tolerance: 2.5 ppm.

### Test Configuration

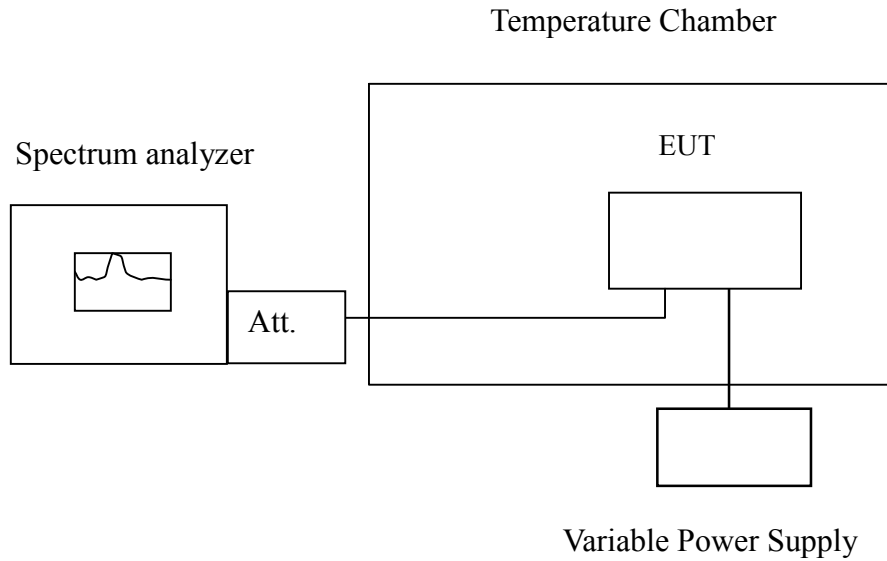

*Remark: Measurement setup for testing on Antenna connector.*



**TEST PROCEDURE**

Set chamber temperature to 20°C. Use a variable AC power supply / DC power source to power the EUT and set the voltage to rated voltage. Set the spectrum analyzer RBW low enough to obtain the desired frequency resolution and recorded the frequency.

Reduce the input voltage to specify extreme voltage variation (± 15%) and endpoint, record the maximum frequency change.

**TEST RESULTS**

*No non-compliance noted.*

Reference Frequency: GSM Mid Channel 836.6 MHz @ 20°C				
Limit: ± 2.5 ppm = 2090Hz				
Power Supply Vdc	Environment Temperature (°C)	Frequency (Hz)	Delta (Hz)	Limit (Hz)
4.07	20	83599996	1	2090
3.7		83599995	0	
3.33		83599989	-6	
3.3END		83599877	-112	

Reference Frequency: GSM Mid Channel 1880 MHz @ 20°C				
Limit: ± 2.5 ppm = 90 Hz				
Power Supply Vdc	Environment Temperature (°C)	Frequency (Hz)	Delta (Hz)	Limit (Hz)
4.07	20	1879999998	4	90
3.7		1879999994	0	
3.33		1879999996	2	
3.3		1879999916	-78	



Reference Frequency: GPRS Mid Channel 836.6 MHz @ 20°C				
Limit: ± 2.5 ppm = 2090Hz				
Power Supply Vdc	Environment Temperature (°C)	Frequency (Hz)	Delta (Hz)	Limit (Hz)
4.07	20	83599989	-7	2090
3.7		83599996	0	
3.33		83599997	1	
3.3END		83599908	-89	

Reference Frequency: GPRS Mid Channel 1880 MHz @ 20°C				
Limit: ± 2.5 ppm = 90 Hz				
Power Supply Vdc	Environment Temperature (°C)	Frequency (Hz)	Delta (Hz)	Limit (Hz)
4.07	20	1879999988	1	90
3.7		1879999987	0	
3.33		1879999999	12	
3.3END		1880000069	82	



Reference Frequency: EGPRS Mid Channel 836.6 MHz @ 20°C				
Limit: ± 2.5 ppm = 2090Hz				
Power Supply Vdc	Environment Temperature (°C)	Frequency (Hz)	Delta (Hz)	Limit (Hz)
4.07	20	83600003	-2	2090
3.7		83600005	0	
3.33		83600006	1	
3.0END		83600084	78	

Reference Frequency: EGPRS Mid Channel 1880 MHz @ 20°C				
Limit: ± 2.5 ppm = 90 Hz				
Power Supply Vdc	Environment Temperature (°C)	Frequency (Hz)	Delta (Hz)	Limit (Hz)
4.07	20	1879999990	2	90
3.7		1879999988	0	
3.33		1879999947	-41	
3.1END		1879999474	-514	



## 7.8 POWERLINE CONDUCTED EMISSIONS

### LIMIT

For an intentional radiator which is designed to be connected to the public utility (AC) power line, the radio frequency voltage that is conducted back onto the AC power line on any frequency or frequencies within the band 150 kHz to 30 MHz shall not exceed 250 microvolts (The limit decreases linearly with the logarithm of the frequency in the range 0.15 MHz to 0.50 MHz). The limits at specific frequency range is listed as follows:

Frequency Range (MHz)	Limits (dB $\mu$ V)	
	Quasi-peak	Average
0.15 to 0.50	66 to 56	56 to 46
0.50 to 5	56	46
5 to 30	60	50

Compliance with this provision shall be based on the measurement of the radio frequency voltage between each power line (LINE and NEUTRAL) and ground at the power terminals.

### Test Configuration

See test photographs attached in Appendix I for the actual connections between EUT and support equipment.

### TEST PROCEDURE

1. The EUT was placed on a table, which is 0.8m above ground plane.
2. Maximum procedure was performed on the six highest emissions to ensure EUT compliance.
3. Repeat above procedures until all frequency measured were complete..

**TEST RESULTS**

The initial step in collecting conducted data is a spectrum analyzer peak scan of the measurement range. Significant peaks are then marked as shown on the following data page, and these signals are then quasi-peaked.

**Operation Mode:** Normal Link

**Test Date:** July 17, 2008

**Temperature:** 22°C

**Tested by:** Ming Chen

**Humidity:** 45% RH

Frequency (MHz)	QP Reading (dBuV)	AV Reading (dBuV)	Corr. factor (dB)	QP Result (dBuV)	AV Result (dBuV)	QP Limit (dBuV)	AV Limit (dBuV)	QP Margin (dB)	AV Margin (dB)	Note
0.1650	42.71	31.51	0.19	42.90	31.70	65.21	55.21	-22.31	-23.51	L1
0.2044	42.24	32.04	0.16	42.40	32.20	63.43	53.43	-21.03	-21.23	L1
0.2432	43.76	29.96	0.14	43.90	30.10	61.99	51.99	-18.09	-21.89	L1
0.2827	41.78	25.88	0.12	41.90	26.00	60.74	50.74	-18.84	-24.74	L1
0.4446	36.85	28.95	0.05	36.90	29.00	56.98	46.98	-20.08	-17.98	L1
9.0094	31.60	23.80	0.50	32.10	24.30	60.00	50.00	-27.90	-25.70	L1
0.2399	43.16	26.06	0.14	43.30	26.20	62.10	52.10	-18.80	-25.90	L2
0.2402	42.96	26.36	0.14	43.10	26.50	62.09	52.09	-18.99	-25.59	L2
0.2816	41.28	24.58	0.12	41.40	24.70	60.77	50.77	-19.37	-26.07	L2
0.4049	35.53	24.43	0.07	35.60	24.50	57.75	47.75	-22.15	-23.25	L2
0.4431	38.25	28.25	0.05	38.30	28.30	57.00	47.00	-18.70	-18.70	L2
0.7276	29.07	20.07	0.03	29.10	20.10	56.00	46.00	-26.90	-25.90	L2

**Remark:**

1. Measuring frequencies from 0.15 MHz to 30MHz.
2. The emissions measured in frequency range from 0.15 MHz to 30MHz were made with an instrument using Quasi-peak detector and average detector.
3. The IF bandwidth of SPA between 0.15MHz to 30MHz was 10kHz; the IF bandwidth of Test Receiver between 0.15MHz to 30MHz was 9kHz;
4. L1 = Line One (Live Line) / L2 = Line Two (Neutral Line)



### Test Plots

#### Conducted emissions (Line 1)

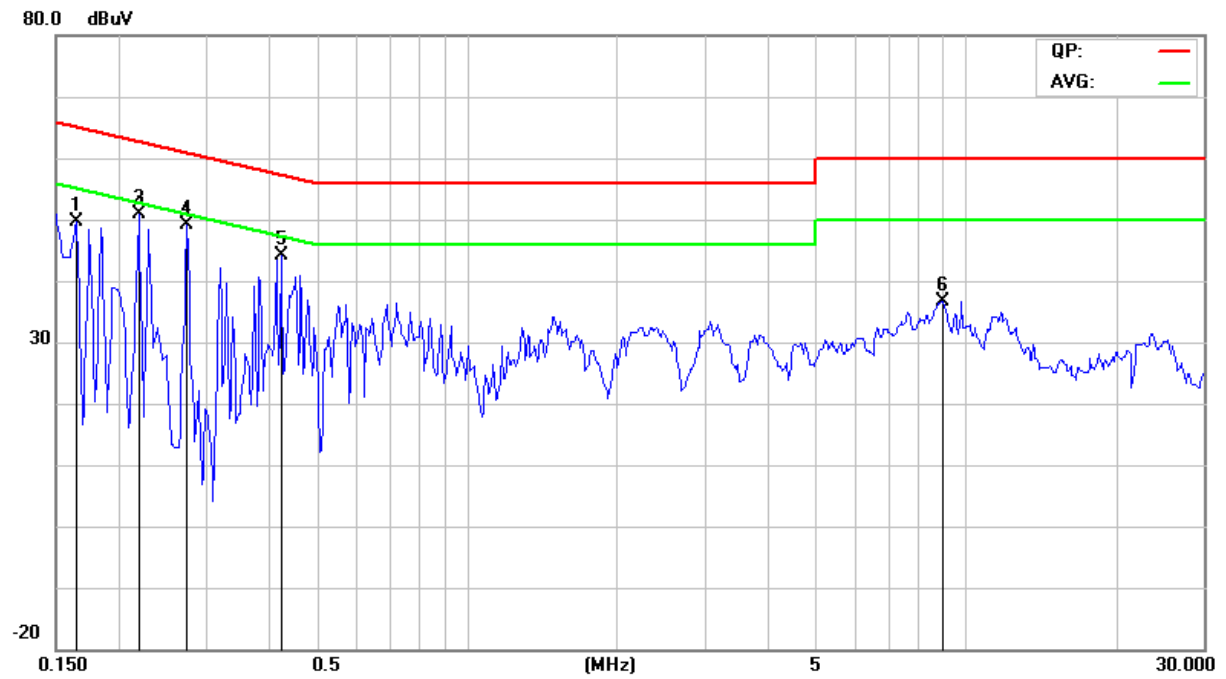

#### Conducted emissions (Line 2)

