

FCC TEST REPORT

(Part 24)

REPORT NO.: RF970324L13

MODEL NO.: E510

RECEIVED: Mar. 24, 2008

TESTED: Apr. 02 ~ Apr. 14, 2008

ISSUED: Apr. 18, 2008

APPLICANT: Huawei Technologies Co., Ltd.

ADDRESS: Administration Building, Huawei Base, Bantian,
Longgang District, Shenzhen 518129 P.R.C.

ISSUED BY: Advance Data Technology Corporation

LAB ADDRESS: No. 47, 14th Ling, Chia Pau Tsuen, Lin Kou Hsiang
244, Taipei Hsien, Taiwan, R.O.C.

TEST LOCATION: No. 19, Hwa Ya 2nd Rd., Wen Hwa Tsuen, Kwei
Shan Hsiang, Taoyuan Hsien 333, Taiwan, R.O.C.

This test report consists of 59 pages in total. It may be duplicated completely for legal use with the approval of the applicant. It should not be reproduced except in full, without the written approval of our laboratory. The client should not use it to claim product endorsement by TAF, A2LA or any government agencies. The test results in the report only apply to the tested sample.



TESTING CERT # 2177-01

TABLE OF CONTENTS

1	CERTIFICATION	4
2	SUMMARY OF TEST RESULTS	5
2.1	MEASUREMENT UNCERTAINTY	6
3	GENERAL INFORMATION.....	7
3.1	GENERAL DESCRIPTION OF EUT.....	7
3.2	DESCRIPTION OF TEST MODES.....	8
3.2.1	CONFIGURATION OF SYSTEM UNDER TEST	9
3.2.2	TEST MODE APPLICABILITY AND TESTED CHANNEL DETAIL	10
3.3	GENERAL DESCRIPTION OF APPLIED STANDARDS	13
3.4	DESCRIPTION OF SUPPORT UNITS	13
4	TEST TYPES AND RESULTS	14
4.1	OUTPUT POWER MEASUREMENT	14
4.1.1	LIMITS OF OUTPUT POWER MEASUREMENT	14
4.1.2	TEST INSTRUMENTS.....	15
4.1.3	TEST PROCEDURES	16
4.1.4	TEST SETUP.....	17
4.1.5	EUT OPERATING CONDITIONS	18
4.1.6	TEST RESULTS	19
4.2	FREQUENCY STABILITY MEASUREMENT.....	21
4.2.1	LIMITS OF FREQUENCY STABILITY MEASUREMENT	21
4.2.2	TEST INSTRUMENTS.....	21
4.2.3	TEST PROCEDURE.....	22
4.2.4	TEST SETUP.....	22
4.2.5	TEST RESULTS	23
4.3	OCCUPIED BANDWIDTH MEASUREMENT	24
4.3.1	LIMITS OF OCCUPIED BANDWIDTH MEASUREMENT	24
4.3.2	TEST INSTRUMENTS.....	24
4.3.3	TEST SETUP.....	24
4.3.4	TEST PROCEDURES	25
4.3.5	EUT OPERATING CONDITION	25
4.3.6	TEST RESULTS	26
4.4	BAND EDGE MEASUREMENT.....	32
4.4.1	LIMITS OF BAND EDGE MEASUREMENT	32
4.4.2	TEST INSTRUMENTS.....	32
4.4.3	TEST SETUP.....	32
4.4.4	TEST PROCEDURES	33
4.4.5	EUT OPERATING CONDITION	33
4.4.6	TEST RESULTS	34
4.5	CONDUCTED SPURIOUS EMISSIONS.....	37
4.5.1	LIMITS OF CONDUCTED SPURIOUS EMISSIONS MEASUREMENT	37
4.5.2	TEST INSTRUMENTS.....	37
4.5.3	TEST PROCEDURE.....	38
4.5.4	TEST SETUP.....	38



4.5.5	EUT OPERATING CONDITIONS	38
4.5.6	TEST RESULTS	39
4.6	RADIATED EMISSION MEASUREMENT (BELOW 1GHz).....	44
4.6.1	LIMITS OF RADIATED EMISSION MEASUREMENT	44
4.6.2	TEST INSTRUMENTS.....	45
4.6.3	TEST PROCEDURES	46
4.6.4	DEVIATION FROM TEST STANDARD	46
4.6.5	TEST SETUP.....	47
4.6.6	EUT OPERATING CONDITIONS	47
4.6.7	TEST RESULTS	48
4.7	RADIATED EMISSION MEASUREMENT (ABOVE 1GHz)	50
4.7.1	LIMITS OF RADIATED EMISSION MEASUREMENT	50
4.7.2	TEST INSTRUMENTS.....	51
4.7.3	TEST PROCEDURES	52
4.7.4	DEVIATION FROM TEST STANDARD	52
4.7.5	TEST SETUP.....	53
4.7.6	EUT OPERATING CONDITIONS	53
4.7.7	TEST RESULTS	54
5	PHOTOGRAPHS OF THE TEST CONFIGURATION.....	57
6	INFORMATION ON THE TESTING LABORATORIES	58
7	APPENDIX A – MODIFICATIONS RECORDERS FOR ENGINEERING CHANGES TO THE EUT BY THE LAB	59



1 CERTIFICATION

PRODUCT : HSPADV-B-T USB Modem
MODEL : E510
BRAND : HUAWEI
APPLICANT : Huawei Technologies Co., Ltd.
TESTED : Apr. 02 ~ Apr. 14, 2008
TEST SAMPLE : MASS-PRODUCTION
TEST STANDARDS : **FCC Part 24, Subpart E**
ANSI C63.4-2003

The above equipment (model: E510) has been tested by **Advance Data Technology Corporation**, and found compliance with the requirement of the above standards. The test record, data evaluation & Equipment Under Test (EUT) configurations represented herein are true and accurate accounts of the measurements of the sample's EMC characteristics under the conditions specified in this report.

PREPARED BY : Rennie Wang , **DATE:** Apr. 18, 2008
Rennie Wang / Senior Specialist

TECHNICAL ACCEPTANCE : Long Chen , **DATE:** Apr. 18, 2008
Responsible for RF Long Chen / Senior Engineer

APPROVED BY : Gary Chang , **DATE:** Apr. 18, 2008
Gary Chang / Assistant Manager

2 SUMMARY OF TEST RESULTS

The EUT has been tested according to the following specifications:

APPLIED STANDARD: FCC Part 24 & Part 2			
STANDARD SECTION	TEST TYPE AND LIMIT	RESULT	REMARK
2.1047(d)	Modulation Characteristics	PASS	Meet the requirement of limit.
2.1046 24.232	Maximum Peak Output Power Limit: max. 2 watts e.i.r.p peak power	PASS	Meet the requirement of limit. Minimum passing margin is 32.71dBm at 1850.20MHz.
2.1055 24.235	Frequency Stability AFC Freq. Error vs. Voltage AFC Freq. Error vs. Temperature Limit: max. ± 2.5 ppm	PASS	Meet the requirement of limit.
2.1049 24.238(b)	Occupied Bandwidth	PASS	Meet the requirement of limit.
24.238(b)	Band Edge Measurements	PASS	Meet the requirement of limit.
2.1051 24.238	Conducted Spurious Emissions	PASS	Meet the requirement of limit.
2.1053 24.238	Radiated Spurious Emissions	PASS	Meet the requirement of limit. Minimum passing margin is -26.63dB at 906.69MHz.

2.1 MEASUREMENT UNCERTAINTY

Where relevant, the following measurement uncertainty levels have been estimated for tests performed on the EUT as specified in CISPR 16-4-2:

MEASUREMENT	FREQUENCY	UNCERTAINTY
Conducted emissions	9kHz ~ 30MHz	2.44 dB
Radiated emissions	30MHz ~ 200MHz	3.34 dB
	200MHz ~ 1000MHz	3.35 dB
	1GHz ~ 18GHz	2.26 dB
	18GHz ~ 40GHz	1.94 dB

This uncertainty represents an expanded uncertainty expressed at approximately the 95% confidence level using a coverage factor of $k=2$.

3 GENERAL INFORMATION

3.1 GENERAL DESCRIPTION OF EUT

PRODUCT	HSPADVBT USB Modem
MODEL NO.	E510
FCC ID	QISE510
POWER SUPPLY	5Vdc from host equipment
MODULATION TYPE	GMSK / 8PSK
FREQUENCY RANGE	1850MHz ~ 1910MHz
NUMBER OF CHANNEL	299
MAX. EIRP POWER	GSM Mode: 32.71dBm (1.866Watts) GPRS Mode: 32.57dBm (1.807Watts) E-GPRS Mode: 29.16dBm (0.824Watts)
ANTENNA TYPE	Fixed Internal antenna with 2.34dBi gain
DATA CABLE	0.8m shielded USB cable without core 0.2m shielded USB cable without core
I/O PORTS	USB
ASSOCIATED DEVICES	NA

NOTE: The above EUT information was declared by manufacturer and for more detailed features description, please refer to the manufacturer's specifications or User's Manual.

3.2 DESCRIPTION OF TEST MODES

299 channels are provided to this EUT in the 1900 band. Therefore, the low, middle and high channels are chosen for testing.

	CHANNEL	FREQUENCY	TX MODE
LOW	512	1850.2 MHz	GSM, GPRS, E-GPRS
MIDDLE	661	1880.0 MHz	GSM, GPRS, E-GPRS
HIGH	810	1909.8 MHz	GSM, GPRS, E-GPRS

NOTE:

1. Below 1 GHz, the channel 512, 661, and 810 were pre-tested in chamber. The channel 512 was chosen for final test.
2. Above 1 GHz, the channel 512, 661, and 810 were tested individually.
3. The worst case for final test is chosen when the power control level set 0.
4. The channel space is 0.2MHz.
5. Since the EUT is considered a portable unit, it was pre-tested on the positioned of each 3 axis. The worst case was found when positioned on X-plane. Therefore only the test data of this X-plane was used for radiated emission measurement test.
6. The EUT is a GPRS class 12 device (Multislot class: 12, Mobile Terminal B), which provide 4 up-link. After pre-tested both functions, found up-link with 1 time slot is worse, therefore, test results of output power, frequency stability, occupied bandwidth and band edge tests came out from this.
7. The EUT is an E-GPRS class 12 device (Multislot class: 12, Mobile Terminal B), which provide 4 up-link. After pre-tested both functions, found up-link with 1 time slot is worse, therefore, test results of output power, frequency stability, occupied bandwidth and band edge tests came out from this.
8. The EUT has GSM, GPRS, E-GPRS functions. After pre-testing, GSM function is the worst case for all the emission tests.

3.2.1 CONFIGURATION OF SYSTEM UNDER TEST

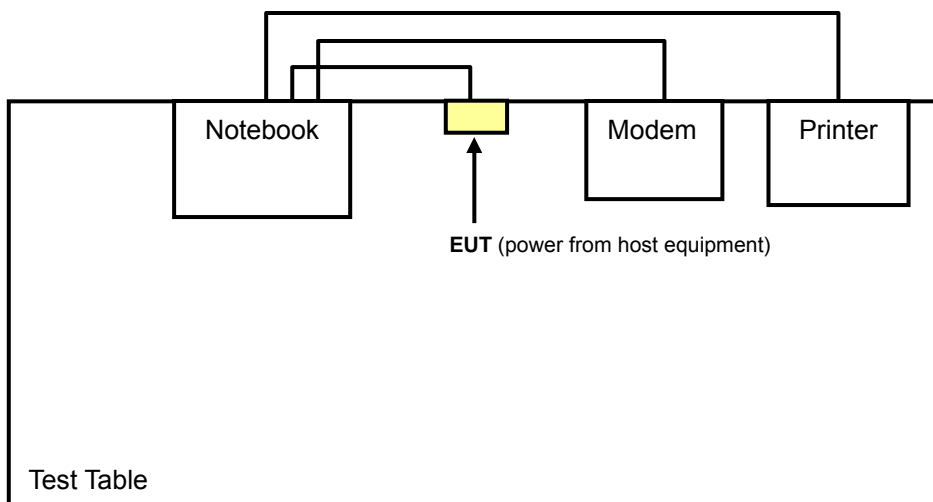

3.2.2 TEST MODE APPLICABILITY AND TESTED CHANNEL DETAIL

EUT CONFIGURE MODE	APPLICABLE TO							DESCRIPTION
	OP	FS	OB	BE	CE	RE<1G	RE≥1G	
A	√	√	√	√	√	√	√	For 0.2m USB cable
B	-	-	-	-	-	√	-	For 0.8m USB cable

Where **OP**: Output power **FS**: Frequency stability
OB: Occupied bandwidth **BE**: Band edge
CE: Conducted spurious emissions **RE<1G**: Radiated emission below 1GHz
RE≥1G: Radiated emission above 1GHz

NOTE: “-“ means no effect.

OUTPUT POWER MEASUREMENT:

- Pre-Scan has been conducted to determine the worst-case mode from all possible combinations between available modulations, xyz axis and antenna ports (if EUT with antenna diversity architecture).
- Following channel(s) was (were) selected for the final test as listed below.

EUT CONFIGURE MODE	AVAILABLE CHANNEL	TESTED CHANNEL	MODULATION TECHNOLOGY	AXIS
A	512 to 810	512, 661, 810	GSM, GPRS, EGPRS	X

FREQUENCY STABILITY MEASUREMENT:

- Pre-Scan has been conducted to determine the worst-case mode from all possible combinations between available modulations, and antenna ports (if EUT with antenna diversity architecture).
- Following channel(s) was (were) selected for the final test as listed below.

EUT CONFIGURE MODE	AVAILABLE CHANNEL	TESTED CHANNEL	MODULATION TECHNOLOGY
A	512 to 810	661	GSM

OCCUPIED BANDWIDTH MEASUREMENT:

- Pre-Scan has been conducted to determine the worst-case mode from all possible combinations between available modulations, and antenna ports (if EUT with antenna diversity architecture).
- Following channel(s) was (were) selected for the final test as listed below.

EUT CONFIGURE MODE	AVAILABLE CHANNEL	TESTED CHANNEL	MODULATION TECHNOLOGY
A	512 to 810	512, 661, 810	GSM, GPRS, EGPRS

BAND EDGE MEASUREMENT:

- Pre-Scan has been conducted to determine the worst-case mode from all possible combinations between available modulations, and antenna ports (if EUT with antenna diversity architecture).
- Following channel(s) was (were) selected for the final test as listed below.

EUT CONFIGURE MODE	AVAILABLE CHANNEL	TESTED CHANNEL	MODULATION TECHNOLOGY
A	512 to 810	512, 810	GSM, GPRS, EGPRS

CONDUCTED SPURIOUS EMISSIONS MEASUREMENT:

- Pre-Scan has been conducted to determine the worst-case mode from all possible combinations between available modulations, and antenna ports (if EUT with antenna diversity architecture).
- Following channel(s) was (were) selected for the final test as listed below.

EUT CONFIGURE MODE	AVAILABLE CHANNEL	TESTED CHANNEL	MODULATION TECHNOLOGY
A	512 to 810	512, 661, 810	GSM

RADIATED EMISSION MEASUREMENT (BELOW 1 GHz):

Pre-Scan has been conducted to determine the worst-case mode from all possible combinations between available modulations, xyz axis and antenna ports (if EUT with antenna diversity architecture).

Following channel(s) was (were) selected for the final test as listed below.

EUT CONFIGURE MODE	AVAILABLE CHANNEL	TESTED CHANNEL	MODULATION TECHNOLOGY	AXIS
A	512 to 810	512	GSM	X
B	512 to 810	512	GSM	X

RADIATED EMISSION MEASUREMENT (ABOVE 1 GHz):

Pre-Scan has been conducted to determine the worst-case mode from all possible combinations between available modulations, xyz axis and antenna ports (if EUT with antenna diversity architecture).

Following channel(s) was (were) selected for the final test as listed below.

EUT CONFIGURE MODE	AVAILABLE CHANNEL	TESTED CHANNEL	MODULATION TECHNOLOGY	AXIS
A	512 to 810	512, 661, 810	GSM	X

3.3 GENERAL DESCRIPTION OF APPLIED STANDARDS

The EUT is a RF product. According to the specifications of the manufacturer, it must comply with the requirements of the following standards:

FCC 47 CFR Part 2

FCC 47 CFR Part 24

ANSI C63.4-2003

ANSI/TIA/EIA-603-C 2004

NOTE: All test items have been performed and recorded as per the above standards.

3.4 DESCRIPTION OF SUPPORT UNITS

The EUT has been tested as an independent unit together with other necessary accessories or support units. The following support units or accessories were used to form a representative test configuration during the tests.

NO.	PRODUCT	BRAND	MODEL NO.	SERIAL NO.	CAL. DATE
1	NOTEBOOK COMPUTER	DELL	PP05L	9954115984	E2K24CLNS
2	PRINTER	EPSON	LQ-300+	DCGY047265	FCC DoC Approved
3	MODEM	ACEEX	1414V/3	0401008260	IFAXDM1414

NO.	SIGNAL CABLE DESCRIPTION OF THE ABOVE SUPPORT UNITS
1	0.8m / 0.2m shielded USB cable without core
2	1.8m braid shielded wire , DB25 connector , w/o core.
3	1.2m braid shielded wire , DB25 & DB9 connector , w/o core.

NOTE: All power cords of the above support units are non shielded (1.8m).

4 TEST TYPES AND RESULTS

4.1 OUTPUT POWER MEASUREMENT

4.1.1 LIMITS OF OUTPUT POWER MEASUREMENT

The radiated peak output power shall be according to the specific rule Part 24.232(b) that “Mobile / Portable station are limited to 2 watts e.i.r.p” and 24.232(c) specific that “Peak transmit power must be measure over any interval of continuous transmission using instrumentation calibration in terms of rms-equivalent voltage.”



4.1.2 TEST INSTRUMENTS

DESCRIPTION & MANUFACTURER	MODEL NO.	SERIAL NO.	CALIBRATED UNTIL
Test Receiver ROHDE & SCHWARZ	ESCI	100424	Jul. 27, 2008
Spectrum Analyzer Agilent	E4446A	MY44360128	Dec. 06, 2008
BILOG Antenna SCHWARZBECK	VULB9168	9168-160	May 31, 2008
HORN Antenna SCHWARZBECK	9120D	9120D-209	Jun. 28, 2008
HORN Antenna SCHWARZBECK	BBHA 9170	BBHA9170243	Dec. 24, 2008
Preamplifier Agilent	8447D	2944A10633	Oct. 28, 2008
Preamplifier Agilent	8449B	3008A01964	Oct. 23, 2008
RF signal cable HUBER+SUHNNER	SUCOFLEX 104	283402/4	Dec. 06, 2008
RF signal cable HUBER+SUHNNER	SUCOFLEX 104	251644/4	Dec. 06, 2008
Software ADT.	ADT_Radiated_V7.6	NA	NA
Antenna Tower inn-co GmbH	MA 4000	013303	NA
Antenna Tower Controller inn-co GmbH	CO2000	017303	NA
Turn Table ADT.	TT100.	TT93021703	NA
Turn Table Controller ADT.	SC100.	SC93021703	NA

- NOTE:**
1. The calibration interval of the above test instruments is 12 months and the calibrations are traceable to NML/ROC and NIST/USA.
 2. The test was performed in HwaYa Chamber 3.
 3. The horn antenna and HP preamplifier (model: 8449B) are used only for the measurement of emission frequency above 1GHz if tested.
 4. The FCC Site Registration No. is 988962.
 5. The IC Site Registration No. is IC3789B-3.

4.1.3 TEST PROCEDURES

- a. The EUT was set up for the maximum peak power with GSM link data modulation. The power was measured with R&S Spectrum Analyzer. All measurements were done at 3 channels, 512, 661 and 810 (low, middle and high operational frequency range.)
- b. The conducted peak output power used the power splitter via EUT RF power connector between simulation base station and spectrum analyzer. The path loss included the splitter loss, cable loss and 20dB pad loss. The spectrum set RB/VB 1MHz, then read peak power value and record to the test. (All transmitted path loss shall be considered in the test report data.)
- c. E.I.R.P peak power measurement. In the fully anechoic chamber, EUT placed on the 1.5m height of Turn Table, rotated the table around 360 degrees to search the maximum radiation power and receiver antenna shall be rotated vertical and horizontal polarization to find the maximum polar radiated power. The “Read Value” is the spectrum reading the maximum power value.
- d. The substitution horn antenna is substituted for EUT at the same position and signal generator export the CW signal to the calibration antenna. Rotated the Turn Table to find the maximum radiation power. “Raw” is the spectrum reading value, “SG” is signal generator export power, “TX Gain” is calibration antenna isotropic gain value, “TX cable” is the transmitted cable loss between the calibration antenna and signal generator. The “Factor” means that the transmission path loss is equal to “SG” - “TX cable” + “TX Gain” – “Raw”.
- e. Actually the real E.I.R.P peak power is equal to “Read Value” + “Factor”
- f. E.R.P power can be calculated form E.I.R.P power by subtracting the gain of dipole,
E.R.P power = E.I.P.R power - 2.15dBi.

NOTE: The resolution bandwidth and video bandwidth of test receiver/spectrum analyzer is 3MHz for Peak detection (PK)

4.1.4 TEST SETUP

EIRP POWER MEASUREMENT:

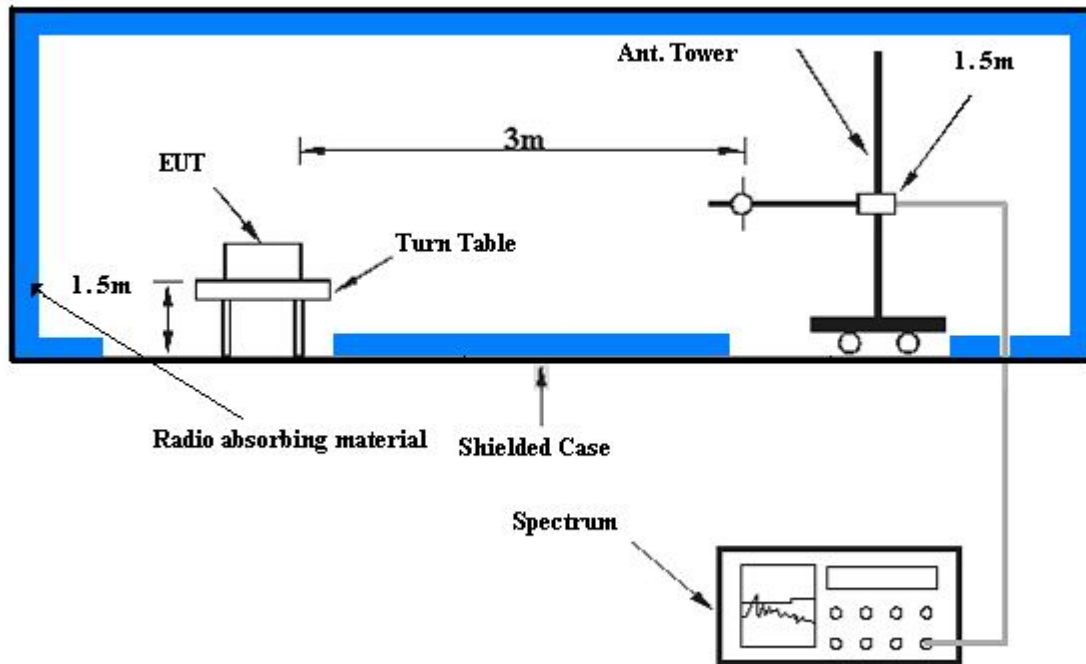

For the actual test configuration, please refer to the attached file (Test Setup Photo).

CONDUCTED POWER MEASUREMENT:

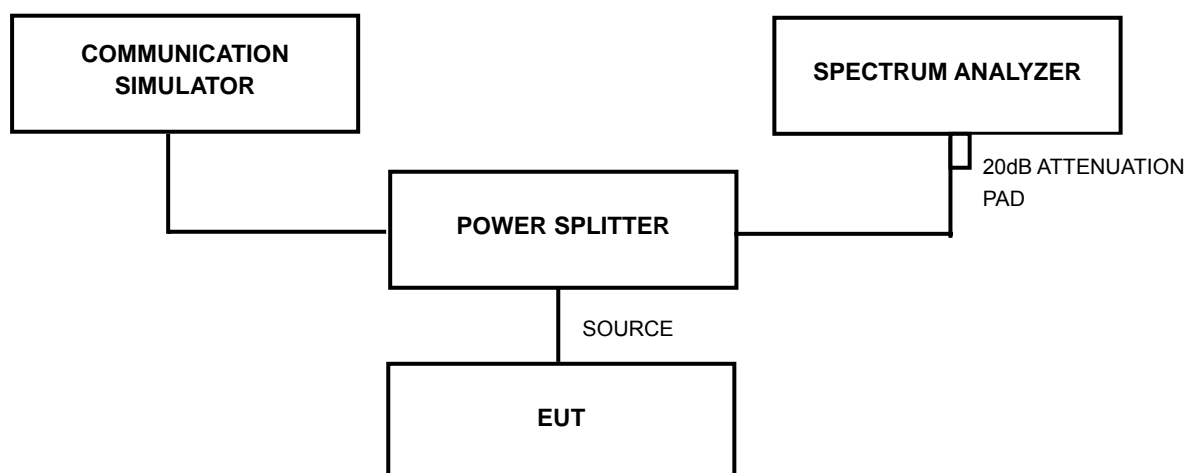

For the actual test configuration, please refer to the related item – Photographs of the Test Configuration.

4.1.5 EUT OPERATING CONDITIONS

- a. The EUT makes a phone call to the communication simulator.
- b. The communication simulator station system controlled an EUT to export maximum output power under transmission mode and specific channel frequency.

4.1.6 TEST RESULTS

MODE	TX connected	POWER CONTROL LEVEL	0
INPUT POWER (SYSTEM)	120Vac, 60 Hz	DETECTOR FUNCTION	Peak
ENVIRONMENTAL CONDITIONS	25deg. C, 65%RH, 991hPa	TESTED BY	Long Chen

FOR GSM MODE

CONDUCTED PEAK OUTPUT POWER					
CHANNEL NO.	FREQUENCY (MHz)	RAW VALUE (dBm)	CORRECTION FACTOR (dB)	PEAK OUTPUT POWER	
				dBm	Watt
512	1850.2	28.10	0.50	28.60	0.724
661	1880.0	28.40	0.50	28.90	0.776
810	1909.8	28.20	0.50	28.70	0.741

FOR GPRS MODE (UP-LINK WITH 1 TIME SLOT)

CONDUCTED PEAK OUTPUT POWER					
CHANNEL NO.	FREQUENCY (MHz)	RAW VALUE (dBm)	CORRECTION FACTOR (dB)	PEAK OUTPUT POWER	
				dBm	Watt
512	1850.2	28.00	0.50	28.50	0.708
661	1880.0	28.20	0.50	28.70	0.741
810	1909.8	28.10	0.50	28.60	0.724

FOR E-GPRS MODE (UP-LINK WITH 1 TIME SLOT)

CONDUCTED PEAK OUTPUT POWER					
CHANNEL NO.	FREQUENCY (MHz)	RAW VALUE (dBm)	CORRECTION FACTOR (dB)	PEAK OUTPUT POWER	
				dBm	Watt
512	1850.2	24.80	0.50	25.30	0.339
661	1880.0	25.00	0.50	25.50	0.355
810	1909.8	25.10	0.50	25.60	0.363

REMARKS: 1. Peak Output Power (dBm) = Raw Value (dBm) + Correction Factor (dB).

2. Correction Factor (dB) = Power Splitter Loss (dB) + Cable Loss (dB).

MODE	TX connected	POWER CONTROL LEVEL	0
INPUT POWER (SYSTEM)	120Vac, 60 Hz	DETECTOR FUNCTION	Peak
ENVIRONMENTAL CONDITIONS	25deg. C, 65%RH, 991hPa	TESTED BY	Long Chen

FOR GSM MODE

EIRP POWER					
CHANNEL NO.	FREQUENCY (MHz)	RAW VALUE (dBm)	CORRECTION FACTOR (dB)	PEAK OUTPUT POWER	
				dBm	Watt
512	1850.2	-7.32	40.03	32.71	1.866
661	1880.0	-7.91	40.32	32.41	1.742
810	1909.8	-8.09	40.62	32.53	1.791

FOR GPRS MODE (UP-LINK WITH 1 TIME SLOT)

EIRP POWER					
CHANNEL NO.	FREQUENCY (MHz)	RAW VALUE (dBm)	CORRECTION FACTOR (dB)	PEAK OUTPUT POWER	
				dBm	Watt
512	1850.2	-7.46	40.03	32.57	1.807
661	1880.0	-8.06	40.32	32.26	1.683
810	1909.8	-8.23	40.62	32.39	1.734

FOR E-GPRS MODE (UP-LINK WITH 1 TIME SLOT)

EIRP POWER					
CHANNEL NO.	FREQUENCY (MHz)	RAW VALUE (dBm)	CORRECTION FACTOR (dB)	PEAK OUTPUT POWER	
				dBm	Watt
512	1850.2	-10.87	40.03	29.16	0.824
661	1880.0	-11.30	40.32	29.02	0.798
810	1909.8	-11.71	40.62	28.91	0.778

REMARKS: 1. Peak Output Power (dBm) = Raw Value (dBm) + Correction Factor (dB).
 2. Correction Factor (dB) = Receiver Antenna Gain (dBi) + Cable Loss (dB) + Free Space Loss (dB).

4.2 FREQUENCY STABILITY MEASUREMENT

4.2.1 LIMITS OF FREQUENCY STABILITY MEASUREMENT

According to the FCC part 2.4235 shall be tested the frequency stability. The rule is defined that "The frequency stability shall be sufficient to ensure that the fundamental emission stays within the authorized frequency block." The frequency error rate is according to the JTC standard that the frequency error rate shall be accurate to within 2.5ppm of the received frequency from the base station. The test extreme voltage is according to the 2.1055(d)(1) Vary primary supply voltage from 85 to 115 percent of the nominal value for other than hand carried battery equipment and the extreme temperature rule is comply with the 2.1055(a)(1) $-30^{\circ}\text{C} \sim 50^{\circ}\text{C}$.

4.2.2 TEST INSTRUMENTS

DESCRIPTION & MANUFACTURER	MODEL NO.	SERIAL NO.	CALIBRATED UNTIL
* Hewlett Packard RF cable	8120-6192	01428251	NA
* Suhner RF cable	Sucoflex104	204850/4	NA
* WIT Standard Temperature & Humidity Chamber	TH-4S-C	W981030	Jun. 28, 2008

- NOTE:**
1. The calibration interval of the above test instruments is 12 months. And the calibrations are traceable to NML/ROC and NIST/USA.
 2. "*" = These equipments are used for the final measurement.
 3. The test was performed in ADT RF OVEN room.

4.2.3 TEST PROCEDURE

- a. Because of the measure the carrier frequency under the condition of the AFC lock, it shall be used the mobile station in the GSM link mode. This is accomplished with the use of the R&S CMU200 simulator station. The oven room could control the temperatures and humidity. The GSM link channel is the 661.
- b. Power must be removed when changing from one temperature to another or one voltage to another voltage. Power warm up is at least 15 min and power applied should perform before recording frequency error.
- c. EUT is connected the external power supply to control the AC input power. The various Volts from the minimum 93.5 Volts to 126.5 Volts. Each step shall be record the frequency error rate.
- d. The temperature range step is 10 degrees in this test items. All temperature levels shall be hold the $\pm 0.5^{\circ}\text{C}$ during the measurement testing.
- e. The each temperature step shall be at least 0.5 hours, consider the EUT could be test under the stability condition.

NOTE: The frequency error was recorded frequency error from the GSM simulator.

4.2.4 TEST SETUP

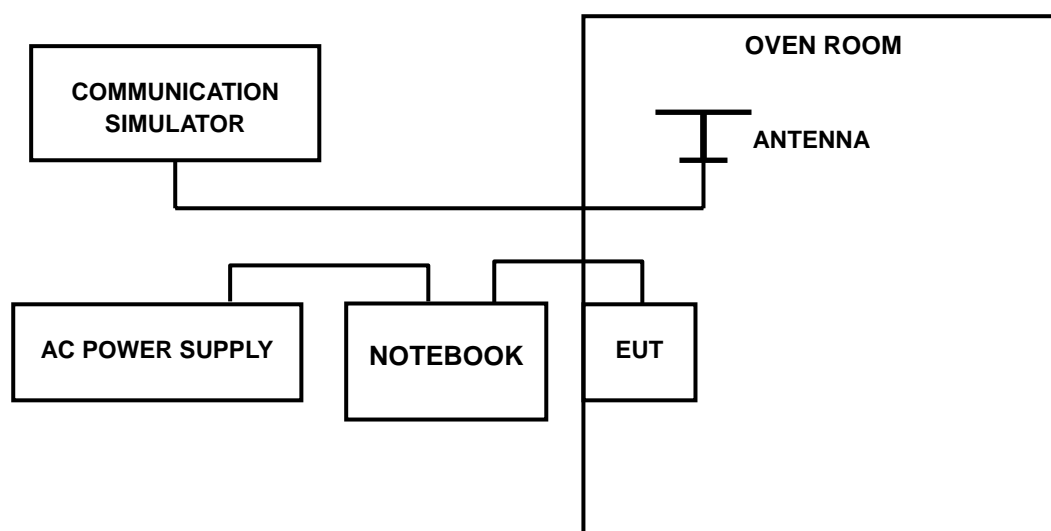



4.2.5 TEST RESULTS

MODE	TX Middle channel	POWER CONTROL LEVEL	0
INPUT POWER (SYSTEM)	120Vac, 60 Hz	ENVIRONMENTAL CONDITIONS	25deg. C, 65%RH, 991hPa
TESTED BY	Long Chen		

AFC FREQUENCY ERROR vs. VOLTAGE			
VOLTAGE (Volts)	FREQUENCY ERROR (Hz)	FREQUENCY ERROR (ppm)	LIMIT (ppm)
126.5	-26	-0.0138297872	2.5
93.5	-31	-0.0164893617	2.5

AFC FREQUENCY ERROR vs. TEMP.			
TEMP. (°C)	FREQUENCY ERROR (Hz)	FREQUENCY ERROR (ppm)	LIMIT (ppm)
50	-20	-0.0106382979	2.5
40	-24	-0.0127659574	2.5
30	-26	-0.0138297872	2.5
20	-28	-0.0148936170	2.5
10	-30	-0.0159574468	2.5
0	-35	-0.0186170213	2.5
-10	-38	-0.0202127660	2.5
-20	-39	-0.0207446809	2.5
-30	-38	-0.0202127660	2.5

4.3 OCCUPIED BANDWIDTH MEASUREMENT

4.3.1 LIMITS OF OCCUPIED BANDWIDTH MEASUREMENT

According to FCC 24.238(b) specified that emission bandwidth is defined as the width of the signal between two points, one below the carrier center frequency and one above the carrier center frequency, outside of which all emissions are attenuated at least 26 dB below the transmitter power.

4.3.2 TEST INSTRUMENTS

DESCRIPTION & MANUFACTURER	MODEL NO.	SERIAL NO.	CALIBRATED UNTIL
* ROHDE & SCHWARZ Spectrum Analyzer	FSP40	100025	Oct. 17, 2008
* Mini-Circuits Power Splitter	ZAPD-4	400005	NA
* Hewlett Packard RF cable	8120-6192	01428251	NA
* JFW 20dB attenuation	50HF-020-SMA	NA	NA
* Suhner RF cable	Sucoflex104	204850/4	NA

NOTE: 1. The calibration interval of the above test instruments is 12 months. And the calibrations are traceable to NML/ROC and NIST/USA.

2. "*" = These equipments are used for the final measurement.

4.3.3 TEST SETUP

Same as Item 4.2.4 (Conducted Power Setup)

4.3.4 TEST PROCEDURES

- a. The EUT was set up for the maximum peak power with GSM link data modulation. The power was measured with R&S Spectrum Analyzer. All measurements were done at 3 channels, 512, 661 and 810 (low, middle and high operational frequency range.)
- b. The conducted occupied bandwidth used the power splitter via EUT RF power connector between simulation base station and spectrum analyzer. This splitter loss and cable loss are the worst loss 4.6dB in the transmitted path track.
- c. FCC 24.238(b) required a measurement bandwidth is the fundamental emission below 26dB bandwidth.

4.3.5 EUT OPERATING CONDITION

- a. The EUT makes a phone call to the communication simulator.
- b. The communication simulator station system controlled a EUT to export maximum and minimum output power under transmission mode and specific channel frequency.

4.3.6 TEST RESULTS

FOR GSM MODE

CHANNEL	MAX. OUTPUT POWER -26 dBc BANDWIDTH (kHz)
LOW	309
MIDDLE	316
HIGH	308

LOW CHANNEL

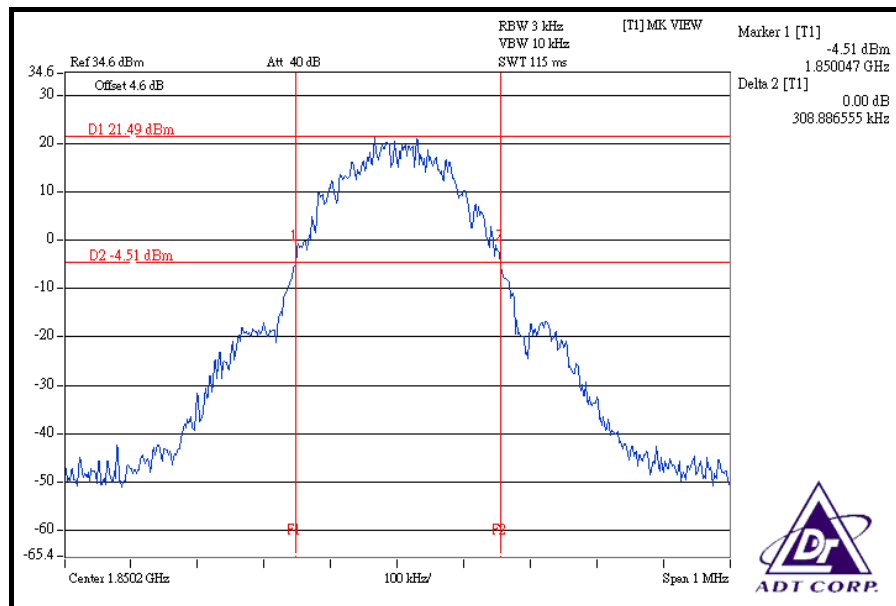

MIDDLE CHANNEL

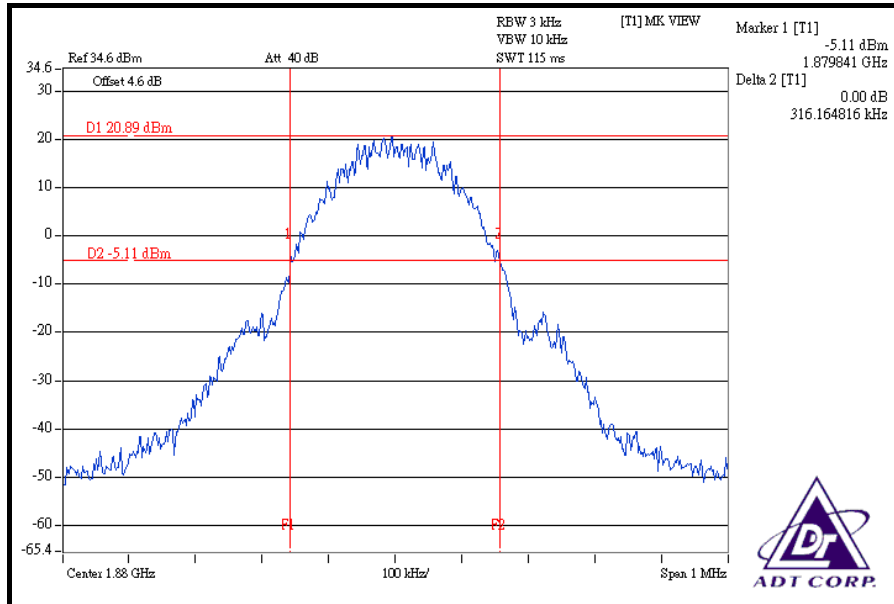

HIGH CHANNEL

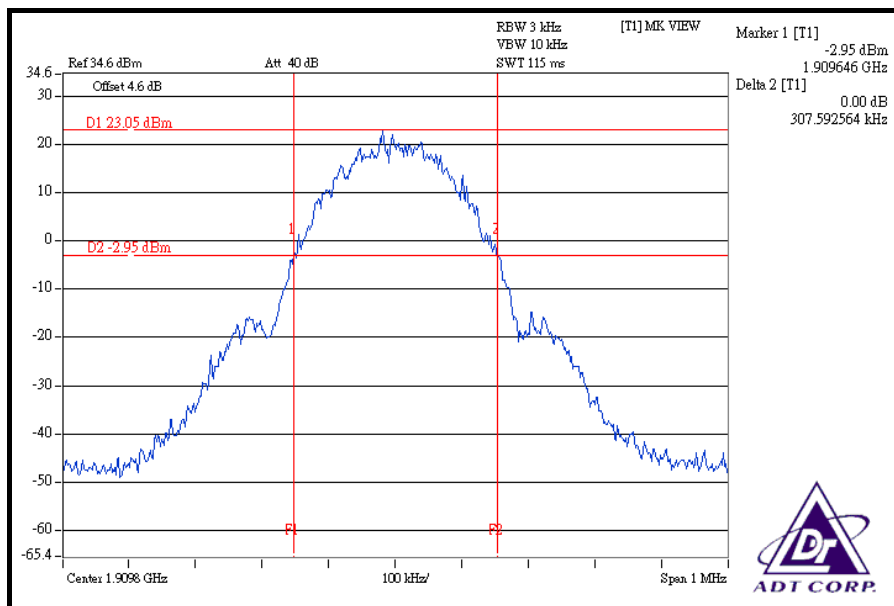

FOR GPRS MODE (UP-LINK WITH 1 TIME SLOT)

CHANNEL	MAX. OUTPUT POWER -26 dBc BANDWIDTH (kHz)
LOW	313
MIDDLE	315
HIGH	317

LOW CHANNEL

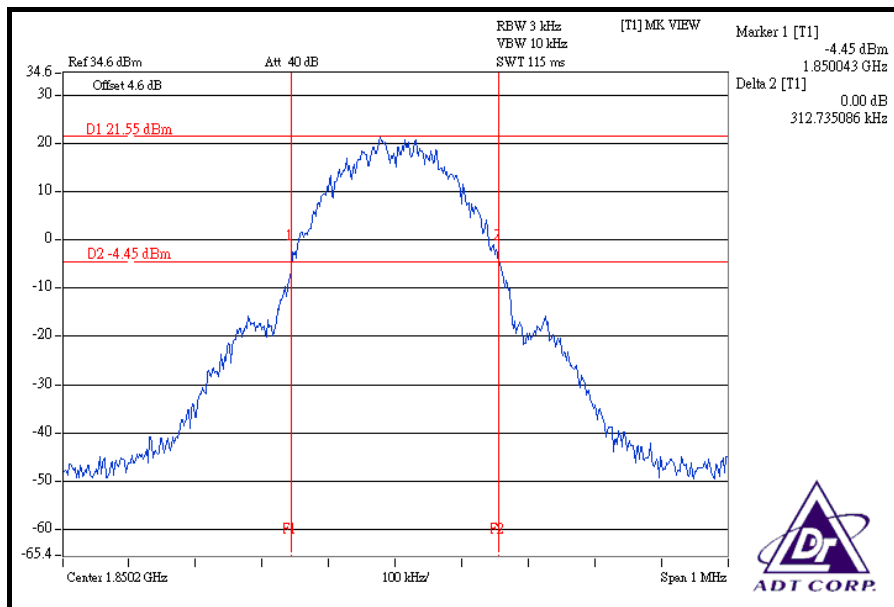

MIDDLE CHANNEL

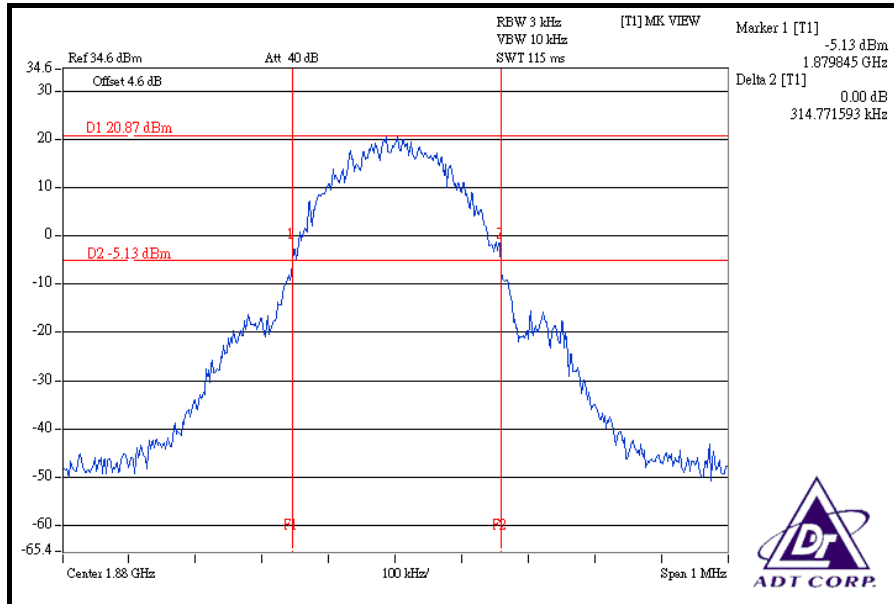

HIGH CHANNEL

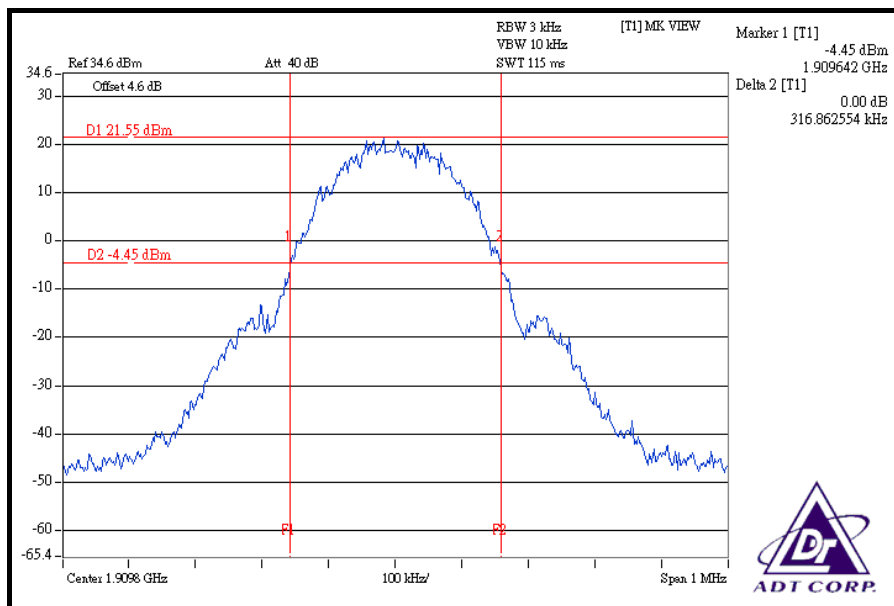

FOR E-GPRS MODE (UP-LINK WITH 1 TIME SLOT)

CHANNEL	MAX. OUTPUT POWER -26 dBc BANDWIDTH (kHz)
LOW	315
MIDDLE	316
HIGH	323

LOW CHANNEL

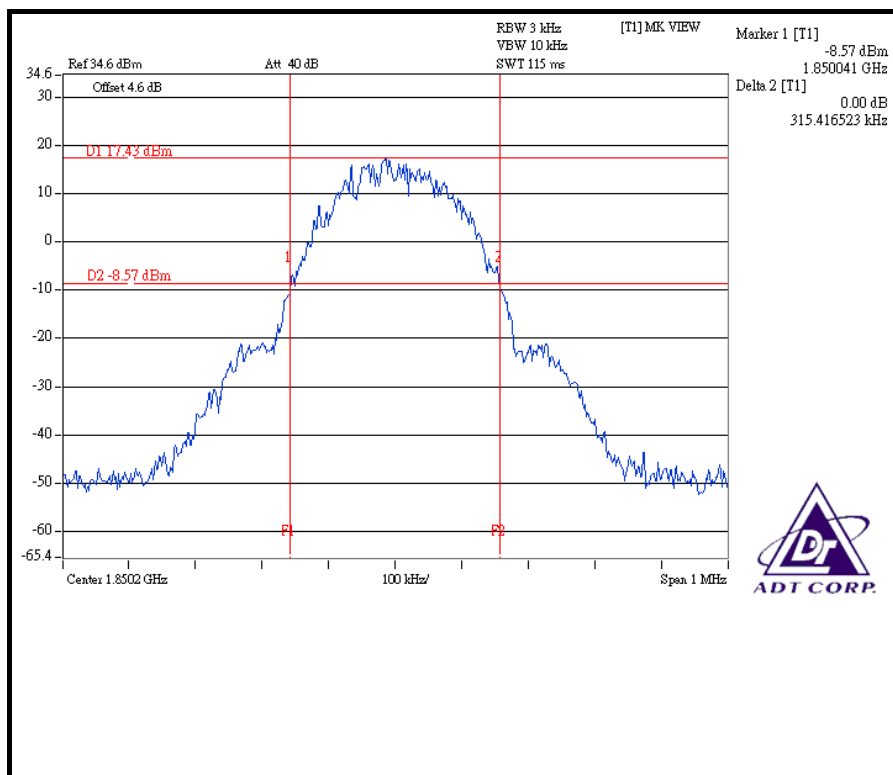

MIDDLE CHANNEL

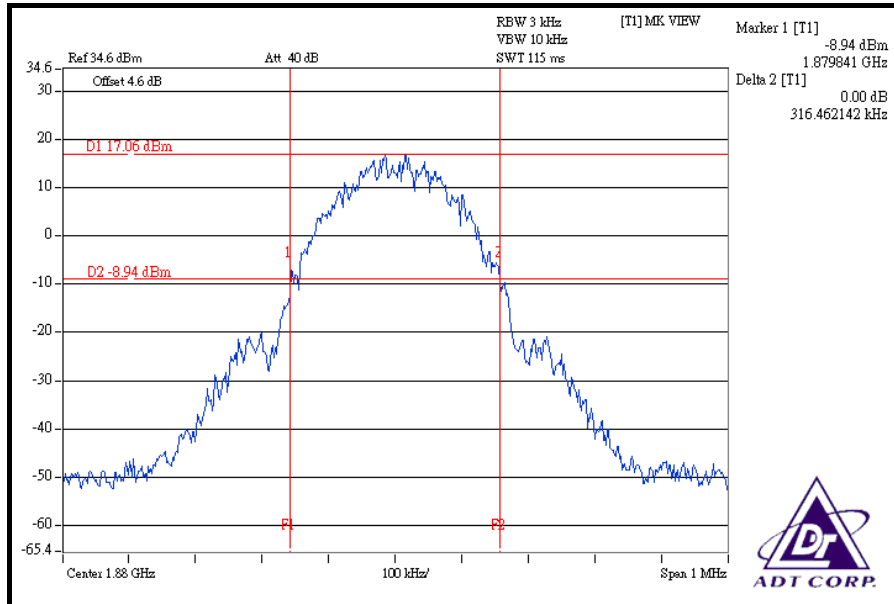

HIGH CHANNEL

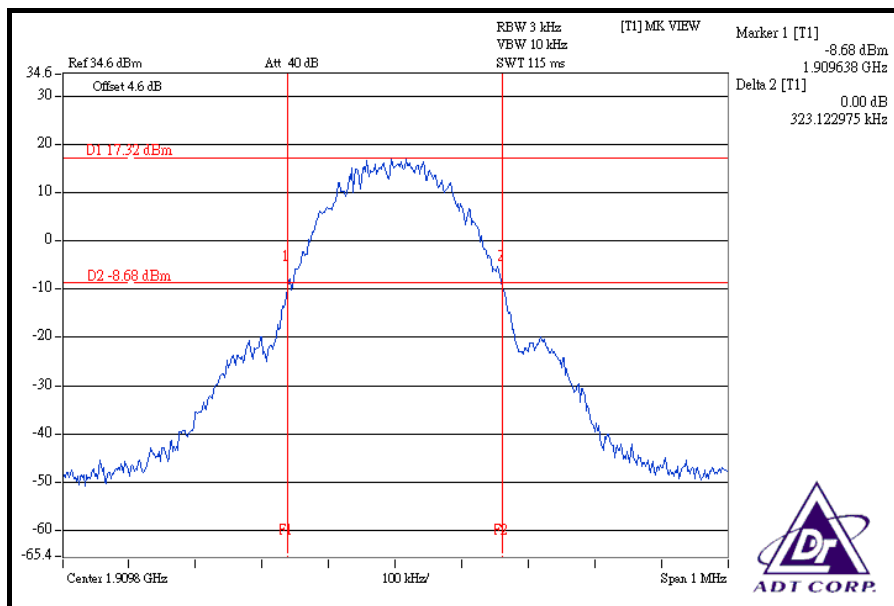

4.4 BAND EDGE MEASUREMENT

4.4.1 LIMITS OF BAND EDGE MEASUREMENT

The PCS frequency bands refer to the FCC 24.229 rule. According to FCC 24.238(a) specified that power of any emission outside of the authorized operating frequency ranges must be attenuated below the transmitting power (P) by a factor of at least $43 + 10 \log(P)$ dB. In the 1 MHz bands immediately outside and adjacent to the frequency block a resolution bandwidth of at least one percent of the emission bandwidth of the fundamental emission of the transmitter may be employed.

4.4.2 TEST INSTRUMENTS

DESCRIPTION & MANUFACTURER	MODEL NO.	SERIAL NO.	CALIBRATED UNTIL
* ROHDE & SCHWARZ Spectrum Analyzer	FSP40	100025	Oct. 17, 2008
* Mini-Circuits Power Splitter	ZAPD-4	400005	NA
* Hewlett Packard RF cable	8120-6192	01428251	NA
* JFW 20dB attenuation	50HF-020-SMA	NA	NA
* Suhner RF cable	Sucoflex104	204850/4	NA

NOTE: 1. The calibration interval of the above test instruments is 12 months. And the calibrations are traceable to NML/ROC and NIST/USA.

2. "*" = These equipments are used for the final measurement.

4.4.3 TEST SETUP

Same as Item 4.2.4 (Conducted Power Setup)

4.4.4 TEST PROCEDURES

- a. The EUT was set up for the maximum peak power with GSM link data modulation. The power was measured with R&S Spectrum Analyzer. All measurements were done at 2 channels, 512 and 810 (low and high operational frequency range.)
- b. The band edge measurement used the power splitter via EUT RF power connector between simulation base station and spectrum analyzer. This splitter loss and cable loss are the worst loss 4.6dB in the transmitted path track.
- c. The center frequency of spectrum is the band edge frequency and span is 1.5 MHz. RB of the spectrum is 3kHz and VB of the spectrum is 10kHz.
- d. Record the max trace plot into the test report.

4.4.5 EUT OPERATING CONDITION

- a. The EUT makes a phone call to the communication simulator.
- b. The communication simulator station system controlled an EUT to export maximum output power under transmission mode and specific channel frequency.

4.4.6 TEST RESULTS

FOR GSM MODE LOWER BAND EDGE

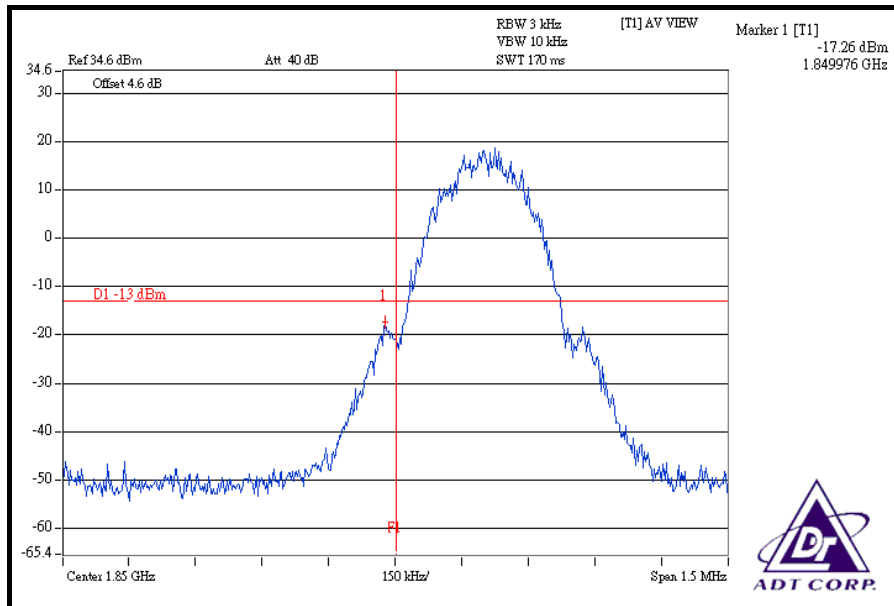

HIGHER BAND EDGE

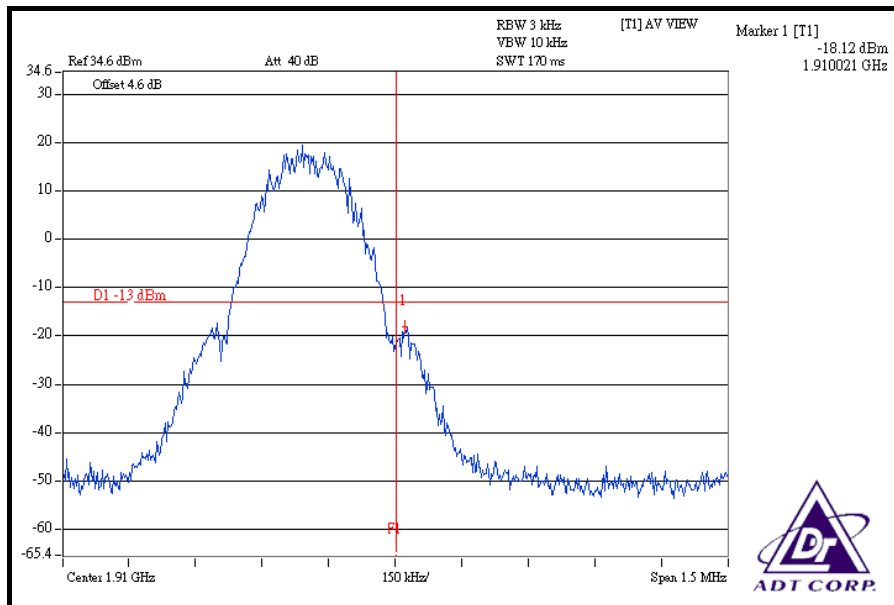

FOR GPRS MODE (UP-LINK WITH 1 TIME SLOT)
LOWER BAND EDGE

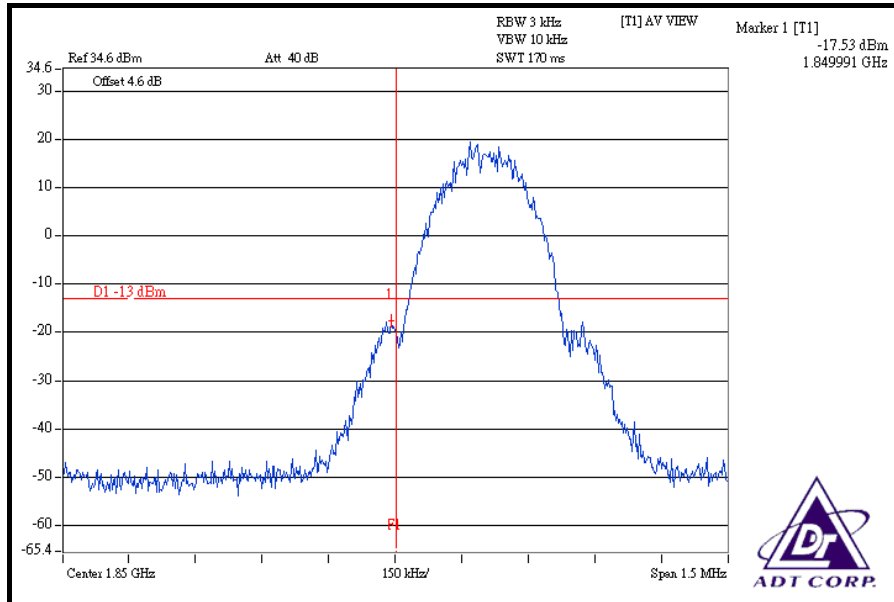

HIGHER BAND EDGE

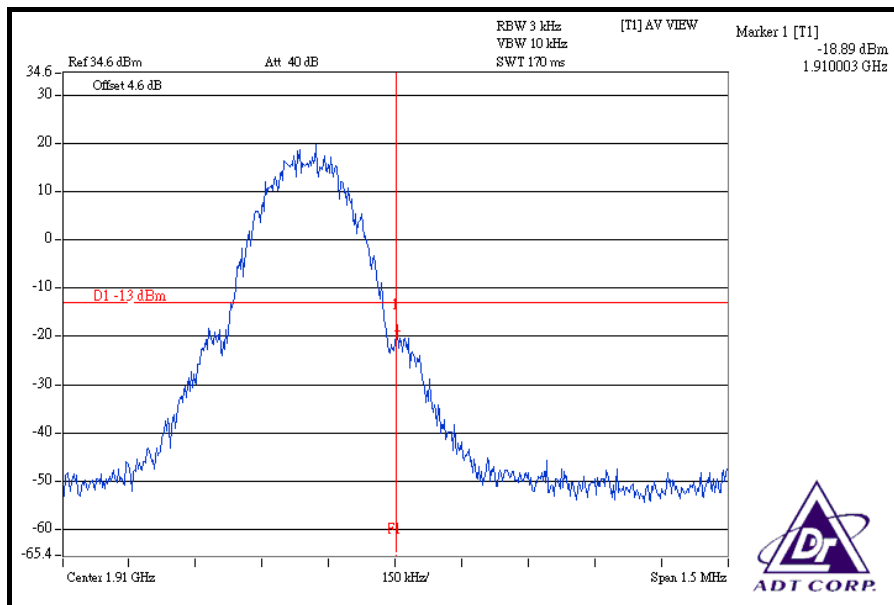

FOR E-GPRS MODE (UP-LINK WITH 1 TIME SLOT)

LOWER BAND EDGE

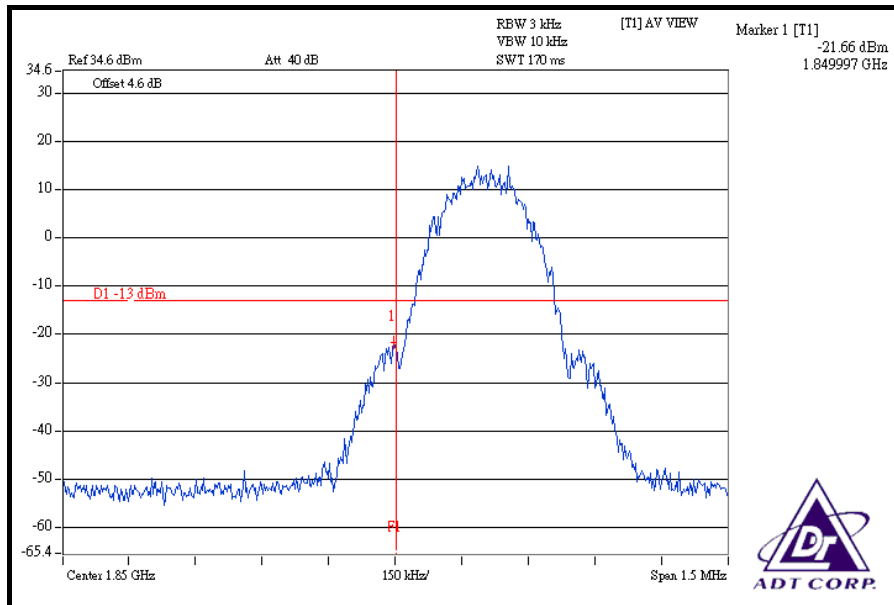

HIGHER BAND EDGE

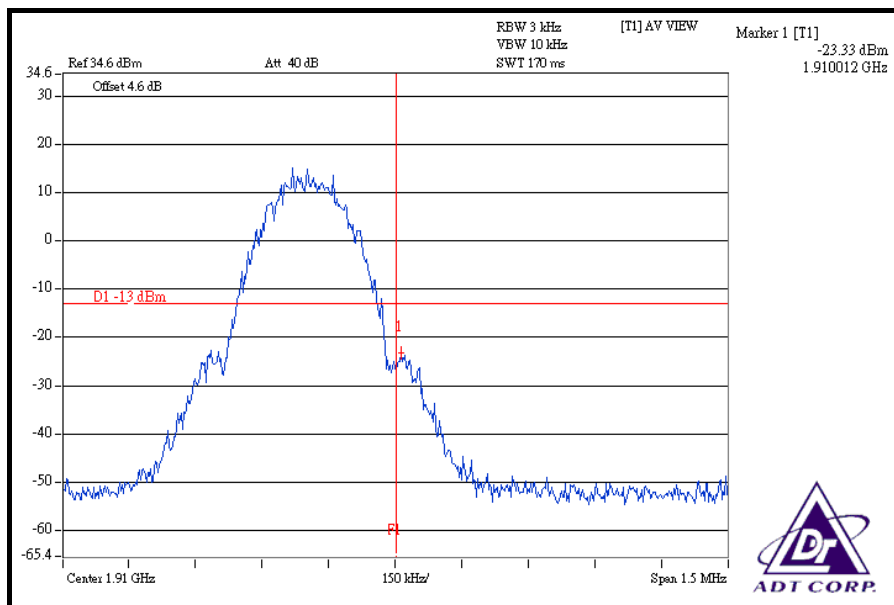

4.5 CONDUCTED SPURIOUS EMISSIONS

4.5.1 LIMITS OF CONDUCTED SPURIOUS EMISSIONS MEASUREMENT

In the FCC 24.238(a), On any frequency outside a licensee's frequency block within USPCS spectrum, the power of any emission shall be attenuated below the transmitter power (P) by at least $43 + 10 \log (P)$ dB. The limit of emission equal to -13dBm .

4.5.2 TEST INSTRUMENTS

DESCRIPTION & MANUFACTURER	MODEL NO.	SERIAL NO.	CALIBRATED UNTIL
* ROHDE & SCHWARZ Spectrum Analyzer	FSP40	100025	Oct. 17, 2008
* Wainwright Instruments Band Reject Filter	WRCG1850/1910-18 30/1930-60/10SS	SN1	NA
* Wainwright Instruments High Pass Filter	WHK3.1/18G-10SS	SN1	NA
* Mini-Circuits Power Splitter	ZAPD-4	400005	NA
* Hewlett Packard RF cable	8120-6192	01428251	NA
* JFW 20dB attenuation	50HF-020-SMA	NA	NA
* Suhner RF cable	Sucoflex104	204850/4	NA

- NOTE:**
1. The calibration interval of the above test instruments is 12 months. And the calibrations are traceable to NML/ROC and NIST/USA.
 2. "*" = These equipments are used for the final measurement.

4.5.3 TEST PROCEDURE

- a. The EUT was set up for the maximum peak power with GSM link data modulation. The power was measured with R&S Spectrum Analyzer. All measurements were done at 3 channels, 512, 661 and 810 (low, middle and high operational frequency range.)
- b. The conducted spurious emission used the power splitter via EUT RF power connector between simulation base station and spectrum analyzer. This splitter loss and cable loss are the worst loss 4.6dB in the transmitted path track.
- c. When the spectrum scanned from 9kHz to 3GHz, it shall be connected to the band reject filter attenuated the carried frequency. The spectrum set RB=1MHz, VB=3MHz.
- d. When the spectrum scanned from 3kHz to 20GHz, it shall be connected to the high pass filter attenuated the carried frequency. The spectrum set set RB=1MHz, VB=3MHz.

4.5.4 TEST SETUP

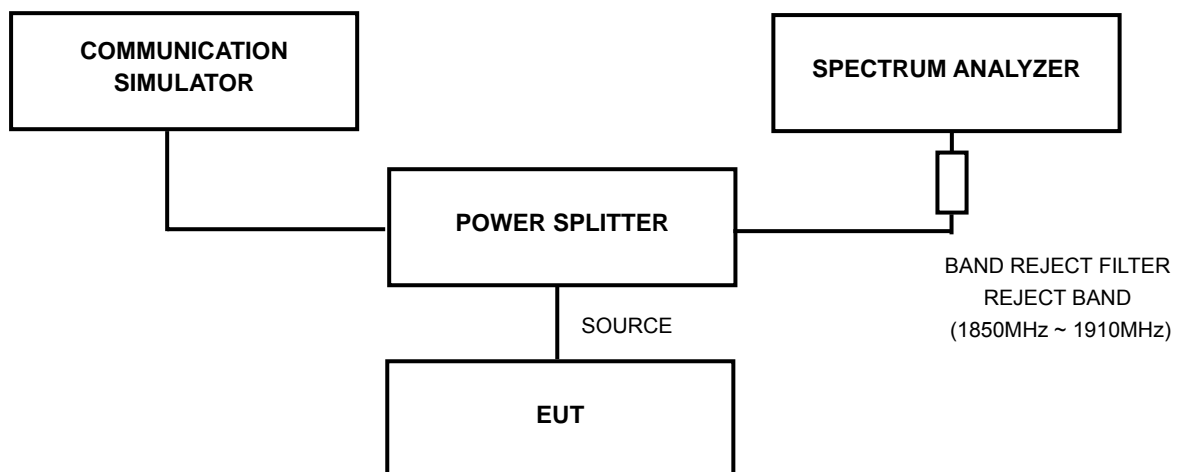

4.5.5 EUT OPERATING CONDITIONS

- a. The EUT makes a phone call to the communication simulator.
- b. The communication simulator station system controlled an EUT to export maximum output power under transmission mode and specific channel frequency.

4.5.6 TEST RESULTS

CH 512: 9kHz ~ 3GHz

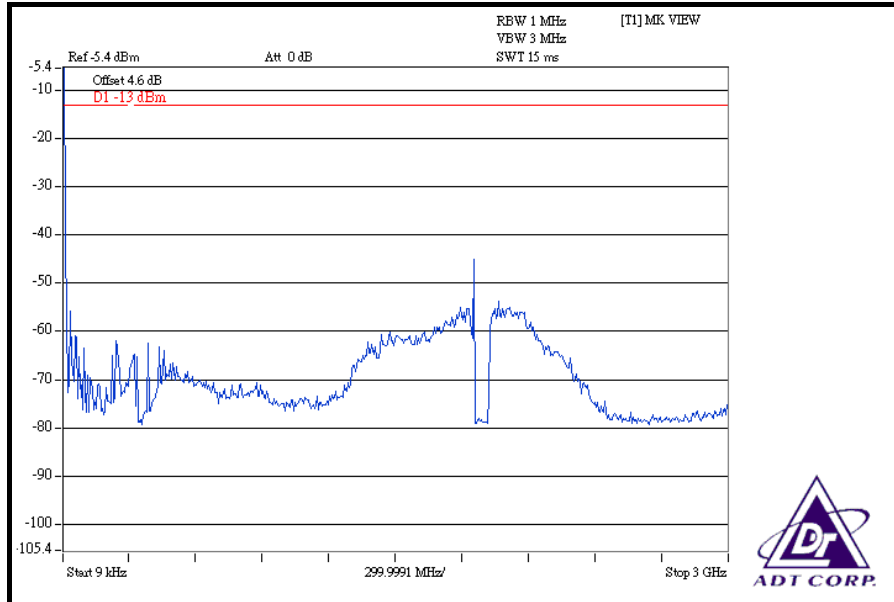

3GHz ~ 10GHz

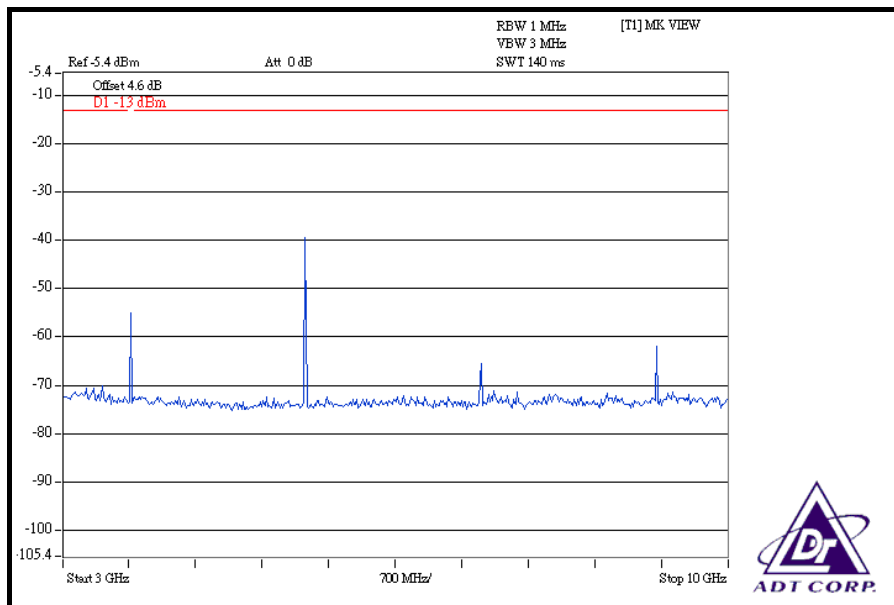

10GHz ~ 20GHz

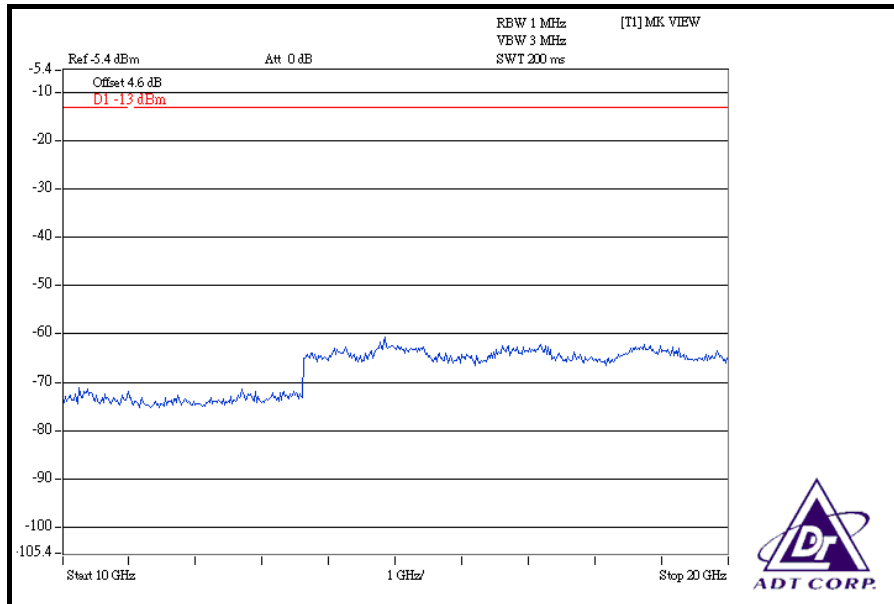

CH 661: 9kHz ~ 3GHz

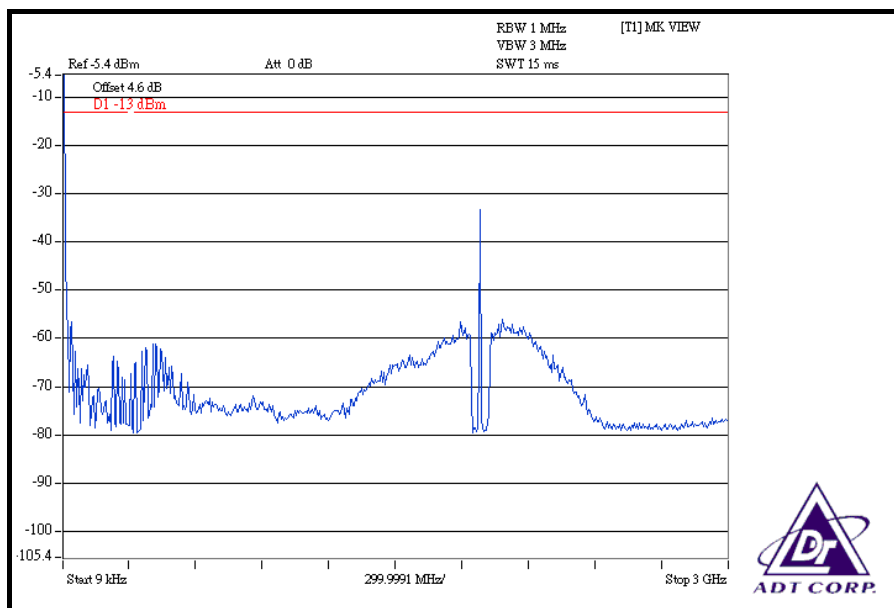

3GHz ~ 10GHz

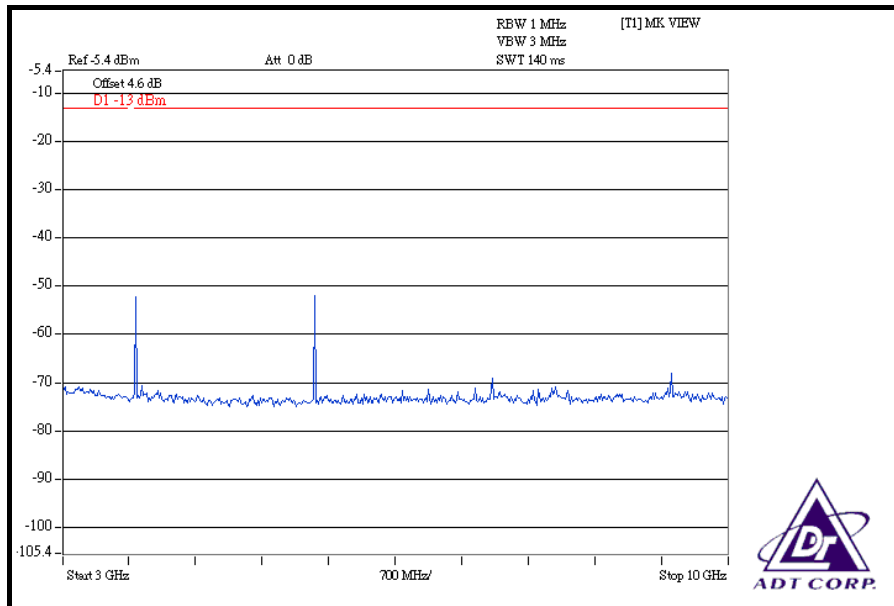

10GHz ~ 20GHz

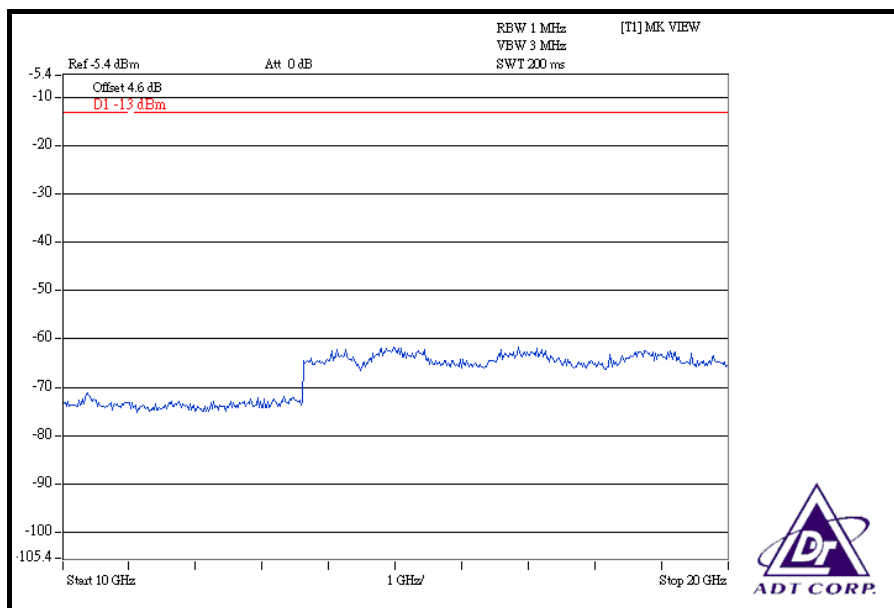

CH 810: 9kHz ~ 3GHz

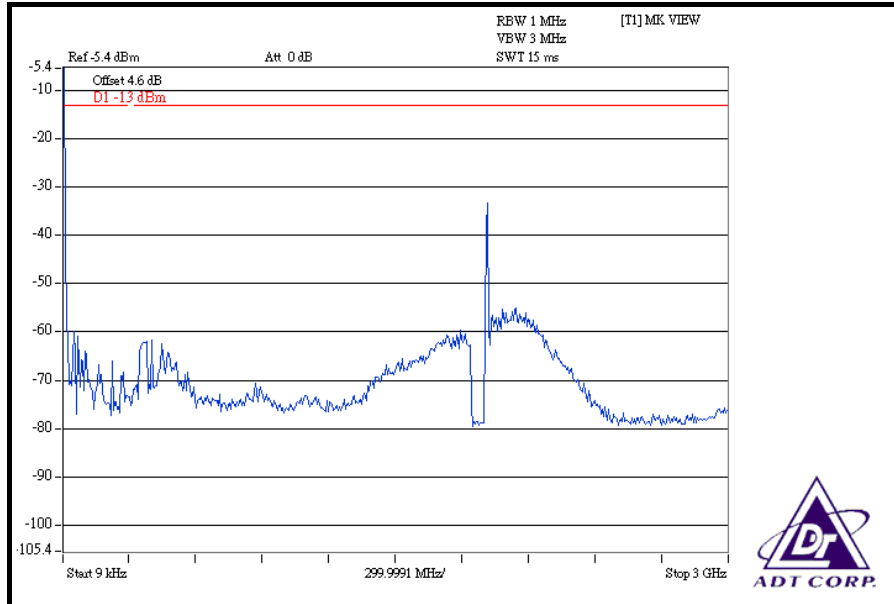

3GHz ~ 10GHz

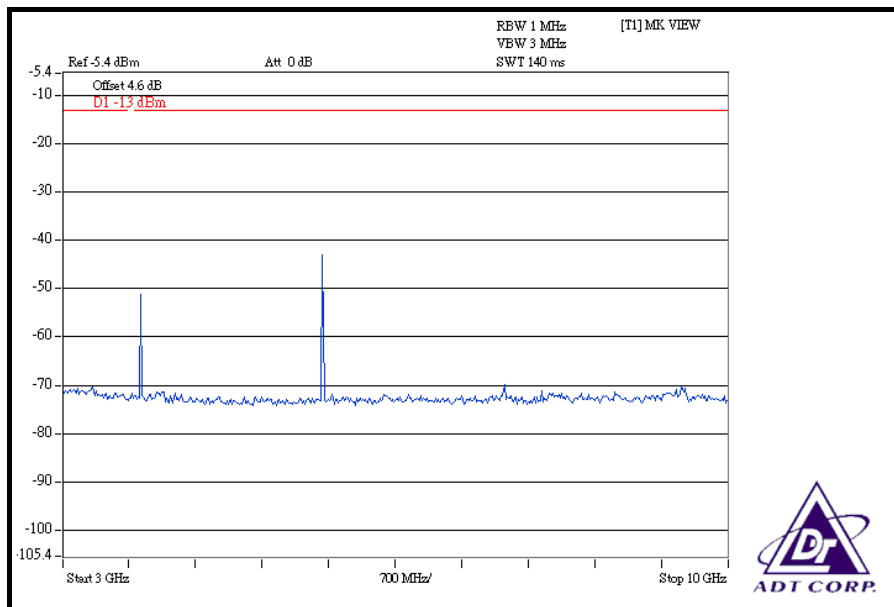

10GHz ~ 20GHz

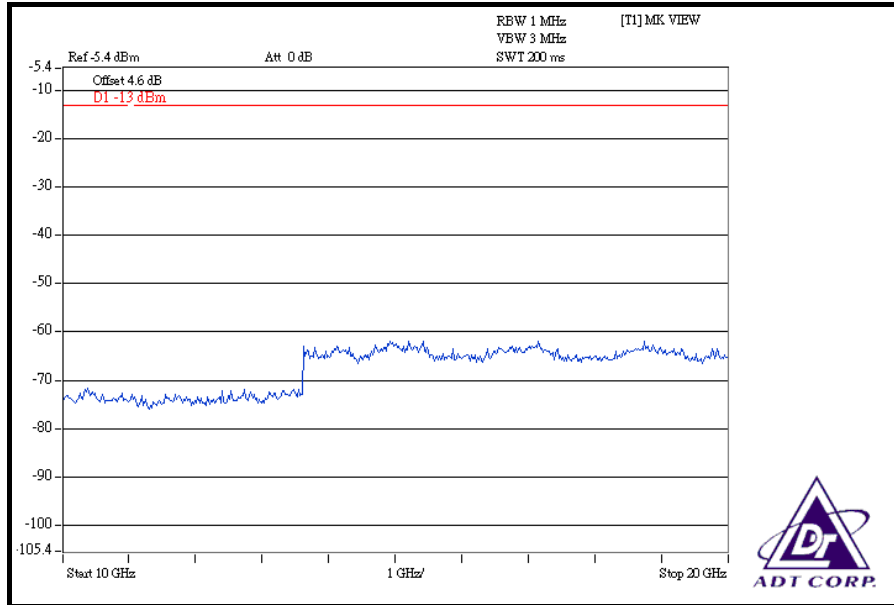

4.6 RADIATED EMISSION MEASUREMENT (BELOW 1GHz)

4.6.1 LIMITS OF RADIATED EMISSION MEASUREMENT

In the FCC 24.238(a), On any frequency outside a licensee's frequency block within USPCS spectrum, the power of any emission shall be attenuated below the transmitter power (P) by at least $43 + 10 \log (P)$ dB. The emission of limit equal to -13 dBm. So the limit of emission is the same absolute specified line.

LIMIT (dBm)	EQUIVALENT FIELD STRENGTH AT 3m (dBuV/m) (NOTE)
-13	82.22

NOTE: The following formula is used to convert the equipment radiated power to field strength.

$$E = [1000000\sqrt{(30P)}] / 3 \text{ uV/m, where P is Watts.}$$



4.6.2 TEST INSTRUMENTS

DESCRIPTION & MANUFACTURER	MODEL NO.	SERIAL NO.	CALIBRATED UNTIL
Test Receiver ROHDE & SCHWARZ	ESCI	100424	Jul. 27, 2008
Spectrum Analyzer Agilent	E4446A	MY44360128	Dec. 06, 2008
BILOG Antenna SCHWARZBECK	VULB9168	9168-160	May 31, 2008
HORN Antenna SCHWARZBECK	9120D	9120D-209	Jun. 28, 2008
HORN Antenna SCHWARZBECK	BBHA 9170	BBHA9170243	Dec. 24, 2008
Preamplifier Agilent	8447D	2944A10633	Oct. 28, 2008
Preamplifier Agilent	8449B	3008A01964	Oct. 23, 2008
RF signal cable HUBER+SUHNNER	SUCOFLEX 104	283402/4	Dec. 06, 2008
RF signal cable HUBER+SUHNNER	SUCOFLEX 104	251644/4	Dec. 06, 2008
Software ADT.	ADT_Radiated_V7.6	NA	NA
Antenna Tower inn-co GmbH	MA 4000	013303	NA
Antenna Tower Controller inn-co GmbH	CO2000	017303	NA
Turn Table ADT.	TT100.	TT93021703	NA
Turn Table Controller ADT.	SC100.	SC93021703	NA

- NOTE:**
1. The calibration interval of the above test instruments is 12 months and the calibrations are traceable to NML/ROC and NIST/USA.
 2. The test was performed in HwaYa Chamber 3.
 3. The horn antenna and HP preamplifier (model: 8449B) are used only for the measurement of emission frequency above 1GHz if tested.
 4. The FCC Site Registration No. is 988962.
 5. The IC Site Registration No. is IC3789B-3.

4.6.3 TEST PROCEDURES

- a. The EUT was placed on the top of a rotating table 0.8 meters above the ground. The table was rotated 360 degrees to determine the position of the highest radiation.
- b. The EUT was set 3 meters away from the receiving antenna, which was mounted on antenna tower and its position at 0.8 m above the ground.
- c. For each suspected emission, the EUT was arranged to its worst case and the rotatable table was turned from 0 degrees to 360 degrees to find the maximum reading and recorded the value.
- d. Repeat step a ~ c for horizontal polarization.

NOTE: The resolution bandwidth of spectrum analyzer is 1 MHz and the video bandwidth is 3 MHz.

4.6.4 DEVIATION FROM TEST STANDARD

No deviation

4.6.5 TEST SETUP

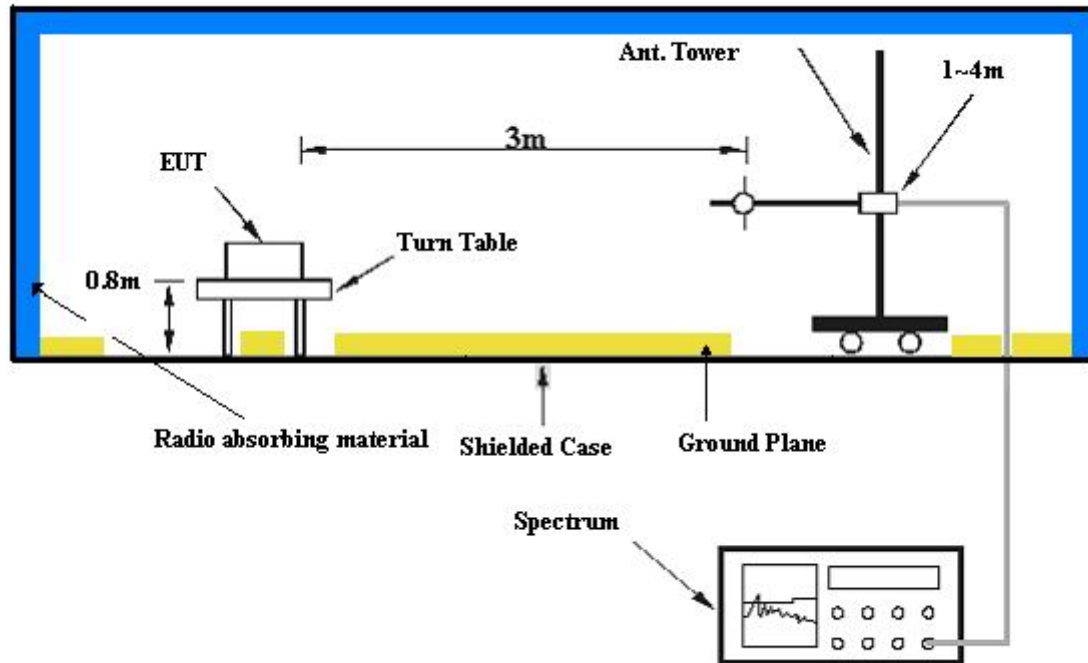

For the actual test configuration, please refer to the attached file (Test Setup Photo).

4.6.6 EUT OPERATING CONDITIONS

- The EUT makes a phone call to the communication simulator.
- The communication simulator station system controlled an EUT to export maximum output power under transmission mode and specific channel frequency.



4.6.7 TEST RESULTS

MODE	TX channel 512	DETECTOR FUNCTION	Peak
FREQUENCY RANGE	Below 1000 MHz	INPUT POWER (SYSTEM)	120Vac, 60 Hz
ENVIRONMENTAL CONDITIONS	25deg. C, 65%RH, 991hPa	TESTED BY	Brad Wu
TEST MODE	A		

ANTENNA POLARITY & TEST DISTANCE: HORIZONTAL AT 3 M								
No.	Freq. (MHz)	Emission Level (dBuV/m)	Limit (dBuV/m)	Margin (dB)	Antenna Height (m)	Table Angle (Degree)	Raw Value (dBuV)	Correction Factor (dB/m)
1	199.12	36.02	82.22	-46.20	1.50 H	244	24.68	11.34
2	665.65	37.58	82.22	-44.64	1.00 H	25	13.80	23.78
3	720.08	49.68	82.22	-32.54	2.00 H	355	24.90	24.78
4	861.98	36.71	82.22	-45.51	1.50 H	133	9.60	27.11
5	891.14	39.35	82.22	-42.87	2.00 H	313	11.87	27.49
6	961.12	41.43	82.22	-40.79	2.00 H	214	13.03	28.40

ANTENNA POLARITY & TEST DISTANCE: VERTICAL AT 3 M								
No.	Freq. (MHz)	Emission Level (dBuV/m)	Limit (dBuV/m)	Margin (dB)	Antenna Height (m)	Table Angle (Degree)	Raw Value (dBuV)	Correction Factor (dB/m)
1	125.25	36.26	82.22	-45.96	1.00 V	28	23.32	12.93
2	175.79	36.95	82.22	-45.27	1.00 V	220	23.63	13.32
3	449.88	35.09	82.22	-47.13	1.00 V	355	15.70	19.40
4	479.04	33.65	82.22	-48.57	1.50 V	142	13.73	19.91
5	720.08	45.35	82.22	-36.87	2.00 V	10	20.57	24.78
6	906.69	55.59	82.22	-26.63	1.00 V	289	27.89	27.70

NOTE:

1. Emission level (dBuV/m) = Raw Value (dBuV) + Correction Factor (dB).
2. Correction Factor (dB/m) = Antenna Factor (dB/m) + Cable Factor (dB).
3. The other emission levels were very low against the limit.
4. Margin value = Emission level – Limit value.
5. This is valid for all 3 channels.

MODE	TX channel 512	DETECTOR FUNCTION	Peak
FREQUENCY RANGE	Below 1000 MHz	INPUT POWER (SYSTEM)	120Vac, 60 Hz
ENVIRONMENTAL CONDITIONS	25deg. C, 65%RH, 991hPa	TESTED BY	Brad Wu
TEST MODE	B		

ANTENNA POLARITY & TEST DISTANCE: HORIZONTAL AT 3 M								
No.	Freq. (MHz)	Emission Level (dBuV/m)	Limit (dBuV/m)	Margin (dB)	Antenna Height (m)	Table Angle (Degree)	Raw Value (dBuV)	Correction Factor (dB/m)
1	86.37	45.85	82.22	-36.37	4.00 H	112	36.34	9.51
2	115.53	47.20	82.22	-35.02	1.50 H	88	35.11	12.09
3	399.34	43.41	82.22	-38.81	1.25 H	82	25.78	17.62
4	863.93	43.42	82.22	-38.80	2.00 H	121	16.29	27.14
5	916.41	49.29	82.22	-32.93	1.50 H	319	21.46	27.84
6	941.68	46.60	82.22	-35.62	1.50 H	106	18.41	28.20

ANTENNA POLARITY & TEST DISTANCE: VERTICAL AT 3 M								
No.	Freq. (MHz)	Emission Level (dBuV/m)	Limit (dBuV/m)	Margin (dB)	Antenna Height (m)	Table Angle (Degree)	Raw Value (dBuV)	Correction Factor (dB/m)
1	45.55	49.43	82.22	-32.79	1.00 V	112	35.19	14.24
2	84.43	45.16	82.22	-37.06	1.25 V	37	35.33	9.83
3	113.59	49.25	82.22	-32.97	1.25 V	160	37.40	11.85
4	309.92	43.46	82.22	-38.76	1.50 V	259	28.05	15.40
5	449.88	44.41	82.22	-37.81	1.25 V	250	25.01	19.40
6	933.91	47.92	82.22	-34.30	1.00 V	55	19.83	28.09

NOTE:

1. Emission level (dBuV/m) = Raw Value (dBuV) + Correction Factor (dB).
2. Correction Factor (dB/m) = Antenna Factor (dB/m) + Cable Factor (dB).
3. The other emission levels were very low against the limit.
4. Margin value = Emission level – Limit value.
5. This is valid for all 3 channels.

4.7 RADIATED EMISSION MEASUREMENT (ABOVE 1GHz)

4.7.1 LIMITS OF RADIATED EMISSION MEASUREMENT

In the FCC 24.238(a), On any frequency outside a licensee's frequency block within USPCS spectrum, the power of any emission shall be attenuated below the transmitter power (P) by at least $43 + 10 \log (P)$ dB. The limit of emission equal to -13dBm .

4.7.2 TEST INSTRUMENTS

DESCRIPTION & MANUFACTURER	MODEL NO.	SERIAL NO.	CALIBRATED UNTIL
Test Receiver ROHDE & SCHWARZ	ESCI	100424	Jul. 27, 2008
Spectrum Analyzer Agilent	E4446A	MY44360128	Dec. 06, 2008
BILOG Antenna SCHWARZBECK	VULB9168	9168-160	May 31, 2008
HORN Antenna SCHWARZBECK	9120D	9120D-209	Jun. 28, 2008
HORN Antenna SCHWARZBECK	BBHA 9170	BBHA9170243	Dec. 24, 2008
Preamplifier Agilent	8447D	2944A10633	Oct. 28, 2008
Preamplifier Agilent	8449B	3008A01964	Oct. 23, 2008
RF signal cable HUBER+SUHNNER	SUCOFLEX 104	283402/4	Dec. 06, 2008
RF signal cable HUBER+SUHNNER	SUCOFLEX 104	251644/4	Dec. 06, 2008
Software ADT.	ADT_Radiated_V7.6	NA	NA
Antenna Tower inn-co GmbH	MA 4000	013303	NA
Antenna Tower Controller inn-co GmbH	CO2000	017303	NA
Turn Table ADT.	TT100.	TT93021703	NA
Turn Table Controller ADT.	SC100.	SC93021703	NA

- NOTE:**
1. The calibration interval of the above test instruments is 12 months and the calibrations are traceable to NML/ROC and NIST/USA.
 2. The test was performed in HwaYa Chamber 3.
 3. The horn antenna and HP preamplifier (model: 8449B) are used only for the measurement of emission frequency above 1GHz if tested.
 4. The FCC Site Registration No. is 988962.
 5. The IC Site Registration No. is IC3789B-3.

4.7.3 TEST PROCEDURES

- a. The EUT was placed on the top of a rotating table 0.8 meters above the ground. The table was rotated 360 degrees to determine the position of the highest radiation.
- b. The EUT was set 3 meters away from the receiving antenna, which was mounted on antenna tower and its position at 0.8 m above the ground.
- c. For each suspected emission, the EUT was arranged to its worst case and the rotatable table was turned from 0 degrees to 360 degrees to find the maximum reading and recorded the value.
- d. The EUT is replaced by a horn antenna connected to a signal generator tuned to the frequency of emission.
- e. The signal generator level has to be adjusted to have the same emission nature.
- f. The radiated power can be calculated via the factor and antenna gain.
- g. Repeat step a ~ f for horizontal polarization.

NOTE: The resolution bandwidth of spectrum analyzer is 1 MHz and the video bandwidth is 3 MHz.

4.7.4 DEVIATION FROM TEST STANDARD

No deviation

4.7.5 TEST SETUP

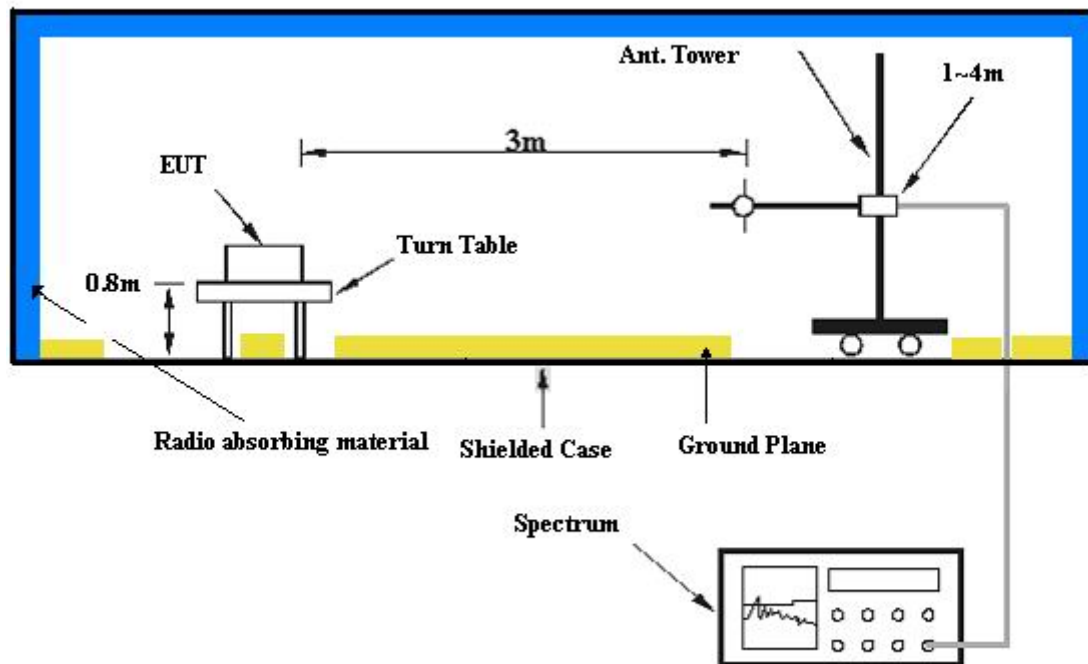

For the actual test configuration, please refer to the attached file (Test Setup Photo).

4.7.6 EUT OPERATING CONDITIONS

- a. The EUT makes a phone call to the communication simulator.
- b. The communication simulator station system controlled an EUT to export maximum output power under transmission mode and specific channel frequency.

4.7.7 TEST RESULTS

MODE	TX channel 512	DETECTOR FUNCTION	Peak
FREQUENCY RANGE	Above 1000 MHz	INPUT POWER (SYSTEM)	120Vac, 60 Hz
ENVIRONMENTAL CONDITIONS	25deg. C, 65%RH, 991hPa	TESTED BY	Long Chen

ANTENNA POLARITY & TEST DISTANCE: HORIZONTAL AT 3 M						
No.	Freq. (MHz)	Emission Level (dBuV)	Limit (dBm)	S.G Power Value (dBm)	Correction Factor (dB)	Power Value (dBm)
1	3700.40	50.79	-13.00	-55.24	10.12	-45.12
2	5550.60	52.17	-13.00	-56.31	11.49	-44.82

ANTENNA POLARITY & TEST DISTANCE: VERTICAL AT 3 M						
No.	Freq. (MHz)	Emission Level (dBuV)	Limit (dBm)	S.G Power Value (dBm)	Correction Factor (dB)	Power Value (dBm)
1	3700.40	51.20	-13.00	-56.13	10.12	-46.01
2	5550.60	54.50	-13.00	-54.07	11.49	-42.58

NOTE: Power Value (dBum) = S.G Power Value (dBm) + Correction Factor (dB).

MODE	TX channel 661	DETECTOR FUNCTION	Peak
FREQUENCY RANGE	Above 1000 MHz	INPUT POWER (SYSTEM)	120Vac, 60 Hz
ENVIRONMENTAL CONDITIONS	25deg. C, 65%RH, 991hPa	TESTED BY	Long Chen

ANTENNA POLARITY & TEST DISTANCE: HORIZONTAL AT 3 M						
No.	Freq. (MHz)	Emission Level (dBuV)	Limit (dBm)	S.G Power Value (dBm)	Correction Factor (dB)	Power Value (dBm)
1	3760.00	50.24	-13.00	-55.83	10.12	-45.71
2	5640.00	51.66	-13.00	-55.56	11.49	-44.07

ANTENNA POLARITY & TEST DISTANCE: VERTICAL AT 3 M						
No.	Freq. (MHz)	Emission Level (dBuV)	Limit (dBm)	S.G Power Value (dBm)	Correction Factor (dB)	Power Value (dBm)
1	3760.00	51.51	-13.00	-54.49	10.12	-44.37
2	5640.00	54.18	-13.00	-53.87	11.49	-42.38

NOTE: Power Value (dBum) = S.G Power Value (dBm) + Correction Factor (dB).



MODE	TX channel 810	DETECTOR FUNCTION	Peak
FREQUENCY RANGE	Above 1000 MHz	INPUT POWER (SYSTEM)	120Vac, 60 Hz
ENVIRONMENTAL CONDITIONS	25deg. C, 65%RH, 991hPa	TESTED BY	Long Chen

ANTENNA POLARITY & TEST DISTANCE: HORIZONTAL AT 3 M						
No.	Freq. (MHz)	Emission Level (dBuV)	Limit (dBm)	S.G Power Value (dBm)	Correction Factor (dB)	Power Value (dBm)
1	3819.60	48.56	-13.00	-57.68	10.17	-47.51
2	5729.40	52.69	-13.00	-54.60	11.49	-43.11

ANTENNA POLARITY & TEST DISTANCE: VERTICAL AT 3 M						
No.	Freq. (MHz)	Emission Level (dBuV)	Limit (dBm)	S.G Power Value (dBm)	Correction Factor (dB)	Power Value (dBm)
1	3819.60	50.45	-13.00	-55.86	10.17	-45.69
2	5729.40	52.69	-13.00	-54.92	11.49	-43.43

NOTE: Power Value (dBum) = S.G Power Value (dBm) + Correction Factor (dB).

5 PHOTOGRAPHS OF THE TEST CONFIGURATION

Please refer to the attached file (Test Setup Photo).



6 INFORMATION ON THE TESTING LABORATORIES

We, ADT Corp., were founded in 1988 to provide our best service in EMC, Radio, Telecom and Safety consultation. Our laboratories are accredited and approved by the following approval agencies according to ISO/IEC 17025.

USA	FCC, UL, A2LA
GERMANY	TUV Rheinland
JAPAN	VCCI
NORWAY	NEMKO
CANADA	INDUSTRY CANADA , CSA
R.O.C.	TAF, BSMI, NCC
NETHERLANDS	Telefication
SINGAPORE	GOST-ASIA (MOU)
RUSSIA	CERTIS (MOU)

Copies of accreditation certificates of our laboratories obtained from approval agencies can be downloaded from our web site: www.adt.com.tw/index.5/phtml.
If you have any comments, please feel free to contact us at the following:

Linko EMC/RF Lab:
Tel: 886-2-26052180
Fax: 886-2-26051924

Hsin Chu EMC/RF Lab:
Tel: 886-3-5935343
Fax: 886-3-5935342

Hwa Ya EMC/RF/Safety/Telecom Lab:
Tel: 886-3-3183232
Fax: 886-3-3185050

Web Site: www.adt.com.tw

The address and road map of all our labs can be found in our web site also.

7 APPENDIX A – MODIFICATIONS RECORDERS FOR ENGINEERING CHANGES TO THE EUT BY THE LAB

No any modifications are made to the EUT by the lab during the test.