

**WSRC-TR-2004-00049**

**Revision 0**

**KEY WORDS:**

**Saltstone Disposal Facility**

**Performance Assessment**

**Closure Cap**

**SALTSTONE DISPOSAL FACILITY  
MECHANICALLY STABILIZED EARTH VAULT  
CLOSURE CAP DEGRADATION:  
SENSITIVITY ANALYSIS (U)**

**FEBRUARY 12, 2004**

**PREPARED BY:**

**Mark A. Phifer**

Westinghouse Savannah River Company LLC

Westinghouse Savannah River Company LLC

Savannah River Site

Aiken, SC 29808



---

Prepared for the U.S. Department of Energy under Contract No. DE-AC09-96SR18500

**This document was prepared in conjunction with work accomplished under Contract No. DE-AC09-96SR18500 with the U. S. Department of Energy.**

**DISCLAIMER**

**This report was prepared as an account of work sponsored by an agency of the United States Government. Neither the United States Government nor any agency thereof, nor any of their employees, makes any warranty, express or implied, or assumes any legal liability or responsibility for the accuracy, completeness, or usefulness of any information, apparatus, product or process disclosed, or represents that its use would not infringe privately owned rights. Reference herein to any specific commercial product, process or service by trade name, trademark, manufacturer, or otherwise does not necessarily constitute or imply its endorsement, recommendation, or favoring by the United States Government or any agency thereof. The views and opinions of authors expressed herein do not necessarily state or reflect those of the United States Government or any agency thereof.**

**This report has been reproduced directly from the best available copy.**

**Available for sale to the public, in paper, from: U.S. Department of Commerce, National Technical Information Service, 5285 Port Royal Road, Springfield, VA 22161,  
phone: (800) 553-6847,  
fax: (703) 605-6900  
email: [orders@ntis.fedworld.gov](mailto:orders@ntis.fedworld.gov)  
online ordering: <http://www.ntis.gov/help/index.asp>**

**Available electronically at <http://www.osti.gov/bridge>  
Available for a processing fee to U.S. Department of Energy and its contractors, in paper, from: U.S. Department of Energy, Office of Scientific and Technical Information, P.O. Box 62, Oak Ridge, TN 37831-0062,  
phone: (865)576-8401,  
fax: (865)576-5728  
email: [reports@adonis.osti.gov](mailto:reports@adonis.osti.gov)**

**WSRC-TR-2004-00049**

**Revision 0**

**KEY WORDS:**

**Saltstone Disposal Facility**

**Performance Assessment**

**Closure Cap**

**SALTSTONE DISPOSAL FACILITY  
MECHANICALLY STABILIZED EARTH VAULT  
CLOSURE CAP DEGRADATION:  
SENSITIVITY ANALYSIS (U)**

**FEBRUARY 12, 2004**

**PREPARED BY:**

**Mark A. Phifer**

Westinghouse Savannah River Company LLC

Westinghouse Savannah River Company LLC

Savannah River Site

Aiken, SC 29808



---

Prepared for the U.S. Department of Energy under Contract No. DE-AC09-96SR18500

**THIS PAGE INTENTIONALLY LEFT BLANK**

**THIS PAGE INTENTIONALLY LEFT BLANK**

## TABLE OF CONTENTS

1.0	Executive Summary.....	1-1
2.0	Introduction.....	2-1
3.0	Intact Closure Cap Infiltration .....	3-1
3.1	Intact SDF GCL Closure Cap Footprint, Configuration, and Properties .....	3-1
3.2	Help Model and Generic Input Data.....	3-3
3.3	Intact Closure Cap Curve Number Input Parameter Values .....	3-4
3.4	Intact Closure Cap Infiltration .....	3-5
4.0	Closure Cap Degradation.....	4-1
4.1	Pine Forest Succession .....	4-1
4.2	Erosion.....	4-1
4.3	Colloidal Clay Migration .....	4-3
4.4	Closure Cap Degradation Summary .....	4-3
5.0	Closure Cap Infiltration for Lower Bounding Scenario (Continuous Bamboo Cover) .....	5-1
5.1	LBS Degraded Layer Properties over Time.....	5-1
5.1.1	LBS Middle Backfill and Upper Drainage Layer .....	5-1
5.1.2	LBS Lower Drainage Layer .....	5-1
5.1.3	LBS Summary Material Properties over Time .....	5-2
5.2	LBS Degraded Closure Cap Infiltration over Time.....	5-2
5.3	LBS Infiltration after Complete Closure Cap Degradation.....	5-3
6.0	Closure Cap Infiltration for Upper Bounding Scenario (Institutional Control To Farm To Pine Forest) .....	6-1
6.1	UBS Degraded Layer Properties over Time .....	6-1
6.1.1	UBS Erosion Barrier .....	6-1
6.1.2	UBS Upper GCL.....	6-1
6.1.3	UBS Middle Backfill and Upper Drainage Layer.....	6-2
6.1.4	UBS Lower Drainage Layer .....	6-2
6.1.5	UBS Summary Material Properties over Time.....	6-3
6.2	UBS Degraded Closure Cap Infiltration over Time .....	6-4
6.3	UBS Infiltration after Complete Closure Cap Degradation .....	6-5
7.0	Summary and Conclusions .....	7-1
8.0	References.....	8-1
9.0	Appendices.....	9-1

**LIST OF FIGURES**

Figure 2.0-1. Saltstone Disposal Facility Closure Cap (Phifer and Nelson 2003)..... 2-2

Figure 2.0-2. Saltstone Disposal Facility MSE Vault (Phifer 2003)..... 2-2

Figure 3.1-1. MSE Vault Layout (Phifer 2003)..... 3-1

Figure 3.1-2. Closure Cap Footprint and Drainage System (Detail A) (Phifer 2003) ..... 3-2

Figure 3.1-3. MSE Vault and Closure Cap Cross-Section (Section A-A) (Phifer 2003)..... 3-2

Figure 7.0-1. Base Case, Lower Bounding, and Upper Bounding Infiltration over Time ..... 7-3

Figure 7.0-2. Lower Drainage Layer Saturated Hydraulic Conductivity for the Base Case,  
Lower Bounding, and Upper Bounding Scenarios over Time..... 7-4

## LIST OF TABLES

Table 3.1-1.	Intact SDF MSE Vault Closure Cap Configuration and Properties (Phifer and Nelson 2003) .....	3-3
Table 3.2-1.	Generic Input Parameter Values – Area and Initial Moisture.....	3-4
Table 3.3-1.	Curve Number (CN) Input Parameter Values for Intact Closure Cap.....	3-5
Table 4.2-1.	USLE Parameter Values.....	4-2
Table 4.4-1.	Lower Bounding Scenario Closure Cap Layer Degradation Assumptions (modified from Phifer and Nelson 2003) .....	4-4
Table 4.4-2.	Upper Bounding Scenario Closure Cap Layer Degradation Assumptions (modified from Phifer and Nelson 2003) .....	4-5
Table 5.1-1.	Lower Bounding Scenario Material Property Summary Results .....	5-2
Table 5.2-1.	Lower Bounding Sensitivity Values .....	5-3
Table 6.1-1.	Upper Bounding Scenario Material Property Summary Results .....	6-3
Table 6.2-1.	Upper Bounding Sensitivity Values.....	6-5
Table 7.0-1.	Base Case, Lower Bounding, and Upper Bounding Infiltration over Time .....	7-3
Table 7.0-2.	Lower Drainage Layer Saturated Hydraulic Conductivity for the Base Case, Lower Bounding, and Upper Bounding Scenarios over Time.....	7-4



## LIST OF APPENDICES

<b>Appendix A</b>	<b>Augusta Synthetic Precipitation Modified with SRS Specific Average Monthly Precipitation Data over 100 Years (file name: Zprec.d4) .....</b>	<b>A-1</b>
<b>Appendix B</b>	<b>Augusta Synthetic Temperature Modified with SRS Specific Average Monthly Temperature Data over 100 Years (file name: Ztemp.d7) .....</b>	<b>B-1</b>
<b>Appendix C</b>	<b>Augusta Synthetic Solar Radiation Data over 100 Years (file name: Zsolar.d13) .....</b>	<b>C-1</b>
<b>Appendix D</b>	<b>Augusta Evapotranspiration Data (file name: Zevap.d11) .....</b>	<b>D-1</b>
<b>Appendix E</b>	<b>Intact SDF MSE Vault Closure Cap (0 Years): HELP Model Input Data and Output File (output file name: ZMSEIout.OUT) .....</b>	<b>E-1</b>
<b>Appendix F</b>	<b>SDF MSE Vault Closure Cap Degraded Property Value Calculations for Lower Bounding Scenario (i.e. Continuous Bamboo Cover) .....</b>	<b>F-1</b>
<b>Appendix G</b>	<b>Lower Bounding Scenario Degraded SDF MSE Vault Closure Cap (100 Years): HELP Model Input Data and Output File (output file name: ZLBS1out.OUT) .....</b>	<b>G-1</b>
<b>Appendix H</b>	<b>Lower Bounding Scenario Degraded SDF MSE Vault Closure Cap (300 Years): HELP Model Input Data and Output File (output file name: ZLBS2out.OUT) .....</b>	<b>H-1</b>
<b>Appendix I</b>	<b>Lower Bounding Scenario Degraded SDF MSE Vault Closure Cap (550 Years): HELP Model Input Data and Output File (output file name: ZLBS3out.OUT) .....</b>	<b>I-1</b>
<b>Appendix J</b>	<b>Lower Bounding Scenario Degraded SDF MSE Vault Closure Cap (1,000 Years): HELP Model Input Data and Output File (output file name: ZLBS4out.OUT) .....</b>	<b>J-1</b>
<b>Appendix K</b>	<b>Lower Bounding Scenario Degraded SDF MSE Vault Closure Cap (1,800 Years): HELP Model Input Data and Output File (output file name: ZLBS5out.OUT) .....</b>	<b>K-1</b>
<b>Appendix L</b>	<b>Lower Bounding Scenario Degraded SDF MSE Vault Closure Cap (3,400 Years): HELP Model Input Data and Output File (output file name: ZLBS6out.OUT) .....</b>	<b>L-1</b>
<b>Appendix M</b>	<b>Lower Bounding Scenario Degraded SDF MSE Vault Closure Cap (5,600 Years): HELP Model Input Data and Output File (output file name: ZLBS7out.OUT) .....</b>	<b>M-1</b>

**LIST OF APPENDICES (continued)**

<b>Appendix N</b>	<b>Lower Bounding Scenario Degraded SDF MSE Vault Closure Cap (10,000 Years): HELP Model Input Data and Output File (output file name: ZLBS8ou.OUT) .....</b>	<b>N-1</b>
<b>Appendix O</b>	<b>SDF MSE Vault Closure Cap Degraded Property Value Calculations for Upper Bounding Scenario (i.e. Institutional Control to Farm to Pine Forest) .....</b>	<b>O-1</b>
<b>Appendix P</b>	<b>Upper Bounding Scenario Degraded SDF MSE Vault Closure Cap (100 Years): HELP Model Input Data and Output File (output file name: ZUBSD1ou.OUT).....</b>	<b>P-1</b>
<b>Appendix Q</b>	<b>Upper Bounding Scenario Degraded SDF MSE Vault Closure Cap (154 Years): HELP Model Input Data and Output File (output file name: ZUBSD2ou.OUT).....</b>	<b>Q-1</b>
<b>Appendix R</b>	<b>Upper Bounding Scenario Degraded SDF MSE Vault Closure Cap (300 Years): HELP Model Input Data and Output File (output file name: ZUBSD3ou.OUT).....</b>	<b>R-1</b>
<b>Appendix S</b>	<b>Upper Bounding Scenario Degraded SDF MSE Vault Closure Cap (550 Years): HELP Model Input Data and Output File (output file name: ZUBSD4ou.OUT).....</b>	<b>S-1</b>
<b>Appendix T</b>	<b>Upper Bounding Scenario Degraded SDF MSE Vault Closure Cap (602 Years): HELP Model Input Data and Output File (output file name: ZUBSD5ou.OUT).....</b>	<b>T-1</b>
<b>Appendix U</b>	<b>Upper Bounding Scenario Degraded SDF MSE Vault Closure Cap (802 Years): HELP Model Input Data and Output File (output file name: ZUBSD6ou.OUT).....</b>	<b>U-1</b>
<b>Appendix V</b>	<b>Upper Bounding Scenario Degraded SDF MSE Vault Closure Cap (1,000 Years): HELP Model Input Data and Output File (output file name: ZUBSD7ou.OUT).....</b>	<b>V-1</b>
<b>Appendix W</b>	<b>Upper Bounding Scenario Degraded SDF MSE Vault Closure Cap (1,800 Years): HELP Model Input Data and Output File (output file name: ZUBSD8ou.OUT).....</b>	<b>W-1</b>
<b>Appendix X</b>	<b>Upper Bounding Scenario Degraded SDF MSE Vault Closure Cap (3,400 Years): HELP Model Input Data and Output File (output file name: ZUBSD9ou.OUT).....</b>	<b>X-1</b>

**LIST OF APPENDICES (continued)**

**Appendix Y Upper Bounding Scenario Degraded SDF MSE Vault Closure  
Cap (5,600 Years): HELP Model Input Data and Output File  
(output file name: ZUBSD10o.OUT)..... Y-1**

**Appendix Z Upper Bounding Scenario Degraded SDF MSE Vault Closure  
Cap (10,000 Years): HELP Model Input Data and Output File  
(output file name: ZUBSD11o.OUT).....Z-1**

**LIST OF ACRONYMS AND ABBREVIATIONS****ACRONYMS**

CLSM	Controlled Low Strength Material
CN	Curve Number
FC	field capacity
FML	flexible membrane liner
GCL	geosynthetic clay liner
GSE	GSE Lining Technology, Inc.
HELP	Hydrologic Evaluation of Landfill Performance
LBS	Lower Bounding Scenario
MMES	Martin Marietta Energy Systems, Inc.
MSE	Mechanically Stabilized Earth
PA	Performance Assessment
PORFLOW	Software for multiphase fluid flow, heat and mass transport in fractured porous media
SCS	Soil Conservation Service
SDF	Saltstone Disposal Facility
SRS	Savannah River Site
UBS	Upper Bounding Scenario
U.S.	United States
USCS	Unified Soil Classification System
USLE	Universal Soil Loss Equation
USDA	United States Department of Agriculture
USEPA	United States Environmental Protection Agency
WP	wilting point
WSRC	Westinghouse Savannah River Company

**LIST OF ACRONYMS AND ABBREVIATIONS (continued)****ABBREVIATIONS**

A	Area
A	Universal Soil Loss Equation soil loss
C	Universal Soil Loss Equation vegetative cover factor
cm	centimeter
cm <sup>2</sup>	square centimeter
cm <sup>3</sup>	cubic centimeter
d	thickness or depth
F	fraction
ft	feet
ft <sup>2</sup>	square feet
ft <sup>3</sup>	cubic feet
ft-msl	feet above mean sea level
g	gram
I	infiltration
in	inch
Instal.	installation
K	saturated hydraulic conductivity
K	Universal Soil Loss Equation soil erodibility factor
L	liter
lbs	pounds
LS	Universal Soil Loss Equation slope length and steepness factor
m <sup>3</sup>	cubic meter
mg	milligram
mil	thousandth of an inch
mph	miles per hour
n	porosity
N	no
No.	number
P	Universal Soil Loss Equation erosion control practice factor
R	Universal Soil Loss Equation rainfall erosion index

**LIST OF ACRONYMS AND ABBREVIATIONS (continued)****ABBREVIATIONS (continued)**

Recirc.	Recirculation
s	second
Sat. Hyd. Cond.	saturated hydraulic conductivity
sec	second
STD.	Standard
T	time
VEG.	Vegetative
V	volume
Vol	volume
Y	yes
yr	year
$\rho_b$	bulk density
$\rho_p$	particle density
'	foot
“	inch
%	percent
#	number
/	per
~	approximately

**THIS PAGE INTENTIONALLY LEFT BLANK**

## 1.0 EXECUTIVE SUMMARY

As part of the current Saltstone Disposal Facility (SDF) Performance Assessment (PA) revision, Mechanically Stabilized Earth (MSE) vault closure cap degradation mechanisms and their impact upon infiltration through the MSE vault closure cap were evaluated for the base case land use scenario (i.e. institutional control to pine forest). The degradation mechanisms evaluated included pine forest succession, erosion, and colloidal clay migration (Phifer 2003). Infiltration through the upper hydraulic barrier layer of the closure cap as determined by this evaluation will be utilized as the infiltration input to subsequent PORFLOW vadose zone contaminant transport modeling, which will also be performed as part of the PA revision.

Additionally as part of the PA revision, a sensitivity analysis has been performed and documented herein, to bound the previous base case land use scenario results. The same degradation mechanisms utilized for the base case, as appropriate, have been utilized in the sensitivity analysis. The bounding sensitivity analysis includes the following two MSE vault, closure cap, land use scenarios:

- Continuous bamboo cover (this scenario bounds the lower end of infiltration), and
- Institutional control to farm to pine forest (this scenario bounds the upper end of infiltration).

The estimated infiltration through the upper GCL for the lower bounding, base case, and upper bounding scenarios at year 1000 were 1.75, 12.04, and 19.46 inches/year, respectively. The maximum infiltration estimated through the upper GCL within the first 10,000 years infiltration for the lower bounding, base case, and upper bounding scenarios were 6.46 inches/year at year 3,400, 14.09 inches/year at year 10,000, and 21.42 inches/year at year 3,400, respectively. The estimated infiltration through the upper GCL at complete degradation of the closure cap for the lower bounding, base case, and upper bounding scenarios were 4.75 inches/year at year 280,000, 18.12 inches/year at year 280,000, and 18.60 at approximately year 38,250.

Based upon the results of this sensitivity analysis, it was estimated that the pine forest succession, degradation mechanism results in the greatest increase in infiltration at approximately 13.5 inches/year. It was estimated that colloidal clay migration into the drainage layer results in an infiltration increase of approximately 6 inches/year. Finally it was estimated that erosion results in the least infiltration increase of the degradation mechanisms at approximately 1 inch/year. Based upon this, it is evident that elimination of the pine forest succession, degradation mechanism would do the most to minimize increases in the infiltration over time.

In addition to infiltration over time, the saturated hydraulic conductivity of the lower drainage layer over time is an important parameter. It is estimated that the lower drainage layer completely silts-in (i.e. has a saturated hydraulic conductivity of 0.0001 cm/s) in year 26,000 for the lower bounding scenario, in year 12,000 for the base case scenario, and in year 8,300 for the upper bounding scenario.



**THIS PAGE INTENTIONALLY LEFT BLANK**

## 2.0 INTRODUCTION

As part of the current Saltstone Disposal Facility (SDF) Performance Assessment (PA) revision, the closure cap configuration was reevaluated and closure cap degradation mechanisms and their impact upon infiltration through the closure cap were evaluated for the base case land use scenario (i.e. institutional control to pine forest). This land use scenario assumes a 100-year institutional control period following final SDF closure during which the closure cap is maintained. At the end of institutional control, it is assumed that a pine forest succeeds the cap's original bamboo cover (Phifer and Nelson 2003).

The revised closure cap configuration is presented in Figure 2.0-1 (Phifer and Nelson 2003). The degradation mechanisms evaluated for this closure cap included pine forest succession, erosion, and colloidal clay migration. These degradation mechanisms resulted in changes in the hydraulic properties of the closure cap layers and resulting increases in infiltration through the closure cap over time. The primary changes caused by the degradation mechanisms that result in increased infiltration are the formation of holes in the upper geosynthetic clay liner (GCL) by pine forest succession and the reduction in the saturated hydraulic conductivity of the drainage layers due to colloidal clay migration into the layers. Erosion can also result in significant increases in infiltration if it causes the removal of soil layers, which provide water storage for the promotion of evapotranspiration.

The infiltration results for the existing SDF concrete vaults (i.e. vaults 1 and 4) and for the proposed Mechanically Stabilized Earth (MSE) vaults were documented within Phifer and Nelson (2003) and Phifer (2003), respectively. The existing SDF vaults (i.e. vaults 1 and 4) are above grade, roofed, reinforced concrete vaults. The proposed MSE vault configuration is presented in Figure 2.0-2 (Phifer 2003). Infiltration through the upper hydraulic barrier layer of the closure cap as determined by these evaluations will be utilized as the infiltration input to subsequent PORFLOW vadose zone contaminant transport modeling, which will also be performed as part of the PA revision.

Additionally as part of the PA revision, a sensitivity analysis has been performed and documented herein, to bound the previous results for the MSE vault, closure cap, base case land use scenario (i.e. institutional control to pine forest). The bounding sensitivity analysis includes the following two MSE vault, closure cap, land use scenarios:

- Continuous bamboo cover, and
- Institutional control to farm to pine forest.

The continuous bamboo cover land use scenario assumes that bamboo, which is shallow-rooted, is the climax species for the closure cap (i.e. pine trees will not encroach upon the bamboo). This scenario results in the least amount of infiltration through the upper hydraulic barrier layer (i.e. lower bounding scenario). The institutional control to farm to pine forest, land use scenario assumes a 100-year institutional control period following final SDF closure during which the closure cap is maintained. At the end of institutional control, it is assumed that the cap's original bamboo cover is removed and that corn is grown until the closure cap layers above the erosion barrier are completely eroded. After the layers above the erosion barrier are gone, it is assumed that a pine forest succeeds corn farming. This scenario results in the greatest amount of infiltration through the upper hydraulic barrier layer (i.e. upper bounding scenario). The same degradation mechanisms, as appropriate, have been evaluated for both the lower and upper bounding scenarios.

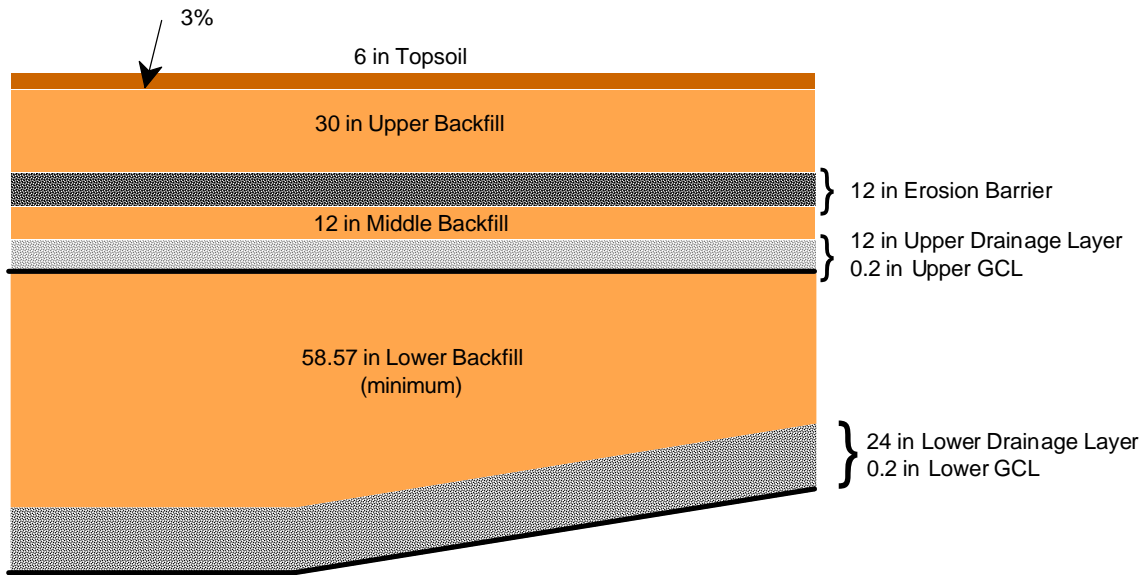

**Figure 2.0-1. Saltstone Disposal Facility Closure Cap (Phifer and Nelson 2003)**

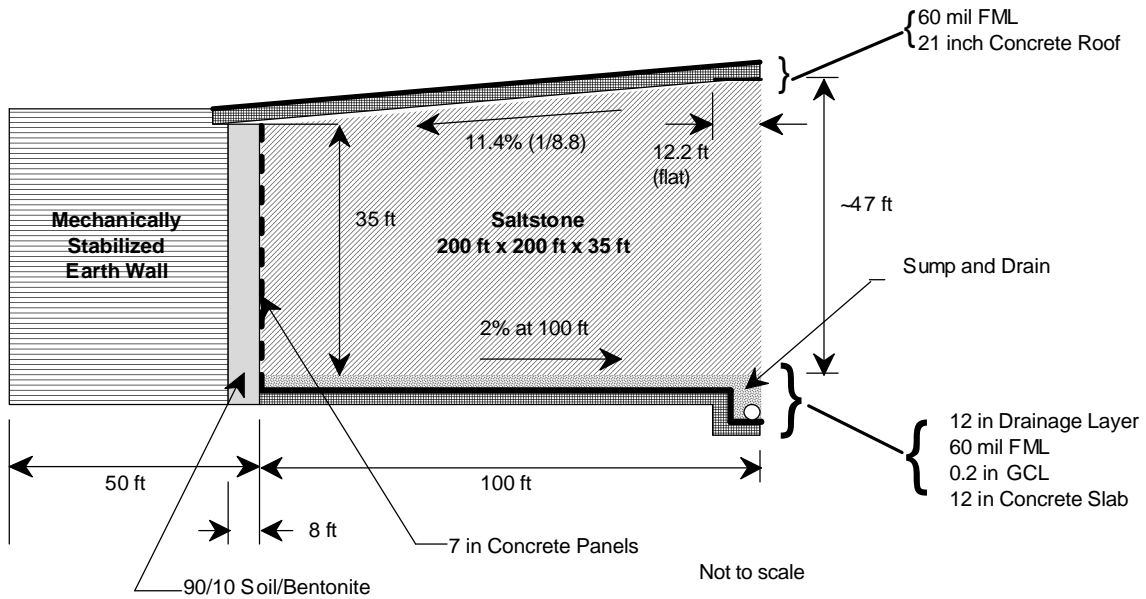
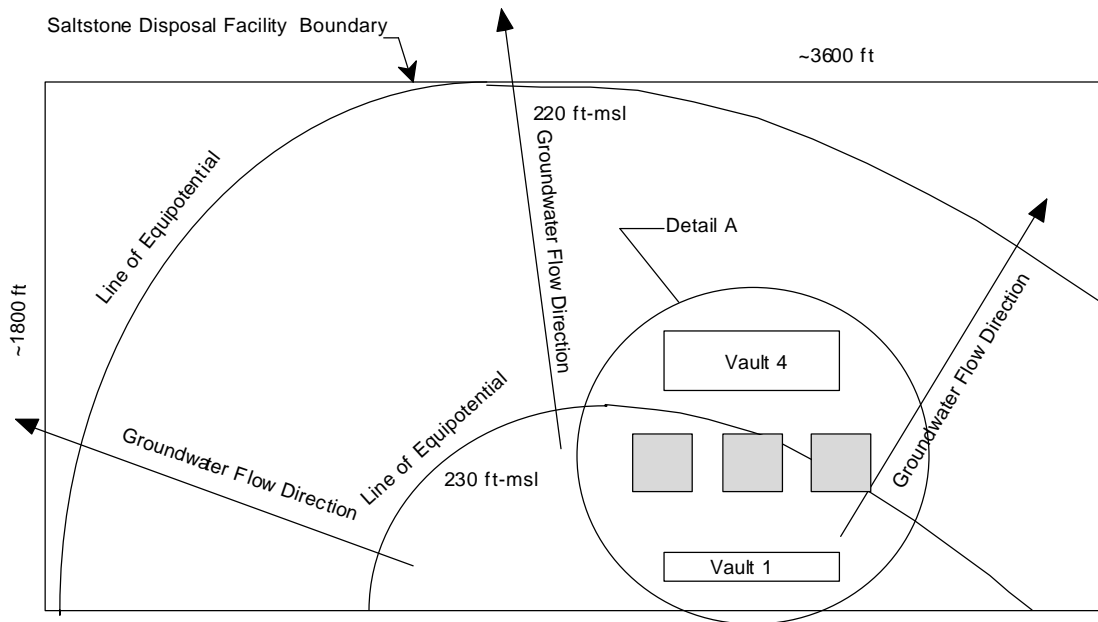

**Figure 2.0-2. Saltstone Disposal Facility MSE Vault (Phifer 2003)**

### 3.0 INTACT CLOSURE CAP INFILTRATION

#### 3.1 Intact SDF GCL Closure Cap Footprint, Configuration, and Properties

The MSE vault layout (Figure 3.1-1) and the closure cap footprint and drainage system configuration (Figure 3.1-2) developed by Phifer (2003) has been utilized for the sensitivity analysis presented herein. Figure 3.1-3 presents the MSE vault and closure cap cross-section as previously described in Section 2.0. The assumption has been made that the lower GCL only covers the MSE vault roof whereas the upper GCL is continuous over the entire closure cap footprint presented in Figure 3.1-2. Table 3.1-1 presents the intact SDF MSE Vault closure cap configuration and soil properties as developed by Phifer and Nelson (2003).



**Figure 3.1-1. MSE Vault Layout (Phifer 2003)**

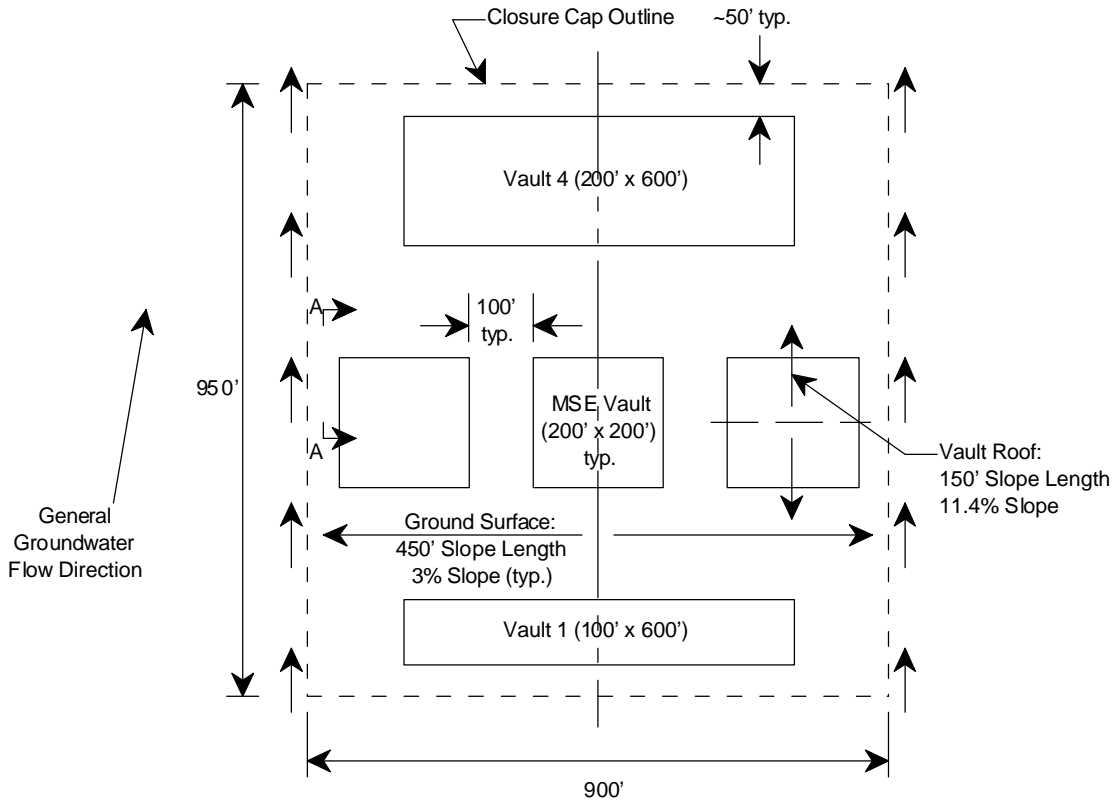

Figure 3.1-2. Closure Cap Footprint and Drainage System (Detail A) (Phifer 2003)

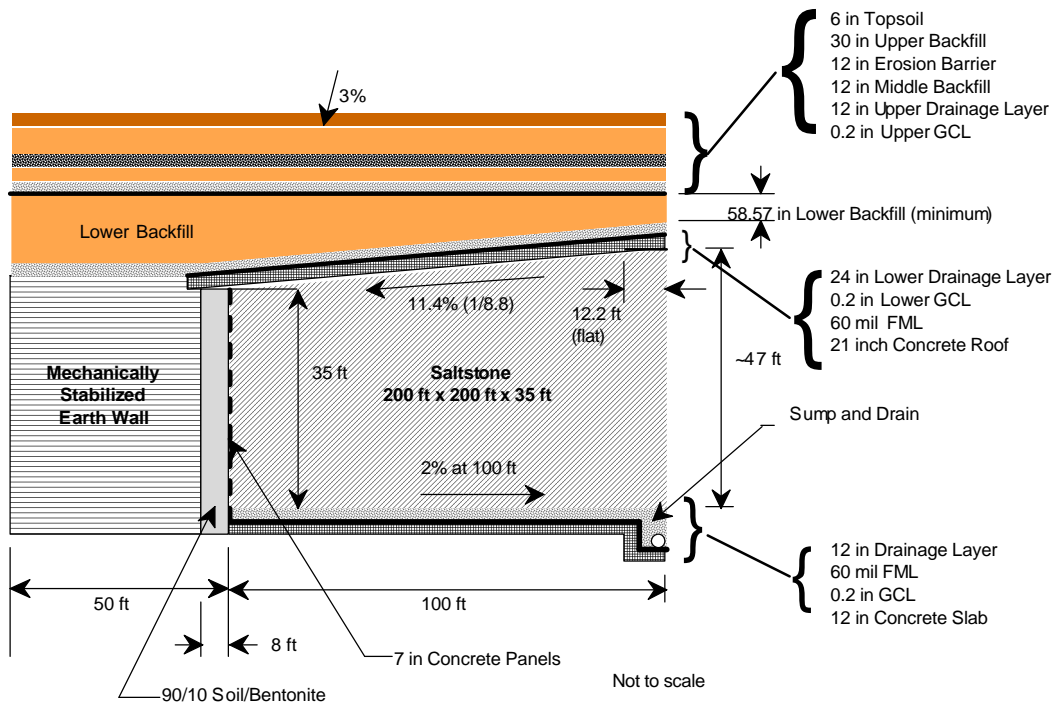

Figure 3.1-3. MSE Vault and Closure Cap Cross-Section (Section A-A) (Phifer 2003)

**Table 3.1-1. Intact SDF MSE Vault Closure Cap Configuration and Properties (Phifer and Nelson 2003)**

Layer	Thickness (inches)	Saturated Hydraulic Conductivity (cm/sec)	Total Porosity (Vol/Vol)	Field Capacity (Vol/Vol)	Wilting Point (Vol/Vol)
Topsoil <sup>1</sup>	6	1.00E-03	0.4	0.11	0.058
Upper Backfill <sup>1</sup>	30	1.00E-04	0.37	0.24	0.136
Erosion Barrier <sup>2</sup>	12	3.97E-04	0.06	0.056	0.052
Middle Backfill <sub>1</sub>	12	1.00E-04	0.37	0.24	0.136
Geotextile Filter Fabric <sup>3</sup>	-	-	-	-	-
Upper Drainage Layer <sup>1</sup>	12	1.00E-01	0.38	0.08	0.013
Upper GCL	0.2 <sup>4</sup>	5.00E-09 <sup>5</sup>	0.75 <sup>6</sup>	0.747 <sup>6</sup>	0.40 <sup>6</sup>
Lower Backfill <sup>1</sup>	58.57 (minimum)	1.00E-04	0.37	0.24	0.136
Geotextile Filter Fabric <sup>5</sup>	-	-	-	-	-
Lower Drainage Layer <sup>1</sup>	24	1.00E-01	0.38	0.08	0.013
Lower GCL	0.2 <sup>4</sup>	5.00E-09 <sup>5</sup>	0.75 <sup>6</sup>	0.747 <sup>6</sup>	0.40 <sup>6</sup>

<sup>1</sup> WSRC 2002<sup>2</sup> Phifer and Nelson 2003; The erosion barrier is assumed to consist of a one foot thick layer of 2-inch to 6-inch granite stone whose voids are filled with a Controlled Low Strength Material (CLSM) or flowable fill.<sup>3</sup> It is assumed that a geotextile filter fabric will be placed above the drainage layers to minimize the infiltration of fines from the overlying layers into the drainage layer. However it is not necessary to include the filter fabric in the HELP models.<sup>4</sup> USEPA 2001<sup>5</sup> GSE 2002<sup>6</sup> USEPA 1994a and USEPA 1994b

### 3.2 HELP Model and Generic Input Data

The Hydrologic Evaluation of Landfill Performance (HELP) model has been utilized to conduct the evaluation of the impact of closure cap degradation upon infiltration for each bounding sensitivity land use scenario (see Section 2.0) for the MSE vault closure cap (see Section 3.1). The HELP model is a quasi-two-dimensional water balance model designed to conduct landfill water balance analyses. The model requires the input of weather, soil, and design data. It provides estimates of runoff, evapotranspiration, lateral drainage, vertical percolation (infiltration), hydraulic head, and water storage for the evaluation of various landfill designs. Personnel at the U.S. Army Engineer Waterways Experiment Station in Vicksburg, Mississippi developed the HELP model, under an interagency agreement with the U.S. Environmental Protection Agency (USEPA). HELP model

version 3.07, issued on November 1, 1997, is the latest version of the model available from the Waterways Experiment Station (USEPA 1994a and USEPA 1994b).

The HELP model requires the input of evapotranspiration, precipitation, temperature, and solar radiation data. Phifer and Nelson (2003) developed the weather data utilized to conduct this evaluation. The HELP model weather data input files, which were utilized for all HELP model runs, are provided in the following appendices:

- Appendix A, Augusta Synthetic Precipitation Modified with SRS Specific Average Monthly Precipitation Data over 100 Years (file name: Zprec.d4),
- Appendix B, Augusta Synthetic Temperature Modified with SRS Specific Average Monthly Temperature Data over 100 Years (file name: Ztemp.d7),
- Appendix C, Augusta Synthetic Solar Radiation Data over 100 Years (file name: Zsolar.d13), and
- Appendix D, Augusta Evapotranspiration Data (file name: Zevap.d11).

Table 3.2-1 provides a listing of generic input parameters (i.e., HELP model query) and the associated values selected. Use of selected fixed values for these HELP model queries provides compatibility between the different HELP model runs. The landfill area is based upon the Figure 3.1-2 length (950 feet) and width (900 feet), which results in a surface area of 760,000 feet squared or 19.63 acres. It has been assumed that the final covers are appropriately sloped so that 100 percent of the covers allow runoff to occur (i.e., there are no depressions). A yes response has been provided to the HELP model query, which asks, “Do you want to specify initial moisture storage? (Y/N).” The amount of water or snow on the surface of the covers was assumed to be zero as the initial model condition.

**Table 3.2-1. Generic Input Parameter Values – Area and Initial Moisture**

Input Parameter (HELP Model Query)	Generic Input Parameter Value
Landfill area	19.63 acres
Percent of area where runoff is possible	100%
Do you want to specify initial moisture storage? (Y/N)	Y
Amount of water or snow on surface	0 in.

As stated the initial moisture storage has been specified for all soil layers. While the initial moisture storage is not a fixed value for all runs, a fixed method of selecting the initial moisture storage value has been utilized for consistency. The initial, soil moisture storage value has been selected as follows:

- The initial moisture storage of soil layers designated as either a vertical percolation layer or a lateral drainage layer was set at the field capacity of the soil.
- The initial moisture storage of soil layers designated as a barrier soil liner was set at the porosity of the soil.

### **3.3 Intact Closure Cap Curve Number Input Parameter Values**

The Soil Conservation Service (SCS) runoff curve number (CN) is another required HELP model input parameter. The HELP model provides three options to specify the CN. The option that produces a HELP model computed curve number, based on surface slope and slope length, soil texture of the top layer, and vegetation, was utilized for the intact closure cap. Table 3.3-1 provides the input values of surface slope and slope length, soil texture of the top layer, and vegetation that were utilized to produce the HELP model computed curve number. The 3 percent slope is that specified for the top surface of the Saltstone final cover within the Saltstone closure plan (Cook et al. 2000). The 450-foot

slope length is based upon Figure 3.1-2. The soil texture, selected as an input for calculation of the CN, is a loamy fine sand per the United States Department of Agriculture (USDA) and a silty sand per Unified Soil Classification System (USCS). This soil texture closely represents the typical vegetative soil layers utilized at the Savannah River Site (SRS). The corresponding number in the HELP default soil texture list is 5. Based upon these input parameter values the HELP model computed a CN of 54.4 for the intact closure cap case.

**Table 3.3-1. Curve Number (CN) Input Parameter Values for Intact Closure Cap**

CN Input Parameter (HELP Model Query)	CN Input Parameter Value
Slope	3%
Slope length	450 ft
Soil Texture	5 (HELP model default soil texture)
Vegetation	4 (i.e., a good stand of grass)
HELP Model Computed Curve Number	54.4

### 3.4 Intact Closure Cap Infiltration

HELP modeling of the Table 3.1-1 intact SDF MSE vault closure cap configuration has been performed utilizing the Section 3.2 input data. As documented in Phifer and Nelson (2003), the HELP model does not need to include the vault in order to obtain an appropriate infiltration through the upper GCL. Therefore the vault has not been included in any of the HELP modeling presented herein. Based upon this modeling the infiltration through the upper GCL has been estimated to be 0.36 inches per year for intact conditions. The following appendix provides the detailed HELP model, input data and output file for the intact condition:

- Appendix E, Intact SDF MSE Vault Closure Cap (0 Years): HELP Model Input Data and Output File (output file name: ZMSEIout.OUT)



**THIS PAGE INTENTIONALLY LEFT BLANK**

#### **4.0 CLOSURE CAP DEGRADATION**

The following two primary closure cap degradation mechanisms have been assumed to significantly impact the infiltration through the MSE vault closure cap over time for the continuous bamboo cover land use scenario (i.e. lower bounding scenario):

- Erosion
- Colloidal clay migration

The pine forest succession, degradation mechanism is not applicable to the continuous bamboo cover land use scenario.

The following three primary closure cap degradation mechanisms have been assumed to significantly impact the infiltration through the MSE vault closure cap over time for the institutional control to farm to pine forest land use scenario (i.e. upper bounding scenario):

- Pine forest succession
- Erosion
- Colloidal clay migration

Phifer and Nelson (2003) discussed each of these degradation mechanisms in detail.

#### **4.1 Pine Forest Succession**

Pine forest succession is only a degradation mechanism for the upper bounding scenario as outlined above. Corn is a shallow-rooted, single harvest per year farm crop in the vicinity of SRS. For the upper bounding scenario, it is assumed that pine trees succeed corn farming after erosion exposes the erosion barrier. Pine trees are the most deeply rooted naturally occurring plants at SRS. (MMES 1992; Cook et al. 2000). The following assumptions, which were made relative to pine forest succession by Phifer and Nelson (2003), have also been utilized for this evaluation as appropriate:

- 200 years after the end of farming it is assumed that the entire cap is dominated by pine.
- Complete turnover of the 400 mature trees per acre occurs every 100 years (in a staggered manner).
- There are 400 mature trees per acre with 4 roots to 6 feet and 1 root to 12 feet. The roots are 3 inches in diameter at a depth of 1 foot and 0.25 inches in diameter at either 6 or 12 feet, whichever is applicable.

#### **4.2 Erosion**

The topsoil and upper backfill layers, which are located above the erosion barrier, are subject to erosion. For the lower bounding scenario erosion is assumed to occur with a bamboo vegetative cover only. For the upper bounding scenario erosion is assumed to occur with a bamboo vegetative cover for the first 100 years followed by erosion with corn cover until both the topsoil and upper backfill layers are completely eroded. The projected erosion rate for both the topsoil and upper backfill layers has been determined utilizing the Universal Soil Loss Equation for both bamboo and corn vegetative covers. The Universal Soil Loss Equation (USLE) is expressed as:

$$A = R \times K \times LS \times C \times P \quad (\text{Eq. 5.2-1})$$

where

A = soil loss (tons/acre/year)

R = rainfall erosion index (100 ft-ton/acre per in/hr)

K = soil erodibility factor, tons/acre per unit of R

LS = slope length and steepness factor, dimensionless

C = vegetative cover factor, dimensionless

P = erosion control practice factor, dimensionless

Table 4.2-1 presents the USLE parameter values utilized and the source of the values for both the topsoil and backfill cover with bamboo and corn.

**Table 4.2-1. USLE Parameter Values**

USLE Parameter	Value Utilized	Source
R for SRS location	260	Horton and Wilhite 1978
K for topsoil	0.28	Phifer and Nelson 2003 and Goldman et al. 1986 Figure 5.6
K for backfill	0.20	Phifer and Nelson 2003 and Goldman et al. 1986 Figure 5.6
LS for 450-foot 3% slope (see Figure 3.1-2)	0.45	Goldman et al. 1986 Table 5.5
C for bamboo <sup>1</sup>	0.001	Horton and Wilhite 1978
C for corn	0.54	Horton and Wilhite 1978
P for no supporting practices	1	Not applicable

<sup>1</sup> Assumed to be the same as a natural successional forest.

Based upon the Universal Soil Loss Equation and the Table 4.2-1 parameter values the following soil losses were estimated:

- Topsoil with bamboo has an estimated soil loss of 0.0328 tons/acre/year ( $A = 260 \times 0.28 \times 0.45 \times 0.001 \times 1$ ). Based upon the dry bulk density the estimated soil loss can be converted to a loss in terms of depth of loss per year. From Jones and Phifer (2002), the dry bulk density of topsoil was taken as 90 lbs/ft<sup>3</sup>. Topsoil with bamboo has an estimated depth of soil loss of approximately 2.0E-04 inches/year.

$$\left( \text{Loss} = \frac{0.0328 \text{ tons} / \text{acre} / \text{year} \times 2000 \text{ lbs} / \text{ton} \times 12 \text{ inches} / \text{foot}}{43560 \text{ ft}^2 / \text{acre} \times 90 \text{ lbs} / \text{ft}^3} \right).$$

- Topsoil with corn has an estimated soil loss of 17.69 tons/acre/year ( $A = 260 \times 0.28 \times 0.45 \times 0.54 \times 1$ ). Based upon the dry bulk density the estimated soil loss can be converted to a loss in terms of depth of loss per year. From Jones and Phifer (2002), the dry

bulk density of topsoil was taken as 90 lbs/ft<sup>3</sup>. Topsoil with corn has an estimated depth of soil loss of approximately 0.11 inches/year.

$$\left( Loss = \frac{17.69 \text{ tons / acre / year} \times 2000 \text{ lbs / ton} \times 12 \text{ inches / foot}}{43560 \text{ ft}^2 / \text{acre} \times 90 \text{ lbs / ft}^3} \right).$$

- Backfill with bamboo has an estimated soil loss of 0.0234 tons/acre/year ( $A = 260 \times 0.20 \times 0.45 \times 0.001 \times 1$ ). Based upon the dry bulk density the estimated soil loss can be converted to a loss in terms of depth of loss per year. From Jones and Phifer (2002), the dry bulk density of backfill was taken as 104 lbs/ft<sup>3</sup>. Backfill with bamboo has an estimated depth of soil loss of approximately 1.2E-04 inches/year.

$$\left( Loss = \frac{0.0234 \text{ tons / acre / year} \times 2000 \text{ lbs / ton} \times 12 \text{ inches / foot}}{43560 \text{ ft}^2 / \text{acre} \times 104 \text{ lbs / ft}^3} \right).$$

- Backfill with corn has an estimated soil loss of 12.64 tons/acre/year ( $A = 260 \times 0.20 \times 0.45 \times 0.54 \times 1$ ). Based upon the dry bulk density the estimated soil loss can be converted to a loss in terms of depth of loss per year. From Jones and Phifer (2002), the dry bulk density of backfill was taken as 104 lbs/ft<sup>3</sup>. Backfill with corn has an estimated depth of soil loss of approximately 0.067 inches/year.

$$\left( Loss = \frac{12.64 \text{ tons / acre / year} \times 2000 \text{ lbs / ton} \times 12 \text{ inches / foot}}{43560 \text{ ft}^2 / \text{acre} \times 104 \text{ lbs / ft}^3} \right).$$

### 4.3 Colloidal Clay Migration

It is assumed that colloidal clay migrates from overlying backfill layers and accumulates in the drainage layers reducing the saturated hydraulic conductivity of the drainage layers over time. As previously documented in Phifer and Nelson (2003), it will be assumed that water flux driven colloidal clay migration at a concentration of 63 mg/L occurs from overlying backfill layers to the drainage layers. It will be further assumed that the colloidal clay accumulates in the drainage layer from the bottom up filling the void space of the drainage layer with clay at a density of 1.1 g/cm<sup>3</sup> (Hillel 1982).

### 4.4 Closure Cap Degradation Summary

Based upon the erosion and colloidal clay migration degradation mechanisms, degradation assumptions for each closure cap layer has been made as outlined in Table 4.4-1 for the lower bounding scenario (i.e. continuous bamboo cover). Based upon the pine forest succession, erosion, and colloidal clay migration degradation mechanisms, degradation assumptions for each closure cap layer has been made as outlined and in Table 4.4-2 for the upper bounding scenario (i.e. institutional control to farm to pine forest). These degradation scenarios form the basis for modifying the thickness and hydraulic properties of each layer over time. This information has been utilized in Section 5.0 to determine infiltration through the upper GCL over time.

**Table 4.4-1. Lower Bounding Scenario Closure Cap Layer Degradation Assumptions (modified from Phifer and Nelson 2003)**

Layer	Degradation Assumption
Vegetation	Bamboo covers the closure cap continuously
Topsoil	Topsoil erosion occurs at 2.0E-04 inches per year with bamboo.
Upper Backfill	Backfill erosion occurs at 1.2E-04 inches per year with bamboo, after the topsoil layer has been depleted.
Erosion Control Barrier	None. Bamboo roots are assumed to have no impact upon the erosion control barrier.
Middle Backfill	Colloidal clay migration from the 1-foot-thick middle backfill to the underlying 1-foot-thick upper drainage layer causes the saturated hydraulic conductivity to increase over time.
Geotextile Filter Fabric	For purposes of colloidal clay migration into the underlying drainage layer the geotextile filter fabric is assumed to be ineffective over the time period under consideration.
Upper Drainage Layer	Colloidal clay migration from the overlying 1-foot-thick backfill into the 1-foot-thick upper drainage layer causes the saturated hydraulic conductivity to decrease over time.
Upper GCL	None. Bamboo roots are assumed to have no impact upon the upper GCL, since the upper GCL is located at a depth beyond the penetration of bamboo roots.
Lower Backfill	None. While it is assumed that colloidal clay migration from this layer to the underlying lower drainage layer occurs, it is also assumed that the thickness of the lower backfill layer (minimum 5-foot) relative to the lower drainage layer (2-foot) prevents the quantity of clay loss necessary to change the hydraulic properties of the lower backfill.
Geotextile Filter Fabric	For purposes of colloidal clay migration into the underlying drainage layer the geotextile filter fabric is assumed to be ineffective over the time period under consideration.
Lower Drainage Layer	Colloidal clay migration from the overlying minimum 5-foot-thick lower backfill into the 1-foot-thick lower drainage layer reduces its saturated hydraulic conductivity over time.
Lower GCL	None. Bamboo roots are assumed to have no impact upon the lower GCL, since the lower GCL is located at a depth beyond the penetration of bamboo roots.

**Table 4.4-2. Upper Bounding Scenario Closure Cap Layer Degradation Assumptions (modified from Phifer and Nelson 2003)**

Layer	Degradation Assumption
Vegetation	Bamboo is maintained during the 100-year institutional control period, corn is grown until the erosion barrier is exposed, pine trees begin to encroach after farming has ceased, and a pine forest covers the cap 200 years after farming has ceased.
Topsoil	Topsoil erosion occurs at 2.0E-04 inches per year with bamboo and 0.11 inches per year with corn.
Upper Backfill	Backfill erosion occurs at 1.2E-04 inches per year with bamboo and 0.067 inches per year with corn, after the topsoil layer has been depleted.
Erosion Control Barrier	Maintenance and farm practices during institutional control and corn farming prevent degradation of the erosion control barrier. Subsequent to corn farming after complete erosion of the topsoil and upper backfill, pine forest succession will result in root penetration through the erosion control barrier. This does not impact its ability to function as an erosion barrier. It will be assumed that root penetration breaks up the flowable fill and separates it from the granite stone. After the root decomposes it will be assumed that segregation of the granite stone and broken up flowable fill occurs, resulting in the flowable fill at the bottom of the hole and the granite stone at the top.
Middle Backfill	Colloidal clay migration from the 1-foot-thick middle backfill to the underlying 1-foot-thick upper drainage layer causes the saturated hydraulic conductivity to increase over time.
Geotextile Filter Fabric	For purposes of colloidal clay migration into the underlying drainage layer the geotextile filter fabric is assumed to be ineffective over the time period under consideration.
Upper Drainage Layer	Colloidal clay migration from the overlying 1-foot-thick backfill into the 1-foot-thick upper drainage layer causes the saturated hydraulic conductivity to decrease over time.
Upper GCL	Maintenance during institutional control period and farming practices prevent degradation of the upper GCL. Subsequent to the institutional control period and corn farming after all of the topsoil and upper backfill have been completely eroded, pine forest succession will result in root penetration through the GCL. This allows the overlying drainage layer to fill the holes after the roots decompose.
Lower Backfill	None. While it is assumed that colloidal clay migration from this layer to the underlying lower drainage layer occurs, it is also assumed that the thickness of the lower backfill layer (minimum 5-foot) relative to the lower drainage layer (2-foot) prevents the quantity of clay loss necessary to change the hydraulic properties of the lower backfill.
Geotextile Filter Fabric	For purposes of colloidal clay migration into the underlying drainage layer the geotextile filter fabric is assumed to be ineffective over the time period under consideration.
Lower Drainage Layer	Colloidal clay migration from the overlying minimum 5-foot-thick lower backfill into the 1-foot-thick lower drainage layer reduces its saturated hydraulic conductivity over time.
Lower GCL	None. Pine tree roots do not penetration to a sufficient enough depth to impact this layer. Additionally the underlying concrete vault roof along with the GCL produces a hard layer and continuous water saturation within and above these layers so that root elongation is stopped.

**THIS PAGE INTENTIONALLY LEFT BLANK**

## 5.0 CLOSURE CAP INFILTRATION FOR LOWER BOUNDING SCENARIO (CONTINUOUS BAMBOO COVER)

### 5.1 LBS Degraded Layer Properties over Time

The SDF GCL closure cap initial (0 year) intact layer thickness and hydraulic property values from top to bottom are provided in Table 3.1-1. The degradation assumptions for each layer of the lower bounding scenario are provided in Table 4.4-1. Based upon the Table 4.4-1 degradation assumptions, the Table 3.3-1 initial SDF closure cap layer thickness and hydraulic property values have been modified to account for degradation at 100, 300, 550, 1,000, 1,800, 3,400, 5,600 and 10,000 years after closure of the SDF. The following discussions provide additional detail associated with determination of the degraded properties for the middle backfill, upper drainage layer, and lower drainage layer as originally presented by Phifer and Nelson (2003).

#### 5.1.1 LBS Middle Backfill and Upper Drainage Layer

It is assumed that water flux driven colloidal-clay migration from the 1-foot-thick middle backfill to the underlying 1-foot-thick upper drainage layer causes the middle backfill saturated hydraulic conductivity to increase over time and that of the upper drainage layer to decrease over time. It has been assumed that clay migration occurs out of the backfill into the drainage layer with the water flux containing 63 mg/L of colloidal clay. Since both layers are of the same thickness and the middle backfill layer has limited clay content, it has been assumed that half the clay content of the backfill will migrate into the drainage layer. At which point the two layers essentially become the same material and material property changes cease. Based upon this it will be assumed that the endpoint saturated hydraulic conductivity of the layers will become that of the log mid-point between the initial backfill and upper drainage layer conditions. It will also be assumed that the endpoint porosity, field capacity, and wilting point will become the arithmetic average of the backfill and upper drainage layer. The hydraulic properties at times prior to the endpoint have been proportioned between that of the endpoint properties and the initial properties based upon the fraction of clay that has migrated out of the backfill.

#### 5.1.2 LBS Lower Drainage Layer

It is assumed that colloidal clay migration from the minimum 5-foot-thick overlying backfill into the 2-foot-thick lower drainage layer is driven by the water flux through the upper GCL. This water flux driven clay migration enters into the lower drainage layer and fills the lower drainage layer from the bottom up. This reduces the saturated hydraulic conductivity of the clay-filled portion from 1.0E-01 to 1.0E-04 cm/s (i.e. to the saturated hydraulic conductivity of the overlying backfill), while the conductivity of the clean portion remains at 1.0E-01 cm/s. As the thickness of the lower drainage layer filled with clay increases, the equivalent hydraulic conductivity of the entire layer decreases. The equivalent horizontal hydraulic conductivity for this layer has been determined from the following equation (Freeze and Cherry 1979):

$$K_h = \sum_{i=1}^n \frac{K_i d_i}{d} \quad (\text{Eq. 6.1-1})$$

where

$K_h$  = equivalent horizontal saturated hydraulic conductivity,

$K_i$  = horizontal saturated hydraulic conductivity of  $i^{\text{th}}$  layer,

$d_i$  = thickness of  $i^{\text{th}}$  layer,



d = total thickness

This is different from that assumed for the upper drainage layer, since the lower drainage layer has significantly more backfill overlying it.

### 5.1.3 LBS Summary Material Properties over Time

The lower bounding scenario calculations associated with determination of the layer thicknesses and hydraulic property values over time are provided in Appendix F. Table 5.1-1 provides the primary Appendix F, material property results (thickness and saturated hydraulic conductivity), for layers which change with time and were utilized in subsequent HELP modeling. The porosity, field capacity, and wilting points are not provided in Table 5.1-1. Values for these parameters are provided in Appendix F.

**Table 5.1-1. Lower Bounding Scenario Material Property Summary Results**

Year	Topsoil Layer Thickness (inches)	Middle Backfill Layer Saturated Hydraulic Conductivity (cm/s)	Upper Drainage Layer Saturated Hydraulic Conductivity (cm/s)	Lower Drainage Layer Saturated Hydraulic Conductivity (cm/s)
0	6	1.00E-04	1.00E-01	1.00E-01
100	5.980	1.20E-04	8.60E-02	1.00E-01
300	5.940	1.60E-04	6.30E-02	9.98E-02
550	5.890	2.30E-04	4.30E-02	9.89E-02
1,000	5.800	4.60E-04	2.10E-02	9.61E-02
1,800	5.640	1.60E-03	6.30E-03	8.96E-02
3,400	5.320	3.20E-03	3.20E-03	7.56E-02
5,600	4.880	3.20E-03	3.20E-03	5.62E-02
10,000	4.0	3.20E-03	3.20E-03	1.74E-02

## 5.2 LBS Degraded Closure Cap Infiltration over Time

Table 5.1-1 and Appendix F data were utilized as input to the HELP model (USEPA 1994a and USEPA 1994b) in order to determine infiltration through the upper GCL for the lower bounding scenario at each degraded time step. The following appendices provide the detailed HELP model, input data and output files for each time step:

- Appendix G, Lower Bounding Scenario Degraded SDF MSE Vault Closure Cap (100 Years): HELP Model Input Data and Output File (output file name: ZLBS1out.OUT)
- Appendix H, Lower Bounding Scenario Degraded SDF MSE Vault Closure Cap (300 Years): HELP Model Input Data and Output File (output file name: ZLBS2out.OUT)
- Appendix I, Lower Bounding Scenario Degraded SDF MSE Vault Closure Cap (550 Years): HELP Model Input Data and Output File (output file name: ZLBS3out.OUT)
- Appendix J, Lower Bounding Scenario Degraded SDF MSE Vault Closure Cap (1,000 Years): HELP Model Input Data and Output File (output file name: ZLBS4out.OUT)
- Appendix K, Lower Bounding Scenario Degraded SDF MSE Vault Closure Cap (1,800 Years): HELP Model Input Data and Output File (output file name: ZLBS5out.OUT)

- Appendix L, Lower Bounding Scenario Degraded SDF MSE Vault Closure Cap (3,400 Years): HELP Model Input Data and Output File (output file name: ZLBS6out.OUT)
- Appendix M, Lower Bounding Scenario Degraded SDF MSE Vault Closure Cap (5,600 Years): HELP Model Input Data and Output File (output file name: ZLBS7out.OUT)
- Appendix N, Lower Bounding Scenario Degraded SDF MSE Vault Closure Cap (10,000 Years): HELP Model Input Data and Output File (output file name: ZLBS8out.OUT)

The following outputs from this evaluation are lower bounding sensitivity values, which will be utilized within the Performance Assessment:

- Infiltration through the upper GCL
- Saturated hydraulic conductivity of the 2-foot-thick lower Drainage Layer

Table 5.2-1 provides a summary of these parameter values.

**Table 5.2-1. Lower Bounding Sensitivity Values**

Year	Infiltration through Upper GCL (in/yr)	Lower Drainage Layer Saturated Hydraulic Conductivity (cm/s)
0	0.36	1.00E-01
100	0.41	1.00E-01
300	0.55	9.99E-02
550	0.80	9.98E-02
1,000	1.75	9.94E-02
1,800	5.05	9.77E-02
3,400	6.46	9.20E-02
5,600	6.44	8.30E-02
10,000	6.40	6.53E-02
26,250	ND	1.00E-04 (year lower drainage layer completely silts in)
280,000	4.75 (infiltration at complete degradation of the closure cap)	1.00E-04

ND = not determined

### 5.3 LBS Infiltration After Complete Closure Cap Degradation

The infiltration through the upper GCL at complete closure cap degradation for the lower bounding scenario and the associated time of occurrence have been determined based upon the following:

- Complete closure cap degradation occurs when both the topsoil and upper backfill have eroded away.
- As outlined in Appendix F, it is assumed that the material properties of the middle backfill and upper drainage layer become the same at year 2246 and remain constant thereafter. Therefore the middle backfill and upper drainage layer material properties will be taken as those determined at year 2246.

- As previously demonstrated in Appendix F, the material properties of the lower drainage layer do not impact infiltration through the upper GCL. Completely silted in conditions will be assumed for the lower drainage layer for determination of this infiltration.

Appendix F provides the material property calculations based upon the above assumptions and the detailed HELP model input data and output file associated with this infiltration through the upper GCL. This infiltration through the upper GCL was determined to be 4.75 inches/year in year 280,000. This infiltration has been included in Table 5.2-1 for comparison purposes.

In addition, the time that the lower drainage layer completely silts in and assumes the properties of the overlying backfill has been estimated to occur in the year 26,250 (see Appendix F). This has also been included in Table 5.2-1.

## **6.0 CLOSURE CAP INFILTRATION FOR UPPER BOUNDING SCENARIO (INSTITUTIONAL CONTROL TO FARM TO PINE FOREST)**

### **6.1 UBS Degraded Layer Properties over Time**

The SDF GCL closure cap initial (0 year) intact layer thickness and hydraulic property values from top to bottom are provided in Table 3.1-1. The degradation assumptions for each layer are provided in Table 4.4-2. Based upon the Table 4.4-2 degradation assumptions, the Table 3.3-1 initial SDF closure cap layer thickness and hydraulic property values have been modified to account for degradation at 100, 154, 300, 550, 602, 802, 1,000, 1,800, 3,400, 5,600 and 10,000 years after closure of the SDF. The following discussions provide additional detail associated with determination of the degraded properties for the erosion barrier, upper GCL, middle backfill, upper drainage layer, and lower drainage layer as originally presented by Phifer and Nelson (2003).

#### **6.1.1 UBS Erosion Barrier**

As outlined in Phifer and Nelson 2003, the erosion barrier is assumed to consist of a one foot thick layer of 2-inch to 6-inch granite stone whose voids are filled with a Controlled Low Strength Material (CLSM) or flowable fill. Under the upper bounding scenario maintenance during the institutional control period and farming practices during corn farming prevent degradation of the erosion control barrier. Subsequent to the institutional control period and corn farming, pine forest succession will result in root penetration through the erosion control barrier. This does not impact its ability to function as an erosion barrier. For this scenario pine forest succession occurs after all of the topsoil and upper backfill have been completely eroded, therefore the upper backfill is not available to fill holes in the erosion barrier after the roots decompose. However it will be assumed that root penetration breaks up the flowable fill and separates it from the granite stone. After the root decomposes it will be assumed that segregation of the granite stone and broken up flowable fill occurs, resulting in the flowable fill at the bottom of the hole and the granite stone at the top. For the purposes of this calculation the properties of the broken up flowable fill will be ignored. Therefore will assume that the degraded barrier consists of intact erosion barrier with holes filled with the granite stone. The equivalent hydraulic properties of the overall erosion barrier change as the area of holes filled with separated and segregated granite stone and broken up flowable fill increases with time. The equivalent hydraulic properties have been estimated over time by area proportioning the properties between that of the intact erosion barrier and infiltrating backfill.

#### **6.1.2 UBS Upper GCL**

Under the upper bounding scenario maintenance during the institutional control period and farming practices during corn farming prevent degradation of the upper GCL. Subsequent to the institutional control period and corn farming after all of the topsoil and upper backfill have been completely eroded, pine forest succession will result in root penetration through the GCL. This allows the overlying drainage layer to fill the holes after the roots decompose. The holes in the GCL essentially act as direct conduits from the upper drainage layer to the lower backfill layer. When saturated conditions occur in the drainage layer after major precipitation events, cones of depression are created around the holes in the GCL with a radius of influence much greater than the radius of the hole. This means that a small area of GCL holes can greatly reduce the lateral flow of water in the drainage layer and increase the vertical flow into the lower backfill. Due to the significant influence of holes in the GCL to the quantity of infiltration, the use of equivalent hydraulic properties is not appropriate, since it does not consider the radius of influence associated with holes. Therefore, within the HELP model the degraded GCL has been modeled as a geomembrane liner with leakage through holes when appropriate. The HELP model considers both water flux through intact portions of the geomembrane using an “equivalent geomembrane hydraulic conductivity” and water flux through holes in the

geomembrane. The HELP model does not assign a porosity, field capacity, or wilting point to geomembranes, however this is not considered essential to the GCL, since it is assumed that the GCL will remain fully saturated and it is below the depth where evapotranspiration is assumed to occur. The HELP model allows the input of up to 999,999 one square centimeter installation defects for a geomembrane liner. Therefore the calculated area of holes created by root penetration has been converted into an equivalent number of one square centimeter installation defects for input to the HELP model when appropriate. Excellent contact is assumed between the GCL and underlying backfill layer as a HELP model input, since the GCL is put in dry and swells into the surrounding soil as it hydrates. As outlined in Phifer (2003) a GCL with randomly spaced holes equivalent to approximately 0.3 percent (i.e. ~120,000 installation defects) of the GCL area results in an infiltration equivalent to that produced without the GCL. Therefore for cases where the equivalent number of installation defects exceeds 999,999, the GCL has been assigned as a barrier soil liner with the same material properties as the overlying upper drainage layer.

### 6.1.3 UBS Middle Backfill and Upper Drainage Layer

It is assumed that water flux driven colloidal-clay migration from the 1-foot-thick middle backfill to the underlying 1-foot-thick upper drainage layer causes the middle backfill saturated hydraulic conductivity to increase over time and that of the upper drainage layer to decrease over time. It has been assumed that clay migration occurs out of the backfill into the drainage layer with the water flux containing 63 mg/L of colloidal clay. Since both layers are of the same thickness and the middle backfill layer has limited clay content, it has been assumed that half the clay content of the backfill will migrate into the drainage layer. At which point the two layers essentially become the same material and material property changes cease. Based upon this it will be assumed that the endpoint saturated hydraulic conductivity of the layers will become that of the log mid-point between the initial backfill and upper drainage layer conditions. It will also be assumed that the endpoint porosity, field capacity, and wilting point will become the arithmetic average of the backfill and upper drainage layer. The hydraulic properties at times prior to the endpoint have been proportioned between that of the endpoint properties and the initial properties based upon the fraction of clay that has migrated out of the backfill.

### 6.1.4 UBS Lower Drainage Layer

It is assumed that colloidal clay migration from the minimum 5-foot-thick overlying backfill into the 2-foot-thick lower drainage layer is driven by the water flux through the upper GCL. This water flux driven clay migration enters into the lower drainage layer and fills the lower drainage layer from the bottom up. This reduces the saturated hydraulic conductivity of the clay-filled portion from 1.0E-01 to 1.0E-04 cm/s (i.e. to the saturated hydraulic conductivity of the overlying backfill), while the conductivity of the clean portion remains at 1.0E-01 cm/s. As the thickness of the lower drainage layer filled with clay increases, the equivalent hydraulic conductivity of the entire layer decreases. The equivalent horizontal hydraulic conductivity for this layer has been determined from the following equation (Freeze and Cherry 1979):

$$K_h = \sum_{i=1}^n \frac{K_i d_i}{d} \quad (\text{Eq. 6.1-1})$$

where

$K_h$  = equivalent horizontal saturated hydraulic conductivity,

$K_i$  = horizontal saturated hydraulic conductivity of  $i^{\text{th}}$  layer,

$d_i$  = thickness of  $i^{\text{th}}$  layer,

d = total thickness

This is different from that assumed for the upper drainage layer, since the lower drainage layer has significantly more backfill overlying it.

### 6.1.5 UBS Summary Material Properties over Time

The upper bounding scenario calculations associated with determination of the layer thicknesses and hydraulic property values over time are provided in Appendix O. Table 6.1-1 provides the primary Appendix O, material property results (thickness, saturated hydraulic conductivity, and holes in the upper GCL), for layers which change with time and were utilized in subsequent HELP modeling. The porosity, field capacity, and wilting points are not provided in Table 6.1-1. Values for these parameters are provided in Appendix O. By year 10,000 all closure cap layers except the erosion barrier have reached their assumed degradation endpoint.

**Table 6.1-1. Upper Bounding Scenario Material Property Summary Results**

Year	Vegetation	Topsoil Layer Thickness (inches)	Upper Backfill Layer Thickness (inches)	Erosion Barrier Saturated Hydraulic Conductivity (cm/s)
0	Bamboo	6	30	3.97E-04
100	Bamboo	5.980	30	3.97E-04
154	Corn	0	30	3.97E-04
300	Corn	0	20.2	3.97E-04
550	Corn	0	3.5	3.97E-04
602	Corn	0	0	3.97E-04
802	Pine Forest	0	0	1.2E-03
1,000	Pine Forest	0	0	2.8E-03
1,800	Pine Forest	0	0	9.1E-03
3,400	Pine Forest	0	0	2.2E-02
5,600	Pine Forest	0	0	3.9E-02
10,000	Pine Forest	0	0	7.5E-02
Year	Middle Backfill Layer Saturated Hydraulic Conductivity (cm/s)	Upper Drainage Layer Saturated Hydraulic Conductivity (cm/s)	Saturated Hydraulic Conductivity (cm/s) / One Square Centimeter Holes in Upper GCL <sup>1</sup> (#/acre)	Lower Drainage Layer Saturated Hydraulic Conductivity (cm/s)
0	1.00E-04	1.00E-01	5.00E-09 / 0	1.00E-01
100	1.20E-04	8.20E-02	5.00E-09 / 0	1.00E-01
154	1.40E-04	7.40E-02	5.00E-09 / 0	1.00E-01
300	1.80E-04	5.60E-02	5.00E-09 / 0	9.99E-02
550	2.90E-04	3.40E-02	5.00E-09 / 0	9.98E-02
602	3.20E-04	3.10E-02	5.00E-09 / 0	9.97E-02
802	4.70E-04	2.10E-02	5.00E-09 / 40,877	9.86E-02
1,000	6.90E-04	1.40E-02	5.00E-09 / 121,703	9.64E-02
1,800	3.20E-03	3.20E-03	5.00E-09 / 448,722	8.62E-02
3,400	3.20E-03	3.20E-03	3.20E-03 / 0	6.47E-02
5,600	3.20E-03	3.20E-03	3.20E-03 / 0	3.54E-02
10,000	3.20E-03	3.20E-03	3.20E-03 / 0	1.00E-04

<sup>1</sup> Number of HELP model installation defects

## 6.2 UBS Degraded Closure Cap Infiltration over Time

Table 6.1-1 and Appendix O data were utilized as input to the HELP model (USEPA 1994a and USEPA 1994b) in order to determine infiltration through the upper GCL for the upper bounding scenario at each degraded time step. The following appendices provide the detailed HELP model, input data and output files for each time step:

- Appendix P, Upper Bounding Scenario Degraded SDF MSE Vault Closure Cap (100 Years): HELP Model Input Data and Output File (output file name: ZUBSD1ou.OUT)
- Appendix Q, Upper Bounding Scenario Degraded SDF MSE Vault Closure Cap (154 Years): HELP Model Input Data and Output File (output file name: ZUBSD2ou.OUT)
- Appendix R, Upper Bounding Scenario Degraded SDF MSE Vault Closure Cap (300 Years): HELP Model Input Data and Output File (output file name: ZUBSD3ou.OUT)
- Appendix S, Upper Bounding Scenario Degraded SDF MSE Vault Closure Cap (550 Years): HELP Model Input Data and Output File (output file name: ZUBSD4ou.OUT)
- Appendix T, Upper Bounding Scenario Degraded SDF MSE Vault Closure Cap (602 Years): HELP Model Input Data and Output File (output file name: ZUBSD5ou.OUT)
- Appendix U, Upper Bounding Scenario Degraded SDF MSE Vault Closure Cap (802 Years): HELP Model Input Data and Output File (output file name: ZUBSD6ou.OUT)
- Appendix V, Upper Bounding Scenario Degraded SDF MSE Vault Closure Cap (1,000 Years): HELP Model Input Data and Output File (output file name: ZUBSD7ou.OUT)
- Appendix W, Upper Bounding Scenario Degraded SDF MSE Vault Closure Cap (1,800 Years): HELP Model Input Data and Output File (output file name: ZUBSD8ou.OUT)
- Appendix X, Upper Bounding Scenario Degraded SDF MSE Vault Closure Cap (3,400 Years): HELP Model Input Data and Output File (output file name: ZUBSD9ou.OUT)
- Appendix Y, Upper Bounding Scenario Degraded SDF MSE Vault Closure Cap (5,600 Years): HELP Model Input Data and Output File (output file name: ZUBSD10o.OUT)
- Appendix Z, Upper Bounding Scenario Degraded SDF MSE Vault Closure Cap (10,000 Years): HELP Model Input Data and Output File (output file name: ZUBSD11o.OUT)

The following outputs from this evaluation are upper bounding sensitivity values, which will be utilized within the Performance Assessment:

- Infiltration through the upper GCL
- Saturated hydraulic conductivity of the 2-foot-thick lower Drainage Layer

Table 6.2-1 provides a summary of these parameter values.

**Table 6.2-1. Upper Bounding Sensitivity Values**

Year	Infiltration through Upper GCL (in/yr)	Lower Drainage Layer Saturated Hydraulic Conductivity (cm/s)
0	0.36	1.00E-01
100	0.43	1.00E-01
154	0.42	1.00E-01
300	0.56	9.99E-02
550	1.22	9.98E-02
602	1.37	9.97E-02
802	16.12	9.86E-02
1,000	19.46	9.64E-02
1,800	21.32	8.62E-02
3,400	21.42	6.47E-02
5,600	21.13	3.54E-02
8,303	ND	1.00E-04 (year lower drainage layer completely silts in)
10,000	20.05	1.00E-04
38,254	18.60 (infiltration at complete degradation of the closure cap)	1.00E-04

ND = not determined

### 6.3 UBS Infiltration after Complete Closure Cap Degradation

The infiltration through the upper GCL at complete closure cap degradation for the upper bounding scenario and the associated time of occurrence have been determined based upon the following:

- As outlined in Section 6.1.5 at year 10,000 all layers except the erosion barrier have reached their assumed degradation endpoint. Therefore the properties of all layers except the erosion barrier will be assigned their year 10,000 values.
- As outlined in Table 4.4-2 complete degradation of the erosion barrier is assumed to result in separation and segregation of the granite stone and flowable fill with the granite stone located on top of the broken up flowable fill. As previous done for the purposes of this calculation the properties of the broken up flowable fill will be ignored. Therefore the properties of the completely degraded erosion barrier are those of the granite stone.

Appendix O provides the material property calculations based upon the above assumptions and the detailed HELP model input data and output file associated with infiltration at complete closure cap degradation through the upper GCL. This infiltration at complete closure cap degradation through the upper GCL was determined to be 18.6 inches/year in year 38,254. This worse case infiltration has been included in Table 6.2-1 for comparison purposes.

In addition, the time that the lower drainage layer completely silts in and assumes the properties of the overlying backfill has been estimated to occur in the year 8,303 (see Appendix O). This has also been included in Table 6.2-1 as input to the PA sensitivity analysis.



**THIS PAGE INTENTIONALLY LEFT BLANK**

## 7.0 SUMMARY AND CONCLUSIONS

Within Phifer (2003) closure cap degradation mechanisms and their impact upon infiltration through the closure cap developed in Phifer and Nelson (2003) have been evaluated for the proposed Mechanically Stabilized Earth (MSE) vaults developed in Winship (2003) for the base case land use scenario (i.e. institutional control to pine forest). This land use scenario is considered to be the most likely scenario. It assumes a 100-year institutional control period following final SDF closure during which the closure cap is maintained. At the end of institutional control, it is assumed that a pine forest succeeds the cap's original bamboo cover. The impact of pine forest succession, erosion, and colloidal clay migration as degradation mechanisms on the infiltration through the MSE vault closure cap has been evaluated. The primary changes caused by the degradation mechanisms that result in increased infiltration are the formation of holes in the upper geosynthetic clay liner (GCL) by pine forest succession and the reduction in the saturated hydraulic conductivity of the drainage layers due to colloidal clay migration into the layers. Holes due to root penetration at approximately 0.3 percent of the GCL area resulted in an infiltration rate as though the GCL were not there at all. A very small area of holes essentially controlled the hydraulic performance of the GCL.

As documented within this report a sensitivity analysis has been performed to bound the previous results for the MSE vault, closure cap, base case land use scenario (i.e. institutional control to pine forest) documented within Phifer 2003. The bounding sensitivity analysis includes the following two MSE vault, closure cap, land use scenarios:

- Continuous bamboo cover, and
- Institutional control to farm to pine forest.

The continuous bamboo cover land use scenario assumes that bamboo, which is shallow-rooted, is the climax species for the closure cap (i.e. pine trees will not encroach upon the bamboo). This scenario results in the least amount of infiltration through the upper hydraulic barrier layer (i.e. lower bounding scenario). The institutional control to farm to pine forest, land use scenario assumes a 100-year institutional control period following final Saltstone Disposal Facility (SDF) closure during which the closure cap is maintained. At the end of institutional control, it is assumed that the cap's original bamboo cover is removed and that corn is grown until the closure cap layers above the erosion barrier are completely eroded. After the layers above the erosion barrier are gone, it is assumed that a pine forest succeeds corn farming. This scenario results in the greatest amount of infiltration through the upper hydraulic barrier layer (i.e. upper bounding scenario). The same degradation mechanisms utilized for the base case scenario (Phifer 2003), as appropriate, have been evaluated for both the lower and upper bounding scenarios.

Table 7.0-1 and Figure 7.0-1 provide the infiltration over time for the base case scenario (i.e. institutional control to pine forest), the lower bounding scenario (i.e. continuous bamboo cover), and the upper bounding scenario (i.e. institutional control to farm to pine forest). The estimated infiltration through the upper GCL for the lower bounding, base case, and upper bounding scenarios at year 1000 were 1.75, 12.04, and 19.46 inches/year, respectively. The maximum infiltration estimated through the upper GCL within the first 10,000 years infiltration for the lower bounding, base case, and upper bounding scenarios were 6.46 inches/year at year 3,400, 14.09 inches/year at year 10,000, and 21.42 inches/year at year 3,400, respectively. The estimated infiltration through the upper GCL at complete degradation of the closure cap for the lower bounding, base case, and upper bounding scenarios were 4.75 inches/year at year 280,000, 18.12 inches/year at year 280,000, and 18.60 at approximately year 38,250.

Within the first 10,000 years the primary reason(s) for the estimated infiltration increases over time for each scenario are as follows:

- The primary reason for the lower bounding scenario (i.e. continuous bamboo cover) estimated infiltration increase through the upper GCL over time is the assumed reduction in the saturated hydraulic conductivity of the upper drainage layer due to colloidal clay migration into the layer. This silting in results in an infiltration increase from 0.36 inches/year to a maximum of 6.46 inches/year within the first 10,000 years.
- The primary reasons for the base case land use scenario (i.e. institutional control to pine forest) estimated infiltration increase through the upper GCL over time, in order of importance, are the formation of holes in the upper GCL by pine forest succession and the reduction in the saturated hydraulic conductivity of the upper drainage layer due to colloidal clay migration into the layer. These primary degradation mechanisms result in an infiltration increase from 0.36 inches/year to a maximum of 14.09 inches/year within the first 10,000 years.
- The primary reasons for the upper bounding scenario (i.e. institutional control to farm to pine forest) estimated infiltration increase through the upper GCL over time, in order of importance, are the formation of holes in the upper GCL by pine forest succession, the reduction in the saturated hydraulic conductivity of the upper drainage layer due to colloidal clay migration into the layer, the increase in the saturated hydraulic conductivity of the erosion barrier due to pine forest succession, and the erosion of the topsoil and upper backfill. These primary degradation mechanisms result in an infiltration increase from 0.36 inches/year to a maximum of 21.42 inches/year within the first 10,000 years.

Based upon the above results the following can be deduced concerning the impact of the closure cap degradation mechanisms (i.e. pine forest succession, erosion, and colloidal clay migration) on infiltration through the upper GCL:

- It is estimated that pine forest succession results in the greatest increase in infiltration through the upper GCL. An approximately 13.5-inches/year increase can be attributed to pine forest succession. It is estimated that pine forest succession produces a 7.5-inches/year increase due to the formation of holes in the upper GCL and a 6-inches/year increase due to the degradation of the erosion barrier.
- It is estimated that the reduction in the saturated hydraulic conductivity of the upper drainage layer due to colloidal clay migration into the layer results in an approximately 6 inches/year increase in infiltration through the upper GCL.
- It is estimated that erosion of the topsoil and upper backfill results in an approximately 1-inch/year increase in infiltration through the upper GCL.

Based upon this it is evident that elimination of the pine forest succession, degradation mechanism would do the most to minimize increases in the infiltration through the upper GCL over time.

In addition to infiltration over time, the saturated hydraulic conductivity of the lower drainage layer over time is an important parameter. Table 7.0-2 and Figure 7.0-2 provide the saturated hydraulic conductivity of the lower drainage layer over time for each of the scenarios. The saturated hydraulic conductivity of the lower drainage layer is assumed to reduce over time from 0.1 cm/s to 0.0001 cm/s over time due to colloidal clay migration into the layer. It is estimated that the lower drainage layer completely silts-in (i.e. has a saturated hydraulic conductivity of 0.0001 cm/s) in year 26,000 for the lower bounding scenario, in year 12,000 for the base case scenario, and in year 8,300 for the upper bounding scenario.

**Table 7.0-1. Base Case, Lower Bounding, and Upper Bounding Infiltration over Time**

Lower Bounding Scenario		Base Case Scenario		Upper Bounding Scenario	
Year	Infiltration <sup>1</sup> (in/yr)	Year	Infiltration <sup>1</sup> (in/yr)	Year	Infiltration <sup>1</sup> (in/yr)
0	0.36	0	0.36	0	0.36
100	0.41	100	0.41	100	0.43
300	0.55	300	3.05	154	0.42
550	0.80	550	7.90	300	0.56
1,000	1.75	1,000	12.04	550	1.22
1,800	5.05	1,800	13.76	602	1.37
3,400	6.46	3,400	14.03	802	16.12
5,600	6.44	5,600	14.08	1,000	19.46
10,000	6.40	10,000	14.09	1,800	21.32
280,000 <sup>3</sup>	4.75	96,667 <sup>2</sup>	14.10	3,400	21.42
		280,000 <sup>3</sup>	18.12	5,600	21.13
				10,000	20.05
				38,254 <sup>3</sup>	18.60

<sup>1</sup> Infiltration through upper GCL

<sup>2</sup> The year 96,667 is not a calculated value; it is an assumed value. It is assumed that infiltration remains at 14.10 inches/year until the upper backfill erodes to the assumed evapotranspiration zone depth of 22 inches in year 96,667. At that point it is assumed that infiltration increases linearly from 14.10 inches/year to the year 280,000 infiltration of 18.12 inches/year.

<sup>3</sup> Infiltration at complete degradation of the closure cap

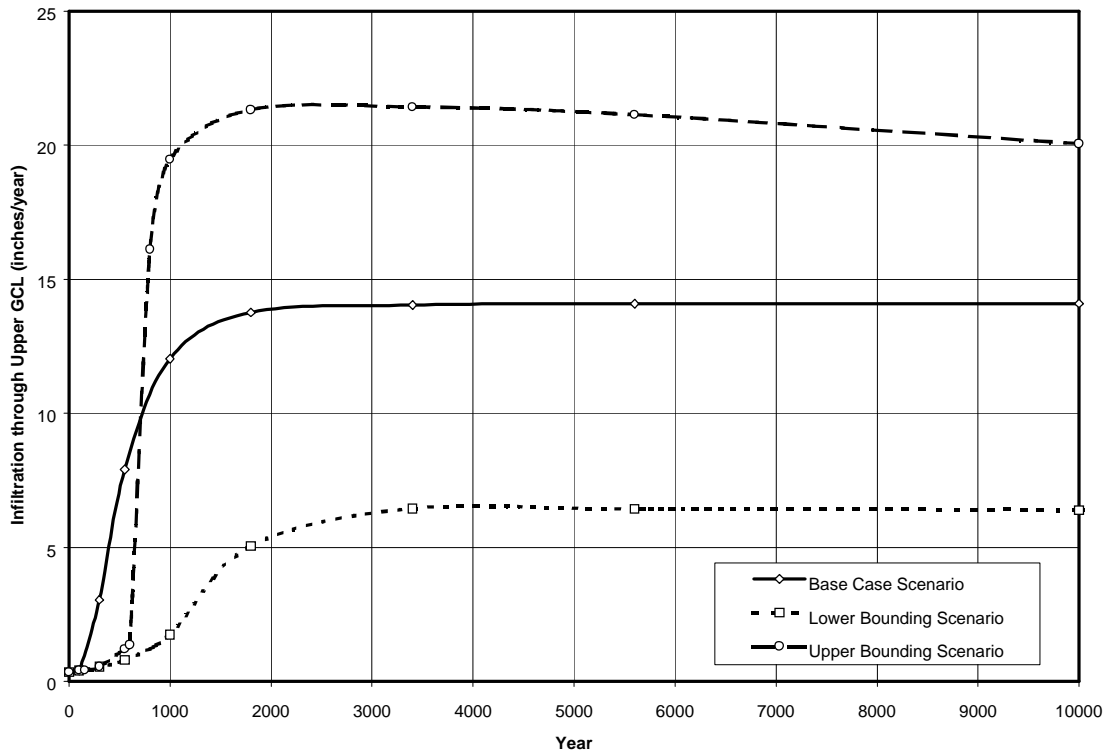

**Figure 7.0-1. Base Case, Lower Bounding, and Upper Bounding Infiltration over Time**

**Table 7.0-2. Lower Drainage Layer Saturated Hydraulic Conductivity for the Base Case, Lower Bounding, and Upper Bounding Scenarios over Time**

Lower Bounding Scenario		Base Case Scenario		Upper Bounding Scenario	
Year	$K_s^1$ (cm/s)	Year	$K_s^1$ (cm/s)	Year	$K_s^1$ (cm/s)
0	1.00E-01	0	1.00E-01	0	1.00E-01
100	1.00E-01	100	1.00E-01	100	1.00E-01
300	9.99E-02	300	9.98E-02	154	1.00E-01
550	9.98E-02	550	9.89E-02	300	9.99E-02
1,000	9.94E-02	1,000	9.61E-02	550	9.98E-02
1,800	9.77E-02	1,800	8.96E-02	602	9.97E-02
3,400	9.20E-02	3,400	7.56E-02	802	9.86E-02
5,600	8.30E-02	5,600	5.62E-02	1,000	9.64E-02
10,000	6.53E-02	10,000	1.74E-02	1,800	8.62E-02
26,250 <sup>2</sup>	1.00E-04	11,953 <sup>2</sup>	1.00E-04	3,400	6.47E-02
				5,600	3.54E-02
				8,303 <sup>2</sup>	1.00E-04

<sup>1</sup> Lower drainage layer saturated hydraulic conductivity

<sup>2</sup> This is the year that the lower drainage layer is assumed to completely silt in and the saturated hydraulic conductivity is assumed to remain at 1.00E-04 cm/s thereafter.

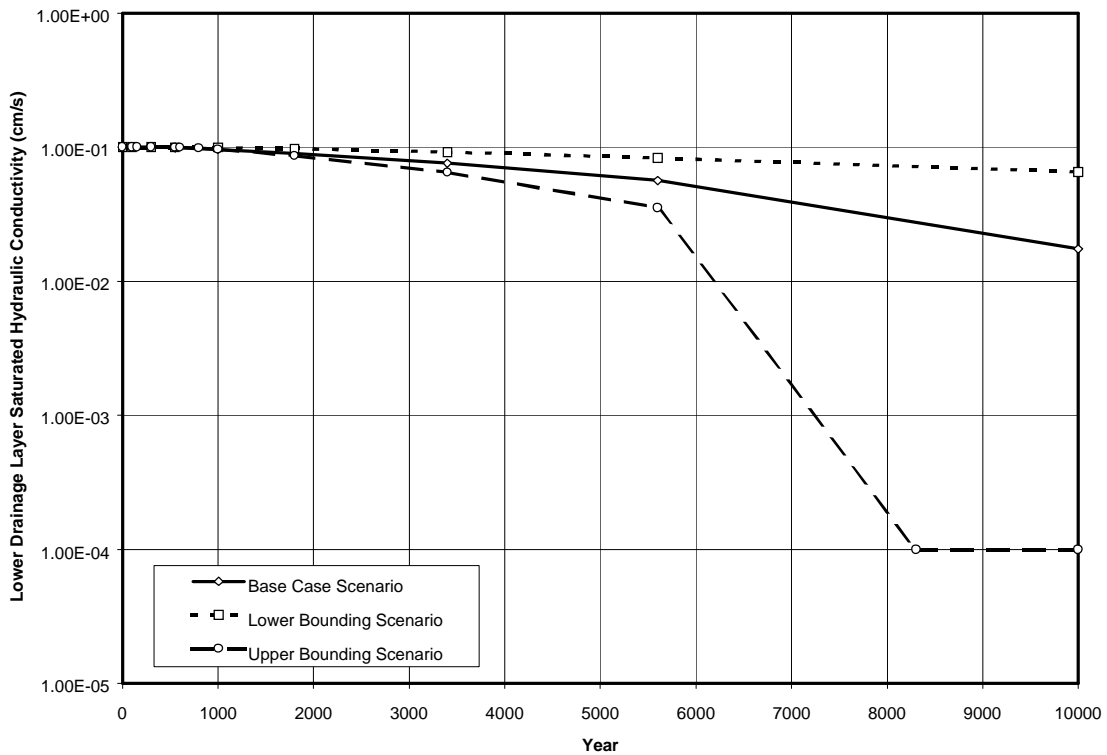

**Figure 7.0-2. Lower Drainage Layer Saturated Hydraulic Conductivity for the Base Case, Lower Bounding, and Upper Bounding Scenarios over Time**

## 8.0 REFERENCES

- Cook, J. R., Wilhite, E. L., and Young, K. E. 2000. *Closure Plan for the Z-Area Saltstone Disposal Facility (U)*, Rev. 0, WSRC-RP-2000-00426, Westinghouse Savannah River Company, Aiken, South Carolina. September 29, 2000.
- Freeze, R. A. and Cherry, J. A. 1979. *Groundwater*, Prentice-Hall, Inc., Englewood Cliffs, New Jersey.
- Goldman, S. J., Jackson, K., and Bursztynsky, T. A. 1986. *Erosion and Sediment Control Handbook*, McGraw-Hill Publishing Company, New York.
- GSE (GSE Lining Technology, Inc.). 2002. Web site:  
<http://www.gseworld.com/findproducts.htm>
- Hillel, D. 1982. *Introduction to Soil Physics*, Academic Press, Inc., San Diego, California.
- Horton, J. H. and Wilhite, E. L. 1978. *Estimated Erosion Rate at the SRP Burial Ground*, DP-1493, E. I. du Pont de Nemours and Company, Aiken, South Carolina. April 1978.
- Jones, W. E. and Phifer, M. A. 2002. *Corrosion and Potential Subsidence Scenarios for Buried B-25 Waste Containers*, WSRC-TR-2002-00354, Westinghouse Savannah River Company, Aiken, South Carolina. September 2002.
- MMES (Martin Marietta Energy Systems, Inc., EG&G Idaho, Inc., Westinghouse Hanford company, and Westinghouse Savannah River Company). 1992. *Radiological Performance Assessment for the Z-Area Saltstone Disposal Facility (U)*, Rev. 0, WSRC-RP-92-1360, Westinghouse Savannah River Company, Aiken, South Carolina. December 18, 1992.
- Phifer, M. A. and Nelson, E. A. 2003. *Saltstone Disposal Facility Closure Cap Configuration and Degradation Base Case: Institutional Control to Pine Forest Scenario (U)*, Rev. 0, WSRC-TR-2003-00436, Westinghouse Savannah River Company, Aiken, South Carolina. September 22, 2003.
- Phifer, M. A. 2003. *Saltstone Disposal Facility Mechanically Stabilized Earth Vault Closure Cap Configuration and Degradation Base Case: Institutional Control to Pine Forest Scenario (U)*, Rev. 0, WSRC-TR-2003-00523, Westinghouse Savannah River Company, Aiken, South Carolina. December 18, 2003.
- USEPA (U.S. Environmental Protection Agency). 1994a. *The Hydrologic Evaluation of Landfill Performance (HELP) Model User's Guide for Version 3*, EPA/600/R-94/168a, Office of Research and Development, United States Environmental Protection Agency, Washington, DC. September 1994.
- USEPA (U.S. Environmental Protection Agency). 1994b. *The Hydrologic Evaluation of Landfill Performance (HELP) Engineering Documentation for Version 3*, EPA/600/R-94/168b, Office of Research and Development, United States Environmental Protection Agency, Washington, DC. September 1994.
- USEPA (U.S. Environmental Protection Agency). 2001. *Geosynthetic Clay Liners Used in Municipal Solid Waste Landfills*, EPA 530-F-97-002, Solid Waste and Emergency Response, United States Environmental Protection Agency, Washington, DC. December 2001.
- Winship, G. 2003. *Closure Business Unit Saltstone Vault Study (U)*, Revision 0, G-ADS-Z-00001, Westinghouse Savannah River Company, Aiken, South Carolina, July 30, 2003.

WSRC (Westinghouse Savannah River Company). 2002. *Saltstone Landfill Design Equivalency Demonstration (U)*, Rev. 0, WSRC-TR-2002-00236, Westinghouse Savannah River Company, Aiken, South Carolina. August 30, 2002.

## 9.0 APPENDICES

<b>Appendix A</b>	<b>Augusta Synthetic Precipitation Modified with SRS Specific Average Monthly Precipitation Data over 100 Years (file name: Zprec.d4)</b> .....	A-1
<b>Appendix B</b>	<b>Augusta Synthetic Temperature Modified with SRS Specific Average Monthly Temperature Data over 100 Years (file name: Ztemp.d7)</b> .....	B-1
<b>Appendix C</b>	<b>Augusta Synthetic Solar Radiation Data over 100 Years (file name: Zsolar.d13)</b> .....	C-1
<b>Appendix D</b>	<b>Augusta Evapotranspiration Data (file name: Zevap.d11)</b> .....	D-1
<b>Appendix E</b>	<b>Intact SDF MSE Vault Closure Cap (0 Years): HELP Model Input Data and Output File (output file name: ZMSEIout.OUT)</b> .....	E-1
<b>Appendix F</b>	<b>SDF MSE Vault Closure Cap Degraded Property Value Calculations for Lower Bounding Scenario (i.e. Continuous Bamboo Cover)</b> .....	F-1
<b>Appendix G</b>	<b>Lower Bounding Scenario Degraded SDF MSE Vault Closure Cap (100 Years): HELP Model Input Data and Output File (output file name: ZLBS1out.OUT)</b> .....	G-1
<b>Appendix H</b>	<b>Lower Bounding Scenario Degraded SDF MSE Vault Closure Cap (300 Years): HELP Model Input Data and Output File (output file name: ZLBS2out.OUT)</b> .....	H-1
<b>Appendix I</b>	<b>Lower Bounding Scenario Degraded SDF MSE Vault Closure Cap (550 Years): HELP Model Input Data and Output File (output file name: ZLBS3out.OUT)</b> .....	I-1
<b>Appendix J</b>	<b>Lower Bounding Scenario Degraded SDF MSE Vault Closure Cap (1,000 Years): HELP Model Input Data and Output File (output file name: ZLBS4out.OUT)</b> .....	J-1
<b>Appendix K</b>	<b>Lower Bounding Scenario Degraded SDF MSE Vault Closure Cap (1,800 Years): HELP Model Input Data and Output File (output file name: ZLBS5out.OUT)</b> .....	K-1
<b>Appendix L</b>	<b>Lower Bounding Scenario Degraded SDF MSE Vault Closure Cap (3,400 Years): HELP Model Input Data and Output File (output file name: ZLBS6out.OUT)</b> .....	L-1
<b>Appendix M</b>	<b>Lower Bounding Scenario Degraded SDF MSE Vault Closure Cap (5,600 Years): HELP Model Input Data and Output File (output file name: ZLBS7out.OUT)</b> .....	M-1



**Appendix N Lower Bounding Scenario Degraded SDF MSE Vault Closure  
Cap (10,000 Years): HELP Model Input Data and Output File  
(output file name: ZLBS8out.OUT) ..... N-1**

**Appendix O SDF MSE Vault Closure Cap Degraded Property Value Calculations  
for Upper Bounding Scenario (i.e. Institutional Control to Farm to  
Pine Forest) ..... O-1**

**Appendix P Upper Bounding Scenario Degraded SDF MSE Vault Closure  
Cap (100 Years): HELP Model Input Data and Output File  
(output file name: ZUBSD1ou.OUT)..... P-1**

**Appendix Q Upper Bounding Scenario Degraded SDF MSE Vault Closure  
Cap (154 Years): HELP Model Input Data and Output File  
(output file name: ZUBSD2ou.OUT)..... Q-1**

**Appendix R Upper Bounding Scenario Degraded SDF MSE Vault Closure  
Cap (300 Years): HELP Model Input Data and Output File  
(output file name: ZUBSD3ou.OUT)..... R-1**

**Appendix S Upper Bounding Scenario Degraded SDF MSE Vault Closure  
Cap (550 Years): HELP Model Input Data and Output File  
(output file name: ZUBSD4ou.OUT)..... S-1**

**Appendix T Upper Bounding Scenario Degraded SDF MSE Vault Closure  
Cap (602 Years): HELP Model Input Data and Output File  
(output file name: ZUBSD5ou.OUT)..... T-1**

**Appendix U Upper Bounding Scenario Degraded SDF MSE Vault Closure  
Cap (802 Years): HELP Model Input Data and Output File  
(output file name: ZUBSD6ou.OUT)..... U-1**

**Appendix V Upper Bounding Scenario Degraded SDF MSE Vault Closure  
Cap (1,000 Years): HELP Model Input Data and Output File  
(output file name: ZUBSD7ou.OUT)..... V-1**

**Appendix W Upper Bounding Scenario Degraded SDF MSE Vault Closure  
Cap (1,800 Years): HELP Model Input Data and Output File  
(output file name: ZUBSD8ou.OUT)..... W-1**

**Appendix X Upper Bounding Scenario Degraded SDF MSE Vault Closure  
Cap (3,400 Years): HELP Model Input Data and Output File  
(output file name: ZUBSD9ou.OUT)..... X-1**

**Appendix Y Upper Bounding Scenario Degraded SDF MSE Vault Closure  
Cap (5,600 Years): HELP Model Input Data and Output File**

**(output file name: ZUBSD10o.OUT)..... Y-1**

**Appendix Z Upper Bounding Scenario Degraded SDF MSE Vault Closure**

**Cap (10,000 Years): HELP Model Input Data and Output File**

**(output file name: ZUBSD11o.OUT).....Z-1**

**THIS PAGE INTENTIONALLY LEFT BLANK**

Appendix A, Augusta Synthetic Precipitation Modified with SRS Specific Average Monthly Precipitation Data over 100 Years (file name: Zprec.d4)

This appendix is in CD format due to its size. Available upon request.

**THIS PAGE INTENTIONALLY LEFT BLANK**

Appendix B, Augusta Synthetic Temperature Modified with SRS Specific Average Monthly Temperature Data over 100 Years (file name: Ztemp.d7)

This appendix is in CD format due to its size. Available upon request.

**THIS PAGE INTENTIONALLY LEFT BLANK**

Appendix C, Augusta Synthetic Solar Radiation Data over 100 Years (file name: Zsolar.d13)

This appendix is in CD format due to its size. Available upon request.



**THIS PAGE INTENTIONALLY LEFT BLANK**

Appendix D, Augusta Evapotranspiration Data (file name: Zevap.d11)

1

AUGUSTA            GEORGIA

33.22    68 323 3.5    22.    6.5    68.0 70.0 77.0 73.0

**THIS PAGE INTENTIONALLY LEFT BLANK**

Appendix E, Intact SDF MSE Vault Closure Cap (0 Years): HELP Model Input Data and Output File (output file name: ZMSEIout.OUT)

Input Data:

Input Parameter (HELP Model Query)		Generic Input Parameter Value					
Landfill area =		19.63 acres					
Percent of area where runoff is possible =		100%					
Do you want to specify initial moisture storage? (Y/N)		Y					
Amount of water or snow on surface =		0 inches					
CN Input Parameter (HELP Model Query)		CN Input Parameter Value					
Slope =		3 %					
Slope length =		450 ft					
Soil Texture =		5 (HELP model default soil texture)					
Vegetation =		4 (i.e., a good stand of grass)					
HELP Model Computed Curve Number = 54.4							
Layer		Layer Number		Layer Type			
Topsoil		1		1 (vertical percolation layer)			
Upper Backfill		2		1 (vertical percolation layer)			
Erosion Barrier		3		1 (vertical percolation layer)			
Middle Backfill		4		1 (vertical percolation layer)			
Upper Drainage Layer		5		2 (lateral drainage layer)			
Upper GCL		6		3 (barrier soil liner)			
Lower Backfill		7		1 (vertical percolation layer)			
Lower Drainage Layer		8		2 (lateral drainage layer)			
Lower GCL		9		3 (barrier soil liner)			
	Layer Type	Layer Thickness (in)	Soil Texture No.	Total Porosity (Vol/Vol)	Field Capacity (Vol/Vol)	Wilting Point (Vol/Vol)	Initial Moisture (Vol/Vol)
1	1	6		0.4	0.11	0.058	0.11
2	1	30		0.37	0.24	0.136	0.24
3	1	12		0.06	0.056	0.052	0.056
4	1	12		0.37	0.24	0.136	0.24
5	2	12		0.38	0.08	0.013	0.08
6	3	0.2		0.75	0.747	0.40	0.75
7	1	58.57		0.37	0.24	0.136	0.24
8	2	24		0.38	0.08	0.013	0.08
9	3	0.2		0.75	0.747	0.40	0.75

The lack of values in the table for particular parameters in particular layers denotes that no HELP model input was required for that parameter in that layer. No data are missing from the table.

## Input Data (continued):

	Layer Type	Sat. Hyd. Conductivity * (cm/sec)	Drainage Length (ft)	Drain Slope (%)	Leachate Recirc. (%)	Recirc. to Layer (#)	Subsurface Inflow (in/yr)
1	1	1.00E-03					
2	1	1.00E-04					
3	1	3.97E-04					
4	1	1.00E-04					
5	2	1.00E-01	450	3			
6	3	5.00E-09					
7	1	1.00E-04					
8	2	1.00E-01	150	11.4			
9	3	5.00E-09					
	Layer Type	Geomembrane Pinhole Density (#/acre)	Geomembrane Instal. Defects (#/acre)	Geomembrane Placement Quality	Geotextile Transmissivity (cm <sup>2</sup> /sec)		
1	1						
2	1						
3	1						
4	1						
5	2						
6	3						
7	1						
8	2						
9	3						

The lack of values in the table for particular parameters in particular layers denotes that no HELP model input was required for that parameter in that layer. No data are missing from the table.

\* The HELP model output often produces an increased number of significant digits for the Effective Saturated Hydraulic Conductivity over that of the actual input



## LAYER 3

-----

## TYPE 1 - VERTICAL PERCOLATION LAYER

MATERIAL TEXTURE NUMBER 0

THICKNESS	=	12.00	INCHES
POROSITY	=	0.0600	VOL/VOL
FIELD CAPACITY	=	0.0560	VOL/VOL
WILTING POINT	=	0.0520	VOL/VOL
INITIAL SOIL WATER CONTENT	=	0.0560	VOL/VOL
EFFECTIVE SAT. HYD. COND.	=	0.396999996000E-03	CM/SEC

## LAYER 4

-----

## TYPE 1 - VERTICAL PERCOLATION LAYER

MATERIAL TEXTURE NUMBER 0

THICKNESS	=	12.00	INCHES
POROSITY	=	0.3700	VOL/VOL
FIELD CAPACITY	=	0.2400	VOL/VOL
WILTING POINT	=	0.1360	VOL/VOL
INITIAL SOIL WATER CONTENT	=	0.2400	VOL/VOL
EFFECTIVE SAT. HYD. COND.	=	0.999999975000E-04	CM/SEC

## LAYER 5

-----

## TYPE 2 - LATERAL DRAINAGE LAYER

MATERIAL TEXTURE NUMBER 0

THICKNESS	=	12.00	INCHES
POROSITY	=	0.3800	VOL/VOL
FIELD CAPACITY	=	0.0800	VOL/VOL
WILTING POINT	=	0.0130	VOL/VOL
INITIAL SOIL WATER CONTENT	=	0.0800	VOL/VOL
EFFECTIVE SAT. HYD. COND.	=	0.100000001000	CM/SEC
SLOPE	=	3.00	PERCENT
DRAINAGE LENGTH	=	450.0	FEET

## LAYER 6

-----

## TYPE 3 - BARRIER SOIL LINER

MATERIAL TEXTURE NUMBER 0

THICKNESS	=	0.20	INCHES
POROSITY	=	0.7500	VOL/VOL
FIELD CAPACITY	=	0.7470	VOL/VOL
WILTING POINT	=	0.4000	VOL/VOL
INITIAL SOIL WATER CONTENT	=	0.7500	VOL/VOL
EFFECTIVE SAT. HYD. COND.	=	0.499999997000E-08	CM/SEC

LAYER 7

-----

TYPE 1 - VERTICAL PERCOLATION LAYER

MATERIAL TEXTURE NUMBER 0

THICKNESS = 58.57 INCHES  
 POROSITY = 0.3700 VOL/VOL  
 FIELD CAPACITY = 0.2400 VOL/VOL  
 WILTING POINT = 0.1360 VOL/VOL  
 INITIAL SOIL WATER CONTENT = 0.2400 VOL/VOL  
 EFFECTIVE SAT. HYD. COND. = 0.999999975000E-04 CM/SEC

LAYER 8

-----

TYPE 2 - LATERAL DRAINAGE LAYER

MATERIAL TEXTURE NUMBER 0

THICKNESS = 24.00 INCHES  
 POROSITY = 0.3800 VOL/VOL  
 FIELD CAPACITY = 0.0800 VOL/VOL  
 WILTING POINT = 0.0130 VOL/VOL  
 INITIAL SOIL WATER CONTENT = 0.0800 VOL/VOL  
 EFFECTIVE SAT. HYD. COND. = 0.100000001000 CM/SEC  
 SLOPE = 11.40 PERCENT  
 DRAINAGE LENGTH = 150.0 FEET

LAYER 9

-----

TYPE 3 - BARRIER SOIL LINER

MATERIAL TEXTURE NUMBER 0

THICKNESS = 0.20 INCHES  
 POROSITY = 0.7500 VOL/VOL  
 FIELD CAPACITY = 0.7470 VOL/VOL  
 WILTING POINT = 0.4000 VOL/VOL  
 INITIAL SOIL WATER CONTENT = 0.7500 VOL/VOL  
 EFFECTIVE SAT. HYD. COND. = 0.499999997000E-08 CM/SEC

GENERAL DESIGN AND EVAPORATIVE ZONE DATA

-----

NOTE: SCS RUNOFF CURVE NUMBER WAS COMPUTED FROM DEFAULT SOIL DATA BASE USING SOIL TEXTURE # 5 WITH A GOOD STAND OF GRASS, A SURFACE SLOPE OF 3.% AND A SLOPE LENGTH OF 450. FEET.

SCS RUNOFF CURVE NUMBER = 54.40  
 FRACTION OF AREA ALLOWING RUNOFF = 100.0 PERCENT  
 AREA PROJECTED ON HORIZONTAL PLANE = 19.630 ACRES  
 EVAPORATIVE ZONE DEPTH = 22.0 INCHES  
 INITIAL WATER IN EVAPORATIVE ZONE = 4.500 INCHES  
 UPPER LIMIT OF EVAPORATIVE STORAGE = 8.320 INCHES  
 LOWER LIMIT OF EVAPORATIVE STORAGE = 2.524 INCHES  
 INITIAL SNOW WATER = 0.000 INCHES  
 INITIAL WATER IN LAYER MATERIALS = 28.649 INCHES  
 TOTAL INITIAL WATER = 28.649 INCHES  
 TOTAL SUBSURFACE INFLOW = 0.00 INCHES/YEAR



EVAPOTRANSPIRATION AND WEATHER DATA

NOTE: EVAPOTRANSPIRATION DATA WAS OBTAINED FROM  
AUGUSTA GEORGIA

STATION LATITUDE = 33.22 DEGREES  
 MAXIMUM LEAF AREA INDEX = 3.50  
 START OF GROWING SEASON (JULIAN DATE) = 68  
 END OF GROWING SEASON (JULIAN DATE) = 323  
 EVAPORATIVE ZONE DEPTH = 22.0 INCHES  
 AVERAGE ANNUAL WIND SPEED = 6.50 MPH  
 AVERAGE 1ST QUARTER RELATIVE HUMIDITY = 68.00 %  
 AVERAGE 2ND QUARTER RELATIVE HUMIDITY = 70.00 %  
 AVERAGE 3RD QUARTER RELATIVE HUMIDITY = 77.00 %  
 AVERAGE 4TH QUARTER RELATIVE HUMIDITY = 73.00 %

NOTE: PRECIPITATION DATA WAS SYNTHETICALLY GENERATED USING  
COEFFICIENTS FOR AUGUSTA GEORGIA

NORMAL MEAN MONTHLY PRECIPITATION (INCHES)

JAN/JUL	FEB/AUG	MAR/SEP	APR/OCT	MAY/NOV	JUN/DEC
4.38	3.95	4.68	2.91	3.56	4.99
5.43	5.41	3.93	3.12	2.96	3.45

NOTE: TEMPERATURE DATA WAS SYNTHETICALLY GENERATED USING  
COEFFICIENTS FOR AUGUSTA GEORGIA

NORMAL MEAN MONTHLY TEMPERATURE (DEGREES FAHRENHEIT)

JAN/JUL	FEB/AUG	MAR/SEP	APR/OCT	MAY/NOV	JUN/DEC
46.30	50.00	57.20	64.30	72.10	78.40
81.60	80.30	75.20	65.10	56.70	48.80

NOTE: SOLAR RADIATION DATA WAS SYNTHETICALLY GENERATED USING  
COEFFICIENTS FOR AUGUSTA GEORGIA  
AND STATION LATITUDE = 33.30 DEGREES

\*\*\*\*\*

AVERAGE MONTHLY VALUES IN INCHES FOR YEARS 1 THROUGH 100

	JAN/JUL	FEB/AUG	MAR/SEP	APR/OCT	MAY/NOV	JUN/DEC
PRECIPITATION						
TOTALS	4.56	3.57	4.76	2.74	3.60	4.97
	5.81	5.32	4.41	2.99	2.75	3.41
STD. DEVIATIONS	2.44	1.60	2.47	1.31	2.12	2.60
	2.83	2.95	2.54	2.28	1.72	1.90

## RUNOFF

-----

TOTALS	0.004	0.000	0.004	0.000	0.000	0.002
	0.027	0.091	0.016	0.006	0.002	0.001
STD. DEVIATIONS	0.020	0.000	0.027	0.000	0.002	0.015
	0.092	0.404	0.086	0.058	0.015	0.004

## EVAPOTRANSPIRATION

-----

TOTALS	1.577	2.093	3.072	3.553	3.661	4.141
	4.897	4.522	3.384	1.619	0.948	1.114
STD. DEVIATIONS	0.221	0.236	0.582	0.760	1.525	1.546
	1.588	1.378	1.039	0.606	0.207	0.206

## LATERAL DRAINAGE COLLECTED FROM LAYER 5

-----

TOTALS	2.5102	2.0619	1.9352	1.2047	0.4142	0.3121
	0.5589	0.8185	0.7450	0.7795	0.9036	1.5056
STD. DEVIATIONS	1.8312	1.5189	1.4896	1.0415	0.4532	0.5842
	0.8112	1.0393	1.0279	1.0745	1.2152	1.3333

## PERCOLATION/LEAKAGE THROUGH LAYER 6

-----

TOTALS	0.0617	0.0514	0.0488	0.0322	0.0142	0.0105
	0.0162	0.0224	0.0208	0.0213	0.0239	0.0381
STD. DEVIATIONS	0.0421	0.0351	0.0336	0.0239	0.0106	0.0141
	0.0193	0.0244	0.0241	0.0253	0.0284	0.0312

## LATERAL DRAINAGE COLLECTED FROM LAYER 8

-----

TOTALS	0.0511	0.0483	0.0446	0.0307	0.0106	0.0070
	0.0123	0.0180	0.0165	0.0174	0.0205	0.0327
STD. DEVIATIONS	0.0320	0.0336	0.0343	0.0278	0.0152	0.0131
	0.0178	0.0224	0.0227	0.0238	0.0276	0.0281

## PERCOLATION/LEAKAGE THROUGH LAYER 9

-----

TOTALS	0.0051	0.0049	0.0053	0.0051	0.0049	0.0035
	0.0036	0.0040	0.0040	0.0038	0.0036	0.0043
STD. DEVIATIONS	0.0009	0.0001	0.0003	0.0005	0.0011	0.0019
	0.0021	0.0020	0.0019	0.0021	0.0021	0.0019

-----  
 AVERAGES OF MONTHLY AVERAGED DAILY HEADS (INCHES)  
 -----

DAILY AVERAGE HEAD ON TOP OF LAYER 6  
 -----

AVERAGES	2.1516	1.9398	1.6538	1.0666	0.3539	0.2755
	0.4775	0.6992	0.6594	0.6660	0.7977	1.2862
STD. DEVIATIONS	1.5865	1.4607	1.2739	0.9329	0.3872	0.5157
	0.6930	0.8878	0.9127	0.9179	1.0727	1.1390

DAILY AVERAGE HEAD ON TOP OF LAYER 9  
 -----

AVERAGES	0.0039	0.0040	0.0034	0.0024	0.0008	0.0005
	0.0009	0.0014	0.0013	0.0013	0.0016	0.0025
STD. DEVIATIONS	0.0024	0.0028	0.0026	0.0022	0.0012	0.0010
	0.0013	0.0017	0.0018	0.0018	0.0022	0.0021

\*\*\*\*\*  
 \*\*\*\*\*

AVERAGE ANNUAL TOTALS & (STD. DEVIATIONS) FOR YEARS 1 THROUGH 100  
 -----

	INCHES		CU. FEET	PERCENT
PRECIPITATION	48.90	( 7.734)	3484469.2	100.00
RUNOFF	0.154	( 0.4340)	10947.61	0.314
EVAPOTRANSPIRATION	34.582	( 3.6251)	2464196.75	70.719
LATERAL DRAINAGE COLLECTED FROM LAYER 5	13.74952	( 5.50704)	979748.062	28.11757
PERCOLATION/LEAKAGE THROUGH LAYER 6	0.36170	( 0.12899)	25773.611	0.73967
AVERAGE HEAD ON TOP OF LAYER 6	1.002	( 0.403)		
LATERAL DRAINAGE COLLECTED FROM LAYER 8	0.30966	( 0.12406)	22065.420	0.63325
PERCOLATION/LEAKAGE THROUGH LAYER 9	0.05203	( 0.00803)	3707.190	0.10639
AVERAGE HEAD ON TOP OF LAYER 9	0.002	( 0.001)		
CHANGE IN WATER STORAGE	0.053	( 1.9051)	3804.31	0.109

\*\*\*\*\*

\*\*\*\*\*

PEAK DAILY VALUES FOR YEARS	1 THROUGH	100
	(INCHES)	(CU. FT.)
PRECIPITATION	6.87	489534.875
RUNOFF	2.647	188618.8120
DRAINAGE COLLECTED FROM LAYER 5	0.45348	32313.73240
PERCOLATION/LEAKAGE THROUGH LAYER 6	0.018346	1307.25354
AVERAGE HEAD ON TOP OF LAYER 6	21.373	
MAXIMUM HEAD ON TOP OF LAYER 6	31.170	
LOCATION OF MAXIMUM HEAD IN LAYER 5 (DISTANCE FROM DRAIN)	121.6 FEET	
DRAINAGE COLLECTED FROM LAYER 8	0.01253	892.95929
PERCOLATION/LEAKAGE THROUGH LAYER 9	0.000195	13.90441
AVERAGE HEAD ON TOP OF LAYER 9	0.029	
MAXIMUM HEAD ON TOP OF LAYER 9	0.055	
LOCATION OF MAXIMUM HEAD IN LAYER 8 (DISTANCE FROM DRAIN)	9.4 FEET	
SNOW WATER	2.36	168188.7190
MAXIMUM VEG. SOIL WATER (VOL/VOL)		0.3692
MINIMUM VEG. SOIL WATER (VOL/VOL)		0.1147

\*\*\* Maximum heads are computed using McEnroe's equations. \*\*\*

Reference: Maximum Saturated Depth over Landfill Liner  
by Bruce M. McEnroe, University of Kansas  
ASCE Journal of Environmental Engineering  
Vol. 119, No. 2, March 1993, pp. 262-270.

\*\*\*\*\*

\*\*\*\*\*

FINAL WATER STORAGE AT END OF YEAR 100

LAYER	( INCHES )	( VOL/VOL )
1	1.6120	0.2687
2	9.2097	0.3070
3	0.7200	0.0600
4	4.1112	0.3426
5	2.0564	0.1714
6	0.1500	0.7500
7	14.0568	0.2400
8	1.9214	0.0801
9	0.1500	0.7500
SNOW WATER	0.000	

\*\*\*\*\*  
\*\*\*\*\*

**Appendix F, SDF MSE Vault Closure Cap Degraded Property Value Calculations for Lower Bounding Scenario (i.e. Continuous Bamboo Cover)**

The MSE vault closure cap initial (0 year) layer thickness and hydraulic property values from top to bottom are provided in Table 3.1-1. The degradation scenarios for each layer are provided in Table 4.4-1. Based upon the Table 4.4-1 degradation scenarios, the Table 3.1-1 initial SDF closure cap layer thickness and hydraulic property values have been modified to account for degradation at 100, 300, 550, 1,000, 1,800, 3,400, 5,600 and 10,000 years after closure of the SDF.

**Topsoil and Upper Backfill Layer Thickness:**

From Section 4.2 the soil loss in terms of depth of loss per year for the topsoil and upper backfill for a bamboo cover was estimated to be 2.0E-04 inches/year and 1.2E-04 inches/year, respectively.

Topsoil Thickness over Time Calculation:

Year	Thickness
0	6" – (0 years × 2.0E-04 inches/year) = 6"
100	6" – (100 years × 2.0E-04 inches/year) = 5.980"
300	6" – (300 years × 2.0E-04 inches/year) = 5.940"
550	6" – (550 years × 2.0E-04 inches/year) = 5.890"
1,000	6" – (1000 years × 2.0E-04 inches/year) = 5.800"
1,800	6" – (1800 years × 2.0E-04 inches/year) = 5.640"
3,400	6" – (3400 years × 2.0E-04 inches/year) = 5.320"
5,600	6" – (5600 years × 2.0E-04 inches/year) = 4.880"
10,000	6" – (10000 years × 2.0E-04 inches/year) = 4.0"

Since the topsoil does not completely erode away within the 10,000 years of interest, no reduction in the upper backfill layer occurs within this time frame.

**Ground Surface Soil Texture:**

The soil texture of the ground surface will change over time due to erosion of the topsoil and upper backfill layers. Soil texture is utilized in the HELP model to determine the SCS Curve Number (CN) and subsequent runoff from the closure cap. The default HELP model ground surface soil textures will be assigned based upon an equivalence between the saturated hydraulic conductivity of the material assumed to be at the ground surface and that of the default HELP model ground surface soil textures.

Default HELP Model Ground Surface Soil Textures:

Ground Surface Material	Ground Surface Material K (cm/s)	HELP Soil Texture	HELP Soil Texture K (cm/s)
Topsoil	1.0E-3	5	1.0E-3
Backfill	1.0E-4	10	1.2E-4
Erosion Barrier	3.97E-4	8	3.7E-4

**Middle Backfill Layer and Upper Drainage Layer Hydraulic Properties:**

It is assumed that colloidal clay migration from the 1-foot-thick middle backfill to the underlying 1-foot-thick upper drainage layer causes the middle backfill saturated hydraulic conductivity to increase over time and that of the upper drainage layer to decrease over time.

Determine mass of clay to fill upper drainage layer void volume (0.38):

Assume clay bulk density is 1.1 g/cm<sup>3</sup>

Look at a 1-ft<sup>2</sup> area of the 1-foot-thick upper drainage layer (i.e. 1 ft<sup>3</sup>)

Void volume = 0.38 × 1 ft<sup>3</sup> = 0.38 ft<sup>3</sup>

$$\text{Clay mass per ft}^3 = 1.1 \text{ g/cm}^3 \times 0.38 \text{ ft}^3 \times 2.831685\text{E-}02 \text{ m}^3/\text{ft}^3 \times 1,000,000 \text{ cm}^3/\text{m}^3 = 11,836.3 \text{ g}$$

Determine available clay mass in the middle backfill layer:

Assume that the middle backfill layer consists of 20% clay and 80% sand with a dry bulk density of 104-lbs/ft<sup>3</sup>.

$$\text{Clay mass} = 104 \text{ lbs/ft}^3 \times 0.20 \times 453.59 \text{ g/lbs} = 9,434.7 \text{ g/ft}^3$$

There is not enough clay in the middle backfill layer to fill the upper drainage layer. Therefore it will be assumed that half the clay content of the middle backfill migrates into the upper drainage layer, at which point the two layers essentially become the same material and material property changes cease. Based upon this it will be assumed that the endpoint saturated hydraulic conductivity of the layers will become that of the log mid-point between the initial backfill and upper drainage layer conditions. It will also be assumed that the endpoint porosity, field capacity, and wilting point will become the arithmetic average of the backfill and upper drainage layer.

Endpoint hydraulic properties:

Intact hydraulic properties:

Hydraulic Parameter	Middle Backfill	Upper Drainage Layer
K	1.0E-04 cm/s	1.0E-01 cm/s
n	0.37	0.38
FC	0.24	0.08
WP	0.136	0.013

Endpoint saturated hydraulic conductivity:

$$\text{Middle backfill: } K_{MB} = 0.0001; \log K_{MB} = -4$$

$$\text{Upper drainage layer: } K_{UDL} = 0.1; \log K_{UDL} = -1$$

$$\text{Log mid-point: } \frac{\log K_{MB} + \log K_{UDL}}{2} = \frac{-1 + (-4)}{2} = -2.5$$

$$K_E = 10^{-2.5} = 3.2\text{E-}03 \text{ cm/s}$$

Endpoint n, FC, and WP:

$$n = (0.37 + 0.38)/2 = 0.375$$

$$FC = (0.24 + 0.08)/2 = 0.16$$

$$WP = (0.136 + 0.013)/2 = 0.0745$$

It will be assumed that the clay migrates out of the middle backfill into the upper drainage layer with the water flux containing 63 mg/L of colloidal clay. It will also be assumed that the time to achieve the endpoint conditions will be based upon the estimated water flux into the upper drainage layer and migration of half the clay content of the middle backfill layer (i.e.  $9,434.7 \text{ g/ft}^3 \div 2 = 4717.4 \text{ g/ft}^3$ ).

Determine flux of water into the upper drainage layer:

Section 3.3 intact SDF closure cap Modeling determined the following average annual flux of water into the upper drainage layer (see Appendix E):

$$\text{Precipitation} = 48.90 \text{ inches/year}$$

$$\text{Runoff} = 0.154 \text{ inches/year}$$

$$\text{Evapotranspiration} = 34.582 \text{ inches/year}$$

$$\text{Flux of water into upper drainage layer} = \text{Precipitation} - (\text{Runoff} + \text{Evapotranspiration})$$

Flux of water into upper drainage layer =  $48.90 \text{ in/yr} - (0.154 \text{ in/yr} + 34.582 \text{ in/yr})$

Flux of water into upper drainage layer =  $14.164 \text{ in/yr}$

Based upon Phifer 2003 this flux of water (~14.2 inches/year) is satisfactory for the determination of the timing to achieve the endpoint conditions for the middle backfill and upper drainage layer.

Determine yearly clay migration into the upper drainage layer:

Flux into upper drainage layer =  $14.2 \text{ in/yr}$

Colloidal clay concentration =  $63 \text{ mg/L}$

Flux through a  $1 \text{ ft}^2$  area =  $14.2 \text{ in/yr} \times \text{ft}/12 \text{ in} \times 1 \text{ ft}^2 = 1.18 \text{ ft}^2/\text{yr}$

Clay flux =  $1.18 \text{ ft}^2/\text{yr} \times 63 \text{ mg/L} \times 2.831685\text{E-}02 \text{ m}^3/\text{ft}^3 \times 1000\text{L}/\text{m}^3 = 2,105 \text{ mg/yr} = 2.1 \text{ g/yr}$

Determine time it takes for the  $4717.4 \text{ g}$  of clay to migrate from the middle backfill layer to the upper drainage layer:

Time =  $4717.4 \text{ g} \div 2.1 \text{ g/yr} = 2,246 \text{ years}$

Determine middle backfill and upper drainage layer hydraulic property variation with time:

It will be assumed that the K of the middle backfill layer is increasing log linearly with time from  $1.0\text{E-}04 \text{ cm/s}$  to  $3.2\text{E-}03 \text{ cm/s}$ , until year 2,246 at which time the K becomes static. Conversely it will be assumed that the K of the upper drainage layer is decreasing log linearly with time from  $1.0\text{E-}01 \text{ cm/s}$  to  $3.2\text{E-}03 \text{ cm/s}$ , until year 2,246 at which time the K becomes static. Porosity (n), FC, and WP will be assumed to behave similarly but in an arithmetic linear manner.

Initial and End State hydraulic properties:

Hydraulic Parameter	Initial Middle Backfill	Initial Upper Drainage Layer	End State at 2,246 years
K	$1.0\text{E-}04 \text{ cm/s}$	$1.0\text{E-}01 \text{ cm/s}$	$3.2\text{E-}03 \text{ cm/s}$
n	0.37	0.38	0.375
FC	0.24	0.08	0.16
WP	0.136	0.013	0.0745

Determine fraction change for each year:

Year	Fraction
0	$0 \div 2246 = 0$
100	$100 \div 2246 = 0.0445$
300	$300 \div 2246 = 0.1336$
550	$550 \div 2246 = 0.2449$
1,000	$1000 \div 2246 = 0.4452$
1,800	$1800 \div 2246 = 0.8014$
3,400	1.0
5,600	1.0
10,000	1.0



Determine variation in K, n, FC, and WP with time in the middle backfill:

Year	Fraction, F	K <sup>1</sup> (cm/s)	n <sup>2</sup>	FC <sup>3</sup>	WP <sup>4</sup>
0	0	0.0001	0.37	0.24	0.136
100	0.0445	0.00012	0.37	0.236	0.133
300	0.1336	0.00016	0.371	0.229	0.128
550	0.2449	0.00023	0.371	0.220	0.121
1,000	0.4452	0.00046	0.372	0.204	0.109
1,800	0.8014	0.0016	0.374	0.176	0.0867
3,400	1.0	0.0032	0.375	0.16	0.0745
5,600	1.0	0.0032	0.375	0.16	0.0745
10,000	1.0	0.0032	0.375	0.16	0.0745

$$^1 K = 10^{[-4 + ((-2.5 - (-4))F)]} = 10^{(-4 + 1.5F)}$$

$$^2 n = 0.37 + (0.375 - 0.37)F$$

$$^3 FC = 0.24 - (0.24 - 0.16)F$$

$$^4 WP = 0.136 - (0.136 - 0.0745)F$$

Determine variation in K, n, FC, and WP with time in the upper drainage layer:

Year	Fraction, F	K <sup>1</sup> (cm/s)	n <sup>2</sup>	FC <sup>3</sup>	WP <sup>4</sup>
0	0	0.1	0.38	0.08	0.013
100	0.0445	0.086	0.38	0.084	0.016
300	0.1336	0.063	0.379	0.089	0.021
550	0.2449	0.043	0.379	0.10	0.028
1,000	0.4452	0.021	0.378	0.116	0.040
1,800	0.8014	0.0063	0.376	0.144	0.062
3,400	1.0	0.0032	0.375	0.16	0.0745
5,600	1.0	0.0032	0.375	0.16	0.0745
10,000	1.0	0.0032	0.375	0.16	0.0745

$$^1 K = 10^{[-1 + ((-2.5 - (-1))F)]} = 10^{(-1 - 1.5F)}$$

$$^2 n = 0.38 - (0.38 - 0.375)F$$

$$^3 FC = 0.08 + (0.16 - 0.08)F$$

$$^4 WP = 0.013 + (0.0745 - 0.013)F$$

#### Lower Drainage Layer Hydraulic Properties:

It is assumed that colloidal clay migration from the overlying backfill is driven by the water flux through the upper GCL. This water flux driven clay migration enters into the 2-foot thick lower drainage layer and fills the lower drainage layer from the bottom up. This reduces the saturated hydraulic conductivity of the clay filled portion from 1.0E-01 to 1.0E-04 cm/s (i.e. the saturated hydraulic conductivity of the overlying backfill layer). As the thickness of the lower drainage layer filled with clay increases the overall hydraulic conductivity of the layer decreases. This is different from that assumed for the upper drainage layer since the lower drainage layer has significantly more backfill overlying it. The HELP model was run for each year with all of the previously degraded properties (see above) without degradation of the lower drainage layer in order to determine the infiltration through the upper GCL. The results are as follows:

Year	Infiltration through upper GCL (inches/year)
0	0.36170
100	0.41335
300	0.55102
550	0.80275
1,000	1.75224
1,800	5.05125
3,400	6.45544
5,600	6.44166
10,000	6.39636

It is assumed that there is a linear increase in the infiltration over time between data points.

Determine cumulative volume of water through the lower drainage layer over time:

Year	Infiltration through upper GCL (inches/year)	Time Step Infiltration <sup>1</sup> (inches)	Cumulative Infiltration <sup>2</sup> (inches)	Cumulative Volume over one ft <sup>2</sup> area <sup>3</sup> (ft <sup>3</sup> )
0	0.36170	0	0	0
100	0.41335	38.75	38.75	3.23
300	0.55102	96.44	135.19	11.26
550	0.80227	169.16	304.35	25.36
1,000	1.75224	574.87	879.22	73.27
1,800	5.05125	2,721.40	3,600.62	300.05
3,400	6.45544	9,205.32	12,805.94	1,067.16
5,600	6.44166	14,186.81	26,992.75	2,249.4
10,000	6.39636	28,243.62	55,236.37	4,603.03

<sup>1</sup> Time Step Infiltration =  $[I_1 \times (T_2 - T_1)] + [1/2 \times (I_2 - I_1)(T_2 - T_1)]$ , where I = infiltration at time 1 or 2;  
T = time at time 1 or 2

<sup>2</sup> Cumulative Infiltration = Previous Cumulative Infiltration + Time Step Infiltration at current time step

<sup>3</sup> Cumulative Volume over one ft<sup>2</sup> area = (Cumulative Infiltration ÷ 12 in/ft) × 1 ft<sup>2</sup>

Determine mass of clay to fill lower drainage layer void volume (0.38):

Assume clay bulk density is 1.1 g/cm<sup>3</sup>

Look at a 1-ft<sup>2</sup> area of the 2-foot-thick upper drainage layer (i.e. 2 ft<sup>3</sup>)

Void volume = 0.38 × 2 ft<sup>3</sup> = 0.76 ft<sup>3</sup>

Clay mass per ft<sup>3</sup> = 1.1 g/cm<sup>3</sup> × 0.76 ft<sup>3</sup> × 2.831685E-02 m<sup>3</sup>/ft<sup>3</sup> × 1,000,000 cm<sup>3</sup>/m<sup>3</sup> = 23,672.9 g

Determine total flux of water into the lower drainage layer required to completely fill it with clay:

It will be assumed that the clay migrates out of the lower backfill into the lower drainage layer with the water flux containing 63 mg/L of colloidal clay.

$$V = \frac{23,672.9 \text{ g} \times 1000 \text{ mg} / \text{g}}{63 \text{ mg} / \text{L} \times 28.31685 \text{ L} / \text{ft}^3} = 13,269.8 \text{ ft}^3$$

Determine the mass of clay that has migrated into the lower drainage layer at the end of each time step:

Year	Mass of clay into lower drainage layer
0	0
100	$3.23 \text{ ft}^3 \times 63 \text{ mg/L} \times 28.31685 \text{ L/ft}^3 \times \text{g}/1000 \text{ mg} = 5.76 \text{ g}$
300	$11.26 \text{ ft}^3 \times 63 \text{ mg/L} \times 28.31685 \text{ L/ft}^3 \times \text{g}/1000 \text{ mg} = 20.09 \text{ g}$
550	$25.36 \text{ ft}^3 \times 63 \text{ mg/L} \times 28.31685 \text{ L/ft}^3 \times \text{g}/1000 \text{ mg} = 45.24 \text{ g}$
1,000	$73.27 \text{ ft}^3 \times 63 \text{ mg/L} \times 28.31685 \text{ L/ft}^3 \times \text{g}/1000 \text{ mg} = 130.71 \text{ g}$
1,800	$300.05 \text{ ft}^3 \times 63 \text{ mg/L} \times 28.31685 \text{ L/ft}^3 \times \text{g}/1000 \text{ mg} = 535.28 \text{ g}$
3,400	$1,067.16 \text{ ft}^3 \times 63 \text{ mg/L} \times 28.31685 \text{ L/ft}^3 \times \text{g}/1000 \text{ mg} = 1,903.77 \text{ g}$
5,600	$2,249.4 \text{ ft}^3 \times 63 \text{ mg/L} \times 28.31685 \text{ L/ft}^3 \times \text{g}/1000 \text{ mg} = 4,012.84 \text{ g}$
10,000	$4,603.03 \text{ ft}^3 \times 63 \text{ mg/L} \times 28.31685 \text{ L/ft}^3 \times \text{g}/1000 \text{ mg} = 8,211.63 \text{ g}$

Determine the fraction of the lower drainage layer filled at the end of each time step:

Year	Fraction of the lower drainage layer filled
0	0
100	$5.76 \text{ g} \div 23,672.9 \text{ g} = 0.000243$
300	$20.09 \text{ g} \div 23,672.9 \text{ g} = 0.000849$
550	$45.24 \text{ g} \div 23,672.9 \text{ g} = 0.00191$
1,000	$130.71 \text{ g} \div 23,672.9 \text{ g} = 0.00552$
1,800	$535.28 \text{ g} \div 23,672.9 \text{ g} = 0.0226$
3,400	$1,903.77 \text{ g} \div 23,672.9 \text{ g} = 0.0804$
5,600	$4,012.84 \text{ g} \div 23,672.9 \text{ g} = 0.170$
10,000	$8,211.63 \text{ g} \div 23,672.9 \text{ g} = 0.347$

The following are the hydraulic properties of the clean and clay filled portion of the lower drainage layer:

Material	Saturated Hydraulic Conductivity (cm/s)	Porosity	Field Capacity	Wilting Point
Clean	1.0E-01	0.38	0.08	0.013
Clay filled	1.0E-04	0.22 (see below)	0.21 (see below)	0.20 (see below)

Determine the porosity of the clay filled portion of the lower drainage layer:

Porosity of the clay:

$$\text{Assumed clay bulk density, } \rho_b = 1.1 \text{ g/cm}^3$$

$$\text{Assumed clay particle density, } \rho_p = 2.6 \text{ g/cm}^3$$

$$\text{Resulting clay porosity, } n = 1 - \frac{r_b}{r_p} = 1 - \frac{1.1 \text{ g/cm}^3}{2.6 \text{ g/cm}^3} = 0.58$$

Porosity of the clay filled portion = Porosity of clean portion  $\times$  porosity of clay

$$\text{Porosity of the clay filled portion} = 0.38 \times 0.58 = 0.22$$

Determine the field capacity and wilting point of the clay filled portion of the lower drainage layer:

Will assume that the field capacity and wilting point of the clay fill portion has the same ratio versus its porosity of 0.22 as the equivalent ratio for kaolin clay.

From WSRC 2002 the following kaolin properties are found:  $n = 0.56$ ;  $FC = 0.55$ ;  $WP = 0.50$

$$FC = 0.22 \times (0.55 \div 0.56) \approx 0.21$$

$$WP = 0.22 \times (0.50 \div 0.56) \approx 0.20$$

Determine the equivalent horizontal hydraulic conductivity of the lower drainage layer over time:

The equivalent horizontal hydraulic conductivity for horizontal flow in a series of horizontal layers with different saturated hydraulic conductivities can be determined from the following equation (Freeze and Cherry 1979):

$$K_h = \sum_{i=1}^n \frac{K_i d_i}{d}, \text{ where } K_h = \text{equivalent horizontal saturated hydraulic conductivity, } K_i = \text{horizontal saturated hydraulic conductivity of } i^{\text{th}} \text{ layer, } d_i = \text{thickness of } i^{\text{th}} \text{ layer, } d = \text{total thickness}$$

The fraction, F, equals  $d_i/d$  for the clay filled portion and  $d_i/d$  for the clean drainage layer material equals  $(1 - F)$ , making the equation:

$$K_h = (K_{filled} \times F) + [K_{clean} \times (1 - F)]$$

Year	Equivalent K (cm/s)
0	0.1
100	$(0.0001 \times 0.000243) + [0.1 \times (1 - 0.000243)] = 0.1$
300	$(0.0001 \times 0.000849) + [0.1 \times (1 - 0.000849)] = 0.0999$
550	$(0.0001 \times 0.00191) + [0.1 \times (1 - 0.00191)] = 0.0998$
1,000	$(0.0001 \times 0.00552) + [0.1 \times (1 - 0.00552)] = 0.0994$
1,800	$(0.0001 \times 0.0226) + [0.1 \times (1 - 0.0226)] = 0.0977$
3,400	$(0.0001 \times 0.0804) + [0.1 \times (1 - 0.0804)] = 0.0920$
5,600	$(0.0001 \times 0.170) + [0.1 \times (1 - 0.170)] = 0.0830$
10,000	$(0.0001 \times 0.347) + [0.1 \times (1 - 0.347)] = 0.0653$

Determine the equivalent n, FC, and WP for the lower drainage layer over time:

In an analogous manner to that for K, the equivalent n, FC, and WP can be determined based upon the fraction filled as follows:

$$n = (n_{filled} \times F) + [n_{clean} \times (1 - F)]$$

$$FC = (FC_{filled} \times F) + [FC_{clean} \times (1 - F)]$$

$$WP = (WP_{filled} \times F) + [WP_{clean} \times (1 - F)]$$

Year	Equivalent n
0	$(0.22 \times 0) + [0.38 \times (1 - 0)] = 0.38$
100	$(0.22 \times 0.000243) + [0.38 \times (1 - 0.000243)] = 0.38$
300	$(0.22 \times 0.000849) + [0.38 \times (1 - 0.000849)] = 0.38$
550	$(0.22 \times 0.00191) + [0.38 \times (1 - 0.00191)] = 0.38$
1,000	$(0.22 \times 0.00552) + [0.38 \times (1 - 0.00552)] = 0.379$
1,800	$(0.22 \times 0.0226) + [0.38 \times (1 - 0.0226)] = 0.376$
3,400	$(0.22 \times 0.0804) + [0.38 \times (1 - 0.0804)] = 0.367$
5,600	$(0.22 \times 0.170) + [0.38 \times (1 - 0.170)] = 0.353$
10,000	$(0.22 \times 0.347) + [0.38 \times (1 - 0.347)] = 0.324$

Year	Equivalent FC
0	$(0.21 \times 0) + [0.08 \times (1 - 0)] = 0.08$
100	$(0.21 \times 0.000243) + [0.08 \times (1 - 0.000243)] = 0.08$
300	$(0.21 \times 0.000849) + [0.08 \times (1 - 0.000849)] = 0.0801$
550	$(0.21 \times 0.00191) + [0.08 \times (1 - 0.00191)] = 0.0802$
1,000	$(0.21 \times 0.00552) + [0.08 \times (1 - 0.00552)] = 0.0807$
1,800	$(0.21 \times 0.0226) + [0.08 \times (1 - 0.0226)] = 0.0829$
3,400	$(0.21 \times 0.0804) + [0.08 \times (1 - 0.0804)] = 0.0904$
5,600	$(0.21 \times 0.170) + [0.08 \times (1 - 0.170)] = 0.102$
10,000	$(0.21 \times 0.347) + [0.08 \times (1 - 0.347)] = 0.125$

Year	Equivalent WP
0	$(0.20 \times 0) + [0.013 \times (1 - 0)] = 0.013$
100	$(0.20 \times 0.000243) + [0.013 \times (1 - 0.000243)] = 0.013$
300	$(0.20 \times 0.000849) + [0.013 \times (1 - 0.000849)] = 0.0132$
550	$(0.20 \times 0.00191) + [0.013 \times (1 - 0.00191)] = 0.0134$
1,000	$(0.20 \times 0.00552) + [0.013 \times (1 - 0.00552)] = 0.0140$
1,800	$(0.20 \times 0.0226) + [0.013 \times (1 - 0.0226)] = 0.0172$
3,400	$(0.20 \times 0.0804) + [0.013 \times (1 - 0.0804)] = 0.0280$
5,600	$(0.20 \times 0.170) + [0.013 \times (1 - 0.170)] = 0.0448$
10,000	$(0.20 \times 0.347) + [0.013 \times (1 - 0.347)] = 0.0779$

#### Summary Lower Drainage Layer Hydraulic Properties with Time:

Year	K (cm/s)	n	FC	WP
0	0.1	0.38	0.08	0.013
100	0.1	0.38	0.08	0.013
300	0.0999	0.38	0.0801	0.0132
550	0.0998	0.38	0.0802	0.0134
1,000	0.0994	0.379	0.0807	0.0140
1,800	0.0977	0.376	0.0829	0.0172
3,400	0.0920	0.367	0.0904	0.0280
5,600	0.0830	0.353	0.102	0.0448
10,000	0.0653	0.324	0.125	0.0779

The HELP model was rerun for each time step with all of the degraded properties (see above) including that of the lower drainage layer. Infiltration through the upper GCL did not change with the addition of the degraded lower drainage layer properties. Therefore the above estimated lower drainage layer hydraulic properties over time are verified.

#### Infiltration through the Upper GCL after Topsoil and Upper Backfill Eroded

The infiltration through the upper GCL at complete closure cap degradation for the lower bounding scenario and the associated time of occurrence have been determined based upon the following:

- Complete closure cap degradation occurs when both the topsoil and upper backfill have eroded away.
- As outlined previously, it is assumed that the material properties of the middle backfill and upper drainage layer become the same at year 2,246 and remain constant thereafter. Therefore the middle backfill and upper drainage layer material properties will be taken as those determined at year 2,246.
- As previously demonstrated, the material properties of the lower drainage layer do not impact infiltration through the upper GCL. Completely silted in conditions will be assumed for the lower drainage layer for determination of this infiltration.

From Section 4.2 the soil loss in terms of depth of loss per year for the topsoil and upper backfill was estimated to be 2.0E-04 inches/year and 1.2E-04 inches/year, respectively.

Determine time required to completely erode the topsoil:

$$6'' \div 2.0E-04 \text{ inches/year} = 30,000 \text{ years}$$

Determine time required to completely erode the upper backfill:

$$30'' \div 1.2E-04 \text{ inches/year} = 250,000 \text{ years}$$

Total time required to completely erode both the topsoil and upper backfill:

$$30,000 \text{ years} + 250,000 \text{ years} = 280,000 \text{ years}$$

Based upon the above the following are the input properties utilized for the topsoil, upper backfill, middle backfill, upper drainage layer, and lower drainage layer for determination of the year 280,000 infiltration through the upper GCL.

Summary Hydraulic Properties for determination of the infiltration through the upper GCL at 280,000 years:

Layer	Thickness (inches)	K (cm/s)	n	FC	WP
Topsoil	0	NA	NA	NA	NA
Upper Backfill	0	NA	NA	NA	NA
Middle Backfill	12	3.2E-03	0.375	0.16	0.0745
Upper Drainage Layer	12	3.2E-03	0.375	0.16	0.0745
Lower Drainage Layer	24	1.0E-04	0.37	0.24	0.136

NA = not applicable

At 280,000 years the topsoil and upper backfill are completely eroded and the erosion barrier is at the ground surface. As outlined previously default HELP model soil texture number 8 is assumed to be equivalent to the erosion barrier based upon the saturated hydraulic conductivities. This HELP model soil texture will be used to determine the CN number for determination of runoff.

The above parameter values were utilized as HELP model input to determine the infiltration through the upper GCL at 280,000 years, when both the topsoil and upper backfill are completely eroded. The detailed HELP model input data and output file associated with this infiltration at year 280,000 are provided at the end of this appendix. The infiltration through the upper GCL at year 280,000 was determined to be 4.75118 inches/year.

#### **Year that Lower Drainage Layer Completely Silts In**

After year 10,000 it will be assumed that the infiltration through the upper GCL is 6.4 inches per year (i.e. maximum infiltration through the upper GCL). From previous calculations above:

- It takes a total of 13,269.8 ft<sup>3</sup> of infiltrating water to completely silt in the lower drainage layer
- Through year 10,000 the infiltrating water volume was 4,603.04 ft<sup>3</sup>

Determine water volume remaining after year 10,000 to completely silt in the lower drainage layer:

$$V = 13,269.8 \text{ ft}^3 - 4,603.04 \text{ ft}^3 = 8,666.76 \text{ ft}^3$$

Determine length of time to obtain this volume at 6.4 inches per year over a 1-ft<sup>2</sup> area:

$$\text{Time} = 8,666.76 \text{ ft}^3 \div (6.4 \text{ in/yr} \times 12 \text{ ft/in} \times 1\text{-ft}^2) = 16,250 \text{ years}$$

Determine time to completely silt in the lower drainage layer:

$$\text{Time} = 10,000 \text{ years} + 16,250 \text{ years} = 26,250 \text{ years}$$

Lower Bounding Scenario Degraded SDF MSE Vault Closure Cap (280,000 years): HELP Model Input Data and Output File (output file name: ZLBSWout.OUT)

Input Data:

Input Parameter (HELP Model Query)		Generic Input Parameter Value					
Landfill area =		19.63 acres					
Percent of area where runoff is possible =		100%					
Do you want to specify initial moisture storage? (Y/N)		Y					
Amount of water or snow on surface =		0 inches					
CN Input Parameter (HELP Model Query)		CN Input Parameter Value					
Slope =		3 %					
Slope length =		450 ft					
Soil Texture =		8 (HELP model default soil texture)					
Vegetation =		4 (i.e., a good stand of grass)					
HELP Model Computed Curve Number = 71.9							
Layer		Layer Number			Layer Type		
Erosion Barrier		1			1 (vertical percolation layer)		
Middle Backfill		2			1 (vertical percolation layer)		
Upper Drainage Layer		3			2 (lateral drainage layer)		
Upper GCL		4			3 (barrier soil liner)		
Lower Backfill		5			1 (vertical percolation layer)		
Lower Drainage Layer		6			2 (lateral drainage layer)		
Lower GCL		7			3 (barrier soil liner)		
	Layer Type	Layer Thickness (in)	Soil Texture No.	Total Porosity (Vol/Vol)	Field Capacity (Vol/Vol)	Wilting Point (Vol/Vol)	Initial Moisture (Vol/Vol)
1	1	12		0.06	0.056	0.052	0.056
2	1	12		0.375	0.16	0.0745	0.16
3	2	12		0.375	0.16	0.0745	0.16
4	3	0.2		0.75	0.747	0.40	0.75
5	1	58.57		0.37	0.24	0.136	0.24
6	2	24		0.37	0.24	0.136	0.24
7	3	0.2		0.75	0.747	0.40	0.75

The lack of values in the table for particular parameters in particular layers denotes that no HELP model input was required for that parameter in that layer. No data are missing from the table.



## Input Data (continued):

	Layer Type	Sat. Hyd. Conductivity * (cm/sec)	Drainage Length (ft)	Drain Slope (%)	Leachate Recirc. (%)	Recirc. to Layer (#)	Subsurface Inflow (in/yr)
1	1	3.97E-04					
2	1	3.20E-03					
3	2	3.20E-03	450	3			
4	3	5.00E-09					
5	1	1.00E-04					
6	2	1.00E-04	150	11.4			
7	3	5.00E-09					
	Layer Type	Geomembrane Pinhole Density (#/acre)	Geomembrane Instal. Defects (#/acre)	Geomembrane Placement Quality	Geotextile Transmissivity (cm <sup>2</sup> /sec)		
1	1						
2	1						
3	2						
4	3						
5	1						
6	2						
7	3						

The lack of values in the table for particular parameters in particular layers denotes that no HELP model input was required for that parameter in that layer. No data are missing from the table.

\* The HELP model output often produces an increased number of significant digits for the Effective Saturated Hydraulic Conductivity over that of the actual input

```

*****
*****
**
**
**          HYDROLOGIC EVALUATION OF LANDFILL PERFORMANCE          **
**          HELP MODEL VERSION 3.07  (1 NOVEMBER 1997)             **
**          DEVELOPED BY ENVIRONMENTAL LABORATORY                   **
**          USAE WATERWAYS EXPERIMENT STATION                       **
**          FOR USEPA RISK REDUCTION ENGINEERING LABORATORY        **
**
**
*****
*****

```

```

PRECIPITATION DATA FILE:   D:\HELP3\Hweather\ZPREC.D4
TEMPERATURE DATA FILE:    D:\HELP3\Hweather\ZTEMP.D7
SOLAR RADIATION DATA FILE: D:\HELP3\Hweather\ZSOLAR.D13
EVAPOTRANSPIRATION DATA:  D:\HELP3\Hweather\ZEVAP.D11
SOIL AND DESIGN DATA FILE: D:\HELP3\Hsdfmse\ZLBSW.D10
OUTPUT DATA FILE:         D:\HELP3\Hsdfmse\ZLBSWout.OUT

```

TIME: 13:28      DATE: 1/14/2004

```

*****
TITLE:  LBS Degraded MSE Vault Closure Cap - 280,000 years
*****

```

NOTE: INITIAL MOISTURE CONTENT OF THE LAYERS AND SNOW WATER WERE SPECIFIED BY THE USER.

LAYER 1  
-----

```

TYPE 1 - VERTICAL PERCOLATION LAYER
MATERIAL TEXTURE NUMBER 0
THICKNESS                = 12.00 INCHES
POROSITY                  = 0.0600 VOL/VOL
FIELD CAPACITY            = 0.0560 VOL/VOL
WILTING POINT            = 0.0520 VOL/VOL
INITIAL SOIL WATER CONTENT = 0.0560 VOL/VOL
EFFECTIVE SAT. HYD. COND. = 0.396999996000E-03 CM/SEC

```

LAYER 2  
-----

```

TYPE 1 - VERTICAL PERCOLATION LAYER
MATERIAL TEXTURE NUMBER 0
THICKNESS                = 12.00 INCHES
POROSITY                  = 0.3750 VOL/VOL
FIELD CAPACITY            = 0.1600 VOL/VOL
WILTING POINT            = 0.0745 VOL/VOL
INITIAL SOIL WATER CONTENT = 0.1600 VOL/VOL
EFFECTIVE SAT. HYD. COND. = 0.319999992000E-02 CM/SEC

```

## LAYER 3

-----

## TYPE 2 - LATERAL DRAINAGE LAYER

MATERIAL TEXTURE NUMBER 0

THICKNESS	=	12.00	INCHES
POROSITY	=	0.3750	VOL/VOL
FIELD CAPACITY	=	0.1600	VOL/VOL
WILTING POINT	=	0.0745	VOL/VOL
INITIAL SOIL WATER CONTENT	=	0.1600	VOL/VOL
EFFECTIVE SAT. HYD. COND.	=	0.319999992000E-02	CM/SEC
SLOPE	=	3.00	PERCENT
DRAINAGE LENGTH	=	450.0	FEET

## LAYER 4

-----

## TYPE 3 - BARRIER SOIL LINER

MATERIAL TEXTURE NUMBER 0

THICKNESS	=	0.20	INCHES
POROSITY	=	0.7500	VOL/VOL
FIELD CAPACITY	=	0.7470	VOL/VOL
WILTING POINT	=	0.4000	VOL/VOL
INITIAL SOIL WATER CONTENT	=	0.7500	VOL/VOL
EFFECTIVE SAT. HYD. COND.	=	0.499999997000E-08	CM/SEC

## LAYER 5

-----

## TYPE 1 - VERTICAL PERCOLATION LAYER

MATERIAL TEXTURE NUMBER 0

THICKNESS	=	58.57	INCHES
POROSITY	=	0.3700	VOL/VOL
FIELD CAPACITY	=	0.2400	VOL/VOL
WILTING POINT	=	0.1360	VOL/VOL
INITIAL SOIL WATER CONTENT	=	0.2400	VOL/VOL
EFFECTIVE SAT. HYD. COND.	=	0.999999975000E-04	CM/SEC

## LAYER 6

-----

## TYPE 2 - LATERAL DRAINAGE LAYER

MATERIAL TEXTURE NUMBER 0

THICKNESS	=	24.00	INCHES
POROSITY	=	0.3700	VOL/VOL
FIELD CAPACITY	=	0.2400	VOL/VOL
WILTING POINT	=	0.1360	VOL/VOL
INITIAL SOIL WATER CONTENT	=	0.2400	VOL/VOL
EFFECTIVE SAT. HYD. COND.	=	0.999999975000E-04	CM/SEC
SLOPE	=	11.40	PERCENT
DRAINAGE LENGTH	=	150.0	FEET

LAYER 7

-----

TYPE 3 - BARRIER SOIL LINER

MATERIAL TEXTURE NUMBER 0

THICKNESS = 0.20 INCHES  
 POROSITY = 0.7500 VOL/VOL  
 FIELD CAPACITY = 0.7470 VOL/VOL  
 WILTING POINT = 0.4000 VOL/VOL  
 INITIAL SOIL WATER CONTENT = 0.7500 VOL/VOL  
 EFFECTIVE SAT. HYD. COND. = 0.499999997000E-08 CM/SEC

GENERAL DESIGN AND EVAPORATIVE ZONE DATA

-----

NOTE: SCS RUNOFF CURVE NUMBER WAS COMPUTED FROM DEFAULT SOIL DATA BASE USING SOIL TEXTURE # 8 WITH A GOOD STAND OF GRASS, A SURFACE SLOPE OF 3.% AND A SLOPE LENGTH OF 450. FEET.

SCS RUNOFF CURVE NUMBER = 71.90  
 FRACTION OF AREA ALLOWING RUNOFF = 100.0 PERCENT  
 AREA PROJECTED ON HORIZONTAL PLANE = 19.630 ACRES  
 EVAPORATIVE ZONE DEPTH = 22.0 INCHES  
 INITIAL WATER IN EVAPORATIVE ZONE = 2.272 INCHES  
 UPPER LIMIT OF EVAPORATIVE STORAGE = 4.470 INCHES  
 LOWER LIMIT OF EVAPORATIVE STORAGE = 1.369 INCHES  
 INITIAL SNOW WATER = 0.000 INCHES  
 INITIAL WATER IN LAYER MATERIALS = 24.629 INCHES  
 TOTAL INITIAL WATER = 24.629 INCHES  
 TOTAL SUBSURFACE INFLOW = 0.00 INCHES/YEAR

EVAPOTRANSPIRATION AND WEATHER DATA

-----

NOTE: EVAPOTRANSPIRATION DATA WAS OBTAINED FROM AUGUSTA GEORGIA

STATION LATITUDE = 33.22 DEGREES  
 MAXIMUM LEAF AREA INDEX = 3.50  
 START OF GROWING SEASON (JULIAN DATE) = 68  
 END OF GROWING SEASON (JULIAN DATE) = 323  
 EVAPORATIVE ZONE DEPTH = 22.0 INCHES  
 AVERAGE ANNUAL WIND SPEED = 6.50 MPH  
 AVERAGE 1ST QUARTER RELATIVE HUMIDITY = 68.00 %  
 AVERAGE 2ND QUARTER RELATIVE HUMIDITY = 70.00 %  
 AVERAGE 3RD QUARTER RELATIVE HUMIDITY = 77.00 %  
 AVERAGE 4TH QUARTER RELATIVE HUMIDITY = 73.00 %

NOTE: PRECIPITATION DATA WAS SYNTHETICALLY GENERATED USING COEFFICIENTS FOR AUGUSTA GEORGIA

NORMAL MEAN MONTHLY PRECIPITATION (INCHES)

JAN/JUL	FEB/AUG	MAR/SEP	APR/OCT	MAY/NOV	JUN/DEC
4.38	3.95	4.68	2.91	3.56	4.99
5.43	5.41	3.93	3.12	2.96	3.45

NOTE: TEMPERATURE DATA WAS SYNTHETICALLY GENERATED USING  
COEFFICIENTS FOR AUGUSTA GEORGIA

NORMAL MEAN MONTHLY TEMPERATURE (DEGREES FAHRENHEIT)

JAN/JUL	FEB/AUG	MAR/SEP	APR/OCT	MAY/NOV	JUN/DEC
46.30	50.00	57.20	64.30	72.10	78.40
81.60	80.30	75.20	65.10	56.70	48.80

NOTE: SOLAR RADIATION DATA WAS SYNTHETICALLY GENERATED USING  
COEFFICIENTS FOR AUGUSTA GEORGIA  
AND STATION LATITUDE = 33.30 DEGREES

\*\*\*\*\*

AVERAGE MONTHLY VALUES IN INCHES FOR YEARS 1 THROUGH 100

	JAN/JUL	FEB/AUG	MAR/SEP	APR/OCT	MAY/NOV	JUN/DEC
PRECIPITATION						
TOTALS	4.56	3.57	4.76	2.74	3.60	4.97
	5.81	5.32	4.41	2.99	2.75	3.41
STD. DEVIATIONS	2.44	1.60	2.47	1.31	2.12	2.60
	2.83	2.95	2.54	2.28	1.72	1.90
RUNOFF						
TOTALS	1.271	0.651	0.859	0.092	0.088	0.115
	0.332	0.448	0.379	0.333	0.327	0.642
STD. DEVIATIONS	1.853	1.145	1.473	0.347	0.334	0.375
	0.741	1.125	0.876	0.960	0.796	1.031
EVAPOTRANSPIRATION						
TOTALS	1.646	2.122	3.124	3.058	3.012	3.768
	4.391	3.990	3.059	1.547	1.034	1.250
STD. DEVIATIONS	0.191	0.241	0.614	0.993	1.377	1.435
	1.525	1.348	1.080	0.666	0.260	0.177

LATERAL DRAINAGE COLLECTED FROM LAYER 3

TOTALS	0.6991	0.6346	0.6647	0.5171	0.4397	0.4194
	0.4874	0.5084	0.5031	0.5194	0.5410	0.6269
STD. DEVIATIONS	0.1663	0.1449	0.1421	0.1106	0.1009	0.1127
	0.1358	0.1254	0.1281	0.1659	0.1843	0.2031

PERCOLATION/LEAKAGE THROUGH LAYER 4

TOTALS	0.5148	0.4622	0.4830	0.3704	0.3155	0.3012
	0.3510	0.3655	0.3628	0.3749	0.3912	0.4587
STD. DEVIATIONS	0.1322	0.1114	0.1101	0.0799	0.0725	0.0809
	0.0994	0.0917	0.0948	0.1232	0.1365	0.1542

LATERAL DRAINAGE COLLECTED FROM LAYER 6

TOTALS	0.1217	0.1148	0.1332	0.1371	0.1486	0.1425
	0.1407	0.1333	0.1222	0.1227	0.1169	0.1215
STD. DEVIATIONS	0.0241	0.0260	0.0342	0.0337	0.0335	0.0268
	0.0222	0.0197	0.0177	0.0169	0.0166	0.0183

PERCOLATION/LEAKAGE THROUGH LAYER 7

TOTALS	0.2485	0.2344	0.2716	0.2791	0.3024	0.2900
	0.2866	0.2717	0.2495	0.2506	0.2389	0.2481
STD. DEVIATIONS	0.0484	0.0520	0.0683	0.0674	0.0670	0.0536
	0.0444	0.0393	0.0353	0.0338	0.0331	0.0366

AVERAGES OF MONTHLY AVERAGED DAILY HEADS (INCHES)

DAILY AVERAGE HEAD ON TOP OF LAYER 4

AVERAGES	19.3304	19.0270	18.1211	14.3182	11.7689	11.6082
	13.1135	13.6633	14.0202	14.0219	15.1354	17.2001
STD. DEVIATIONS	5.0087	4.5875	4.1763	3.1330	2.7496	3.1696
	3.7718	3.4770	3.7177	4.6718	5.3506	5.8492

DAILY AVERAGE HEAD ON TOP OF LAYER 7

AVERAGES	9.2267	9.5590	10.1047	10.7419	11.2712	11.1683
	10.6730	10.1073	9.5791	9.3045	9.1634	9.2125
STD. DEVIATIONS	1.8269	2.1831	2.5920	2.6422	2.5414	2.1011
	1.6843	1.4907	1.3838	1.2808	1.2976	1.3878

\*\*\*\*\*

\*\*\*\*\*

AVERAGE ANNUAL TOTALS & (STD. DEVIATIONS) FOR YEARS 1 THROUGH 100				
	INCHES		CU. FEET	PERCENT
PRECIPITATION	48.90	( 7.734)	3484469.2	100.00
RUNOFF	5.536	( 4.2083)	394483.44	11.321
EVAPOTRANSPIRATION	32.000	( 3.5431)	2280228.75	65.440
LATERAL DRAINAGE COLLECTED FROM LAYER 3	6.56065	( 0.86511)	467491.531	13.41643
PERCOLATION/LEAKAGE THROUGH LAYER 4	4.75118	( 0.64628)	338554.094	9.71609
AVERAGE HEAD ON TOP OF LAYER 4	15.111	( 2.076)		
LATERAL DRAINAGE COLLECTED FROM LAYER 6	1.55519	( 0.24069)	110818.258	3.18035
PERCOLATION/LEAKAGE THROUGH LAYER 7	3.17143	( 0.48148)	225985.906	6.48552
AVERAGE HEAD ON TOP OF LAYER 7	10.009	( 1.552)		
CHANGE IN WATER STORAGE	0.077	( 2.2223)	5460.91	0.157

\*\*\*\*\*

\*\*\*\*\*

PEAK DAILY VALUES FOR YEARS		1 THROUGH	100
		(INCHES)	(CU. FT.)
PRECIPITATION		6.87	489534.875
RUNOFF		5.358	381824.9370
DRAINAGE COLLECTED FROM LAYER	3	0.03085	2197.92114
PERCOLATION/LEAKAGE THROUGH LAYER	4	0.030784	2193.54272
AVERAGE HEAD ON TOP OF LAYER	4	36.000	
MAXIMUM HEAD ON TOP OF LAYER	4	47.656	
LOCATION OF MAXIMUM HEAD IN LAYER	3	152.3 FEET	
(DISTANCE FROM DRAIN)			
DRAINAGE COLLECTED FROM LAYER	6	0.00656	467.62650
PERCOLATION/LEAKAGE THROUGH LAYER	7	0.013291	947.06079
AVERAGE HEAD ON TOP OF LAYER	7	15.429	
MAXIMUM HEAD ON TOP OF LAYER	7	24.531	
LOCATION OF MAXIMUM HEAD IN LAYER	6	29.2 FEET	
(DISTANCE FROM DRAIN)			
SNOW WATER		2.36	168188.7190
MAXIMUM VEG. SOIL WATER (VOL/VOL)			0.2032
MINIMUM VEG. SOIL WATER (VOL/VOL)			0.0622

\*\*\* Maximum heads are computed using McEnroe's equations. \*\*\*

Reference: Maximum Saturated Depth over Landfill Liner  
 by Bruce M. McEnroe, University of Kansas  
 ASCE Journal of Environmental Engineering  
 Vol. 119, No. 2, March 1993, pp. 262-270.

\*\*\*\*\*



\*\*\*\*\*

FINAL WATER STORAGE AT END OF YEAR 100

LAYER	( INCHES )	( VOL/VOL )
1	0.9491	0.0791
2	4.2708	0.3559
3	4.5000	0.3750
4	0.1500	0.7500
5	14.9780	0.2557
6	7.2945	0.3039
7	0.1500	0.7500
SNOW WATER	0.000	

\*\*\*\*\*  
\*\*\*\*\*

Appendix G, Lower Bounding Scenario Degraded SDF MSE Vault Closure Cap (100 Years): HELP Model Input Data and Output File (output file name: ZLBS1out.OUT)

Input Data:

Input Parameter (HELP Model Query)		Generic Input Parameter Value					
Landfill area =		19.63 acres					
Percent of area where runoff is possible =		100%					
Do you want to specify initial moisture storage? (Y/N)		Y					
Amount of water or snow on surface =		0 inches					
CN Input Parameter (HELP Model Query)		CN Input Parameter Value					
Slope =		3 %					
Slope length =		450 ft					
Soil Texture =		5 (HELP model default soil texture)					
Vegetation =		4 (i.e., a good stand of grass)					
HELP Model Computed Curve Number = 54.4							
Layer		Layer Number		Layer Type			
Topsoil		1		1 (vertical percolation layer)			
Upper Backfill		2		1 (vertical percolation layer)			
Erosion Barrier		3		1 (vertical percolation layer)			
Middle Backfill		4		1 (vertical percolation layer)			
Upper Drainage Layer		5		2 (lateral drainage layer)			
Upper GCL		6		3 (barrier soil liner)			
Lower Backfill		7		1 (vertical percolation layer)			
Lower Drainage Layer		8		2 (lateral drainage layer)			
Lower GCL		9		3 (barrier soil liner)			
	Layer Type	Layer Thickness (in)	Soil Texture No.	Total Porosity (Vol/Vol)	Field Capacity (Vol/Vol)	Wilting Point (Vol/Vol)	Initial Moisture (Vol/Vol)
1	1	5.980		0.4	0.11	0.058	0.11
2	1	30		0.37	0.24	0.136	0.24
3	1	12		0.06	0.056	0.052	0.056
4	1	12		0.37	0.236	0.133	0.236
5	2	12		0.38	0.084	0.016	0.084
6	3	0.2		0.75	0.747	0.40	0.75
7	1	58.57		0.37	0.24	0.136	0.24
8	2	24		0.38	0.08	0.013	0.08
9	3	0.2		0.75	0.747	0.40	0.75

The lack of values in the table for particular parameters in particular layers denotes that no HELP model input was required for that parameter in that layer. No data are missing from the table.

## Input Data (continued):

	Layer Type	Sat. Hyd. Conductivity * (cm/sec)	Drainage Length (ft)	Drain Slope (%)	Leachate Recirc. (%)	Recirc. to Layer (#)	Subsurface Inflow (in/yr)
1	1	1.00E-03					
2	1	1.00E-04					
3	1	3.97E-04					
4	1	1.20E-04					
5	2	8.60E-02	450	3			
6	3	5.00E-09					
7	1	1.00E-04					
8	2	1.00E-01	150	11.4			
9	3	5.00E-09					
	Layer Type	Geomembrane Pinhole Density (#/acre)	Geomembrane Instal. Defects (#/acre)	Geomembrane Placement Quality	Geotextile Transmissivity (cm <sup>2</sup> /sec)		
1	1						
2	1						
3	1						
4	1						
5	2						
6	3						
7	1						
8	2						
9	3						

The lack of values in the table for particular parameters in particular layers denotes that no HELP model input was required for that parameter in that layer. No data are missing from the table.

\* The HELP model output often produces an increased number of significant digits for the Effective Saturated Hydraulic Conductivity over that of the actual input

```

*****
*****
**
**
**          HYDROLOGIC EVALUATION OF LANDFILL PERFORMANCE          **
**          HELP MODEL VERSION 3.07 (1 NOVEMBER 1997)              **
**          DEVELOPED BY ENVIRONMENTAL LABORATORY                  **
**          USAE WATERWAYS EXPERIMENT STATION                    **
**          FOR USEPA RISK REDUCTION ENGINEERING LABORATORY      **
**
**
*****
*****

```

```

PRECIPITATION DATA FILE:  D:\HELP3\Hweather\ZPREC.D4
TEMPERATURE DATA FILE:   D:\HELP3\Hweather\ZTEMP.D7
SOLAR RADIATION DATA FILE: D:\HELP3\Hweather\ZSOLAR.D13
EVAPOTRANSPIRATION DATA: D:\HELP3\Hweather\ZEVAP.D11
SOIL AND DESIGN DATA FILE: D:\HELP3\Hsdfmse\ZLBS1.D10
OUTPUT DATA FILE:        D:\HELP3\Hsdfmse\ZLBS1out.OUT

```

TIME: 9:10 DATE: 12/11/2003

```

*****
TITLE:  LBS Degraded MSE Vault Closure Cap - 100 Years
*****

```

NOTE: INITIAL MOISTURE CONTENT OF THE LAYERS AND SNOW WATER WERE SPECIFIED BY THE USER.

LAYER 1  
-----

```

          TYPE 1 - VERTICAL PERCOLATION LAYER
          MATERIAL TEXTURE NUMBER 0
THICKNESS           = 5.98 INCHES
POROSITY            = 0.4000 VOL/VOL
FIELD CAPACITY     = 0.1100 VOL/VOL
WILTING POINT      = 0.0580 VOL/VOL
INITIAL SOIL WATER CONTENT = 0.1100 VOL/VOL
EFFECTIVE SAT. HYD. COND. = 0.100000005000E-02 CM/SEC

```

LAYER 2  
-----

```

          TYPE 1 - VERTICAL PERCOLATION LAYER
          MATERIAL TEXTURE NUMBER 0
THICKNESS           = 30.00 INCHES
POROSITY            = 0.3700 VOL/VOL
FIELD CAPACITY     = 0.2400 VOL/VOL
WILTING POINT      = 0.1360 VOL/VOL
INITIAL SOIL WATER CONTENT = 0.2400 VOL/VOL
EFFECTIVE SAT. HYD. COND. = 0.999999975000E-04 CM/SEC

```

LAYER 3

-----

TYPE 1 - VERTICAL PERCOLATION LAYER

MATERIAL TEXTURE NUMBER 0

THICKNESS = 12.00 INCHES  
 POROSITY = 0.0600 VOL/VOL  
 FIELD CAPACITY = 0.0560 VOL/VOL  
 WILTING POINT = 0.0520 VOL/VOL  
 INITIAL SOIL WATER CONTENT = 0.0560 VOL/VOL  
 EFFECTIVE SAT. HYD. COND. = 0.396999996000E-03 CM/SEC

LAYER 4

-----

TYPE 1 - VERTICAL PERCOLATION LAYER

MATERIAL TEXTURE NUMBER 0

THICKNESS = 12.00 INCHES  
 POROSITY = 0.3700 VOL/VOL  
 FIELD CAPACITY = 0.2360 VOL/VOL  
 WILTING POINT = 0.1330 VOL/VOL  
 INITIAL SOIL WATER CONTENT = 0.2360 VOL/VOL  
 EFFECTIVE SAT. HYD. COND. = 0.119999997000E-03 CM/SEC

LAYER 5

-----

TYPE 2 - LATERAL DRAINAGE LAYER

MATERIAL TEXTURE NUMBER 0

THICKNESS = 12.00 INCHES  
 POROSITY = 0.3800 VOL/VOL  
 FIELD CAPACITY = 0.0840 VOL/VOL  
 WILTING POINT = 0.0160 VOL/VOL  
 INITIAL SOIL WATER CONTENT = 0.0840 VOL/VOL  
 EFFECTIVE SAT. HYD. COND. = 0.860000029000E-01 CM/SEC  
 SLOPE = 3.00 PERCENT  
 DRAINAGE LENGTH = 450.0 FEET

LAYER 6

-----

TYPE 3 - BARRIER SOIL LINER

MATERIAL TEXTURE NUMBER 0

THICKNESS = 0.20 INCHES  
 POROSITY = 0.7500 VOL/VOL  
 FIELD CAPACITY = 0.7470 VOL/VOL  
 WILTING POINT = 0.4000 VOL/VOL  
 INITIAL SOIL WATER CONTENT = 0.7500 VOL/VOL  
 EFFECTIVE SAT. HYD. COND. = 0.499999997000E-08 CM/SEC

LAYER 7

-----

TYPE 1 - VERTICAL PERCOLATION LAYER

MATERIAL TEXTURE NUMBER 0

THICKNESS = 58.57 INCHES  
 POROSITY = 0.3700 VOL/VOL  
 FIELD CAPACITY = 0.2400 VOL/VOL  
 WILTING POINT = 0.1360 VOL/VOL  
 INITIAL SOIL WATER CONTENT = 0.2400 VOL/VOL  
 EFFECTIVE SAT. HYD. COND. = 0.999999975000E-04 CM/SEC

LAYER 8

-----

TYPE 2 - LATERAL DRAINAGE LAYER

MATERIAL TEXTURE NUMBER 0

THICKNESS = 24.00 INCHES  
 POROSITY = 0.3800 VOL/VOL  
 FIELD CAPACITY = 0.0800 VOL/VOL  
 WILTING POINT = 0.0130 VOL/VOL  
 INITIAL SOIL WATER CONTENT = 0.0800 VOL/VOL  
 EFFECTIVE SAT. HYD. COND. = 0.100000001000 CM/SEC  
 SLOPE = 11.40 PERCENT  
 DRAINAGE LENGTH = 150.0 FEET

LAYER 9

-----

TYPE 3 - BARRIER SOIL LINER

MATERIAL TEXTURE NUMBER 0

THICKNESS = 0.20 INCHES  
 POROSITY = 0.7500 VOL/VOL  
 FIELD CAPACITY = 0.7470 VOL/VOL  
 WILTING POINT = 0.4000 VOL/VOL  
 INITIAL SOIL WATER CONTENT = 0.7500 VOL/VOL  
 EFFECTIVE SAT. HYD. COND. = 0.499999997000E-08 CM/SEC

GENERAL DESIGN AND EVAPORATIVE ZONE DATA

-----

NOTE: SCS RUNOFF CURVE NUMBER WAS COMPUTED FROM DEFAULT SOIL DATA BASE USING SOIL TEXTURE # 5 WITH A GOOD STAND OF GRASS, A SURFACE SLOPE OF 3.% AND A SLOPE LENGTH OF 450. FEET.

SCS RUNOFF CURVE NUMBER = 54.40  
 FRACTION OF AREA ALLOWING RUNOFF = 100.0 PERCENT  
 AREA PROJECTED ON HORIZONTAL PLANE = 19.630 ACRES  
 EVAPORATIVE ZONE DEPTH = 22.0 INCHES  
 INITIAL WATER IN EVAPORATIVE ZONE = 4.503 INCHES  
 UPPER LIMIT OF EVAPORATIVE STORAGE = 8.319 INCHES  
 LOWER LIMIT OF EVAPORATIVE STORAGE = 2.526 INCHES  
 INITIAL SNOW WATER = 0.000 INCHES  
 INITIAL WATER IN LAYER MATERIALS = 28.647 INCHES  
 TOTAL INITIAL WATER = 28.647 INCHES  
 TOTAL SUBSURFACE INFLOW = 0.00 INCHES/YEAR

EVAPOTRANSPIRATION AND WEATHER DATA

NOTE: EVAPOTRANSPIRATION DATA WAS OBTAINED FROM  
AUGUSTA GEORGIA

STATION LATITUDE = 33.22 DEGREES  
 MAXIMUM LEAF AREA INDEX = 3.50  
 START OF GROWING SEASON (JULIAN DATE) = 68  
 END OF GROWING SEASON (JULIAN DATE) = 323  
 EVAPORATIVE ZONE DEPTH = 22.0 INCHES  
 AVERAGE ANNUAL WIND SPEED = 6.50 MPH  
 AVERAGE 1ST QUARTER RELATIVE HUMIDITY = 68.00 %  
 AVERAGE 2ND QUARTER RELATIVE HUMIDITY = 70.00 %  
 AVERAGE 3RD QUARTER RELATIVE HUMIDITY = 77.00 %  
 AVERAGE 4TH QUARTER RELATIVE HUMIDITY = 73.00 %

NOTE: PRECIPITATION DATA WAS SYNTHETICALLY GENERATED USING  
COEFFICIENTS FOR AUGUSTA GEORGIA

NORMAL MEAN MONTHLY PRECIPITATION (INCHES)

JAN/JUL	FEB/AUG	MAR/SEP	APR/OCT	MAY/NOV	JUN/DEC
4.38	3.95	4.68	2.91	3.56	4.99
5.43	5.41	3.93	3.12	2.96	3.45

NOTE: TEMPERATURE DATA WAS SYNTHETICALLY GENERATED USING  
COEFFICIENTS FOR AUGUSTA GEORGIA

NORMAL MEAN MONTHLY TEMPERATURE (DEGREES FAHRENHEIT)

JAN/JUL	FEB/AUG	MAR/SEP	APR/OCT	MAY/NOV	JUN/DEC
46.30	50.00	57.20	64.30	72.10	78.40
81.60	80.30	75.20	65.10	56.70	48.80

NOTE: SOLAR RADIATION DATA WAS SYNTHETICALLY GENERATED USING  
COEFFICIENTS FOR AUGUSTA GEORGIA  
AND STATION LATITUDE = 33.30 DEGREES

\*\*\*\*\*

AVERAGE MONTHLY VALUES IN INCHES FOR YEARS 1 THROUGH 100

	JAN/JUL	FEB/AUG	MAR/SEP	APR/OCT	MAY/NOV	JUN/DEC
PRECIPITATION						
TOTALS	4.56	3.57	4.76	2.74	3.60	4.97
	5.81	5.32	4.41	2.99	2.75	3.41
STD. DEVIATIONS	2.44	1.60	2.47	1.31	2.12	2.60
	2.83	2.95	2.54	2.28	1.72	1.90

## RUNOFF

-----

TOTALS	0.004	0.000	0.004	0.000	0.000	0.002
	0.027	0.091	0.016	0.006	0.002	0.001
STD. DEVIATIONS	0.020	0.000	0.027	0.000	0.002	0.015
	0.093	0.404	0.086	0.058	0.015	0.004

## EVAPOTRANSPIRATION

-----

TOTALS	1.577	2.093	3.072	3.553	3.657	4.141
	4.898	4.520	3.385	1.619	0.948	1.115
STD. DEVIATIONS	0.221	0.236	0.582	0.761	1.521	1.545
	1.589	1.377	1.040	0.606	0.207	0.205

## LATERAL DRAINAGE COLLECTED FROM LAYER 5

-----

TOTALS	2.4637	2.0770	1.9305	1.2378	0.4334	0.3122
	0.5454	0.8086	0.7465	0.7762	0.8953	1.4750
STD. DEVIATIONS	1.7880	1.5043	1.4526	1.0508	0.4452	0.5705
	0.7811	1.0159	1.0054	1.0565	1.1950	1.2982

## PERCOLATION/LEAKAGE THROUGH LAYER 6

-----

TOTALS	0.0705	0.0597	0.0558	0.0377	0.0163	0.0121
	0.0180	0.0252	0.0237	0.0243	0.0271	0.0429
STD. DEVIATIONS	0.0501	0.0418	0.0382	0.0287	0.0120	0.0156
	0.0214	0.0275	0.0276	0.0289	0.0323	0.0351

## LATERAL DRAINAGE COLLECTED FROM LAYER 8

-----

TOTALS	0.0570	0.0532	0.0544	0.0394	0.0137	0.0081
	0.0140	0.0206	0.0187	0.0201	0.0235	0.0377
STD. DEVIATIONS	0.0354	0.0340	0.0407	0.0385	0.0217	0.0149
	0.0199	0.0253	0.0244	0.0260	0.0305	0.0319

## PERCOLATION/LEAKAGE THROUGH LAYER 9

-----

TOTALS	0.0051	0.0049	0.0054	0.0051	0.0050	0.0039
	0.0037	0.0041	0.0040	0.0039	0.0037	0.0043
STD. DEVIATIONS	0.0009	0.0002	0.0003	0.0005	0.0009	0.0017
	0.0020	0.0020	0.0019	0.0020	0.0021	0.0019



-----  
 AVERAGES OF MONTHLY AVERAGED DAILY HEADS (INCHES)  
 -----

DAILY AVERAGE HEAD ON TOP OF LAYER 6						
AVERAGES	2.4840	2.2841	1.9194	1.2805	0.4305	0.3204
	0.5418	0.8032	0.7723	0.7744	0.9190	1.4652
STD. DEVIATIONS	1.8885	1.7392	1.4460	1.1237	0.4423	0.5856
	0.7759	1.0092	1.0497	1.0610	1.2266	1.2896
DAILY AVERAGE HEAD ON TOP OF LAYER 9						
AVERAGES	0.0043	0.0044	0.0041	0.0031	0.0010	0.0006
	0.0011	0.0016	0.0015	0.0015	0.0018	0.0029
STD. DEVIATIONS	0.0027	0.0028	0.0031	0.0030	0.0016	0.0012
	0.0015	0.0019	0.0019	0.0020	0.0024	0.0024
*****						
*****						
AVERAGE ANNUAL TOTALS & (STD. DEVIATIONS) FOR YEARS 1 THROUGH 100						
-----						
	INCHES		CU. FEET		PERCENT	
PRECIPITATION	48.90	( 7.734)	3484469.2	100.00		
RUNOFF	0.154	( 0.4339)	10950.01	0.314		
EVAPOTRANSPIRATION	34.578	( 3.6236)	2463907.00	70.711		
LATERAL DRAINAGE COLLECTED FROM LAYER 5	13.70162	( 5.47438)	976335.062	28.01962		
PERCOLATION/LEAKAGE THROUGH LAYER 6	0.41335	( 0.15024)	29453.703	0.84529		
AVERAGE HEAD ON TOP OF LAYER 6	1.166	( 0.472)				
LATERAL DRAINAGE COLLECTED FROM LAYER 8	0.36024	( 0.14546)	25669.234	0.73668		
PERCOLATION/LEAKAGE THROUGH LAYER 9	0.05310	( 0.00792)	3783.417	0.10858		
AVERAGE HEAD ON TOP OF LAYER 9	0.002	( 0.001)				
CHANGE IN WATER STORAGE	0.054	( 1.9521)	3824.79	0.110		
*****						

\*\*\*\*\*

PEAK DAILY VALUES FOR YEARS	1 THROUGH 100	
	(INCHES)	(CU. FT.)
PRECIPITATION	6.87	489534.875
RUNOFF	2.648	188654.3750
DRAINAGE COLLECTED FROM LAYER 5	0.39526	28164.91210
PERCOLATION/LEAKAGE THROUGH LAYER 6	0.032853	2341.00708
AVERAGE HEAD ON TOP OF LAYER 6	38.433	
MAXIMUM HEAD ON TOP OF LAYER 6	50.445	
LOCATION OF MAXIMUM HEAD IN LAYER 5 (DISTANCE FROM DRAIN)	156.8 FEET	
DRAINAGE COLLECTED FROM LAYER 8	0.01464	1042.84534
PERCOLATION/LEAKAGE THROUGH LAYER 9	0.000199	14.20408
AVERAGE HEAD ON TOP OF LAYER 9	0.034	
MAXIMUM HEAD ON TOP OF LAYER 9	0.071	
LOCATION OF MAXIMUM HEAD IN LAYER 8 (DISTANCE FROM DRAIN)	0.0 FEET	
SNOW WATER	2.36	168188.7190
MAXIMUM VEG. SOIL WATER (VOL/VOL)		0.3691
MINIMUM VEG. SOIL WATER (VOL/VOL)		0.1148

\*\*\* Maximum heads are computed using McEnroe's equations. \*\*\*

Reference: Maximum Saturated Depth over Landfill Liner  
by Bruce M. McEnroe, University of Kansas  
ASCE Journal of Environmental Engineering  
Vol. 119, No. 2, March 1993, pp. 262-270.

\*\*\*\*\*

\*\*\*\*\*

FINAL WATER STORAGE AT END OF YEAR 100

---

LAYER	( INCHES )	( VOL/VOL )
1	1.6080	0.2689
2	8.9916	0.2997
3	0.7200	0.0600
4	4.2406	0.3534
5	2.1757	0.1813
6	0.1500	0.7500
7	14.0568	0.2400
8	1.9215	0.0801
9	0.1500	0.7500
SNOW WATER	0.000	

\*\*\*\*\*  
\*\*\*\*\*

Appendix H, Lower Bounding Scenario Degraded SDF MSE Vault Closure Cap (300 Years): HELP Model Input Data and Output File (output file name: ZLBS2out.OUT)

Input Data:

Input Parameter (HELP Model Query)		Generic Input Parameter Value					
Landfill area =		19.63 acres					
Percent of area where runoff is possible =		100%					
Do you want to specify initial moisture storage? (Y/N)		Y					
Amount of water or snow on surface =		0 inches					
CN Input Parameter (HELP Model Query)		CN Input Parameter Value					
Slope =		3 %					
Slope length =		450 ft					
Soil Texture =		5 (HELP model default soil texture)					
Vegetation =		4 (i.e., a good stand of grass)					
HELP Model Computed Curve Number = 54.4							
Layer		Layer Number		Layer Type			
Topsoil		1		1 (vertical percolation layer)			
Upper Backfill		2		1 (vertical percolation layer)			
Erosion Barrier		3		1 (vertical percolation layer)			
Middle Backfill		4		1 (vertical percolation layer)			
Upper Drainage Layer		5		2 (lateral drainage layer)			
Upper GCL		6		3 (barrier soil liner)			
Lower Backfill		7		1 (vertical percolation layer)			
Lower Drainage Layer		8		2 (lateral drainage layer)			
Lower GCL		9		3 (barrier soil liner)			
	Layer Type	Layer Thickness (in)	Soil Texture No.	Total Porosity (Vol/Vol)	Field Capacity (Vol/Vol)	Wilting Point (Vol/Vol)	Initial Moisture (Vol/Vol)
1	1	5.940		0.4	0.11	0.058	0.11
2	1	30		0.37	0.24	0.136	0.24
3	1	12		0.06	0.056	0.052	0.056
4	1	12		0.371	0.229	0.128	0.229
5	2	12		0.379	0.089	0.021	0.089
6	3	0.2		0.75	0.747	0.40	0.75
7	1	58.57		0.37	0.24	0.136	0.24
8	2	24		0.38	0.0801	0.0132	0.0801
9	3	0.2		0.75	0.747	0.40	0.75

The lack of values in the table for particular parameters in particular layers denotes that no HELP model input was required for that parameter in that layer. No data are missing from the table.

## Input Data (continued):

	Layer Type	Sat. Hyd. Conductivity * (cm/sec)	Drainage Length (ft)	Drain Slope (%)	Leachate Recirc. (%)	Recirc. to Layer (#)	Subsurface Inflow (in/yr)
1	1	1.00E-03					
2	1	1.00E-04					
3	1	3.97E-04					
4	1	1.60E-04					
5	2	6.30E-02	450	3			
6	3	5.00E-09					
7	1	1.00E-04					
8	2	9.99E-02	150	11.4			
9	3	5.00E-09					
	Layer Type	Geomembrane Pinhole Density (#/acre)	Geomembrane Instal. Defects (#/acre)	Geomembrane Placement Quality	Geotextile Transmissivity (cm <sup>2</sup> /sec)		
1	1						
2	1						
3	1						
4	1						
5	2						
6	3						
7	1						
8	2						
9	3						

The lack of values in the table for particular parameters in particular layers denotes that no HELP model input was required for that parameter in that layer. No data are missing from the table.

\* The HELP model output often produces an increased number of significant digits for the Effective Saturated Hydraulic Conductivity over that of the actual input



## LAYER 3

-----

## TYPE 1 - VERTICAL PERCOLATION LAYER

MATERIAL TEXTURE NUMBER 0

THICKNESS	=	12.00	INCHES
POROSITY	=	0.0600	VOL/VOL
FIELD CAPACITY	=	0.0560	VOL/VOL
WILTING POINT	=	0.0520	VOL/VOL
INITIAL SOIL WATER CONTENT	=	0.0560	VOL/VOL
EFFECTIVE SAT. HYD. COND.	=	0.396999996000E-03	CM/SEC

## LAYER 4

-----

## TYPE 1 - VERTICAL PERCOLATION LAYER

MATERIAL TEXTURE NUMBER 0

THICKNESS	=	12.00	INCHES
POROSITY	=	0.3710	VOL/VOL
FIELD CAPACITY	=	0.2290	VOL/VOL
WILTING POINT	=	0.1280	VOL/VOL
INITIAL SOIL WATER CONTENT	=	0.2290	VOL/VOL
EFFECTIVE SAT. HYD. COND.	=	0.159999996000E-03	CM/SEC

## LAYER 5

-----

## TYPE 2 - LATERAL DRAINAGE LAYER

MATERIAL TEXTURE NUMBER 0

THICKNESS	=	12.00	INCHES
POROSITY	=	0.3790	VOL/VOL
FIELD CAPACITY	=	0.0890	VOL/VOL
WILTING POINT	=	0.0210	VOL/VOL
INITIAL SOIL WATER CONTENT	=	0.0890	VOL/VOL
EFFECTIVE SAT. HYD. COND.	=	0.630000010000E-01	CM/SEC
SLOPE	=	3.00	PERCENT
DRAINAGE LENGTH	=	450.0	FEET

## LAYER 6

-----

## TYPE 3 - BARRIER SOIL LINER

MATERIAL TEXTURE NUMBER 0

THICKNESS	=	0.20	INCHES
POROSITY	=	0.7500	VOL/VOL
FIELD CAPACITY	=	0.7470	VOL/VOL
WILTING POINT	=	0.4000	VOL/VOL
INITIAL SOIL WATER CONTENT	=	0.7500	VOL/VOL
EFFECTIVE SAT. HYD. COND.	=	0.499999997000E-08	CM/SEC

LAYER 7

-----

TYPE 1 - VERTICAL PERCOLATION LAYER

MATERIAL TEXTURE NUMBER 0

THICKNESS = 58.57 INCHES  
 POROSITY = 0.3700 VOL/VOL  
 FIELD CAPACITY = 0.2400 VOL/VOL  
 WILTING POINT = 0.1360 VOL/VOL  
 INITIAL SOIL WATER CONTENT = 0.2400 VOL/VOL  
 EFFECTIVE SAT. HYD. COND. = 0.999999975000E-04 CM/SEC

LAYER 8

-----

TYPE 2 - LATERAL DRAINAGE LAYER

MATERIAL TEXTURE NUMBER 0

THICKNESS = 24.00 INCHES  
 POROSITY = 0.3800 VOL/VOL  
 FIELD CAPACITY = 0.0801 VOL/VOL  
 WILTING POINT = 0.0132 VOL/VOL  
 INITIAL SOIL WATER CONTENT = 0.0801 VOL/VOL  
 EFFECTIVE SAT. HYD. COND. = 0.998999998000E-01 CM/SEC  
 SLOPE = 11.40 PERCENT  
 DRAINAGE LENGTH = 150.0 FEET

LAYER 9

-----

TYPE 3 - BARRIER SOIL LINER

MATERIAL TEXTURE NUMBER 0

THICKNESS = 0.20 INCHES  
 POROSITY = 0.7500 VOL/VOL  
 FIELD CAPACITY = 0.7470 VOL/VOL  
 WILTING POINT = 0.4000 VOL/VOL  
 INITIAL SOIL WATER CONTENT = 0.7500 VOL/VOL  
 EFFECTIVE SAT. HYD. COND. = 0.499999997000E-08 CM/SEC

GENERAL DESIGN AND EVAPORATIVE ZONE DATA

-----

NOTE: SCS RUNOFF CURVE NUMBER WAS COMPUTED FROM DEFAULT SOIL DATA BASE USING SOIL TEXTURE # 5 WITH A GOOD STAND OF GRASS, A SURFACE SLOPE OF 3.% AND A SLOPE LENGTH OF 450. FEET.

SCS RUNOFF CURVE NUMBER = 54.40  
 FRACTION OF AREA ALLOWING RUNOFF = 100.0 PERCENT  
 AREA PROJECTED ON HORIZONTAL PLANE = 19.630 ACRES  
 EVAPORATIVE ZONE DEPTH = 22.0 INCHES  
 INITIAL WATER IN EVAPORATIVE ZONE = 4.508 INCHES  
 UPPER LIMIT OF EVAPORATIVE STORAGE = 8.318 INCHES  
 LOWER LIMIT OF EVAPORATIVE STORAGE = 2.529 INCHES  
 INITIAL SNOW WATER = 0.000 INCHES  
 INITIAL WATER IN LAYER MATERIALS = 28.621 INCHES  
 TOTAL INITIAL WATER = 28.621 INCHES  
 TOTAL SUBSURFACE INFLOW = 0.00 INCHES/YEAR



EVAPOTRANSPIRATION AND WEATHER DATA

NOTE: EVAPOTRANSPIRATION DATA WAS OBTAINED FROM  
AUGUSTA GEORGIA

STATION LATITUDE = 33.22 DEGREES  
 MAXIMUM LEAF AREA INDEX = 3.50  
 START OF GROWING SEASON (JULIAN DATE) = 68  
 END OF GROWING SEASON (JULIAN DATE) = 323  
 EVAPORATIVE ZONE DEPTH = 22.0 INCHES  
 AVERAGE ANNUAL WIND SPEED = 6.50 MPH  
 AVERAGE 1ST QUARTER RELATIVE HUMIDITY = 68.00 %  
 AVERAGE 2ND QUARTER RELATIVE HUMIDITY = 70.00 %  
 AVERAGE 3RD QUARTER RELATIVE HUMIDITY = 77.00 %  
 AVERAGE 4TH QUARTER RELATIVE HUMIDITY = 73.00 %

NOTE: PRECIPITATION DATA WAS SYNTHETICALLY GENERATED USING  
COEFFICIENTS FOR AUGUSTA GEORGIA

NORMAL MEAN MONTHLY PRECIPITATION (INCHES)

JAN/JUL	FEB/AUG	MAR/SEP	APR/OCT	MAY/NOV	JUN/DEC
4.38	3.95	4.68	2.91	3.56	4.99
5.43	5.41	3.93	3.12	2.96	3.45

NOTE: TEMPERATURE DATA WAS SYNTHETICALLY GENERATED USING  
COEFFICIENTS FOR AUGUSTA GEORGIA

NORMAL MEAN MONTHLY TEMPERATURE (DEGREES FAHRENHEIT)

JAN/JUL	FEB/AUG	MAR/SEP	APR/OCT	MAY/NOV	JUN/DEC
46.30	50.00	57.20	64.30	72.10	78.40
81.60	80.30	75.20	65.10	56.70	48.80

NOTE: SOLAR RADIATION DATA WAS SYNTHETICALLY GENERATED USING  
COEFFICIENTS FOR AUGUSTA GEORGIA  
AND STATION LATITUDE = 33.30 DEGREES

\*\*\*\*\*

AVERAGE MONTHLY VALUES IN INCHES FOR YEARS 1 THROUGH 100

	JAN/JUL	FEB/AUG	MAR/SEP	APR/OCT	MAY/NOV	JUN/DEC
PRECIPITATION						
TOTALS	4.56	3.57	4.76	2.74	3.60	4.97
	5.81	5.32	4.41	2.99	2.75	3.41
STD. DEVIATIONS	2.44	1.60	2.47	1.31	2.12	2.60
	2.83	2.95	2.54	2.28	1.72	1.90

## RUNOFF

-----

TOTALS	0.004	0.000	0.004	0.000	0.000	0.002
	0.027	0.091	0.016	0.006	0.002	0.001
STD. DEVIATIONS	0.019	0.000	0.027	0.000	0.002	0.014
	0.092	0.404	0.086	0.058	0.014	0.004

## EVAPOTRANSPIRATION

-----

TOTALS	1.577	2.094	3.075	3.555	3.655	4.138
	4.896	4.521	3.385	1.618	0.948	1.115
STD. DEVIATIONS	0.221	0.236	0.581	0.760	1.525	1.545
	1.588	1.379	1.041	0.606	0.207	0.205

## LATERAL DRAINAGE COLLECTED FROM LAYER 5

-----

TOTALS	2.3380	2.0986	1.9285	1.3079	0.4980	0.3138
	0.5201	0.7785	0.7430	0.7687	0.8730	1.3955
STD. DEVIATIONS	1.6582	1.4511	1.3519	1.0540	0.4456	0.5338
	0.7239	0.9511	0.9498	1.0111	1.1450	1.2156

## PERCOLATION/LEAKAGE THROUGH LAYER 6

-----

TOTALS	0.0941	0.0827	0.0751	0.0528	0.0230	0.0157
	0.0227	0.0322	0.0312	0.0321	0.0351	0.0542
STD. DEVIATIONS	0.0790	0.0636	0.0513	0.0430	0.0160	0.0195
	0.0266	0.0356	0.0358	0.0380	0.0418	0.0445

## LATERAL DRAINAGE COLLECTED FROM LAYER 8

-----

TOTALS	0.0677	0.0652	0.0800	0.0624	0.0322	0.0130
	0.0180	0.0262	0.0252	0.0276	0.0295	0.0483
STD. DEVIATIONS	0.0380	0.0335	0.0621	0.0612	0.0474	0.0262
	0.0246	0.0305	0.0298	0.0363	0.0380	0.0424

## PERCOLATION/LEAKAGE THROUGH LAYER 9

-----

TOTALS	0.0051	0.0049	0.0054	0.0052	0.0053	0.0045
	0.0041	0.0042	0.0042	0.0043	0.0040	0.0044
STD. DEVIATIONS	0.0009	0.0004	0.0002	0.0005	0.0004	0.0014
	0.0018	0.0020	0.0018	0.0019	0.0019	0.0018

-----  
 AVERAGES OF MONTHLY AVERAGED DAILY HEADS (INCHES)  
 -----

DAILY AVERAGE HEAD ON TOP OF LAYER 6  
 -----

AVERAGES	3.3788	3.2382	2.6511	1.8731	0.6753	0.4396
	0.7053	1.0640	1.0578	1.0550	1.2232	1.8923
STD. DEVIATIONS	2.9857	2.6532	1.9439	1.6851	0.6042	0.7480
	0.9816	1.3175	1.3750	1.4131	1.6044	1.6483

DAILY AVERAGE HEAD ON TOP OF LAYER 9  
 -----

AVERAGES	0.0051	0.0054	0.0061	0.0049	0.0024	0.0010
	0.0014	0.0020	0.0020	0.0021	0.0023	0.0037
STD. DEVIATIONS	0.0029	0.0028	0.0047	0.0048	0.0036	0.0021
	0.0019	0.0023	0.0023	0.0028	0.0030	0.0032

\*\*\*\*\*  
 \*\*\*\*\*

AVERAGE ANNUAL TOTALS & (STD. DEVIATIONS) FOR YEARS 1 THROUGH 100  
 -----

	INCHES		CU. FEET	PERCENT
PRECIPITATION	48.90	( 7.734)	3484469.2	100.00
RUNOFF	0.153	( 0.4340)	10931.62	0.314
EVAPOTRANSPIRATION	34.578	( 3.6248)	2463907.00	70.711
LATERAL DRAINAGE COLLECTED FROM LAYER 5	13.56355	( 5.37926)	966496.750	27.73727
PERCOLATION/LEAKAGE THROUGH LAYER 6	0.55102	( 0.21286)	39263.957	1.12683
AVERAGE HEAD ON TOP OF LAYER 6	1.604	( 0.678)		
LATERAL DRAINAGE COLLECTED FROM LAYER 8	0.49539	( 0.20561)	35299.797	1.01306
PERCOLATION/LEAKAGE THROUGH LAYER 9	0.05562	( 0.00756)	3963.011	0.11373
AVERAGE HEAD ON TOP OF LAYER 9	0.003	( 0.001)		
CHANGE IN WATER STORAGE	0.054	( 2.0574)	3871.06	0.111

\*\*\*\*\*

\*\*\*\*\*

PEAK DAILY VALUES FOR YEARS		1 THROUGH	100
		(INCHES)	(CU. FT.)
PRECIPITATION		6.87	489534.875
RUNOFF		2.646	188573.8440
DRAINAGE COLLECTED FROM LAYER	5	0.29450	20985.16410
PERCOLATION/LEAKAGE THROUGH LAYER	6	0.040637	2895.64722
AVERAGE HEAD ON TOP OF LAYER	6	47.587	
MAXIMUM HEAD ON TOP OF LAYER	6	60.203	
LOCATION OF MAXIMUM HEAD IN LAYER	5	171.0 FEET	
	(DISTANCE FROM DRAIN)		
DRAINAGE COLLECTED FROM LAYER	8	0.01707	1216.03259
PERCOLATION/LEAKAGE THROUGH LAYER	9	0.000204	14.55278
AVERAGE HEAD ON TOP OF LAYER	9	0.040	
MAXIMUM HEAD ON TOP OF LAYER	9	0.080	
LOCATION OF MAXIMUM HEAD IN LAYER	8	0.0 FEET	
	(DISTANCE FROM DRAIN)		
SNOW WATER		2.36	168188.7190
MAXIMUM VEG. SOIL WATER (VOL/VOL)			0.3688
MINIMUM VEG. SOIL WATER (VOL/VOL)			0.1149

\*\*\* Maximum heads are computed using McEnroe's equations. \*\*\*

Reference: Maximum Saturated Depth over Landfill Liner  
 by Bruce M. McEnroe, University of Kansas  
 ASCE Journal of Environmental Engineering  
 Vol. 119, No. 2, March 1993, pp. 262-270.

\*\*\*\*\*

\*\*\*\*\*

FINAL WATER STORAGE AT END OF YEAR 100

---

LAYER	( INCHES )	( VOL/VOL )
1	1.6020	0.2697
2	9.2013	0.3067
3	0.7200	0.0600
4	3.9717	0.3310
5	2.2773	0.1898
6	0.1500	0.7500
7	14.0568	0.2400
8	1.9240	0.0802
9	0.1500	0.7500
SNOW WATER	0.000	

\*\*\*\*\*  
\*\*\*\*\*

Appendix I, Lower Bounding Scenario Degraded SDF MSE Vault Closure Cap (550 Years): HELP Model Input Data and Output File (output file name: ZLBS3out.OUT)

Input Data:

Input Parameter (HELP Model Query)		Generic Input Parameter Value					
Landfill area =		19.63 acres					
Percent of area where runoff is possible =		100%					
Do you want to specify initial moisture storage? (Y/N)		Y					
Amount of water or snow on surface =		0 inches					
CN Input Parameter (HELP Model Query)		CN Input Parameter Value					
Slope =		3 %					
Slope length =		450 ft					
Soil Texture =		5 (HELP model default soil texture)					
Vegetation =		4 (i.e., a good stand of grass)					
HELP Model Computed Curve Number = 54.4							
Layer		Layer Number		Layer Type			
Topsoil		1		1 (vertical percolation layer)			
Upper Backfill		2		1 (vertical percolation layer)			
Erosion Barrier		3		1 (vertical percolation layer)			
Middle Backfill		4		1 (vertical percolation layer)			
Upper Drainage Layer		5		2 (lateral drainage layer)			
Upper GCL		6		3 (barrier soil liner)			
Lower Backfill		7		1 (vertical percolation layer)			
Lower Drainage Layer		8		2 (lateral drainage layer)			
Lower GCL		9		3 (barrier soil liner)			
	Layer Type	Layer Thickness (in)	Soil Texture No.	Total Porosity (Vol/Vol)	Field Capacity (Vol/Vol)	Wilting Point (Vol/Vol)	Initial Moisture (Vol/Vol)
1	1	5.890		0.4	0.11	0.058	0.11
2	1	30		0.37	0.24	0.136	0.24
3	1	12		0.06	0.056	0.052	0.056
4	1	12		0.371	0.220	0.121	0.220
5	2	12		0.379	0.10	0.028	0.10
6	3	0.2		0.75	0.747	0.40	0.75
7	1	58.57		0.37	0.24	0.136	0.24
8	2	24		0.38	0.0802	0.0134	0.0802
9	3	0.2		0.75	0.747	0.40	0.75

The lack of values in the table for particular parameters in particular layers denotes that no HELP model input was required for that parameter in that layer. No data are missing from the table.

## Input Data (continued):

	Layer Type	Sat. Hyd. Conductivity * (cm/sec)	Drainage Length (ft)	Drain Slope (%)	Leachate Recirc. (%)	Recirc. to Layer (#)	Subsurface Inflow (in/yr)
1	1	1.00E-03					
2	1	1.00E-04					
3	1	3.97E-04					
4	1	2.30E-04					
5	2	4.30E-02	450	3			
6	3	5.00E-09					
7	1	1.00E-04					
8	2	9.98E-02	150	11.4			
9	3	5.00E-09					
	Layer Type	Geomembrane Pinhole Density (#/acre)	Geomembrane Instal. Defects (#/acre)	Geomembrane Placement Quality	Geotextile Transmissivity (cm <sup>2</sup> /sec)		
1	1						
2	1						
3	1						
4	1						
5	2						
6	3						
7	1						
8	2						
9	3						

The lack of values in the table for particular parameters in particular layers denotes that no HELP model input was required for that parameter in that layer. No data are missing from the table.

\* The HELP model output often produces an increased number of significant digits for the Effective Saturated Hydraulic Conductivity over that of the actual input





## LAYER 3

-----

## TYPE 1 - VERTICAL PERCOLATION LAYER

MATERIAL TEXTURE NUMBER 0

THICKNESS	=	12.00	INCHES
POROSITY	=	0.0600	VOL/VOL
FIELD CAPACITY	=	0.0560	VOL/VOL
WILTING POINT	=	0.0520	VOL/VOL
INITIAL SOIL WATER CONTENT	=	0.0560	VOL/VOL
EFFECTIVE SAT. HYD. COND.	=	0.396999996000E-03	CM/SEC

## LAYER 4

-----

## TYPE 1 - VERTICAL PERCOLATION LAYER

MATERIAL TEXTURE NUMBER 0

THICKNESS	=	12.00	INCHES
POROSITY	=	0.3710	VOL/VOL
FIELD CAPACITY	=	0.2200	VOL/VOL
WILTING POINT	=	0.1210	VOL/VOL
INITIAL SOIL WATER CONTENT	=	0.2200	VOL/VOL
EFFECTIVE SAT. HYD. COND.	=	0.230000005000E-03	CM/SEC

## LAYER 5

-----

## TYPE 2 - LATERAL DRAINAGE LAYER

MATERIAL TEXTURE NUMBER 0

THICKNESS	=	12.00	INCHES
POROSITY	=	0.3790	VOL/VOL
FIELD CAPACITY	=	0.1000	VOL/VOL
WILTING POINT	=	0.0280	VOL/VOL
INITIAL SOIL WATER CONTENT	=	0.1000	VOL/VOL
EFFECTIVE SAT. HYD. COND.	=	0.430000015000E-01	CM/SEC
SLOPE	=	3.00	PERCENT
DRAINAGE LENGTH	=	450.0	FEET

## LAYER 6

-----

## TYPE 3 - BARRIER SOIL LINER

MATERIAL TEXTURE NUMBER 0

THICKNESS	=	0.20	INCHES
POROSITY	=	0.7500	VOL/VOL
FIELD CAPACITY	=	0.7470	VOL/VOL
WILTING POINT	=	0.4000	VOL/VOL
INITIAL SOIL WATER CONTENT	=	0.7500	VOL/VOL
EFFECTIVE SAT. HYD. COND.	=	0.499999997000E-08	CM/SEC

## LAYER 7

-----

## TYPE 1 - VERTICAL PERCOLATION LAYER

MATERIAL TEXTURE NUMBER 0

THICKNESS	=	58.57	INCHES
POROSITY	=	0.3700	VOL/VOL
FIELD CAPACITY	=	0.2400	VOL/VOL
WILTING POINT	=	0.1360	VOL/VOL
INITIAL SOIL WATER CONTENT	=	0.2400	VOL/VOL
EFFECTIVE SAT. HYD. COND.	=	0.999999975000E-04	CM/SEC

## LAYER 8

-----

## TYPE 2 - LATERAL DRAINAGE LAYER

MATERIAL TEXTURE NUMBER 0

THICKNESS	=	24.00	INCHES
POROSITY	=	0.3800	VOL/VOL
FIELD CAPACITY	=	0.0802	VOL/VOL
WILTING POINT	=	0.0134	VOL/VOL
INITIAL SOIL WATER CONTENT	=	0.0802	VOL/VOL
EFFECTIVE SAT. HYD. COND.	=	0.997999981000E-01	CM/SEC
SLOPE	=	11.40	PERCENT
DRAINAGE LENGTH	=	150.0	FEET

## LAYER 9

-----

## TYPE 3 - BARRIER SOIL LINER

MATERIAL TEXTURE NUMBER 0

THICKNESS	=	0.20	INCHES
POROSITY	=	0.7500	VOL/VOL
FIELD CAPACITY	=	0.7470	VOL/VOL
WILTING POINT	=	0.4000	VOL/VOL
INITIAL SOIL WATER CONTENT	=	0.7500	VOL/VOL
EFFECTIVE SAT. HYD. COND.	=	0.499999997000E-08	CM/SEC

## GENERAL DESIGN AND EVAPORATIVE ZONE DATA

-----

NOTE: SCS RUNOFF CURVE NUMBER WAS COMPUTED FROM DEFAULT SOIL DATA BASE USING SOIL TEXTURE # 5 WITH A GOOD STAND OF GRASS, A SURFACE SLOPE OF 3.% AND A SLOPE LENGTH OF 450. FEET.

SCS RUNOFF CURVE NUMBER	=	54.40	
FRACTION OF AREA ALLOWING RUNOFF	=	100.0	PERCENT
AREA PROJECTED ON HORIZONTAL PLANE	=	19.630	ACRES
EVAPORATIVE ZONE DEPTH	=	22.0	INCHES
INITIAL WATER IN EVAPORATIVE ZONE	=	4.514	INCHES
UPPER LIMIT OF EVAPORATIVE STORAGE	=	8.317	INCHES
LOWER LIMIT OF EVAPORATIVE STORAGE	=	2.533	INCHES
INITIAL SNOW WATER	=	0.000	INCHES
INITIAL WATER IN LAYER MATERIALS	=	28.642	INCHES
TOTAL INITIAL WATER	=	28.642	INCHES
TOTAL SUBSURFACE INFLOW	=	0.00	INCHES/YEAR

EVAPOTRANSPIRATION AND WEATHER DATA

NOTE: EVAPOTRANSPIRATION DATA WAS OBTAINED FROM AUGUSTA GEORGIA

STATION LATITUDE = 33.22 DEGREES  
 MAXIMUM LEAF AREA INDEX = 3.50  
 START OF GROWING SEASON (JULIAN DATE) = 68  
 END OF GROWING SEASON (JULIAN DATE) = 323  
 EVAPORATIVE ZONE DEPTH = 22.0 INCHES  
 AVERAGE ANNUAL WIND SPEED = 6.50 MPH  
 AVERAGE 1ST QUARTER RELATIVE HUMIDITY = 68.00 %  
 AVERAGE 2ND QUARTER RELATIVE HUMIDITY = 70.00 %  
 AVERAGE 3RD QUARTER RELATIVE HUMIDITY = 77.00 %  
 AVERAGE 4TH QUARTER RELATIVE HUMIDITY = 73.00 %

NOTE: PRECIPITATION DATA WAS SYNTHETICALLY GENERATED USING COEFFICIENTS FOR AUGUSTA GEORGIA

NORMAL MEAN MONTHLY PRECIPITATION (INCHES)

JAN/JUL	FEB/AUG	MAR/SEP	APR/OCT	MAY/NOV	JUN/DEC
4.38	3.95	4.68	2.91	3.56	4.99
5.43	5.41	3.93	3.12	2.96	3.45

NOTE: TEMPERATURE DATA WAS SYNTHETICALLY GENERATED USING COEFFICIENTS FOR AUGUSTA GEORGIA

NORMAL MEAN MONTHLY TEMPERATURE (DEGREES FAHRENHEIT)

JAN/JUL	FEB/AUG	MAR/SEP	APR/OCT	MAY/NOV	JUN/DEC
46.30	50.00	57.20	64.30	72.10	78.40
81.60	80.30	75.20	65.10	56.70	48.80

NOTE: SOLAR RADIATION DATA WAS SYNTHETICALLY GENERATED USING COEFFICIENTS FOR AUGUSTA GEORGIA AND STATION LATITUDE = 33.30 DEGREES

\*\*\*\*\*

AVERAGE MONTHLY VALUES IN INCHES FOR YEARS 1 THROUGH 100

	JAN/JUL	FEB/AUG	MAR/SEP	APR/OCT	MAY/NOV	JUN/DEC
PRECIPITATION						
TOTALS	4.56	3.57	4.76	2.74	3.60	4.97
	5.81	5.32	4.41	2.99	2.75	3.41
STD. DEVIATIONS	2.44	1.60	2.47	1.31	2.12	2.60
	2.83	2.95	2.54	2.28	1.72	1.90

## RUNOFF

-----

TOTALS	0.004	0.000	0.004	0.000	0.000	0.002
	0.027	0.091	0.017	0.006	0.002	0.001
STD. DEVIATIONS	0.019	0.000	0.027	0.000	0.002	0.014
	0.092	0.405	0.086	0.058	0.014	0.004

## EVAPOTRANSPIRATION

-----

TOTALS	1.578	2.094	3.079	3.557	3.652	4.139
	4.897	4.519	3.383	1.619	0.948	1.116
STD. DEVIATIONS	0.221	0.236	0.581	0.759	1.525	1.546
	1.589	1.381	1.040	0.605	0.207	0.205

## LATERAL DRAINAGE COLLECTED FROM LAYER 5

-----

TOTALS	2.1396	2.0683	1.9324	1.3893	0.5976	0.3361
	0.4900	0.7308	0.7287	0.7540	0.8439	1.2986
STD. DEVIATIONS	1.4409	1.3054	1.2193	1.0322	0.4679	0.4810
	0.6458	0.8569	0.8682	0.9250	1.0730	1.1106

## PERCOLATION/LEAKAGE THROUGH LAYER 6

-----

TOTALS	0.1345	0.1293	0.1139	0.0807	0.0366	0.0226
	0.0305	0.0434	0.0440	0.0453	0.0489	0.0726
STD. DEVIATIONS	0.1321	0.1276	0.0880	0.0696	0.0245	0.0253
	0.0341	0.0478	0.0502	0.0530	0.0581	0.0589

## LATERAL DRAINAGE COLLECTED FROM LAYER 8

-----

TOTALS	0.0822	0.0852	0.1146	0.1101	0.0798	0.0372
	0.0262	0.0335	0.0356	0.0379	0.0398	0.0615
STD. DEVIATIONS	0.0469	0.0421	0.0927	0.1067	0.1021	0.0731
	0.0330	0.0349	0.0381	0.0422	0.0498	0.0545

## PERCOLATION/LEAKAGE THROUGH LAYER 9

-----

TOTALS	0.0051	0.0048	0.0054	0.0052	0.0054	0.0050
	0.0049	0.0045	0.0044	0.0046	0.0044	0.0047
STD. DEVIATIONS	0.0009	0.0007	0.0004	0.0007	0.0002	0.0007
	0.0011	0.0017	0.0016	0.0017	0.0016	0.0016

-----  
 AVERAGES OF MONTHLY AVERAGED DAILY HEADS (INCHES)  
 -----

DAILY AVERAGE HEAD ON TOP OF LAYER 6  
 -----

AVERAGES	4.9100	5.1798	4.1221	2.9643	1.1873	0.6900
	0.9734	1.4764	1.5521	1.5436	1.7459	2.5799
STD. DEVIATIONS	5.0026	5.3145	3.3389	2.7254	0.9295	0.9875
	1.2831	1.7908	1.9474	1.9914	2.2570	2.2064

DAILY AVERAGE HEAD ON TOP OF LAYER 9  
 -----

AVERAGES	0.0062	0.0071	0.0087	0.0086	0.0061	0.0029
	0.0020	0.0025	0.0028	0.0029	0.0031	0.0047
STD. DEVIATIONS	0.0036	0.0035	0.0070	0.0084	0.0078	0.0057
	0.0025	0.0027	0.0030	0.0032	0.0039	0.0041

\*\*\*\*\*  
 \*\*\*\*\*

AVERAGE ANNUAL TOTALS & (STD. DEVIATIONS) FOR YEARS 1 THROUGH 100  
 -----

	INCHES		CU. FEET	PERCENT
PRECIPITATION	48.90	( 7.734)	3484469.2	100.00
RUNOFF	0.153	( 0.4343)	10927.06	0.314
EVAPOTRANSPIRATION	34.580	( 3.6259)	2464083.75	70.716
LATERAL DRAINAGE COLLECTED FROM LAYER 5	13.30920	( 5.18660)	948372.375	27.21713
PERCOLATION/LEAKAGE THROUGH LAYER 6	0.80227	( 0.35070)	57167.426	1.64064
AVERAGE HEAD ON TOP OF LAYER 6	2.410	( 1.133)		
LATERAL DRAINAGE COLLECTED FROM LAYER 8	0.74364	( 0.33083)	52989.637	1.52074
PERCOLATION/LEAKAGE THROUGH LAYER 9	0.05861	( 0.00648)	4176.500	0.11986
AVERAGE HEAD ON TOP OF LAYER 9	0.005	( 0.002)		
CHANGE IN WATER STORAGE	0.055	( 2.1936)	3919.94	0.112

\*\*\*\*\*

\*\*\*\*\*

PEAK DAILY VALUES FOR YEARS		1 THROUGH	100
		(INCHES)	(CU. FT.)
PRECIPITATION		6.87	489534.875
RUNOFF		2.652	188986.2810
DRAINAGE COLLECTED FROM LAYER	5	0.20953	14930.45610
PERCOLATION/LEAKAGE THROUGH LAYER	6	0.051125	3643.01270
AVERAGE HEAD ON TOP OF LAYER	6	59.920	
MAXIMUM HEAD ON TOP OF LAYER	6	73.605	
LOCATION OF MAXIMUM HEAD IN LAYER	5	187.8 FEET	
(DISTANCE FROM DRAIN)			
DRAINAGE COLLECTED FROM LAYER	8	0.02171	1546.84204
PERCOLATION/LEAKAGE THROUGH LAYER	9	0.000214	15.21794
AVERAGE HEAD ON TOP OF LAYER	9	0.051	
MAXIMUM HEAD ON TOP OF LAYER	9	0.100	
LOCATION OF MAXIMUM HEAD IN LAYER	8	0.8 FEET	
(DISTANCE FROM DRAIN)			
SNOW WATER		2.36	168188.7190
MAXIMUM VEG. SOIL WATER (VOL/VOL)			0.3691
MINIMUM VEG. SOIL WATER (VOL/VOL)			0.1151

\*\*\* Maximum heads are computed using McEnroe's equations. \*\*\*

Reference: Maximum Saturated Depth over Landfill Liner  
 by Bruce M. McEnroe, University of Kansas  
 ASCE Journal of Environmental Engineering  
 Vol. 119, No. 2, March 1993, pp. 262-270.

\*\*\*\*\*

\*\*\*\*\*

FINAL WATER STORAGE AT END OF YEAR 100

LAYER	( INCHES )	( VOL/VOL )
1	1.5975	0.2712
2	9.1910	0.3064
3	0.7200	0.0600
4	3.8479	0.3207
5	2.5027	0.2086
6	0.1500	0.7500
7	14.0568	0.2400
8	1.9266	0.0803
9	0.1500	0.7500
SNOW WATER	0.000	

\*\*\*\*\*  
\*\*\*\*\*

Appendix J, Lower Bounding Scenario Degraded SDF MSE Vault Closure Cap (1,000 Years): HELP Model Input Data and Output File (output file name: ZLBS4out.OUT)

Input Data:

Input Parameter (HELP Model Query)		Generic Input Parameter Value					
Landfill area =		19.63 acres					
Percent of area where runoff is possible =		100%					
Do you want to specify initial moisture storage? (Y/N)		Y					
Amount of water or snow on surface =		0 inches					
CN Input Parameter (HELP Model Query)		CN Input Parameter Value					
Slope =		3 %					
Slope length =		450 ft					
Soil Texture =		5 (HELP model default soil texture)					
Vegetation =		4 (i.e., a good stand of grass)					
HELP Model Computed Curve Number = 54.4							
Layer		Layer Number		Layer Type			
Topsoil		1		1 (vertical percolation layer)			
Upper Backfill		2		1 (vertical percolation layer)			
Erosion Barrier		3		1 (vertical percolation layer)			
Middle Backfill		4		1 (vertical percolation layer)			
Upper Drainage Layer		5		2 (lateral drainage layer)			
Upper GCL		6		3 (barrier soil liner)			
Lower Backfill		7		1 (vertical percolation layer)			
Lower Drainage Layer		8		2 (lateral drainage layer)			
Lower GCL		9		3 (barrier soil liner)			
	Layer Type	Layer Thickness (in)	Soil Texture No.	Total Porosity (Vol/Vol)	Field Capacity (Vol/Vol)	Wilting Point (Vol/Vol)	Initial Moisture (Vol/Vol)
1	1	5.8		0.4	0.11	0.058	0.11
2	1	30		0.37	0.24	0.136	0.24
3	1	12		0.06	0.056	0.052	0.056
4	1	12		0.372	0.204	0.109	0.204
5	2	12		0.378	0.116	0.040	0.116
6	3	0.2		0.75	0.747	0.40	0.75
7	1	58.57		0.37	0.24	0.136	0.24
8	2	24		0.379	0.0807	0.0140	0.0807
9	3	0.2		0.75	0.747	0.40	0.75

The lack of values in the table for particular parameters in particular layers denotes that no HELP model input was required for that parameter in that layer. No data are missing from the table.



## Input Data (continued):

	Layer Type	Sat. Hyd. Conductivity * (cm/sec)	Drainage Length (ft)	Drain Slope (%)	Leachate Recirc. (%)	Recirc. to Layer (#)	Subsurface Inflow (in/yr)
1	1	1.00E-03					
2	1	1.00E-04					
3	1	3.97E-04					
4	1	4.60E-04					
5	2	2.10E-02	450	3			
6	3	5.00E-09					
7	1	1.00E-04					
8	2	9.94E-02	150	11.4			
9	3	5.00E-09					
	Layer Type	Geomembrane Pinhole Density (#/acre)	Geomembrane Instal. Defects (#/acre)	Geomembrane Placement Quality	Geotextile Transmissivity (cm <sup>2</sup> /sec)		
1	1						
2	1						
3	1						
4	1						
5	2						
6	3						
7	1						
8	2						
9	3						

The lack of values in the table for particular parameters in particular layers denotes that no HELP model input was required for that parameter in that layer. No data are missing from the table.

\* The HELP model output often produces an increased number of significant digits for the Effective Saturated Hydraulic Conductivity over that of the actual input



## LAYER 3

-----

## TYPE 1 - VERTICAL PERCOLATION LAYER

MATERIAL TEXTURE NUMBER 0

THICKNESS	=	12.00	INCHES
POROSITY	=	0.0600	VOL/VOL
FIELD CAPACITY	=	0.0560	VOL/VOL
WILTING POINT	=	0.0520	VOL/VOL
INITIAL SOIL WATER CONTENT	=	0.0560	VOL/VOL
EFFECTIVE SAT. HYD. COND.	=	0.396999996000E-03	CM/SEC

## LAYER 4

-----

## TYPE 1 - VERTICAL PERCOLATION LAYER

MATERIAL TEXTURE NUMBER 0

THICKNESS	=	12.00	INCHES
POROSITY	=	0.3720	VOL/VOL
FIELD CAPACITY	=	0.2040	VOL/VOL
WILTING POINT	=	0.1090	VOL/VOL
INITIAL SOIL WATER CONTENT	=	0.2040	VOL/VOL
EFFECTIVE SAT. HYD. COND.	=	0.460000010000E-03	CM/SEC

## LAYER 5

-----

## TYPE 2 - LATERAL DRAINAGE LAYER

MATERIAL TEXTURE NUMBER 0

THICKNESS	=	12.00	INCHES
POROSITY	=	0.3780	VOL/VOL
FIELD CAPACITY	=	0.1160	VOL/VOL
WILTING POINT	=	0.0400	VOL/VOL
INITIAL SOIL WATER CONTENT	=	0.1160	VOL/VOL
EFFECTIVE SAT. HYD. COND.	=	0.209999997000E-01	CM/SEC
SLOPE	=	3.00	PERCENT
DRAINAGE LENGTH	=	450.0	FEET

## LAYER 6

-----

## TYPE 3 - BARRIER SOIL LINER

MATERIAL TEXTURE NUMBER 0

THICKNESS	=	0.20	INCHES
POROSITY	=	0.7500	VOL/VOL
FIELD CAPACITY	=	0.7470	VOL/VOL
WILTING POINT	=	0.4000	VOL/VOL
INITIAL SOIL WATER CONTENT	=	0.7500	VOL/VOL
EFFECTIVE SAT. HYD. COND.	=	0.499999997000E-08	CM/SEC

LAYER 7

-----

TYPE 1 - VERTICAL PERCOLATION LAYER

MATERIAL TEXTURE NUMBER 0

THICKNESS = 58.57 INCHES  
 POROSITY = 0.3700 VOL/VOL  
 FIELD CAPACITY = 0.2400 VOL/VOL  
 WILTING POINT = 0.1360 VOL/VOL  
 INITIAL SOIL WATER CONTENT = 0.2400 VOL/VOL  
 EFFECTIVE SAT. HYD. COND. = 0.999999975000E-04 CM/SEC

LAYER 8

-----

TYPE 2 - LATERAL DRAINAGE LAYER

MATERIAL TEXTURE NUMBER 0

THICKNESS = 24.00 INCHES  
 POROSITY = 0.3790 VOL/VOL  
 FIELD CAPACITY = 0.0807 VOL/VOL  
 WILTING POINT = 0.0140 VOL/VOL  
 INITIAL SOIL WATER CONTENT = 0.0807 VOL/VOL  
 EFFECTIVE SAT. HYD. COND. = 0.993999988000E-01 CM/SEC  
 SLOPE = 11.40 PERCENT  
 DRAINAGE LENGTH = 150.0 FEET

LAYER 9

-----

TYPE 3 - BARRIER SOIL LINER

MATERIAL TEXTURE NUMBER 0

THICKNESS = 0.20 INCHES  
 POROSITY = 0.7500 VOL/VOL  
 FIELD CAPACITY = 0.7470 VOL/VOL  
 WILTING POINT = 0.4000 VOL/VOL  
 INITIAL SOIL WATER CONTENT = 0.7500 VOL/VOL  
 EFFECTIVE SAT. HYD. COND. = 0.499999997000E-08 CM/SEC

GENERAL DESIGN AND EVAPORATIVE ZONE DATA

-----

NOTE: SCS RUNOFF CURVE NUMBER WAS COMPUTED FROM DEFAULT SOIL DATA BASE USING SOIL TEXTURE # 5 WITH A GOOD STAND OF GRASS, A SURFACE SLOPE OF 3.% AND A SLOPE LENGTH OF 450. FEET.

SCS RUNOFF CURVE NUMBER = 54.40  
 FRACTION OF AREA ALLOWING RUNOFF = 100.0 PERCENT  
 AREA PROJECTED ON HORIZONTAL PLANE = 19.630 ACRES  
 EVAPORATIVE ZONE DEPTH = 22.0 INCHES  
 INITIAL WATER IN EVAPORATIVE ZONE = 4.526 INCHES  
 UPPER LIMIT OF EVAPORATIVE STORAGE = 8.314 INCHES  
 LOWER LIMIT OF EVAPORATIVE STORAGE = 2.540 INCHES  
 INITIAL SNOW WATER = 0.000 INCHES  
 INITIAL WATER IN LAYER MATERIALS = 28.644 INCHES  
 TOTAL INITIAL WATER = 28.644 INCHES  
 TOTAL SUBSURFACE INFLOW = 0.00 INCHES/YEAR

EVAPOTRANSPIRATION AND WEATHER DATA

NOTE: EVAPOTRANSPIRATION DATA WAS OBTAINED FROM  
AUGUSTA GEORGIA

STATION LATITUDE = 33.22 DEGREES  
 MAXIMUM LEAF AREA INDEX = 3.50  
 START OF GROWING SEASON (JULIAN DATE) = 68  
 END OF GROWING SEASON (JULIAN DATE) = 323  
 EVAPORATIVE ZONE DEPTH = 22.0 INCHES  
 AVERAGE ANNUAL WIND SPEED = 6.50 MPH  
 AVERAGE 1ST QUARTER RELATIVE HUMIDITY = 68.00 %  
 AVERAGE 2ND QUARTER RELATIVE HUMIDITY = 70.00 %  
 AVERAGE 3RD QUARTER RELATIVE HUMIDITY = 77.00 %  
 AVERAGE 4TH QUARTER RELATIVE HUMIDITY = 73.00 %

NOTE: PRECIPITATION DATA WAS SYNTHETICALLY GENERATED USING  
COEFFICIENTS FOR AUGUSTA GEORGIA

NORMAL MEAN MONTHLY PRECIPITATION (INCHES)

JAN/JUL	FEB/AUG	MAR/SEP	APR/OCT	MAY/NOV	JUN/DEC
4.38	3.95	4.68	2.91	3.56	4.99
5.43	5.41	3.93	3.12	2.96	3.45

NOTE: TEMPERATURE DATA WAS SYNTHETICALLY GENERATED USING  
COEFFICIENTS FOR AUGUSTA GEORGIA

NORMAL MEAN MONTHLY TEMPERATURE (DEGREES FAHRENHEIT)

JAN/JUL	FEB/AUG	MAR/SEP	APR/OCT	MAY/NOV	JUN/DEC
46.30	50.00	57.20	64.30	72.10	78.40
81.60	80.30	75.20	65.10	56.70	48.80

NOTE: SOLAR RADIATION DATA WAS SYNTHETICALLY GENERATED USING  
COEFFICIENTS FOR AUGUSTA GEORGIA  
AND STATION LATITUDE = 33.30 DEGREES

\*\*\*\*\*

AVERAGE MONTHLY VALUES IN INCHES FOR YEARS 1 THROUGH 100

	JAN/JUL	FEB/AUG	MAR/SEP	APR/OCT	MAY/NOV	JUN/DEC
PRECIPITATION						
TOTALS	4.56	3.57	4.76	2.74	3.60	4.97
	5.81	5.32	4.41	2.99	2.75	3.41
STD. DEVIATIONS	2.44	1.60	2.47	1.31	2.12	2.60
	2.83	2.95	2.54	2.28	1.72	1.90

## RUNOFF

-----

TOTALS	0.012	0.000	0.004	0.000	0.000	0.002
	0.027	0.092	0.016	0.006	0.002	0.001
STD. DEVIATIONS	0.104	0.000	0.027	0.000	0.002	0.013
	0.093	0.405	0.086	0.058	0.014	0.004

## EVAPOTRANSPIRATION

-----

TOTALS	1.578	2.095	3.082	3.560	3.649	4.138
	4.895	4.520	3.384	1.619	0.949	1.116
STD. DEVIATIONS	0.220	0.236	0.580	0.763	1.523	1.547
	1.591	1.378	1.038	0.606	0.207	0.205

## LATERAL DRAINAGE COLLECTED FROM LAYER 5

-----

TOTALS	1.6448	1.7169	1.8024	1.4864	0.8979	0.4949
	0.4867	0.6368	0.6632	0.6987	0.7410	1.0747
STD. DEVIATIONS	0.9452	0.7966	0.8238	0.8185	0.5947	0.4206
	0.4797	0.6512	0.6542	0.7044	0.7991	0.8655

## PERCOLATION/LEAKAGE THROUGH LAYER 6

-----

TOTALS	0.2609	0.3021	0.2854	0.2036	0.1031	0.0582
	0.0574	0.0758	0.0826	0.0873	0.1003	0.1355
STD. DEVIATIONS	0.2650	0.3207	0.2736	0.1892	0.0688	0.0452
	0.0515	0.0779	0.0956	0.1010	0.1440	0.1287

## LATERAL DRAINAGE COLLECTED FROM LAYER 8

-----

TOTALS	0.1105	0.1277	0.2548	0.2629	0.2612	0.1961
	0.1188	0.0678	0.0576	0.0717	0.0715	0.0885
STD. DEVIATIONS	0.1125	0.1155	0.2835	0.2666	0.2174	0.1640
	0.1262	0.0744	0.0475	0.0702	0.0773	0.0845

## PERCOLATION/LEAKAGE THROUGH LAYER 9

-----

TOTALS	0.0050	0.0046	0.0055	0.0055	0.0058	0.0055
	0.0055	0.0054	0.0051	0.0052	0.0049	0.0051
STD. DEVIATIONS	0.0012	0.0011	0.0009	0.0009	0.0004	0.0003
	0.0004	0.0003	0.0007	0.0008	0.0011	0.0012

-----  
 AVERAGES OF MONTHLY AVERAGED DAILY HEADS (INCHES)  
 -----

DAILY AVERAGE HEAD ON TOP OF LAYER 6  
 -----

AVERAGES	9.6996	12.3618	10.6247	7.7825	3.7120	2.0811
	1.9798	2.6776	3.0434	3.1155	3.7426	4.9498
STD. DEVIATIONS	10.0502	13.3405	10.3789	7.4141	2.6101	1.7706
	1.9516	2.9533	3.7430	3.8267	5.6371	4.8722

DAILY AVERAGE HEAD ON TOP OF LAYER 9  
 -----

AVERAGES	0.0084	0.0107	0.0194	0.0207	0.0199	0.0155
	0.0091	0.0052	0.0045	0.0055	0.0056	0.0068
STD. DEVIATIONS	0.0086	0.0097	0.0216	0.0210	0.0166	0.0129
	0.0096	0.0057	0.0037	0.0054	0.0061	0.0065

\*\*\*\*\*  
 \*\*\*\*\*

AVERAGE ANNUAL TOTALS & (STD. DEVIATIONS) FOR YEARS 1 THROUGH 100  
 -----

	INCHES		CU. FEET	PERCENT
PRECIPITATION	48.90	( 7.734)	3484469.2	100.00
RUNOFF	0.162	( 0.4445)	11558.63	0.332
EVAPOTRANSPIRATION	34.584	( 3.6263)	2464362.75	70.724
LATERAL DRAINAGE COLLECTED FROM LAYER 5	12.34439	( 4.38623)	879622.625	25.24409
PERCOLATION/LEAKAGE THROUGH LAYER 6	1.75224	( 0.99064)	124859.273	3.58331
AVERAGE HEAD ON TOP OF LAYER 6	5.481	( 3.227)		
LATERAL DRAINAGE COLLECTED FROM LAYER 8	1.68928	( 0.96325)	120372.531	3.45454
PERCOLATION/LEAKAGE THROUGH LAYER 9	0.06294	( 0.00316)	4484.968	0.12871
AVERAGE HEAD ON TOP OF LAYER 9	0.011	( 0.006)		
CHANGE IN WATER STORAGE	0.057	( 2.6430)	4068.29	0.117

\*\*\*\*\*

\*\*\*\*\*

PEAK DAILY VALUES FOR YEARS		1 THROUGH	100
		(INCHES)	(CU. FT.)
PRECIPITATION		6.87	489534.875
RUNOFF		2.657	189349.7810
DRAINAGE COLLECTED FROM LAYER	5	0.11176	7963.75391
PERCOLATION/LEAKAGE THROUGH LAYER	6	0.060947	4342.92725
AVERAGE HEAD ON TOP OF LAYER	6	71.471	
MAXIMUM HEAD ON TOP OF LAYER	6	86.212	
LOCATION OF MAXIMUM HEAD IN LAYER	5	201.5 FEET	
	(DISTANCE FROM DRAIN)		
DRAINAGE COLLECTED FROM LAYER	8	0.05388	3839.00903
PERCOLATION/LEAKAGE THROUGH LAYER	9	0.000278	19.84088
AVERAGE HEAD ON TOP OF LAYER	9	0.127	
MAXIMUM HEAD ON TOP OF LAYER	9	0.252	
LOCATION OF MAXIMUM HEAD IN LAYER	8	0.0 FEET	
	(DISTANCE FROM DRAIN)		
SNOW WATER		2.36	168188.7190
MAXIMUM VEG. SOIL WATER (VOL/VOL)			0.3779
MINIMUM VEG. SOIL WATER (VOL/VOL)			0.1154

\*\*\* Maximum heads are computed using McEnroe's equations. \*\*\*

Reference: Maximum Saturated Depth over Landfill Liner  
 by Bruce M. McEnroe, University of Kansas  
 ASCE Journal of Environmental Engineering  
 Vol. 119, No. 2, March 1993, pp. 262-270.

\*\*\*\*\*



\*\*\*\*\*

FINAL WATER STORAGE AT END OF YEAR 100

LAYER	( INCHES )	( VOL/VOL )
1	1.5657	0.2700
2	8.9783	0.2993
3	0.7200	0.0600
4	3.8123	0.3177
5	2.9804	0.2484
6	0.1500	0.7500
7	14.0568	0.2400
8	1.9393	0.0808
9	0.1500	0.7500
SNOW WATER	0.000	

\*\*\*\*\*  
\*\*\*\*\*

Appendix K, Lower Bounding Scenario Degraded SDF MSE Vault Closure Cap (1,800 Years): HELP Model Input Data and Output File (output file name: ZLBS5out.OUT)

Input Data:

Input Parameter (HELP Model Query)		Generic Input Parameter Value					
Landfill area =		19.63 acres					
Percent of area where runoff is possible =		100%					
Do you want to specify initial moisture storage? (Y/N)		Y					
Amount of water or snow on surface =		0 inches					
CN Input Parameter (HELP Model Query)		CN Input Parameter Value					
Slope =		3 %					
Slope length =		450 ft					
Soil Texture =		5 (HELP model default soil texture)					
Vegetation =		4 (i.e., a good stand of grass)					
HELP Model Computed Curve Number = 54.4							
Layer		Layer Number		Layer Type			
Topsoil		1		1 (vertical percolation layer)			
Upper Backfill		2		1 (vertical percolation layer)			
Erosion Barrier		3		1 (vertical percolation layer)			
Middle Backfill		4		1 (vertical percolation layer)			
Upper Drainage Layer		5		2 (lateral drainage layer)			
Upper GCL		6		3 (barrier soil liner)			
Lower Backfill		7		1 (vertical percolation layer)			
Lower Drainage Layer		8		2 (lateral drainage layer)			
Lower GCL		9		3 (barrier soil liner)			
	Layer Type	Layer Thickness (in)	Soil Texture No.	Total Porosity (Vol/Vol)	Field Capacity (Vol/Vol)	Wilting Point (Vol/Vol)	Initial Moisture (Vol/Vol)
1	1	5.640		0.4	0.11	0.058	0.11
2	1	30		0.37	0.24	0.136	0.24
3	1	12		0.06	0.056	0.052	0.056
4	1	12		0.374	0.176	0.0867	0.176
5	2	12		0.376	0.144	0.062	0.144
6	3	0.2		0.75	0.747	0.40	0.75
7	1	58.57		0.37	0.24	0.136	0.24
8	2	24		0.376	0.0829	0.0172	0.0829
9	3	0.2		0.75	0.747	0.40	0.75

The lack of values in the table for particular parameters in particular layers denotes that no HELP model input was required for that parameter in that layer. No data are missing from the table.

## Input Data (continued):

	Layer Type	Sat. Hyd. Conductivity * (cm/sec)	Drainage Length (ft)	Drain Slope (%)	Leachate Recirc. (%)	Recirc. to Layer (#)	Subsurface Inflow (in/yr)
1	1	1.00E-03					
2	1	1.00E-04					
3	1	3.97E-04					
4	1	1.60E-03					
5	2	6.30E-03	450	3			
6	3	5.00E-09					
7	1	1.00E-04					
8	2	9.77E-02	150	11.4			
9	3	5.00E-09					
	Layer Type	Geomembrane Pinhole Density (#/acre)	Geomembrane Instal. Defects (#/acre)	Geomembrane Placement Quality	Geotextile Transmissivity (cm <sup>2</sup> /sec)		
1	1						
2	1						
3	1						
4	1						
5	2						
6	3						
7	1						
8	2						
9	3						

The lack of values in the table for particular parameters in particular layers denotes that no HELP model input was required for that parameter in that layer. No data are missing from the table.

\* The HELP model output often produces an increased number of significant digits for the Effective Saturated Hydraulic Conductivity over that of the actual input

```

*****
*****
**
**
**
**          HYDROLOGIC EVALUATION OF LANDFILL PERFORMANCE          **
**          HELP MODEL VERSION 3.07 (1 NOVEMBER 1997)              **
**          DEVELOPED BY ENVIRONMENTAL LABORATORY                  **
**          USAE WATERWAYS EXPERIMENT STATION                     **
**          FOR USEPA RISK REDUCTION ENGINEERING LABORATORY       **
**
**
*****
*****

```

```

PRECIPITATION DATA FILE:  D:\HELP3\Hweather\ZPREC.D4
TEMPERATURE DATA FILE:   D:\HELP3\Hweather\ZTEMP.D7
SOLAR RADIATION DATA FILE: D:\HELP3\Hweather\ZSOLAR.D13
EVAPOTRANSPIRATION DATA: D:\HELP3\Hweather\ZEVAP.D11
SOIL AND DESIGN DATA FILE: D:\HELP3\Hsdfmse\ZLBS5.D10
OUTPUT DATA FILE:        D:\HELP3\Hsdfmse\ZLBS5out.OUT

```

```

TIME:  14:57    DATE:  12/11/2003

```

```

*****

```

```

TITLE:  LBS Degraded MSE Vault Closure Cap - 1,800 Years

```

```

*****

```

```

NOTE:  INITIAL MOISTURE CONTENT OF THE LAYERS AND SNOW WATER
       WERE SPECIFIED BY THE USER.

```

```

LAYER  1
-----

```

```

TYPE 1 - VERTICAL PERCOLATION LAYER
MATERIAL TEXTURE NUMBER  0
THICKNESS                =    5.64  INCHES
POROSITY                  =    0.4000 VOL/VOL
FIELD CAPACITY            =    0.1100 VOL/VOL
WILTING POINT            =    0.0580 VOL/VOL
INITIAL SOIL WATER CONTENT =    0.1100 VOL/VOL
EFFECTIVE SAT. HYD. COND. =  0.100000005000E-02 CM/SEC

```

```

LAYER  2
-----

```

```

TYPE 1 - VERTICAL PERCOLATION LAYER
MATERIAL TEXTURE NUMBER  0
THICKNESS                =   30.00  INCHES
POROSITY                  =    0.3700 VOL/VOL
FIELD CAPACITY            =    0.2400 VOL/VOL
WILTING POINT            =    0.1360 VOL/VOL
INITIAL SOIL WATER CONTENT =    0.2400 VOL/VOL
EFFECTIVE SAT. HYD. COND. =  0.999999975000E-04 CM/SEC

```

## LAYER 3

-----

## TYPE 1 - VERTICAL PERCOLATION LAYER

MATERIAL TEXTURE NUMBER 0

THICKNESS	=	12.00	INCHES
POROSITY	=	0.0600	VOL/VOL
FIELD CAPACITY	=	0.0560	VOL/VOL
WILTING POINT	=	0.0520	VOL/VOL
INITIAL SOIL WATER CONTENT	=	0.0560	VOL/VOL
EFFECTIVE SAT. HYD. COND.	=	0.396999996000E-03	CM/SEC

## LAYER 4

-----

## TYPE 1 - VERTICAL PERCOLATION LAYER

MATERIAL TEXTURE NUMBER 0

THICKNESS	=	12.00	INCHES
POROSITY	=	0.3740	VOL/VOL
FIELD CAPACITY	=	0.1760	VOL/VOL
WILTING POINT	=	0.0867	VOL/VOL
INITIAL SOIL WATER CONTENT	=	0.1760	VOL/VOL
EFFECTIVE SAT. HYD. COND.	=	0.159999996000E-02	CM/SEC

## LAYER 5

-----

## TYPE 2 - LATERAL DRAINAGE LAYER

MATERIAL TEXTURE NUMBER 0

THICKNESS	=	12.00	INCHES
POROSITY	=	0.3760	VOL/VOL
FIELD CAPACITY	=	0.1440	VOL/VOL
WILTING POINT	=	0.0620	VOL/VOL
INITIAL SOIL WATER CONTENT	=	0.1440	VOL/VOL
EFFECTIVE SAT. HYD. COND.	=	0.630000001000E-02	CM/SEC
SLOPE	=	3.00	PERCENT
DRAINAGE LENGTH	=	450.0	FEET

## LAYER 6

-----

## TYPE 3 - BARRIER SOIL LINER

MATERIAL TEXTURE NUMBER 0

THICKNESS	=	0.20	INCHES
POROSITY	=	0.7500	VOL/VOL
FIELD CAPACITY	=	0.7470	VOL/VOL
WILTING POINT	=	0.4000	VOL/VOL
INITIAL SOIL WATER CONTENT	=	0.7500	VOL/VOL
EFFECTIVE SAT. HYD. COND.	=	0.499999997000E-08	CM/SEC

LAYER 7

-----

TYPE 1 - VERTICAL PERCOLATION LAYER

MATERIAL TEXTURE NUMBER 0

THICKNESS = 58.57 INCHES  
 POROSITY = 0.3700 VOL/VOL  
 FIELD CAPACITY = 0.2400 VOL/VOL  
 WILTING POINT = 0.1360 VOL/VOL  
 INITIAL SOIL WATER CONTENT = 0.2400 VOL/VOL  
 EFFECTIVE SAT. HYD. COND. = 0.999999975000E-04 CM/SEC

LAYER 8

-----

TYPE 2 - LATERAL DRAINAGE LAYER

MATERIAL TEXTURE NUMBER 0

THICKNESS = 24.00 INCHES  
 POROSITY = 0.3760 VOL/VOL  
 FIELD CAPACITY = 0.0829 VOL/VOL  
 WILTING POINT = 0.0172 VOL/VOL  
 INITIAL SOIL WATER CONTENT = 0.0829 VOL/VOL  
 EFFECTIVE SAT. HYD. COND. = 0.976999998000E-01 CM/SEC  
 SLOPE = 11.40 PERCENT  
 DRAINAGE LENGTH = 150.0 FEET

LAYER 9

-----

TYPE 3 - BARRIER SOIL LINER

MATERIAL TEXTURE NUMBER 0

THICKNESS = 0.20 INCHES  
 POROSITY = 0.7500 VOL/VOL  
 FIELD CAPACITY = 0.7470 VOL/VOL  
 WILTING POINT = 0.4000 VOL/VOL  
 INITIAL SOIL WATER CONTENT = 0.7500 VOL/VOL  
 EFFECTIVE SAT. HYD. COND. = 0.499999997000E-08 CM/SEC

GENERAL DESIGN AND EVAPORATIVE ZONE DATA

-----

NOTE: SCS RUNOFF CURVE NUMBER WAS COMPUTED FROM DEFAULT SOIL DATA BASE USING SOIL TEXTURE # 5 WITH A GOOD STAND OF GRASS, A SURFACE SLOPE OF 3.% AND A SLOPE LENGTH OF 450. FEET.

SCS RUNOFF CURVE NUMBER = 54.40  
 FRACTION OF AREA ALLOWING RUNOFF = 100.0 PERCENT  
 AREA PROJECTED ON HORIZONTAL PLANE = 19.630 ACRES  
 EVAPORATIVE ZONE DEPTH = 22.0 INCHES  
 INITIAL WATER IN EVAPORATIVE ZONE = 4.547 INCHES  
 UPPER LIMIT OF EVAPORATIVE STORAGE = 8.309 INCHES  
 LOWER LIMIT OF EVAPORATIVE STORAGE = 2.552 INCHES  
 INITIAL SNOW WATER = 0.000 INCHES  
 INITIAL WATER IN LAYER MATERIALS = 28.679 INCHES  
 TOTAL INITIAL WATER = 28.679 INCHES  
 TOTAL SUBSURFACE INFLOW = 0.00 INCHES/YEAR

EVAPOTRANSPIRATION AND WEATHER DATA

NOTE: EVAPOTRANSPIRATION DATA WAS OBTAINED FROM  
AUGUSTA GEORGIA

STATION LATITUDE = 33.22 DEGREES  
 MAXIMUM LEAF AREA INDEX = 3.50  
 START OF GROWING SEASON (JULIAN DATE) = 68  
 END OF GROWING SEASON (JULIAN DATE) = 323  
 EVAPORATIVE ZONE DEPTH = 22.0 INCHES  
 AVERAGE ANNUAL WIND SPEED = 6.50 MPH  
 AVERAGE 1ST QUARTER RELATIVE HUMIDITY = 68.00 %  
 AVERAGE 2ND QUARTER RELATIVE HUMIDITY = 70.00 %  
 AVERAGE 3RD QUARTER RELATIVE HUMIDITY = 77.00 %  
 AVERAGE 4TH QUARTER RELATIVE HUMIDITY = 73.00 %

NOTE: PRECIPITATION DATA WAS SYNTHETICALLY GENERATED USING  
COEFFICIENTS FOR AUGUSTA GEORGIA

NORMAL MEAN MONTHLY PRECIPITATION (INCHES)

JAN/JUL	FEB/AUG	MAR/SEP	APR/OCT	MAY/NOV	JUN/DEC
4.38	3.95	4.68	2.91	3.56	4.99
5.43	5.41	3.93	3.12	2.96	3.45

NOTE: TEMPERATURE DATA WAS SYNTHETICALLY GENERATED USING  
COEFFICIENTS FOR AUGUSTA GEORGIA

NORMAL MEAN MONTHLY TEMPERATURE (DEGREES FAHRENHEIT)

JAN/JUL	FEB/AUG	MAR/SEP	APR/OCT	MAY/NOV	JUN/DEC
46.30	50.00	57.20	64.30	72.10	78.40
81.60	80.30	75.20	65.10	56.70	48.80

NOTE: SOLAR RADIATION DATA WAS SYNTHETICALLY GENERATED USING  
COEFFICIENTS FOR AUGUSTA GEORGIA  
AND STATION LATITUDE = 33.30 DEGREES

\*\*\*\*\*

AVERAGE MONTHLY VALUES IN INCHES FOR YEARS 1 THROUGH 100

	JAN/JUL	FEB/AUG	MAR/SEP	APR/OCT	MAY/NOV	JUN/DEC
PRECIPITATION						
TOTALS	4.56	3.57	4.76	2.74	3.60	4.97
	5.81	5.32	4.41	2.99	2.75	3.41
STD. DEVIATIONS	2.44	1.60	2.47	1.31	2.12	2.60
	2.83	2.95	2.54	2.28	1.72	1.90

## RUNOFF

-----

TOTALS	0.124	0.072	0.102	0.000	0.000	0.002
	0.026	0.092	0.016	0.006	0.010	0.006
STD. DEVIATIONS	0.491	0.389	0.527	0.000	0.001	0.013
	0.093	0.406	0.085	0.058	0.063	0.045

## EVAPOTRANSPIRATION

-----

TOTALS	1.579	2.097	3.087	3.566	3.669	4.146
	4.893	4.519	3.390	1.618	0.948	1.115
STD. DEVIATIONS	0.219	0.234	0.584	0.758	1.516	1.540
	1.590	1.378	1.037	0.606	0.207	0.204

## LATERAL DRAINAGE COLLECTED FROM LAYER 5

-----

TOTALS	0.8475	0.8986	1.0052	0.9369	0.8403	0.6801
	0.6089	0.5825	0.5483	0.5604	0.5386	0.6537
STD. DEVIATIONS	0.3587	0.2635	0.2533	0.2462	0.2565	0.2485
	0.2469	0.2833	0.2925	0.3184	0.3378	0.3696

## PERCOLATION/LEAKAGE THROUGH LAYER 6

-----

TOTALS	0.6047	0.6857	0.7575	0.6290	0.4159	0.2881
	0.2484	0.2578	0.2450	0.2573	0.2893	0.3726
STD. DEVIATIONS	0.4816	0.4709	0.4642	0.3924	0.2430	0.1671
	0.1428	0.1988	0.2045	0.2421	0.3495	0.3609

## LATERAL DRAINAGE COLLECTED FROM LAYER 8

-----

TOTALS	0.2789	0.4035	0.6079	0.6753	0.6623	0.5074
	0.4180	0.3351	0.2848	0.2697	0.2476	0.2890
STD. DEVIATIONS	0.3428	0.4258	0.5285	0.4594	0.3733	0.2289
	0.1662	0.1448	0.1491	0.1961	0.2280	0.3300

## PERCOLATION/LEAKAGE THROUGH LAYER 9

-----

TOTALS	0.0051	0.0050	0.0061	0.0063	0.0066	0.0061
	0.0061	0.0059	0.0056	0.0057	0.0055	0.0057
STD. DEVIATIONS	0.0017	0.0016	0.0016	0.0012	0.0008	0.0005
	0.0005	0.0005	0.0005	0.0008	0.0007	0.0010



-----  
 AVERAGES OF MONTHLY AVERAGED DAILY HEADS (INCHES)  
 -----

DAILY AVERAGE HEAD ON TOP OF LAYER 6  
 -----

AVERAGES	22.7387	28.3245	28.5346	24.4540	15.5748	11.0924
	9.2256	9.5782	9.4041	9.5604	11.1402	13.9346
STD. DEVIATIONS	18.2684	19.5820	17.6081	15.3822	9.2174	6.5515
	5.4173	7.5401	8.0160	9.1831	13.6987	13.6904

DAILY AVERAGE HEAD ON TOP OF LAYER 9  
 -----

AVERAGES	0.0217	0.0344	0.0472	0.0542	0.0514	0.0407
	0.0325	0.0260	0.0228	0.0209	0.0199	0.0224
STD. DEVIATIONS	0.0266	0.0364	0.0410	0.0368	0.0290	0.0184
	0.0129	0.0112	0.0120	0.0152	0.0183	0.0256

\*\*\*\*\*  
 \*\*\*\*\*

AVERAGE ANNUAL TOTALS & (STD. DEVIATIONS) FOR YEARS 1 THROUGH 100  
 -----

	INCHES		CU. FEET	PERCENT
PRECIPITATION	48.90	( 7.734)	3484469.2	100.00
RUNOFF	0.457	( 0.9444)	32559.99	0.934
EVAPOTRANSPIRATION	34.626	( 3.6406)	2467356.75	70.810
LATERAL DRAINAGE COLLECTED FROM LAYER 5	8.70105	( 2.16949)	620009.875	17.79352
PERCOLATION/LEAKAGE THROUGH LAYER 6	5.05125	( 2.34617)	359936.500	10.32974
AVERAGE HEAD ON TOP OF LAYER 6	16.130	( 7.591)		
LATERAL DRAINAGE COLLECTED FROM LAYER 8	4.97956	( 2.26762)	354828.156	10.18313
PERCOLATION/LEAKAGE THROUGH LAYER 9	0.06975	( 0.00476)	4969.981	0.14263
AVERAGE HEAD ON TOP OF LAYER 9	0.033	( 0.015)		
CHANGE IN WATER STORAGE	0.067	( 3.7668)	4744.57	0.136

\*\*\*\*\*

\*\*\*\*\*

PEAK DAILY VALUES FOR YEARS	1 THROUGH	100
	(INCHES)	(CU. FT.)
PRECIPITATION	6.87	489534.875
RUNOFF	2.662	189714.1560
DRAINAGE COLLECTED FROM LAYER 5	0.04469	3184.31494
PERCOLATION/LEAKAGE THROUGH LAYER 6	0.061091	4353.16406
AVERAGE HEAD ON TOP OF LAYER 6	71.640	
MAXIMUM HEAD ON TOP OF LAYER 6	86.396	
LOCATION OF MAXIMUM HEAD IN LAYER 5 (DISTANCE FROM DRAIN)	201.7 FEET	
DRAINAGE COLLECTED FROM LAYER 8	0.06161	4390.11670
PERCOLATION/LEAKAGE THROUGH LAYER 9	0.000296	21.10303
AVERAGE HEAD ON TOP OF LAYER 9	0.148	
MAXIMUM HEAD ON TOP OF LAYER 9	0.295	
LOCATION OF MAXIMUM HEAD IN LAYER 8 (DISTANCE FROM DRAIN)	0.0 FEET	
SNOW WATER	2.36	168188.7190
MAXIMUM VEG. SOIL WATER (VOL/VOL)		0.3777
MINIMUM VEG. SOIL WATER (VOL/VOL)		0.1160

\*\*\* Maximum heads are computed using McEnroe's equations. \*\*\*

Reference: Maximum Saturated Depth over Landfill Liner  
 by Bruce M. McEnroe, University of Kansas  
 ASCE Journal of Environmental Engineering  
 Vol. 119, No. 2, March 1993, pp. 262-270.

\*\*\*\*\*

\*\*\*\*\*

FINAL WATER STORAGE AT END OF YEAR 100

---

LAYER	( INCHES )	( VOL/VOL )
1	1.5516	0.2751
2	8.9333	0.2978
3	0.7200	0.0600
4	3.2987	0.2749
5	4.2930	0.3578
6	0.1500	0.7500
7	14.2484	0.2433
8	1.9922	0.0830
9	0.1500	0.7500
SNOW WATER	0.000	

\*\*\*\*\*  
\*\*\*\*\*

Appendix L, Lower Bounding Scenario Degraded SDF MSE Vault Closure Cap (3,400 Years): HELP Model Input Data and Output File (output file name: ZLBS6out.OUT)

Input Data:

Input Parameter (HELP Model Query)		Generic Input Parameter Value					
Landfill area =		19.63 acres					
Percent of area where runoff is possible =		100%					
Do you want to specify initial moisture storage? (Y/N)		Y					
Amount of water or snow on surface =		0 inches					
CN Input Parameter (HELP Model Query)		CN Input Parameter Value					
Slope =		3 %					
Slope length =		450 ft					
Soil Texture =		5 (HELP model default soil texture)					
Vegetation =		4 (i.e., a good stand of grass)					
HELP Model Computed Curve Number = 54.4							
Layer		Layer Number		Layer Type			
Topsoil		1		1 (vertical percolation layer)			
Upper Backfill		2		1 (vertical percolation layer)			
Erosion Barrier		3		1 (vertical percolation layer)			
Middle Backfill		4		1 (vertical percolation layer)			
Upper Drainage Layer		5		2 (lateral drainage layer)			
Upper GCL		6		3 (barrier soil liner)			
Lower Backfill		7		1 (vertical percolation layer)			
Lower Drainage Layer		8		2 (lateral drainage layer)			
Lower GCL		9		3 (barrier soil liner)			
	Layer Type	Layer Thickness (in)	Soil Texture No.	Total Porosity (Vol/Vol)	Field Capacity (Vol/Vol)	Wilting Point (Vol/Vol)	Initial Moisture (Vol/Vol)
1	1	5.320		0.4	0.11	0.058	0.11
2	1	30		0.37	0.24	0.136	0.24
3	1	12		0.06	0.056	0.052	0.056
4	1	12		0.375	0.16	0.0745	0.16
5	2	12		0.375	0.16	0.0745	0.16
6	3	0.2		0.75	0.747	0.40	0.75
7	1	58.57		0.37	0.24	0.136	0.24
8	2	24		0.367	0.0904	0.0280	0.0904
9	3	0.2		0.75	0.747	0.40	0.75

The lack of values in the table for particular parameters in particular layers denotes that no HELP model input was required for that parameter in that layer. No data are missing from the table.

## Input Data (continued):

	Layer Type	Sat. Hyd. Conductivity * (cm/sec)	Drainage Length (ft)	Drain Slope (%)	Leachate Recirc. (%)	Recirc. to Layer (#)	Subsurface Inflow (in/yr)
1	1	1.00E-03					
2	1	1.00E-04					
3	1	3.97E-04					
4	1	3.20E-03					
5	2	3.20E-03	450	3			
6	3	5.00E-09					
7	1	1.00E-04					
8	2	9.20E-02	150	11.4			
9	3	5.00E-09					
	Layer Type	Geomembrane Pinhole Density (#/acre)	Geomembrane Instal. Defects (#/acre)	Geomembrane Placement Quality	Geotextile Transmissivity (cm <sup>2</sup> /sec)		
1	1						
2	1						
3	1						
4	1						
5	2						
6	3						
7	1						
8	2						
9	3						

The lack of values in the table for particular parameters in particular layers denotes that no HELP model input was required for that parameter in that layer. No data are missing from the table.

\* The HELP model output often produces an increased number of significant digits for the Effective Saturated Hydraulic Conductivity over that of the actual input

```

*****
*****
**
**
**
**          HYDROLOGIC EVALUATION OF LANDFILL PERFORMANCE          **
**          HELP MODEL VERSION 3.07 (1 NOVEMBER 1997)              **
**          DEVELOPED BY ENVIRONMENTAL LABORATORY                  **
**          USAE WATERWAYS EXPERIMENT STATION                     **
**          FOR USEPA RISK REDUCTION ENGINEERING LABORATORY       **
**
**
*****
*****

```

```

PRECIPITATION DATA FILE:  D:\HELP3\Hweather\ZPREC.D4
TEMPERATURE DATA FILE:   D:\HELP3\Hweather\ZTEMP.D7
SOLAR RADIATION DATA FILE: D:\HELP3\Hweather\ZSOLAR.D13
EVAPOTRANSPIRATION DATA: D:\HELP3\Hweather\ZEVAP.D11
SOIL AND DESIGN DATA FILE: D:\HELP3\Hsdfmse\ZLBS6.D10
OUTPUT DATA FILE:        D:\HELP3\Hsdfmse\ZLBS6out.OUT

```

TIME: 15: 0      DATE: 12/11/2003

```

*****
TITLE:  LBS Degraded MSE Vault Closure Cap - 3,400 Years
*****

```

NOTE: INITIAL MOISTURE CONTENT OF THE LAYERS AND SNOW WATER WERE SPECIFIED BY THE USER.

LAYER 1  
-----

```

TYPE 1 - VERTICAL PERCOLATION LAYER
MATERIAL TEXTURE NUMBER 0
THICKNESS                = 5.32 INCHES
POROSITY                  = 0.4000 VOL/VOL
FIELD CAPACITY            = 0.1100 VOL/VOL
WILTING POINT             = 0.0580 VOL/VOL
INITIAL SOIL WATER CONTENT = 0.1100 VOL/VOL
EFFECTIVE SAT. HYD. COND. = 0.100000005000E-02 CM/SEC

```

LAYER 2  
-----

```

TYPE 1 - VERTICAL PERCOLATION LAYER
MATERIAL TEXTURE NUMBER 0
THICKNESS                = 30.00 INCHES
POROSITY                  = 0.3700 VOL/VOL
FIELD CAPACITY            = 0.2400 VOL/VOL
WILTING POINT             = 0.1360 VOL/VOL
INITIAL SOIL WATER CONTENT = 0.2400 VOL/VOL
EFFECTIVE SAT. HYD. COND. = 0.999999975000E-04 CM/SEC

```

## LAYER 3

-----

## TYPE 1 - VERTICAL PERCOLATION LAYER

MATERIAL TEXTURE NUMBER 0

THICKNESS	=	12.00	INCHES
POROSITY	=	0.0600	VOL/VOL
FIELD CAPACITY	=	0.0560	VOL/VOL
WILTING POINT	=	0.0520	VOL/VOL
INITIAL SOIL WATER CONTENT	=	0.0560	VOL/VOL
EFFECTIVE SAT. HYD. COND.	=	0.396999996000E-03	CM/SEC

## LAYER 4

-----

## TYPE 1 - VERTICAL PERCOLATION LAYER

MATERIAL TEXTURE NUMBER 0

THICKNESS	=	12.00	INCHES
POROSITY	=	0.3750	VOL/VOL
FIELD CAPACITY	=	0.1600	VOL/VOL
WILTING POINT	=	0.0745	VOL/VOL
INITIAL SOIL WATER CONTENT	=	0.1600	VOL/VOL
EFFECTIVE SAT. HYD. COND.	=	0.319999992000E-02	CM/SEC

## LAYER 5

-----

## TYPE 2 - LATERAL DRAINAGE LAYER

MATERIAL TEXTURE NUMBER 0

THICKNESS	=	12.00	INCHES
POROSITY	=	0.3750	VOL/VOL
FIELD CAPACITY	=	0.1600	VOL/VOL
WILTING POINT	=	0.0745	VOL/VOL
INITIAL SOIL WATER CONTENT	=	0.1600	VOL/VOL
EFFECTIVE SAT. HYD. COND.	=	0.319999992000E-02	CM/SEC
SLOPE	=	3.00	PERCENT
DRAINAGE LENGTH	=	450.0	FEET

## LAYER 6

-----

## TYPE 3 - BARRIER SOIL LINER

MATERIAL TEXTURE NUMBER 0

THICKNESS	=	0.20	INCHES
POROSITY	=	0.7500	VOL/VOL
FIELD CAPACITY	=	0.7470	VOL/VOL
WILTING POINT	=	0.4000	VOL/VOL
INITIAL SOIL WATER CONTENT	=	0.7500	VOL/VOL
EFFECTIVE SAT. HYD. COND.	=	0.499999997000E-08	CM/SEC

LAYER 7

-----

TYPE 1 - VERTICAL PERCOLATION LAYER

MATERIAL TEXTURE NUMBER 0

THICKNESS = 58.57 INCHES  
 POROSITY = 0.3700 VOL/VOL  
 FIELD CAPACITY = 0.2400 VOL/VOL  
 WILTING POINT = 0.1360 VOL/VOL  
 INITIAL SOIL WATER CONTENT = 0.2400 VOL/VOL  
 EFFECTIVE SAT. HYD. COND. = 0.999999975000E-04 CM/SEC

LAYER 8

-----

TYPE 2 - LATERAL DRAINAGE LAYER

MATERIAL TEXTURE NUMBER 0

THICKNESS = 24.00 INCHES  
 POROSITY = 0.3670 VOL/VOL  
 FIELD CAPACITY = 0.0904 VOL/VOL  
 WILTING POINT = 0.0280 VOL/VOL  
 INITIAL SOIL WATER CONTENT = 0.0904 VOL/VOL  
 EFFECTIVE SAT. HYD. COND. = 0.920000002000E-01 CM/SEC  
 SLOPE = 11.40 PERCENT  
 DRAINAGE LENGTH = 150.0 FEET

LAYER 9

-----

TYPE 3 - BARRIER SOIL LINER

MATERIAL TEXTURE NUMBER 0

THICKNESS = 0.20 INCHES  
 POROSITY = 0.7500 VOL/VOL  
 FIELD CAPACITY = 0.7470 VOL/VOL  
 WILTING POINT = 0.4000 VOL/VOL  
 INITIAL SOIL WATER CONTENT = 0.7500 VOL/VOL  
 EFFECTIVE SAT. HYD. COND. = 0.499999997000E-08 CM/SEC

GENERAL DESIGN AND EVAPORATIVE ZONE DATA

-----

NOTE: SCS RUNOFF CURVE NUMBER WAS COMPUTED FROM DEFAULT SOIL DATA BASE USING SOIL TEXTURE # 5 WITH A GOOD STAND OF GRASS, A SURFACE SLOPE OF 3.% AND A SLOPE LENGTH OF 450. FEET.

SCS RUNOFF CURVE NUMBER = 54.40  
 FRACTION OF AREA ALLOWING RUNOFF = 100.0 PERCENT  
 AREA PROJECTED ON HORIZONTAL PLANE = 19.630 ACRES  
 EVAPORATIVE ZONE DEPTH = 22.0 INCHES  
 INITIAL WATER IN EVAPORATIVE ZONE = 4.588 INCHES  
 UPPER LIMIT OF EVAPORATIVE STORAGE = 8.300 INCHES  
 LOWER LIMIT OF EVAPORATIVE STORAGE = 2.577 INCHES  
 INITIAL SNOW WATER = 0.000 INCHES  
 INITIAL WATER IN LAYER MATERIALS = 28.824 INCHES  
 TOTAL INITIAL WATER = 28.824 INCHES  
 TOTAL SUBSURFACE INFLOW = 0.00 INCHES/YEAR



EVAPOTRANSPIRATION AND WEATHER DATA

NOTE: EVAPOTRANSPIRATION DATA WAS OBTAINED FROM  
AUGUSTA GEORGIA

STATION LATITUDE = 33.22 DEGREES  
 MAXIMUM LEAF AREA INDEX = 3.50  
 START OF GROWING SEASON (JULIAN DATE) = 68  
 END OF GROWING SEASON (JULIAN DATE) = 323  
 EVAPORATIVE ZONE DEPTH = 22.0 INCHES  
 AVERAGE ANNUAL WIND SPEED = 6.50 MPH  
 AVERAGE 1ST QUARTER RELATIVE HUMIDITY = 68.00 %  
 AVERAGE 2ND QUARTER RELATIVE HUMIDITY = 70.00 %  
 AVERAGE 3RD QUARTER RELATIVE HUMIDITY = 77.00 %  
 AVERAGE 4TH QUARTER RELATIVE HUMIDITY = 73.00 %

NOTE: PRECIPITATION DATA WAS SYNTHETICALLY GENERATED USING  
COEFFICIENTS FOR AUGUSTA GEORGIA

NORMAL MEAN MONTHLY PRECIPITATION (INCHES)

JAN/JUL	FEB/AUG	MAR/SEP	APR/OCT	MAY/NOV	JUN/DEC
4.38	3.95	4.68	2.91	3.56	4.99
5.43	5.41	3.93	3.12	2.96	3.45

NOTE: TEMPERATURE DATA WAS SYNTHETICALLY GENERATED USING  
COEFFICIENTS FOR AUGUSTA GEORGIA

NORMAL MEAN MONTHLY TEMPERATURE (DEGREES FAHRENHEIT)

JAN/JUL	FEB/AUG	MAR/SEP	APR/OCT	MAY/NOV	JUN/DEC
46.30	50.00	57.20	64.30	72.10	78.40
81.60	80.30	75.20	65.10	56.70	48.80

NOTE: SOLAR RADIATION DATA WAS SYNTHETICALLY GENERATED USING  
COEFFICIENTS FOR AUGUSTA GEORGIA  
AND STATION LATITUDE = 33.30 DEGREES

\*\*\*\*\*

AVERAGE MONTHLY VALUES IN INCHES FOR YEARS 1 THROUGH 100

	JAN/JUL	FEB/AUG	MAR/SEP	APR/OCT	MAY/NOV	JUN/DEC
PRECIPITATION						
TOTALS	4.56	3.57	4.76	2.74	3.60	4.97
	5.81	5.32	4.41	2.99	2.75	3.41
STD. DEVIATIONS	2.44	1.60	2.47	1.31	2.12	2.60
	2.83	2.95	2.54	2.28	1.72	1.90

## RUNOFF

-----

TOTALS	0.189	0.100	0.143	0.004	0.000	0.001
	0.027	0.097	0.016	0.011	0.027	0.014
STD. DEVIATIONS	0.673	0.479	0.667	0.045	0.003	0.010
	0.095	0.432	0.085	0.071	0.155	0.098

## EVAPOTRANSPIRATION

-----

TOTALS	1.580	2.099	3.102	3.578	3.662	4.148
	4.894	4.513	3.390	1.617	0.948	1.117
STD. DEVIATIONS	0.217	0.232	0.571	0.772	1.509	1.535
	1.591	1.378	1.038	0.606	0.208	0.204

## LATERAL DRAINAGE COLLECTED FROM LAYER 5

-----

TOTALS	0.7061	0.7367	0.8269	0.7617	0.6572	0.5233
	0.4857	0.4785	0.4540	0.4635	0.4519	0.5515
STD. DEVIATIONS	0.3023	0.2301	0.2274	0.2180	0.2081	0.1769
	0.1797	0.2126	0.2210	0.2388	0.2626	0.2969

## PERCOLATION/LEAKAGE THROUGH LAYER 6

-----

TOTALS	0.7497	0.8052	0.8989	0.7431	0.5188	0.3884
	0.3586	0.3771	0.3527	0.3638	0.3939	0.5051
STD. DEVIATIONS	0.5002	0.4625	0.4578	0.3925	0.2465	0.1705
	0.1638	0.2393	0.2291	0.2635	0.3650	0.3957

## LATERAL DRAINAGE COLLECTED FROM LAYER 8

-----

TOTALS	0.4184	0.5602	0.7668	0.8250	0.7772	0.5795
	0.4829	0.4148	0.3865	0.3884	0.3664	0.4091
STD. DEVIATIONS	0.3823	0.4734	0.5376	0.4609	0.3666	0.2308
	0.1663	0.1512	0.1852	0.2098	0.2339	0.3463

## PERCOLATION/LEAKAGE THROUGH LAYER 9

-----

TOTALS	0.0057	0.0055	0.0067	0.0068	0.0070	0.0064
	0.0063	0.0061	0.0059	0.0061	0.0058	0.0060
STD. DEVIATIONS	0.0014	0.0016	0.0016	0.0012	0.0008	0.0005
	0.0004	0.0005	0.0005	0.0006	0.0007	0.0009

-----  
 AVERAGES OF MONTHLY AVERAGED DAILY HEADS (INCHES)  
 -----

DAILY AVERAGE HEAD ON TOP OF LAYER 6  
 -----

AVERAGES	28.2410	33.2948	33.8990	28.9293	19.4818	15.0244
	13.4043	14.1063	13.6250	13.6019	15.2386	18.9590
STD. DEVIATIONS	18.9748	19.2312	17.3660	15.3861	9.3492	6.6842
	6.2147	9.0772	8.9794	9.9972	14.3057	15.0098

DAILY AVERAGE HEAD ON TOP OF LAYER 9  
 -----

AVERAGES	0.0345	0.0507	0.0632	0.0703	0.0641	0.0494
	0.0398	0.0342	0.0329	0.0320	0.0312	0.0337
STD. DEVIATIONS	0.0315	0.0429	0.0443	0.0393	0.0302	0.0197
	0.0137	0.0125	0.0158	0.0173	0.0199	0.0285

\*\*\*\*\*  
 \*\*\*\*\*

AVERAGE ANNUAL TOTALS & (STD. DEVIATIONS) FOR YEARS 1 THROUGH 100  
 -----

	INCHES		CU. FEET	PERCENT
	-----	-----	-----	-----
PRECIPITATION	48.90	( 7.734)	3484469.2	100.00
RUNOFF	0.630	( 1.1808)	44884.09	1.288
EVAPOTRANSPIRATION	34.647	( 3.6413)	2468838.50	70.853
LATERAL DRAINAGE COLLECTED FROM LAYER 5	7.09687	( 1.76355)	505701.156	14.51300
PERCOLATION/LEAKAGE THROUGH LAYER 6	6.45544	( 2.45320)	459994.594	13.20128
AVERAGE HEAD ON TOP OF LAYER 6	20.650	( 7.927)		
LATERAL DRAINAGE COLLECTED FROM LAYER 8	6.37531	( 2.36287)	454284.781	13.03742
PERCOLATION/LEAKAGE THROUGH LAYER 9	0.07418	( 0.00536)	5285.910	0.15170
AVERAGE HEAD ON TOP OF LAYER 9	0.045	( 0.017)		
CHANGE IN WATER STORAGE	0.077	( 3.8107)	5475.16	0.157

\*\*\*\*\*

\*\*\*\*\*

PEAK DAILY VALUES FOR YEARS	1 THROUGH	100
	(INCHES)	(CU. FT.)
PRECIPITATION	6.87	489534.875
RUNOFF	2.665	189900.2810
DRAINAGE COLLECTED FROM LAYER 5	0.03708	2642.50122
PERCOLATION/LEAKAGE THROUGH LAYER 6	0.060819	4333.77344
AVERAGE HEAD ON TOP OF LAYER 6	71.320	
MAXIMUM HEAD ON TOP OF LAYER 6	86.046	
LOCATION OF MAXIMUM HEAD IN LAYER 5 (DISTANCE FROM DRAIN)	201.3 FEET	
DRAINAGE COLLECTED FROM LAYER 8	0.06125	4364.23340
PERCOLATION/LEAKAGE THROUGH LAYER 9	0.000303	21.60339
AVERAGE HEAD ON TOP OF LAYER 9	0.157	
MAXIMUM HEAD ON TOP OF LAYER 9	0.310	
LOCATION OF MAXIMUM HEAD IN LAYER 8 (DISTANCE FROM DRAIN)	0.0 FEET	
SNOW WATER	2.36	168188.7190
MAXIMUM VEG. SOIL WATER (VOL/VOL)		0.3773
MINIMUM VEG. SOIL WATER (VOL/VOL)		0.1171

\*\*\* Maximum heads are computed using McEnroe's equations. \*\*\*

Reference: Maximum Saturated Depth over Landfill Liner  
by Bruce M. McEnroe, University of Kansas  
ASCE Journal of Environmental Engineering  
Vol. 119, No. 2, March 1993, pp. 262-270.

\*\*\*\*\*

\*\*\*\*\*

FINAL WATER STORAGE AT END OF YEAR 100

---

LAYER	( INCHES )	( VOL/VOL )
1	1.4523	0.2730
2	8.9073	0.2969
3	0.7200	0.0600
4	3.8066	0.3172
5	4.5000	0.3750
6	0.1500	0.7500
7	14.6459	0.2501
8	2.1751	0.0906
9	0.1500	0.7500
SNOW WATER	0.000	

\*\*\*\*\*  
\*\*\*\*\*

Appendix M, Lower Bounding Scenario Degraded SDF MSE Vault Closure Cap (5,600 Years): HELP Model Input Data and Output File (output file name: ZLBS7out.OUT)

Input Data:

Input Parameter (HELP Model Query)		Generic Input Parameter Value					
Landfill area =		19.63 acres					
Percent of area where runoff is possible =		100%					
Do you want to specify initial moisture storage? (Y/N)		Y					
Amount of water or snow on surface =		0 inches					
CN Input Parameter (HELP Model Query)		CN Input Parameter Value					
Slope =		3 %					
Slope length =		450 ft					
Soil Texture =		5 (HELP model default soil texture)					
Vegetation =		4 (i.e., a good stand of grass)					
HELP Model Computed Curve Number = 54.4							
Layer		Layer Number		Layer Type			
Topsoil		1		1 (vertical percolation layer)			
Upper Backfill		2		1 (vertical percolation layer)			
Erosion Barrier		3		1 (vertical percolation layer)			
Middle Backfill		4		1 (vertical percolation layer)			
Upper Drainage Layer		5		2 (lateral drainage layer)			
Upper GCL		6		3 (barrier soil liner)			
Lower Backfill		7		1 (vertical percolation layer)			
Lower Drainage Layer		8		2 (lateral drainage layer)			
Lower GCL		9		3 (barrier soil liner)			
	Layer Type	Layer Thickness (in)	Soil Texture No.	Total Porosity (Vol/Vol)	Field Capacity (Vol/Vol)	Wilting Point (Vol/Vol)	Initial Moisture (Vol/Vol)
1	1	4.880		0.4	0.11	0.058	0.11
2	1	30		0.37	0.24	0.136	0.24
3	1	12		0.06	0.056	0.052	0.056
4	1	12		0.375	0.16	0.0745	0.16
5	2	12		0.375	0.16	0.0745	0.16
6	3	0.2		0.75	0.747	0.40	0.75
7	1	58.57		0.37	0.24	0.136	0.24
8	2	24		0.353	0.102	0.0448	0.102
9	3	0.2		0.75	0.747	0.40	0.75

The lack of values in the table for particular parameters in particular layers denotes that no HELP model input was required for that parameter in that layer. No data are missing from the table.

## Input Data (continued):

	Layer Type	Sat. Hyd. Conductivity (cm/sec)	Drainage Length (ft)	Drain Slope (%)	Leachate Recirc. (%)	Recirc. to Layer (#)	Subsurface Inflow (in/yr)
1	1	1.00E-03					
2	1	1.00E-04					
3	1	3.97E-04					
4	1	3.20E-03					
5	2	3.20E-03	450	3			
6	3	5.00E-09					
7	1	1.00E-04					
8	2	8.30E-02	150	11.4			
9	3	5.00E-09					
	Layer Type	Geomembrane Pinhole Density (#/acre)	Geomembrane Instal. Defects (#/acre)	Geomembrane Placement Quality	Geotextile Transmissivity (cm <sup>2</sup> /sec)		
1	1						
2	1						
3	1						
4	1						
5	2						
6	3						
7	1						
8	2						
9	3						

The lack of values in the table for particular parameters in particular layers denotes that no HELP model input was required for that parameter in that layer. No data are missing from the table.

\* The HELP model output often produces an increased number of significant digits for the Effective Saturated Hydraulic Conductivity over that of the actual input





## LAYER 3

-----

## TYPE 1 - VERTICAL PERCOLATION LAYER

MATERIAL TEXTURE NUMBER 0

THICKNESS	=	12.00	INCHES
POROSITY	=	0.0600	VOL/VOL
FIELD CAPACITY	=	0.0560	VOL/VOL
WILTING POINT	=	0.0520	VOL/VOL
INITIAL SOIL WATER CONTENT	=	0.0560	VOL/VOL
EFFECTIVE SAT. HYD. COND.	=	0.396999996000E-03	CM/SEC

## LAYER 4

-----

## TYPE 1 - VERTICAL PERCOLATION LAYER

MATERIAL TEXTURE NUMBER 0

THICKNESS	=	12.00	INCHES
POROSITY	=	0.3750	VOL/VOL
FIELD CAPACITY	=	0.1600	VOL/VOL
WILTING POINT	=	0.0745	VOL/VOL
INITIAL SOIL WATER CONTENT	=	0.1600	VOL/VOL
EFFECTIVE SAT. HYD. COND.	=	0.319999992000E-02	CM/SEC

## LAYER 5

-----

## TYPE 2 - LATERAL DRAINAGE LAYER

MATERIAL TEXTURE NUMBER 0

THICKNESS	=	12.00	INCHES
POROSITY	=	0.3750	VOL/VOL
FIELD CAPACITY	=	0.1600	VOL/VOL
WILTING POINT	=	0.0745	VOL/VOL
INITIAL SOIL WATER CONTENT	=	0.1600	VOL/VOL
EFFECTIVE SAT. HYD. COND.	=	0.319999992000E-02	CM/SEC
SLOPE	=	3.00	PERCENT
DRAINAGE LENGTH	=	450.0	FEET

## LAYER 6

-----

## TYPE 3 - BARRIER SOIL LINER

MATERIAL TEXTURE NUMBER 0

THICKNESS	=	0.20	INCHES
POROSITY	=	0.7500	VOL/VOL
FIELD CAPACITY	=	0.7470	VOL/VOL
WILTING POINT	=	0.4000	VOL/VOL
INITIAL SOIL WATER CONTENT	=	0.7500	VOL/VOL
EFFECTIVE SAT. HYD. COND.	=	0.499999997000E-08	CM/SEC

LAYER 7

-----

TYPE 1 - VERTICAL PERCOLATION LAYER

MATERIAL TEXTURE NUMBER 0

THICKNESS = 58.57 INCHES  
 POROSITY = 0.3700 VOL/VOL  
 FIELD CAPACITY = 0.2400 VOL/VOL  
 WILTING POINT = 0.1360 VOL/VOL  
 INITIAL SOIL WATER CONTENT = 0.2400 VOL/VOL  
 EFFECTIVE SAT. HYD. COND. = 0.999999975000E-04 CM/SEC

LAYER 8

-----

TYPE 2 - LATERAL DRAINAGE LAYER

MATERIAL TEXTURE NUMBER 0

THICKNESS = 24.00 INCHES  
 POROSITY = 0.3530 VOL/VOL  
 FIELD CAPACITY = 0.1020 VOL/VOL  
 WILTING POINT = 0.0448 VOL/VOL  
 INITIAL SOIL WATER CONTENT = 0.1020 VOL/VOL  
 EFFECTIVE SAT. HYD. COND. = 0.829999968000E-01 CM/SEC  
 SLOPE = 11.40 PERCENT  
 DRAINAGE LENGTH = 150.0 FEET

LAYER 9

-----

TYPE 3 - BARRIER SOIL LINER

MATERIAL TEXTURE NUMBER 0

THICKNESS = 0.20 INCHES  
 POROSITY = 0.7500 VOL/VOL  
 FIELD CAPACITY = 0.7470 VOL/VOL  
 WILTING POINT = 0.4000 VOL/VOL  
 INITIAL SOIL WATER CONTENT = 0.7500 VOL/VOL  
 EFFECTIVE SAT. HYD. COND. = 0.499999997000E-08 CM/SEC

GENERAL DESIGN AND EVAPORATIVE ZONE DATA

-----

NOTE: SCS RUNOFF CURVE NUMBER WAS COMPUTED FROM DEFAULT SOIL DATA BASE USING SOIL TEXTURE # 5 WITH A GOOD STAND OF GRASS, A SURFACE SLOPE OF 3.% AND A SLOPE LENGTH OF 450. FEET.

SCS RUNOFF CURVE NUMBER = 54.40  
 FRACTION OF AREA ALLOWING RUNOFF = 100.0 PERCENT  
 AREA PROJECTED ON HORIZONTAL PLANE = 19.630 ACRES  
 EVAPORATIVE ZONE DEPTH = 22.0 INCHES  
 INITIAL WATER IN EVAPORATIVE ZONE = 4.646 INCHES  
 UPPER LIMIT OF EVAPORATIVE STORAGE = 8.286 INCHES  
 LOWER LIMIT OF EVAPORATIVE STORAGE = 2.611 INCHES  
 INITIAL SNOW WATER = 0.000 INCHES  
 INITIAL WATER IN LAYER MATERIALS = 29.054 INCHES  
 TOTAL INITIAL WATER = 29.054 INCHES  
 TOTAL SUBSURFACE INFLOW = 0.00 INCHES/YEAR

EVAPOTRANSPIRATION AND WEATHER DATA

NOTE: EVAPOTRANSPIRATION DATA WAS OBTAINED FROM  
AUGUSTA GEORGIA

STATION LATITUDE = 33.22 DEGREES  
 MAXIMUM LEAF AREA INDEX = 3.50  
 START OF GROWING SEASON (JULIAN DATE) = 68  
 END OF GROWING SEASON (JULIAN DATE) = 323  
 EVAPORATIVE ZONE DEPTH = 22.0 INCHES  
 AVERAGE ANNUAL WIND SPEED = 6.50 MPH  
 AVERAGE 1ST QUARTER RELATIVE HUMIDITY = 68.00 %  
 AVERAGE 2ND QUARTER RELATIVE HUMIDITY = 70.00 %  
 AVERAGE 3RD QUARTER RELATIVE HUMIDITY = 77.00 %  
 AVERAGE 4TH QUARTER RELATIVE HUMIDITY = 73.00 %

NOTE: PRECIPITATION DATA WAS SYNTHETICALLY GENERATED USING  
COEFFICIENTS FOR AUGUSTA GEORGIA

NORMAL MEAN MONTHLY PRECIPITATION (INCHES)

JAN/JUL	FEB/AUG	MAR/SEP	APR/OCT	MAY/NOV	JUN/DEC
4.38	3.95	4.68	2.91	3.56	4.99
5.43	5.41	3.93	3.12	2.96	3.45

NOTE: TEMPERATURE DATA WAS SYNTHETICALLY GENERATED USING  
COEFFICIENTS FOR AUGUSTA GEORGIA

NORMAL MEAN MONTHLY TEMPERATURE (DEGREES FAHRENHEIT)

JAN/JUL	FEB/AUG	MAR/SEP	APR/OCT	MAY/NOV	JUN/DEC
46.30	50.00	57.20	64.30	72.10	78.40
81.60	80.30	75.20	65.10	56.70	48.80

NOTE: SOLAR RADIATION DATA WAS SYNTHETICALLY GENERATED USING  
COEFFICIENTS FOR AUGUSTA GEORGIA  
AND STATION LATITUDE = 33.30 DEGREES

\*\*\*\*\*

AVERAGE MONTHLY VALUES IN INCHES FOR YEARS 1 THROUGH 100

	JAN/JUL	FEB/AUG	MAR/SEP	APR/OCT	MAY/NOV	JUN/DEC
PRECIPITATION						
TOTALS	4.56	3.57	4.76	2.74	3.60	4.97
	5.81	5.32	4.41	2.99	2.75	3.41
STD. DEVIATIONS	2.44	1.60	2.47	1.31	2.12	2.60
	2.83	2.95	2.54	2.28	1.72	1.90

## RUNOFF

-----

TOTALS	0.199	0.104	0.146	0.005	0.000	0.001
	0.028	0.098	0.017	0.011	0.029	0.014
STD. DEVIATIONS	0.695	0.489	0.677	0.052	0.002	0.009
	0.100	0.439	0.084	0.074	0.167	0.101

## EVAPOTRANSPIRATION

-----

TOTALS	1.582	2.102	3.113	3.587	3.646	4.143
	4.892	4.511	3.390	1.615	0.949	1.119
STD. DEVIATIONS	0.216	0.231	0.569	0.781	1.507	1.531
	1.590	1.378	1.040	0.605	0.209	0.202

## LATERAL DRAINAGE COLLECTED FROM LAYER 5

-----

TOTALS	0.7063	0.7361	0.8265	0.7595	0.6533	0.5203
	0.4842	0.4777	0.4534	0.4639	0.4518	0.5529
STD. DEVIATIONS	0.3008	0.2294	0.2269	0.2185	0.2080	0.1763
	0.1797	0.2131	0.2218	0.2402	0.2624	0.2965

## PERCOLATION/LEAKAGE THROUGH LAYER 6

-----

TOTALS	0.7488	0.8038	0.8968	0.7385	0.5134	0.3868
	0.3586	0.3767	0.3524	0.3664	0.3938	0.5057
STD. DEVIATIONS	0.4978	0.4592	0.4533	0.3883	0.2423	0.1701
	0.1663	0.2394	0.2293	0.2676	0.3641	0.3937

## LATERAL DRAINAGE COLLECTED FROM LAYER 8

-----

TOTALS	0.4021	0.5292	0.7519	0.8185	0.7929	0.5999
	0.4972	0.4223	0.3855	0.3881	0.3652	0.4071
STD. DEVIATIONS	0.3726	0.4574	0.5398	0.4611	0.3740	0.2382
	0.1718	0.1527	0.1810	0.2105	0.2328	0.3431

## PERCOLATION/LEAKAGE THROUGH LAYER 9

-----

TOTALS	0.0058	0.0056	0.0068	0.0070	0.0072	0.0065
	0.0064	0.0062	0.0060	0.0061	0.0059	0.0061
STD. DEVIATIONS	0.0015	0.0017	0.0017	0.0013	0.0009	0.0006
	0.0005	0.0006	0.0005	0.0007	0.0007	0.0010

-----  
 AVERAGES OF MONTHLY AVERAGED DAILY HEADS (INCHES)  
 -----

DAILY AVERAGE HEAD ON TOP OF LAYER 6  
 -----

AVERAGES	28.2053	33.2354	33.8176	28.7483	19.2768	14.9615
	13.4026	14.0891	13.6130	13.7003	15.2351	18.9832
STD. DEVIATIONS	18.8840	19.0935	17.1958	15.2203	9.1923	6.6687
	6.3077	9.0808	8.9881	10.1493	14.2708	14.9333

DAILY AVERAGE HEAD ON TOP OF LAYER 9  
 -----

AVERAGES	0.0367	0.0531	0.0687	0.0773	0.0725	0.0566
	0.0454	0.0386	0.0364	0.0355	0.0345	0.0372
STD. DEVIATIONS	0.0340	0.0460	0.0493	0.0435	0.0342	0.0225
	0.0157	0.0140	0.0171	0.0192	0.0220	0.0314

\*\*\*\*\*  
 \*\*\*\*\*

AVERAGE ANNUAL TOTALS & (STD. DEVIATIONS) FOR YEARS 1 THROUGH 100  
 -----

	INCHES		CU. FEET	PERCENT
PRECIPITATION	48.90	( 7.734)	3484469.2	100.00
RUNOFF	0.653	( 1.2111)	46552.36	1.336
EVAPOTRANSPIRATION	34.649	( 3.6322)	2468960.50	70.856
LATERAL DRAINAGE COLLECTED FROM LAYER 5	7.08591	( 1.76126)	504920.219	14.49059
PERCOLATION/LEAKAGE THROUGH LAYER 6	6.44166	( 2.44030)	459012.531	13.17310
AVERAGE HEAD ON TOP OF LAYER 6	20.606	( 7.885)		
LATERAL DRAINAGE COLLECTED FROM LAYER 8	6.35997	( 2.34966)	453192.062	13.00606
PERCOLATION/LEAKAGE THROUGH LAYER 9	0.07568	( 0.00583)	5392.924	0.15477
AVERAGE HEAD ON TOP OF LAYER 9	0.049	( 0.018)		
CHANGE IN WATER STORAGE	0.076	( 3.8352)	5451.10	0.156

\*\*\*\*\*

\*\*\*\*\*

PEAK DAILY VALUES FOR YEARS		1 THROUGH	100
		(INCHES)	(CU. FT.)
PRECIPITATION		6.87	489534.875
RUNOFF		2.694	191971.8440
DRAINAGE COLLECTED FROM LAYER	5	0.03685	2625.91138
PERCOLATION/LEAKAGE THROUGH LAYER	6	0.060445	4307.11182
AVERAGE HEAD ON TOP OF LAYER	6	70.880	
MAXIMUM HEAD ON TOP OF LAYER	6	85.565	
LOCATION OF MAXIMUM HEAD IN LAYER	5	200.8 FEET	
	(DISTANCE FROM DRAIN)		
DRAINAGE COLLECTED FROM LAYER	8	0.06089	4338.53662
PERCOLATION/LEAKAGE THROUGH LAYER	9	0.000317	22.56991
AVERAGE HEAD ON TOP OF LAYER	9	0.172	
MAXIMUM HEAD ON TOP OF LAYER	9	0.343	
LOCATION OF MAXIMUM HEAD IN LAYER	8	0.0 FEET	
	(DISTANCE FROM DRAIN)		
SNOW WATER		2.36	168188.7190
MAXIMUM VEG. SOIL WATER (VOL/VOL)			0.3767
MINIMUM VEG. SOIL WATER (VOL/VOL)			0.1187

\*\*\* Maximum heads are computed using McEnroe's equations. \*\*\*

Reference: Maximum Saturated Depth over Landfill Liner  
 by Bruce M. McEnroe, University of Kansas  
 ASCE Journal of Environmental Engineering  
 Vol. 119, No. 2, March 1993, pp. 262-270.

\*\*\*\*\*

\*\*\*\*\*

FINAL WATER STORAGE AT END OF YEAR 100

LAYER	( INCHES )	( VOL/VOL )
1	1.4151	0.2900
2	9.0114	0.3004
3	0.6720	0.0560
4	3.7003	0.3084
5	4.5000	0.3750
6	0.1500	0.7500
7	14.6508	0.2501
8	2.4539	0.1022
9	0.1500	0.7500
SNOW WATER	0.000	

\*\*\*\*\*  
\*\*\*\*\*

Appendix N, Lower Bounding Scenario Degraded SDF MSE Vault Closure Cap (10,000 Years): HELP Model Input Data and Output File (output file name: ZLBS8out.OUT)

Input Data:

Input Parameter (HELP Model Query)		Generic Input Parameter Value						
Landfill area =		19.63 acres						
Percent of area where runoff is possible =		100%						
Do you want to specify initial moisture storage? (Y/N)		Y						
Amount of water or snow on surface =		0 inches						
CN Input Parameter (HELP Model Query)		CN Input Parameter Value						
Slope =		3 %						
Slope length =		450 ft						
Soil Texture =		5 (HELP model default soil texture)						
Vegetation =		4 (i.e., a good stand of grass)						
HELP Model Computed Curve Number = 54.4								
Layer			Layer Number			Layer Type		
Topsoil			1			1 (vertical percolation layer)		
Upper Backfill			2			1 (vertical percolation layer)		
Erosion Barrier			3			1 (vertical percolation layer)		
Middle Backfill			4			1 (vertical percolation layer)		
Upper Drainage Layer			5			2 (lateral drainage layer)		
Upper GCL			6			3 (barrier soil liner)		
Lower Backfill			7			1 (vertical percolation layer)		
Lower Drainage Layer			8			2 (lateral drainage layer)		
Lower GCL			9			3 (barrier soil liner)		
	Layer Type	Layer Thickness (in)	Soil Texture No.	Total Porosity (Vol/Vol)	Field Capacity (Vol/Vol)	Wilting Point (Vol/Vol)	Initial Moisture (Vol/Vol)	
1	1	4.0		0.4	0.11	0.058	0.11	
2	1	30		0.37	0.24	0.136	0.24	
3	1	12		0.06	0.056	0.052	0.056	
4	1	12		0.375	0.16	0.0745	0.16	
5	2	12		0.375	0.16	0.0745	0.16	
6	3	0.2		0.75	0.747	0.40	0.75	
7	1	58.57		0.37	0.24	0.136	0.24	
8	2	24		0.324	0.125	0.0779	0.125	
9	3	0.2		0.75	0.747	0.40	0.75	

The lack of values in the table for particular parameters in particular layers denotes that no HELP model input was required for that parameter in that layer. No data are missing from the table.



## Input Data (continued):

	Layer Type	Sat. Hyd. Conductivity * (cm/sec)	Drainage Length (ft)	Drain Slope (%)	Leachate Recirc. (%)	Recirc. to Layer (#)	Subsurface Inflow (in/yr)
1	1	1.00E-03					
2	1	1.00E-04					
3	1	3.97E-04					
4	1	3.20E-03					
5	2	3.20E-03	450	3			
6	3	5.00E-09					
7	1	1.00E-04					
8	2	6.53E-02	150	11.4			
9	3	5.00E-09					
	Layer Type	Geomembrane Pinhole Density (#/acre)	Geomembrane Instal. Defects (#/acre)	Geomembrane Placement Quality	Geotextile Transmissivity (cm <sup>2</sup> /sec)		
1	1						
2	1						
3	1						
4	1						
5	2						
6	3						
7	1						
8	2						
9	3						

The lack of values in the table for particular parameters in particular layers denotes that no HELP model input was required for that parameter in that layer. No data are missing from the table.

\* The HELP model output often produces an increased number of significant digits for the Effective Saturated Hydraulic Conductivity over that of the actual input

```

*****
*****
**
**
**          HYDROLOGIC EVALUATION OF LANDFILL PERFORMANCE          **
**          HELP MODEL VERSION 3.07  (1 NOVEMBER 1997)              **
**          DEVELOPED BY ENVIRONMENTAL LABORATORY                    **
**          USAE WATERWAYS EXPERIMENT STATION                       **
**          FOR USEPA RISK REDUCTION ENGINEERING LABORATORY         **
**
**
*****
*****

```

```

PRECIPITATION DATA FILE:   D:\HELP3\Hweather\ZPREC.D4
TEMPERATURE DATA FILE:    D:\HELP3\Hweather\ZTEMP.D7
SOLAR RADIATION DATA FILE: D:\HELP3\Hweather\ZSOLAR.D13
EVAPOTRANSPIRATION DATA:  D:\HELP3\Hweather\ZEVAP.D11
SOIL AND DESIGN DATA FILE: D:\HELP3\Hsdfmse\ZLBS8.D10
OUTPUT DATA FILE:         D:\HELP3\Hsdfmse\ZLBS8out.OUT

```

TIME: 15:12      DATE: 12/11/2003

```

*****
TITLE:  LBS Degraded MSE Vault Closure Cap - 10,000 Years
*****

```

NOTE: INITIAL MOISTURE CONTENT OF THE LAYERS AND SNOW WATER WERE SPECIFIED BY THE USER.

LAYER 1  
-----

```

TYPE 1 - VERTICAL PERCOLATION LAYER
MATERIAL TEXTURE NUMBER 0
THICKNESS                = 4.00 INCHES
POROSITY                  = 0.4000 VOL/VOL
FIELD CAPACITY            = 0.1100 VOL/VOL
WILTING POINT             = 0.0580 VOL/VOL
INITIAL SOIL WATER CONTENT = 0.1100 VOL/VOL
EFFECTIVE SAT. HYD. COND. = 0.100000005000E-02 CM/SEC

```

LAYER 2  
-----

```

TYPE 1 - VERTICAL PERCOLATION LAYER
MATERIAL TEXTURE NUMBER 0
THICKNESS                = 30.00 INCHES
POROSITY                  = 0.3700 VOL/VOL
FIELD CAPACITY            = 0.2400 VOL/VOL
WILTING POINT             = 0.1360 VOL/VOL
INITIAL SOIL WATER CONTENT = 0.2400 VOL/VOL
EFFECTIVE SAT. HYD. COND. = 0.999999975000E-04 CM/SEC

```

## LAYER 3

-----

## TYPE 1 - VERTICAL PERCOLATION LAYER

MATERIAL TEXTURE NUMBER 0

THICKNESS	=	12.00	INCHES
POROSITY	=	0.0600	VOL/VOL
FIELD CAPACITY	=	0.0560	VOL/VOL
WILTING POINT	=	0.0520	VOL/VOL
INITIAL SOIL WATER CONTENT	=	0.0560	VOL/VOL
EFFECTIVE SAT. HYD. COND.	=	0.396999996000E-03	CM/SEC

## LAYER 4

-----

## TYPE 1 - VERTICAL PERCOLATION LAYER

MATERIAL TEXTURE NUMBER 0

THICKNESS	=	12.00	INCHES
POROSITY	=	0.3750	VOL/VOL
FIELD CAPACITY	=	0.1600	VOL/VOL
WILTING POINT	=	0.0745	VOL/VOL
INITIAL SOIL WATER CONTENT	=	0.1600	VOL/VOL
EFFECTIVE SAT. HYD. COND.	=	0.319999992000E-02	CM/SEC

## LAYER 5

-----

## TYPE 2 - LATERAL DRAINAGE LAYER

MATERIAL TEXTURE NUMBER 0

THICKNESS	=	12.00	INCHES
POROSITY	=	0.3750	VOL/VOL
FIELD CAPACITY	=	0.1600	VOL/VOL
WILTING POINT	=	0.0745	VOL/VOL
INITIAL SOIL WATER CONTENT	=	0.1600	VOL/VOL
EFFECTIVE SAT. HYD. COND.	=	0.319999992000E-02	CM/SEC
SLOPE	=	3.00	PERCENT
DRAINAGE LENGTH	=	450.0	FEET

## LAYER 6

-----

## TYPE 3 - BARRIER SOIL LINER

MATERIAL TEXTURE NUMBER 0

THICKNESS	=	0.20	INCHES
POROSITY	=	0.7500	VOL/VOL
FIELD CAPACITY	=	0.7470	VOL/VOL
WILTING POINT	=	0.4000	VOL/VOL
INITIAL SOIL WATER CONTENT	=	0.7500	VOL/VOL
EFFECTIVE SAT. HYD. COND.	=	0.499999997000E-08	CM/SEC

LAYER 7

-----

TYPE 1 - VERTICAL PERCOLATION LAYER

MATERIAL TEXTURE NUMBER 0

THICKNESS = 58.57 INCHES  
 POROSITY = 0.3700 VOL/VOL  
 FIELD CAPACITY = 0.2400 VOL/VOL  
 WILTING POINT = 0.1360 VOL/VOL  
 INITIAL SOIL WATER CONTENT = 0.2400 VOL/VOL  
 EFFECTIVE SAT. HYD. COND. = 0.999999975000E-04 CM/SEC

LAYER 8

-----

TYPE 2 - LATERAL DRAINAGE LAYER

MATERIAL TEXTURE NUMBER 0

THICKNESS = 24.00 INCHES  
 POROSITY = 0.3240 VOL/VOL  
 FIELD CAPACITY = 0.1250 VOL/VOL  
 WILTING POINT = 0.0779 VOL/VOL  
 INITIAL SOIL WATER CONTENT = 0.1250 VOL/VOL  
 EFFECTIVE SAT. HYD. COND. = 0.653000027000E-01 CM/SEC  
 SLOPE = 11.40 PERCENT  
 DRAINAGE LENGTH = 150.0 FEET

LAYER 9

-----

TYPE 3 - BARRIER SOIL LINER

MATERIAL TEXTURE NUMBER 0

THICKNESS = 0.20 INCHES  
 POROSITY = 0.7500 VOL/VOL  
 FIELD CAPACITY = 0.7470 VOL/VOL  
 WILTING POINT = 0.4000 VOL/VOL  
 INITIAL SOIL WATER CONTENT = 0.7500 VOL/VOL  
 EFFECTIVE SAT. HYD. COND. = 0.499999997000E-08 CM/SEC

GENERAL DESIGN AND EVAPORATIVE ZONE DATA

-----

NOTE: SCS RUNOFF CURVE NUMBER WAS COMPUTED FROM DEFAULT SOIL DATA BASE USING SOIL TEXTURE # 5 WITH A GOOD STAND OF GRASS, A SURFACE SLOPE OF 3.% AND A SLOPE LENGTH OF 450. FEET.

SCS RUNOFF CURVE NUMBER = 54.40  
 FRACTION OF AREA ALLOWING RUNOFF = 100.0 PERCENT  
 AREA PROJECTED ON HORIZONTAL PLANE = 19.630 ACRES  
 EVAPORATIVE ZONE DEPTH = 22.0 INCHES  
 INITIAL WATER IN EVAPORATIVE ZONE = 4.760 INCHES  
 UPPER LIMIT OF EVAPORATIVE STORAGE = 8.260 INCHES  
 LOWER LIMIT OF EVAPORATIVE STORAGE = 2.680 INCHES  
 INITIAL SNOW WATER = 0.000 INCHES  
 INITIAL WATER IN LAYER MATERIALS = 29.509 INCHES  
 TOTAL INITIAL WATER = 29.509 INCHES  
 TOTAL SUBSURFACE INFLOW = 0.00 INCHES/YEAR

EVAPOTRANSPIRATION AND WEATHER DATA

NOTE: EVAPOTRANSPIRATION DATA WAS OBTAINED FROM  
AUGUSTA GEORGIA

STATION LATITUDE = 33.22 DEGREES  
 MAXIMUM LEAF AREA INDEX = 3.50  
 START OF GROWING SEASON (JULIAN DATE) = 68  
 END OF GROWING SEASON (JULIAN DATE) = 323  
 EVAPORATIVE ZONE DEPTH = 22.0 INCHES  
 AVERAGE ANNUAL WIND SPEED = 6.50 MPH  
 AVERAGE 1ST QUARTER RELATIVE HUMIDITY = 68.00 %  
 AVERAGE 2ND QUARTER RELATIVE HUMIDITY = 70.00 %  
 AVERAGE 3RD QUARTER RELATIVE HUMIDITY = 77.00 %  
 AVERAGE 4TH QUARTER RELATIVE HUMIDITY = 73.00 %

NOTE: PRECIPITATION DATA WAS SYNTHETICALLY GENERATED USING  
COEFFICIENTS FOR AUGUSTA GEORGIA

NORMAL MEAN MONTHLY PRECIPITATION (INCHES)

JAN/JUL	FEB/AUG	MAR/SEP	APR/OCT	MAY/NOV	JUN/DEC
4.38	3.95	4.68	2.91	3.56	4.99
5.43	5.41	3.93	3.12	2.96	3.45

NOTE: TEMPERATURE DATA WAS SYNTHETICALLY GENERATED USING  
COEFFICIENTS FOR AUGUSTA GEORGIA

NORMAL MEAN MONTHLY TEMPERATURE (DEGREES FAHRENHEIT)

JAN/JUL	FEB/AUG	MAR/SEP	APR/OCT	MAY/NOV	JUN/DEC
46.30	50.00	57.20	64.30	72.10	78.40
81.60	80.30	75.20	65.10	56.70	48.80

NOTE: SOLAR RADIATION DATA WAS SYNTHETICALLY GENERATED USING  
COEFFICIENTS FOR AUGUSTA GEORGIA  
AND STATION LATITUDE = 33.30 DEGREES

\*\*\*\*\*

AVERAGE MONTHLY VALUES IN INCHES FOR YEARS 1 THROUGH 100

	JAN/JUL	FEB/AUG	MAR/SEP	APR/OCT	MAY/NOV	JUN/DEC
PRECIPITATION						
TOTALS	4.56	3.57	4.76	2.74	3.60	4.97
	5.81	5.32	4.41	2.99	2.75	3.41
STD. DEVIATIONS	2.44	1.60	2.47	1.31	2.12	2.60
	2.83	2.95	2.54	2.28	1.72	1.90

## RUNOFF

-----

TOTALS	0.219	0.114	0.156	0.007	0.000	0.003
	0.035	0.109	0.019	0.017	0.033	0.016
STD. DEVIATIONS	0.739	0.514	0.696	0.066	0.003	0.018
	0.119	0.464	0.089	0.098	0.188	0.115

## EVAPOTRANSPIRATION

-----

TOTALS	1.584	2.108	3.140	3.612	3.609	4.134
	4.884	4.501	3.380	1.616	0.950	1.120
STD. DEVIATIONS	0.215	0.228	0.564	0.782	1.515	1.533
	1.589	1.384	1.041	0.605	0.210	0.203

## LATERAL DRAINAGE COLLECTED FROM LAYER 5

-----

TOTALS	0.7082	0.7352	0.8236	0.7552	0.6466	0.5160
	0.4821	0.4779	0.4540	0.4640	0.4523	0.5537
STD. DEVIATIONS	0.2980	0.2269	0.2258	0.2175	0.2065	0.1756
	0.1805	0.2132	0.2211	0.2408	0.2613	0.2968

## PERCOLATION/LEAKAGE THROUGH LAYER 6

-----

TOTALS	0.7491	0.7978	0.8870	0.7266	0.5032	0.3823
	0.3560	0.3762	0.3522	0.3677	0.3929	0.5054
STD. DEVIATIONS	0.4923	0.4514	0.4462	0.3795	0.2321	0.1673
	0.1627	0.2382	0.2268	0.2690	0.3590	0.3908

## LATERAL DRAINAGE COLLECTED FROM LAYER 8

-----

TOTALS	0.4173	0.5182	0.7265	0.7998	0.7744	0.5897
	0.4941	0.4211	0.3873	0.3888	0.3704	0.4195
STD. DEVIATIONS	0.3557	0.4362	0.5367	0.4572	0.3722	0.2297
	0.1645	0.1459	0.1761	0.2009	0.2239	0.3274

## PERCOLATION/LEAKAGE THROUGH LAYER 9

-----

TOTALS	0.0064	0.0061	0.0072	0.0074	0.0076	0.0069
	0.0067	0.0065	0.0062	0.0064	0.0062	0.0065
STD. DEVIATIONS	0.0012	0.0015	0.0019	0.0015	0.0013	0.0009
	0.0008	0.0007	0.0006	0.0006	0.0007	0.0010

-----  
 AVERAGES OF MONTHLY AVERAGED DAILY HEADS (INCHES)  
 -----

DAILY AVERAGE HEAD ON TOP OF LAYER 6  
 -----

AVERAGES	28.2173	32.9866	33.4489	28.2828	18.8872	14.7858
	13.3038	14.0691	13.6039	13.7477	15.2020	18.9731
STD. DEVIATIONS	18.6747	18.7677	16.9263	14.8758	8.8037	6.5536
	6.1715	9.0357	8.8889	10.2054	14.0708	14.8230

DAILY AVERAGE HEAD ON TOP OF LAYER 9  
 -----

AVERAGES	0.0485	0.0661	0.0844	0.0960	0.0899	0.0708
	0.0574	0.0489	0.0465	0.0452	0.0445	0.0487
STD. DEVIATIONS	0.0413	0.0558	0.0623	0.0549	0.0432	0.0276
	0.0191	0.0169	0.0211	0.0233	0.0269	0.0380

\*\*\*\*\*  
 \*\*\*\*\*

AVERAGE ANNUAL TOTALS & (STD. DEVIATIONS) FOR YEARS 1 THROUGH 100  
 -----

	INCHES		CU. FEET	PERCENT
PRECIPITATION	48.90	( 7.734)	3484469.2	100.00
RUNOFF	0.727	( 1.2877)	51799.17	1.487
EVAPOTRANSPIRATION	34.638	( 3.6111)	2468202.50	70.834
LATERAL DRAINAGE COLLECTED FROM LAYER 5	7.06888	( 1.74841)	503706.125	14.45575
PERCOLATION/LEAKAGE THROUGH LAYER 6	6.39636	( 2.39499)	455784.531	13.08046
AVERAGE HEAD ON TOP OF LAYER 6	20.459	( 7.737)		
LATERAL DRAINAGE COLLECTED FROM LAYER 8	6.30706	( 2.29410)	449421.781	12.89785
PERCOLATION/LEAKAGE THROUGH LAYER 9	0.08019	( 0.00749)	5714.427	0.16400
AVERAGE HEAD ON TOP OF LAYER 9	0.062	( 0.023)		
CHANGE IN WATER STORAGE	0.079	( 3.8209)	5626.00	0.161

\*\*\*\*\*

\*\*\*\*\*

PEAK DAILY VALUES FOR YEARS	1 THROUGH	100
	(INCHES)	(CU. FT.)
PRECIPITATION	6.87	489534.875
RUNOFF	2.802	199632.0160
DRAINAGE COLLECTED FROM LAYER 5	0.03639	2592.87378
PERCOLATION/LEAKAGE THROUGH LAYER 6	0.059697	4253.78760
AVERAGE HEAD ON TOP OF LAYER 6	70.000	
MAXIMUM HEAD ON TOP OF LAYER 6	84.603	
LOCATION OF MAXIMUM HEAD IN LAYER 5 (DISTANCE FROM DRAIN)	199.8 FEET	
DRAINAGE COLLECTED FROM LAYER 8	0.06027	4294.41650
PERCOLATION/LEAKAGE THROUGH LAYER 9	0.000355	25.26759
AVERAGE HEAD ON TOP OF LAYER 9	0.217	
MAXIMUM HEAD ON TOP OF LAYER 9	0.429	
LOCATION OF MAXIMUM HEAD IN LAYER 8 (DISTANCE FROM DRAIN)	0.0 FEET	
SNOW WATER	2.36	168188.7190
MAXIMUM VEG. SOIL WATER (VOL/VOL)		0.3755
MINIMUM VEG. SOIL WATER (VOL/VOL)		0.1218

\*\*\* Maximum heads are computed using McEnroe's equations. \*\*\*

Reference: Maximum Saturated Depth over Landfill Liner  
by Bruce M. McEnroe, University of Kansas  
ASCE Journal of Environmental Engineering  
Vol. 119, No. 2, March 1993, pp. 262-270.

\*\*\*\*\*



\*\*\*\*\*

FINAL WATER STORAGE AT END OF YEAR 100

LAYER	( INCHES )	( VOL/VOL )
1	1.1692	0.2923
2	9.0112	0.3004
3	0.6720	0.0560
4	3.7853	0.3154
5	4.5000	0.3750
6	0.1500	0.7500
7	14.6568	0.2502
8	3.3096	0.1379
9	0.1500	0.7500
SNOW WATER	0.000	

\*\*\*\*\*  
\*\*\*\*\*

**Appendix O, SDF MSE Vault Closure Cap Degraded Property Value Calculations for Upper Bounding Scenario (i.e. Institutional Control to Farm to Pine Forest)**

The MSE vault closure cap initial (0 year) layer thickness and hydraulic property values from top to bottom are provided in Table 3.1-1. The degradation scenarios for each layer are provided in Table 4.4-2. Based upon the Table 4.4-2 degradation scenarios, the Table 3.1-1 initial SDF closure cap layer thickness and hydraulic property values have been modified to account for degradation at 100, 154, 300, 550, 602, 802, 1,000, 1,800, 3,400, 5,600 and 10,000 years after closure of the SDF.

**Topsoil and Upper Backfill Layer Thickness:**

From Section 4.2 the soil loss in terms of depth of loss per year for the topsoil was estimated to be 2.0E-04 inches/year with bamboo and 0.11 inches/year with corn. For the backfill it was estimated to be 1.2E-04 inches/year with bamboo and 0.067 inches/year with corn.

**Topsoil / Upper Backfill Thickness Over Time Calculation:**

Year	Vegetation	Topsoil / Upper Backfill Thickness
0	bamboo	6" – (0 years × 2.0E-04 inches/year) = 6" / 30"
100	bamboo	6" – (100 years × 2.0E-04 inches/year) = 5.980" / 30"
How long does it take for the topsoil to be completely eroded away with corn which is assumed to be planted immediately after the 100 year institutional control period has ended: 5.980" ÷ 0.11 inches/year = 54 years 100 years + 54 years = 154 years		
154	corn	0" / 30"
How long does it take for the upper backfill to be completely eroded away with corn which is assumed to be planted immediately after the 100 year institutional control period has ended: 30" ÷ 0.067 inches/year = 448 years 154 years + 448 years = 602 years		
300	corn	0" / 30" – ((300 years – 154 years) × 0.067 inches/year) = 20.218"
550	corn	0" / 30" – ((550 years – 154 years) × 0.067 inches/year) = 3.468"
602	corn	0" / 0"
802	pine trees	0" / 0"
1,000	pine trees	0" / 0"
1,800	pine trees	0" / 0"
3,400	pine trees	0" / 0"
5,600	pine trees	0" / 0"
10,000	pine trees	0" / 0"

**Erosion Barrier Hydraulic Properties:**

As outlined in Phifer and Nelson 2003, the erosion barrier is assumed to consist of a one foot thick layer of 2-inch to 6-inch granite stone whose voids are filled with a Controlled Low Strength Material (CLSM) or flowable fill. Maintenance during the institutional control period and farming practices during corn farming prevent degradation of the erosion control barrier. Subsequent to the institutional control period and corn farming, pine forest succession will result in root penetration through the erosion control barrier. This does not impact its ability to function as an erosion barrier. For this scenario pine forest succession occurs after all of the topsoil and upper backfill have been completely eroded, therefore the upper backfill is not available to fill holes in the erosion barrier after the roots decompose. However it will be assumed that root penetration breaks up the flowable fill and separates it from the granite stone. After the root decomposes it will be assumed that segregation of the granite stone and broken up flowable fill occurs, resulting in the flowable fill at the bottom of the hole and the granite stone at the top. For the purposes of this calculation the properties of the broken up flowable fill will be ignored. Therefore will assume that the degraded barrier consists of intact erosion barrier with holes filled with the granite stone.

The following are the assumed properties of the intact erosion barrier and granite stone:

Material	K	N	FC	WP
Intact erosion barrier <sup>1</sup>	3.97E-04	0.06	0.056	0.052
Granite stone <sup>2</sup>	3.0E-01	0.397	0.032	0.013

<sup>1</sup> Phifer and Nelson 2003

<sup>2</sup> USEPA 1994a and USEPA 1994b

From Section 4.1 the following assumptions relative to pine forest succession that impact the erosion barrier hydraulic properties were made:

- 200 years after the end of farming it is assumed that the entire cap is dominated by pine (i.e. 400 mature trees per acre).
- Complete turnover of the 400 mature trees per acre occurs every 100 years (in a staggered manner).
- There are 400 mature trees per acre with 4 roots to 6 feet and 1 root to 12 feet. The roots are 3 inches in diameter at a depth of 1 foot and 0.25 inches in diameter at either 6 or 12 feet, whichever is applicable.

Area of holes in erosion barrier due to root penetration:

Average Erosion Barrier Depth after topsoil and upper backfill completely eroded (see Table 3.1-1):

$$\text{Average depth} = \frac{1}{2}(12'') = 6'' \approx 0.5'$$

Root Diameter for 4-6' roots at 0.5':

$$3'' \text{ diameter at } 1' \text{ depth and } 0.25'' \text{ at } 6'$$

$$(3'' - 0.25'') / (6' - 1') = 0.55'' / ft$$

$$\text{Diameter} = 3'' + (0.5' \times 0.55''/ft) = 3.275''$$

Area of for 4-6' roots at 0.5':

$$\text{Area} = 4 \times \frac{1}{4}\pi D^2 = \pi D^2 = \pi(3.275'')^2 = 33.7 \text{ in}^2$$

Root Diameter for 1-12' root at 0.5':

$$3'' \text{ diameter at } 1' \text{ depth and } 0.25'' \text{ at } 12'$$

$$(3'' - 0.25'') / (12' - 1') = 0.25'' / ft$$

$$\text{Diameter} = 3'' + (0.5' \times 0.25''/ft) = 3.125''$$

Area of for 1-12' roots at 0.5':

$$\text{Area} = \frac{1}{4}\pi D^2 = \frac{1}{4}\pi(3.125'')^2 = 7.7 \text{ in}^2$$

Total area of holes in erosion barrier per tree:

$$\text{Total area} = 33.7 \text{ in}^2 + 7.7 \text{ in}^2 = 41.4 \text{ in}^2 \times ft^2/144 \text{ in}^2 \approx 0.29 \text{ ft}^2/\text{tree}$$

Total area of holes per acre per 100 years:

$$400 \text{ trees/acre}/100 \text{ years}$$

$$\text{Total area} = 0.29 \text{ ft}^2/\text{tree} \times 400 \text{ trees/acre}/100 \text{ years} = 116 \text{ ft}^2/\text{acre}/100 \text{ years}$$

Year	Vegetation	Area of holes in erosion barrier / acre
0	Bamboo	0
100	Bamboo	0
154	Corn	0
300	Corn	0
550	Corn	0
602	Corn	0
802 <sup>1</sup>	Pine trees	116 ft <sup>2</sup> / acre
1,000	Pine trees	116 ft <sup>2</sup> / acre + [(1000 yrs – 802 yrs) × 116 ft <sup>2</sup> / acre/100 years] = 346 ft <sup>2</sup> / acre
1,800	Pine trees	116 ft <sup>2</sup> / acre + [(1800 yrs – 802 yrs) × 116 ft <sup>2</sup> / acre/100 years] = 1274 ft <sup>2</sup> / acre
3,400	Pine trees	116 ft <sup>2</sup> / acre + [(3400 yrs – 802 yrs) × 116 ft <sup>2</sup> / acre/100 years] = 3130 ft <sup>2</sup> / acre
5,600	Pine trees	116 ft <sup>2</sup> / acre + [(5600 yrs – 802 yrs) × 116 ft <sup>2</sup> / acre/100 years] = 5682 ft <sup>2</sup> / acre
10,000	Pine trees	116 ft <sup>2</sup> / acre + [(10000 yrs – 802 yrs) × 116 ft <sup>2</sup> / acre/100 years] = 10786 ft <sup>2</sup> / acre

<sup>1</sup> 200 years after corn farming ceases (i.e. at year 802) it is assumed that the entire cap is covered with pine (i.e. 400 mature trees per acre). It is assumed that each “generation” of roots becomes instantaneous voids at the 100-year turnover period.

Year	Vegetation	Fraction (f) of erosion barrier area comprising holes
0	Bamboo	0 ÷ 43560 ft <sup>2</sup> / acre = 0
100	Bamboo	0 ÷ 43560 ft <sup>2</sup> / acre = 0
154	Corn	0 ÷ 43560 ft <sup>2</sup> / acre = 0
300	Corn	0 ÷ 43560 ft <sup>2</sup> / acre = 0
550	Corn	0 ÷ 43560 ft <sup>2</sup> / acre = 0
602	Corn	0 ÷ 43560 ft <sup>2</sup> / acre = 0
802	Pine trees	116 ft <sup>2</sup> / acre ÷ 43560 ft <sup>2</sup> / acre = 0.00266
1,000	Pine trees	346 ft <sup>2</sup> / acre ÷ 43560 ft <sup>2</sup> / acre = 0.00794
1,800	Pine trees	1274 ft <sup>2</sup> / acre ÷ 43560 ft <sup>2</sup> / acre = 0.0292
3,400	Pine trees	3130 ft <sup>2</sup> / acre ÷ 43560 ft <sup>2</sup> / acre = 0.0718
5,600	Pine trees	5682 ft <sup>2</sup> / acre ÷ 43560 ft <sup>2</sup> / acre = 0.130
10,000	Pine trees	10786 ft <sup>2</sup> / acre ÷ 43560 ft <sup>2</sup> / acre = 0.248

The equivalent horizontal hydraulic conductivity for horizontal flow in a series of horizontal layers with different saturated hydraulic conductivities can be determined from the following equation (Freeze and Cherry 1979):

$$K_h = \sum_{i=1}^n \frac{K_i d_i}{d}, \text{ where } K_h = \text{equivalent horizontal saturated hydraulic conductivity, } K_i = \text{horizontal saturated hydraulic conductivity of } i^{\text{th}} \text{ layer, } d_i = \text{thickness of } i^{\text{th}} \text{ layer, } d = \text{total thickness}$$

In a similar manner the equivalent vertical hydraulic conductivity for vertical flow in a horizontal zone containing areas of materials with different saturated hydraulic conductivities can be determined based upon an area proportionality as follows:

$$K_v = \sum_{i=1}^n \frac{K_i A_i}{A}, \text{ where } K_v = \text{equivalent vertical saturated hydraulic conductivity, } K_i = \text{vertical saturated hydraulic conductivity of } i^{\text{th}} \text{ layer, } A_i = \text{Area of } i^{\text{th}} \text{ layer, } A = \text{total area}$$

The following are the input saturated hydraulic conductivities (see above):

Intact erosion barrier = 3.97E-04 cm/s

Granite stone = 3.0E-01 cm/s

The fraction (F) provided above is equivalent to  $A_i/A$  for the granite stone that is assumed to fill the holes in the erosion barrier and one minus the fraction (1 - F) is equivalent to  $A_i/A$  for the for the intact erosion barrier, making the equation:

$$K_v = (3.0E-01 \times F) + (3.97E-04 \times (1 - F))$$

Year	$K_v$
0	$(3.0E-01 \text{ cm/s} \times 0) + (3.97E-04 \text{ cm/s} \times (1 - 0)) = 3.97E-04 \text{ cm/s}$
100	$(3.0E-01 \text{ cm/s} \times 0) + (3.97E-04 \text{ cm/s} \times (1 - 0)) = 3.97E-04 \text{ cm/s}$
154	$(3.0E-01 \text{ cm/s} \times 0) + (3.97E-04 \text{ cm/s} \times (1 - 0)) = 3.97E-04 \text{ cm/s}$
300	$(3.0E-01 \text{ cm/s} \times 0) + (3.97E-04 \text{ cm/s} \times (1 - 0)) = 3.97E-04 \text{ cm/s}$
550	$(3.0E-01 \text{ cm/s} \times 0) + (3.97E-04 \text{ cm/s} \times (1 - 0)) = 3.97E-04 \text{ cm/s}$
602	$(3.0E-01 \text{ cm/s} \times 0) + (3.97E-04 \text{ cm/s} \times (1 - 0)) = 3.97E-04 \text{ cm/s}$
802	$(3.0E-01 \text{ cm/s} \times 0.00266) + (3.97E-04 \text{ cm/s} \times (1 - 0.00266)) = 1.2E-03 \text{ cm/s}$
1,000	$(3.0E-01 \text{ cm/s} \times 0.00794) + (3.97E-04 \text{ cm/s} \times (1 - 0.00794)) = 2.8E-03 \text{ cm/s}$
1,800	$(3.0E-01 \text{ cm/s} \times 0.0292) + (3.97E-04 \text{ cm/s} \times (1 - 0.0292)) = 9.1E-03 \text{ cm/s}$
3,400	$(3.0E-01 \text{ cm/s} \times 0.0718) + (3.97E-04 \text{ cm/s} \times (1 - 0.0718)) = 2.2E-02 \text{ cm/s}$
5,600	$(3.0E-01 \text{ cm/s} \times 0.130) + (3.97E-04 \text{ cm/s} \times (1 - 0.130)) = 3.9E-02 \text{ cm/s}$
10,000	$(3.0E-01 \text{ cm/s} \times 0.248) + (3.97E-04 \text{ cm/s} \times (1 - 0.248)) = 7.5E-02 \text{ cm/s}$

In an analogous manner the equivalent porosity (n), field capacity (FC), and wilting point (WP) can be determined based upon an area proportionality as follows:

$$n = \sum_{i=1}^n n_i A_i$$

$$FC = \sum_{i=1}^n FC_i A_i$$

$$WP = \sum_{i=1}^n WP_i A_i$$

The following are the input properties (see above):

Material	Porosity	Field Capacity	Wilting Point
Erosion Barrier	0.06	0.056	0.052
Granite Stone	0.397	0.032	0.013

Year	n
0	$(0.397 \times 0) + (0.06 \times (1 - 0)) = 0.06$
100	$(0.397 \times 0) + (0.06 \times (1 - 0)) = 0.06$
154	$(0.397 \times 0) + (0.06 \times (1 - 0)) = 0.06$
300	$(0.397 \times 0) + (0.06 \times (1 - 0)) = 0.06$
550	$(0.397 \times 0) + (0.06 \times (1 - 0)) = 0.06$
602	$(0.397 \times 0) + (0.06 \times (1 - 0)) = 0.06$
802	$(0.397 \times 0.00266) + (0.06 \times (1 - 0.00266)) = 0.061$
1,000	$(0.397 \times 0.00794) + (0.06 \times (1 - 0.00794)) = 0.063$
1,800	$(0.397 \times 0.0292) + (0.06 \times (1 - 0.0292)) = 0.070$
3,400	$(0.397 \times 0.0718) + (0.06 \times (1 - 0.0718)) = 0.084$
5,600	$(0.397 \times 0.130) + (0.06 \times (1 - 0.130)) = 0.104$
10,000	$(0.397 \times 0.248) + (0.06 \times (1 - 0.248)) = 0.144$

Year	FC
0	$(0.032 \times 0) + (0.056 \times (1 - 0)) = 0.056$
100	$(0.032 \times 0) + (0.056 \times (1 - 0)) = 0.056$
154	$(0.032 \times 0) + (0.056 \times (1 - 0)) = 0.056$
300	$(0.032 \times 0) + (0.056 \times (1 - 0)) = 0.056$
550	$(0.032 \times 0) + (0.056 \times (1 - 0)) = 0.056$
602	$(0.032 \times 0) + (0.056 \times (1 - 0)) = 0.056$
802	$(0.032 \times 0.00266) + (0.056 \times (1 - 0.00266)) = 0.0559$
1,000	$(0.032 \times 0.00794) + (0.056 \times (1 - 0.00794)) = 0.0558$
1,800	$(0.032 \times 0.0292) + (0.056 \times (1 - 0.0292)) = 0.0553$
3,400	$(0.032 \times 0.0718) + (0.056 \times (1 - 0.0718)) = 0.0543$
5,600	$(0.032 \times 0.130) + (0.056 \times (1 - 0.130)) = 0.0529$
10,000	$(0.032 \times 0.248) + (0.056 \times (1 - 0.248)) = 0.050$

Year	WP
0	$(0.013 \times 0) + (0.052 \times (1 - 0)) = 0.052$
100	$(0.013 \times 0) + (0.052 \times (1 - 0)) = 0.052$
154	$(0.013 \times 0) + (0.052 \times (1 - 0)) = 0.052$
300	$(0.013 \times 0) + (0.052 \times (1 - 0)) = 0.052$
550	$(0.013 \times 0) + (0.052 \times (1 - 0)) = 0.052$
602	$(0.013 \times 0) + (0.052 \times (1 - 0)) = 0.052$
802	$(0.013 \times 0.00266) + (0.052 \times (1 - 0.00266)) = 0.0519$
1,000	$(0.013 \times 0.00794) + (0.052 \times (1 - 0.00794)) = 0.0517$
1,800	$(0.013 \times 0.0292) + (0.052 \times (1 - 0.0292)) = 0.0509$
3,400	$(0.013 \times 0.0718) + (0.052 \times (1 - 0.0718)) = 0.0492$
5,600	$(0.013 \times 0.130) + (0.052 \times (1 - 0.130)) = 0.0469$
10,000	$(0.013 \times 0.248) + (0.052 \times (1 - 0.248)) = 0.0423$

**Summary Erosion Barrier Hydraulic Properties with Time:**

Year	$K_v$	n	FC	WP
0	3.97E-04 cm/s	0.06	0.056	0.052
100	3.97E-04 cm/s	0.06	0.056	0.052
154	3.97E-04 cm/s	0.06	0.056	0.052
300	3.97E-04 cm/s	0.06	0.056	0.052
550	3.97E-04 cm/s	0.06	0.056	0.052
602	3.97E-04 cm/s	0.06	0.056	0.052
802	1.2E-03 cm/s	0.061	0.0559	0.0519
1,000	2.8E-03 cm/s	0.063	0.0558	0.0517
1,800	9.1E-03 cm/s	0.070	0.0553	0.0509
3,400	2.2E-02 cm/s	0.084	0.0543	0.0492
5,600	3.9E-02 cm/s	0.104	0.0529	0.0469
10,000	7.5E-02 cm/s	0.144	0.050	0.0423

**Ground Surface Soil Texture:**

The soil texture of the ground surface will change over time due to erosion of the topsoil and upper backfill layers and the degradation of the erosion barrier. Soil texture is utilized in the HELP model to determine the SCS Curve Number (CN) and subsequent runoff from the closure cap. The default HELP model ground surface soil textures will be assigned based upon an equivalence between the saturated hydraulic conductivity of the material assumed to be at the ground surface and that of the default HELP model ground surface soil textures.

**Default HELP Model Ground Surface Soil Textures:**

Year	Ground Surface Material	Ground Surface Material K (cm/s)	HELP Soil Texture	HELP Soil Texture K (cm/s)
0	Topsoil	1.0E-3	5	1.0E-3
100	Topsoil	1.0E-3	5	1.0E-3
154	Backfill	1.0E-4	10	1.2E-4
300	Backfill	1.0E-4	10	1.2E-4
550	Backfill	1.0E-4	10	1.2E-4
602	Erosion Barrier	3.97E-4	8	3.7E-4
802	Erosion Barrier	1.2E-3	5	1.0E-3
1000	Erosion Barrier	2.8E-3	3	3.1E-3
1800	Erosion Barrier	9.1E-3	1	1.0E-2
3400	Erosion Barrier	2.2E-2	1	1.0E-2
5600	Erosion Barrier	3.9E-2	1	1.0E-2
10000	Erosion Barrier	7.5E-2	1	1.0E-2

**Upper GCL Holes:**

Maintenance during the institutional control period and farming practices during corn farming prevent degradation of the upper GCL. Subsequent to the institutional control period and corn farming after all of the topsoil and upper backfill have been completely eroded, pine forest succession will result in root penetration through the GCL. This allows the overlying drainage layer to fill the holes after the roots decompose. The holes in the GCL essentially act as direct conduits from the upper drainage layer to the lower backfill layer. When saturated conditions occur in the drainage layer after major precipitation events, cones of depression are created around the holes in the GCL with a radius of influence much greater than the radius of the hole. This means that a small area of GCL holes can greatly reduce the lateral flow of water in the drainage layer and increase the vertical flow into the lower backfill.

From Section 4.1 the following assumptions were made relative to the succession of bamboo by a pine forest that result in root penetration into the upper GCL:

- 200 years after the end of farming it is assumed that the entire cap is dominated by pine (i.e. 400 mature trees per acre).
- Complete turnover of the 400 mature trees per acre occurs every 100 years (in a staggered manner).
- There are 400 mature trees per acre with 4 roots to 6 feet and 1 root to 12 feet. The roots are 3 inches in diameter at a depth of 1 foot and 0.25 inches in diameter at either 6 or 12 feet, whichever is applicable.

Area of holes in upper GCL due to root penetration:

Upper GCL Depth (see Table 3.1-1) = 12" + 12" + 12" = 36" = 3'

Root Diameter for 4-6' roots at 3':

3" diameter at 1' depth and 0.25" at 6'

$$(3'' - 0.25'') / (6' - 1') = 0.55'' / ft$$

$$\text{Diameter} = 0.25'' + [(6' - 3') \times 0.55'' / ft] = 1.9''$$

Area of for 4-6' roots at 3':

$$\text{Area} = 4 \times \frac{1}{4}\pi D^2 = \pi D^2 = \pi(1.9'')^2 = 11.3 \text{ in}^2$$

Root Diameter for 1-12' root at 3':

3" diameter at 1' depth and 0.25" at 12'

$$(3'' - 0.25'') / (12' - 1') = 0.25'' / ft$$

$$\text{Diameter} = 0.25'' + [(12' - 3') \times 0.25'' / ft] = 2.5''$$

Area of for 1-12' root at 3':

$$\text{Area} = \frac{1}{4}\pi D^2 = \frac{1}{4}\pi(2.5'')^2 = 4.91 \text{ in}^2$$

Total area of holes in erosion barrier per tree:

$$\text{Total area} = 11.3 \text{ in}^2 + 4.91 \text{ in}^2 = 16.21 \text{ in}^2 \times \text{ft}^2 / 144 \text{ in}^2 \approx 0.11 \text{ ft}^2 / \text{tree}$$

Total area of holes per acre per 100 years:

400 trees/acre/100 years

$$\text{Total area} = 0.11 \text{ ft}^2 / \text{tree} \times 400 \text{ trees/acre/100 years} = 44 \text{ ft}^2 / \text{acre/100 years}$$

Year	Vegetation	Area of holes in upper GCL / acre due to root penetration
0	Bamboo	0
100	Bamboo	0
154	Corn	0
300	Corn	0
550	Corn	0
602	Corn	0
802 <sup>1</sup>	Pine trees	44 ft <sup>2</sup> / acre
1,000	Pine trees	44 ft <sup>2</sup> / acre + [(1000 yrs - 802 yrs) × 44 ft <sup>2</sup> / acre/100 years = 131 ft <sup>2</sup> / acre
1,800	Pine trees	44 ft <sup>2</sup> / acre + [(1800 yrs - 802 yrs) × 44 ft <sup>2</sup> / acre/100 years = 483 ft <sup>2</sup> / acre
3,400	Pine trees	44 ft <sup>2</sup> / acre + [(3400 yrs - 802 yrs) × 44 ft <sup>2</sup> / acre/100 years = 1187 ft <sup>2</sup> / acre
5,600	Pine trees	44 ft <sup>2</sup> / acre + [(5600 yrs - 802 yrs) × 44 ft <sup>2</sup> / acre/100 years = 2155 ft <sup>2</sup> / acre
10,000	Pine trees	44 ft <sup>2</sup> / acre + [(10000 yrs - 802 yrs) × 44 ft <sup>2</sup> / acre/100 years = 4091 ft <sup>2</sup> / acre

<sup>1</sup> 200 years after corn farming ceases (i.e. at year 802) it is assumed that the entire cap is covered with pine (i.e. 400 mature trees per acre)



Number of one-square-centimeter holes in upper GCL per acre due to root penetration (each HELP model installation defect for a flexible membrane liner (FML) is assumed to be one square centimeter):

$$1 \text{ cm}^2 = 0.001076391 \text{ ft}^2 \text{ so } 0.001076391 \text{ ft}^2/\text{installation defect}$$

Year	Percent of GCL area degraded due to root penetration
0	0
100	0
154	0
300	0
550	0
602	0
802	$(44 \text{ ft}^2/\text{acre} \div 43560 \text{ ft}^2/\text{acre}) \times 100 = 0.10$
1,000	$(131 \text{ ft}^2/\text{acre} \div 43560 \text{ ft}^2/\text{acre}) \times 100 = 0.30$
1,800	$(483 \text{ ft}^2/\text{acre} \div 43560 \text{ ft}^2/\text{acre}) \times 100 = 1.11$
3,400	$(1187 \text{ ft}^2/\text{acre} \div 43560 \text{ ft}^2/\text{acre}) \times 100 = 2.72$
5,600	$(2155 \text{ ft}^2/\text{acre} \div 43560 \text{ ft}^2/\text{acre}) \times 100 = 4.95$
10,000	$(4091 \text{ ft}^2/\text{acre} \div 43560 \text{ ft}^2/\text{acre}) \times 100 = 9.39$

Year	# of installation defects in upper GCL / acre due to root penetration
0	0
100	0
154	0
300	0
550	0
602	0
802	$44 \text{ ft}^2/\text{acre} \div 0.001076391 \text{ ft}^2/\text{installation defect} = 40,877$
1,000	$131 \text{ ft}^2/\text{acre} \div 0.001076391 \text{ ft}^2/\text{installation defect} = 121,703$
1,800	$483 \text{ ft}^2/\text{acre} \div 0.001076391 \text{ ft}^2/\text{installation defect} = 448,722$
3,400	$1187 \text{ ft}^2/\text{acre} \div 0.001076391 \text{ ft}^2/\text{installation defect} = 1,102,759$
5,600	$2155 \text{ ft}^2/\text{acre} \div 0.001076391 \text{ ft}^2/\text{installation defect} = 2,002,060$
10,000	$4091 \text{ ft}^2/\text{acre} \div 0.001076391 \text{ ft}^2/\text{installation defect} = 3,800,664$

The number of installation defects that can entered into the HELP model is limited to a maximum of 999,999. Therefore the number of installation defects calculated above for years 3,400, 5,600, and 10,000 can not be entered. As outlined in Phifer 2003 the upper GCL becomes ineffective as a barrier layer when holes comprise 0.29 percent of the layer's area. Therefore for determination of the flux at years 3,400, 5,600, and 10,000, the GCL will be assigned as a barrier soil liner with the same material properties as the overlying upper drainage layer.

Year	HELP Model Layer Type	# of installation defects
0	3	NA
100	3	NA
154	3	NA
300	3	NA
550	3	NA
602	3	NA
802	4	40,877
1,000	4	121,703
1,800	4	448,722
3,400	3	NA
5,600	3	NA
10,000	3	NA

### Middle Backfill Layer and Upper Drainage Layer Hydraulic Properties:

It is assumed that colloidal clay migration from the 1-foot-thick middle backfill to the underlying 1-foot-thick upper drainage layer causes the middle backfill saturated hydraulic conductivity to increase over time and that of the upper drainage layer to decrease over time.

Determine mass of clay to fill upper drainage layer void volume (0.38):

Assume clay bulk density is  $1.1 \text{ g/cm}^3$

Look at a  $1\text{-ft}^2$  area of the 1-foot-thick upper drainage layer (i.e.  $1 \text{ ft}^3$ )

Void volume =  $0.38 \times 1 \text{ ft}^3 = 0.38 \text{ ft}^3$

Clay mass per  $\text{ft}^3 = 1.1 \text{ g/cm}^3 \times 0.38 \text{ ft}^3 \times 2.831685\text{E-}02 \text{ m}^3/\text{ft}^3 \times 1,000,000 \text{ cm}^3/\text{m}^3 = 11,836.3 \text{ g}$

Determine available clay mass in the middle backfill layer:

Assume that the middle backfill layer consists of 20% clay and 80% sand with a dry bulk density of  $104\text{-lbs}/\text{ft}^3$ .

Clay mass =  $104 \text{ lbs}/\text{ft}^3 \times 0.20 \times 453.59 \text{ g}/\text{lbs} = 9,434.7 \text{ g}/\text{ft}^3$

There is not enough clay in the middle backfill layer to fill the upper drainage layer. Therefore it will be assumed that half the clay content of the middle backfill migrates into the upper drainage layer, at which point the two layers essentially become the same material and material property changes cease. Based upon this it will be assumed that the endpoint saturated hydraulic conductivity of the layers will become that of the log mid-point between the initial backfill and upper drainage layer conditions. It will also be assumed that the endpoint porosity, field capacity, and wilting point will become the arithmetic average of the backfill and upper drainage layer.

Endpoint hydraulic properties:

Intact hydraulic properties:

Hydraulic Parameter	Middle Backfill	Upper Drainage Layer
K	$1.0\text{E-}04 \text{ cm/s}$	$1.0\text{E-}01 \text{ cm/s}$
n	0.37	0.38
FC	0.24	0.08
WP	0.136	0.013

Endpoint saturated hydraulic conductivity:

Middle backfill:  $K_{MB} = 0.0001$ ;  $\log K_{MB} = -4$

Upper drainage layer:  $K_{UDL} = 0.1$ ;  $\log K_{UDL} = -1$

Log mid-point:  $\frac{\log K_{MB} + \log K_{UDL}}{2} = \frac{-1 + (-4)}{2} = -2.5$

$K_E = 10^{-2.5} = 3.2\text{E-}03 \text{ cm/s}$

Endpoint n, FC, and WP:

$n = (0.37 + 0.38)/2 = 0.375$

$FC = (0.24 + 0.08)/2 = 0.16$

$WP = (0.136 + 0.013)/2 = 0.0745$

It will be assumed that the clay migrates out of the middle backfill into the upper drainage layer with the water flux containing  $63 \text{ mg/L}$  of colloidal clay. It will also be assumed that the time to achieve the endpoint

conditions will be based upon the estimated water flux into the upper drainage layer and migration of half the clay content of the middle backfill layer (i.e.  $9,434.7 \text{ g/ft}^3 \div 2 = 4717.4 \text{ g/ft}^3$ ).

Determine flux of water into the upper drainage layer:

Section 3.4 intact SDF closure cap Modeling determined the following average annual flux of water into the upper drainage layer (see Appendix E):

Precipitation = 48.90 inches/year

Runoff = 0.154 inches/year

Evapotranspiration = 34.582 inches/year

Flux of water into upper drainage layer = Precipitation – (Runoff + Evapotranspiration)

Flux of water into upper drainage layer = 48.90 in/yr – (0.154 in/yr + 34.582 in/yr)

Flux of water into upper drainage layer = 14.164 in/yr

The above flux is based upon the best-case cap conditions. Therefore, a water flux into the upper drainage layer that is calculated close to the anticipated time when the endpoint properties are reached is needed. Within Phifer 2003 the endpoint properties were reached in year 2246 based upon a water flux into the upper drainage layer of ~14.2 in/yr. Higher water fluxes into the upper drainage layer are anticipated for this scenario for latter times, which should result the endpoint being reached sooner. Therefore will determine the flux based upon the preliminary 1,800 year conditions as follows:

- The topsoil and upper backfill are completely eroded away at year 1,800 year (see above).
- 1,800 year erosion barrier conditions with  $K = 9.1\text{E-}03 \text{ cm/s}$ ;  $n = 0.070$ ;  $FC = 0.0553$ ;  $WP = 0.0509$  (see above).
- 1,800 HELP model soil texture class of 1 (see above).
- Middle backfill and upper drainage layer at end state conditions with  $K = 3.2\text{E-}03 \text{ cm/s}$ ;  $n = 0.375$ ;  $FC = 0.16$ ;  $WP = 0.0745$  (see above). In Phifer 2003 for the base case scenario the end state conditions were determined to occur at year 2246, therefore end state conditions at year 1,800 should be a reasonable assumption for this scenario.
- Upper GCL as a flexible membrane liner (layer type #4) 448,722 installation defects (see above).
- Lower drainage layer with intact backfill properties (used since 1,800 year conditions not yet determined).
- The detailed HELP model input data and output file associated with the preliminary 1,800-year conditions is provided at the end of this appendix. The following are the pertinent values extracted from the output file:

Precipitation = 48.90 inches/year

Runoff = 0.000 inches/year

Evapotranspiration = 27.492 inches/year

Flux of water into upper drainage layer = Precipitation – (Runoff + Evapotranspiration)

Flux of water into upper drainage layer = 48.90 in/yr – (0.000 in/yr + 27.492 in/yr)

Flux of water into upper drainage layer = 21.408 in/yr

Will take the average of the initial and 1,800 years fluxes as the water flux into the upper drainage layer for determination of the middle backfill and upper drainage layer properties over time:

$$\text{Average flux into upper drainage layer} = (14.164 \text{ in/yr} + 21.408 \text{ in/yr}) / 2 = 17.786 \text{ in/yr}$$

Determine yearly clay migration into the upper drainage layer:

$$\text{Flux into upper drainage layer} \approx 17.8 \text{ in/yr}$$

$$\text{Colloidal clay concentration} = 63 \text{ mg/L}$$

$$\text{Flux through a } 1 \text{ ft}^2 \text{ area} = 17.8 \text{ in/yr} \times \text{ft}/12 \text{ in} \times 1 \text{ ft}^2 = 1.48 \text{ ft}^2/\text{yr}$$

$$\text{Clay flux} = 1.48 \text{ ft}^2/\text{yr} \times 63 \text{ mg/L} \times 2.831685\text{E-}02 \text{ m}^3/\text{ft}^3 \times 1000\text{L}/\text{m}^3 = 2,640 \text{ mg/yr} = 2.64 \text{ g/yr}$$

Determine time it takes for the 4717.4 g of clay to migrate from the middle backfill layer to the upper drainage layer:

$$\text{Time} = 4717.4 \text{ g} \div 2.64 \text{ g/yr} = 1,787 \text{ years}$$

Determine middle backfill and upper drainage layer hydraulic property variation with time:

It will be assumed that the K of the middle backfill layer is increasing log linearly with time from 1.0E-04 cm/s to 3.2E-03 cm/s, until year 1,787 at which time the K becomes static. Conversely it will be assumed that the K of the upper drainage layer is decreasing log linearly with time from 1.0E-01 cm/s to 3.2E-03 cm/s, until year 1,787 at which time the K becomes static. Porosity (n), FC, and WP will be assumed to behave similarly but in an arithmetic linear manner.

Initial and End State hydraulic properties:

Hydraulic Parameter	Initial Middle Backfill	Initial Upper Drainage Layer	End State at 1,787 years
K	1.0E-04 cm/s	1.0E-01 cm/s	3.2E-03 cm/s
n	0.37	0.38	0.375
FC	0.24	0.08	0.16
WP	0.136	0.013	0.0745

Determine fraction change for each year:

Year	Fraction
0	$0 \div 1787 = 0$
100	$100 \div 1787 = 0.056$
154	$154 \div 1787 = 0.0862$
300	$300 \div 1787 = 0.168$
550	$550 \div 1787 = 0.308$
602	$602 \div 1787 = 0.337$
802	$802 \div 1787 = 0.449$
1,000	$1000 \div 1787 = 0.560$
1,800	1.0
3,400	1.0
5,600	1.0
10,000	1.0

Determine variation in K, n, FC, and WP with time in the middle backfill:

Year	Fraction, F	K <sup>1</sup> (cm/s)	n <sup>2</sup>	FC <sup>3</sup>	WP <sup>4</sup>
0	0	0.0001	0.37	0.24	0.136
100	0.056	0.00012	0.37	0.236	0.132
154	0.0862	0.00014	0.37	0.233	0.131
300	0.168	0.00018	0.371	0.226	0.126
550	0.308	0.00029	0.372	0.215	0.117
602	0.337	0.00032	0.372	0.213	0.115
802	0.449	0.00047	0.372	0.204	0.108
1,000	0.560	0.00069	0.373	0.195	0.102
1,800	1.0	0.0032	0.375	0.16	0.0745
3,400	1.0	0.0032	0.375	0.16	0.0745
5,600	1.0	0.0032	0.375	0.16	0.0745
10,000	1.0	0.0032	0.375	0.16	0.0745

$$^1 K = 10^{[-4 + ((-2.5 - (-4))F)]} = 10^{(-4 + 1.5F)}$$

$$^2 n = 0.37 + (0.375 - 0.37)F$$

$$^3 FC = 0.24 - (0.24 - 0.16)F$$

$$^4 WP = 0.136 - (0.136 - 0.0745)F$$

Determine variation in K, n, FC, and WP with time in the upper drainage layer:

Year	Fraction, F	K <sup>1</sup> (cm/s)	n <sup>2</sup>	FC <sup>3</sup>	WP <sup>4</sup>
0	0	0.1	0.38	0.08	0.013
100	0.056	0.082	0.38	0.084	0.0164
154	0.0862	0.074	0.38	0.087	0.0183
300	0.168	0.056	0.379	0.093	0.0233
550	0.308	0.034	0.378	0.105	0.0319
602	0.337	0.031	0.378	0.107	0.0337
802	0.449	0.021	0.378	0.116	0.0406
1,000	0.560	0.014	0.377	0.125	0.0474
1,800	1.0	0.0032	0.375	0.16	0.0745
3,400	1.0	0.0032	0.375	0.16	0.0745
5,600	1.0	0.0032	0.375	0.16	0.0745
10,000	1.0	0.0032	0.375	0.16	0.0745

$$^1 K = 10^{[-1 + ((-2.5 - (-1))F)]} = 10^{(-1 - 1.5F)}$$

$$^2 n = 0.38 - (0.38 - 0.375)F$$

$$^3 FC = 0.08 + (0.16 - 0.08)F$$

$$^4 WP = 0.013 + (0.0745 - 0.013)F$$

#### Lower Drainage Layer Hydraulic Properties:

It is assumed that colloidal clay migration from the minimum 5-foot-thick overlying backfill into the 2-foot-thick lower drainage layer is driven by the water flux through the upper GCL. This water flux driven clay migration enters into the lower drainage layer and fills the lower drainage layer from the bottom up. This reduces the saturated hydraulic conductivity of the clay-filled portion from 1.0E-01 to 1.0E-04 cm/s (i.e. to the saturated hydraulic conductivity of the overlying backfill), while the conductivity of the clean portion remains at 1.0E-01 cm/s. As the thickness of the lower drainage layer filled with clay increases, the equivalent hydraulic conductivity of the entire layer decreases. This is different from that assumed for the upper drainage layer since the lower drainage layer has significantly more backfill overlying it. The HELP model was run for each year with all of the previously degraded properties (see above) without degradation

of the lower drainage layer in order to determine the infiltration through the upper GCL. The results are as follows:

Year	Infiltration through upper GCL (inches/year)
0	0.36170
100	0.43127
154	0.42058
300	0.56138
550	1.21999
602	1.37415
802	16.11727
1,000	19.46389
1,800	21.31867
3,400	21.42358
5,600	21.13124
10,000	20.05366

It is assumed that there is a linear change in the infiltration over time between data points.

Determine cumulative volume of water through the lower drainage layer over time:

Year	Infiltration through upper GCL (inches/year)	Time Step Infiltration <sup>1</sup> (inches)	Cumulative Infiltration <sup>2</sup> (inches)	Cumulative Volume over one ft <sup>2</sup> area <sup>3</sup> (ft <sup>3</sup> )
0	0.36170	0	0	0
100	0.43127	39.648	39.648	3.304
154	0.42058	23.000	62.648	5.221
300	0.56138	71.683	134.331	11.194
550	1.21999	222.671	357.002	29.750
602	1.37415	67.448	424.450	35.371
802	16.11727	1,749.142	2,173.592	181.133
1,000	19.46389	3,522.535	5,696.127	474.677
1,800	21.31867	16,313.024	22,009.151	1,834.096
3,400	21.42358	34,193.800	56,202.951	4,683.579
5,600	21.13124	46,810.302	103,013.253	8,584.438
10,000	20.05366	90,606.780	193,620.033	16,135.003

<sup>1</sup> Time Step Infiltration =  $[I_1 \times (T_2 - T_1)] + [1/2 \times (I_2 - I_1)(T_2 - T_1)]$ , where I = infiltration at time 1 or 2; T = time at time 1 or 2

<sup>2</sup> Cumulative Infiltration = Previous cumulative Infiltration + Time Step Infiltration at current time step

<sup>3</sup> Cumulative Volume over one ft<sup>2</sup> area = (Cumulative Infiltration ÷ 12 in/ft) × 1 ft<sup>2</sup>

Determine mass of clay to fill lower drainage layer void volume (0.38):

Assume clay bulk density is 1.1 g/cm<sup>3</sup>

Look at a 1-ft<sup>2</sup> area of the 2-foot-thick upper drainage layer (i.e. 2 ft<sup>3</sup>)

Void volume = 0.38 × 2 ft<sup>3</sup> = 0.76 ft<sup>3</sup>

Clay mass per ft<sup>3</sup> = 1.1 g/cm<sup>3</sup> × 0.76 ft<sup>3</sup> × 2.831685E-02 m<sup>3</sup>/ft<sup>3</sup> × 1,000,000 cm<sup>3</sup>/m<sup>3</sup> = 23,672.9 g

Determine total flux of water into the lower drainage layer required to completely fill it with clay:

It will be assumed that the clay migrates out of the lower backfill into the lower drainage layer with the water flux containing 63 mg/L of colloidal clay.

$$V = \frac{23,672.9 \text{ g} \times 1000 \text{ mg} / \text{g}}{63 \text{ mg} / \text{L} \times 28.31685 \text{ L} / \text{ft}^3} = 13,269.8 \text{ ft}^3$$

Determine the mass of clay that has migrated into the lower drainage layer at the end of each time step:

Year	Mass of clay into lower drainage layer
0	0
100	$3.3 \text{ ft}^3 \times 63 \text{ mg/L} \times 28.31685 \text{ L} / \text{ft}^3 \times \text{g}/1000 \text{ mg} = 5.9 \text{ g}$
154	$5.2 \text{ ft}^3 \times 63 \text{ mg/L} \times 28.31685 \text{ L} / \text{ft}^3 \times \text{g}/1000 \text{ mg} = 9.3 \text{ g}$
300	$11.2 \text{ ft}^3 \times 63 \text{ mg/L} \times 28.31685 \text{ L} / \text{ft}^3 \times \text{g}/1000 \text{ mg} = 20.0 \text{ g}$
550	$29.75 \text{ ft}^3 \times 63 \text{ mg/L} \times 28.31685 \text{ L} / \text{ft}^3 \times \text{g}/1000 \text{ mg} = 53.1 \text{ g}$
602	$35.4 \text{ ft}^3 \times 63 \text{ mg/L} \times 28.31685 \text{ L} / \text{ft}^3 \times \text{g}/1000 \text{ mg} = 63.2 \text{ g}$
802	$181.1 \text{ ft}^3 \times 63 \text{ mg/L} \times 28.31685 \text{ L} / \text{ft}^3 \times \text{g}/1000 \text{ mg} = 323.1 \text{ g}$
1,000	$474.7 \text{ ft}^3 \times 63 \text{ mg/L} \times 28.31685 \text{ L} / \text{ft}^3 \times \text{g}/1000 \text{ mg} = 846.8 \text{ g}$
1,800	$1,834.1 \text{ ft}^3 \times 63 \text{ mg/L} \times 28.31685 \text{ L} / \text{ft}^3 \times \text{g}/1000 \text{ mg} = 3,272.0 \text{ g}$
3,400	$4,683.6 \text{ ft}^3 \times 63 \text{ mg/L} \times 28.31685 \text{ L} / \text{ft}^3 \times \text{g}/1000 \text{ mg} = 8,355.4 \text{ g}$
5,600	$8,584.4 \text{ ft}^3 \times 63 \text{ mg/L} \times 28.31685 \text{ L} / \text{ft}^3 \times \text{g}/1000 \text{ mg} = 15,314.3 \text{ g}$
10,000	$16,135.0 \text{ ft}^3 \times 63 \text{ mg/L} \times 28.31685 \text{ L} / \text{ft}^3 \times \text{g}/1000 \text{ mg} = 28,784.2 \text{ g}$

Determine the fraction of the lower drainage layer filled at the end of each time step:

Year	Fraction of the lower drainage layer filled
0	0
100	$5.9 \text{ g} \div 23,672.9 \text{ g} = 0.000249$
154	$9.3 \text{ g} \div 23,672.9 \text{ g} = 0.000393$
300	$20.0 \text{ g} \div 23,672.9 \text{ g} = 0.000845$
550	$53.1 \text{ g} \div 23,672.9 \text{ g} = 0.00224$
602	$63.2 \text{ g} \div 23,672.9 \text{ g} = 0.00267$
802	$323.1 \text{ g} \div 23,672.9 \text{ g} = 0.0136$
1,000	$846.8 \text{ g} \div 23,672.9 \text{ g} = 0.0358$
1,800	$3,272.0 \text{ g} \div 23,672.9 \text{ g} = 0.138$
3,400	$8,355.4 \text{ g} \div 23,672.9 \text{ g} = 0.353$
5,600	$15,314.3 \text{ g} \div 23,672.9 \text{ g} = 0.647$
10,000	$28,784.2 \text{ g} \div 23,672.9 \text{ g} = 1.216$ (the fraction can not be greater than 1.0; this indicates that the lower drainage layer is completely fill prior to year 10,000)

The following are the hydraulic properties of the clean and clay filled portion of the lower drainage layer:

Material	Saturated Hydraulic Conductivity (cm/s)	Porosity	Field Capacity	Wilting Point
Clean	1.0E-01	0.38	0.08	0.013
Clay filled	1.0E-04	0.22 (see below)	0.21 (see below)	0.20 (see below)

Determine the porosity of the clay filled portion of the lower drainage layer:

Porosity of the clay:

$$\text{Assumed clay bulk density, } \rho_b = 1.1 \text{ g/cm}^2$$

$$\text{Assumed clay particle density, } \rho_p = 2.6 \text{ g/cm}^2$$

$$\text{Resulting clay porosity, } n = 1 - \frac{\rho_b}{\rho_p} = 1 - \frac{1.1 \text{ g/cm}^2}{2.6 \text{ g/cm}^2} = 0.58$$

Porosity of the clay filled portion = Porosity of clean portion  $\times$  porosity of clay

$$\text{Porosity of the clay filled portion} = 0.38 \times 0.58 = 0.22$$

Determine the field capacity and wilting point of the clay filled portion of the lower drainage layer:

Will assume that the field capacity and wilting point of the clay fill portion has the same ratio versus its porosity of 0.22 as the equivalent ratio for kaolin clay.

From WSRC 2002 the following kaolin properties are found:  $n = 0.56$ ;  $FC = 0.55$ ;  $WP = 0.50$

$$FC = 0.22 \times (0.55 \div 0.56) \approx 0.21$$

$$WP = 0.22 \times (0.50 \div 0.56) \approx 0.20$$

Determine the equivalent horizontal hydraulic conductivity of the lower drainage layer over time:

The equivalent horizontal hydraulic conductivity for horizontal flow in a series of horizontal layers with different saturated hydraulic conductivities can be determined from the following equation (Freeze and Cherry 1979):

$$K_h = \sum_{i=1}^n \frac{K_i d_i}{d}, \text{ where } K_h = \text{equivalent horizontal saturated hydraulic conductivity, } K_i = \text{horizontal saturated hydraulic conductivity of } i^{\text{th}} \text{ layer, } d_i = \text{thickness of } i^{\text{th}} \text{ layer, } d = \text{total thickness}$$

The fraction,  $F$ , equals  $d_i/d$  for the clay filled portion and  $d_i/d$  for the clean drainage layer material equals  $(1 - F)$ , making the equation:

$$K_h = (K_{filled} \times F) + [K_{clean} \times (1 - F)]$$

Year	Equivalent K (cm/s)
0	0.1
100	$(0.0001 \times 0.000249) + [0.1 \times (1 - 0.000249)] = 0.1$
154	$(0.0001 \times 0.000393) + [0.1 \times (1 - 0.000393)] = 0.1$
300	$(0.0001 \times 0.000845) + [0.1 \times (1 - 0.000845)] = 0.0999$
550	$(0.0001 \times 0.00224) + [0.1 \times (1 - 0.00224)] = 0.0998$
602	$(0.0001 \times 0.00267) + [0.1 \times (1 - 0.00267)] = 0.0997$
802	$(0.0001 \times 0.0136) + [0.1 \times (1 - 0.0136)] = 0.986$
1,000	$(0.0001 \times 0.0358) + [0.1 \times (1 - 0.0358)] = 0.0964$
1,800	$(0.0001 \times 0.138) + [0.1 \times (1 - 0.138)] = 0.0862$
3,400	$(0.0001 \times 0.353) + [0.1 \times (1 - 0.353)] = 0.0647$
5,600	$(0.0001 \times 0.647) + [0.1 \times (1 - 0.647)] = 0.0354$
10,000	$(0.0001 \times 1.0) + [0.1 \times (1 - 1.0)] = 0.0001$

Determine the equivalent  $n$ ,  $FC$ , and  $WP$  for the lower drainage layer over time:

In an analogous manner to that for  $K$ , the equivalent  $n$ ,  $FC$ , and  $WP$  can be determined based upon the fraction filled as follows:

$$n = (n_{filled} \times F) + [n_{clean} \times (1 - F)]$$

$$FC = (FC_{filled} \times F) + [FC_{clean} \times (1 - F)]$$

$$WP = (WP_{filled} \times F) + [WP_{clean} \times (1 - F)]$$



Year	Equivalent n
0	$(0.22 \times 0) + [0.38 \times (1 - 0)] = 0.38$
100	$(0.22 \times 0.000249) + [0.38 \times (1 - 0.000249)] = 0.38$
154	$(0.22 \times 0.000393) + [0.38 \times (1 - 0.000393)] = 0.38$
300	$(0.22 \times 0.000845) + [0.38 \times (1 - 0.000845)] = 0.38$
550	$(0.22 \times 0.00224) + [0.38 \times (1 - 0.00224)] = 0.38$
602	$(0.22 \times 0.00267) + [0.38 \times (1 - 0.00267)] = 0.38$
802	$(0.22 \times 0.0136) + [0.38 \times (1 - 0.0136)] = 0.378$
1,000	$(0.22 \times 0.0358) + [0.38 \times (1 - 0.0358)] = 0.374$
1,800	$(0.22 \times 0.138) + [0.38 \times (1 - 0.138)] = 0.358$
3,400	$(0.22 \times 0.353) + [0.38 \times (1 - 0.353)] = 0.324$
5,600	$(0.22 \times 0.647) + [0.38 \times (1 - 0.647)] = 0.276$
10,000	$(0.22 \times 1.0) + [0.38 \times (1 - 1.0)] = 0.22$

Year	Equivalent FC
0	$(0.21 \times 0) + [0.08 \times (1 - 0)] = 0.08$
100	$(0.21 \times 0.000249) + [0.08 \times (1 - 0.000249)] = 0.08$
154	$(0.21 \times 0.000393) + [0.08 \times (1 - 0.000393)] = 0.08$
300	$(0.21 \times 0.000845) + [0.08 \times (1 - 0.000845)] = 0.08$
550	$(0.21 \times 0.00224) + [0.08 \times (1 - 0.00224)] = 0.0803$
602	$(0.21 \times 0.00267) + [0.08 \times (1 - 0.00267)] = 0.0803$
802	$(0.21 \times 0.0136) + [0.08 \times (1 - 0.0136)] = 0.0818$
1,000	$(0.21 \times 0.0358) + [0.08 \times (1 - 0.0358)] = 0.0846$
1,800	$(0.21 \times 0.138) + [0.08 \times (1 - 0.138)] = 0.0979$
3,400	$(0.21 \times 0.353) + [0.08 \times (1 - 0.353)] = 0.126$
5,600	$(0.21 \times 0.647) + [0.08 \times (1 - 0.647)] = 0.164$
10,000	$(0.21 \times 1.0) + [0.08 \times (1 - 1.0)] = 0.21$

Year	Equivalent WP
0	$(0.20 \times 0) + [0.013 \times (1 - 0)] = 0.013$
100	$(0.20 \times 0.000249) + [0.013 \times (1 - 0.000249)] = 0.013$
154	$(0.20 \times 0.000393) + [0.013 \times (1 - 0.000393)] = 0.0131$
300	$(0.20 \times 0.000845) + [0.013 \times (1 - 0.000845)] = 0.0132$
550	$(0.20 \times 0.00224) + [0.013 \times (1 - 0.00224)] = 0.0134$
602	$(0.20 \times 0.00267) + [0.013 \times (1 - 0.00267)] = 0.0135$
802	$(0.20 \times 0.0136) + [0.013 \times (1 - 0.0136)] = 0.0155$
1,000	$(0.20 \times 0.0358) + [0.013 \times (1 - 0.0358)] = 0.0197$
1,800	$(0.20 \times 0.138) + [0.013 \times (1 - 0.138)] = 0.0388$
3,400	$(0.20 \times 0.353) + [0.013 \times (1 - 0.353)] = 0.0790$
5,600	$(0.20 \times 0.647) + [0.013 \times (1 - 0.647)] = 0.134$
10,000	$(0.20 \times 1.0) + [0.013 \times (1 - 1.0)] = 0.20$

**Summary Lower Drainage Layer Hydraulic Properties with Time:**

Year	K (cm/s)	n	FC	WP
0	0.1	0.38	0.08	0.013
100	0.1	0.38	0.08	0.013
154	0.1	0.38	0.08	0.0131
300	0.0999	0.38	0.08	0.0132
550	0.0998	0.38	0.0803	0.0134
602	0.0997	0.38	0.0803	0.0135
802	0.0986	0.378	0.0818	0.0155
1,000	0.0964	0.374	0.0846	0.0197
1,800	0.0862	0.358	0.0979	0.0388
3,400	0.0647	0.324	0.126	0.0790
5,600	0.0354	0.276	0.164	0.134
10,000	0.0001	0.22	0.21	0.20

The HELP model was rerun for each time step with all of the degraded properties (see above) including that of the lower drainage layer. Infiltration through the upper GCL did not change with the addition of the degraded lower drainage layer properties. Therefore the above estimated lower drainage layer hydraulic properties over time are verified.

**Infiltration through the Upper GCL at Complete Degradation**

The infiltration through the upper GCL at complete degradation and the associated time of occurrence have been determined based upon the following:

- As outlined above at year 10,000 all layers except the erosion barrier have reached their assumed degradation endpoint. Therefore the properties of all layers except the erosion barrier will be assigned their year 10,000 values.
- As outlined in Table 4.4-2 complete degradation of the erosion barrier is assumed to result in separation and segregation of the granite stone and flowable fill with the granite stone located on top of the broken up flowable fill. As previous done for the purposes of this calculation the properties of the broken up flowable fill will be ignored. Therefore the properties of the completely degraded erosion barrier are those of the granite stone as shown below:

Material	Saturated Hydraulic Conductivity (cm/s)	Porosity	Field Capacity	Wilting Point
Completely Degraded Erosion Barrier (i.e. Granite Stone)	3.0E-01	0.397	0.032	0.013

The above parameter values for the completely degraded erosion barrier (i.e. granite stone) replaced the previous year 10,000 HELP run to determine infiltration at complete degradation. The detailed HELP model input data and output file associated with this completely degraded case are provided at the end of this appendix. The infiltration through the upper GCL at complete degradation was determined to be 18.59674 inches/year.

Determine time required for complete degradation of the erosion barrier:

Complete degradation of the erosion barrier will occur after pine trees have completely penetrated the entire area.

From previous erosion barrier calculations:

$$116 \text{ ft}^2/\text{acre} + [(X - 802 \text{ yrs}) \times 116 \text{ ft}^2/\text{acre}/100 \text{ years}] = 43,560 \text{ ft}^2/\text{acre}$$

$$(X - 802 \text{ yrs}) \times 116 \text{ ft}^2/\text{acre}/100 \text{ years} = 43,444 \text{ ft}^2/\text{acre}$$

$$X - 802 \text{ yrs} = 37,452 \text{ yrs}$$

$$X = 38,254 \text{ yrs}$$

**Year that Lower Drainage Layer Completely Silts In**

From previous calculations above the following were determined:

- It takes a total of 13,269.8 ft<sup>3</sup> of infiltrating water to completely silt in the lower drainage layer.
- The lower drainage layer completely silts in between year 5,600 and 10,000.
- Through year 5,600 the infiltrating water volume was 8,584.438 ft<sup>3</sup>.
- At year 5,600 the infiltration through the upper GCL was 21.13124 inches/year, and at year 10,000 it was 20.05366 inches/year.
- It is assumed that infiltration varies linearly between year 5,600 and year 10,000.

Determine water volume remaining after year 5,600 to completely silt in the lower drainage layer:

$$V = 13,269.8 \text{ ft}^3 - 8,584.438 \text{ ft}^3 = 4,685.362 \text{ ft}^3$$

Determine time to completely silt in the lower drainage layer:

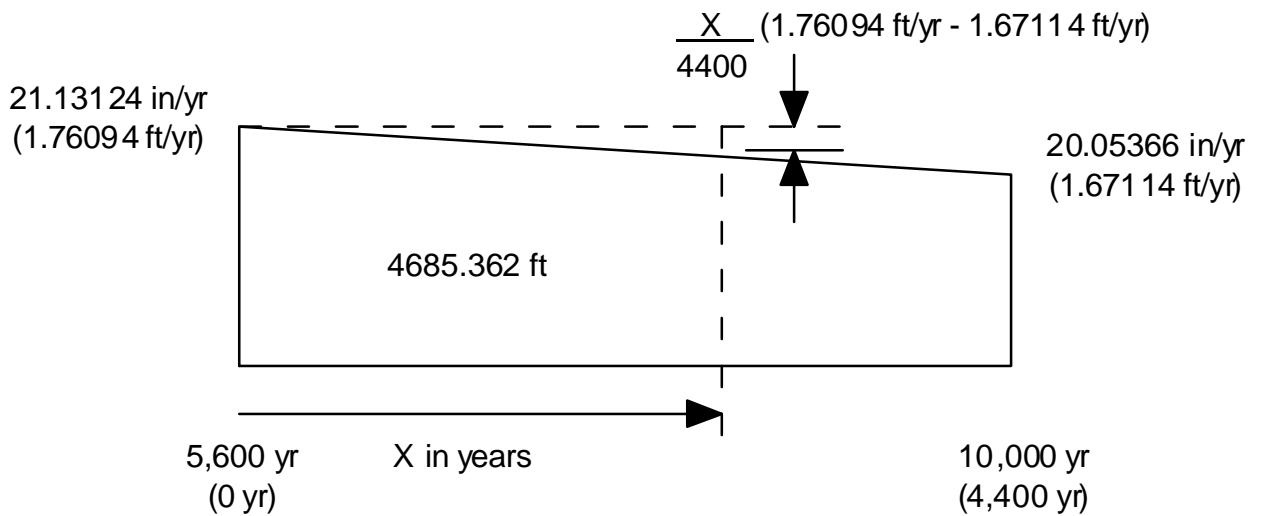

$$1.76094 \text{ ft/yr } X - \frac{1}{2} X \left[ \frac{X}{4,400 \text{ yr}} (1.76094 \text{ ft/yr} - 1.67114 \text{ ft/yr}) \right] = 4,685.362 \text{ ft}$$

$$1.76094 \text{ ft/yr } X - 1.02E-5 \text{ ft/yr}^2 X^2 = 4,685.362 \text{ ft}$$

Determine X:

X	4,685.362
3,000	5,191.02
2,500	4,338.6
2,700	4,680.18
2,703	4,685.3 (close enough!)

Year lower drainage layer completely silts in:

$$\text{Year} = 5,600 + 2,703 = 8,303$$

At year 8,803 the lower drainage layer completely silts in and has the following properties: saturated hydraulic conductivity =  $1.0\text{E-}04$  cm/s; porosity = 0.22; field capacity = 0.21; wilting point = 0.20.

Upper Bounding Scenario Degraded SDF MSE Vault Closure Cap (Preliminary 1,800 Years): HELP Model Input Data and Output Files (output file name: ZUBSP18o.OUT)

Input Data:

Input Parameter (HELP Model Query)		Generic Input Parameter Value					
Landfill area =		19.63 acres					
Percent of area where runoff is possible =		100%					
Do you want to specify initial moisture storage? (Y/N)		Y					
Amount of water or snow on surface =		0 in					
CN Input Parameter (HELP Model Query)		CN Input Parameter Value					
Slope =		3 %					
Slope length =		450 ft					
Soil Texture =		1 (HELP model default soil texture)					
Vegetation =		4 (i.e., a good stand of grass)					
HELP Model Computed Curve Number = 26.90							
Layer		Layer Number		Layer Type			
Erosion Barrier		1		1 (vertical percolation layer)			
Middle Backfill		2		1 (vertical percolation layer)			
Upper Drainage Layer		3		2 (lateral drainage layer)			
Upper GCL		4		4 (flexible membrane liner)			
Lower Backfill		5		1 (vertical percolation layer)			
Lower Drainage Layer		6		2 (lateral drainage layer)			
Lower GCL		7		3 (barrier soil liner)			
	Layer Type	Layer Thickness (in)	Soil Texture No.	Total Porosity (Vol/Vol)	Field Capacity (Vol/Vol)	Wilting Point (Vol/Vol)	Initial Moisture (Vol/Vol)
1	1	12		0.070	0.0553	0.0509	0.0553
2	1	12		0.375	0.16	0.0745	0.16
3	2	12		0.375	0.16	0.0745	0.16
4 *	4	0.2		0.75	0.747	0.040	0.75
5	1	58.57		0.37	0.24	0.136	0.24
6	2	24		0.38	0.08	0.013	0.08
7	3	0.2		0.75	0.747	0.40	0.75

The lack of values in the table for particular parameters in particular layers denotes that no HELP model input was required for that parameter in that layer. No data is missing from the table.

\* The input porosity, field capacity, and wilting point values of the upper GCL are ignored by the HELP model, since the upper GCL is designated as an geomembrane in order for the HELP model to take into account the holes produced by root penetration.

## Input Data (continued):

	Layer Type	Sat. Hyd. Conductivity * (cm/sec)	Drainage Length (ft)	Drain Slope (%)	Leachate Recirc. (%)	Recirc. to Layer (#)	Subsurface Inflow (in/yr)
1	1	9.1E-03					
2	1	3.20E-03					
3	2	3.20E-03	450	3			
4	4	5.00E-09					
5	1	1.00E-04					
6	2	1.00E-01	150	11.4			
7	3	5.00E-09					
	Layer Type	Geomembrane Pinhole Density (#/acre)	Geomembrane Instal. Defects (#/acre)	Geomembrane Placement Quality	Geotextile Transmissivity (cm <sup>2</sup> /sec)		
1	1						
2	1						
3	2						
4	4	0	448,722	1			
5	1						
6	2						
7	3						

The lack of values in the table for particular parameters in particular layers denotes that no HELP model input was required for that parameter in that layer. No data is missing from the table.

\* The HELP model output often produces an increased number of significant digits for the Effective Saturated Hydraulic Conductivity over that of the actual input



## LAYER 3

-----

## TYPE 2 - LATERAL DRAINAGE LAYER

MATERIAL TEXTURE NUMBER 0

THICKNESS	=	12.00	INCHES
POROSITY	=	0.3750	VOL/VOL
FIELD CAPACITY	=	0.1600	VOL/VOL
WILTING POINT	=	0.0745	VOL/VOL
INITIAL SOIL WATER CONTENT	=	0.1600	VOL/VOL
EFFECTIVE SAT. HYD. COND.	=	0.319999992000E-02	CM/SEC
SLOPE	=	3.00	PERCENT
DRAINAGE LENGTH	=	450.0	FEET

## LAYER 4

-----

## TYPE 4 - FLEXIBLE MEMBRANE LINER

MATERIAL TEXTURE NUMBER 0

THICKNESS	=	0.20	INCHES
POROSITY	=	0.0000	VOL/VOL
FIELD CAPACITY	=	0.0000	VOL/VOL
WILTING POINT	=	0.0000	VOL/VOL
INITIAL SOIL WATER CONTENT	=	0.0000	VOL/VOL
EFFECTIVE SAT. HYD. COND.	=	0.499999997000E-08	CM/SEC
FML PINHOLE DENSITY	=	0.00	HOLES/ACRE
FML INSTALLATION DEFECTS	=	448722.00	HOLES/ACRE
FML PLACEMENT QUALITY	=	1	- PERFECT

## LAYER 5

-----

## TYPE 1 - VERTICAL PERCOLATION LAYER

MATERIAL TEXTURE NUMBER 0

THICKNESS	=	58.57	INCHES
POROSITY	=	0.3700	VOL/VOL
FIELD CAPACITY	=	0.2400	VOL/VOL
WILTING POINT	=	0.1360	VOL/VOL
INITIAL SOIL WATER CONTENT	=	0.2400	VOL/VOL
EFFECTIVE SAT. HYD. COND.	=	0.999999975000E-04	CM/SEC

## LAYER 6

-----

## TYPE 2 - LATERAL DRAINAGE LAYER

MATERIAL TEXTURE NUMBER 0

THICKNESS	=	24.00	INCHES
POROSITY	=	0.3800	VOL/VOL
FIELD CAPACITY	=	0.0800	VOL/VOL
WILTING POINT	=	0.0130	VOL/VOL
INITIAL SOIL WATER CONTENT	=	0.0800	VOL/VOL
EFFECTIVE SAT. HYD. COND.	=	0.100000001000	CM/SEC
SLOPE	=	11.40	PERCENT
DRAINAGE LENGTH	=	150.0	FEET



LAYER 7

-----

TYPE 3 - BARRIER SOIL LINER

MATERIAL TEXTURE NUMBER 0

THICKNESS = 0.20 INCHES  
 POROSITY = 0.7500 VOL/VOL  
 FIELD CAPACITY = 0.7470 VOL/VOL  
 WILTING POINT = 0.4000 VOL/VOL  
 INITIAL SOIL WATER CONTENT = 0.7500 VOL/VOL  
 EFFECTIVE SAT. HYD. COND. = 0.499999997000E-08 CM/SEC

GENERAL DESIGN AND EVAPORATIVE ZONE DATA

-----

NOTE: SCS RUNOFF CURVE NUMBER WAS COMPUTED FROM DEFAULT SOIL DATA BASE USING SOIL TEXTURE # 1 WITH A GOOD STAND OF GRASS, A SURFACE SLOPE OF 3.% AND A SLOPE LENGTH OF 450. FEET.

SCS RUNOFF CURVE NUMBER = 26.90  
 FRACTION OF AREA ALLOWING RUNOFF = 100.0 PERCENT  
 AREA PROJECTED ON HORIZONTAL PLANE = 19.630 ACRES  
 EVAPORATIVE ZONE DEPTH = 22.0 INCHES  
 INITIAL WATER IN EVAPORATIVE ZONE = 2.264 INCHES  
 UPPER LIMIT OF EVAPORATIVE STORAGE = 4.590 INCHES  
 LOWER LIMIT OF EVAPORATIVE STORAGE = 1.356 INCHES  
 INITIAL SNOW WATER = 0.000 INCHES  
 INITIAL WATER IN LAYER MATERIALS = 20.630 INCHES  
 TOTAL INITIAL WATER = 20.630 INCHES  
 TOTAL SUBSURFACE INFLOW = 0.00 INCHES/YEAR

EVAPOTRANSPIRATION AND WEATHER DATA

-----

NOTE: EVAPOTRANSPIRATION DATA WAS OBTAINED FROM AUGUSTA GEORGIA

STATION LATITUDE = 33.22 DEGREES  
 MAXIMUM LEAF AREA INDEX = 3.50  
 START OF GROWING SEASON (JULIAN DATE) = 68  
 END OF GROWING SEASON (JULIAN DATE) = 323  
 EVAPORATIVE ZONE DEPTH = 22.0 INCHES  
 AVERAGE ANNUAL WIND SPEED = 6.50 MPH  
 AVERAGE 1ST QUARTER RELATIVE HUMIDITY = 68.00 %  
 AVERAGE 2ND QUARTER RELATIVE HUMIDITY = 70.00 %  
 AVERAGE 3RD QUARTER RELATIVE HUMIDITY = 77.00 %  
 AVERAGE 4TH QUARTER RELATIVE HUMIDITY = 73.00 %

NOTE: PRECIPITATION DATA WAS SYNTHETICALLY GENERATED USING COEFFICIENTS FOR AUGUSTA GEORGIA

NORMAL MEAN MONTHLY PRECIPITATION (INCHES)

JAN/JUL	FEB/AUG	MAR/SEP	APR/OCT	MAY/NOV	JUN/DEC
4.38	3.95	4.68	2.91	3.56	4.99
5.43	5.41	3.93	3.12	2.96	3.45

NOTE: TEMPERATURE DATA WAS SYNTHETICALLY GENERATED USING  
COEFFICIENTS FOR AUGUSTA GEORGIA

NORMAL MEAN MONTHLY TEMPERATURE (DEGREES FAHRENHEIT)

JAN/JUL	FEB/AUG	MAR/SEP	APR/OCT	MAY/NOV	JUN/DEC
46.30	50.00	57.20	64.30	72.10	78.40
81.60	80.30	75.20	65.10	56.70	48.80

NOTE: SOLAR RADIATION DATA WAS SYNTHETICALLY GENERATED USING  
COEFFICIENTS FOR AUGUSTA GEORGIA  
AND STATION LATITUDE = 33.30 DEGREES

\*\*\*\*\*

AVERAGE MONTHLY VALUES IN INCHES FOR YEARS 1 THROUGH 100

	JAN/JUL	FEB/AUG	MAR/SEP	APR/OCT	MAY/NOV	JUN/DEC
PRECIPITATION						
TOTALS	4.56	3.57	4.76	2.74	3.60	4.97
	5.81	5.32	4.41	2.99	2.75	3.41
STD. DEVIATIONS	2.44	1.60	2.47	1.31	2.12	2.60
	2.83	2.95	2.54	2.28	1.72	1.90
RUNOFF						
TOTALS	0.000	0.000	0.000	0.000	0.000	0.000
	0.000	0.000	0.000	0.000	0.000	0.000
STD. DEVIATIONS	0.000	0.000	0.000	0.000	0.000	0.000
	0.000	0.000	0.000	0.000	0.000	0.000
EVAPOTRANSPIRATION						
TOTALS	1.533	1.848	2.491	2.259	2.667	3.342
	3.735	3.302	2.593	1.394	1.079	1.249
STD. DEVIATIONS	0.293	0.300	0.645	0.744	1.019	1.215
	1.151	1.059	0.903	0.614	0.322	0.226

LATERAL DRAINAGE COLLECTED FROM LAYER 3

TOTALS	0.0108	0.0062	0.0084	0.0026	0.0036	0.0052
	0.0074	0.0075	0.0065	0.0050	0.0054	0.0072
STD. DEVIATIONS	0.0074	0.0052	0.0067	0.0028	0.0049	0.0051
	0.0064	0.0080	0.0065	0.0061	0.0052	0.0059

PERCOLATION/LEAKAGE THROUGH LAYER 4

TOTALS	3.0512	1.7476	2.3858	0.7227	1.0296	1.4571
	2.1022	2.0406	1.8313	1.4116	1.5195	2.0197
STD. DEVIATIONS	2.0978	1.4638	1.8930	0.7843	1.3935	1.4405
	1.8048	1.9848	1.8437	1.7074	1.4556	1.6787

LATERAL DRAINAGE COLLECTED FROM LAYER 6

TOTALS	2.5956	2.1551	2.2481	1.6060	1.0289	1.1417
	1.8238	2.0841	1.8564	1.6368	1.3646	1.6380
STD. DEVIATIONS	1.9272	1.5168	1.6230	1.0743	0.8091	1.0756
	1.4530	1.7694	1.4302	1.3590	1.2418	1.2948

PERCOLATION/LEAKAGE THROUGH LAYER 7

TOTALS	0.0102	0.0090	0.0097	0.0082	0.0072	0.0069
	0.0084	0.0091	0.0087	0.0083	0.0075	0.0080
STD. DEVIATIONS	0.0041	0.0032	0.0033	0.0023	0.0017	0.0027
	0.0036	0.0039	0.0030	0.0031	0.0028	0.0032

AVERAGES OF MONTHLY AVERAGED DAILY HEADS (INCHES)

DAILY AVERAGE HEAD ON TOP OF LAYER 4

AVERAGES	0.2885	0.1810	0.2256	0.0705	0.0973	0.1424
	0.1988	0.2001	0.1790	0.1336	0.1484	0.1909
STD. DEVIATIONS	0.1985	0.1519	0.1791	0.0766	0.1318	0.1408
	0.1708	0.2119	0.1803	0.1619	0.1423	0.1588

DAILY AVERAGE HEAD ON TOP OF LAYER 7

AVERAGES	0.1969	0.1792	0.1705	0.1259	0.0780	0.0895
	0.1383	0.1581	0.1455	0.1241	0.1069	0.1242
STD. DEVIATIONS	0.1462	0.1263	0.1231	0.0842	0.0614	0.0843
	0.1102	0.1342	0.1121	0.1031	0.0973	0.0982

\*\*\*\*\*

\*\*\*\*\*

AVERAGE ANNUAL TOTALS & (STD. DEVIATIONS) FOR YEARS 1 THROUGH 100				
	INCHES		CU. FEET	PERCENT
PRECIPITATION	48.90	( 7.734)	3484469.2	100.00
RUNOFF	0.000	( 0.0000)	0.00	0.000
EVAPOTRANSPIRATION	27.492	( 2.7375)	1959003.12	56.221
LATERAL DRAINAGE COLLECTED FROM LAYER 3	0.07578	( 0.02295)	5399.602	0.15496
PERCOLATION/LEAKAGE THROUGH LAYER 4	21.31867	( 6.36277)	1519102.370	43.59638
AVERAGE HEAD ON TOP OF LAYER 4	0.171	( 0.052)		
LATERAL DRAINAGE COLLECTED FROM LAYER 6	21.17908	( 6.39207)	1509155.370	43.31091
PERCOLATION/LEAKAGE THROUGH LAYER 7	0.10113	( 0.01490)	7206.182	0.20681
AVERAGE HEAD ON TOP OF LAYER 7	0.136	( 0.041)		
CHANGE IN WATER STORAGE	0.052	( 1.8590)	3704.81	0.106

\*\*\*\*\*

\*\*\*\*\*

PEAK DAILY VALUES FOR YEARS		1 THROUGH	100
		(INCHES)	(CU. FT.)
PRECIPITATION		6.87	489534.875
RUNOFF		0.000	0.0000
DRAINAGE COLLECTED FROM LAYER	3	0.02213	1576.94116
PERCOLATION/LEAKAGE THROUGH LAYER	4	3.401600	242387.45300
AVERAGE HEAD ON TOP OF LAYER	4	17.964	
MAXIMUM HEAD ON TOP OF LAYER	4	27.399	
LOCATION OF MAXIMUM HEAD IN LAYER	3	113.1 FEET	
(DISTANCE FROM DRAIN)			
DRAINAGE COLLECTED FROM LAYER	6	1.77993	126832.40600
PERCOLATION/LEAKAGE THROUGH LAYER	7	0.003729	265.69943
AVERAGE HEAD ON TOP OF LAYER	7	4.185	
MAXIMUM HEAD ON TOP OF LAYER	7	7.565	
LOCATION OF MAXIMUM HEAD IN LAYER	6	12.7 FEET	
(DISTANCE FROM DRAIN)			
SNOW WATER		2.36	168188.7190
MAXIMUM VEG. SOIL WATER (VOL/VOL)			0.1959
MINIMUM VEG. SOIL WATER (VOL/VOL)			0.0616

\*\*\* Maximum heads are computed using McEnroe's equations. \*\*\*

Reference: Maximum Saturated Depth over Landfill Liner  
 by Bruce M. McEnroe, University of Kansas  
 ASCE Journal of Environmental Engineering  
 Vol. 119, No. 2, March 1993, pp. 262-270.

\*\*\*\*\*

\*\*\*\*\*

FINAL WATER STORAGE AT END OF YEAR 100

LAYER	( INCHES )	( VOL/VOL )
1	0.8162	0.0680
2	2.4742	0.2062
3	2.5665	0.2139
4	0.0000	0.0000
5	17.8803	0.3053
6	1.9425	0.0809
7	0.1500	0.7500
SNOW WATER	0.000	

\*\*\*\*\*  
\*\*\*\*\*

Upper Bounding Scenario Degraded SDF MSE Vault Closure Cap (38,254 Years): HELP Model Input Data and Output File (output file name: ZUBSD12o.OUT)

Input Data:

Input Parameter (HELP Model Query)		Generic Input Parameter Value					
Landfill area =		19.63 acres					
Percent of area where runoff is possible =		100%					
Do you want to specify initial moisture storage? (Y/N)		Y					
Amount of water or snow on surface =		0 inches					
CN Input Parameter (HELP Model Query)		CN Input Parameter Value					
Slope =		3 %					
Slope length =		450 ft					
Soil Texture =		1 (HELP model default soil texture)					
Vegetation =		4 (i.e., a good stand of grass)					
HELP Model Computed Curve Number = 26.9							
Layer		Layer Number		Layer Type			
Erosion Barrier		1		1 (vertical percolation layer)			
Middle Backfill		2		1 (vertical percolation layer)			
Upper Drainage Layer		3		2 (lateral drainage layer)			
Upper GCL		4		3 (barrier soil liner)			
Lower Backfill		5		1 (vertical percolation layer)			
Lower Drainage Layer		6		2 (lateral drainage layer)			
Lower GCL		7		3 (barrier soil liner)			
	Layer Type	Layer Thickness (in)	Soil Texture No.	Total Porosity (Vol/Vol)	Field Capacity (Vol/Vol)	Wilting Point (Vol/Vol)	Initial Moisture (Vol/Vol)
1	1	12		0.397	0.032	0.013	0.032
2	1	12		0.375	0.16	0.0745	0.16
3	2	12		0.375	0.16	0.0745	0.16
4	3	0.2		0.375	0.16	0.0745	0.375
5	1	58.57		0.37	0.24	0.136	0.24
6	2	24		0.22	0.21	0.20	0.21
7	3	0.2		0.75	0.747	0.40	0.75

The lack of values in the table for particular parameters in particular layers denotes that no HELP model input was required for that parameter in that layer. No data are missing from the table.

## Input Data (continued):

	Layer Type	Sat. Hyd. Conductivity * (cm/sec)	Drainage Length (ft)	Drain Slope (%)	Leachate Recirc. (%)	Recirc. to Layer (#)	Subsurface Inflow (in/yr)
1	1	3.00E-01					
2	1	3.20E-03					
3	2	3.20E-03	450	3			
4	3	3.20E-03					
5	1	1.00E-04					
6	2	1.00E-04	150	11.4			
7	3	5.00E-09					
	Layer Type	Geomembrane Pinhole Density (#/acre)	Geomembrane Instal. Defects (#/acre)	Geomembrane Placement Quality	Geotextile Transmissivity (cm <sup>2</sup> /sec)		
1	1						
2	1						
3	2						
4	3						
5	1						
6	2						
7	3						

The lack of values in the table for particular parameters in particular layers denotes that no HELP model input was required for that parameter in that layer. No data are missing from the table.

\* The HELP model output often produces an increased number of significant digits for the Effective Saturated Hydraulic Conductivity over that of the actual input





## LAYER 3

-----

## TYPE 2 - LATERAL DRAINAGE LAYER

MATERIAL TEXTURE NUMBER 0

THICKNESS	=	12.00	INCHES
POROSITY	=	0.3750	VOL/VOL
FIELD CAPACITY	=	0.1600	VOL/VOL
WILTING POINT	=	0.0745	VOL/VOL
INITIAL SOIL WATER CONTENT	=	0.1600	VOL/VOL
EFFECTIVE SAT. HYD. COND.	=	0.319999992000E-02	CM/SEC
SLOPE	=	3.00	PERCENT
DRAINAGE LENGTH	=	450.0	FEET

## LAYER 4

-----

## TYPE 3 - BARRIER SOIL LINER

MATERIAL TEXTURE NUMBER 0

THICKNESS	=	0.20	INCHES
POROSITY	=	0.3750	VOL/VOL
FIELD CAPACITY	=	0.1600	VOL/VOL
WILTING POINT	=	0.0745	VOL/VOL
INITIAL SOIL WATER CONTENT	=	0.3750	VOL/VOL
EFFECTIVE SAT. HYD. COND.	=	0.319999992000E-02	CM/SEC

## LAYER 5

-----

## TYPE 1 - VERTICAL PERCOLATION LAYER

MATERIAL TEXTURE NUMBER 0

THICKNESS	=	58.57	INCHES
POROSITY	=	0.3700	VOL/VOL
FIELD CAPACITY	=	0.2400	VOL/VOL
WILTING POINT	=	0.1360	VOL/VOL
INITIAL SOIL WATER CONTENT	=	0.2400	VOL/VOL
EFFECTIVE SAT. HYD. COND.	=	0.999999975000E-04	CM/SEC

## LAYER 6

-----

## TYPE 2 - LATERAL DRAINAGE LAYER

MATERIAL TEXTURE NUMBER 0

THICKNESS	=	24.00	INCHES
POROSITY	=	0.2200	VOL/VOL
FIELD CAPACITY	=	0.2100	VOL/VOL
WILTING POINT	=	0.2000	VOL/VOL
INITIAL SOIL WATER CONTENT	=	0.2100	VOL/VOL
EFFECTIVE SAT. HYD. COND.	=	0.999999975000E-04	CM/SEC
SLOPE	=	11.40	PERCENT
DRAINAGE LENGTH	=	150.0	FEET

LAYER 7

-----

TYPE 3 - BARRIER SOIL LINER

MATERIAL TEXTURE NUMBER 0

THICKNESS	=	0.20	INCHES
POROSITY	=	0.7500	VOL/VOL
FIELD CAPACITY	=	0.7470	VOL/VOL
WILTING POINT	=	0.4000	VOL/VOL
INITIAL SOIL WATER CONTENT	=	0.7500	VOL/VOL
EFFECTIVE SAT. HYD. COND.	=	0.499999997000E-08	CM/SEC

GENERAL DESIGN AND EVAPORATIVE ZONE DATA

-----

NOTE: SCS RUNOFF CURVE NUMBER WAS COMPUTED FROM DEFAULT SOIL DATA BASE USING SOIL TEXTURE # 1 WITH A GOOD STAND OF GRASS, A SURFACE SLOPE OF 3.% AND A SLOPE LENGTH OF 450. FEET.

SCS RUNOFF CURVE NUMBER	=	26.90	
FRACTION OF AREA ALLOWING RUNOFF	=	100.0	PERCENT
AREA PROJECTED ON HORIZONTAL PLANE	=	19.630	ACRES
EVAPORATIVE ZONE DEPTH	=	22.0	INCHES
INITIAL WATER IN EVAPORATIVE ZONE	=	1.984	INCHES
UPPER LIMIT OF EVAPORATIVE STORAGE	=	8.514	INCHES
LOWER LIMIT OF EVAPORATIVE STORAGE	=	0.901	INCHES
INITIAL SNOW WATER	=	0.000	INCHES
INITIAL WATER IN LAYER MATERIALS	=	23.546	INCHES
TOTAL INITIAL WATER	=	23.546	INCHES
TOTAL SUBSURFACE INFLOW	=	0.00	INCHES/YEAR

EVAPOTRANSPIRATION AND WEATHER DATA

-----

NOTE: EVAPOTRANSPIRATION DATA WAS OBTAINED FROM AUGUSTA GEORGIA

STATION LATITUDE	=	33.22	DEGREES
MAXIMUM LEAF AREA INDEX	=	3.50	
START OF GROWING SEASON (JULIAN DATE)	=	68	
END OF GROWING SEASON (JULIAN DATE)	=	323	
EVAPORATIVE ZONE DEPTH	=	22.0	INCHES
AVERAGE ANNUAL WIND SPEED	=	6.50	MPH
AVERAGE 1ST QUARTER RELATIVE HUMIDITY	=	68.00	%
AVERAGE 2ND QUARTER RELATIVE HUMIDITY	=	70.00	%
AVERAGE 3RD QUARTER RELATIVE HUMIDITY	=	77.00	%
AVERAGE 4TH QUARTER RELATIVE HUMIDITY	=	73.00	%

NOTE: PRECIPITATION DATA WAS SYNTHETICALLY GENERATED USING COEFFICIENTS FOR AUGUSTA GEORGIA

NORMAL MEAN MONTHLY PRECIPITATION (INCHES)

JAN/JUL	FEB/AUG	MAR/SEP	APR/OCT	MAY/NOV	JUN/DEC
4.38	3.95	4.68	2.91	3.56	4.99
5.43	5.41	3.93	3.12	2.96	3.45

NOTE: TEMPERATURE DATA WAS SYNTHETICALLY GENERATED USING  
COEFFICIENTS FOR AUGUSTA GEORGIA

NORMAL MEAN MONTHLY TEMPERATURE (DEGREES FAHRENHEIT)

JAN/JUL	FEB/AUG	MAR/SEP	APR/OCT	MAY/NOV	JUN/DEC
46.30	50.00	57.20	64.30	72.10	78.40
81.60	80.30	75.20	65.10	56.70	48.80

NOTE: SOLAR RADIATION DATA WAS SYNTHETICALLY GENERATED USING  
COEFFICIENTS FOR AUGUSTA GEORGIA  
AND STATION LATITUDE = 33.30 DEGREES

\*\*\*\*\*

AVERAGE MONTHLY VALUES IN INCHES FOR YEARS 1 THROUGH 100

	JAN/JUL	FEB/AUG	MAR/SEP	APR/OCT	MAY/NOV	JUN/DEC
PRECIPITATION						
TOTALS	4.56	3.57	4.76	2.74	3.60	4.97
	5.81	5.32	4.41	2.99	2.75	3.41
STD. DEVIATIONS	2.44	1.60	2.47	1.31	2.12	2.60
	2.83	2.95	2.54	2.28	1.72	1.90
RUNOFF						
TOTALS	0.000	0.000	0.000	0.000	0.000	0.000
	0.000	0.000	0.000	0.000	0.000	0.000
STD. DEVIATIONS	0.000	0.000	0.000	0.000	0.000	0.000
	0.000	0.000	0.000	0.000	0.000	0.000
EVAPOTRANSPIRATION						
TOTALS	1.645	2.060	2.823	2.715	2.955	3.623
	4.143	3.684	2.854	1.490	1.031	1.267
STD. DEVIATIONS	0.237	0.285	0.686	0.819	1.241	1.356
	1.351	1.199	0.977	0.629	0.262	0.182

LATERAL DRAINAGE COLLECTED FROM LAYER 3

TOTALS	0.0000	0.0000	0.0000	0.0000	0.0000	0.0000
	0.0000	0.0000	0.0000	0.0000	0.0000	0.0000
STD. DEVIATIONS	0.0000	0.0000	0.0000	0.0000	0.0000	0.0000
	0.0000	0.0000	0.0000	0.0000	0.0000	0.0000

PERCOLATION/LEAKAGE THROUGH LAYER 4

TOTALS	2.9510	1.6175	2.0985	0.5246	0.7190	1.0807
	1.7117	1.6609	1.5355	1.2406	1.4540	2.0028
STD. DEVIATIONS	2.1257	1.4928	1.8893	0.7271	1.2286	1.2965
	1.6165	1.9208	1.7769	1.6397	1.4920	1.6936

LATERAL DRAINAGE COLLECTED FROM LAYER 6

TOTALS	0.5891	0.6215	0.6790	0.6232	0.5102	0.4146
	0.4172	0.4755	0.4824	0.4936	0.4489	0.4834
STD. DEVIATIONS	0.3052	0.2573	0.2660	0.2568	0.2296	0.2164
	0.2364	0.2720	0.2427	0.2586	0.2700	0.2850

PERCOLATION/LEAKAGE THROUGH LAYER 7

TOTALS	1.1548	1.2145	1.3285	1.2239	1.0136	0.8274
	0.8323	0.9424	0.9569	0.9789	0.8891	0.9562
STD. DEVIATIONS	0.5759	0.4739	0.4919	0.4766	0.4371	0.4194
	0.4610	0.5249	0.4666	0.4952	0.5137	0.5461

AVERAGES OF MONTHLY AVERAGED DAILY HEADS (INCHES)

DAILY AVERAGE HEAD ON TOP OF LAYER 4

AVERAGES	0.0452	0.0249	0.0296	0.0081	0.0096	0.0159
	0.0240	0.0221	0.0186	0.0181	0.0223	0.0274
STD. DEVIATIONS	0.0382	0.0251	0.0316	0.0129	0.0177	0.0213
	0.0261	0.0270	0.0233	0.0297	0.0278	0.0265

DAILY AVERAGE HEAD ON TOP OF LAYER 7

AVERAGES	43.6097	50.3192	50.1942	47.7751	38.2504	32.2369
	31.3769	35.5542	37.3121	36.9337	34.6518	36.0772
STD. DEVIATIONS	21.8427	19.6512	18.6593	18.6803	16.5818	16.4323
	17.4825	19.9018	18.2875	18.7808	20.1343	20.7074

\*\*\*\*\*

\*\*\*\*\*

AVERAGE ANNUAL TOTALS & (STD. DEVIATIONS) FOR YEARS 1 THROUGH 100

---

	INCHES		CU. FEET	PERCENT
PRECIPITATION	48.90	( 7.734)	3484469.2	100.00
RUNOFF	0.000	( 0.0000)	0.00	0.000
EVAPOTRANSPIRATION	30.290	( 3.0661)	2158378.25	61.943
LATERAL DRAINAGE COLLECTED FROM LAYER 3	0.00002	( 0.00001)	1.422	0.00004
PERCOLATION/LEAKAGE THROUGH LAYER 4	18.59674	( 6.32641)	1325146.250	38.03008
AVERAGE HEAD ON TOP OF LAYER 4	0.022	( 0.008)		
LATERAL DRAINAGE COLLECTED FROM LAYER 6	6.23846	( 1.96206)	444533.625	12.75757
PERCOLATION/LEAKAGE THROUGH LAYER 7	12.31864	( 3.71703)	877787.937	25.19144
AVERAGE HEAD ON TOP OF LAYER 7	39.524	( 11.963)		
CHANGE IN WATER STORAGE	0.053	( 3.0163)	3768.12	0.108

\*\*\*\*\*

\*\*\*\*\*

PEAK DAILY VALUES FOR YEARS	1 THROUGH	100
	(INCHES)	(CU. FT.)
PRECIPITATION	6.87	489534.875
RUNOFF	0.000	0.0000
DRAINAGE COLLECTED FROM LAYER 3	0.00001	0.62330
PERCOLATION/LEAKAGE THROUGH LAYER 4	4.176939	297635.71900
AVERAGE HEAD ON TOP OF LAYER 4	2.578	
MAXIMUM HEAD ON TOP OF LAYER 4	0.013	
LOCATION OF MAXIMUM HEAD IN LAYER 3 (DISTANCE FROM DRAIN)	39.4 FEET	
DRAINAGE COLLECTED FROM LAYER 6	0.03765	2682.47388
PERCOLATION/LEAKAGE THROUGH LAYER 7	0.070386	5015.48437
AVERAGE HEAD ON TOP OF LAYER 7	82.570	
MAXIMUM HEAD ON TOP OF LAYER 7	101.074	
LOCATION OF MAXIMUM HEAD IN LAYER 6 (DISTANCE FROM DRAIN)	63.2 FEET	
SNOW WATER	2.36	168188.7190
MAXIMUM VEG. SOIL WATER (VOL/VOL)		0.2400
MINIMUM VEG. SOIL WATER (VOL/VOL)		0.0410

\*\*\* Maximum heads are computed using McEnroe's equations. \*\*\*

Reference: Maximum Saturated Depth over Landfill Liner  
 by Bruce M. McEnroe, University of Kansas  
 ASCE Journal of Environmental Engineering  
 Vol. 119, No. 2, March 1993, pp. 262-270.

\*\*\*\*\*

\*\*\*\*\*

FINAL WATER STORAGE AT END OF YEAR 100

LAYER	( INCHES )	( VOL/VOL )
1	1.4229	0.1186
2	2.2049	0.1837
3	1.9200	0.1600
4	0.0750	0.3750
5	17.8738	0.3052
6	5.1872	0.2161
7	0.1500	0.7500
SNOW WATER	0.000	

\*\*\*\*\*  
\*\*\*\*\*



**THIS PAGE INTENTIONALLY LEFT BLANK**

Appendix P, Upper Bounding Scenario Degraded SDF MSE Vault Closure Cap (100 Years): HELP Model Input Data and Output File (output file name: ZUBSD1ou.OUT)

Input Data:

Input Parameter (HELP Model Query)		Generic Input Parameter Value					
Landfill area =		19.63 acres					
Percent of area where runoff is possible =		100%					
Do you want to specify initial moisture storage? (Y/N)		Y					
Amount of water or snow on surface =		0 inches					
CN Input Parameter (HELP Model Query)		CN Input Parameter Value					
Slope =		3 %					
Slope length =		450 ft					
Soil Texture =		5 (HELP model default soil texture)					
Vegetation =		4 (i.e., a good stand of grass)					
HELP Model Computed Curve Number = 54.4							
Layer		Layer Number		Layer Type			
Topsoil		1		1 (vertical percolation layer)			
Upper Backfill		2		1 (vertical percolation layer)			
Erosion Barrier		3		1 (vertical percolation layer)			
Middle Backfill		4		1 (vertical percolation layer)			
Upper Drainage Layer		5		2 (lateral drainage layer)			
Upper GCL		6		3 (barrier soil liner)			
Lower Backfill		7		1 (vertical percolation layer)			
Lower Drainage Layer		8		2 (lateral drainage layer)			
Lower GCL		9		3 (barrier soil liner)			
	Layer Type	Layer Thickness (in)	Soil Texture No.	Total Porosity (Vol/Vol)	Field Capacity (Vol/Vol)	Wilting Point (Vol/Vol)	Initial Moisture (Vol/Vol)
1	1	5.980		0.4	0.11	0.058	0.11
2	1	30		0.37	0.24	0.136	0.24
3	1	12		0.06	0.056	0.052	0.056
4	1	12		0.37	0.236	0.132	0.236
5	2	12		0.38	0.084	0.0164	0.084
6	3	0.2		0.75	0.747	0.40	0.75
7	1	58.57		0.37	0.24	0.136	0.24
8	2	24		0.38	0.08	0.013	0.08
9	3	0.2		0.75	0.747	0.40	0.75

The lack of values in the table for particular parameters in particular layers denotes that no HELP model input was required for that parameter in that layer. No data are missing from the table.

## Input Data (continued):

	Layer Type	Sat. Hyd. Conductivity * (cm/sec)	Drainage Length (ft)	Drain Slope (%)	Leachate Recirc. (%)	Recirc. to Layer (#)	Subsurface Inflow (in/yr)
1	1	1.00E-03					
2	1	1.00E-04					
3	1	3.97E-04					
4	1	1.20E-04					
5	2	8.20E-02	450	3			
6	3	5.00E-09					
7	1	1.00E-04					
8	2	1.00E-01	150	11.4			
9	3	5.00E-09					
	Layer Type	Geomembrane Pinhole Density (#/acre)	Geomembrane Instal. Defects (#/acre)	Geomembrane Placement Quality	Geotextile Transmissivity (cm <sup>2</sup> /sec)		
1	1						
2	1						
3	1						
4	1						
5	2						
6	3						
7	1						
8	2						
9	3						

The lack of values in the table for particular parameters in particular layers denotes that no HELP model input was required for that parameter in that layer. No data are missing from the table.

\* The HELP model output often produces an increased number of significant digits for the Effective Saturated Hydraulic Conductivity over that of the actual input



## LAYER 3

-----

## TYPE 1 - VERTICAL PERCOLATION LAYER

MATERIAL TEXTURE NUMBER 0

THICKNESS	=	12.00	INCHES
POROSITY	=	0.0600	VOL/VOL
FIELD CAPACITY	=	0.0560	VOL/VOL
WILTING POINT	=	0.0520	VOL/VOL
INITIAL SOIL WATER CONTENT	=	0.0560	VOL/VOL
EFFECTIVE SAT. HYD. COND.	=	0.396999996000E-03	CM/SEC

## LAYER 4

-----

## TYPE 1 - VERTICAL PERCOLATION LAYER

MATERIAL TEXTURE NUMBER 0

THICKNESS	=	12.00	INCHES
POROSITY	=	0.3700	VOL/VOL
FIELD CAPACITY	=	0.2360	VOL/VOL
WILTING POINT	=	0.1320	VOL/VOL
INITIAL SOIL WATER CONTENT	=	0.2360	VOL/VOL
EFFECTIVE SAT. HYD. COND.	=	0.119999997000E-03	CM/SEC

## LAYER 5

-----

## TYPE 2 - LATERAL DRAINAGE LAYER

MATERIAL TEXTURE NUMBER 0

THICKNESS	=	12.00	INCHES
POROSITY	=	0.3800	VOL/VOL
FIELD CAPACITY	=	0.0840	VOL/VOL
WILTING POINT	=	0.0164	VOL/VOL
INITIAL SOIL WATER CONTENT	=	0.0840	VOL/VOL
EFFECTIVE SAT. HYD. COND.	=	0.820000023000E-01	CM/SEC
SLOPE	=	3.00	PERCENT
DRAINAGE LENGTH	=	450.0	FEET

## LAYER 6

-----

## TYPE 3 - BARRIER SOIL LINER

MATERIAL TEXTURE NUMBER 0

THICKNESS	=	0.20	INCHES
POROSITY	=	0.7500	VOL/VOL
FIELD CAPACITY	=	0.7470	VOL/VOL
WILTING POINT	=	0.4000	VOL/VOL
INITIAL SOIL WATER CONTENT	=	0.7500	VOL/VOL
EFFECTIVE SAT. HYD. COND.	=	0.499999997000E-08	CM/SEC

LAYER 7

-----

TYPE 1 - VERTICAL PERCOLATION LAYER

MATERIAL TEXTURE NUMBER 0

THICKNESS = 58.57 INCHES  
 POROSITY = 0.3700 VOL/VOL  
 FIELD CAPACITY = 0.2400 VOL/VOL  
 WILTING POINT = 0.1360 VOL/VOL  
 INITIAL SOIL WATER CONTENT = 0.2400 VOL/VOL  
 EFFECTIVE SAT. HYD. COND. = 0.999999975000E-04 CM/SEC

LAYER 8

-----

TYPE 2 - LATERAL DRAINAGE LAYER

MATERIAL TEXTURE NUMBER 0

THICKNESS = 24.00 INCHES  
 POROSITY = 0.3800 VOL/VOL  
 FIELD CAPACITY = 0.0800 VOL/VOL  
 WILTING POINT = 0.0130 VOL/VOL  
 INITIAL SOIL WATER CONTENT = 0.0800 VOL/VOL  
 EFFECTIVE SAT. HYD. COND. = 0.100000001000 CM/SEC  
 SLOPE = 11.40 PERCENT  
 DRAINAGE LENGTH = 150.0 FEET

LAYER 9

-----

TYPE 3 - BARRIER SOIL LINER

MATERIAL TEXTURE NUMBER 0

THICKNESS = 0.20 INCHES  
 POROSITY = 0.7500 VOL/VOL  
 FIELD CAPACITY = 0.7470 VOL/VOL  
 WILTING POINT = 0.4000 VOL/VOL  
 INITIAL SOIL WATER CONTENT = 0.7500 VOL/VOL  
 EFFECTIVE SAT. HYD. COND. = 0.499999997000E-08 CM/SEC

GENERAL DESIGN AND EVAPORATIVE ZONE DATA

-----

NOTE: SCS RUNOFF CURVE NUMBER WAS COMPUTED FROM DEFAULT SOIL DATA BASE USING SOIL TEXTURE # 5 WITH A GOOD STAND OF GRASS, A SURFACE SLOPE OF 3.% AND A SLOPE LENGTH OF 450. FEET.

SCS RUNOFF CURVE NUMBER = 54.40  
 FRACTION OF AREA ALLOWING RUNOFF = 100.0 PERCENT  
 AREA PROJECTED ON HORIZONTAL PLANE = 19.630 ACRES  
 EVAPORATIVE ZONE DEPTH = 22.0 INCHES  
 INITIAL WATER IN EVAPORATIVE ZONE = 4.503 INCHES  
 UPPER LIMIT OF EVAPORATIVE STORAGE = 8.319 INCHES  
 LOWER LIMIT OF EVAPORATIVE STORAGE = 2.526 INCHES  
 INITIAL SNOW WATER = 0.000 INCHES  
 INITIAL WATER IN LAYER MATERIALS = 28.647 INCHES  
 TOTAL INITIAL WATER = 28.647 INCHES  
 TOTAL SUBSURFACE INFLOW = 0.00 INCHES/YEAR

EVAPOTRANSPIRATION AND WEATHER DATA

NOTE: EVAPOTRANSPIRATION DATA WAS OBTAINED FROM  
AUGUSTA GEORGIA

STATION LATITUDE = 33.22 DEGREES  
 MAXIMUM LEAF AREA INDEX = 3.50  
 START OF GROWING SEASON (JULIAN DATE) = 68  
 END OF GROWING SEASON (JULIAN DATE) = 323  
 EVAPORATIVE ZONE DEPTH = 22.0 INCHES  
 AVERAGE ANNUAL WIND SPEED = 6.50 MPH  
 AVERAGE 1ST QUARTER RELATIVE HUMIDITY = 68.00 %  
 AVERAGE 2ND QUARTER RELATIVE HUMIDITY = 70.00 %  
 AVERAGE 3RD QUARTER RELATIVE HUMIDITY = 77.00 %  
 AVERAGE 4TH QUARTER RELATIVE HUMIDITY = 73.00 %

NOTE: PRECIPITATION DATA WAS SYNTHETICALLY GENERATED USING  
COEFFICIENTS FOR AUGUSTA GEORGIA

NORMAL MEAN MONTHLY PRECIPITATION (INCHES)

JAN/JUL	FEB/AUG	MAR/SEP	APR/OCT	MAY/NOV	JUN/DEC
4.38	3.95	4.68	2.91	3.56	4.99
5.43	5.41	3.93	3.12	2.96	3.45

NOTE: TEMPERATURE DATA WAS SYNTHETICALLY GENERATED USING  
COEFFICIENTS FOR AUGUSTA GEORGIA

NORMAL MEAN MONTHLY TEMPERATURE (DEGREES FAHRENHEIT)

JAN/JUL	FEB/AUG	MAR/SEP	APR/OCT	MAY/NOV	JUN/DEC
46.30	50.00	57.20	64.30	72.10	78.40
81.60	80.30	75.20	65.10	56.70	48.80

NOTE: SOLAR RADIATION DATA WAS SYNTHETICALLY GENERATED USING  
COEFFICIENTS FOR AUGUSTA GEORGIA  
AND STATION LATITUDE = 33.30 DEGREES

\*\*\*\*\*

AVERAGE MONTHLY VALUES IN INCHES FOR YEARS 1 THROUGH 100

	JAN/JUL	FEB/AUG	MAR/SEP	APR/OCT	MAY/NOV	JUN/DEC
PRECIPITATION						
TOTALS	4.56	3.57	4.76	2.74	3.60	4.97
	5.81	5.32	4.41	2.99	2.75	3.41
STD. DEVIATIONS	2.44	1.60	2.47	1.31	2.12	2.60
	2.83	2.95	2.54	2.28	1.72	1.90

## RUNOFF

-----

TOTALS	0.004	0.000	0.004	0.000	0.000	0.002
	0.027	0.091	0.016	0.006	0.002	0.001
STD. DEVIATIONS	0.020	0.000	0.027	0.000	0.002	0.015
	0.093	0.404	0.086	0.058	0.015	0.004

## EVAPOTRANSPIRATION

-----

TOTALS	1.577	2.093	3.072	3.553	3.657	4.141
	4.898	4.520	3.385	1.619	0.948	1.115
STD. DEVIATIONS	0.221	0.236	0.582	0.761	1.521	1.545
	1.589	1.377	1.040	0.606	0.207	0.205

## LATERAL DRAINAGE COLLECTED FROM LAYER 5

-----

TOTALS	2.4473	2.0838	1.9296	1.2481	0.4364	0.3120
	0.5422	0.8056	0.7456	0.7750	0.8928	1.4653
STD. DEVIATIONS	1.7695	1.4993	1.4379	1.0556	0.4450	0.5670
	0.7744	1.0088	0.9990	1.0513	1.1885	1.2857

## PERCOLATION/LEAKAGE THROUGH LAYER 6

-----

TOTALS	0.0736	0.0626	0.0583	0.0397	0.0170	0.0126
	0.0186	0.0262	0.0247	0.0253	0.0282	0.0445
STD. DEVIATIONS	0.0531	0.0439	0.0397	0.0307	0.0125	0.0162
	0.0222	0.0286	0.0288	0.0301	0.0336	0.0364

## LATERAL DRAINAGE COLLECTED FROM LAYER 8

-----

TOTALS	0.0588	0.0548	0.0579	0.0421	0.0155	0.0085
	0.0146	0.0214	0.0195	0.0213	0.0242	0.0394
STD. DEVIATIONS	0.0362	0.0336	0.0426	0.0421	0.0247	0.0155
	0.0206	0.0261	0.0248	0.0274	0.0312	0.0332

## PERCOLATION/LEAKAGE THROUGH LAYER 9

-----

TOTALS	0.0051	0.0049	0.0054	0.0051	0.0050	0.0040
	0.0038	0.0041	0.0040	0.0040	0.0038	0.0043
STD. DEVIATIONS	0.0009	0.0002	0.0003	0.0005	0.0009	0.0017
	0.0020	0.0020	0.0019	0.0020	0.0021	0.0019



-----  
 AVERAGES OF MONTHLY AVERAGED DAILY HEADS (INCHES)  
 -----

DAILY AVERAGE HEAD ON TOP OF LAYER 6  
 -----

AVERAGES	2.6013	2.4050	2.0133	1.3575	0.4546	0.3359
	0.5649	0.8393	0.8101	0.8108	0.9611	1.5265
STD. DEVIATIONS	2.0034	1.8262	1.5053	1.2013	0.4636	0.6104
	0.8067	1.0510	1.0972	1.1069	1.2795	1.3395

DAILY AVERAGE HEAD ON TOP OF LAYER 9  
 -----

AVERAGES	0.0045	0.0046	0.0044	0.0033	0.0012	0.0007
	0.0011	0.0016	0.0015	0.0016	0.0019	0.0030
STD. DEVIATIONS	0.0027	0.0028	0.0032	0.0033	0.0019	0.0012
	0.0016	0.0020	0.0019	0.0021	0.0024	0.0025

\*\*\*\*\*  
 \*\*\*\*\*

AVERAGE ANNUAL TOTALS & (STD. DEVIATIONS) FOR YEARS 1 THROUGH 100  
 -----

	INCHES		CU. FEET	PERCENT
PRECIPITATION	48.90	( 7.734)	3484469.2	100.00
RUNOFF	0.154	( 0.4339)	10950.01	0.314
EVAPOTRANSPIRATION	34.578	( 3.6236)	2463907.00	70.711
LATERAL DRAINAGE COLLECTED FROM LAYER 5	13.68366	( 5.46188)	975054.875	27.98288
PERCOLATION/LEAKAGE THROUGH LAYER 6	0.43127	( 0.15765)	30730.955	0.88194
AVERAGE HEAD ON TOP OF LAYER 6	1.223	( 0.497)		
LATERAL DRAINAGE COLLECTED FROM LAYER 8	0.37786	( 0.15286)	26925.406	0.77273
PERCOLATION/LEAKAGE THROUGH LAYER 9	0.05339	( 0.00788)	3804.487	0.10918
AVERAGE HEAD ON TOP OF LAYER 9	0.002	( 0.001)		
CHANGE IN WATER STORAGE	0.054	( 1.9679)	3827.47	0.110

\*\*\*\*\*

\*\*\*\*\*

PEAK DAILY VALUES FOR YEARS		1 THROUGH	100
		(INCHES)	(CU. FT.)
PRECIPITATION		6.87	489534.875
RUNOFF		2.648	188654.3750
DRAINAGE COLLECTED FROM LAYER	5	0.37728	26883.74800
PERCOLATION/LEAKAGE THROUGH LAYER	6	0.033315	2373.92480
AVERAGE HEAD ON TOP OF LAYER	6	38.977	
MAXIMUM HEAD ON TOP OF LAYER	6	51.035	
LOCATION OF MAXIMUM HEAD IN LAYER	5	157.7 FEET	
(DISTANCE FROM DRAIN)			
DRAINAGE COLLECTED FROM LAYER	8	0.01501	1069.88452
PERCOLATION/LEAKAGE THROUGH LAYER	9	0.000200	14.25814
AVERAGE HEAD ON TOP OF LAYER	9	0.035	
MAXIMUM HEAD ON TOP OF LAYER	9	0.073	
LOCATION OF MAXIMUM HEAD IN LAYER	8	0.0 FEET	
(DISTANCE FROM DRAIN)			
SNOW WATER		2.36	168188.7190
MAXIMUM VEG. SOIL WATER (VOL/VOL)			0.3691
MINIMUM VEG. SOIL WATER (VOL/VOL)			0.1148

\*\*\* Maximum heads are computed using McEnroe's equations. \*\*\*

Reference: Maximum Saturated Depth over Landfill Liner  
 by Bruce M. McEnroe, University of Kansas  
 ASCE Journal of Environmental Engineering  
 Vol. 119, No. 2, March 1993, pp. 262-270.

\*\*\*\*\*

\*\*\*\*\*

FINAL WATER STORAGE AT END OF YEAR 100

LAYER	( INCHES )	( VOL/VOL )
1	1.6080	0.2689
2	8.9916	0.2997
3	0.7200	0.0600
4	4.2368	0.3531
5	2.1832	0.1819
6	0.1500	0.7500
7	14.0568	0.2400
8	1.9215	0.0801
9	0.1500	0.7500
SNOW WATER	0.000	

\*\*\*\*\*  
\*\*\*\*\*

Appendix Q, Upper Bounding Scenario Degraded SDF MSE Vault Closure Cap (154 Years): HELP Model Input Data and Output File (output file name: ZUBSD2ou.OUT)

Input Data:

Input Parameter (HELP Model Query)		Generic Input Parameter Value					
Landfill area =		19.63 acres					
Percent of area where runoff is possible =		100%					
Do you want to specify initial moisture storage? (Y/N)		Y					
Amount of water or snow on surface =		0 inches					
CN Input Parameter (HELP Model Query)		CN Input Parameter Value					
Slope =		3 %					
Slope length =		450 ft					
Soil Texture =		10 (HELP model default soil texture)					
Vegetation =		4 (i.e., a good stand of grass)					
HELP Model Computed Curve Number = 80.1							
Layer		Layer Number		Layer Type			
Upper Backfill		1		1 (vertical percolation layer)			
Erosion Barrier		2		1 (vertical percolation layer)			
Middle Backfill		3		1 (vertical percolation layer)			
Upper Drainage Layer		4		2 (lateral drainage layer)			
Upper GCL		5		3 (barrier soil liner)			
Lower Backfill		6		1 (vertical percolation layer)			
Lower Drainage Layer		7		2 (lateral drainage layer)			
Lower GCL		8		3 (barrier soil liner)			
	Layer Type	Layer Thickness (in)	Soil Texture No.	Total Porosity (Vol/Vol)	Field Capacity (Vol/Vol)	Wilting Point (Vol/Vol)	Initial Moisture (Vol/Vol)
1	1	30		0.37	0.24	0.136	0.24
2	1	12		0.06	0.056	0.052	0.056
3	1	12		0.37	0.233	0.131	0.233
4	2	12		0.38	0.087	0.0183	0.087
5	3	0.2		0.75	0.747	0.40	0.75
6	1	58.57		0.37	0.24	0.136	0.24
7	2	24		0.38	0.08	0.0131	0.08
8	3	0.2		0.75	0.747	0.40	0.75

The lack of values in the table for particular parameters in particular layers denotes that no HELP model input was required for that parameter in that layer. No data are missing from the table.

## Input Data (continued):

	Layer Type	Sat. Hyd. Conductivity * (cm/sec)	Drainage Length (ft)	Drain Slope (%)	Leachate Recirc. (%)	Recirc. to Layer (#)	Subsurface Inflow (in/yr)
1	1	1.00E-04					
2	1	3.97E-04					
3	1	1.40E-04					
4	2	7.40E-02	450	3			
5	3	5.00E-09					
6	1	1.00E-04					
7	2	1.00E-01	150	11.4			
8	3	5.00E-09					
	Layer Type	Geomembrane Pinhole Density (#/acre)	Geomembrane Instal. Defects (#/acre)	Geomembrane Placement Quality	Geotextile Transmissivity (cm <sup>2</sup> /sec)		
1	1						
2	1						
3	1						
4	2						
5	3						
6	1						
7	2						
8	3						

The lack of values in the table for particular parameters in particular layers denotes that no HELP model input was required for that parameter in that layer. No data are missing from the table.

\* The HELP model output often produces an increased number of significant digits for the Effective Saturated Hydraulic Conductivity over that of the actual input



## LAYER 3

-----

## TYPE 1 - VERTICAL PERCOLATION LAYER

MATERIAL TEXTURE NUMBER 0

THICKNESS	=	12.00	INCHES
POROSITY	=	0.3700	VOL/VOL
FIELD CAPACITY	=	0.2330	VOL/VOL
WILTING POINT	=	0.1310	VOL/VOL
INITIAL SOIL WATER CONTENT	=	0.2330	VOL/VOL
EFFECTIVE SAT. HYD. COND.	=	0.140000004000E-03	CM/SEC

## LAYER 4

-----

## TYPE 2 - LATERAL DRAINAGE LAYER

MATERIAL TEXTURE NUMBER 0

THICKNESS	=	12.00	INCHES
POROSITY	=	0.3800	VOL/VOL
FIELD CAPACITY	=	0.0870	VOL/VOL
WILTING POINT	=	0.0183	VOL/VOL
INITIAL SOIL WATER CONTENT	=	0.0870	VOL/VOL
EFFECTIVE SAT. HYD. COND.	=	0.740000010000E-01	CM/SEC
SLOPE	=	3.00	PERCENT
DRAINAGE LENGTH	=	450.0	FEET

## LAYER 5

-----

## TYPE 3 - BARRIER SOIL LINER

MATERIAL TEXTURE NUMBER 0

THICKNESS	=	0.20	INCHES
POROSITY	=	0.7500	VOL/VOL
FIELD CAPACITY	=	0.7470	VOL/VOL
WILTING POINT	=	0.4000	VOL/VOL
INITIAL SOIL WATER CONTENT	=	0.7500	VOL/VOL
EFFECTIVE SAT. HYD. COND.	=	0.499999997000E-08	CM/SEC

## LAYER 6

-----

## TYPE 1 - VERTICAL PERCOLATION LAYER

MATERIAL TEXTURE NUMBER 0

THICKNESS	=	58.57	INCHES
POROSITY	=	0.3700	VOL/VOL
FIELD CAPACITY	=	0.2400	VOL/VOL
WILTING POINT	=	0.1360	VOL/VOL
INITIAL SOIL WATER CONTENT	=	0.2400	VOL/VOL
EFFECTIVE SAT. HYD. COND.	=	0.999999975000E-04	CM/SEC

LAYER 7

-----

TYPE 2 - LATERAL DRAINAGE LAYER

MATERIAL TEXTURE NUMBER 0

THICKNESS	=	24.00	INCHES
POROSITY	=	0.3800	VOL/VOL
FIELD CAPACITY	=	0.0800	VOL/VOL
WILTING POINT	=	0.0131	VOL/VOL
INITIAL SOIL WATER CONTENT	=	0.0800	VOL/VOL
EFFECTIVE SAT. HYD. COND.	=	0.100000001000	CM/SEC
SLOPE	=	11.40	PERCENT
DRAINAGE LENGTH	=	150.0	FEET

LAYER 8

-----

TYPE 3 - BARRIER SOIL LINER

MATERIAL TEXTURE NUMBER 0

THICKNESS	=	0.20	INCHES
POROSITY	=	0.7500	VOL/VOL
FIELD CAPACITY	=	0.7470	VOL/VOL
WILTING POINT	=	0.4000	VOL/VOL
INITIAL SOIL WATER CONTENT	=	0.7500	VOL/VOL
EFFECTIVE SAT. HYD. COND.	=	0.499999997000E-08	CM/SEC

GENERAL DESIGN AND EVAPORATIVE ZONE DATA

-----

NOTE: SCS RUNOFF CURVE NUMBER WAS COMPUTED FROM DEFAULT SOIL DATA BASE USING SOIL TEXTURE #10 WITH A GOOD STAND OF GRASS, A SURFACE SLOPE OF 3.%, AND A SLOPE LENGTH OF 450. FEET.

SCS RUNOFF CURVE NUMBER	=	80.10	
FRACTION OF AREA ALLOWING RUNOFF	=	100.0	PERCENT
AREA PROJECTED ON HORIZONTAL PLANE	=	19.630	ACRES
EVAPORATIVE ZONE DEPTH	=	22.0	INCHES
INITIAL WATER IN EVAPORATIVE ZONE	=	5.280	INCHES
UPPER LIMIT OF EVAPORATIVE STORAGE	=	8.140	INCHES
LOWER LIMIT OF EVAPORATIVE STORAGE	=	2.992	INCHES
INITIAL SNOW WATER	=	0.000	INCHES
INITIAL WATER IN LAYER MATERIALS	=	27.989	INCHES
TOTAL INITIAL WATER	=	27.989	INCHES
TOTAL SUBSURFACE INFLOW	=	0.00	INCHES/YEAR



EVAPOTRANSPIRATION AND WEATHER DATA

NOTE: EVAPOTRANSPIRATION DATA WAS OBTAINED FROM  
AUGUSTA GEORGIA

STATION LATITUDE = 33.22 DEGREES  
 MAXIMUM LEAF AREA INDEX = 3.50  
 START OF GROWING SEASON (JULIAN DATE) = 68  
 END OF GROWING SEASON (JULIAN DATE) = 323  
 EVAPORATIVE ZONE DEPTH = 22.0 INCHES  
 AVERAGE ANNUAL WIND SPEED = 6.50 MPH  
 AVERAGE 1ST QUARTER RELATIVE HUMIDITY = 68.00 %  
 AVERAGE 2ND QUARTER RELATIVE HUMIDITY = 70.00 %  
 AVERAGE 3RD QUARTER RELATIVE HUMIDITY = 77.00 %  
 AVERAGE 4TH QUARTER RELATIVE HUMIDITY = 73.00 %

NOTE: PRECIPITATION DATA WAS SYNTHETICALLY GENERATED USING  
COEFFICIENTS FOR AUGUSTA GEORGIA

NORMAL MEAN MONTHLY PRECIPITATION (INCHES)

JAN/JUL	FEB/AUG	MAR/SEP	APR/OCT	MAY/NOV	JUN/DEC
4.38	3.95	4.68	2.91	3.56	4.99
5.43	5.41	3.93	3.12	2.96	3.45

NOTE: TEMPERATURE DATA WAS SYNTHETICALLY GENERATED USING  
COEFFICIENTS FOR AUGUSTA GEORGIA

NORMAL MEAN MONTHLY TEMPERATURE (DEGREES FAHRENHEIT)

JAN/JUL	FEB/AUG	MAR/SEP	APR/OCT	MAY/NOV	JUN/DEC
46.30	50.00	57.20	64.30	72.10	78.40
81.60	80.30	75.20	65.10	56.70	48.80

NOTE: SOLAR RADIATION DATA WAS SYNTHETICALLY GENERATED USING  
COEFFICIENTS FOR AUGUSTA GEORGIA  
AND STATION LATITUDE = 33.30 DEGREES

\*\*\*\*\*

AVERAGE MONTHLY VALUES IN INCHES FOR YEARS 1 THROUGH 100

	JAN/JUL	FEB/AUG	MAR/SEP	APR/OCT	MAY/NOV	JUN/DEC
PRECIPITATION						
TOTALS	4.56	3.57	4.76	2.74	3.60	4.97
	5.81	5.32	4.41	2.99	2.75	3.41
STD. DEVIATIONS	2.44	1.60	2.47	1.31	2.12	2.60
	2.83	2.95	2.54	2.28	1.72	1.90

## RUNOFF

-----

TOTALS	0.230	0.087	0.178	0.024	0.077	0.143
	0.291	0.361	0.211	0.144	0.096	0.111
STD. DEVIATIONS	0.341	0.178	0.312	0.081	0.183	0.254
	0.425	0.716	0.403	0.331	0.227	0.191

## EVAPOTRANSPIRATION

-----

TOTALS	1.595	2.128	3.237	3.622	3.388	4.096
	4.863	4.449	3.320	1.611	0.951	1.130
STD. DEVIATIONS	0.211	0.217	0.523	0.842	1.515	1.531
	1.595	1.384	1.061	0.623	0.225	0.201

## LATERAL DRAINAGE COLLECTED FROM LAYER 4

-----

TOTALS	2.2963	1.9286	1.7335	1.0582	0.3039	0.2517
	0.4476	0.5892	0.5929	0.6475	0.8246	1.4170
STD. DEVIATIONS	1.5435	1.3489	1.2928	0.9441	0.3547	0.4610
	0.6451	0.7477	0.8434	0.8876	1.0578	1.1919

## PERCOLATION/LEAKAGE THROUGH LAYER 5

-----

TOTALS	0.0751	0.0638	0.0580	0.0373	0.0141	0.0113
	0.0172	0.0219	0.0220	0.0236	0.0288	0.0475
STD. DEVIATIONS	0.0478	0.0422	0.0394	0.0289	0.0112	0.0149
	0.0206	0.0237	0.0264	0.0280	0.0332	0.0373

## LATERAL DRAINAGE COLLECTED FROM LAYER 7

-----

TOTALS	0.0624	0.0573	0.0562	0.0394	0.0111	0.0076
	0.0135	0.0176	0.0176	0.0197	0.0240	0.0414
STD. DEVIATIONS	0.0357	0.0343	0.0396	0.0381	0.0176	0.0140
	0.0194	0.0220	0.0249	0.0270	0.0298	0.0339

## PERCOLATION/LEAKAGE THROUGH LAYER 8

-----

TOTALS	0.0052	0.0049	0.0054	0.0051	0.0048	0.0036
	0.0036	0.0040	0.0040	0.0039	0.0037	0.0044
STD. DEVIATIONS	0.0008	0.0003	0.0001	0.0003	0.0011	0.0018
	0.0021	0.0020	0.0018	0.0021	0.0021	0.0018

-----  
 AVERAGES OF MONTHLY AVERAGED DAILY HEADS (INCHES)  
 -----

DAILY AVERAGE HEAD ON TOP OF LAYER 5  
 -----

AVERAGES	2.6586	2.4524	2.0023	1.2634	0.3509	0.3002
	0.5167	0.6802	0.7072	0.7474	0.9836	1.6358
STD. DEVIATIONS	1.8039	1.7532	1.4946	1.1301	0.4094	0.5500
	0.7447	0.8632	1.0061	1.0247	1.2618	1.3759

DAILY AVERAGE HEAD ON TOP OF LAYER 8  
 -----

AVERAGES	0.0047	0.0048	0.0043	0.0031	0.0008	0.0006
	0.0010	0.0013	0.0014	0.0015	0.0019	0.0031
STD. DEVIATIONS	0.0027	0.0028	0.0030	0.0030	0.0013	0.0011
	0.0015	0.0017	0.0019	0.0020	0.0023	0.0026

\*\*\*\*\*  
 \*\*\*\*\*

AVERAGE ANNUAL TOTALS & (STD. DEVIATIONS) FOR YEARS 1 THROUGH 100  
 -----

	INCHES		CU. FEET	PERCENT
	-----	-----	-----	-----
PRECIPITATION	48.90	( 7.734)	3484469.2	100.00
RUNOFF	1.953	( 1.2038)	139173.55	3.994
EVAPOTRANSPIRATION	34.391	( 3.5912)	2450586.25	70.329
LATERAL DRAINAGE COLLECTED FROM LAYER 4	12.09099	( 4.72285)	861566.687	24.72591
PERCOLATION/LEAKAGE THROUGH LAYER 5	0.42058	( 0.14847)	29969.580	0.86009
AVERAGE HEAD ON TOP OF LAYER 5	1.192	( 0.467)		
LATERAL DRAINAGE COLLECTED FROM LAYER 7	0.36785	( 0.14403)	26211.666	0.75224
PERCOLATION/LEAKAGE THROUGH LAYER 8	0.05272	( 0.00812)	3756.311	0.10780
AVERAGE HEAD ON TOP OF LAYER 8	0.002	( 0.001)		
CHANGE IN WATER STORAGE	0.045	( 1.7733)	3174.83	0.091

\*\*\*\*\*

\*\*\*\*\*

PEAK DAILY VALUES FOR YEARS	1 THROUGH 100	
	(INCHES)	(CU. FT.)
PRECIPITATION	6.87	489534.875
RUNOFF	3.729	265714.0000
DRAINAGE COLLECTED FROM LAYER 4	0.33581	23928.91800
PERCOLATION/LEAKAGE THROUGH LAYER 5	0.018371	1309.04749
AVERAGE HEAD ON TOP OF LAYER 5	21.403	
MAXIMUM HEAD ON TOP OF LAYER 5	31.206	
LOCATION OF MAXIMUM HEAD IN LAYER 4 (DISTANCE FROM DRAIN)	121.6 FEET	
DRAINAGE COLLECTED FROM LAYER 7	0.01387	988.50873
PERCOLATION/LEAKAGE THROUGH LAYER 8	0.000198	14.09545
AVERAGE HEAD ON TOP OF LAYER 8	0.033	
MAXIMUM HEAD ON TOP OF LAYER 8	0.065	
LOCATION OF MAXIMUM HEAD IN LAYER 7 (DISTANCE FROM DRAIN)	0.0 FEET	
SNOW WATER	2.36	168188.7190
MAXIMUM VEG. SOIL WATER (VOL/VOL)		0.3479
MINIMUM VEG. SOIL WATER (VOL/VOL)		0.1360

\*\*\* Maximum heads are computed using McEnroe's equations. \*\*\*

Reference: Maximum Saturated Depth over Landfill Liner  
by Bruce M. McEnroe, University of Kansas  
ASCE Journal of Environmental Engineering  
Vol. 119, No. 2, March 1993, pp. 262-270.

\*\*\*\*\*

\*\*\*\*\*

FINAL WATER STORAGE AT END OF YEAR 100

LAYER	( INCHES )	( VOL/VOL )
1	8.7843	0.2928
2	0.6720	0.0560
3	3.6450	0.3038
4	3.0638	0.2553
5	0.1500	0.7500
6	14.0568	0.2400
7	1.9223	0.0801
8	0.1500	0.7500
SNOW WATER	0.000	

\*\*\*\*\*  
\*\*\*\*\*

Appendix R, Upper Bounding Scenario Degraded SDF MSE Vault Closure Cap (300 Years): HELP Model Input Data and Output File (output file name: ZUBSD3ou.OUT)

Input Data:

Input Parameter (HELP Model Query)		Generic Input Parameter Value					
Landfill area =		19.63 acres					
Percent of area where runoff is possible =		100%					
Do you want to specify initial moisture storage? (Y/N)		Y					
Amount of water or snow on surface =		0 inches					
CN Input Parameter (HELP Model Query)		CN Input Parameter Value					
Slope =		3 %					
Slope length =		450 ft					
Soil Texture =		10 (HELP model default soil texture)					
Vegetation =		4 (i.e., a good stand of grass)					
HELP Model Computed Curve Number = 80.1							
Layer		Layer Number		Layer Type			
Upper Backfill		1		1 (vertical percolation layer)			
Erosion Barrier		2		1 (vertical percolation layer)			
Middle Backfill		3		1 (vertical percolation layer)			
Upper Drainage Layer		4		2 (lateral drainage layer)			
Upper GCL		5		3 (barrier soil liner)			
Lower Backfill		6		1 (vertical percolation layer)			
Lower Drainage Layer		7		2 (lateral drainage layer)			
Lower GCL		8		3 (barrier soil liner)			
	Layer Type	Layer Thickness (in)	Soil Texture No.	Total Porosity (Vol/Vol)	Field Capacity (Vol/Vol)	Wilting Point (Vol/Vol)	Initial Moisture (Vol/Vol)
1	1	20.218		0.37	0.24	0.136	0.24
2	1	12		0.06	0.056	0.052	0.056
3	1	12		0.371	0.226	0.126	0.226
4	2	12		0.379	0.093	0.0233	0.093
5	3	0.2		0.75	0.747	0.40	0.75
6	1	58.57		0.37	0.24	0.136	0.24
7	2	24		0.38	0.08	0.0132	0.08
8	3	0.2		0.75	0.747	0.40	0.75

The lack of values in the table for particular parameters in particular layers denotes that no HELP model input was required for that parameter in that layer. No data are missing from the table.

## Input Data (continued):

	Layer Type	Sat. Hyd. Conductivity * (cm/sec)	Drainage Length (ft)	Drain Slope (%)	Leachate Recirc. (%)	Recirc. to Layer (#)	Subsurface Inflow (in/yr)
1	1	1.00E-04					
2	1	3.97E-04					
3	1	1.80E-04					
4	2	5.60E-02	450	3			
5	3	5.00E-09					
6	1	1.00E-04					
7	2	9.99E-02	150	11.4			
8	3	5.00E-09					
	Layer Type	Geomembrane Pinhole Density (#/acre)	Geomembrane Instal. Defects (#/acre)	Geomembrane Placement Quality	Geotextile Transmissivity (cm <sup>2</sup> /sec)		
1	1						
2	1						
3	1						
4	2						
5	3						
6	1						
7	2						
8	3						

The lack of values in the table for particular parameters in particular layers denotes that no HELP model input was required for that parameter in that layer. No data are missing from the table.

\* The HELP model output often produces an increased number of significant digits for the Effective Saturated Hydraulic Conductivity over that of the actual input





## LAYER 3

-----

## TYPE 1 - VERTICAL PERCOLATION LAYER

MATERIAL TEXTURE NUMBER 0

THICKNESS	=	12.00	INCHES
POROSITY	=	0.3710	VOL/VOL
FIELD CAPACITY	=	0.2260	VOL/VOL
WILTING POINT	=	0.1260	VOL/VOL
INITIAL SOIL WATER CONTENT	=	0.2260	VOL/VOL
EFFECTIVE SAT. HYD. COND.	=	0.180000003000E-03	CM/SEC

## LAYER 4

-----

## TYPE 2 - LATERAL DRAINAGE LAYER

MATERIAL TEXTURE NUMBER 0

THICKNESS	=	12.00	INCHES
POROSITY	=	0.3790	VOL/VOL
FIELD CAPACITY	=	0.0930	VOL/VOL
WILTING POINT	=	0.0233	VOL/VOL
INITIAL SOIL WATER CONTENT	=	0.0930	VOL/VOL
EFFECTIVE SAT. HYD. COND.	=	0.560000017000E-01	CM/SEC
SLOPE	=	3.00	PERCENT
DRAINAGE LENGTH	=	450.0	FEET

## LAYER 5

-----

## TYPE 3 - BARRIER SOIL LINER

MATERIAL TEXTURE NUMBER 0

THICKNESS	=	0.20	INCHES
POROSITY	=	0.7500	VOL/VOL
FIELD CAPACITY	=	0.7470	VOL/VOL
WILTING POINT	=	0.4000	VOL/VOL
INITIAL SOIL WATER CONTENT	=	0.7500	VOL/VOL
EFFECTIVE SAT. HYD. COND.	=	0.499999997000E-08	CM/SEC

## LAYER 6

-----

## TYPE 1 - VERTICAL PERCOLATION LAYER

MATERIAL TEXTURE NUMBER 0

THICKNESS	=	58.57	INCHES
POROSITY	=	0.3700	VOL/VOL
FIELD CAPACITY	=	0.2400	VOL/VOL
WILTING POINT	=	0.1360	VOL/VOL
INITIAL SOIL WATER CONTENT	=	0.2400	VOL/VOL
EFFECTIVE SAT. HYD. COND.	=	0.999999975000E-04	CM/SEC

## LAYER 7

-----

## TYPE 2 - LATERAL DRAINAGE LAYER

MATERIAL TEXTURE NUMBER 0

THICKNESS	=	24.00	INCHES
POROSITY	=	0.3800	VOL/VOL
FIELD CAPACITY	=	0.0800	VOL/VOL
WILTING POINT	=	0.0132	VOL/VOL
INITIAL SOIL WATER CONTENT	=	0.0800	VOL/VOL
EFFECTIVE SAT. HYD. COND.	=	0.998999998000E-01	CM/SEC
SLOPE	=	11.40	PERCENT
DRAINAGE LENGTH	=	150.0	FEET

## LAYER 8

-----

## TYPE 3 - BARRIER SOIL LINER

MATERIAL TEXTURE NUMBER 0

THICKNESS	=	0.20	INCHES
POROSITY	=	0.7500	VOL/VOL
FIELD CAPACITY	=	0.7470	VOL/VOL
WILTING POINT	=	0.4000	VOL/VOL
INITIAL SOIL WATER CONTENT	=	0.7500	VOL/VOL
EFFECTIVE SAT. HYD. COND.	=	0.499999997000E-08	CM/SEC

## GENERAL DESIGN AND EVAPORATIVE ZONE DATA

-----

NOTE: SCS RUNOFF CURVE NUMBER WAS COMPUTED FROM DEFAULT SOIL DATA BASE USING SOIL TEXTURE #10 WITH A GOOD STAND OF GRASS, A SURFACE SLOPE OF 3.%, AND A SLOPE LENGTH OF 450. FEET.

SCS RUNOFF CURVE NUMBER	=	80.10	
FRACTION OF AREA ALLOWING RUNOFF	=	100.0	PERCENT
AREA PROJECTED ON HORIZONTAL PLANE	=	19.630	ACRES
EVAPORATIVE ZONE DEPTH	=	22.0	INCHES
INITIAL WATER IN EVAPORATIVE ZONE	=	4.952	INCHES
UPPER LIMIT OF EVAPORATIVE STORAGE	=	7.588	INCHES
LOWER LIMIT OF EVAPORATIVE STORAGE	=	2.842	INCHES
INITIAL SNOW WATER	=	0.000	INCHES
INITIAL WATER IN LAYER MATERIALS	=	25.629	INCHES
TOTAL INITIAL WATER	=	25.629	INCHES
TOTAL SUBSURFACE INFLOW	=	0.00	INCHES/YEAR

EVAPOTRANSPIRATION AND WEATHER DATA

NOTE: EVAPOTRANSPIRATION DATA WAS OBTAINED FROM  
AUGUSTA GEORGIA

STATION LATITUDE = 33.22 DEGREES  
 MAXIMUM LEAF AREA INDEX = 3.50  
 START OF GROWING SEASON (JULIAN DATE) = 68  
 END OF GROWING SEASON (JULIAN DATE) = 323  
 EVAPORATIVE ZONE DEPTH = 22.0 INCHES  
 AVERAGE ANNUAL WIND SPEED = 6.50 MPH  
 AVERAGE 1ST QUARTER RELATIVE HUMIDITY = 68.00 %  
 AVERAGE 2ND QUARTER RELATIVE HUMIDITY = 70.00 %  
 AVERAGE 3RD QUARTER RELATIVE HUMIDITY = 77.00 %  
 AVERAGE 4TH QUARTER RELATIVE HUMIDITY = 73.00 %

NOTE: PRECIPITATION DATA WAS SYNTHETICALLY GENERATED USING  
COEFFICIENTS FOR AUGUSTA GEORGIA

NORMAL MEAN MONTHLY PRECIPITATION (INCHES)

JAN/JUL	FEB/AUG	MAR/SEP	APR/OCT	MAY/NOV	JUN/DEC
4.38	3.95	4.68	2.91	3.56	4.99
5.43	5.41	3.93	3.12	2.96	3.45

NOTE: TEMPERATURE DATA WAS SYNTHETICALLY GENERATED USING  
COEFFICIENTS FOR AUGUSTA GEORGIA

NORMAL MEAN MONTHLY TEMPERATURE (DEGREES FAHRENHEIT)

JAN/JUL	FEB/AUG	MAR/SEP	APR/OCT	MAY/NOV	JUN/DEC
46.30	50.00	57.20	64.30	72.10	78.40
81.60	80.30	75.20	65.10	56.70	48.80

NOTE: SOLAR RADIATION DATA WAS SYNTHETICALLY GENERATED USING  
COEFFICIENTS FOR AUGUSTA GEORGIA  
AND STATION LATITUDE = 33.30 DEGREES

\*\*\*\*\*

AVERAGE MONTHLY VALUES IN INCHES FOR YEARS 1 THROUGH 100

	JAN/JUL	FEB/AUG	MAR/SEP	APR/OCT	MAY/NOV	JUN/DEC
PRECIPITATION						
TOTALS	4.56	3.57	4.76	2.74	3.60	4.97
	5.81	5.32	4.41	2.99	2.75	3.41
STD. DEVIATIONS	2.44	1.60	2.47	1.31	2.12	2.60
	2.83	2.95	2.54	2.28	1.72	1.90

## RUNOFF

-----

TOTALS	0.231	0.086	0.177	0.024	0.077	0.143
	0.291	0.361	0.211	0.144	0.096	0.111
STD. DEVIATIONS	0.342	0.178	0.310	0.081	0.184	0.255
	0.427	0.716	0.403	0.330	0.226	0.192

## EVAPOTRANSPIRATION

-----

TOTALS	1.612	2.139	3.242	3.495	3.292	4.043
	4.791	4.373	3.269	1.592	0.959	1.148
STD. DEVIATIONS	0.211	0.215	0.534	0.898	1.478	1.512
	1.574	1.371	1.051	0.637	0.230	0.200

## LATERAL DRAINAGE COLLECTED FROM LAYER 4

-----

TOTALS	2.2735	1.8902	1.7018	1.0030	0.3272	0.3113
	0.5343	0.6563	0.6542	0.7026	0.8841	1.4480
STD. DEVIATIONS	1.4394	1.2978	1.2490	0.9080	0.3709	0.4838
	0.6752	0.7577	0.8370	0.8988	1.0346	1.1357

## PERCOLATION/LEAKAGE THROUGH LAYER 5

-----

TOTALS	0.0990	0.0823	0.0741	0.0457	0.0184	0.0173
	0.0263	0.0313	0.0311	0.0330	0.0399	0.0630
STD. DEVIATIONS	0.0653	0.0580	0.0515	0.0378	0.0149	0.0196
	0.0275	0.0308	0.0339	0.0367	0.0422	0.0463

## LATERAL DRAINAGE COLLECTED FROM LAYER 7

-----

TOTALS	0.0746	0.0676	0.0781	0.0572	0.0243	0.0131
	0.0212	0.0255	0.0247	0.0284	0.0325	0.0548
STD. DEVIATIONS	0.0356	0.0352	0.0563	0.0620	0.0394	0.0204
	0.0267	0.0284	0.0291	0.0356	0.0353	0.0415

## PERCOLATION/LEAKAGE THROUGH LAYER 8

-----

TOTALS	0.0053	0.0049	0.0054	0.0052	0.0053	0.0048
	0.0048	0.0049	0.0048	0.0048	0.0044	0.0048
STD. DEVIATIONS	0.0006	0.0003	0.0001	0.0002	0.0002	0.0008
	0.0010	0.0011	0.0010	0.0012	0.0015	0.0014

-----  
 AVERAGES OF MONTHLY AVERAGED DAILY HEADS (INCHES)  
 -----

DAILY AVERAGE HEAD ON TOP OF LAYER 5  
 -----

AVERAGES	3.5600	3.2229	2.6118	1.5926	0.4992	0.4907
	0.8150	1.0016	1.0312	1.0741	1.3936	2.2090
STD. DEVIATIONS	2.4719	2.4125	1.9524	1.4814	0.5657	0.7626
	1.0300	1.1572	1.3194	1.3772	1.6309	1.7325

DAILY AVERAGE HEAD ON TOP OF LAYER 8  
 -----

AVERAGES	0.0057	0.0056	0.0059	0.0045	0.0018	0.0010
	0.0016	0.0019	0.0019	0.0022	0.0025	0.0042
STD. DEVIATIONS	0.0027	0.0029	0.0043	0.0049	0.0030	0.0016
	0.0020	0.0022	0.0023	0.0027	0.0028	0.0032

\*\*\*\*\*  
 \*\*\*\*\*

AVERAGE ANNUAL TOTALS & (STD. DEVIATIONS) FOR YEARS 1 THROUGH 100  
 -----

	INCHES		CU. FEET	PERCENT
PRECIPITATION	48.90	( 7.734)	3484469.2	100.00
RUNOFF	1.953	( 1.2009)	139192.66	3.995
EVAPOTRANSPIRATION	33.956	( 3.5509)	2419606.25	69.440
LATERAL DRAINAGE COLLECTED FROM LAYER 4	12.38653	( 4.71636)	882625.750	25.33028
PERCOLATION/LEAKAGE THROUGH LAYER 5	0.56138	( 0.19807)	40002.363	1.14802
AVERAGE HEAD ON TOP OF LAYER 5	1.625	( 0.635)		
LATERAL DRAINAGE COLLECTED FROM LAYER 7	0.50194	( 0.19286)	35766.445	1.02645
PERCOLATION/LEAKAGE THROUGH LAYER 8	0.05940	( 0.00465)	4232.409	0.12146
AVERAGE HEAD ON TOP OF LAYER 8	0.003	( 0.001)		
CHANGE IN WATER STORAGE	0.043	( 1.7258)	3045.79	0.087

\*\*\*\*\*

\*\*\*\*\*

PEAK DAILY VALUES FOR YEARS	1 THROUGH	100
	(INCHES)	(CU. FT.)
PRECIPITATION	6.87	489534.875
RUNOFF	3.725	265455.3750
DRAINAGE COLLECTED FROM LAYER 4	0.25747	18346.30660
PERCOLATION/LEAKAGE THROUGH LAYER 5	0.032847	2340.56616
AVERAGE HEAD ON TOP OF LAYER 5	38.426	
MAXIMUM HEAD ON TOP OF LAYER 5	50.278	
LOCATION OF MAXIMUM HEAD IN LAYER 4 (DISTANCE FROM DRAIN)	156.5 FEET	
DRAINAGE COLLECTED FROM LAYER 7	0.01678	1195.40491
PERCOLATION/LEAKAGE THROUGH LAYER 8	0.000204	14.51149
AVERAGE HEAD ON TOP OF LAYER 8	0.039	
MAXIMUM HEAD ON TOP OF LAYER 8	0.078	
LOCATION OF MAXIMUM HEAD IN LAYER 7 (DISTANCE FROM DRAIN)	0.0 FEET	
SNOW WATER	2.36	168188.7190
MAXIMUM VEG. SOIL WATER (VOL/VOL)		0.3215
MINIMUM VEG. SOIL WATER (VOL/VOL)		0.1292

\*\*\* Maximum heads are computed using McEnroe's equations. \*\*\*

Reference: Maximum Saturated Depth over Landfill Liner  
by Bruce M. McEnroe, University of Kansas  
ASCE Journal of Environmental Engineering  
Vol. 119, No. 2, March 1993, pp. 262-270.

\*\*\*\*\*

\*\*\*\*\*

FINAL WATER STORAGE AT END OF YEAR 100

LAYER	( INCHES )	( VOL/VOL )
1	5.4079	0.2675
2	0.8921	0.0743
3	3.7346	0.3112
4	3.5871	0.2989
5	0.1500	0.7500
6	14.0595	0.2400
7	1.9222	0.0801
8	0.1500	0.7500
SNOW WATER	0.000	

\*\*\*\*\*  
\*\*\*\*\*

Appendix S, Upper Bounding Scenario Degraded SDF MSE Vault Closure Cap (550 Years): HELP Model Input Data and Output File (output file name: ZUBSD4ou.OUT)

Input Data:

Input Parameter (HELP Model Query)		Generic Input Parameter Value					
Landfill area =		19.63 acres					
Percent of area where runoff is possible =		100%					
Do you want to specify initial moisture storage? (Y/N)		Y					
Amount of water or snow on surface =		0 inches					
CN Input Parameter (HELP Model Query)		CN Input Parameter Value					
Slope =		3 %					
Slope length =		450 ft					
Soil Texture =		10 (HELP model default soil texture)					
Vegetation =		4 (i.e., a good stand of grass)					
HELP Model Computed Curve Number = 80.1							
Layer		Layer Number		Layer Type			
Upper Backfill		1		1 (vertical percolation layer)			
Erosion Barrier		2		1 (vertical percolation layer)			
Middle Backfill		3		1 (vertical percolation layer)			
Upper Drainage Layer		4		2 (lateral drainage layer)			
Upper GCL		5		3 (barrier soil liner)			
Lower Backfill		6		1 (vertical percolation layer)			
Lower Drainage Layer		7		2 (lateral drainage layer)			
Lower GCL		8		3 (barrier soil liner)			
	Layer Type	Layer Thickness (in)	Soil Texture No.	Total Porosity (Vol/Vol)	Field Capacity (Vol/Vol)	Wilting Point (Vol/Vol)	Initial Moisture (Vol/Vol)
1	1	3.468		0.37	0.24	0.136	0.24
2	1	12		0.06	0.056	0.052	0.056
3	1	12		0.372	0.215	0.117	0.215
4	2	12		0.378	0.105	0.0319	0.105
5	3	0.2		0.75	0.747	0.40	0.75
6	1	58.57		0.37	0.24	0.136	0.24
7	2	24		0.38	0.0803	0.0134	0.0803
8	3	0.2		0.75	0.747	0.40	0.75

The lack of values in the table for particular parameters in particular layers denotes that no HELP model input was required for that parameter in that layer. No data are missing from the table.



## Input Data (continued):

	Layer Type	Sat. Hyd. Conductivity * (cm/sec)	Drainage Length (ft)	Drain Slope (%)	Leachate Recirc. (%)	Recirc. to Layer (#)	Subsurface Inflow (in/yr)
1	1	1.00E-04					
2	1	3.97E-04					
3	1	2.90E-04					
4	2	3.40E-02	450	3			
5	3	5.00E-09					
6	1	1.00E-04					
7	2	9.98E-02	150	11.4			
8	3	5.00E-09					
	Layer Type	Geomembrane Pinhole Density (#/acre)	Geomembrane Instal. Defects (#/acre)	Geomembrane Placement Quality	Geotextile Transmissivity (cm <sup>2</sup> /sec)		
1	1						
2	1						
3	1						
4	2						
5	3						
6	1						
7	2						
8	3						

The lack of values in the table for particular parameters in particular layers denotes that no HELP model input was required for that parameter in that layer. No data are missing from the table.

\* The HELP model output often produces an increased number of significant digits for the Effective Saturated Hydraulic Conductivity over that of the actual input



## LAYER 3

-----

## TYPE 1 - VERTICAL PERCOLATION LAYER

MATERIAL TEXTURE NUMBER 0

THICKNESS	=	12.00	INCHES
POROSITY	=	0.3720	VOL/VOL
FIELD CAPACITY	=	0.2150	VOL/VOL
WILTING POINT	=	0.1170	VOL/VOL
INITIAL SOIL WATER CONTENT	=	0.2150	VOL/VOL
EFFECTIVE SAT. HYD. COND.	=	0.289999996000E-03	CM/SEC

## LAYER 4

-----

## TYPE 2 - LATERAL DRAINAGE LAYER

MATERIAL TEXTURE NUMBER 0

THICKNESS	=	12.00	INCHES
POROSITY	=	0.3780	VOL/VOL
FIELD CAPACITY	=	0.1050	VOL/VOL
WILTING POINT	=	0.0319	VOL/VOL
INITIAL SOIL WATER CONTENT	=	0.1050	VOL/VOL
EFFECTIVE SAT. HYD. COND.	=	0.340000018000E-01	CM/SEC
SLOPE	=	3.00	PERCENT
DRAINAGE LENGTH	=	450.0	FEET

## LAYER 5

-----

## TYPE 3 - BARRIER SOIL LINER

MATERIAL TEXTURE NUMBER 0

THICKNESS	=	0.20	INCHES
POROSITY	=	0.7500	VOL/VOL
FIELD CAPACITY	=	0.7470	VOL/VOL
WILTING POINT	=	0.4000	VOL/VOL
INITIAL SOIL WATER CONTENT	=	0.7500	VOL/VOL
EFFECTIVE SAT. HYD. COND.	=	0.499999997000E-08	CM/SEC

## LAYER 6

-----

## TYPE 1 - VERTICAL PERCOLATION LAYER

MATERIAL TEXTURE NUMBER 0

THICKNESS	=	58.57	INCHES
POROSITY	=	0.3700	VOL/VOL
FIELD CAPACITY	=	0.2400	VOL/VOL
WILTING POINT	=	0.1360	VOL/VOL
INITIAL SOIL WATER CONTENT	=	0.2400	VOL/VOL
EFFECTIVE SAT. HYD. COND.	=	0.999999975000E-04	CM/SEC

## LAYER 7

-----

## TYPE 2 - LATERAL DRAINAGE LAYER

MATERIAL TEXTURE NUMBER 0

THICKNESS	=	24.00	INCHES
POROSITY	=	0.3800	VOL/VOL
FIELD CAPACITY	=	0.0803	VOL/VOL
WILTING POINT	=	0.0134	VOL/VOL
INITIAL SOIL WATER CONTENT	=	0.0803	VOL/VOL
EFFECTIVE SAT. HYD. COND.	=	0.997999981000E-01	CM/SEC
SLOPE	=	11.40	PERCENT
DRAINAGE LENGTH	=	150.0	FEET

## LAYER 8

-----

## TYPE 3 - BARRIER SOIL LINER

MATERIAL TEXTURE NUMBER 0

THICKNESS	=	0.20	INCHES
POROSITY	=	0.7500	VOL/VOL
FIELD CAPACITY	=	0.7470	VOL/VOL
WILTING POINT	=	0.4000	VOL/VOL
INITIAL SOIL WATER CONTENT	=	0.7500	VOL/VOL
EFFECTIVE SAT. HYD. COND.	=	0.499999997000E-08	CM/SEC

## GENERAL DESIGN AND EVAPORATIVE ZONE DATA

-----

NOTE: SCS RUNOFF CURVE NUMBER WAS COMPUTED FROM DEFAULT  
SOIL DATA BASE USING SOIL TEXTURE #10 WITH A  
GOOD STAND OF GRASS, A SURFACE SLOPE OF 3.%,  
AND A SLOPE LENGTH OF 450. FEET.

SCS RUNOFF CURVE NUMBER	=	80.10	
FRACTION OF AREA ALLOWING RUNOFF	=	100.0	PERCENT
AREA PROJECTED ON HORIZONTAL PLANE	=	19.630	ACRES
EVAPORATIVE ZONE DEPTH	=	22.0	INCHES
INITIAL WATER IN EVAPORATIVE ZONE	=	2.909	INCHES
UPPER LIMIT OF EVAPORATIVE STORAGE	=	4.433	INCHES
LOWER LIMIT OF EVAPORATIVE STORAGE	=	1.860	INCHES
INITIAL SNOW WATER	=	0.000	INCHES
INITIAL WATER IN LAYER MATERIALS	=	21.628	INCHES
TOTAL INITIAL WATER	=	21.628	INCHES
TOTAL SUBSURFACE INFLOW	=	0.00	INCHES/YEAR

EVAPOTRANSPIRATION AND WEATHER DATA

NOTE: EVAPOTRANSPIRATION DATA WAS OBTAINED FROM AUGUSTA GEORGIA

STATION LATITUDE = 33.22 DEGREES  
 MAXIMUM LEAF AREA INDEX = 3.50  
 START OF GROWING SEASON (JULIAN DATE) = 68  
 END OF GROWING SEASON (JULIAN DATE) = 323  
 EVAPORATIVE ZONE DEPTH = 22.0 INCHES  
 AVERAGE ANNUAL WIND SPEED = 6.50 MPH  
 AVERAGE 1ST QUARTER RELATIVE HUMIDITY = 68.00 %  
 AVERAGE 2ND QUARTER RELATIVE HUMIDITY = 70.00 %  
 AVERAGE 3RD QUARTER RELATIVE HUMIDITY = 77.00 %  
 AVERAGE 4TH QUARTER RELATIVE HUMIDITY = 73.00 %

NOTE: PRECIPITATION DATA WAS SYNTHETICALLY GENERATED USING COEFFICIENTS FOR AUGUSTA GEORGIA

NORMAL MEAN MONTHLY PRECIPITATION (INCHES)

JAN/JUL	FEB/AUG	MAR/SEP	APR/OCT	MAY/NOV	JUN/DEC
4.38	3.95	4.68	2.91	3.56	4.99
5.43	5.41	3.93	3.12	2.96	3.45

NOTE: TEMPERATURE DATA WAS SYNTHETICALLY GENERATED USING COEFFICIENTS FOR AUGUSTA GEORGIA

NORMAL MEAN MONTHLY TEMPERATURE (DEGREES FAHRENHEIT)

JAN/JUL	FEB/AUG	MAR/SEP	APR/OCT	MAY/NOV	JUN/DEC
46.30	50.00	57.20	64.30	72.10	78.40
81.60	80.30	75.20	65.10	56.70	48.80

NOTE: SOLAR RADIATION DATA WAS SYNTHETICALLY GENERATED USING COEFFICIENTS FOR AUGUSTA GEORGIA AND STATION LATITUDE = 33.30 DEGREES

\*\*\*\*\*

AVERAGE MONTHLY VALUES IN INCHES FOR YEARS 1 THROUGH 100

	JAN/JUL	FEB/AUG	MAR/SEP	APR/OCT	MAY/NOV	JUN/DEC
PRECIPITATION						
TOTALS	4.56	3.57	4.76	2.74	3.60	4.97
	5.81	5.32	4.41	2.99	2.75	3.41
STD. DEVIATIONS	2.44	1.60	2.47	1.31	2.12	2.60
	2.83	2.95	2.54	2.28	1.72	1.90

## RUNOFF

-----

TOTALS	0.192	0.084	0.144	0.021	0.072	0.125
	0.267	0.333	0.181	0.123	0.063	0.068
STD. DEVIATIONS	0.429	0.246	0.311	0.072	0.162	0.219
	0.378	0.670	0.362	0.316	0.162	0.138

## EVAPOTRANSPIRATION

-----

TOTALS	1.681	2.097	2.865	2.406	2.802	3.438
	3.898	3.454	2.698	1.466	1.068	1.298
STD. DEVIATIONS	0.228	0.294	0.738	0.909	1.126	1.312
	1.269	1.166	0.950	0.679	0.282	0.203

## LATERAL DRAINAGE COLLECTED FROM LAYER 4

-----

TOTALS	2.1202	1.8138	1.7760	1.2001	0.7499	0.9084
	1.3365	1.4961	1.3923	1.2466	1.2125	1.5414
STD. DEVIATIONS	1.1708	1.1039	1.0639	0.8652	0.6453	0.7220
	0.9105	0.9416	0.8999	1.0017	0.9693	0.9844

## PERCOLATION/LEAKAGE THROUGH LAYER 5

-----

TOTALS	0.1595	0.1349	0.1310	0.0858	0.0550	0.0654
	0.0942	0.1066	0.0999	0.0904	0.0883	0.1090
STD. DEVIATIONS	0.1091	0.0999	0.0905	0.0605	0.0429	0.0483
	0.0611	0.0677	0.0659	0.0729	0.0725	0.0684

## LATERAL DRAINAGE COLLECTED FROM LAYER 7

-----

TOTALS	0.1088	0.0975	0.1294	0.1274	0.1065	0.0765
	0.0763	0.0852	0.0864	0.0878	0.0821	0.0924
STD. DEVIATIONS	0.0636	0.0553	0.0790	0.1025	0.1050	0.0774
	0.0490	0.0434	0.0495	0.0607	0.0612	0.0632

## PERCOLATION/LEAKAGE THROUGH LAYER 8

-----

TOTALS	0.0053	0.0048	0.0055	0.0053	0.0055	0.0053
	0.0054	0.0054	0.0052	0.0054	0.0052	0.0054
STD. DEVIATIONS	0.0006	0.0006	0.0004	0.0003	0.0002	0.0002
	0.0002	0.0003	0.0004	0.0005	0.0003	0.0002

-----  
 AVERAGES OF MONTHLY AVERAGED DAILY HEADS (INCHES)  
 -----

DAILY AVERAGE HEAD ON TOP OF LAYER 5  
 -----

AVERAGES	5.8522	5.4113	4.7682	3.1614	1.8873	2.3646
	3.3727	3.8440	3.7151	3.2328	3.2608	3.9337
STD. DEVIATIONS	4.1391	4.1516	3.4339	2.3734	1.6279	1.8951
	2.3196	2.5676	2.5839	2.7640	2.8427	2.5945

DAILY AVERAGE HEAD ON TOP OF LAYER 8  
 -----

AVERAGES	0.0083	0.0081	0.0098	0.0100	0.0081	0.0060
	0.0058	0.0065	0.0068	0.0067	0.0064	0.0070
STD. DEVIATIONS	0.0048	0.0046	0.0060	0.0080	0.0080	0.0061
	0.0037	0.0033	0.0039	0.0046	0.0048	0.0048

\*\*\*\*\*  
 \*\*\*\*\*

AVERAGE ANNUAL TOTALS & (STD. DEVIATIONS) FOR YEARS 1 THROUGH 100  
 -----

	INCHES		CU. FEET	PERCENT
PRECIPITATION	48.90	( 7.734)	3484469.2	100.00
RUNOFF	1.674	( 1.1207)	119312.50	3.424
EVAPOTRANSPIRATION	29.172	( 2.9357)	2078691.75	59.656
LATERAL DRAINAGE COLLECTED FROM LAYER 4	16.79392	( 5.06796)	1196682.870	34.34333
PERCOLATION/LEAKAGE THROUGH LAYER 5	1.21999	( 0.38499)	86932.844	2.49487
AVERAGE HEAD ON TOP OF LAYER 5	3.734	( 1.244)		
LATERAL DRAINAGE COLLECTED FROM LAYER 7	1.15625	( 0.35664)	82390.602	2.36451
PERCOLATION/LEAKAGE THROUGH LAYER 8	0.06366	( 0.00121)	4536.280	0.13019
AVERAGE HEAD ON TOP OF LAYER 8	0.007	( 0.002)		
CHANGE IN WATER STORAGE	0.040	( 1.7923)	2855.07	0.082

\*\*\*\*\*

\*\*\*\*\*

PEAK DAILY VALUES FOR YEARS	1 THROUGH	100
	(INCHES)	(CU. FT.)
PRECIPITATION	6.87	489534.875
RUNOFF	3.631	258749.8590
DRAINAGE COLLECTED FROM LAYER 4	0.15807	11263.81930
PERCOLATION/LEAKAGE THROUGH LAYER 5	0.033553	2390.87256
AVERAGE HEAD ON TOP OF LAYER 5	39.256	
MAXIMUM HEAD ON TOP OF LAYER 5	51.171	
LOCATION OF MAXIMUM HEAD IN LAYER 4 (DISTANCE FROM DRAIN)	157.9 FEET	
DRAINAGE COLLECTED FROM LAYER 7	0.01737	1237.79187
PERCOLATION/LEAKAGE THROUGH LAYER 8	0.000205	14.59881
AVERAGE HEAD ON TOP OF LAYER 8	0.041	
MAXIMUM HEAD ON TOP OF LAYER 8	0.084	
LOCATION OF MAXIMUM HEAD IN LAYER 7 (DISTANCE FROM DRAIN)	0.0 FEET	
SNOW WATER	2.36	168188.7190
MAXIMUM VEG. SOIL WATER (VOL/VOL)		0.2015
MINIMUM VEG. SOIL WATER (VOL/VOL)		0.0845

\*\*\* Maximum heads are computed using McEnroe's equations. \*\*\*

Reference: Maximum Saturated Depth over Landfill Liner  
by Bruce M. McEnroe, University of Kansas  
ASCE Journal of Environmental Engineering  
Vol. 119, No. 2, March 1993, pp. 262-270.

\*\*\*\*\*



\*\*\*\*\*

FINAL WATER STORAGE AT END OF YEAR 100

LAYER	( INCHES )	( VOL/VOL )
1	0.8942	0.2578
2	0.7993	0.0666
3	3.1131	0.2594
4	4.5360	0.3780
5	0.1500	0.7500
6	14.0638	0.2401
7	1.9286	0.0804
8	0.1500	0.7500
SNOW WATER	0.000	

\*\*\*\*\*  
\*\*\*\*\*

Appendix T, Upper Bounding Scenario Degraded SDF MSE Vault Closure Cap (602 Years): HELP Model Input Data and Output File (output file name: ZUBSD5ou.OUT)

Input Data:

Input Parameter (HELP Model Query)		Generic Input Parameter Value					
Landfill area =		19.63 acres					
Percent of area where runoff is possible =		100%					
Do you want to specify initial moisture storage? (Y/N)		Y					
Amount of water or snow on surface =		0 inches					
CN Input Parameter (HELP Model Query)		CN Input Parameter Value					
Slope =		3 %					
Slope length =		450 ft					
Soil Texture =		8 (HELP model default soil texture)					
Vegetation =		4 (i.e., a good stand of grass)					
HELP Model Computed Curve Number = 71.9							
Layer		Layer Number		Layer Type			
Erosion Barrier		1		1 (vertical percolation layer)			
Middle Backfill		2		1 (vertical percolation layer)			
Upper Drainage Layer		3		2 (lateral drainage layer)			
Upper GCL		4		3 (barrier soil liner)			
Lower Backfill		5		1 (vertical percolation layer)			
Lower Drainage Layer		6		2 (lateral drainage layer)			
Lower GCL		7		3 (barrier soil liner)			
	Layer Type	Layer Thickness (in)	Soil Texture No.	Total Porosity (Vol/Vol)	Field Capacity (Vol/Vol)	Wilting Point (Vol/Vol)	Initial Moisture (Vol/Vol)
1	1	12		0.06	0.056	0.052	0.056
2	1	12		0.372	0.213	0.115	0.213
3	2	12		0.378	0.107	0.0337	0.107
4	3	0.2		0.75	0.747	0.40	0.75
5	1	58.57		0.37	0.24	0.136	0.24
6	2	24		0.38	0.0803	0.0135	0.0803
7	3	0.2		0.75	0.747	0.40	0.75

The lack of values in the table for particular parameters in particular layers denotes that no HELP model input was required for that parameter in that layer. No data are missing from the table.

## Input Data (continued):

	Layer Type	Sat. Hyd. Conductivity * (cm/sec)	Drainage Length (ft)	Drain Slope (%)	Leachate Recirc. (%)	Recirc. to Layer (#)	Subsurface Inflow (in/yr)
1	1	3.97E-04					
2	1	3.20E-04					
3	2	3.10E-02	450	3			
4	3	5.00E-09					
5	1	1.00E-04					
6	2	9.97E-02	150	11.4			
7	3	5.00E-09					
	Layer Type	Geomembrane Pinhole Density (#/acre)	Geomembrane Instal. Defects (#/acre)	Geomembrane Placement Quality	Geotextile Transmissivity (cm <sup>2</sup> /sec)		
1	1						
2	1						
3	2						
4	3						
5	1						
6	2						
7	3						

The lack of values in the table for particular parameters in particular layers denotes that no HELP model input was required for that parameter in that layer. No data are missing from the table.

\* The HELP model output often produces an increased number of significant digits for the Effective Saturated Hydraulic Conductivity over that of the actual input



## LAYER 3

-----

## TYPE 2 - LATERAL DRAINAGE LAYER

MATERIAL TEXTURE NUMBER 0

THICKNESS	=	12.00	INCHES
POROSITY	=	0.3780	VOL/VOL
FIELD CAPACITY	=	0.1070	VOL/VOL
WILTING POINT	=	0.0337	VOL/VOL
INITIAL SOIL WATER CONTENT	=	0.1070	VOL/VOL
EFFECTIVE SAT. HYD. COND.	=	0.309999995000E-01	CM/SEC
SLOPE	=	3.00	PERCENT
DRAINAGE LENGTH	=	450.0	FEET

## LAYER 4

-----

## TYPE 3 - BARRIER SOIL LINER

MATERIAL TEXTURE NUMBER 0

THICKNESS	=	0.20	INCHES
POROSITY	=	0.7500	VOL/VOL
FIELD CAPACITY	=	0.7470	VOL/VOL
WILTING POINT	=	0.4000	VOL/VOL
INITIAL SOIL WATER CONTENT	=	0.7500	VOL/VOL
EFFECTIVE SAT. HYD. COND.	=	0.499999997000E-08	CM/SEC

## LAYER 5

-----

## TYPE 1 - VERTICAL PERCOLATION LAYER

MATERIAL TEXTURE NUMBER 0

THICKNESS	=	58.57	INCHES
POROSITY	=	0.3700	VOL/VOL
FIELD CAPACITY	=	0.2400	VOL/VOL
WILTING POINT	=	0.1360	VOL/VOL
INITIAL SOIL WATER CONTENT	=	0.2400	VOL/VOL
EFFECTIVE SAT. HYD. COND.	=	0.999999975000E-04	CM/SEC

## LAYER 6

-----

## TYPE 2 - LATERAL DRAINAGE LAYER

MATERIAL TEXTURE NUMBER 0

THICKNESS	=	24.00	INCHES
POROSITY	=	0.3800	VOL/VOL
FIELD CAPACITY	=	0.0803	VOL/VOL
WILTING POINT	=	0.0135	VOL/VOL
INITIAL SOIL WATER CONTENT	=	0.0803	VOL/VOL
EFFECTIVE SAT. HYD. COND.	=	0.996999964000E-01	CM/SEC
SLOPE	=	11.40	PERCENT
DRAINAGE LENGTH	=	150.0	FEET

LAYER 7

-----

TYPE 3 - BARRIER SOIL LINER

MATERIAL TEXTURE NUMBER 0

THICKNESS = 0.20 INCHES  
 POROSITY = 0.7500 VOL/VOL  
 FIELD CAPACITY = 0.7470 VOL/VOL  
 WILTING POINT = 0.4000 VOL/VOL  
 INITIAL SOIL WATER CONTENT = 0.7500 VOL/VOL  
 EFFECTIVE SAT. HYD. COND. = 0.499999997000E-08 CM/SEC

GENERAL DESIGN AND EVAPORATIVE ZONE DATA

-----

NOTE: SCS RUNOFF CURVE NUMBER WAS COMPUTED FROM DEFAULT SOIL DATA BASE USING SOIL TEXTURE # 8 WITH A GOOD STAND OF GRASS, A SURFACE SLOPE OF 3.% AND A SLOPE LENGTH OF 450. FEET.

SCS RUNOFF CURVE NUMBER = 71.90  
 FRACTION OF AREA ALLOWING RUNOFF = 100.0 PERCENT  
 AREA PROJECTED ON HORIZONTAL PLANE = 19.630 ACRES  
 EVAPORATIVE ZONE DEPTH = 22.0 INCHES  
 INITIAL WATER IN EVAPORATIVE ZONE = 2.802 INCHES  
 UPPER LIMIT OF EVAPORATIVE STORAGE = 4.440 INCHES  
 LOWER LIMIT OF EVAPORATIVE STORAGE = 1.774 INCHES  
 INITIAL SNOW WATER = 0.000 INCHES  
 INITIAL WATER IN LAYER MATERIALS = 20.796 INCHES  
 TOTAL INITIAL WATER = 20.796 INCHES  
 TOTAL SUBSURFACE INFLOW = 0.00 INCHES/YEAR

EVAPOTRANSPIRATION AND WEATHER DATA

-----

NOTE: EVAPOTRANSPIRATION DATA WAS OBTAINED FROM AUGUSTA GEORGIA

STATION LATITUDE = 33.22 DEGREES  
 MAXIMUM LEAF AREA INDEX = 3.50  
 START OF GROWING SEASON (JULIAN DATE) = 68  
 END OF GROWING SEASON (JULIAN DATE) = 323  
 EVAPORATIVE ZONE DEPTH = 22.0 INCHES  
 AVERAGE ANNUAL WIND SPEED = 6.50 MPH  
 AVERAGE 1ST QUARTER RELATIVE HUMIDITY = 68.00 %  
 AVERAGE 2ND QUARTER RELATIVE HUMIDITY = 70.00 %  
 AVERAGE 3RD QUARTER RELATIVE HUMIDITY = 77.00 %  
 AVERAGE 4TH QUARTER RELATIVE HUMIDITY = 73.00 %

NOTE: PRECIPITATION DATA WAS SYNTHETICALLY GENERATED USING  
COEFFICIENTS FOR AUGUSTA GEORGIA

NORMAL MEAN MONTHLY PRECIPITATION (INCHES)

JAN/JUL	FEB/AUG	MAR/SEP	APR/OCT	MAY/NOV	JUN/DEC
4.38	3.95	4.68	2.91	3.56	4.99
5.43	5.41	3.93	3.12	2.96	3.45

NOTE: TEMPERATURE DATA WAS SYNTHETICALLY GENERATED USING  
COEFFICIENTS FOR AUGUSTA GEORGIA

NORMAL MEAN MONTHLY TEMPERATURE (DEGREES FAHRENHEIT)

JAN/JUL	FEB/AUG	MAR/SEP	APR/OCT	MAY/NOV	JUN/DEC
46.30	50.00	57.20	64.30	72.10	78.40
81.60	80.30	75.20	65.10	56.70	48.80

NOTE: SOLAR RADIATION DATA WAS SYNTHETICALLY GENERATED USING  
COEFFICIENTS FOR AUGUSTA GEORGIA  
AND STATION LATITUDE = 33.30 DEGREES

\*\*\*\*\*

AVERAGE MONTHLY VALUES IN INCHES FOR YEARS 1 THROUGH 100

	JAN/JUL	FEB/AUG	MAR/SEP	APR/OCT	MAY/NOV	JUN/DEC
PRECIPITATION						
TOTALS	4.56	3.57	4.76	2.74	3.60	4.97
	5.81	5.32	4.41	2.99	2.75	3.41
STD. DEVIATIONS	2.44	1.60	2.47	1.31	2.12	2.60
	2.83	2.95	2.54	2.28	1.72	1.90
RUNOFF						
TOTALS	0.161	0.069	0.092	0.003	0.011	0.022
	0.078	0.154	0.082	0.049	0.032	0.010
STD. DEVIATIONS	0.562	0.347	0.377	0.017	0.042	0.061
	0.182	0.517	0.351	0.301	0.148	0.046
EVAPOTRANSPIRATION						
TOTALS	1.652	2.095	2.878	2.482	2.872	3.546
	3.979	3.557	2.740	1.472	1.052	1.274
STD. DEVIATIONS	0.223	0.279	0.718	0.929	1.184	1.353
	1.295	1.189	0.961	0.674	0.274	0.193

LATERAL DRAINAGE COLLECTED FROM LAYER 3

TOTALS	2.1452	1.8435	1.8081	1.1962	0.7402	0.8998
	1.3499	1.5439	1.4473	1.2928	1.2685	1.5860
STD. DEVIATIONS	1.1233	1.0668	1.0407	0.8585	0.6646	0.7492
	0.9321	0.9897	0.9184	1.0140	0.9760	1.0000

PERCOLATION/LEAKAGE THROUGH LAYER 4

TOTALS	0.1795	0.1499	0.1462	0.0937	0.0595	0.0711
	0.1052	0.1228	0.1145	0.1040	0.1025	0.1253
STD. DEVIATIONS	0.1160	0.1014	0.0960	0.0667	0.0496	0.0562
	0.0714	0.0822	0.0753	0.0861	0.0841	0.0821

LATERAL DRAINAGE COLLECTED FROM LAYER 6

TOTALS	0.1153	0.1068	0.1487	0.1476	0.1273	0.0851
	0.0808	0.0893	0.0959	0.1076	0.0994	0.1067
STD. DEVIATIONS	0.0718	0.0628	0.0876	0.1128	0.1174	0.0863
	0.0553	0.0501	0.0570	0.0794	0.0719	0.0758

PERCOLATION/LEAKAGE THROUGH LAYER 7

TOTALS	0.0052	0.0048	0.0055	0.0054	0.0055	0.0053
	0.0054	0.0053	0.0052	0.0054	0.0052	0.0054
STD. DEVIATIONS	0.0009	0.0006	0.0004	0.0003	0.0002	0.0002
	0.0003	0.0006	0.0007	0.0006	0.0004	0.0004

AVERAGES OF MONTHLY AVERAGED DAILY HEADS (INCHES)

DAILY AVERAGE HEAD ON TOP OF LAYER 4

AVERAGES	6.6097	6.0338	5.3468	3.4717	2.0567	2.5883
	3.7906	4.4596	4.2917	3.7471	3.8162	4.5531
STD. DEVIATIONS	4.3961	4.2118	3.6413	2.6149	1.8810	2.2030
	2.7065	3.1156	2.9477	3.2623	3.2952	3.1154

DAILY AVERAGE HEAD ON TOP OF LAYER 7

AVERAGES	0.0088	0.0089	0.0113	0.0116	0.0097	0.0067
	0.0061	0.0068	0.0075	0.0082	0.0078	0.0081
STD. DEVIATIONS	0.0055	0.0053	0.0067	0.0089	0.0089	0.0068
	0.0042	0.0038	0.0045	0.0060	0.0057	0.0058

\*\*\*\*\*



\*\*\*\*\*

AVERAGE ANNUAL TOTALS & (STD. DEVIATIONS) FOR YEARS 1 THROUGH 100				
	INCHES		CU. FEET	PERCENT
PRECIPITATION	48.90	( 7.734)	3484469.2	100.00
RUNOFF	0.764	( 0.9983)	54414.64	1.562
EVAPOTRANSPIRATION	29.600	( 2.9900)	2109233.00	60.532
LATERAL DRAINAGE COLLECTED FROM LAYER 3	17.12147	( 5.19863)	1220022.500	35.01315
PERCOLATION/LEAKAGE THROUGH LAYER 4	1.37415	( 0.44696)	97917.969	2.81013
AVERAGE HEAD ON TOP OF LAYER 4	4.230	( 1.442)		
LATERAL DRAINAGE COLLECTED FROM LAYER 6	1.31049	( 0.40512)	93381.766	2.67994
PERCOLATION/LEAKAGE THROUGH LAYER 7	0.06352	( 0.00198)	4526.362	0.12990
AVERAGE HEAD ON TOP OF LAYER 7	0.008	( 0.003)		
CHANGE IN WATER STORAGE	0.041	( 1.8707)	2890.97	0.083

\*\*\*\*\*

\*\*\*\*\*

PEAK DAILY VALUES FOR YEARS		1 THROUGH	100
		(INCHES)	(CU. FT.)
PRECIPITATION		6.87	489534.875
RUNOFF		3.519	250773.2190
DRAINAGE COLLECTED FROM LAYER	3	0.14393	10256.28910
PERCOLATION/LEAKAGE THROUGH LAYER	4	0.030784	2193.54272
AVERAGE HEAD ON TOP OF LAYER	4	36.000	
MAXIMUM HEAD ON TOP OF LAYER	4	47.656	
LOCATION OF MAXIMUM HEAD IN LAYER	3	152.3 FEET	
	(DISTANCE FROM DRAIN)		
DRAINAGE COLLECTED FROM LAYER	6	0.01739	1239.02258
PERCOLATION/LEAKAGE THROUGH LAYER	7	0.000205	14.60376
AVERAGE HEAD ON TOP OF LAYER	7	0.041	
MAXIMUM HEAD ON TOP OF LAYER	7	0.078	
LOCATION OF MAXIMUM HEAD IN LAYER	6	5.2 FEET	
	(DISTANCE FROM DRAIN)		
SNOW WATER		2.36	168188.7190
MAXIMUM VEG. SOIL WATER (VOL/VOL)			0.2018
MINIMUM VEG. SOIL WATER (VOL/VOL)			0.0806

\*\*\* Maximum heads are computed using McEnroe's equations. \*\*\*

Reference: Maximum Saturated Depth over Landfill Liner  
 by Bruce M. McEnroe, University of Kansas  
 ASCE Journal of Environmental Engineering  
 Vol. 119, No. 2, March 1993, pp. 262-270.

\*\*\*\*\*

\*\*\*\*\*

FINAL WATER STORAGE AT END OF YEAR 100

LAYER	( INCHES )	( VOL/VOL )
1	0.7980	0.0665
2	3.2212	0.2684
3	4.5360	0.3780
4	0.1500	0.7500
5	14.0695	0.2402
6	1.9283	0.0803
7	0.1500	0.7500
SNOW WATER	0.000	

\*\*\*\*\*  
\*\*\*\*\*

Appendix U, Upper Bounding Scenario Degraded SDF MSE Vault Closure Cap (802 Years): HELP Model Input Data and Output File (output file name: ZUBSD6ou.OUT)

Input Data:

Input Parameter (HELP Model Query)		Generic Input Parameter Value					
Landfill area =		19.63 acres					
Percent of area where runoff is possible =		100%					
Do you want to specify initial moisture storage? (Y/N)		Y					
Amount of water or snow on surface =		0 inches					
CN Input Parameter (HELP Model Query)		CN Input Parameter Value					
Slope =		3 %					
Slope length =		450 ft					
Soil Texture =		5 (HELP model default soil texture)					
Vegetation =		4 (i.e., a good stand of grass)					
HELP Model Computed Curve Number = 54.4							
Layer		Layer Number		Layer Type			
Erosion Barrier		1		1 (vertical percolation layer)			
Middle Backfill		2		1 (vertical percolation layer)			
Upper Drainage Layer		3		2 (lateral drainage layer)			
Upper GCL		4		4 (geomembrane liner)			
Lower Backfill		5		1 (vertical percolation layer)			
Lower Drainage Layer		6		2 (lateral drainage layer)			
Lower GCL		7		3 (barrier soil liner)			
	Layer Type	Layer Thickness (in)	Soil Texture No.	Total Porosity (Vol/Vol)	Field Capacity (Vol/Vol)	Wilting Point (Vol/Vol)	Initial Moisture (Vol/Vol)
1	1	12		0.061	0.059	0.0519	0.059
2	1	12		0.372	0.204	0.108	0.204
3	2	12		0.378	0.116	0.0406	0.116
4 *	4	0.2		0.75	0.747	0.40	0.75
5	1	58.57		0.37	0.24	0.136	0.24
6	2	24		0.378	0.0818	0.0155	0.0818
7	3	0.2		0.75	0.747	0.40	0.75

The lack of values in the table for particular parameters in particular layers denotes that no HELP model input was required for that parameter in that layer. No data are missing from the table.

\* The input porosity, field capacity, and wilting point values of the upper GCL are ignored by the HELP model, since the upper GCL is designated as an geomembrane in order for the HELP model to take into account the holes produced by root penetration.

## Input Data (continued):

	Layer Type	Sat. Hyd. Conductivity * (cm/sec)	Drainage Length (ft)	Drain Slope (%)	Leachate Recirc. (%)	Recirc. to Layer (#)	Subsurface Inflow (in/yr)
1	1	1.20E-03					
2	1	4.70E-04					
3	2	2.10E-02	450	3			
4	4	5.00E-09					
5	1	1.00E-04					
6	2	9.86E-02	150	11.4			
7	3	5.00E-09					
	Layer Type	Geomembrane Pinhole Density (#/acre)	Geomembrane Instal. Defects (#/acre)	Geomembrane Placement Quality	Geotextile Transmissivity (cm <sup>2</sup> /sec)		
1	1						
2	1						
3	2						
4	4	0	40,877	1			
5	1						
6	2						
7	3						

The lack of values in the table for particular parameters in particular layers denotes that no HELP model input was required for that parameter in that layer. No data are missing from the table.

\* The HELP model output often produces an increased number of significant digits for the Effective Saturated Hydraulic Conductivity over that of the actual input



## LAYER 3

-----

## TYPE 2 - LATERAL DRAINAGE LAYER

MATERIAL TEXTURE NUMBER 0

THICKNESS	=	12.00	INCHES
POROSITY	=	0.3780	VOL/VOL
FIELD CAPACITY	=	0.1160	VOL/VOL
WILTING POINT	=	0.0406	VOL/VOL
INITIAL SOIL WATER CONTENT	=	0.1160	VOL/VOL
EFFECTIVE SAT. HYD. COND.	=	0.209999997000E-01	CM/SEC
SLOPE	=	3.00	PERCENT
DRAINAGE LENGTH	=	450.0	FEET

## LAYER 4

-----

## TYPE 4 - FLEXIBLE MEMBRANE LINER

MATERIAL TEXTURE NUMBER 0

THICKNESS	=	0.20	INCHES
POROSITY	=	0.0000	VOL/VOL
FIELD CAPACITY	=	0.0000	VOL/VOL
WILTING POINT	=	0.0000	VOL/VOL
INITIAL SOIL WATER CONTENT	=	0.0000	VOL/VOL
EFFECTIVE SAT. HYD. COND.	=	0.499999997000E-08	CM/SEC
FML PINHOLE DENSITY	=	0.00	HOLES/ACRE
FML INSTALLATION DEFECTS	=	40877.00	HOLES/ACRE
FML PLACEMENT QUALITY	=	1 - PERFECT	

## LAYER 5

-----

## TYPE 1 - VERTICAL PERCOLATION LAYER

MATERIAL TEXTURE NUMBER 0

THICKNESS	=	58.57	INCHES
POROSITY	=	0.3700	VOL/VOL
FIELD CAPACITY	=	0.2400	VOL/VOL
WILTING POINT	=	0.1360	VOL/VOL
INITIAL SOIL WATER CONTENT	=	0.2400	VOL/VOL
EFFECTIVE SAT. HYD. COND.	=	0.999999975000E-04	CM/SEC

## LAYER 6

-----

## TYPE 2 - LATERAL DRAINAGE LAYER

MATERIAL TEXTURE NUMBER 0

THICKNESS	=	24.00	INCHES
POROSITY	=	0.3780	VOL/VOL
FIELD CAPACITY	=	0.0818	VOL/VOL
WILTING POINT	=	0.0155	VOL/VOL
INITIAL SOIL WATER CONTENT	=	0.0818	VOL/VOL
EFFECTIVE SAT. HYD. COND.	=	0.986000001000E-01	CM/SEC
SLOPE	=	11.40	PERCENT
DRAINAGE LENGTH	=	150.0	FEET

LAYER 7

-----

TYPE 3 - BARRIER SOIL LINER

MATERIAL TEXTURE NUMBER 0

THICKNESS = 0.20 INCHES  
 POROSITY = 0.7500 VOL/VOL  
 FIELD CAPACITY = 0.7470 VOL/VOL  
 WILTING POINT = 0.4000 VOL/VOL  
 INITIAL SOIL WATER CONTENT = 0.7500 VOL/VOL  
 EFFECTIVE SAT. HYD. COND. = 0.499999997000E-08 CM/SEC

GENERAL DESIGN AND EVAPORATIVE ZONE DATA

-----

NOTE: SCS RUNOFF CURVE NUMBER WAS COMPUTED FROM DEFAULT SOIL DATA BASE USING SOIL TEXTURE # 5 WITH A GOOD STAND OF GRASS, A SURFACE SLOPE OF 3.% AND A SLOPE LENGTH OF 450. FEET.

SCS RUNOFF CURVE NUMBER = 54.40  
 FRACTION OF AREA ALLOWING RUNOFF = 100.0 PERCENT  
 AREA PROJECTED ON HORIZONTAL PLANE = 19.630 ACRES  
 EVAPORATIVE ZONE DEPTH = 22.0 INCHES  
 INITIAL WATER IN EVAPORATIVE ZONE = 2.748 INCHES  
 UPPER LIMIT OF EVAPORATIVE STORAGE = 4.452 INCHES  
 LOWER LIMIT OF EVAPORATIVE STORAGE = 1.703 INCHES  
 INITIAL SNOW WATER = 0.000 INCHES  
 INITIAL WATER IN LAYER MATERIALS = 20.718 INCHES  
 TOTAL INITIAL WATER = 20.718 INCHES  
 TOTAL SUBSURFACE INFLOW = 0.00 INCHES/YEAR

EVAPOTRANSPIRATION AND WEATHER DATA

-----

NOTE: EVAPOTRANSPIRATION DATA WAS OBTAINED FROM AUGUSTA GEORGIA

STATION LATITUDE = 33.22 DEGREES  
 MAXIMUM LEAF AREA INDEX = 3.50  
 START OF GROWING SEASON (JULIAN DATE) = 68  
 END OF GROWING SEASON (JULIAN DATE) = 323  
 EVAPORATIVE ZONE DEPTH = 22.0 INCHES  
 AVERAGE ANNUAL WIND SPEED = 6.50 MPH  
 AVERAGE 1ST QUARTER RELATIVE HUMIDITY = 68.00 %  
 AVERAGE 2ND QUARTER RELATIVE HUMIDITY = 70.00 %  
 AVERAGE 3RD QUARTER RELATIVE HUMIDITY = 77.00 %  
 AVERAGE 4TH QUARTER RELATIVE HUMIDITY = 73.00 %



NOTE: PRECIPITATION DATA WAS SYNTHETICALLY GENERATED USING  
COEFFICIENTS FOR AUGUSTA GEORGIA

NORMAL MEAN MONTHLY PRECIPITATION (INCHES)

JAN/JUL	FEB/AUG	MAR/SEP	APR/OCT	MAY/NOV	JUN/DEC
4.38	3.95	4.68	2.91	3.56	4.99
5.43	5.41	3.93	3.12	2.96	3.45

NOTE: TEMPERATURE DATA WAS SYNTHETICALLY GENERATED USING  
COEFFICIENTS FOR AUGUSTA GEORGIA

NORMAL MEAN MONTHLY TEMPERATURE (DEGREES FAHRENHEIT)

JAN/JUL	FEB/AUG	MAR/SEP	APR/OCT	MAY/NOV	JUN/DEC
46.30	50.00	57.20	64.30	72.10	78.40
81.60	80.30	75.20	65.10	56.70	48.80

NOTE: SOLAR RADIATION DATA WAS SYNTHETICALLY GENERATED USING  
COEFFICIENTS FOR AUGUSTA GEORGIA  
AND STATION LATITUDE = 33.30 DEGREES

\*\*\*\*\*

AVERAGE MONTHLY VALUES IN INCHES FOR YEARS 1 THROUGH 100

	JAN/JUL	FEB/AUG	MAR/SEP	APR/OCT	MAY/NOV	JUN/DEC
PRECIPITATION						
TOTALS	4.56	3.57	4.76	2.74	3.60	4.97
	5.81	5.32	4.41	2.99	2.75	3.41
STD. DEVIATIONS	2.44	1.60	2.47	1.31	2.12	2.60
	2.83	2.95	2.54	2.28	1.72	1.90
RUNOFF						
TOTALS	0.000	0.000	0.000	0.000	0.000	0.000
	0.000	0.031	0.002	0.006	0.000	0.000
STD. DEVIATIONS	0.000	0.000	0.000	0.000	0.000	0.000
	0.002	0.189	0.017	0.055	0.000	0.000
EVAPOTRANSPIRATION						
TOTALS	1.584	1.951	2.649	2.426	2.784	3.457
	3.865	3.464	2.702	1.454	1.105	1.281
STD. DEVIATIONS	0.270	0.294	0.649	0.774	1.083	1.279
	1.205	1.125	0.934	0.637	0.316	0.205

LATERAL DRAINAGE COLLECTED FROM LAYER 3

TOTALS	0.5647	0.3776	0.4326	0.1885	0.1588	0.2448
	0.3709	0.3800	0.3364	0.2718	0.2850	0.3798
STD. DEVIATIONS	0.3742	0.2982	0.3383	0.1913	0.2212	0.2347
	0.3075	0.3179	0.3075	0.3007	0.2639	0.2820

PERCOLATION/LEAKAGE THROUGH LAYER 4

TOTALS	2.2772	1.5210	1.7431	0.7586	0.6393	0.9848
	1.4945	1.5553	1.3635	1.1064	1.1482	1.5253
STD. DEVIATIONS	1.5280	1.2145	1.3727	0.7687	0.8877	0.9441
	1.2445	1.3491	1.2729	1.2537	1.0692	1.1319

LATERAL DRAINAGE COLLECTED FROM LAYER 6

TOTALS	1.7592	1.8681	1.6771	1.5063	0.8715	0.7715
	1.0464	1.5153	1.3806	1.3645	1.1043	1.1461
STD. DEVIATIONS	1.4343	1.2836	1.0709	0.9687	0.4896	0.6680
	0.8377	1.2075	0.9939	1.0005	0.9407	0.9090

PERCOLATION/LEAKAGE THROUGH LAYER 7

TOTALS	0.0083	0.0084	0.0085	0.0081	0.0069	0.0061
	0.0064	0.0078	0.0076	0.0077	0.0069	0.0070
STD. DEVIATIONS	0.0034	0.0028	0.0023	0.0020	0.0013	0.0019
	0.0026	0.0030	0.0023	0.0025	0.0023	0.0024

AVERAGES OF MONTHLY AVERAGED DAILY HEADS (INCHES)

DAILY AVERAGE HEAD ON TOP OF LAYER 4

AVERAGES	2.3071	1.6893	1.7657	0.7931	0.6461	1.0302
	1.5134	1.5752	1.4268	1.1199	1.2015	1.5450
STD. DEVIATIONS	1.5487	1.3497	1.3914	0.8057	0.9001	0.9890
	1.2617	1.3675	1.3333	1.2710	1.1200	1.1474

DAILY AVERAGE HEAD ON TOP OF LAYER 7

AVERAGES	0.1353	0.1576	0.1290	0.1197	0.0670	0.0613
	0.0805	0.1166	0.1097	0.1050	0.0878	0.0882
STD. DEVIATIONS	0.1103	0.1084	0.0824	0.0770	0.0377	0.0531
	0.0644	0.0929	0.0790	0.0770	0.0748	0.0699

\*\*\*\*\*

\*\*\*\*\*

AVERAGE ANNUAL TOTALS & (STD. DEVIATIONS) FOR YEARS 1 THROUGH 100				
	INCHES		CU. FEET	PERCENT
PRECIPITATION	48.90	( 7.734)	3484469.2	100.00
RUNOFF	0.038	( 0.1965)	2740.38	0.079
EVAPOTRANSPIRATION	28.723	( 2.8346)	2046702.00	58.738
LATERAL DRAINAGE COLLECTED FROM LAYER 3	3.99102	( 1.25187)	284387.844	8.16158
PERCOLATION/LEAKAGE THROUGH LAYER 4	16.11727	( 5.09535)	1148466.750	32.95959
AVERAGE HEAD ON TOP OF LAYER 4	1.384	( 0.438)		
LATERAL DRAINAGE COLLECTED FROM LAYER 6	16.01076	( 4.97200)	1140877.120	32.74178
PERCOLATION/LEAKAGE THROUGH LAYER 7	0.08980	( 0.01248)	6399.206	0.18365
AVERAGE HEAD ON TOP OF LAYER 7	0.105	( 0.033)		
CHANGE IN WATER STORAGE	0.047	( 2.1262)	3362.64	0.097

\*\*\*\*\*

\*\*\*\*\*

PEAK DAILY VALUES FOR YEARS		1 THROUGH	100
		(INCHES)	(CU. FT.)
PRECIPITATION		6.87	489534.875
RUNOFF		1.385	98725.5234
DRAINAGE COLLECTED FROM LAYER	3	0.09975	7108.17578
PERCOLATION/LEAKAGE THROUGH LAYER	4	0.933570	66523.31250
AVERAGE HEAD ON TOP OF LAYER	4	29.325	
MAXIMUM HEAD ON TOP OF LAYER	4	40.406	
LOCATION OF MAXIMUM HEAD IN LAYER	3	139.9 FEET	
(DISTANCE FROM DRAIN)			
DRAINAGE COLLECTED FROM LAYER	6	0.59060	42084.27730
PERCOLATION/LEAKAGE THROUGH LAYER	7	0.001368	97.45431
AVERAGE HEAD ON TOP OF LAYER	7	1.408	
MAXIMUM HEAD ON TOP OF LAYER	7	2.687	
LOCATION OF MAXIMUM HEAD IN LAYER	6	5.0 FEET	
(DISTANCE FROM DRAIN)			
SNOW WATER		2.36	168188.7190
MAXIMUM VEG. SOIL WATER (VOL/VOL)			0.2024
MINIMUM VEG. SOIL WATER (VOL/VOL)			0.0774

\*\*\* Maximum heads are computed using McEnroe's equations. \*\*\*

Reference: Maximum Saturated Depth over Landfill Liner  
 by Bruce M. McEnroe, University of Kansas  
 ASCE Journal of Environmental Engineering  
 Vol. 119, No. 2, March 1993, pp. 262-270.

\*\*\*\*\*

\*\*\*\*\*

FINAL WATER STORAGE AT END OF YEAR 100

LAYER	( INCHES )	( VOL/VOL )
1	0.7932	0.0661
2	2.6548	0.2212
3	4.1493	0.3458
4	0.0000	0.0000
5	15.7171	0.2683
6	1.9726	0.0822
7	0.1500	0.7500
SNOW WATER	0.000	

\*\*\*\*\*  
\*\*\*\*\*

Appendix V, Upper Bounding Scenario Degraded SDF MSE Vault Closure Cap (1,000 Years): HELP Model Input Data and Output File (output file name: ZUBSD7ou.OUT)

Input Data:

Input Parameter (HELP Model Query)		Generic Input Parameter Value					
Landfill area =		19.63 acres					
Percent of area where runoff is possible =		100%					
Do you want to specify initial moisture storage? (Y/N)		Y					
Amount of water or snow on surface =		0 inches					
CN Input Parameter (HELP Model Query)		CN Input Parameter Value					
Slope =		3 %					
Slope length =		450 ft					
Soil Texture =		3 (HELP model default soil texture)					
Vegetation =		4 (i.e., a good stand of grass)					
HELP Model Computed Curve Number = 46.6							
Layer		Layer Number		Layer Type			
Erosion Barrier		1		1 (vertical percolation layer)			
Middle Backfill		2		1 (vertical percolation layer)			
Upper Drainage Layer		3		2 (lateral drainage layer)			
Upper GCL		4		4 (geomembrane liner)			
Lower Backfill		5		1 (vertical percolation layer)			
Lower Drainage Layer		6		2 (lateral drainage layer)			
Lower GCL		7		3 (barrier soil liner)			
	Layer Type	Layer Thickness (in)	Soil Texture No.	Total Porosity (Vol/Vol)	Field Capacity (Vol/Vol)	Wilting Point (Vol/Vol)	Initial Moisture (Vol/Vol)
1	1	12		0.063	0.0558	0.0517	0.0558
2	1	12		0.373	0.195	0.102	0.195
3	2	12		0.377	0.125	0.0474	0.125
4 *	4	0.2		0.75	0.747	0.40	0.75
5	1	58.57		0.37	0.24	0.136	0.24
6	2	24		0.374	0.0846	0.0197	0.0846
7	3	0.2		0.75	0.747	0.40	0.75

The lack of values in the table for particular parameters in particular layers denotes that no HELP model input was required for that parameter in that layer. No data are missing from the table.

\* The input porosity, field capacity, and wilting point values of the upper GCL are ignored by the HELP model, since the upper GCL is designated as an geomembrane in order for the HELP model to take into account the holes produced by root penetration.

## Input Data (continued):

	Layer Type	Sat. Hyd. Conductivity * (cm/sec)	Drainage Length (ft)	Drain Slope (%)	Leachate Recirc. (%)	Recirc. to Layer (#)	Subsurface Inflow (in/yr)
1	1	2.80E-03					
2	1	6.90E-04					
3	2	1.40E-02	450	3			
4	4	5.00E-09					
5	1	1.00E-04					
6	2	9.64E-02	150	11.4			
7	3	5.00E-09					
	Layer Type	Geomembrane Pinhole Density (#/acre)	Geomembrane Instal. Defects (#/acre)	Geomembrane Placement Quality	Geotextile Transmissivity (cm <sup>2</sup> /sec)		
1	1						
2	1						
3	2						
4	4	0	121,703	1			
5	1						
6	2						
7	3						

The lack of values in the table for particular parameters in particular layers denotes that no HELP model input was required for that parameter in that layer. No data are missing from the table.

\* The HELP model output often produces an increased number of significant digits for the Effective Saturated Hydraulic Conductivity over that of the actual input





LAYER 3

-----

TYPE 2 - LATERAL DRAINAGE LAYER

MATERIAL TEXTURE NUMBER 0

THICKNESS = 12.00 INCHES  
 POROSITY = 0.3770 VOL/VOL  
 FIELD CAPACITY = 0.1250 VOL/VOL  
 WILTING POINT = 0.0474 VOL/VOL  
 INITIAL SOIL WATER CONTENT = 0.1250 VOL/VOL  
 EFFECTIVE SAT. HYD. COND. = 0.140000004000E-01 CM/SEC  
 SLOPE = 3.00 PERCENT  
 DRAINAGE LENGTH = 450.0 FEET

LAYER 4

-----

TYPE 4 - FLEXIBLE MEMBRANE LINER

MATERIAL TEXTURE NUMBER 0

THICKNESS = 0.20 INCHES  
 POROSITY = 0.0000 VOL/VOL  
 FIELD CAPACITY = 0.0000 VOL/VOL  
 WILTING POINT = 0.0000 VOL/VOL  
 INITIAL SOIL WATER CONTENT = 0.0000 VOL/VOL  
 EFFECTIVE SAT. HYD. COND. = 0.499999997000E-08 CM/SEC  
 FML PINHOLE DENSITY = 0.00 HOLES/ACRE  
 FML INSTALLATION DEFECTS = 121703.00 HOLES/ACRE  
 FML PLACEMENT QUALITY = 1 - PERFECT

LAYER 5

-----

TYPE 1 - VERTICAL PERCOLATION LAYER

MATERIAL TEXTURE NUMBER 0

THICKNESS = 58.57 INCHES  
 POROSITY = 0.3700 VOL/VOL  
 FIELD CAPACITY = 0.2400 VOL/VOL  
 WILTING POINT = 0.1360 VOL/VOL  
 INITIAL SOIL WATER CONTENT = 0.2400 VOL/VOL  
 EFFECTIVE SAT. HYD. COND. = 0.999999975000E-04 CM/SEC

LAYER 6

-----

TYPE 2 - LATERAL DRAINAGE LAYER

MATERIAL TEXTURE NUMBER 0

THICKNESS = 24.00 INCHES  
 POROSITY = 0.3740 VOL/VOL  
 FIELD CAPACITY = 0.0846 VOL/VOL  
 WILTING POINT = 0.0197 VOL/VOL  
 INITIAL SOIL WATER CONTENT = 0.0846 VOL/VOL  
 EFFECTIVE SAT. HYD. COND. = 0.964000002000E-01 CM/SEC  
 SLOPE = 11.40 PERCENT  
 DRAINAGE LENGTH = 150.0 FEET

LAYER 7

-----

TYPE 3 - BARRIER SOIL LINER

MATERIAL TEXTURE NUMBER 0

THICKNESS = 0.20 INCHES  
 POROSITY = 0.7500 VOL/VOL  
 FIELD CAPACITY = 0.7470 VOL/VOL  
 WILTING POINT = 0.4000 VOL/VOL  
 INITIAL SOIL WATER CONTENT = 0.7500 VOL/VOL  
 EFFECTIVE SAT. HYD. COND. = 0.499999997000E-08 CM/SEC

GENERAL DESIGN AND EVAPORATIVE ZONE DATA

-----

NOTE: SCS RUNOFF CURVE NUMBER WAS COMPUTED FROM DEFAULT SOIL DATA BASE USING SOIL TEXTURE # 3 WITH A GOOD STAND OF GRASS, A SURFACE SLOPE OF 3.% AND A SLOPE LENGTH OF 450. FEET.

SCS RUNOFF CURVE NUMBER = 46.60  
 FRACTION OF AREA ALLOWING RUNOFF = 100.0 PERCENT  
 AREA PROJECTED ON HORIZONTAL PLANE = 19.630 ACRES  
 EVAPORATIVE ZONE DEPTH = 22.0 INCHES  
 INITIAL WATER IN EVAPORATIVE ZONE = 2.620 INCHES  
 UPPER LIMIT OF EVAPORATIVE STORAGE = 4.486 INCHES  
 LOWER LIMIT OF EVAPORATIVE STORAGE = 1.640 INCHES  
 INITIAL SNOW WATER = 0.000 INCHES  
 INITIAL WATER IN LAYER MATERIALS = 20.747 INCHES  
 TOTAL INITIAL WATER = 20.747 INCHES  
 TOTAL SUBSURFACE INFLOW = 0.00 INCHES/YEAR

EVAPOTRANSPIRATION AND WEATHER DATA

-----

NOTE: EVAPOTRANSPIRATION DATA WAS OBTAINED FROM AUGUSTA GEORGIA

STATION LATITUDE = 33.22 DEGREES  
 MAXIMUM LEAF AREA INDEX = 3.50  
 START OF GROWING SEASON (JULIAN DATE) = 68  
 END OF GROWING SEASON (JULIAN DATE) = 323  
 EVAPORATIVE ZONE DEPTH = 22.0 INCHES  
 AVERAGE ANNUAL WIND SPEED = 6.50 MPH  
 AVERAGE 1ST QUARTER RELATIVE HUMIDITY = 68.00 %  
 AVERAGE 2ND QUARTER RELATIVE HUMIDITY = 70.00 %  
 AVERAGE 3RD QUARTER RELATIVE HUMIDITY = 77.00 %  
 AVERAGE 4TH QUARTER RELATIVE HUMIDITY = 73.00 %

NOTE: PRECIPITATION DATA WAS SYNTHETICALLY GENERATED USING  
COEFFICIENTS FOR AUGUSTA GEORGIA

NORMAL MEAN MONTHLY PRECIPITATION (INCHES)

JAN/JUL	FEB/AUG	MAR/SEP	APR/OCT	MAY/NOV	JUN/DEC
4.38	3.95	4.68	2.91	3.56	4.99
5.43	5.41	3.93	3.12	2.96	3.45

NOTE: TEMPERATURE DATA WAS SYNTHETICALLY GENERATED USING  
COEFFICIENTS FOR AUGUSTA GEORGIA

NORMAL MEAN MONTHLY TEMPERATURE (DEGREES FAHRENHEIT)

JAN/JUL	FEB/AUG	MAR/SEP	APR/OCT	MAY/NOV	JUN/DEC
46.30	50.00	57.20	64.30	72.10	78.40
81.60	80.30	75.20	65.10	56.70	48.80

NOTE: SOLAR RADIATION DATA WAS SYNTHETICALLY GENERATED USING  
COEFFICIENTS FOR AUGUSTA GEORGIA  
AND STATION LATITUDE = 33.30 DEGREES

\*\*\*\*\*

AVERAGE MONTHLY VALUES IN INCHES FOR YEARS 1 THROUGH 100

	JAN/JUL	FEB/AUG	MAR/SEP	APR/OCT	MAY/NOV	JUN/DEC
PRECIPITATION						
TOTALS	4.56	3.57	4.76	2.74	3.60	4.97
	5.81	5.32	4.41	2.99	2.75	3.41
STD. DEVIATIONS	2.44	1.60	2.47	1.31	2.12	2.60
	2.83	2.95	2.54	2.28	1.72	1.90
RUNOFF						
TOTALS	0.000	0.000	0.000	0.000	0.000	0.000
	0.000	0.016	0.000	0.000	0.000	0.000
STD. DEVIATIONS	0.000	0.000	0.000	0.000	0.000	0.000
	0.000	0.108	0.000	0.000	0.000	0.000
EVAPOTRANSPIRATION						
TOTALS	1.560	1.908	2.564	2.331	2.752	3.435
	3.843	3.445	2.680	1.432	1.085	1.261
STD. DEVIATIONS	0.284	0.306	0.679	0.776	1.048	1.266
	1.190	1.111	0.921	0.628	0.321	0.215

LATERAL DRAINAGE COLLECTED FROM LAYER 3

TOTALS	0.1591	0.0963	0.1224	0.0422	0.0508	0.0715
	0.1046	0.1020	0.0921	0.0742	0.0793	0.1075
STD. DEVIATIONS	0.1083	0.0794	0.0982	0.0458	0.0697	0.0701
	0.0916	0.0954	0.0941	0.0887	0.0754	0.0848

PERCOLATION/LEAKAGE THROUGH LAYER 4

TOTALS	2.8051	1.6978	2.1573	0.7456	0.8955	1.2598
	1.8439	1.8287	1.6240	1.3140	1.3973	1.8949
STD. DEVIATIONS	1.9112	1.3971	1.7294	0.8067	1.2268	1.2351
	1.6183	1.7622	1.6595	1.5871	1.3296	1.4924

LATERAL DRAINAGE COLLECTED FROM LAYER 6

TOTALS	2.3210	2.1014	2.0537	1.6187	0.9418	0.9990
	1.5182	1.8522	1.6550	1.5295	1.2744	1.4739
STD. DEVIATIONS	1.7721	1.4986	1.4568	1.0790	0.6680	0.9729
	1.2097	1.5345	1.2871	1.2451	1.1581	1.2035

PERCOLATION/LEAKAGE THROUGH LAYER 7

TOTALS	0.0097	0.0090	0.0094	0.0084	0.0071	0.0067
	0.0077	0.0087	0.0083	0.0081	0.0073	0.0077
STD. DEVIATIONS	0.0041	0.0033	0.0032	0.0023	0.0015	0.0025
	0.0033	0.0037	0.0029	0.0030	0.0028	0.0031

AVERAGES OF MONTHLY AVERAGED DAILY HEADS (INCHES)

DAILY AVERAGE HEAD ON TOP OF LAYER 4

AVERAGES	0.9716	0.6445	0.7471	0.2663	0.3099	0.4506
	0.6385	0.6331	0.5809	0.4549	0.5000	0.6562
STD. DEVIATIONS	0.6624	0.5308	0.5994	0.2889	0.4250	0.4423
	0.5608	0.6107	0.5943	0.5499	0.4761	0.5173

DAILY AVERAGE HEAD ON TOP OF LAYER 7

AVERAGES	0.1826	0.1813	0.1616	0.1316	0.0741	0.0812
	0.1194	0.1457	0.1345	0.1203	0.1036	0.1160
STD. DEVIATIONS	0.1394	0.1294	0.1146	0.0877	0.0526	0.0791
	0.0952	0.1207	0.1046	0.0980	0.0941	0.0947

\*\*\*\*\*

\*\*\*\*\*

AVERAGE ANNUAL TOTALS & (STD. DEVIATIONS) FOR YEARS 1 THROUGH 100				
	INCHES		CU. FEET	PERCENT
PRECIPITATION	48.90	( 7.734)	3484469.2	100.00
RUNOFF	0.016	( 0.1078)	1143.22	0.033
EVAPOTRANSPIRATION	28.295	( 2.7952)	2016190.25	57.862
LATERAL DRAINAGE COLLECTED FROM LAYER 3	1.10213	( 0.33837)	78534.008	2.25383
PERCOLATION/LEAKAGE THROUGH LAYER 4	19.46389	( 5.99995)	1386936.620	39.80339
AVERAGE HEAD ON TOP OF LAYER 4	0.571	( 0.176)		
LATERAL DRAINAGE COLLECTED FROM LAYER 6	19.33876	( 5.95606)	1378019.750	39.54748
PERCOLATION/LEAKAGE THROUGH LAYER 7	0.09811	( 0.01463)	6991.046	0.20063
AVERAGE HEAD ON TOP OF LAYER 7	0.129	( 0.040)		
CHANGE IN WATER STORAGE	0.050	( 2.0018)	3591.10	0.103

\*\*\*\*\*

\*\*\*\*\*

PEAK DAILY VALUES FOR YEARS		1 THROUGH	100
		(INCHES)	(CU. FT.)
PRECIPITATION		6.87	489534.875
RUNOFF		0.980	69863.4219
DRAINAGE COLLECTED FROM LAYER	3	0.06879	4901.85645
PERCOLATION/LEAKAGE THROUGH LAYER	4	2.165414	154300.68700
AVERAGE HEAD ON TOP OF LAYER	4	23.259	
MAXIMUM HEAD ON TOP OF LAYER	4	34.250	
LOCATION OF MAXIMUM HEAD IN LAYER	3	128.0 FEET	
	(DISTANCE FROM DRAIN)		
DRAINAGE COLLECTED FROM LAYER	6	0.98597	70257.18750
PERCOLATION/LEAKAGE THROUGH LAYER	7	0.002215	157.83235
AVERAGE HEAD ON TOP OF LAYER	7	2.405	
MAXIMUM HEAD ON TOP OF LAYER	7	4.489	
LOCATION OF MAXIMUM HEAD IN LAYER	6	8.2 FEET	
	(DISTANCE FROM DRAIN)		
SNOW WATER		2.36	168188.7190
MAXIMUM VEG. SOIL WATER (VOL/VOL)			0.2039
MINIMUM VEG. SOIL WATER (VOL/VOL)			0.0746

\*\*\* Maximum heads are computed using McEnroe's equations. \*\*\*

Reference: Maximum Saturated Depth over Landfill Liner  
 by Bruce M. McEnroe, University of Kansas  
 ASCE Journal of Environmental Engineering  
 Vol. 119, No. 2, March 1993, pp. 262-270.

\*\*\*\*\*

\*\*\*\*\*

FINAL WATER STORAGE AT END OF YEAR 100

---

LAYER	( INCHES )	( VOL/VOL )
1	0.7954	0.0663
2	2.7523	0.2294
3	3.2982	0.2748
4	0.0000	0.0000
5	16.7511	0.2860
6	2.0395	0.0850
7	0.1500	0.7500
SNOW WATER	0.000	

\*\*\*\*\*  
\*\*\*\*\*

Appendix W, Upper Bounding Scenario Degraded SDF MSE Vault Closure Cap (1,800 Years): HELP Model Input Data and Output File (output file name: ZUBSD8ou.OUT)

Input Data:

Input Parameter (HELP Model Query)		Generic Input Parameter Value					
Landfill area =		19.63 acres					
Percent of area where runoff is possible =		100%					
Do you want to specify initial moisture storage? (Y/N)		Y					
Amount of water or snow on surface =		0 inches					
CN Input Parameter (HELP Model Query)		CN Input Parameter Value					
Slope =		3 %					
Slope length =		450 ft					
Soil Texture =		1 (HELP model default soil texture)					
Vegetation =		4 (i.e., a good stand of grass)					
HELP Model Computed Curve Number = 26.9							
Layer		Layer Number			Layer Type		
Erosion Barrier		1			1 (vertical percolation layer)		
Middle Backfill		2			1 (vertical percolation layer)		
Upper Drainage Layer		3			2 (lateral drainage layer)		
Upper GCL		4			4 (geomembrane liner)		
Lower Backfill		5			1 (vertical percolation layer)		
Lower Drainage Layer		6			2 (lateral drainage layer)		
Lower GCL		7			3 (barrier soil liner)		
	Layer Type	Layer Thickness (in)	Soil Texture No.	Total Porosity (Vol/Vol)	Field Capacity (Vol/Vol)	Wilting Point (Vol/Vol)	Initial Moisture (Vol/Vol)
1	1	12		0.070	0.0553	0.0509	0.0553
2	1	12		0.375	0.16	0.0745	0.16
3	2	12		0.375	0.16	0.0745	0.16
4 *	4	0.2		0.75	0.747	0.40	0.75
5	1	58.57		0.37	0.24	0.136	0.24
6	2	24		0.358	0.0979	0.0388	0.0979
7	3	0.2		0.75	0.747	0.40	0.75

The lack of values in the table for particular parameters in particular layers denotes that no HELP model input was required for that parameter in that layer. No data are missing from the table.

\* The input porosity, field capacity, and wilting point values of the upper GCL are ignored by the HELP model, since the upper GCL is designated as an geomembrane in order for the HELP model to take into account the holes produced by root penetration.



## Input Data (continued):

	Layer Type	Sat. Hyd. Conductivity * (cm/sec)	Drainage Length (ft)	Drain Slope (%)	Leachate Recirc. (%)	Recirc. to Layer (#)	Subsurface Inflow (in/yr)
1	1	9.10E-03					
2	1	3.20E-03					
3	2	3.20E-03	450	3			
4	4	5.00E-09					
5	1	1.00E-04					
6	2	8.62E-02	150	11.4			
7	3	5.00E-09					
	Layer Type	Geomembrane Pinhole Density (#/acre)	Geomembrane Instal. Defects (#/acre)	Geomembrane Placement Quality	Geotextile Transmissivity (cm <sup>2</sup> /sec)		
1	1						
2	1						
3	2						
4	4	0	448,722	1			
5	1						
6	2						
7	3						

The lack of values in the table for particular parameters in particular layers denotes that no HELP model input was required for that parameter in that layer. No data are missing from the table.

\* The HELP model output often produces an increased number of significant digits for the Effective Saturated Hydraulic Conductivity over that of the actual input



LAYER 3

-----

TYPE 2 - LATERAL DRAINAGE LAYER

MATERIAL TEXTURE NUMBER 0

THICKNESS = 12.00 INCHES  
 POROSITY = 0.3750 VOL/VOL  
 FIELD CAPACITY = 0.1600 VOL/VOL  
 WILTING POINT = 0.0745 VOL/VOL  
 INITIAL SOIL WATER CONTENT = 0.1600 VOL/VOL  
 EFFECTIVE SAT. HYD. COND. = 0.319999992000E-02 CM/SEC  
 SLOPE = 3.00 PERCENT  
 DRAINAGE LENGTH = 450.0 FEET

LAYER 4

-----

TYPE 4 - FLEXIBLE MEMBRANE LINER

MATERIAL TEXTURE NUMBER 0

THICKNESS = 0.20 INCHES  
 POROSITY = 0.0000 VOL/VOL  
 FIELD CAPACITY = 0.0000 VOL/VOL  
 WILTING POINT = 0.0000 VOL/VOL  
 INITIAL SOIL WATER CONTENT = 0.0000 VOL/VOL  
 EFFECTIVE SAT. HYD. COND. = 0.499999997000E-08 CM/SEC  
 FML PINHOLE DENSITY = 0.00 HOLES/ACRE  
 FML INSTALLATION DEFECTS = 448722.00 HOLES/ACRE  
 FML PLACEMENT QUALITY = 1 - PERFECT

LAYER 5

-----

TYPE 1 - VERTICAL PERCOLATION LAYER

MATERIAL TEXTURE NUMBER 0

THICKNESS = 58.57 INCHES  
 POROSITY = 0.3700 VOL/VOL  
 FIELD CAPACITY = 0.2400 VOL/VOL  
 WILTING POINT = 0.1360 VOL/VOL  
 INITIAL SOIL WATER CONTENT = 0.2400 VOL/VOL  
 EFFECTIVE SAT. HYD. COND. = 0.999999975000E-04 CM/SEC

LAYER 6

-----

TYPE 2 - LATERAL DRAINAGE LAYER

MATERIAL TEXTURE NUMBER 0

THICKNESS = 24.00 INCHES  
 POROSITY = 0.3580 VOL/VOL  
 FIELD CAPACITY = 0.0979 VOL/VOL  
 WILTING POINT = 0.0388 VOL/VOL  
 INITIAL SOIL WATER CONTENT = 0.0979 VOL/VOL  
 EFFECTIVE SAT. HYD. COND. = 0.861999989000E-01 CM/SEC  
 SLOPE = 11.40 PERCENT  
 DRAINAGE LENGTH = 150.0 FEET

LAYER 7

-----

TYPE 3 - BARRIER SOIL LINER

MATERIAL TEXTURE NUMBER 0

THICKNESS = 0.20 INCHES  
 POROSITY = 0.7500 VOL/VOL  
 FIELD CAPACITY = 0.7470 VOL/VOL  
 WILTING POINT = 0.4000 VOL/VOL  
 INITIAL SOIL WATER CONTENT = 0.7500 VOL/VOL  
 EFFECTIVE SAT. HYD. COND. = 0.499999997000E-08 CM/SEC

GENERAL DESIGN AND EVAPORATIVE ZONE DATA

-----

NOTE: SCS RUNOFF CURVE NUMBER WAS COMPUTED FROM DEFAULT SOIL DATA BASE USING SOIL TEXTURE # 1 WITH A GOOD STAND OF GRASS, A SURFACE SLOPE OF 3.% AND A SLOPE LENGTH OF 450. FEET.

SCS RUNOFF CURVE NUMBER = 26.90  
 FRACTION OF AREA ALLOWING RUNOFF = 100.0 PERCENT  
 AREA PROJECTED ON HORIZONTAL PLANE = 19.630 ACRES  
 EVAPORATIVE ZONE DEPTH = 22.0 INCHES  
 INITIAL WATER IN EVAPORATIVE ZONE = 2.264 INCHES  
 UPPER LIMIT OF EVAPORATIVE STORAGE = 4.590 INCHES  
 LOWER LIMIT OF EVAPORATIVE STORAGE = 1.356 INCHES  
 INITIAL SNOW WATER = 0.000 INCHES  
 INITIAL WATER IN LAYER MATERIALS = 21.060 INCHES  
 TOTAL INITIAL WATER = 21.060 INCHES  
 TOTAL SUBSURFACE INFLOW = 0.00 INCHES/YEAR

EVAPOTRANSPIRATION AND WEATHER DATA

-----

NOTE: EVAPOTRANSPIRATION DATA WAS OBTAINED FROM AUGUSTA GEORGIA

STATION LATITUDE = 33.22 DEGREES  
 MAXIMUM LEAF AREA INDEX = 3.50  
 START OF GROWING SEASON (JULIAN DATE) = 68  
 END OF GROWING SEASON (JULIAN DATE) = 323  
 EVAPORATIVE ZONE DEPTH = 22.0 INCHES  
 AVERAGE ANNUAL WIND SPEED = 6.50 MPH  
 AVERAGE 1ST QUARTER RELATIVE HUMIDITY = 68.00 %  
 AVERAGE 2ND QUARTER RELATIVE HUMIDITY = 70.00 %  
 AVERAGE 3RD QUARTER RELATIVE HUMIDITY = 77.00 %  
 AVERAGE 4TH QUARTER RELATIVE HUMIDITY = 73.00 %

NOTE: PRECIPITATION DATA WAS SYNTHETICALLY GENERATED USING  
COEFFICIENTS FOR AUGUSTA GEORGIA

NORMAL MEAN MONTHLY PRECIPITATION (INCHES)

JAN/JUL	FEB/AUG	MAR/SEP	APR/OCT	MAY/NOV	JUN/DEC
4.38	3.95	4.68	2.91	3.56	4.99
5.43	5.41	3.93	3.12	2.96	3.45

NOTE: TEMPERATURE DATA WAS SYNTHETICALLY GENERATED USING  
COEFFICIENTS FOR AUGUSTA GEORGIA

NORMAL MEAN MONTHLY TEMPERATURE (DEGREES FAHRENHEIT)

JAN/JUL	FEB/AUG	MAR/SEP	APR/OCT	MAY/NOV	JUN/DEC
46.30	50.00	57.20	64.30	72.10	78.40
81.60	80.30	75.20	65.10	56.70	48.80

NOTE: SOLAR RADIATION DATA WAS SYNTHETICALLY GENERATED USING  
COEFFICIENTS FOR AUGUSTA GEORGIA  
AND STATION LATITUDE = 33.30 DEGREES

\*\*\*\*\*

AVERAGE MONTHLY VALUES IN INCHES FOR YEARS 1 THROUGH 100

	JAN/JUL	FEB/AUG	MAR/SEP	APR/OCT	MAY/NOV	JUN/DEC
PRECIPITATION						
TOTALS	4.56	3.57	4.76	2.74	3.60	4.97
	5.81	5.32	4.41	2.99	2.75	3.41
STD. DEVIATIONS	2.44	1.60	2.47	1.31	2.12	2.60
	2.83	2.95	2.54	2.28	1.72	1.90
RUNOFF						
TOTALS	0.000	0.000	0.000	0.000	0.000	0.000
	0.000	0.000	0.000	0.000	0.000	0.000
STD. DEVIATIONS	0.000	0.000	0.000	0.000	0.000	0.000
	0.000	0.000	0.000	0.000	0.000	0.000
EVAPOTRANSPIRATION						
TOTALS	1.533	1.848	2.491	2.259	2.667	3.342
	3.735	3.302	2.593	1.394	1.079	1.249
STD. DEVIATIONS	0.293	0.300	0.645	0.744	1.019	1.215
	1.151	1.059	0.903	0.614	0.322	0.226

LATERAL DRAINAGE COLLECTED FROM LAYER 3

TOTALS	0.0108	0.0062	0.0084	0.0026	0.0036	0.0052
	0.0074	0.0075	0.0065	0.0050	0.0054	0.0072
STD. DEVIATIONS	0.0074	0.0052	0.0067	0.0028	0.0049	0.0051
	0.0064	0.0080	0.0065	0.0061	0.0052	0.0059

PERCOLATION/LEAKAGE THROUGH LAYER 4

TOTALS	3.0512	1.7476	2.3858	0.7227	1.0296	1.4571
	2.1022	2.0406	1.8313	1.4116	1.5195	2.0197
STD. DEVIATIONS	2.0978	1.4638	1.8930	0.7843	1.3935	1.4405
	1.8048	1.9848	1.8437	1.7074	1.4556	1.6787

LATERAL DRAINAGE COLLECTED FROM LAYER 6

TOTALS	2.5536	2.1825	2.2402	1.6574	1.0316	1.1275
	1.7972	2.0915	1.8523	1.6568	1.3644	1.6171
STD. DEVIATIONS	1.9086	1.5207	1.5988	1.0939	0.7808	1.0859
	1.4237	1.7540	1.4075	1.3401	1.2384	1.2753

PERCOLATION/LEAKAGE THROUGH LAYER 7

TOTALS	0.0110	0.0098	0.0104	0.0089	0.0075	0.0072
	0.0089	0.0098	0.0092	0.0089	0.0079	0.0085
STD. DEVIATIONS	0.0047	0.0036	0.0038	0.0027	0.0019	0.0031
	0.0040	0.0045	0.0034	0.0034	0.0032	0.0035

AVERAGES OF MONTHLY AVERAGED DAILY HEADS (INCHES)

DAILY AVERAGE HEAD ON TOP OF LAYER 4

AVERAGES	0.2885	0.1810	0.2256	0.0705	0.0973	0.1424
	0.1988	0.2001	0.1790	0.1336	0.1484	0.1909
STD. DEVIATIONS	0.1985	0.1519	0.1791	0.0766	0.1318	0.1408
	0.1708	0.2119	0.1803	0.1619	0.1423	0.1588

DAILY AVERAGE HEAD ON TOP OF LAYER 7

AVERAGES	0.2247	0.2106	0.1971	0.1507	0.0908	0.1025
	0.1581	0.1840	0.1684	0.1458	0.1241	0.1423
STD. DEVIATIONS	0.1679	0.1469	0.1407	0.0995	0.0687	0.0987
	0.1253	0.1543	0.1280	0.1179	0.1126	0.1122

\*\*\*\*\*

\*\*\*\*\*

AVERAGE ANNUAL TOTALS & (STD. DEVIATIONS) FOR YEARS 1 THROUGH 100				
	INCHES		CU. FEET	PERCENT
PRECIPITATION	48.90	( 7.734)	3484469.2	100.00
RUNOFF	0.000	( 0.0000)	0.00	0.000
EVAPOTRANSPIRATION	27.492	( 2.7375)	1959003.12	56.221
LATERAL DRAINAGE COLLECTED FROM LAYER 3	0.07578	( 0.02295)	5399.602	0.15496
PERCOLATION/LEAKAGE THROUGH LAYER 4	21.31867	( 6.36277)	1519102.370	43.59638
AVERAGE HEAD ON TOP OF LAYER 4	0.171	( 0.052)		
LATERAL DRAINAGE COLLECTED FROM LAYER 6	21.17214	( 6.37298)	1508660.870	43.29672
PERCOLATION/LEAKAGE THROUGH LAYER 7	0.10798	( 0.01688)	7694.309	0.22082
AVERAGE HEAD ON TOP OF LAYER 7	0.158	( 0.048)		
CHANGE IN WATER STORAGE	0.052	( 1.9127)	3711.20	0.107

\*\*\*\*\*

\*\*\*\*\*

PEAK DAILY VALUES FOR YEARS		1 THROUGH	100
		(INCHES)	(CU. FT.)
PRECIPITATION		6.87	489534.875
RUNOFF		0.000	0.0000
DRAINAGE COLLECTED FROM LAYER	3	0.02213	1576.94116
PERCOLATION/LEAKAGE THROUGH LAYER	4	3.401600	242387.45300
AVERAGE HEAD ON TOP OF LAYER	4	17.964	
MAXIMUM HEAD ON TOP OF LAYER	4	27.399	
LOCATION OF MAXIMUM HEAD IN LAYER	3	113.1 FEET	
(DISTANCE FROM DRAIN)			
DRAINAGE COLLECTED FROM LAYER	6	1.72149	122668.17200
PERCOLATION/LEAKAGE THROUGH LAYER	7	0.004163	296.63727
AVERAGE HEAD ON TOP OF LAYER	7	4.695	
MAXIMUM HEAD ON TOP OF LAYER	7	8.419	
LOCATION OF MAXIMUM HEAD IN LAYER	6	13.8 FEET	
(DISTANCE FROM DRAIN)			
SNOW WATER		2.36	168188.7190
MAXIMUM VEG. SOIL WATER (VOL/VOL)			0.1959
MINIMUM VEG. SOIL WATER (VOL/VOL)			0.0616

\*\*\* Maximum heads are computed using McEnroe's equations. \*\*\*

Reference: Maximum Saturated Depth over Landfill Liner  
 by Bruce M. McEnroe, University of Kansas  
 ASCE Journal of Environmental Engineering  
 Vol. 119, No. 2, March 1993, pp. 262-270.

\*\*\*\*\*



\*\*\*\*\*

FINAL WATER STORAGE AT END OF YEAR 100

LAYER	( INCHES )	( VOL/VOL )
1	0.8162	0.0680
2	2.4742	0.2062
3	2.5665	0.2139
4	0.0000	0.0000
5	17.8803	0.3053
6	2.3810	0.0992
7	0.1500	0.7500
SNOW WATER	0.000	

\*\*\*\*\*  
\*\*\*\*\*

Appendix X, Upper Bounding Scenario Degraded SDF MSE Vault Closure Cap (3,400 Years): HELP Model Input Data and Output File (output file name: ZUBSD9ou.OUT)

Input Data:

Input Parameter (HELP Model Query)		Generic Input Parameter Value					
Landfill area =		19.63 acres					
Percent of area where runoff is possible =		100%					
Do you want to specify initial moisture storage? (Y/N)		Y					
Amount of water or snow on surface =		0 inches					
CN Input Parameter (HELP Model Query)		CN Input Parameter Value					
Slope =		3 %					
Slope length =		450 ft					
Soil Texture =		1 (HELP model default soil texture)					
Vegetation =		4 (i.e., a good stand of grass)					
HELP Model Computed Curve Number = 26.9							
Layer		Layer Number		Layer Type			
Erosion Barrier		1		1 (vertical percolation layer)			
Middle Backfill		2		1 (vertical percolation layer)			
Upper Drainage Layer		3		2 (lateral drainage layer)			
Upper GCL		4		3 (barrier soil liner)			
Lower Backfill		5		1 (vertical percolation layer)			
Lower Drainage Layer		6		2 (lateral drainage layer)			
Lower GCL		7		3 (barrier soil liner)			
	Layer Type	Layer Thickness (in)	Soil Texture No.	Total Porosity (Vol/Vol)	Field Capacity (Vol/Vol)	Wilting Point (Vol/Vol)	Initial Moisture (Vol/Vol)
1	1	12		0.084	0.0543	0.0492	0.0543
2	1	12		0.375	0.16	0.0745	0.16
3	2	12		0.375	0.16	0.0745	0.16
4	3	0.2		0.375	0.16	0.0745	0.375
5	1	58.57		0.37	0.24	0.136	0.24
6	2	24		0.324	0.126	0.0790	0.126
7	3	0.2		0.75	0.747	0.40	0.75

The lack of values in the table for particular parameters in particular layers denotes that no HELP model input was required for that parameter in that layer. No data are missing from the table.

## Input Data (continued):

	Layer Type	Sat. Hyd. Conductivity * (cm/sec)	Drainage Length (ft)	Drain Slope (%)	Leachate Recirc. (%)	Recirc. to Layer (#)	Subsurface Inflow (in/yr)
1	1	2.20E-02					
2	1	3.20E-03					
3	2	3.20E-03	450	3			
4	3	3.20E-03					
5	1	1.00E-04					
6	2	6.47E-02	150	11.4			
7	3	5.00E-09					
	Layer Type	Geomembrane Pinhole Density (#/acre)	Geomembrane Instal. Defects (#/acre)	Geomembrane Placement Quality	Geotextile Transmissivity (cm <sup>2</sup> /sec)		
1	1						
2	1						
3	2						
4	3						
5	1						
6	2						
7	3						

The lack of values in the table for particular parameters in particular layers denotes that no HELP model input was required for that parameter in that layer. No data are missing from the table.

\* The HELP model output often produces an increased number of significant digits for the Effective Saturated Hydraulic Conductivity over that of the actual input



## LAYER 3

-----

## TYPE 2 - LATERAL DRAINAGE LAYER

MATERIAL TEXTURE NUMBER 0

THICKNESS	=	12.00	INCHES
POROSITY	=	0.3750	VOL/VOL
FIELD CAPACITY	=	0.1600	VOL/VOL
WILTING POINT	=	0.0745	VOL/VOL
INITIAL SOIL WATER CONTENT	=	0.1600	VOL/VOL
EFFECTIVE SAT. HYD. COND.	=	0.319999992000E-02	CM/SEC
SLOPE	=	3.00	PERCENT
DRAINAGE LENGTH	=	450.0	FEET

## LAYER 4

-----

## TYPE 3 - BARRIER SOIL LINER

MATERIAL TEXTURE NUMBER 0

THICKNESS	=	0.20	INCHES
POROSITY	=	0.3750	VOL/VOL
FIELD CAPACITY	=	0.1600	VOL/VOL
WILTING POINT	=	0.0745	VOL/VOL
INITIAL SOIL WATER CONTENT	=	0.3750	VOL/VOL
EFFECTIVE SAT. HYD. COND.	=	0.319999992000E-02	CM/SEC

## LAYER 5

-----

## TYPE 1 - VERTICAL PERCOLATION LAYER

MATERIAL TEXTURE NUMBER 0

THICKNESS	=	58.57	INCHES
POROSITY	=	0.3700	VOL/VOL
FIELD CAPACITY	=	0.2400	VOL/VOL
WILTING POINT	=	0.1360	VOL/VOL
INITIAL SOIL WATER CONTENT	=	0.2400	VOL/VOL
EFFECTIVE SAT. HYD. COND.	=	0.999999975000E-04	CM/SEC

## LAYER 6

-----

## TYPE 2 - LATERAL DRAINAGE LAYER

MATERIAL TEXTURE NUMBER 0

THICKNESS	=	24.00	INCHES
POROSITY	=	0.3240	VOL/VOL
FIELD CAPACITY	=	0.1260	VOL/VOL
WILTING POINT	=	0.0790	VOL/VOL
INITIAL SOIL WATER CONTENT	=	0.1260	VOL/VOL
EFFECTIVE SAT. HYD. COND.	=	0.647000000000E-01	CM/SEC
SLOPE	=	11.40	PERCENT
DRAINAGE LENGTH	=	150.0	FEET

LAYER 7

-----

TYPE 3 - BARRIER SOIL LINER

MATERIAL TEXTURE NUMBER 0

THICKNESS = 0.20 INCHES  
 POROSITY = 0.7500 VOL/VOL  
 FIELD CAPACITY = 0.7470 VOL/VOL  
 WILTING POINT = 0.4000 VOL/VOL  
 INITIAL SOIL WATER CONTENT = 0.7500 VOL/VOL  
 EFFECTIVE SAT. HYD. COND. = 0.499999997000E-08 CM/SEC

GENERAL DESIGN AND EVAPORATIVE ZONE DATA

-----

NOTE: SCS RUNOFF CURVE NUMBER WAS COMPUTED FROM DEFAULT SOIL DATA BASE USING SOIL TEXTURE # 1 WITH A GOOD STAND OF GRASS, A SURFACE SLOPE OF 3.% AND A SLOPE LENGTH OF 450. FEET.

SCS RUNOFF CURVE NUMBER = 26.90  
 FRACTION OF AREA ALLOWING RUNOFF = 100.0 PERCENT  
 AREA PROJECTED ON HORIZONTAL PLANE = 19.630 ACRES  
 EVAPORATIVE ZONE DEPTH = 22.0 INCHES  
 INITIAL WATER IN EVAPORATIVE ZONE = 2.252 INCHES  
 UPPER LIMIT OF EVAPORATIVE STORAGE = 4.758 INCHES  
 LOWER LIMIT OF EVAPORATIVE STORAGE = 1.335 INCHES  
 INITIAL SNOW WATER = 0.000 INCHES  
 INITIAL WATER IN LAYER MATERIALS = 21.797 INCHES  
 TOTAL INITIAL WATER = 21.797 INCHES  
 TOTAL SUBSURFACE INFLOW = 0.00 INCHES/YEAR

EVAPOTRANSPIRATION AND WEATHER DATA

-----

NOTE: EVAPOTRANSPIRATION DATA WAS OBTAINED FROM AUGUSTA GEORGIA

STATION LATITUDE = 33.22 DEGREES  
 MAXIMUM LEAF AREA INDEX = 3.50  
 START OF GROWING SEASON (JULIAN DATE) = 68  
 END OF GROWING SEASON (JULIAN DATE) = 323  
 EVAPORATIVE ZONE DEPTH = 22.0 INCHES  
 AVERAGE ANNUAL WIND SPEED = 6.50 MPH  
 AVERAGE 1ST QUARTER RELATIVE HUMIDITY = 68.00 %  
 AVERAGE 2ND QUARTER RELATIVE HUMIDITY = 70.00 %  
 AVERAGE 3RD QUARTER RELATIVE HUMIDITY = 77.00 %  
 AVERAGE 4TH QUARTER RELATIVE HUMIDITY = 73.00 %

NOTE: PRECIPITATION DATA WAS SYNTHETICALLY GENERATED USING  
COEFFICIENTS FOR AUGUSTA GEORGIA

NORMAL MEAN MONTHLY PRECIPITATION (INCHES)

JAN/JUL	FEB/AUG	MAR/SEP	APR/OCT	MAY/NOV	JUN/DEC
4.38	3.95	4.68	2.91	3.56	4.99
5.43	5.41	3.93	3.12	2.96	3.45

NOTE: TEMPERATURE DATA WAS SYNTHETICALLY GENERATED USING  
COEFFICIENTS FOR AUGUSTA GEORGIA

NORMAL MEAN MONTHLY TEMPERATURE (DEGREES FAHRENHEIT)

JAN/JUL	FEB/AUG	MAR/SEP	APR/OCT	MAY/NOV	JUN/DEC
46.30	50.00	57.20	64.30	72.10	78.40
81.60	80.30	75.20	65.10	56.70	48.80

NOTE: SOLAR RADIATION DATA WAS SYNTHETICALLY GENERATED USING  
COEFFICIENTS FOR AUGUSTA GEORGIA  
AND STATION LATITUDE = 33.30 DEGREES

\*\*\*\*\*

AVERAGE MONTHLY VALUES IN INCHES FOR YEARS 1 THROUGH 100

	JAN/JUL	FEB/AUG	MAR/SEP	APR/OCT	MAY/NOV	JUN/DEC
PRECIPITATION						
TOTALS	4.56	3.57	4.76	2.74	3.60	4.97
	5.81	5.32	4.41	2.99	2.75	3.41
STD. DEVIATIONS	2.44	1.60	2.47	1.31	2.12	2.60
	2.83	2.95	2.54	2.28	1.72	1.90
RUNOFF						
TOTALS	0.000	0.000	0.000	0.000	0.000	0.000
	0.000	0.000	0.000	0.000	0.000	0.000
STD. DEVIATIONS	0.000	0.000	0.000	0.000	0.000	0.000
	0.000	0.000	0.000	0.000	0.000	0.000
EVAPOTRANSPIRATION						
TOTALS	1.526	1.853	2.479	2.282	2.698	3.334
	3.739	3.292	2.580	1.386	1.055	1.247
STD. DEVIATIONS	0.281	0.305	0.637	0.734	1.051	1.207
	1.165	1.054	0.894	0.606	0.311	0.218

LATERAL DRAINAGE COLLECTED FROM LAYER 3

TOTALS	0.0000	0.0000	0.0000	0.0000	0.0000	0.0000
	0.0000	0.0000	0.0000	0.0000	0.0000	0.0000
STD. DEVIATIONS	0.0000	0.0000	0.0000	0.0000	0.0000	0.0000
	0.0000	0.0000	0.0000	0.0000	0.0000	0.0000

PERCOLATION/LEAKAGE THROUGH LAYER 4

TOTALS	3.0795	1.7500	2.4184	0.6934	0.9936	1.4985
	2.1156	2.0484	1.8259	1.4336	1.5242	2.0425
STD. DEVIATIONS	2.1241	1.5193	1.9330	0.7578	1.3707	1.4961
	1.8446	2.0089	1.8271	1.7159	1.4725	1.6994

LATERAL DRAINAGE COLLECTED FROM LAYER 6

TOTALS	2.5807	2.1593	2.2623	1.6326	1.0453	1.1434
	1.7990	2.0776	1.8699	1.6549	1.3869	1.6361
STD. DEVIATIONS	1.9494	1.5073	1.6332	1.0596	0.7973	1.0450
	1.4402	1.7426	1.4120	1.3360	1.2182	1.2751

PERCOLATION/LEAKAGE THROUGH LAYER 7

TOTALS	0.0131	0.0114	0.0122	0.0101	0.0084	0.0086
	0.0107	0.0116	0.0108	0.0103	0.0093	0.0101
STD. DEVIATIONS	0.0062	0.0047	0.0051	0.0033	0.0025	0.0033
	0.0045	0.0055	0.0044	0.0042	0.0038	0.0041

AVERAGES OF MONTHLY AVERAGED DAILY HEADS (INCHES)

DAILY AVERAGE HEAD ON TOP OF LAYER 4

AVERAGES	0.0446	0.0272	0.0334	0.0101	0.0125	0.0224
	0.0263	0.0287	0.0270	0.0185	0.0226	0.0284
STD. DEVIATIONS	0.0359	0.0283	0.0320	0.0132	0.0192	0.0249
	0.0284	0.0355	0.0308	0.0229	0.0261	0.0256

DAILY AVERAGE HEAD ON TOP OF LAYER 7

AVERAGES	0.3025	0.2775	0.2652	0.1977	0.1225	0.1385
	0.2109	0.2435	0.2265	0.1940	0.1680	0.1918
STD. DEVIATIONS	0.2285	0.1939	0.1914	0.1284	0.0935	0.1266
	0.1688	0.2043	0.1710	0.1566	0.1476	0.1495

\*\*\*\*\*



\*\*\*\*\*

AVERAGE ANNUAL TOTALS & (STD. DEVIATIONS) FOR YEARS 1 THROUGH 100				
	INCHES		CU. FEET	PERCENT
PRECIPITATION	48.90	( 7.734)	3484469.2	100.00
RUNOFF	0.000	( 0.0000)	0.00	0.000
EVAPOTRANSPIRATION	27.471	( 2.7402)	1957474.75	56.177
LATERAL DRAINAGE COLLECTED FROM LAYER 3	0.00002	( 0.00001)	1.677	0.00005
PERCOLATION/LEAKAGE THROUGH LAYER 4	21.42358	( 6.40759)	1526578.120	43.81092
AVERAGE HEAD ON TOP OF LAYER 4	0.025	( 0.008)		
LATERAL DRAINAGE COLLECTED FROM LAYER 6	21.24801	( 6.40753)	1514067.250	43.45188
PERCOLATION/LEAKAGE THROUGH LAYER 7	0.12671	( 0.02043)	9028.894	0.25912
AVERAGE HEAD ON TOP OF LAYER 7	0.212	( 0.064)		
CHANGE IN WATER STORAGE	0.055	( 1.9035)	3896.46	0.112

\*\*\*\*\*

\*\*\*\*\*

PEAK DAILY VALUES FOR YEARS		1 THROUGH	100
		(INCHES)	(CU. FT.)
PRECIPITATION		6.87	489534.875
RUNOFF		0.000	0.0000
DRAINAGE COLLECTED FROM LAYER	3	0.00001	0.53023
PERCOLATION/LEAKAGE THROUGH LAYER	4	5.288364	376832.43700
AVERAGE HEAD ON TOP OF LAYER	4	2.776	
MAXIMUM HEAD ON TOP OF LAYER	4	0.012	
LOCATION OF MAXIMUM HEAD IN LAYER	3		
(DISTANCE FROM DRAIN)		0.0 FEET	
DRAINAGE COLLECTED FROM LAYER	6	2.12129	151156.32800
PERCOLATION/LEAKAGE THROUGH LAYER	7	0.006725	479.21652
AVERAGE HEAD ON TOP OF LAYER	7	7.708	
MAXIMUM HEAD ON TOP OF LAYER	7	13.261	
LOCATION OF MAXIMUM HEAD IN LAYER	6		
(DISTANCE FROM DRAIN)		19.3 FEET	
SNOW WATER		2.36	168188.7190
MAXIMUM VEG. SOIL WATER (VOL/VOL)			0.1617
MINIMUM VEG. SOIL WATER (VOL/VOL)			0.0607

\*\*\* Maximum heads are computed using McEnroe's equations. \*\*\*

Reference: Maximum Saturated Depth over Landfill Liner  
 by Bruce M. McEnroe, University of Kansas  
 ASCE Journal of Environmental Engineering  
 Vol. 119, No. 2, March 1993, pp. 262-270.

\*\*\*\*\*

\*\*\*\*\*

FINAL WATER STORAGE AT END OF YEAR 100

LAYER	( INCHES )	( VOL/VOL )
1	0.8775	0.0731
2	2.2755	0.1896
3	1.9200	0.1600
4	0.0750	0.3750
5	18.5832	0.3173
6	3.3844	0.1410
7	0.1500	0.7500
SNOW WATER	0.000	

\*\*\*\*\*  
\*\*\*\*\*

Appendix Y, Upper Bounding Scenario Degraded SDF MSE Vault Closure Cap (5,600 Years): HELP Model Input Data and Output File (output file name: ZUBSD10o.OUT)

Input Data:

Input Parameter (HELP Model Query)		Generic Input Parameter Value					
Landfill area =		19.63 acres					
Percent of area where runoff is possible =		100%					
Do you want to specify initial moisture storage? (Y/N)		Y					
Amount of water or snow on surface =		0 inches					
CN Input Parameter (HELP Model Query)		CN Input Parameter Value					
Slope =		3 %					
Slope length =		450 ft					
Soil Texture =		1 (HELP model default soil texture)					
Vegetation =		4 (i.e., a good stand of grass)					
HELP Model Computed Curve Number = 26.9							
Layer		Layer Number		Layer Type			
Erosion Barrier		1		1 (vertical percolation layer)			
Middle Backfill		2		1 (vertical percolation layer)			
Upper Drainage Layer		3		2 (lateral drainage layer)			
Upper GCL		4		3 (barrier soil liner)			
Lower Backfill		5		1 (vertical percolation layer)			
Lower Drainage Layer		6		2 (lateral drainage layer)			
Lower GCL		7		3 (barrier soil liner)			
	Layer Type	Layer Thickness (in)	Soil Texture No.	Total Porosity (Vol/Vol)	Field Capacity (Vol/Vol)	Wilting Point (Vol/Vol)	Initial Moisture (Vol/Vol)
1	1	12		0.104	0.0529	0.0469	0.0529
2	1	12		0.375	0.16	0.0745	0.16
3	2	12		0.375	0.16	0.0745	0.16
4	3	0.2		0.375	0.16	0.0745	0.375
5	1	58.57		0.37	0.24	0.136	0.24
6	2	24		0.276	0.164	0.134	0.164
7	3	0.2		0.75	0.747	0.40	0.75

The lack of values in the table for particular parameters in particular layers denotes that no HELP model input was required for that parameter in that layer. No data are missing from the table.

## Input Data (continued):

	Layer Type	Sat. Hyd. Conductivity * (cm/sec)	Drainage Length (ft)	Drain Slope (%)	Leachate Recirc. (%)	Recirc. to Layer (#)	Subsurface Inflow (in/yr)
1	1	3.90E-02					
2	1	3.20E-03					
3	2	3.20E-03	450	3			
4	3	3.20E-03					
5	1	1.00E-04					
6	2	3.54E-02	150	11.4			
7	3	5.00E-09					
	Layer Type	Geomembrane Pinhole Density (#/acre)	Geomembrane Instal. Defects (#/acre)	Geomembrane Placement Quality	Geotextile Transmissivity (cm <sup>2</sup> /sec)		
1	1						
2	1						
3	2						
4	3						
5	1						
6	2						
7	3						

The lack of values in the table for particular parameters in particular layers denotes that no HELP model input was required for that parameter in that layer. No data are missing from the table.

\* The HELP model output often produces an increased number of significant digits for the Effective Saturated Hydraulic Conductivity over that of the actual input



LAYER 3

-----

TYPE 2 - LATERAL DRAINAGE LAYER

MATERIAL TEXTURE NUMBER 0

THICKNESS = 12.00 INCHES  
 POROSITY = 0.3750 VOL/VOL  
 FIELD CAPACITY = 0.1600 VOL/VOL  
 WILTING POINT = 0.0745 VOL/VOL  
 INITIAL SOIL WATER CONTENT = 0.1600 VOL/VOL  
 EFFECTIVE SAT. HYD. COND. = 0.319999992000E-02 CM/SEC  
 SLOPE = 3.00 PERCENT  
 DRAINAGE LENGTH = 450.0 FEET

LAYER 4

-----

TYPE 3 - BARRIER SOIL LINER

MATERIAL TEXTURE NUMBER 0

THICKNESS = 0.20 INCHES  
 POROSITY = 0.3750 VOL/VOL  
 FIELD CAPACITY = 0.1600 VOL/VOL  
 WILTING POINT = 0.0745 VOL/VOL  
 INITIAL SOIL WATER CONTENT = 0.3750 VOL/VOL  
 EFFECTIVE SAT. HYD. COND. = 0.319999992000E-02 CM/SEC

LAYER 5

-----

TYPE 1 - VERTICAL PERCOLATION LAYER

MATERIAL TEXTURE NUMBER 0

THICKNESS = 58.57 INCHES  
 POROSITY = 0.3700 VOL/VOL  
 FIELD CAPACITY = 0.2400 VOL/VOL  
 WILTING POINT = 0.1360 VOL/VOL  
 INITIAL SOIL WATER CONTENT = 0.2400 VOL/VOL  
 EFFECTIVE SAT. HYD. COND. = 0.999999975000E-04 CM/SEC

LAYER 6

-----

TYPE 2 - LATERAL DRAINAGE LAYER

MATERIAL TEXTURE NUMBER 0

THICKNESS = 24.00 INCHES  
 POROSITY = 0.2760 VOL/VOL  
 FIELD CAPACITY = 0.1640 VOL/VOL  
 WILTING POINT = 0.1340 VOL/VOL  
 INITIAL SOIL WATER CONTENT = 0.1640 VOL/VOL  
 EFFECTIVE SAT. HYD. COND. = 0.353999995000E-01 CM/SEC  
 SLOPE = 11.40 PERCENT  
 DRAINAGE LENGTH = 150.0 FEET

LAYER 7

-----

TYPE 3 - BARRIER SOIL LINER

MATERIAL TEXTURE NUMBER 0

THICKNESS = 0.20 INCHES  
 POROSITY = 0.7500 VOL/VOL  
 FIELD CAPACITY = 0.7470 VOL/VOL  
 WILTING POINT = 0.4000 VOL/VOL  
 INITIAL SOIL WATER CONTENT = 0.7500 VOL/VOL  
 EFFECTIVE SAT. HYD. COND. = 0.499999997000E-08 CM/SEC

GENERAL DESIGN AND EVAPORATIVE ZONE DATA

-----

NOTE: SCS RUNOFF CURVE NUMBER WAS COMPUTED FROM DEFAULT SOIL DATA BASE USING SOIL TEXTURE # 1 WITH A GOOD STAND OF GRASS, A SURFACE SLOPE OF 3.% AND A SLOPE LENGTH OF 450. FEET.

SCS RUNOFF CURVE NUMBER = 26.90  
 FRACTION OF AREA ALLOWING RUNOFF = 100.0 PERCENT  
 AREA PROJECTED ON HORIZONTAL PLANE = 19.630 ACRES  
 EVAPORATIVE ZONE DEPTH = 22.0 INCHES  
 INITIAL WATER IN EVAPORATIVE ZONE = 2.235 INCHES  
 UPPER LIMIT OF EVAPORATIVE STORAGE = 4.998 INCHES  
 LOWER LIMIT OF EVAPORATIVE STORAGE = 1.308 INCHES  
 INITIAL SNOW WATER = 0.000 INCHES  
 INITIAL WATER IN LAYER MATERIALS = 22.693 INCHES  
 TOTAL INITIAL WATER = 22.693 INCHES  
 TOTAL SUBSURFACE INFLOW = 0.00 INCHES/YEAR

EVAPOTRANSPIRATION AND WEATHER DATA

-----

NOTE: EVAPOTRANSPIRATION DATA WAS OBTAINED FROM AUGUSTA GEORGIA

STATION LATITUDE = 33.22 DEGREES  
 MAXIMUM LEAF AREA INDEX = 3.50  
 START OF GROWING SEASON (JULIAN DATE) = 68  
 END OF GROWING SEASON (JULIAN DATE) = 323  
 EVAPORATIVE ZONE DEPTH = 22.0 INCHES  
 AVERAGE ANNUAL WIND SPEED = 6.50 MPH  
 AVERAGE 1ST QUARTER RELATIVE HUMIDITY = 68.00 %  
 AVERAGE 2ND QUARTER RELATIVE HUMIDITY = 70.00 %  
 AVERAGE 3RD QUARTER RELATIVE HUMIDITY = 77.00 %  
 AVERAGE 4TH QUARTER RELATIVE HUMIDITY = 73.00 %



NOTE: PRECIPITATION DATA WAS SYNTHETICALLY GENERATED USING  
COEFFICIENTS FOR AUGUSTA GEORGIA

NORMAL MEAN MONTHLY PRECIPITATION (INCHES)

JAN/JUL	FEB/AUG	MAR/SEP	APR/OCT	MAY/NOV	JUN/DEC
4.38	3.95	4.68	2.91	3.56	4.99
5.43	5.41	3.93	3.12	2.96	3.45

NOTE: TEMPERATURE DATA WAS SYNTHETICALLY GENERATED USING  
COEFFICIENTS FOR AUGUSTA GEORGIA

NORMAL MEAN MONTHLY TEMPERATURE (DEGREES FAHRENHEIT)

JAN/JUL	FEB/AUG	MAR/SEP	APR/OCT	MAY/NOV	JUN/DEC
46.30	50.00	57.20	64.30	72.10	78.40
81.60	80.30	75.20	65.10	56.70	48.80

NOTE: SOLAR RADIATION DATA WAS SYNTHETICALLY GENERATED USING  
COEFFICIENTS FOR AUGUSTA GEORGIA  
AND STATION LATITUDE = 33.30 DEGREES

\*\*\*\*\*

AVERAGE MONTHLY VALUES IN INCHES FOR YEARS 1 THROUGH 100

	JAN/JUL	FEB/AUG	MAR/SEP	APR/OCT	MAY/NOV	JUN/DEC
PRECIPITATION						
TOTALS	4.56	3.57	4.76	2.74	3.60	4.97
	5.81	5.32	4.41	2.99	2.75	3.41
STD. DEVIATIONS	2.44	1.60	2.47	1.31	2.12	2.60
	2.83	2.95	2.54	2.28	1.72	1.90
RUNOFF						
TOTALS	0.000	0.000	0.000	0.000	0.000	0.000
	0.000	0.000	0.000	0.000	0.000	0.000
STD. DEVIATIONS	0.000	0.000	0.000	0.000	0.000	0.000
	0.000	0.000	0.000	0.000	0.000	0.000
EVAPOTRANSPIRATION						
TOTALS	1.552	1.901	2.514	2.338	2.740	3.354
	3.756	3.305	2.609	1.399	1.041	1.249
STD. DEVIATIONS	0.282	0.299	0.633	0.757	1.082	1.229
	1.170	1.081	0.894	0.604	0.291	0.210

LATERAL DRAINAGE COLLECTED FROM LAYER 3

TOTALS	0.0000	0.0000	0.0000	0.0000	0.0000	0.0000
	0.0000	0.0000	0.0000	0.0000	0.0000	0.0000
STD. DEVIATIONS	0.0000	0.0000	0.0000	0.0000	0.0000	0.0000
	0.0000	0.0000	0.0000	0.0000	0.0000	0.0000

PERCOLATION/LEAKAGE THROUGH LAYER 4

TOTALS	3.0476	1.7224	2.3844	0.6803	0.9666	1.4297
	2.0996	2.0526	1.7938	1.4017	1.5138	2.0388
STD. DEVIATIONS	2.1362	1.4842	1.9591	0.7621	1.3798	1.4819
	1.8388	2.0183	1.8568	1.6957	1.4708	1.6996

LATERAL DRAINAGE COLLECTED FROM LAYER 6

TOTALS	2.5804	2.1134	2.2429	1.5738	1.0200	1.1036
	1.7592	2.0828	1.8197	1.6138	1.3541	1.6445
STD. DEVIATIONS	1.9666	1.5155	1.6294	1.0640	0.7936	1.0363
	1.4611	1.7751	1.3895	1.3488	1.2126	1.3003

PERCOLATION/LEAKAGE THROUGH LAYER 7

TOTALS	0.0197	0.0167	0.0179	0.0139	0.0110	0.0113
	0.0151	0.0169	0.0153	0.0143	0.0127	0.0144
STD. DEVIATIONS	0.0113	0.0087	0.0093	0.0061	0.0045	0.0059
	0.0083	0.0101	0.0079	0.0077	0.0069	0.0075

AVERAGES OF MONTHLY AVERAGED DAILY HEADS (INCHES)

DAILY AVERAGE HEAD ON TOP OF LAYER 4

AVERAGES	0.0440	0.0288	0.0330	0.0095	0.0144	0.0184
	0.0275	0.0249	0.0261	0.0183	0.0213	0.0306
STD. DEVIATIONS	0.0353	0.0261	0.0359	0.0107	0.0226	0.0211
	0.0298	0.0287	0.0341	0.0256	0.0230	0.0295

DAILY AVERAGE HEAD ON TOP OF LAYER 7

AVERAGES	0.5528	0.4965	0.4805	0.3484	0.2185	0.2443
	0.3769	0.4462	0.4028	0.3458	0.2998	0.3523
STD. DEVIATIONS	0.4213	0.3566	0.3491	0.2356	0.1700	0.2294
	0.3130	0.3803	0.3076	0.2890	0.2684	0.2786

\*\*\*\*\*

\*\*\*\*\*

AVERAGE ANNUAL TOTALS & (STD. DEVIATIONS) FOR YEARS 1 THROUGH 100				
	INCHES		CU. FEET	PERCENT
PRECIPITATION	48.90	( 7.734)	3484469.2	100.00
RUNOFF	0.000	( 0.0000)	0.00	0.000
EVAPOTRANSPIRATION	27.756	( 2.7635)	1977837.50	56.762
LATERAL DRAINAGE COLLECTED FROM LAYER 3	0.00002	( 0.00001)	1.710	0.00005
PERCOLATION/LEAKAGE THROUGH LAYER 4	21.13124	( 6.44700)	1505746.620	43.21309
AVERAGE HEAD ON TOP OF LAYER 4	0.025	( 0.009)		
LATERAL DRAINAGE COLLECTED FROM LAYER 6	20.90792	( 6.42289)	1489833.870	42.75641
PERCOLATION/LEAKAGE THROUGH LAYER 7	0.17926	( 0.03686)	12773.592	0.36659
AVERAGE HEAD ON TOP OF LAYER 7	0.380	( 0.117)		
CHANGE IN WATER STORAGE	0.056	( 1.8648)	4022.33	0.115

\*\*\*\*\*

\*\*\*\*\*

PEAK DAILY VALUES FOR YEARS		1 THROUGH	100
		(INCHES)	(CU. FT.)
PRECIPITATION		6.87	489534.875
RUNOFF		0.000	0.0000
DRAINAGE COLLECTED FROM LAYER	3	0.00001	0.57965
PERCOLATION/LEAKAGE THROUGH LAYER	4	3.774003	268923.71900
AVERAGE HEAD ON TOP OF LAYER	4	2.143	
MAXIMUM HEAD ON TOP OF LAYER	4	0.013	
LOCATION OF MAXIMUM HEAD IN LAYER	3		
(DISTANCE FROM DRAIN)		23.2 FEET	
DRAINAGE COLLECTED FROM LAYER	6	2.19062	156097.14100
PERCOLATION/LEAKAGE THROUGH LAYER	7	0.012542	893.73029
AVERAGE HEAD ON TOP OF LAYER	7	14.549	
MAXIMUM HEAD ON TOP OF LAYER	7	23.311	
LOCATION OF MAXIMUM HEAD IN LAYER	6		
(DISTANCE FROM DRAIN)		28.3 FEET	
SNOW WATER		2.36	168188.7190
MAXIMUM VEG. SOIL WATER (VOL/VOL)			0.1658
MINIMUM VEG. SOIL WATER (VOL/VOL)			0.0594

\*\*\* Maximum heads are computed using McEnroe's equations. \*\*\*

Reference: Maximum Saturated Depth over Landfill Liner  
 by Bruce M. McEnroe, University of Kansas  
 ASCE Journal of Environmental Engineering  
 Vol. 119, No. 2, March 1993, pp. 262-270.

\*\*\*\*\*

\*\*\*\*\*

FINAL WATER STORAGE AT END OF YEAR 100

LAYER	( INCHES )	( VOL/VOL )
1	0.9601	0.0800
2	2.2836	0.1903
3	2.4705	0.2059
4	0.0750	0.3750
5	18.0053	0.3074
6	4.3929	0.1830
7	0.1500	0.7500
SNOW WATER	0.000	

\*\*\*\*\*  
\*\*\*\*\*

Appendix Z, Upper Bounding Scenario Degraded SDF MSE Vault Closure Cap (10,000 Years): HELP Model Input Data and Output File (output file name: ZUBSD11o.OUT)

Input Data:

Input Parameter (HELP Model Query)		Generic Input Parameter Value					
Landfill area =		19.63 acres					
Percent of area where runoff is possible =		100%					
Do you want to specify initial moisture storage? (Y/N)		Y					
Amount of water or snow on surface =		0 inches					
CN Input Parameter (HELP Model Query)		CN Input Parameter Value					
Slope =		3 %					
Slope length =		450 ft					
Soil Texture =		1 (HELP model default soil texture)					
Vegetation =		4 (i.e., a good stand of grass)					
HELP Model Computed Curve Number = 26.9							
Layer		Layer Number		Layer Type			
Erosion Barrier		1		1 (vertical percolation layer)			
Middle Backfill		2		1 (vertical percolation layer)			
Upper Drainage Layer		3		2 (lateral drainage layer)			
Upper GCL		4		3 (barrier soil liner)			
Lower Backfill		5		1 (vertical percolation layer)			
Lower Drainage Layer		6		2 (lateral drainage layer)			
Lower GCL		7		3 (barrier soil liner)			
	Layer Type	Layer Thickness (in)	Soil Texture No.	Total Porosity (Vol/Vol)	Field Capacity (Vol/Vol)	Wilting Point (Vol/Vol)	Initial Moisture (Vol/Vol)
1	1	12		0.144	0.050	0.0423	0.050
2	1	12		0.375	0.16	0.0745	0.16
3	2	12		0.375	0.16	0.0745	0.16
4	3	0.2		0.375	0.16	0.0745	0.375
5	1	58.57		0.37	0.24	0.136	0.24
6	2	24		0.22	0.21	0.20	0.21
7	3	0.2		0.75	0.747	0.40	0.75

The lack of values in the table for particular parameters in particular layers denotes that no HELP model input was required for that parameter in that layer. No data are missing from the table.

## Input Data (continued):

	Layer Type	Sat. Hyd. Conductivity * (cm/sec)	Drainage Length (ft)	Drain Slope (%)	Leachate Recirc. (%)	Recirc. to Layer (#)	Subsurface Inflow (in/yr)
1	1	7.50E-02					
2	1	3.20E-03					
3	2	3.20E-03	450	3			
4	3	3.20E-03					
5	1	1.00E-04					
6	2	1.00E-04	150	11.4			
7	3	5.00E-09					
	Layer Type	Geomembrane Pinhole Density (#/acre)	Geomembrane Instal. Defects (#/acre)	Geomembrane Placement Quality	Geotextile Transmissivity (cm <sup>2</sup> /sec)		
1	1						
2	1						
3	2						
4	3						
5	1						
6	2						
7	3						

The lack of values in the table for particular parameters in particular layers denotes that no HELP model input was required for that parameter in that layer. No data are missing from the table.

\* The HELP model output often produces an increased number of significant digits for the Effective Saturated Hydraulic Conductivity over that of the actual input





## LAYER 3

-----

## TYPE 2 - LATERAL DRAINAGE LAYER

MATERIAL TEXTURE NUMBER 0

THICKNESS	=	12.00	INCHES
POROSITY	=	0.3750	VOL/VOL
FIELD CAPACITY	=	0.1600	VOL/VOL
WILTING POINT	=	0.0745	VOL/VOL
INITIAL SOIL WATER CONTENT	=	0.1600	VOL/VOL
EFFECTIVE SAT. HYD. COND.	=	0.319999992000E-02	CM/SEC
SLOPE	=	3.00	PERCENT
DRAINAGE LENGTH	=	450.0	FEET

## LAYER 4

-----

## TYPE 3 - BARRIER SOIL LINER

MATERIAL TEXTURE NUMBER 0

THICKNESS	=	0.20	INCHES
POROSITY	=	0.3750	VOL/VOL
FIELD CAPACITY	=	0.1600	VOL/VOL
WILTING POINT	=	0.0745	VOL/VOL
INITIAL SOIL WATER CONTENT	=	0.3750	VOL/VOL
EFFECTIVE SAT. HYD. COND.	=	0.319999992000E-02	CM/SEC

## LAYER 5

-----

## TYPE 1 - VERTICAL PERCOLATION LAYER

MATERIAL TEXTURE NUMBER 0

THICKNESS	=	58.57	INCHES
POROSITY	=	0.3700	VOL/VOL
FIELD CAPACITY	=	0.2400	VOL/VOL
WILTING POINT	=	0.1360	VOL/VOL
INITIAL SOIL WATER CONTENT	=	0.2400	VOL/VOL
EFFECTIVE SAT. HYD. COND.	=	0.999999975000E-04	CM/SEC

## LAYER 6

-----

## TYPE 2 - LATERAL DRAINAGE LAYER

MATERIAL TEXTURE NUMBER 0

THICKNESS	=	24.00	INCHES
POROSITY	=	0.2200	VOL/VOL
FIELD CAPACITY	=	0.2100	VOL/VOL
WILTING POINT	=	0.2000	VOL/VOL
INITIAL SOIL WATER CONTENT	=	0.2100	VOL/VOL
EFFECTIVE SAT. HYD. COND.	=	0.999999975000E-04	CM/SEC
SLOPE	=	11.40	PERCENT
DRAINAGE LENGTH	=	150.0	FEET

LAYER 7

-----

TYPE 3 - BARRIER SOIL LINER

MATERIAL TEXTURE NUMBER 0

THICKNESS = 0.20 INCHES  
 POROSITY = 0.7500 VOL/VOL  
 FIELD CAPACITY = 0.7470 VOL/VOL  
 WILTING POINT = 0.4000 VOL/VOL  
 INITIAL SOIL WATER CONTENT = 0.7500 VOL/VOL  
 EFFECTIVE SAT. HYD. COND. = 0.499999997000E-08 CM/SEC

GENERAL DESIGN AND EVAPORATIVE ZONE DATA

-----

NOTE: SCS RUNOFF CURVE NUMBER WAS COMPUTED FROM DEFAULT SOIL DATA BASE USING SOIL TEXTURE # 1 WITH A GOOD STAND OF GRASS, A SURFACE SLOPE OF 3.% AND A SLOPE LENGTH OF 450. FEET.

SCS RUNOFF CURVE NUMBER = 26.90  
 FRACTION OF AREA ALLOWING RUNOFF = 100.0 PERCENT  
 AREA PROJECTED ON HORIZONTAL PLANE = 19.630 ACRES  
 EVAPORATIVE ZONE DEPTH = 22.0 INCHES  
 INITIAL WATER IN EVAPORATIVE ZONE = 2.200 INCHES  
 UPPER LIMIT OF EVAPORATIVE STORAGE = 5.478 INCHES  
 LOWER LIMIT OF EVAPORATIVE STORAGE = 1.253 INCHES  
 INITIAL SNOW WATER = 0.000 INCHES  
 INITIAL WATER IN LAYER MATERIALS = 23.762 INCHES  
 TOTAL INITIAL WATER = 23.762 INCHES  
 TOTAL SUBSURFACE INFLOW = 0.00 INCHES/YEAR

EVAPOTRANSPIRATION AND WEATHER DATA

-----

NOTE: EVAPOTRANSPIRATION DATA WAS OBTAINED FROM AUGUSTA GEORGIA

STATION LATITUDE = 33.22 DEGREES  
 MAXIMUM LEAF AREA INDEX = 3.50  
 START OF GROWING SEASON (JULIAN DATE) = 68  
 END OF GROWING SEASON (JULIAN DATE) = 323  
 EVAPORATIVE ZONE DEPTH = 22.0 INCHES  
 AVERAGE ANNUAL WIND SPEED = 6.50 MPH  
 AVERAGE 1ST QUARTER RELATIVE HUMIDITY = 68.00 %  
 AVERAGE 2ND QUARTER RELATIVE HUMIDITY = 70.00 %  
 AVERAGE 3RD QUARTER RELATIVE HUMIDITY = 77.00 %  
 AVERAGE 4TH QUARTER RELATIVE HUMIDITY = 73.00 %

NOTE: PRECIPITATION DATA WAS SYNTHETICALLY GENERATED USING  
COEFFICIENTS FOR AUGUSTA GEORGIA

NORMAL MEAN MONTHLY PRECIPITATION (INCHES)

JAN/JUL	FEB/AUG	MAR/SEP	APR/OCT	MAY/NOV	JUN/DEC
4.38	3.95	4.68	2.91	3.56	4.99
5.43	5.41	3.93	3.12	2.96	3.45

NOTE: TEMPERATURE DATA WAS SYNTHETICALLY GENERATED USING  
COEFFICIENTS FOR AUGUSTA GEORGIA

NORMAL MEAN MONTHLY TEMPERATURE (DEGREES FAHRENHEIT)

JAN/JUL	FEB/AUG	MAR/SEP	APR/OCT	MAY/NOV	JUN/DEC
46.30	50.00	57.20	64.30	72.10	78.40
81.60	80.30	75.20	65.10	56.70	48.80

NOTE: SOLAR RADIATION DATA WAS SYNTHETICALLY GENERATED USING  
COEFFICIENTS FOR AUGUSTA GEORGIA  
AND STATION LATITUDE = 33.30 DEGREES

\*\*\*\*\*

AVERAGE MONTHLY VALUES IN INCHES FOR YEARS 1 THROUGH 100

	JAN/JUL	FEB/AUG	MAR/SEP	APR/OCT	MAY/NOV	JUN/DEC
PRECIPITATION						
TOTALS	4.56	3.57	4.76	2.74	3.60	4.97
	5.81	5.32	4.41	2.99	2.75	3.41
STD. DEVIATIONS	2.44	1.60	2.47	1.31	2.12	2.60
	2.83	2.95	2.54	2.28	1.72	1.90
RUNOFF						
TOTALS	0.000	0.000	0.000	0.000	0.000	0.000
	0.000	0.000	0.000	0.000	0.000	0.000
STD. DEVIATIONS	0.000	0.000	0.000	0.000	0.000	0.000
	0.000	0.000	0.000	0.000	0.000	0.000
EVAPOTRANSPIRATION						
TOTALS	1.603	1.982	2.647	2.496	2.850	3.465
	3.926	3.444	2.711	1.427	1.034	1.248
STD. DEVIATIONS	0.274	0.289	0.662	0.780	1.172	1.282
	1.271	1.131	0.938	0.621	0.283	0.207

LATERAL DRAINAGE COLLECTED FROM LAYER 3

TOTALS	0.0000	0.0000	0.0000	0.0000	0.0000	0.0000
	0.0000	0.0000	0.0000	0.0000	0.0000	0.0000
STD. DEVIATIONS	0.0000	0.0000	0.0000	0.0000	0.0000	0.0000
	0.0000	0.0000	0.0000	0.0000	0.0000	0.0000

PERCOLATION/LEAKAGE THROUGH LAYER 4

TOTALS	3.0360	1.6629	2.2625	0.6128	0.8417	1.2964
	1.9344	1.9023	1.6896	1.3447	1.4465	2.0238
STD. DEVIATIONS	2.1295	1.5215	1.9195	0.7182	1.3150	1.4168
	1.7582	1.9775	1.7861	1.6770	1.4752	1.6978

LATERAL DRAINAGE COLLECTED FROM LAYER 6

TOTALS	0.6172	0.6376	0.7047	0.6478	0.5428	0.4570
	0.4763	0.5382	0.5468	0.5502	0.4971	0.5225
STD. DEVIATIONS	0.2997	0.2523	0.2622	0.2575	0.2307	0.2204
	0.2463	0.2794	0.2450	0.2597	0.2649	0.2778

PERCOLATION/LEAKAGE THROUGH LAYER 7

TOTALS	1.2083	1.2448	1.3764	1.2694	1.0765	0.9097
	0.9467	1.0622	1.0801	1.0874	0.9831	1.0320
STD. DEVIATIONS	0.5623	0.4635	0.4824	0.4756	0.4364	0.4234
	0.4758	0.5336	0.4657	0.4923	0.5018	0.5288

AVERAGES OF MONTHLY AVERAGED DAILY HEADS (INCHES)

DAILY AVERAGE HEAD ON TOP OF LAYER 4

AVERAGES	0.0454	0.0246	0.0299	0.0085	0.0104	0.0188
	0.0239	0.0242	0.0234	0.0183	0.0193	0.0327
STD. DEVIATIONS	0.0366	0.0252	0.0338	0.0128	0.0198	0.0230
	0.0226	0.0295	0.0287	0.0263	0.0235	0.0311

DAILY AVERAGE HEAD ON TOP OF LAYER 7

AVERAGES	45.6372	51.5823	52.0127	49.5576	40.6339	35.4604
	35.7117	40.0956	42.1399	41.0525	38.3359	38.9516
STD. DEVIATIONS	21.3258	19.2214	18.2994	18.6430	16.5548	16.5915
	18.0489	20.2354	18.2515	18.6704	19.6669	20.0545

\*\*\*\*\*

\*\*\*\*\*

AVERAGE ANNUAL TOTALS & (STD. DEVIATIONS) FOR YEARS 1 THROUGH 100				
	INCHES		CU. FEET	PERCENT
PRECIPITATION	48.90	( 7.734)	3484469.2	100.00
RUNOFF	0.000	( 0.0000)	0.00	0.000
EVAPOTRANSPIRATION	28.832	( 2.9518)	2054464.25	58.961
LATERAL DRAINAGE COLLECTED FROM LAYER 3	0.00002	( 0.00001)	1.605	0.00005
PERCOLATION/LEAKAGE THROUGH LAYER 4	20.05366	( 6.38813)	1428961.500	41.00945
AVERAGE HEAD ON TOP OF LAYER 4	0.023	( 0.008)		
LATERAL DRAINAGE COLLECTED FROM LAYER 6	6.73828	( 1.97717)	480149.156	13.77969
PERCOLATION/LEAKAGE THROUGH LAYER 7	13.27656	( 3.72127)	946046.312	27.15037
AVERAGE HEAD ON TOP OF LAYER 7	42.598	( 11.974)		
CHANGE IN WATER STORAGE	0.053	( 3.0144)	3808.61	0.109

\*\*\*\*\*

\*\*\*\*\*

PEAK DAILY VALUES FOR YEARS	1 THROUGH	100
	(INCHES)	(CU. FT.)
PRECIPITATION	6.87	489534.875
RUNOFF	0.000	0.0000
DRAINAGE COLLECTED FROM LAYER 3	0.00001	0.55582
PERCOLATION/LEAKAGE THROUGH LAYER 4	3.645235	259748.15600
AVERAGE HEAD ON TOP OF LAYER 4	2.729	
MAXIMUM HEAD ON TOP OF LAYER 4	0.013	
LOCATION OF MAXIMUM HEAD IN LAYER 3 (DISTANCE FROM DRAIN)	0.0 FEET	
DRAINAGE COLLECTED FROM LAYER 6	0.03765	2682.47388
PERCOLATION/LEAKAGE THROUGH LAYER 7	0.070386	5015.48437
AVERAGE HEAD ON TOP OF LAYER 7	82.570	
MAXIMUM HEAD ON TOP OF LAYER 7	101.074	
LOCATION OF MAXIMUM HEAD IN LAYER 6 (DISTANCE FROM DRAIN)	63.2 FEET	
SNOW WATER	2.36	168188.7190
MAXIMUM VEG. SOIL WATER (VOL/VOL)		0.1752
MINIMUM VEG. SOIL WATER (VOL/VOL)		0.0569

\*\*\* Maximum heads are computed using McEnroe's equations. \*\*\*

Reference: Maximum Saturated Depth over Landfill Liner  
by Bruce M. McEnroe, University of Kansas  
ASCE Journal of Environmental Engineering  
Vol. 119, No. 2, March 1993, pp. 262-270.

\*\*\*\*\*

\*\*\*\*\*

FINAL WATER STORAGE AT END OF YEAR 100

---

LAYER	( INCHES )	( VOL/VOL )
1	1.1711	0.0976
2	2.2645	0.1887
3	2.4673	0.2056
4	0.0750	0.3750
5	17.7770	0.3035
6	5.2018	0.2167
7	0.1500	0.7500
SNOW WATER	0.000	

\*\*\*\*\*  
\*\*\*\*\*

**THIS PAGE INTENTIONALLY LEFT BLANK**