

705 Advanced Preparation and Special Postage Payment Systems

Overview

- 1.0 Customized MarketMail
- 2.0 Manifest Mailing System
- 3.0 Optional Procedure Mailing System
- 4.0 Alternate Mailing System
- 5.0 First-Class Mail or Standard Mail Mailings With Different Payment Methods
- 6.0 Combining Mailings of Standard Mail, Package Services, and Parcel Select Parcels
- 7.0 Combining Package Services and Parcel Select Parcels for Destination Entry
- 8.0 Preparing Pallets
- 9.0 Combining Bundles of Automation and Nonautomation Flats in Trays and Sacks
- 10.0 Merging Bundles of Flats in Sacks and Pallets Using the City State Product
- 11.0 Combining Automation Price and Nonautomation Price Flats in Bundles
- 12.0 Merging Bundles of Flats on Pallets Using a 5% Threshold
- 13.0 Merging Bundles of Flats on Pallets Using the City State Product and a 5% Threshold
- 14.0 Plant Load Mailings
- 15.0 Plant-Verified Drop Shipment
- 16.0 Express Mail Open and Distribute and Priority Mail Open and Distribute
- 17.0 Express Mail Reshipment Service
- 18.0 Metered Mail Drop Shipment
- 19.0 Postage Due Weight Averaging Program
- 20.0 Optional Combined Parcel Mailings
- 21.0 Repositionable Notes (RPNs)

1.0 Customized MarketMail

1.1 Basic Standards

1.1.1 General

Customized MarketMail (CMM) is an option for mailing nonrectangular and irregular-shaped Regular Standard Mail and Nonprofit Standard Mail pieces if the pieces weigh 3.3 ounces or less and meet the physical characteristics and the dimensional requirements in 1.1.3 and the mail preparation standards in 1.4. Other Regular and Nonprofit Standard Mail pieces measuring 3/4 inch thick or less and meeting the applicable standards in 1.0 may be entered as CMM at the mailer's option. CMM must be entered directly at a destination delivery unit (DDU).

1.1.2 Eligibility Standards

All pieces in a CMM mailing must:

705.1.1.3

- a. Meet the basic standards for Standard Mail in [243.2.0, Content Standards for Standard Mail Letters](#) through [243.4.0, Price Eligibility for Standard Mail](#) and, for Nonprofit Standard Mail, the additional standards in [703.1.0](#).
- b. Be part of a single mailing of at least 200 addressed pieces. All pieces must be identical in size, shape, and weight unless excepted by standard under an approved postage payment system.
- c. Bear a complete delivery address using the general addressing formats in [602.1.0](#) or the exceptional or occupant address formats in [602.3.0, Use of Alternative Addressing](#), with the correct ZIP Code or ZIP+4 code. Each piece also must bear a carrier release endorsement as specified in [508.1.0, Recipient Options](#). These additional addressing standards apply:
 1. Detached address labels (DALs) under [602.4.0, Detached Address Labels \(DALs\)](#) are not permitted.
 2. Ancillary service endorsements under [507.1.0, Treatment of Mail](#), are not permitted.
 3. The ZIP Code accuracy standard in [243.3.8](#) must be met.
 4. At the mailer's option, a carrier route information line under [708.6.0](#) may be added. If this option is used, a carrier route code must be applied to every piece in the mailing and must meet the carrier route accuracy standard in [243.6.2](#).
- d. Be marked, sorted, and documented as specified in [1.4](#).
- e. Be entered at the destination delivery unit appropriate to the delivery address on the corresponding mail, as a mailing subject to the applicable requirements in [243.2.0](#) through [243.4.0, Price Eligibility for Standard Mail](#) and [246.2.0](#) through [246.5.0 in Enter and Deposit](#), as a mailing using Express Mail or Priority Mail Open and Distribute under [16.5](#) and [16.5.13](#), or as a plant-verified drop shipment (PVDS) mailing under [15.0](#). Minimum volumes per destination are not required.

1.1.3 Physical Standards

Mailpieces prepared as Customized MarketMail (CMM) under [1.0](#) must meet these additional standards and physical characteristics:

- a. The material used for constructing the pieces must be free of sharp edges, protrusions, and other design elements that could cause harm or injury to USPS personnel handling these pieces.
- b. The dimensions of the pieces must not be smaller than the minimum dimensions for letter-size mail in [201](#) or greater than the maximum dimensions for flat-size mail in [301](#). Length and height are defined as follows:
 1. The length and the axis of length are determined by drawing a straight line between the two outer points most distant from each other.
 2. The height is determined by drawing perpendicular lines to the points that are the greatest distance above and below the axis of length. The sum of these two lines defines the height.
- c. The maximum weight may not exceed 3.3 ounces.

- d. Pieces may be rectangular or nonrectangular, may be uniform or nonuniform in thickness, and may include die cuts, holes, and voids.
- e. Pieces must be flexible enough to fit inside a minimum-size mail receptacle measuring 4-7/8 inches wide, 14-7/8 inches high, and 5-7/8 inches long (deep).
- f. Design approval by the district business mail entry manager is not required, but it is recommended.

1.2 Prices

Pieces mailed as Customized *MarketMail* under 1.0 must not exceed 3.3 ounces and must pay the following prices:

- a. Regular Standard Mail: \$0.460 per piece.
- b. Nonprofit Standard Mail: \$0.334 per piece.

1.3 Extra Services

CMM is not eligible for any extra service.

1.4 Preparation Standards

1.4.1 All Mailings

All mailings and all pieces in each mailing prepared as Customized MarketMail (CMM) are subject to specific preparation standards in 1.4 and to these general standards:

- a. All pieces must meet the standards for basic eligibility in 243.2.0 through 243.4.0 in *Prices and Eligibility* and specific eligibility in 246.2.0 through 246.5.0 in *Enter and Deposit*. Nonprofit Standard Mail pieces must meet the additional eligibility standards in 703.1.0.
- b. CMM pieces must not be part of a mailing containing any other type of Standard Mail pieces.
- c. Each mailing must meet the applicable standards for mail preparation in 245.1.0 and 245.2.0 and the following:
 - 1. Subject to the marking standards in 202, Regular Standard Mail pieces must be marked "Presorted Standard" (or "PRSRT STD") and Nonprofit Standard Mail pieces must be marked "Nonprofit Organization" (or "Nonprofit Org." or "Nonprofit"). All pieces must also be marked "Customized MarketMail," "CUST MKTMAIL," or "CMM."
 - 2. At the mailer's option, a carrier route information line under 708.6.0 may be added. If this option is used, a carrier route code must be applied to every piece in the mailing and must be applied using CASS-certified software and the current USPS Carrier Route File scheme, printed Carrier Route Files, or another AIS product containing carrier route information, subject to 509.1.0, *Address Information System Products*, and 708.3.0, *Coding Accuracy Support System (CASS)*. Carrier route information must be updated within 90 days before the mailing date.
- d. Pieces are subject to the price eligibility specified in 1.0, *Customized MarketMail*.

1.4.2 Required Endorsement

Any matter mailed as Customized MarketMail must bear the endorsement "Carrier—Leave If No Response" placed directly below the return address. If any other endorsement is used, the carrier route release endorsement must be separated by the equivalent of one blank line of the type size used.

1.4.3 Postage

CMM is subject to the same options of postage payment (precanceled stamps, metered postage, or permit imprint) for Standard Mail pieces as permitted under [244, Postage Payment and Documentation](#).

1.4.4 Documentation

A complete, signed postage statement, using the correct USPS form or an approved facsimile, must accompany each mailing. Mailings of nonidentical-weight pieces or mailings using more than three different types of containers must also be supported by standardized documentation meeting the standards in [708.1.0](#). Documentation for nonidentical-weight pieces is not required if the correct postage is affixed to each piece.

1.4.5 Required Bundling

Bundling is required before sacking, traying, or filling other types of mailing containers. A bundle must be prepared when two or more addressed pieces are destined to the same 5-digit ZIP Code or to the same carrier route if the optional carrier route presort level is used. The maximum weight for any bundle is 20 pounds. Pieces of irregular thickness must be counterstacked as provided in [245.2.0](#). At the mailer's option, facing slips, optional endorsement lines, or pressure-sensitive bundle labels may be used on bundles. CMM pieces prepared in optional carrier route bundles are subject to [243.6.0](#) but are not required to meet any minimum number of pieces per route.

1.4.6 Bundling and Labeling

Preparation sequence, bundle size, and labeling:

- a. *Carrier route* (optional), no minimum; and carrier route information line (required).
- b. *5-digit* (required), no minimum; and facing slip (optional), red Label 5 (optional), or optional endorsement line (OEL).

1.4.7 Required Containerizing

The following standards apply to containerizing CMM bundles:

- a. Bundles and single pieces to a destination must be prepared in 5-digit containers or optionally in 5-digit scheme under [L606](#), carrier route, or 5-digit carrier routes containers, with no minimum volume (piece or weight) required for an individual container.
- b. Bundles for PVDS drop shipment mailings or non-PVDS mailings under [246.2.0](#) through [246.5.0](#) must be placed in letter trays, flat trays, or sacks. Bundles in Priority Mail and Express Mail Open and Distribute shipments under [16.5](#) may be placed in USPS-supplied or mailer-supplied mailing containers.

- c. The container size must be appropriate to the dimensions of the pieces, and the number of containers must be appropriate to the volume of pieces in the mailing.
- d. If more than three types of containers are used, the mailing must be prepared using an approved manifest mailing system (MMS), unless the manager, Business Mailer Support approves another postage payment system. Each mailing presented in mailer-supplied containers must include sample containers for tare weight calculations.

1.4.8 Containerizing and Labeling

Containers are prepared and labeled as follows:

- a. PVDS drop shipments and non-PVDS mailings under [246.2.0](#) through [246.5.0](#), *Destination Delivery Unit (DDU) Entry* must be prepared in 5-digit trays or sacks, or as an option, in 5-digit scheme (under [L606](#), Column B), carrier route, or 5-digit carrier routes trays or sacks, labeled as follows:
 1. Line 1: For 5-digit, carrier route, 5-digit carrier routes, city, state, and 5-digit ZIP Code on mail; for 5-digit scheme (optional), [L606](#).
 2. Line 2: "DEL LTR STD CMM MAN" (for letter trays); "DEL FLTS STD CMM MAN" (for flat trays); "DEL STD CMM MAN" (for sacks).
 3. Line 3: Office of mailing or mailer information (see [707.21.0](#), *Sack and Tray Labels*).
- b. Express Mail and Priority Mail Open and Distribute shipments must be prepared in USPS-provided Express Mail or Priority Mail containers (pouches, sacks, cartons, or envelopes) or in mailer-supplied containers, labeled under [16.5](#).

2.0 Manifest Mailing System

2.1 Description

2.1.1 Using an MMS

A manifest mailing system (MMS) is a method of verifying postage payment of permit imprint mailings, as an alternative to weight verification. The MMS is an automated system that allows a mailer to document postage and fees for all pieces in First-Class Mail, Standard Mail, Parcel Select, Package Services, and international permit imprint mailings. Each piece is assigned a unique identification number that is listed on the manifest along with pertinent information about the mailpiece. The USPS randomly selects pieces from the mailing and compares them to the manifest to determine if postage was accurately reported. The standards in [2.2](#) describe how to mail using an MMS.

2.1.2 Electronic Verification System

Mailers using a MMS when presenting Parcel Select destination entry mailings under [456.2.0](#) or, commingled parcel mailings under [6.0](#) or [7.0](#), may document and pay postage using the Electronic Verification System (eVS) (see [2.9](#)). Business Mailer Support (BMS), USPS Headquarters, must approve these systems. Unless

705.2.2

authorized by Business Mailer Support, mailers may not commingle eVS mail with non-eVS mail within the same mailing or place eVS mail and non-eVS mail in or on the same mailing container.

2.2 Basic Standards

2.2.1 Authorization Document

A MMS is established through a letter of authorization or by a service agreement as follows:

- a. A MMS approved by the district, as defined in [2.4.6a](#), is authorized with a letter signed by the district Customer Service manager, and addressed to the mailer making the MMS application. The authorization letter contains provisions regarding mailer and USPS responsibilities, including document retention and quality control.
- b. A MMS approved by Business Mailer Support, as defined in [2.4.6b](#), is authorized with a service agreement signed by the mailer and the Business Mailer Support manager. The service agreement contains provisions regarding mailer and USPS responsibilities, including document retention and quality control.

2.2.2 Mailer System

The mailer must have an automated system that produces mail consistent with postal standards and calculates postage accurately. For presorted mail, the system also must determine the qualifying presort level and the correct price of postage for each piece and perform the presort routines. The mailer must assign a unique identification number to each piece. Letter- and flat-size mail produced using batch processing must bear the keyline information in [2.3](#). The system must produce a manifest for each mailing that allows USPS verification of the postage and levels of presort. The manifest must account for every piece in the mailing, as follows:

- a. For presorted letter- and flat-size mail produced using batch processing, the manifest must list destination ZIP Codes, presort categories, batch number ranges, postage amounts, and cumulative postage amounts.
- b. For mail produced using itemized processing, the manifest must list the postage for each piece and those factors used to calculate the correct amount of postage, such as the destination postal zone and piece weight. Each page of the manifest must show cumulative postage totals.
- c. When extra services are used, the manifest must include the fees for each piece.
- d. A summary listing the required information on the postage statement must be included as the last page of the manifest.
- e. A separate summary and register of mailings is required for all plant-verified drop shipment (PVDS) mailings.

2.2.3 Manifest Format

The two basic manifest formats are:

- a. *Itemized processing.* Each piece of mail is individually listed by unique identification number, weight, and other pertinent information. Publication 401, *Guide to the Manifest Mailing System*, contains specific formats for manifests using itemized processing.
- b. *Batch processing.* The mailing is divided into groups of mailpieces with consecutive identification numbers. Only the identification numbers of the first and last pieces of each group are listed, along with the piece count and the total postage charges for the entire batch. This method is limited to piece price letter- and flat-size mailings. Publication 401 contains specific formats for manifests using batch processing.

2.2.4 Mailer Quality Control

The mailer must implement a quality control program that ensures proper mail preparation and provides accurate documentation. The mailer must implement a quality control program that ensures proper mail preparation and provides accurate documentation. The authorization letter or service agreement must detail the USPS-approved quality control procedures.

2.2.5 Permit Imprint

Mailings deposited under the MMS program must meet the standards for permit imprint mail in [604.5.0](#), except that presorted letter-size or flat-size mail produced using batch processing must include the qualified price abbreviation in the keyline.

2.2.6 Marking

MMS mailings must meet the marking standards for the price claimed. Markings on presorted letter-size and flat-size mail produced using batch processing are placed in the keyline as described in [2.3.3](#). Markings on itemized mailpieces may be:

- a. Incorporated as part of the permit imprint.
- b. Printed or rubber-stamped above the address and immediately below or to the left of the permit imprint.
- c. Produced as otherwise specified in the MMS authorization.
- d. Provided in an endorsement line in the address area, directly above the top line of the address, if no additional information except carrier route information appears on the endorsement line.

2.2.7 Postage Statement

The mailer must submit a complete postage statement with each mailing. If the entry office postmaster approves, mailers may submit a computerized facsimile of the applicable USPS postage statement. Data fields may be omitted on facsimile if they pertain to prices not claimed in the mailing.

2.2.8 Manifest Adjustments

When mailpieces are mutilated, spoiled, or destroyed during normal operations and cannot be presented as part of the mailing, a method of adjusting the manifest and postage statement that has been approved by the USPS must be used. Whether the method in [2.2.8a](#) or [2.2.8b](#) is used, the total number of pieces must be deducted at the end of the manifest and the postage statement adjusted. Use one of the following methods:

705.2.3

- a. For manifests using itemized processing, line out the identification number, weight, and postage information (if applicable, also line out the piece on Form 3877) or write the unique identification number, piece weight, and postage (and, if applicable, the fee amount) on a separate listing. Deduct the total number of pieces, piece weights, and postage and fees from the totals shown on the manifest, summary, and postage statement.
- b. For manifests using batch processing, write the adjustments directly on the manifest listing showing the consecutive serial number, weight increment, price category, and postage of each item next to the batch that includes the serial number. Alternatively, a separate list may be prepared as an attachment to the manifest showing, for each spoiled piece, the consecutive serial number, weight increment, price category, and postage. The total number of pieces, piece weight, and postage must be deducted from the batch, manifest summary, and postage statement.

2.3 Keyline**2.3.1 Batch Mailings**

The keyline printed on each piece of presorted letter- or flat-size First-Class Mail or Standard Mail produced using batch processing must contain, in order, the consecutive unique piece number, the weight increment (First-Class Mail only), the price category for which the piece qualifies, and the postage paid by weight and price category (see [Exhibit 2.3.1](#)).

Exhibit 2.3.1 Letter-Size Keyline Information

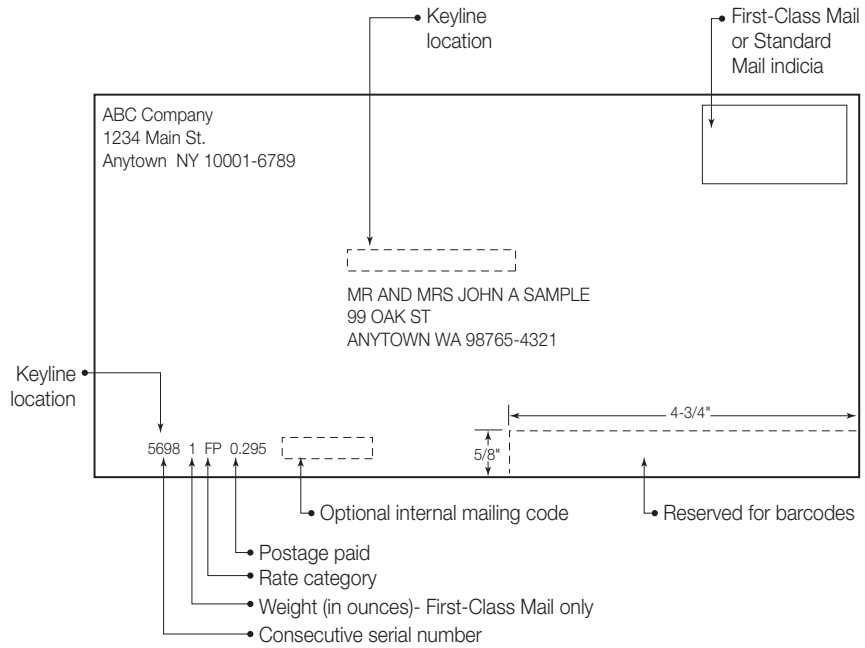

2.3.2 Mailer Codes

Codes for internal mailer use may be printed to the right of the postage-paid information, if at least two spaces separate the postage paid and any internal code information.

2.3.3 Price Category Abbreviations

Keylines on First-Class Mail or Standard Mail may use only the price category abbreviations in Exhibit 2.3.3a or Exhibit 2.3.3b, respectively. All pieces that qualify for more than one postage price must show each price category abbreviation, separated by a “/” (slash) (e.g., EB/DS).

a. First-Class Mail:

Exhibit 2.3.3a Price Category Abbreviations—First-Class Mail

CODE	PRICE CATEGORY
AV	Automation 5-Digit
AT	Automation 3-Digit
AB	Automation AADC Letters
AB	Automation ADC Flats
MB	Automation Mixed AADC Letters
MB	Automation Mixed ADC Flats
FP	Presorted
SP	Single-Piece Price (when fewer than 500 pieces accompany automation price mail)

b. Standard Mail:

Exhibit 2.3.3b Price Category Abbreviations—Standard Mail

CODE	PRICE CATEGORY
AV	Automation 5-Digit [letters only]
AT	Automation 3-Digit [letters only]
AB	Automation AADC Letters
AB	Automation AADC Flats
MB	Automation Mixed AADC Letters
MB	Automation Mixed ADC Flats
MA	Machinable AADC Letters
MM	Machinable Mixed AADC Letters
NV	Nonmachinable 5-digit Letters
NT	Nonmachinable 3-digit Letters
NA	Nonmachinable ADC Letters
NM	Nonmachinable Mixed ADC Letters
EB	Enhanced Carrier Route Basic
EH	Enhanced Carrier Route High Density
ES	Enhanced Carrier Route Saturation
NF	Not Flat-Machinable
DB	Destination Bulk Mail Center (DBMC)
DS	Destination Sectional Center Facility (DSCF)
DD	Destination Delivery Unit (DDU)

2.3.4 Keyline Location—Batch Mailings

The keyline must be readily identifiable and placed anywhere on the address side that does not conflict with other standards (see [Exhibit 2.3.1](#) for examples). On letter-size mail, the keyline must not interfere with the OCR read area (see [202.2.1](#)) or barcode clear zone (see [202.5.1](#)). If printed on an insert, the keyline must conform to [202.5.0](#).

2.3.5 Unique ID Number Location—Itemized Mailings

The unique identification number must be printed on the address side of each itemized piece. It may be a product number or any other number that is not duplicated within the mailing. The numbers must be printed in overall ascending order, or in ascending order within each zone, 5-digit, 3-digit, or BMC ZIP Code area on the manifest.

2.4 Authorization**2.4.1 Application**

The mailer must submit an MMS application and supporting documentation as specified on the application to the postmaster of each Post Office where mailings will be deposited. Publication 401 contains an application to mail using an MMS. Application procedures for mailers who want to manifest and pay postage for

Express Mail using an Express Mail Manifesting System are outlined in 2.6. Publication 205, *Electronic Verification System Technical Guide*, provides the eVS application procedures for mailers.

2.4.2 Approval Review

After the mailer completes the development and installation of the MMS, the following will occur:

- a. For a MMS approved by the district, as defined in 2.4.5a, a district USPS representative will review the system and the district Customer Service manager will give final approval if the system is functioning as required.
- b. For a MMS approved by Business Mailer Support, as defined in 2.4.5b, a district USPS representative will review the system and the district Customer Service manager will give temporary approval if the system is functioning as required. A final review will be conducted by a Business Mailer Support representative within 90 days of the date of the temporary approval, and the Business Mailer Support manager will give final approval if the system is functioning as required.

2.4.3 General Requirements for Authorization

General requirements for authorization are as follows:

- a. Verification samples are deemed representative of the entire mailing, and postage adjustment calculations are applied to the total mailing. The mailer must pay additional postage for any underpayments identified during USPS verification. A mailer may elect to overpay postage for pieces that are borderline weight or price increments to avoid postage underpayment adjustments.
- b. If the total postage or the total weight of pieces sampled during a verification results in an underpayment by more than 1.5%, total postage for the mailing is adjusted.
- c. For eVS mailings prepared under 2.9, USPS charges eVS mailers for postage due for any underpaid, unmanifested, or mis-shipped destination delivery unit (DDU) parcels at the end of the review period following the monthly mailing period as follows:
 1. *Underpaid Parcels*. If the total postage of parcels sampled during the mailing period indicates that the mailer has underpaid postage by more than 1.5% when compared with the corresponding parcel records in the mailer's manifest files, USPS determines additional postage due based on the total postage already paid for the mailing month using the procedures in Publication 205.
 2. *Unmanifested Parcels*. USPS charges eVS mailers for parcels not listed in the mailer's manifest files but identified by USPS processing scans or acceptance and delivery scans as being mailed. USPS determines the postage charges using sampling data and the procedures in Publication 205.
 3. *Mis-Shipped DDU Parcels*. USPS charges eVS mailers the appropriate single-piece price less the original price paid for parcels identified by acceptance scans to be deposited at incorrect destination delivery units.

705.2.4.4

USPS transports these mis-shipped parcels to the correct destination delivery units. USPS determines the additional postage using scanning data and the procedures in Publication 205. Parcels mis-shipped at destination BMCs or destination SCFs are handled through parcel sampling and are treated as underpaid parcels.

- d. The mailer must notify the USPS in writing of any system change that affects postage calculation, generation of required documentation, or mail presorting before the mailing is presented.
- e. Postage must be paid by an advance deposit account from which funds may be deducted by the USPS to cover any deficiency discovered after acceptance of the mail.

2.4.4 Authorization Period

The authorization period for an MMS is as follows:

- a. A MMS, not approved to use the Minimum Volume Reduction Provision (MVRP) defined in Publication 401, and approved by the district as defined in [2.4.5a](#), remains in effect until such time as the district Customer Service manager or the mailer cancels the agreement. If Postal Service periodic reviews or mailer supplied information demonstrates a need for modification to the agreement, the authorization will be modified with concurrence by the district Customer Service manager and the mailer.
- b. A MMS approved to use a MVRP as defined in Publication 401, remains in effect for the time period specified in the MVRP, unless the district Customer Service manager or the mailer cancels the MMS authorization. The MVRP authorization will be reviewed at the end of the authorization period and may be renewed by decision of the district Customer Service manager.
- c. A MMS approved by Business Mailer Support as defined in [2.4.5b](#), remains in effect until such time as the Business Mailer Support manager or the mailer cancels the agreement. If Postal Service periodic reviews or mailer supplied information demonstrates a need for modification of the agreement, the authorization will be modified with concurrence by the Business Mailer Support manager and the mailer.

2.4.5 Approval Authority

Approval authority for manifest mailing systems is as follows:

- a. The district Customer Service manager approves systems that produce separate or mixed mailings of single-piece price First-Class Mail, Package Services, Parcel Select, international mail, including mailings with extra services and predetermined weights, or presorted First-Class Mail letter systems not exceeding 25,000 pieces per manifest or 50,000 total pieces in daily manifested mail volume.
- b. The Business Mailer Support manager, USPS Headquarters, approves MMS that produce presorted First-Class Mail (except as noted in [2.4.5a](#)) or Standard Mail mailings, Package Services or Parcel Select presort mailings, PVDS mailings, or eVS mailings.

2.4.6 Denial

If an MMS application is denied, the mailer may appeal the decision as follows:

- a. For MMS applications denied by the district Customer Service manager, the mailer may, within 15 days from the receipt of the notice, file a written appeal, including any additional evidence in support of why the MMS should be authorized. This appeal is sent to the Business Mailer Support manager, USPS Headquarters, who issues the final agency decision.
- b. For MMS applications denied by the Business Mailer Support manager, the mailer may, within 15 days from the receipt of the notice, file a written appeal, including any additional evidence in support of why the MMS should be authorized. This appeal is sent to the Marketing and Technology Channel Management manager, USPS Headquarters, who issues the final agency decision.

2.4.7 Renewal

Only MMS with an approved Minimum Volume Reduction Provision (MVRP) requires renewal. MMS with MVRP are renewed prior to the expiration date by the Sales manager that originally authorized the MVRP. The Sales manager reviews all supporting documentation to determine if the mailer continues to meet the requirements of the MVRP. The MVRP is renewed when the review demonstrates that the MVRP continues to meet established requirements.

2.5 Revocation

2.5.1 Revocation Authority

The revocation authority for MMS is as follows:

- a. The district Customer Service manager may revoke a MMS authorization when the final approval had originally been given through that office.
- b. The Business Mailer Support manager may revoke any MMS authorization.

2.5.2 Reasons for Revocation

The reasons for revocation of an MMS are as follows:

- a. The mailer provides incorrect data on the manifest list and appears unable or unwilling to correct the problems.
- b. The mailer is not properly completing the required quality control procedures.
- c. The mailings no longer meet MMS criteria established by standards in 2.0 or in the MMS authorization letter or service agreement.
- d. The mailer does not present mailings under MMS for more than 6 months (except as noted in the authorization letter or service agreement).
- e. The mailer continues to present mailings that are improperly prepared and proper postage is not being paid.

2.5.3 Corrective Action

After a notice of revocation is issued, the mailer and the USPS determine corrective actions, including an implementation schedule. At the conclusion, the USPS reexamines the mailer's system. Failure to correct identified problems is sufficient grounds to revoke the mailer's MMS authorization.

2.5.4 Appeal of Revocation

The mailer may appeal following receipt of the notice of revocation and may continue to mail under the MMS during the appeal process. Appeals are handled as follows:

- a. For MMS authorizations given final approval by the district Customer Service manager, the mailer has 15 days from the date of receipt of the notice to file a written appeal with the Business Mailer Support manager. The appeal must include the reason why the MMS authorization should not be revoked. The Business Mailer Support manager issues the final agency decision. The final revocation takes effect 15 days after receipt by the mailer.
- b. For MMS authorizations given final approval by the Business Mailer Support manager, the mailer has 15 days from the date of receipt of the notice to file a written appeal with the Marketing and Technology Channel Management manager, USPS Headquarters. The appeal must include the reason why the MMS authorization should not be revoked. The Marketing and Technology Channel Management manager, USPS Headquarters, issues the final agency decision. The final revocation takes effect 15 days after receipt by the mailer.

2.6 Express Mail Manifesting Agreements

2.6.1 Description

Express Mail Manifesting (EMM) is an automated system that allows a mailer to document postage and fees for all pieces in an Express Mail mailing by transmitting an electronic file to the USPS.

2.6.2 What May Be Manifested

[1-18-09] [11-6-08] EMM may be used to pay postage for Express Mail, Express Mail International; Express Mail Military Service to qualifying APO/FPO and DPO addresses; and, Express Mail Custom Designed service. EMM also may be used to pay any extra service fees. Postage for other classes of mail cannot be paid through EMM.

2.6.3 Service Guarantee

Express Mail items mailed using an EMM are covered by current Express Mail service and postage guarantees:

- a. Mailers using Express Mail Manifesting (EMM) receive Sunday/holiday guaranteed delivery at no additional charge without paying a premium.
- b. Refunds for service failures are subject to the standards in [604.9.5](#). Reimbursements are paid under [604.9.5.7](#).

2.6.4 Postage Payment

Postage for EMM is paid through an Express Mail corporate account (EMCA) using the information in the mailer's electronic file. Mailers wishing to mail using an EMM system must apply for an EMCA using the procedures in [114](#) before an EMM agreement will be authorized.

2.6.5 Mail Volume

EMM is designed for large volume mailings; however, there are no minimum volume requirements.

2.7 Basic Standards

2.7.1 Mailer Participation Requirements

To participate in Express Mail Manifesting, mailers must:

- a. Develop or purchase computer software that will meet the EMM technical requirements outlined in Publication 97, *Express Mail Manifesting Technical Guide*.
- b. Obtain a Mailer ID for each mailing location.
- c. Obtain USPS certification that the mailer's software and barcoded labels meet EMM requirements.
- d. Develop and administer effective quality control procedures that will ensure the integrity of the system.
- e. Use one-ply Express Mail labels that meet the requirements in Publication 97.
- f. Be able to have the USPS accept and dispatch EMM items from their company or a postal facility at the times approved by the district marketing manager.
- g. Receive authorization to mail items using EMM under [2.8](#).

2.7.2 Mailer Quality Control

The mailer must implement a quality control program that ensures proper mail preparation and provides accurate documentation. The service agreement must detail the USPS-approved quality control procedures.

2.7.3 Mailer System Accuracy/Manifest Adjustments

The USPS verifies the accuracy of the EMM system by selecting mailpieces at random and comparing them to a verification manifest. If the sampling indicates that the total postage (for the sample mailpieces) is understated by more than 1.5%, the mailer must either withdraw the mailing or pay postage at an adjusted price. Specific procedures are outlined in Publication 97.

2.7.4 Markings, Label Specifications, and Barcodes

No special price markings are required on EMM items. However, barcoded EMM labels are required on all EMM mailpieces, and specific label formats must be followed. Detailed barcode and Express Mail label specifications and options are published in Publication 97. The labels are subject to approval by Product Information Requirements, Product Development, USPS Headquarters, and the National Customer Support Center (NCSC). Mailers must follow the specific certification procedures outlined in Publication 97.

2.7.5 Mail Entry

Mailers must present a photocopy or facsimile of Form 3152-E and a verification manifest with each mailing.

2.7.6 Manifest Data Edit Error/Warning Listing

Mailers must retrieve and retain the Manifest Data Edit Error/Warning Listing for each mailing that will be made available by the host computer. The listing confirms whether an electronic transmission was successful or contained errors or warnings. Specific information about this requirement is included in Publication 97 and in the mailer's EMM agreement.

2.7.7 Form 3152-E for Postage Payment

Form 3152-E is presented with each mailing. There is no postage affixed to the mailpieces and no postage statement presented with mailings. Postage payment is completed by electronic withdrawal of funds from a mailer's Express Mail corporate account. Form 3152-E must include the following information:

- a. Number of pieces in the mailing.
- b. Total weight of pieces in the mailing.
- c. Total postage and extra service fees, if applicable, for the mailing.
- d. EMCA number.
- e. Electronic file number from header record positions 4-25.
- f. Mailer signature.
- g. Date of mailing.

2.8 Applications, Agreement Renewals, Modifications, Suspensions, and Cancellations**2.8.1 Applications**

Mailers must apply to use an EMM system by completing the application in Publication 97. The application must be sent to the USPS sales representative at the Post Office where the items will be accepted as mail. After the application and other documentation has been received and reviewed, the application and Form 1357-S is faxed to Product Information, Product Requirements, USPS Headquarters. This office will send the contact page of the application to the Postal NCSC Delivery Confirmation Office. The Delivery Confirmation Office will send a test kit to the applicant via electronic mail to test the electronic file transmission accuracy. The application for EMM must be accompanied by the following:

- a. A completed Form 1357-S.
- b. A copy of Form 5637 showing that an Express Mail corporate account has been established.
- c. A Mailer ID for each mailing location.
- d. Sample copies of a verification manifest created from the mailer's EMM software.
- e. An EMM label sample.
- f. A price matrix, if applicable.

2.8.2 Approval

A temporary service agreement will be issued by the district marketing manager through the Business Mail Entry Office for 90 days at the location where the mailings will be verified and accepted when a review of the mailer's application and mailing operation indicates the mailer meets the eligibility requirements for entry of Express Mail items using an EMM system. Prior to the end of the 90 day temporary agreement the district business mail entry manager will conduct a final review to ensure that the system continues to meet standards. Upon a successful review, the district Customer Sales and Service manager gives final approval of the EMM

system. Publication 97-A, Express Mail Manifesting Implementation and Administration Guide, outlines the specific responsibilities of the various USPS departments in approval process.

2.8.3 Denial

If an application for EMM is denied by the district marketing manager, the denial is effective 15 days from the mailer's receipt of the notice unless a written appeal is filed within that time to the Business Mailer Support manager, USPS Headquarters, who issues the final agency decision on the application.

2.8.4 Changes, Additions, or Modifications to the Service Agreement

If a mailer proposes to change the method of presenting or documenting mailings from the method specified in the agreement, or the mailer is no longer able to comply with the standards that apply to the authorization, the mailer must immediately notify the district marketing manager.

2.8.5 Renewal

EMM agreements are valid for 2 years. The district Customer Service and Sales manager, USPS Headquarters, will conduct renewal reviews.

2.8.6 USPS Suspension

The district Customer Service and Sales manager may suspend an EMM agreement at any time, pending review, when there is an indication that postal revenue is not fully protected. The district Customer Service and Sales manager will notify the mailer of the decision in writing. The suspension becomes effective upon the mailer's receipt of the notification.

2.8.7 USPS Cancellation

The district Customer Service and Sales manager may cancel an EMM agreement upon 15 days notice if:

- a. The mailer fails to provide a manifest with correct data.
- b. The required quality control procedures described in the EMM agreement are not properly performed.
- c. The EMM does not comply with USPS requirements.
- d. Mailings are presented that are not properly prepared or paid.
- e. No Express Mail manifest mailings are presented for more than 6 months (unless approved by the Business Mailer Support manager).
- f. The mailer has relocated or has changed ownership without notification.
- g. The 2-year renewal review reveals that the EMM agreement should no longer be authorized or the mailer is not complying with the agreement.

2.8.8 Cancellation Notice and Appeal

The cancellation takes effect 15 days from the mailer's receipt of the notice unless, within that time, the mailer files a written appeal with the Business Mailer Support manager. The appeal must present additional information explaining why the EMM agreement should not be canceled. The Business Mailer Support manager will issue the final agency decision.

2.9 Electronic Verification System

2.9.1 Description

The Electronic Verification System (eVS) is a manifest mailing system that allows parcel mailers to document and pay postage and extra services fees by transmitting electronic files to the Postal Service without generating paper manifests, postage statements, or clearance documents, with the following principal features:

- a. *File Creation.* eVS requires the creation of an electronic file containing specific data records organized into manifests. Each manifest within the file corresponds to a data record for each destination entry facility or each origin/entry Post Office, with records for the parcels grouped under the record for the entry facility or entry Post Office. Successfully accepted files and the records within those files are used by eVS to generate electronic postage statements for automatic debiting of the mailer's postage payment account. Files must be prepared as specified in Publication 205, *Electronic Verification System Technical Guide*.
- b. *Daily Mailing and Presort Eligibility.* A mailing, which is determined by all file transmissions received from the eVS mailer within a 24-hour cycle, must meet all presort and volume requirements for the class of mail and price category claimed. The 24-hour cycle begins at 2:00:00 a.m. and ends at 1:59:59 a.m. Central Time.
- c. *Sampling.* eVS sampling data, which are used to monitor postage and preparation accuracy, is primarily captured after the mailer deposits the mailing at a destination entry facility.
- d. *Monthly Data Reconciliation.* eVS sampling data are reconciled against all the mailer's manifests received during a calendar month rather than against each individual mailing. All mailings entered during a calendar month are treated as a single mailing for the purpose of reconciliation and the collection of any postage due.

2.9.2 Availability

eVS may be used only for parcel mail paid with a permit imprint and only for the following classes and subclasses of mail, price categories, and mail processing categories, except for those prices or processing categories as noted:

- a. *First-Class Mail.* Single-piece price and presorted prices; machinable and nonmachinable parcel processing categories. Field testing for First-Class Mail prices available July 1, 2007.
- b. *Priority Mail.* Single-piece price, flat-rate envelope, and flat-rate box; all parcel processing categories. Field testing for Priority Mail prices available July 1, 2007.
- c. *Regular Standard Mail.* Presorted prices, destination bulk mail center (DBMC) prices, destination sectional center facility (DSCF) prices, and destination delivery unit (DDU) prices; machinable parcels, irregular parcels, and Not Flat-Machinable pieces. Field testing for irregular presorted prices and Not Flat-Machinable prices available after May 14, 2007.

- d. *Nonprofit Standard Mail*. Presorted prices, DBMC prices, DSCF prices, and DDU prices; machinable parcels, irregular parcels, and Not Flat-Machinable parcels. Field testing for irregular presorted prices and Not Flat-Machinable prices available after May 14, 2007.
- e. *Parcel Post*. Parcel Post prices include Intra-BMC prices and inter-BMC prices (including balloon and oversized prices); machinable parcels and nonmachinable parcels.
- f. *Parcel Select*. Prices include DBMC prices, DSCF prices, and DDU prices (including balloon and oversized prices); machinable parcels and nonmachinable parcels; origin BMC and BMC presort prices, and barcoded machinable parcel discounts.
- g. *Bound Printed Matter*. Nonpresorted prices, presorted prices, DBMC prices, DSCF prices, and DDU prices; machinable parcels and irregular parcels. Field testing for nonpresorted prices, machinable and irregular parcels, available after May 14, 2007.
- h. *Media Mail*. Single-piece prices, basic prices, and 5-digit prices; machinable parcels. Field testing for all irregular parcels available after May 14, 2007.
- i. *Library Mail*. Single-piece prices, basic prices, and 5-digit prices; machinable parcels and irregular parcels. Field testing for all Library Mail prices available after May 14, 2007.

2.9.3 Extra Services

eVS mailers may use the following Extra Services if they are available for the specific class of mail used:

- a. Delivery Confirmation.
- b. Signature Confirmation.
- c. Certified Mail.
- d. Insured Mail, if Form 3877 is used.
- e. Collect on Delivery (COD), if Form 3877 is used.
- f. Return Receipt.
- g. Return Receipt for Merchandise.
- h. Restricted Delivery.
- i. Special Handling.
- j. Bulk Insurance.

2.9.4 Use

Mailers depositing permit imprint parcels for those classes of mail and price categories specified in [2.9.2](#) may document and pay postage using eVS. Mailers authorized to commingle Standard Mail parcels, Package Services, and Parcel Select presorted parcels under [6.0](#) and [7.0](#) also may use eVS to document and pay postage for all parcels in the mailing for those mail classes and subclasses available under [2.9.2](#).

2.9.5 General Requirements

General requirements for participation are as follows:

- a. *Permit Account Number.* The mailer must have or establish a single permit account number for eVS at the business mail entry unit designated by the administering district manager. The Post Office where the business mail entry unit is located is generally considered the Post Office of Account for the eVS mailer. The eVS permit account number is to be used exclusively for eVS mailings. No other permit number may be used for eVS mailings.
- b. *Postage Payment Account.* The mailer must have or establish a *PostalOne!* postage payment debit account for the withdrawal of funds from postage statements generated by eVS from the electronic files transmitted by the mailer.
- c. *Annual Mailing Fees.* The mailer must pay all applicable presort and destination entry mailing fees at the administering district business mail entry unit.
- d. *Customer Identification Number.* The mailer must have or obtain a Mailer ID from the Postal Service. This customer identification number must be registered with the Postal Service and used to identify all electronic manifests transmitted by the mailer for eVS mailings. The mailer may use the same customer identification number in the Package Identification Code (PIC) or different numbers in the PIC if these additional numbers are also registered with the Postal Service. The mailer is required to keep the Postal Service updated on changes and additions to customer identification numbers.
- e. *Application.* The mailer must complete and submit the eVS application available from the Postal Service.
- f. *Computer Access.* The mailer must obtain computer access to eVS and, if necessary, to *PostalOne!*
- g. *File Transfer.* The mailer must complete and submit Form 1357-S to set up the file transfer mechanism with the Postal Service. Form 1357-S is not required for Electronic Data Interchange (EDI).
- h. *Software.* The mailer must develop or obtain computer software that meets eVS electronic file specifications for manifesting parcels and the barcode specifications for producing accurate and scannable barcodes used on the parcel mailing labels.
- i. *File and Label Certification.* The mailer must have electronic files and barcodes certified by the Postal Service.
- j. *Quality Assurance.* The mailer must develop and administer effective quality assurance procedures to ensure the integrity and accuracy of the mailer's mail production, postage payment, and file transmissions.
- k. *Mailing Test.* The mailer must complete a test during which eVS manifest files are transmitted and mailings are made to determine the accuracy of the mailer's system.
- l. *Mailing Agreement.* The mailer must enter into an eVS manifest mailing agreement with the Postal Service.

2.9.6 System Requirements

A mailer using eVS must have or contract with a service provider that has an automated system that produces mail according to USPS standards and calculates postage and extra services fees accurately. The system used for eVS must:

- a. Create and submit electronic manifest files as described in Publication 205 and assign a unique file number for each manifest file containing the mailer's customer identification number used for all file transmissions.
- b. Produce a manifest file for each mailing or mailing segment deposited at a destination Postal Service facility or entry Post Office as identified by ZIP Code.
- c. Provide all required data in each manifest record for each parcel for the destination Postal Service facility or entry Post Office.
- d. Assign each parcel a unique package identification code used for producing a corresponding unique barcode containing a customer identification number.
- e. Transmit electronic manifest files on or before the date of mailing.

2.9.7 Postage Payment

All eVS mailings must be paid with a permit imprint and meet the standards for permit imprint mail in [604.5.0](#). USPS calculates postage payment and electronically debits postage from the mailer's postage account based on information received from the mailer's electronic manifest and data collected through USPS operational and sampling scans. Mailers must pay for postage through a Centralized Account Payment System (CAPS) debit account.

2.9.8 Verification and Postage Adjustments

USPS randomly samples parcels and considers verification samples to be representative of the entire mailing period. Verification data is used to make the following monthly adjustments for postage due, collected on the 21st day after the last day of the month of mailing:

- a. *Postage Adjustment Factor (PAF) Payment.* USPS applies postage adjustment calculations, based on verification samples, to all pieces mailed during the mailing period. A mailing period is defined as a calendar month for purposes of calculating adjustments in eVS. USPS adjusts the total postage for the mailing period if the total postage of the pieces sampled during the mailing period results in an underpayment greater than 1.5%. The mailer must pay postage for any underpayments identified by USPS verification. The mailer must maintain sufficient funds in the mailer's postage account to cover any underpayments discovered after acceptance of the mail.
- b. *Unmanifested Parcel Payment.* The mailer is responsible for postage payment of unmanifested parcels. Unmanifested parcels are those parcels for which the Postal Service has obtained information from scanning operations but has not received or successfully processed manifest files and records corresponding to the parcels. The mailer must pay postage for unmanifested parcels or pieces identified by USPS. The mailer must maintain sufficient funds in the mailer's postage account to cover postage due discovered after acceptance of the mail.

- c. *Mis-shipped DDU Parcel Payment.* The mailer is responsible for postage payment of destination delivery unit (DDU) mis-shipped parcels. DDU Misshipped parcels are DDU price parcels delivered to the incorrect Postal Service facility by the mailer and transported by the Postal Service to the correct facility. The mailer must pay postage for DDU mis-shipped parcels identified by USPS. The mailer must maintain sufficient funds in the mailer's postage account to cover postage due discovered after acceptance of the mail.

2.9.9 Authorization

Mailers must be authorized to participate in eVS according to the following procedures:

- a. Mailers must meet the general requirements and system requirements for eVS and submit an eVS application and supporting documentation as specified in Publication 205, *Electronic Verification System Technical Guide*, to the Business Mailer Support manager, USPS Headquarters (see [608.8.0](#) for address).
- b. After mailers successfully complete development and testing for eVS, the USPS grants temporary approval. USPS conducts a review within 90 days of the temporary approval and grants final approval if the mailer's system is working as required. The Business Mailer Support manager, USPS Headquarters, has final authority for eVS approval.
- c. After receiving final authorization, the mailer and a USPS representative must sign a service agreement. The agreement contains provisions regarding mailer and USPS responsibilities, including electronic documentation, document retention, quality control, and the duration of the agreement.

2.9.10 Denial

If USPS denies an eVS application, the mailer may appeal the decision within 15 days from the receipt of the notice by filing a written appeal, including evidence showing why the mailer should be authorized to use eVS. The mailer sends the appeal to the Business Mail Acceptance manager, USPS Headquarters, who issues the final agency decision (see [608.8.0](#) for address).

2.9.11 Revocation

The Business Mailer Support manager may revoke authorization for eVS participation for any of the following reasons:

- a. A mailer does not provide correct data in electronic manifests and is not able or willing to correct the problems.
- b. A mailer does not properly complete the required quality control procedures.
- c. A mailer does not produce mailings meeting eVS criteria established by this standard or in the mailer's eVS manifest mailing agreement.
- d. A mailer does not present mailings using eVS for more than 6 months (except as noted in the service agreement).
- e. A mailer does not present properly prepared mailings.
- f. A mailer does not pay proper postage.

2.9.12 Corrective Action

After USPS issues a notice of revocation to a mailer, the mailer and the USPS determine corrective actions, including an implementation schedule. At the conclusion of the implementation period, the USPS reexamines the mailer's system to determine if it complies with the program requirements. Failure to correct identified problems is sufficient grounds to sustain revocation of the mailer's eVS authorization.

2.9.13 Appeal of Revocation

After receiving initial notice of revocation, a mailer has 15 days from the date of receipt of the revocation notice to file a written appeal with the Business Mail Acceptance manager, USPS Headquarters. The appeal must include the reason the eVS authorization should not be revoked. The mailer may continue to mail using eVS during the appeal process. The Business Mail Acceptance manager issues the final agency decision. The final revocation takes effect 15 days after the date of the final agency decision.

3.0 Optional Procedure Mailing System**3.1 Basic Information****3.1.1 Description**

An Optional Procedure Mailing System is a method of verifying and accepting First-Class Mail, Standard Mail, Package Services, or Parcel Select paid by permit imprint. Mailings may consist of identical-weight or nonidentical-weight pieces. The Optional Procedure Mailing System reviews a mailer's financial, production, and other business records in lieu of standard weight verification procedures. Postage verification is normally completed by a USPS audit of business records kept by the mailer. A USPS audit is designed to detect underpayment of postage. The burden rests with the mailer to prove any overpayment of postage.

3.1.2 General Qualification

An Optional Procedure Mailing System is authorized when all of the following conditions are met: The mailer's plant is operating and mailing when the application is submitted.

- a. The mailer's records provide a sound audit trail that ensures proper postage is collected.
- b. Mailings qualify as permit imprint mailings under the applicable standards.
- c. The administering Post Office or district can provide trained, qualified employees during the mailer's hours of mailing operations.

3.1.3 Quality Control

The mailer must implement a documented quality control program that ensures integrity of the system, accuracy and proper maintenance of Optional Procedure records, eligibility of the mailings prepared for the postage prices claimed, and ability to take corrective actions.

3.1.4 Service Agreement

A service agreement must be signed by the mailer, the postmaster, the district manager, and the Business Mailer Support manager before the first Optional Procedure mailing is presented. Before the service agreement is finalized the mailer must submit an Optional Procedure Mailing System application and that application must be approved under the procedures in 3.2. The agreement must set forth, among other things, the mailing information described in 3.2.3 and 3.2.5.

3.2 Authorization

3.2.1 Application

The mailer must submit an Optional Procedure Mailing System application to the postmaster at the office of mailing. Publication 407, *Optional Procedure (OP) Mailing System*, available through business mail entry units and www.usps.com, contains an application and detailed information about mailer standards, responsibilities, and qualifying criteria. The mailer must submit, as part of the application, a complete sample job with all records to be part of the audit trail identified and labeled; a detailed explanation of how each record supports the number of pieces and presort level price of postage claimed on the postage statements; and a detailed description of current internal quality control procedures as they relate to production and presentation of mailing.

3.2.2 Business Mailer Support Action

The Business Mailer Support manager, USPS Headquarters, approves or denies applications for Optional Procedure Mailing Systems.

3.2.3 Approval

When the application is approved, a written service agreement is signed between the USPS and the mailer to specify the types of mailings that may be mailed under the Optional Procedure Mailing System (e.g., the classes of mail, processing categories, permit numbers to be used, and whether the mailer is authorized to mail identical-weight and/or nonidentical-weight pieces).

3.2.4 Authorization Period

Authorization remains in effect until such time as the Business Mailer Support manager or the mailer cancels the agreement. If Postal Service periodic reviews or mailer supplied information demonstrates a need for modification of the agreement, then the authorization will be modified with concurrence by the Business Mailer Support manager and the mailer.

3.2.5 Denial

If the application is denied, the denial is effective 15 days from the mailer's receipt of the notice unless, within that time, the mailer files a written appeal with the Business Mailer Support manager. The appeal must present additional information explaining why the Optional Procedure application should be approved. If the manager determines that the application should be denied, the file is forwarded to the Marketing and Technology Channel Management manager, USPS Headquarters, who will issue the final agency decision to the mailer.

3.2.6 Changes

If the mailer proposes to change the method of presenting or documenting mailings from that specified in the agreement, or the mailer is no longer able to comply with the standards that apply to the authorization, the mailer must immediately notify the Business Mailer Support manager, through the postmaster of the administering Post Office. The Business Mailer Support manager will notify the mailer in writing if the Optional Procedure agreement should be modified, continued, or canceled.

3.2.7 Additions or Modifications to the Service Agreement

If the mailer requests additional options or modifications to the Optional Procedure agreement, the mailer must submit a written request to the Business Mailer Support manager stating the requested change or modification and complete documentation supporting each change or modification. The mailer's request must be submitted before the change or modification is made. Changes to the Optional Procedure service agreement cannot be made until the Business Mailer Support manager has notified the mailer in writing that the changes or modifications have been approved and an addendum is added to the Optional Procedure service agreement.

3.2.8 USPS Suspension

The Business Mailer Support manager may suspend an Optional Procedure Mailing System at any time, pending review, when there is an indication that postal revenue is not fully protected. The Business Mailer Support manager will notify the mailer in writing of the decision. The suspension becomes effective upon the mailer's receipt of the notification.

3.2.9 Mailer Cancellation

The mailer may cancel an Optional Procedure Mailing System authorization at any time by written notice to the administering Post Office.

3.2.10 USPS Cancellation

The USPS may cancel an Optional Procedure Mailing System authorization if:

- a. The mailer provides misleading or incorrect data to avoid paying postage, makes no mailings under the Optional Procedure agreement during any consecutive 12-month period, or routinely fails to comply with the Optional Procedure agreement or the standards applicable to the Optional Procedure Mailing System.
- b. An audit reveals that the Optional Procedure Mailing System agreement should no longer be authorized or the mailer is not complying with the agreement.

3.2.11 Cancellation Notice and Appeal

The cancellation takes effect 15 days from the mailer's receipt of the notice unless, within that time, the mailer files a written appeal with the Business Mailer Support manager. The appeal must present additional information explaining why the Optional Procedure Mailing System authorization should not be canceled. If the Business Mailer Support manager does not uphold the appeal, the appeal letter, additional information, and the complete record underlying the decision to cancel the authorization are forwarded to the Marketing and Technology Channel Management manager, USPS Headquarters, who issues the final agency decision to the mailer.

3.3 Records

3.3.1 Mailer Responsibility

The mailer must submit accurate postage statements and keep accurate records. The mailer must prepare a complete record for each mailing, label all component records as they are created with the mailing (and/or order) to which they relate, and keep it at a central location for 1 year. Records used for verification of Optional Procedure mailings must be records that are also routinely kept for production of other than Optional Procedure mailings.

3.3.2 Mailer Running Summary

The mailer must maintain a running summary of mailings made to the USPS. The summary must include the permit number, date of mailing, postage statement sequence number, total pieces, weight of a single piece (or weight ranges of nonidentical-weight pieces), and the total weight and total postage for each mailing. For plant-verified drop shipment (PVDS) mailings the grand totals from the consolidated postage statement are entered on the summary.

3.3.3 Contents

Each mailing record must contain a sample of the mailpiece, the corresponding postage statement, and source documents required for the audit trail as specified in the mailer's Optional Procedure agreement.

4.0 Alternate Mailing System

4.1 Basic Information

4.1.1 Purpose

An Alternate Mailing System (AMS) provides for other methods of accepting permit imprint mail, not established in [2.0, Manifest Mailing System](#), or [3.0, Optional Procedure Mailing System](#), that show proper postage payment and mail preparation without verification by weight.

4.1.2 Postage Adjustment

Underpayments identified during USPS verification may require a postage adjustment. Verification samples are considered to be representative of the entire mailing and postage adjustment calculations are applied to the total mailing. The total corrected postage for the entire mailing is deducted from the mailer's permit imprint advance deposit account.

4.2 Authorization

4.2.1 Procedure

A mailer may request authorization to pay postage by an AMS by submitting a written request to the postmaster at the office of mailing. The request must include a complete description of the types of matter to be mailed, the proposed method of paying postage, the proposed method to determine correct mail preparation, and a statement of the reasons for requesting the alternate system. The USPS may review the mailer's operation before ruling on the application.

4.2.2 Conditions

The conditions of authorization are:

- a. Authorization to use AMS must benefit the USPS.
- b. Authorization to use AMS must include a signed AMS agreement.
- c. An AMS agreement must specify the terms and conditions of the AMS.
- d. All postage must be paid by permit imprint unless otherwise permitted in writing by the Business Mailer Support manager.
- e. There must be no additional cost to the USPS for an AMS agreement beyond the costs of current mail acceptance procedures for the mail in question.
- f. The mailer must implement a quality control program that ensures proper mail preparation and accurate documentation, subject to USPS approval. The service agreement must include details of this program. Each AMS mailing must include a statement from the mailer certifying that the approved quality control verification is done.

4.2.3 Business Mailer Support Action

The Business Mailer Support manager approves or denies a written request for AMS.

4.2.4 Approval

If the application is approved, a service agreement must be signed by the USPS and the mailer.

4.2.5 Authorization Period

Authorization remains in effect until such time as the Business Mailer Support manager or the mailer cancels the agreement. If Postal Service periodic reviews or mailer supplied information demonstrates a need for modification of the agreement, then the authorization will be modified with concurrence by the Business Mailer Support manager and the mailer.

4.2.6 Denial

If the application is denied the mailer may file a written appeal within 15 days from the receipt of the notice, including additional evidence explaining why the AMS request should be approved, to the Marketing and Technology Channel Management manager, USPS Headquarters, who reviews the appeal and issues the final agency decision.

4.2.7 Revocation

The Business Mailer Support manager may revoke an AMS authorization if the mailer:

- a. Provides incorrect data for mailings and appears unable or unwilling to correct all problems.
- b. Is not conducting required quality control procedures.
- c. No longer meets the criteria established by standard or the AMS agreement.
- d. Does not present mailings under AMS for more than 6 months (except under the service agreement).

705.4.2.8

- e. Continues to present mailings improperly prepared or mailings without correct postage.

4.2.8 Notice of Revocation

After a revocation notice is issued, the mailer and the USPS decide on the corrective actions and set up an implementation schedule, after which the USPS reexamines the mailer's system. Failure to correct identified problems is sufficient grounds to revoke a mailer's AMS authorization.

4.2.9 Appeal

Revocation proceeds if the mailer is unable or unwilling to correct the discrepancies found. The mailer may file a written appeal within 15 days from the date of receipt of the notice, which includes evidence explaining why the AMS authorization should not be revoked. The appeal must be filed with the Business Mailer Support manager for referral to the Marketing and Technology Channel Management manager, USPS Headquarters, who issues the final agency decision. The mailer may continue to present mail under the AMS pending a decision on appeal. The revocation decision takes effect 15 days after receipt by the mailer.

5.0 First-Class Mail or Standard Mail Mailings With Different Payment Methods

5.1 Basic Provisions

5.1.1 General

After specific USPS authorization, a mailer may prepare separate First-Class Mail or Standard Mail letter-size automation price mailings that each contain pieces paid with more than one of the three authorized methods of postage payment (permit imprint, meter stamp, or precanceled stamp) or that contain pieces having different prices of postage affixed or multiple ounces of First-Class Mail permit imprint mail or nonidentical-weight permit imprint mail. For this standard, *mailer* or *presenter* is the entity preparing the combined mailing and presenting it to the USPS. All standards applying to each method of payment apply in a combined mailing, unless excepted below.

5.1.2 Postage Payment

Postage that is due to the USPS for permit imprint mail and additional postage for postage-affixed pieces is paid through the mailer's advance deposit account.

5.1.3 Value Added

To request value added refunds of postage overpayments for the metered part of combined mailings, see [604.9.0](#).

5.1.4 Mailer Processing

The mailer must have an automated mailing system that can be shown to correctly produce automation price letter-size mailings under the applicable standards and accurately compute and document the postage due.

5.1.5 Authorization Process

To be authorized to prepare automation price combined letter-size mailings, a mailer must submit a written request to the postmaster serving the mailer's production plant. This request must:

- a. Identify the postage payment methods to be combined, the prices of postage to be affixed to precanceled stamped or metered pieces, and, for First-Class Mail, the weight increments of pieces to be combined.
- b. Describe all steps in the automated mailing system to be used to prepare combined mailings. Include a flow chart showing how jobs are handled from the time received from clients or other departments through the time the combined mailing is presented to the Post Office for verification and acceptance.
- c. Include samples of all reports that the mailing system can generate. Number and annotate samples to describe step-by-step how the data are obtained and how each data element is supported and can be verified. Describe at which step in the mailing operation the reports may be generated, and how the reports relate to each other and to the preparation of postage statements.
- d. Describe how rejects are handled during mail preparation.
- e. Describe in detail internal quality control procedures that ensure that mailings are properly prepared, that postage statement and supporting data are accurate, and that correct postage is paid. Submit copies of quality control instructions and checklists used.

5.1.6 On-Site Review

The USPS examines the mailer's operation as part of the application process. During the on-site review, the mailer must:

- a. Produce a controlled test mailing with supporting documentation.
- b. Show that internal quality control procedures are satisfactorily administered.
- c. Show that the mailing system provides acceptable documentation by which the USPS can verify postage statement data.

5.1.7 Interim Authorization

If the mailer meets standards, the USPS grants a 90-day interim authorization to prepare combined mailings. During this time, USPS monitors the mailer's system to ensure continued compliance with all applicable standards.

5.1.8 Final Authorization

At the end of the 90-day interim authorization, if the mailer's program meets all applicable standards, Business Mailer Support prepares a detailed authorization for the mailer to follow in preparing combined mailings. The mailer must give advance written notice to Business Mailer Support regarding any planned changes to the system used to prepare combined mailings.

5.1.9 Authorization Period

Authorization remains in effect until such time as the Business Mailer Support manager or the mailer cancels the agreement. If Postal Service periodic reviews or mailer supplied information demonstrates a need for modification of the agreement, then the authorization will be modified with concurrence by the Business Mailer Support manager and the mailer.

5.1.10 Denial

If an application is denied, the mailer may, within 15 days from receipt of the notice, file a written appeal, including additional evidence explaining why the request should be approved, to the Marketing and Technology Channel Management manager, USPS Headquarters, who issues the final agency decision.

5.1.11 Suspension

The Business Mailer Support manager may suspend a combined mailing system agreement at any time, pending investigation, if the manager finds that postage is not being fully paid or mail is not being prepared according to standards. The decision to suspend the agreement may be appealed to the Marketing and Technology Channel Management manager, USPS Headquarters, within 15 days of the receipt of the notice, by submitting a written appeal with explanation. The suspension remains in effect during the appeal. A suspension is ended when the mailer comes into compliance.

5.1.12 Cancellation by USPS

The USPS may cancel an authorization to prepare combined mailings at any time if the mailer:

- a. Provides misleading or incorrect data to avoid payment of postage.
- b. Makes no combined mailings under the agreement during any consecutive 12-month period.
- c. Fails to comply with applicable standards or the agreement, including required quality control procedures, and does not make changes to comply after USPS notification.

5.1.13 Cancellation Procedure

If the USPS decides to cancel an authorization, cancellation becomes effective 15 days from the mailer's receipt of the notice, unless the mailer files a written appeal within that time with the Business Mailer Support manager. The appeal must include additional information explaining why the combined mailing authorization should not be canceled. If the manager denies the appeal, both the appeal and the additional information are sent to the Marketing and Technology Channel Management manager, USPS Headquarters, who issues the final agency decision.

5.1.14 Cancellation by Mailer

The mailer may cancel an authorization to prepare combined mailings at any time by notifying the administering Post Office in writing.

5.2 Postage

5.2.1 Metered Pieces—First-Class Mail

Metered pieces in a combined mailing must bear postage for the first ounce at the Presorted price or at an automation price for which the pieces are eligible and, if applicable, the full amount of postage due for additional ounces. Additional postage due for metered pieces in a combined mailing is deducted from the mailer's postage due advance deposit account. Full postage at single-piece First-Class Mail prices must be paid on accompanying single-piece price mail using one of the methods under [134.1.0](#). Additional preparation to verify postage due may be required by the USPS.

5.2.2 Metered Pieces—Standard Mail

Metered pieces in a combined mailing must bear postage at a Presorted or automation price for which the pieces are eligible. Additional postage due for metered pieces in a combined mailing is deducted from the mailer's postage due advance deposit account. Full postage at single-piece First-Class Mail prices must be paid on accompanying single-piece price mail using one of the methods under [243.3.0](#), [705.5.0](#), and [134.1.0](#). Additional preparation to verify postage due may be required by the USPS.

5.2.3 Precanceled Pieces—First-Class Mail

Pieces with precanceled stamps in a combined mailing must not weigh more than 1 ounce and must bear postage in any denomination of precanceled stamps permitted in a Presorted or automation price mailing. Additional postage due for precanceled stamp pieces in a combined mailing is deducted from the mailer's postage due advance deposit account. Full postage at the single-piece First-Class Mail price must be paid on accompanying single-piece price mail using one of the methods under [134.1.0](#). Additional preparation to verify postage due may be required by the USPS.

5.2.4 Precanceled Pieces—Standard Mail

Pieces with precanceled stamps in a combined mailing must bear postage in any denomination of precanceled stamp permitted in an automation price mailing. Nonprofit postage may appear only on pieces in a Nonprofit price mailing that are eligible for and claimed at a Nonprofit price. Additional postage due for precanceled stamp pieces in a combined mailing is deducted from the mailer's postage due advance deposit account. Full postage at single-piece First-Class Mail prices must be paid on accompanying single-piece price mail using one of the methods under [243.3.0](#), [243.5.0](#), or [134.1.0](#). Additional preparation to verify postage due may be required by the USPS.

5.2.5 Permit Imprint Pieces—First-Class Mail and Standard Mail

Pieces in a combined mailing may bear the permit imprint of the mailer or the mailer's clients. Postage for the permit imprint part of a combined mailing must be paid from the mailer's permit imprint advance deposit account. Postage is deducted only from this account, regardless of the permit numbers or company permit imprints on pieces in a combined mailing. Full postage at single-piece First-Class Mail prices must be paid on accompanying single-piece price mail using one of the methods under [134.1.0](#) and, for Standard Mail, [243.3.0](#) and [243.5.0](#). Additional preparation to verify postage due may be required by the USPS.

5.3 Producing the Combined Mailing

5.3.1 Mailer Quality Control

Before merging different pieces into a combined presorted mailing, the mailer must have quality control procedures to ensure that:

- a. Meter dates are correct.
- b. Meter impressions are legible.
- c. Permits and licenses are current at office of mailing.
- d. In First-Class Mail mailings, full postage on 2-ounce and 3-ounce metered and precanceled stamped pieces is affixed for the ounces in addition to postage for the first ounce at a price acceptable for inclusion in the mailing.
- e. In Standard Mail mailings, full postage is affixed at a price acceptable for inclusion in the mailing.
- f. Barcodes meet all applicable standards.
- g. Mailings are prepared under the relevant standards.
- h. Source mailing information (on client, job, or segment) is entered accurately into the automated mailing system.
- i. When markings are applied by an MLOCR, they properly show the applicable identifier/price code described in 5.3.2 that specifies the product month designator, MASS/FASTforward system identifier, the method of postage payment, and the price of postage affixed for metered and precanceled stamp mail or other postage information for permit imprint mail. These markings must be linked by the computer system to the price entered by the mailer when the pieces are run through the MLOCR.

5.3.2 Price and Postage Marking

The following markings must be applied to each piece in the mailing when markings are applied by an MLOCR. These seven-character markings provide the automation price marking information and additional information including the product month designator, MASS/FASTforward (FF) system identifier, manufacturer code, and price marking information. The product month designator is the first character position and represents the product month of the USPS ZIP+4 Product installed with the system's lookup engine responsible for the ZIP+4 assignment. Each product month is designated by a character "A" through "L" (with "A" meaning January, "B" meaning February, etc.). The MASS/FF System Identifier is characters 2 through 4 and represents the certified system identifier responsible for the ZIP+4 assignment. There is a one-to-one relationship between the certified system serial number and the assigned identifier. The manufacturer code is the fifth character and is assigned at the manufacturer's discretion with one exception: the character "Z" is assigned when the mailpiece contains a delivery point barcode in the address block and the MLOCR does not perform a lookup but simply reproduces the address block barcode. The price marking is represented in the last two characters according to the chart below. The applicable marking must appear on each mailpiece in one of the locations authorized under 202 for letters, 302 for flats, or 402 for parcels.

a. First-Class Mail:

PRICE MARKING		
Letters	Flats	PRICE AND POSTAGE CATEGORY
P1	F1	Barcoded 1-ounce Permit Imprint
P2	F2	Barcoded 2-ounce Permit Imprint
P3	F3	Barcoded 3-ounce Permit Imprint
P4	F4	Barcoded 4-ounce Permit Imprint
	F5	Barcoded 5-ounce Permit Imprint
	F6	Barcoded 6-ounce Permit Imprint
	F7	Barcoded 7-ounce Permit Imprint
	F8	Barcoded 8-ounce Permit Imprint
	F9	Barcoded 9-ounce Permit Imprint
	F0	Barcoded 10-ounce Permit Imprint
	FA	Barcoded 11-ounce Permit Imprint
	FB	Barcoded 12-ounce Permit Imprint
	FC	Barcoded 13-ounce Permit Imprint
51	MF	Barcoded 5-Digit Meter Postage Affixed - 1 ounce
52		Barcoded 5-Digit Meter Postage Affixed - 2 ounces
53		Barcoded 5-Digit Meter Postage Affixed - 3 ounces
54		Barcoded 5-Digit Meter Postage Affixed - 4 ounces
31	MT	Barcoded 3-Digit Meter Postage Affixed - 1 ounce
32		Barcoded 3-Digit Meter Postage Affixed - 2 ounces
33		Barcoded 3-Digit Meter Postage Affixed - 3 ounces
34		Barcoded 3-Digit Meter Postage Affixed - 4 ounces
A1	MD	Barcoded AADC Meter Postage Affixed - 1 ounce
A2		Barcoded AADC Meter Postage Affixed - 2 ounces
A3		Barcoded AADC Meter Postage Affixed - 3 ounces
A4		Barcoded AADC Meter Postage Affixed - 4 ounces
M1	MX	Barcoded Mixed AADC Meter Postage Affixed - 1 ounce
M2		Barcoded Mixed AADC Meter Postage Affixed - 2 ounces
M3		Barcoded Mixed AADC Meter Postage Affixed - 3 ounces
M4		Barcoded Mixed AADC Meter Postage Affixed - 4 ounces
11		Presorted Meter Postage Affixed - 1 ounce

705.5.3.3

PRICE MARKING		
Letters	Flats	PRICE AND POSTAGE CATEGORY
12		Presorted Meter Postage Affixed - 2 ounces
13		Presorted Meter Postage Affixed - 3 ounces
14		Presorted Meter Postage Affixed - 4 ounces
S1		Precanceled \$0.15 Stamp Affixed (card)
S2		Precanceled \$0.25 Stamp Affixed

b. Standard Mail (letters only):

PRICE MARKING	PRICE AND POSTAGE CATEGORY
PI	Barcoded Regular Permit Imprint
NI	Barcoded Nonprofit Permit Imprint
M5	Barcoded 5-Digit Meter Regular Postage Affixed*
N5	Barcoded 5-Digit Meter Nonprofit Postage Affixed*
M3	Barcoded 3-Digit Meter Regular Postage Affixed*
N3	Barcoded 3-Digit Meter Nonprofit Postage Affixed*
MA	Barcoded AADC Meter Regular Postage Affixed*
NA	Barcoded AADC Meter Nonprofit Postage Affixed*
MM	Barcoded Mixed AADC Meter Regular Postage Affixed*
NM	Barcoded Mixed AADC Meter Nonprofit Postage Affixed*
M8	Machinable AADC Meter Regular Postage Affixed*
N8	Machinable AADC Meter Nonprofit Postage Affixed*
M9	Machinable Mixed AADC Meter Regular Postage Affixed*
N9	Machinable Mixed AADC Meter Meter Nonprofit Postage Affixed*
SR	Precanceled \$0.10 Regular Price Stamp Affixed
SN	Precanceled \$0.05 Nonprofit Stamp Affixed

* The same code is used regardless of the destination entry price, if any, for which the piece is metered.

5.3.3 Merging Methods and Documentation

During the initial count of each source mailing (i.e., the quantity of mail originated by each of the mailer's clients) by the mailer's automated mailing system, pieces must be grouped by payment method (and, within each for First-Class Mail, by ounce increment). All pieces within each postage-affixed group must have the same amount of postage affixed (for First-Class Mail, the same amount of postage must be affixed for the first ounce). The mailer must keep records of each source that was merged in the combined mailing to allow the USPS to identify each source, the number of pieces by postage payment method, and, within each, by ounce increment (for First-Class Mail), or by amount of postage affixed (for Standard Mail). The mailer must keep these records (in the form of computer-generated printouts or computer media approved by Business Mailer Support) in a central location for 90 days after the mailing date of the combined mailing.

5.3.4 Rejected Pieces

Pieces rejected for any reason by the mailer's automated sorting system and pulled out of the combined mailing stream must be identified by the mailer, specifically accounted for in documentation, and:

- a. If postage-affixed, bear postage or have additional postage affixed to equal a price no lower than:
 1. For First-Class Mail, the correct Presorted First-Class Mail.
 2. For Standard Mail, the correct 5-Digit or AADC (as applicable) Presorted Standard Mail price for letters.
- b. If paid by permit imprint, separately presented to the USPS for verification of postage.

5.4 Documentation

5.4.1 Submission

Mailers are required to submit or generate the following reports:

For each First-Class Mail or Standard Mail combined mailing, the mailer must provide these materials:

- a. For each postage payment method, a complete and accurate postage statement endorsed "Combined Mailing" at the top.
 1. A separate Form(s) 3553.
 2. The USPS qualification report in standardized format detailing by ZIP Code the number of pieces qualifying for each price by presort level. If plant-verified drop shipment (PVDS) is used for Standard Mail, a separate USPS qualification report must be generated for each entry destination.
 3. The USPS Summary ZIP Destination report in one of two standardized formats that lists by tray destination and price category: each mail category, postage payment type, weight, and price affixed (report all postage affixed First-Class Mail pieces as weighing one ounce); number of pieces; dollar amount of postage affixed to those pieces; cumulative postage affixed; total postage; net postage due; cumulative postage due; and a running total of the number of pieces. If plant-verified drop shipment (PVDS) is used for Standard Mail, a separate USPS Summary ZIP Destination report must be generated for each entry destination. This report is not required if there is only one metered price in the mailing. Business Mailer Support may authorize submission of only portions of this report.
 4. The USPS Postage Summary in a standardized format. This report shows, by type of payment method, the total postage claimed for all pieces in the mailing by price level and the total postage affixed by price level. It also shows a grand total summary of postage affixed, postage claimed, and total postage due. If plant-verified drop shipment (PVDS) is used for Standard Mail, a separate USPS Postage Summary report must be generated for each entry destination.

705.5.4.2

5. Other documentation that may be required by other standards for the price claimed.
- b. The USPS Customer Mail Report must be generated for each mailing but is required to be submitted to the USPS only when requested by USPS personnel for the resolution of errors (shortpaid and potential MLOCR profiling) detected in a specific mailing. The Customer Mail Report must list each customer by name and provide the following information about their mail: price affixed, mail category including postage payment type, weight, total postage, postage affixed, number of pieces, cumulative number of pieces, number of pieces rejected, and total pieces fed.

5.4.2 Permit Imprint

To prepare the postage statement for permit imprint pieces, the mailer multiplies the number of such pieces qualifying for each price level (and, for First-Class Mail, in each weight increment) (as documented by the mailer) by the corresponding price. The result is the net postage due for the permit imprint part of the combined mailing. If the mailing contains nonidentical-weight permit imprint pieces, the postage statement must be so annotated.

5.4.3 Postage Affixed

In completing the separate postage statements for postage-affixed pieces:

- a. Multiply the number of pieces at each price level (which, for First-Class Mail, are treated as weighing 1 ounce or less, regardless of actual weight) by the corresponding price of postage. The product is the postage due before adjustments are made for the value of postage affixed to those pieces.
- b. Multiply the amount of postage (or, for First-Class Mail only, first ounce postage) affixed by the number of pieces at each amount, to determine the total postage already paid.
- c. Set the amount paid against the amount due to find the postage to be paid by or to the mailer for the postage-affixed pieces.

5.4.4 Reporting Results

Any additional postage due is paid through the mailer's advance deposit account for combined mailings. A "value added" refund of any overpayment of meter postage may be requested under [604.9.0](#).

6.0 Combining Mailings of Standard Mail, Package Services, and Parcel Select Parcels

6.1 Basic Standards for Combining Parcels and NFMs

6.1.1 Basic Standards

Standard Mail parcels, NFMs, Package Services, and Parcel Select parcels in combined mailings must meet the following standards:

- a. Each parcel in a combined mailing is subject to the applicable content and price eligibility standards for the price claimed.

- b. Mailers must be authorized under [6.1.4](#).
- c. Mailers must pay all applicable presort mailing and destination entry mailing fees.
- d. Minimum volume requirements for Standard Mail, Parcel Select, Presorted Bound Printed Matter, Presorted Library Mail, and Presorted Media Mail must be met separately and are based solely on the quantity of pieces eligible for each price at the required presort level. Pieces claimed at other prices in the same sack or on the same pallet do not count towards these minimum volume requirements.

6.1.2 Postage Payment

Mailers must pay postage for all pieces with a permit imprint at the Post Office serving the mailer's plant using an approved postage payment system. The applicable system agreement must include procedures for combined mailings approved by Business Mailer Support. Types of permissible postage payment systems are as follows:

- a. Manifest Mailing System (MMS) under [2.0](#). Mailers may document and pay postage using the Electronic Verification System (eVS) under [2.9](#).
- b. Optional Procedure (OP) Mailing System under [3.0](#).
- c. Alternate Mailing System (AMS) under [4.0](#).

6.1.3 Documentation

Mailers must prepare separate postage statements for Standard Mail, Package Services, and Parcel Select pieces for each of the mailings in the combined mailing. At the time of mailing, mailers must provide all postage statements and a Business Mailer Support-approved manifest prepared according to [2.0](#) and this section. Presort documentation is required as applicable for each price claimed if the manifest does not list pieces in presort order.

6.1.4 Authorization

A mailer who wants to present combined parcel mailings must submit a written request to Business Mailer Support (See [608.8.1](#) for address). The request must show the mailer's name and address, the mailing office, evidence of authorization to mail under [2.0](#), procedures for combined mailing, the expected date of first mailing, a sample of the required manifest, and a sample USPS Qualification report. Business Mailer Support will review documentation and provide written authorization, which may not exceed 2 years. A mailer may terminate an authorization at any time by written notice to the postmaster of the office serving the mailer's location. Business Mailer Support may terminate an authorization, by written notice, if the mailer does not meet the standards.

6.2 Combining Parcels and NFMs—DBMC Entry

Mailers may combine Standard Mail NFMs 6 ounces or more and machinable parcels with Package Services and Parcel Select machinable parcels for entry at a BMC when authorized by the USPS under [6.1.4](#).

705.6.2.1

6.2.1 Eligible Prices

Combined pieces may be eligible for Standard Mail, Parcel Post, Parcel Select DBMC/ASF, single-piece and Presorted Media Mail, single-piece and Presorted Library Mail, Bound Printed Matter DBMC, and single-piece and Presorted Bound Printed Matter prices. Mailers may not combine Carrier Route Bound Printed Matter with other parcels.

6.2.2 Additional Standards

Standard Mail machinable parcels, NFMs 6 ounces or more, and Package Services and Parcel Select machinable parcels prepared for DBMC entry must meet the following conditions in addition to the basic standards in 6.1:

- a. Each piece in a combined Standard Mail, Package Services, and Parcel Select mailing must meet the criteria for machinable parcels in 401.1.5 or the criteria in 401.2.2.2 for NFMs 6 ounces or more.
- b. Parcel Select machinable parcels must bear a barcode under 708.5.0 for the ZIP Code of the delivery address.
- c. Parcels may be claimed at single-piece, Presorted, and DBMC/ASF destination entry prices as applicable.
- d. Mailers must prepare all parcels in sacks under 6.2.3, or on pallets or in pallet boxes under 8.0, to achieve the finest level of sortation.
- e. Mailers must deposit combined machinable parcels and NFMs at BMCs or ASFs (see Exhibit 6.2.3) under applicable standards in 15.0.

6.2.3 Sacking and Labeling

Preparation sequence, sack size, and labeling:

- a. *5-digit scheme*, optional, but required for Standard Mail 5-digit price eligibility, 10-piece or 20-pound minimum; labeling:
 1. Line 1: use L606.
 2. Line 2: "STD/PSVC MACH 5D SCH."
- b. *5-digit*, optional, but required for Standard Mail 5-digit price eligibility, 10-piece or 20-pound minimum; labeling:
 1. Line 1: use city, state, and 5-digit ZIP Code on mail (see 8.6.4 for overseas military mail).
 2. Line 2: "STD/PSVC MACH 5D."
- c. *ASF*, optional, allowed only for mail deposited at an ASF to claim DBMC price, 10-piece or 20-pound minimum; labeling:
 1. Line 1: use L602, Column B. DBMC price eligibility determined by Exhibit 6.2.3.
 2. Line 2: "STD/PSVC MACH ASF."
- d. *BMC*, required, 10-piece or 20-pound minimum; labeling:
 1. Line 1: use L601, Column B. DBMC price eligibility determined by Exhibit 6.2.3.

2. Line 2: "STD/PSVC MACH BMC."
- e. *Mixed BMC*, required, no minimum; labeling:
 1. Line 1: "MXD" followed by [L601](#) Column B information for BMC serving 3-digit ZIP Code prefix of entry Post Office.
 2. Line 2: "STD/PSVC MACH WKG."

Exhibit 6.2.3 BMC/ASF – DBMC Price Eligibility

ELIGIBLE DESTINATION ZIP CODES	ENTRY FACILITY
005, 068-079, 085-098, 100-119, 124-127	BMC New Jersey NJ 00102
010-067, 120-123, 128,129	BMC Springfield MA 05500
130-136, 140-149 [Except machinable parcels]	ASF Buffalo NY 140
130-136, 140-168, 260-266, 439-449 [Machinable parcels only or machinable parcels combined with bedloaded nonmachinable parcels]	BMC Pittsburgh PA 15195
150-168, 260-266, 439-449 [Except machinable parcels]	BMC Pittsburgh PA 15195
080-084, 137-139, 169-199	BMC Philadelphia PA 19205
200-212, 214-239, 244, 254, 267, 268	BMC Washington DC 20499
240-243, 245-249, 270-297, 376	BMC Greensboro NC 27075
298, 300-312, 317-319, 350-352, 354-368, 373, 374, 377-379, 398, 399	BMC Atlanta GA 31195
299, 313-316, 320-342, 344, 346, 347, 349.	BMC Jacksonville FL 32099
369-372, 375, 380-397, 700, 701, 703-705, 707, 708, 713, 714, 716, 717, 719-729	BMC Memphis TN 38999
250-253, 255-259, 400-418, 421, 422, 425-427, 430-433, 437, 438, 450-462, 469-474	BMC Cincinnati OH 45900
434-436, 465-468, 480-497	BMC Detroit MI 48399
500-516, 520-528, 612, 680, 681, 683-689	BMC Des Moines IA 50999
498, 499, 540-564, 566	BMC Minneapolis/St. Paul MN 55202
570-577	ASF Sioux Falls SD 570
565, 567, 580-588	ASF Fargo ND 580
590-599, 821	ASF Billings MT 590
463, 464, 530-532, 534, 535, 537-539, 600-611, 613	BMC Chicago IL 60808
420, 423, 424, 475-479, 614-620, 622-639	BMC St. Louis MO 63299
640, 641, 644-658, 660-679, 739	BMC Kansas City KS 64399
730, 731, 734-738, 740, 741, 743-746, 748, 749	ASF Oklahoma City OK 730
706, 710-712, 718, 733, 747, 750-799, 880, 885	BMC Dallas TX 75199
690-693, 800-816, 820, 822-831, 856, 857	BMC Denver CO 80088
832-834, 836, 837, 840-847, 898, 979	ASF Salt Lake City UT 840
850, 852, 853, 855, 859, 860, 863, 864	ASF Phoenix AZ 852
865, 870-875, 877-879, 881-884	ASF Albuquerque NM 870
889-891, 893, 900-908, 910-928, 930-935	BMC Los Angeles CA 90901
894, 895, 897, 936-966	BMC San Francisco CA 94850
835, 838, 970-978, 980-986, 988-994	BMC Seattle WA 98000

6.3 Combining Parcels—Parcel Select OBMC Presort, BMC Presort, DSCF, and DDU Prices

6.3.1 Qualification

Combination requirements for specific discounts and prices are as follows:

- a. When claiming Parcel Select OBMC Presort discounts and Parcel Select BMC Presort discounts, machinable Standard Mail parcels and NFMs 6 ounces or more may be combined with machinable Package Services parcels under [6.3](#).
- b. When claiming the DSCF price for Parcel Select, Bound Printed Matter parcels, all Standard Mail parcels and NFMs may be combined with Package Services and Parcel Select parcels under [6.3](#).
- c. All Standard Mail parcels and NFMs may be combined with Package Services and Parcel Select parcels prepared for DDU prices under [6.3](#).

6.3.2 Preparation and Prices

Combined parcels must be prepared as follows:

- a. *Minimum Mailing Volume.* Separate minimum mailing volume requirements must be met for Standard Mail parcels, Package Services, and for Parcel Select parcels.
- b. *Parcel Select or Bound Printed Matter Qualifying for DSCF Prices.* Mailers must prepare the combined mailings under the applicable 5-digit scheme and 5-digit sack requirements in [455.4.2](#) or the applicable 5-digit scheme and 5-digit pallet requirements in [8.0](#) for the Parcel Select DSCF prices. All other requirements for Parcel Select DSCF prices and Standard Mail prices, as applicable, must be met. The following additional requirements apply:
 1. If sacked under [455.4.2](#), the minimum requirement of seven pieces per sack must be met with only Package Services and Parcel Select parcels. After the minimum sack volume has been met, Standard Mail parcels may be included in the sack or in overflow sacks.
 2. If palletized under the option to prepare 5-digit scheme or 5-digit pallets when there are at least 50 pieces and 250 pounds per pallet, this pallet minimum must be met with only Package Services and Parcel Select parcels. After the minimum pallet volume has been met, Standard Mail parcels may be included on the pallet or in overflow sacks.
 3. If palletized under the alternate pallet preparation where no pallet may contain fewer than 35 pieces and 200 pounds provided the average number of pieces on pallets qualifying for the DSCF price is at least 50, Standard Mail parcels may not be combined with Package Services and Parcel Select parcels.
 4. If palletized under the option to prepare 5-digit scheme or 5-digit pallets under the 36-inch-high (mail only) pallet minimum, any combination of Standard Mail, Package Services, and Parcel Select parcels may be used to meet the minimum pallet height requirement.

705.6.4

5. Line 2 of 5-digit scheme pallet and sack labels must read: “STD/PSVC MACH 5D SCH.” Line 2 of 5-digit pallet and sack labels must read: “STD/PSVC MACH 5D.”
6. Standard Mail parcels are eligible for presorted prices according to [443](#).
- c. Parcel Select Qualifying for OBMC Presort or BMC Presort Prices. Mailers must prepare the combined mailings under the BMC pallet requirements in [8.0](#) for machinable parcels at Parcel Select OBMC Presort or BMC Presort prices. All other requirements for Parcel Select OBMC Presort or BMC Presort prices and Standard Mail prices must be met. The following additional requirements apply:
 1. The minimum height requirement for each pallet or pallet box on a pallet may be met using any combination of Standard Mail, Package Services, and Parcel Select parcels.
 2. Line 2 of BMC pallet box labels must read: “STD/PSVC MACH BMC.”
- d. Package Services, Parcel Select, and Standard Mail parcels and NFM parcels qualifying for DDU prices:
 1. The combined mailings must be prepared under the applicable 5-digit scheme and 5-digit sack requirements in [445.4.0](#) or the applicable 5-digit scheme and 5-digit pallet requirements in [8.22](#) for the Parcel Select or Bound Printed Matter DDU prices.
 2. Line 2 of 5-digit scheme container labels must read, “STD/PSVC PARCELS 5D SCH.” Line 2 of 5-digit container labels must read, “STD/PSVC PARCELS 5D.”

6.4 Combining Package Services, Parcel Select, and Standard Mail—Optional 3-Digit SCF Entry

6.4.1 Entry at Designated SCFs

Mailers may deposit pieces otherwise eligible for the Package Services, Parcel Select, and Standard Mail DBMC prices and the Standard Mail DSCF price at an SCF designated by the USPS for destination ZIP Codes listed in labeling list [L607](#).

6.4.2 Qualification and Preparation

Parcel Select and Bound Printed Matter machinable parcels, and Standard Mail parcels and NFM pieces, may be prepared for entry at designated SCFs under these standards:

- a. Standard Mail parcels and NFM pieces that weigh less than 2 ounces and Standard Mail parcels that are tubes, rolls, triangles, and similar pieces may not be included.
- b. Mailers must prepare pieces on 3-digit pallets or in 3-digit pallet boxes, or unload and physically separate the pieces into containers as specified by the destination facility.
- c. Parcel Select and Bound Printed Matter parcels are eligible for the applicable DBMC entry price.

- d. Standard Mail machinable parcels and NFMs 6 ounces or more are eligible for the BMC presort level, DBMC price; NFM pieces less than 6 ounces and irregular parcels are eligible for the 3-digit presort level, DSCF price.
- e. All pieces must be for delivery within the service area of the SCF where they are deposited by the mailer.
- f. Postage on all zone-priced parcels deposited at the SCF is computed using the zone chart for that postal facility.

7.0 Combining Package Services and Parcel Select Parcels for Destination Entry

7.1 Combining Parcels—DSCF and DDU Entry

7.1.1 Qualification

Mailers may combine Package Services and Parcel Select parcels in 5-digit scheme and 5-digit sacks or on 5-digit scheme and 5-digit pallets for entry either at a destination sectional center facility (DSCF) or a destination delivery unit (DDU) when authorized by the USPS under 7.5. Mailers must pay all applicable fees for presort and drop shipment and must meet the minimum volume requirements for Presort prices and Parcel Select prices. Combined Package Services and Parcel Select mailings must meet the standards in 455.4.0 and 466.3.0 through 466.6.0, except as provided by this section. Mailers may not combine Carrier Route Bound Printed Matter with other parcels under these standards. Parcels entered at SCFs and DDUs under these standards are not eligible for the barcode discount.

7.1.2 Basic Standards

Package Services and Parcel Select parcels that qualify as machinable, nonmachinable, and irregular under 401 and meet the following conditions may be combined in 5-digit scheme and 5-digit sacks or 5-digit scheme and 5-digit pallets under these conditions:

- a. Minimum volume requirements for Parcel Select, Presorted Bound Printed Matter, Presorted Library Mail, and Presorted Media Mail must be met separately before combining.
- b. Postage must be paid via permit imprint under an approved manifest mailing system as provided in 3.0. For mailings presented under 7.0, mailers may document and pay postage using the Electronic Verification System (eVS) under 2.9.
- c. All parcels must be prepared in sacks under 7.2 or on pallets under 7.3. For mail entered at the DSCF prices, pallet preparation is not permitted for 5-digit ZIP Codes that are unable to handle pallets. Refer to the Drop Ship Product maintained by the National Customer Support Center (NCSC) (see 608.8.0 for address) to determine which 5-digit delivery facilities can handle pallets. If a DDU facility cannot handle pallets, and a mailer transports mail to the DDU facility on pallets, the driver will have to unload the pallets into a container specified by the delivery unit.

705.7.1.3

- d. Pieces may be claimed at single-piece prices, Presorted prices, and destination entry prices under [7.2.1](#) or [7.1.6](#).
- e. Separate postage statements must be prepared for each subclass and destination entry price as appropriate.
- f. The deposit of combined Package Services and Parcel Select at a DSCF or DDU must be in accordance with applicable drop shipment standards.

7.1.3 Combined Parcels Prepared in Sacks—Price Eligibility

In addition to the applicable standards in [455.4.0](#) and [466.3.0](#) through [466.6.0](#) for destination entry Parcel Select and Package Services, the following standards apply for combined parcels prepared in sacks:

- a. Parcel Select DSCF prices apply to parcels that are contained in 5-digit scheme and 5-digit sacks, each containing at least 10 pieces of any combination of Parcel Select and Package Services mail, or contained in overflow sacks under [7.2.2](#), provided all other requirements for the DSCF price in [453.3.0](#) and [455.4.2](#) are met. Parcel Select DDU prices apply to parcels that are contained in 5-digit scheme and 5-digit sacks, each containing at least 10 pieces of any combination of Parcel Select and Package Services mail, or contained in overflow sacks under [7.2.2](#), provided all other requirements for the DDU price in [453.3.0](#) and [455.4.1](#) are met.
- b. Presorted Bound Printed Matter DSCF prices apply to parcels that are contained in 5-digit scheme and 5-digit sacks, each containing at least 10 pieces of any combination of Parcel Select and Package Services mail, or contained in overflow sacks under [7.2.2](#), provided all other requirements for the DSCF price in [466.3.0](#) through [466.6.0](#) are met. Presorted Bound Printed Matter DDU prices apply to parcels that are contained in 5-digit scheme and 5-digit sacks, each containing at least 10 pieces of any combination of Parcel Select and Package Services mail, or contained in overflow sacks under [7.2.2](#), provided all other requirements for the DDU price in [466.3.0](#) through [466.6.0](#) are met.
- c. Presorted Library Mail 5-digit prices apply to parcels that are contained in 5-digit scheme and 5-digit sacks, each containing at least 10 pieces of any combination of Parcel Select and Package Services mail, or contained in overflow sacks under [7.2.2](#).
- d. Presorted Media Mail 5-digit prices apply to parcels that are contained in 5-digit scheme and 5-digit sacks, each containing at least 10 pieces of any combination of Parcel Select and Package Services mail, or contained in overflow sacks under [7.2.2](#).
- e. Single-piece price parcels that are contained in 5-digit scheme and 5-digit sacks, each containing at least 10 pieces of any combination of Parcel Select and Package Services mail, or contained in overflow sacks under [7.2.2](#), qualify for single-piece prices.

7.1.4 Sack Preparation

Only 5-digit scheme and 5-digit sacks may be prepared. Each sack of combined Parcel Select and Package Services mail must contain at least 10 pieces. One overflow sack containing fewer than 10 pieces is permitted per 5-digit scheme and 5-digit destination.

7.1.5 Sack Labeling

Sack labels must be prepared as follows:

- a. *5-digit scheme*, optional; labeling:
 1. Line 1: use [L606](#), Column B.
 2. Line 2: "PSVC PARCELS 5D SCH."
- b. *5-digit*, labeling:
 1. Line 1: use city, state, and 5-digit ZIP Code destination of pieces.
 2. Line 2: "PSVC PARCELS 5D."

7.1.6 Combined Parcels Prepared on Pallets—Price Eligibility

In addition to the applicable standards in [455.4.0](#), [Preparing Destination Entry Parcel Select](#), and [466.3.0](#) through [466.6.0](#) in [Enter and Deposit](#) for destination entry parcels, the following standards apply for combined parcels prepared on pallets:

- a. Parcel Select DSCF prices apply to pieces that are prepared on 5-digit scheme and 5-digit pallets, each containing at least 50 pieces and 250 pounds or 36 inches of Parcel Select and Package Services mail, or contained in overflow sacks under [7.1.8](#), and deposited at a DSCF under [455.4.0](#). Parcel Select DDU prices apply to pieces that are prepared on 5-digit scheme and 5-digit pallets, each containing at least 50 pieces and 250 pounds or 36 inches of Parcel Select and Package Services mail, or contained in overflow sacks under [7.1.8](#), and deposited at a DDU under [455.4.0](#).
- b. Presorted Bound Printed Matter DSCF prices apply to pieces that are prepared on 5-digit scheme and 5-digit pallets, each containing at least 50 pieces and 250 pounds or at least 36 inches of Parcel Select and Package Services mail, or contained in overflow sacks under [7.1.8](#), and deposited at a DSCF under [466.3.0](#) through [466.6.0](#). Presorted Bound Printed Matter DDU prices apply to pieces that are prepared on 5-digit scheme and 5-digit pallets, each containing at least 50 pieces and 250 pounds or at least 36 inches of Parcel Select and Package Services mail, or contained in overflow sacks under [7.1.8](#), and deposited at a DDU under [466.3.0](#) through [466.6.0](#).
- c. Presorted Library Mail 5-digit prices apply to pieces that are prepared on 5-digit scheme and 5-digit pallets, each containing at least 50 pieces and 250 pounds or 36 inches of Parcel Select and Package Services mail, or contained in overflow sacks under [7.1.8](#).
- d. Presorted Media Mail 5-digit prices apply to pieces that are prepared on 5-digit scheme and 5-digit pallets, each containing at least 50 pieces and 250 pounds or 36 inches of Parcel Select and Package Services mail, or contained in overflow sacks under [7.1.8](#).

705.7.1.7

- e. Single-piece price parcels that are prepared on 5-digit scheme and 5-digit pallets, each containing at least 50 pieces and 250 pounds or 36 inches of Parcel Select and Package Services mail, or contained in overflow sacks under [7.1.8](#), qualify for single-piece prices.

7.1.7 Pallet Preparation

Only 5-digit scheme and 5-digit pallets may be prepared. Each 5-digit scheme and 5-digit pallet of combined Parcel Select and Package Services must contain at least:

(1) 50 parcels and 250 pounds of mail, or (2) 36 inches of mail (excluding the height of the pallet). Pallets prepared using either minimum requirement may be combined in the same mailing.

7.1.8 Overflow Sacks

After filling pallets to a 5-digit scheme or 5-digit destination, any remaining pieces that do not meet the minimum pallet requirements may be prepared in 5-digit scheme or 5-digit overflow sacks. Overflow sacks must be labeled under [7.2.3](#).

7.1.9 Pallet Labeling

Pallet labels must be prepared as follows:

- a. *5-digit scheme*, optional; labeling:
 - 1. Line 1: use [L606](#), Column B.
 - 2. Line 2: "PSVC PARCELS 5D SCH."
- b. *5-digit*, labeling:
 - 1. Line 1: use city, state, and 5-digit ZIP Code destination of pieces.
 - 2. Line 2: "PSVC PARCELS 5D."

7.2 Combining Parcel Select and Package Services Machinable Parcels for DBMC Entry**7.2.1 Qualification**

Mailers may combine Parcel Select and Package Services machinable parcels for entry at a BMC when authorized by the USPS under [7.5](#). These parcels may be eligible for Parcel Post, Parcel Select DBMC/ASF, single-piece and Presorted Media Mail, single-piece and Presorted Library Mail, Bound Printed Matter DBMC, and single-piece and Presorted Bound Printed Matter prices. Mailers may not combine Carrier Route Bound Printed Matter with other parcels.

7.2.2 Basic Standards

Parcel Select and Package Services parcels must meet the following conditions:

- a. Each piece in a combined machinable parcels mailing must meet the criteria for machinable parcels in [401.1.5](#).
- b. Each parcel in a combined machinable parcels mailing is subject to the applicable content and price eligibility standards for the price claimed.
- c. Parcel Select machinable parcels must bear a barcode under [708.5.0](#) for the ZIP Code of the delivery address.

- d. Postage must be paid via permit imprint under an approved manifest mailing system as provided in 3.0. For mailings presented under 7.0, mailers may document and pay postage using the Electronic Verification System (eVS) under 2.9.
- e. Mailers must pay all applicable presort mailing and destination entry mailing fees.
- f. Minimum volume requirements for Parcel Select, Presorted Bound Printed Matter, Presorted Library Mail, and Presorted Media Mail must be met separately and are based solely on the quantity of pieces eligible for each price at the required presort level. Pieces claimed at other prices in the same sack or on the same pallet do not count toward these minimum volume requirements.
- g. Parcels may be claimed at single-piece, Presorted, and DBMC/ASF destination entry prices as applicable.
- h. Mailers must prepare all parcels in sacks under 6.2.3, or on pallets or in pallet boxes under 8.0, to achieve the finest level of sortation.
- i. Mailers must deposit combined machinable parcels at BMCs under applicable standards in 15.0.

7.2.3 Sacking and Labeling

Preparation sequence, sack size, and labeling:

- a. *5-digit scheme*, optional, 10-piece or 20-pound minimum; labeling:
 - 1. Line 1: use L606, Column B.
 - 2. Line 2: "PSVC MACH 5D SCH."
- b. *5-digit*, optional except for Bound Printed Matter, required for 5-digit price for Media Mail and Library Mail, 10-piece or 20-pound minimum; labeling:
 - 1. Line 1: use city, state, and 5-digit ZIP Code on mail (see 8.0 for overseas military mail).
 - 2. Line 2: "PSVC MACH 5D."
- c. *ASF*, optional, allowed only for mail deposited at an ASF to claim DBMC price, 10-piece or 20-pound minimum; labeling:
 - 1. Line 1: use L602, Column B. DBMC price eligibility is determined by 6.3.
 - 2. Line 2: "PSVC MACH ASF."
- d. *BMC*, required, 10-piece or 20-pound minimum; labeling:
 - 1. Line 1: use L601, Column B. DBMC price eligibility is determined by 6.3.
 - 2. Line 2: "PSVC MACH BMC."

7.2.4 Pallet Presort and Labeling

Mailers must prepare pallets in the sequence listed below and complete each required level before preparing the next optional or required level. Unless indicated as optional, all sort levels are required under the conditions shown. Destination entry price eligibility applies only to Parcel Select (see 453.3.0 and 455.4.0) and Bound

705.7.3

Printed Matter (see [466.3.0](#)). Mailers may, at their option, prepare all machinable parcels for destination entry (see [7.0](#)). Mailers must label pallets according to the Line 1 and Line 2 information listed below and under [8.0](#).

- a. *5-digit scheme*, optional. Pallet may contain parcels for the same 5-digit scheme under [L606](#). Pallets need not be prepared for all 5-digit scheme destinations. For 5-digit destinations not part of [L606](#), or for which scheme sorts are not performed, prepare 5-digit pallets under [2.4](#). Labeling:
 1. Line 1: use [L606](#), column B.
 2. Line 2: "PSVC MACH 5D," as applicable; followed by "SCHEME" (or "SCH").
- b. *5-digit*, optional except for Bound Printed Matter, required for 5-digit price eligibility for Media Mail and Library Mail. Pallet must contain parcels only for the same 5-digit ZIP Code. Labeling:
 1. Line 1: use city, state, and 5-digit ZIP Code destination (see [8.0](#) for military mail).
 2. Line 2: "PSVC MACH 5D," as applicable.
- c. *ASF*, required if claiming DBMC prices, otherwise optional. Not available for the Buffalo, NY ASF. Pallets must contain only parcels for the 3-digit ZIP Code groups in [L602](#). Labeling:
 1. Line 1: use [L602](#), column B.
 2. Line 2: "PSVC MACH ASF," as applicable.
- d. *BMC*, required. Pallets must contain only parcels for the 3-digit ZIP Code groups in [L601](#). Labeling:
 1. Line 1: use [L601](#), column B. DBMC price eligibility is determined by [Exhibit 446.3.1](#).
 2. Line 2: "PSVC MACH BMC," as applicable.

7.3 Postage Payment

Postage for all pieces must be paid with permit imprint at the Post Office serving the mailer's plant under [2.0](#).

7.4 Documentation

Mailers must complete separate postage statements for each of the mailings contained within the combined mailing. At the time of mailing, mailers must provide all postage statements and a Business Mailer Support-approved manifest prepared according to [2.0](#) and this section.

7.5 Authorization

A mailer who wants to present combined parcel mailings must submit a written request to Business Mailer Support (See [608.8.1](#) for address). The request must show the mailer's name and address, the mailing office, evidence of authorization to mail under [2.0](#), procedures for combined mailing, the expected date of first mailing, a sample of the required manifest, and a sample USPS Qualification report. Business Mailer Support will review documentation and provide written authorization, which may not exceed 2 years. A mailer may terminate an

authorization at any time by written notice to the postmaster of the office serving the mailer's location. Business Mailer Support may terminate an authorization, by written notice, if the mailer does not meet the standards.

8.0 Preparing Pallets

8.1 Physical Characteristics

8.1.1 Standards

All pallets presented to the USPS, whether USPS-provided or mailer-provided, must meet the standards in 8.1.2 through 8.1.4. Mail on such pallets must meet the standards for the class and price claimed.

8.1.2 Construction

Pallets must be made of high-quality material that can hold loads equal to a gross weight of 2,200 pounds. Pallets must measure 48 by 40 inches and must allow four-way entry by forklift trucks and two-way entry by pallet jacks.

8.1.3 Securing Pallets

Except for stacked pallets under 8.3.1 and pallet boxes under 8.4.3, each loaded pallet of mail must be prepared to maintain the integrity of the mail and the entire pallet load during transport and handling using one of the following methods:

- a. Securing with at least two straps or bands of appropriate material. Wire or metal bands, straps, buckles, seals, and similar metal fastening devices cannot be used.
- b. Wrapping with stretchable or shrinkable plastic.
- c. Securing with at least two straps or bands of appropriate material and wrapping with stretchable or shrinkable plastic. Wire and metal bands and straps, metal buckles, metal seals, and similar metal fastening devices cannot be used.

8.1.4 Nonconforming Mailer

The USPS informs any mailer or mailer's agent who presents palletized mailings, including plant-verified drop shipment (PVDS), when the mailer's pallets fail to meet basic pallet integrity and safety standards. After a mailer is notified and allowed to make changes to improve load integrity, if the mailer's methods, or those of the mailer's agent, do not work, the mailer is considered nonconforming. A nonconforming mailer must meet the specifications for nonconforming mailers for top-cap use, stacking of pallets, pallet box construction, and maximum height/tiers of trays in 8.2 through 8.5, respectively. A mailer is suspended from the pallet program if the mailer's pallets continue to fail to meet the minimum load integrity levels after being notified and allowed to make changes.

8.2 Top Caps

8.2.1 Use

Top caps are used as follows:

705.8.2.2

- a. Except as provided below, all pallets of sacks, trays, parcels, bundles of mail, or pallet boxes must be top-capped if the pallets are stacked two, three, or four tiers high when presented to the USPS for acceptance.
- b. The top pallet need not be top-capped if the strapping or banding securing the stacked pallets together neither damages the mail on the top pallet nor allows the stack to shift.
- c. Lower pallet(s) containing either parcels or bundles of mail need not be top-capped if the top surface of each pallet load provides a sturdy, flat surface, parallel to the pallet base, that allows safe and efficient stacking of pallets placed on top and prevents sliding of the top pallet(s), damage to the loaded mail, or crushing of the load.

8.2.2 Construction

Any material may be used as a top cap if it provides a flat, level surface horizontal to the base pallet, protects the integrity of the mail below it while supporting a loaded pallet above, and allows easy entry of a forklift to remove the upper pallet(s). Flimsy paper or fiberboard (e.g., the ends of paper rolls) or similar material is inadequate and may not be used as a top cap.

8.2.3 Securing

A top cap must be secured to the pallet horizontal to the plane of the base pallet, with either stretchwrap or at least two crossed straps or bands, so that the cap stays in place to protect the mail and maintain the integrity of the pallet load.

8.2.4 Use by Nonconforming Mailer

A nonconforming mailer (see 8.1.4) must use top caps on all pallets of sacks, letter mail trays, parcels, or bundles of mail, regardless of weight, or on pallets containing pallet boxes no more than 60 inches high. Top caps must be approximately 48 by 40 inches and meet one of these construction standards:

- a. Five-wood boards, with uniform edges and nine-leg pallet contact for stacking.
- b. Fiberboard box-end style, with a minimum 3-inch side and wall material of at least double-wall corrugated fiberboard C-flute and/or B-flute.
- c. Fiberboard honeycomb covered on both sides, with heavy linerboard at least 1/2 inch thick.
- d. Corrugated fiberboard C-flute sheet covering the entire top of the load, with standard pallet solid fiberboard corner edge protectors.

8.3 Stacking Pallets**8.3.1 Physical Characteristics**

Pallets may be stacked two, three, or four tiers high if:

- a. The combined gross weight of the stacked pallets (pallets, top caps, and mail) does not exceed 2,200 pounds.
- b. The heaviest pallet is on the bottom and the lightest is on the top.
- c. Individual pallets are secured with straps or stretchable or shrinkable plastic as specified in 8.1.3.

- d. The stack of pallets is secured with at least two straps or bands of appropriate material to maintain the integrity of the stacked pallets during transport and handling. Wire or metal bands, straps, buckles, seals, and similar metal fastening devices cannot be used. The stack of pallets cannot be secured together with stretchable or shrinkable plastic.
- e. Each pallet is top-capped as specified in 8.2.
- f. The combined height of the stacked pallets and their loads does not exceed 84 inches. *Exception:* Pallets prepared for entry at Anchorage or Fairbanks, Alaska, cannot exceed 72 inches (pallets, top caps, and mail).

8.3.2 Pallet Height Restriction for Nonconforming Mailer

A nonconforming mailer (see 8.1.4) who stacks pallets is subject to the requirements of 8.3.1 with the additional restrictions that the combined height of any stacked pallets may not exceed 77 inches and that stacking pallets four tiers high is permitted only for pallets of parcels.

8.4 Pallet Boxes

8.4.1 Use

A mailer may use pallet boxes constructed of single-, double-, or triple-wall corrugated fiberboard placed on pallets to hold sacks or parcels. Pallet boxes must protect the mail and maintain the integrity of the pallet loads throughout transportation, handling, and processing. Single-wall corrugated fiberboard may be used only for light loads (such as lightweight parcels) that do not require transportation by the USPS beyond the entry office, or for Parcel Select DSCF price mail. Mailers must supply their own pallet boxes. The base of the boxes must measure approximately 40 by 48 inches. Pallet standards require the use of pallet boxes meeting the size requirements in 8.4.2 for machinable Parcel Select claiming OBMC Presort and BMC Presort discounts. Pallet standards prohibit use of pallet boxes for nonmachinable Parcel Select claiming OBMC Presort and BMC Presort discounts. Pallet boxes meeting the size dimensions in 8.4.2 also may be used at the mailer's option for Parcel Select DSCF and Parcel Select DDU price mail.

8.4.2 Height

The combined height of a single pallet, pallet box, and mail may not exceed 77 inches. The contents of the box may not extend above the top rim of the box. For all Parcel Select and Package Services mailings entered at a DSCF or DDU, the height of the pallet box may not exceed 60 inches (excluding the pallet). For Parcel Select OBMC Presort and BMC Presort price mailings of machinable pieces, the height of the pallet box must not exceed 69 inches (excluding the pallet).

8.4.3 Securing

Pallet boxes must be secured to the pallet with strapping, banding, stretchable plastic, shrinkwrap, or other material (wire or metal bands, straps, buckles, seals, and similar metal fastening devices cannot be used) that ensures that the pallet can be safely unloaded from vehicles, transported, and processed as a single unit to the point where the contents are distributed with the load intact if:

705.8.4.4

- a. The pallet and its contents are transported by the USPS from the office where the mail is accepted to another postal facility where the contents are distributed; and
- b. The weight of the mail in the box is not sufficient to hold the box in place on the pallet during transportation and processing.

8.4.4 Use by Nonconforming Mailer

Except when mailing Parcel Select claiming a DSCF or DDU price, a nonconforming mailer (see 8.1.4) may use pallet boxes only if the boxes are constructed of triple-wall corrugated fiberboard (C-flute and/or B-flute material) with a maximum height (pallet and box) of 77 inches.

8.5 General Preparation

8.5.1 Presort

Pallet sortation is generally intended to presort the palletized portion of a mailing to at least the finest extent required for the corresponding class of mail and method of preparation. Pallet sortation is sequential from the lowest (finest) level to the highest and must be completed at each required level before the next optional or required level is prepared. Standard preparation terms are defined in the Mail Preparation section for each class of mail, standard presort levels are defined in 8.0, and advanced presort levels are defined in 10.0, 12.0, and 13.0. For sacks, trays, or machinable parcels on pallets, the mailer must prepare all required pallet levels before any mixed ADC or mixed BMC pallets are prepared for a mailing or job. Bundles must not be placed on mixed ADC or mixed BMC pallets. Bundles that cannot be placed on pallets must be prepared in sacks under the standards for the price claimed. The standards for bundle reallocation to protect the SCF, ADC, or BMC pallet (8.11, 8.13, and 8.14) are optional methods of pallet preparation designed to retain as much mail as possible at the SCF, ADC, or BMC level. These standards may result in some bundles of Periodicals flats and irregular parcels and Standard Mail flats that are part of a mailing job prepared in part as palletized flats at automation prices not being placed on the finest level of pallet possible. Mailers must use PAVE-certified presort software to prepare mailings using bundle reallocation (bundle reallocation is optional, but if performed, it must be done for the complete mailing job).

8.5.2 Required Preparation

The following standards apply to Periodicals, Standard Mail, Parcel Select, and Package Services, except Parcel Select mailed at BMC Presort, OBMC Presort, DSCF, and DDU prices.

- a. Mailers must prepare a pallet to the required sortation level(s) for the class of mail when a mailing contains 500 or more pounds of bundles, sacks, or parcels or 72 linear feet or six layers of letter trays for the destination.
- b. For bundles of flat-size mailpieces or bundles of irregular parcels on pallets, after preparing all possible pallets under 8.5.2a, when 250 or more pounds of bundles remain for an ADC (Periodicals) or for a BMC/ASF (Standard Mail, Parcel Select, and Package Services), mailers must prepare the ADC or

BMC/ASF pallet, as applicable for the class of mail. Exception: If there are no ADC or BMC/ASF pallets in a mailing and 250 or more pounds remain for an SCF, mailers must prepare the SCF pallet.

- c. If bundles remain that cannot be prepared on an ADC, BMC/ASF, or SCF pallet, mailers must place those bundles in sacks (8.9.1).

8.5.3 Minimum Load

The following minimum load standards apply to mail prepared on pallets:

- a. For Periodicals, Standard Mail, Parcel Select, and Package Services (except for Parcel Select mailed at BMC Presort, OBMC Presort, DSCF, and DDU prices):
 1. In a single mailing, the minimum load per pallet is 250 pounds of bundles, parcels, or sacks, except as provided in items 2 through 4 below. When preparing letter trays on pallets, the minimum load is 36 linear feet or three layers of trays, except as provided in item 3 below.
 2. There is no minimum load for pallets entered at a destination delivery unit (DDU) if the mail on those pallets is for that unit's service area.
 3. A pallet may contain a minimum of 100 pounds of nonletter-size mail or 12 linear feet of letter trays if it is a BMC or ASF pallet entered at the destination BMC or ASF; an ADC pallet entered at the destination ADC; an SCF pallet entered at the destination SCF; or the only pallet entered at an individual destination BMC or ASF, ADC, or SCF facility.
 4. At an SCF, a 5-digit, 3-digit, or SCF pallet may contain less than the required minimum load of mail for that SCF's service area only if the SCF manager provides written authorization for such preparation.
- b. Parcel Select mailed at BMC Presort, OBMC Presort, DSCF, and DDU prices. A minimum load for the price claimed may be stated in terms of weight, combined piece minimum and weight, or minimum height. There are separate minimum mail heights for machinable parcels and for nonmachinable parcels claimed at OBMC Presort and BMC Presort prices. Mail entered at the Parcel Post DSCF prices and prepared directly on pallets or in pallet boxes on pallets must be prepared under either a minimum height requirement or under one of two options requiring a minimum number of pieces and pounds per pallet. There is no minimum weight requirement for an SCF pallet containing 5-digit scheme and 5-digit sacks prepared for the DSCF price. There are no minimums for the Parcel Select DDU price.

8.5.4 Minimum Height of Mail

The definitions of the minimum height of mail used to qualify for OBMC Presort, BMC Presort, and DSCF Parcel Select prices are as follows:

- a. *Machinable parcels.* The minimum height of mail in a pallet box is the shortest vertical distance measured from the bottom of a pallet box to the top of the lowest mailpiece. The height of the pallet is not included in this measurement.
- b. *Nonmachinable parcels.* The minimum height of mail on a pallet is the shortest vertical distance measured from the top of the pallet to the top of the lowest mailpiece. The height of the pallet is not included in this measurement.

8.5.5 Maximum Load

The maximum weight (mail and pallet) is 2,200 pounds. The maximum height of a single pallet (mail and pallet) is 77 inches for bundles, parcels, sacks, or pallet boxes, or 77 inches or 12 layers of trays (whichever occurs first) for letter trays.

Exception: A single pallet that is prepared for entry at Anchorage or Fairbanks, Alaska, has a maximum height of 72 inches (pallet, top cap, and mail).

8.5.6 Mail on Pallets

[9-11-08] These standards apply to mail on pallets:

- a. Pieces in trays, bundles, and sacks must be prepared under the standards for the class of mail and price claimed.
- b. When two or more Periodicals mailings, two or more Standard Mail mailings, or two or more Bound Printed Matter mailings are placed together on pallets, the mailer must keep records for each mailing as required by the standards for the class of mail.
- c. For letter-size Standard Mail and Periodicals prepared in trays on pallets, mailers must prepare carrier route price mail on separate 5-digit pallets (5-digit carrier routes pallets) from automation price or nonautomation price mail (5-digit pallets).
- d. For determining minimum pallet volume, mail in letter trays is measured in full layers of trays or in linear feet. A 2-foot tray equals 2 linear feet; a 1-foot tray equals 1 linear foot.
- e. Heavier, fuller trays must be placed at the bottom of the load.
- f. For Bound Printed Matter irregular parcels, Presorted and Carrier Route price mail may be combined on all levels of pallet. For Bound Printed Matter flats, Presorted and Carrier Route price mail may be combined on all levels of pallet except as provided in 8.5.6g.
- g. For sacks of Periodicals, Standard Mail, and Bound Printed Matter flats or irregular parcels, carrier route price mail must be prepared on separate 5-digit pallets from automation price and/or presorted price mail.
- h. Periodicals, Standard Mail, and Bound Printed Matter flats or irregular parcels prepared in carrier route and noncarrier route 5-digit bundles may be placed on the same merged 5-digit scheme, merged 5-digit, and 5-digit metro pallet, as appropriate.
- i. All presort bundles on pallets must be placed with the addresses facing up.

8.5.7 Arranging Pieces in a Bundle (“Facing”)

Except as noted in 8.5.8, all pieces in a bundle must be “faced” (arranged with the addresses in the same read direction), with an address visible on the top piece.

8.5.8 Counter-Stacking—Sacked and Palletized Mail

Bundles of flats and other pieces of nonuniform thickness may be prepared by counter-stacking under these conditions:

- a. Counter-stacking should be used only to create bundles of more uniform thickness that are more likely to maintain their integrity during transportation and processing.

- b. Counter-stacking is appropriate for saddle-stitched mailpieces and pieces where one edge is thicker than other edges or one corner is thicker than other corners.
- c. When counter-stacking, pieces must all have addresses facing up and be divided into no more than four approximately equal groups, with each group rotated 180 degrees from the preceding and succeeding group(s); prepare as few groups as possible to create a bundle of uniform thickness.
- d. Counter-stacked groups within a bundle should be as thick as possible, generally at least 1 inch thick.
- e. When pieces are nonuniform in thickness because they are thicker in the center instead of along an edge or corner, counter-stacking will generally not result in a bundle of uniform thickness (i.e., a football-shaped bundle would be created). Instead of counter-stacking such pieces, limit the height (thickness) of the bundle to 3 to 6 inches to ensure the bundle will stay together during normal transit and handling.

8.5.9 Address Visibility

Mailers preparing presort bundles must ensure that the delivery address information on the top mailpiece in each bundle is visible and readable by the naked eye. Mailers using strapping that might cover the address can avoid obstructing visibility by using clear, smooth strapping tightly secured around the bundle. Mailers using barcoded pressure-sensitive bundle labels, optional endorsement lines, carrier route information lines, or carrier route facing slips also must ensure that the information in these presort designations is visible and readable by the naked eye. This standard does not apply to the following:

- a. Customized MarketMail.
- b. Bundles placed in or on 5-digit or 5-digit scheme (L001) sacks or pallets.
- c. Bundles placed in carrier route and 5-digit carrier routes sacks.
- d. Bundles of mailpieces at carrier route prices entered at a destination delivery unit (DDU).
- e. Bundles of Standard Mail flat-size pieces prepared in letter trays under 345.3.4.

8.5.10 Labeling Bundles

[7-3-08] Unless excepted by standard, the presort level of each bundle (other than carrier route bundles) must be identified either with an optional endorsement line under 708.7.0 or with a barcoded pressure-sensitive bundle label. On letter-size mail (including card-size pieces), the bundle label must be placed in the lower left corner of the address side of the top piece in the bundle. On flat-size mail, the label may be placed anywhere on the address side of the top piece in the bundle. Barcoded pressure-sensitive bundle labels must not obscure the delivery address block. Banding or shrinkwrap must not obscure any bundle label. The following colors and presort characters apply to bundle labels:

- a. Firm (Periodicals use only), blue Label F.
- b. 5-digit scheme presort level, red Label 5 SCH.
- c. 5-digit presort level, red Label 5.

705.8.5.11

- d. 3-digit scheme presort level, green Label 3 SCH.
- e. 3-digit presort level, green Label 3.
- f. ADC presort level, pink Label A.
- g. Mixed ADC presort level, tan Label X.

8.5.11 Securing Bundles on Pallets

Bundles must withstand normal transit and handling without breaking and without causing injury to USPS employees or damage to USPS equipment. Mailers must meet the following standards when preparing and securing bundles:

- a. Secure bundles with banding, shrinkwrap, or shrinkwrap supplemented with one or more bands. *Banding* includes plastic bands, rubber bands, twine, string, and similar material. Mailers must meet the following standards when banding bundles:
 - 1. Do not place any bands closer than 1 inch from any bundle edge.
 - 2. When using twine or string to band bundles, secure the knot(s) so the twine or string does not come loose during transit and processing.
 - 3. Do not use wire or metal banding.
 - 4. Do not use any loose banding.
- b. When using only banding to secure bundles, apply banding under the following additional requirements:
 - 1. Use at least one band to encircle the length of the bundle and use at least one band to encircle the girth of the bundle.
 - 2. Use tension sufficient to tighten and depress the edges of the bundle so that pieces do not slip out of the banding during transit and processing.

8.5.12 Sacked Mail

Mail that is not palletized (e.g., the mailer chooses not to prepare BMC pallets, or the bundles do not meet the machinability standards in [8.5.7](#) through [8.5.11](#)) must be prepared under the standards for the price claimed. For Periodicals, the mailer must separately sack bundles of each publication that are not palletized or that are excluded from palletization. Trays that are not palletized must be bedloaded. Sacks (including sacks of bundles not placed on pallets) containing bundles remaining after all pallets are prepared may be presented with the palletized mail (and reported on the same postage statement) if separated from the palletized portion of the mailing.

8.5.13 Nonconforming

For a nonconforming mailer (see [8.1.4](#)) of letter-size mail in trays, the combined height of a pallet and its load cannot exceed six layers of MM or EMM letter trays.

8.6 Pallet Labels

8.6.1 Placement

[10-9-08] At least two clearly visible labels must be affixed on two adjacent sides of each pallet. It is recommended that pallets prepared through plant-load or drop-shipment agreements be placed on transportation so that a pallet placard on each pallet faces toward the rear of the vehicle.

8.6.2 Specifications

[10-9-08] Pallet placards must be pink for Periodicals and white for First-Class Mail, Standard Mail, Package Services, and Parcel Select. Pallet placards must measure at least 8 inches by 11 inches, except that pallet or other USPS container placards bearing Intelligent Mail container barcodes may measure no less than 4 inches by 7 inches when prepared under 708.6.6.6. Placards bearing Intelligent Mail container barcodes must meet the standards for Intelligent Mail container placards in 708.6.6 and at <http://ribbs.usps.gov>.

8.6.3 Lettering

Lettering for required information on pallet labels must be at least 1/2 inch high (or at least 48-point type). *Exception:* When customers apply USPS-specified pallet barcodes to pallet labels, the lettering for the required information on line 3 (origin line) must be at least 1/8 inch high (or at least 12-point type). See the “surface visibility” information at <http://ribbs.usps.gov> for more information about pallet barcodes.

8.6.4 Line 1 (Destination Line)

Line 1 (destination line) must meet these standards:

- a. *Placement.* Line 1 must be the first visible line on the label. It must be completely visible and legible when placed on the pallet. If the pallet label does not provide enough space for all required Line 1 information, the destination ZIP Code may be placed right-justified on the line immediately below the rest of Line 1 and above Line 2 (content line). A standard abbreviation for the destination city name may be used.
- b. *Information.* Line 1 must contain only the information specified by standard, including the appropriate destination facility prefix (e.g., “ADC”). Two zeros may follow the 3-digit ZIP Code prefix required by labeling standards (e.g., 223 as 22300).
- c. *Overseas military mail.* On 5-digit pallets for overseas military destinations, Line 1 shows, from left to right, “APO” or “FPO,” followed by “AE” (for ZIP Codes within the ZIP Code prefix range 090-098), “AA” (for ZIP Codes within the 3-digit ZIP Code prefix 340), or “AP” (for ZIP Codes within the ZIP Code prefix range 962-966), followed by the destination 5-digit ZIP Code of the mail on the pallet.

8.6.5 Line 2 (Content Line)

[8-6-08] Line 2 (content line) must meet these standards:

- a. *Content line information.* Pallet labels must indicate whether the mail on the pallet is barcoded, or not barcoded, or both. The content line (line 2 of required information) must be the second visible line on the label. This line must show

705.8.6.6

the class and processing category of the mail on the pallet and other information as specified by standard. If the content line of a pallet label does not provide enough space for all required information, the content information may be continued right-justified on the line immediately below the content line and above the office of mailing or mailer information line.

- b. *Codes.* The codes shown below must be used as appropriate on Line 2 of sack, tray, and pallet labels.

CONTENT TYPE	CODE
Barcoded	BC
Barcoded and Nonbarcoded	BC/NBC
Carrier Route	C (type of route)
Carrier Routes	CR-RT or CR-RTS
Digit	D
First-Class Mail	FCM
Flats	FLTS
General Delivery Unit	G
Highway Contract Route	H
Irregular Parcels	IRREG (Periodicals, Standard Mail, and Package Services only)
Letters	LTR or LTRS
Machinable	MACH
Mixed	MXD
Mixed Machinable and Irregular Parcels	MACH & IRREG (Standard Mail only)
Nonmachinable	NON MACH
Nonbarcoded	NON BC (sacks) NBC (pallets and cotrayed or cosacked mail under 705.9.0)
Nonmachinable Parcels	NON MACH
Package Services	PSVC
Parcels	PARCELS (First-Class Mail and Package Services only)
Periodicals	PER (see 707.21.1.3) NEWS (see 707.21.1.3)
Post Office Box Section	B
Rural Route	R
Scheme	SCH
Standard Mail	STD
Working	WKG

8.6.6 Line 3 (Origin Line)

The office of mailing or mailer information line (line 3 of required information) must be the bottom line of required information unless the pallet or pallet box contains mail prepared under the Electronic Verification System (eVS). Line 3 must show either the

city and state of the entry Post Office or the mailer's name and the city and state of the mailer's location. It is recommended that the mailer's name also appear with the city and state of the entry Post Office. Electronic Verification System

All pallets and pallet boxes containing parcels prepared and identified using the Electronic Verification System (eVS) under 2.9 must show "eVS" (or the alternatives "EVS" or "E-VS") directly below line 3 (origin line) using the same size and lettering used for Line 3.

8.6.7 5-Digit, 5-Digit Carrier Routes, and 5-Digit Scheme Carrier Routes Pallets

All 5-digit carrier routes or 5-digit scheme carrier routes pallets must show the words "CARRIER ROUTES" (or "CR-RTS") after the processing category description on the content line under 8.0, 10.0, 12.0, and 13.0. 5-digit pallets of Bound Printed Matter that contain only carrier route price mail also must show the words "CARRIER ROUTES" (or "CR-RTS") after the "5D" pallet level description on the contents line.

8.6.8 Extraneous Information

Extraneous information is permitted on pallet labels if:

- a. The print size is smaller than a 1/2 inch.
- b. It does not consist of a numbered series resembling a ZIP Code or 3-digit ZIP Code prefix.
- c. It does not appear on or between the lines reserved for USPS required information (blank lines are permitted). Exception: For combined mailings of Standard Mail and Package Services machinable parcels, mailer codes and extraneous information may appear between the content line and the office of mailing or mailer information line.
- d. It is below the office of mailing or mailer information line.
- e. A 1-inch clear space is maintained around the lines reserved for USPS required information.
- f. On the office of mailing or mailer information line, the mailer's name or abbreviation, "Mailer," "From" (or "FR"), "Entered at," or a similar notation precedes the required information, or mailer codes or other extraneous information appear to the right of the required information.

8.6.9 Periodicals Publications

Except as provided in 8.16 for copalletized mailings, Periodicals publications must use one of the following for Line 2 class information:

- a. "PER."
- b. "NEWS" if published weekly or more often or if authorized newspaper treatment as of March 1, 1984.

8.6.10 Pallet Bundle Information

It is recommended that mailers preparing bundles on pallets add to the pallet label, below the office of mailing or mailer information line and according to the provisions of 8.6.8, additional information listing the number of bundles for each bundle

sortation and price level on the pallet (i.e., the number of carrier route bundles, the number of 5-digit, 3-digit, and ADC automation price bundles, and the number of 5-digit, 3-digit, and ADC Presorted price bundles on each pallet).

8.7 Copalletized, Combined, or Mixed-Price Level Mailings of Flat-Size Pieces

8.7.1 General

Palletized mailings (including combined, copalletized, and mixed price level mailings) must be prepared under the standards for the class of mail, subject to specific authorization by Business Mailer Support when required.

8.7.2 Application

The mailer (or publisher or agent) must submit a written request to Business Mailer Support to present the types of pallets described in this section. A separate request is required for each type of pallet at each location, but multiple, concurrent applications are acceptable. A mailer who cannot meet the minimum palletization standards without copalletizing, combining, or commingling mixed price mailings might still qualify if the total copalletized, combined, or commingled mailing meets minimum pallet standards. The request must be received at least 30 days before the first mailing and include the names, addresses, and telephone numbers of the mail owner and of the firm or person preparing the mail; a description of the mailing (e.g., size, weight, class, price, volume, mailing frequency, and postage payment method); the type of authorization requested; and a sample of the applicable documentation under [8.0](#), or [10.0](#), [12.0](#), and [13.0](#).

8.7.3 Periodicals Publications

To combine more than one Periodicals publication on pallets, the mailer must merge and presort copies of all the publications into common bundles to achieve the finest presort level for the combined mailing. To copalletize different Periodicals flat-size publications, the mailer must consolidate on pallets all independently sorted bundles for each publication to achieve the finest presort level for the mailing. A combined or copalletized mailing prepared using bundle reallocation under [8.11](#) or [8.13](#) may not always result in all bundles being placed on the finest pallet level possible. Both combined and copalletized publications must be supported by the documentation required in [8.0](#), or [10.0](#), [12.0](#), and [13.0](#). Preferred Periodicals may be combined with Regular Periodicals only as permitted by standard.

8.7.4 Standard Mail

To copalletize different Standard Mail flat-size mailings, the mailer must consolidate on pallets all independently sorted bundles from each mailing to achieve the finest presort level for the mailing, except that a copalletized mailing prepared under [8.11](#) or [8.14](#) using the bundle reallocation option may not always result in all bundles being placed on the finest pallet level possible. At the time of mailing, the mailer must present computer-generated listings required in [8.0](#), or [10.0](#), [12.0](#), and [13.0](#) that include a summary list consolidating the copalletized multiple mailings and a list of the contents of each pallet by ZIP Code and presort level.

8.7.5 Cancellation

An authorization may be canceled by Business Mailer Support if the mailer does not meet the standards for pallets or the prices claimed or the mailer does not submit information on future mailings as requested by Business Mailer Support. A mailer may appeal canceled authorizations through Business Mailer Support to the Business Mail Acceptance manager, USPS Headquarters.

8.8 Basic Uses

These types of mail may be palletized:

- a. Letter-size mail in trays.
- b. Bundles of nonletter-size mail not prepared in sacks.
- c. Bundles or parcels in sacks.
- d. Machinable or irregular parcels.
- e. Copalletized multiple flat-size mailings, subject to [8.0, *Preparing Pallets*](#).
- f. Combined mailings of machinable parcels (Standard Mail and Package Services), subject to [6.0](#).
- g. Two or more Periodicals publications combined or copalletized, subject to [8.0](#).
- h. Combined mailings of Nonprofit Standard Mail mixed price levels, subject to [8.0](#).
- i. Commingled zoned price Parcel Select and Package Services, subject to [455.1.7](#).

8.9 Bundles on Pallets

8.9.1 Applicability

Presort destination bundles of Periodicals, Standard Mail, and Package Services flats and irregular parcels may be placed directly on pallets under [8.9.2](#) through [8.9.5](#) and [8.10](#). Mail that cannot be placed on pallets must be prepared in sacks under the applicable standards. Sacks containing any remaining bundles after all pallets are prepared may be presented with the palletized portion of the mailing job (and, subject to [8.16.5](#), reported on the same postage statement) if the sacked portion is presented separately from the palletized portion.

8.9.2 Basic Bundling Standards

Bundle preparation for Periodicals, Standard Mail, and Package Services mailpieces must meet the applicable standards for each class or subclass of mail. Bundles may be sorted onto pallets under [8.10](#) and [10.0](#), [12.0](#), and [13.0](#).

8.9.3 Periodicals

Bundle size: Six-piece minimum (lower volume bundles permitted under [707.22.0, *Preparing Nonbarcoded \(Presorted\) Periodicals*](#), and [707.23.0, *Preparing Carrier Route Periodicals*](#)), 20-pound maximum, except that:

- a. Firm bundles may contain as few as two copies of a publication. Mailers must not consolidate firm bundles with other bundles to the same 5-digit destination. Only In-County firm bundles may be counted as an addressed piece for presort standards (see [707.22.0](#) and [707.23.0](#)).

705.8.9.4

- b. All pieces for the same presort destination must be in one bundle if they weigh less than 10 pounds. Otherwise, bundles must weigh from 10 to 20 pounds each.
- c. Carrier route and 5-digit bundles placed on 5-digit or finer pallets may weigh up to 40 pounds when entered at a DDU.
- d. The last bundle to a presort destination may contain less than 10 pounds.

8.9.4 Standard Mail

Bundle size: 10-piece or 15-piece minimum as applicable; 20-pound maximum, except that:

- a. All pieces for the same presort destination must be in one bundle if they weigh less than 10 pounds. Otherwise, bundles must weigh from 10 to 20 pounds each.
- b. The last bundle to a presort destination may contain less than 10 pounds.

8.9.5 Bound Printed Matter

Bound Printed Matter on pallets must be bundled as follows:

- a. Minimum Bundle Size. Bundle mail under the minimum bundle size of “10 pieces or 10 pounds, whichever comes first” according to these standards:
 - 1. For identical-weight pieces, a single-piece weight of 1 pound results in 10 pieces weighing 10 pounds. Identical-weight pieces weighing 1 pound or less must be prepared using the 10-piece minimum; those that weigh more must be prepared using the 10-pound minimum.
 - 2. For nonidentical-weight pieces, mailers must either use the minimum that applies to the average piece weight for the entire mailing (divide the net weight of the mailing by the number of pieces; the resulting average single-piece weight determines whether the 10-piece or 10-pound minimum applies). Alternatively, bundle by the actual piece count or mail weight for each bundle destination, provided documentation can be presented with the mailing that shows (specifically for each bundle) the number of pieces and their total weight.
 - 3. Mailers must note on the accompanying postage statement whether they applied the 10-piece or 10-pound threshold, or both.
- b. Presorted and Carrier Route Bound Printed Matter:
 - 1. Only individual pieces of flats or irregular parcels that weigh less than 10 pounds each may be prepared as bundles on pallets. Presorted price pieces that weigh 10 or more pounds each must be prepared and palletized as machinable parcels under [8.10.4, Package Services Flats—Bundles and Sacks](#), or prepared in sacks under [365.5.0](#) for flats and [465.5.0](#) for parcels. Carrier route pieces that individually weigh 10 or more pounds each must either be prepared and palletized as machinable parcels under [8.10.4, Package Services Flats—Bundles and Sacks](#), and qualify for Presorted prices or be prepared in sacks under [365.6.0](#) for flats and [465.6.0](#) for parcels and qualify for carrier route prices.

2. Bundles must be prepared under [365.5.0](#) for presorted flats and [465.5.0](#) for presorted parcels, or [11.0](#), as appropriate. The minimum bundle size is 10 addressed pieces or 10 pounds, whichever occurs first, except that the last bundle to a presort destination may contain fewer than 10 pieces or weigh less than 10 pounds. When there are at least 10 pieces but less than 10 pounds for a presort destination, the pieces must be prepared in a single physical bundle. The maximum physical bundle size for pallets prepared under [8.10.4a](#) through [8.10.4d](#), and [8.10.5a](#) through [8.10.5g](#) is 40 pounds. The maximum physical bundle size for pallets prepared under [8.10.4e](#) through [8.10.4i](#), and [8.10.5h](#) through [8.10.5i](#) is 20 pounds. The total number of bundles for a single presort destination must not exceed the number of 10-pound increments to that destination. Each physical bundle must contain at least two addressed pieces.

8.10 Pallet Presort and Labeling

8.10.1 First-Class Mail—Letter or Flats Trays

[11-6-08] Mailers may palletize First-Class Mail according to a local customer/supplier agreement or under 8.10.1. First-Class Mail palletization is optional, but mailers using this option must prepare pallets in the sequence listed below and complete each required level before preparing the next optional or required level. Pallets must contain at least 72 linear feet of letter trays (six full layers) or 24 linear feet of flats trays (three full layers). Maximum pallet height is 12 layers or 77 inches of letter trays (whichever occurs first) or 77 inches of flats trays. When available and with approval by the plant manager of the origin facility, mailers may use all-purpose containers (APCs) or other USPS-approved containers. Mailers approved to use APCs must prepare containers when they have a minimum of 48 linear feet of letter trays or 16 linear feet of flats trays to a presort destination.

Preparation, sequence, and labeling:

- a. 5-digit. Optional. Based on the origin ZIP Code, for 5-digit ZIP codes within the 3-digit destinations listed in [L201](#) column B. Pallet may contain trays only for the same 5-digit ZIP Code (for non-automation letters and flats) or 5-digit scheme ZIP codes (automation letters only). Place 5-digit scheme trays on 5-digit pallets according to the destination shown in the current City State Product. Labeling:
 1. Line 1: city, state, and 5-digit ZIP Code destination.
 2. Line 2: "FCM LTRS" or "FCM FLTS," followed by "5D."
- b. Origin SCF (local mail). Required; no minimum. Pallet contains trays destined for the 3-digit ZIP Codes serviced by the origin SCF facility in L005; MXD AADC trays when the 3-digit ZIP Code on the tray indicates the origin facility is the processing facility for that mail (see [L201](#), Column C). Mailers may, at their option, place AADC trays on origin SCF pallets when the tray's "label to" 3-digit ZIP Code (from [L801](#)) is within the origin SCF's service area. Labeling:
 1. Line 1: [L002](#), Column C.
 2. Line 2: "FCM LTRS" or "FCM FLTS," followed by "SCF."

- c. SCF. Required. For destinations listed in [L201](#), based on origin ZIP Code. Pallet may contain trays destined for the 3-digit ZIP Codes in L005. Mailers may, at their option, place AADC trays on SCF pallets when the tray's "label to" 3-digit ZIP Code (from [L801](#)) is within that SCF's service area. Labeling:
 - 1. Line 1: [L002](#), Column C.
 - 2. Line 2: "FCM LTRS" or "FCM FLTS," followed by "SCF."
- d. AADC. Required, for machinable and automation letters only. For destinations listed in [L201](#), based on origin ZIP Code. Pallet may contain letter trays only for the 3-digit ZIP Code group in [L801](#). Labeling:
 - 1. Line 1: [L801](#), Column B.
 - 2. Line 2: "FCM LTRS," followed by "AADC."
- e. ADC. Required, for flats and nonmachinable letters only. For destinations listed in [L201](#), based on origin ZIP Code. Pallet may contain trays only for the 3-digit ZIP Code groups in [L004](#). Labeling:
 - 1. Line 1: [L004](#), Column B.
 - 2. Line 2: "FCM LTRS" or "FCM FLTS," followed by "ADC."
- f. Origin Mixed ADC Surface. Required. Pallet may contain trays destined for the 3-digit ZIP Codes in [L201](#), based on origin ZIP Code. Labeling:
 - 1. Line 1: "OMX" followed by city, state, and ZIP Code information for ADC serving 3-digit ZIP Code prefix of entry post office, as shown in [L201](#).
 - 2. Line 2: "FCM LTRS" or "FCM FLTS," followed by "WKG."
- g. Mixed ADC Air (all other). Required; no minimum. May contain surface trays when no mixed ADC surface container is prepared under [8.10.1f](#). Labeling:
 - 1. Line 1: "MXD" followed by city, state, and ZIP Code information for ADC serving 3-digit ZIP Code prefix of entry post office, as shown in [L004](#).
 - 2. Line 2: "FCM LTRS" or "FCM FLTS," followed by "WKG."

8.10.2 Periodicals—Bundles, Sacks, or Trays

[7-3-08] Pallets must be prepared under [8.0](#) in the sequence listed below and completed at each required level before the next optional or required level is prepared. Unless indicated as optional, all sort levels are required under the conditions shown. See [707.29.0](#) for additional requirements for destination entry prices eligibility. For mailings of sacks or trays on pallets, pallet preparation begins with [8.10.2e](#). Pallets must be labeled according to the Line 1 and Line 2 information listed below and under [8.6](#). All pallets prepared under [8.10.2](#) may contain firm bundles, and pallets prepared under [8.10.2a](#) through [8.10.2i](#) may contain low-volume bundles. Bundles of Periodicals flats and irregular parcels may also be palletized under [10.0](#), [12.0](#), or [13.0](#). For pieces meeting the standards in [707.26.0](#), mailers may prepare the nonpalletized (residual) portion of a mailing in sacks under [10.0](#).

- a. *Merged 5-digit scheme*, required, permitted for bundles only. Not permitted for bundles containing noncarrier route automation-compatible flats under [301.3.0](#). Required for bundles containing all other flats or irregular parcels.

Pallet must contain carrier route bundles and noncarrier route 5-digit bundles (automation price and/or Presorted price bundles) for the same 5-digit scheme under [L001](#). For 5-digit destinations not part of [L001](#), merged 5-digit pallet preparation begins with [8.10.2d](#). Labeling:

1. Line 1: [L001](#).
 2. Line 2: "PER" or "NEWS," as applicable; followed by "FLTS" or "IRREG," as applicable; followed by "CR/5D"; followed by "SCHEME" (or "SCH").
- b. *5-digit scheme carrier routes*, required, permitted for bundles only. Pallet must contain only carrier route bundles for the same 5-digit scheme under [L001](#). For 5-digit destinations not part of [L001](#), 5-digit carrier routes pallet preparation begins with [8.10.2e](#). Labeling:
1. Line 1: [L001](#).
 2. Line 2: "PER" or "NEWS," as applicable; followed by "FLTS" or "IRREG," as applicable; followed by "CARRIER ROUTES" (or "CR-RTS"); followed by "SCHEME" (or "SCH").
- c. *5-digit scheme*, required, permitted for bundles only. Not permitted for bundles containing automation-compatible flats under [301.3.0](#). Required for bundles containing all other flats and irregular parcels. Pallet must contain only 5-digit bundles of automation price and/or Presorted price mail for the same 5-digit scheme under [L001](#). For 5-digit destinations not part of [L001](#), 5-digit pallet preparation begins with [8.10.2f](#). Labeling:
1. Line 1: [L001](#).
 2. Line 2: "PER" or "NEWS," as applicable; followed by "FLTS" or "IRREG," as applicable; followed by "5D"; followed by "BARCODED" (or "BC") if pallet contains automation price mail; followed by "NONBARCODED" (or "NBC") if pallet contains Presorted price mail; followed by "SCHEME" (or "SCH").
- d. *Merged 5-digit*, required, permitted for bundles only. Not permitted for bundles containing noncarrier route automation-compatible flats under [301.3.0](#). Required for bundles containing all other flats or irregular parcels. Pallet must contain carrier route bundles and noncarrier route 5-digit bundles (automation price and/or Presorted price bundles) for the same 5-digit ZIP Code. Labeling:
1. Line 1: city, state, and 5-digit ZIP Code destination (see [8.6.4c](#) for overseas military mail).
 2. Line 2: "PER" or "NEWS," as applicable; followed by "FLTS" or "IRREG," as applicable; followed by "CR/5D."
- e. *5-digit carrier routes*, required, except for trays; permitted for bundles, sacks, and trays. Pallet must contain only carrier route mail for the same 5-digit ZIP Code. Labeling:
1. Line 1: city, state, and 5-digit ZIP Code destination (see [8.6.4c](#) for overseas military mail).
 2. Line 2: "PER" or "NEWS," as applicable; followed by "FLTS," "IRREG," or "LTRS," as applicable; followed by "CARRIER ROUTES" (or "CR-RTS").

705.8.10.2

- f. *5-digit*, required, except for trays; permitted for bundles, sacks, and trays. Pallet must contain only automation price and/or Presorted price mail for the same 5-digit ZIP Code or the same 5-digit scheme under [L007](#) (for automation-compatible flats only under [301.3.0](#)). Five-digit scheme bundles are assigned to pallets according to the “label to” 5-digit ZIP Code in [L007](#). Labeling:
1. Line 1: city, state, and 5-digit ZIP Code destination (see [8.6.4c](#) for overseas military mail).
 2. Line 2: “PER” or “NEWS,” as applicable; followed by “FLTS,” “IRREG,” or “LTRS,” as applicable; followed by “5D”; followed by “BARCODED” (or “BC”) if pallet contains automation price mail; followed by “NONBARCODED” (or “NBC”) if pallet contains Presorted price mail.
- g. *5-digit metro*, optional, permitted for bundles only. Pallet may contain carrier route, automation price, and/or Presorted price bundles for the 5-digit ZIP Codes in [L006](#), Column A, and for 3-digit ZIP Code groups in [L006](#), Column B. Labeling:
1. Line 1: [L006](#).
 2. Line 2: “PER” or “NEWS,” as applicable; followed by “FLTS” or “IRREG,” as applicable; followed by “METRO” (or “MET”); followed by “BARCODED” (or “BC”) if pallet contains automation price mail; followed by “NONBARCODED” (or “NBC”) if pallet contains carrier route and/or Presorted price mail.
- h. *3-digit*, optional, option not available for bundles for 3-digit ZIP Code prefixes marked “N” in [L002](#). Pallet may contain mail for the same 3-digit ZIP Code or the same 3-digit scheme under [L008](#) (for automation-compatible flats only under [301.3.0](#)). Three-digit scheme bundles are assigned to pallets according to the “label to” 3-digit ZIP Code in [L008](#). Labeling:
1. Line 1: [L002](#), Column A.
 2. Line 2: “PER” or “NEWS,” as applicable; followed by “FLTS,” “IRREG,” or “LTRS,” as applicable; followed by “3D”; followed by “BARCODED” (or “BC”) if pallet contains automation price mail; followed by “NONBARCODED” (or “NBC”) if pallet contains carrier route and/or Presorted price mail.
- i. *SCF*, required, permitted for bundles, sacks, and trays. Pallet may contain carrier route, automation price, and/or Presorted price mail for the 3-digit ZIP Code groups in [L005](#). Mailers may place origin mixed ADC (OMX) sacks on origin SCF pallets. Labeling:
1. Line 1: [L002](#), Column C.
 2. Line 2: “PER” or “NEWS,” as applicable; followed by “FLTS,” “IRREG,” or “LTRS,” as applicable; followed by “SCF”; followed by “BARCODED” (or “BC”) if pallet contains automation price mail; followed by “NONBARCODED” (or “NBC”) if pallet contains carrier route and/or Presorted price mail.

- j. *ADC*, required, permitted for bundles, sacks, and trays. Pallet may contain carrier route, automation price, and/or Presorted price mail for the 3-digit ZIP Code groups in [L004](#). Labeling:
 - 1. Line 1: [L004](#).
 - 2. Line 2: “PER” or “NEWS,” as applicable; followed by “FLTS,” “IRREG,” or “LTRS,” as applicable; followed by “ADC”; followed by “BARCODED” (or “BC”) if pallet contains automation price mail; followed by “NONBARCODED” (or “NBC”) if pallet contains carrier route and/or Presorted price mail.
- k. *Origin Mixed ADC (OMX)*, optional, no minimum, permitted for sacks only. Pallet may contain carrier route, automation price, and/or presorted price mail. Labeling:
 - 1. Line 1: Use the destination information shown in [L201](#), Column C for mail entered at the corresponding entry Post Offices in [L201](#), Column A.
 - 2. Line 2: “PER” or “NEWS,” as applicable; followed by “FLTS,” “IRREG,” or “LTRS,” as applicable; followed by “BARCODED” (or “BC”) if pallet contains automation price mail; followed by “NONBARCODED” (or “NBC”) if pallet contains nonautomation price mail; followed by “WKG.”
- l. *Mixed ADC*, optional, permitted for sacks and trays only. Pallet may contain carrier route, automation price, and/or presorted price mail. Pallets must not contain origin mixed ADC (OMX) sacks. Labeling:
 - 1. Line 1: “MXD” followed by city, state, and ZIP Code information for ADC serving 3-digit ZIP Code prefix of entry Post Office as shown in [L004](#), Column A (label to plant serving entry Post Office if authorized by processing and distribution manager).
 - 2. Line 2: “PER” or “NEWS,” as applicable; followed by “FLTS,” “IRREG,” or “LTRS,” as applicable; followed by “BARCODED” (or “BC”) if pallet contains automation price mail; followed by “NONBARCODED” (or “NBC”) if pallet contains carrier route and/or Presorted price mail; followed by “WKG.”

8.10.3 Standard Mail—Bundles, Sacks, or Trays

[7-3-08] Mailers must prepare pallets under [8.0](#) in the sequence listed below and complete each required level before preparing the next optional or required level. Unless indicated as optional, all sort levels are required. For irregular parcels, use this preparation only for pieces in carrier route bundles or in sacks. Palletize unbundled or unsacked irregular parcels under [705.8.10.6](#). Pallets must be labeled according to the Line 1 and Line 2 information listed below and under [8.6](#). Mailers also may palletize bundles of Standard Mail flats under [10.0](#), [12.0](#), or [13.0](#).

- a. *5-digit scheme carrier routes*, required, permitted for bundles only. Pallet must contain only carrier route bundles for the same 5-digit scheme under [L001](#). For 5-digit destinations not part of [L001](#), 5-digit carrier routes pallet preparation begins with [8.10.2e](#). Labeling:
 - 1. Line 1: [L001](#).

2. Line 2: “STD” followed by “FLTS” or “IRREG,” as applicable; followed by “CARRIER ROUTES” (or “CR-RTS”); followed by “SCHEME” (or “SCH”).
- b. *5-digit carrier routes*, required except for trays, permitted for bundles, sacks, and trays. Pallet must contain only carrier route mail for the same 5-digit ZIP Code. Labeling:
 1. Line 1: city, state, and 5-digit ZIP Code destination (see [8.6.4c](#) for overseas military mail).
 2. Line 2: For flats and irregular parcels, “STD” followed by “FLTS” or “IRREG,” as applicable; followed by “CARRIER ROUTES” (or “CR-RTS”). For letters, “STD LTRS”; followed by “CARRIER ROUTES” (or “CR-RTS”); followed by “BC” if pallet contains barcoded letters; followed by “MACH” if pallet contains machinable letters; followed by “MAN” if pallet contains nonmachinable letters.
- c. *5-digit*, required except for trays, permitted for bundles, sacks, and trays. Pallet must contain only automation price and/or Presorted price mail for the same 5-digit ZIP Code or same 5-digit scheme. 5-digit scheme bundles and sacks are assigned to 5-digit pallets according to the “label to” 5-digit ZIP Code. Labeling:
 1. Line 1: city, state, and 5-digit ZIP Code destination (see [8.6.4c](#) for overseas military mail).
 2. Line 2: For flats and irregular parcels, “STD” followed by “FLTS” or “IRREG,” as applicable; followed by “5D”; followed by “BARCODED” (or “BC”) if pallet contains automation price mail; followed by “NONBARCODED” (or “NBC”) if pallet contains Presorted price mail. For letters, “STD LTRS 5D”; followed by “BC” if pallet contains barcoded letters; followed by “MACH” if pallet contains machinable letters; followed by “MAN” if pallet contains nonmachinable letters.
- d. *5-digit metro*, optional, permitted for bundles only. Pallet may contain carrier route, automation price, and/or Presorted price bundles for the 5-digit ZIP Codes in [L006](#), Column A, and for 3-digit ZIP Code groups in [L006](#), Column B. Pallet labeling:
 1. Line 1: [L006](#).
 2. Line 2: For flats and irregular parcels, “STD” followed by “FLTS” or “IRREG,” as applicable; followed by “METRO” (or “MET”); followed by “BARCODED” (or “BC”) if pallet contains automation price mail; followed by “NONBARCODED” (or “NBC”) if pallet contains carrier route and/or Presorted price mail.
- e. *3-digit*, optional, option not available for bundles for 3-digit ZIP Code prefixes marked “N” in [L002](#). Pallet may contain mail for the same 3-digit ZIP Code or the same 3-digit scheme under [L008](#) (for automation-compatible flats only under [301.3.0, Physical Standards for Automation Flats](#)). Three-digit scheme bundles are assigned to pallets according to the “label to” 3-digit ZIP Code in [L008](#). Labeling:
 1. Line 1: [L002](#), Column A.

2. Line 2: For flats and irregular parcels, “STD” followed by “FLTS” or “IRREG,” as applicable; followed by “3D”; followed by “BARCODED” (or “BC”) if pallet contains automation price mail; followed by “NONBARCODED” (or “NBC”) if pallet contains carrier route and/or Presorted price mail. For letters, “STD LTRS 3D”; followed by “BC” if pallet contains barcoded letters; followed by “MACH” if pallet contains machinable letters; followed by “MAN” if pallet contains nonmachinable letters.
- f. *SCF*, required, permitted for bundles, sacks, and trays. Pallet may contain carrier route, automation price, and/or Presorted price mail for the 3-digit ZIP Code groups in [L005](#). Mailers may, at their option, place AADC trays on SCF pallets when the tray's “label to” 3-digit ZIP Code (from [L801](#)) is within that SCF's service area. Mailers may also, at their option, place mixed ADC or mixed AADC trays, labeled per [L010](#), on an SCF pallet entered at the SCF facility responsible for the processing of mixed ADC or mixed AADC trays for that BMC/ASF facility. Labeling:
1. Line 1: [L002](#), Column C.
 2. Line 2: For flats and irregular parcels, “STD” followed by “FLTS” or “IRREG,” as applicable; followed by “SCF”; followed by “BARCODED” (or “BC”) if pallet contains automation price mail; followed by “NONBARCODED” (or “NBC”) if pallet contains carrier route and/or Presorted price mail. For letters, “STD LTRS SCF”; followed by “BC” if pallet contains barcoded letters; followed by “MACH” if pallet contains machinable letters; followed by “MAN” if pallet contains nonmachinable letters.
- g. *ASF*, required unless bundle reallocation used under [8.13](#), permitted for bundles, sacks, and trays. Pallet may contain carrier route, automation price, and/or Presorted price mail for the 3-digit ZIP Code groups in [L602](#). ADC bundles, sacks, or trays are assigned to pallets according to the “label to” ZIP Code in [L004](#) or [L603](#), as appropriate. AADC trays are assigned to pallets according to the “label to” ZIP Code in [L801](#). At the mailer's option, appropriate mixed ADC bundles and sacks of flats; and mixed ADC and mixed AADC trays of letters, may be sorted to ASF pallets according to the “label to” ZIP Code in [L010](#). Mixed ADC sacks of irregular parcels may be sorted to ASF pallets according to the “label to” ZIP Code in [L604](#). All mixed ADC bundles, sacks, and trays and mixed AADC trays must contain only pieces destinating within the ASF in [6.3](#). Labeling:
1. Line 1: [L602](#).
 2. Line 2: For flats and irregular parcels, “STD” followed by “FLTS” or “IRREG,” as applicable; followed by “ASF”; followed by “BARCODED” (or “BC”) if pallet contains automation price mail; followed by “NONBARCODED” (or “NBC”) if pallet contains carrier route and/or Presorted price mail. For letters, “STD LTRS ASF”; followed by “BC” if pallet contains barcoded letters; followed by “MACH” if pallet contains machinable letters; followed by “MAN” if pallet contains nonmachinable letters.

705.8.10.4

- h. *BMC*, required, permitted for bundles, sacks, and trays. Pallet may contain carrier route, automation price, and/or Presorted price mail for the 3-digit ZIP Code groups in [L601](#). ADC bundles, sacks, or trays are assigned to pallets according to the “label to” ZIP Code in [L004](#) or [L603](#), as appropriate. AADC trays are assigned to pallets according to the “label to” ZIP Code in [L801](#). At the mailer’s option, appropriate mixed ADC bundles and sacks of flats; and mixed ADC trays and mixed AADC trays of letters, may be sorted to BMC pallets according to the “label to” ZIP Code in [L010](#). Mixed ADC sacks of irregular parcels may be sorted to ASF pallets according to the “label to” ZIP Code in [L604](#). All mixed ADC bundles, sacks, and trays and mixed AADC trays must contain only pieces destinating within the BMC service area. Labeling:
 - 1. Line 1: [L601](#).
 - 2. Line 2: For flats and irregular parcels, “STD” followed by “FLTS” or “IRREG,” as applicable; followed by “BMC”; followed by “BARCODED” (or “BC”) if pallet contains automation price mail; followed by “NONBARCODED” (or “NBC”) if pallet contains carrier route and/or Presorted price mail. For letters, “STD LTRS BMC”; followed by “BC” if pallet contains barcoded letters; followed by “MACH” if pallet contains machinable letters; followed by “MAN” if pallet contains nonmachinable letters.
- i. *Mixed BMC*, optional, permitted for sacks and trays only. Pallet may contain carrier route, automation price, and/or Presorted price mail. Labeling:
 - 1. Line 1: “MXD” followed by information in [L601](#), Column B, for BMC serving 3-digit ZIP Code prefix of entry Post Office (label to plant serving entry Post Office if authorized by processing and distribution manager).
 - 2. Line 2: For flats and irregular parcels, “STD” followed by “FLTS” or “IRREG,” as applicable; followed by “BARCODED” (or “BC”) if pallet contains automation price mail; followed by “NONBARCODED” (or “NBC”) if pallet contains carrier route and/or Presorted price mail; followed by “WKG.” For letters, “STD LTRS”; followed by “BC” if pallet contains barcoded letters; followed by “MACH” if pallet contains machinable letters; followed by “MAN” if pallet contains nonmachinable letters; followed by “WKG.”

8.10.4 Package Services Flats—Bundles and Sacks

[7-3-08] Pallets must be prepared under [8.0](#) in the sequence listed below and completed at each required level before the next optional or required level is prepared. Unless indicated as optional, all sort levels are required under the conditions shown. Carrier route mail and Presorted price mail with a barcode apply only to Bound Printed Matter mailings. Destination entry price eligibility also applies only to Bound Printed Matter (see [366](#) for flats). At the mailer’s option, all Package Services flats may be prepared for destination entry. For mailings of sacks on pallets, pallet preparation begins with [8.10.4b](#). Pallets must be labeled according to the Line 1 and Line 2 information listed below and under [8.6](#).

- a. *5-digit scheme carrier routes*, required, permitted for bundles only. Pallet must contain only carrier route bundles for the same 5-digit scheme under [L001](#). For 5-digit destinations not part of [L001](#), 5-digit carrier routes pallet preparation begins with [8.10.4b](#). Labeling:
 1. Line 1: [L001](#).
 2. Line 2: "PSVC FLTS"; followed by "CARRIER ROUTES" (or "CR-RTS"); followed by "SCHEME" (or "SCH").
- b. *5-digit carrier routes*, required, permitted for bundles and sacks. Pallet must contain only carrier route mail for the same 5-digit ZIP Code. Labeling:
 1. Line 1: city, state, and 5-digit ZIP Code destination (see [8.6.4c](#) for overseas military mail).
 2. Line 2: "PSVC FLTS"; followed by "CARRIER ROUTES" (or "CR-RTS").
- c. *5-digit*, required, permitted for bundles and sacks. Pallet must contain only Presorted price mail with or without a barcode for the same 5-digit ZIP Code or same 5-digit scheme under [L007](#) (for automation-compatible flats only under [301.3.0](#)). Five-digit scheme bundles are assigned to pallets according to the "label to" 5-digit ZIP Code in [L007](#). Labeling:
 1. Line 1: city, state, and 5-digit ZIP Code destination (see [8.6.4c](#) for overseas military mail).
 2. Line 2: "PSVC FLTS 5D"; followed by "BARCODED" (or "BC") if pallet contains Presorted price mail with a barcode; followed by "NONBARCODED" (or "NBC") if pallet contains Presorted price mail without a barcode.
- d. *5-digit metro*, optional, permitted for bundles only. Pallet may contain carrier route and/or Presorted price mail with or without a barcode for the 5-digit ZIP Codes in [L006](#), Column A, and for the 3-digit ZIP Code groups in [L006](#), Column B. Labeling:
 1. Line 1: [L006](#).
 2. Line 2: "PSVC FLTS"; followed by "METRO" (or "MET"); followed by "BARCODED" (or "BC") if pallet contains Presorted price mail with a barcode; followed by "NONBARCODED" (or "NBC") if pallet contains carrier route and/or Presorted price mail without a barcode.
- e. *3-digit*, optional, option not available for bundles for 3-digit ZIP Code prefixes marked "N" in [L002](#). Pallet may contain mail with or without a barcode for the same 3-digit ZIP Code or the same 3-digit scheme under [L008](#) (for automation-compatible flats only under [301.3.0](#)). Three-digit scheme bundles are assigned to pallets according to the "label to" 3-digit ZIP Code in [L008](#). Labeling:
 1. Line 1: [L002](#), Column A.
 2. Line 2: "PSVC FLTS 3D"; followed by "BARCODED" (or "BC") if pallet contains Presorted price mail with a barcode; followed by "NONBARCODED" (or "NBC") if pallet contains carrier route and/or Presorted price mail without a barcode.

705.8.10.5

- f. *SCF*, required, permitted for bundles and sacks. Pallet may contain carrier route and/or Presorted price mail with or without a barcode for the 3-digit ZIP Code groups in [L005](#). Labeling:
 - 1. Line 1: [L002](#), Column C.
 - 2. Line 2: "PSVC FLTS SCF"; followed by "BARCODED" (or "BC") if pallet contains Presorted price mail with a barcode; followed by "NONBARCODED" (or "NBC") if pallet contains carrier route and/or Presorted price mail without a barcode.
- g. *ASF*, required, permitted for bundles and sacks. Pallet may contain carrier route and/or Presorted price mail with or without a barcode for the 3-digit ZIP Code groups in [L602](#). ADC bundles or sacks are assigned to pallets according to the "label to" ZIP Code in [L004](#). At the mailer's option, appropriate mixed ADC bundles or sacks may be sorted to ASF pallets according to the "label to" ZIP Code in [L010](#). All mixed ADC bundles and sacks must contain only pieces destinating within the ASF in [6.3](#). Labeling:
 - 1. Line 1: [L602](#).
 - 2. Line 2: "PSVC FLTS ASF"; followed by "BARCODED" (or "BC") if pallet contains Presorted price mail with a barcode; followed by "NONBARCODED" (or "NBC") if pallet contains carrier route and/or Presorted price mail without a barcode.
- h. *BMC*, required, permitted for bundles and sacks. Pallet may contain carrier route and/or Presorted price mail with or without a barcode for the 3-digit ZIP Code groups in [L601](#). ADC bundles or sacks are assigned to pallets according to the "label to" ZIP Code in [L004](#). At the mailer's option, appropriate mixed ADC bundles or sacks may be sorted to BMC pallets according to the "label to" ZIP Code in [L010](#). All mixed ADC bundles and sacks must contain only pieces destinating within the BMC in [6.3](#). Labeling:
 - 1. Line 1: [L601](#).
 - 2. Line 2: "PSVC FLTS BMC"; followed by "BARCODED" (or "BC") if pallet contains Presorted price mail with a barcode; followed by "NONBARCODED" (or "NBC") if pallet contains carrier route and/or Presorted price mail without a barcode.
- i. *Mixed BMC*, optional, permitted for sacks only. Pallet may contain carrier route and/or Presorted price mail with or without a barcode. Labeling:
 - 1. Line 1: "MXD" followed by information in [L601](#), Column B, for BMC serving 3-digit ZIP Code prefix of entry Post Office (label to plant serving entry Post Office if authorized by processing and distribution manager).
 - 2. Line 2: "PSVC FLTS WKG."

8.10.5 Package Services Irregular Parcels—Bundles and Sacks

Pallets must be prepared under [8.0](#) in the sequence listed below and completed at each required level before the next optional or required level is prepared. Unless indicated as optional, all sort levels are required under the conditions shown. Carrier route ([8.10.5a](#), [8.10.5b](#), [8.10.5d](#), and [8.10.5e](#)) applies to Bound Printed Matter

mailings only. Destination entry price eligibility applies only to Parcel Select (see 456) and Bound Printed Matter (see 466 for parcels). At the mailer's option, all Package Services irregular parcels also may be prepared for destination entry (see 7.0). For mailings of sacks on pallets, pallet preparation begins with 8.10.5e. Pallets must be labeled according to the Line 1 and Line 2 information listed below and under 8.6.

- a. *Merged 5-digit scheme*, required, permitted for bundles only. Pallet must contain carrier route bundles and noncarrier route 5-digit bundles (Presorted price bundles) for the same 5-digit scheme under L001. For 5-digit destinations not part of L001, merged 5-digit pallet preparation begins with 8.10.5d. Labeling:
 1. Line 1: L001.
 2. Line 2: "PSVC IRREG CR/5D"; followed by "SCHEME" (or "SCH").
- b. *5-digit scheme carrier routes*, required, permitted for bundles only. Pallet must contain only carrier route bundles for the same 5-digit scheme under L001. For 5-digit destinations not part of L001, 5-digit carrier routes pallet preparation begins with 8.10.5e. Labeling:
 1. Line 1: L001.
 2. Line 2: "PSVC IRREG"; followed by "CARRIER ROUTES" (or "CR-RTS"); followed by "SCHEME" (or "SCH").
- c. *5-digit scheme*, required, permitted for bundles only. Pallet must contain only 5-digit bundles of Presorted price mail for the same 5-digit scheme under L001. For 5-digit destinations not part of L001, 5-digit pallet preparation begins with 8.10.5d. Labeling:
 1. Line 1: L001.
 2. Line 2: "PSVC IRREG 5D"; followed by "SCHEME" (or "SCH").
- d. *Merged 5-digit*, required, permitted for bundles only. Pallet must contain carrier route bundles and noncarrier route 5-digit bundles (Presorted price bundles) for the same 5-digit ZIP Code. Labeling:
 1. Line 1: city, state, and 5-digit ZIP Code destination (see 8.6.4c for overseas military mail).
 2. Line 2: "PSVC IRREG CR/5D."
- e. *5-digit carrier routes*, required, permitted for bundles and sacks. Pallet must contain only carrier route mail for the same 5-digit ZIP Code. Labeling:
 1. Line 1: city, state, and 5-digit ZIP Code destination (see 8.6.4c for overseas military mail).
 2. Line 2: "PSVC IRREG"; followed by "CARRIER ROUTES" (or "CR-RTS").
- f. *5-digit*, required, permitted for bundles and sacks. Pallet must contain only Presorted price mail for the same 5-digit ZIP Code. Labeling:
 1. Line 1: city, state, and 5-digit ZIP Code destination (see 8.6.4c for overseas military mail).
 2. Line 2: "PSVC IRREG 5D."

705.8.10.5

- g. *5-digit metro*, optional, permitted for bundles only. Pallet must contain carrier route and/or Presorted price bundles for the 5-digit ZIP Codes in [L006](#), Column A, and for the 3-digit ZIP Code groups in [L006](#), Column B. Labeling:
 - 1. Line 1: [L006](#).
 - 2. Line 2: "PSVC IRREG"; followed by "METRO" (or "MET").
- h. *3-digit*, optional, option not available for bundles for 3-digit ZIP Code prefixes marked "N" in [L002](#). Pallet must contain parcels only for the same 3-digit ZIP Code. Labeling:
 - 1. Line 1: [L002](#), Column A.
 - 2. Line 2: "PSVC IRREG 3D."
- i. *SCF*, required, permitted for bundles and sacks. Pallet may contain carrier route and/or Presorted price mail for the 3-digit ZIP Code groups in [L005](#). Labeling:
 - 1. Line 1: [L002](#), Column C.
 - 2. Line 2: "PSVC IRREG SCF."
- j. *ASF*, required, permitted for bundles and sacks. Pallet may contain carrier route and/or Presorted price mail for the 3-digit ZIP Code groups in [L602](#). ADC bundles or sacks are assigned to pallets according to the "label to" ZIP Code in [L004](#). At the mailer's option, appropriate mixed ADC bundles or sacks may be sorted to ASF pallets according to the "label to" ZIP Code in [L010](#). All mixed ADC bundles and sacks must contain only pieces destinating within the ASF in [6.3](#). Labeling:
 - 1. Line 1: [L602](#).
 - 2. Line 2: "PSVC IRREG ASF."
- k. *BMC*, required, permitted for bundles and sacks. Pallet may contain carrier route and/or Presorted price mail for the 3-digit ZIP Code groups in [L601](#). ADC ([L004](#)) bundles or sacks are assigned to pallets according to the "label to" ZIP Code in [L004](#). At the mailer's option, appropriate mixed ADC bundles or sacks may be sorted to BMC pallets according to the "label to" ZIP Code in [L010](#). All mixed ADC bundles and sacks must contain only pieces destinating within the BMC in [6.3](#). Labeling:
 - 1. Line 1: [L601](#).
 - 2. Line 2: "PSVC IRREG BMC."
- l. *Mixed BMC*, optional, permitted for sacks only. Pallet may contain carrier route and/or Presorted price mail. Labeling:
 - 1. Line 1: "MXD" followed by information in [L601](#), Column B, for BMC serving 3-digit ZIP Code prefix of entry Post Office (or labeled to plant serving entry Post Office if authorized by processing and distribution manager).
 - 2. Line 2: "PSVC IRREG WKG."

8.10.6 Package Services, Parcel Select, and Standard Mail Machinable Parcels, and Not Flat-Machinable Pieces Weighing 6 Ounces or More

Pallets must be prepared under 8.0 in the sequence listed below and completed at each required level before the next optional or required level is prepared. Unless indicated as optional, all sort levels are required under the conditions shown. At the mailer's option, Inter-BMC/ASF and Intra-BMC/ASF Parcel Select and Parcel Post mailings may be prepared on pallets under this section. Destination entry price eligibility applies only to Standard Mail (see 446 for parcels and NFMs that weigh 6 ounces or more), Parcel Select (see 456), and Bound Printed Matter (see 466). Combined mailings of Standard Mail, Parcel Select, and Package Services machinable parcels also must meet the standards in 6.0. Pallets must be labeled according to the Line 1 and Line 2 information listed below and under 8.6.

- a. *5-digit scheme, required.* Pallet must contain parcels or NFMs for the same 5-digit scheme under L606. For 5-digit destinations not part of L606, or for which scheme sorts are not performed, 5-digit pallets are prepared under 8.10.6b. Labeling:
 1. Line 1: Use L606.
 2. Line 2: "STD MACH 5D," "STD NFM MACH 5D," or "PSVC MACH 5D," as applicable; followed by "SCHEME" (or "SCH").
- b. *5-digit, required.* Pallet must contain parcels or NFMs only for the same 5-digit ZIP Code. Labeling:
 1. Line 1: city, state, and 5-digit ZIP Code destination (see 8.6.4c for overseas military mail).
 2. Line 2: "STD MACH 5D," "STD NFM MACH 5D," or "PSVC MACH 5D," as applicable.
- c. *ASF, optional, but required for DBMC prices.* Not available for the Buffalo NY ASF in L602. Pallets must contain only parcels or NFMs for the 3-digit ZIP Code groups in L602. Labeling:
 1. Line 1: Use L602.
 2. Line 2: "STD MACH ASF," "STD NFM MACH ASF," or "PSVC MACH ASF," as applicable.
- d. *BMC, required.* Pallets must contain only parcels or NFMs for the 3-digit ZIP Code groups in L601. Labeling:
 1. Line 1: Use L601.
 2. Line 2: "STD MACH BMC," "STD NFM MACH BMC," or "PSVC MACH BMC," as applicable.
- e. *Mixed BMC, optional.* Labeling:
 1. Line 1: "MXD" followed by information in L601, Column B, for BMC serving 3-digit ZIP Code prefix of entry Post Office (or labeled to plant serving entry Post Office if authorized by processing and distribution manager).
 2. Line 2: "STD MACH WKG," "STD NFM MACH WKG," or "PSVC MACH WKG," as applicable.

705.8.10.7

8.10.7 Standard Mail Irregular Parcels Weighing 2 Ounces or More

Mailers who palletize unbundled or unsacked irregular parcels must make pallets or pallet boxes when there are 250 pounds or more for the destination levels below. Pallets or pallet boxes of irregular parcels (except tubes, rolls, and similar pieces) weighing 2 ounces or more must be prepared under 8.0 in the sequence listed below and completed at each required level before the next optional or required level is prepared. Unless indicated as optional, all sort levels are required. Label pallets or pallet boxes according to the Line 1 and Line 2 information listed below and under 8.6. Mailers may not prepare tubes, rolls, and similar pieces or pieces that weigh less than 2 ounces on pallets or in pallet boxes, except for pieces in carrier route bundles or in sacks under 8.10.3.

- a. *5-digit scheme, required.* Pallet or pallet box must contain parcels only for the same 5-digit scheme under L606. Mailers may combine NFMs under 6 ounces with irregular parcels under 8.10.7. For 5-digit destinations not part of L606 prepare 5-digit pallets under 8.10.6b. Labeling:
 1. Line 1: Use L606.
 2. Line 2: "STD IRREG 5D; followed by "SCHEME" (or "SCH").
- b. *5-digit, required.* Pallet or pallet box must contain parcels only for the same 5-digit ZIP Code. Labeling:
 1. Line 1: city, state, and 5-digit ZIP Code destination (see 8.6.4c for overseas military mail).
 2. Line 2: "STD IRREG 5D."
- c. *3-digit, optional,* option not available for bundles for 3-digit ZIP Code prefixes marked "N" in L002. Pallet or pallet box must contain parcels only for the same 3-digit ZIP Code. Labeling:
 1. Line 1: Use L002, Column A.
 2. Line 2: "STD IRREG 3D."
- d. *ADC, required.* Pallet or pallet box must contain parcels for the 3-digit ZIP Code groups in L004. Labeling:
 1. Line 1: Use L004.
 2. Line 2: "STD IRREG ADC."
- e. *Mixed ADC, optional.* Labeling:
 1. Line 1: "MXD" followed by city, state, and ZIP Code information for ADC serving 3-digit ZIP Code prefix of entry Post Office as shown in L009, Column A.
 2. Line 2: "STD IRREG WKG."

8.10.8 Standard Mail Not Flat-Machinable Pieces Weighing Less Than 6 Ounces

Mailers must prepare pieces on pallets or in pallet boxes when there are 250 pounds or more of NFMs for the destination levels below. Prepare pallets or pallet boxes of NFM pieces weighing less than 6 ounces under 8.0 in the sequence listed below and completed at each required level before the next optional or

required level is prepared. Unless indicated as optional, all sort levels are required. The height of a 5-digit bundle must be at least 1 inch less than the longest dimension of the individual mailpiece. For example, a mailpiece measuring 7 inches long, 5 inches high, and 1/2 inch thick must be placed in a bundle no higher than 6 inches. Mailers may combine NFMs under 6 ounces with irregular parcels over 2 ounces (that are not tubes or rolls) under 8.10.7. Label pallets or pallet boxes according to the Line 1 and Line 2 information listed below and under 8.6.

- a. *5-digit scheme, required.* Pallet or pallet box must contain NFMs only for the same 5-digit scheme under L606. For 5-digit destinations not part of L606 prepare 5-digit pallets under 8.10.7b. Labeling:
 1. Line 1: Use L606.
 2. Line 2: "STD NFM 5D"; followed by "SCHEME" (or "SCH").
- b. *5-digit, required.* Pallet or pallet box must contain NFMs only for the same 5-digit ZIP Code. Labeling:
 1. Line 1: city, state, and 5-digit ZIP Code destination (see 8.6.4c for overseas military mail).
 2. Line 2: "STD NFM 5D."
- c. *3-digit, optional,* option not available for bundles for 3-digit ZIP Code prefixes marked "N" in L002. Pallet or pallet box must contain NFMs only for the same 3-digit ZIP Code. Labeling:
 1. Line 1: Use L002, Column A.
 2. Line 2: "STD NFM 3D."
- d. *ADC, required.* Pallet or pallet box must contain NFMs for the 3-digit ZIP Code groups in L004. Labeling:
 1. Line 1: Use L004.
 2. Line 2: "STD NFM ADC."
- e. *Mixed ADC, optional.* Labeling:
 1. Line 1: "MXD" followed by city, state, and ZIP Code information for ADC serving 3-digit ZIP Code prefix of entry Post Office as shown in L009, Column A.
 2. Line 2: "STD NFM WKG."

8.11 Bundle Reallocation to Protect SCF Pallet for Periodicals Flats and Irregular Parcels and Standard Mail Flats on Pallets

8.11.1 Basic Standards

Bundle reallocation to protect the SCF pallet is an optional preparation method (if performed, bundle reallocation must be done for the entire mailing job); only PAVE-certified presort software may be used to create pallets under the standards in 8.11.2 through 8.11.4. Presort software determines if mail for an SCF service area would fall beyond the SCF level if all finer level pallets are prepared. Reallocation is performed only when there is mail for the SCF service area that would fall beyond the SCF pallet level (e.g., to an ADC or BMC pallet). The amount of mail required to

bring the mail that would fall beyond the SCF level back to an SCF level is the minimum volume that will be reallocated. For the purposes of reallocation, 5-digit metro pallets are considered to be 3-digit pallets (because they contain subsets of mail for a 3-digit ZIP Code area).

8.11.2 General Rules

Reallocation rules are as follows:

- a. Bundle preparation is not affected by the reallocation process. Reallocate only complete bundles and only the minimum number of bundles necessary to create an SCF pallet meeting the minimum pallet weight. Based on the weight of individual pieces within a bundle and bundling parameters, the weight of mail that is reallocated may be slightly more than the minimum volume required to create an SCF pallet.
- b. Reallocate bundles from the highest (least fine) pallet level possible. If it is not possible to reallocate some mail from a 3-digit pallet first, then attempt to eliminate a 3-digit pallet and reallocate all mail from that pallet to create an SCF pallet; if mail cannot be reallocated from a 3-digit pallet, then attempt to reallocate some mail from any 5-digit level pallet.
- c. The reallocation process may result in the elimination of a 3-digit pallet to create an SCF pallet, but a 5-digit level pallet may not be eliminated to create an SCF pallet.
- d. When reallocating mail to create an SCF pallet, reallocate mail from only one more finely sorted pallet. This may be accomplished by reallocating a portion of a 3-digit pallet, reallocating all mail from a 3-digit pallet, or reallocating a portion of one of the following pallets: 5-digit, 5-digit carrier routes, merged 5-digit, 5-digit scheme, 5-digit scheme carrier routes, or merged 5-digit scheme.
- e. Mailers may use any minimum pallet weight(s) permitted by standards and may use different minimum weights for different pallet levels in conjunction with bundle reallocation.

8.11.3 Reallocation of Bundles If Optional 3-Digit Pallets Are Prepared

Reallocation rules are as follows:

- a. Attempt to identify a 3-digit pallet of adequate weight that can support reallocation of one or more bundles to bring the mail that has fallen through the SCF level back to the SCF level without eliminating the pallet. A sufficient volume of mail must remain on the 3-digit pallet after reallocation to meet the 3-digit pallet weight minimum established by the mailer in compliance with applicable standards. If a 3-digit pallet of adequate weight is available, create an SCF pallet by combining the reallocated mail from the 3-digit pallet with the mail that would fall beyond the SCF pallet level.
- b. If no single 3-digit pallet within the SCF service area contains an adequate volume of mail to allow reallocation of a portion of the mail on a pallet as described in the previous step, then eliminate one 3-digit pallet and reallocate all of the mail to create an SCF pallet by combining it with the mail that would fall beyond the SCF pallet level. As a result, the software will not prepare one 3-digit pallet for the SCF service area if it is detrimental to the SCF pallet.

- c. If preparation is under 8.0 and there are no 3-digit pallets, attempt to identify a 5-digit level pallet of adequate weight to support reallocation of one or more bundles to bring the mail that would fall beyond the SCF pallet level back to the SCF level. If preparation is under 10.0, 12.0, or 13.0 and there are no 3-digit pallets, attempt to identify a 5-digit level pallet of adequate weight to support reallocation of one or more bundles to bring the mail that would fall beyond the SCF pallet level back to the SCF level. A sufficient volume of mail must remain on the applicable pallet after reallocation to meet the pallet weight minimum established by the mailer in compliance with applicable standards. If a 5-digit level pallet of adequate weight is available, create an SCF pallet by combining the reallocated bundles with the mail that would fall beyond the SCF pallet level.
- d. If no single 5-digit level pallet within the SCF service area contains an adequate volume of mail to allow reallocation of a portion of the mail on a pallet as described in 8.11.3c, then no bundles will be reallocated and an SCF pallet will not be prepared; the mail that falls beyond the SCF pallet level must be placed on the next appropriate pallet (ADC, ASF, or BMC) or in the next appropriate sack.

8.11.4 Reallocation of Bundles If Optional 3-Digit Pallets Are Not Prepared

Reallocation rules are as follows:

- a. Attempt to identify a 5-digit level pallet of adequate weight to support reallocation of one or more bundles to bring the mail that would fall beyond the SCF pallet level back to the SCF level. A sufficient volume of mail must remain on the 5-digit level pallet after reallocation to meet the pallet weight minimum established by the mailer in compliance with applicable standards. If a 5-digit level pallet of adequate weight is available, create an SCF pallet by combining the reallocated bundles with the mail that would fall beyond the SCF pallet level.
- b. If no single 5-digit level pallet within the SCF service area contains an adequate volume of mail to allow reallocation of a portion of the mail on a pallet as described in 8.11.4a, then no bundles will be reallocated and an SCF pallet will not be prepared; the mail that falls beyond the SCF pallet level must be placed on the next appropriate pallet (ADC, ASF, or BMC) or in the next appropriate sack.

8.11.5 Documentation

Mailings must be supported by documentation produced by PAVE-certified software meeting the standards in 708.1.0.

8.12 Bundle Reallocation to Protect ADC Pallet for Periodicals Flats and Irregular Parcels on Pallets

8.12.1 Basic Standards

Bundle reallocation to protect the ADC pallet is an optional preparation method authorized for mailers using PAVE-certified presort software and may be used to create pallets under the standards in 8.12.2 and 8.12.3. Presort software determines if mail for an ADC service area falls beyond the ADC level if all finer level pallets are prepared. Reallocation is performed only when there is mail for the ADC

705.8.12.2

service area that falls beyond the ADC pallet level (e.g., to sacks). Reallocate only the minimum number of bundles necessary to create an ADC pallet at the minimum required weight.

8.12.2 General Rules

Reallocation rules are as follows:

- a. Bundle preparation is not affected by the reallocation process. Reallocate only complete bundles and only the minimum number of bundles necessary to create an ADC pallet meeting the minimum pallet weight. Based on the weight of individual pieces within a bundle and bundling parameters, the weight of mail that is reallocated may be slightly more than the minimum volume required to create an ADC pallet.
- b. Reallocate only bundles of an SCF pallet from the same city and state as the ADC ([L005](#), Column B). This may be accomplished by reallocating a portion of the bundles from an SCF pallet or reallocating all mail from the SCF pallet. Bundles may be reallocated from a protected SCF (PSCF) pallet prepared under [8.11](#).
- c. Mailers may use any minimum pallet weight(s) permitted by standards and may use different minimum weights for different pallet levels in conjunction with bundle reallocation.

8.12.3 Documentation

Mailings must be supported by documentation produced by PAVE-certified software meeting the standards in [708.1.0](#).

8.13 Bundle Reallocation to Protect BMC Pallet for Standard Mail Flats on Pallets

8.13.1 Basic Standards

Bundle reallocation to protect the BMC pallet level is an optional preparation method (if performed, bundle reallocation must be done for the complete mailing job); only PAVE-certified presort software may be used to create pallets under the standards in [8.13.2](#) through [8.13.4](#). The software will determine if mail for a BMC service area would fall beyond the BMC level when ASF pallets are prepared. Reallocation is performed only when there is mail for the BMC service area that would fall beyond the BMC pallet level as a result of an ASF pallet being prepared. The amount required to bring the mail back to the BMC level is the minimum volume that would be reallocated from an ASF pallet, when possible. The following “parent” BMCs can be protected with bundle reallocation by using mail from the ASF “child” pallets indicated in [Exhibit 8.13.1](#).

Exhibit 8.13.1 “Parent” BMC/“Child” ASF

“PARENT” BMC SERVICE AREAS	“CHILD” ASF ZIP CODE AREAS SERVED
Pittsburgh BMC	Buffalo ASF: 130-136; 140-149
Denver BMC	Albuquerque ASF: 865, 870-875, 877-879, 881-884 Phoenix ASF: 850, 852, 853, 855, 859, 860, 863, 864 Salt Lake City ASF: 832-834, 836, 837, 840-847, 898, 979 Billings ASF: 590-599, 821
Dallas BMC	Oklahoma City ASF: 730, 731, 734-738, 740, 741, 743-746, 748, 749
Des Moines BMC	Sioux Falls ASF: 570-577
Minneapolis BMC	Fargo ASF: 565, 567, 580-588

8.13.2 General Rules

In general, when reallocating:

- a. The reallocation process does not affect bundle preparation. Reallocate only complete bundles and only the minimum number of bundles necessary to create a BMC pallet that meets the minimum pallet weight. Based on the weight of individual pieces within a bundle and bundling parameters, the weight of mail that is reallocated may be slightly more than the minimum volume required to create a BMC pallet.
- b. Use [Exhibit 8.13.1](#) to reallocate bundles from the ASF pallet to create a BMC pallet. The ASF pallet may be eliminated to protect the BMC pallet.
- c. Reallocate mail only from one ASF pallet. Bundle reallocation is to be used only between the “parent” BMC and the “child” ASF. Mail from finer levels of pallets (e.g., SCF pallets) may not be reallocated.
- d. Mailers may use any minimum pallet weight(s) permitted by standard and may use different minimum weights for different pallet levels in conjunction with bundle reallocation.

8.13.3 Reallocation of Bundles From ASF Pallets

When reallocating bundles from ASF pallets:

- a. Use [Exhibit 8.13.1](#) to identify an ASF pallet of adequate weight that can support reallocation of one or more bundles to bring the mail that has fallen through the BMC level back to the BMC level without eliminating the ASF pallet. A sufficient amount of mail must remain on the ASF pallet after reallocation to meet the minimum ASF pallet weight. If an ASF pallet of adequate weight is available, then create a BMC pallet by combining the reallocated mail from the ASF pallet with the mail that would fall beyond the BMC pallet level.
- b. If no single ASF pallet within the BMC service area contains an adequate volume of mail to allow reallocation of the portion of the mail on a pallet as described in [8.13.3a](#), then eliminate one ASF pallet and reallocate all of the mail to create a BMC pallet.

8.13.4 Documentation

Mailings must be supported by documentation produced by PAVE-certified software meeting the standards in [708.1.0](#).

705.8.14

8.14 Pallets of Bundles, Sacks, and Trays

8.14.1 Periodicals

Additional pallet preparation:

- a. *Combined mailings.* When two or more publications are part of a combined mailing, the mailer must keep records for each mailing (publication) as required by standard.
- b. *Destination Delivery Unit prices.* Pieces claimed at destination delivery unit prices do not require separation from pieces claimed at other prices on the same pallet.
- c. *Carrier route mail on separate 5-digit pallets.* Carrier route sorted pieces must be prepared on separate 5-digit pallets (5-digit carrier routes or 5-digit scheme carrier routes pallets). *Exception:* When flats are prepared as bundles on pallets under 10.0, 12.0, or 13.0, then carrier route mail, 5-digit machinable barcoded price mail, and 5-digit machinable nonbarcoded price mail may be placed on the same merged 5-digit pallet or on the same merged 5-digit scheme pallet for those 5-digit ZIP Codes for which 1) there are “A” or “C” indicators in the City State Product under 10.0, or 2) the 5-digit bundles are within the 5% threshold requirement under 12.0, or 3) the 5-digit bundles are either all for 5-digit ZIP Codes that have an “A” or “C” indicator in the City State Product or are for 5-digit ZIP Codes with a “B” or “D” indicator in the City State Product and the pieces in such 5-digit bundles meet the 5% threshold under 13.0.

8.14.2 Standard Mail

Additional pallet preparation:

- a. *Combined mailings.* Nonprofit Standard Mail may be included in the same mailing or palletized on the same pallet as Regular Standard Mail only as permitted by standard. Mailers may include machinable parcels, irregular parcels, and Not Flat-Machinable pieces on 5-digit pallets.
- b. *Destination Delivery Unit prices.* Pieces claimed at destination delivery unit prices do not require separation from pieces claimed at other prices on the same pallet.
- c. *Carrier route mail on separate 5-digit pallets.* Carrier route price pieces must be prepared on separate 5-digit pallets (5-digit carrier routes or 5-digit scheme carrier routes pallets) from automation price and/or Presorted price pieces (prepared on 5-digit pallets or 5-digit scheme pallets). *Exception:* When flat-size pieces are prepared as bundles on pallets under 10.0, 12.0, or 13.0, then carrier route sorted mail, 5-digit sorted automation price mail, and 5-digit sorted Presorted price mail may be placed on the same merged 5-digit pallet or on the same merged 5-digit scheme pallet for those 5-digit ZIP Codes for which 1) there are “A” or “C” indicators in the City State Product under 10.0, or 2) the 5-digit bundles are within the 5% threshold requirement under 12.0, or 3) the 5-digit bundles are either all for 5-digit ZIP Codes that have an “A” or “C” indicator in the City State Product, or are for 5-digit ZIP Codes with a “B” or “D” indicator in the City State Product and the pieces in such 5-digit bundles meet the 5% threshold under 13.0.

8.14.3 BMC and Mixed BMC Pallets

Bundles placed on BMC pallets must be machinable on BMC parcel sorting equipment. Line 2 on pallet labels must reflect the processing category of the pieces. A BMC or mixed BMC (trays and sacks only) pallet may include pieces that are eligible for the DBMC price and others that are ineligible.

8.14.4 Commingled Zones

Pieces of Parcel Select and Package Services for different zones may be commingled only under [455.1.7](#) for Parcel Select parcels or [365.5.3.3](#) or [365.6.3.3](#) for Bound Printed Matter flats or [465.5.1.3](#) or [465.6.1.3](#) for Bound Printed Matter parcels.

8.14.5 Securing Trays

Trays must be sleeved and strapped under [235.3.0](#) for First-Class Mail letters, [245.3.0](#) for Standard Mail letters, [335.3.0](#) for First-Class Mail flats, [345.3.0](#) for Standard Mail flats, [365.3.0](#) for Bound Printed Matter flats, [375.3.0](#) for Media Mail flats, [385.3.0](#) for Library Mail flats, *except that* strapping is not required for any letter tray placed on a 5-digit, 3-digit, or SCF pallet secured with stretchwrap. In addition, if the processing and distribution manager gives a written waiver, strapping is not required for any letter tray that originates and destines in the same SCF (mail processing plant) service area.

8.15 Sacks

All sacks remaining after all pallets are prepared may be presented with the palletized mailing (on the same postage statement) if the sacks are set apart from the palletized portion of the mailing.

8.16 Copalletized Flat-size Pieces—Periodicals or Standard Mail**8.16.1 Basic Standards**

Copalletized flat-size mailings must meet the applicable standards in [8.0](#). In addition, if copalletized under [10.0](#), [12.0](#), or [13.0](#), the provisions of one of those preparation options must also be met. Any combination of automation price mailings and nonautomation price mailings is subject to the restrictions in [8.14](#). Bundles in a copalletized mailing qualify for the appropriate presort level price, regardless of the pallet level on which they are placed.

8.16.2 Periodicals

Additional standards are as follows:

- a. Periodicals eligible for preferred prices (In-County, Nonprofit, Classroom, and Science-of-Agriculture) may be combined with Periodicals eligible for Outside-County prices.
- b. All pallets in a copalletized mailing are identified on the content line (Line 2) of the label with only “NEWS” (see [8.6](#)) or “PER” as the class designation under these conditions:
 1. If at least 51% of the total number of copies in the copalletized mailing can qualify for “NEWS” treatment, then all pallets in such a mailing are labeled “NEWS,” unless the mailer chooses to use “PER.”

705.8.16.3

2. If less than 51% of the total number of copies in a copalletized mailing can qualify for “NEWS” treatment, then all pallets in such a mailing are labeled “PER.”
- c. Documentation meeting the basic standard in [708.1.0](#) must be provided with each mailing. Before copalletizing, the mailer must obtain the written approval of the Business Mailer Support manager. Approval is based on the mailer’s demonstrated ability to provide documentation meeting these standards:
 1. Documentation by bundle and by publication and edition showing the number of addressed pieces and copies in each bundle and the per piece presort price claimed, or a listing by pallet showing (by presort level and destination) the number of copies and pieces for each publication and edition. For large volume mailing jobs reported on a single listing, the mailer may provide the abbreviated documentation in [708.b](#).
 2. Documentation showing the number of copies and pieces claimed at the SCF price.
 3. Documentation showing that bundles are sorted to the appropriate finest pallet level in the mailing.
 4. Documentation showing that 5-digit, 3-digit, SCF, and ADC pallets are prepared when the applicable minimum volume is developed in the copalletized mailing for these destinations.
 5. A listing showing the destination of pallets in the copalletized mailing.
 6. If the sacked portion of the mailing is presented with the copalletized portion, a report by sack showing the number of pieces (and copies) at each presort level.

8.16.3 Standard Mail

Additional standards are as follows:

- a. Nonprofit Standard mailings may be copalletized with one another but not with mailings at other prices unless permitted by standard.
- b. Nonidentical-weight pieces may be copalletized only if the correct postage is affixed to each piece or if otherwise authorized by Business Mailer Support.
- c. All pieces in mailings to be copalletized must be subject to the minimum per piece price, or all subject to the per pound price, unless otherwise authorized by Business Mailer Support.
- d. All pieces must have postage paid with permit imprint, or all pieces must have postage affixed.
- e. When requested, the mailer must present pallets selected by USPS employees for verification.

8.16.4 Pallet Labels

Pallet labels for copalletized mailings must meet the provisions of [8.6](#) and [8.10](#), or if applicable, [8.6](#) and [10.0](#), [12.0](#), or [13.0](#).

8.16.5 Postage Statement

Separate postage statements are required:

- a. For Periodicals, a separate postage statement is required for each publication and/or edition that is part of the copalletized mailing. The mailer must note on or in an attachment to the postage statement the name and issue date of the publications with which each publication and/or edition was copalletized.
- b. For Standard Mail, a separate postage statement must be prepared for each mailing that is part of a single copalletized shipment, *except that* copalletized Regular and Enhanced Carrier Route mailings (or Nonprofit and Nonprofit Enhanced Carrier Route mailings) produced as part of the same job may be reported on the same postage statement.

8.17 Pallets of Machinable Parcels

8.17.1 Standard Mail

Pieces may be eligible for the 3/5 price when prepared under [8.10.6a.](#) through [8.10.6d.](#). This eligibility includes pieces sorted under [8.10.6c.](#) and [8.10.6d.](#) to the service area of the *entry* ASF/BMC.

8.17.2 DBMC Price

A BMC pallet may include pieces that are eligible for the DBMC price and pieces that are ineligible.

8.17.3 Top Caps

When top caps are used, the mailer must write the tare weight of the top cap on the pallet label or in another prominent location.

8.18 Parcel Select—Bulk Mail Center (BMC) Presort Discount

8.18.1 Machinable Parcels

To qualify for the BMC Presort discount:

- a. Machinable pieces must be sorted to BMCs under [L601](#) in 69-inch pallet boxes. Each pallet box must contain at least 52 inches of mail (not including pallet) for a BMC. Overflow pallet boxes are not permitted. Preparation in sacks, directly on pallets, or in other containers is not permitted.
- b. Pallet box preparation and Line 1 labeling: destination BMC (required); for Line 1 use [L601](#).
- c. Pallet box Line 2 labeling: "PSVC MACH BMC."

8.18.2 Nonmachinable Parcels

To qualify for the BMC Presort discount:

- a. Nonmachinable pieces must be sorted to BMCs and ASFs under [L605](#) directly on pallets. Each pallet for a BMC or ASF destination must have a minimum height of 42 inches of mail (not including the height of the pallet). Overflow pallets are not permitted. Preparation in sacks, pallet boxes, or in other containers is not permitted.
- b. Pallet preparation and Line 1 labeling: destination BMC or destination ASF, required; for Line 1, use [L605](#).
- c. Pallet Line 2 labeling: "PSVC NON MACH BMC" or "PSVC NON MACH ASF" as applicable.

8.19 Parcel Select—Origin Bulk Mail Center (OBMC) Presort Discount

8.19.1 Machinable Parcels

To qualify for the OBMC Presort discount:

- a. Machinable pieces must be sorted to BMCs under [L601](#) in 69-inch pallet boxes. Each pallet box must contain at least 52 inches of mail (not including pallet) for a BMC. Overflow pallet boxes are not permitted. Preparation in sacks, directly on pallets, or in other containers is not permitted.
- b. Pallet box preparation and Line 1 labeling: destination BMC, required; for Line 1, use [L601](#).
- c. Pallet box Line 2 labeling: “PSVC MACH BMC.”

8.19.2 Nonmachinable Parcels

To qualify for the OBMC Presort discount:

- a. Nonmachinable pieces must be sorted to BMCs and ASFs under [L605](#) directly on pallets. Each pallet for a BMC or ASF destination must have a minimum height of 42 inches of mail (not including the height of the pallet). Overflow pallets are not allowed. Preparation in sacks, pallet boxes, or in other containers is not permitted.
- b. Pallet preparation and Line 1 labeling: destination BMC or destination ASF, required; for Line 1, use [L605](#).
- c. Pallet Line 2 labeling: “PSVC NON MACH BMC” or “PSVC NON MACH ASF” as applicable.

8.20 Parcel Select DSCF Prices—Parcels on Pallets

8.20.1 Basic Preparation, Parcels on Pallets

Unless prepared under [8.20.2](#), or in sacks, mail must be prepared for the DSCF price as follows:

- a. *General.* Parcels for each SCF area must be sorted to 5-digit scheme, 5-digit, or 3-digit (nonmachinable) destinations on pallets. For purposes of this section, the term “pallets” includes preparation of parcels directly on pallets and in pallet boxes on pallets. Except when prepared under [8.20.2](#), each 5-digit scheme, 5-digit, and 3-digit pallet must meet a minimum volume requirement under one of the criteria in [8.20.1b](#). Machinable and nonmachinable pieces may be combined on the same pallet or in the same overflow sack when sorted to 5-digit scheme or 5-digit destinations. In a single mailing mailers may prepare some pallets under the minimum volume requirement in [8.20.1b1](#) and some pallets under the minimum volume requirement in [8.20.1b2](#). A mailing entered at a destination SCF facility containing pallets prepared under [8.20.1](#) also may include mail that is sacked for the DSCF price. Double-stacking is permitted if the requirements of [8.3](#) are met.
- b. *Minimum volume.* The minimum volume per 5-digit scheme, 5-digit, and 3-digit pallet can be met in one of the following ways:
 1. Pieces may be placed on 5-digit scheme, 5-digit, and 3-digit pallets, each containing at least 50 pieces and 250 pounds.

2. Pieces may be placed on 5-digit scheme, 5-digit, and 3-digit pallets, each having a minimum height of 36 inches of mail (excluding the height of the pallet) (see [8.5.4](#)).
- c. *Overflow*. After filling a pallet(s) to a 5-digit scheme, 5-digit, or 3-digit destination, any remaining pieces that do not meet the minimum pallet requirements may be prepared in one or both of the following ways:
 1. Placed in 5-digit scheme, 5-digit, or 3-digit overflow sacks (no minimum number of pieces per sack) that are labeled in accordance with the 5-digit scheme, 5-digit, or 3-digit sacking requirements for the DSCF price in [455.4.2](#). Overflow pieces sacked in this manner are eligible for the DSCF prices.
 2. Placed on a 5-digit scheme, 5-digit, or 3-digit pallet labeled under [8.20.1d](#) that does not meet the minimums for the DSCF price. Overflow pieces palletized in this manner are not eligible for the DSCF prices but are eligible for the DBMC prices.
- d. *5-digit scheme*. Pallet labeling:
 1. Line 1: use [L606](#), Column B.
 2. Line 2: "PSVC PARCELS 5D SCH."
- e. *5-digit*. Pallet labeling:
 1. Line 1: use city, state, and 5-digit ZIP Code destination of contents.
 2. Line 2: "PSVC PARCELS 5D."
- f. *3-digit*. Pallet labeling:
 1. Line 1: use [L002](#), Column C.
 2. Line 2: "PSVC PARCELS 3D."
- g. *Separation*. If sacks prepared under [455](#) are included in the same mailing as pallets prepared under this section, at the time of acceptance the mailer must separate sacks that are overflow from palletized mail from those sacks that were prepared under the provisions of [455](#).

8.20.2 Alternate Preparation, Parcels on Pallets

DSCF price mailings not prepared under [8.20.1](#) may be prepared as follows:

- a. *General*. All DSCF price mail in the mailing must be sorted to 5-digit scheme, 5-digit, or 3-digit destinations under [8.20.2](#) (i.e., mail prepared under [8.20.1](#) and mail sacked under [455.4.2](#) must not be included in a mailing prepared under [8.20.2](#)). For purposes of this section, the term "pallets" includes preparation of parcels directly on pallets and in pallet boxes on pallets. Machinable and nonmachinable pieces may be combined on the same pallet. Double-stacking is permitted if the requirements of [8.3](#) are met.
- b. *Minimum volume*. To qualify for the DSCF price, no pallet may contain fewer than 35 pieces and 200 pounds, and for the entire mailing the average number of DSCF price pieces per 5-digit scheme, 5-digit, or 3-digit destination must be at least 50.

705.8.20.3

- c. *Overflow.* After filling pallets to a 5-digit scheme, 5-digit, or 3-digit destination, any remaining pieces that do not meet the minimum pallet requirements may be prepared in one or both of the following ways:
 1. Placed in 5-digit scheme, 5-digit, or 3-digit overflow sacks (no minimum number of pieces per sack) that are labeled in accordance with the DSCF sacking requirements in [455.4.2](#). Overflow pieces sacked in this manner are eligible for the DSCF prices.
 2. Placed on a 5-digit scheme, 5-digit, or 3-digit pallet labeled under [8.20.2d](#) that does not meet the minimums for the DSCF price. Overflow pieces palletized in this manner are not eligible for the DSCF prices but are eligible for the DBMC prices.
- d. *5-digit scheme.* Pallet labeling:
 1. Line 1: use [L606](#), Column B.
 2. Line 2: "PSVC PARCELS 5D SCH."
 3. In the mailer area below Line 3: use the pallet ID number.
- e. *5-digit.* Pallet labeling:
 1. Line 1: city, state, and 5-digit ZIP Code destination of contents.
 2. Line 2: "PSVC PARCELS 5D."
 3. In mailer area below line 3: use the pallet ID number.
- f. *3-digit.* Pallet labeling:
 1. Line 1: use [L002](#), Column C.
 2. Line 2: "PSVC PARCELS 3D."
 3. In the mailer area below Line 3: use the pallet ID number.
- g. *Documentation.* A list of each 5-digit scheme, 5-digit, and 3-digit pallet in the mailing that qualifies for the DSCF price must be submitted. The pallets in the mailing that qualify for the DSCF price must be renumbered sequentially, and this pallet identification number must be printed below Line 3 on the pallet label. The documentation must list each pallet in sequential order by pallet identification number. For each pallet, the listing must show: the pallet identification number, the applicable 5-digit scheme, 5-digit, or 3-digit destination of the pallet, the total weight of pieces on the pallet, the total number of pieces on the pallet, and the running total of pieces (i.e., the number equal to the number of pieces for that pallet plus the sum of the pieces on all pallets listed before it). This documentation must not include: pieces prepared in overflow sacks at the DSCF prices, pieces prepared on overflow pallets at the DBMC prices, or pieces claimed at any other price in the mailing.

8.20.3 5-Digit ZIP Codes for Which Pallets May Not Be Prepared

Refer to the Drop Shipment Product available from the National Customer Support Center (NCSC) (see [608.8.0](#)) to determine if the facility serving the 5-digit ZIP Code destination can handle pallets. If a facility cannot handle pallets, the DSCF price is not applicable unless the mail can be prepared under the sacking requirement in [455.4.2](#).

8.21 Parcel Select DSCF Prices—Sacks on Pallets

Mailers who prepared DSCF price mail in 5-digit scheme or 5-digit sacks under [455.4.2](#) may place 5-digit sacks for the same SCF area on an SCF pallet (including a pallet box on a pallet). Mailers who prepare overflow from pallets under [8.20.1](#) or [8.20.2](#) may place 5-digit scheme or 5-digit sacks for the same SCF area on an SCF pallet (including a pallet box on a pallet). See [8.20.1g](#) for requirements concerning separation of sacks prepared under [455.4.2](#) from sacks prepared under [8.20.1](#). There are no pallet minimums for such pallets. Mailers may prepare such SCF pallets without preparing all possible 5-digit scheme and 5-digit pallets. The pallets must be labeled in the following manner:

- a. *5-digit scheme pallets*, optional; labeling:
 1. Line 1: use [L606](#), Column B.
 2. Line 2: “PSVC PP 5D SCHEME” or “PSVC PP 5D SCH.”
- b. *5-digit pallets*, labeling:
 1. Line 1: use [L002](#), Column C.
 2. Line 2: “PSVC PP 5D.”

8.22 Parcel Select and Bound Printed Matter DDU Prices

Parcels may be bedloaded, sacked, or palletized. For purposes of this section the term “pallets” includes preparation of parcels directly on pallets and preparation of parcels in pallet boxes on pallets. There are no preparation or presort requirements for DDU price mailings other than separation by 5-digit scheme and 5-digit destination. Machinable and nonmachinable pieces may be combined. Refer to the Drop Shipment Product maintained by the National Customer Support Center (NCSC) (see [608.8.0](#)) and the information in [455.4.1](#). If a DDU facility cannot handle pallets, and a mailer transports mail to the DDU facility on pallets, the driver must unload the pallets into a container specified by the delivery unit. If pieces are sacked or palletized, they must be prepared to 5-digit scheme (optional) and 5-digit destinations, and labeled as follows:

- a. *5-digit scheme sacks or pallets*, optional; labeling:
 1. Line 1: use [L606](#), Column B.
 2. Line 2: “PSVC PARCELS 5D SCH.”
- b. *5-digit sacks or pallets*, labeling:
 1. Line 1: use city, state, and 5-digit ZIP Code destination of pieces.
 2. Line 2: “PSVC PARCELS 5D.”

9.0 Combining Bundles of Automation and Nonautomation Flats in Trays and Sacks

9.1 First-Class Mail

9.1.1 Basic Standards

Bundles of flats in an automation price mailing prepared under [335.6.5](#) must be cotrayed with bundles of flats in a Presorted price mailing under the following conditions:

- a. The automation price pieces and Presorted price pieces are part of the same mailing job and reported on the same postage statement.
- b. Pieces in the automation price mailing must meet the criteria for a flat under [301.3.0](#). Pieces in the Presorted price mailing must meet the criteria for a flat under [301.1.1](#).
- c. The automation price mailing must meet the eligibility criteria in [333.5.0](#), except that the traying criteria in [9.1.4](#) must be met rather than the traying criteria in [335.6.0](#).
- d. The Presorted price mailing must meet the eligibility criteria in [333.3.0](#), except that the traying and documentation criteria in [9.1.1](#) and [9.1.4](#) must be met rather than the traying and documentation criteria in [335.6.0](#).
- e. The prices for pieces in the automation price mailing are applied based on the level of bundle to which they are sorted under [333.5.2, Price Application—Bundle-Based Flats](#), and [333.5.3, Price Application—Tray-Based Flats](#).
- f. The pieces must be marked according to [302](#).
- g. The bundles prepared from the automation price mailing and the bundles prepared from the Presorted price mailing must be sorted into the same trays as described in [9.1.4](#).
- h. A complete, signed postage statement, using the correct USPS form or an approved facsimile, must accompany each mailing job prepared under these procedures. In addition to the applicable postage statement, documentation produced by PAVE-certified software or standardized documentation under [708.1.0](#) must be submitted with each cotrayed mailing job that describes for each tray sortation level the number of pieces qualifying for each applicable automation price and the number of pieces qualifying for the Presorted price.
- i. Barcoded tray labels under [708.6.0](#) must be used to label the trays.

9.1.2 Bundle Preparation

Except for mail prepared under the cobundling option in [9.1.3](#), the automation price mailing must be bundled and labeled under [335.6.5](#). The Presorted price mailing must be bundled and labeled under [335.5.0](#).

9.1.3 Optional Cobundling Preparation

As an option to the basic bundling requirements in [9.1.2](#), a mailer may choose to cobundle automation price and Presorted price flat-size pieces, subject to the conditions in [11.0](#).

9.1.4 Tray Preparation and Labeling

Presorted price and automation price bundles prepared under [9.1.2](#) or [9.1.3](#) must be presorted together into trays (cotrayed) in the sequence listed below. Trays must be labeled using the following information for Lines 1 and 2 and [335.4.0](#) for other sack label criteria.

- a. *5-digit*, required, full trays only (no overflow trays); labeling:
 1. Line 1: use city, state, and 5-digit ZIP Code destination (see [335.4.3](#) for military mail).
 2. Line 2: "FCM FLTS 5D BC/NBC."
- b. *3-digit*, required, full trays only (no overflow trays); labeling:
 1. Line 1: use [L002](#), Column A.
 2. Line 2: "FCM FLTS 3D BC/NBC."
- c. *Origin/entry 3-digit*, required for each 3-digit ZIP Code served by the SCF of the origin (verification) office, optional for each 3-digit ZIP Code served by the SCF of an entry office other than the origin office, no minimum; labeling:
 1. Line 1: use [L002](#), Column A.
 2. Line 2: "FCM FLTS 3D BC/NBC."
- d. *ADC*, required, full trays only (no overflow trays); use [L004](#) to determine ZIP Codes served by each ADC; labeling:
 1. Line 1: use [L004](#), Column B.
 2. Line 2: "FCM FLTS ADC BC/NBC."
- e. *Mixed ADC*, required, no minimum; labeling:
 1. Line 1: use L201; for mail originating in ZIP Code areas in Column A, use "MXD" followed by the city, state, and 3-digit ZIP Code prefix in the corresponding row in Column C (use "MXD" instead of "OMX" in the destination line and ignore Column B).
 2. Line 2: "FCM FLTS BC/NBC WKG."

9.2 Periodicals

9.2.1 Basic Standards

Bundles of flat-size pieces in a machinable barcoded (automation) price mailing must be cosacked with bundles of flat-size pieces in a machinable nonbarcoded price mailing under the following conditions:

- a. The pieces in the machinable barcoded price mailing and in the machinable nonbarcoded price mailing must be part of the same mailing job and must be reported on the appropriate postage statement(s).
- b. The machinable barcoded price mailing must meet the eligibility criteria in [707.14.0](#), except that the sacking and documentation criteria in [9.2.1](#), [9.2.3](#), and [9.2.4](#) must be met rather than the sacking and documentation criteria in [707.25.0](#).

705.9.2.2

- c. The machinable nonbarcoded price mailing must meet the eligibility criteria in [707.12.0](#), except that the sacking and documentation criteria in [9.2.1](#), [9.2.3](#), and [9.2.4](#) must be met rather than the sacking and documentation criteria in [707.25.0](#).
- d. The bundles prepared from the machinable barcoded price mailing and the bundles prepared from the machinable nonbarcoded price mailing must be sorted into the same sacks as described in [9.2.3](#) and [9.2.4](#).
- e. A complete, signed, appropriate postage statement(s), using the correct USPS form or an approved facsimile, must accompany each mailing job prepared under these procedures. In addition to the applicable postage statement, documentation produced by PAVE-certified software or standardized documentation under [708.1.0](#) must be submitted with each cosacked mailing job that describes for each sack sortation level the number of pieces qualifying for each applicable price.
- f. Barcoded sack labels under [708.6.0](#) must be used to label sacks.

9.2.2 Bundle Preparation

The machinable barcoded price mailing must be bundled and labeled under [707.25.0](#) (all bundle levels) and the machinable nonbarcoded price mailing must be bundled and labeled under [707.22.0](#) (excluding carrier route bundles).

9.2.3 Bundles With Fewer Than Six Pieces

5-digit and 3-digit bundles prepared under [707.22.0](#) and [707.25.0](#) may contain fewer than six pieces when the publisher determines that such preparation improves service. These low-volume bundles may be placed in 5-digit, 3-digit, and SCF sacks that contain at least 24 pieces or on 5-digit, 3-digit, or SCF pallets. Pieces in low-volume bundles must claim the applicable mixed ADC price (Outside-County) or basic price (In-County).

9.2.4 Sack Preparation and Labeling

Machinable barcoded price and machinable nonbarcoded price bundles must be presorted together into sacks (cosacked) in the sequence listed below. Sacks must be labeled using the following information for Lines 1 and 2 and [707.21.0](#) for other sack label criteria. If, due to the physical size of the mailpieces, the machinable barcoded price pieces are considered flat-size under [301.3.0](#) and the machinable nonbarcoded price pieces are considered irregular parcels under [401.1.6](#), the processing category shown on the sack label must show "FLTS."

- a. *5-digit/scheme*, required; scheme sort required only for pieces meeting the criteria in [301.3.0](#); 24-piece minimum, fewer pieces not permitted; labeling:
 1. Line 1: For 5-digit scheme sacks, use L007, Column B. For 5-digit sacks, use city, state, and 5-digit ZIP Code destination on pieces.
 2. Line 2: "PER" or "NEWS" as applicable and, for 5-digit scheme sacks, "FLT 5D SCH BC/NBC"; for 5-digit sacks, "FLT 5D BC/NBC."
- b. *3-digit*, required at 24 pieces, fewer pieces not permitted; labeling:
 1. Line 1: use L002, Column A.
 2. Line 2: "PER" or "NEWS" as applicable and "FLTS 3D BC/NBC."

- c. *SCF*, required at 24 pieces, fewer pieces not permitted; labeling:
 - 1. Line 1: use [L002](#), Column C.
 - 2. Line 2: “PER” or “NEWS” as applicable and “FLTS SCF BC/NBC.”
- d. *Origin/entry SCF*, required for the SCF of the origin (verification) office, optional for the SCF of an entry office other than the origin office, no minimum; labeling:
 - 1. Line 1: use [L002](#), Column C.
 - 2. Line 2: “PER” or “NEWS” as applicable and “FLTS SCF BC/NBC.”
- e. *ADC*, required at 24 pieces, fewer pieces not permitted (bundles of fewer than six pieces are not permitted); labeling:
 - 1. Line 1: use [L004](#), Column B.
 - 2. Line 2: “PER” or “NEWS” as applicable and “FLTS ADC BC/NBC.”
- f. *Origin mixed ADC*, required for any remaining pieces for destinations in [L201](#), Column B, corresponding to the origin ZIP Code in Column A. There is no minimum for the number of pieces in the sack, but bundles of fewer than six pieces at 5-digit, 3-digit, and ADC bundle levels are not permitted.
 - 1. Line 1: Use [L201](#), Column C.
 - 2. Line 2: “PER” or “NEWS” as applicable, followed by “FLTS WKG W FCM.”
- g. *Mixed ADC*, required, no minimum, except that bundles of fewer than six pieces at 5-digit, 3-digit, and ADC bundle levels are not permitted. Labeling:
 - 1. Line 1: use [L009](#), Column B.
 - 2. Line 2: “PER” or “NEWS” as applicable and “FLTS BC/NBC WKG.”

9.2.5 Optional Tray Preparation—Machinable Flat-Size Pieces

As an option, mailers may place in flats trays (see 707.20.4) machinable pieces meeting the criteria in [301.3.0](#) that would normally be placed in sacks. Mailers must either bundle or group all pieces as specified in [707.25.0](#) and [707.22.0](#) for each 5-digit scheme, 5-digit, 3-digit scheme, 3-digit, SCF, and ADC destination. Bundling is not permitted unless it achieves a finer presort than the presort destination of the tray. The trays are subject to a container charge, and any bundles are subject to a bundle charge. Tray preparation, sequence, and labeling:

- a. *5-digit scheme* (required), 24-piece minimum, labeling:
 - 1. Line 1: [L007](#), Column B.
 - 2. Line 2: “PER” or “NEWS” as applicable; followed by “FLTS”; followed by “5D SCH BC/NBC.”
- b. *5-digit* (required), 24-piece minimum, labeling:
 - 1. Line 1: city, state, and 5-digit ZIP Code on mail (see [708.6.2.2](#) for overseas military mail).
 - 2. Line 2: “PER” or “NEWS” as applicable; followed by “FLTS”; followed by “5D BC/NBC.”
- c. *3-digit* (required), 24-piece minimum, labeling:

705.9.3

1. Line 1: L002, Column A.
 2. Line 2: "PER" or "NEWS" as applicable; followed by "FLTS"; followed by "3D BC/NBC."
- d. SCF (required), 24-piece minimum, labeling:
1. Line 1: L002, Column C.
 2. Line 2: "PER" or "NEWS" as applicable; followed by "FLTS"; followed by "SCF BC/NBC."
- e. *Origin SCF* (required) and *entry SCF(s)* (optional), no minimum, labeling:
1. Line 1: L002, Column C.
 2. Line 2: "PER" or "NEWS" as applicable; followed by "FLTS"; followed by "SCF BC/NBC."
- f. ADC (required), 24-piece minimum, no overflow tray allowed, labeling:
1. Line 1: use L004, Column B.
 2. Line 2: "PER" or "NEWS" as applicable; followed by "FLTS"; followed by "ADC"; followed by " BC/NBC."
- g. *Origin mixed ADC* (required), no minimum, for any remaining pieces for destinations in L201, Column B, of the origin ZIP Code in Column A, labeling:
1. Line 1: Use L201, Column C.
 2. Line 2: "PER" or "NEWS" as applicable; followed by "FLTS"; followed by "WKG W FCM."
- h. *Mixed ADC* (required), no minimum, labeling:
1. Line 1: Use L009.
 2. Line 2: "PER" "NEWS" as applicable; followed by "FLTS"; followed by "BC/NBC WKG."

9.3 Standard Mail

9.3.1 Basic Standards

Bundles of flats in an automation price mailing must be cosacked with bundles of flats in a Presorted price mailing under the following conditions:

- a. The automation price pieces and the Presorted price pieces are part of the same mailing job and are reported on the same postage statement.
- b. Pieces in the automation price mailing must meet the criteria for a flat under 301.3.0. Pieces in the Presorted price mailing must meet the criteria for a flat under 301.1.1.
- c. The automation price mailing must meet the eligibility criteria in 343.7.0, except that the sacking and documentation criteria in 9.3.1, 9.3.4, and 9.3.5 must be met rather than the sacking and documentation criteria in 345.7.0.

- d. The Presorted price mailing must meet the eligibility criteria in [343.2.0](#) and [343.3.0](#), except that the sacking and documentation criteria in [9.3.1](#), [9.3.4](#), and [9.3.5](#) must be met rather than the sacking and documentation criteria in [345.5.0](#).
- e. The prices for pieces in the automation price mailing are applied based on the number of pieces in the bundle and the level of bundle to which they are sorted under [343.7.0](#). The prices for pieces in the Presorted price mailing are based on the number of pieces in the bundle and the level of sack in which they are placed under [343.3.6](#) and [343.3.7](#).
- f. The pieces must be marked according to [302](#).
- g. The bundles prepared from the automation price mailing and the bundles prepared from the Presorted price mailing must be sorted into the same sacks as described in [9.3.4](#) and [9.3.5](#).
- h. A complete, signed postage statement(s), using the correct USPS form or an approved facsimile, must accompany each mailing job prepared under these procedures. In addition to the applicable postage statement, documentation produced by PAVE-certified software or standardized documentation under [708.1.0](#) must be submitted with each cosacked mailing job that describes for each sack sortation level the number of pieces qualifying for each applicable automation price and the number of pieces qualifying for each applicable Presorted price.
- i. Barcoded sack labels under [708.6.0](#) must be used to label the sacks.

9.3.2 Bundle Preparation

Except for mail prepared under the cobundling option in [9.3.3](#), the automation price mailing must be bundled and labeled under [345.7.0](#) and the Presorted price mailing must be bundled and labeled under [345.5.0](#). Loose packing under [345.5.0](#) is not permitted.

9.3.3 Optional Cobundling Preparation

As an option to the basic bundling requirements in [9.3.2](#), a mailer may choose to cobundle automation price and Presorted price flat-size pieces, subject to the conditions in [11.0](#).

9.3.4 Sacking Under 125-Piece or 15-Pound Rules

When the minimum quantity of 125 pieces or 15 pounds of mail is specified for a sack sortation level in [9.3.5](#), the provisions of [345.7.4.2](#) apply.

9.3.5 Sack Preparation and Labeling

Presorted price and automation price bundles prepared under [9.3.2](#) and [9.3.3](#) must be presorted together into sacks (cosacked) in the sequence listed below. Sacks must be labeled using the following information for Lines 1 and 2, and [345.4.0](#) for other sack label criteria.

- a. 5-digit/scheme, required; scheme sort required, only for pieces meeting the automation-compatibility criteria in [301.3.0](#); 125-piece/15-pound minimum; labeling:

705.9.3.6

1. Line 1: For 5-digit scheme sacks, use [L007](#), Column B. For 5-digit sacks, use city, state, and 5-digit ZIP Code destination on pieces.
 2. Line 2: For 5-digit scheme sacks, “STD FLT 5D SCH BC/NBC”; for 5-digit sacks, “STD FLT 5D BC/NBC.”
- b. *3-digit*, required, 125-piece/15-pound minimum; labeling:
1. Line 1: use [L002](#), Column A.
 2. Line 2: “STD FLTS 3D BC/NBC.”
- c. *Origin/entry 3-digit*, required for each 3-digit ZIP Code served by the SCF of the origin (verification) office, optional for each 3-digit ZIP Code served by the SCF of an entry office other than the origin office, no minimum; labeling:
1. Line 1: use [L002](#), Column A.
 2. Line 2: “STD FLTS 3D BC/NBC.”
- d. *ADC*, required, 125-piece/15-pound minimum; use [L004](#) to determine ZIP Codes served by each ADC; labeling:
1. Line 1: use [L004](#), Column B.
 2. Line 2: “STD FLTS ADC BC/NBC.”
- e. *Mixed ADC*, required, no minimum; labeling:
1. Line 1: use [L009](#), Column B.
 2. Line 2: “STD FLTS BC/NBC WKG.”

9.3.6 Tray Preparation and Labeling

Presorted price and automation price bundles meeting the standards in [345.3.0](#) for letter trays and prepared under [9.3.2](#) must be presorted together into trays (cotrayed) in the sequence in [9.3.5](#). Trays must be labeled using the information for Lines 1 and 2 and [345.4.0](#) for other tray label criteria. Cobundling under this option is not permitted.

9.4 Bound Printed Matter**9.4.1 Basic Standards**

Bundles of flat-size pieces in a Presorted price mailing qualifying for and claiming the barcode discount under [363.2.0](#), [363.3.0](#), and [363.5.0](#) must be cosacked with bundles of flat-size pieces from a Presorted price mailing (not claiming the barcode discount) under the following conditions:

- a. The Presorted price pieces qualifying for and claiming the barcode discount and the Presorted price pieces must be part of the same mailing job and be reported on the same postage statement.
- b. The Presorted price pieces qualifying for and claiming the barcode discount must meet the criteria for flat-size mail under [301.3.0](#). Pieces in the Presorted price mailing must meet the criteria for flat-size mail under [301.2.0](#).

- c. The Presorted price mailing qualifying for and claiming the barcode discount must meet the eligibility criteria in [363.2.0](#), [363.3.0](#), and [363.5.0](#), the mail preparation standards in [365.7.0](#), the sacking requirements in [9.4.4](#), and the documentation criteria in [9.4.1h](#).
- d. The Presorted price mailing must meet the eligibility criteria in [363.2.0](#), [363.3.0](#), and [363.5.0](#), the mail preparation standards in [365.5.0](#), the sacking requirements in [9.4.4](#), and the documentation criteria in [9.4.1h](#).
- e. The prices for pieces in the Presorted price mailing qualifying for and claiming the barcode discount are applied based on meeting the sortation requirements in [365.7.0](#), and when applicable, the zone. The prices for pieces in the Presorted price mailing are based on meeting the sortation requirements in [365.5.0](#), and when applicable, the zone.
- f. The pieces must be marked according to [302](#).
- g. The bundles prepared from the Presorted price mailing qualifying for the barcode discount and the bundles prepared from the Presorted price mailing must be sorted into the same sacks as described in [9.4.4](#).
- h. A complete, signed postage statement(s), using the correct USPS form or an approved facsimile, must accompany each mailing job prepared under these procedures. In addition to the applicable postage statement, standardized documentation under [708.1.0](#) must be submitted with each cosacked mailing job that describes for each sack sortation level the number of pieces qualifying for the barcode discount and the number of pieces qualifying for each applicable Presorted price.
- i. Barcoded sack labels under [708.6.0](#) must be used to label the sacks.

9.4.2 Bundle Preparation

Except for mail prepared under the cobundling option in [9.4.3](#), the Presorted price mailing qualifying for and claiming the barcode discount must be bundled and labeled under [365.7.0](#), and the Presorted price mailing must be bundled and labeled under [365.5.0](#).

9.4.3 Optional Cobundling Preparation

As an alternative to the basic bundling requirements in [9.4.2](#), flat-size Presorted price pieces qualifying for and claiming the barcode discount may be cobundled with flat-size Presorted price pieces, subject to [11.0](#).

9.4.4 Sack Preparation and Labeling

Bundles of Presorted price pieces qualifying for and claiming the barcode discount and Presorted price pieces prepared under [9.4.2](#) or [9.4.3](#) must be presorted together into sacks (cosacked) using the following preparation sequence, sack size, and labeling:

- a. *5-digit/scheme*, required; scheme sort required, only for pieces meeting the automation-compatibility criteria in [301.3.0](#); minimum 20 addressed pieces; labeling:
 - 1. Line 1: For 5-digit scheme sacks, use [L007](#), Column B. For 5-digit sacks, use city, state, and 5-digit ZIP Code destination on pieces.

705.10.1

2. Line 2: For 5-digit scheme sacks, "PSVC FLT 5D SCH BC/NBC"; for 5-digit sacks, "PSVC FLT 5D BC/NBC."
- b. *3-digit*, required, except for optional bundles with 3-digit ZIP Code prefixes indicated by an "N" in L002, when optional SCF sacks are prepared; minimum 20 addressed pieces; labeling:
 1. Line 1: L002, Column A.
 2. Line 2: "PSVC FLTS 3D BC/NBC."
- c. *SCF*, optional, minimum 20 addressed pieces; labeling:
 1. Line 1: L005, Column B.
 2. Line 2: "PSVC FLTS SCF BC/NBC."
- d. *ADC*, required, minimum 20 addressed pieces (use L004 to determine ZIP Codes served by each ADC); labeling:
 1. Line 1: L004, Column B.
 2. Line 2: "PSVC FLTS ADC BC/NBC."
- e. *Mixed ADC*, required, no minimum; labeling:
 1. Line 1: use L009, Column B.
 2. Line 2: "PSVC FLTS BC/NBC WKG."

10.0 Merging Bundles of Flats in Sacks and Pallets Using the City State Product

10.1 Periodicals

10.1.1 Basic Standards

Carrier route bundles in a carrier route price mailing may be placed in the same sack or on the same pallet as 5-digit bundles from a machinable barcoded price mailing and 5-digit bundles from a machinable nonbarcoded price mailing (including pieces cobundled under 11.0) under the following conditions:

- a. A carrier route mailing must be part of the mailing job, unless cobundled under 11.0 using 5-digit scheme (L007) or 3-digit scheme (L008) bundle preparation, and sacked under 10.1.4.
- b. The pieces in the carrier route mailing, the machinable barcoded price mailing, and the machinable nonbarcoded price mailing must be part of the same mailing job.
- c. Pieces in the machinable price mailing must meet the flats criteria in 301.3.0; pieces that meet the flats criteria in 707.26.0 also may be sacked under this option. Pieces in the machinable nonbarcoded price mailing and the carrier route mailing must be flat-size.
- d. Mailers must use the Carrier Route Indicators field in the City State Product (see 509.1.2) to prepare the mailing and enter the mailing no later than 90 days after the release date of the City State Product used.

- e. Carrier route bundles may be cosacked or copalletized with machinable barcoded price 5-digit bundles, machinable nonbarcoded price 5-digit bundles, and cobundled 5-digit bundles only for those 5-digit ZIP Codes that have an “A” or “C” indicator in the Carrier Route Indicators field in the City State Product indicating eligibility for such cosacking or copalletization. Containers of mail sorted in this manner are called “merged 5-digit” sacks or pallets. Containers of mail sorted in this manner for which scheme (L001) sortation is also performed are called “merged 5-digit scheme” sacks or pallets. Pieces in 5-digit scheme (L007) bundles may not be placed in merged 5-digit containers.
- f. If sortation under this section is performed, merged 5-digit sacks or pallets must be prepared for all 5-digit ZIP Codes with an “A” or “C” indicator in the City State Product that permits such preparation when there is enough volume for the 5-digit ZIP Code to prepare such a sack under 10.1.4 or such a pallet under 10.1.5. In addition, all possible merged 5-digit scheme sacks must be prepared under 10.1.4, or all possible merged 5-digit scheme and 5-digit scheme pallets must be prepared under 10.1.5.
- g. For mailings prepared in sacks, mailers may not combine firm bundles and 5-digit scheme pieces in 5-digit scheme bundles or in 5-digit scheme sacks. Firm bundles must be placed in a separate individual 5-digit sack under 10.1.4g to maintain 5-digit price eligibility. Mailers may combine firm bundles with 5-digit scheme, 3-digit scheme, and other presort destination bundles in carrier route, 5-digit, 3-digit, SCF, ADC, and mixed ADC sacks. Only an In-County firm bundle can contribute toward the six-piece minimum for price eligibility.
- h. The bundles from each separated mailing must be sorted together into sacks (cosacked) under 10.1.4 or on pallets (copalletized) under 10.1.5 using presort software that is PAVE-certified.
- i. A complete, signed postage statement(s), using the correct USPS form or an approved facsimile, must accompany each mailing job prepared under these procedures. In addition to the postage statement(s), documentation prepared by PAVE-certified software must be submitted with each cosacked or copalletized mailing job that describes for each sack sortation level and sack, or each pallet sortation level and pallet, the number of pieces qualifying for each applicable price.
- j. Barcoded sack labels under 708.6.0 must be used to label sacks.

10.1.2 Bundle Preparation

Bundles must be prepared as follows:

- a. *Sacked mailings.* The carrier route mailing must be bundled and labeled under 707.23.0. Except when prepared under the cobundling option in 11.0, the barcoded price mailing must be bundled and labeled under 707.25.0 and the nonbarcoded price mailing must be bundled and labeled under 707.22.0.
- b. *Palletized mailings.* Bundles placed on pallets must be prepared under the standards in 8.9.

10.1.3 Bundles With Fewer Than Six Pieces

Carrier route, 5-digit scheme, 5-digit, 3-digit scheme, and 3-digit bundles may contain fewer than six pieces when the publisher determines that such preparation improves service. Pieces in these low-volume bundles must be claimed at the applicable mixed ADC price (Outside-County) or basic price (In-County).

Low-volume bundles are permitted only when they are sacked or prepared on pallets as follows:

- a. Place low-volume carrier route, 5-digit, 3-digit scheme, and 3-digit bundles in only the following containers:
 1. Carrier route, merged 5-digit scheme, 5-digit scheme carrier routes, merged 5-digit, 5-digit carrier routes, 5-digit, 3-digit, and SCF sacks that contain at least 24 pieces.
 2. Merged 3-digit sacks that contain at least one six-piece carrier route bundle.
 3. Origin/entry SCF sacks.
 4. On merged 5-digit scheme, 5-digit scheme carrier routes, 5-digit scheme, merged 5-digit, 5-digit carrier routes, 5-digit, 5-digit metro, 3-digit, or SCF pallets, as appropriate.
- b. Place low-volume 5-digit scheme bundles in only 5-digit scheme, 3-digit, and SCF sacks that contain at least 24 pieces, or in origin/entry SCF sacks, or on 3-digit or SCF pallets, as appropriate.

10.1.4 Sack Preparation and Labeling

Mailers must prepare sacks containing the individual carrier route and 5-digit bundles from the carrier route, barcoded, and nonbarcoded price mailings in the mailing job in the following manner and sequence. All carrier route bundles must be placed in sacks under [10.1.4a](#) through [10.1.4e](#) and [10.1.4h](#) as described below. When sorting is performed under this section, mailers must prepare merged 5-digit scheme sacks, 5-digit scheme carrier routes sacks, and merged 5-digit sacks for all possible 5-digit schemes or 5-digit ZIP Codes as applicable, using [L001](#) (merged 5-digit scheme and 5-digit scheme carrier routes sort only) and the Carrier Route Indicators field in the City State Product when there is enough volume for the 5-digit scheme or 5-digit ZIP Code to prepare such sacks under [10.1.4, Sack Preparation and Labeling](#). Mailers must label sacks according to the Line 1 and Line 2 information listed below and under [707.20.1, Basic Standards](#). If, due to the physical size of the mailpieces, the barcoded pieces are considered flat-size under [707.26.0](#), and the carrier route pieces and nonbarcoded pieces are considered irregular parcels under [401.1.6](#), "FLTS" must be shown as the processing category on the sack label. If a mailing job does not contain barcoded price pieces and the carrier route pieces and the nonbarcoded pieces are irregular parcel shaped, use "IRREG" for the processing category on the contents line of the label.

- a. *Carrier route*, required, may contain only carrier route bundles. Must be prepared when there are 24 or more pieces for the same carrier route. Smaller volume not permitted. Labeling:
 1. Line 1: use city, state, and 5-digit ZIP Code destination (see [707.21.1.2](#) for military mail).

2. Line 2: “PER” or “NEWS” as applicable; followed by “FLTS” or “IRREG” as applicable; followed by “CR” for basic price, “WSH” for high-density price, or “WSS” for saturation price; followed by the route type and number.
- b. *Merged 5-digit scheme*, required at 24 pieces, fewer pieces not permitted. Must contain at least one 5-digit ZIP Code in the scheme with an “A” or “C” indicator in the City State Product. May contain carrier route bundles for any 5-digit ZIP Code(s) in a single scheme listed in [L001](#) as well as machinable barcoded price 5-digit bundles and machinable nonbarcoded price 5-digit bundles for those 5-digit ZIP Codes in the schemes that have an “A” or “C” indicator in the City State Product. For 5-digit ZIP Code(s) in a scheme that has a “B” or “D” indicator in the City State Product, prepare sack(s) under [10.1.4g](#) and [10.1.4h](#). For 5-digit ZIP Codes not included in a scheme, prepare sacks under [10.1.4d](#) through [10.1.4h](#). Labeling:
 1. Line 1: use [L001](#), Column B.
 2. Line 2: “PER” or “NEWS” as applicable, followed by “FLTS” or “IRREG” as applicable, followed by “CR/5D SCH.”
 - c. *5-digit scheme carrier routes*, required at 24 pieces, fewer pieces not permitted. May contain only carrier route bundles for 5-digit ZIP Code(s) in a single scheme listed in [L001](#) when all the 5-digits in the scheme have a “B” or “D” indicator in the City State Product. Mailers must prepare this sack if there are any carrier route bundle(s) for such a scheme. Labeling:
 1. Line 1: use [L001](#), Column B.
 2. Line 2: “PER” or “NEWS” as applicable, followed by “FLTS” or “IRREG” as applicable, followed by “CR-RTS SCH.”
 - d. *Merged 5-digit*, required at 24 pieces, fewer pieces not permitted. Must be prepared only for those 5-digit ZIP Codes that are not part of a scheme and that have an “A” or “C” indicator in the City State Product. May contain carrier route bundles, machinable barcoded price 5-digit bundles, and machinable nonbarcoded price 5-digit bundles. Labeling:
 1. Line 1: use city, state, and 5-digit ZIP Code destination (see [707.21.1.2](#) for military mail).
 2. Line 2: “PER” or “NEWS” as applicable, followed by “FLTS” or “IRREG” as applicable, followed by “CR/5D.”
 - e. *5-digit carrier routes*, required at 24 pieces, fewer pieces not permitted. Include only carrier route bundles for a 5-digit ZIP Code remaining after preparing sacks under [10.1.4a](#) through [10.1.4d](#). May contain only carrier route bundles for any 5-digit ZIP Code that is not part of a scheme listed in [L001](#) and that has a “B” or “D” indicator in the City State Product. Labeling:
 1. Line 1: use city, state, and 5-digit ZIP Code destination (see [707.21.1.2](#) for military mail).
 2. Line 2: “PER” or “NEWS” as applicable, followed by “FLTS” or “IRREG” as applicable, followed by “CR-RTS.”

705.10.1.5

- f. *5-digit scheme*, required at 24 pieces, fewer pieces not permitted. May contain only machinable barcoded price and cobundled machinable barcoded and nonbarcoded price 5-digit scheme bundles for the same 5-digit scheme destination. Labeling:
 - 1. Line 1: [L007](#), Column B.
 - 2. Line 2: “PER” or “NEWS” as applicable, followed by “FLTS 5D SCH BC.”
- g. *5-digit*, required at 24 pieces, fewer pieces not permitted, except as provided in [10.1.1g](#) for firm bundles. May contain only barcoded price 5-digit bundles and nonbarcoded price 5-digit bundles for the same 5-digit ZIP Code for any 5-digit ZIP Code that has a “B” or “D” indicator in the City State Product. Labeling:
 - 1. Line 1: use city, state, and 5-digit ZIP Code destination (see [707.21.1.2](#) for military mail).
 - 2. Line 2: “PER” or “NEWS” as applicable, followed by “FLTS 5D BC/NBC,” except if there are no barcoded price bundles in the mailing job, label under [707.22.6](#).
- h. *Merged 3-digit*. May contain carrier route bundles, any 5-digit and 5-digit scheme bundles remaining after preparing sacks under 10.1.4a through [10.1.4g](#), and any 3-digit and 3-digit scheme bundles. When preparation of this sack level is permitted, mailers must prepare a sack if there are any remaining carrier route bundles for the 3-digit area. Required with at least one six-piece carrier route bundle. Must contain at least one carrier route bundle for the 3-digit area, or a minimum of 24 pieces. As an option to preparing bundles in merged 3-digit sacks, mailers may place those bundles in flats trays (see [707.20.4](#)). Labeling:
 - 1. Line 1: use [L002](#), Column A.
 - 2. Line 2: “PER” or “NEWS” as applicable, followed by “FLTS” or “IRREG” as applicable, followed by “CR/5D/3D.” If there are no barcoded price bundles in the mailing job, label under [707.22.6](#).
- i. *SCF through mixed ADC*. Any 5-digit scheme and 5-digit bundles remaining after preparing sacks under [10.1.4a](#) through [10.1.4h](#) and all 3-digit, 3-digit scheme, ADC, origin mixed ADC, and mixed ADC bundles must be sacked and labeled under [9.2](#) for cosacking of barcoded price and nonbarcoded price bundles, except if there are no barcoded price bundles in the mailing job, sack and label under [707.22.6](#), or if there are no nonbarcoded price bundles in the mailing job, sack and label under [707.25.4](#).

10.1.5 Pallet Preparation and Labeling

[7-3-08] Mailers must prepare pallets of bundles in the manner and sequence listed below and under [8.0, Preparing Pallets](#). When sortation under this option is performed, mailers must prepare all merged 5-digit scheme, 5-digit scheme carrier routes, 5-digit scheme, and merged 5-digit pallets that are possible in the mailing based on the volume of mail to the destination using [L001](#) and/or the City State Product. Mailers must label pallets according to the Line 1 and Line 2 information listed below and under [8.6, Pallet Labels](#).

- a. *Merged 5-digit scheme*, required and permitted only when there is at least one 5-digit ZIP Code in the scheme that has an “A” or “C” indicator in the City State Product. May contain carrier route bundles for any 5-digit ZIP Code(s) in a single scheme listed in [L001](#) as well as machinable barcoded price 5-digit bundles and machinable nonbarcoded price 5-digit bundles for those 5-digit ZIP Codes in the scheme that have an “A” or “C” indicator in the City State Product. For schemes in which all of the 5-digit ZIP Codes have a “B” or “D” indicator in the City State Product, begin preparing pallets under [10.1.5c](#) (5-digit scheme carrier routes pallet). For 5-digit ZIP Codes not included in a scheme, begin preparing pallets under [10.1.5c](#) (merged 5-digit pallet). Labeling:
 1. Line 1: use [L001](#), Column B.
 2. Line 2: “PER” or “NEWS” as applicable; followed by “FLTS”; followed by “CR/5D SCHEME.”
- b. *5-digit scheme carrier routes*, required. May contain only carrier route bundles for carrier routes in an [L001](#) scheme for which all of the 5-digit ZIP Codes in the scheme have a “B” or “D” indicator in the City State Product. Labeling:
 1. Line 1: use [L001](#), Column B.
 2. Line 2: “PER” or “NEWS” as applicable; followed by “FLTS”; followed by “CR-RTS SCHEME.”
- c. *Merged 5-digit*, required. May contain carrier route bundles, machinable barcoded price 5-digit bundles, and machinable nonbarcoded price 5-digit for those 5-digit ZIP Codes that are not part of a scheme and that have an “A” or “C” indicator in the City State Product. Labeling:
 1. Line 1: use city, state, and 5-digit ZIP Code destination (see [8.6.4](#) for military mail).
 2. Line 2: “PER” or “NEWS” as applicable; followed by “FLTS”; followed by “CR/5D.”
- d. *5-digit carrier routes*, required. May contain only carrier route price bundles for the same 5-digit ZIP Code for those 5-digit ZIP Codes that are not part of a scheme and that have a “B” or “D” indicator in the City State Product. Labeling:
 1. Line 1: use city, state, and 5-digit ZIP Code destination (see [8.6.4](#) for military mail).
 2. Line 2: “PER” or “NEWS” as applicable; followed by “FLTS”; followed by “CARRIER ROUTES” or “CR-RTS.”
- e. *5-digit*, required. May contain only machinable barcoded price 5-digit bundles and machinable nonbarcoded price 5-digit bundles for the same 5-digit ZIP Code with a “B” or “D” indicator in the City State Product, or 5-digit scheme ([L007](#)) bundles. Five-digit scheme bundles are assigned to 5-digit pallets according to the “label to” 5-digit ZIP Code in [L007](#). Labeling:
 1. Line 1: use city, state, and 5-digit ZIP Code destination (see [8.6.4](#) for military mail).

705.10.1.5

2. Line 2: “PER” or “NEWS” as applicable; followed by “FLTS”; followed by “5D”; followed by “BARCODED” or “BC” if the pallet contains machinable barcoded mail; followed by “NONBARCODED” or “NBC” if the pallet contains machinable nonbarcoded mail.
- f. *5-digit metro*, optional. May contain carrier route, machinable barcoded, and machinable nonbarcoded price bundles for the 5-digit ZIP Codes listed in [L006](#), Column A, and for the 3-digit ZIP Code areas listed in [L006](#), Column B.
Labeling:
 1. Line 1: use [L006](#), Column C.
 2. Line 2: “PER” or “NEWS”; followed by “FLTS”; followed by “METRO” or “MET”; followed by “BARCODED” or “BC” if the pallet contains machinable barcoded price mail; followed by “NONBARCODED” or “NBC” if the pallet contains machinable nonbarcoded price and/or carrier route mail.
- g. *3-digit*, optional. Option not available for 3-digit ZIP Code prefixes marked “N” in [L002](#). May contain carrier route price, machinable barcoded price, and machinable nonbarcoded price mail, including 3-digit scheme ([L008](#)) bundles. Three-digit scheme bundles are assigned to 3-digit pallets according to the “label to” 3-digit ZIP Code in [L008](#). Labeling:
 1. Line 1: use [L002](#), Column A.
 2. Line 2: “PER” or “NEWS” as applicable; followed by “FLTS”; followed by “3D,” followed by “BARCODED” or “BC” if the pallet contains machinable barcoded price mail; followed by “NONBARCODED” or “NBC” if the pallet contains machinable nonbarcoded price mail and/or carrier route mail.
- h. *SCF*, required. May contain carrier route price, machinable barcoded price, and machinable nonbarcoded price bundles. Labeling:
 1. Line 1: use [L002](#), Column C.
 2. Line 2: “PER” or “NEWS” as applicable; followed by “FLTS”; followed by “SCF”; followed by “BARCODED” or “BC” if the pallet contains machinable barcoded price mail; followed by “NONBARCODED” or “NBC” if the pallet contains machinable nonbarcoded price mail and/or carrier route mail.
- i. *ADC*, required. May contain carrier route price, machinable barcoded price, and machinable nonbarcoded price bundles. Labeling:
 1. Line 1: use [L004](#), Column B.
 2. Line 2: “PER” or “NEWS” as applicable; followed by “FLTS”; followed by “ADC”; followed by “BARCODED” or “BC” if the pallet contains machinable barcoded price mail; followed by “NONBARCODED” or “NBC” if the pallet contains machinable nonbarcoded price mail and/or carrier route mail.

10.2 Standard Mail

10.2.1 Basic Standards

Carrier route bundles from a carrier route price mailing may be placed in the same sack or on the same pallet as 5-digit bundles from an automation price mailing and 5-digit bundles from a Presorted price mailing (including pieces cobundled under 11.0) under the following conditions:

- a. A carrier route mailing must be part of the mailing job, unless cobundled under 11.0 utilizing 5-digit scheme (L007) or 3-digit scheme (L008) bundle preparation and sacked under 10.1.4.
- b. The pieces in the carrier route price mailing, the automation price mailing, and the Presorted price mailing must be part of the same mailing job, and all three mailings must be reported on the same postage statement.
- c. Pieces in the automation price mailing must meet the criteria for a flat under 301.3.0. Pieces in the Presorted price mailing and the carrier route mailing must meet the criteria for a flat under 301.1.0.
- d. Mailers must use the Carrier Route Indicators field in the City State Product to prepare the mailing and enter the mailing no later than 90 days after the release date of the City State Product used.
- e. Carrier route bundles may be cosacked or copalletized with automation price 5-digit bundles, Presorted price 5-digit bundles, and cobundled 5-digit bundles only for those 5-digit ZIP Codes that have an “A” or “C” indicator in the Carrier Route Indicators field in the City State Product indicating eligibility for such cosacking or copalletization. Containers of mail sorted in this manner are called “merged 5-digit” sacks or pallets. Containers of mail sorted in this manner for which scheme (L001) sortation is also performed are called “merged 5-digit scheme” sacks or pallets. Pieces in 5-digit scheme (L007) bundles may not be placed in merged 5-digit containers.
- f. If sortation under this section is performed, merged 5-digit sacks or pallets must be prepared for all 5-digit ZIP Codes with an “A” or “C” indicator in the City State Product that permits such preparation when there is enough volume for the 5-digit ZIP Code to prepare that sack or pallet.
- g. For sacked mailings, the prices for pieces in the carrier route mailing are based on the criteria in 343.6.0, the prices for pieces in the automation price mailing are applied based on the number of pieces in the bundle and the level of bundle to which they are sorted under 343.7.0, and the prices for pieces in the Presorted price mailing are based on the number of pieces in the bundle and the level of sack to which they are sorted under 343.5.0.
- h. The pieces in each separate mailing must bear the applicable markings required under 345.5.0, 345.6.0, or 345.7.0 and under 302.
- i. For palletized mailings, the prices are based on the level of bundle that the pieces are contained in under 343.6.0 and 343.7.0.
- j. The bundles from each separate mailing must be sorted together into sacks (cosacked) under 10.2.3 and 10.2.4 or on pallets (copalletized) under 10.2.5 using presort software that is PAVE-certified.

705.10.2.2

- k. A complete, signed postage statement, using the correct USPS form or an approved facsimile, must accompany each mailing job prepared under these procedures.
- l. In addition to the applicable postage statement, documentation produced by PAVE-certified software must be submitted with each cosacked or copalletized mailing job that describes for each sack sortation level and sack, or each pallet sortation level and pallet, the number of pieces qualifying for each applicable carrier route price, each applicable automation price, and each applicable Presorted price.
- m. Barcoded sack labels under [708.6.0](#) must be used to label sacks.

10.2.2 Bundle Preparation

Bundles must be prepared as follows:

- a. *Sacked mailings.* The carrier route mailing must be bundled and labeled under [345.6.0](#). Except when prepared under the cobundling option in [11.0](#), the automation price mailing must be bundled and labeled under [345.7.0](#) and the Presorted price mailing must be bundled and labeled under [345.5.0](#).
- b. *Palletized mailings.* Bundles placed on pallets must be prepared under the standards in [8.0](#), *Preparing Pallets*.

10.2.3 Sacking Under 125-Piece or 15-Pound Rules

When the minimum quantity of 125 pieces or 15 pounds of mail is specified for a sack sortation level in [10.2.4](#), the provisions of [345.7.4.2](#) apply.

10.2.4 Sack Preparation and Labeling

Mailers must prepare sacks in the following manner and sequence. All carrier route bundles must be placed in sacks under [10.2.4a](#) through [10.2.4e](#) as described below. Mailers must prepare all merged 5-digit scheme sacks, 5-digit scheme carrier routes sacks, and merged 5-digit sacks that are possible in the mailing based on the volume of mail to the destination using [L001](#) and the Carrier Route Indicators field in the City State Product. Mailers must label sacks according to the Line 1 and Line 2 information listed below and under [345.4.0](#), *Sack and Tray Labels*.

- a. *Carrier route*, required, may contain only carrier route bundles. Must be prepared when there are 125 pieces or 15 pounds of pieces for the same carrier route. Smaller volume not permitted. Labeling:
 - 1. Line 1: use city, state, and 5-digit ZIP Code destination (see [345.4.2](#) for military mail).
 - 2. Line 2: "STD FLTS"; followed by "ECRLOT," "ECRWSH," or "ECRWSS" as applicable for basic, high-density, and saturation price mail; followed by the route type and number.
- b. *Merged 5-digit scheme*, required and permitted only when there is at least one 5-digit ZIP Code in the scheme with an "A" or "C" indicator in the City State Product. May contain carrier route bundles for any 5-digit ZIP Code(s) in a single scheme listed in [L001](#) as well as automation price 5-digit bundles and Presorted price 5-digit bundles for those 5-digit ZIP Codes in the scheme with an "A" or "C" indicator in the City State Product. When preparation of this sack

level is permitted, a sack must be prepared if there are any carrier route bundle(s) for the scheme. If there is not at least one carrier route bundle for any 5-digit destination in the scheme, preparation of this sack is required when there are at least 125 pieces or 15 pounds of pieces in 5-digit bundles for any of the 5-digit ZIP Codes in the scheme that have an “A” or “C” indicator in the City State Product (smaller volume not permitted). For a 5-digit ZIP Code(s) in a scheme with a “B” or “D” indicator in the City State Product, prepare sack(s) for the automation price and Presorted price bundles under [10.2.4g](#) and [10.2.4h](#). For 5-digit ZIP Codes not included in a scheme, prepare sacks under [10.2.4d](#) through [10.2.4h](#). Labeling:

1. Line 1: use [L001](#), Column B.
 2. Line 2: “STD FLTS CR/5D SCH.”
- c. *5-digit scheme carrier routes*, required, may contain only carrier route bundles for 5-digit ZIP Code(s) in a single scheme listed in [L001](#) when all the 5-digit ZIP Codes in the scheme have a “B” or “D” indicator in the City State Product. Must be prepared if there are any carrier route bundle(s) for such a scheme. Labeling:
1. Line 1: use [L001](#), Column B.
 2. Line 2: “STD FLTS CR-RTS SCH.”
- d. *Merged 5-digit*, required. Must be prepared only for those 5-digit ZIP Codes that are not part of a scheme and that have an “A” or “C” indicator in the City State Product. May contain carrier route bundles, automation price 5-digit bundles, and Presorted price 5-digit bundles. Must be prepared if there are any carrier route bundles for the 5-digit destination. If there is not at least one carrier route bundle for the 5-digit destination, must be prepared when there are at least 125 pieces or 15 pounds of pieces in 5-digit bundles for the same 5-digit destination (smaller volume not permitted). Labeling:
1. Line 1: use city, state, and 5-digit ZIP Code destination (see [345.4.2](#) for military mail).
 2. Line 2: “STD FLTS CR/5D.”
- e. *5-digit carrier routes*, required. Sack only carrier route bundles for a 5-digit ZIP Code remaining after preparing sacks under [10.2.4a](#) through [10.2.4d](#) to this level. May contain only carrier route bundles for any 5-digit ZIP Code that is not part of a scheme listed in [L001](#) and that has a “B” or “D” indicator in the City State Product. No sack minimum. Labeling:
1. Line 1: use city, state, and 5-digit ZIP Code destination (see [345.4.2](#) for military mail).
 2. Line 2: “STD FLTS CR-RTS.”
- f. *5-digit scheme*, required. May contain automation price, Presorted price, and cobundled automation and Presorted price 5-digit scheme bundles for the same 5-digit scheme destination. Must be prepared when there are at least 125 pieces or 15 pounds of pieces for the 5-digit scheme destination. Smaller volume not permitted. Labeling:
1. Line 1: [L007](#), Column B.

705.10.2.5

2. Line 2: "STD FLTS 5D SCH BC/NBC."
- g. *5-digit*, required, may contain only automation price 5-digit bundles and Presorted price 5-digit bundles for a 5-digit ZIP Code that has a "B" or "D" indicator in the City State Product. Must be prepared when there are at least 125 pieces or 15 pounds of pieces for the 5-digit ZIP Code. Smaller volume not permitted. Labeling:
1. Line 1: use city, state, and 5-digit ZIP Code destination (see [345.4.2](#) for military mail).
 2. Line 2: "STD FLTS 5D BC/NBC," except if there are no automation price bundles in the mailing job, use "STD FLTS 5D NON BC."
- h. *3-digit through mixed ADC sacks*. Any 5-digit scheme and 5-digit bundles remaining after preparing sacks under [10.2.4a](#) through [10.2.4g](#), and all 3-digit, ADC, and Mixed ADC bundles, must be sacked and labeled according to the applicable requirements under [9.3](#) for cosacking of automation price and Presorted price bundles, except if there are no automation price bundles in the mailing job, sack and label under [345.5.7](#), or, if there are no Presorted price bundles in the mailing job, sack and label under [345.7.4.3](#).

10.2.5 Pallet Preparation and Labeling

[7-3-08] Mailers must prepare pallets in the manner and sequence listed below and under [8.0](#). Mailers must prepare all merged 5-digit scheme, 5-digit scheme carrier routes, 5-digit scheme, and merged 5-digit pallets that are possible in the mailing based on the volume of mail to the destination using [L001](#) and/or the City State Product. Mailers must label pallets according to the Line 1 and Line 2 information listed below and under [8.6](#).

- a. *Merged 5-digit scheme*, required and permitted only when there is at least one 5-digit ZIP Code in the scheme that has an "A" or "C" indicator in the City State Product. May contain carrier route bundles for any 5-digit ZIP Code(s) in a single scheme listed in [L001](#) as well as automation price 5-digit bundles and Presorted price 5-digit bundles for those 5-digit ZIP Codes in the scheme that have an "A" or "C" indicator in the City State Product. For schemes in which all of the 5-digit ZIP Codes have a "B" or "D" indicator in the City State Product, begin preparing pallets under [10.2.5b](#) (5-digit scheme carrier routes pallet). For 5-digit ZIP Codes not included in a scheme, begin preparing pallets under [10.2.5c](#) (merged 5-digit pallet). Labeling:
1. Line 1: use [L001](#), Column B.
 2. Line 2: "STD FLTS CR/5D SCHEME."
- b. *5-digit scheme carrier routes*, required, may contain only carrier route bundles for carrier routes in an [L001](#) scheme for which all of the 5-digit ZIP Codes in the scheme have a "B" or "D" indicator in the City State Product. Labeling:
1. Line 1: use [L001](#), Column B.
 2. Line 2: "STD FLTS CR-RTS SCHEME."

- c. *Merged 5-digit*, required, may contain carrier route price bundles, automation price 5-digit bundles, and Presorted price 5-digit bundles for those 5-digit ZIP Codes that are not part of a scheme and that have an “A” or “C” indicator in the City State Product. Labeling:
 1. Line 1: use city, state, and 5-digit ZIP Code destination (see [8.6.4](#) for military mail).
 2. Line 2: “STD FLTS CR/5D.”
- d. *5-digit carrier routes*, required, may contain only carrier route price bundles for the same 5-digit ZIP Code for those 5-digit ZIP Codes that are not part of a scheme and that have a “B” or “D” indicator in the City State Product. Labeling:
 1. Line 1: use city, state, and 5-digit ZIP Code destination (see [8.6.4](#) for military mail).
 2. Line 2: “STD FLTS,” followed by “CARRIER ROUTES” or “CR-RTS.”
- e. *5-digit*, required, may contain only automation price 5-digit bundles and Presorted price 5-digit bundles for the same 5-digit ZIP Code with a “B” or “D” indicator in the City State Product, or 5-digit scheme ([L007](#)) bundles (automation price and cobundled automation and Presorted price pieces only). Five-digit scheme bundles are assigned to 5-digit pallets according to the “label to” 5-digit ZIP Code in [L007](#). Labeling:
 1. Line 1: use city, state, and 5-digit ZIP Code destination (see [8.6.4](#) for military mail).
 2. Line 2: “STD FLTS 5D”; followed by “BARCODED” or “BC” if the pallet contains automation price mail; followed by “NONBARCODED” or “NBC” if the pallet contains Presorted price mail.
- f. *5-digit metro*, optional, may contain carrier route, automation, and Presorted price bundles for the 5-digit ZIP Codes listed in [L006](#), Column A, and for the 3-digit ZIP Code areas listed in [L006](#), Column B. Labeling:
 1. Line 1: use [L006](#), Column C.
 2. Line 2: “STD FLTS” followed by “METRO” or “MET”; followed by “BARCODED” or “BC” if the pallet contains automation price mail; followed by “NONBARCODED” or “NBC” if the pallet contains Presorted price and/or carrier route mail.
- g. *3-digit*, optional, option not available for 3-digit ZIP Code prefixes marked “N” in [L002](#). May contain carrier route price, automation price, and Presorted price mail, including 3-digit scheme ([L008](#)) bundles (automation and cobundled automation and Presorted price pieces only). Three-digit scheme bundles are assigned to 3-digit pallets according to the “label to” 3-digit ZIP Code in [L008](#). Labeling:
 1. Line 1: use [L002](#), Column A.
 2. Line 2: “STD FLTS 3D”; followed by “BARCODED” or “BC” if the pallet contains automation price mail; followed by “NONBARCODED” or “NBC” if the pallet contains Presorted price mail and/or carrier route price mail.

705.11.1

- h. *SCF*, required, may contain carrier route price, automation price, and Presorted price bundles. Labeling:
 - 1. Line 1: use [L002](#), Column C.
 - 2. Line 2: “STD FLTS SCF”; followed by “BARCODED” or “BC” if the pallet contains automation price mail; followed by “NONBARCODED” or “NBC” if the pallet contains Presorted price mail and/or carrier route price mail.
- i. *ASF*, required, except that an ASF sort may not be required if using bundle reallocation under [8.13.3](#). May contain carrier route price, automation price, and/or Presorted price bundles. Sort ADC bundles to ASF pallets based on the “label to” ZIP Code for the ADC destination of the bundle in [L004](#). At the mailer’s option, sort appropriate mixed ADC bundles to ASF pallets based on the “label to” ZIP Code for the ADC destination of the bundle in [L010](#). All optional mixed ADC bundles on ASF pallets must contain only pieces destinating within the ASF as shown in [6.3](#). See [346.3.0](#) for additional requirements for DBMC price eligibility. Labeling:
 - 1. Line 1: use [L602](#), Column B.
 - 2. Line 2: “STD FLTS ASF”; followed by “BARCODED” or “BC” if the pallet contains automation price mail; followed by “NONBARCODED” or “NBC” if the pallet contains Presorted price mail and/or carrier route price mail.
- j. *BMC*, required, may contain carrier route price, automation price, and/or Presorted price bundles. Sort ADC bundles to BMC pallets based on the “label to” ZIP Code for the ADC destination of the bundle in [L004](#). At the mailer’s option, sort appropriate mixed ADC bundles to BMC pallets based on the “label to” ZIP Code for the ADC destination of the bundle in [L010](#). All optional mixed ADC bundles on BMC pallets must contain only pieces destinating within the BMC as shown in [6.3](#). See [346.3.0](#) for additional requirements for DBMC price eligibility. Labeling:
 - 1. Line 1: use [L601](#), Column B.
 - 2. Line 2: “STD FLTS BMC”; followed by “BARCODED” or “BC” if the pallet contains automation price mail; followed by “NONBARCODED” or “NBC” if the pallet contains Presorted price mail and/or carrier route price mail.

11.0 Combining Automation Price and Nonautomation Price Flats in Bundles

11.1 First-Class Mail

11.1.1 Basic Standards

Mailers may choose to cobundle (see [335.1.4m](#)) automation price and nonautomation price pieces as an option to the basic bundling requirements in [9.0](#), [Combining Bundles of Automation and Nonautomation Flats in Trays and Sacks](#), subject to the following conditions:

- a. The pieces in the automation price mailing and the nonautomation price mailing must be part of the same mailing job and must be reported on the appropriate postage statement.
- b. The pieces in the mailing job must be flat-size and meet any other size and mailpiece design requirements applicable to the price category for which they are prepared.
- c. The basic standards in [9.0](#) must be met.
- d. A minimum of 500 automation price pieces and 500 nonautomation price pieces are required. The total number of automation price and nonautomation price pieces must be used to meet the minimum volume requirements for bundles and containers to a presort destination.
- e. Nonautomation price pieces must contain a 5-digit barcode and be cobundled with automation price pieces for the same presort destination. If this optional preparation method is used, all automation price and nonautomation price pieces in the same mailing job and reported on the same postage statement must be cobundled.
- f. Mailers must sort automation price pieces and nonautomation price pieces for each presort destination so that only one physical bundle for each logical presort destination (see [335.1.4i](#)) includes both automation price pieces (containing a ZIP+4 or delivery point barcode) and nonautomation price pieces (containing a 5-digit barcode).

11.1.2 Bundle Preparation

Preparation sequence, bundle size, and labeling:

- a. *5-digit*, required, 10-piece minimum; red Label 5 or optional endorsement line (OEL).
- b. *3-digit*, required, 10-piece minimum; green Label 3 or OEL.
- c. *ADC*, required, 10-piece minimum; pink Label A or OEL.
- d. *Mixed ADC*, required, no minimum; tan Label X or OEL.

11.2 Periodicals

11.2.1 Basic Standards

Mailers may choose to cobundle (see [707.18.4aa](#)) barcoded price and nonbarcoded price flat-size pieces as an option to the basic bundling requirements in [707.22.0](#) and [707.25.0](#). 5-digit scheme and 3-digit scheme bundles also must meet the additional standards in [707.18.4i](#) and [707.18.4r](#). Mailing jobs (for flats meeting the criteria in [301.3.0](#)) prepared using the 5-digit scheme and/or the 3-digit scheme bundle preparation must be sacked under [9.0](#) or [10.0](#) or palletized under [10.0](#), [12.0](#), or [13.0](#). All bundles are subject to the following conditions:

- a. The pieces in the barcoded price mailing and the nonbarcoded price mailing must be part of the same mailing job and must be reported on the appropriate postage statement.
- b. Mailings prepared in sacks must meet the basic standards in [9.0](#) or [10.0](#).

705.11.2.2

- c. Mailings prepared on pallets must meet the basic standards in [8.0](#), [10.0](#), [12.0](#), or [13.0](#).
- d. The total number of barcoded price and nonbarcoded price pieces must be used to meet the minimum volume requirements for bundles and containers.
- e. Nonbarcoded price pieces must contain a 5-digit barcode and be cobundled with barcoded price pieces for the same presort destination. All pieces in the mailing job are reported on the same postage statement and must be cobundled.
- f. Within a bundle, all pieces must meet the machinable flats requirements in [301.3.0](#) or all pieces must meet the nonmachinable flats requirements in [707.26.0](#).
- g. Mailers must sort pieces for each presort destination so that only one physical bundle for each logical presort destination (see [707.18.4z](#)) includes both barcoded price pieces (containing a ZIP+4 or delivery point barcode) and nonbarcoded price pieces (containing a 5-digit barcode).

11.2.2 Bundle Preparation

[7-3-08] Pieces meeting the criteria in [301.3.0](#) must be prepared in 5-digit scheme bundles for those 5-digit ZIP Codes identified in [L007](#) and in 3-digit scheme bundles for those 3-digit ZIP Codes identified in [L008](#). Preparation sequence, bundle size, and labeling:

- a. *Firm*, two-piece minimum; blue Label F or optional endorsement line (OEL).
- b. *5-digit scheme*, required for pieces prepared under [301.3.0](#), six-piece minimum, fewer pieces permitted under [11.2.3](#); red Label 5 SCH, or OEL.
- c. *5-digit*, required, six-piece minimum, fewer pieces permitted under [11.2.3](#); red Label 5 or OEL.
- d. *3-digit scheme*, required for pieces prepared under [301.3.0](#), six-piece minimum, fewer pieces permitted under [11.2.3](#); green Label 3 SCH or OEL.
- e. *3-digit*, required, six-piece minimum, fewer pieces permitted under [11.2.3](#); green Label 3 or OEL.
- f. *ADC*, required, six-piece minimum; pink Label A or OEL.
- g. *Origin mixed ADC*, required, no minimum; for any remaining pieces for destinations in [L201](#), Column B, corresponding to the origin ZIP Code in Column A; tan Label X or OEL.
- h. *Mixed ADC*, required, no minimum; tan Label X or OEL.

11.2.3 Bundles With Fewer Than Six Pieces

5-digit scheme, 5-digit, 3-digit scheme, and 3-digit bundles may contain fewer than six pieces when the publisher determines that such preparation improves service. Pieces in these low-volume bundles must be claimed at the applicable mixed ADC price (Outside-County) or basic price (In-County). Low-volume bundles are permitted only when they are sacked or prepared on pallets as follows:

- a. Place low-volume 5-digit and 3-digit bundles in only 5-digit scheme, 5-digit, 3-digit, and SCF sacks that contain at least 24 pieces; or in origin/entry SCF sacks; or on merged 5-digit scheme, 5-digit scheme, merged 5-digit, 5-digit, 5-digit metro, 3-digit, or SCF pallets, as appropriate.
- b. Place low-volume 5-digit scheme and 3-digit scheme bundles in only 5-digit scheme, 3-digit, and SCF sacks that contain at least 24 pieces, or in origin/entry SCF sacks, or on 3-digit or SCF pallets, as appropriate.

11.3 Standard Mail

11.3.1 Basic Standards

Mailers may choose to cobundle (see [345.1.4u](#)) automation price and nonautomation price flat-size pieces as an option to the basic bundling requirements in [345.5.0](#) and [345.7.0](#). All pieces in the same bundle must meet the standards in [301.3.0](#). 5-digit scheme and 3-digit scheme bundles must meet the additional standards in [345.1.4f](#). and [345.1.4n](#). Mailing jobs prepared using the 5-digit scheme and/or 3-digit scheme bundle preparation (for flats meeting the criteria in [301.3.0](#)) must be sacked under [10.0](#) or palletized under [10.0](#), [12.0](#), or [13.0](#). All bundles are subject to the following conditions:

- a. The pieces in the automation price mailing and the nonautomation price mailing must be part of the same mailing job and must be reported on the appropriate postage statement.
- b. Mailings prepared in sacks must meet the basic standards in [9.0](#) or [10.0](#).
- c. Mailings prepared on pallets must meet the basic standards in [8.0](#), [10.0](#), [12.0](#), or [13.0](#).
- d. A minimum of 200 pieces or 50 pounds of automation price pieces are required; the nonautomation price mailing may meet the residual volume requirements in [343.3.6](#). The total number of automation price and nonautomation price pieces must be used to meet the minimum volume requirements for bundles and containers.
- e. Nonautomation price pieces must contain a 5-digit barcode and be cobundled with automation price pieces for the same presort destination. If this optional preparation method is used, all automation price and nonautomation price pieces in the same mailing job and reported on the same postage statement must be cobundled.
- f. Mailers must sort nonautomation price pieces and automation price pieces for each presort destination so that only one physical bundle for each logical presort destination (see [345.1.4t](#)) includes both nonautomation price pieces (containing a 5-digit barcode) and automation price pieces (containing a ZIP+4 or delivery point barcode).

11.3.2 Bundle Preparation

[7-3-08] Pieces meeting the criteria in [301.3.0](#) must be prepared in 5-digit scheme bundles for those 5-digit ZIP Codes identified in [L007](#) and in 3-digit scheme bundles for those 3-digit ZIP Codes identified in [L008](#). Preparation sequence, bundle size, and labeling:

705.11.4

- a. 5-digit scheme, required:
 1. For mailings containing only pieces weighing 5 ounces (0.3125 pound) or less: 15-piece minimum; red Label 5 SCH or OEL.
 2. For mailings containing any pieces weighing more than 5 ounces (0.3125 pound): 10-piece minimum; red Label 5 or OEL.
- b. *5-digit*, required:
 1. For mailings containing only pieces weighing 5 ounces (0.3125 pound) or less and measuring 3/4 inch thick or less: 15-piece minimum; red Label 5 or OEL.
 2. For mailings containing any pieces weighing more than 5 ounces (0.3125 pound) or measuring more than 3/4 inch thick: 10-piece minimum; red Label 5 or OEL.
- c. *3-digit scheme*, required, 10-piece minimum; green Label 3 SCH or OEL.
- d. *3-digit*, required, 10-piece minimum; green Label 3 or OEL.
- e. *ADC*, required, 10-piece minimum; pink Label A or OEL.
- f. *Mixed ADC*, required, no minimum; tan Label X or OEL.

11.4 Bound Printed Matter

11.4.1 Basic Standards

Mailers may choose to cobundle (see [365.1.5I](#)) nonautomation price flat-size with and without a barcode, as an option to the basic bundling requirements in [365.5.0](#) and [365.7.0](#), subject to the following conditions:

- a. The pieces in the nonautomation price mailing qualifying for and claiming the barcode discount and the pieces in the nonautomation price mailing must be part of the same mailing job and reported on the same postage statement.
- b. The mailing job must consist entirely of automation-compatible pieces meeting the criteria in [301.3.0](#), and may be prepared in 5-digit scheme bundles using [L007](#) and 3-digit scheme bundles using [L008](#).
- c. Cobundled pieces must be cosacked under [9.0](#) or palletized under [8.0](#).
- d. A separate minimum of 300 nonautomation price pieces qualifying for and claiming the barcode discount and a separate minimum of 300 nonautomation price pieces are required. The combined total number of pieces qualifying for and claiming the barcode discount and the nonautomation price must be used to meet the minimum volume requirements for bundles and sacks.
- e. Nonautomation price pieces must contain a 5-digit barcode and be cobundled with nonautomation price pieces qualifying for and claiming the barcode discount for the same presort destination.
- f. Unless presented using an approved manifest mailing system under [2.0](#), nonautomation price pieces qualifying for and claiming the barcode discount and nonautomation price pieces for each presort destination must be sorted so that only one physical bundle for each logical presort destination includes both

nonautomation price pieces qualifying for the barcode discount (containing a ZIP+4 or delivery point barcode) and nonautomation price pieces (containing a 5-digit barcode).

11.4.2 Bundle Preparation

[7-3-08] Preparation sequence, bundle size, and labeling:

- a. *5-digit scheme*, optional, minimum 10 addressed pieces or 10 pounds, maximum bundle weight 20 pounds; red Label 5 SCH or OEL.
- b. *5-digit*, required, minimum 10 addressed pieces or 10 pounds, maximum bundle weight 20 pounds; red Label 5 or optional endorsement line (OEL).
- c. *3-digit scheme*, optional, minimum 10 addressed pieces or 10 pounds, maximum bundle weight 20 pounds; green Label 3 SCH or OEL.
- d. *3-digit*, required, minimum 10 addressed pieces or 10 pounds, maximum bundle weight 20 pounds; green Label 3 or OEL.
- e. *ADC*, required, minimum 10 addressed pieces or 10 pounds, maximum bundle weight 20 pounds; pink Label A or OEL.
- f. *Mixed ADC*, required, no minimum, maximum bundle weight 20 pounds; tan Label X or OEL.

12.0 Merging Bundles of Flats on Pallets Using a 5% Threshold

12.1 Periodicals

12.1.1 Basic Standards

Five-digit scheme bundles (under [L007](#)) and 3-digit scheme bundles (under [L008](#)) must be prepared according to standards in [12.1.5](#). However, neither 5-digit scheme bundles nor 3-digit scheme bundles may be copalletized on any merged pallets. Five-digit bundles from a barcoded price mailing and 5-digit bundles from a nonbarcoded price mailing (including pieces cobundled under [11.0](#)) may be placed on the same pallet as carrier route bundles under the following conditions:

- a. A carrier route mailing must be part of the same mailing job as the barcoded price mailing and/or the nonbarcoded price mailing.
- b. Pieces in the barcoded price mailing must meet the criteria for a flat under [301.3.0](#) or [707.26.0](#). These two types of flats cannot be combined in the same bundle.
- c. When firm bundles, carrier route bundles, and 5-digit bundles are placed together on the same merged 5-digit scheme or merged 5-digit pallet, pieces in 5-digit bundles (other than firm bundles) must not exceed the 5% limit described in [12.1.4](#).
- d. All possible merged 5-digit scheme and 5-digit scheme pallets must be prepared according to standards in [12.1.5](#).
- e. The bundles from each separate mailing must be sorted together on pallets (copalletized) under [12.1.5](#) using presort software that is PAVE-certified.

705.12.1.2

- f. A complete, signed postage statement, using the correct USPS form or an approved facsimile, must accompany each mailing job. In addition, documentation prepared by PAVE-certified software must be submitted with each mailing job. Documentation, under [708.1.0](#), must describe for each “logical” pallet sortation level and each physical pallet the number of addressed pieces qualifying for each carrier route price, each Presorted price, and each automation price. Within the body of the documentation beneath the listing for the last physical pallet for each logical pallet presort destination, a separate 5% threshold summary also must be provided for each merged 5-digit scheme and each merged 5-digit logical pallet destination. *Note:* The separate 5% threshold summary must be for the mail on all of the physical pallets (i.e., the “logical” pallet) for that presort destination. This summary must describe for each 5-digit ZIP Code:
 1. The total number of all addressed pieces.
 2. The total number of addressed pieces sorted in carrier route bundles and firm bundles (each firm bundle is claimed as one addressed piece).
 3. The total number of addressed pieces sorted in 5-digit bundles (other than firm bundles).
 4. Of the total number of all addressed pieces in [12.1.1f1](#), the percentage of addressed pieces sorted in 5-digit bundles (other than firm bundles).
- g. Portions of the mailing job that cannot be palletized must be prepared in sacks.

12.1.2 Bundle Preparation

Bundles must be prepared under the standards in [8.0](#).

12.1.3 Low-Volume Bundles

Carrier route and 5-digit bundles may contain fewer than six pieces when the publisher determines that such preparation improves service. Pieces in these low-volume bundles must be claimed at the applicable mixed ADC price (Outside-County) or basic price (In-County).

12.1.4 5% Threshold

Firm bundles (claimed as one addressed piece), carrier route bundles, and 5-digit bundles may be placed together on the same merged 5-digit scheme or merged 5-digit logical pallet under [12.1.5](#) if all of the following conditions in items [12.1.4a](#) through [12.1.4e](#) below are met:

- a. For the purpose of calculating the 5% threshold, firm bundles (regardless of the price claimed) are added together with the number of addressed pieces in carrier route bundles.
- b. The number of pieces prepared in 5-digit bundles (other than firm bundles) for any single 5-digit ZIP Code on a “logical” merged 5-digit scheme or merged 5-digit pallet must not exceed 5% of the total number of addressed pieces for the 5-digit ZIP Code on the logical pallet for that presort destination.
- c. The 5% threshold is calculated separately for each 5-digit ZIP Code. For example, if a scheme contains four different 5-digit ZIP Codes, a separate 5% threshold applies to each 5-digit ZIP Code for the scheme on a merged 5-digit

scheme pallet. Since 5-digit scheme bundles may not be placed on merged pallets, pieces in 5-digit scheme bundles do not count as 5-digit sorted pieces for purposes of determining the 5% limit.

- d. When firm bundles, other than those claimed at carrier route prices, are placed on a merged 5-digit scheme or a merged 5-digit pallet, addressed pieces in all corresponding 5-digit bundles up to 5% also must be merged. If the number of addressed pieces placed in 5-digit bundles (for an individual 5-digit ZIP Code) exceeds the 5% threshold, the mailer may place a portion of the addressed pieces (up to 5%) on a merged 5-digit scheme or a merged 5-digit pallet. Mailers are encouraged, but not required, to include such pieces on a merged pallet in this sequence: nonbarcoded price bundles, followed by barcoded price bundles.
- e. For the purpose of determining the 5% threshold, addressed pieces in low-volume carrier route bundles count as carrier route sorted pieces, and addressed pieces in low-volume 5-digit bundles count as 5-digit sorted pieces, even though the mixed ADC price (Outside-County) or basic price (In-County) is paid for such pieces.

12.1.5 Pallet Preparation and Labeling

[7-3-08] Mailers must prepare pallets of bundles in the manner and sequence listed below and under 8.0. Mailers must prepare all merged 5-digit scheme, 5-digit scheme carrier routes, 5-digit scheme, and merged 5-digit pallets that are possible in the mailing based on the volume of mail to the destination using L001 and the 5% threshold, as applicable. Mailers must label pallets according to the Line 1 and Line 2 information listed below and under 8.6. If, due to the physical size of the mailpieces, the barcoded price pieces are considered flat-size under 301.3.0 and the carrier route sorted pieces and nonbarcoded price pieces are considered irregular parcels under 401.1.6, "FLTS" must be shown as the processing category on the pallet label. If a mailing contains no barcoded price pieces and the carrier route mailing and the nonbarcoded price mailing are irregular parcels, use "IRREG" for the processing category on the contents line of the pallet label.

- a. *Merged 5-digit scheme*, required; permitted only when 5-digit bundles for at least one 5-digit ZIP Code in the scheme may be merged with carrier route bundles under the 5% threshold standard in 12.1.4. May contain carrier route bundles for any 5-digit ZIP Code in a single scheme listed in L001. May also contain barcoded price 5-digit bundles and nonbarcoded price 5-digit bundles up to a maximum of 5% of the total number of pieces for each 5-digit ZIP Code in the scheme under 12.1.4. For 5-digit ZIP Codes not included in a scheme, begin preparing pallets under 12.1.5d (merged 5-digit pallet). Labeling:
 1. Line 1: use L001, Column B.
 2. Line 2: "PER" or "NEWS" as applicable; followed by "FLTS" or "IRREG" as applicable; followed by "CR/5D SCHEME."
- b. *5-digit scheme carrier routes*, required; may contain only carrier route bundles for all carrier routes in an L001 scheme when a merged 5-digit scheme pallet could not be prepared under 12.1.5a. Labeling:
 1. Line 1 use L001, Column B.

705.12.1.5

2. Line 2: “PER” or “NEWS” as applicable; followed by “FLTS” or “IRREG” as applicable; followed by “CR-RTS SCHEME.”
- c. *5-digit scheme*, not permitted for flats that meet the dimension, weight, and flexibility criteria for automation flats in [301.3.0](#) (including pieces in merged bundles) and not permitted for sacks or trays. Required for all other flats and irregular parcels. Five-digit scheme bundles are assigned to 5-digit pallets according to the “label to” 5-digit ZIP Code in [L007](#). Labeling:
 1. Line 1: use [L001](#), Column B.
 2. Line 2: “PER” or “NEWS” as applicable; followed by “FLTS” or “IRREG” as applicable; followed by “5D”; followed by “BARCODED” or “BC” if the pallet contains barcoded price mail; followed by “NONBARCODED” or “NBC” if the pallet contains nonbarcoded price mail; followed by “SCHEME” or “SCH.”
- d. *Merged 5-digit*, required; permitted only when 5-digit bundles may be merged with carrier route bundles under the 5% threshold standard in [12.1.4](#) for a 5-digit ZIP Code that is not part of an [L001](#) scheme. May contain carrier route bundles, barcoded price 5-digit bundles, and nonbarcoded price 5-digit bundles. The number of pieces in 5-digit bundles is limited to 5% of the total number of pieces placed on the pallet under [12.1.4](#). Labeling:
 1. Line 1: use city, state, and 5-digit ZIP Code destination (see [8.6.4](#) for military mail).
 2. Line 2: “PER” or “NEWS” as applicable; followed by “FLTS” or “IRREG” as applicable; followed by “CR/5D.”
- e. *5-digit carrier routes*, required; may contain only carrier route price bundles for the same 5-digit ZIP Code that is not part of a scheme for which a merged 5-digit pallet could not be prepared under [12.1.5d](#). Labeling:
 1. Line 1: use city, state, and 5-digit ZIP Code destination (see [8.6.4](#) for military mail).
 2. Line 2: “PER” or “NEWS” as applicable; followed by “FLTS” or “IRREG” as applicable; followed by “CARRIER ROUTES” or “CR-RTS.”
- f. *5-digit*, required; may contain only barcoded price 5-digit bundles and nonbarcoded price 5-digit bundles for the same 5-digit ZIP Code that could not be placed on a merged 5-digit pallet, or 5-digit scheme ([L007](#)) bundles (barcoded price and cobundled barcoded and nonbarcoded price pieces only). Five-digit scheme bundles are assigned to 5-digit pallets according to the OEL “label to” 5-digit ZIP Code. Labeling:
 1. Line 1: use city, state, and 5-digit ZIP Code destination (see [8.6.4](#) for military mail).
 2. Line 2: “PER” or “NEWS” as applicable; followed by “FLTS” or “IRREG” as applicable; followed by “5D”; followed by “BARCODED” or “BC” if the pallet contains barcoded price mail; followed by “NONBARCODED” or “NBC” if the pallet contains nonbarcoded price mail.

- g. *5-digit metro*, optional; may contain carrier route, barcoded, and nonbarcoded price bundles for the 5-digit ZIP Codes listed in [L006](#), Column A, and for the 3-digit ZIP Code areas listed in [L006](#), Column B. Labeling:
1. Line 1: use [L006](#), Column C.
 2. Line 2: “PER” or “NEWS”; followed by “FLTS” or “IRREG”; followed by “METRO” or “MET”; followed by “BARCODED” or “BC” if the pallet contains barcoded price mail; followed by “NONBARCODED” or “NBC” if the pallet contains nonbarcoded price and/or carrier route mail.
- h. *3-digit*, optional; option not available for 3-digit ZIP Code prefixes marked “N” in [L002](#). May contain carrier route price, barcoded price, and nonbarcoded price mail, including 3-digit scheme ([L008](#)) bundles (barcoded and cobundled barcoded and nonbarcoded price pieces only). Three-digit scheme bundles are assigned to 3-digit pallets according to the “label to” 3-digit ZIP Code in [L008](#). Labeling:
1. Line 1: use [L002](#), Column A.
 2. Line 2: “PER” or “NEWS” as applicable; followed by “FLTS” or “IRREG” as applicable; followed by “3D”; followed by “BARCODED” or “BC” if the pallet contains barcoded price mail; followed by “NONBARCODED” or “NBC” if the pallet contains nonbarcoded price mail and/or carrier route mail.
- i. *SCF*, required; may contain carrier route price, barcoded price, and nonbarcoded price bundles. Labeling:
1. Line 1: use [L002](#), Column C.
 2. Line 2: “PER” or “NEWS” as applicable; followed by “FLTS” or “IRREG” as applicable; followed by “SCF”; followed by “BARCODED” or “BC” if the pallet contains barcoded price mail; followed by “NONBARCODED” or “NBC” if the pallet contains nonbarcoded price mail and/or carrier route mail.
- j. *ADC*, required; may contain carrier route price, barcoded price, and nonbarcoded price bundles. Labeling:
1. Line 1: use [L004](#), Column B.
 2. Line 2: “PER” or “NEWS” as applicable; followed by “FLTS” or “IRREG” as applicable; followed by “ADC”; followed by “BARCODED” or “BC” if the pallet contains barcoded price mail; followed by “NONBARCODED” or “NBC” if the pallet contains nonbarcoded price mail and/or carrier route mail.

12.2 Standard Mail

12.2.1 Basic Standards

Five-digit scheme bundles (under [L007](#)) and 3-digit scheme bundles (under [L008](#)) must be prepared. Five-digit scheme bundles may not be copalletized on any merged pallets. Five-digit bundles from an automation price mailing and 5-digit bundles from a Presorted price mailing (including pieces cobundled under [11.0](#)) may be placed on the same pallet as carrier route bundles under the following conditions:

705.12.2.1

- a. A carrier route mailing must be part of the mailing job.
- b. The pieces in the carrier route price mailing, the automation price mailing, and the Presorted price mailing must be part of the same mailing job and all three mailings must be reported on the same postage statement.
- c. Pieces in the automation price mailing must meet the criteria for a flat under [301.3.0](#). Pieces in the Presorted price mailing and the carrier route mailing must meet the criteria for a flat under [301.1.0](#).
- d. Automation price 5-digit bundles, Presorted price 5-digit bundles, and cobundled 5-digit bundles may be copalletized with carrier route bundles only when the pieces in the 5-digit bundles do not exceed the 5% limit described in [12.2.3](#). Pallets of mail sorted in this manner are called “merged 5-digit” pallets. Pallets of mail sorted in this manner for which scheme sortation is also performed are called “merged 5-digit scheme” pallets. Since 5-digit scheme bundles cannot be placed on merged pallets, pieces in 5-digit scheme bundles do not count as 5-digit sorted pieces for purposes of determining the 5% limit.
- e. If sortation under this section is performed, merged 5-digit scheme pallets must be prepared whenever there is enough volume of carrier route and 5-digit bundles under [8.0](#) and [12.2.3](#) to prepare such pallets.
- f. The carrier route mailing must meet the eligibility criteria in [343.6.0](#), the automation price mailing must meet the eligibility criteria in [343.7.0](#), and the Presorted price mailing must meet the eligibility criteria in [343.5.0](#).
- g. The prices are based on the level of bundle that the pieces are contained in under [343.5.0](#) and [343.7.0](#).
- h. The bundles from each separate mailing must be sorted together on pallets (copalletized) using presort software that is PAVE-certified.
- i. The pieces in each separate mailing must bear the applicable markings required under [345.5.0](#), *Preparing Nonautomation Flats*, [345.6.0](#), *Preparing Enhanced Carrier Route Flats*, or [345.7.0](#), *Preparing Automation Price Flats*, and under [302](#), *Elements on the Face of a Mailpiece*.
- j. A complete, signed postage statement, using the correct USPS form or an approved facsimile, must accompany each mailing job prepared under these procedures.
- k. In addition to the postage statement(s), documentation prepared by PAVE-certified software must be submitted with each copalletized mailing job that describes for each pallet sortation level and pallet the number of pieces qualifying for each applicable carrier route price, each applicable automation price, and each applicable Presorted price under [708.1.0](#). A separate 5% threshold summary also must be provided under [708.1.0](#) for each “logical” merged 5-digit scheme or “logical” merged 5-digit pallet presort destination. This 5% threshold summary must show for each 5-digit ZIP Code on the logical merged 5-digit scheme or logical merged 5-digit pallet: the total number of pieces on the pallet for the 5-digit ZIP Code; the total number of pieces sorted in carrier route bundles for the 5-digit ZIP Code; the total number of pieces sorted in 5-digit bundles for the 5-digit ZIP Code, and; of the total number of

pieces for the 5-digit ZIP Code, the percentage of pieces sorted in 5-digit bundles for that 5-digit ZIP Code. This additional 5% threshold summary must appear within the body of the documentation beneath the pallet price listing for the last physical pallet for the logical pallet presort destination. Note: If there are two or more physical pallets for the same presort destination, for example, the same merged 5-digit pallet destination, these two or more physical pallets would be considered as one “logical pallet.” The separate pallet summary must be for the mail on all of the physical pallets (the “logical pallet”) for that presort destination.

- I. Portions of the mailing job that cannot be palletized must be prepared in sacks.

12.2.2 Bundle Preparation

Bundles placed on pallets must be prepared under the standards in [8.0, *Preparing Pallets*](#).

12.2.3 5%-Threshold Standard

Five-digit bundles and carrier route bundles may be placed on the same merged 5-digit scheme and merged 5-digit pallet if all of the following conditions are met:

- a. The number of pieces prepared in 5-digit bundles for any single 5-digit ZIP Code on a logical merged 5-digit or merged 5-digit scheme pallet does not exceed 5% of the total number of pieces for the 5-digit ZIP Code on the pallet(s) for the presort destination. That is, the total number of pieces for a 5-digit ZIP Code in 5-digit and carrier route bundles must not be greater than the number of pieces in carrier route bundles divided by 0.95.
- b. The 5% threshold is calculated separately for each 5-digit ZIP Code. For example, if a scheme contains four different 5-digit ZIP Codes, a separate 5% threshold applies to each 5-digit ZIP Code for the scheme on a merged 5-digit scheme pallet. Since 5-digit scheme bundles may not be placed on merged pallets, pieces in 5-digit scheme bundles do not count as 5-digit sorted pieces for purposes of determining the 5% limit.
- c. Except when bundles are prepared under the cobundling option in [11.0](#), all the mail in a logical 5-digit bundle must be able to be placed on the logical pallet under the 5% rule. A logical 5-digit bundle is all pieces for a mailing (price level) prepared in a 5-digit bundle or bundles for the same 5-digit destination. For each 5-digit ZIP Code, it is possible to have a logical 5-digit bundle of automation price mail and a logical 5-digit bundle of Presorted price mail. If the total number of pieces in a logical 5-digit bundle exceeds the 5% limit, none of the pieces for that 5-digit bundle level may be placed on a merged 5-digit or merged 5-digit scheme pallet. For some ZIP Codes, the total number of pieces prepared in logical 5-digit bundles (both an automation price 5-digit bundle and a Presorted price 5-digit bundle) may exceed 5% of the total mail for that ZIP Code, but the number of pieces for an individual automation price logical 5-digit bundle for that ZIP Code does not exceed the 5% limit nor does an individual Presorted price logical 5-digit bundle for that ZIP Code exceed the 5% limit. In such instances, mailers may choose to place all of the pieces in a logical 5-digit bundle for a single price category on the logical merged 5-digit or merged 5-digit scheme pallet so that the 5% threshold is not exceeded.

705.12.2.4

- d. Except for bundles prepared under the cobundling option in 11.0, if the total number of pieces in both the logical 5-digit automation price bundle and the logical 5-digit Presorted price bundle each separately exceed 5% of the total number of pieces for the 5-digit ZIP Code, none of the pieces in 5-digit bundles may be merged with carrier route bundles on a merged 5-digit or merged 5-digit scheme pallet.
- e. For mailing jobs prepared using the cobundling option in 11.0, if the total number of pieces prepared in a logical 5-digit bundle (containing automation price and Presorted price pieces) exceeds the 5% limit for a 5-digit ZIP Code in 12.2.3a, a mailer may, for each 5-digit ZIP Code, choose to place a portion of the pieces prepared in the logical 5-digit bundle on a merged 5-digit or 5-digit scheme pallet using one of the options below. Regardless of the option selected, a minimum of 10 pieces or 15 pieces as applicable must be prepared in 5-digit bundle(s) placed on the merged pallet and a minimum of 10 or 15 remaining pieces as applicable prepared in 5-digit bundle(s) not placed on the merged pallet, with the total number of pieces not exceeding the 5% limit. The options are:
 1. Place either all automation price pieces or all Presorted price pieces for the 5-digit ZIP Code on the merged pallet.
 2. Place a portion of either the automation price pieces or the Presorted price pieces for the 5-digit ZIP Code on the merged pallet.
 3. Place either all the automation price pieces plus a portion of the Presorted price pieces or all the Presorted price pieces plus a portion of the automation price pieces for the 5-digit ZIP Code on the merged pallet.

12.2.4 Pallet Preparation and Labeling

[7-3-08] Mailers must prepare pallets of bundles in the manner and sequence listed below and under 8.0. Mailers must prepare all merged 5-digit scheme, 5-digit scheme carrier routes, 5-digit scheme, and merged 5-digit pallets that are possible in the mailing based on the volume of mail to the destination using L001 and the 5% threshold. Mailers must label pallets according to the Line 1 and Line 2 information listed below and under 8.6.

- a. *Merged 5-digit scheme*, required, permitted only when 5-digit bundles for at least one 5-digit ZIP Code in the scheme may be merged with carrier route bundles under the 5% threshold standard in 12.2.3. May contain carrier route bundles for any 5-digit ZIP Code in a single scheme listed in L001. May also contain automation price 5-digit bundles and Presorted price 5-digit bundles up to a maximum of 5% of the total number of pieces for each 5-digit ZIP Code in the scheme under 12.2.3. For 5-digit ZIP Codes not included in a scheme, begin preparing pallets under 12.2.4c (merged 5-digit pallet). Labeling:
 1. Line 1: use L001, Column B.
 2. Line 2: "STD FLTS CR/5D SCHEME."
- b. *5-digit scheme carrier routes*, required, may contain only carrier route bundles for all carrier routes in an L001 scheme when a merged 5-digit scheme pallet could not be prepared under 12.2.4a. Labeling:

1. Line 1: use [L001](#), Column B.
 2. Line 2: "STD FLTS CR-RTS SCHEME."
- c. *Merged 5-digit*, required, permitted only when 5-digit bundles may be merged with carrier route bundles under the 5% threshold standard in [12.2.3](#) for a 5-digit ZIP Code that is not part of an [L001](#) scheme. May contain carrier route price bundles, automation price 5-digit bundles, and Presorted price 5-digit bundles. The number of pieces in 5-digit bundles is limited to 5% of the total number of pieces placed on the pallet under [12.2.3](#). Labeling:
1. Line 1: use city, state, and 5-digit ZIP Code destination (see [8.6.4](#) for military mail).
 2. Line 2: "STD FLTS CR/5D."
- d. *5-digit carrier routes*, required, may contain only carrier route price bundles for the same 5-digit ZIP Code that is not part of a scheme and for which a merged 5-digit pallet could not be prepared under [12.2.4c](#). Labeling:
1. Line 1: use city, state, and 5-digit ZIP Code destination (see [8.6.4](#) for military mail).
 2. Line 2: "STD FLTS"; followed by "CARRIER ROUTES" or "CR-RTS."
- e. *5-digit*, required, may contain only automation price 5-digit bundles and Presorted price 5-digit bundles for the same 5-digit ZIP Code that could not be placed on a merged 5-digit pallet, or 5-digit scheme ([L007](#)) bundles (automation price and cobundled automation and Presorted price pieces only). Five-digit scheme bundles are assigned to 5-digit pallets according to the "label to" 5-digit ZIP Code in [L007](#). Labeling:
1. Line 1: use city, state, and 5-digit ZIP Code destination (see [8.6.4](#) for military mail).
 2. Line 2: "STD FLTS 5D"; followed by "BARCODED" or "BC" if the pallet contains automation price mail; followed by "NONBARCODED" or "NBC" if the pallet contains Presorted price mail.
- f. *5-digit metro*, optional, may contain carrier route, automation, and Presorted price bundles for the 5-digit ZIP Codes listed in [L006](#), Column A, and for the 3-digit ZIP Code areas listed in [L006](#), Column B.
1. Line 1: use [L006](#), Column C.
 2. Line 2: "STD FLTS" followed by "METRO" or "MET"; followed by "BARCODED" or "BC" if the pallet contains automation price mail; followed by "NONBARCODED" or "NBC" if the pallet contains Presorted price and/or carrier route mail.
- g. *3-digit*, optional, option not available for 3-digit ZIP Code prefixes marked "N" in [L002](#). May contain carrier route price, automation price, and Presorted price mail, including 3-digit scheme ([L008](#)) bundles (automation and cobundled automation and Presorted price pieces only). Three-digit scheme bundles are assigned to 3-digit pallets according to the "label to" 3-digit ZIP Code in [L008](#). Labeling:

705.12.2.4

1. Line 1: use [L002](#), Column A.
 2. Line 2: “STD FLTS 3D”; followed by “BARCODED” or “BC” if the pallet contains automation price mail; followed by “NONBARCODED” or “NBC” if the pallet contains Presorted price mail and/or carrier route price mail.
- h. *SCF*, required, may contain carrier route price, automation price, and Presorted price bundles. Labeling:
1. Line 1: use [L002](#), Column C.
 2. Line 2: “STD FLTS SCF”; followed by “BARCODED” or “BC” if the pallet contains automation price mail; followed by “NONBARCODED” or “NBC” if the pallet contains Presorted price mail and/or carrier route price mail.
- i. *ASF*, required, except that an ASF sort may not be required if using bundle reallocation under [8.13.3](#). May contain carrier route price, automation price, and/or Presorted price bundles. Sort ADC bundles to ASF pallets based on the “label to” ZIP Code for the ADC destination of the bundle in [L004](#). At the mailer’s option, sort appropriate mixed ADC bundles to ASF pallets based on the “label to” ZIP Code for the ADC destination of the bundle in [L010](#). All optional mixed ADC bundles on ASF pallets must contain only pieces destinating within the ASF as shown in [6.3](#). See [346.3.0](#) for additional requirements for DBMC price eligibility. Labeling:
1. Line 1: use [L602](#), Column B.
 2. Line 2: “STD FLTS ASF”; followed by “BARCODED” or “BC” if the pallet contains automation price mail; followed by “NONBARCODED” or “NBC” if the pallet contains Presorted price mail and/or carrier route price mail.
- j. *BMC*, required, may contain carrier route price, automation price, and/or Presorted price bundles. Sort ADC bundles to BMC pallets based on the “label to” ZIP Code for the ADC destination of the bundle in [L004](#). At the mailer’s option, sort appropriate mixed ADC bundles to BMC pallets based on the “label to” ZIP Code for the ADC destination of the bundle in [L010](#). All optional mixed ADC bundles on BMC pallets must contain only pieces destinating within the BMC as shown in [6.3](#). See [346.3.0](#) for additional requirements for DBMC price eligibility. Labeling:
1. Line 1: use [L601](#), Column B.
 2. Line 2: “STD FLTS BMC”; followed by “BARCODED” or “BC” if the pallet contains automation price mail; followed by “NONBARCODED” or “NBC” if the pallet contains Presorted price mail and/or carrier route price mail.

13.0 Merging Bundles of Flats on Pallets Using the City State Product and a 5% Threshold

13.1 Periodicals

13.1.1 Basic Standards

Five-digit scheme bundles (using [L007](#)) and 3-digit scheme bundles (using [L008](#)) must be prepared according to standards in [13.1.4](#). Five-digit scheme bundles and 3-digit scheme bundles may not be copalletized on any merged pallets. Five-digit bundles from a barcoded price mailing and 5-digit bundles from a nonbarcoded price mailing (including pieces cobundled under [11.0](#)) may be placed on the same pallet as carrier route bundles under the following conditions:

- a. A carrier route mailing must be part of the same mailing job as the barcoded price mailing and/or the nonbarcoded price mailing.
- b. Pieces in the barcoded price mailing must meet the criteria for a flat under [301.3.0](#) or [707.26.0](#). These two types of flats cannot be combined in the same bundle.
- c. Mailers must use the Carrier Route Indicators field in the City State Product and the 5% limit criteria in [13.1.4](#) to prepare the mailing. The mailing must be entered no later than 90 days after the release date of the City State Product used.
- d. When firm bundles, carrier route bundles, and 5-digit bundles are placed together on the same merged 5-digit scheme or merged 5-digit pallet according to standards in [13.1.4](#) and [13.1.5](#), the following conditions also apply:
 1. For 5-digit ZIP Codes identified with an “A” or “C” indicator in the City State Product, merged 5-digit scheme and merged 5-digit pallets may be prepared with no limit to the number of addressed pieces placed in 5-digit bundles.
 2. For 5-digit ZIP Codes identified with a “B” or “D” indicator in the City State Product, the number of addressed pieces placed in 5-digit bundles (other than firm bundles) must not exceed 5% of the total number of addressed pieces placed on the merged 5-digit scheme or merged 5-digit pallet, for each corresponding 5-digit ZIP Code. For merged 5-digit scheme pallets, the 5% threshold is calculated separately for each individual 5-digit ZIP Code.
- e. All possible merged 5-digit scheme, 5-digit scheme carrier routes, and 5-digit scheme pallets must be prepared according to standards in [13.1.5](#).
- f. The bundles from each separate mailing must be sorted together on pallets (copalletized) under [13.1.5](#) using presort software that is PAVE-certified.
- g. A complete, signed postage statement, using the correct USPS form or an approved facsimile, must accompany each mailing job. In addition, documentation produced by PAVE-certified software must be submitted with each mailing job. Documentation, under [708.1.0](#), must describe for each “logical” pallet sortation level and each physical pallet the number of addressed

pieces qualifying for each carrier route price, each nonbarcoded price, and each barcoded price. Within the body of the documentation beneath the listing for the last physical pallet for each logical pallet presort destination, a separate 5% threshold summary also must be provided for each merged 5-digit scheme and each merged 5-digit logical pallet destination that contains mail for one or more 5-digit ZIP Codes with a “B” or “D” indicator in the City State Product.

Note: The separate 5% threshold summary must be for the mail on all of the physical pallets (i.e., the “logical” pallet) for that presort destination. This summary must describe for each 5-digit ZIP Code:

1. The total number of all addressed pieces.
 2. The total number of addressed pieces sorted in carrier route bundles and firm bundles (each firm bundle is claimed as one addressed piece).
 3. The total number of addressed pieces sorted in 5-digit bundles (other than firm bundles).
 4. Of the total number of all addressed pieces in [13.1.1g1](#), the percentage of addressed pieces sorted in 5-digit bundles (other than firm bundles).
- h. Portions of the mailing job that cannot be palletized must be prepared in sacks.

13.1.2 Bundle Preparation

Bundles must be prepared under the standards in [8.0](#).

13.1.3 Low-Volume Bundles

Carrier route and 5-digit bundles may contain fewer than six pieces when the publisher determines that such preparation improves service. Pieces in these low-volume bundles must be claimed at the applicable mixed ADC price (Outside-County) or basic price (In-County).

13.1.4 5% Threshold—5-Digit ZIP Codes Identified with a “B” or “D” Indicator

Firm bundles (claimed as one addressed piece), carrier route bundles, and 5-digit bundles may be placed together on the same merged 5-digit scheme or merged 5-digit logical pallet under [13.1.5](#) if all of the following conditions in items [13.1.4a](#) through [13.1.4e](#) below are met:

- a. For the purpose of calculating the 5% threshold, firm bundles (regardless of the price claimed) are added together with the number of addressed pieces in carrier route bundles.
- b. The number of pieces prepared in 5-digit bundles (other than firm bundles) for any single 5-digit ZIP Code with a “B” or “D” indicator (in the City State Product) on a logical merged 5-digit scheme or merged 5-digit pallet must not exceed 5% of the total number of addressed pieces for the 5-digit ZIP Code on the logical pallet for the presort destination. Five-digit ZIP Codes with an “A” or “C” indicator (in the City State Product) are not subject to the 5% limit.
- c. The 5% threshold is calculated separately for each 5-digit ZIP Code with a “B” or “D” indicator. For example, if a scheme contains four different 5-digit ZIP Codes, a separate 5% threshold applies to each 5-digit ZIP Code with a “B” or “D” indicator for the scheme on a merged 5-digit scheme pallet. (5-digit ZIP

Codes with an “A” or “C” indicator are not subject to the 5% limit.) Since 5-digit scheme bundles may not be placed on merged pallets, pieces in 5-digit scheme bundles do not count as 5-digit sorted pieces for purposes of determining the 5% limit.

- d. When firm bundles, other than those claimed at carrier route prices, are placed on a merged 5-digit scheme or a merged 5-digit pallet, addressed pieces in all corresponding 5-digit bundles up to 5% also must be merged. If the number of addressed pieces placed in 5-digit bundles (for an individual 5-digit ZIP Code) exceeds the 5% threshold, the mailer may place a portion of the addressed pieces (up to 5%) on a merged 5-digit scheme or a merged 5-digit pallet. Mailers are encouraged, but not required, to include such pieces on a merged pallet in this sequence: presorted price bundles, followed by cobundles (if using [11.0](#)), followed by automation price bundles.
- e. For the purpose of determining the 5% threshold, addressed pieces in low-volume carrier route bundles count as carrier route sorted pieces, and addressed pieces in low-volume 5-digit bundles count as 5-digit sorted pieces, even though the mixed ADC price (Outside-County) or basic price (In-County) is paid for such pieces.

13.1.5 Pallet Preparation and Labeling

[\[7-3-08\]](#) Mailers must prepare pallets of bundles in the manner and sequence listed below and under [8.0](#). Mailers must prepare all merged 5-digit scheme, 5-digit scheme carrier routes, 5-digit scheme, and merged 5-digit pallets that are possible in the mailing based on the volume of mail to the destination ([8.0](#)) using [L001](#), the City State Product, and the 5% threshold ([13.1.4](#)), as applicable. Mailers must label pallets according to the Line 1 and Line 2 information listed below and under [8.6](#). If, due to the physical size of the mailpieces, the barcoded price pieces are considered flat-size under [301.3.0](#) and the carrier route sorted pieces and nonbarcoded price pieces are considered irregular parcels under [401.1.6](#), “FLTS” must be shown as the processing category on the pallet label. If a mailing contains no barcoded price pieces and the carrier route mailing and the nonbarcoded price mailing are irregular parcels, use “IRREG” for the processing category on the contents line of the pallet label.

- a. *Merged 5-digit scheme*, required; for schemes that contain at least one 5-digit ZIP Code that has an “A” or “C” indicator in the City State Product, the pallet contains 1) carrier route bundles for all 5-digit ZIP Codes in the scheme, 2) 5-digit barcoded price and 5-digit nonbarcoded price bundles for those 5-digit ZIP Codes in the scheme with an “A” or “C” indicator in the City State Product, and 3) 5-digit barcoded price and/or 5-digit nonbarcoded price bundles for those 5-digit ZIP Codes in the scheme with a “B” or “D” indicator when the number of pieces in the 5-digit bundle(s) does not exceed 5% of the total number of pieces for that 5-digit ZIP Code under [13.1.4](#). For schemes in which all 5-digit ZIP Codes have “B” or “D” indicators and for which there is at least one 5-digit ZIP Code for which 5-digit bundles may be placed on the pallet under the 5% limit in [13.1.4](#), place all carrier route bundles plus the 5-digit bundles within the 5% limit on the pallet. For schemes in which all 5-digit ZIP Codes have “B” or “D” indicators and for which there are no 5-digit ZIP Codes

705.13.1.5

for which 5-digit bundles may be placed on the pallet under the 5% limit, do not prepare a merged 5-digit scheme pallet (sort bundles to pallets under [13.1.5b](#) through [13.1.5j](#)). Labeling:

1. Line 1: use [L001](#), Column B.
 2. Line 2: “PER” or “NEWS” as applicable; followed by “FLTS” or “IRREG” as applicable; and followed by “CR/5D SCHEME.”
- b. *5-digit scheme carrier routes*, required, may contain only carrier route bundles for all carrier routes in an [L001](#) scheme for which all 5-digit ZIP Codes in the scheme have a “B” or “D” indicator and for which no 5-digit bundles could be placed on a merged 5-digit scheme pallet with the carrier route bundles because the 5-digit bundles exceeded the 5% threshold. Labeling:
1. Line 1: use [L001](#), Column B.
 2. Line 2: “PER” or “NEWS” as applicable; followed by “FLTS” or “IRREG” as applicable; and followed by “CR-RTS SCHEME.”
- c. *5-digit scheme*, not permitted for flats that meet the dimension, weight, and flexibility criteria for automation flats in [301.3.0](#) (including pieces in merged bundles) and not permitted for sacks or trays. Required for all other flats and irregular parcels. May contain only 5-digit bundles of barcoded price and nonbarcoded price mail for the same 5-digit scheme under [L001](#) for which one or more 5-digit ZIP Codes in the scheme had a “B” or “D” indicator in the City State Product, and the 5-digit bundles could not be placed on a merged 5-digit scheme pallet (the pieces exceeded the 5% threshold). Labeling:
1. Line 1: use [L001](#), Column B.
 2. Line 2: “PER” or “NEWS” as applicable; followed by “FLTS” or “IRREG” as applicable; followed by “5D”; followed by “BARCODED” or “BC” if the pallet contains barcoded price mail; followed by “NONBARCODED” or “NBC” if the pallet contains nonbarcoded price mail; and followed by “SCHEME” or “SCH.”
- d. *Merged 5-digit*, required, may contain carrier route bundles, barcoded price 5-digit bundles, and nonbarcoded price 5-digit bundles for those 5-digit ZIP Codes that are not part of a scheme. For 5-digit ZIP Codes with an “A” or “C” indicator in the City State Product, there is no limit on the number of pieces in 5-digit bundles that may be placed on the pallet and a merged 5-digit pallet is prepared even if there are no 5-digit bundles for that ZIP Code. For those 5-digit ZIP Codes with a “B” or “D” indicator in the City State Product, the number of pieces in 5-digit bundles is limited to 5% of the total number of pieces for the 5-digit pallet destination under [13.1.4](#). However, if no 5-digit bundles for ZIP Codes with “B” or “D” indicators can be placed on this level pallet under the 5% limit, do not prepare this a merged 5-digit pallet (sort bundles under [13.1.5e](#) through [13.1.5j](#)). Labeling:
1. Line 1: use city, state, and 5-digit ZIP Code destination (see [8.6.4](#) for military mail).
 2. Line 2: “PER” or “NEWS” as applicable; followed by “FLTS” or IRREG” as applicable; and followed by “CR/5D.”

- e. *5-digit carrier routes*, required, may contain only carrier route price bundles for the same 5-digit ZIP Code that is not part of a scheme and that could not be placed on a merged 5-digit pallet. Labeling:
 - 1. Line 1: use city, state, and 5-digit ZIP Code destination (see [8.6.4](#) for military mail).
 - 2. Line 2: “PER” or “NEWS” as applicable; followed by “FLTS” or “IRREG” as applicable; and followed by “CARRIER ROUTES” or “CR-RTS.”
- f. *5-digit*, required, may contain only barcoded price 5-digit bundles and nonbarcoded price 5-digit bundles for the same 5-digit ZIP Code that could not be placed on a merged 5-digit pallet, or 5-digit scheme ([L007](#)) bundles (barcoded price and cobundled barcoded and nonbarcoded price pieces only). Five-digit scheme bundles are assigned to 5-digit pallets according to the “label to” 5-digit ZIP Code in [L007](#). Labeling:
 - 1. Line 1: use city, state, and 5-digit ZIP Code destination (see [8.6.4](#) for military mail).
 - 2. Line 2: “PER” or “NEWS” as applicable; followed by “FLTS” or “IRREG” as applicable; followed by “5D”; followed by “BARCODED” or “BC” if the pallet contains barcoded price mail; and followed by “NONBARCODED” or “NBC” if the pallet contains nonbarcoded price mail.
- g. *5-digit metro*, optional, may contain carrier route, barcoded, and nonbarcoded price bundles for the 5-digit ZIP Codes listed in [L006](#), Column A, and for the 3-digit ZIP Code areas listed in [L006](#), Column B. Labeling:
 - 1. Line 1: use [L006](#), Column C.
 - 2. Line 2: “PER” or “NEWS”; followed by “FLTS” or “IRREG”; followed by “METRO” or “MET”; followed by “BARCODED” or “BC” if the pallet contains barcoded price mail; followed by “NONBARCODED” or “NBC” if the pallet contains nonbarcoded price and/or carrier route mail.
- h. *3-digit*, optional, option not available for 3-digit ZIP Code prefixes marked “N” in [L002](#). May contain carrier route price, barcoded price, and nonbarcoded price mail, including 3-digit scheme ([L008](#)) bundles (barcoded and cobundled barcoded and nonbarcoded price pieces only). Three-digit scheme bundles are assigned to 3-digit pallets according to the “label to” 3-digit ZIP Code in [L008](#). Labeling:
 - 1. Line 1: use [L002](#), Column A.
 - 2. Line 2: “PER” or “NEWS” as applicable; followed by “FLTS” or “IRREG” as applicable; followed by “3D”; followed by “BARCODED” or “BC” if the pallet contains barcoded price mail; and followed by “NONBARCODED” or “NBC” if the pallet contains nonbarcoded price mail and/or carrier route mail.
- i. *SCF*, required, may contain carrier route price, barcoded price, and nonbarcoded price bundles. Labeling:
 - 1. Line 1: use [L002](#), Column C.

2. Line 2: “PER” or “NEWS” as applicable; followed by “FLTS” or “IRREG” as applicable; followed by “SCF”; followed by “BARCODED” or “BC” if the pallet contains barcoded price mail; and followed by “NONBARCODED” or “NBC” if the pallet contains nonbarcoded price mail and/or carrier route mail.
- j. ADC, required, may contain carrier route price, barcoded price, and nonbarcoded price bundles. Labeling:
1. Line 1: use L004, Column B.
 2. Line 2: “PER” or “NEWS” as applicable; followed by “FLTS” or “IRREG” as applicable; followed by “ADC”; followed by “BARCODED” or “BC” if the pallet contains barcoded price mail; and followed by “NONBARCODED” or “NBC” if the pallet contains nonbarcoded price mail and/or carrier route mail.

13.2 Standard Mail

13.2.1 Basic Standards

Five-digit scheme bundles (under L007) and 3-digit scheme bundles (under L008) must be prepared. Five-digit scheme bundles may not be copalletized on any merged pallets. Five-digit bundles from an automation price mailing and 5-digit bundles from a Presorted price mailing (including pieces cobundled under 11.0) may be placed on the same pallet as carrier route bundles under the following conditions:

- a. A carrier route mailing must be part of the mailing job.
- b. The pieces in the carrier route price mailing, the automation price mailing, and the Presorted price mailing must be part of the same mailing job, and all three mailings must be reported on the same postage statement.
- c. Pieces in the automation price mailing must meet the criteria for a flat under 301.3.0. Pieces in the Presorted price mailing and the carrier route mailing must meet the criteria for a flat under 301.1.1.
- d. Mailers must use the Carrier Route Indicators field in the City State Product and the 5% limit criteria in 13.2.3 to prepare the mailing. The mailing must be entered no later than 90 days after the release date of the City State Product used.
- e. Automation price 5-digit bundles, Presorted price 5-digit bundles, and cobundled 5-digit bundles may be copalletized with carrier route bundles and firm bundles on merged 5-digit or merged 5-digit scheme pallets as follows:
 1. For 5-digit ZIP Codes with an “A” or “C” indicator in the Carrier Route Indicators field in the City State Product, carrier route and 5-digit bundles may be merged with no limit on the number of pieces in 5-digit bundles placed on the pallet. 5-digit scheme bundles may not be used.
 2. For 5-digit ZIP Codes with a “B” or “D” indicator in the Carrier Route Indicators field in the City State Product, the pieces in the 5-digit bundles must not exceed 5% of the total number of pieces for each individual 5-digit ZIP Code on the pallet as described in 13.2.3. Since 5-digit

scheme bundles cannot be placed on merged pallets, pieces in 5-digit scheme bundles do not count as 5-digit sorted pieces for purposes of determining the 5% limit.

- f. If sortation under this section is performed, then merged 5-digit scheme pallets must be prepared whenever there is enough volume of carrier route and 5-digit bundles under 8.0 to prepare such pallets using the criteria in 13.2.1e and the sortation criteria in 13.2.4.
- g. The carrier route mailing must meet the eligibility criteria in 343.6.0, the automation price mailing must meet the eligibility criteria in 343.7.0, and the Presorted price mailing must meet the eligibility criteria in 343.5.0.
- h. The prices are based on the level of bundle that the pieces are contained in under 343.5.0 and 343.7.0.
- i. The pieces in each separate mailing must bear the applicable markings required under 345.5.0, 345.6.0, or 345.7.0 and under 302, *Elements on the Face of a Mailpiece*.
- j. The bundles from each separate mailing must be sorted together on pallets (copalletized) using presort software that is PAVE-certified.
- k. A complete, signed postage statement, using the correct USPS form or an approved facsimile, must accompany each mailing job prepared under these procedures.
- l. In addition to the applicable postage statement, documentation produced by PAVE-certified software must be submitted with each copalletized mailing job that describes for each pallet sortation level and pallet the number of pieces qualifying for each applicable carrier route price, each applicable automation price, and each applicable Presorted price. A separate 5% threshold summary also must be provided under 708.1.0 for each "logical" merged 5-digit scheme or "logical" merged 5-digit pallet presort destination that contains mail for one or more 5-digit ZIP Codes with a "B" or "D" indicator in the City State Product. This 5% threshold summary must show for each 5-digit ZIP Code with a "B" or "D" indicator on the logical merged 5-digit scheme or logical merged 5-digit pallet: the total number of pieces on the pallet for the 5-digit ZIP Code; the total number of pieces sorted in carrier route bundles for the 5-digit ZIP Code; the total number of pieces sorted in 5-digit bundles for the 5-digit ZIP Code, and; of the total number of pieces for the 5-digit ZIP Code, the percentage of pieces sorted in 5-digit bundles for that 5-digit ZIP Code. This additional 5% threshold summary must appear within the body of the documentation beneath the pallet price listing for the last physical pallet for the logical pallet presort destination. *Note:* If there are two or more physical pallets for the same presort destination, for example, the same merged 5-digit pallet destination, these two or more physical pallets would be considered as one "logical pallet." The separate pallet summary must be for the mail on all of the physical pallets (the "logical pallet") for that presort destination.
- m. Portions of the mailing job that cannot be palletized must be prepared in sacks.

13.2.2 Bundle Preparation

Bundles placed on pallets must be prepared under the standards in 8.0.

13.2.3 5% Threshold Standard

Five-digit bundles, carrier route bundles, and firm bundles may be placed on the same merged 5-digit scheme or merged 5-digit pallet under [13.2.4](#) if all of the following conditions are met:

- a. The number of pieces prepared in 5-digit bundles for any single 5-digit ZIP Code with a “B” or “D” indicator on a logical merged 5-digit or merged 5-digit scheme pallet does not exceed 5% of the total number of pieces for the 5-digit ZIP Code on the logical pallet for the presort destination. That is, the total number of pieces for a 5-digit ZIP Code in 5-digit and carrier route bundles must not be greater than the number of pieces in carrier route bundles divided by 0.95. 5-digit ZIP Codes with an “A” or “C” indicator are not subject to the 5% limit.
- b. The 5% threshold is calculated separately for each 5-digit ZIP Code with a “B” or “D” indicator. For example, if a scheme contains four different 5-digit ZIP Codes, a separate 5% threshold applies to each 5-digit ZIP Code with a “B” or “D” indicator for the scheme on a merged 5-digit scheme pallet. (Five-digit ZIP Codes with an “A” or “C” indicator are not subject to the 5% limit.) Since 5-digit scheme bundles cannot be placed on merged pallets, pieces in 5-digit scheme bundles do not count as 5-digit sorted pieces for purposes of determining the 5% limit.
- c. Except when bundles are prepared under the cobundling option in [11.0](#), all mail in a logical 5-digit bundle for a 5-digit ZIP Code with a “B” or “D” indicator must be able to be placed on the logical pallet under the 5% rule. A logical 5-digit bundle is all pieces for a mailing (price level) prepared in a 5-digit bundle or bundles for the same 5-digit destination. For each 5-digit ZIP Code, it is possible to have a logical 5-digit bundle of automation price mail and a logical 5-digit bundle of Presorted price mail. If the total number of pieces in a logical 5-digit bundle exceeds the 5% limit, none of the pieces for that 5-digit bundle level may be placed on a merged 5-digit or merged 5-digit scheme pallet. For some ZIP Codes, the total number of pieces prepared in logical 5-digit bundles (both an automation price logical 5-digit bundle and a Presorted price logical 5-digit bundle) may exceed 5% of the total mail for that ZIP Code, but the number of pieces for an individual automation price logical 5-digit bundle for that ZIP Code does not exceed the 5% limit nor does an individual Presorted price logical 5-digit bundle for that ZIP Code exceed the 5% limit. In such instances, mailers may choose to place all of the pieces in a logical 5-digit bundle for a single price category on the logical merged 5-digit or merged 5-digit scheme pallet so that the 5% threshold is not exceeded.
- d. Except for bundles prepared under the cobundling option in [11.0](#), if the total number of pieces in both the logical 5-digit automation price bundle and the logical 5-digit Presorted price bundle each separately exceed 5% of the total number of pieces for the 5-digit ZIP Code with a “B” or “D” indicator, none of the pieces in 5-digit bundles may be merged with carrier route bundles on a merged 5-digit or merged 5-digit scheme pallet.

- e. For mailing jobs prepared using the cobundling option in 11.0, if the total number of pieces prepared in a logical 5-digit bundle (containing automation price and Presorted price pieces) exceeds the 5% limit for a 5-digit ZIP Code in 13.2.3a, a mailer may, for each 5-digit ZIP Code, choose to place a portion of the pieces prepared in the logical 5-digit bundle on a merged 5-digit or 5-digit scheme pallet using one of the options below. Regardless of the option selected, a minimum of 10 pieces or 15 pieces as applicable must be prepared in 5-digit bundle(s) placed on the merged pallet and a minimum of 10 or 15 remaining pieces as applicable prepared in 5-digit bundle(s) not placed on the merged pallet, with the total number of pieces not exceeding the 5% limit. The options are:
1. Place either all automation price pieces or all Presorted price pieces for the 5-digit ZIP Code on the merged pallet.
 2. Place a portion of either the automation price pieces or the Presorted price pieces for the 5-digit ZIP Code on the merged pallet.
 3. Place either all the automation price pieces plus a portion of the Presorted price pieces or all the Presorted price pieces plus a portion of the automation price pieces for the 5-digit ZIP Code on the merged pallet.

13.2.4 Pallet Preparation and Labeling

[7-3-08] Mailers must prepare pallets of bundles in the manner and sequence listed below and under 8.0. Mailers must prepare all merged 5-digit scheme, 5-digit scheme carrier routes, 5-digit scheme, and merged 5-digit pallets that are possible in the mailing based on the volume of mail to the destination using L001, the City State Product, and the 5% threshold. Mailers must label pallets according to the Line 1 and Line 2 information listed below and under 8.6.

- a. *Merged 5-digit scheme*, required; for schemes that contain at least one 5-digit ZIP Code that has an “A” or “C” indicator in the City State Product, the pallet contains: carrier route bundles for all 5-digit ZIP Codes in the scheme; 5-digit automation price and 5-digit Presorted price bundles for those 5-digit ZIP Codes in the scheme with an “A” or “C” indicator in the City State Product; and 5-digit automation price and/or 5-digit Presorted price bundles for those 5-digit ZIP Codes in the scheme with a “B” or “D” indicator when the number of pieces in the 5-digit bundle(s) does not exceed 5% of the total number of pieces for that 5-digit ZIP Code under 13.2.3. For schemes in which all 5-digit ZIP Codes have “B” or “D” indicators and for which there is at least one 5-digit ZIP Code for which 5-digit bundles may be placed on the pallet under the 5% limit in 13.2.3, place all carrier route bundles plus the 5-digit bundles within the 5% limit on the pallet. For schemes in which all 5-digit ZIP Codes have “B” or “D” indicators and for which there are no 5-digit ZIP Codes for which 5-digit bundles may be placed on the pallet under the 5% limit, do not prepare a merged 5-digit scheme pallet (sort bundles to pallets under 13.2.4b through 13.2.4j). Labeling:
1. Line 1: use L001, Column B.
 2. Line 2: “STD FLTS CR/5D SCHEME.”

705.13.2.4

- b. *5-digit scheme carrier routes*, required, may contain only carrier route bundles for all carrier routes in an **L001** scheme for which all 5-digit ZIP Codes in the scheme have a “B” or “D” indicator and for which no 5-digit bundles could be placed on a merged 5-digit scheme pallet with the carrier route bundles because the 5-digit bundles exceeded the 5% threshold. Labeling:
 1. Line 1: use **L001**, Column B.
 2. Line 2: “STD FLTS CR-RTS SCHEME.”
- c. *Merged 5-digit*, required, may contain carrier route bundles, automation price 5-digit bundles, and Presorted price 5-digit bundles for those 5-digit ZIP Codes that are not part of a scheme. For 5-digit ZIP Codes with an “A” or “C” indicator in the City State Product, there is no limit on the number of pieces in 5-digit bundles that may be placed on the pallet, and a merged 5-digit pallet is prepared even if there are no 5-digit bundles for that ZIP Code. For those 5-digit ZIP Codes with a “B” or “D” indicator in the City State Product, the number of pieces in 5-digit bundles is limited to 5% of the total number of pieces for the 5-digit pallet destination under **13.2.3**. However, if no 5-digit bundles for ZIP Codes with “B” or “D” indicators can be placed on this level pallet under the 5% limit, do not prepare a merged 5-digit pallet (sort bundles to pallets under **13.2.4d** through **13.2.4j**). Labeling:
 1. Line 1: use city, state abbreviation, and 5-digit ZIP Code destination (see **8.6.4** for military mail).
 2. Line 2: “STD FLTS CR/5D.”
- d. *5-digit carrier routes*, required, may contain only carrier route price bundles for the same 5-digit ZIP Code that is not part of a scheme and that could not be placed on a merged 5-digit pallet. Labeling:
 1. Line 1: use city, state, and 5-digit ZIP Code destination (see **8.6.4** for military mail).
 2. Line 2: “STD FLTS,” followed by “CARRIER ROUTES” or “CR-RTS.”
- e. *5-digit*, required, may contain only automation price 5-digit bundles and Presorted price 5-digit bundles for the same 5-digit ZIP Code that could not be placed on a merged 5-digit pallet, or 5-digit scheme (**L007**) bundles (automation price and cobundled automation and Presorted price pieces only). Five-digit scheme bundles are assigned to 5-digit pallets according to the “label to” 5-digit ZIP Code in **L007**. Labeling:
 1. Line 1: use city, state, and 5-digit ZIP Code destination (see **8.6.4** for military mail).
 2. Line 2: “STD FLTS 5D”; followed by “BARCODED” or “BC” if the pallet contains automation price mail; and followed by “NONBARCODED” or “NBC” if the pallet contains Presorted price mail.
- f. *5-digit metro*, optional, may contain carrier route, automation, and Presorted price bundles for the 5-digit ZIP Codes listed in **L006**, Column A, and for the 3-digit ZIP Code areas listed in **L006**, Column B. Labeling:
 1. Line 1: use **L006**, Column C.

2. Line 2: “STD FLTS” followed by “METRO” or “MET”; followed by “BARCODED” or “BC” if the pallet contains automation price mail; followed by “NONBARCODED” or “NBC” if the pallet contains Presorted price and/or carrier route mail.
- g. *3-digit*, optional, option not available for 3-digit ZIP Code prefixes marked “N” in [L002](#). May contain carrier route price, automation price, and Presorted price mail, including 3-digit scheme ([L008](#)) bundles (automation and cobundled automation and Presorted price pieces only). Three-digit scheme bundles are assigned to 3-digit pallets according to the “label to” 3-digit ZIP Code in [L008](#). Labeling:
 1. Line 1: use [L002](#), Column A.
 2. Line 2: “STD FLTS 3D”; followed by “BARCODED” or “BC” if the pallet contains automation price mail; and followed by “NONBARCODED” or “NBC” if the pallet contains Presorted price mail and/or carrier route price mail.
- h. *SCF*, required, may contain carrier route price, automation price, and Presorted price bundles. Labeling:
 1. Line 1: use [L002](#), Column C.
 2. Line 2: “STD FLTS SCF”; followed by “BARCODED” or “BC” if the pallet contains automation price mail; and followed by “NONBARCODED” or “NBC” if the pallet contains Presorted price mail and/or carrier route price mail.
- i. *ASF*, required, except that an ASF sort may not be required if using bundle reallocation under [8.13.3](#). May contain carrier route price, automation price, and/or Presorted price bundles. Sort ADC bundles to ASF pallets based on the “label to” ZIP Code for the ADC destination of the bundle in [L004](#). At the mailer’s option, sort appropriate mixed ADC bundles to ASF pallets based on the “label to” ZIP Code for the ADC destination of the bundle in [L010](#). All optional mixed ADC bundles on ASF pallets must contain only pieces destinating within the ASF as shown in [6.3](#). See [346.3.0](#) for additional requirements for DBMC price eligibility. Labeling:
 1. Line 1: use [L602](#), Column B.
 2. Line 2: “STD FLTS ASF”; followed by “BARCODED” or “BC” if the pallet contains automation price mail; and followed by “NONBARCODED” or “NBC” if the pallet contains Presorted price mail and/or carrier route price mail.
- j. *BMC*, required, may contain carrier route price, automation price, and/or Presorted price bundles. Sort ADC bundles to BMC pallets based on the “label to” ZIP Code for the ADC destination of the bundle in [L004](#). At the mailer’s option, sort appropriate mixed ADC bundles to BMC pallets based on the “label to” ZIP Code for the ADC destination of the bundle in [L010](#). All optional mixed ADC bundles on BMC pallets must contain only pieces destinating within the BMC as shown in [6.3](#). See [363.3.0](#) for additional requirements for DBMC price eligibility. Labeling:
 1. Line 1: use [L601](#), Column B.

705.14.1

2. Line 2: "STD FLTS BMC," followed by "BARCODED" or "BC" if the pallet contains automation price mail; and followed by "NONBARCODED" or "NBC" if the pallet contains Presorted price mail and/or carrier route price mail.

14.0 Plant Load Mailings

14.1 Basic Information

14.1.1 Purpose

In a plant load operation, the USPS receives mail at a mailer's plant and transports it to bypass handling otherwise required at one or more postal facilities. Plant loads are authorized if they benefit the USPS. The USPS selects the appropriate mode of transportation and determines responsibility as shown below.

TYPE	WHO ARRANGES, PAYS TRANSPORT	RESPONSIBILITY	POSTAGE PAID FROM	ADDITIONAL FORMS ¹
Collection ²	USPS	USPS	Affixed/Mailer Plant	None
Pickup ³	USPS with fee	USPS	Affixed/Mailer Plant	Form 5541
Drop Shipment ⁴	Mailer/USPS	USPS	Acceptance Post Office	None
Drop Shipment Metered Mail	Mailer	Mailer	Post Office of Licen se	None/ Endo rsem ent
Business Mail Entry Unit (BMEU)	Mailer	Mailer	BMEU Post Office	None
Destination Entry (drop shipment)	Mailer	Mailer	Entry Office	Form 8125
Periodicals Additional Entry	Mailer	Mailer	Entry Office	Form 3510
Periodicals Exceptional Dispatch	Mailer	Mailer	Entry Office	Statements
Periodicals Airport Mail Facility	Mailer	Mailer	Entry Office	Form 3510
Plant Load	USPS	USPS	Mailer Plant	None
Expedited Plant Load Shipment	Mailer	Mailer	Mailer Plant	Form 8017

1. Postage statements and other appropriate mailing documentation forms are required.

2. Collection applies to mail that is part of an approved collection service and may include Presorted First-Class Mail and all automation price mail. It generally does not apply to mailings at bulk prices.

3. Express Mail, Priority Mail, and scheduled Parcel Post only.

4. Express Mail or Priority Mail service to expedite other class. Only at designated postal facilities; mailers must submit/present shipment to acceptance unit designated by postmaster (mailer transportation). USPS transports by Express Mail or Priority Mail from origin Post Office to destination Post Office of the shipment. If authorized, the shipment is accepted at mailer plant acceptance unit and transported from mailer plant with other mail on USPS transportation.

14.1.2 Service Objectives

The service objectives for the class of mail transported apply to the plant-loaded mail. Plant-loaded mail may have deferred service objectives if provided in the plant load agreement.

14.1.3 Service Not Provided

The USPS does not hold, store, or delay the dispatch of plant-loaded mail released to the USPS, except under the plant load agreement with the mailer. The USPS does not relocate trailers on the mailer's premises.

14.2 Application for Plant Load Privileges**14.2.1 Application**

To have mail plant-loaded, the mailer must complete Form 3815 and submit it to the postmaster of the Post Office serving the mailer's plant.

14.2.2 Approval

Generally, a plant load application is approved if transportation is available and cost savings to the USPS are shown. If the application is approved, the mailer must enter into a plant load agreement with the USPS.

14.2.3 Denial and Appeal

If the application is denied, the mailer may appeal through the local postmaster within 10 calendar days of the mailer's receipt of the denial notice to the vice president of area operations for the area in which the mailer's plant is located, giving the reasons why the application should be approved.

14.3 Plant Load Operations**14.3.1 Mixed Mail Classes**

A mailer may combine Periodicals, Standard Mail, Parcel Select, and Package Services in a single vehicle if the mailings are physically separated, a postage statement is submitted for each mailing, and the service standards are met for each class of mail combined in the vehicle or trailer.

14.3.2 Compliance

The mailer must meet all relevant mailing standards and the terms of the plant load agreement. Destination loads must be prepared under [14.5](#) through [14.7](#) and as specified by the postmaster administering the plant load.

14.3.3 Reimbursement by Mailer

Under the plant load privileges and the terms of the plant load agreement, the mailer must reimburse the USPS for services it furnished while providing plant load service, including:

- a. Detention charges when trailers furnished by the USPS are held up for some action or inaction of the mailer.
- b. Costs for bobtailing, deadheading, or waiting/holding, if such charges are incurred by the USPS to provide plant load service for some action or inaction of the mailer.

705.14.4

14.4 Expedited Plant Load Shipment**14.4.1 Definition**

Under an expedited plant load shipment authorization, the USPS verifies and receives postage payment for mailable matter at the mailer's plant, after which the mailer transports the shipment (at the mailer's expense) to a destination postal facility.

14.4.2 Authorization

Only an authorized plant load mailer may prepare and transport expedited plant load shipments. Authorization is by written request to the postal official who authorized the plant load. The request must state, for each destination to which mail is to be transported, the material to be deposited as an expedited plant load shipment (e.g., the class, characteristics, and quantity), the frequency of mailing, and whether the request is for one or for a series of mailings. The mailer must meet all conditions in the authorization, if approved.

14.4.3 Liability

The mailer assumes all liability and responsibility for any loss or damage to the shipment before it is deposited in and accepted at a postal facility, whether or not a third party is used to transport the shipment. The USPS is not liable or responsible for any loss of or damage to an expedited plant load shipment before it is deposited in and accepted at a postal facility.

14.4.4 Postage Refund

The USPS does not refund postage for any failure to provide service caused in whole or in part by any event that occurs before the shipment is deposited in and accepted at a postal facility, except under the applicable standards for refunds.

14.5 Mailer Responsibilities**14.5.1 General**

The plant load mailer must meet the terms of the plant load agreement and the standards that apply to the class of mail prepared, prices claimed, and method of paying postage used.

14.5.2 Verification at USPS Facility

If mail verification does not occur at the mailer's plant, the mailer must:

- a. Keep a plant load control log with a copy of each postage statement, numbered sequentially; the number of each vehicle used to transport plant-loaded mail; and the name of the postal facility where verification is to occur.
- b. Not shrinkwrap or otherwise secure the mail to inhibit verification.
- c. Correct preparation errors found in the mail when verified or pay additional postage at the price for which it qualifies.

14.5.3 Postage

Unless otherwise permitted by standard, the mailer must pay all applicable postage and fees to the origin Post Office before a plant-loaded mailing is dispatched.

14.6 Intradistrict Plant-Loaded Shipments

Intradistrict plant-loaded shipments must fill 50% or more of a vehicle by weight or cube (a minimum of 23,000 pounds or 1,600 cubic feet).

14.7 Interdistrict Plant-Loaded Shipments**14.7.1 One Mailing**

The mailer must prepare interdistrict plant-loaded vehicles containing one mailing under 14.7.2 through 14.7.4 as appropriate to the class of mail.

14.7.2 First-Class Mail

For plant-loaded shipments of First-Class Mail:

- a. If there is enough mail for the same SCF service area to fill 60% or more of a vehicle by weight or by cube (a minimum of 28,000 pounds or 2,000 cubic feet), the mailer must prepare a direct vehicle for that SCF.
- b. After making up all possible SCF vehicles, if there is enough mail for the same ADC service area to fill 60% or more of a vehicle by weight or by cube, the mailer must prepare a direct vehicle for that ADC.

14.7.3 Periodicals

For plant-loaded shipments of Periodicals:

- a. If there is enough mail for the same SCF service area to fill 60% or more of a vehicle by weight or by cube, the mailer must prepare a direct vehicle for that SCF.
- b. After making up all possible SCF vehicles, if there is enough mail for the same ADC service area to fill 60% or more of a vehicle by weight or by cube, the mailer must prepare a direct vehicle for that ADC.
- c. After making up all possible SCF and ADC vehicles, if there is enough mail for the same transfer hub service area to fill 60% or more of a vehicle by weight or by cube, the mailer must prepare a direct vehicle for that transfer hub.

14.7.4 Standard Mail, Parcel Select, and Package Services

For plant-loaded shipments of Standard Mail, Parcel Select, and Package Services:

- a. If there is enough mail for the same SCF service area to fill 60% or more of a vehicle by weight or by cube (a minimum of 28,000 pounds or 2,000 cubic feet), the mailer must prepare a direct vehicle for that SCF.
- b. After making up all possible SCF vehicles, if there is enough mail for the same ASF or BMC service area to fill 60% or more of a vehicle by weight or by cube, the mailer must prepare a direct vehicle for that BMC or ASF.

14.7.5 Two or More Mailings

The mailer must prepare interdistrict plant-loaded vehicles containing two or more mailings under 14.7.6 and 14.7.7 as appropriate to the class of mail.

14.7.6 Insufficient Volume

Two or more mailings that independently have insufficient volume to require direct destination vehicles to be prepared may be combined to make up an origin vehicle without meeting the standards in 14.7.7.

705.14.7.7

14.7.7 Sufficient Volume

Two or more mailings, which independently have sufficient volume to require destination vehicles to be prepared, must meet these standards when combined:

- a. For First-Class Mail, if there is enough mail for the same ADC service area to fill 60% or more of a vehicle by weight or by cube, the mailer must prepare a direct vehicle for the ADC.
- b. For Periodicals, if there is enough mail for the service area of the same transfer hub to fill 60% or more of a vehicle by weight or by cube, the mailer must prepare a direct vehicle for that transfer hub.
- c. For Standard Mail, Parcel Select, and Package Services, if there is enough mail for the same ASF or BMC service area to fill 60% or more of a vehicle by weight or by cube, the mailer must prepare a direct vehicle for that ASF or BMC.

14.7.8 Destination

The preparation standards for plant-loaded vehicles are determined by the destination of the mailings accepted by the USPS at the mailer's plant.

14.7.9 Two Options

If a plant-loaded mailing does not meet the preparation standards for plant-loaded vehicles under [14.7.1](#) through [14.7.8](#), the mailer has two options:

- a. Rework the mailing so that it meets the applicable standard. If the mailing is verified and accepted as mail by the USPS at the mailer's plant and then it is determined that the vehicle preparation standards are not met, the mailer must rework the mailing.
- b. Transport the mailing at the mailer's expense to a postal facility within the origin service area designated by the origin postmaster and with the capability to process that class of mail. If this option is chosen, all applicable postage statements must be provided with the mailings.

15.0 Plant-Verified Drop Shipment

15.1 Description

15.1.1 Purpose

Plant-verified drop shipment (PVDS) enables origin verification and postage payment for shipments transported by a mailer (or third party) at the mailer's expense, on the mailer's own or contracted vehicle, to destination USPS facilities for acceptance as mail. The mailings may be prepared for deposit at a destination entry price, or they may be claimed at the applicable prices from the destination entry facility.

15.1.2 Function

Under PVDS:

- a. Mailings are verified at origin by USPS employees assigned to a detached mail unit (DMU) at a mailer's plant or at the business mail entry unit (BMEU) at the origin Post Office serving the mailer's plant. The shipments are then released for transportation to destination USPS facilities.

- b. For Periodicals, postage is paid at a valid original entry or additional entry Post Office serving the mailer's plant, unless an alternative postage payment method is authorized.
- c. For Standard Mail, Parcel Select, and Package Services, postage and fees are paid under a valid permit at the Post Office serving the mailer's plant, or as designated by the district manager.
- d. The shipment is deposited at the destination USPS facility, by the mailer or the mailer's agent, where it is verified and accepted as mail by USPS employees and released for processing.

15.1.3 Other Mailings

The following mailings must be verified, accepted, and paid for at the destination USPS facility:

- a. Periodicals mailings not verified at origin under PVDS or under the Centralized Postage Payment System (see [707.16.0](#) and [707.17.0](#)). The destination USPS facility must be a valid original entry or additional entry Post Office if mailings are submitted there for postal verification.
- b. Standard Mail, Parcel Select, and Package Services mailings not verified and paid for at origin under PVDS. Mailers must have a valid permit at the destination USPS facility for postage payment.

15.1.4 Dates

The postage statement may be submitted before or at the time a shipment is presented to the origin Post Office DMU or BMEU. The date shown by the mailer and the Post Office round stamp date on the postage statement and Form 8125 represents the date the origin Post Office DMU or BMEU verified the shipment and cleared it for dispatch by the mailer to the destination USPS facility. It does not necessarily represent the date the USPS accepts the PVDS at the USPS destination facility as mail.

15.1.5 Postage Refund

The USPS does not refund postage for any failure to provide service caused by any event that occurs before the shipment is deposited and accepted into the mailstream and becomes mail at a destination postal facility, except under [604.9.0](#).

15.2 Program Participation

15.2.1 Mailer Responsibility

A mailer participating in PVDS must comply with [15.0](#). If the mailer does not meet these requirements, the mailer may be prohibited from participating in PVDS by the local postmaster. Any mailer denied a request for PVDS may file an appeal under [607.2.0](#).

15.2.2 Verification at Mailer's Plant

Before PVDS verification can be performed at the mailer's plant, the mailer must have either a USPS plant load authorization for that plant or a postage payment agreement with the USPS that establishes a detached mail unit (DMU) at that plant. The DMU must be separate from the mailer's activities, in an enclosed, secure, and safe work area with a telephone. The work area must be approved by the USPS. The mailer may submit a letter to the postmaster serving the plant and request

PVDS verification at the plant. The postmaster may agree to the mailer's request to verify PVDS shipments at the plant on an as-needed basis, if an approved DMU is established and staffing can be accommodated.

15.2.3 Verification at Origin BMEU

PVDS verification can be performed at the origin business mail entry unit (BMEU) under these conditions:

- a. There is no detached mail unit (DMU) at the mailer's plant.
- b. The mailer is in the service area of the Post Office where the PVDS is to be verified and where postage is to be paid, unless another postal facility is designated by the district manager.
- c. Each vehicle contains only one mailer's shipment(s), each physically separated.
- d. A completed postage statement and Form 8125 accompanies each PVDS (or segment, if the PVDS is contained in more than one vehicle).
- e. If an alternate method of paying postage with permit imprint is used, in addition to [15.2.3d](#), (additional) required documentation must accompany each PVDS (or segment, if the PVDS is contained in more than one vehicle).
- f. The PVDS can be physically verified at the origin BMEU. Shipments to be verified may not be wrapped or otherwise prepared if a presort and postage verification cannot be performed without destroying the physical integrity of the shipment.
- g. The BMEU has enough space and staff to handle verification, and scales to calculate per piece and gross weights are available. If the Post Office serving the mailer's plant lacks resources, another postal facility may be designated by the district manager.
- h. The mailer must transport all shipments to the Post Office, unload them for verification. When cleared for dispatch, reload the shipments back onto the mailer's vehicle for transportation to the destination USPS facility.

15.2.4 Periodicals

Periodicals postage must be paid at the Post Office verifying the copies or as designated by the district. Postage is calculated from the destination USPS facility where the mail is deposited and accepted (or from the facility where the Express Mail or Priority Mail Open and Distribute designates). The publisher must ensure that sufficient funds are on deposit to pay for all mailings before their release. A publisher authorized under an alternative postage payment system must pay postage under the corresponding standards.

15.2.5 Standard Mail, Parcel Select, and Package Services

The mailer must pay any applicable permit fees, mailing fees, and postage for Standard Mail, Parcel Select, and Package Services PVDS at either the Post Office serving the mailer's plant or the Post Office that does BMEU verification as designated by the district. If permit imprints are used to pay postage, the mailer must ensure that sufficient funds are on deposit to pay for all shipments before their release. For Nonprofit Standard Mail prices, a valid authorization must be on file at the Post Office where postage is paid. No permit, fees, or authorizations are required at the destination USPS facility where PVDS mailings are deposited.

15.2.6 Postage Statement—Periodicals

The mailer must submit a Form 3541 for each edition of each issue of each publication prepared for deposit at each destination USPS facility when the corresponding copies are presented to the DMU or the Post Office BMEU for verification. When required by the USPS, the mailer must submit consolidated postage statements and a postage statement register.

15.2.7 Postage Statement—Standard Mail

At the time mail is presented for verification, the mailer must submit an appropriate Form 3602 representing all the pieces from the mailing job and Form 3602-C (or postage statement register) for all PVDS verified at the mailer's DMU or the Post Office BMEU. The mailer must enter the required information on Form 3602-C for each PVDS to be deposited at each destination USPS facility, in lieu of providing a separate Form 3602 for each PVDS.

15.2.8 Postage Statement—Parcel Select and Package Services

At the time mail is presented for verification, the mailer must submit an appropriate postage statement for each PVDS mailing destined for each destination USPS facility. When required by the USPS, the mailer must submit consolidated postage statements and a postage statement register.

15.2.9 Form 8125 and Form 8125-C

Form 8125 is used to report a single PVDS that the mailer will transport from origin to a destination USPS facility. Computer-generated Form 8125-C (format available at www.usps.com) provides for reporting multiple PVDS mailings that are prepared by an individual mailer and that are cleared at origin on the same day for entry at a single destination USPS facility on the same vehicle (see 15.2.11). The mailer must submit a completed Form 8125 (signed and dated by the DMU or BMEU) for each PVDS to the destination USPS facility. The form must be submitted in duplicate, or in triplicate if the mailer desires a signed and dated copy returned to its representative when depositing the mail at the destination USPS facility. Form 8125 is not required for PVDS sent via Express Mail or Priority Mail Open and Distribute under 16.0.

15.2.10 Facsimile Forms 8125 and 8125-C

Facsimile Forms 8125 may be used in lieu of the USPS form. Formats must be approved in advance by the district manager of Business Mail Entry or designee. Formats must include all required information, including the correct title (preceded by the word "facsimile") and edition date, in locations as close as possible to where they appear on the USPS form. Data fields that do not pertain to information relating to the PVDS, and other extraneous information that appears on the USPS form, do not have to be included. Form 8125-C must always be computer-generated. Form 8125-C may omit the "Number of Pieces" and "Piece Weight" columns for mailings prepared in sacks, trays, or on pallets if there is sufficient information for the origin Post Office and destination USPS facility to identify the mailings and to compare the information on the form with the physical mail. The mailer must report the number of pieces in each mailing on Form 8125-C if the mailings consist of individual mailpieces that are not prepared in containers (e.g., bedloaded parcels). For mailings consisting of identical-weight pieces, mailers should report the piece weight where possible.

705.15.2.11

15.2.11 Mailer Transport of PVDS

Using any means of transportation, including Express Mail or Priority Mail Open and Distribute shipment, the mailer must transport PVDS mailings from origin to the destination USPS facility. The mailer must not transport PVDS mailings on the same vehicle with shipments not entered as PVDS. For Standard Mail, Parcel Select, and Package Services PVDS, the mailer must meet the scheduling standards for mail deposit at destination USPS facilities. If a vehicle contains mail paid at Parcel Select destination entry prices, the applicable standards for scheduling of deposits and unloading of vehicles apply to any other mail on the same vehicle for the same destination USPS facility. Any material classified as hazardous under [601.10.0](#) may not be carried in the same vehicle as PVDS mailings.

15.2.12 Separation of PVDS Mailings

When a vehicle contains more than one PVDS for a single destination USPS facility, the shipments must be separated to allow reconciliation with each accompanying Form 8125. Vehicles containing shipments for multiple destination USPS facilities must be kept physically separated. Where applicable, a single Form 8125 that identifies all the mail for a single facility must be prepared for a shipment of copalletized or combined mailings.

15.2.13 PVDS Seal

The mailer may ask that a PVDS band seal secure the vehicle containing verified mailings before dispatch to the destination facility.

15.3 Liability

The mailer assumes all responsibility and liability for any loss or damage to PVDS mailings before they are deposited and accepted as mail at destination USPS facilities, including third party transportation.

15.4 Standard Mail Documentation**15.4.1 Same Day**

All mailings or segments of the same job submitted for verification and release on the same day under PVDS must be reported on a single postage statement and Form 3602-C (or postage statement register).

15.4.2 Documentation

In addition to the documentation required in [708.1.0](#), the mailer must also submit the documentation below at the time the first mailing identified on Form 3602-C is presented for verification:

- a. Form 3602-C, which serves as the postage statement register, along with the appropriate postage statement. All mailing volumes, weights, and postage for each price category are entered on the postage statement and used to debit the mailer's account for permit imprint mailings and to enter data on postage-affixed mailings.
- b. A separate Form 8125 for each PVDS listed on Form 3602-C (or postage statement register). Each PVDS must be identified with a unique statement number (e.g., the date and a sequential three-digit suffix) on the Form 3602-C (or postage statement register) and the corresponding Form 8125, as appropriate.

- c. A separate postage statement showing the mailing Post Office is the same as the Post Office of PVDS origin for any portion of a job accepted by the local verifying office under a standard plant load arrangement. Plant load mailings are not considered a PVDS and are not reported on Forms 3602-C and 8125.

15.5 Parcel Select and Package Services PVDS Option

15.5.1 General Standards

Under this option, in addition to the individual postage statements required for each Parcel Select or Package Services mailing, the mailer may be required to submit postage statement registers and consolidated postage statements for PVDS mailings. A single, unique USPS mailing number must be on all related individual postage statements and postage statement register listing these individual statements, and the associated consolidated postage statement. When a mailer is required to submit consolidated postage statements, the information on these statements is used to debit the mailer's account.

15.5.2 Individual Postage Statements

The mailer must submit a complete postage statement for each mailing for each destination USPS facility when the mailing is presented for verification and postage payment. In addition to the information required on all individual postage statements, if the mailer is required to submit consolidated postage statements (for three or more entry Post Offices) for debiting of the advance deposit account, each individual postage statement must include a uniquely assigned postage statement sequence number that must not exceed nine digits. The numbers must be sequential within a job or mailing cycle for mailings verified, paid for, and cleared for dispatch on the same day. The statements must also include a unique USPS mailing number corresponding to the number on the related postage statement register and consolidated postage statement.

15.5.3 Postage Statement Register

A postage statement register is a computer-generated line item listing of all individual postage statements for PVDS permit imprint mailings verified and released for dispatch on a single day from a job or mailing cycle. All postage statements listed on a postage statement register must be represented by a corresponding consolidated postage statement. The total postage charge on the postage statement register must be identical to the total postage charge on the corresponding consolidated statement. The following information must appear on each postage statement register:

- a. At the top of the first page the endorsement "Register of Postage Statements"; name and location of the mailing agent; date mailings are verified and cleared for dispatch; the permit imprint number; the unique USPS mailing number corresponding to the number on related postage statements; and the related consolidated statement.
- b. Each line item must include (based on the individual postage statement on that line) the unique postage statement sequence number; destination USPS facility; and, for that statement, total postage, weight, and number of pieces.

705.15.5.4

- c. The sum of the total postage charges must appear with total weight, and total pieces must be listed from each postage statement. The total postage charge on the register must match total postage charge on the related consolidated statement.
- d. If necessary, manual corrections may be made to the postage statement register listing the data from any revised individual statement. These corrections must be documented by the DMU, and the corrected register must be signed and dated by both the mailer and the USPS representative approving the changes. The changes on the register must be reflected on the associated consolidated postage statement.

15.5.4 Submitting Register

The mailer must submit the postage statement register to the DMU before or when presenting the first individual mailing on the register to the DMU for verification and dispatch.

15.5.5 Consolidated Postage Statement

The consolidated postage statement assembles data from the individual postage statements representing permit imprint mailings verified, paid for, and released for dispatch on a single day from a job or mailing cycle. The consolidated postage statement must be a computer-generated facsimile similar in format to the appropriate USPS postage statement. The mailer must sign and date the consolidated statement. Certain data elements not on the individual postage statements must be reflected on the consolidated statement, including the range of unique individual statement sequence numbers, the number of individual statements represented, and the endorsement "Consolidated Postage Statement." Other data elements on individual statements, such as each Post Office of deposit for PVDS mailings, are not shown on the consolidated statement. Each individual statement must contain a USPS mailing number that corresponds to the USPS mailing number on the related consolidated statement. The consolidated statements are used to debit the mailer's account. The following information must be identical for each individual statement consolidated onto a single (consolidated) postage statement:

- a. Mailing date.
- b. Name and location of mailing agent.
- c. Processing category.
- d. Permit imprint number.
- e. Job or mailing cycle description.
- f. Unique USPS mailing number corresponding to the number on related individual postage statements.

15.5.6 Calculating and Reporting Data

Each field on the consolidated postage statement represents the sum of the figures in that field from the individual postage statements. The figures reported on the consolidated statement must be rounded in accordance with [604.7.1.3](#). All fields containing data on the individual statements must be rolled up to the consolidated

statement. The total postage on the consolidated statement must be the sum of the total postage for all individual postage statements. This total is used to debit the mailer's account.

15.5.7 Submitting Statement

The mailer must submit the consolidated postage statement to the DMU at or before the time the last individual postage statement it represents is submitted to the DMU for the day's mailing.

16.0 Express Mail Open and Distribute and Priority Mail Open and Distribute

16.1 Prices and Fees

16.1.1 Basis of Price

Mailers must pay Express Mail and Priority Mail postage based on the weight of the entire contents of the Express Mail or Priority Mail shipment. Do not include the tare weight of the external container. Do not apply Priority Mail dimensional weight pricing or Periodicals container prices to the external container.

16.1.2 Zone Prices

Compute zone prices for Priority Mail from the accepting Post Office to the destination facility for the container (not the destination Post Office for the enclosed mail).

16.1.3 Enclosed Mail

The mail enclosed in an Express Mail or Priority Mail Open and Distribute container must be either entirely single-piece price matter or entirely presorted matter that is part of the same mailing.

16.1.4 Calculating Payment for Enclosed Mail

Mailers must prepay postage and fees for the enclosed mail under the applicable standards. When the enclosed mail is zone-priced, the zone is computed from the postal facility where the Express Mail Open and Distribute or Priority Mail Open and Distribute container destines.

16.1.5 Payment Method

Postage on the enclosed mail may be paid by any method permitted for that mail class, except for ordinary postage stamps requiring cancellation. Express Mail postage must be paid under 114. Priority Mail postage must be paid with adhesive stamps or meter stamps affixed to green Tag 161, pink Tag 190, or orange Label 23 or with a permit imprint through a manifest mailing system, optional procedure mailing system, or alternate mailing system authorized under 2.0, 3.0, or 4.0. If a permit imprint is used for Priority Mail postage, the permit imprint must be affixed to or hand-stamped on the Tag 161, Tag 190, or Label 23, or be part of the address label.

16.1.6 Postage Statement for Enclosed Mail

The mailer must provide the correct postage statement for the enclosed mail. The postage statement must show the total number of Express Mail Open and Distribute or Priority Mail Open and Distribute containers used for the mailing in addition to the number of sacks, trays, or other enclosed containers. If the enclosed mail is zone-priced, the mailer must either provide documentation that details the pieces and postage, by zone for each Express Mail Open and Distribute or Priority Mail Open and Distribute shipment destination, or provide a separate postage statement for each Express Mail Open and Distribute or Priority Mail Open and Distribute shipment destination. The mailer must always present the mailing to the designated USPS acceptance unit for verification of postage and fees. A postage statement is not required for the Express Mail or Priority Mail portion of the Open and Distribute shipment, unless Priority Mail postage is paid by permit imprint.

16.1.7 Authorization

No authorization is required for Express Mail Open and Distribute or Priority Mail Open and Distribute. The mailer must pay all applicable fees, obtain necessary authorizations for the enclosed mail, and pay postage at the Post Office where the Express Mail Open and Distribute or Priority Mail Open and Distribute shipment is mailed.

16.2 Basic Standards**16.2.1 Description of Express Mail Open and Distribute and Priority Mail Open and Distribute**

Express Mail Open and Distribute and Priority Mail Open and Distribute provide alternatives for mailers who want to expedite mailings of other classes of mail to destination postal facilities. Mailers prepare the mailings according to standards for the enclosed class of mail, enclose the mail in containers for expedited service as either Express Mail Open and Distribute or Priority Mail Open and Distribute, and present the mailings to a postal acceptance unit by the critical entry time for USPS shipment under [16.0](#). Mailers may use Express Mail Open and Distribute or Priority Mail Open and Distribute for all or part of their mailings.

16.2.2 Content Standards

The Express Mail or Priority Mail shipment and the enclosed mail must meet all corresponding eligibility and preparation standards (see [110](#) for Express Mail standards and [120](#) for Priority Mail standards). For mail enclosed in an Express Mail Open and Distribute container, available extra services are indicated in [16.3.2](#). For mail enclosed in a Priority Mail Open and Distribute container, available extra services are indicated in [16.4.2](#). Mailpieces requiring cancellation may not be included in an Express Mail Open and Distribute or a Priority Mail Open and Distribute shipment. Mailers are not required to place bundles of mail in sacks or trays when all of the mail enclosed in an Open and Distribute container is destined to a 5-digit facility.

16.3 Additional Standards for Express Mail Open and Distribute

16.3.1 Service Objectives

The Express Mail service guarantee for an Express Mail Open and Distribute shipment ends upon receipt of the Express Mail container at the destination postal facility of the shipment. The service guarantee does not apply to the delivery of the enclosed mail to the addressees.

16.3.2 Extra Services

No extra services may be added to the Express Mail segment of an Express Mail Open and Distribute shipment, and the enclosed mail may receive only the following extra services:

- a. First-Class Mail pieces may be sent with Certified Mail service or special handling or, for parcels only, Delivery Confirmation or Signature Confirmation service.
- b. Priority Mail pieces may be sent with Certified Mail service, special handling, Delivery Confirmation, or Signature Confirmation service.
- c. Standard Mail parcels and NFMs (except Customized *MarketMail* pieces) may be sent with electronic option Delivery Confirmation service.
- d. Parcel Select and Package Services mail may be sent with special handling or, for parcels only, Delivery Confirmation or Signature Confirmation service.

16.4 Additional Standards for Priority Mail Open and Distribute

16.4.1 Service Objectives

All Priority Mail Open and Distribute containers receive expeditious handling and transportation. The USPS follows uniform guidelines for delivering the containers to a destination postal facility but does not guarantee delivery within a specified time.

16.4.2 Extra Services

[7-3-08] No extra services are available for Priority Mail Open and Distribute containers. The mail enclosed in the container may receive only the following services:

- a. First-Class Mail pieces may be sent with Certified Mail service or special handling or, for parcels only, Delivery Confirmation or Signature Confirmation service.
- b. Standard Mail parcels and NFMs (except Customized *MarketMail* pieces) may be sent with electronic option Delivery Confirmation service.
- c. Parcel Select and Package Services mail may be sent with special handling or, for parcels only, Delivery Confirmation or Signature Confirmation service.

16.5 Preparation

16.5.1 Containers for Expedited Transport

[9-11-08] Acceptable containers for expedited transport are as follows:

- a. An Express Mail Open and Distribute shipment must be contained in a USPS-approved sack using Tag 157, except as provided in [16.5.1c](#) and [16.5.1d](#).

- b. A Priority Mail Open and Distribute shipment must be contained in either a USPS-approved sack using Tag 161 or Tag 190 or in a letter-size tray using Label 23, except as provided in [16.5.1c](#) and [16.5.1d](#).
- c. An Express Mail or Priority Mail Open and Distribute shipment destined to a DDU may be contained in a USPS-provided Express Mail flat-rate envelope using Tag 157 or Priority Mail flat-rate envelope or boxes using Tag 190.
- d. Customized *MarketMail* (CMM) pieces may be contained in USPS-provided Express Mail or Priority Mail envelopes and boxes or in any properly labeled container supplied by the mailer.

16.5.2 Express Mail and Priority Mail Container Labels

Sack and tray labels for Express Mail or Priority Mail sacks and trays containing Open and Distribute shipments must be barcoded and meet the requirements in [708.6.0](#). All lines of information must be completely visible when inserted into the label holder. Label sacks and trays as follows:

- a. Line 1 (destination line) provides information on the destination entry office where the enclosed mail is to be distributed. For destination delivery unit (DDU) distribution, use the facility name and ZIP Code found in the Drop Shipment Address File available at the USPS FAST Web site at: <https://fast.usps.com>. (click on “Resources” in the left-hand navigation bar, then “Drop Ship Product File Download”).
 1. For SCF distribution, use the destination in [L005](#), Column B. For ADC distribution, use the destination in [L004](#), Column B. For BMC distribution, use the destination in [L601](#), Column B. For ASF distribution, use [L602](#), Column B.
 2. For Line 2 (content line), print “EXPRESS MAIL OPEN AND DIST” or “PRIORITY MAIL OPEN AND DIST,” as applicable.
 3. For Line 3 (origin line), show the city and state of the entry Post Office or the mailer's name and the city and state of the mailer's location. It is recommended that the mailer's name also appear with the city and state of the entry Post Office. See [708.6.2.5](#) for additional standards.

16.5.3 Tag 157—Express Mail Open and Distribute

[\[9-11-08\]](#) In addition to the Express Mail sack label, mailers must place the proper Express Mail mailing labels in EP-13 envelopes and attach the envelope to a black-and-white Tag 157 to each sack or container to identify it as an Express Mail Open and Distribute shipment. This tag or an approved facsimile also must be affixed to containers used for Express Mail Open and Distribute shipments prepared under [16.5.1c](#) or [16.5.1d](#).

16.5.4 Tags 161 and 190—Priority Mail Open and Distribute

[\[9-11-08\]](#) [\[7-3-08\]](#) Tag 161 and Tag 190 (or approved facsimiles) provide a place to affix Priority Mail postage and the address label for the destination facility. Tag 161 or Tag 190 must be attached to each Priority Mail sack, in addition to the Priority Mail sack label, or container to identify it as a Priority Mail Open and Distribute shipment as follows:

- a. Attach Tag 161 to sacks used as Priority Mail Open and Distribute containers to a BMC, ASF, ADC, or SCF facility.
- b. Attach Tag 190 to sacks used as Priority Mail Open and Distribute containers to a DDU. This tag or an approved facsimile also must be affixed to containers used for Priority Mail Open and Distribute shipments prepared under [16.5.1c](#) or [16.5.1d](#).

16.5.5 Label 23—Priority Mail Open and Distribute

As an alternative to sacks for Priority Mail Open and Distribute shipments, mailers may use letter trays (or mailer-supplied containers for CMM pieces) as follows:

- a. Label 23 is affixed to the letter tray or mailer-supplied container. A single Label 23 may be used to identify two letter trays strapped together. Mailer-supplied containers may not be strapped together.
- b. If two letter trays are strapped together, each tray must be of identical size and individually strapped under [235.3.4](#). Label 23 must be affixed to the sleeve of the top tray before strapping. The trays must be strapped securely around the length of the two trays.
- c. The total weight of two trays strapped together or mailer-supplied containers used for CMM may not exceed 70 pounds.

16.5.6 Address Labels

[7-3-08] In addition to Tag 157, Label 23, Tag 161, or Tag 190, USPS-supplied containers and envelopes and mailer-supplied containers used for Express Mail Open and Distribute or Priority Mail Open and Distribute must bear an address label that states “OPEN AND DISTRIBUTE AT:” followed by the facility name. Find the facility name and other information for addressing the labels, according to the type of facility, in [16.5.8](#) through [16.5.12](#).

16.5.7 Address Label Service Barcode Requirement

[7-3-08] An electronic Service barcode using the concatenated GS1-128 symbology must be incorporated in the address label. Mailers must prepare address labels using the formats in [16.5.8](#) through [16.5.12](#), including the service type code “55” to identify the service and the human-readable text “USPS SCAN ON ARRIVAL” above the barcode. USPS certification is required from the National Customer Support Center (NCSC) for each printer used to print barcoded open and distribute address labels, except for barcodes created using USPS Shipping Assistant. NCSC contact information, formatting specifications for barcodes and electronic files, and certification, are included in Publication 91, *Confirmation Services Technical Guide*. Mailers can use any of the following options available to create a label with a Service barcode for Priority Mail Open and Distribute address labels:

- a. Select a service software developer from the list of companies that have met Postal Service specifications for the electronic file and barcode available at <http://www.usps.com/shipping/shipsystems.htm>.
- b. Register and download the USPS Shipping Assistant desktop application available at <http://www.usps.com/shippingassistant/>.

705.16.5.7

- c. Register and integrate the USPS Web Tools Application Program Interface (API) for Priority Mail Open and Distribute using your own developers, available at <http://www.usps.com/webtools/>.
- d. Use Publication 91, *Confirmation Services Technical Guide*, for technical specifications and requirements.

16.5.8 DDU Address Labels

[7-3-08] For the DDU address label, use the name of the DDU on the top line; the street address of the facility on the next line; and city, state, and ZIP+4 code on the last line of the address block. For the DDU address label, use the destination facility name, the street address, city, state, and ZIP+4 found in the Drop Entry Point View File available at USPS' FAST Web site: <https://fast.usps.com> (click on Reports>Mail Direction Search>Drop Entry Point View). Directly below the address, indicate the class and processing category of the enclosed mail. See Exhibit 16.5.8 for an example of a DDU address label.

Exhibit 16.5.8 DDU Address Label

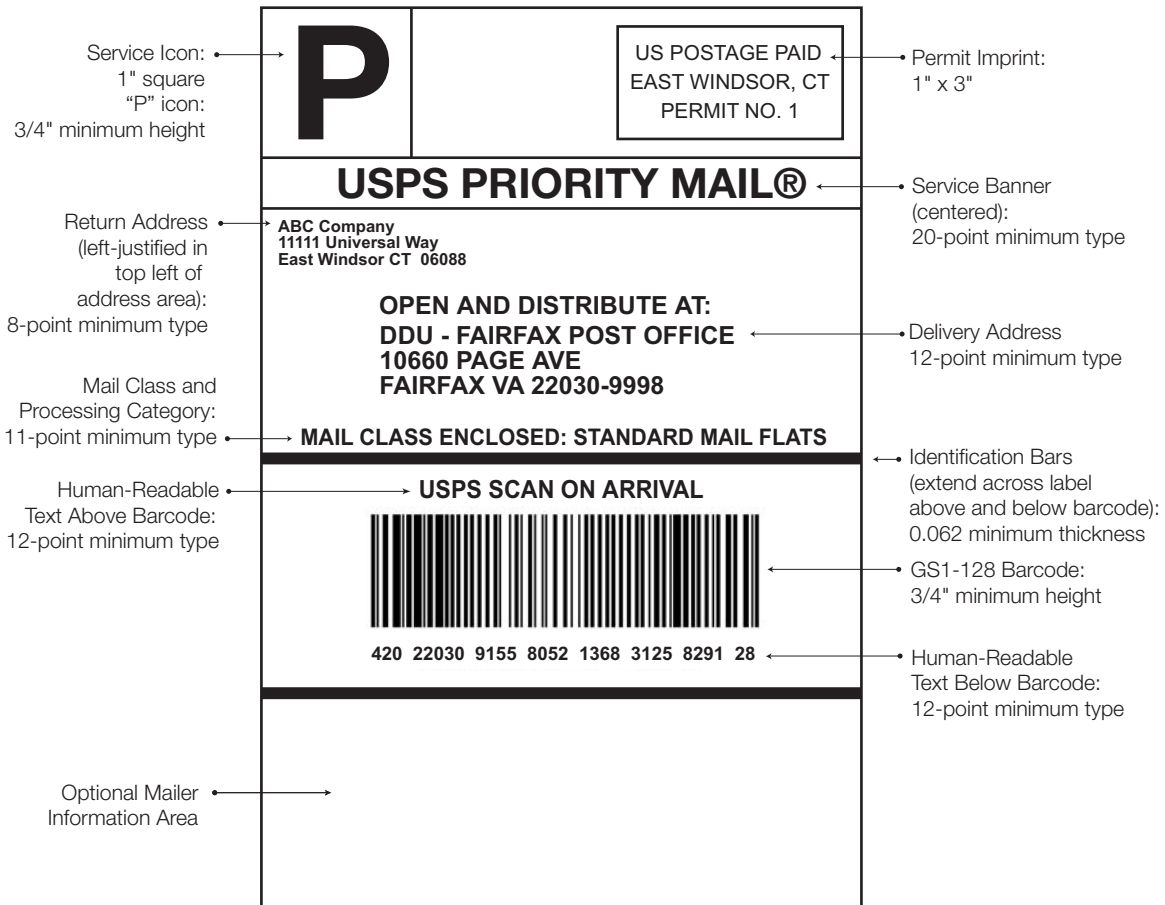

Label:
4" x 6"

705.16.5.9

16.5.9 SCF Address Labels

[7-3-08] For the SCF address label, use SCF followed by the city, state, and ZIP Code found in the Drop Entry Point View File available at USPS' FAST Web site: <https://fast.usps.com>. Directly below the SCF facility name, indicate the class and processing category of the enclosed mail. See Exhibit 16.5.9 for an example of an SCF address label.

Exhibit 16.5.9 SCF Address Label

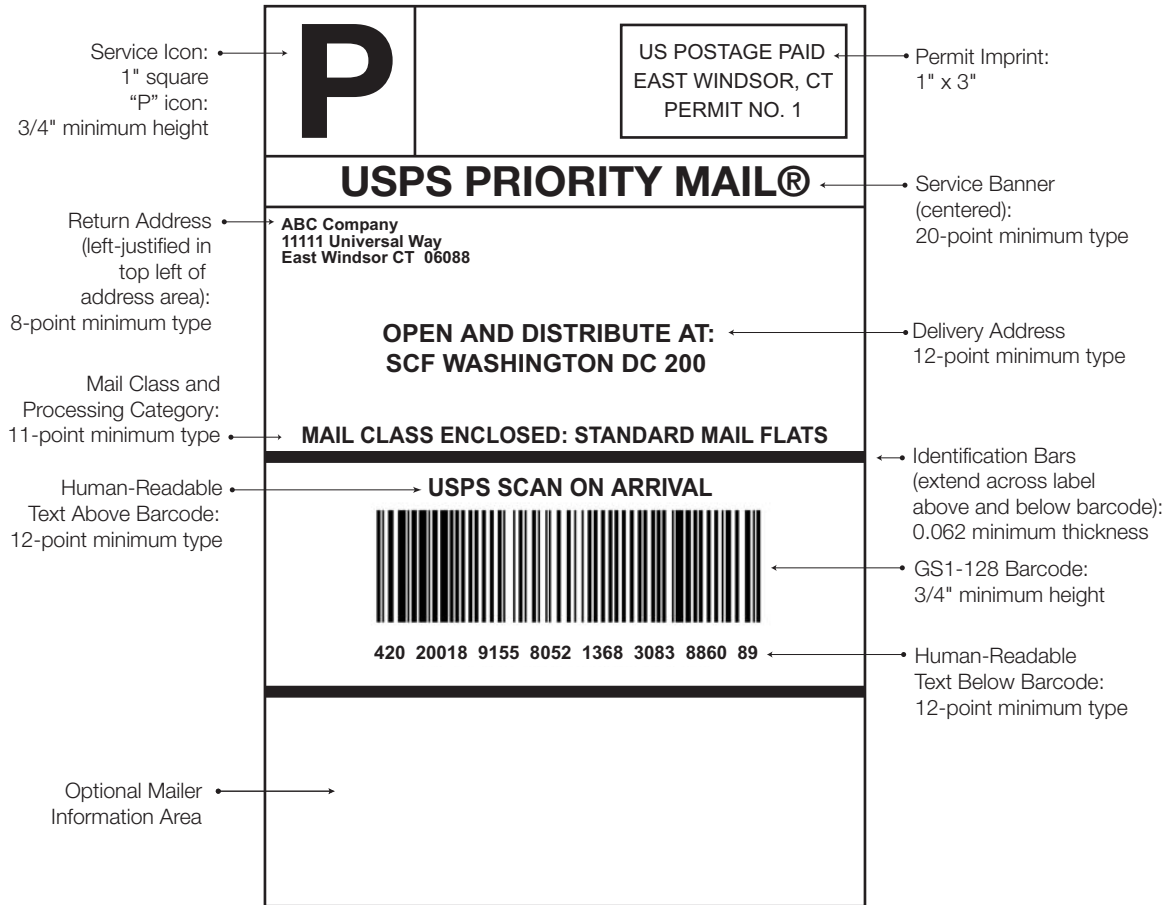

Label:
4" x 6"

16.5.10 ADC Address Labels

[7-3-08] For the ADC address label, use ADC followed by the city, state, and ZIP Code found in the Drop Entry Point View File available at USPS' FAST Web site: <https://fast.usps.com>. Directly below the ADC facility name, indicate the class and processing category of the enclosed mail. See Exhibit 16.5.10 for an example of an ADC address label.

Exhibit 16.5.10 ADC Address Label

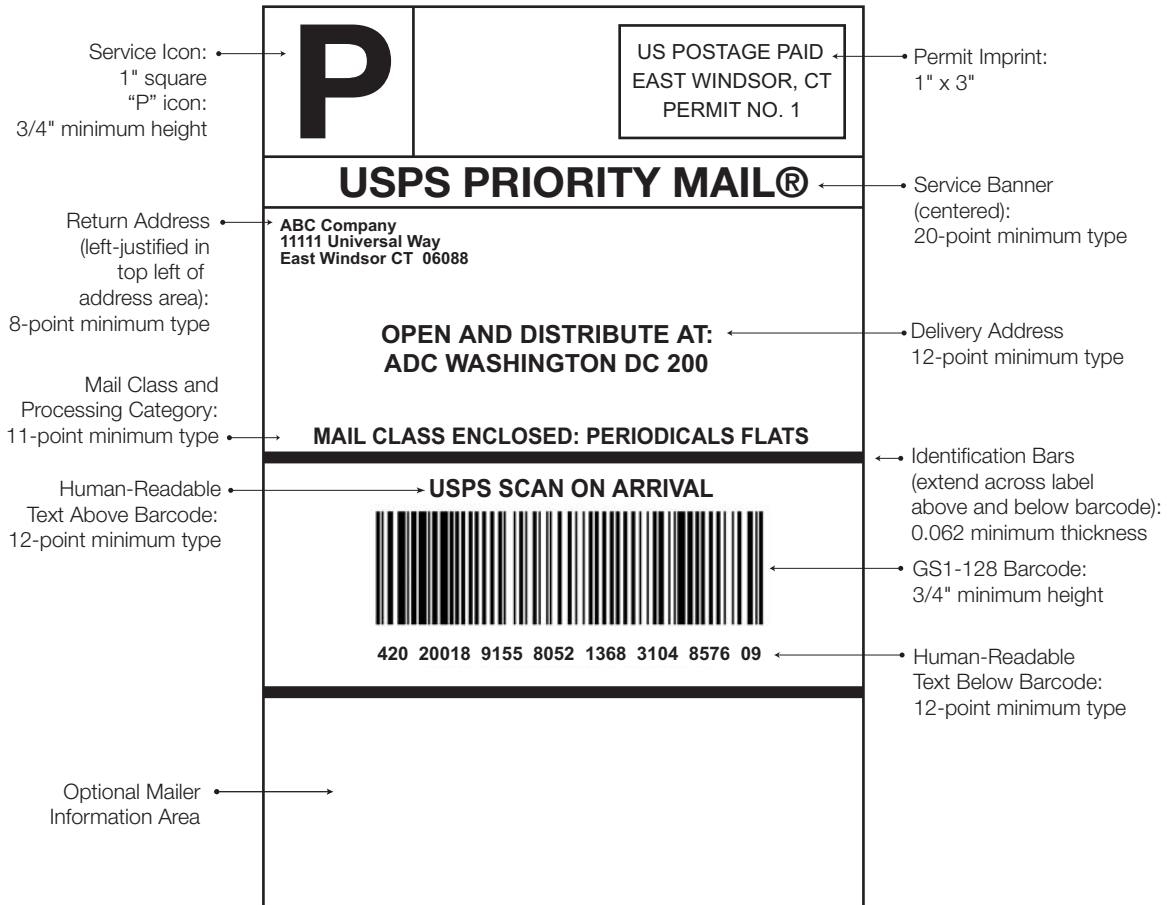

Label:
4" x 6"

705.16.5.11

16.5.11 BMC Address Labels

[7-3-08] For the BMC address label, use BMC followed by the city, state, and ZIP Code found in the Drop Entry Point View File available at USPS' FAST Web site: <https://fast.usps.com>. Directly below the facility name, indicate the class and processing category of the enclosed mail. See Exhibit 16.5.11 for an example of a BMC address label.

Exhibit 16.5.11 BMC Address Label

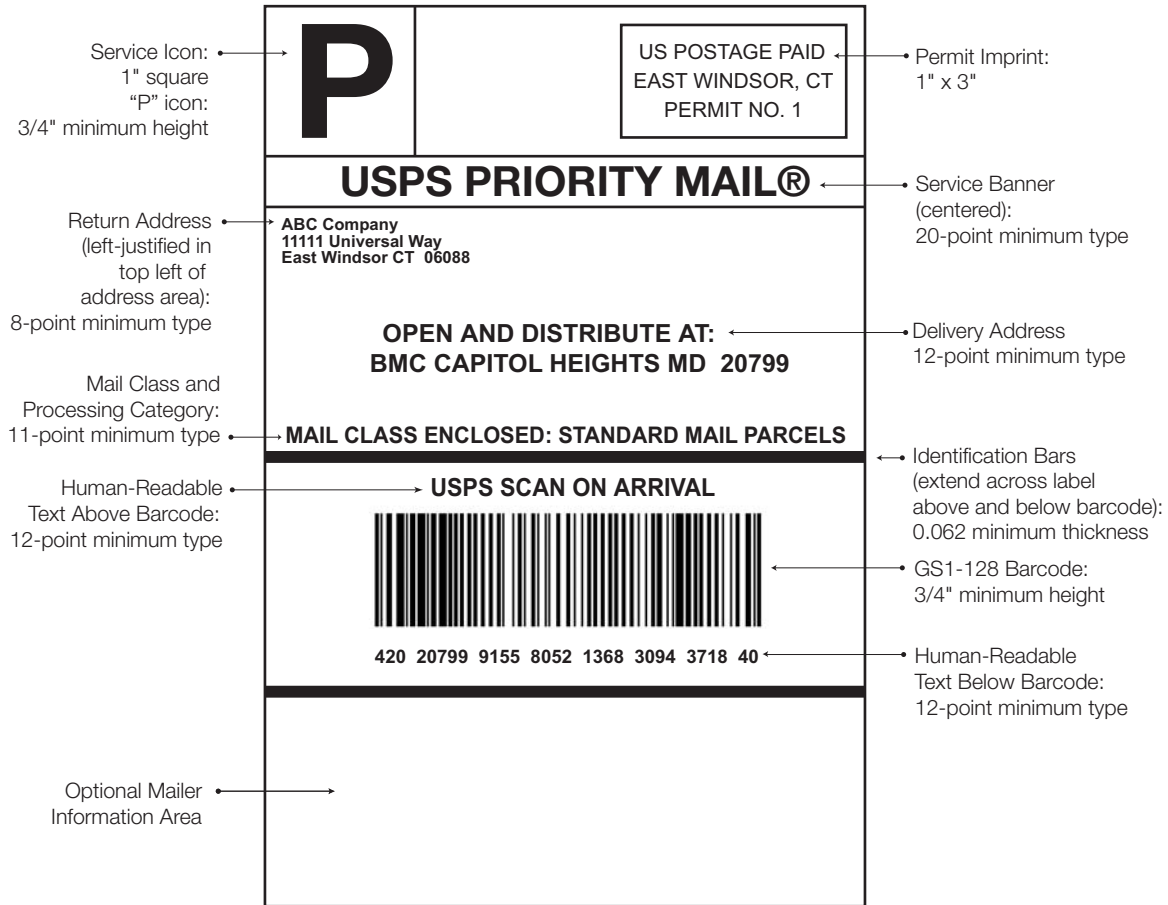

Label:
4" x 6"

16.5.12 ASF Address Labels

[7-3-08] For the ASF address label, use ASF followed by the city, state, and ZIP Code found in the Drop Entry Point View File under BMC available at USPS' FAST Web site: <https://fast.usps.com>. Directly below the address, indicate the class and processing category of the enclosed mail. See Exhibit 16.5.12, *ASF Address Label* for an example of an ASF address label.

Exhibit 16.5.12 ASF Address Label

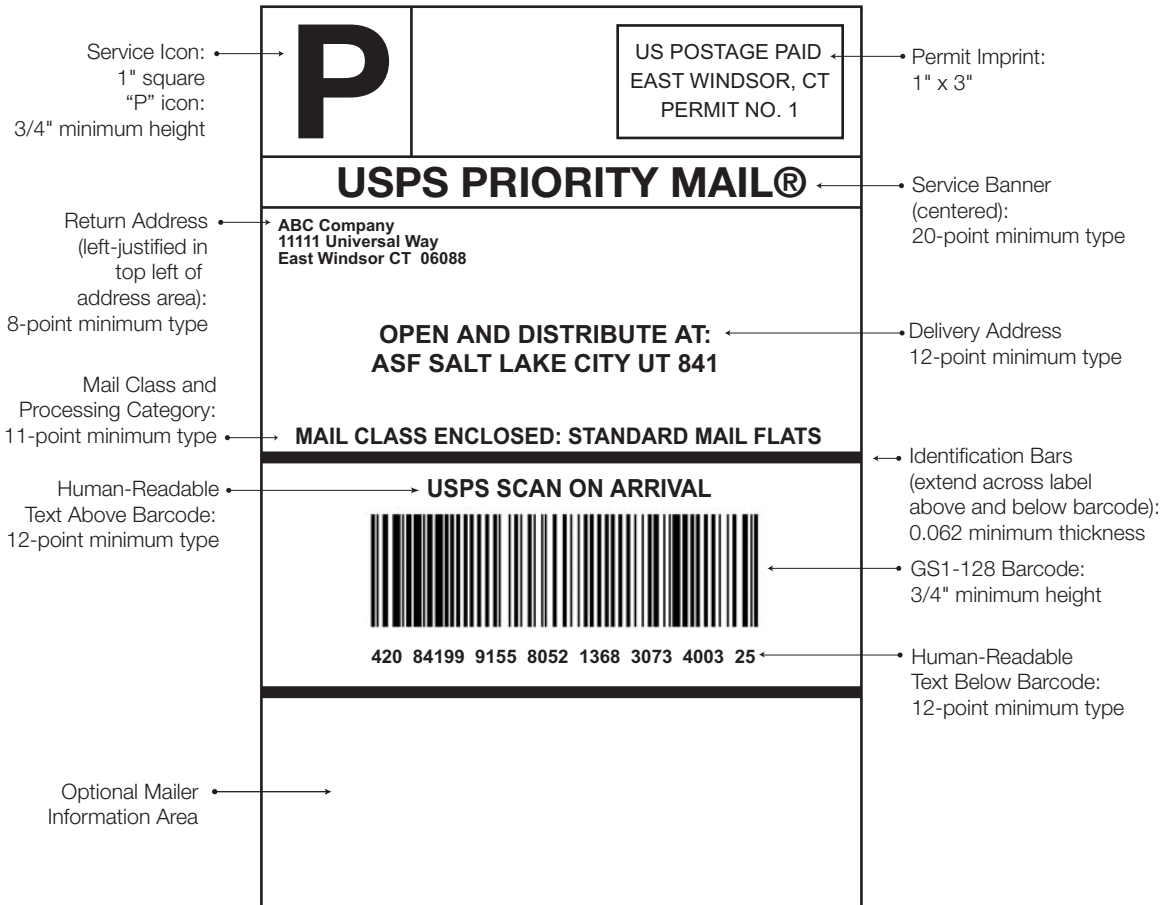

Label:
4" x 6"

705.16.5.13

16.5.13 Markings on Enclosed Mail

The enclosed mail may show one of the optional markings below. The optional marking must be placed directly below or to the left of the postage area. The optional marking may appear in any type font. When an optional marking is used, the type size of the required price marking (see 202 for letters, 302 for flats, or 402 for parcels) must be at least 8 points.

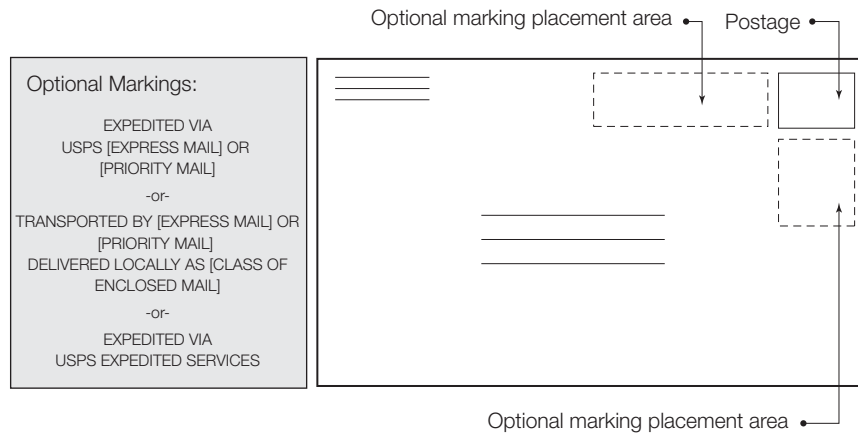
**16.6 Enter and Deposit****16.6.1 Verification and Entry**

Mailers must prepare Express Mail Open and Distribute and Priority Mail Open and Distribute shipments under 16.2 and 16.5 and present shipments at a business mail entry unit (BMEU) or other location designated by the postmaster to accept both the enclosed mail and when applicable, Express Mail. Mailers must present shipments to the BMEU with enough time for acceptance, processing, and dispatch, before the facility's critical entry time for Express Mail or Priority Mail.

17.0 Express Mail Reshipment Service**17.1 Basic Information****17.1.1 General**

The USPS gathers mail addressed to Post Office boxes or business street addresses and dispatches it as a Custom Designed or Next Day Service shipment under a service agreement (PS Form 5637) between the USPS and the mailer, subject to these standards:

- a. Service frequency is scheduled.
- b. The mailer is charged a Pickup on Demand fee each time mail is collected for reshipment from a Post Office no matter how many Post Office boxes or business street addresses the mailer may have at that office.

- c. Express Mail postage and fees are paid by Express Mail Corporate Account or federal agency “Postage and Fees Paid” indicia. The sack or container and its contents are considered a single piece for calculation of the Express Mail price of postage and must not exceed 70 lbs.
- d. The mailer must keep a postage-due, merchandise return service, or business reply mail account at the postal facility where the Post Office box or business street address is located for any shortpaid, merchandise return service, or business reply mail. The service agreement (PS Form 5637) must state that such an account exists.
- e. Express Mail reshipment service is not available for Registered Mail, Certified Mail, COD, insured, or Express Mail items. The mailer must give instructions for redirecting such items on PS Form 1093, Application for Post Office Box or Caller Service, for mail originally addressed to Post Office boxes, or on PS Form 5637 for mail originally addressed to business street addresses.
- f. The service agreement must list the Business Development Team at the originating office as the “Firm Representative” and show the pickup time is when the USPS employee gathers the mail and prepares it for dispatch as Express Mail.
- g. Commencement and termination of service agreements are subject to the standards for Express Mail Custom Designed Service.

18.0 Metered Mail Drop Shipment

18.1 Basic Information

18.1.1 General

A customer may affix postage using a postage meter (postage evidencing system) licensed at one Post Office (licensing Post Office) and deposit that mail at another Post Office (entry Post Office) only if prior authorization is obtained from the USPS under one of the procedures described below. Such authorization may be revoked under [18.2.6](#) when the USPS determines that information or circumstances supporting the original authorization may no longer be accurate, complete, or applicable. ([604.4.0](#) provides an exception to this standard for metered Express Mail, Priority Mail, and single-piece price metered mail.) These general conditions apply:

- a. The meter stamp or indicium must show the name of the licensing Post Office.
- b. Metered mailpieces that bear meter impressions or other endorsements containing the wrong Post Office name, authorization number (as applicable), or other required information are not accepted.
- c. A metered mail drop shipment must be deposited at the time and place and under any additional condition specified by the USPS.
- d. Annual mailing fees, as applicable for the class of mail, must be paid at the office(s) where mailings will be entered, as required under [233.3.4](#) or [243.3.4](#).

705.18.1.2

18.1.2 Effect on Service

The USPS assumes no responsibility for the material presented until it is accepted into the mail. The USPS is not responsible for service delays when the mailer does not meet the applicable preparation or entry requirements. Entry of mail by drop shipment may adversely affect the USPS's ability to achieve the applicable service objectives.

18.1.3 Changes

A mailer authorized to drop ship metered mail must inform the approving official of all changes to the information originally provided as part of the application. When the USPS asks, the mailer must submit additional information supporting that authorization. Failure to provide this information is grounds to revoke the authorization.

18.2 Authorization**18.2.1 Options 1 & 2**

Authorizations under Options 1 and 2 in [18.3, Option 1: Deposit at P&DC/F](#), and [18.4, Option 2: Deposit at Another Post Office](#), are granted to meter license holders. The meter license holder must apply in writing to the district manager of business mail entry whose district includes the licensing Post Office of the meter holder.

18.2.2 Options 3 & 4

Authorization under Option 3 in [18.5, Option 3: Consolidated Drop Shipment With Endorsement](#), is granted to mailers intending to present mail for other meter license holders (including their own mail, if applicable) at one location other than the licensing office(s), whereas authorization under Option 4 in [18.6, Option 4: Consolidated Drop Shipment Without Endorsement](#), is granted for mailings presented at more than one location. For authorization under Option 3, the mailer or consolidator must apply in writing to the district manager of business mail entry whose district includes the Post Office(s) where the mailings are verified for presort preparation and payment of postage. Applications under Option 4 must be submitted to the manager, Business Mailer Support.

18.2.3 Application

The application must describe the classes of mail to be deposited and the volume, processing category, frequency of mailing, and requested deposit schedule of each. The application must also state how the mail to be entered meets applicable eligibility and service standards and must identify any third party preparing and presenting the mail. The application must be prepared on the mailer's letterhead and signed by an authorized manager or representative. There is no USPS form for this purpose. Additional information is required for Options 3 and 4. Mailers seeking authorization under Option 4 must contact Business Mailer Support, USPS Headquarters, for guidance (see [608.8.0](#) for address).

18.2.4 Notification

The manager of business mail entry (or the manager, Business Mailer Support under Option 4) notifies the applicant in writing of approval or conditions of approval, including the drop shipment (DS) authorization number, or denial.

18.2.5 Application Denial

A decision denying an application for operational reasons may be appealed within 15 days of its receipt to the area manager of processing and distribution. If denied because of noncompliance with applicable eligibility standards, the applicant may appeal the denial under [607.2.0](#).

18.2.6 Revocation

An authorization may be revoked:

- a. When it is determined that the authorized entry no longer reduces postal handling or improves service, or is not in the best interests of the USPS.
- b. For nonuse during any consecutive 12 months.
- c. When used in operating any unlawful scheme or enterprise, or for any noncompliance with the regulations governing the use of postage meters.

18.2.7 USPS Authorities

Authorization is revoked by:

- a. The manager of business mail entry of the district originally issuing authorization or the manager, Business Mailer Support.
- b. The postmaster of the licensing Post Office (under any option) when it is used in operating any unlawful scheme or enterprise, or for any noncompliance with the regulations for postage meters.

18.2.8 Nonuse

If revocation is for nonuse, and the mailer shows that use is to resume within 90 days after the revocation notice, revocation may be deferred for a period not to exceed 90 days from the date of the original revocation notice.

18.2.9 Appeal

Written appeal of the revocation notice may be made within 15 days of its receipt, under [607.2.0](#).

18.3 Option 1: Deposit at P&DC/F

Metered mail of any class may be entered and deposited by the licensed meter holder or an agent at the local processing and distribution center/facility (P&DC/F) making the initial originating distribution of mail deposited at the Post Office where the meter license is held. Mail must be prepared under the standards for the class and price claimed and as specified in the drop shipment authorization. The mailer may be required to prepare and deposit the mail in an additional manner that best enhances postal handling as specified in the drop shipment authorization. Any such requirements are modified to reflect changes in the mailings subsequently presented by the mailer. Failure to meet these standards may lead to revocation of the authorization.

18.4 Option 2: Deposit at Another Post Office**18.4.1 Eligibility**

Metered mail of any class may be entered and deposited by the licensed meter holder or an agent at a Post Office other than the licensing Post Office or P&DC/F serving the licensing Post Office. Mail must be prepared under the standards for the

class and price claimed and as specified in the drop shipment authorization. The mailer may be required to perform additional preparation and meet specific deposit schedules to enhance postal handling. Any such requirements are specified in the drop shipment authorization and may be modified to reflect changes in the mailings subsequently presented by the mailer. Failure to meet these standards may lead to revocation of the authorization.

18.4.2 Endorsement

Each mailpiece deposited under this option must contain an endorsement with the city and state of the entry Post Office, the words “Drop Shipment Authorization” (or the abbreviation “D/S AUTH”), and the unique authorization number issued by the district manager of business mail entry serving the entry Post Office. If the abbreviation “D/S AUTH” is not used, the mailing office ZIP Code may be used instead of the city and state of mailing. The endorsement must be included in digital indicia or placed outside the indicium boundary in 8-point or larger type by a computer or mechanical method providing a clear and legible impression. For letter press indicia, the endorsement must appear in the ad plate area. The application and the endorsement format must be approved by the district manager of business mail entry before mail is deposited under this option.

EXAMPLES

Full Endorsement – Mailing Office City and State

MAILED AT CHICAGO IL	DROP SHIPMENT
DROP SHIPMENT	AUTHORIZATION 48
AUTHORIZATION 12	MAILED AT YAKIMA
	WA

Full Endorsement – Mailing Office ZIP Code

MAILED AT 606	DROP SHIPMENT
DROP SHIPMENT	AUTHORIZATION 48
AUTHORIZATION 12	MAILED AT 98901

Abbreviated Format

CHICAGO IL	D/S AUTH 48
D/S AUTH 12	YAKIMA WA

18.4.3 Not Valid

Drop shipment endorsements authorized before March 19, 1989, are no longer valid.

18.4.4 Price and Class Marking

The drop shipment endorsement placed in the ad plate area or within the indicium boundary may include the marking required by the standards for the price claimed if that marking is placed directly below the drop ship endorsement and meets the standards in 202 for letters, 302 for flats, and 402 for parcels. The marking may also be provided separately directly below the indicium boundary if the marking meets the relevant size and legibility standards.

18.5 Option 3: Consolidated Drop Shipment With Endorsement

18.5.1 General

A mailer presenting a consolidated mailing may apply to collect metered mail bearing postage from meters licensed at different Post Offices and present such mailings at one Post Office, subject to the conditions and limitations in 18.5. All conditions for presenting presort mailings must be met as applicable for the class of mail. All applicable conditions under 604.9.4, *Value Added Refunds*, and 5.0, *First-Class Mail or Standard Mail Mailings With Different Payment Methods*, must also be met.

18.5.2 Barcoded and Nonbarcoded Portions

The majority of the mail consolidated for entry under Option 3 must be prepared in a single mailing (with a single postage statement) in which all pieces, regardless of price claimed, have the correct barcode (ZIP+4 for flats, delivery point for letters and cards) and are physically compatible with automated mail processing equipment. The entry Post Office may reject a mailing if all pieces do not have the correct barcode. A minor portion of the consolidated mail may be prepared as a second, separate mailing (with its own postage statement) in which the pieces do not bear the correct barcode (or are not compatible with automated processing equipment) but do meet the standards that apply to the prices claimed.

18.5.3 Service Objective

When a mailpiece is part of a consolidated mailing, the service objective that applies must be the same as or better than that which would have applied had the piece been entered at the licensing Post Office. As part of the application, documentation must be provided by the mailer to show compliance with this standard to USPS satisfaction. (Typical documentation lists the service objective that applies to each licensing Post Office from whose area mail is to be consolidated and the standard that applies to that mail when it is entered under Option 3.)

18.5.4 Information

An application under Option 3 must be submitted by the mailer (i.e., the party to present the consolidated mailing to the USPS). In addition to the information detailed in 18.2.3, the application must identify the meter licensees whose mail is to be consolidated and the serial numbers of each licensee's meters.

18.5.5 Notice to Licensees

After receiving an authorization notice, the mailer must give written notice to each licensee whose mail is to be consolidated under the authorization. The mailer's notice must include a copy of the authorization, a full explanation of preparation requirements, and a reminder that consolidation of their mail can adversely affect service. The mailer must give copies of each licensee notice to the entry office and licensing office postmasters.

18.5.6 Additional Standards

Metered mail deposited under Option 3 must be prepared as specified by the USPS. This preparation may extend beyond that which is required to qualify for the price paid for the mail, and may require the mail to be configured and its deposit scheduled to enhance USPS handling. Failure to meet these standards can lead to revocation of the authorization.

18.5.7 Endorsement

Each mailpiece deposited under this option must be endorsed with the letters “DS,” followed by a unique drop shipment authorization number (issued by the manager of business mail entry of the district in which the mail is entered) and the words “MAILED AT,” followed by the 3-digit ZIP Code prefix of the entry Post Office. The endorsement may also include the correct mailing date. (Including this date does not relieve the meter licensee(s) from meeting the standards for correct dating of metered mail.) The endorsement must be printed immediately below the meter stamp or indicium or in the lower left corner of the mailpiece, in 8-point or larger type, by a computer or another mechanical method providing a clear and legible endorsement. The district manager of business mail entry issuing the authorization number must approve the endorsement before drop shipment mailings may be made under this option.

EXAMPLES

DS12 MAILED AT 606 – 04/01/04

MAILED AT 606 DS12 – 04/01/04

DS48 MAILED AT 981

MAILED AT 981 DS48

18.5.8 Placement

The drop shipment endorsement must not interfere with the barcode clear zone or any other marking.

18.5.9 Preparation

The preparation and documentation standards that apply to the prices claimed in the mailing remain unaffected by entry under Option 3.

18.5.10 Consolidation

Mail collected from licensees for mailing under Option 3 may not be further collected or consolidated by any other mailer or consolidator.

18.6 Option 4: Consolidated Drop Shipment Without Endorsement**18.6.1 General**

A mailer presenting a consolidated mailing may apply to collect metered mail bearing postage from meters licensed at different Post Offices and consolidate that mail for mailing (entry and deposit) at other entry Post Offices, subject to the conditions and limitations in [18.6](#). All conditions for presenting presort mailings must be met as applicable for the class of mail. All applicable conditions under [604.9.4](#), [Value Added Refunds](#), and [5.0](#), [First-Class Mail or Standard Mail Mailings With Different Payment Methods](#), must also be met.

18.6.2 Barcoded and Nonbarcoded Portions

The majority of the mail consolidated for entry under Option 4 must be prepared in a single mailing (with a single postage statement) in which all pieces, regardless of price claimed, have the correct barcode (ZIP+4 for flats, delivery point for letters and cards) and are physically compatible with automated mail processing equipment. The entry Post Office may reject a mailing if all pieces do not have the correct barcode. A minor portion of the consolidated mail may be prepared as a second,

separate mailing (with its own postage statement) in which the pieces do not bear the correct barcode (or are not compatible with automated processing equipment) but do meet the standards that apply to the prices claimed.

18.6.3 Service Objective

When a mailpiece is part of a consolidated mailing, the service objective that applies must be the same as or better than that which would have applied had the piece been entered at the licensing Post Office. As part of the application, documentation must be provided by the mailer to show compliance with this standard to USPS satisfaction. (Typical documentation lists the service objective that applies to each pair of origin/destination 3-digit ZIP Codes in the consolidated mailing, both if entered at the licensing Post Office and if entered as authorized under Option 4.)

18.6.4 Information

An application under Option 4 must be submitted by the mailer (i.e., the party to present the consolidated mailing to the USPS). The information in [18.2, Authorization](#), must be provided for each Post Office at which mail is to be entered under Option 4. The application must also detail: the meter licensees whose mail is to be consolidated and the serial numbers of each licensee's meters; the mailer's method of sortation, documentation, and quality control; and the mailer's procedures for ensuring that all pieces in the consolidated mailing are entered to meet or exceed the service objectives for the place of origin.

18.6.5 Notice to Licensees

After receiving the authorization notice, the mailer must give written notice to each licensee whose mail is to be consolidated under the authorization. The mailer's notice must include a copy of the authorization, a full explanation of preparation requirements, and a reminder that consolidation of their mail can adversely affect service. The mailer must give copies of each licensee notice to the entry office and licensing office postmasters.

18.6.6 Additional Standards

Metered mail deposited under Option 4 must be prepared in segments for entry at postal facilities according to schemes and schedules provided by the USPS. Further, each segment must be prepared for dispatch without additional postal processing or handling, and deposited at places and times specified by the USPS. The USPS may stipulate preparation beyond that required to qualify for the price paid for the mail. Failure to meet these standards can lead to revocation of the authorization.

18.6.7 Transportation

The mailer must provide transportation for the consolidated mailing, unless the USPS provides plant load service.

18.6.8 Endorsement

A drop shipment endorsement is not required on pieces mailed under Option 4.

18.6.9 Preparation

The preparation and documentation standards that apply to the prices claimed in the mailing remain unaffected by entry under Option 4.

705.18.6.10

18.6.10 Consolidation

Mail collected from licensees for mailing under Option 4 may not be further collected or consolidated by any other mailer or consolidator.

18.6.11 Documentation

The mailer/consolidator must keep documentation supporting each consolidated mailing, including the volume collected from each meter licensee, for at least 1 year from the date of mailing, and make it available for postal inspection on request.

19.0 Postage Due Weight Averaging Program**19.1 Basic Information****19.1.1 Description**

The Postage Due Weight Averaging (PDWA) program is a comprehensive, statistically valid program to calculate postage due returns in bulk, rather than rating each individual piece. This program, subject to application, approval, and service agreement, is available for customers who receive a minimum of 50,000 combined postage due parcels and flats, Merchandise Return Service (MRS), or Bulk Parcel Return Service (BPRS) pieces. The PDWA program applies a postage due cost factor, generated through a 4-week rolling average sampling period, to assess postage and fees based upon the net weight of each container. A new postage due cost factor is calculated and applied weekly, based on the previous 4 weeks of sampling data. The 4-week rolling average is not applicable if a new PDWA system is implemented or if there is a postage price change. When these circumstances occur, the new postage due cost factor is determined through the sampling in the first week. That new postage due cost factor is then applied in the first 2 weeks. After the fourth week of sampling, the postage due cost factor is a complete 4-week rolling average. PDWA is designed to significantly reduce processing time and provide for shorter verification time for customers.

19.1.2 General Qualification

A PDWA program may be authorized for applicants who receive a minimum of 50,000 combined returns per year. Returns can include all classes of mail where postage due fees are assessed, including MRS and BPRS return pieces. Only parcels and flats may be processed through the PDWA program. See [19.2](#) for application process.

19.1.3 Quality Control

PDWA customers may elect to establish and conduct a quality control program to ensure that all missorted and accountable mail (including certified, collect on delivery (COD), return receipt for merchandise, Delivery Confirmation service, and Signature Confirmation services pieces) is identified and returned to the servicing Post Office prior to being opened. The program must include:

- a. Training all employees who process returns on how to identify accountable items.
- b. Permanently displaying examples of accountable return items in full view of employees responsible for the identification of accountable returns.

- c. Instructional material pertaining to identifying accountable returns.
- d. The random selection and tracking of individual sample pieces within the customer's operational process to assure that they are identified.

If the customer elects to not implement a quality control program, the customer must assume all responsibility for claims filed by clients who returned their product to them via accountable mail.

19.1.4 Service Agreement

A service agreement must be signed by the customer and agent, the postmaster, plant manager, district manager, marketing manager, and Business Mailer Support manager. The service agreement must specify, among other things, the customer's quality control procedures and procedures for handling missorted and accountable mail.

19.2 Authorization

19.2.1 Application

The customer or agent must submit a PDWA application to the postmaster of the office through which delivery service is provided. The customer must provide information including current permits, authorizations, and average volume figures. The postmaster will provide input regarding staffing, hours of operation, standard operating procedures, and recommendations or comments for approval.

19.2.2 Approval

The Business Mailer Support manager, USPS Headquarters, approves or denies applications for PDWA systems.

19.2.3 Denial

If the PDWA application is not approved, the Business Mailer Support manager will send a written notice to the applicant with the reason for denial.

19.2.4 Authorization Period

Authorization remains in effect until the Business Mailer Support manager or the customer cancels the agreement. If Postal Service periodic reviews or customer-supplied information indicates a need for modification of the authorization, then the authorization will be amended with concurrence of the Business Mailer Support manager and the customer.

19.2.5 USPS Suspension

The Business Mailer Support manager may suspend a PDWA service agreement at any time if the agreement does not provide adequate revenue protection, or the customer (or agent) fails to meet the criteria established by the agreement.

19.2.6 Mailer Cancellation

The customer may cancel a PDWA agreement by writing to the Business Mailer Support manager (see DMM 608.8.0 for address).

705.20.1

20.0 Optional Combined Parcel Mailings

20.1 **Basic Standards for Combining Parcel Select, Package Services, and Standard Mail Parcels**

20.1.1 **Basic Standards**

Package Services parcels, Parcel Select parcels, Standard Mail parcels and Not Flat-Machinables (NFM)s in a combined parcel mailing must meet the following standards:

- a. Each parcel in a combined mailing is subject to the applicable content and price eligibility standards for the price claimed.
- b. Mailers must be authorized under [8.1.4](#).
- c. Mailers must pay all applicable presort mailing and destination entry mailing fees.
- d. Combined mailings must meet the following minimum volume requirements:
 1. Standard Mail—Minimum 200 pieces or 50 pounds of Standard Mail parcels and NFM)s combined.
 2. Package Services and Parcel Select—Minimum 50 parcels of Parcel Post, Parcel Select, Bound Printed Matter, Library Mail, and Media Mail parcels combined.
 3. If claiming Presorted BPM, Media Mail or Library Mail prices—Minimum 300 parcels per subclass.

20.1.2 **Postage Payment**

Mailers must pay postage for all pieces with a permit imprint at the Post Office serving the mailer's plant using an approved Manifest Mailing System (MMS) under [2.0](#). The MMS agreement must include procedures for combined mailings approved by Business Mailer Support. Mailers may document and pay postage using the Electronic Verification System (eVS) under [2.9](#).

20.1.3 **Documentation**

Mailers must prepare separate postage statements for Standard Mail, Parcel Select, and Package Services pieces in the combined mailing. At the time of mailing, mailers must provide all postage statements and a Business Mailer Support-approved manifest prepared according to [2.0](#) and this section. Presort documentation is required as applicable for each price claimed if the manifest does not list pieces in presort order.

20.1.4 **Authorization**

A mailer who wants to present combined parcel mailings must submit a written request to the Manager, Business Mailer Support (See [608.8.1](#) for address). The request must show the mailer's name and address, the mailing office, evidence of authorization to mail under [2.0](#), procedures for the combined parcel mailing, the expected date of first mailing, a sample of the required manifest, and a sample USPS Qualification report. Business Mailer Support will review the documentation and provide written authorization when approved. A mailer may terminate an

authorization at any time by written notice to the postmaster of the office serving the mailer's location. Business Mailer Support may terminate an authorization, by written notice, if the mailer does not meet the standards.

20.2 Price Eligibility

20.2.1 Eligible Prices

Combined parcels may be eligible for Standard Mail, Parcel Post, Parcel Select, single-piece and Presorted Media Mail, single-piece and Presorted Library Mail, single-piece and Presorted Bound Printed Matter, and destination entry prices and discounts as applicable. Inter-BMC Parcel Select may be eligible for BMC presort and OBMC presort discounts.

20.2.2 Price Application

Apply prices based on the criteria in 400 and the following standards:

- a. Standard Mail machinable parcels, irregular parcels and NFM prices are based on the container level and entry. See [443.5.0, Additional Eligibility Standards for Presorted Standard Mail Pieces](#).
- b. Bound Printed Matter parcels qualify for single-piece prices or Presorted Bound Printed Matter prices as follows:
 1. Presorted prices for BPM pieces prepared in other than MXD ADC/MXD BMC containers when there are at least 300 pieces of BPM in the combined mailing.
 2. Single-piece prices for pieces prepared in MXD ADC/MXD BMC containers and when there are less than 300 pieces of BPM in the combined mailing.
 3. Destination entry prices based on entry.
- c. Media Mail parcels qualify for single-piece, basic, or 5-digit prices as follows:
 1. 5-digit prices for pieces prepared in 5-digit/scheme containers when there are at least 300 pieces of Media Mail in the combined mailing.
 2. Basic prices for pieces prepared in 3-digit, ADC, and BMC containers when there are at least 300 pieces of Media Mail in the combined mailing.
 3. Single-piece prices for pieces prepared in MXD ADC/MXD BMC containers and when there are less than 300 pieces of Media Mail in the combined mailing.
- d. Library Mail parcels qualify for single-piece, basic, or 5-digit prices as follows:
 1. 5-digit prices for pieces prepared in 5-digit/scheme containers when there are at least 300 pieces of Library Mail in the combined mailing.
 2. Basic prices for pieces prepared in 3-digit, ADC, and BMC containers when there are at least 300 pieces of Library Mail in the combined mailing.
 3. Single-piece prices for pieces in MXD ADC/MXD BMC containers and when there are less than 300 pieces of Library Mail in the combined mailing.
- e. Parcel Select prices are based on the following:

705.20.3

1. Destination entry for pieces in 5-digit, 3-digit, ADC, or BMC containers.
 2. BMC presort discounts for origin entered (other than a BMC) Parcel Select pieces placed in 5-dig, 3-digit, ADC, or BMC containers.
 3. OBMC presort discounts for origin BMC entered Parcel Select pieces placed in 5-digit, 3-digit, ADC, or BMC containers.
- f. Parcel Post prices are based on Intra-BMC and Inter-BMC prices for pieces placed in MXD ADC/MXD BMC containers.

20.3 Mail Preparation

20.3.1 Basic Standards

Prepare combined mailings as follows:

- a. Different parcel types must be prepared separately for combined parcel mailings as indicated below:
 1. Standard Mail, Parcel Select, and Package Services Machinable Parcels and NFMs 6 ounces or more, or as provided under [401.1.5.2](#) for lightweight machinable parcels. Use “STD/PSVC MACH” for line 2 content labeling.
 2. Standard Mail, Parcel Select, and Package Services Irregular Parcels and NFMs weighing at least 2 ounces and up to, but not including, 6 ounces (APPS-machinable pieces), except for tubes, rolls, triangles, and other similarly irregularly-shaped pieces. Use “STD/PSVC” for line 2 content labeling.
 3. Standard Mail, Parcel Select, and Package Services tubes, rolls, triangles, and similarly irregularly-shaped parcels; and all parcels and NFMs weighing under 2 ounces (not APPS-machinable pieces). Use “STD/PSVC IRREG” for line 2 content labeling.
 4. All parcel types and NFM pieces may be combined in 5-digit and 5-digit scheme containers. Use “STD/PSVC PARCELS” for line 2 content labeling.
- b. Mailers must prepare all parcels in sacks under [445.5.0](#), or on pallets, or in pallet boxes under [8.0](#) to achieve the finest level of sortation.

20.3.2 Combining Standard Mail, Parcel Select, and Package Services Machinable Parcels and NFM 6 Ounces or More

Prepare and enter combined machinable parcels as shown in the table below:

COMBINED PREPARATION			
Entry	5-Digit/Scheme ¹	BMC/ASF (Required)	Mixed BMC (Required)
Origin	Sacks - 15-piece or 30-lb minimum Pallets - 250-lb minimum	Sacks - 10-piece or 20-lb minimum Pallets - 250-lb minimum	Sacks - No minimum Pallets - 250-lb minimum
DBMC	Sacks - 15-piece or 30-lb minimum Pallets - 100-lb minimum	Sacks - 10-piece or 20-lb minimum Pallets - 100-lb minimum	
DSCF	Sacks - 10-piece or 10-lb minimum Pallets - 100-lb minimum		
DDU	Sacks - No minimum Pallets - No minimum		

1. All parcel types may be combined in 5-digit containers to meet minimum volumes.

20.3.3 Combining Standard Mail, Parcel Select, and Package Services Parcels and NFM 2 up to 6 Ounces (APPS-Machinable)

Prepare and enter combined APPS-machinable parcels (pieces weighing at least 2 ounces and up to, but not including, 6 ounces that are not tubes, rolls, triangles or similarly irregularly-shaped parcels) as shown in the table below.

COMBINED PREPARATION				
Entry	5-Digit/Scheme ¹	3-Digit (Required)	ADC (Required)	Mixed ADC (Required)
Origin	Sacks - 15-piece or 30-lb minimum Pallets - 250-lb minimum	Sacks - 10-piece or 20-lb minimum Pallets - 250-lb minimum	Sacks - 10-piece or 20-lb minimum Pallets - 250-lb minimum	Sacks - No minimum Pallets - 250-lb minimum
DBMC	Sacks - 15-piece or 30-lb minimum Pallets - 100-lb minimum	Sacks - 10-piece or 20-lb minimum Pallets - 100-lb minimum	Sacks - 10-piece or 20-lb minimum Pallets - 100-lb minimum	
DSCF	Sacks - 10-piece or 10-lb minimum Pallets - 100-lb minimum	Sacks - 10-piece or 20-lb minimum Pallets - 100-lb minimum		
DDU	Sacks - No minimum Pallets - No minimum			

1. All parcel types may be combined in 5-digit containers to meet minimum volumes.

20.3.4 Combining Standard Mail, Parcel Select, and Package Services Irregular Parcels and NFM under 2 Ounces (Not APPS-Machinable)

Prepare and enter combined not APPS-machinable parcels as shown in the table below.

705.21.1

COMBINED PREPARATION				
Entry	5-Digit/Scheme ¹	3-Digit (Required)	ADC (Required)	Mixed ADC (Required)
Origin	Sacks - 15-piece or 30-lb minimum Pallets - 250-lb minimum	Sacks - 10-piece or 20-lb minimum Pallets - 250-lb minimum	Sacks - 10-piece or 20-lb minimum Pallets - 250-lb minimum	Sacks - No minimum Pallets - 250-lb minimum
DBMC	Sacks - 15-piece or 30-lb minimum Pallets - 100-lb minimum	Sacks - 10-piece or 20-lb minimum Pallets - 100-lb minimum	Sacks - 10-piece or 20-lb minimum Pallets - 100-lb minimum	
DSCF	Sacks - 10-piece or 10-lb minimum Pallets - 100-lb minimum	Sacks - 10-piece or 20-lb minimum Pallets - 100-lb minimum		
DDU	Sacks - No minimum Pallets - No minimum			

1. All parcel types may be combined in 5-digit containers to meet minimum volumes.

21.0 Repositionable Notes (RPNs)

21.1 Use

RPNs must meet all of the following standards:

- RPNs may be attached to letter- and flat-size commercial First-Class Mail, Standard Mail, and Periodicals mailpieces.
- For letter-size mailpieces, attach a single RPN to the address side of the mailpiece as specified in [Exhibit 21.1b](#).

Exhibit 21.1b Placing RPNs on Letters

Repositionable Notes (RPNs) may be placed only within the specified area of the letter.

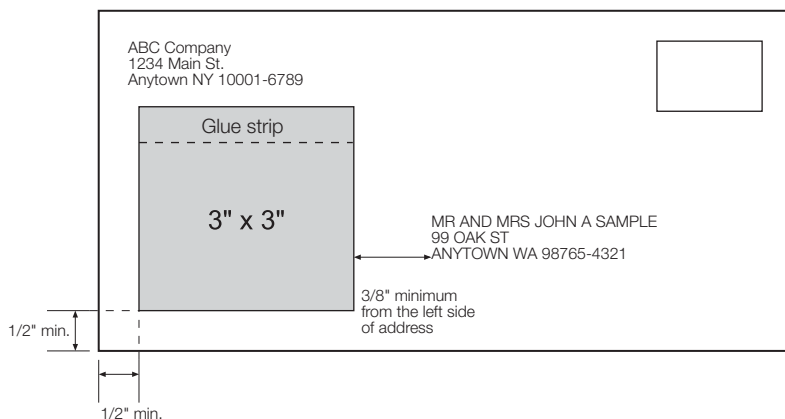

- For flat-size mailpieces, a single RPN may be attached to either the address side or nonaddress side of the mailpiece and attached in the locations described and shown in [Exhibit 21.3g1](#) and [Exhibit 21.3g2](#).
- RPNs are included as an integral part of the mailpiece for weight and postage price computation purposes.

- e. The written and graphic characteristics of the notes are considered when determining eligibility of mailpieces mailed at the Standard Mail and Nonprofit Standard Mail prices.
- f. Attach the RPNs to all pieces in the mailing.

21.2 Mailpiece Characteristics

Each mailpiece must:

- a. Not be in a plastic wrapper (e.g., polybag, polywrap, or shrinkwrap).
- b. Be letter-size (including cards) or flat-size.

21.3 RPN Characteristics

RPNs must:

- a. Measure 3 inches by 3 inches, plus or minus 1/8 inch for either dimension.
- b. Not contain phosphorescent or red fluorescent colorants.
- c. Be adhered with a minimum of 3/4 inch (with a tolerance of 1/16 inch) adhesive strip across the top portion on the reverse side of the note.
- d. Not be placed in a manner that interferes with the delivery address, price markings, or postage and must not display a specific address or ZIP Code. References to general landmarks are permissible.
- e. Not be manually affixed.
- f. On letter-size mailpieces:
 - 1. Position the RPN parallel with the length of the mailpiece.
 - 2. Affix RPNs with labeling equipment to ensure adequate adhesion; do not affix RPNs manually.
 - 3. Place the RPN to the left of the delivery address, no closer than 3/8 inch from the left edge of the delivery address.
 - 4. Place the RPN at least 1/2 inch (with a tolerance of 1/8 inch) from the bottom and left edges of the mailpiece.
- g. On flat-size mailpieces:
 - 1. If the RPN is placed on the address side of the mailpiece, position the RPN according to [Exhibit 21.3g1](#).

Exhibit 21.3g1 Placing RPNs on Flats—Address Side

Repositionable Notes (RPNs) may be placed only within the specified gray areas of the flat.

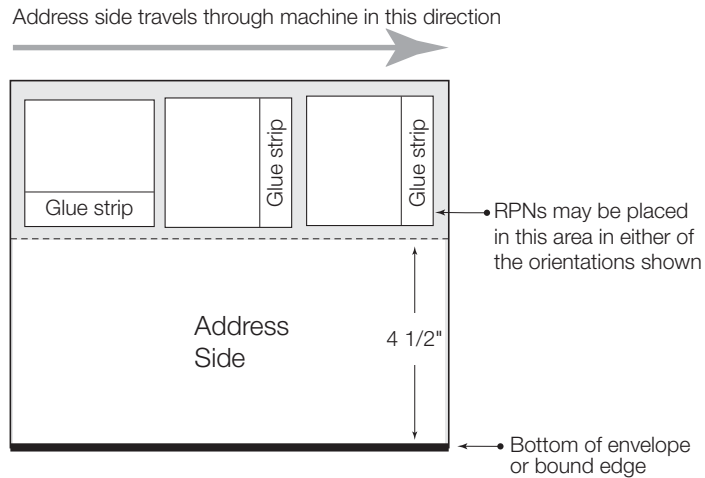

2. If the RPN is placed on the nonaddressed side of the mailpiece, position the RPN according to [Exhibit 21.3g2](#).

Exhibit 21.3g2 Placing RPNs on Flats—Nonaddress Side

Repositionable Notes (RPNs) may be placed only within the specified gray areas of the flat.

**The RPNs marked with a * represent the only allowable positions for RPNs on the non-address side with the glue strip orientation shown.*

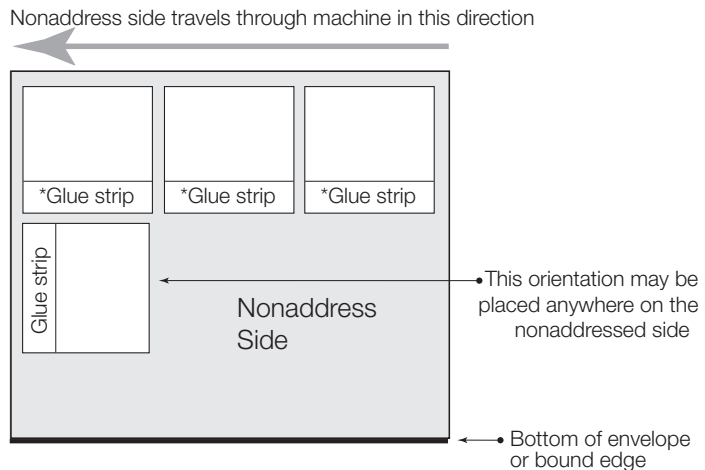

21.4 RPNs on Automation-Price Mailpieces

21.4.1 Letter-Size Mailpieces

Letter-size mailpieces with RPNs claiming automation prices must meet the standards in 1.0 through 3.0, 201.3.0, and the following additional standards:

- a. Each mailpiece must be rectangular and have a surface smoothness of 195 Sheffield Units or smoother.
- b. *Enveloped mailpieces.* Each mailpiece prepared in an envelope must be constructed from paperstock having a basis weight of 20 pounds or greater. Window envelopes must have a closed panel made of polystyrene or glassine. Each enveloped mailpiece is limited to the following dimensions:
 1. For height, no less than 4-1/8 inches and no more than 6 inches high.
 2. For length, no less than 8 inches and no more than 9-1/2 inches long.
 3. For thickness, no less than 0.02 inch and no more than 0.125 inch thick.*Oversize cards.* Each mailpiece prepared as an oversize card is limited to the following dimensions:
 4. For height, no less than 4-1/2 inches and no more than 6 inches high.
 5. For length, no less than 8-1/2 inches and no more than 9 inches long.
 6. For thickness, no less than 0.009 inch thick (cards 5-3/4 inches or more in height must be no less than 0.012 inch thick.)

21.4.2 Flat-Size Mailpieces

Flat-size mailpieces with RPNs claiming automation prices must meet the standards in [1.0](#) through [3.0](#) and [301.3.0](#).

21.5 Prices

Commercial First-Class Mail - \$0.005
Standard Mail and Periodicals - \$0.015

21.6 Compliance

Mailers must comply as follows:

- a. RPNs must be obtained from an approved RPN vendor (see www.usps.com for a listing of approved vendors). Prospective vendors can obtain USPS standards and test procedures from USPS Engineering (see [608.8.0](#) for address). Testing must be performed by a certified independent laboratory.
- b. Mailers must present evidence at the time of mailing to show that their RPNs have been supplied by an approved vendor. The vendor name on the reverse side of the note will be sufficient as evidence; in lieu of the vendor name printed on the notes, an invoice from the approved vendor for purchase of the RPNs will constitute such evidence.
- c. As part of each mailing, mailers must include two pieces addressed to the manager, USPS Engineering Letter Technology, Attn: RPN Sample (see [608.8.0](#) for address).

