



SONY[®]

2-698-598-41(1)

Wireless Stereo Headset

Operating Instructions _____

US

Manual de instrucciones _____

ES



DR-BT10CX

©2006 Sony Corporation

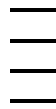



WARNING

To reduce the risk of fire or electric shock, do not expose this apparatus to rain or moisture.

To reduce the risk of electrical shock, do not open the cabinet. Refer servicing to qualified personnel only.

Do not install the appliance in a confined space, such as a bookcase or built-in cabinet.

To reduce the risk of fire, do not cover the ventilation of the apparatus with newspapers, tablecloths, curtains, etc. And do not place lighted candles on the apparatus.

To reduce the risk of fire or electric shock, do not place objects filled with liquids, such as vases, on the apparatus.

Connect the AC power adaptor to an easily accessible AC outlet. Should you notice an abnormality in the AC power adaptor, disconnect it from the AC outlet immediately.

For the customers in the USA

Owner's Record

The model number is located at the side of the unit, and the serial number is located inside the holding clip. Record these numbers in the spaces provided below. Refer to them whenever you call upon your Sony dealer regarding this product.
Model No. DR-BT10CX
Serial No. _____

Information

This device complies with Part 15 of FCC Rules and RSS-Gen of IC Rules. Operation is subject to the following two conditions: (1) this device may not cause interference, and (2) this device must accept any interference, including interference that may cause undesired operation of this device.

You are cautioned that any changes or modifications not expressly approved in this manual could void your authority to operate this equipment.

This equipment must not be co-located or operated in conjunction with any other antenna or transmitter.

This equipment complies with FCC/IC radiation exposure limits set forth for uncontrolled equipment and meets the FCC radio frequency (RF) Exposure Guidelines in Supplement C to OET65 and RSS-102 of the IC radio frequency (RF) Exposure rules. This equipment has very low levels of RF energy that it is deemed to comply without testing of specific absorption ratio (SAR).

The Bluetooth word mark and logos are owned by the Bluetooth SIG, Inc. and any use of such marks by Sony Corporation is under license. Other trademarks and trade names are those of their respective owners.

MPEG Layer-3 audio coding technology and patents licensed from Fraunhofer IIS and Thomson.





For the customers in the USA and Canada

RECYCLING LITHIUM-ION BATTERIES

Lithium-Ion batteries are recyclable. You can help preserve our environment by returning your used rechargeable batteries to the collection and recycling location nearest you.



For more information regarding recycling of rechargeable batteries, call toll free 1-800-822-8837, or visit <http://www.rbrcc.org/>

Caution: Do not handle damaged or leaking Lithium-Ion batteries.

Pour les utilisateurs au Canada Informations

Cet appareil est conforme à la section 15 de la réglementation FCC ainsi qu'à la RSS-Gen de la réglementation IC. Son utilisation est autorisée seulement aux conditions suivantes : (1) il ne doit pas produire de brouillage et (2) l'utilisateur du dispositif doit être prêt à accepter tout brouillage radioélectrique reçu, même si ce brouillage est susceptible de compromettre le fonctionnement du dispositif.

Vous devez savoir que tout changement ou toute modification non expressément approuvé dans ce mode d'emploi risque d'annuler votre pouvoir d'utiliser cet appareil.

Cet émetteur est conforme aux limitations concernant l'exposition aux radiations établies par la FCC/IC définies dans un environnement non contrôlé ainsi qu'aux directives relatives à l'exposition aux fréquences radio (RF) FCC du supplément C du bulletin OET65 et au règlement RSS-102 relatif à l'exposition aux radiofréquences (RF) IC. Cet équipement présente des niveaux d'énergie RF très bas considérés comme conformes et ne nécessite pas de test du débit d'absorption spécifique (SAR).



Table Of Contents

Welcome! 4
 3 steps to BLUETOOTH function 5

Location and Function of Parts 6

Charging the unit 7

Pairing 9
 What is pairing? 9
 Procedures of pairing 9

Wearing the headset 11

Indications of BLUETOOTH function .. 12

Listening to music 13

Calling 15
 Controlling the BLUETOOTH mobile phone – HFP, HSP .. 17

Calling while playing back music 18

Disposing of the unit 19

Precautions 20

What is BLUETOOTH technology? 22

Troubleshooting 23

Initializing the unit 24

Specifications 25

US





Welcome!

Thank you for purchasing this Sony Wireless Stereo Headset. This unit uses BLUETOOTH™ wireless technology.

- You can enjoy music from your BLUETOOTH device capable of transmitting music.
- You can enjoy hands-free talking with your BLUETOOTH mobile phone inside your bag.
- You can charge the unit using the supplied battery charging stand.

For details on BLUETOOTH technology, see page 22.

Talking on the phone Enjoy listening to music

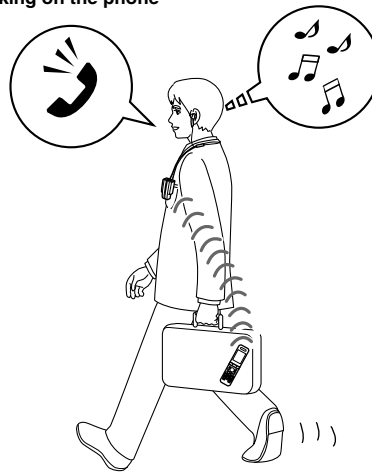

4

US





3 steps to BLUETOOTH function

Pairing (each device)

First, register ("pair") a BLUETOOTH device (mobile phone, etc.) and this unit with each other. Once pairing is established, there is no need for pairing again.

BLUETOOTH mobile phone, etc.

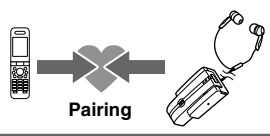

Wireless Stereo Headset

→ Page 9

Listening to music

Calling

BLUETOOTH connection

Operate the BLUETOOTH device to make BLUETOOTH connection.

Connection

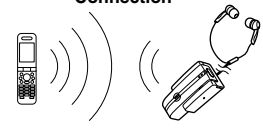

A2DP

→ Page 13

BLUETOOTH connection

When the unit is turned on, the unit starts making the BLUETOOTH connection to the recognized mobile phone automatically.

Connection

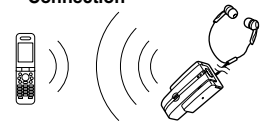

HFP

HSP

→ Page 15

Listening to music

You can listen to music played on the BLUETOOTH device.

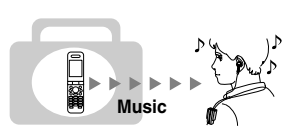

→ Page 13 - 14

Talking on the phone

You can make and receive a call by operating unit.

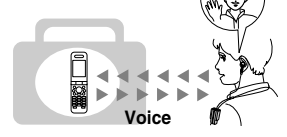

→ Page 16 - 17

5

US

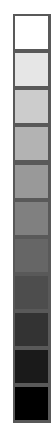

GETTING STARTED

Location and Function of Parts

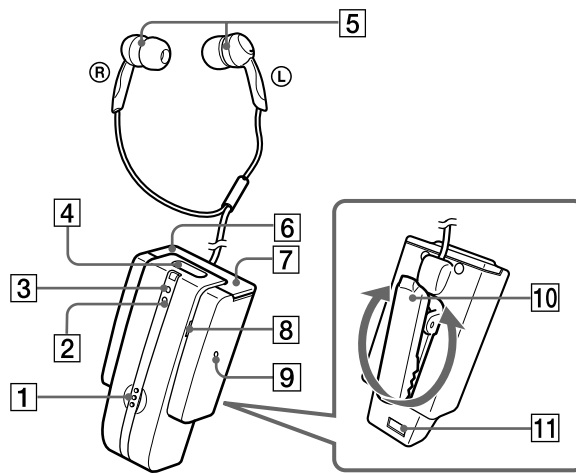

1 Multi function button
Controls various call functions.

2 Indicator (red)
Indicates the power status of the unit.

3 Indicator (blue)
Indicates the communication status of the unit.

4 POWER button

5 Earpieces

6 VOL - button

7 VOL + button

8 Microphone

9 RESET button

10 Holding clip

Adjust the holding clip to the desired angle and clip to your pocket or collar.

11 Contact point

6

US



Charging the unit

The unit contains a rechargeable Lithium-Ion battery, which should be charged before using for the first time.

1 Connect the supplied AC power adaptor with the battery charging stand.

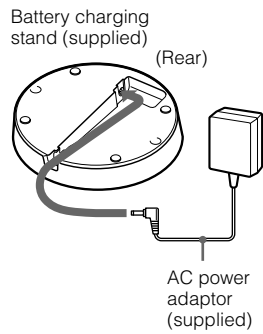

3 Put the unit on the battery charging stand.

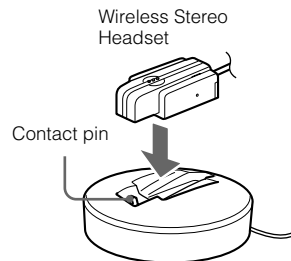

Note
If the holding clip is turned, the unit cannot be set on the battery charging stand and charging does not start. Turn the holding clip back to the original position before charging.

2 Connect the supplied AC power adaptor to an AC outlet.

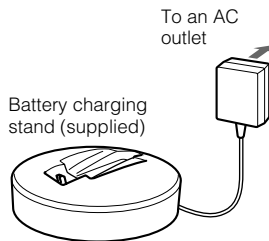

Rest the unit on the battery charging stand so that the unit's contact point meets the contact pin on the battery charging stand, and make sure that the indicator (red) lights up.

Charging is completed in about 3 hours* and the indicator (red) goes off automatically.

* Time required for empty battery to recharge.

Tip
When charging the battery, the unit is turned off automatically.

Continued 7

US





Caution

If this unit detects a problem while charging, the indicator (red) may turn off, although charging is not complete.

Check for the following causes:

- Ambient temperature exceeds the range of 0 °C – 40 °C (32 °F – 104 °F).
- There is a problem with the battery.

In this case, charge again within the above-mentioned temperature range. If the problem persists, consult your nearest Sony dealer.

Notes

- If the battery is not used for a long time, battery may be quickly depleted, however, after a few recharges, battery life will improve.
- If the life of the built-in rechargeable battery drops to half the normal length, the battery should be replaced. Consult your nearest Sony dealer for replacement of the rechargeable battery.
- Avoid exposure to temperature extremes, direct sunlight, moisture, sand, dust or mechanical shock. Never leave in a car parked in the sun.
- Use only the supplied AC power adaptor. Do not use any other AC power adaptor.

Usage hours*

Status	Approx. usage hours
Communication time (including music playback time) (up to)	11 hours
Standby time (up to)	100 hours

* Time stated above may vary, depending on ambient temperature or conditions of use.

Checking the remaining battery

When pressing the POWER button while the unit is turned on, the indicator (red) flashes. You can check the remaining battery by the number of times the indicator (red) flashes.

Indicator (red)	Status
3 times	Full
2 times	Mid
1 time	Low (needs to charge)

Note

You cannot check the remaining battery immediately after the unit is turned on, or while pairing.

When the battery is almost empty

The indicator (red) flashes slowly automatically.

When the battery becomes empty, a beep sounds and the unit will turn off automatically.





Pairing

What is pairing?

BLUETOOTH devices need to be “paired” with each other beforehand.

Once BLUETOOTH devices are paired, there is no need for pairing again, except in the following cases:

- When pairing information is deleted after repair, etc.
- When this unit is paired with 9 or more devices.

This unit can be paired with 8 BLUETOOTH devices; if a new device is paired after 8 devices have been paired, the device whose latest connection time is the oldest among the 8 paired devices is replaced by the new one.

- When recognition of the unit by the device to be connected is deleted.
- When this unit is initialized. All pairing information is deleted.

Procedures of pairing

- 1 Place the connecting device within 1 m (3 ft) of this unit.**
- 2 Press and hold the POWER button for 7 seconds or more to standby for pairing while the unit is turned off.**



Notes

- After about 3 seconds, power is turned on and the indicator (blue) and indicator (red) flash together twice. Keep the button pressed without releasing until both indicators start flashing together, then release the button. This unit enters into pairing mode.
- If pairing is not established within about 5 minutes, pairing mode will be canceled and this unit will turn off. In this case, start over from step **1**.

Continued 9

US





3 Perform pairing procedure on the connecting device to detect this unit.

The list of detected devices appears on the display of the connecting device. This unit is displayed as "DR-BT10CX."

Note

If "DR-BT10CX" is not displayed, repeat from step **1**.

4 Select "DR-BT10CX" on the display of the connecting device.

5 If Passcode* input is required on the display of a connecting device, input "0000."

Pairing is complete when the indicator (blue) flashes slowly. The message standing for "Pairing complete" appears on the display of some BLUETOOTH devices.

* Passcode may be called "Passkey," "PIN code," "PIN number," or "Password."

Note

Passcode of this unit is fixed at "0000." This unit cannot be paired with a BLUETOOTH device whose Passcode is not "0000."

6 Start the BLUETOOTH connection from the BLUETOOTH device.

This unit memorizes the device as the latest connected device. Some BLUETOOTH devices may connect with the unit automatically when pairing is complete.

When pairing with a BLUETOOTH device that cannot display a list of detected devices or that has no display

You may pair the device by setting both this unit and the connecting device to pairing mode. For details, refer to the operating instructions supplied with the connecting device.

Tips

- To pair with other BLUETOOTH devices, repeat steps **1** to **5** for each device.
- To delete all pairing information, see "Initializing the unit" (page 24).





Wearing the headset

Wear the earpiece marked **R** in your right ear and the one marked **L** in your left ear.

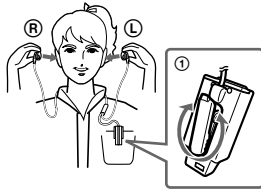

- 1 Turn the holding clip to the desired angle and clip to your pocket or collar.



How to install the earbuds correctly

If the earbuds do not fit your ears correctly, low-bass sound may not be heard. To enjoy better sound quality, adjust the earbuds position to sit on your ears comfortably or push them into the inside of your ears so that they fit your ears snugly. If the earbuds do not fit your ears, try ones of other size.

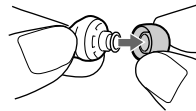



How to use the holder

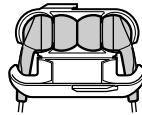













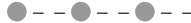









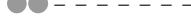

Store the earpieces. It prevents the cord from tangling if you store the earbuds.





Indications of BLUETOOTH function

 : Indicator (blue)
 : Indicator (red)

Status		Flashing patterns	
Pairing	Searching		
			
Connecting	Connectable		
			—
Connecting	Connecting		
			
Connected	HFP/HSP or A2DP (with no voice or music)		
			—
Connected	HFP/HSP and A2DP (with no voice or music)		
			—
Music	Listening		
			—
Phone	Incoming call		
			—
	Talking		
			—
	Calling while playing back music		
			—



OPERATING THE UNIT

Listening to music

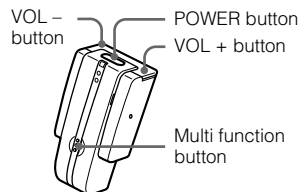

- Check the following before operating the unit.
- The BLUETOOTH device is turned on.
 - Pairing of this unit and the BLUETOOTH device is complete.
 - The BLUETOOTH device supports the transmitting music function (profile: A2DP).

1 Press and hold the POWER button for about 3 seconds while the unit is turned off.
The indicator (blue) and indicator (red) flash together twice and the unit is turned on.

Note
Do not press and hold the POWER button for more than 7 seconds, otherwise pairing mode is entered.

2 Make the BLUETOOTH connection (A2DP) from a BLUETOOTH device to this unit.
Refer to the operating instructions supplied with the BLUETOOTH device on how to operate it.

3 Start playback on the BLUETOOTH device.

- Notes**
- When you play music by connecting the unit to a BLUETOOTH device using HSP (Headset Profile)*, sound quality will not be high. For better sound, change the BLUETOOTH connection to A2DP (Advanced Audio Distribution Profile)* by operating the BLUETOOTH device.
 - This unit cannot control music playback functions of the connected device.
- * For detail on profiles, see page 22.

To adjust the volume
While playing music, you can adjust the volume using the VOL button of this unit.

- Tips**
- When the volume level is low, raise the volume of the connected device. The sound will be clearer.
 - Volume level for listening to music and calling can be set independently.





Operation of the multi function button

You can control the unit by using the multi function button.

Use the multi function button as follows:

Status	Press	
	once	and hold
In stop mode	-	①
In play mode	②	③

① Connects with BLUETOOTH mobile phone, etc.*

② Receives a telephone call*

③ Rejects a telephone call*

* It is available when connecting the BLUETOOTH mobile phone to this unit with the BLUETOOTH connection of HFP (Hands-free Profile) or HSP (Headset Profile). For details on profiles, see page 22.

Notes

- You cannot adjust the volume of the BLUETOOTH device by the unit VOL buttons.
- Operation of the BLUETOOTH connecting device by this unit will vary depending on its specification.

To stop use

1 Terminate the BLUETOOTH connection by operating the BLUETOOTH device.

2 Press and hold the POWER button for about 3 seconds.

The indicator (blue) and indicator (red) light up together, and the unit turns off.

Tip

When you finish playing music, the BLUETOOTH connection may terminate automatically, depending on the BLUETOOTH device.





Calling

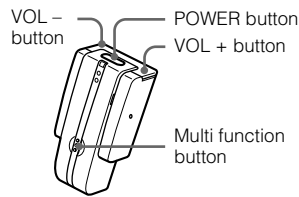

Check the following before operating the unit.

- The BLUETOOTH function is active on the mobile phone.
- Pairing of this unit and the BLUETOOTH mobile phone is complete.

1 Press and hold the POWER button for about 3 seconds while the unit is turned off.

The indicator (blue) and indicator (red) flash together twice, the unit turns on and then this unit automatically connects to the last BLUETOOTH mobile phone that was used.

Note

Do not press and hold the POWER button for more than 7 seconds, otherwise pairing mode is entered.

When you want to connect the unit to a different BLUETOOTH mobile phone from the last time, follow the procedure in "When this unit does not connect to a BLUETOOTH mobile phone automatically."

When this unit does not connect to a BLUETOOTH mobile phone automatically

1 Make the BLUETOOTH connection (HFP or HSP) from the BLUETOOTH mobile phone to this unit.

Refer to the manual supplied with your BLUETOOTH mobile phone for operation details.

The list of recognized devices appears on the display of the BLUETOOTH mobile phone.

This unit is displayed as "DR-BT10CX."

When you use the BLUETOOTH mobile phone features both HFP (Hands-free Profile) and HSP (Headset Profile)*, set to HFP.

* For details on profiles, see page 22.

Note

When listening to music by operating this unit connected to a BLUETOOTH mobile phone, make the BLUETOOTH connection by operating the BLUETOOTH mobile phone. This cannot be done with the multi function button.



Continued 15

US





To call

1 Use the buttons on your mobile phone when making a call.

If no sound is heard through this unit, press the multi function button.

Tip

You can call in the following way, depending on the BLUETOOTH mobile phone. Refer to the manual supplied with your mobile phone on operating details.

- When not communicating, you can call using the voice-dial function by pressing the multi function button.
- You can call a specific number by pressing the multi function button for about 2 seconds.

To receive a call

When the telephone is ringing, ring tone will be heard through the unit.

1 Press the multi function button on the unit.

The ring tone differs in the following ways, depending on your mobile phone.

- ring tone set on the unit
- ring tone set on the mobile phone
- ring tone set on the mobile phone only for BLUETOOTH connection

Note

If you pressed the call button on the BLUETOOTH mobile phone, some BLUETOOTH mobile phones may have handset use priority. In this case, set to talk with the unit by pressing and holding the multi function button for about 2 seconds, or by operating the BLUETOOTH mobile phone. For details, refer to the manual supplied with your BLUETOOTH mobile phone.

To adjust the volume

Push the VOL button to adjust the volume.

Tips

- You cannot adjust the volume when not communicating.
- Volume level for calling and listening to music can be set independently.

To terminate a call

You can end a call by pressing the multi function button on the unit.

To stop use

1 Terminate BLUETOOTH connection by the BLUETOOTH mobile phone.

2 Press and hold the POWER button for about 3 seconds to turn off the power.

The indicator (blue) and indicator (red) light up together, and the unit turns off.





Controlling the BLUETOOTH mobile phone – HFP, HSP

The operation of the buttons on this unit varies depending on your mobile phone. HFP (Hands-free Profile) or HSP (Headset Profile) is used for BLUETOOTH mobile phone. Refer to the operating instructions supplied with your BLUETOOTH mobile phone on supported BLUETOOTH profiles or how to operate.

- *1 Some functions may not be supported depending on the BLUETOOTH mobile phone.
- *2 This may vary, depending on the BLUETOOTH mobile phone.
- *3 Some functions may not be supported when calling using the BLUETOOTH mobile phone.

HFP (Hands-free Profile)

Status	Multi function button	
	Short Press	Long Press
Standby	Start Voice Dial	Last number redial
Voice Dial active	Cancel Voice Dial	–
Outgoing call	End outgoing call	–
Incoming call	Answer	Reject
During call	End call	Change active device

HSP (Headset Profile)

Status	Multi function button	
	Short Press	Long Press
Standby	–	Dial*1
Outgoing call	End outgoing call*1	End outgoing call or change active device to headset*2
Incoming call	Answer	–
During call	End call*3	Change active device to headset





Calling while playing back music

If the BLUETOOTH connection is active with the mobile phone, you can switch the unit to call even when listening to music. Before starting, see “Calling” (page 15) on operating details.

To call while playing back music

- 1 Stop music playback, and then press and hold the multi function button for about 2 seconds to change the call mode.**

- 2 Call the phone by operating your mobile phone.**

If no sound is heard through this unit, press the multi function button.

To receive a call while playing back music

The sound through the unit changes to a ring tone automatically.

- 1 Press the multi function button and talk.**

After finishing the call, press the multi function button. This unit is switched back to music playback. Note that music playback does not stop.

If the sound does not change to a ring tone automatically

- 1 Stop music playback.**
- 2 When ringing, press the multi function button and talk.**





ADDITIONAL INFORMATION

Disposing of the unit

For environmental conservation, be sure to remove the built-in rechargeable battery from the unit before disposing, and dispose of the battery appropriately.

1 Remove 2 screws.

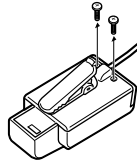

2 Open the case and detach the connector.

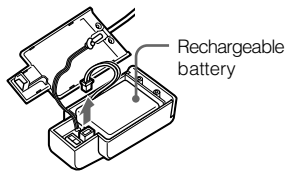

3 Remove the rechargeable battery and dispose of it.

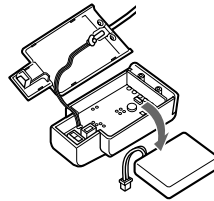



Precautions

On BLUETOOTH communication

- BLUETOOTH wireless technology operates within a range of about 10 m (about 30 ft). Maximum communication range may vary depending on obstacles (person, metal, wall, etc.) or electromagnetic environment.
- The antenna of this unit is built into the unit. The sensitivity of BLUETOOTH communication will improve by placing a connected BLUETOOTH device near the unit.
- The following conditions may affect the sensitivity of BLUETOOTH communication.
 - There is an obstacle such as a person, metal, or wall between this unit and BLUETOOTH device.
 - A device using 2.4 GHz frequency, such as a wireless LAN device, cordless telephone, or microwave oven, is in use near this unit.
- Because BLUETOOTH devices and wireless LAN (IEEE802.11b/g) use the same frequency, microwave interference may occur and resulting in communication speed deterioration, noise, or invalid connection if this unit is used near a wireless LAN device. In such as case, perform the following.
 - Use this unit at least 10 m (about 30 ft) away from the wireless LAN device.
 - If this unit is used within 10 m (about 30 ft) of a wireless LAN device, turn off the wireless LAN device.
 - Install this unit and BLUETOOTH device as near to each other as possible.
- Microwaves emitting from a BLUETOOTH device may affect the operation of electronic medical devices. Turn off this unit and other

BLUETOOTH devices in the following locations, as it may cause an accident.

- where inflammable gas is present, in a hospital, train, airplane, or a petrol station
 - near automatic doors or a fire alarm
- This unit supports security capabilities that comply with the BLUETOOTH standard to provide a secure connection when the BLUETOOTH wireless technology is used, but security may not be enough depending on the setting. Be careful when communicating using BLUETOOTH wireless technology.
 - We do not take any responsibility for the leakage of information during BLUETOOTH communication.
 - Connection with all BLUETOOTH devices cannot be guaranteed.
 - A device featuring BLUETOOTH function is required to conform to the BLUETOOTH standard specified by BLUETOOTH SIG, and be authenticated.
 - Even if the connected device conforms to the above mentioned BLUETOOTH standard, some devices may not be connected or work correctly, depending on the features or specifications of the device.
 - While talking on the phone hands free, noise may occur, depending on the device or communication environment.
 - Depending on the device to be connected, it may require some time to start communication.





On the supplied AC power adaptor

- Use the AC power adaptor supplied with this unit. Do not use any other AC power adaptor since it may cause the unit to malfunction.

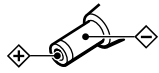

Polarity of the plug

- If you are not going to use this unit for a long time, unplug the AC power adaptor from the AC outlet. To remove the AC power adaptor from the wall outlet, grasp the adaptor plug itself; never pull the cord.

- Listening with this unit at high volume may affect your hearing. For traffic safety, do not use this unit while driving or cycling.
- If the earbuds become wet, wipe it with a dry towel before using.
- Clean the earbuds by hand-washing with a mild detergent solution. Remove the earbuds when you clean them. After cleaning, dry the earbuds well before use.
- The earbuds may deteriorate due to long-term storage or use.
- Do not strain the cord when adjusting the length, as it may be damaged.
- If you have any questions or problems concerning this unit that are not covered in this manual, please consult your nearest Sony dealer.

Others

- Do not place this unit in a place exposed to humidity, dust, soot or steam, subject to direct sunlight, or in a car waiting at a traffic signal. It may cause a malfunction.
- Using the BLUETOOTH device may not function on mobile phones, depending on radio wave conditions and location where the equipment is being used.
- If you experience discomfort after using the BLUETOOTH device, stop using the BLUETOOTH device immediately. Should any problem persist, consult your nearest Sony dealer.
- Do not allow small children to use this unit.
- Do not use this unit in a place where it may be snagged, such as near a shredder, or machine facility, etc.
- The left and right connectors will uncouple for safety if excessive pressure is applied. To reduce the risk of this unit from falling, avoid excessive movement.





What is BLUETOOTH technology?

BLUETOOTH wireless technology is a short-range wireless technology that enables wireless data communication between digital devices, such as a computer or digital camera. BLUETOOTH wireless technology operates within a range of about 10 m (about 30 ft). Connecting two devices as necessary is common, but some devices can be connected to multiple devices at the same time. You do not need to use a cable for connection since BLUETOOTH is a wireless technology, nor is it necessary for the devices to face one another, such is the case with infrared technology. For example, you can use such a device in a bag or pocket.

BLUETOOTH technology is an international standard supported by millions of companies all over the world, and employed by various companies worldwide.

Communication System and Compatible BLUETOOTH Profiles of this unit

Profile is standardization of the function for each BLUETOOTH device specification. This unit supports the following BLUETOOTH version and profiles:

Communication System : BLUETOOTH Specification version 2.0

Compatible BLUETOOTH Profiles:

- A2DP (Advanced Audio Distribution Profile): Transmitting or receiving audio content of high-quality.
- HSP (Headset Profile)*: Talking on the phone/Operating the phone.
- HFP (Hands-free Profile)*: Talking on the phone/Operating the phone by hands-free.

* When you use a BLUETOOTH mobile phone supported by both HFP (Hands-free Profile) and HSP (Headset Profile), set to HFP.

Note

To be able to use the BLUETOOTH function, the BLUETOOTH device to be connected requires the same profile as the unit's.

Note also that even if the same profile exists, devices may vary in function depending on their specifications.





Troubleshooting

If you run into any problems using this unit, use the following checklist. Should any problem persist, consult your nearest Sony dealer.

Common

The unit is not turned on.

- Charge the battery of the unit.
- The unit is not turned on while charging. Remove the unit from the battery charging stand and then turn on the unit.

Pairing cannot be done.

- Bring this unit and the BLUETOOTH device closer together.

Cannot make the BLUETOOTH connection.

- Check that this unit is turned on.
- Check that the BLUETOOTH connecting device is turned on and the BLUETOOTH function is on.
- Connection with the BLUETOOTH device may not be memorized on this unit. Make the BLUETOOTH connection from the BLUETOOTH device to this unit soon after pairing is complete.
- This unit or BLUETOOTH connecting device is in sleep mode.
- The BLUETOOTH connection is terminated. Make the BLUETOOTH connection again.

Distorted sound

- Ensure that this unit is not receiving interference from a wireless LAN, other 2.4 GHz wireless device, or microwave oven.
- Re-position this unit.

The correspondence distance is short. (Sound skips.)

- If a device that generates electromagnetic radiation, such as a wireless LAN, other BLUETOOTH device(s), or a microwave oven is nearby, move away from such sources.

Cannot operate the unit. (Connection has hung up.)

- Press the RESET button. Pairing information is not deleted by this operation.

When listening to music

No sound

- Check that both this unit and the BLUETOOTH device are turned on.
- Check that both this unit and the BLUETOOTH device are making the BLUETOOTH connection, A2DP (Advanced Audio Distribution Profile).
- Check that music is being played back by the BLUETOOTH device.
- Check that the volume of the unit is not set too low.
- Check that the volume of the BLUETOOTH device is not set too low if the BLUETOOTH device has a volume control.
- Pair this unit and BLUETOOTH device again.



Continued 23

US





Low sound level

- ➔ Turn up the volume of this unit.
- ➔ Turn up the volume of the BLUETOOTH device if the BLUETOOTH device has a volume control.

Low sound quality

- ➔ Switch the BLUETOOTH connection to A2DP (Advanced Audio Distribution Profile) when HSP (Headset Profile) is set.

When calling

The recipient's voice cannot be heard.

- ➔ Check that both this unit and the BLUETOOTH mobile phone are turned on.
- ➔ Check the connection between this unit and the BLUETOOTH mobile phone.
- ➔ Check that output of the BLUETOOTH mobile phone is set for this unit.
- ➔ Check that the volume of the unit is not set too low.
- ➔ Check that the volume of the BLUETOOTH mobile phone is not set too low if the BLUETOOTH mobile phone has a volume control.
- ➔ If you are listening to music using this unit, stop playback, press the multi function button and talk.

Low sound from recipient

- ➔ Turn up the volume of this unit.
- ➔ Turn up the volume of the BLUETOOTH mobile phone if the BLUETOOTH mobile phone has a volume control.

Initializing the unit

You can reset this unit to its default (such as volume setting) and delete all pairing information.

- 1 If this unit is turned on, press and hold the **POWER** button for about 2 seconds to turn off this unit.

- 2 Press and hold the **POWER** button and **multi function button** together for about 7 seconds.

The indicator (blue) and indicator (red) flash together four times, and this unit is reset to the default setting. All pairing information is deleted.





Specifications

General

Communication system

BLUETOOTH Specification version 2.0

Output

BLUETOOTH Specification Power Class 2

Maximum communication range

Line of sight approx. 10 m (30 ft) *¹

Frequency band

2.4 GHz band (2.4000 GHz – 2.4835 GHz)

Modulation method

FHSS

Compatible BLUETOOTH Profiles*²

A2DP (Advanced Audio Distribution Profile)

HSP (Headset Profile)

HFP (Hands-free Profile)

Supported codecs

SBC & MP3 decoder

Supplied accessories

AC power adaptor (1)

Battery charging stand (1)

Earbuds (S × 2, M × 2, L × 2)

Holder (1)

*¹ The actual range will vary depending on factors such as obstacles between devices, magnetic fields around a microwave oven, static electricity, reception sensitivity, antenna's performance, operating system, software application, etc.

*² BLUETOOTH standard profiles indicate the purpose of BLUETOOTH communication between devices.

Headset

Power source

DC 3.7 V: Built-in lithium-ion rechargeable battery

Dimensions

Approx. 25 × 51 × 29 mm

(1 × 2 × 1 3/16 in) (w/h/d)

Cord (from unit to earpiece)

Approx. 0.3 m (11 7/8 in)

Mass

Approx. 27 g (1.0 oz) including earpieces and cord

Earpieces: Approx. 4 g (0.15 oz) not including cord

Receiver**Type**

Closed, dynamic

Driver unit

9 mm dome type (CCAW adopted)

Reproduction frequency range

20 – 20,000 Hz

Microphone**Type**

Omni directional, electret condenser

Effective frequency range

100 – 4,000 Hz

Design and specifications are subject to change without notice.





ADVERTENCIA

Para reducir el riesgo de incendios o electrocución, no exponga el aparato a la lluvia ni a la humedad.

Para evitar descargas eléctricas, no abra la unidad. En caso de avería, solicite los servicios de personal cualificado.

No sitúe el aparato en un espacio cerrado, como una estantería o un armario empotrado.

Para reducir el riesgo de incendios, no cubra la ventilación del aparato con periódicos, manteles, cortinas, etc. ni coloque velas encendidas encima del mismo.

Para reducir el riesgo de incendio o sacudida eléctrica, no ponga objetos que contengan líquido, tal como floreros, encima del aparato.

Conecte el adaptador de alimentación de ca a una toma de ca de fácil acceso. Si percibe alguna anomalía en el adaptador de alimentación de ca, desconéctelo inmediatamente de la toma de ca.

Información

Se le advierte de que la realización de cambios o modificaciones no aprobados explícitamente en este manual pueden anular su autoridad para utilizar este equipo.

El equipo no debe colocarse ni utilizarse junto con ninguna otra antena o transmisor.

La marca de la palabra Bluetooth y sus logotipos son propiedad de Bluetooth SIG, Inc. y cualquier uso de los mismos por parte de Sony Corporation se realiza bajo licencia.

Las demás marcas y nombres comerciales pertenecen a sus respectivos propietarios.

Tecnología de codificación de audio MPEG Layer-3 y patentes bajo licencia de Fraunhofer IIS y Thomson.





Para clientes de los EE UU y
CANADÁ

**RECYCLADO DE BATERIAS
DE IONES DE LITIO**

Las baterías de iones de litio son reciclables. Usted podrá ayudar a conservar el medio ambiente devolviendo las baterías usadas al punto de reciclaje mas cercano. Para más información sobre el reciclado de baterías, llame al número gratuito 1-800-822-8837, o visite <http://www.rbrc.org/>



Precaución: No utilice baterías de iones de litio dañadas o con fugas.



Índice

Bienvenido 4
 Funcionamiento del dispositivo
 BLUETOOTH en sólo
 3 pasos 5

**Ubicación y función de los
componentes 6**

Carga de la unidad 7

Emparejamiento 9
 ¿Qué es el emparejamiento? 9
 Procedimientos de
 emparejamiento 9

**Utilización de los
auriculares 11**

**Indicaciones de la función
BLUETOOTH 12**

Escuchar música 13

**Realización de
llamadas 15**
 Control del teléfono móvil
 BLUETOOTH – HFP y
 HSP 17

**Realización de llamadas
durante la reproducción
de música 18**

Desecho de la unidad 19

Precauciones 20

**¿Qué es la tecnología
BLUETOOTH? 22**

Solución de problemas 23

**Inicialización de la
unidad 24**

Especificaciones 25

ES





Bienvenido

Gracias por adquirir los auriculares estéreo inalámbricos de Sony. Esta unidad utiliza la tecnología inalámbrica BLUETOOTH™.

- Disfrutará de la música con su dispositivo BLUETOOTH.
- Además, podrá utilizar el teléfono móvil BLUETOOTH sin sacarlo del bolso gracias a la función manos libres.
- Podrá recargar la unidad con el soporte de carga de la batería que se le ha suministrado.

Para obtener más información sobre la tecnología BLUETOOTH, consulte la página 22.

Hablar por teléfono

Escuchar música

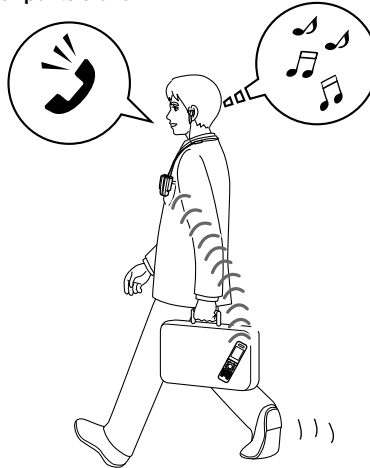

4

ES





Funcionamiento del dispositivo BLUETOOTH en sólo 3 pasos

Emparejamiento (de cada dispositivo)

En primer lugar, registre ("empareje") un dispositivo BLUETOOTH (teléfono móvil, etc.) y esta unidad entre sí. Una vez que se haya establecido el emparejamiento, no será necesario volver a realizarlo.

Teléfono móvil
BLUETOOTH,
etc.



Auriculares
estéreo
inalámbricos

→ Página 9

Escuchar música

Realizar llamadas

Conexión BLUETOOTH

Utilice el dispositivo BLUETOOTH para realizar la conexión BLUETOOTH.

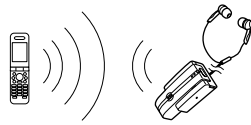

Conexión

A2DP

→ Página 13

Conexión BLUETOOTH

Cuando la unidad se enciende, ésta empieza a realizar la conexión BLUETOOTH con el teléfono móvil reconocido automáticamente.

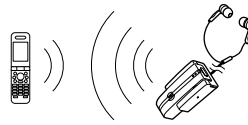

Conexión

HFP

HSP

→ Página 15

Escuchar música

Es posible escuchar música reproducida en el dispositivo BLUETOOTH.

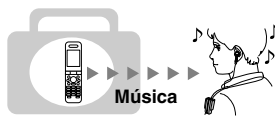

Música

→ Páginas 13 - 14

Hablar por teléfono

Puede realizar y recibir llamadas mediante esta unidad.

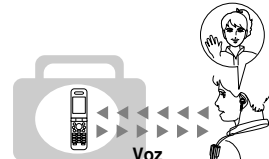

Voz

→ Páginas 16 - 17

5

ES



PROCEDIMIENTOS INICIALES

Ubicación y función de los componentes

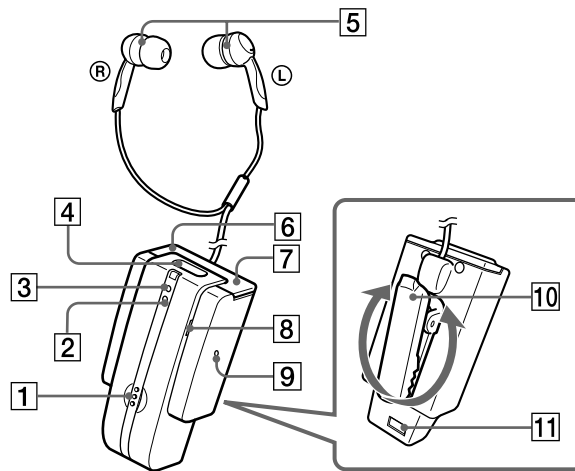

- 1 Botón multifunción**
Controla varias funciones de llamada.
- 2 Indicador (rojo)**
Indica el estado de la alimentación de la unidad.
- 3 Indicador (azul)**
Indica el estado de la comunicación de la unidad.
- 4 Botón POWER**
- 5 Auriculares**

- 6 Botón VOL -**
- 7 Botón VOL +**
- 8 Micrófono**
- 9 Botón RESET**
- 10 Clip de sujeción**
Ajuste el clip de sujeción en el ángulo deseado y fíjelo en el bolsillo o el cuello de la camisa.
- 11 Punto de contacto**

6
ES



Carga de la unidad

La unidad contiene una batería de iones de litio recargable, que se debe cargar antes de utilizarla por primera vez.

1 Conecte el adaptador de alimentación de ca suministrado al soporte de carga de la batería.

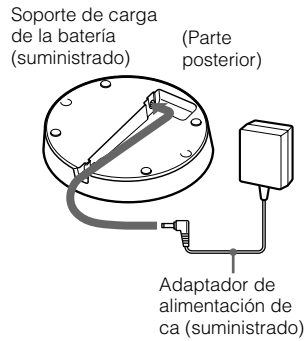

2 Conecte el adaptador de alimentación de ca suministrado a una toma de corriente de ca.

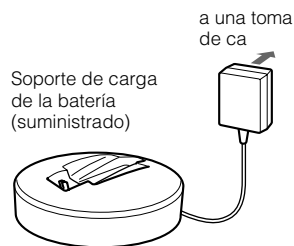

3 Coloque la unidad en el soporte de carga de la batería.

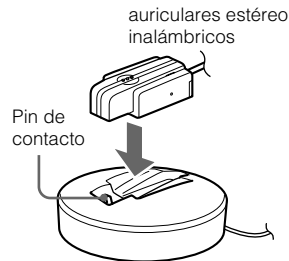

Nota

Si el clip de sujeción está girado, la unidad no se puede colocar en el soporte de carga de la batería y la carga no se iniciará. Coloque de nuevo el clip de sujeción en su posición original antes de iniciar la carga.

Coloque la unidad sobre el soporte de carga de la batería de modo que el punto de contacto de la unidad coincida con el pin de contacto de dicho soporte y asegúrese de que el indicador (rojo) se ilumina.

La carga se completa en aproximadamente 3 horas* y el indicador (rojo) se apaga automáticamente.

* Tiempo necesario para volver a cargar una batería agotada.

Sugerencia

Al cargar la batería, la unidad se apaga automáticamente.

Continúa 7

ES





Precaución

Si la unidad detecta un problema durante la carga, es posible que el indicador (rojo) se apague aunque no haya finalizado la carga. Compruebe si se debe a las causas siguientes:

- La temperatura ambiente supera el rango de 0 °C a 40 °C.
- La batería tiene un problema.

En este caso, cárguela de nuevo en el rango de temperatura indicado anteriormente.

Si el problema persiste, póngase en contacto con el distribuidor Sony más cercano.

Notas

- Si no se utiliza la batería durante un período de tiempo prolongado, es posible que la carga se agote rápidamente. Sin embargo, después de varias recargas, aumentará la duración.
- Si la vida útil de la batería recargable incorporada disminuye hasta la mitad de la duración normal, la batería deberá reemplazarse. Para reemplazar la batería recargable, póngase en contacto con el distribuidor Sony más cercano.
- Evite la exposición de la unidad a temperaturas extremas, la luz solar directa, la humedad, la arena, el polvo o los golpes. No la deje nunca en un automóvil estacionado al sol.
- Utilice únicamente el adaptador de alimentación de ca suministrado. No utilice ningún otro adaptador de alimentación de ca.

Duración*

Estado	Duración aproximada
Tiempo de comunicación (incluido el tiempo de reproducción de música) (máximo)	11 horas
Tiempo en espera (máximo)	100 horas

* La duración puede variar según la temperatura ambiente o las condiciones de uso.

Comprobación de la batería restante

Si presiona el botón POWER mientras la unidad está encendida, el indicador (rojo) parpadeará. Puede comprobar la batería restante mediante el número de veces que parpadea el indicador (rojo).

Indicador (rojo)	Estado
3 veces	Completa
2 veces	Media
1 vez	Baja (debe cargarla)

Nota

No es posible comprobar la carga restante inmediatamente después de encender la unidad o durante el emparejamiento.

Cuando la batería está prácticamente agotada

El indicador (rojo) parpadea lentamente de forma automática. Cuando la batería se agota por completo, suena un pitido y la unidad se apaga automáticamente.





Emparejamiento

¿Qué es el emparejamiento?

Los dispositivos BLUETOOTH deben "emparejarse" previamente entre sí.

Una vez que los dispositivos BLUETOOTH se han emparejado, no es necesario volver a hacerlo excepto en los casos siguientes:

- Cuando la información de emparejamiento se ha eliminado tras una reparación, etc.
- Cuando la unidad se ha emparejado con 9 o más dispositivos. Esta unidad se puede emparejar hasta con 8 dispositivos BLUETOOTH; si se empareja un noveno dispositivo, éste reemplazará al más antiguo de los 8 restantes.
- Cuando se elimina el reconocimiento de la unidad en el dispositivo que desea conectar.
- Cuando se ha inicializado esta unidad. Se elimina toda la información de emparejamiento.

Procedimientos de emparejamiento

- 1 Coloque el dispositivo que desea conectar a menos de 1 metro de la unidad.**
- 2 Mantenga presionado el botón POWER durante más de 7 segundos para poner en espera el emparejamiento mientras la unidad se desconecta.**



Notas

- Transcurridos 3 segundos, la alimentación se enciende y los indicadores (azul) y (rojo) parpadean juntos dos veces. Mantenga presionado el botón hasta que ambos indicadores comiencen a parpadear a la vez y, a continuación, suéltelo. La unidad pasa al modo de emparejamiento.
- Si el emparejamiento no se ha establecido en unos 5 minutos, el modo de emparejamiento se cancelará y la unidad se apagará. En tal caso, vuelva a comenzar desde el paso **1**.

Continúa 9

ES



3 Realice el procedimiento de emparejamiento en el dispositivo que desea conectar para que detecte esta unidad.

La lista de los dispositivos detectados aparecerá en la pantalla del dispositivo que desea conectar. Esta unidad se muestra como "DR-BT10CX".

Nota

Si no aparece "DR-BT10CX", repita el procedimiento desde el paso 1.

4 Seleccione "DR-BT10CX" en la pantalla del dispositivo que desea conectar.

5 Si se solicita la entrada de una contraseña* en la pantalla del dispositivo que desea conectar, introduzca "0000".

El emparejamiento finaliza cuando el indicador (azul) parpadea lentamente. En la pantalla de algunos dispositivos BLUETOOTH aparece un mensaje que indica que el emparejamiento ha finalizado.

* La contraseña puede denominarse "clave de acceso", "código PIN", "número PIN" o "código de acceso".

Nota

La clave de acceso de la unidad está fijada en "0000". La unidad no puede emparejarse con otro dispositivo BLUETOOTH cuya clave de acceso no sea "0000".

6 Inicie la conexión BLUETOOTH desde el dispositivo BLUETOOTH.

La unidad memoriza este dispositivo como el último al que se ha conectado.

Es posible que algunos dispositivos BLUETOOTH se conecten automáticamente a esta unidad al finalizar el emparejamiento.

Cuando realice el emparejamiento con un dispositivo BLUETOOTH que no pueda mostrar una lista de dispositivos detectados o no disponga de pantalla

Puede realizar el emparejamiento mediante el ajuste de la unidad y del dispositivo que desea conectar en modo de emparejamiento. Para obtener más detalles, consulte el manual de instrucciones que acompaña al dispositivo que desea conectar.

Sugerencias

- Para realizar un emparejamiento con otros dispositivos BLUETOOTH, repita los pasos del 1 al 5 para cada dispositivo.
- Para eliminar toda la información de emparejamiento, consulte "Inicialización de la unidad" (página 24).



10

ES





Utilización de los auriculares

Póngase el auricular con la marca **R** en la oreja derecha y el auricular con la marca **L** en la izquierda.

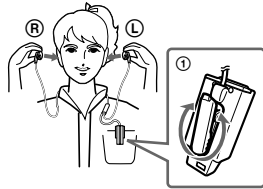

- ① Ajuste el clip de sujeción en el ángulo deseado y fíjelo en el bolsillo o el cuello de la camisa.



Cómo instalar los adaptadores correctamente

Si los adaptadores no se ajustan a los oídos correctamente, es posible que no pueda oír los sonidos graves. A fin de escuchar un sonido de mejor calidad, coloque los adaptadores de modo que se ajusten perfectamente a los oídos. En caso de no adaptarse, pruebe unos de otra talla.

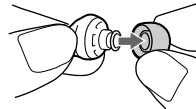

Utilización del soporte

Guarde los auriculares. Evita que el cable se enrede al guardarlos.

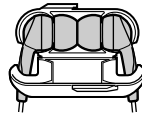



Indicaciones de la función BLUETOOTH

A : Indicador (azul)

R : Indicador (rojo)

	Estado	Patrones de parpadeo
Emparejamiento	Búsqueda	A ● - ● - ● - ● - ● - ● - ● - ● - ... R ● - ● - ● - ● - ● - ● - ● - ● - ...
	Conexión	A ● - - ● - - ● - - ● - - ● - - ● - - ● - - ... R -
Conexión establecida	HFP/HSP o A2DP (sin voz ni música)	A ● - - - - - - - - - - ● - - - - - ... R -
	HFP/HSP y A2DP (sin voz ni música)	A ● - ● - - - - - - - - ● - ● - - - - - ... R -
Música	Escucha	A ● ● - - - - - - - - ● ● - - - - - ... R -
Teléfono	Llamada entrante	A ● ● ● ● ● ● ... R -
	Conversación	A ● ● - - - - - - - - ● ● - - - - - ... R -
	Realización de llamadas durante la reproducción de música	A ● ● ● - - - - - - - - ● ● ● - - - - - ... R -



USO DE LA UNIDAD

Escuchar música

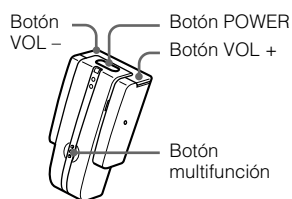

Antes de utilizar la unidad, compruebe los puntos siguientes.

- El dispositivo BLUETOOTH está encendido.
- Ha finalizado el emparejamiento de esta unidad y el dispositivo BLUETOOTH.
- El dispositivo BLUETOOTH admite la función de transmisión de música (perfil: A2DP).

1 Con la unidad apagada, mantenga presionado el botón POWER durante aproximadamente 3 segundos.

Los indicadores (azul) y (rojo) parpadean dos veces juntos y la unidad se enciende.

Nota

No debe mantener presionado el botón POWER durante más de 7 segundos ya que, en ese caso, la unidad pasará al modo emparejamiento.

2 Realice la conexión BLUETOOTH (A2DP) desde un dispositivo BLUETOOTH a esta unidad.

Consulte el manual de instrucciones suministrado con el dispositivo BLUETOOTH para saber cómo realizarla.

3 Inicie la reproducción del dispositivo BLUETOOTH.

Notas

- Cuando reproduzca música mediante la conexión de la unidad a un dispositivo BLUETOOTH con HSP (Headset Profile)*, la calidad del sonido no será alta. Para una mejor calidad de sonido, cambie la conexión BLUETOOTH a A2DP (Advanced Audio Distribution Profile)* mediante el dispositivo BLUETOOTH.

- La unidad no puede controlar las funciones de reproducción de música del dispositivo conectado.

* Para obtener más información sobre los perfiles, consulte la página 22.

Para ajustar el volumen

Durante la reproducción de música, puede ajustar el volumen con los botones VOL de esta unidad.

Sugerencias

- Si el volumen es bajo, suba el volumen del dispositivo conectado. El sonido será más nítido.
- El volumen para escuchar música y el volumen para realizar llamadas pueden ajustarse independientemente.

Continúa 13

ES



Utilización del botón multifunción

Puede controlar la unidad con el botón multifunción.

Utilice este botón como se indica a continuación:

Estado	Presione	
	una vez	y mantenga presionado
en modo de parada	–	①
en modo de reproducción	②	③

- ① Permite establecer la conexión con el teléfono móvil BLUETOOTH, etc.*
- ② Permite recibir una llamada de teléfono*
- ③ Permite rechazar una llamada de teléfono*

* Está disponible al conectar el teléfono móvil BLUETOOTH a esta unidad mediante la conexión BLUETOOTH de HFP (Hands-free Profile) o HSP (Headset Profile). Para obtener más información sobre los perfiles, consulte la página 22.

Notas

- No es posible ajustar el volumen del dispositivo BLUETOOTH con los botones de volumen de la unidad.
- El funcionamiento del dispositivo de conexión BLUETOOTH en esta unidad variará dependiendo de las especificaciones.

Para detener el uso

1 Finalice la conexión desde el dispositivo BLUETOOTH.

2 Mantenga presionado el botón POWER durante unos 3 segundos.

Los indicadores (azul) y (rojo) se iluminan a la vez y la unidad se apaga.

Sugerencia

Cuando finalice la reproducción de música, es posible que la conexión BLUETOOTH finalice automáticamente, según el dispositivo BLUETOOTH que se utilice.





Realización de llamadas

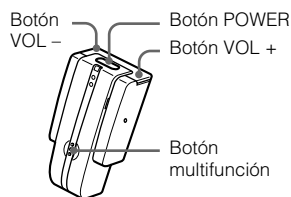

Antes de utilizar la unidad, compruebe los puntos siguientes.

- La función BLUETOOTH está activada en el teléfono móvil.
- Ha finalizado el emparejamiento de esta unidad y el teléfono móvil BLUETOOTH.

1 Con la unidad apagada, mantenga presionado el botón POWER durante aproximadamente 3 segundos.

Los indicadores (azul) y (rojo) parpadean dos veces juntos, la unidad se enciende y, a continuación, ésta se conecta automáticamente al último teléfono móvil BLUETOOTH que se ha usado.

Nota

No debe mantener presionado el botón POWER durante más de 7 segundos ya que, en ese caso, la unidad pasará al modo de emparejamiento.

Cuando desee conectar la unidad a un teléfono móvil BLUETOOTH distinto del que ha conectado la última vez, siga el procedimiento que se indica en el apartado "Si la unidad no se conecta a un teléfono móvil BLUETOOTH automáticamente".

Si la unidad no se conecta a un teléfono móvil BLUETOOTH automáticamente

1 Realice la conexión BLUETOOTH (HFP o HSP) desde el teléfono móvil BLUETOOTH a esta unidad.

Para obtener más información sobre el procedimiento a seguir, consulte el manual suministrado con el teléfono móvil BLUETOOTH.

La lista de dispositivos reconocidos aparecerá en la pantalla del teléfono móvil BLUETOOTH. Esta unidad aparece como "DR-BT10CX". Cuando utilice las funciones HFP (Hands-free Profile) y HSP (Headset Profile)* del teléfono móvil BLUETOOTH, ajústelo en HFP.

* Para obtener más información sobre los perfiles, consulte la página 22.

Nota

Cuando escuche música utilizando la unidad conectada a un teléfono móvil BLUETOOTH, realice la conexión BLUETOOTH utilizando el teléfono móvil BLUETOOTH. No es posible realizar la conexión mediante el botón multifunción.

Continúa 15

ES





Para llamar

1 Utilice los botones del teléfono móvil para realizar llamadas.

Si no se escucha ningún sonido en la unidad, presione el botón multifunción.

Sugerencia

Puede realizar llamadas de la manera siguiente, según el teléfono móvil BLUETOOTH que utilice. Para obtener más información sobre el funcionamiento, consulte el manual suministrado con el teléfono móvil BLUETOOTH.

- Cuando se realicen comunicaciones, podrá llamar utilizando la función de marcación por voz si presiona el botón multifunción.
- Puede llamar a un número específico manteniendo presionado el botón multifunción unos 2 segundos.

Para recibir una llamada

Cuando suena el teléfono, el tono se escucha en la unidad.

1 Presione el botón multifunción de la unidad.

El tono de llamada varía de las formas siguientes, dependiendo del teléfono móvil.

- tono de llamada ajustado en la unidad
- tono de llamada ajustado en el teléfono móvil
- tono de llamada ajustado en el teléfono móvil sólo para la conexión BLUETOOTH

Nota

Si ha presionado el botón de llamada en el teléfono móvil BLUETOOTH, tenga en cuenta que es probable que algunos teléfonos tengan activada la prioridad para utilizar el teléfono. En este caso, ajústelo para hablar con la unidad manteniendo presionado el botón

16 multifunción durante unos dos segundos o

ES

bien realice el ajuste desde el teléfono móvil BLUETOOTH. Para obtener más información, consulte el manual suministrado con el teléfono móvil BLUETOOTH.

Para ajustar el volumen

Presione el botón VOL para ajustar el volumen.

Sugerencias

- No puede ajustar el volumen cuando no se realicen comunicaciones.
- El nivel de volumen para realizar llamadas o escuchar música se puede ajustar de forma independiente.

Para finalizar una llamada

Para finalizar una llamada puede presionar el botón multifunción de la unidad.

Para detener el uso

1 Termine las comunicaciones BLUETOOTH en el teléfono móvil.

2 Para apagar la alimentación de la unidad, mantenga presionado el botón POWER durante unos 3 segundos.

Los indicadores (azul) y (rojo) se iluminan a la vez y la unidad se apaga.





Control del teléfono móvil BLUETOOTH – HFP y HSP

El uso de los botones de esta unidad varía según el teléfono móvil que utilice.

Para efectuar el emparejamiento con un teléfono móvil BLUETOOTH se utiliza el perfil HFP (Hands-free Profile) o HSP (Headset Profile). Consulte el manual de instrucciones suministrado junto con el teléfono móvil para obtener información sobre los perfiles BLUETOOTH admitidos y cómo funcionan.

HFP (Hands-free Profile)

Estado	Botón multifunción	
	Presionar	Mantener presionado
En espera	Inicia la marcación por voz	Repite la marcación del último número
Activa la marcación por voz	Cancela la marcación por voz	–
Llamada saliente	Fin de la llamada saliente	–
Llamada entrante	Responde a la llamada	Rechaza la llamada
Durante la llamada	Finaliza la llamada	Cambio de dispositivo activo

HSP (Headset Profile)

Estado	Botón multifunción	
	Presionar	Mantener presionado
En espera	–	Marcación*1
Llamada saliente	Fin de la llamada saliente*1	Fin de la llamada saliente o cambio del dispositivo activo a los auriculares*2
Llamada entrante	Responde a la llamada	–
Durante la llamada	Finaliza la llamada	Cambio del dispositivo activo a los auriculares

*1 Es posible que algunas funciones no se admitan dependiendo del teléfono móvil BLUETOOTH.

*2 Puede variar en función del teléfono móvil BLUETOOTH utilizado.

*3 Es posible que algunas funciones no se admitan cuando se realice una llamada mediante un teléfono móvil BLUETOOTH.





Realización de llamadas durante la reproducción de música

Si la conexión BLUETOOTH está activada en el teléfono móvil, puede realizar llamadas incluso cuando escucha música. Para obtener más información sobre el funcionamiento antes de comenzar, consulte el apartado “Realización de llamadas” (página 15).

Para llamar mientras se reproduce música

1 Detenga la reproducción de música y, a continuación, mantenga presionado el botón multifunción durante unos dos segundos para cambiar al modo de llamada.

2 Realice la llamada utilizando el teléfono móvil.

Si no se escucha ningún sonido en la unidad, presione el botón multifunción.

Para recibir una llamada mientras está escuchando música

La unidad cambiará automáticamente el sonido que se esté emitiendo por el tono de llamada.

1 Presione el botón multifunción de la unidad y hable.

Cuando termine la llamada, presione el botón multifunción. La unidad vuelve a reproducir la música. Tenga en cuenta que la reproducción no se detiene.

Si el sonido no cambia automáticamente a un tono de llamada

1 Detenga la reproducción de música.

2 Cuando suene el tono, presione el botón multifunción de la unidad y hable.



INFORMACIÓN COMPLEMENTARIA

Desecho de la unidad

Para una mejor conservación del medio ambiente, asegúrese de retirar la batería recargable incorporada antes de deshacerse de la unidad y proceda al desecho de dicha batería de la forma adecuada.

1 Retire los 2 tornillos.

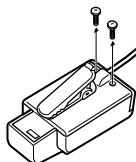

2 Abra la carcasa y extraiga el conector.

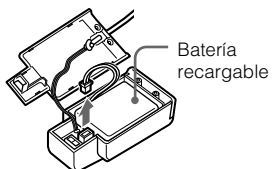

3 Extraiga la batería recargable y deséchela.

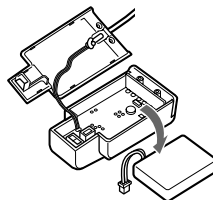



Precauciones

Comunicación BLUETOOTH

- La tecnología inalámbrica BLUETOOTH funciona en un rango de aproximadamente 10 metros. El rango máximo de comunicación puede variar en función de los obstáculos (personas, objetos metálicos, paredes, etc.) o del entorno electromagnético.
- La antena está incorporada en la unidad. La sensibilidad de la comunicación BLUETOOTH mejorará al colocar el dispositivo BLUETOOTH conectado cerca de la unidad.
- Las condiciones siguientes pueden afectar la sensibilidad de la comunicación BLUETOOTH.
 - La existencia de obstáculos como, por ejemplo, una persona, un objeto metálico o una pared entre esta unidad y el dispositivo BLUETOOTH.
 - El uso de dispositivos que utilicen una frecuencia de 2,4 GHz como, por ejemplo, un dispositivo LAN inalámbrico, un teléfono inalámbrico o un microondas cerca de la unidad.
- Como los dispositivos BLUETOOTH y las LAN inalámbricas (IEEE802.11b/g) utilizan la misma frecuencia, pueden producirse interferencias de microondas que provoquen el deterioro de la velocidad de la comunicación, la aparición de ruido o una conexión no válida si la unidad se utiliza cerca de un dispositivo LAN inalámbrico. En este caso, realice el procedimiento siguiente.
 - Utilice esta unidad a una distancia mínima de 10 m del dispositivo LAN inalámbrico.
 - Si utiliza esta unidad a menos de 10 m de un dispositivo LAN inalámbrico, apague el dispositivo LAN inalámbrico.
- Instale esta unidad y el dispositivo BLUETOOTH a la distancia más corta posible entre sí.
- Las microondas que emite un dispositivo BLUETOOTH pueden afectar el funcionamiento de dispositivos médicos electrónicos. Apague esta unidad y los demás dispositivos BLUETOOTH en los lugares siguientes, ya que podrían provocar un accidente:
 - donde exista gas inflamable, en un hospital, tren, avión o gasolinera
 - cerca de puertas automáticas o alarmas de incendios
- Esta unidad admite funciones de seguridad que cumplen con el estándar BLUETOOTH para proporcionar una conexión segura al utilizar la tecnología inalámbrica BLUETOOTH, pero es posible que la seguridad no sea suficiente según el ajuste. Tenga cuidado al realizar una comunicación con la tecnología inalámbrica BLUETOOTH.
- No se aceptan responsabilidades por la pérdida de información que pudiera producirse durante una comunicación BLUETOOTH.
- No se puede garantizar la conexión con todos los dispositivos BLUETOOTH.
 - Un dispositivo que disponga de la función BLUETOOTH debe cumplir el estándar BLUETOOTH especificado por BLUETOOTH SIG y estar autenticado.
 - Incluso en el caso de que el dispositivo conectado cumpla el estándar BLUETOOTH mencionado anteriormente, es posible que algunos dispositivos no puedan conectarse o funcionar correctamente, según las características o las especificaciones del dispositivo.





- Mientras esté hablando con el manos libres del teléfono, puede producirse ruido, según el dispositivo o el entorno de comunicación.
- En función del dispositivo que vaya conectarse, es posible que transcurra cierto tiempo antes de que se inicie la comunicación.

Adaptador de alimentación de ca suministrado

- Utilice solamente el adaptador de alimentación de ca suministrado con esta unidad. No utilice ningún otro adaptador de alimentación de ca, ya que puede causar un mal funcionamiento de la unidad.

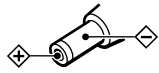

Polaridad de la clavija



- Si no va a utilizar la unidad durante un período prolongado de tiempo, desconecte el adaptador de alimentación de ca de la toma de ca. Para retirar el adaptador de alimentación de ca de la toma de corriente de pared, tire del adaptador, nunca del cable.

Otros

- No coloque esta unidad en lugares expuestos a humedad, polvo, hollín, vapor o luz solar directa, ni la deje en un automóvil en espera ante una señal de tráfico. Se pueden producir fallos de funcionamiento.
- Es posible que el dispositivo BLUETOOTH no funcione en teléfonos móviles dependiendo del estado de las ondas de radio y del lugar donde se utilice el equipo.
- Si experimenta malestar después de utilizar el dispositivo BLUETOOTH, deje de utilizarlo inmediatamente. Si el problema persiste, consulte con el distribuidor Sony más cercano.

- No permita que los niños utilicen esta unidad.
- No utilice esta unidad en un lugar donde pueda quedar atrapada, como cerca de una desfibradora, una instalación de maquinaria, etc.
- Si se ejerce una presión excesiva, los conectores izquierdo y derecho se desconectarán por motivos de seguridad. Para reducir el riesgo de caídas, evite que se produzca demasiado movimiento.
- Si usa la unidad a un volumen alto, puede sufrir daños en los oídos. Por razones de seguridad vial, no la utilice mientras conduce o va en bicicleta.
- Si las almohadillas se humedecen, antes de utilizarlas límpielas con una toalla seca.
- Lave las almohadillas a mano con una solución de detergente poco concentrada. Extráigalas para lavarlas. Después de lavarlas, séquelas antes de utilizarlas.
- Las almohadillas pueden deteriorarse debido a un almacenamiento o uso prolongados.
- No retuerza el cable al ajustar la longitud, ya que podría dañarse.
- Si desea realizar alguna consulta o solucionar algún problema relativo a la unidad que no se trate en este manual, póngase en contacto con el distribuidor Sony más cercano a su domicilio.





¿Qué es la tecnología BLUETOOTH?

BLUETOOTH es una tecnología inalámbrica de corto alcance que permite la comunicación inalámbrica de datos entre dispositivos digitales como, por ejemplo, un ordenador o una cámara digital. La tecnología inalámbrica BLUETOOTH funciona en un rango de aproximadamente 10 metros. Lo habitual es conectar dos dispositivos, pero algunos dispositivos admiten la conexión a varios dispositivos a la vez. No es necesario utilizar un cable para realizar la conexión, ya que BLUETOOTH es una tecnología inalámbrica, ni tampoco es necesario encerrar los dispositivos entre sí, como sucede con la tecnología de infrarrojos. Por ejemplo, puede utilizar los dispositivos en una bolsa o en un bolsillo.

La tecnología BLUETOOTH es una convención internacional reconocida y utilizada por millones de empresas de todo el mundo.

Sistema de comunicación y perfiles BLUETOOTH compatibles de la unidad

Un perfil es una estandarización de la función para cada especificación del dispositivo BLUETOOTH. Esta unidad es compatible con el perfil y la versión BLUETOOTH siguientes:

Sistema de comunicación:

Especificación BLUETOOTH versión 2.0

Perfiles BLUETOOTH compatibles:

- A2DP (Advanced Audio Distribution Profile): Transmisión o recepción de contenido de audio de alta calidad.
- HSP (Headset Profile)*: Hablar por teléfono/funcionamiento del teléfono.
- HFP (Hands-free Profile)*: Hablar por el teléfono/Usó del teléfono mediante la función de manos libres.

* Cuando utilice un teléfono móvil BLUETOOTH compatible con las funciones HFP (Hands-free Profile) y HSP (Headset Profile), ajústelo en HFP.

Nota

Para poder utilizar la función BLUETOOTH, el dispositivo BLUETOOTH que desea conectar debe tener el mismo perfil que la unidad. Tenga en cuenta también que aunque exista el mismo perfil, el funcionamiento de los dispositivos puede variar dependiendo de las especificaciones de los mismos.





Solución de problemas

Si surge algún problema al utilizar esta unidad, utilice la siguiente lista de comprobaciones. Si el problema persiste, consulte con el distribuidor Sony más cercano.

Común

La unidad no está encendida

- ➔ Cargue la batería de la unidad.
- ➔ La unidad no está encendida mientras se carga. Retire la unidad del soporte de carga de la batería y enciéndala.

No se puede llevar a cabo el emparejamiento

- ➔ Acerque esta unidad y el dispositivo BLUETOOTH.

No se ha realizado la conexión BLUETOOTH

- ➔ Compruebe que la unidad está encendida.
- ➔ Compruebe que el dispositivo BLUETOOTH que desea conectar está encendido y que la función BLUETOOTH está activada.
- ➔ Es posible que la unidad no memorice la conexión con el dispositivo BLUETOOTH. Realice la conexión BLUETOOTH del dispositivo BLUETOOTH a la unidad inmediatamente después de finalizar el emparejamiento.
- ➔ Esta unidad o el dispositivo BLUETOOTH que desea conectar está en modo en espera.
- ➔ Ha finalizado la conexión BLUETOOTH. Realice la conexión BLUETOOTH de nuevo.

El sonido aparece distorsionado

- ➔ Asegúrese de que la unidad no está recibiendo interferencias de una red LAN inalámbrica, de algún otro dispositivo inalámbrico de 2,4 GHz ni de un microondas.
- ➔ Vuelva a colocar la unidad.

La distancia de correspondencia es demasiado corta (se producen saltos del sonido)

- ➔ Si hay cerca un dispositivo que genera radiación electromagnética como, por ejemplo, una LAN inalámbrica, otro dispositivo BLUETOOTH o un microondas, aleje la unidad de estas fuentes.

La unidad no funciona (se ha colgado la conexión)

- ➔ Presione el botón RESET. Al realizar esta función, la información del emparejamiento no se elimina.

Al escuchar música

No hay sonido

- ➔ Compruebe que tanto la unidad como el dispositivo BLUETOOTH están encendidos.
- ➔ Compruebe que esta unidad y el dispositivo BLUETOOTH están realizando la conexión BLUETOOTH, A2DP (Advanced Audio Distribution Profile).
- ➔ Compruebe que se reproduce música en el dispositivo BLUETOOTH.
- ➔ Compruebe que el volumen de la unidad no esté demasiado bajo.
- ➔ Compruebe que el volumen del dispositivo BLUETOOTH no esté demasiado bajo si éste cuenta con control de volumen.
- ➔ Vuelva a emparejar la unidad y el dispositivo BLUETOOTH.



Continúa 23

ES





El nivel del sonido es bajo

- Suba el volumen de la unidad.
- Suba el volumen del dispositivo BLUETOOTH si éste cuenta con control de volumen.

Sonido de baja calidad

- Cambie la conexión BLUETOOTH a A2DP (Advanced Audio Distribution Profile) cuando se ajuste HSP (Headset Profile).

Al realizar llamadas

No se escucha la voz del interlocutor

- Compruebe que tanto la unidad como el teléfono móvil BLUETOOTH estén encendidos.
- Compruebe la conexión de la unidad con el teléfono móvil BLUETOOTH.
- Compruebe que la salida del teléfono móvil BLUETOOTH esté ajustada para esta unidad.
- Compruebe que el volumen de la unidad no esté demasiado bajo.
- Compruebe que el volumen del teléfono móvil BLUETOOTH no esté demasiado bajo si éste cuenta con control de volumen.
- Si escucha música en la unidad, detenga la reproducción, presione el botón multifunción y hable.

El sonido del interlocutor es bajo

- Suba el volumen de la unidad.
- Suba el volumen del teléfono móvil BLUETOOTH si éste cuenta con un control de volumen.

Inicialización de la unidad

Puede restablecer la unidad a la configuración predeterminada (así como el volumen) y eliminar la información de emparejamiento.

1 Si la unidad está encendida, mantenga presionado el botón POWER durante unos 2 segundos para apagarla.

2 Mantenga presionados los botones POWER y multifunción a la vez durante unos 7 segundos.

Los indicadores (azul) y (rojo) parpadearán juntos cuatro veces y la unidad se restablecerá a los ajustes predeterminados. Toda la información de emparejamiento se elimina.



Especificaciones

Generales

Sistema de comunicación

Especificación BLUETOOTH versión 2.0

Salida

Clase de potencia 2 de especificación BLUETOOTH

Rango de comunicación máximo

Línea de vista de aprox. 10 m *¹

Banda de frecuencia

Banda de 2,4 GHz (2,4000 GHz – 2,4835 GHz)

Método de modulación

FHSS

Perfiles BLUETOOTH compatibles*²

A2DP (Advanced Audio Distribution Profile)

HSP (Headset Profile)

HFP (Hands-free Profile)

Códecs compatibles

Decodificador de SBC y MP3

Accesorios suministrados

Adaptador de corriente de ca (1)

Soporte de carga de la batería (1)

Adaptadores (S × 2, M × 2, L × 2)

Soporte (1)

*¹ El rango real variará en función de factores como, por ejemplo, los obstáculos que puedan interponerse entre los dispositivos, los campos magnéticos que puedan existir en torno a hornos microondas, la electricidad estática, interferencias, las condiciones de las ondas radioeléctricas, la sensibilidad de recepción o el rendimiento de la antena, del sistema operativo, de la aplicación de software, etc.

*² Los perfiles estándar BLUETOOTH indican la finalidad de la comunicación BLUETOOTH entre dispositivos.

Auriculares

Fuente de alimentación

cc de 3,7 V: batería recargable de iones de litio incorporada

Dimensiones

Aprox. 25 × 51 × 29 mm (an/al/prf)

Cable (de la unidad a los auriculares)

Aprox. 0,3 m

Peso

Aprox. 27 g incluyendo auriculares y cable

Auriculares: Aprox. 4 g

(sin incluir el cable)

Receptor

Tipo

Cerrado, dinámico

Auriculares

9 mm tipo cúpula (con CCAW)

Gama de frecuencias de reproducción

De 20 a 20.000 Hz

Micrófono

Tipo

Condensador de electroto omnidireccional

Gama de frecuencia efectiva

100 – 4.000 Hz

El diseño y las especificaciones están sujetos a cambios sin previo aviso.



DR-BT10CX_U2 [US,ES] 2-698-598-41(1)



DR-BT10CX_U2 [US,ES] 2-698-598-41(1)



<http://www.sony.net/>

Printed in Malaysia



* 2 6 9 8 5 9 8 4 1 * (1)



DR-BT10CX_U2 [US,ES] 2-698-598-41(1)