



HCT CO., LTD.

SAN 136-1, AMI-RI , BUBAL-EUP, ICHEON-SI, KYOUNGKI-DO, 467-701, KOREA

TEL: +82 31 639 8565 FAX : +82 31 639 8525 www.hct.co.kr

CERTIFICATE OF COMPLIANCE

FCC Part 24 & 22 Certification

Nokia, Inc.

12278 Scripps Summit Drive, San Diego, CA 92131

Date of Issue: October 24, 2007

Test Report No.: HCT-SAR07-1003

Test Site: HCT CO., LTD.

FCC ID :

QMNRM-347

APPLICANT :

Nokia, Inc.

EUT Type: Dual-Band CDMA/ EV-DO Phone with Bluetooth
Tx Frequency: 824.70 MHz - 848.31 MHz (CDMA)
1 851.25 MHz - 1 908.75 MHz (PCS CDMA)
2 402 MHz - 2 480 MHz (Bluetooth)
Rx Frequency: 869.70 MHz - 893.31 MHz (CDMA)
1 931.25 MHz - 1 988.75 MHz (PCS CDMA)
2 402 MHz - 2 480 MHz (Bluetooth)
Max. RF Output Power: 0.251 W ERP CDMA (24.00 dBm)
0.259 W EIRP PCS CDMA (24.14 dBm)
0.479 W ERP CDMA EVDO (26.80 dBm)
0.418 W EIRP PCS CDMA EVDO (26.21 dBm)
Trade Name/Model(s): Nokia / RM-347
FCC Classification: Licensed Portable Transmitter Held to Ear (PCE)
Application Type: Certification
FCC Rule Part(s): §24(E), §22(H), §2
IC Rule Part(s): RSS-129, RSS-133, RSS-GEN, RSS-210
Emission Designator(s): 1M28F9W

This equipment has been shown to be capable of compliance with the applicable technical standards as indicated in the measurement report and was tested in accordance with the measurement procedures specified in § 2.947.

I attest to the accuracy of data. All measurements reported herein were performed by me or were made under my supervision and are correct to the best of my knowledge and belief. I assume full responsibility for the completeness of these measurements and vouch for the qualifications of all persons taking them.

HCT CO., LTD. Certifies that no party to this application has been denied FCC benefits pursuant to section 5301 of the Anti- Drug Abuse Act of 1998, 21 U.S. C. 853(a)

Report prepared by

: Young-Kwan Kim
Test Engineer of RF Part

Approved by

: Sang- Jun Lee
Manager of RF Part

Table of Contents

1. SCOPE -----	3
2. INTRODUCTION -----	4
3. INSERTS-----	5
4. DESCRIPTION OF TESTS-----	6
5. EFFECTIVE RADIATED POWER OUTPUT -----	13
6. EQUIVALENT ISOTROPIC RADIATED POWER-----	14
7. RADIATED MEASUREMENTS-----	15
8. FREQUENCY STABILITY -----	27
9. LIST OF TEST EQUIPMENT -----	29
10. SAMPLE CALCULATIONS -----	30
11. CONCLUSION-----	31
12. TEST PLOT-----	32

MEASUREMENT REPORT

1. SCOPE

Measurement and determination of electromagnetic emissions (EME) of radio frequency devices including intentional and/or unintentional radiators for compliance with the technical rules and regulations of the Federal Communications Commission.

General Information

Company Name:	Nokia, Inc.
Address:	12278 Scripps Summit Drive, San Diego, CA 92131
Attention:	Mary Washington
Tel. / Fax :	858-831-5000 / 8585-831-6500

- FCC ID: QMNRM-347
- Quantity: Quantity production is planned
- EUT Type: Dual-Band CDMA/ EV-DO Phone with Bluetooth
- Trade Name: Nokia
- Model(s): RM-347
- Serial Number(s): A00000011E6481
- Emission Designator(s): 1M28F9W
- Tx Frequency: 824.70 MHz - 848.31 MHz (CDMA)
1 851.25 MHz - 1 908.75 MHz (PCS CDMA)
2 402 MHz - 2 480 MHz (Bluetooth)
- Rx Frequency: 869.70 MHz - 893.31 MHz (CDMA)
1 931.25 MHz - 1 988.75 MHz (PCS CDMA)
2 402 MHz - 2 480 MHz (Bluetooth)
- Application Type: Certification
- FCC Classification: Licensed Portable Transmitter Held to Ear (PCE)
- FCC Rule Part(s): §24(E), §22(H), §2
- IC Rule Part(s): RSS-129, RSS-133, RSS-GEN, RSS-210
- Modulation(s): CDMA/ PCS CDMA
- Antenna Type: Intenna
- Date(s) of Tests: October 21, 2007~ October 23, 2007
- Place of Tests: HCT CO., LTD.
Icheon, Kyounki-Do, KOREA
- Report Serial No.: HCT-SAR07-1003

2. INTRODUCTION

EUT DESCRIPTION

The FIH Technology Korea RM-347 Dual-Band CDMA phone. Its basic purpose is used for communications. It transmits from CDMA (824.70~848.31), PCS CDMA (1 851.25~1 908.75) MHz and receives from CDMA (869.70~893.31), PCS CDMA (1 931.25~1 988.75) MHz. The RF power is rated at CDMA(0.251 W), PCS CDMA(0.259 W).

MEASURING INSTRUMENT CALIBRATION

The measuring equipment, which was utilized in performing the tests documented herein, has been calibrated in accordance with the manufacturer's recommendations for utilizing calibration equipment, which is traceable to recognized national standards.

Test Facility

The open area test site and conducted measurement facility used to collect the radiated data are located at the 254-1, Maekok-Ri, Hobup-Myun, Ichon-Si, Kyoungki-Do, 467-701, KOREA. The site is constructed in conformance with the requirements of ANSI C63.4 and CISPR Publication 22. Detailed description of test facility was submitted to the Commission and accepted dated July 6, 2006(Registration Number: 90661)

3. INSERTS

Function of Active Devices (Confidential)

The Function of active devices are shown in Attachment K.

Block/Circuit Diagrams & Description (Confidential)

The circuit diagrams & description are shown in Attachment J, and the block diagrams are shown in Attachment I.

Operating Instructions

The instruction manual is shown in Attachment M.

Parts List & Tune-Up Procedure (Confidential)

The parts list & tune-up procedure are shown in Attachment L.

Description of Freq. Stabilization Circuit (Confidential)

The description of frequency stabilization circuit is shown in Attachment K.

Description for Suppression of Spurious Radiation, for Limiting Modulation, and Harmonic Suppresion Circuits (Confidential)

The description of suppression stabilization circuits are shown in Attachment K

4. DESCRIPTION OF TESTS

4.1 Conducted RF Power Test

Test Set-up

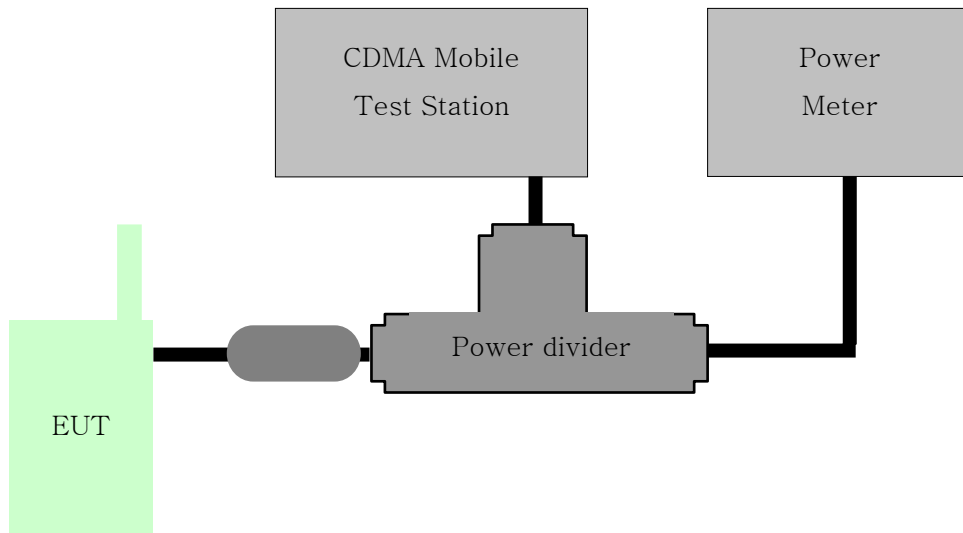

Test Procedure

According to FCC §2.1046 (A), for transmitters other than single sideband, independent sideband and controlled carrier radiotelephone, power output shall be measured at the RF output terminals when the transmitter is adjusted in accordance with the tune-up procedure to give the values of current and voltage on the circuit elements specified in § 2.1033(c)(8). The electrical characteristics of the radio frequency load attached to the output terminals when this test is made shall be stated.

- 1) The EUT was coupled to the power meter and the base station simulator through a power divider. The radio frequency load attached to the EUT antenna terminal was 50 Ohm. The loss of the cables in the test system is calibrated to correct the reading.
- 2) Set EUT maximum power through base station.
- 3) Select lowest, middle, and highest channels for each band.

4.2 Effective Radiated Power.

Test Set-up

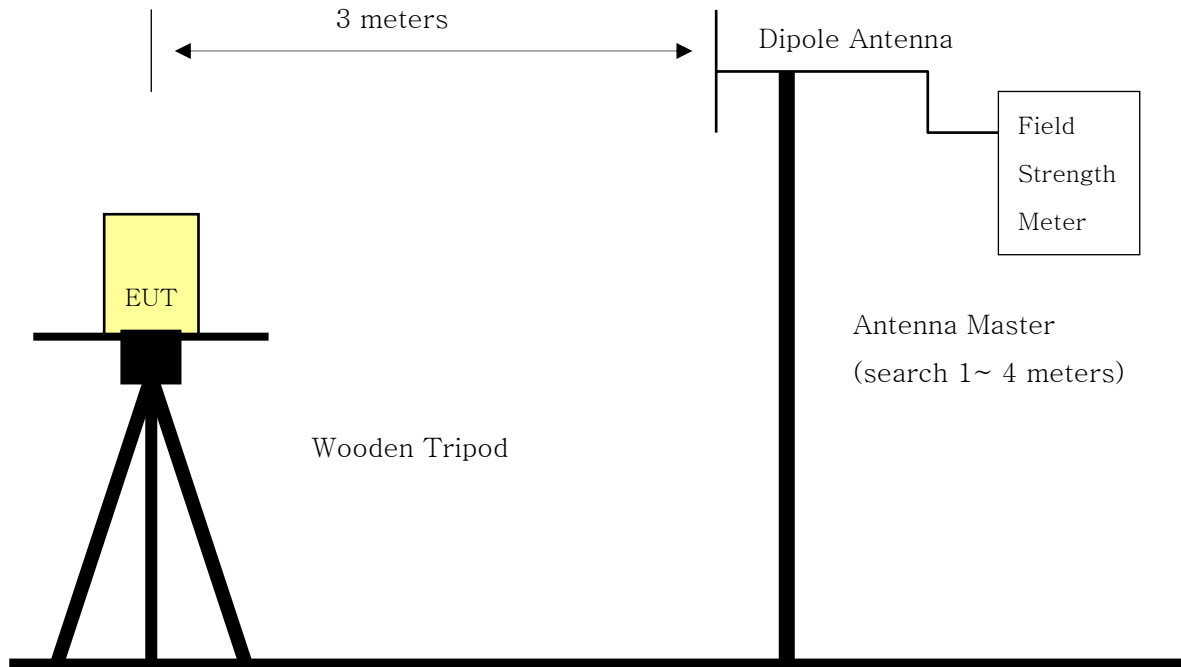

Open Field Test Site

Test Procedure

The measurement facilities used for this test have been documented in previous filings with the commission pursuant to section 2.948.

The open field test site is situated in open field with ground screen whose site attenuation characteristics meet ANSI C63.4 –2003. A mast capable of lifting the receiving antenna from a height of one to four meters is used together with a rotative wooden platform mounted at three from the antenna mast.

- 1) The EUT mounted on a wooden tripod is 0.8 meter above test site ground level.
- 2) During the test, the turn table is rotated and the antenna height is also varied from 1 to 4 meters until the maximum signal is found.
- 3) Record the field strength meter's level.
- 4) Replace the EUT with $\lambda/2$ dipole antenna that is connected to a calibrated signal generator.
- 5) Increase the signal generator output till the field strength meter's level is equal to the item (4).
- 6) The signal generator output level is the rating of effective radiated power (ERP).
- 7) The instrument settings used (RBW/ VBW) during ERP/ EIRP output power measurement are as Below;
 - . Below 1 GHz : RBW 3 MHz, VBW 3 MHz
 - . Above 1 GHz : RBW 3 MHz, VBW 3 MHz

4.3 Occupied bandwidth.

Test Set-up

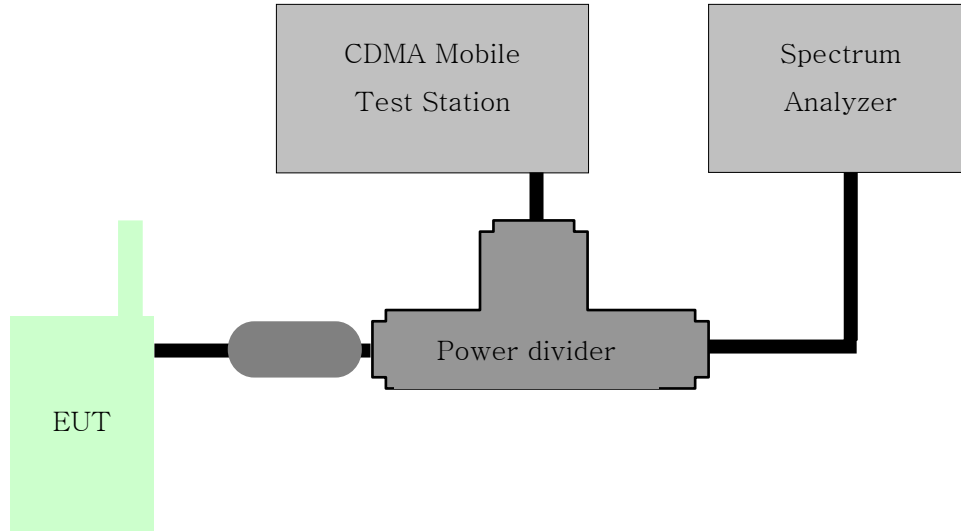

Test Procedure

The EUT was setup to maximum output power at its lowest channel. The occupied bandwidth was measured using a spectrum analyzer. The measurements are repeated for the highest and a middle channel. The EUT's occupied bandwidth is measured as the width of the signal between two points, one below the carrier center frequency and one above the carrier frequency, outside of which all emissions are attenuated at least 26 dB below the transmitter power. Plots of the EUT's occupied bandwidth are shown herein.

4.4 Spurious and Harmonic Emissions at Antenna Terminal.

Test Set-up

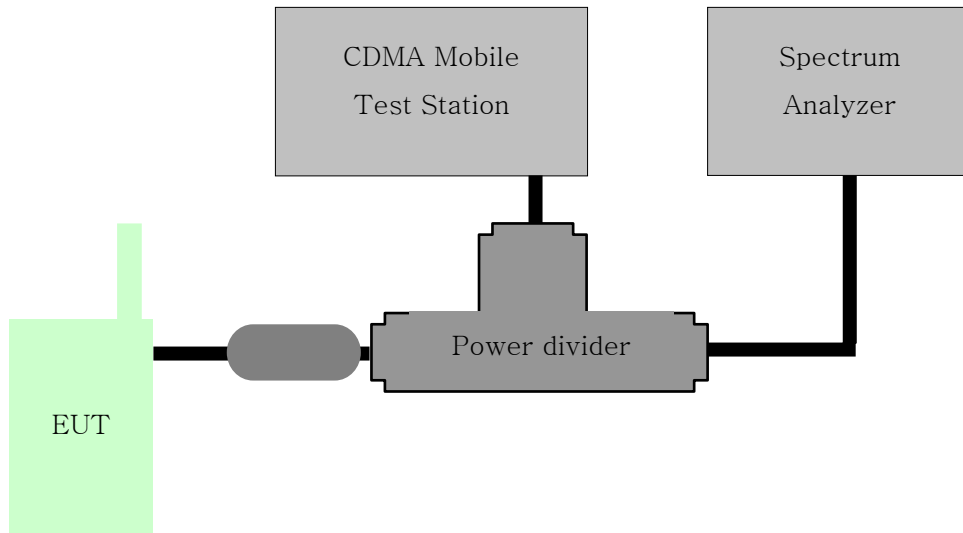

Test Procedure

The EUT was setup to maximum output power at its lowest channel. The Resolution BW of the analyzer is set to 1 % of the emission bandwidth to show compliance with the -13 dBm limit, in the 1 MHz bands immediately outside and adjacent to the edge of the frequency block. The 1 MHz RBW was used to scan from 10 MHz to 10 GHz. (PCS Mode : 10 MHz to 20 GHz). A display line was placed at -13 dBm to show compliance. The high, lowest and a middle channel were tested for out of band measurements.

4.5 Field strength of spurious radiation .

Test Set-up

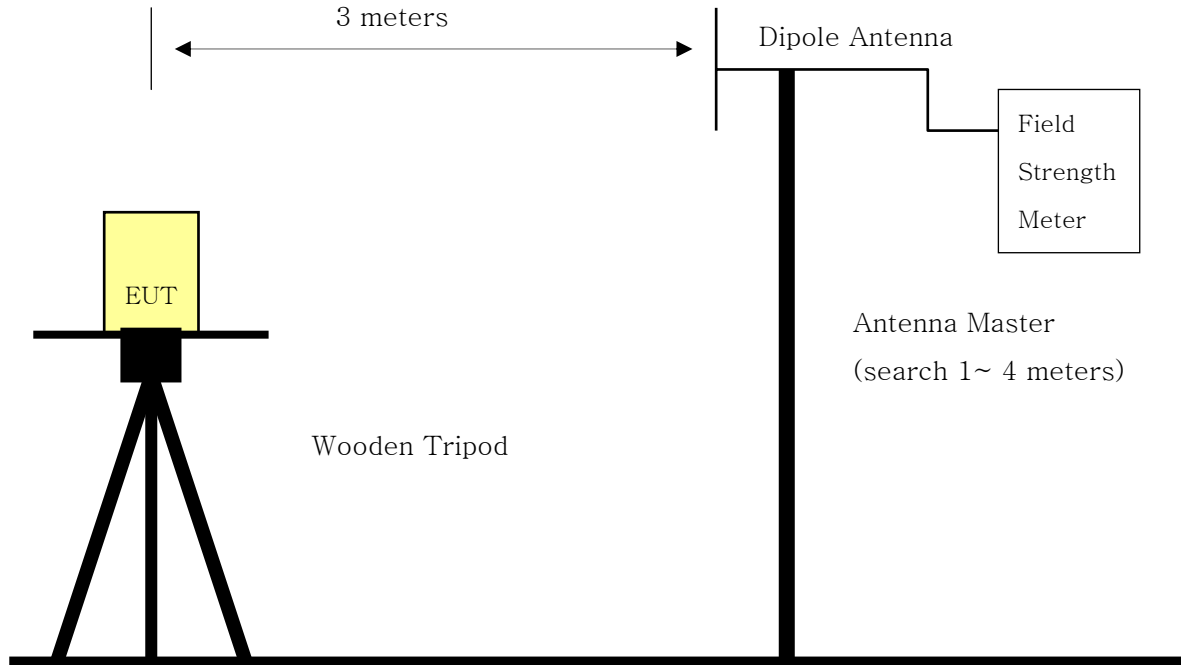

Open Field Test Site

Test Procedure

The measurement facilities used for this test have been documented in previous filings with the commission pursuant to section 2.948.

The open field test site is situated in open field with ground screen whose site attenuation characteristics meet ANSI C63.4 –2003. A mast capable of lifting the receiving antenna from a height of one to four meters is used together with a rotative wooden platform mounted at three from the antenna mast.

- 1) The unit mounted on a wooden table 1.5 m × 1.0 m × 0.80 m is 0.8 meter above test site ground level.
- 2) During the emission test, the turn table is rotated and the EUT is manipulated to find the configuration resulting in maximum emission under normal condition of installation and operation.
- 3) The antenna height and polarization are also varied from 1 to 4 meters until the maximum signal is found.
- 4) The spectrum shall be scanned up to the 10th harmonic of the fundamental frequency.
- 5) The instrument settings used (RBW/ VBW) during ERP/ EIRP output power measurement are as below ;
 - . Below 1 GHz : RBW 3 MHz, VBW 3 MHz
 - . Above 1 GHz : RBW 3 MHz, VBW 3 MHz

4.6 Frequency stability .

4.6.1 Frequency stability with variation of ambient temperature.

Test Set-up

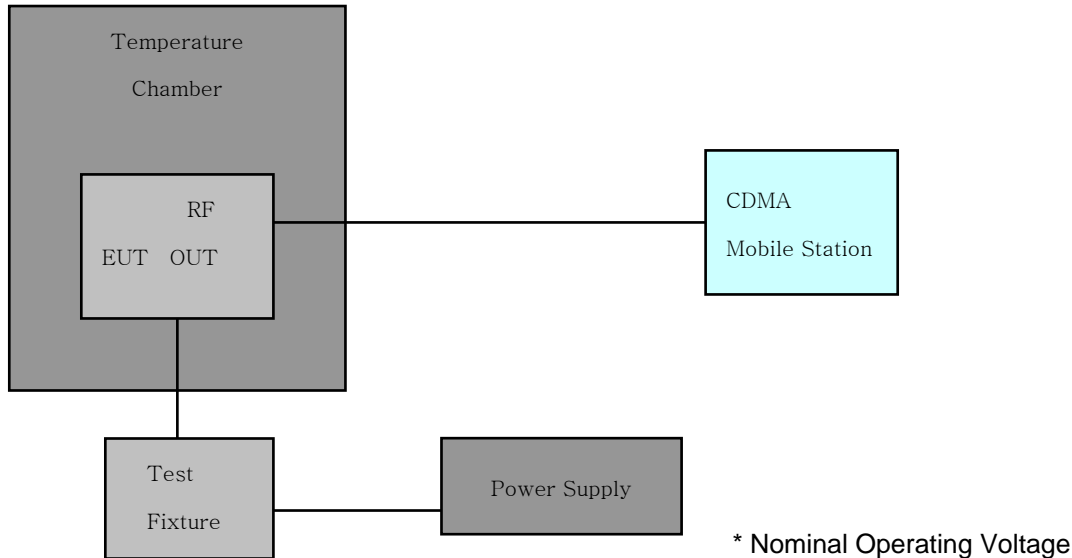

Test Procedure

The frequency stability of the transmitter is measured by:

- a.) **Temperature:** The temperature is varied from - 30 °C to + 50 °C using an environmental chamber.
- b.) **Primary Supply Voltage:** The primary supply voltage is varied from battery end point to 115 % of the voltage normally at the input to the device or at the power supply terminals if cables are not normally supplied.

Specification — The frequency stability shall be sufficient to ensure that the fundamental emission stays within the authorized frequency block. The frequency stability of the transmitter shall be maintained within $\pm 0.00025\%$ (± 2.5 ppm) of the center frequency.

Time Period and Procedure:

1. The carrier frequency of the transmitter and the individual oscillators is measured at room temperature (25 °C to 27 °C to provide a reference).
2. The equipment is subjected to an overnight “soak” at - 30 °C without any power applied.
3. After the overnight “soak” at 30 °C (usually 14-16 hours), the equipment is turned on in a “standby” condition for one minute before applying power to the transmitter. Measurement of the carrier frequency of the transmitter and the individual oscillators is made within a three minute interval after applying power to the transmitter.
4. Frequency measurements are made at 10 °C interval up to room temperature. At least a period of one and one half-hour is provided to allow stabilization of the equipment at each temperature level.
5. Again the transmitter carrier frequency and the individual oscillators is measured at room temperature to begin measurement of the upper temperature levels.
6. Frequency were made at 10 °C intervals starting at - 30 °C up to + 50 °C allowing at least two hours at each temperature for stabilization. In all measurements the frequency is measured within three minutes after applying power to the transmitter.
7. The artificial load is mounted external to the temperature chamber.

NOTE: The EUT is tested down to the battery endpoint.

4.6.2 Frequency stability with variation of primary supply voltage.

Test Set-up

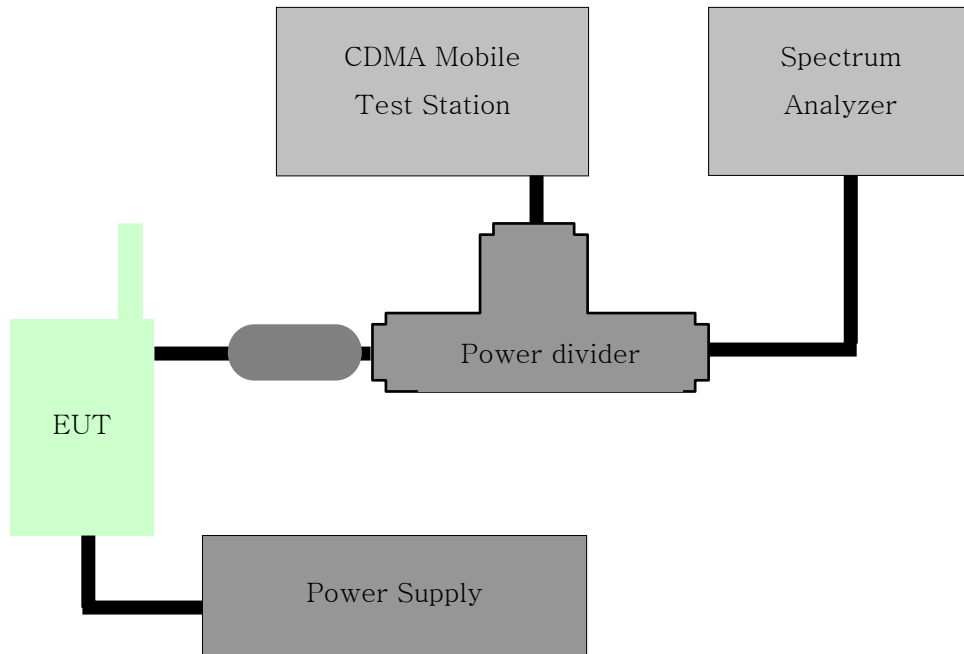

Test Procedure

- 1) The primary supply is varied in steps of from battery end point to 115 % of the nominal supply voltage, or reduce primary supply voltage to the battery operating end point.
- 2) The frequency is recorded each 10 °C step.

5. Effective Radiated Power Output (CDMA)

Radiated measurements at 3 meters

Modulation: CDMA

Mode	Freq. Tuned (MHz)	REF. LEVEL (dBm)	POL (H/V)	ERP (W)	ERP (dBm)	BATTERY
CDMA	824.70	- 23.34	H	0.240	23.81	Standard
CDMA	836.52	- 23.15	H	0.251	24.00	Standard
CDMA	848.31	- 23.23	H	0.247	23.92	Standard
CDMA	836.52	- 23.27	H	0.244	23.88	Extended
EVDO	824.70	- 20.67	H	0.445	26.48	Standard
EVDO	836.52	- 20.35	H	0.479	26.80	Standard
EVDO	848.31	- 20.71	H	0.441	26.44	Standard
EVDO	836.52	- 20.70	H	0.442	26.45	Extended

Note: Extended batteries are the options for this phone

NOTES:

Effective Radiated Power Output Measurements by Substitution Method
according to ANSI/TIA/EIA-603-C-2004, Aug. 17, 2004:

The EUT was placed on a wooden turn table 3-meters from the receive antenna. The receive antenna height and turntable rotation was adjusted for the highest reading on the receive spectrum analyzer. For CDMA signals, a peak detector is used, with RBW = VBW = 3 MHz. For AMPS, GSM, and NADC TDMA signals, a peak detector is used, with RBW = VBW = 1 MHz. A half-wave dipole was substituted in place of the EUT. This dipole antenna was driven by a signal generator and the level of the signal generator was adjusted to obtain the same receive spectrum analyzer reading. The conducted power at the terminals of the dipole is measured. The ERP is recorded.

6. Equivalent Isotropic Radiated Power (E.I.R.P.) PCS CDMA

Radiated measurements at 3 meters

Modulation: PCS CDMA

Mode	Freq. Tuned (MHz)	RFF. LEVEL (dBm)	POL (H/V)	Azimuth (0 angle)	EIRP (W)	EIRP (dBm)	BATTERY
PCS CDMA	1 851.25	- 29.42	V	80	0.259	24.14	Standard
PCS CDMA	1 880.00	- 29.66	V	80	0.245	23.90	Standard
PCS CDMA	1 908.75	- 29.75	V	80	0.240	23.81	Standard
PCS CDMA	1 851.25	- 29.51	V	80	0.254	24.05	Extended
EVDO	1 851.25	- 27.73	V	80	0.383	25.83	Standard
EVDO	1 880.00	- 27.35	V	80	0.418	26.21	Standard
EVDO	1 908.75	- 27.66	V	80	0.389	25.90	Standard
EVDO	1 880.00	- 27.49	V	80	0.405	26.07	Extended

Note: Extended batteries are the options for this phone

NOTES:

Equivalent Isotropic Radiated Power Measurements by Substitution Method
according to ANSI/TIA/EIA-603-C-2004, Aug. 17, 2004:

The EUT was placed on a wooden turn table 3-meters from the receive antenna. The receive antenna height and turntable rotation was adjusted for the highest reading on the receive spectrum analyzer. For CDMA signals, a peak detector is used, with RBW = VBW = 3 MHz. For AMPS, GSM, and NADC TDMA signals, a peak detector is used, with RBW = VBW = 1 MHz. A Horn antenna was substituted in place of the EUT. This Horn antenna was driven by a signal generator and the level of the signal generator was adjusted to obtain the same receive spectrum analyzer reading. The conducted power at the terminals of the Horn antenna is measured. The difference between the gain of the horn and an isotropic antenna is taken into consideration and the EIRP is recorded.

7. Radiated Measurements

7.1 CELLULAR CDMA Radiated Measurements

Field Strength of SPURIOUS Radiation

■ OPERATING FREQUENCY:	824.70 MHz
■ CHANNEL:	1013 (Low)
■ MEASURED OUTPUT POWER:	24.00 dBm = 0.251 W
■ MODULATION SIGNAL:	CDMA (Internal)
■ DISTANCE:	3 meters
■ LIMIT: - (43 + 10 log ₁₀ (W)) =	- 36.99 dBc

Freq. (MHz)	LEVEL @ ANTENNA TERMINALS (dBm)	SUBSTITUTE ANTENNA GAIN (dBd)	CORRECT GENERATOR LEVEL (dBm)	POL (H/V)	(dBc)
1 649.40	- 62.80	7.3	- 55.50	H	- 74.2
2 474.10	- 53.02	8.3	- 44.72	H	- 62.9
3 298.80	- 63.51	9.7	- 53.81	H	- 71.1

NOTES:

Radiated Spurious Emission Measurements by Substitution Method
according to ANSI/TIA/EIA-603-C-2004, Aug. 17, 2004:

The EUT was placed on a wooden turn table 3-meters from the receive antenna. The receive antenna height and turntable rotation was adjusted for the highest reading on the receive spectrum analyzer. For CDMA signals, a peak detector is used, with RBW = VBW = 3 MHz. For AMPS, GSM, and NADC TDMA signals, a peak detector is used, with RBW = VBW = 1 MHz. A half-wave dipole was substituted in place of the EUT. This dipole antenna was driven by a signal generator and the level of the signal generator was adjusted to obtain the same receive spectrum analyzer reading. This spurious level is recorded. For readings above 1 GHz, the above procedure is repeated using horn antennas and the difference between the gain of the horn and an isotropic or dipole antenna are taken into consideration.

7. Radiated Measurements

7.2 CELLULAR CDMA Radiated Measurements

Field Strength of SPURIOUS Radiation

■ OPERATING FREQUENCY:	836.52 MHz
■ CHANNEL:	384 (Mid)
■ MEASURED OUTPUT POWER:	24.00 dBm = 0.251 W
■ MODULATION SIGNAL:	CDMA (Internal)
■ DISTANCE:	3 meters
■ LIMIT: - (43 + 10 log ₁₀ (W)) =	- 36.99 dBc

Freq. (MHz)	LEVEL @ ANTENNA TERMINALS (dBm)	SUBSTITUTE ANTENNA GAIN (dBd)	CORRECT GENERATOR LEVEL (dBm)	POL (H/V)	(dBc)
1 673.04	- 62.11	7.3	- 54.81	H	- 73.5
2 509.56	- 56.30	8.3	- 48.00	H	- 66.2
3 346.08	- 66.60	9.7	- 56.90	H	- 74.2

NOTES:

Radiated Spurious Emission Measurements by Substitution Method
according to ANSI/TIA/EIA-603-C-2004, Aug. 17, 2004:

The EUT was placed on a wooden turn table 3-meters from the receive antenna. The receive antenna height and turntable rotation was adjusted for the highest reading on the receive spectrum analyzer. For CDMA signals, a peak detector is used, with RBW = VBW = 3 MHz. For AMPS, GSM, and NADC TDMA signals, a peak detector is used, with RBW = VBW = 1 MHz. A half-wave dipole was substituted in place of the EUT. This dipole antenna was driven by a signal generator and the level of the signal generator was adjusted to obtain the same receive spectrum analyzer reading. This spurious level is recorded. For readings above 1 GHz, the above procedure is repeated using horn antennas and the difference between the gain of the horn and an isotropic or dipole antenna are taken into consideration.

7. Radiated Measurements

7.3 CELLULAR CDMA Radiated Measurements

Field Strength of SPURIOUS Radiation

■ OPERATING FREQUENCY:	848.31 MHz
■ CHANNEL:	777 (High)
■ MEASURED OUTPUT POWER:	24.00 dBm = 0.251 W
■ MODULATION SIGNAL:	CDMA (Internal)
■ DISTANCE:	3 meters
■ LIMIT: - (43 + 10 log ₁₀ (W)) =	- 36.99 dBc

Freq. (MHz)	LEVEL @ ANTENNA TERMINALS (dBm)	SUBSTITUTE ANTENNA GAIN (dBd)	CORRECT GENERATOR LEVEL (dBm)	POL (H/V)	(dBc)
1 696.62	- 66.02	7.3	- 58.72	H	- 77.4
2 544.93	- 57.51	8.3	- 49.21	H	- 67.4
3 393.24	- 70.84	9.7	- 61.14	H	- 78.4

NOTES:

Radiated Spurious Emission Measurements by Substitution Method
according to ANSI/TIA/EIA-603-C-2004, Aug. 17, 2004:

The EUT was placed on a wooden turn table 3-meters from the receive antenna. The receive antenna height and turntable rotation was adjusted for the highest reading on the receive spectrum analyzer. For CDMA signals, a peak detector is used, with RBW = VBW = 3 MHz. For AMPS, GSM, and NADC TDMA signals, a peak detector is used, with RBW = VBW = 1 MHz. A half-wave dipole was substituted in place of the EUT. This dipole antenna was driven by a signal generator and the level of the signal generator was adjusted to obtain the same receive spectrum analyzer reading. This spurious level is recorded. For readings above 1 GHz, the above procedure is repeated using horn antennas and the difference between the gain of the horn and an isotropic or dipole antenna are taken into consideration.

7. Radiated Measurements

7.4 CELLULAR PCS CDMA Radiated Measurements

Field Strength of SPURIOUS Radiation

■ OPERATING FREQUENCY:	_____	1 851.25 MHz
■ CHANNEL:	_____	25 (Low)
■ MEASURED OUTPUT POWER:	_____	24.14 dBm = 0.259 W
■ MODULATION SIGNAL:	_____	PCS CDMA (Internal)
■ DISTANCE:	_____	3 meters
■ LIMIT: - (43 + 10 log ₁₀ (W)) =	_____	- 37.13 dBc

Freq. (MHz)	LEVEL@ ANTENNA TERMINALS (dBm)	SUBSTITUTE ANTENNA GAIN (dBi)	CORRECT GENERATOR LEVEL (dBm)	POL (H/V)	(dBc)
3 702.50	- 63.61	12.4	- 51.21	V	- 66.0
5 553.75	- 72.23	11.7	- 60.53	V	- 76.5
7 405.00	- 67.71	11.5	- 56.21	V	- 72.9

NOTES:

Radiated Spurious Emission Measurements by Substitution Method
according to ANSI/TIA/EIA-603-C-2004, Aug. 17, 2004:

The EUT was placed on a wooden turn table 3-meters from the receive antenna. The receive antenna height and turntable rotation was adjusted for the highest reading on the receive spectrum analyzer. For CDMA signals, a peak detector is used, with RBW = VBW = 3 MHz. For AMPS, GSM, and NADC TDMA signals, a peak detector is used, with RBW = VBW = 1 MHz. A half-wave dipole was substituted in place of the EUT. This dipole antenna was driven by a signal generator and the level of the signal generator was adjusted to obtain the same receive spectrum analyzer reading. This spurious level is recorded. For readings above 1 GHz, the above procedure is repeated using horn antennas and the difference between the gain of the horn and an isotropic or dipole antenna are taken into consideration.

7. Radiated Measurements

7.5 CELLULAR PCS CDMA Radiated Measurements

Field Strength of SPURIOUS Radiation

■ OPERATING FREQUENCY:	_____	1 880.00 MHz
■ CHANNEL:	_____	600 (Middle)
■ MEASURED OUTPUT POWER:	_____	24.14 dBm = 0.259 W
■ MODULATION SIGNAL:	_____	PCS CDMA (Internal)
■ DISTANCE:	_____	3 meters
■ LIMIT: - (43 + 10 log ₁₀ (W)) =	_____	- 37.13 dBc

Freq. (MHz)	LEVEL @ ANTENNA TERMINALS (dBm)	SUBSTITUTE ANTENNA GAIN (dBi)	CORRECT GENERATOR LEVEL (dBm)	POL (H/V)	(dBc)
3 760.00	- 66.62	12.4	- 54.22	V	- 69.0
5 640.00	- 72.19	11.7	- 60.49	V	- 76.4
7 520.00	- 73.11	11.5	- 61.61	V	- 78.3

NOTES:

Radiated Spurious Emission Measurements by Substitution Method
according to ANSI/TIA/EIA-603-C-2004, Aug. 17, 2004:

The EUT was placed on a wooden turn table 3-meters from the receive antenna. The receive antenna height and turntable rotation was adjusted for the highest reading on the receive spectrum analyzer. For CDMA signals, a peak detector is used, with RBW = VBW = 3 MHz. For AMPS, GSM, and NADC TDMA signals, a peak detector is used, with RBW = VBW = 1 MHz. A half-wave dipole was substituted in place of the EUT. This dipole antenna was driven by a signal generator and the level of the signal generator was adjusted to obtain the same receive spectrum analyzer reading. This spurious level is recorded. For readings above 1 GHz, the above procedure is repeated using horn antennas and the difference between the gain of the horn and an isotropic or dipole antenna are taken into consideration.

7. Radiated Measurements

7.6 CELLULAR PCS CDMA Radiated Measurements

Field Strength of SPURIOUS Radiation

■ OPERATING FREQUENCY:	_____	1 908.75 MHz
■ CHANNEL:	_____	1175 (High)
■ MEASURED OUTPUT POWER:	_____	24.14 dBm = 0.259 W
■ MODULATION SIGNAL:	_____	PCS CDMA (Internal)
■ DISTANCE:	_____	3 meters
■ LIMIT: - (43 + 10 log ₁₀ (W)) =	_____	- 37.13 dBc

Freq. (MHz)	LEVEL @ ANTENNA TERMINALS (dBm)	SUBSTITUTE ANTENNA GAIN (dBi)	CORRECT GENERATOR LEVEL (dBm)	POL (H/V)	(dBc)
3 817.50	- 59.78	12.4	- 47.38	V	- 62.1
5 726.25	- 71.68	11.7	- 59.98	V	- 75.9
7 635.00	- 66.90	11.5	- 55.40	V	- 72.0

NOTES:

Radiated Spurious Emission Measurements by Substitution Method
according to ANSI/TIA/EIA-603-C-2004, Aug. 17, 2004:

The EUT was placed on a wooden turn table 3-meters from the receive antenna. The receive antenna height and turntable rotation was adjusted for the highest reading on the receive spectrum analyzer. For CDMA signals, a peak detector is used, with RBW = VBW = 3 MHz. For AMPS, GSM, and NADC TDMA signals, a peak detector is used, with RBW = VBW = 1 MHz. A half-wave dipole was substituted in place of the EUT. This dipole antenna was driven by a signal generator and the level of the signal generator was adjusted to obtain the same receive spectrum analyzer reading. This spurious level is recorded. For readings above 1 GHz, the above procedure is repeated using horn antennas and the difference between the gain of the horn and an isotropic or dipole antenna are taken into consideration.

7. Radiated Measurements

7.7 CELLULAR CDMA EVDO Radiated Measurements

Field Strength of SPURIOUS Radiation

■ OPERATING FREQUENCY:	824.70 MHz
■ CHANNEL:	1013 (Low)
■ MEASURED OUTPUT POWER:	26.80 dBm = 0.479 W
■ MODULATION SIGNAL:	CDMA EVDO (Internal)
■ DISTANCE:	3 meters
■ LIMIT: - (43 + 10 log ₁₀ (W)) =	- 39.80 dBc

Freq. (MHz)	LEVEL @ ANTENNA TERMINALS (dBm)	SUBSTITUTE ANTENNA GAIN (dBd)	CORRECT GENERATOR LEVEL (dBm)	POL (H/V)	(dBc)
1 649.40	- 55.62	7.3	- 48.32	H	- 69.8
2 474.10	- 49.61	8.3	- 41.31	H	- 62.3
3 298.80	- 61.12	9.7	- 51.42	H	- 71.5

NOTES:

Radiated Spurious Emission Measurements by Substitution Method
according to ANSI/TIA/EIA-603-C-2004, Aug. 17, 2004:

The EUT was placed on a wooden turn table 3-meters from the receive antenna. The receive antenna height and turntable rotation was adjusted for the highest reading on the receive spectrum analyzer. For CDMA signals, a peak detector is used, with RBW = VBW = 3 MHz. For AMPS, GSM, and NADC TDMA signals, a peak detector is used, with RBW = VBW = 1 MHz. A half-wave dipole was substituted in place of the EUT. This dipole antenna was driven by a signal generator and the level of the signal generator was adjusted to obtain the same receive spectrum analyzer reading. This spurious level is recorded. For readings above 1 GHz, the above procedure is repeated using horn antennas and the difference between the gain of the horn and an isotropic or dipole antenna are taken into consideration.

7. Radiated Measurements

7.8 CELLULAR CDMA EVDO Radiated Measurements

Field Strength of SPURIOUS Radiation

■ OPERATING FREQUENCY:	836.52 MHz
■ CHANNEL:	384 (Mid)
■ MEASURED OUTPUT POWER:	26.80 dBm = 0.479 W
■ MODULATION SIGNAL:	CDMA EVDO (Internal)
■ DISTANCE:	3 meters
■ LIMIT: - (43 + 10 log ₁₀ (W)) =	- 39.80 dBc

Freq. (MHz)	LEVEL @ ANTENNA TERMINALS (dBm)	SUBSTITUTE ANTENNA GAIN (dBd)	CORRECT GENERATOR LEVEL (dBm)	POL (H/V)	(dBc)
1 673.04	- 55.73	7.3	- 48.43	H	- 69.9
2 509.56	- 59.43	8.3	- 51.13	H	- 72.1
3 346.08	- 58.92	9.7	- 49.22	H	- 69.3

NOTES:

Radiated Spurious Emission Measurements by Substitution Method
according to ANSI/TIA/EIA-603-C-2004, Aug. 17, 2004:

The EUT was placed on a wooden turn table 3-meters from the receive antenna. The receive antenna height and turntable rotation was adjusted for the highest reading on the receive spectrum analyzer. For CDMA signals, a peak detector is used, with RBW = VBW = 3 MHz. For AMPS, GSM, and NADC TDMA signals, a peak detector is used, with RBW = VBW = 1 MHz. A half-wave dipole was substituted in place of the EUT. This dipole antenna was driven by a signal generator and the level of the signal generator was adjusted to obtain the same receive spectrum analyzer reading. This spurious level is recorded. For readings above 1 GHz, the above procedure is repeated using horn antennas and the difference between the gain of the horn and an isotropic or dipole antenna are taken into consideration.

7. Radiated Measurements

7.9 CELLULAR CDMA EVDO Radiated Measurements

Field Strength of SPURIOUS Radiation

■ OPERATING FREQUENCY:	848.31 MHz
■ CHANNEL:	777 (High)
■ MEASURED OUTPUT POWER:	26.80 dBm = 0.479 W
■ MODULATION SIGNAL:	CDMA EVDO (Internal)
■ DISTANCE:	3 meters
■ LIMIT: - (43 + 10 log ₁₀ (W)) =	- 39.80 dBc

Freq. (MHz)	LEVEL @ ANTENNA TERMINALS (dBm)	SUBSTITUTE ANTENNA GAIN (dBd)	CORRECT GENERATOR LEVEL (dBm)	POL (H/V)	(dBc)
1 696.62	- 57.44	7.3	- 50.14	H	- 71.6
2 544.93	- 51.65	8.3	- 43.35	H	- 64.4
3 393.24	- 53.81	9.7	- 44.11	H	- 64.2

NOTES:

Radiated Spurious Emission Measurements by Substitution Method
according to ANSI/TIA/EIA-603-C-2004, Aug. 17, 2004:

The EUT was placed on a wooden turn table 3-meters from the receive antenna. The receive antenna height and turntable rotation was adjusted for the highest reading on the receive spectrum analyzer. For CDMA signals, a peak detector is used, with RBW = VBW = 3 MHz. For AMPS, GSM, and NADC TDMA signals, a peak detector is used, with RBW = VBW = 1 MHz. A half-wave dipole was substituted in place of the EUT. This dipole antenna was driven by a signal generator and the level of the signal generator was adjusted to obtain the same receive spectrum analyzer reading. This spurious level is recorded. For readings above 1 GHz, the above procedure is repeated using horn antennas and the difference between the gain of the horn and an isotropic or dipole antenna are taken into consideration.

7. Radiated Measurements

7.10 CELLULAR PCS CDMA EVDO Radiated Measurements

Field Strength of SPURIOUS Radiation

■ OPERATING FREQUENCY:	_____	1 851.25 MHz
■ CHANNEL:	_____	25 (Low)
■ MEASURED OUTPUT POWER:	_____	26.21 dBm = 0.418 W
■ MODULATION SIGNAL:	_____	PCS CDMA EVDO(Internal)
■ DISTANCE:	_____	3 meters
■ LIMIT: - (43 + 10 log ₁₀ (W)) =	_____	- 39.21 dBc

Freq. (MHz)	LEVEL@ ANTENNA TERMINALS (dBm)	SUBSTITUTE ANTENNA GAIN (dBi)	CORRECT GENERATOR LEVEL (dBm)	POL (H/V)	(dBc)
3 702.50	- 52.76	12.4	- 40.36	V	- 57.2
5 553.75	- 50.83	11.7	- 39.13	V	- 57.1
7 405.00	- 61.72	11.5	- 50.22	V	- 68.9

NOTES:

Radiated Spurious Emission Measurements by Substitution Method
according to ANSI/TIA/EIA-603-C-2004, Aug. 17, 2004:

The EUT was placed on a wooden turn table 3-meters from the receive antenna. The receive antenna height and turntable rotation was adjusted for the highest reading on the receive spectrum analyzer. For CDMA signals, a peak detector is used, with RBW = VBW = 3 MHz. For AMPS, GSM, and NADC TDMA signals, a peak detector is used, with RBW = VBW = 1 MHz. A half-wave dipole was substituted in place of the EUT. This dipole antenna was driven by a signal generator and the level of the signal generator was adjusted to obtain the same receive spectrum analyzer reading. This spurious level is recorded. For readings above 1 GHz, the above procedure is repeated using horn antennas and the difference between the gain of the horn and an isotropic or dipole antenna are taken into consideration.

7. Radiated Measurements

7.11 CELLULAR PCS CDMA EVDO Radiated Measurements

Field Strength of SPURIOUS Radiation

■ OPERATING FREQUENCY:	_____	1 880.00 MHz
■ CHANNEL:	_____	600 (Middle)
■ MEASURED OUTPUT POWER:	_____	26.21 dBm = 0.418 W
■ MODULATION SIGNAL:	_____	PCS CDMA EVDO(Internal)
■ DISTANCE:	_____	3 meters
■ LIMIT: - (43 + 10 log ₁₀ (W)) =	_____	- 39.21 dBc

Freq. (MHz)	LEVEL @ ANTENNA TERMINALS (dBm)	SUBSTITUTE ANTENNA GAIN (dBi)	CORRECT GENERATOR LEVEL (dBm)	POL (H/V)	(dBc)
3 760.00	- 63.61	12.4	- 51.21	V	- 68.0
5 640.00	- 66.07	11.7	- 54.37	V	- 72.4
7 520.00	- 65.91	11.5	- 54.41	V	- 73.1

NOTES:

Radiated Spurious Emission Measurements by Substitution Method
according to ANSI/TIA/EIA-603-C-2004, Aug. 17, 2004:

The EUT was placed on a wooden turn table 3-meters from the receive antenna. The receive antenna height and turntable rotation was adjusted for the highest reading on the receive spectrum analyzer. For CDMA signals, a peak detector is used, with RBW = VBW = 3 MHz. For AMPS, GSM, and NADC TDMA signals, a peak detector is used, with RBW = VBW = 1 MHz. A half-wave dipole was substituted in place of the EUT. This dipole antenna was driven by a signal generator and the level of the signal generator was adjusted to obtain the same receive spectrum analyzer reading. This spurious level is recorded. For readings above 1 GHz, the above procedure is repeated using horn antennas and the difference between the gain of the horn and an isotropic or dipole antenna are taken into consideration.

7. Radiated Measurements

7.12 CELLULAR PCS CDMA EVDO Radiated Measurements

Field Strength of SPURIOUS Radiation

■ OPERATING FREQUENCY:	_____	1 908.75 MHz
■ CHANNEL:	_____	1175 (High)
■ MEASURED OUTPUT POWER:	_____	26.21 dBm = 0.418 W
■ MODULATION SIGNAL:	_____	PCS CDMA EVDO(Internal)
■ DISTANCE:	_____	3 meters
■ LIMIT: - (43 + 10 log ₁₀ (W)) =	_____	- 39.21 dBc

Freq. (MHz)	LEVEL @ ANTENNA TERMINALS (dBm)	SUBSTITUTE ANTENNA GAIN (dBi)	CORRECT GENERATOR LEVEL (dBm)	POL (H/V)	(dBc)
3 817.50	- 52.52	12.4	- 40.12	V	- 56.9
5 726.25	- 61.92	11.7	- 50.22	V	- 68.2
7 635.00	- 59.92	11.5	- 48.42	V	- 67.1

NOTES:

Radiated Spurious Emission Measurements by Substitution Method
according to ANSI/TIA/EIA-603-C-2004, Aug. 17, 2004:

The EUT was placed on a wooden turn table 3-meters from the receive antenna. The receive antenna height and turntable rotation was adjusted for the highest reading on the receive spectrum analyzer.

For CDMA signals, a peak detector is used, with RBW = VBW = 3 MHz. For AMPS, GSM, and NADC TDMA signals, a peak detector is used, with RBW = VBW = 1 MHz. A half-wave dipole was substituted in place of the EUT. This dipole antenna was driven by a signal generator and the level of the signal generator was adjusted to obtain the same receive spectrum analyzer reading. This spurious level is recorded. For readings above 1 GHz, the above procedure is repeated using horn antennas and the difference between the gain of the horn and an isotropic or dipole antenna are taken into consideration.

8. FREQUENCY STABILITY

8.1 FREQUENCY STABILITY (CDMA)

OPERATING FREQUENCY: 836 520 000 Hz
 CHANNEL: 384
 REFERENCE VOLTAGE: 3.7 VDC
 DEVIATION LIM IT: ± 0.000 25 % or 2.5 ppm

Voltage (%)	Power (VDC)	Temp. (°C)	Frequency (Hz)	Frequency Error (Hz)	Deviation (%)	ppm
100%	3,700	+20(Ref)	836,519,964	-36	-0,000004	-0,019
100%		-30	836,519,948	-52	-0,000006	-0,028
100%		-20	836,520,038	38	0,000005	0,020
100%		-10	836,519,957	-43	-0,000005	-0,023
100%		0	836,520,034	34	0,000004	0,018
100%		+10	836,519,961	-39	-0,000005	-0,021
100%		+20	836,519,964	-36	-0,000004	-0,019
100%		+30	836,519,959	-41	-0,000005	-0,022
100%		+40	836,520,052	52	0,000006	0,028
100%		+50	836,520,047	47	0,000006	0,025
115%	4,255	+20	836,519,959	-41	-0,000005	-0,022
Batt Endpoint	3,200	+20	836,520,051	51	0,000006	0,027

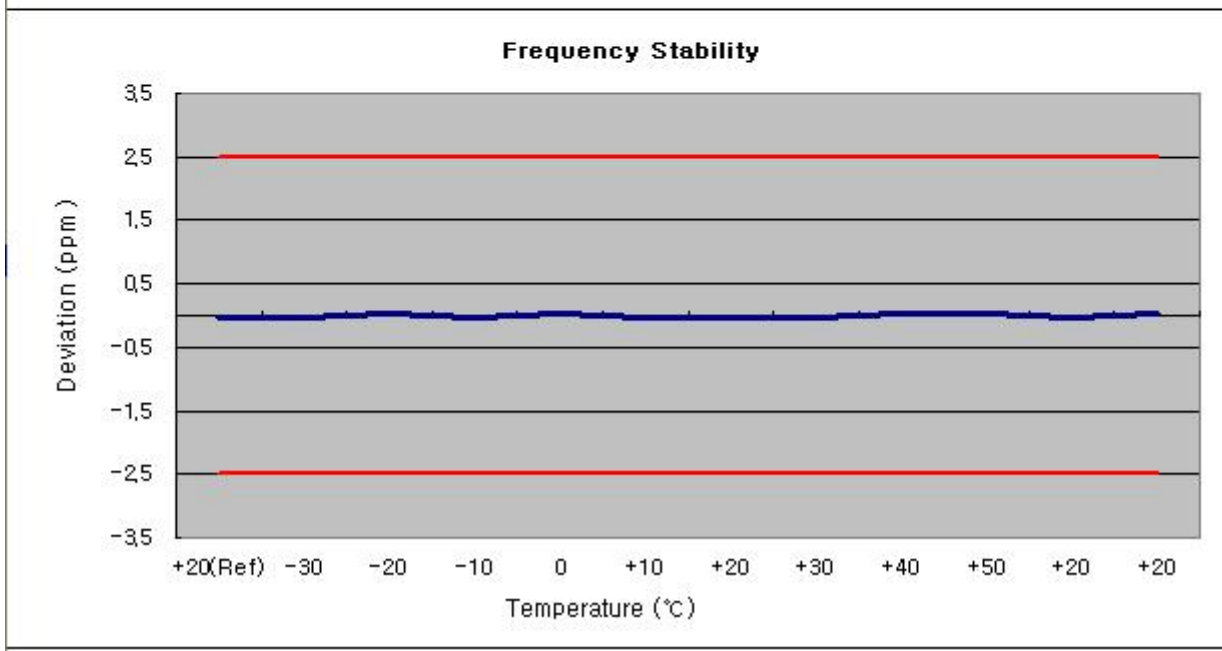

8. FREQUENCY STABILITY

8.2 FREQUENCY STABILITY (PCS CDMA)

OPERATING FREQUENCY: 1 880 000 000 Hz
 CHANNEL: 600
 REFERENCE VOLTAGE: 3.7 VDC
 DEVIATION LIM IT: ± 0.000 25 % or 2.5 ppm

Voltage (%)	Power (VDC)	Temp. (°C)	Frequency (Hz)	Frequency Error (Hz)	Deviation (%)	ppm
100%	3.700	+20(Ref)	1,799,999,974	-26	-0,000003	-0,014
100%		-30	1,800,000,047	47	0,000006	0,025
100%		-20	1,800,000,039	39	0,000005	0,021
100%		-10	1,799,999,959	-41	-0,000005	-0,022
100%		0	1,799,999,966	-34	-0,000004	-0,018
100%		+10	1,800,000,031	31	0,000004	0,016
100%		+20	1,799,999,974	-26	-0,000003	-0,014
100%		+30	1,799,999,971	-29	-0,000003	-0,015
100%		+40	1,800,000,035	35	0,000004	0,019
100%		+50	1,799,999,957	-43	-0,000005	-0,023
115%	4.255	+20	1,800,000,038	38	0,000005	0,020
Batt. Endpoint	3.200	+20	1,799,999,959	-41	-0,000005	-0,022

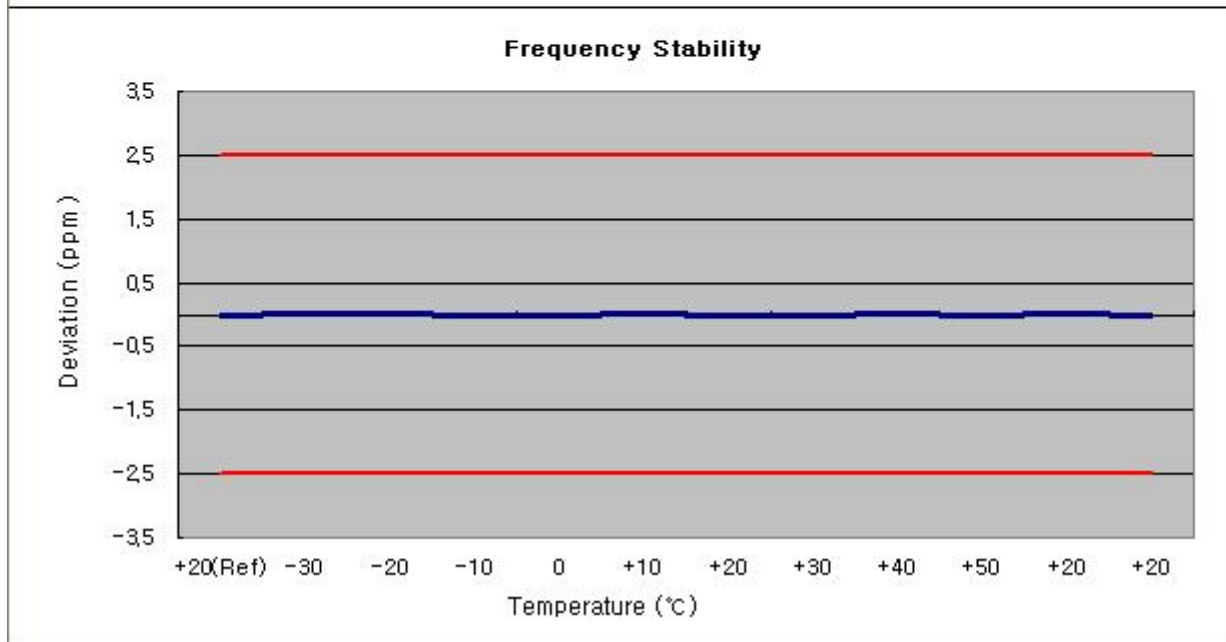

9. LIST OF TEST EQUIPMENT

Manufacture	Model/ Equipment	Serial Number	Calibration Date	Calibration Interval	Calibration Due
R&S	ESI40/ Spectrum Analyzer	831564/003	11/06/2006	Annual	11/06/2007
Advantest	R3273/ Spectrum Analyzer	J04821	03/15/2007	Annual	03/15/2008
HP	8664A/ Signal Generator	3744A02069	04/10/2007	Annual	04/10/2008
Agilent	E4416A/ Power Meter	GB41291412	01/22/2007	Annual	01/22/2008
Agilent	E9327A/ Power Sensor	US40440910	01/24/2007	Annual	01/24/2008
Agilent	HP8901B/ Modulation Analyzer	3438A05231	08/04/2007	Annual	08/04/2008
Agilent	8903A/ Audio Analyzer	2433A04322	08/04/2007	Annual	08/04/2008
R&S	CMU200/ Base Station	839117/011	01/28/2007	Annual	01/28/2008
Agilent	8960 (E5515C)/ Base Station	GB44400269	02/11/2007	Annual	02/11/2008
Tescom	TC-3000/ Bluetooth Simulator	3000A4900112	01/22/2007	Annual	01/22/2008
MITEQ	AMF-6D-01180-35-20P/ AMP	990893	02/24/2007	Annual	02/24/2008
Wainwright	WHK1.2/15G-10EF/H.P.F	2	06/28/2007	Annual	06/28/2008
Wainwright	WHK3.3/18G-10EF/H.P.F	1	06/28/2007	Annual	06/28/2008
Agilent	778D/ Dual Directional Coupler	16072	11/09/2006	Annual	11/09/2007
Agilent	1506A/ Power Divider	99441	11/10/2006	Annual	11/10/2007
Digital	EP-3010/ Power Supply	3110117	12/29/2006	Annual	12/29/2007
Schwarzbeck	UHAP/ Dipole Antenna	630	11/13/2006	Annual	11/13/2007
Schwarzbeck	UHAP/ Dipole Antenna	605	11/13/2006	Annual	11/13/2007
R&S	HFH2-Z2/ Loop Antenna	881056/070	12/11/2006	Annual	12/11/2007
Schwarzbeck	VULB9160/ TRILOG Antenna	3150	03/19/2007	Annual	03/19/2008
Schwarzbeck	VULB9160/ TRILOG Antenna	4150	01/23/2007	Annual	01/23/2008
Schwarzbeck	BBHA 9120D/ Horn Antenna	147	03/31/2006	Biennial	03/31/2008
Schwarzbeck	BBHA 9120D/ Horn Antenna	1201	05/02/2006	Biennial	05/02/2008
Korea Engineering	KR-1005L / Chamber	KRAB07063-2CH	01/08/2007	Annual	01/08/2008

10. SAMPLE CALCULATIONS

A. ERP Sample Calculation

Freq. Tuned (MHz)	LEVEL (dBm)	ANT. GAIN (dB)	C.L (dB)	AMP (dB)	POL (H/V)	ERP (W)	ERP (dBm)	BATTERY
824.70	- 23.34	2.65	2.5	47	H	0.240	23.81	Standard

- 1) The EUT mounted on a wooden tripod is 0.8 meter above test site ground level.
- 2) During the test , the turn table is rotated and the antenna height is also varied from 1 to 4 meters until the maximum signal is found.
- 3) Record the field strength meter's level. (**LEVEL**)
- 4) Replace the EUT with dipole antenna that is connected to a calibrated signal generator.
- 5) Increase the signal generator output till the field strength meter's level is equal to the item.
- 6) The signal generator output level with cable loss is the rating of effective radiated power(**ERP**).
(Cable loss means the factor between Signal Generator and Transmitting Antenna.)

For more details, please refer to the test set-up procedure.

B. Emission Designator

Emission Designator = 1M28F9W

CDMA BW = 1.28 MHz

F = Frequency Modulation

9 = Composite Digital Info

W = Combination (Audio/Data)

(Measured at the 99.75 % power bandwidth)

11. CONCLUSION

The data collected shows that the **Dual-Band CDMA/ EV-DO Phone with Bluetooth**

FCC ID: QMNRM-347 complies with all the requirements of Parts 2 and 22, 24 of the FCC rules.

12. TEST PLOTS

■ Cellular MODE (1013 CH.) Conducted Spurious

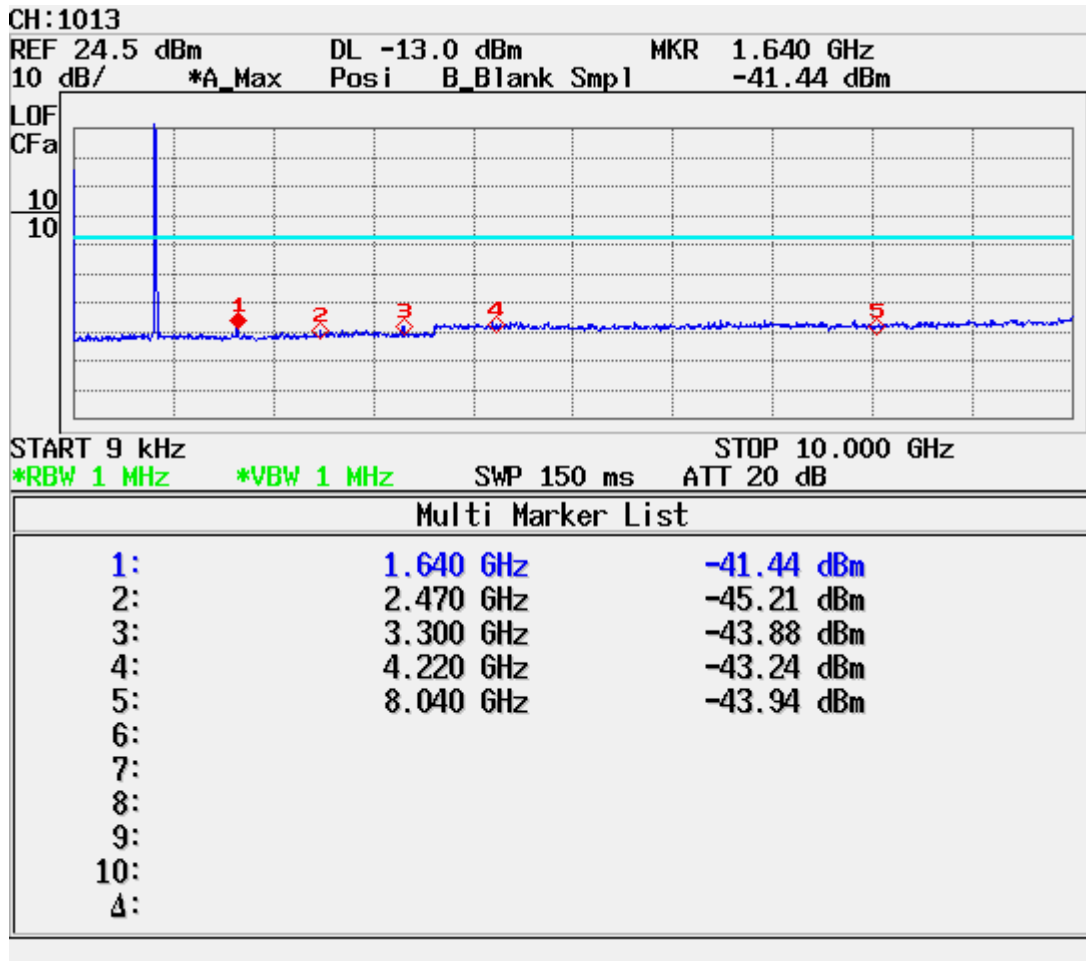

■ Cellular MODE (384 CH.) Conducted Spurious

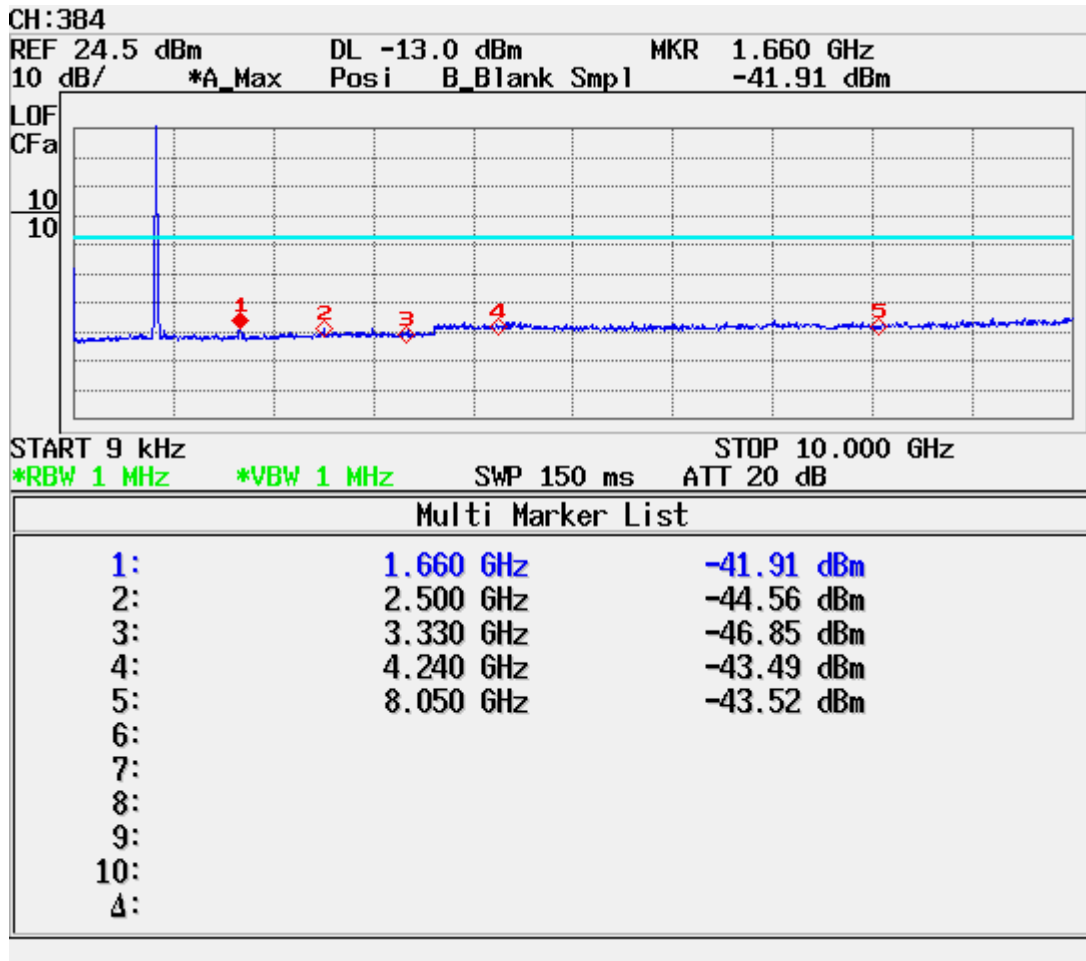

■ Cellular MODE (777 CH.) Conducted Spurious

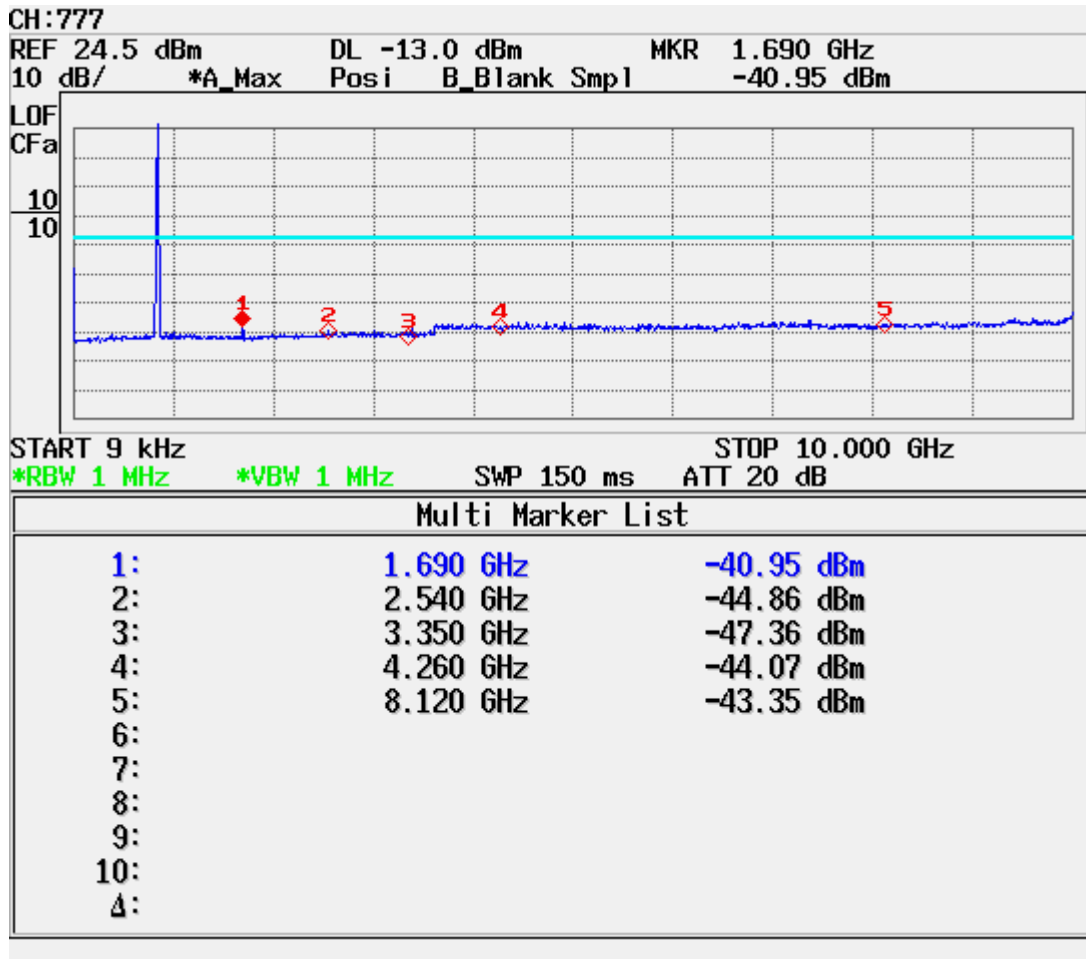

■ US PCS MODE (25 CH.) Conducted Spurious

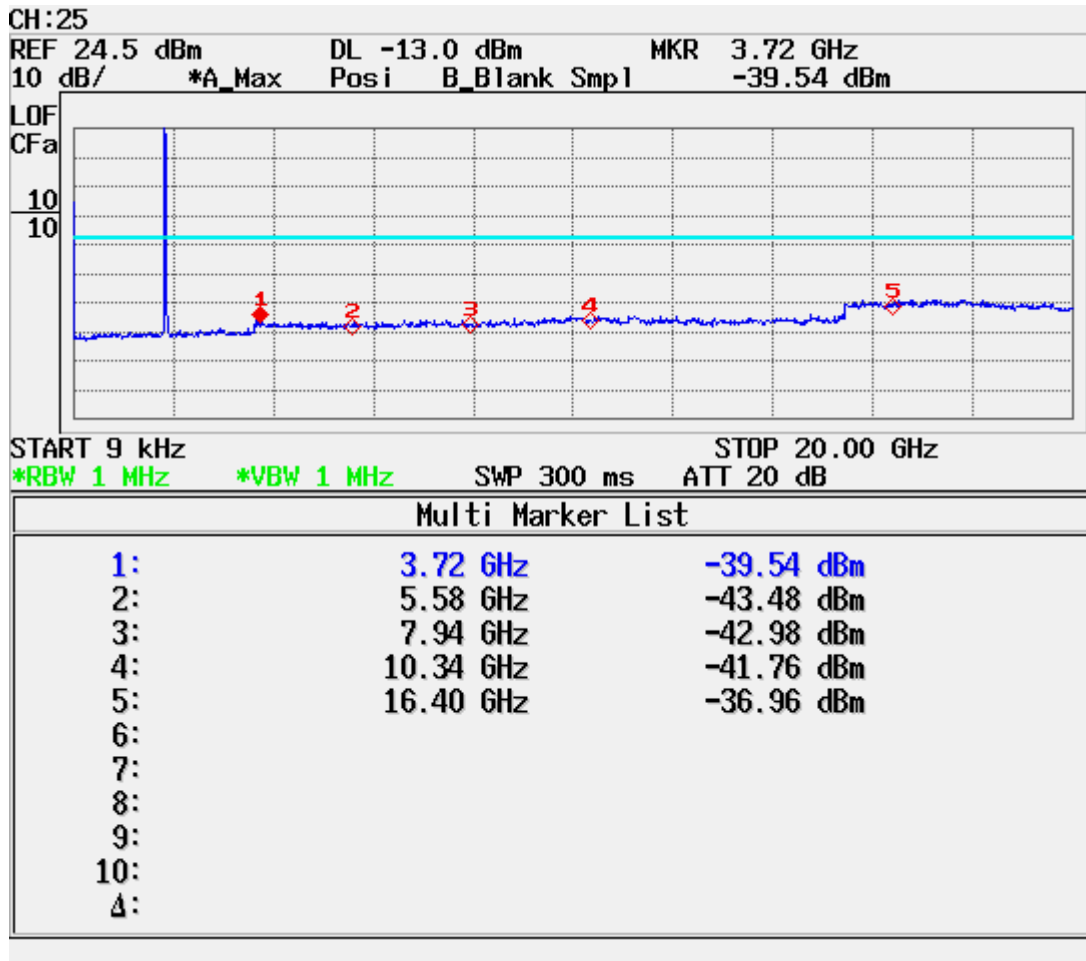

■ US PCS MODE (600 CH.) Conducted Spurious

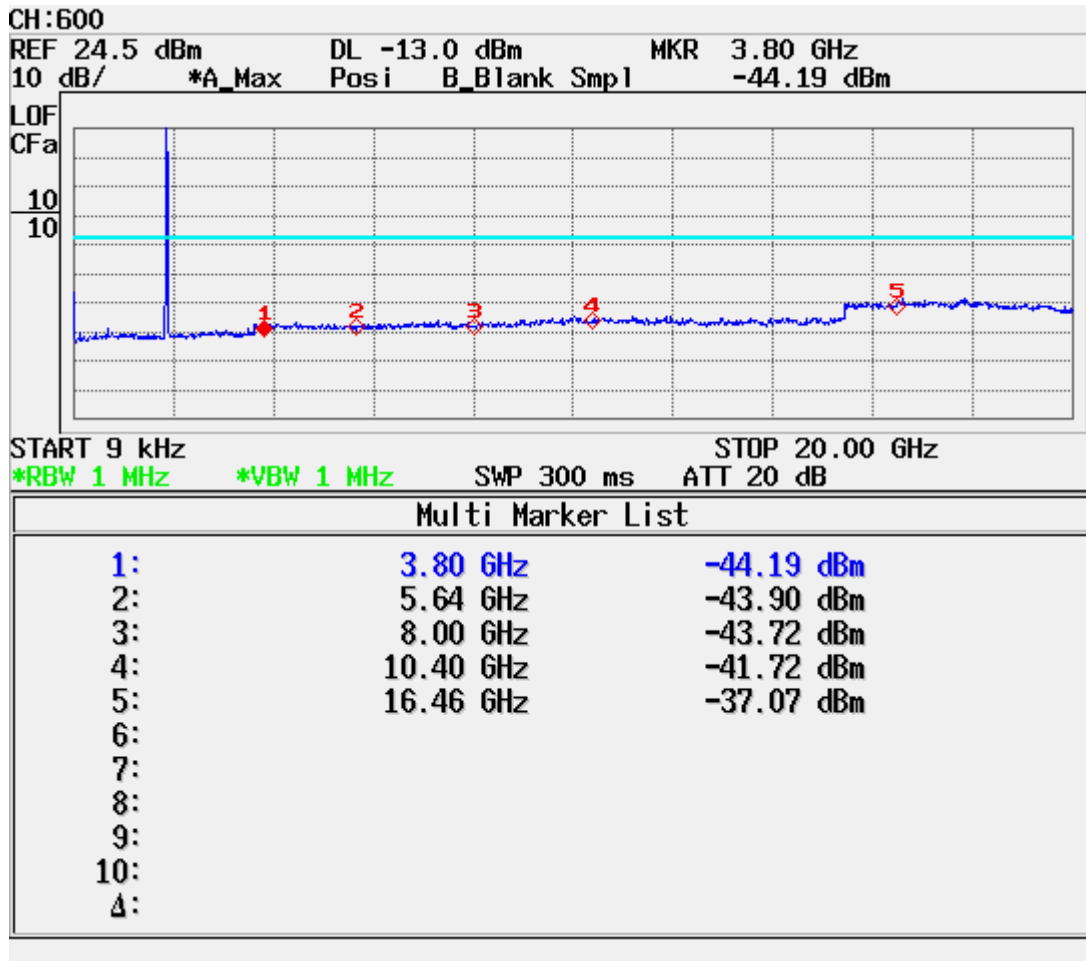

■ US PCS MODE (1175 CH.) Conducted Spurious

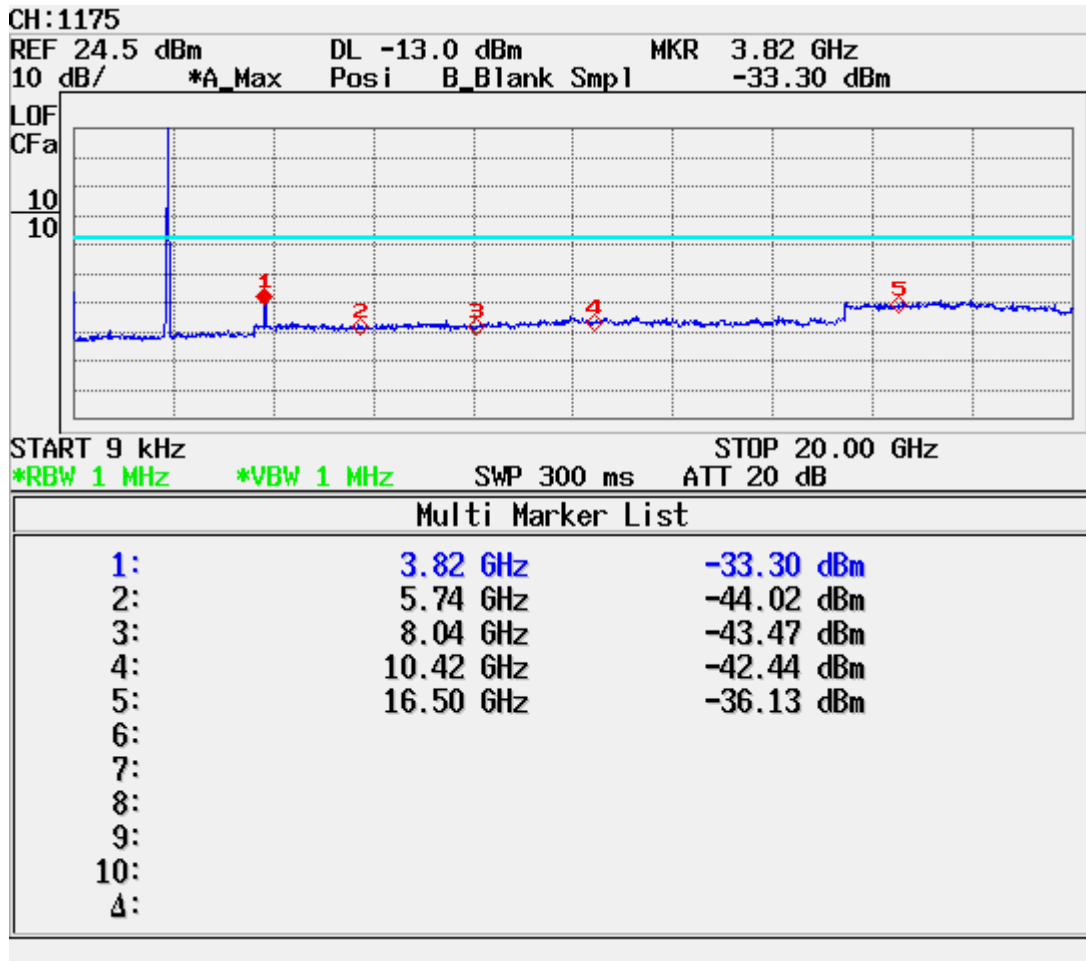

■ Conducted RF Power

Maximum Power Output table for FCC ID: QMNRM-347

Band	Channel	SO2	SO2	SO55	SO55	TDSO	1xEvDO	1xEvDO
		RC1/1	RC3/3	RC1/1	RC3/3	RC3/3	(FTAP)	(RTAP)
CDMA	1013	24.52	24.51	24.49	24.52	24.51	26.11	26.02
	384	24.44	24.38	24.43	24.46	24.48	26.16	26.12
	777	24.46	24.49	24.45	24.51	24.50	26.15	26.10
PCS	25	23.94	23.93	23.97	23.98	23.94	25.16	25.09
	600	23.93	23.93	23.97	23.96	23.98	25.50	25.42
	1175	23.92	23.91	23.94	23.95	23.96	25.42	25.38

■ Cellular Mode (384 CH.) : Occupied Bandwidth

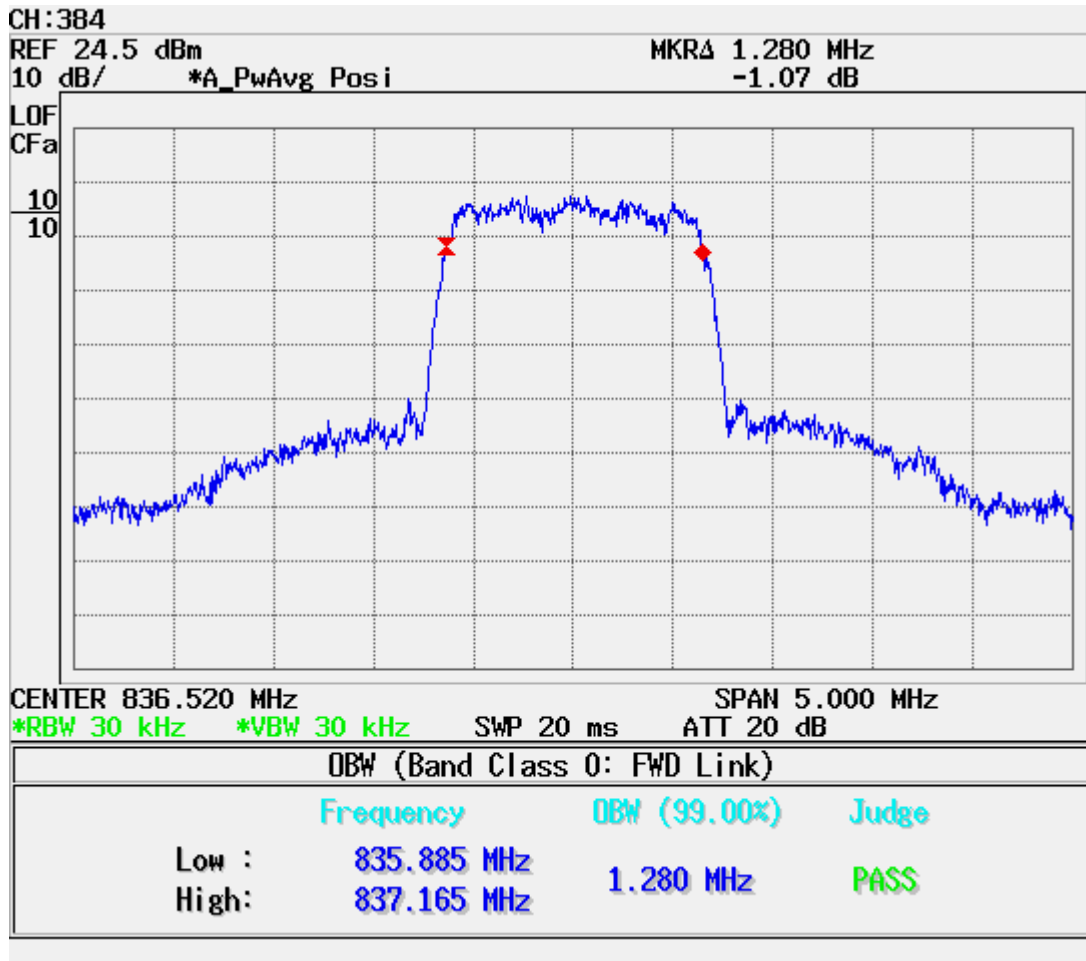

■ US PCS Mode (600 CH) : Occupied Bandwidth

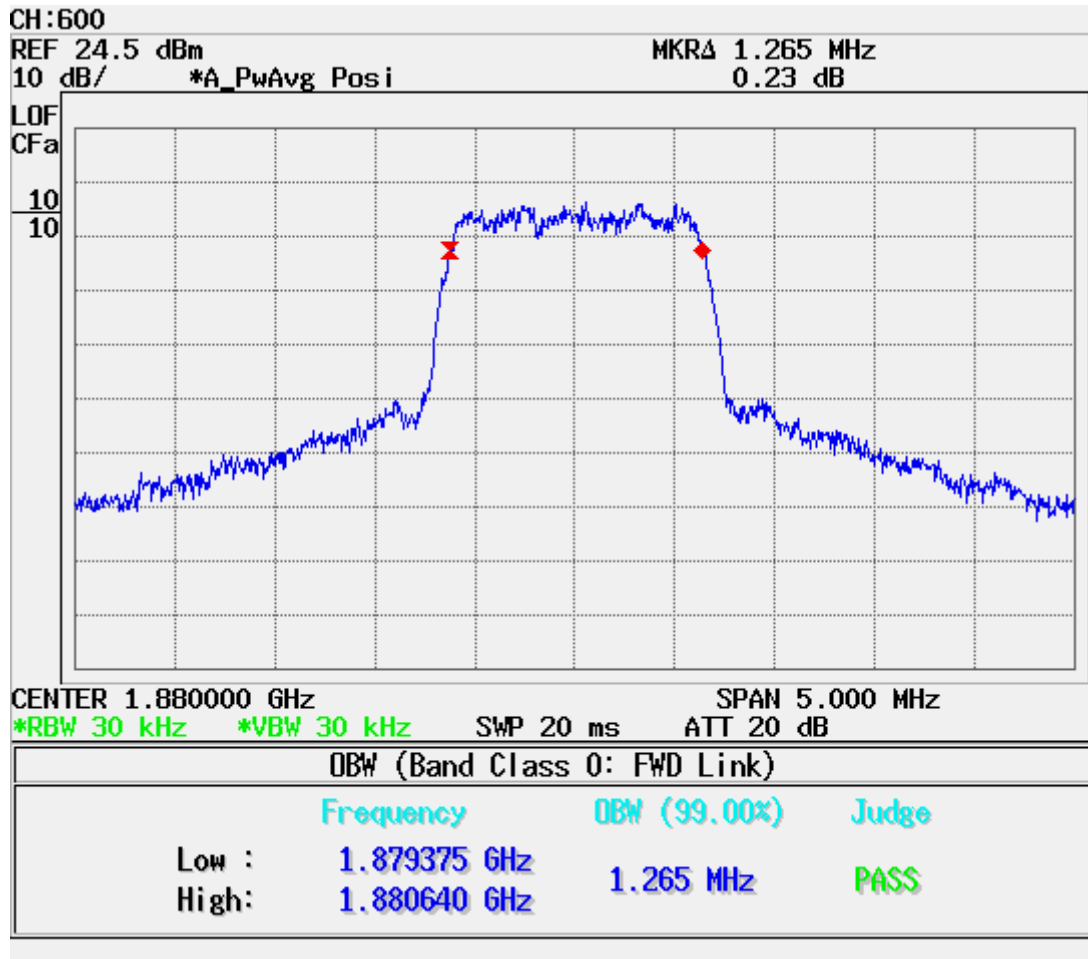

■ Cellular (1013 CH.) Band Edge

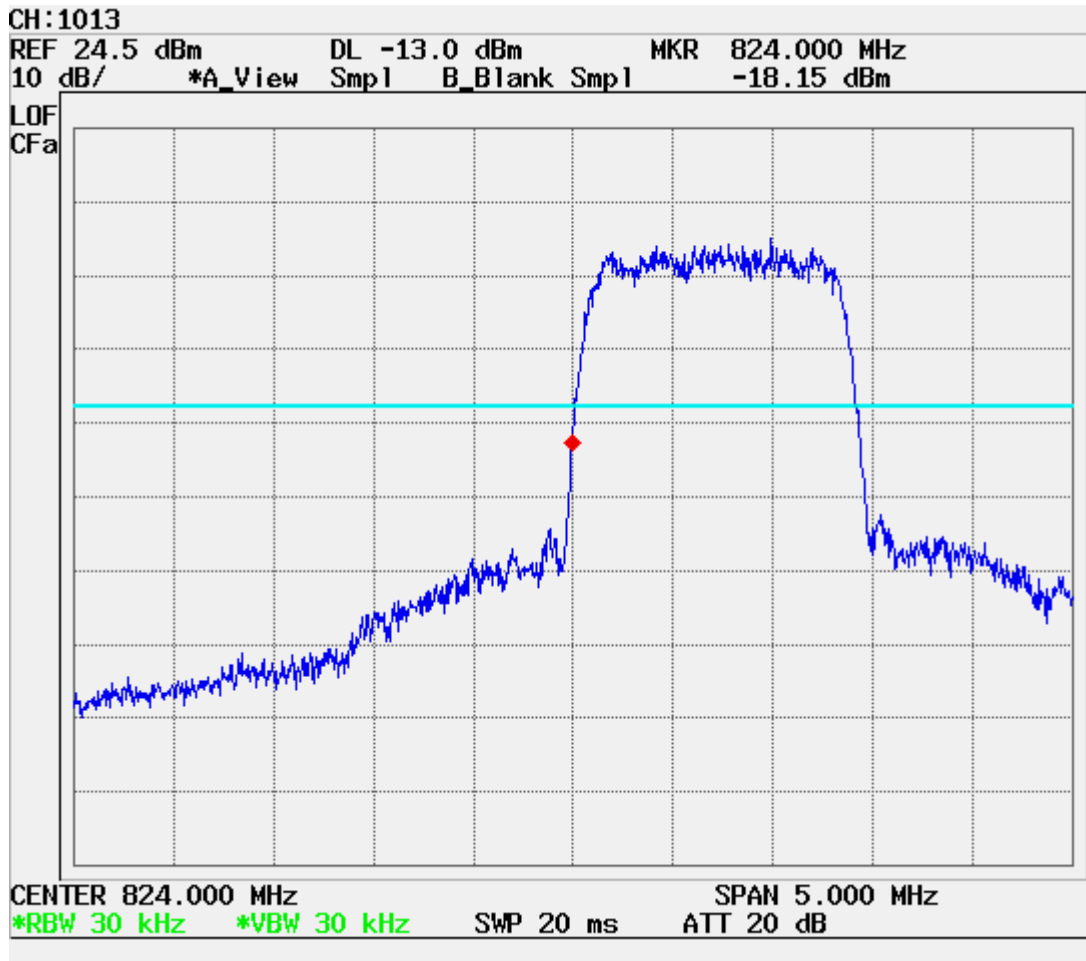

■ Cellular (777 CH.) Band Edge

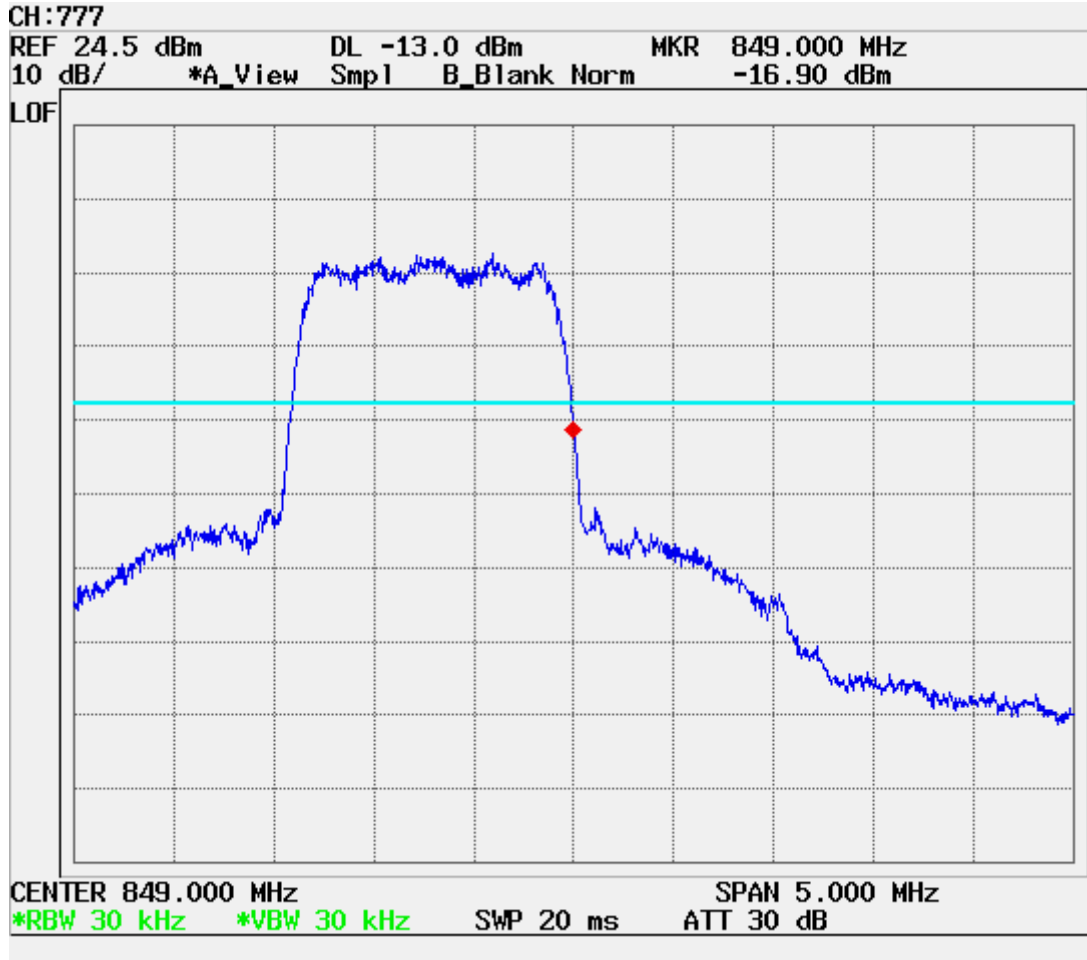

■ US PCS Mode Band Edge (25 CH.)

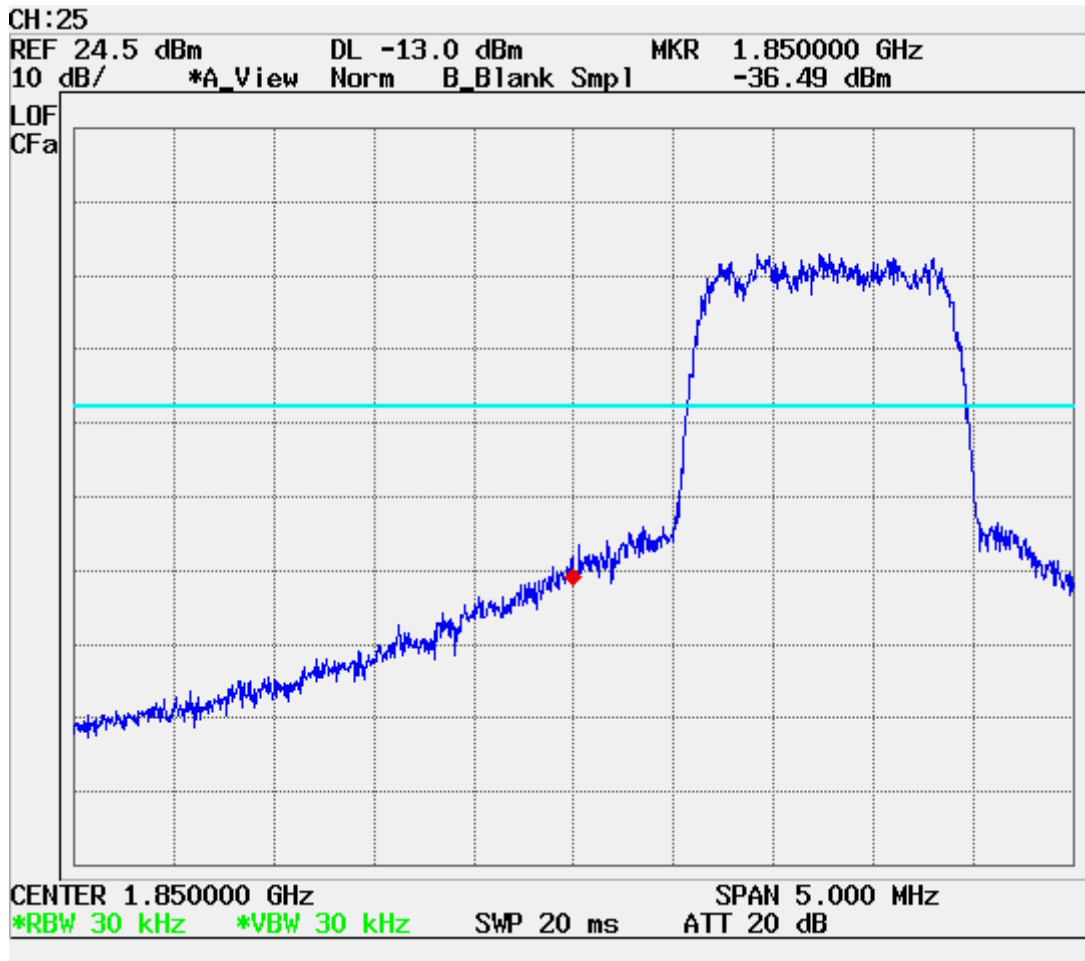

■ US PCS Mode Band Edge (1175 CH.)

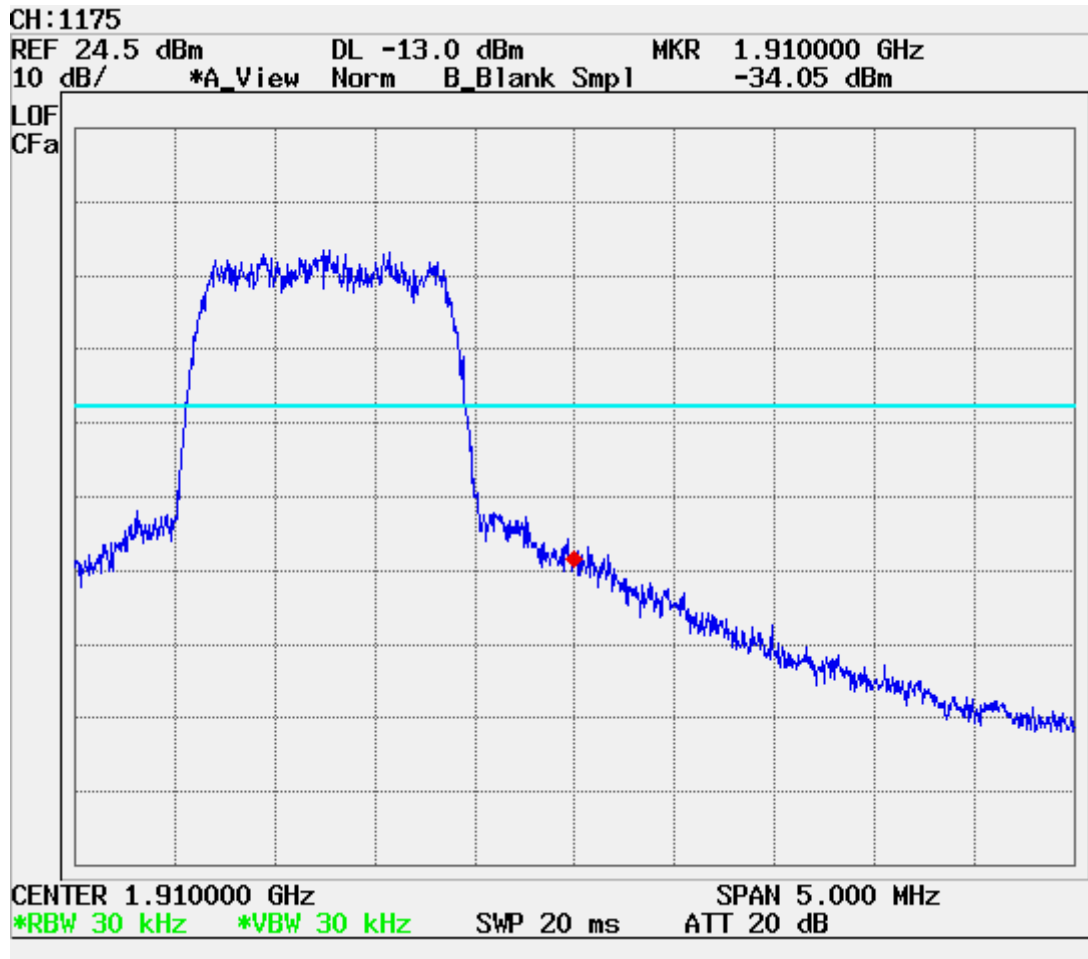

■ CDMA (1013 CH) : SPURIOUS EMISSION - RECEIVER OPERATING

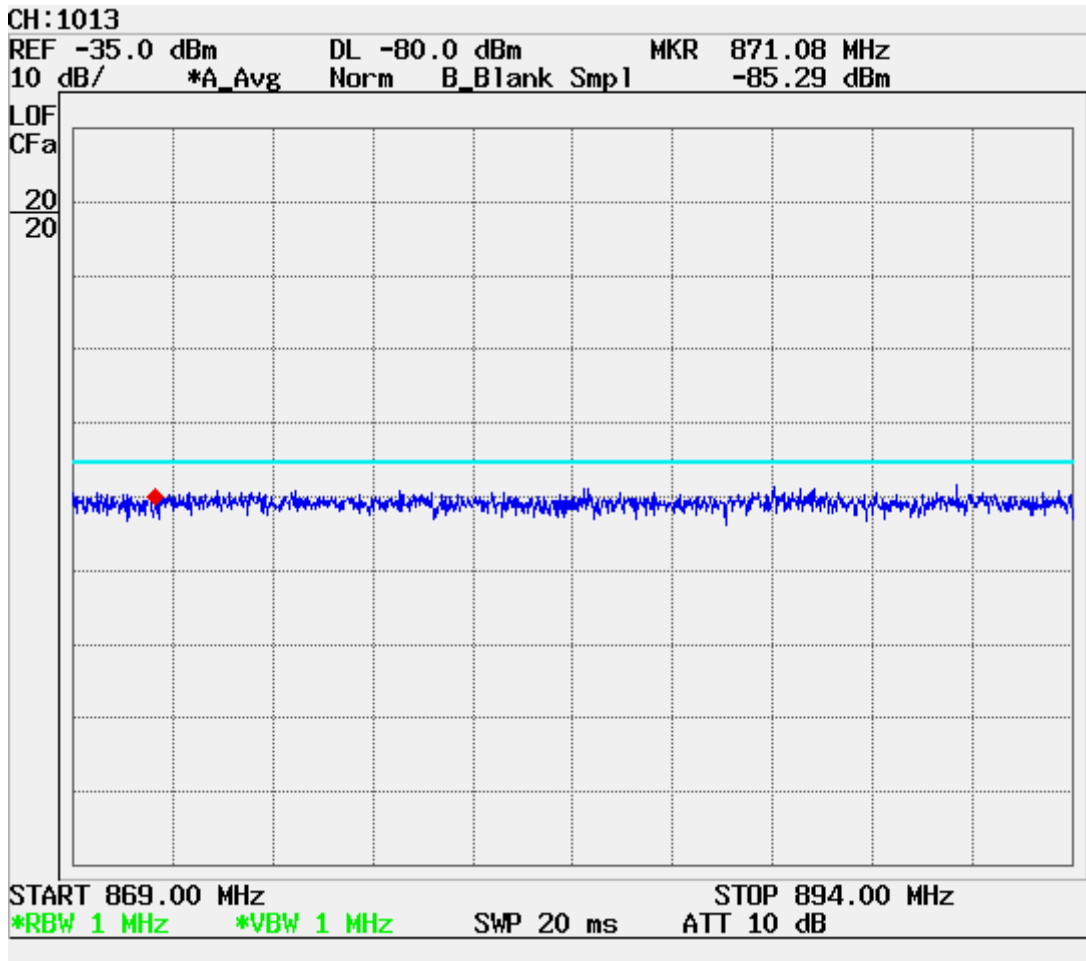

■ CDMA (384 CH) : SPURIOUS EMISSION - RECEIVER OPERATING

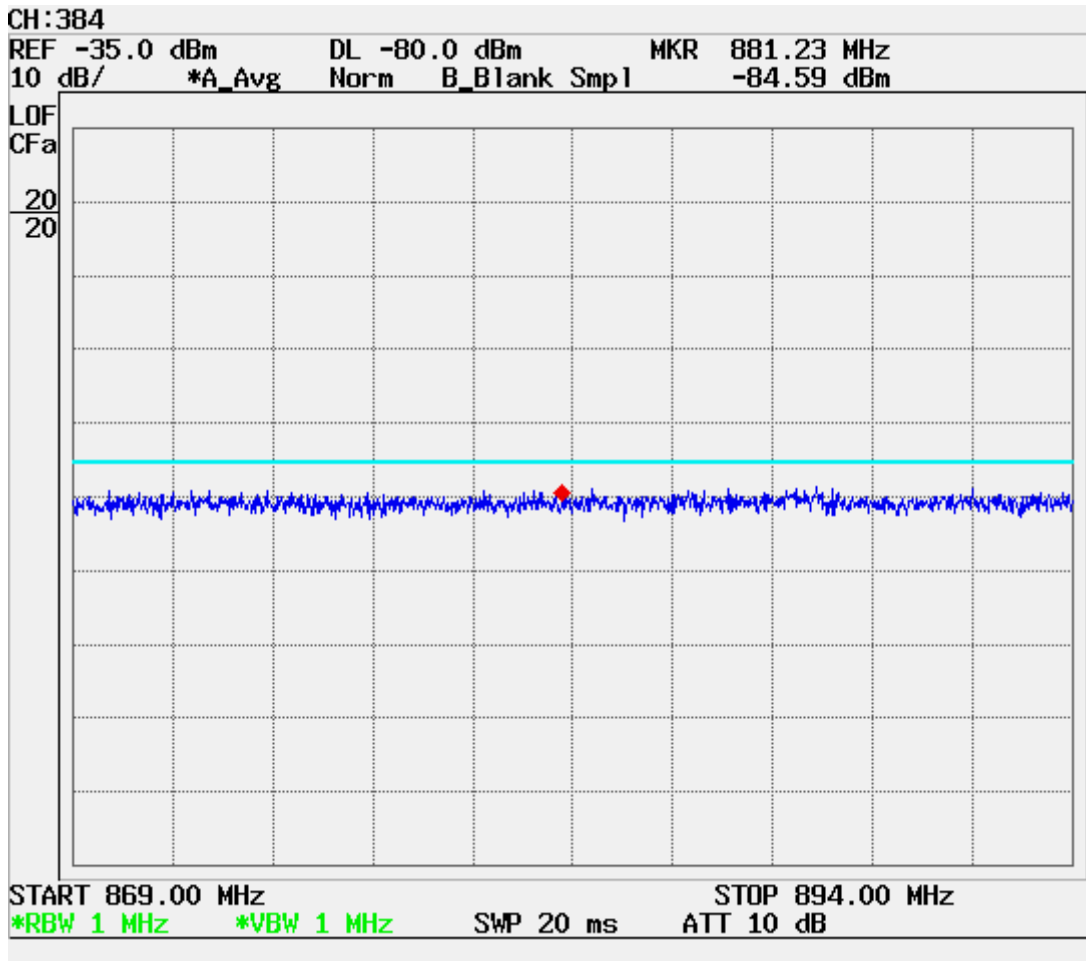

■ CDMA (777 CH) : SPURIOUS EMISSION - RECEIVER OPERATING

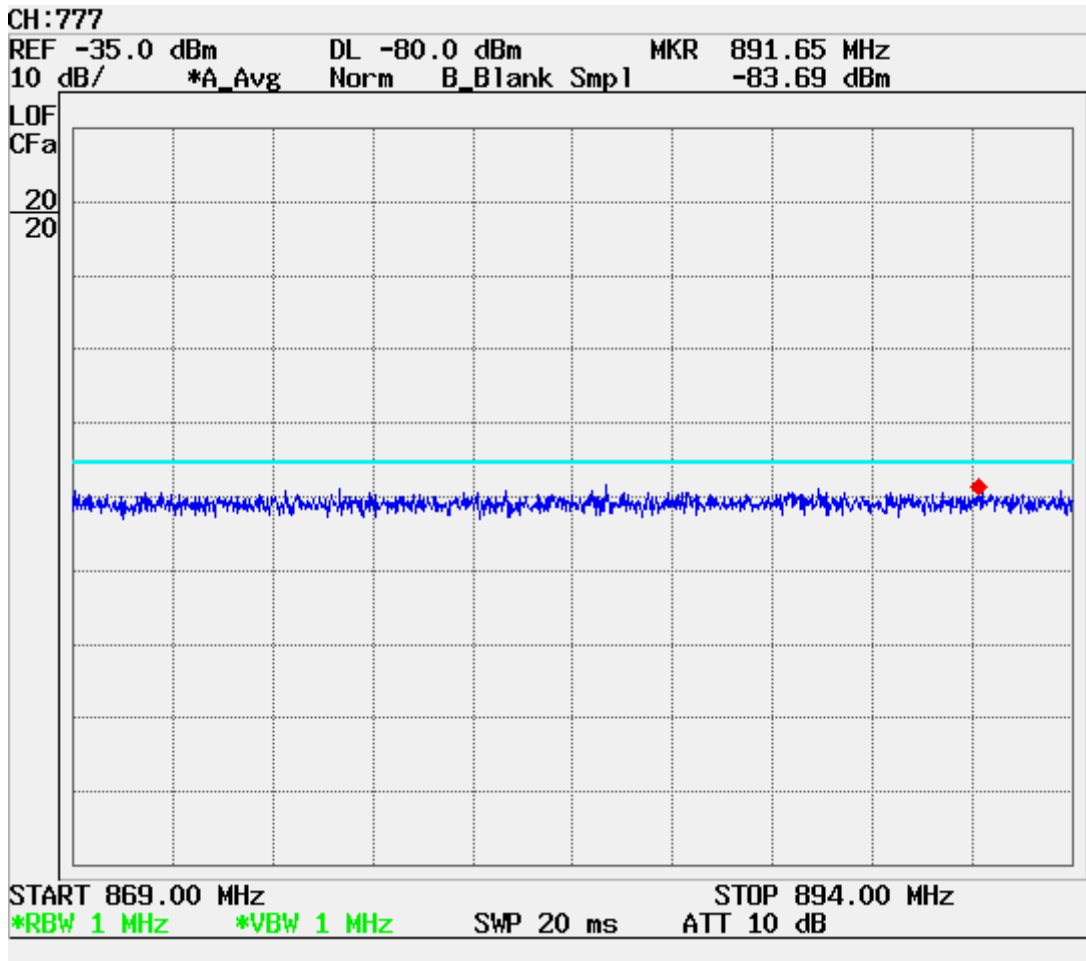

■ Cellular (1013 CH) : Standby Output Power

RSS-129, Section 9.3

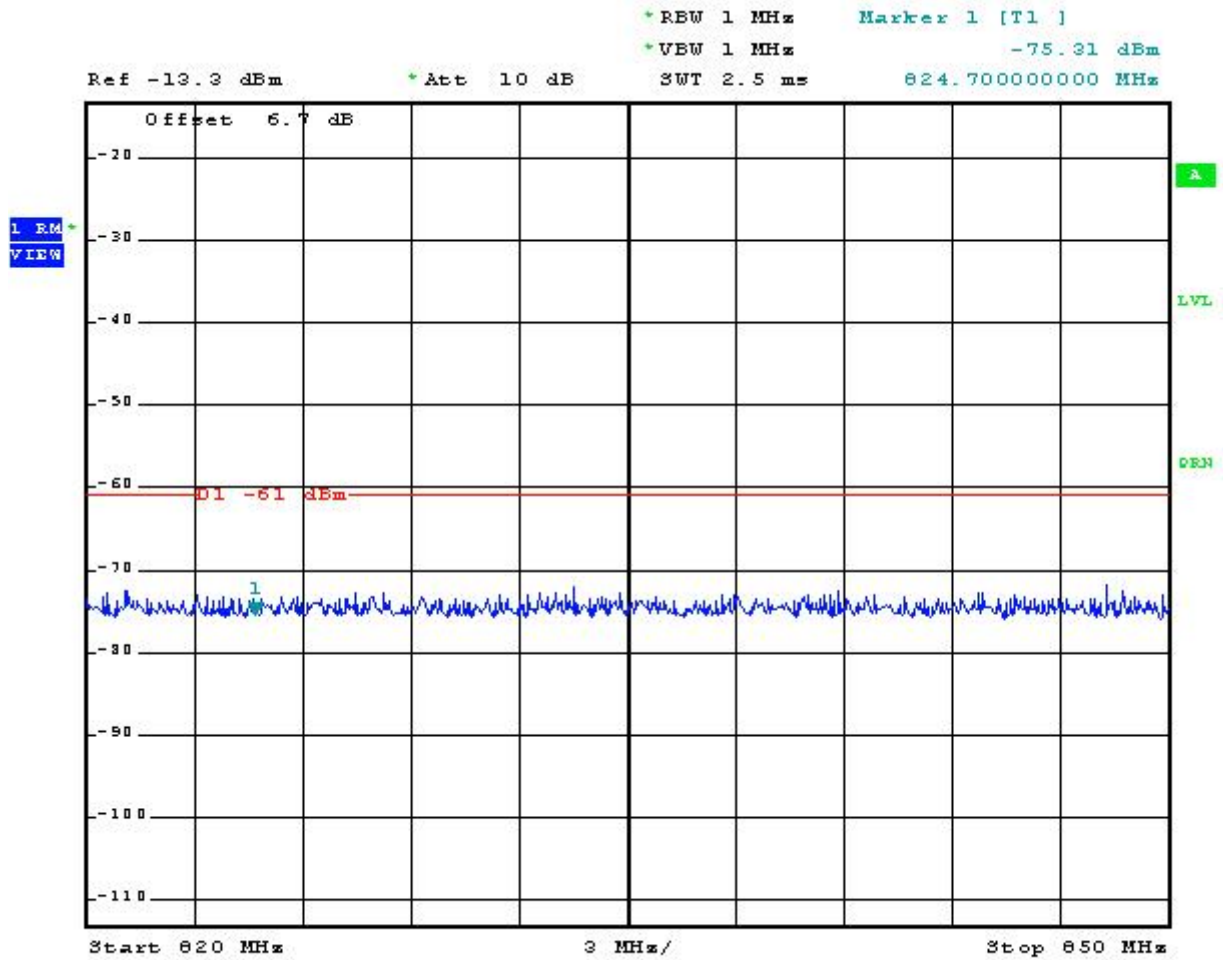

■ Cellular (384 CH) : Standby Output Power

RSS-129, Section 9.3

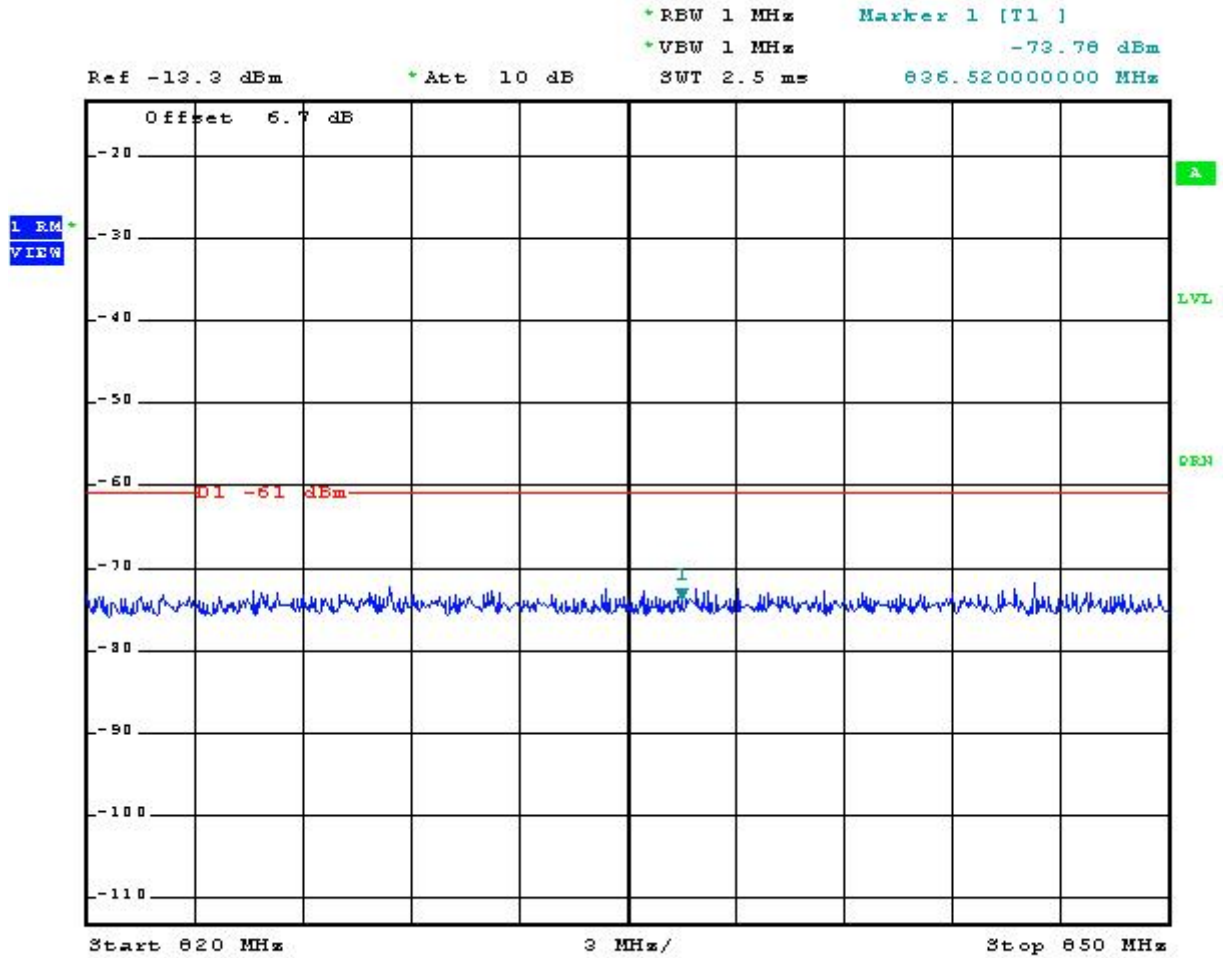

■ Cellular (777 CH) : Standby Output Power

RSS-129, Section 9.3

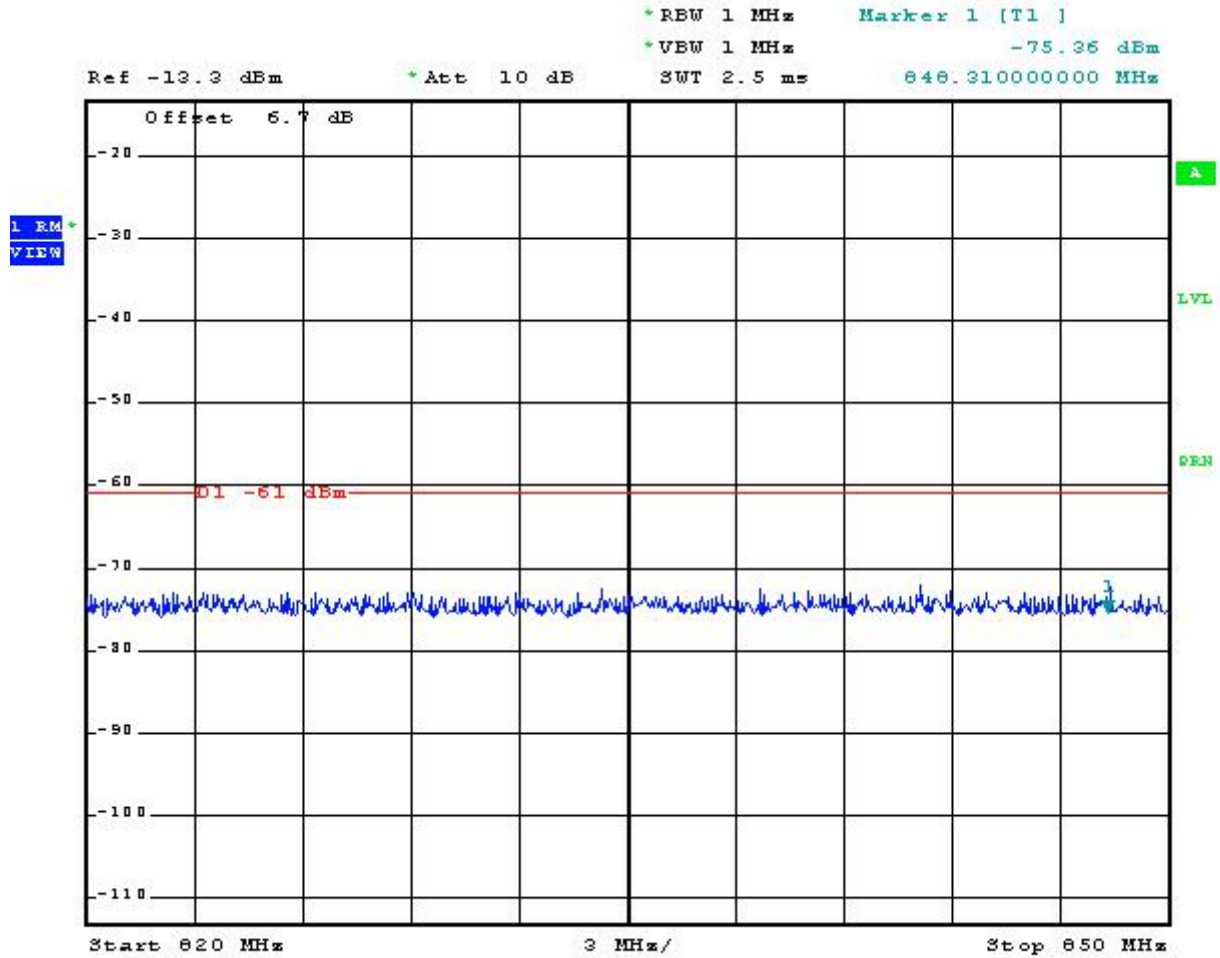

■ Minimum Controlled Output Power

RSS-129, Section 9.4

Mode	CH	Minimum Power(dBm)
Cellular	1013	- 61.18
	384	- 60.68
	777	- 61.11