

ENDF/B-VII EU-157

Principal cross sections

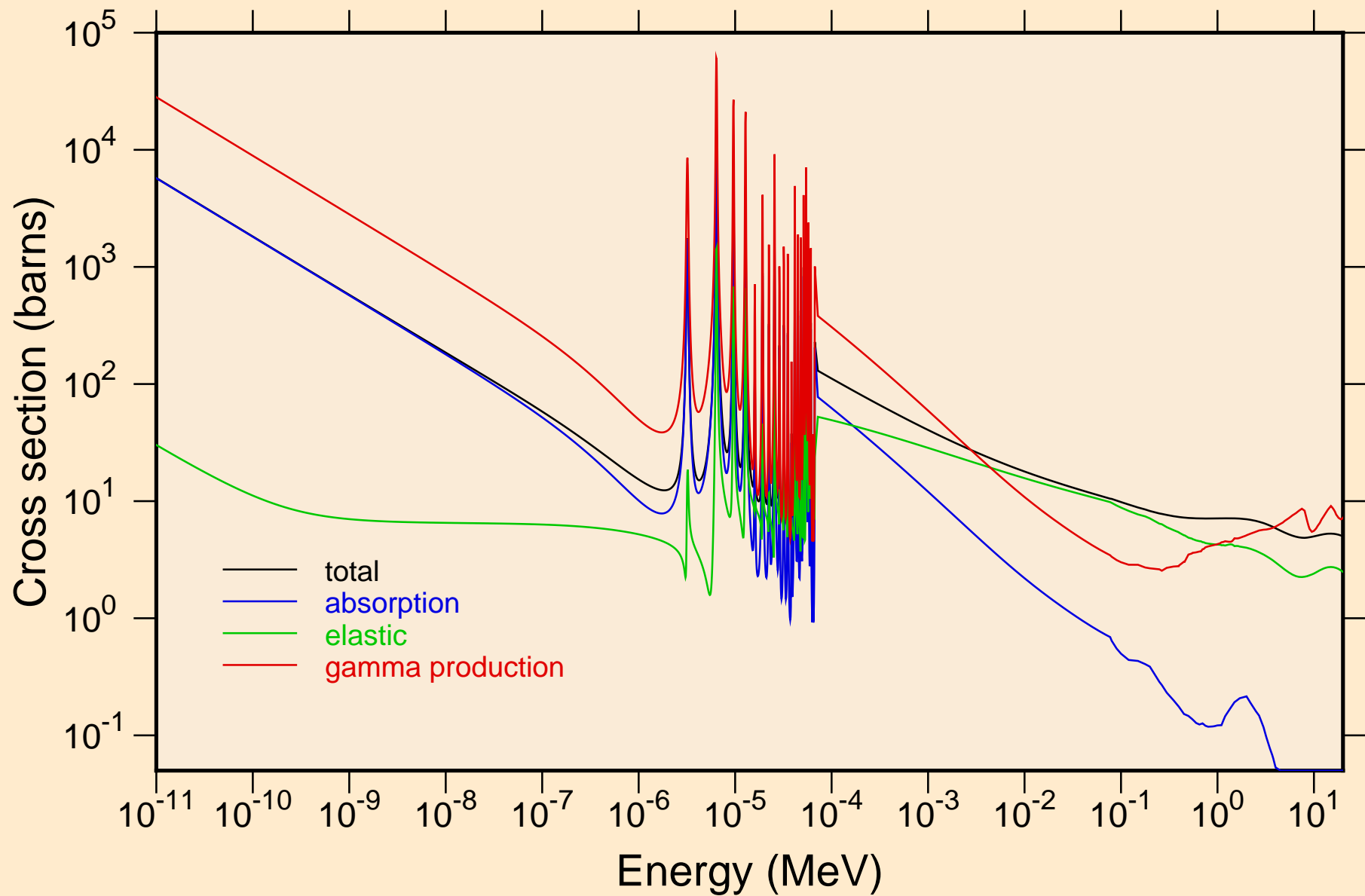

ENDF/B-VII EU-157
resonance total cross section

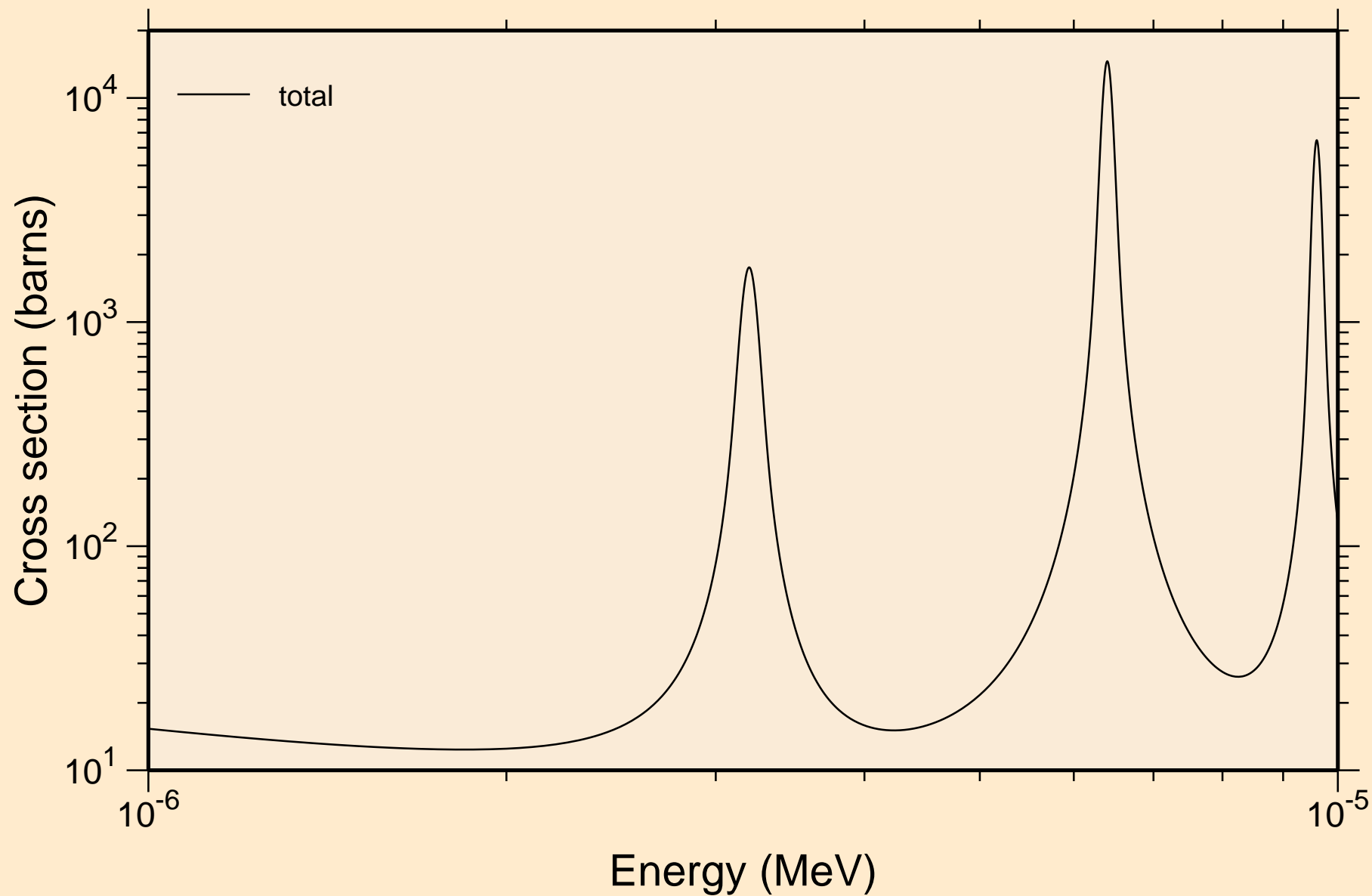

ENDF/B-VII EU-157
resonance total cross section

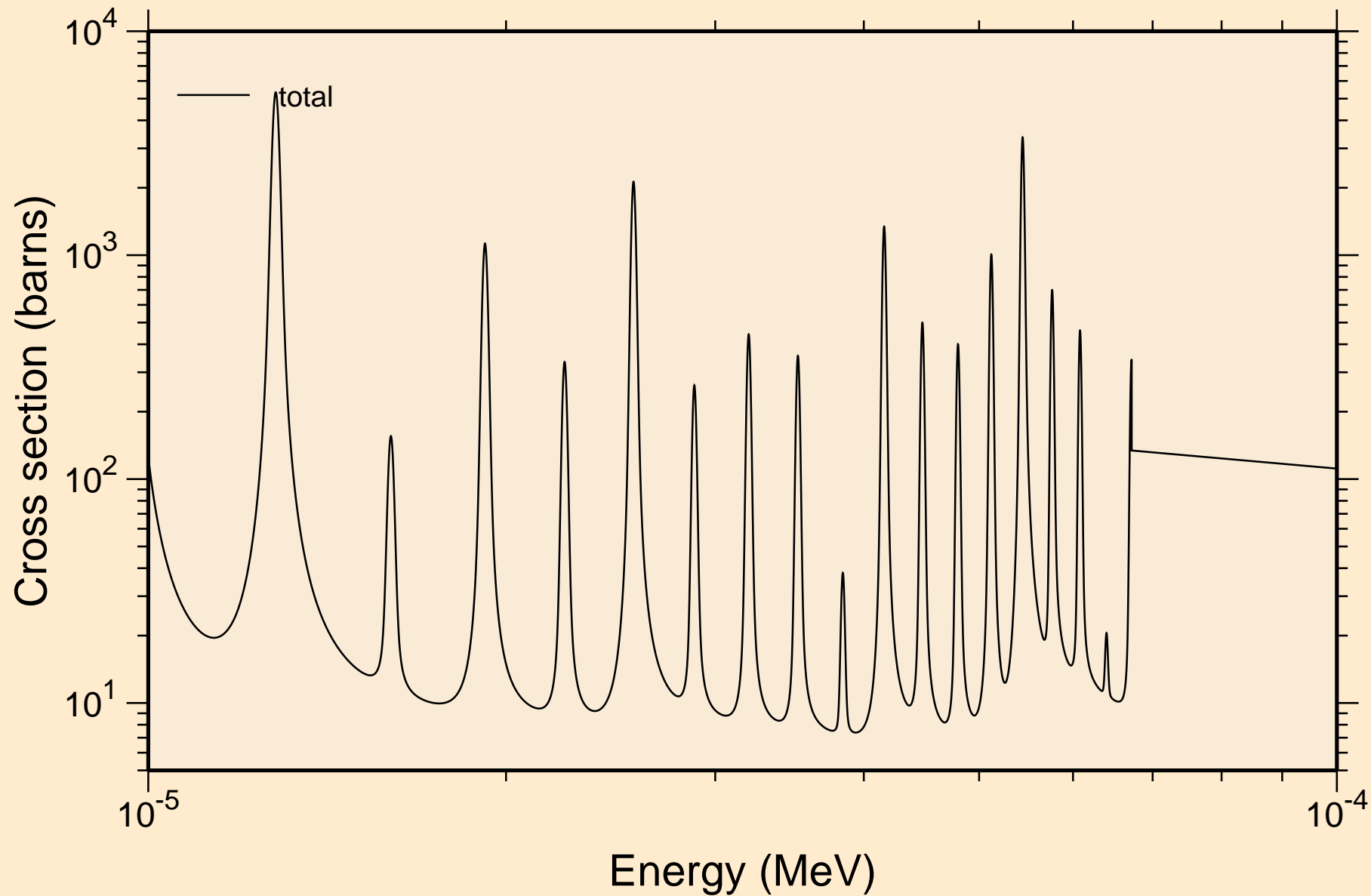

ENDF/B-VII EU-157
resonance absorption cross sections

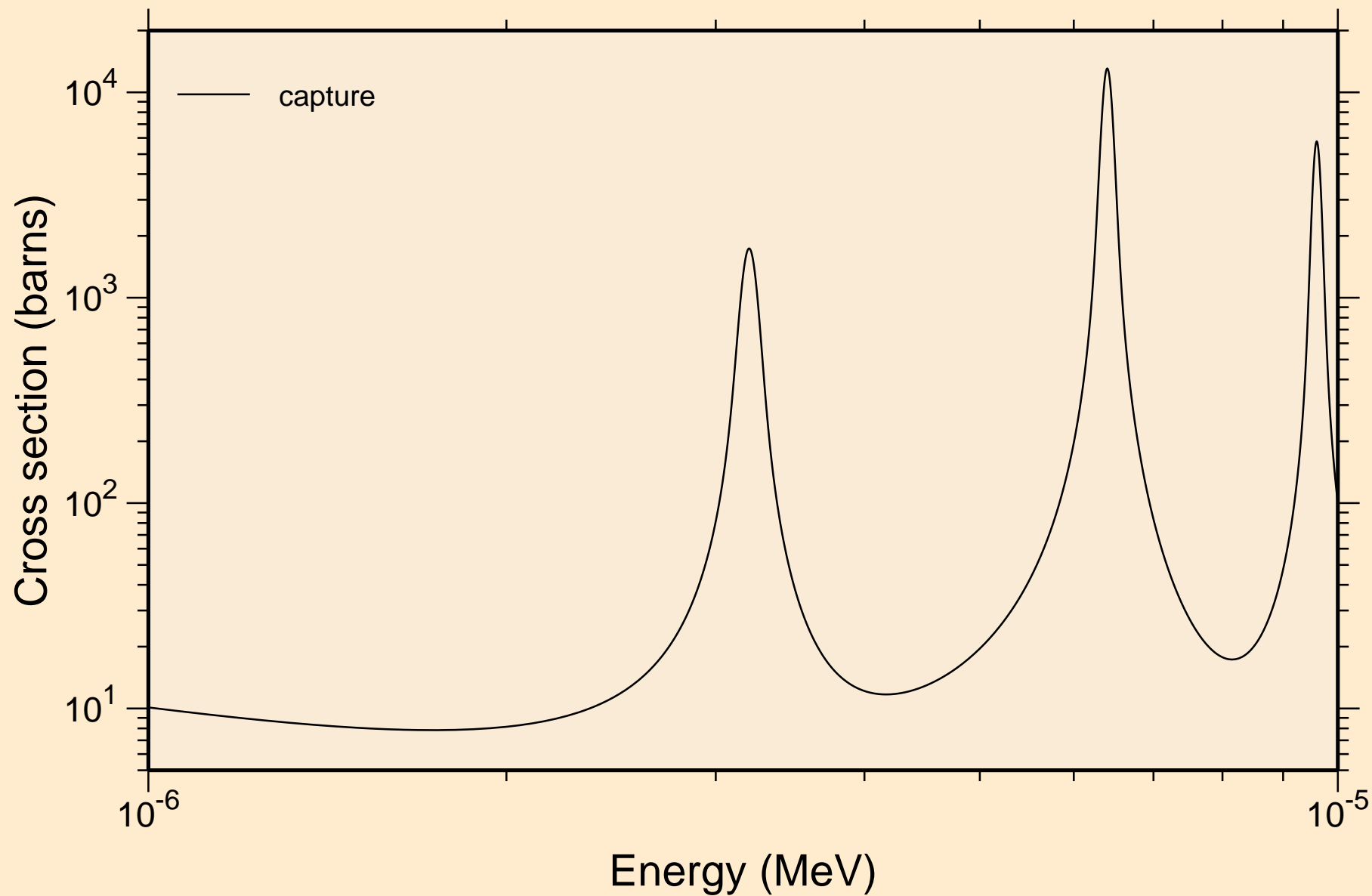

ENDF/B-VII EU-157 resonance absorption cross sections

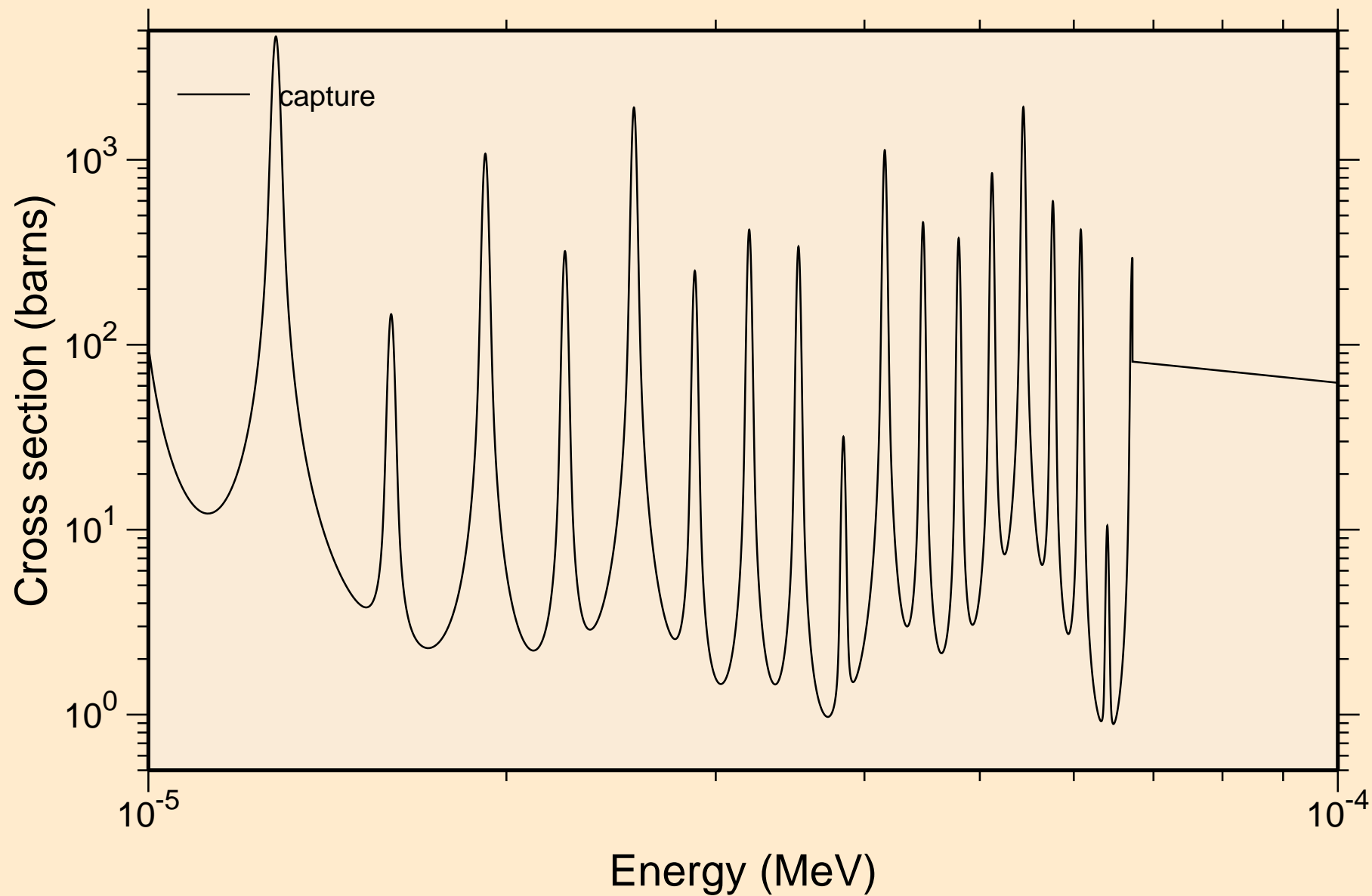

ENDF/B-VII EU-157
UR total cross section

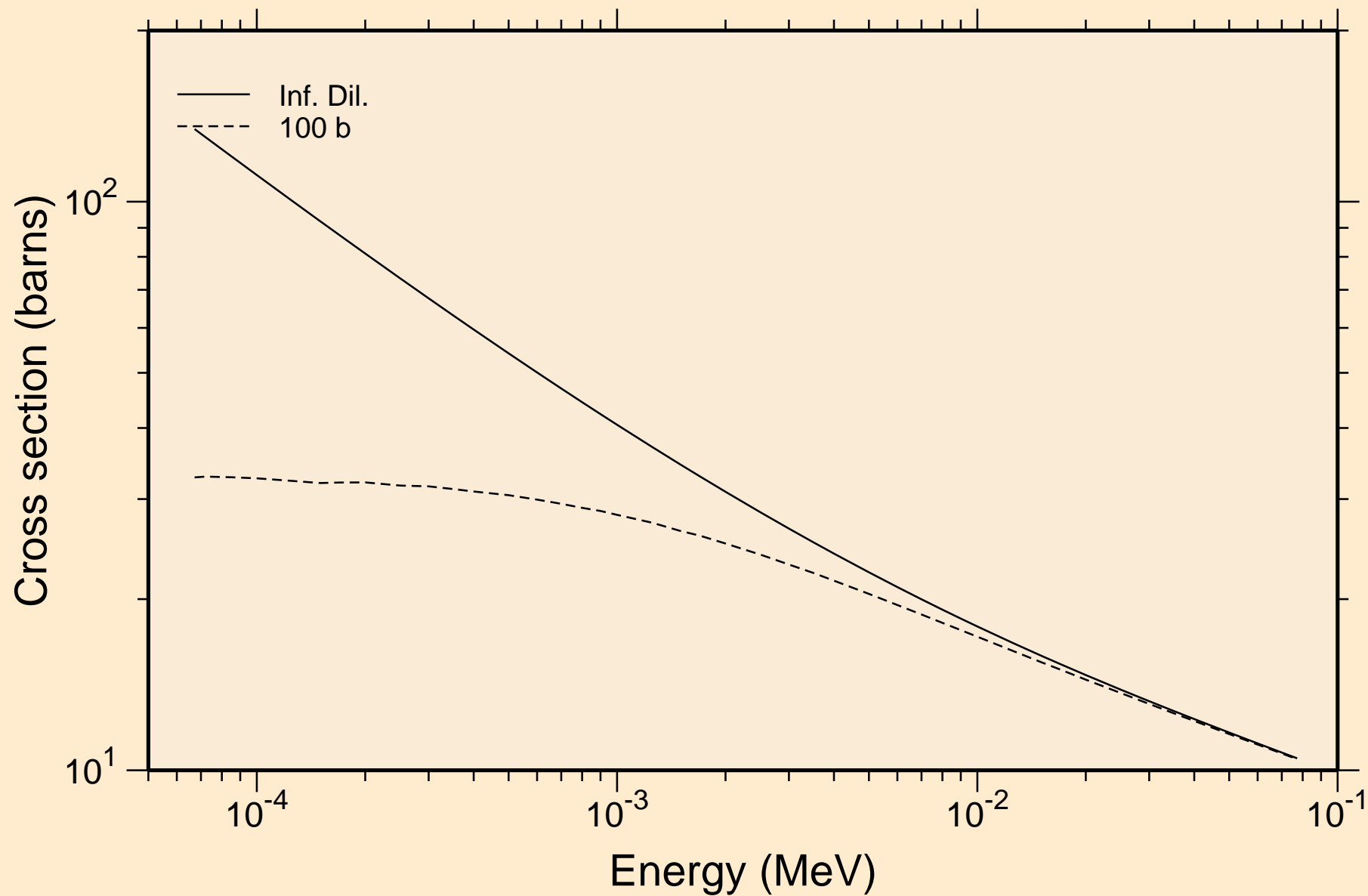

ENDF/B-VII EU-157
UR elastic cross section

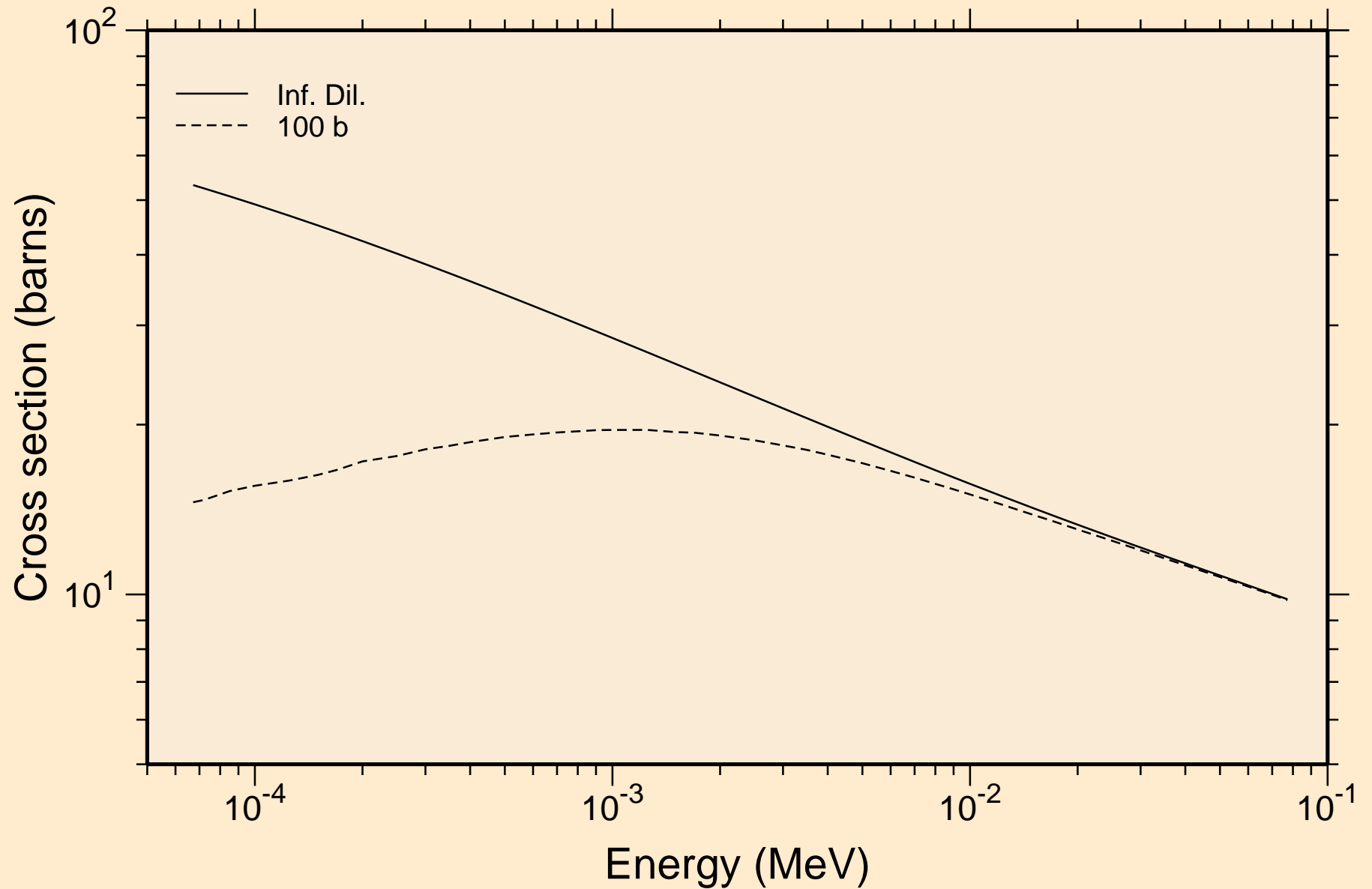

ENDF/B-VII EU-157

UR capture cross section

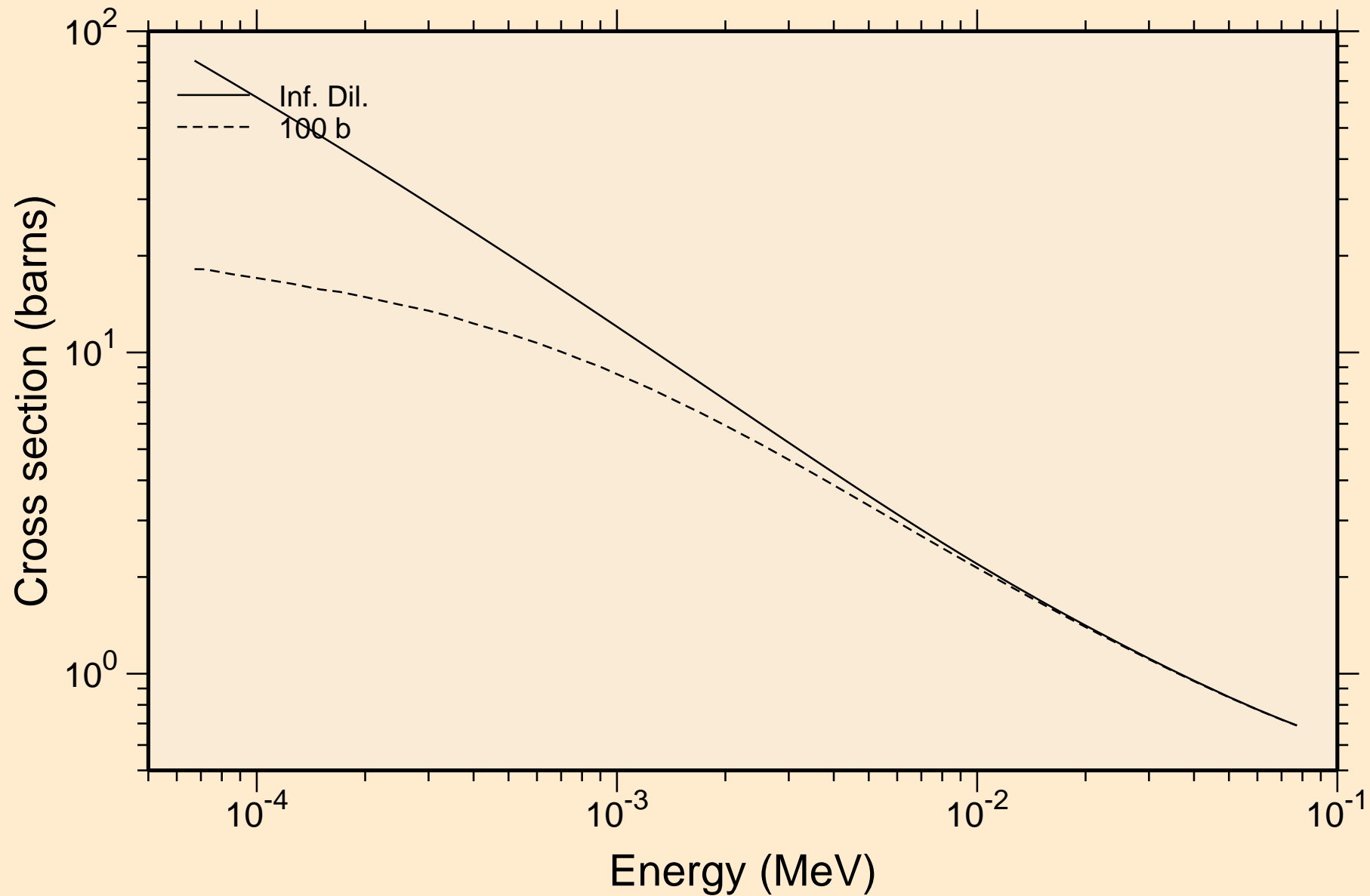

ENDF/B-VII EU-157

Heating

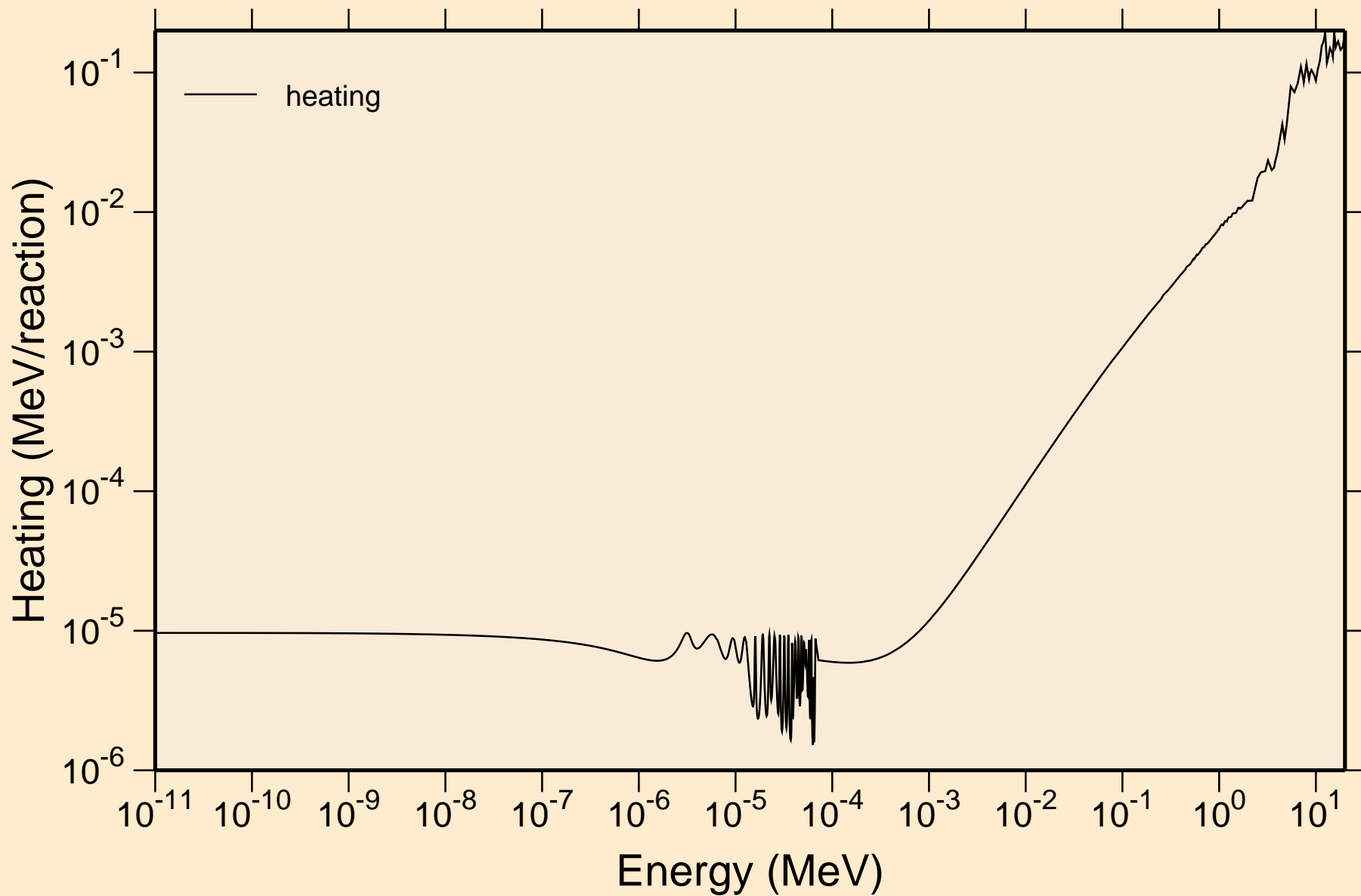

ENDF/B-VII EU-157

Damage

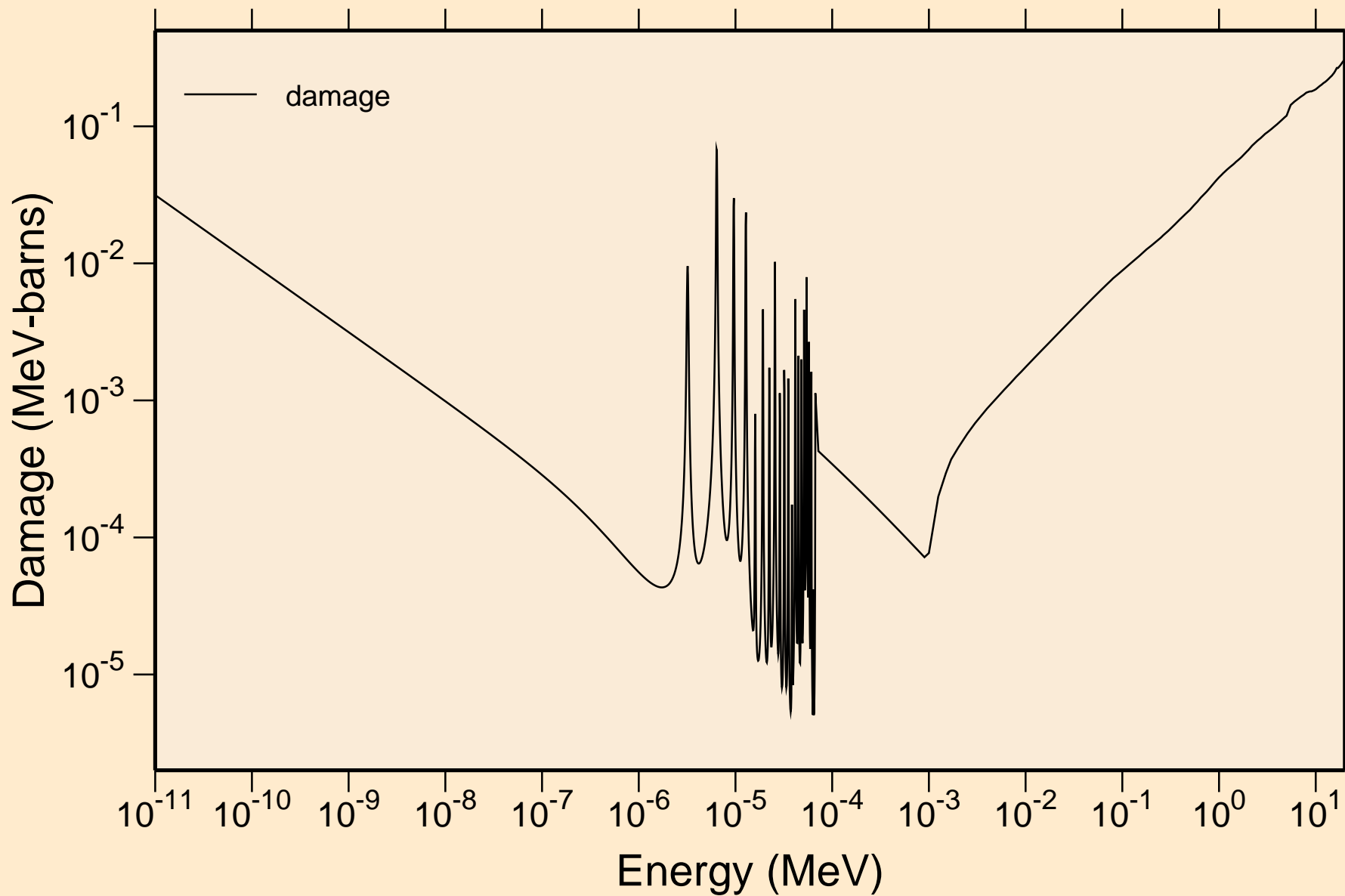

ENDF/B-VII EU-157

Non-threshold reactions

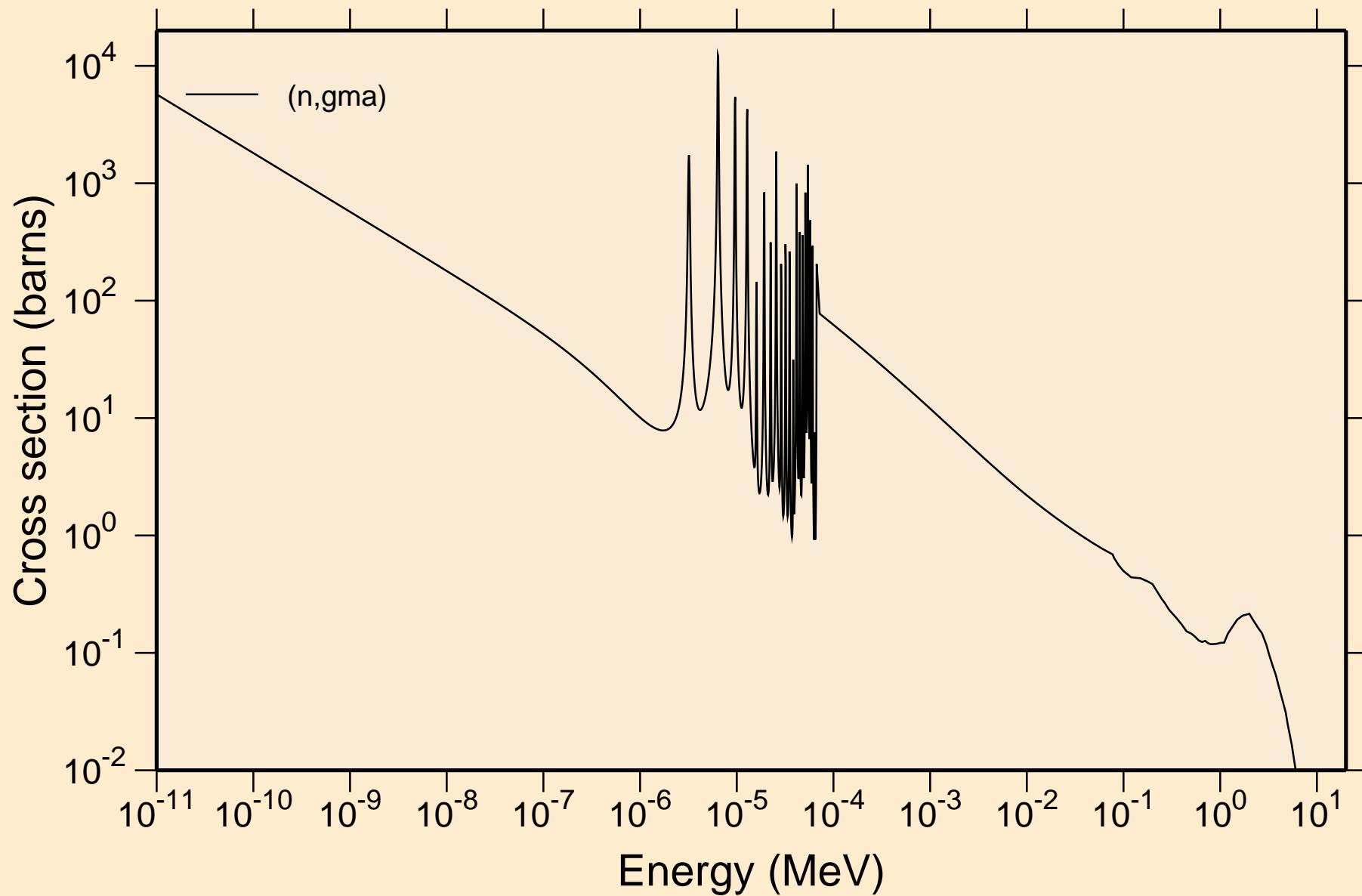

ENDF/B-VII EU-157

Principal cross sections

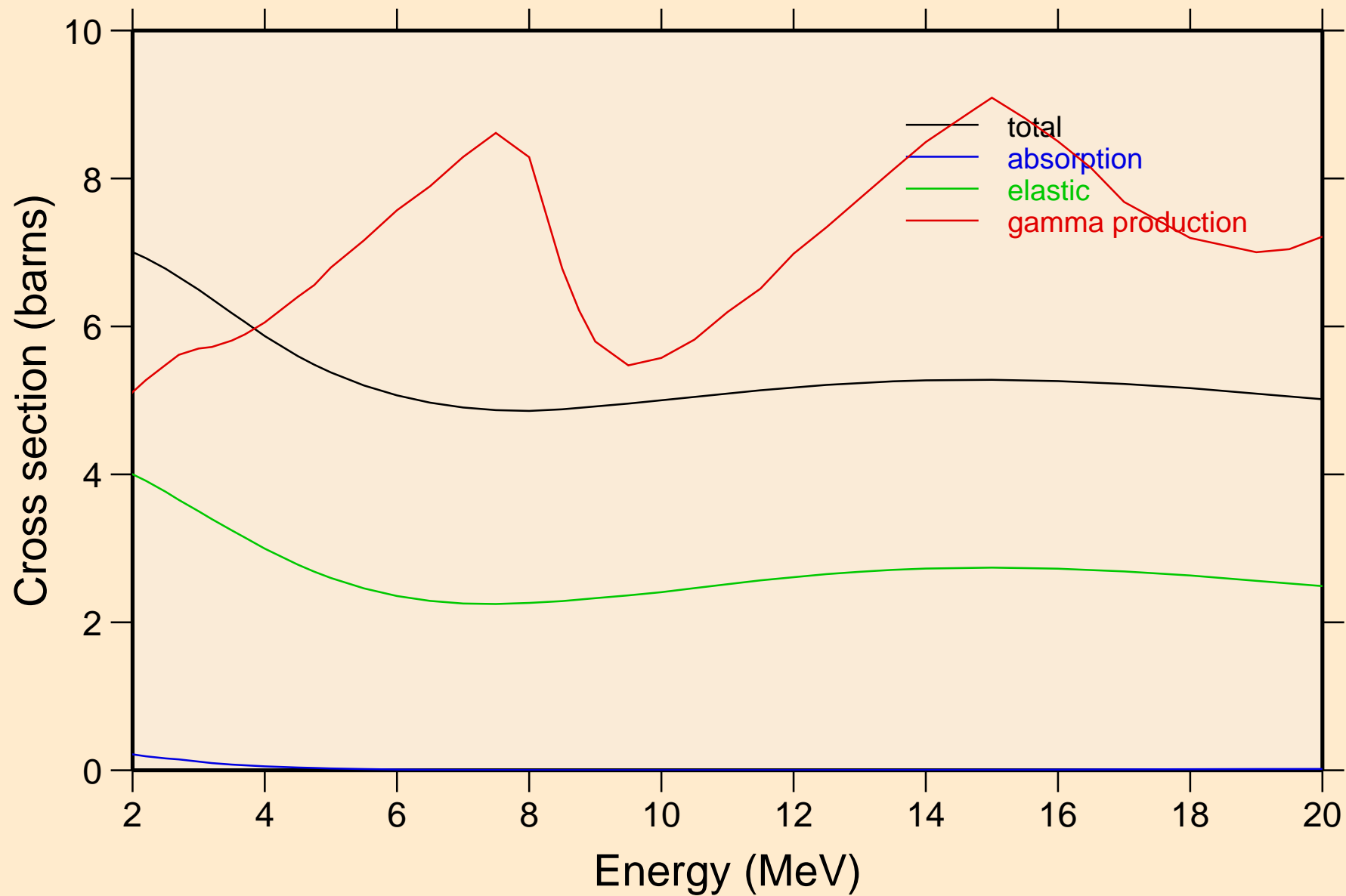

ENDF/B-VII EU-157

Heating

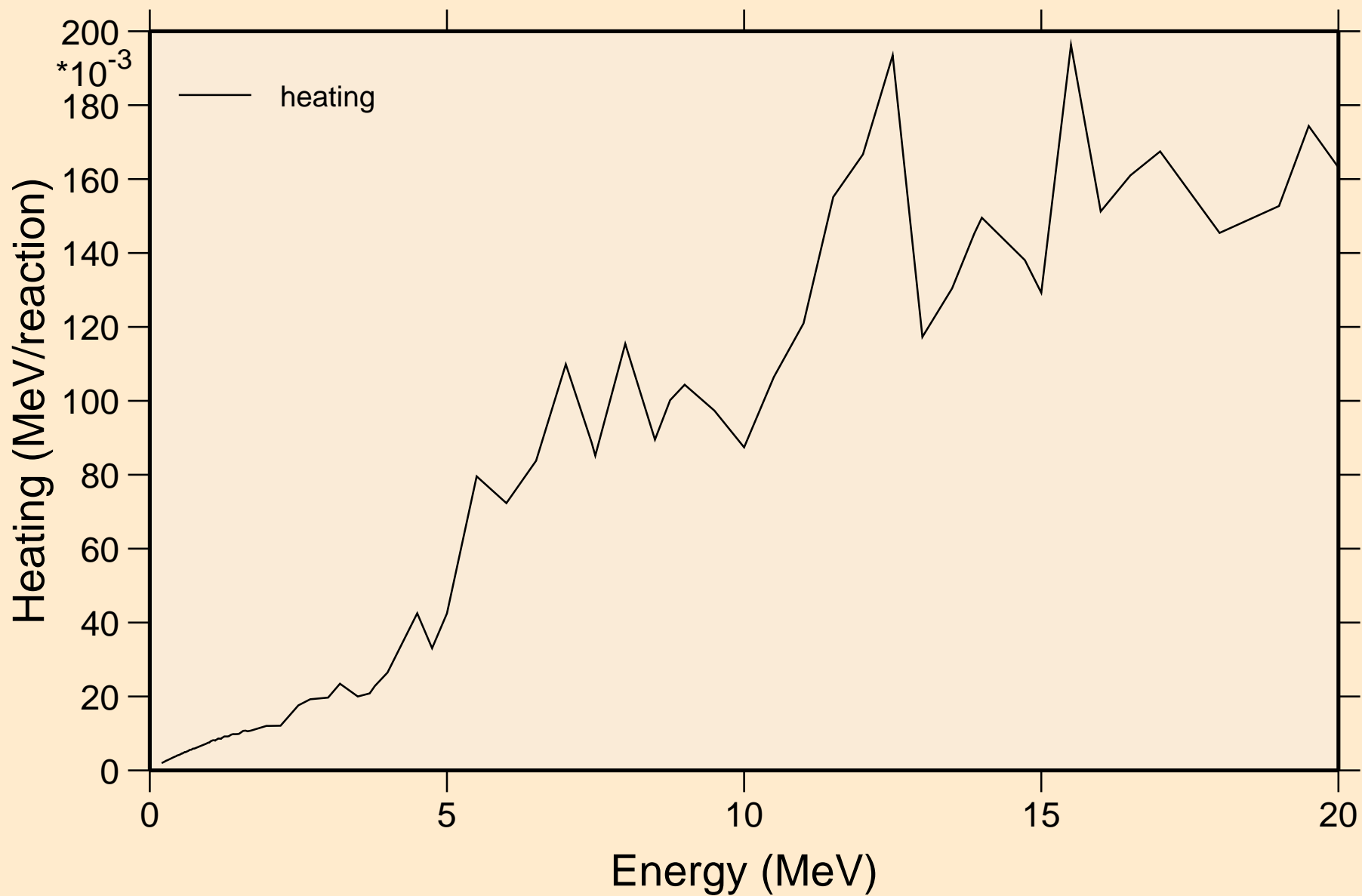

ENDF/B-VII EU-157

Damage

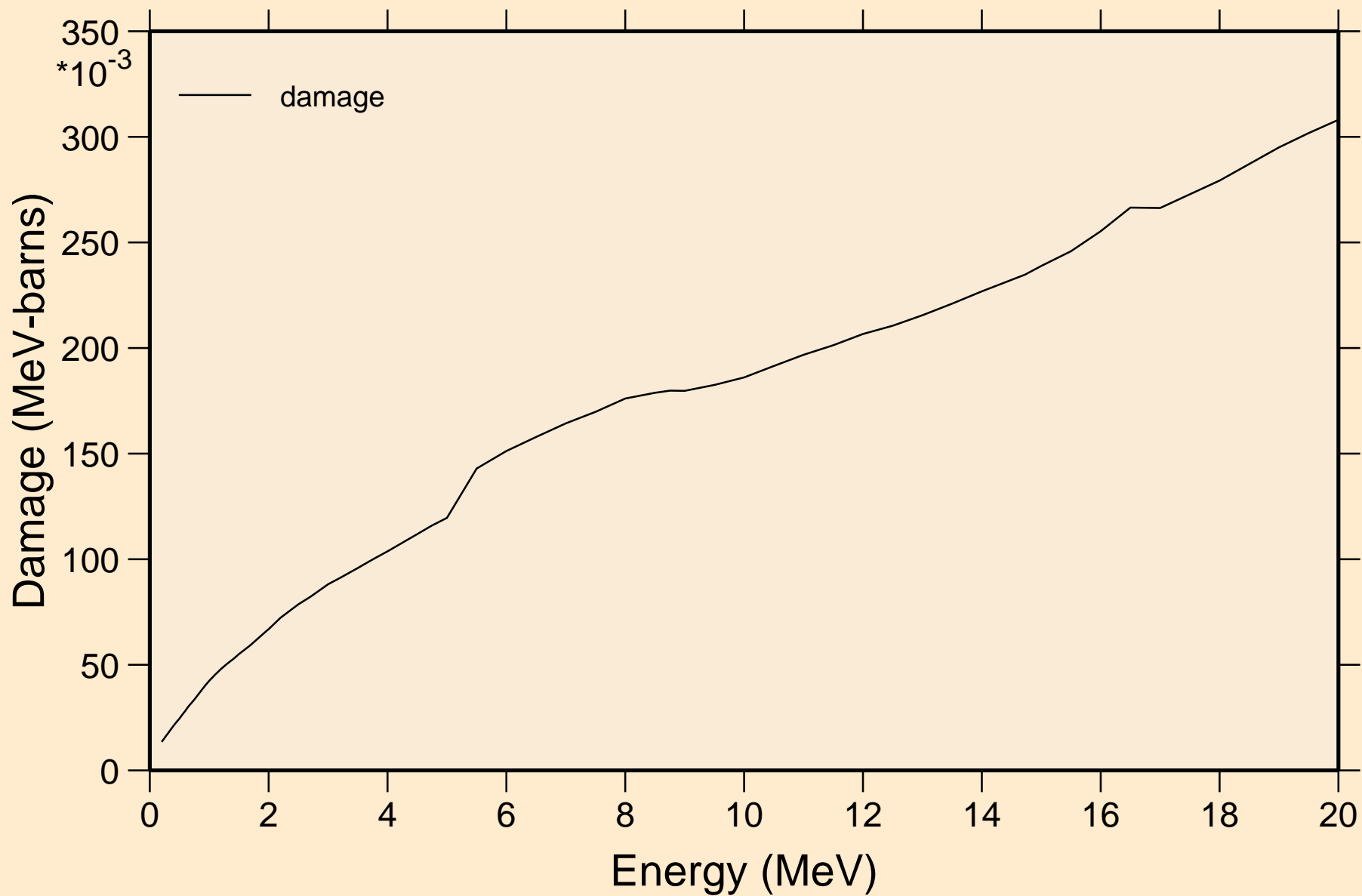

ENDF/B-VII EU-157
Non-threshold reactions

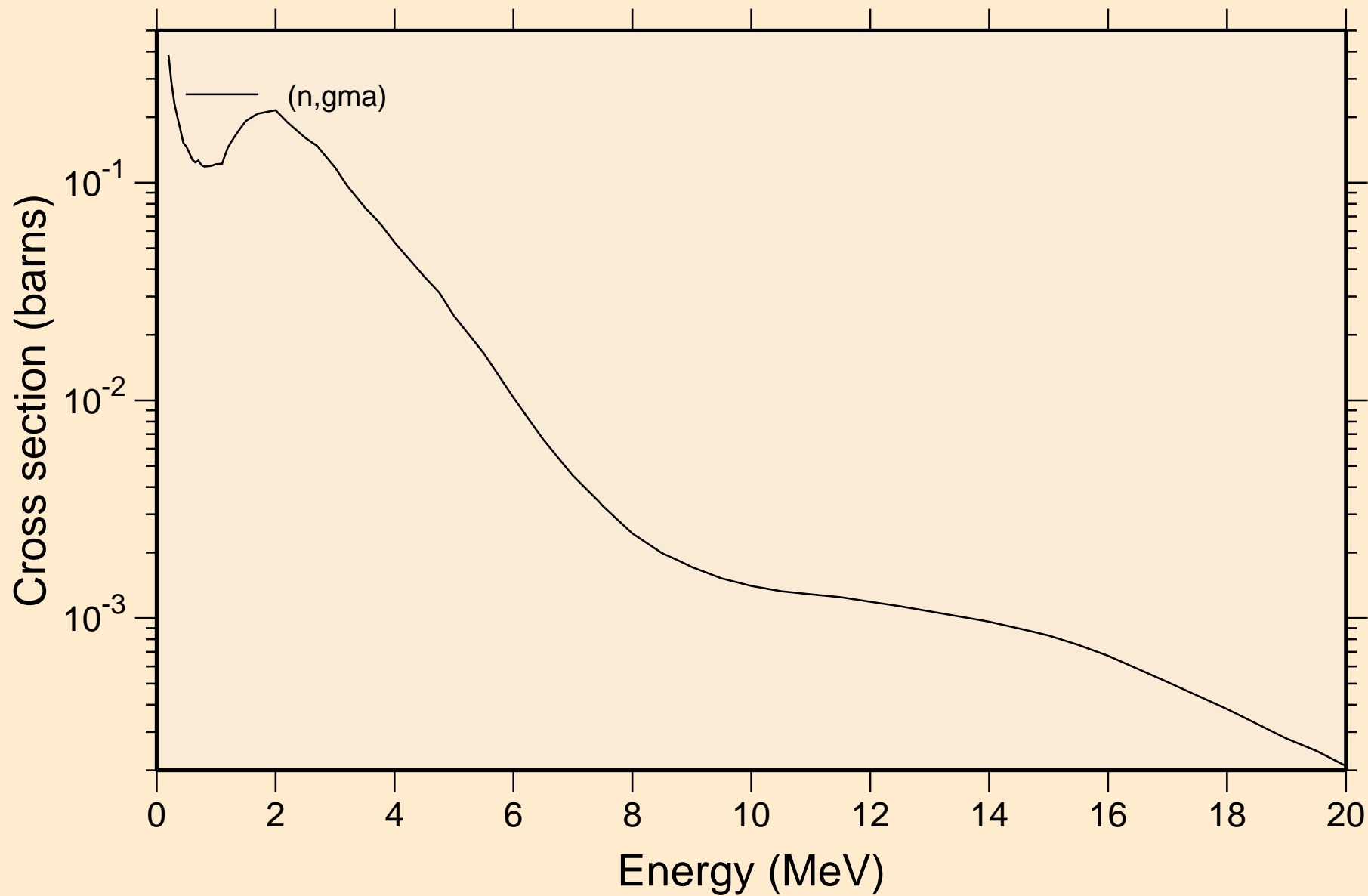

ENDF/B-VII EU-157

Inelastic levels

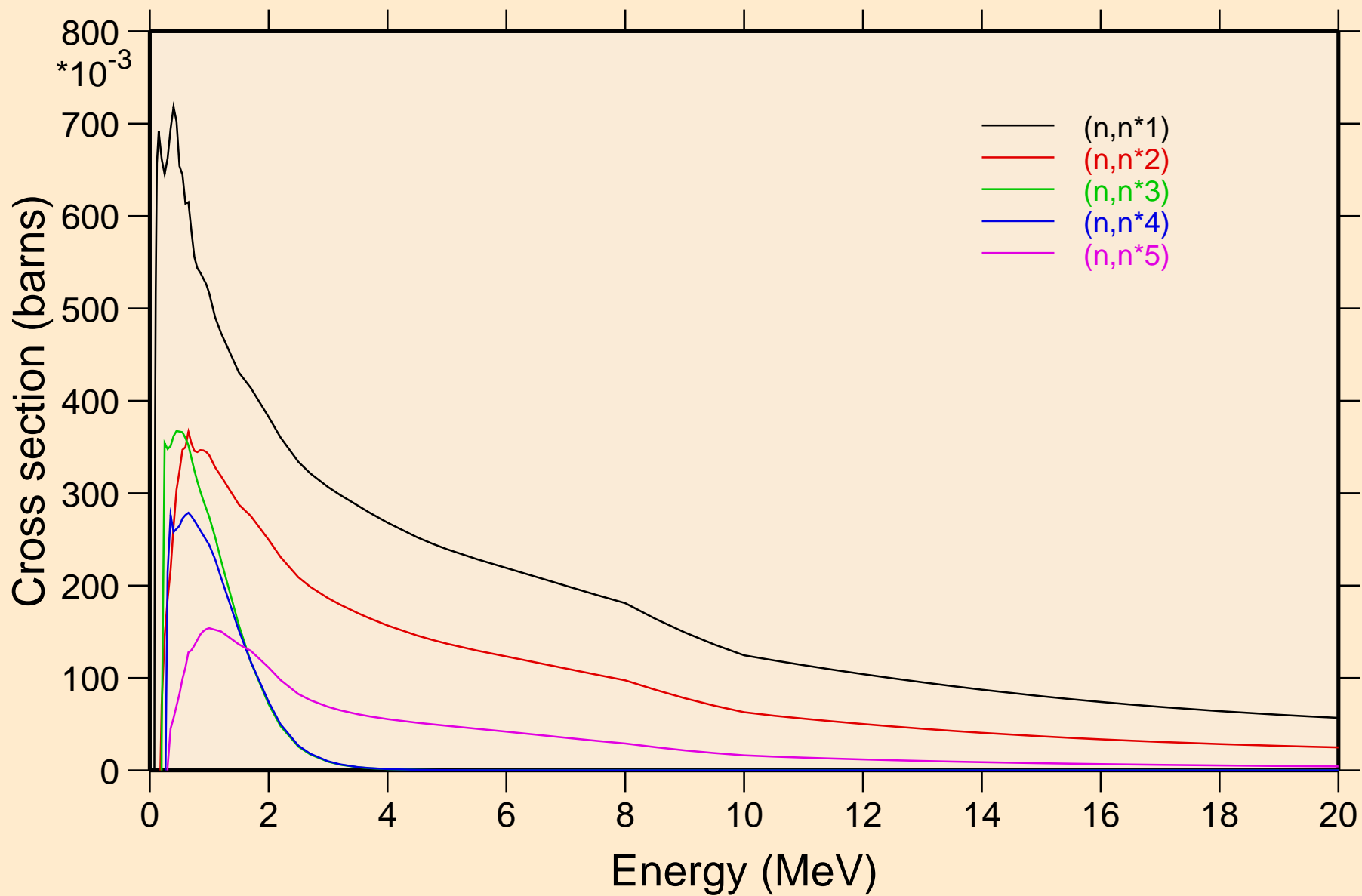

ENDF/B-VII EU-157

Inelastic levels

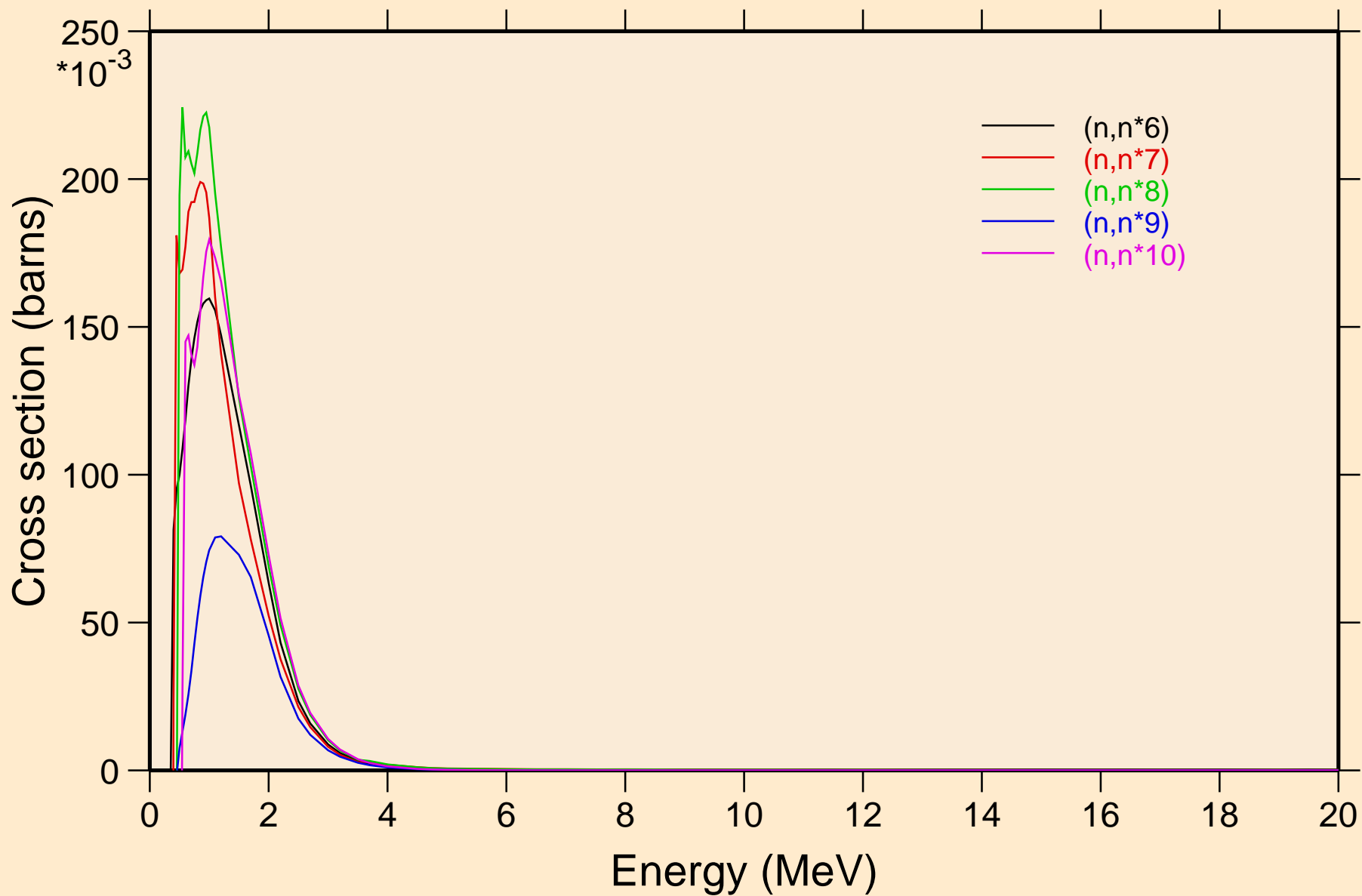

ENDF/B-VII EU-157

Inelastic levels

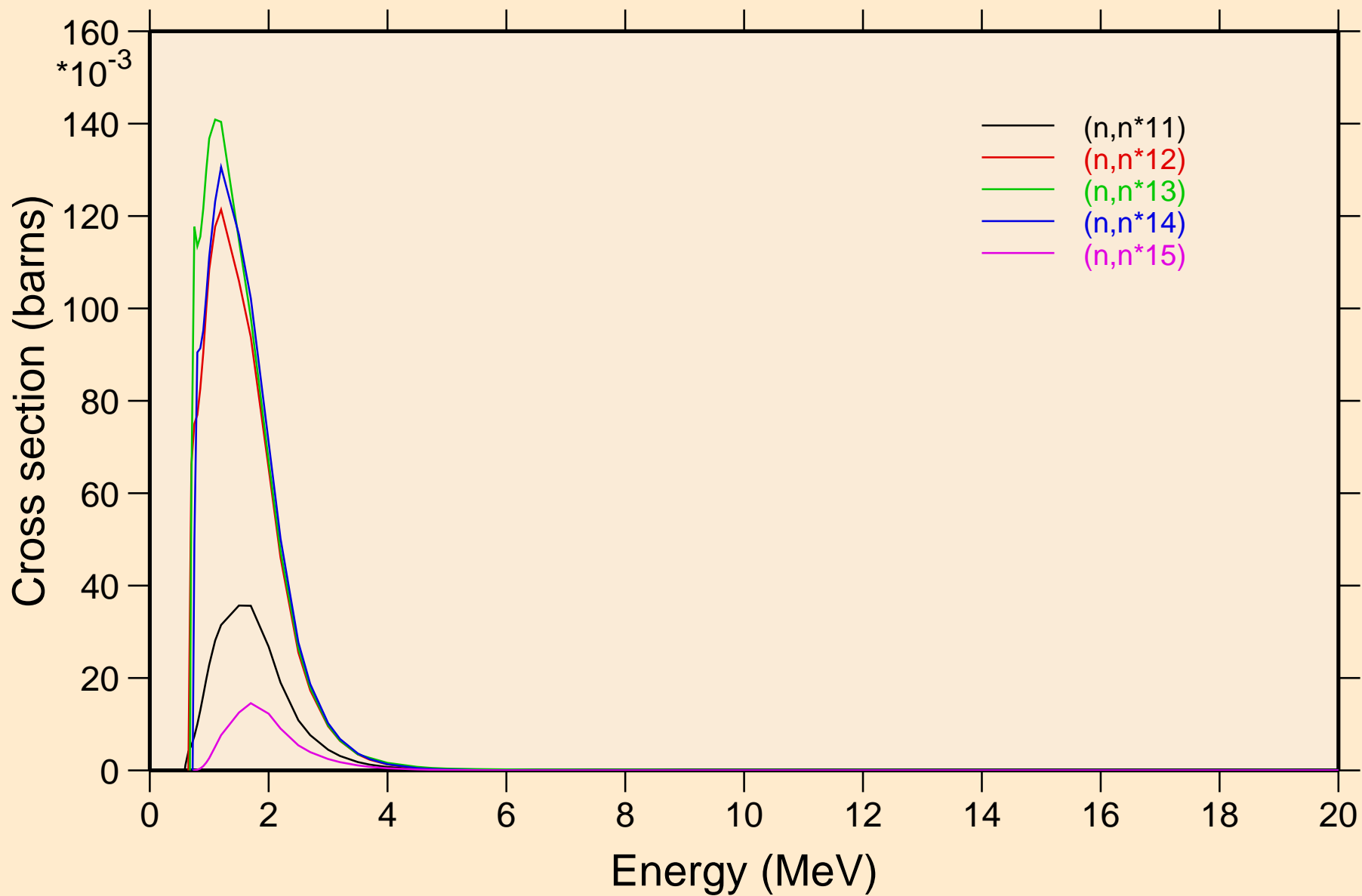

ENDF/B-VII EU-157

Inelastic levels

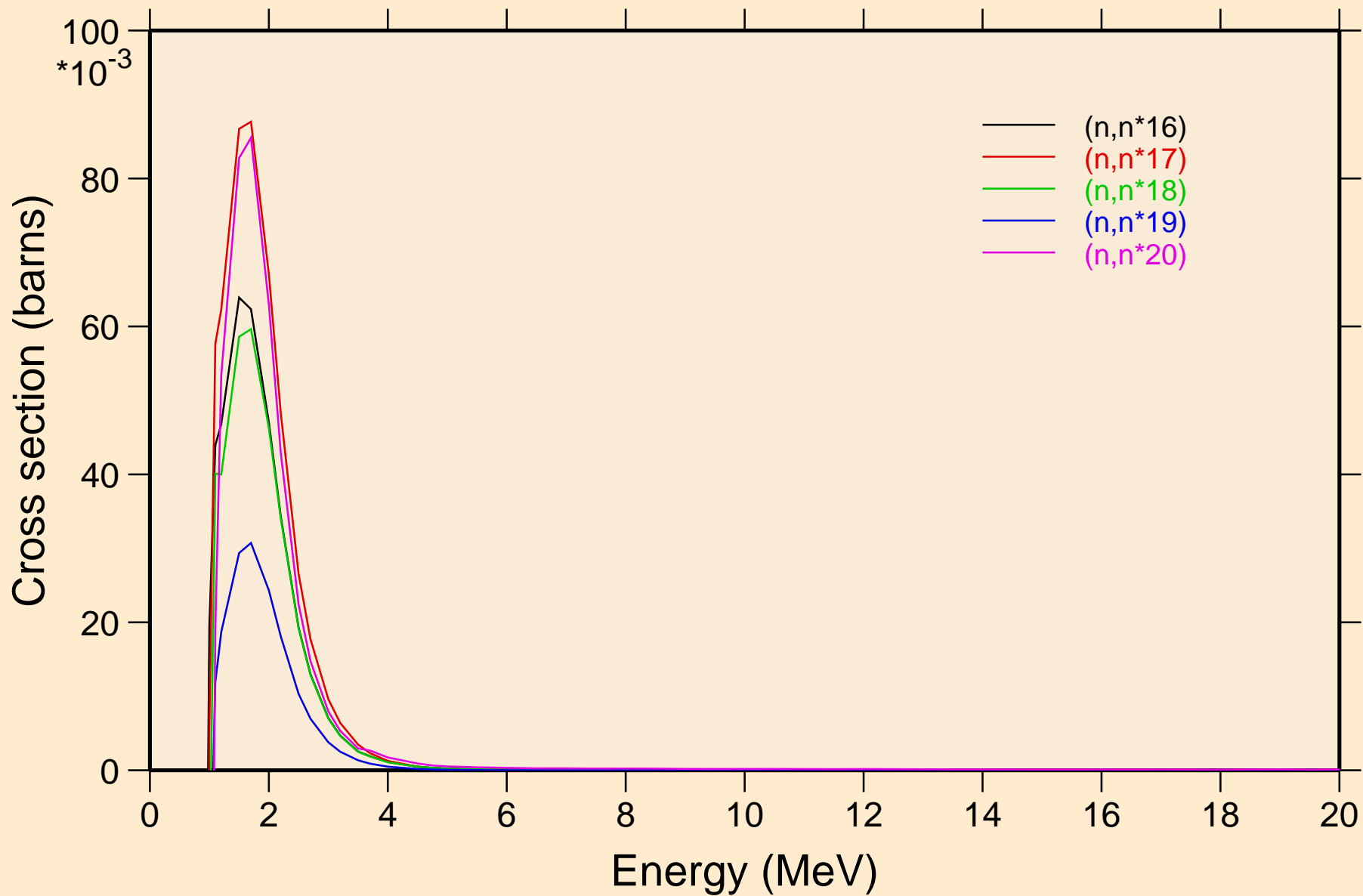

ENDF/B-VII EU-157

Inelastic levels

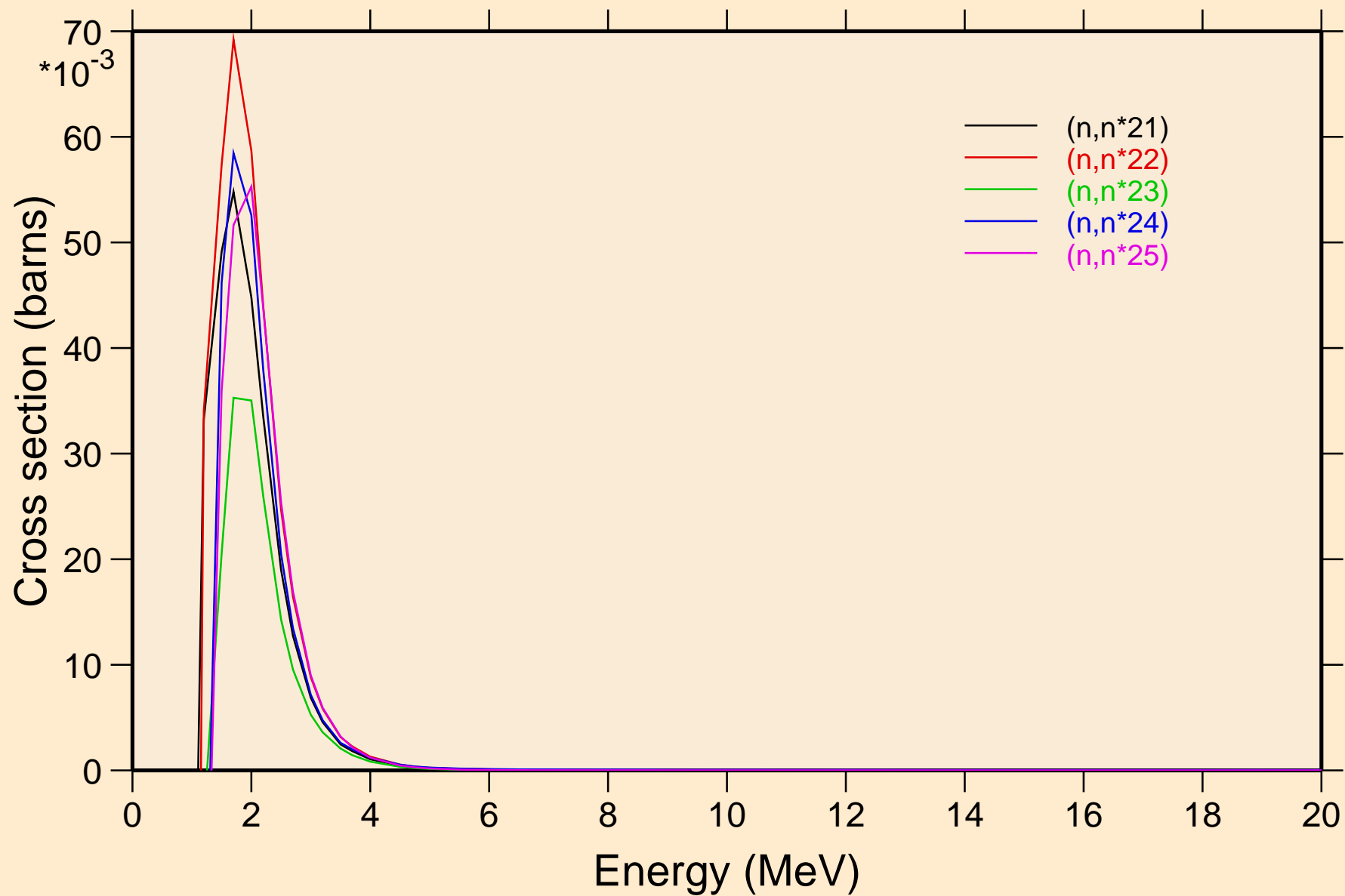

ENDF/B-VII EU-157

Inelastic levels

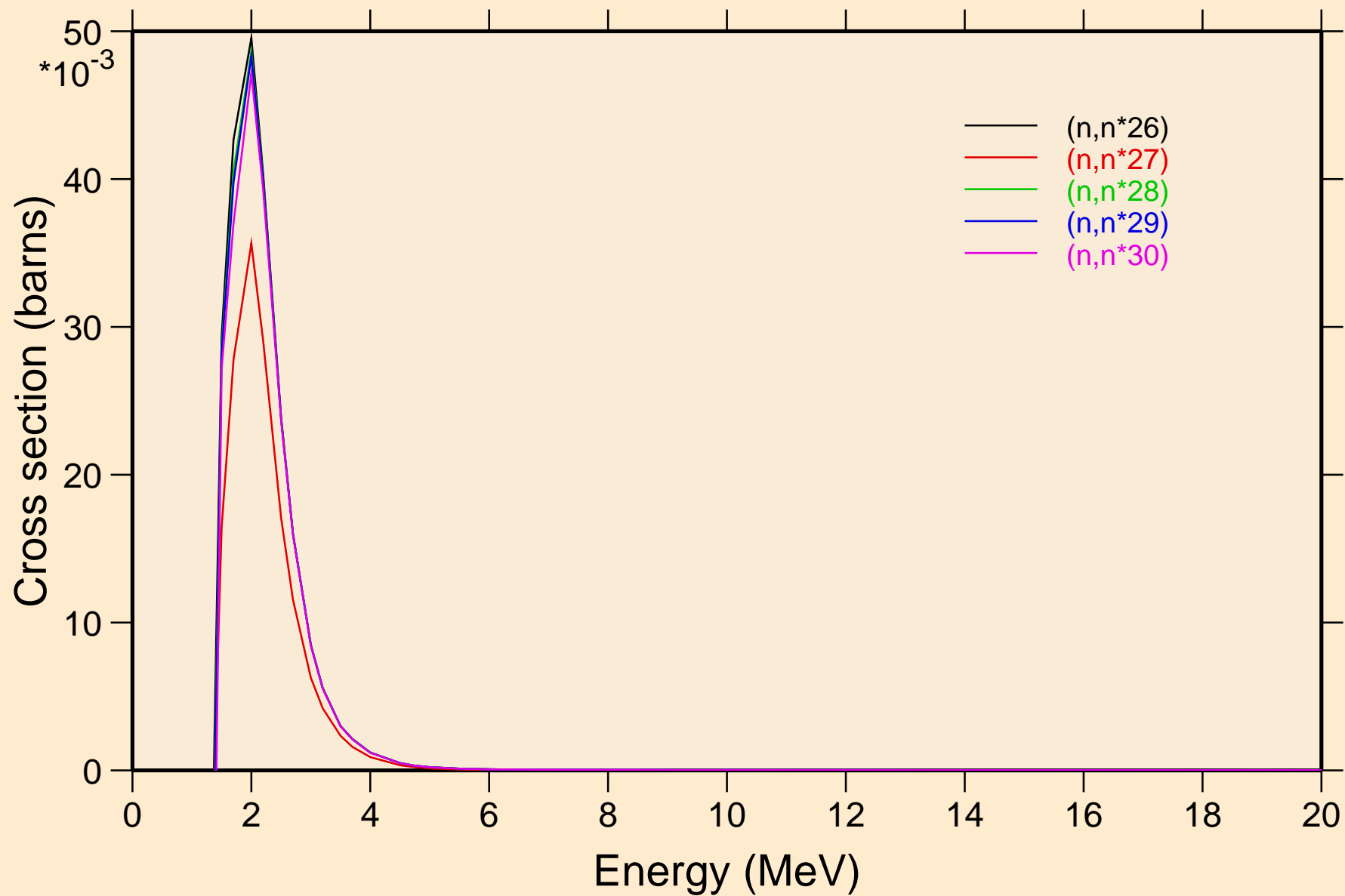

ENDF/B-VII EU-157

Inelastic levels

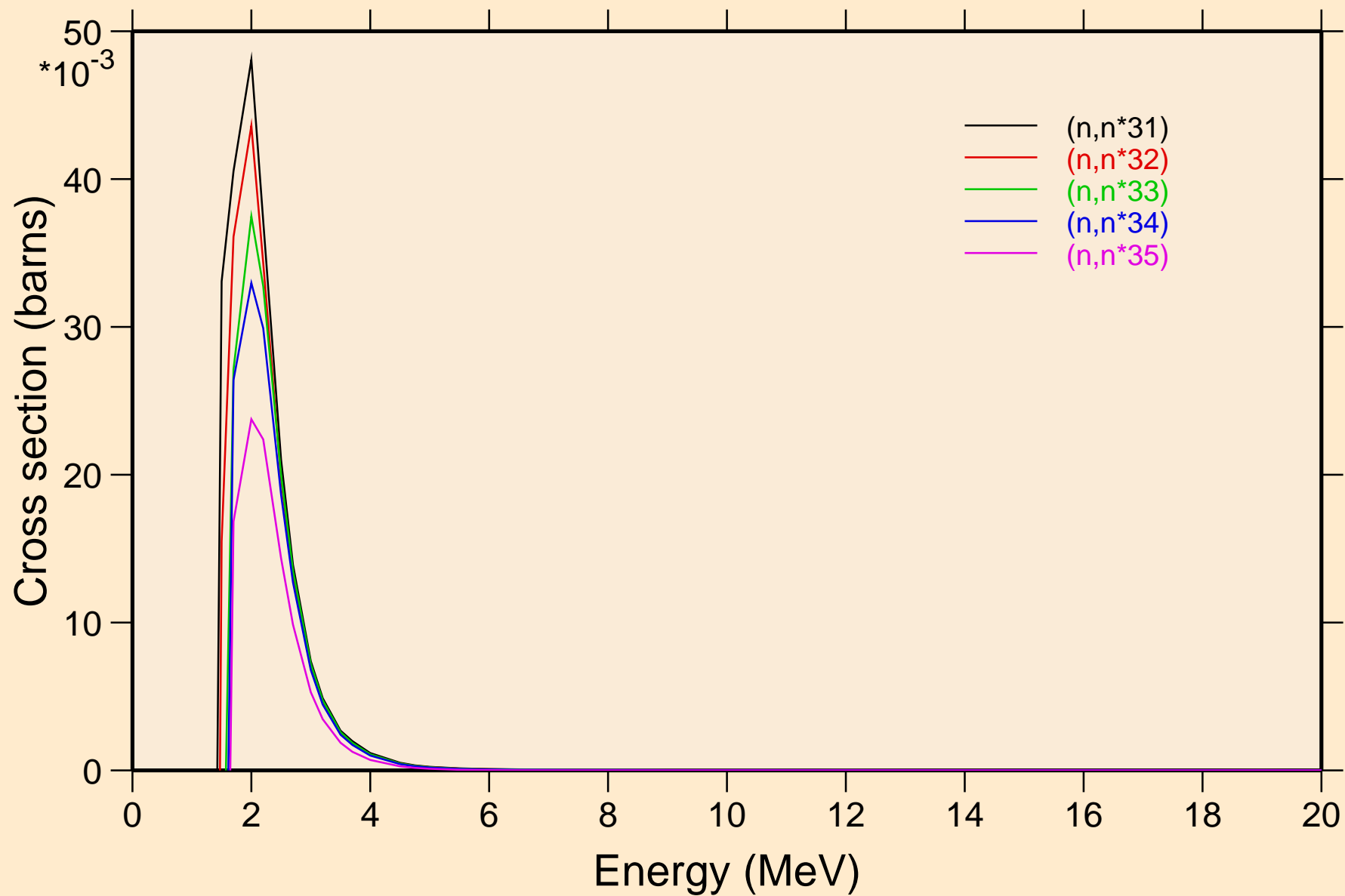

ENDF/B-VII EU-157

Threshold reactions

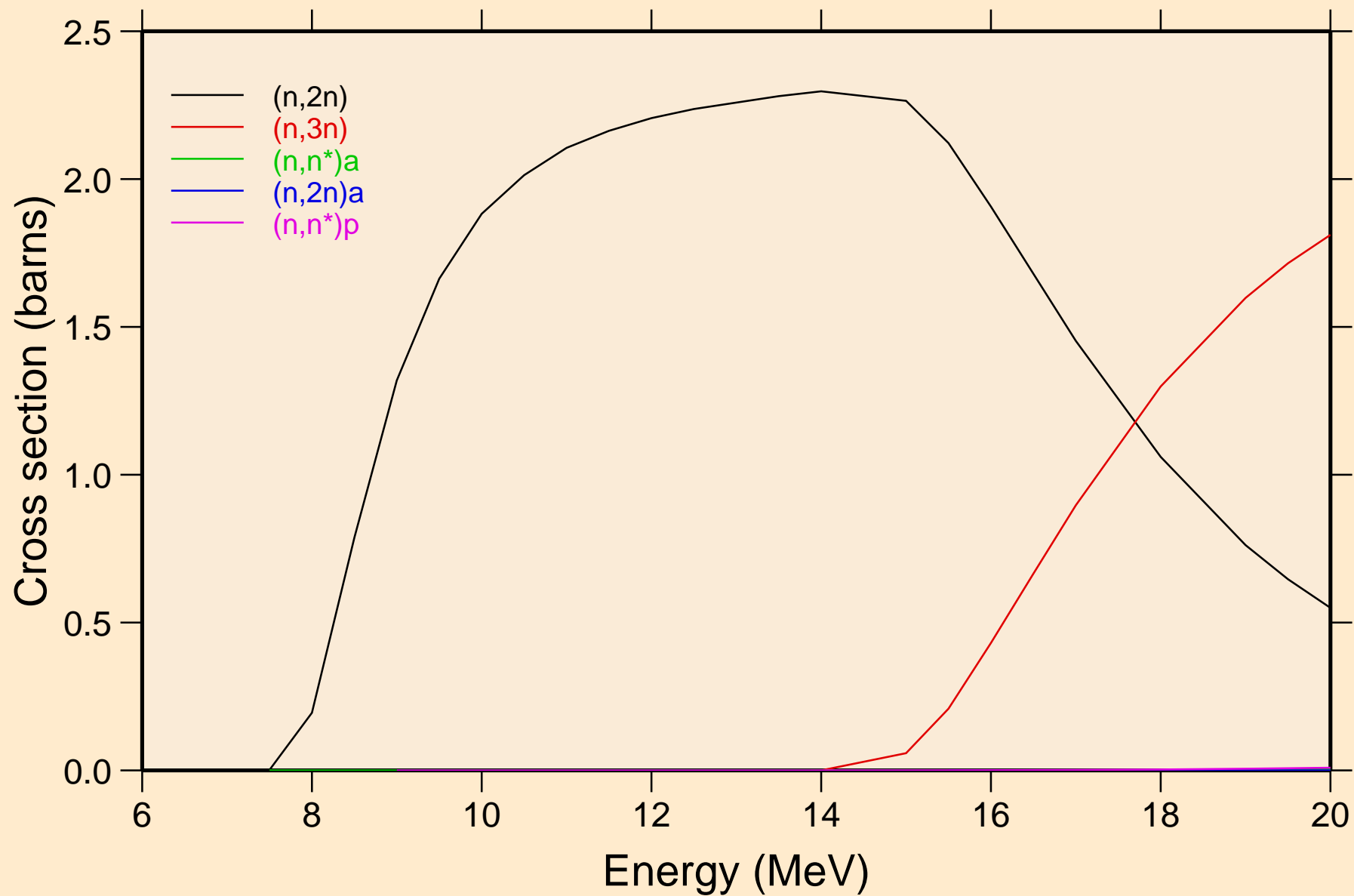

ENDF/B-VII EU-157

Threshold reactions

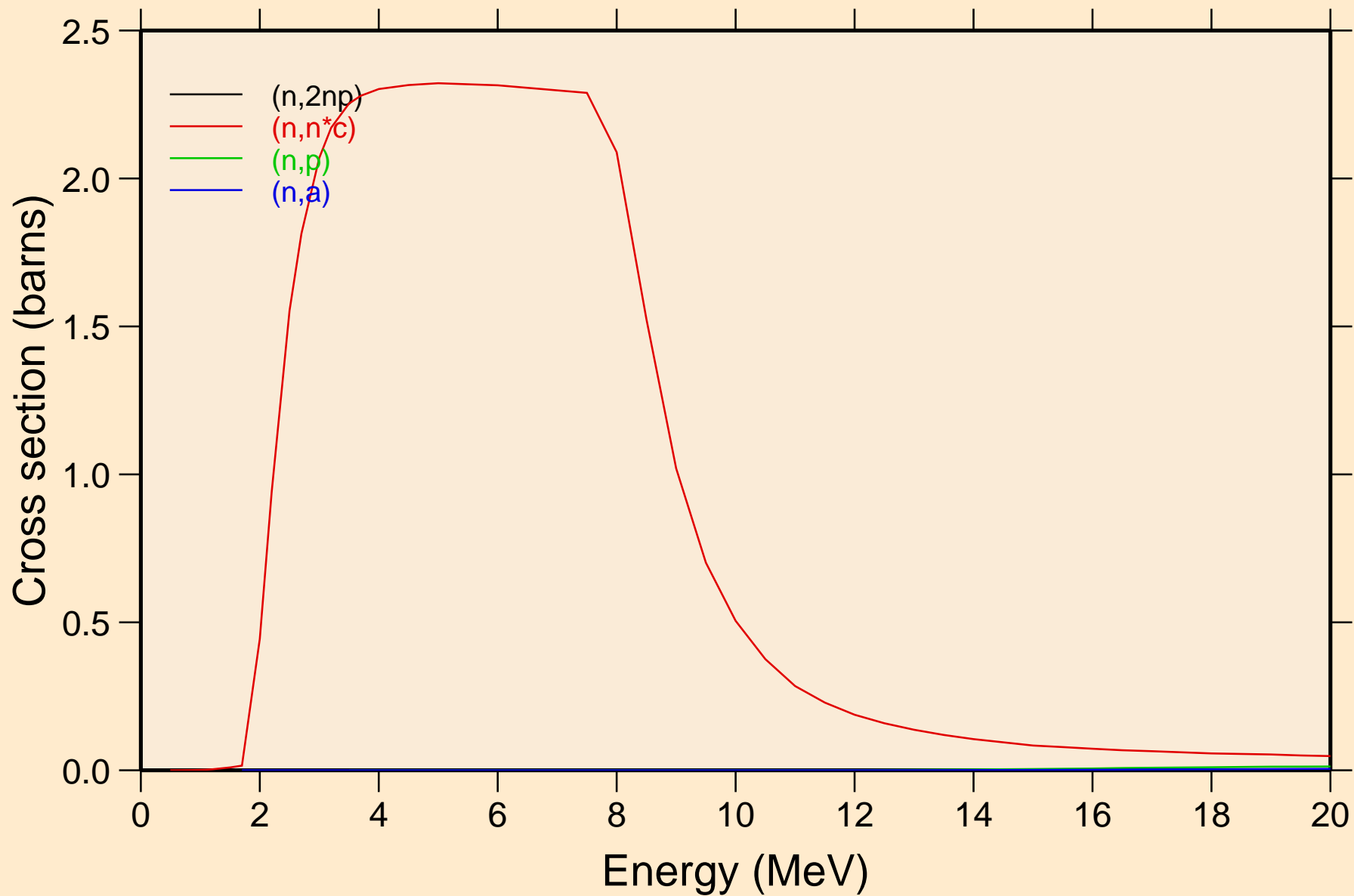

ENDF/B-VII EU-157

Threshold reactions

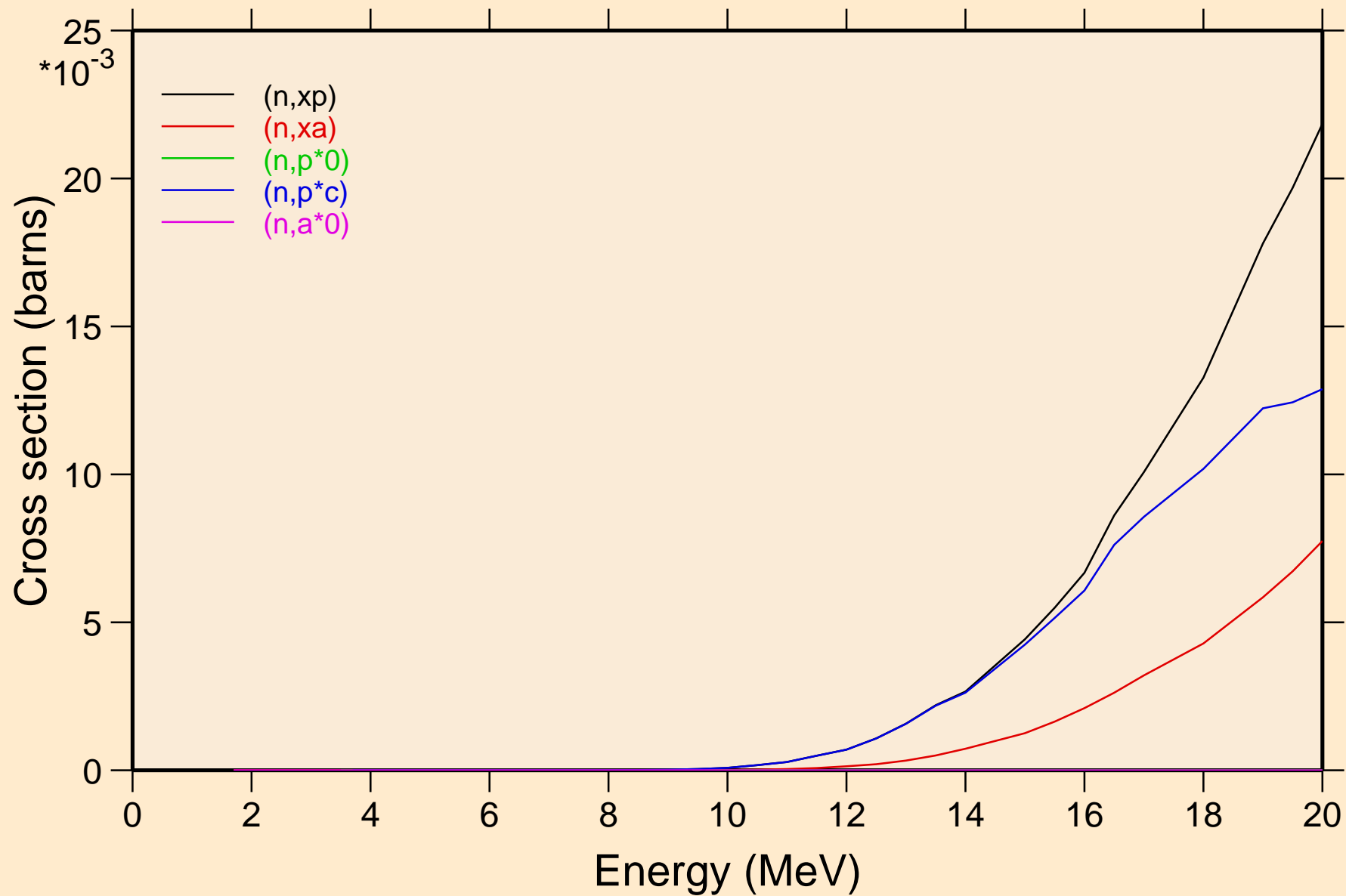

ENDF/B-VII EU-157

Threshold reactions

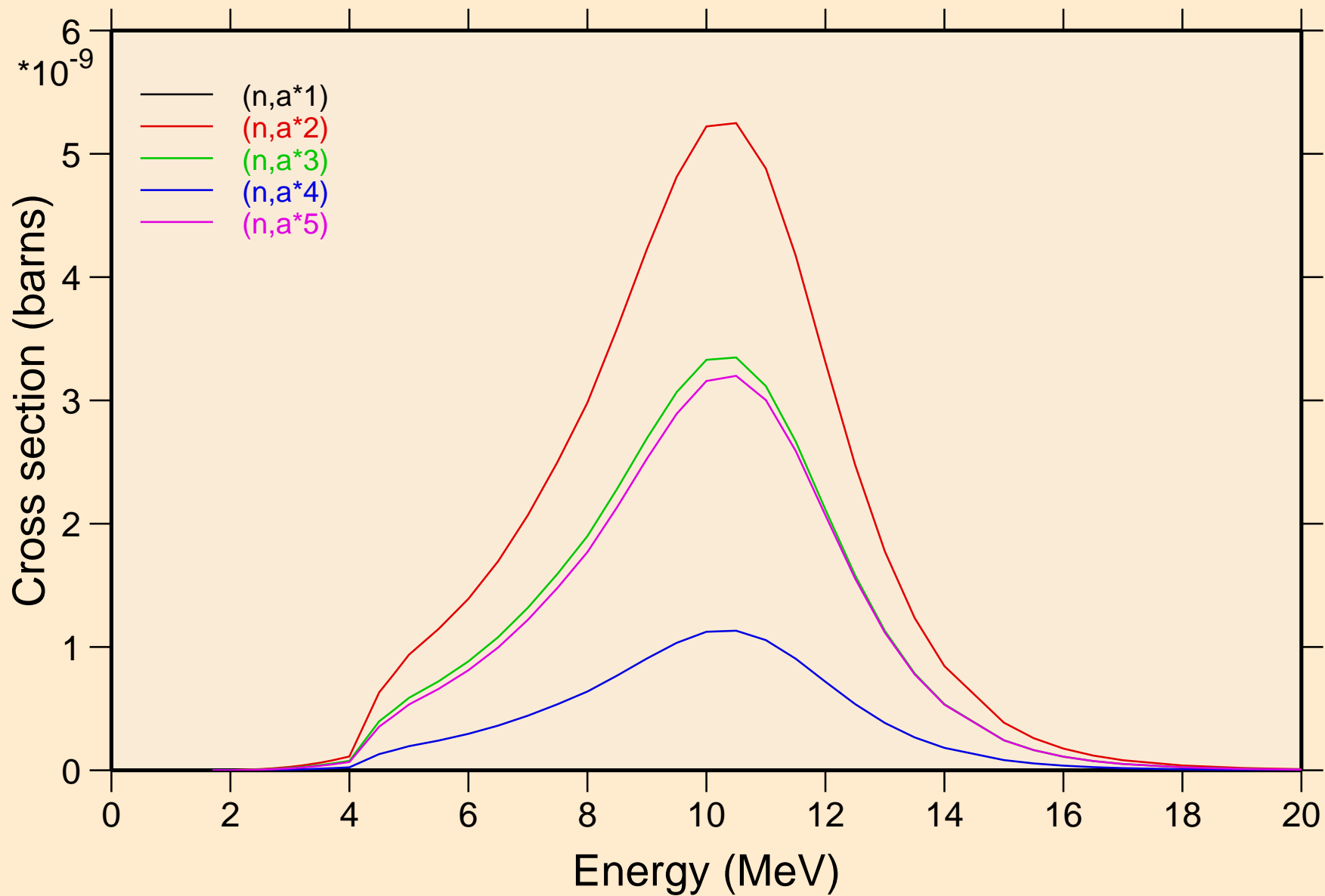

ENDF/B-VII EU-157

Threshold reactions

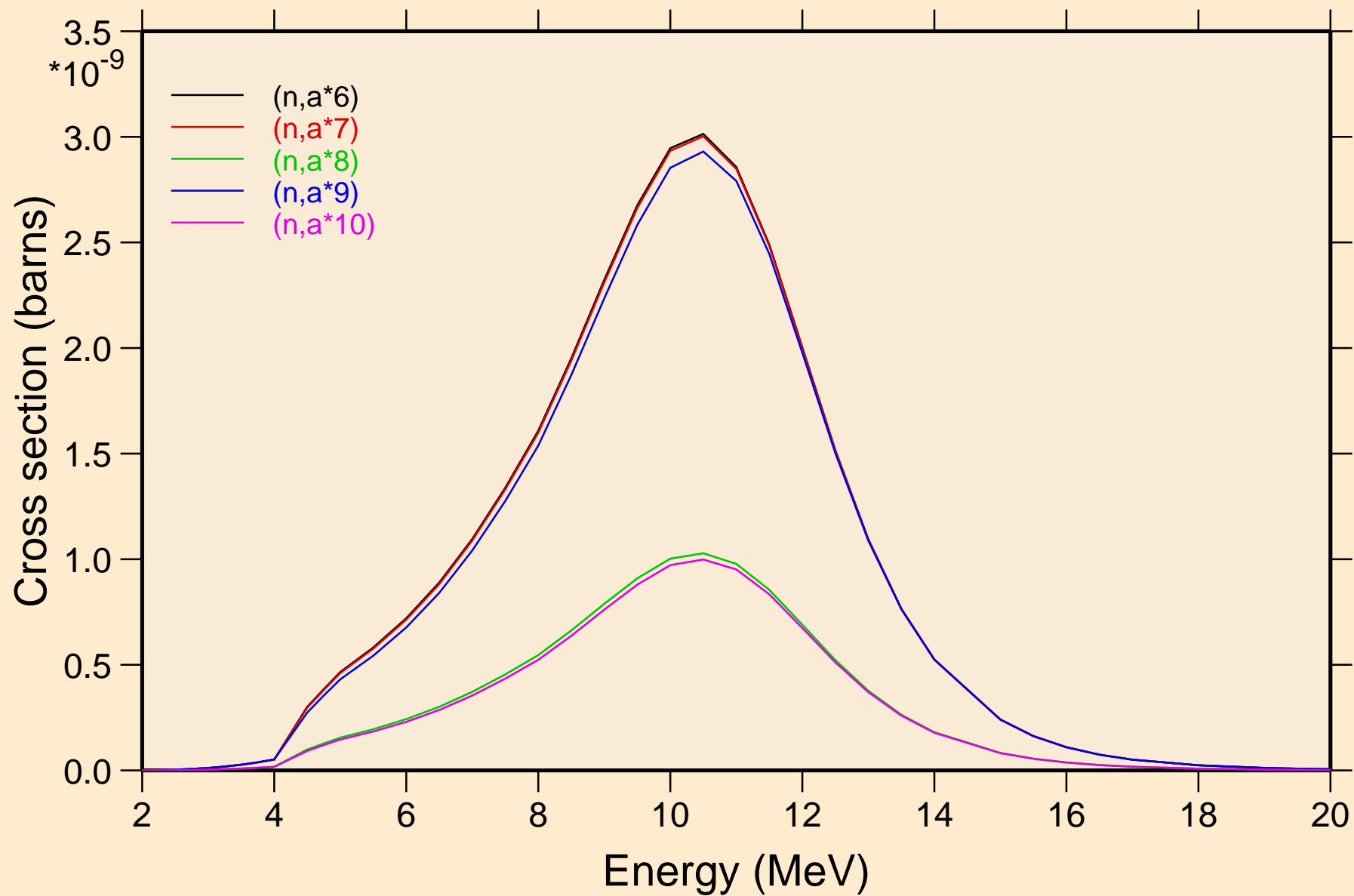

ENDF/B-VII EU-157

Threshold reactions

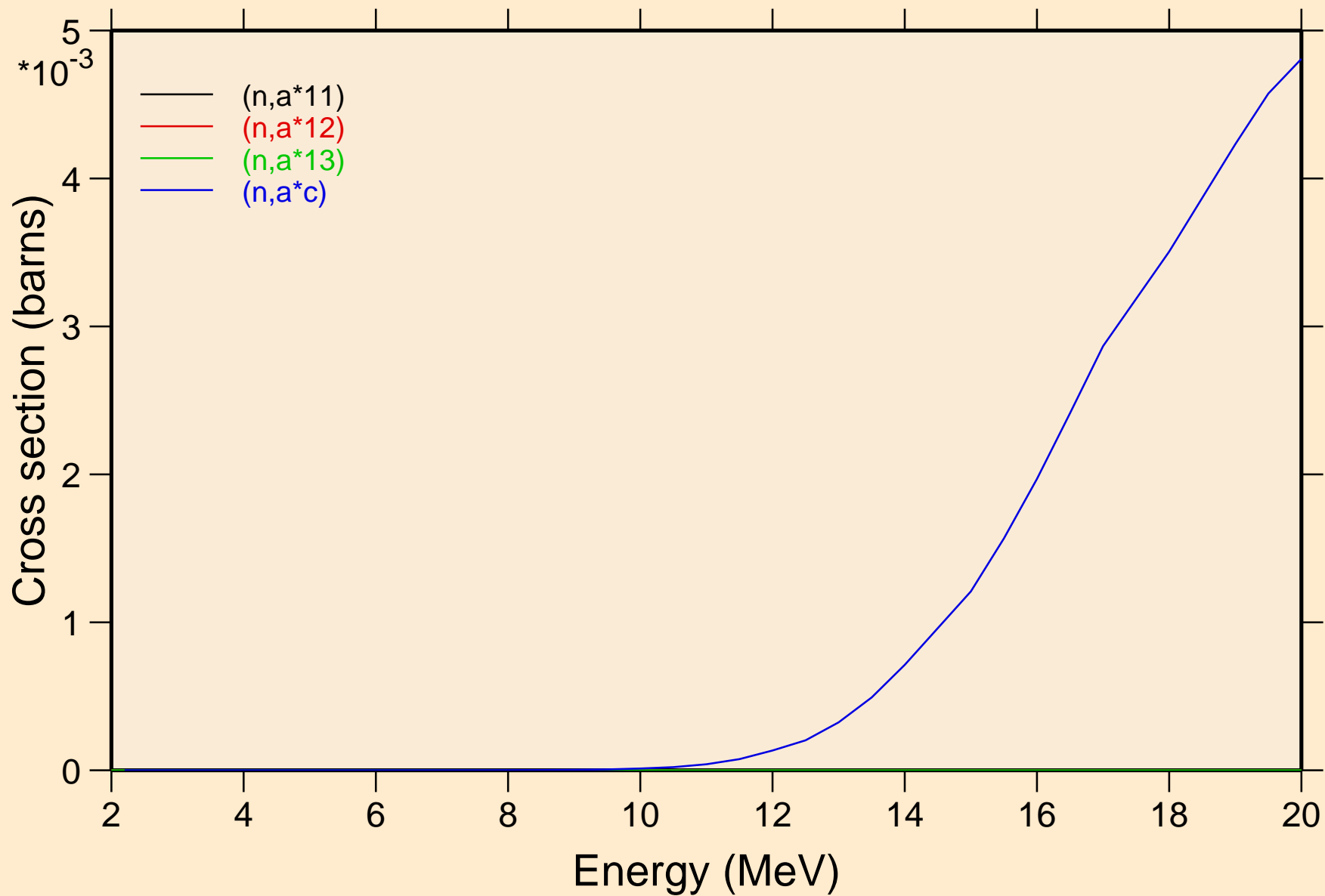

ENDF/B-VII EU-157
angular distribution for elastic

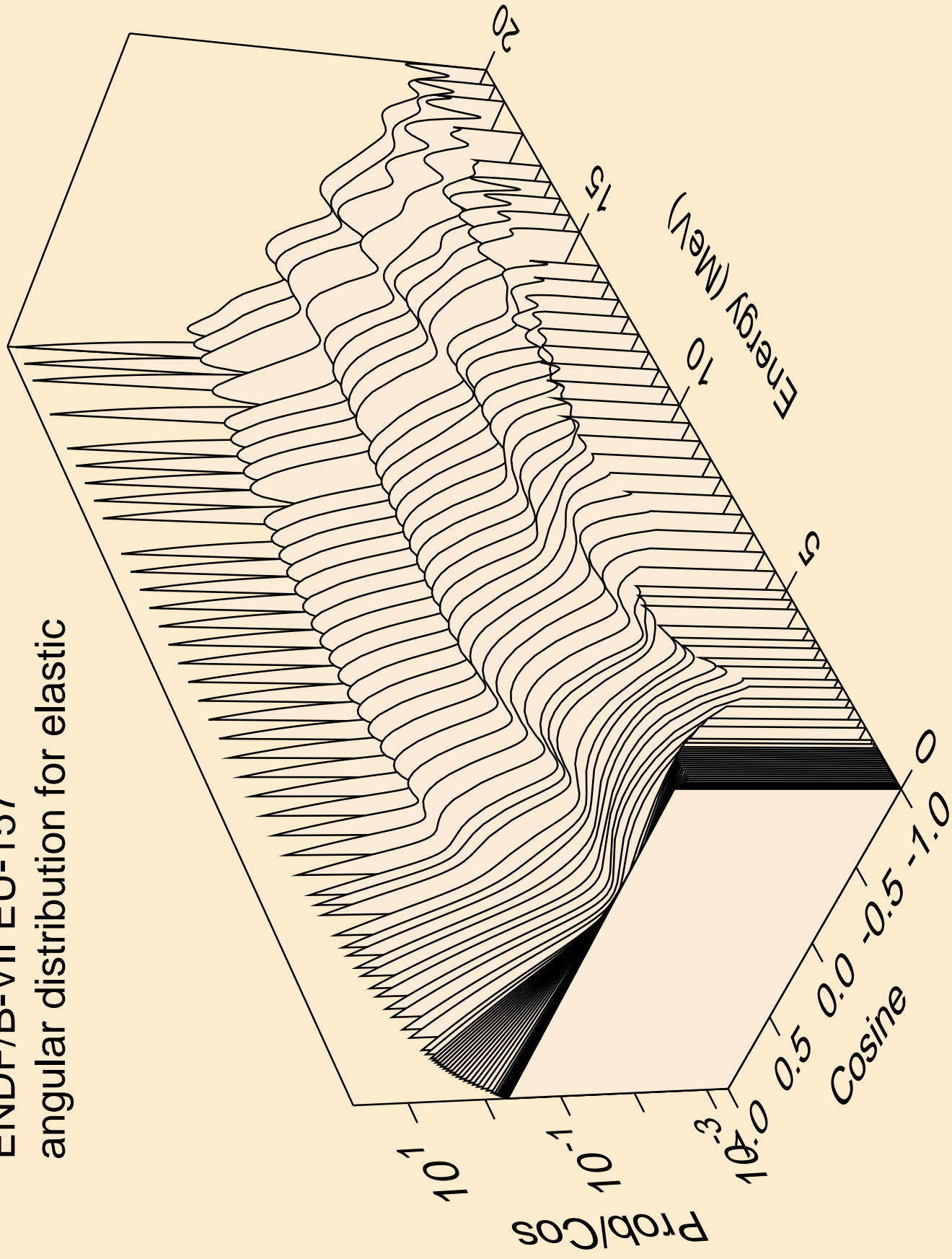

ENDF/B-VII EU-157
angular distribution for (n,n*1)

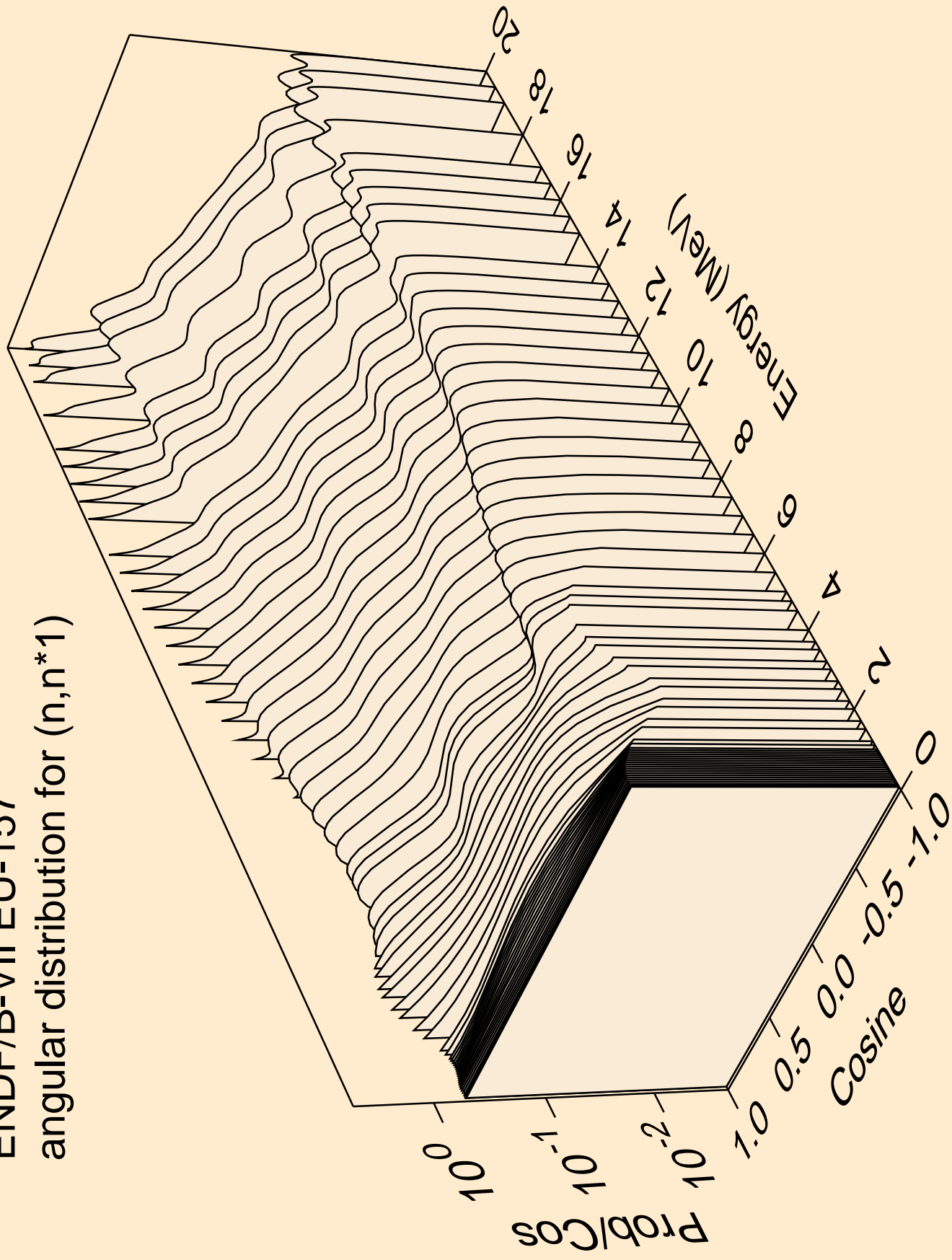

ENDF/B-VII EU-157
angular distribution for (n,n*2)

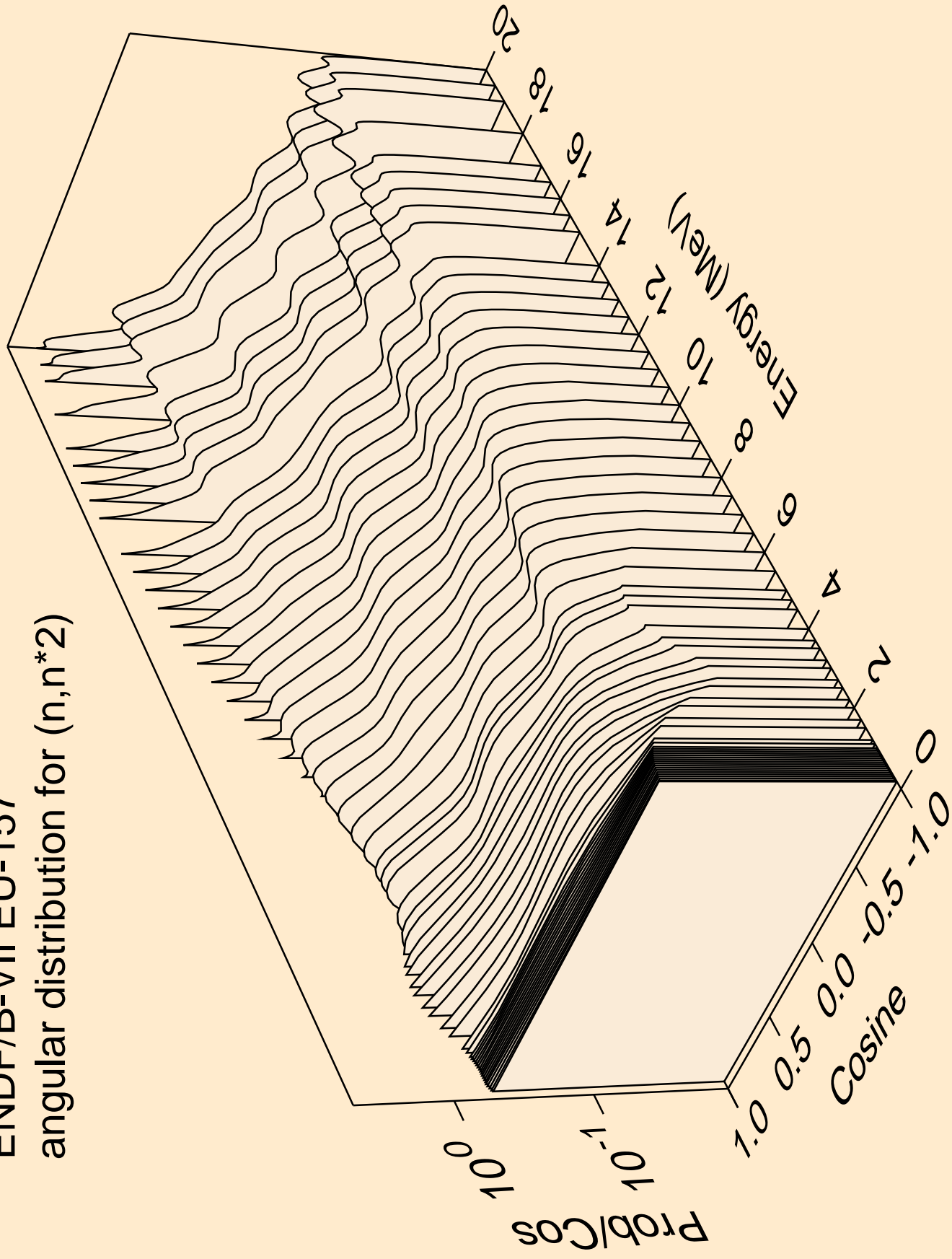

ENDF/B-VII EU-157
angular distribution for (n,n*3)

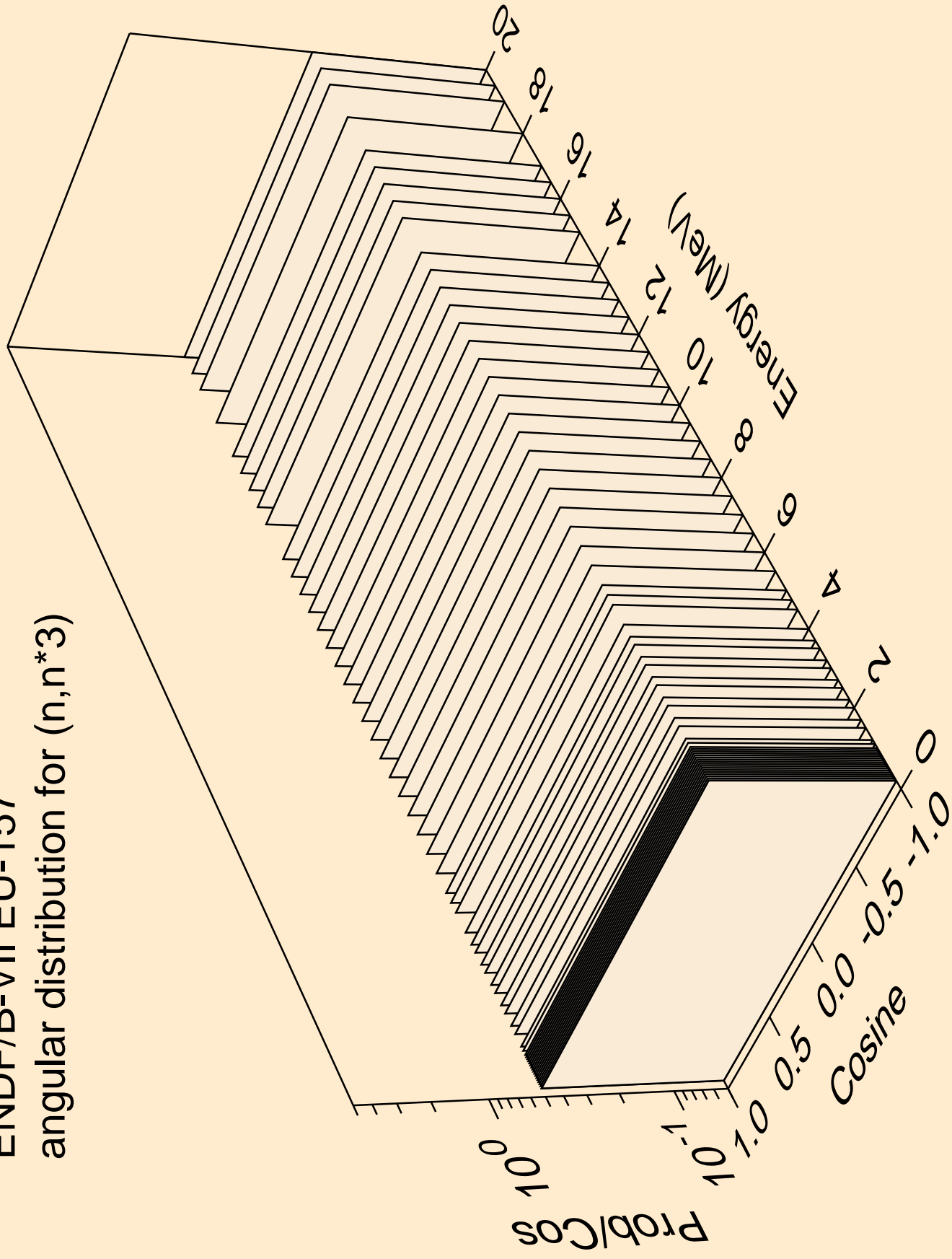

ENDF/B-VII EU-157
angular distribution for (n,n*4)

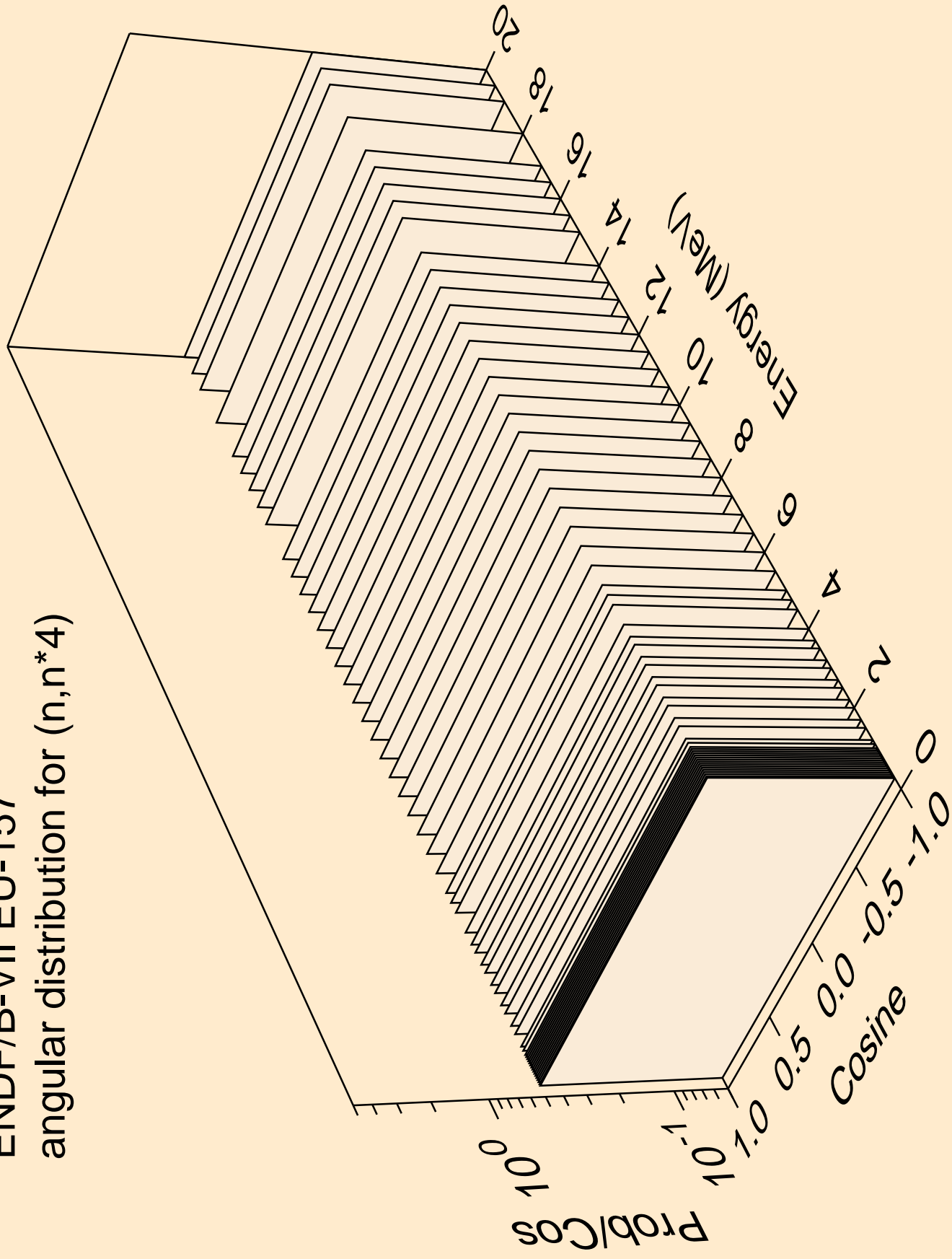

ENDF/B-VII EU-157
angular distribution for (n,n*5)

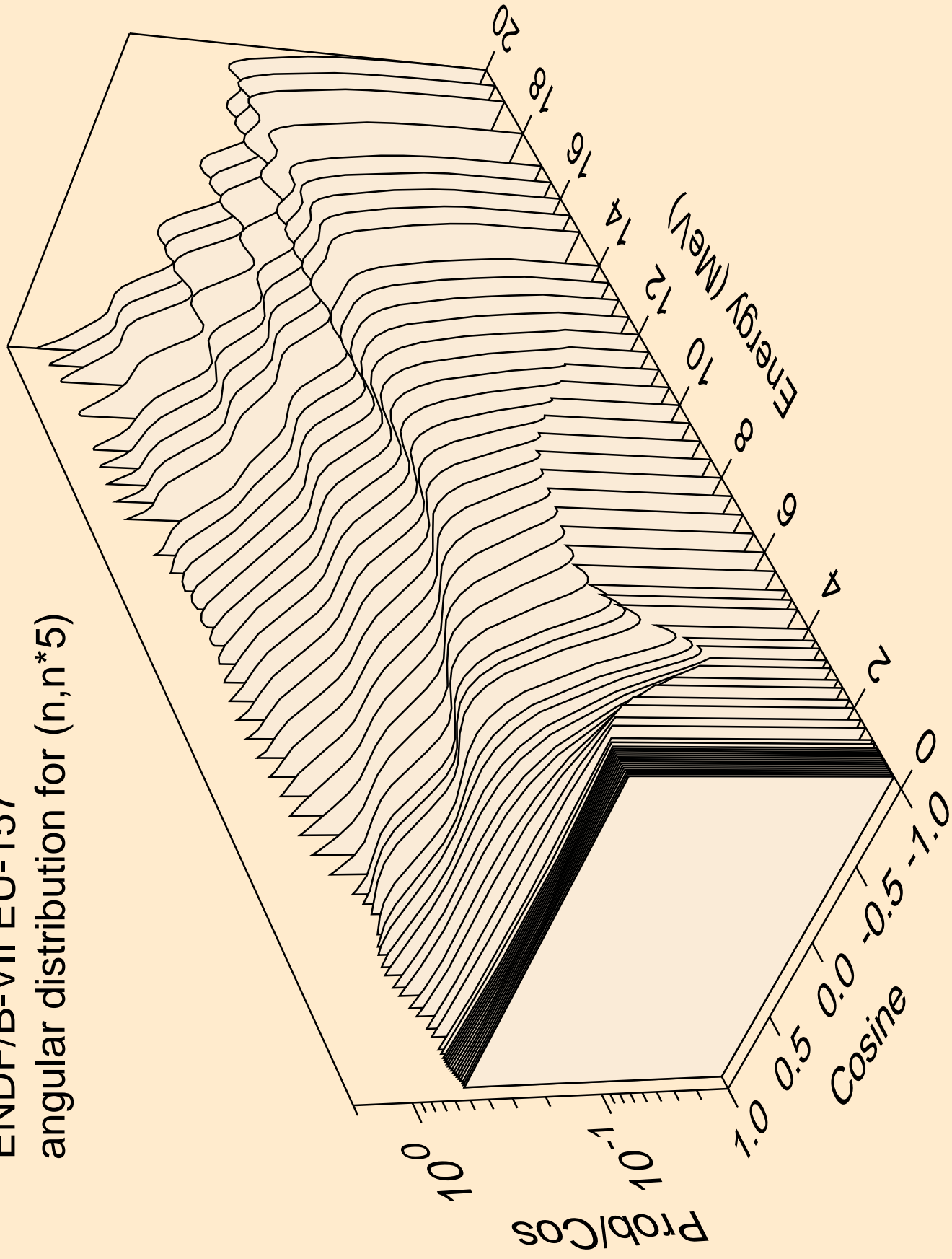

ENDF/B-VII EU-157
angular distribution for (n,n*6)

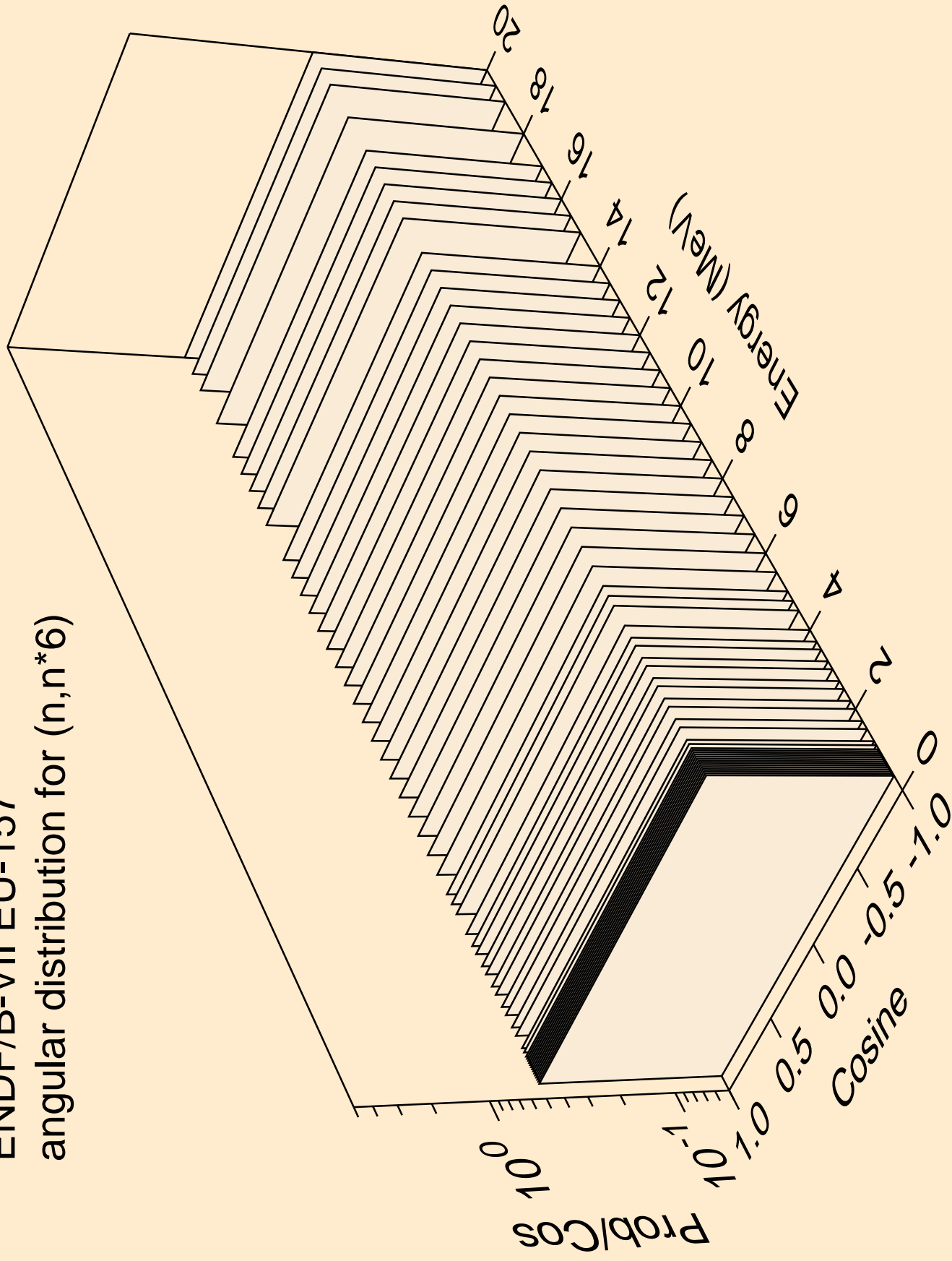

ENDF/B-VII EU-157
angular distribution for (n,n*7)

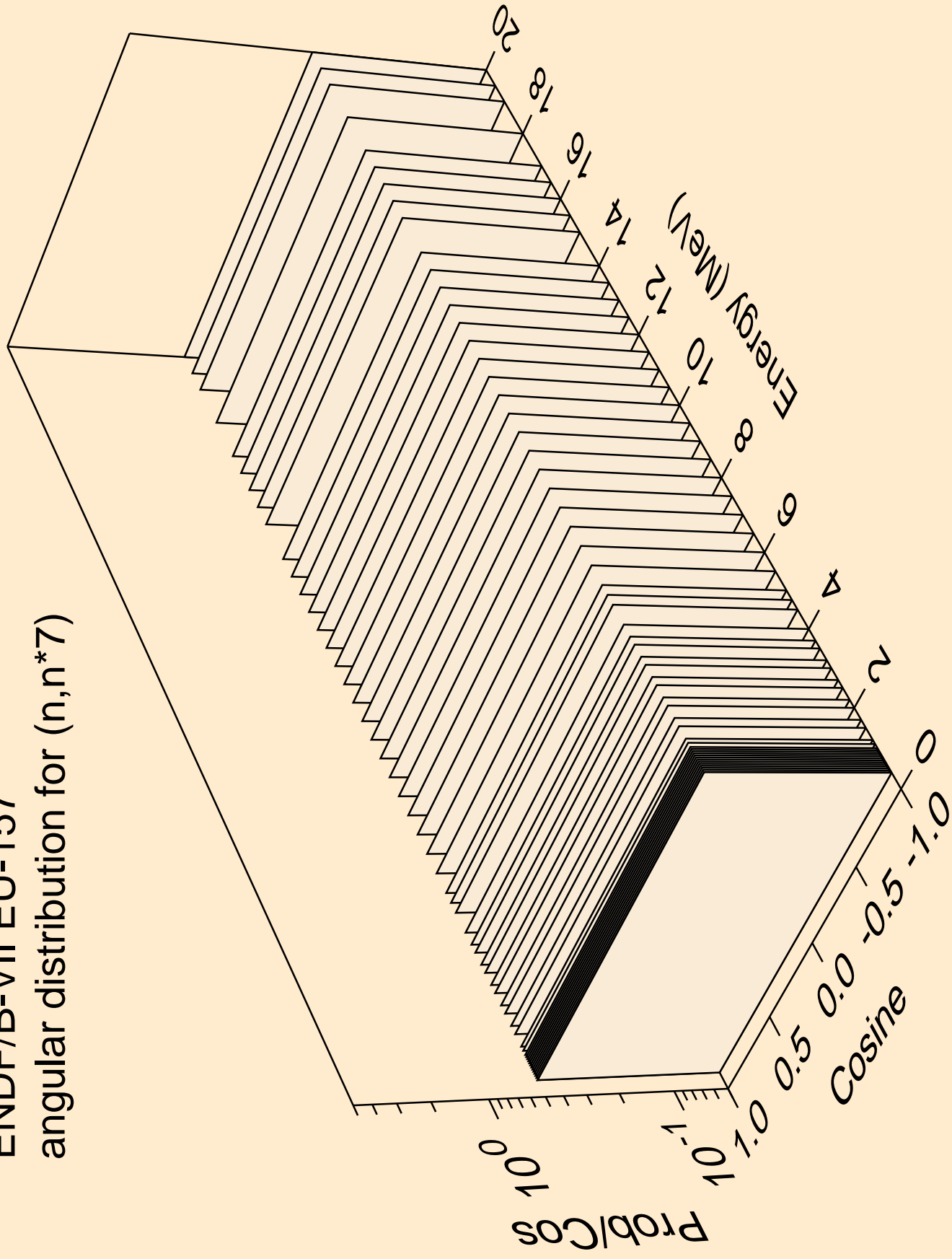

ENDF/B-VII EU-157
angular distribution for (n,n*8)

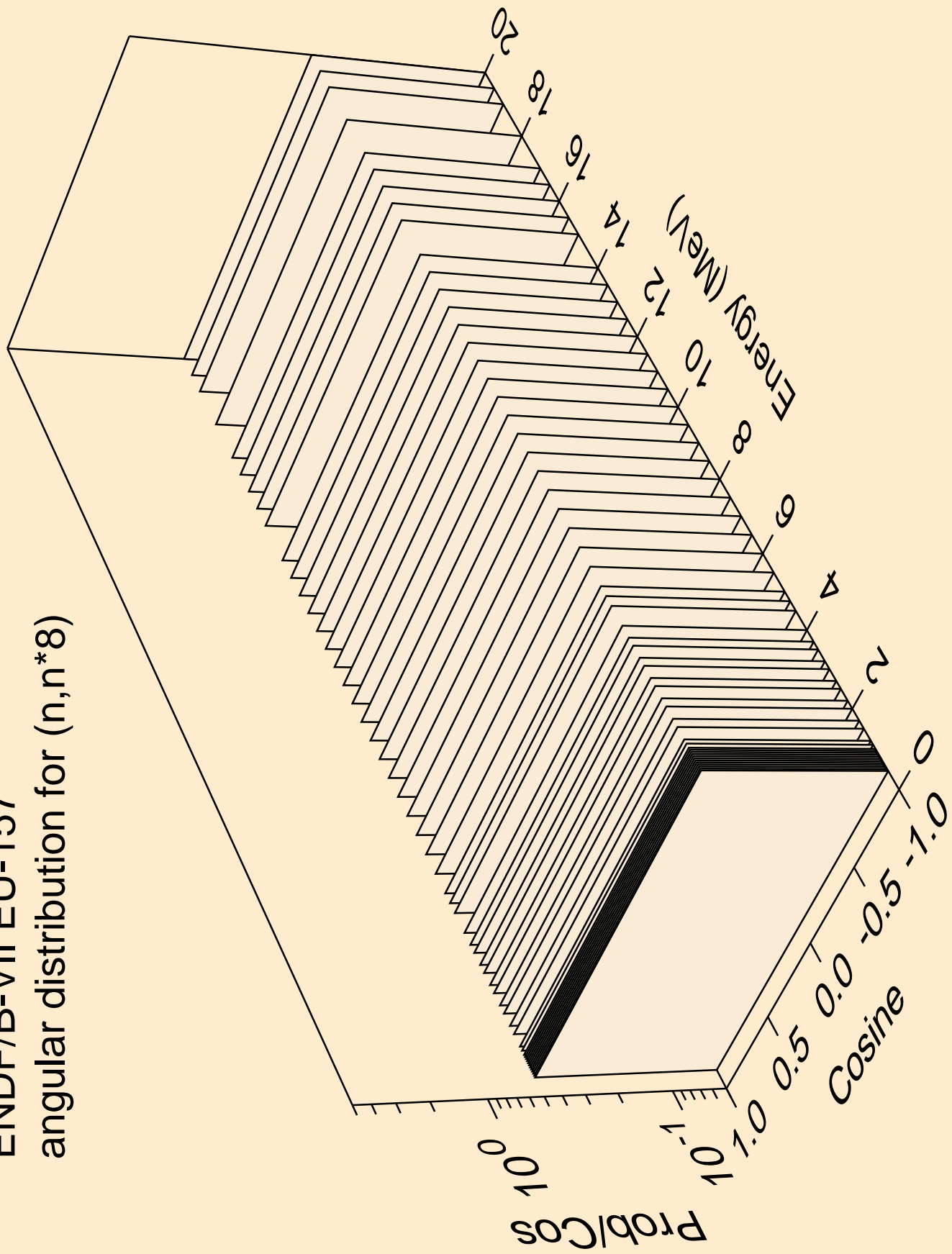

ENDF/B-VII EU-157
angular distribution for (n,n*9)

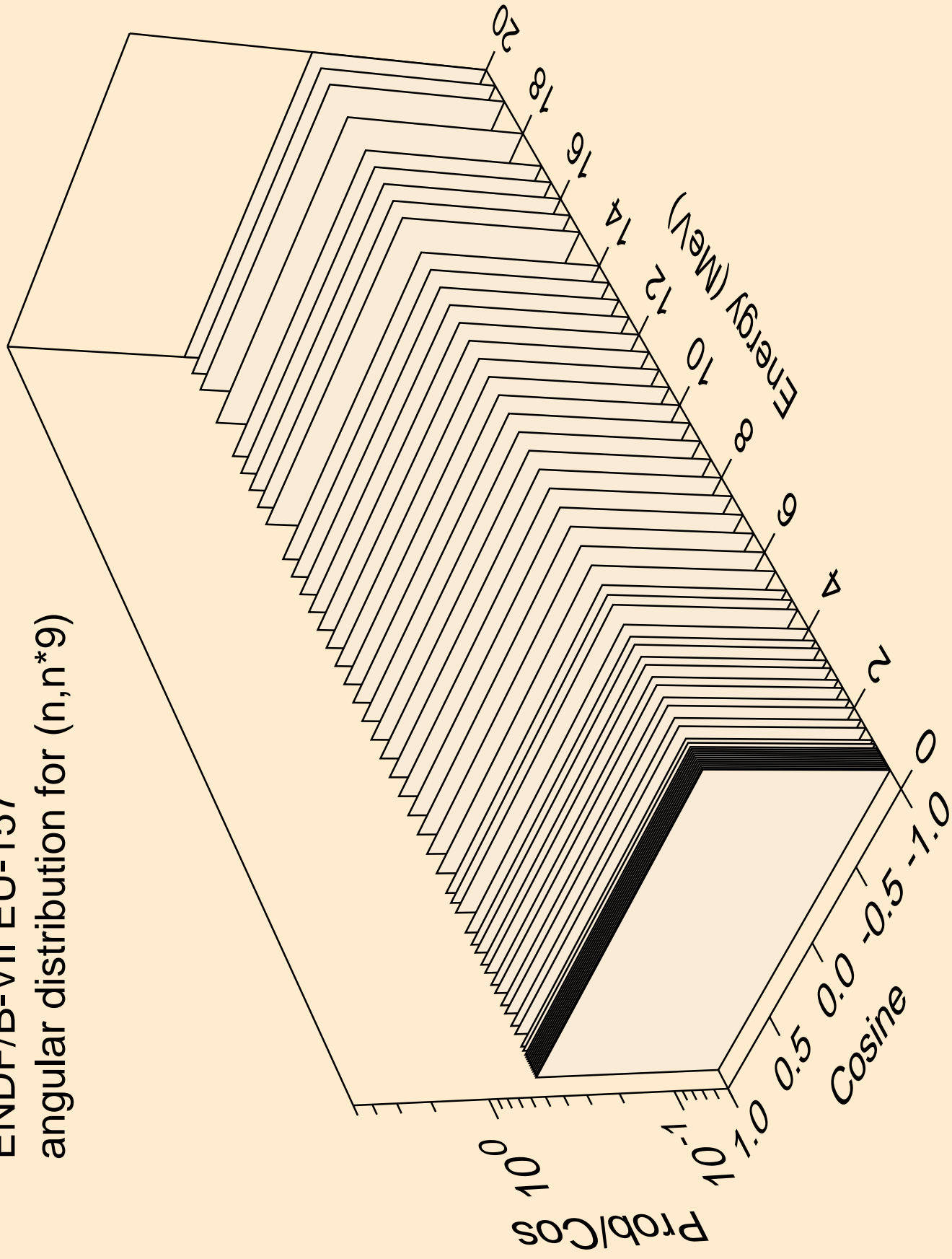

ENDF/B-VII EU-157
angular distribution for (n,n*10)

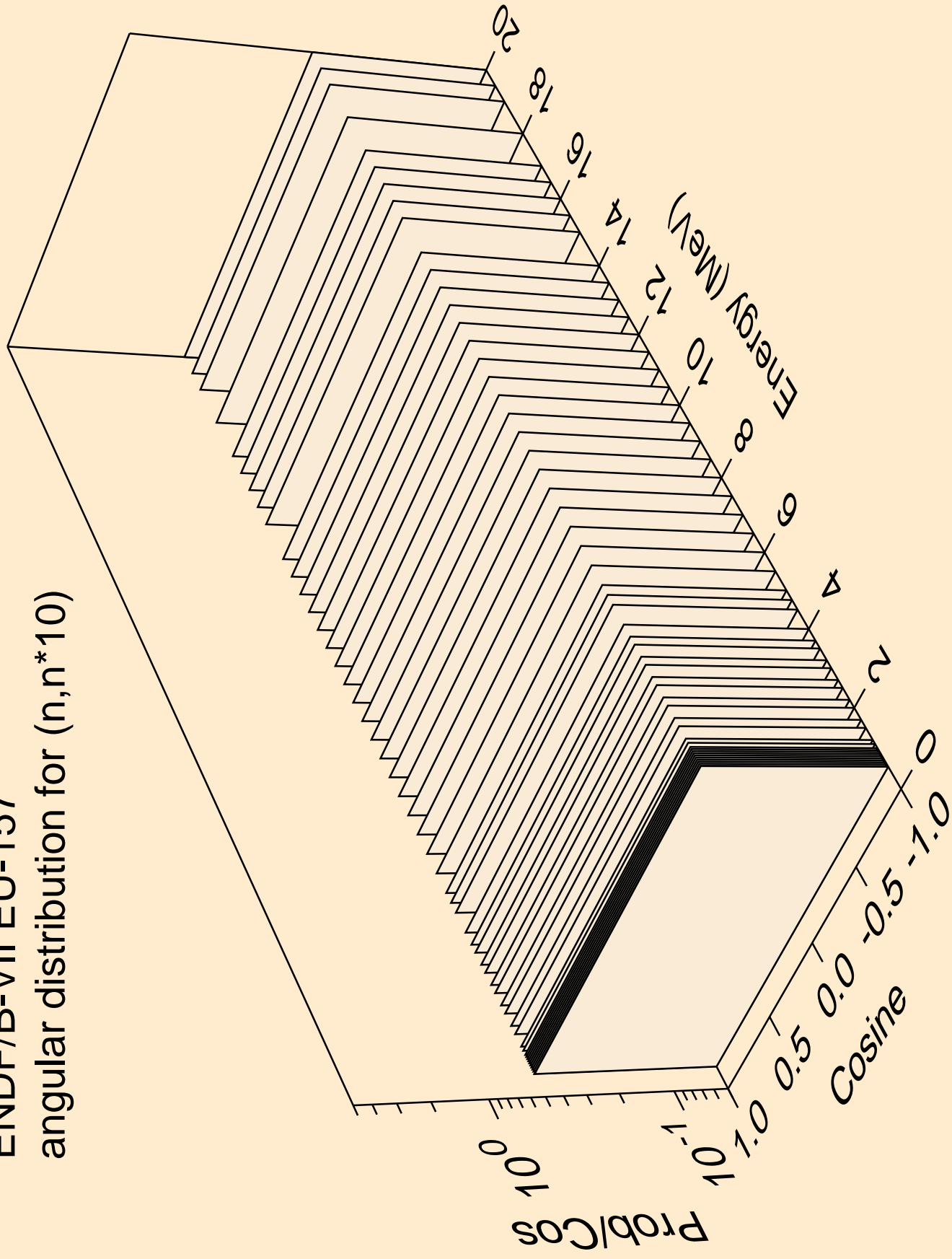

ENDF/B-VII EU-157
angular distribution for (n,n*11)

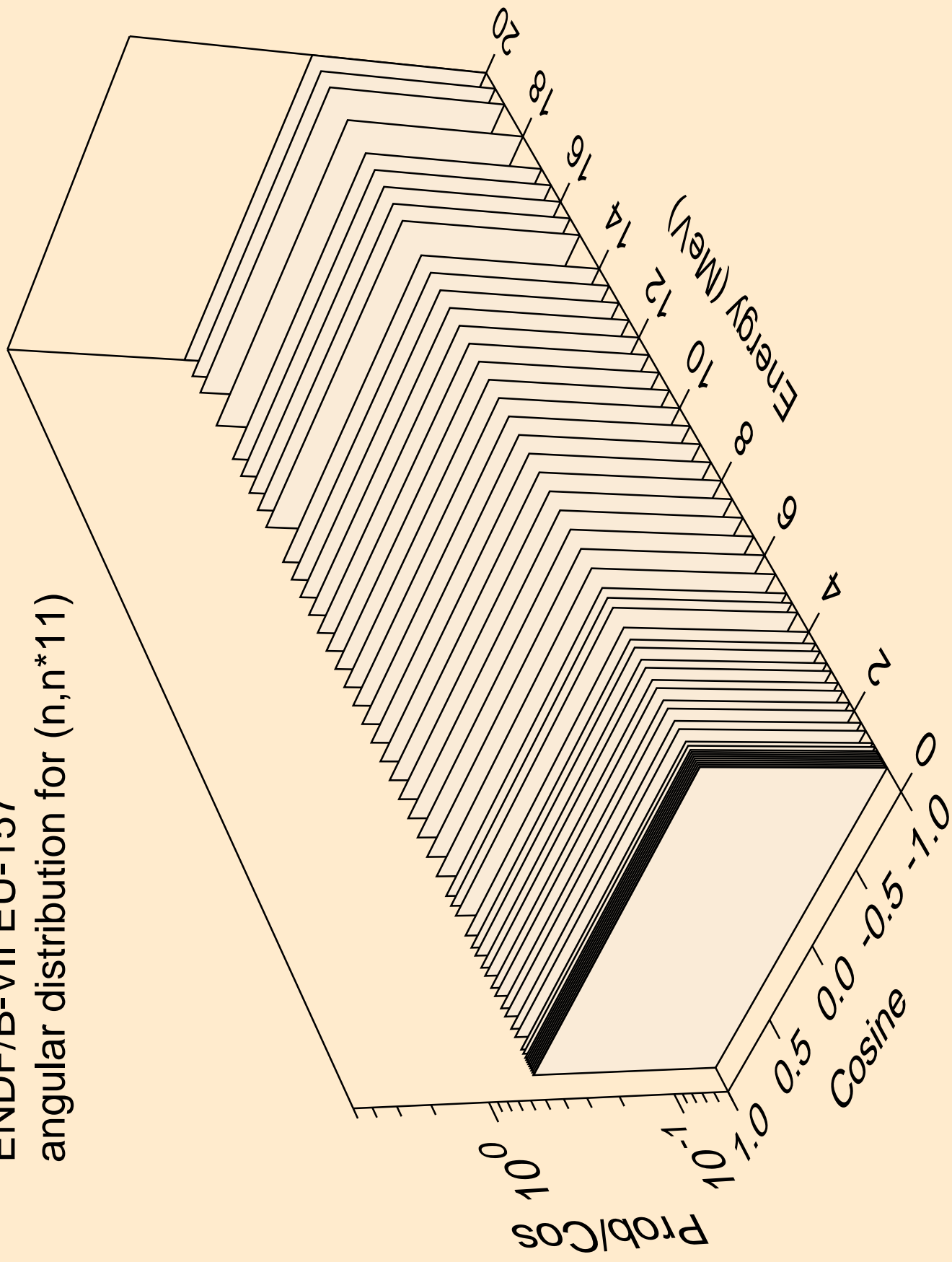

ENDF/B-VII EU-157
angular distribution for (n,n*12)

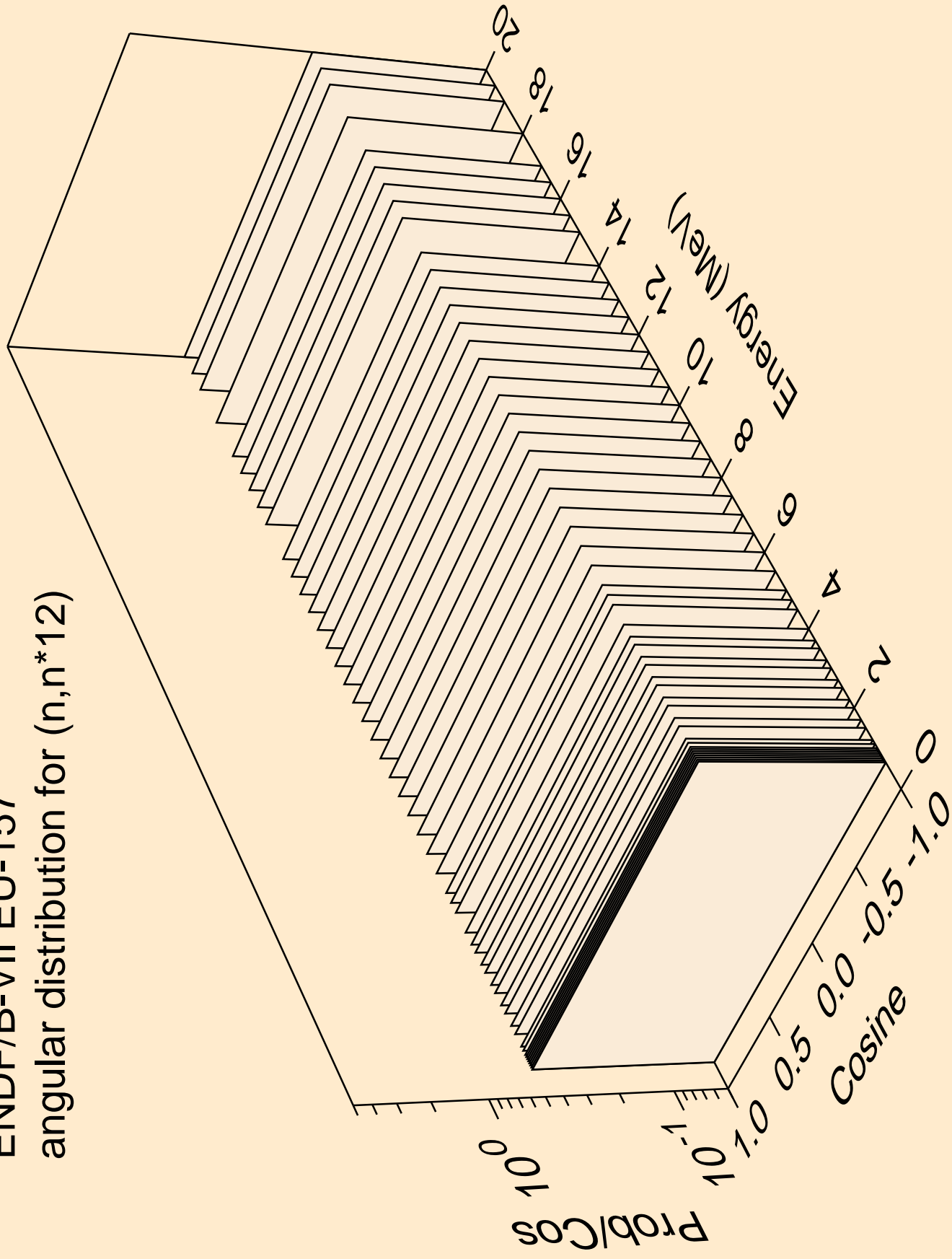

ENDF/B-VII EU-157
angular distribution for (n,n*13)

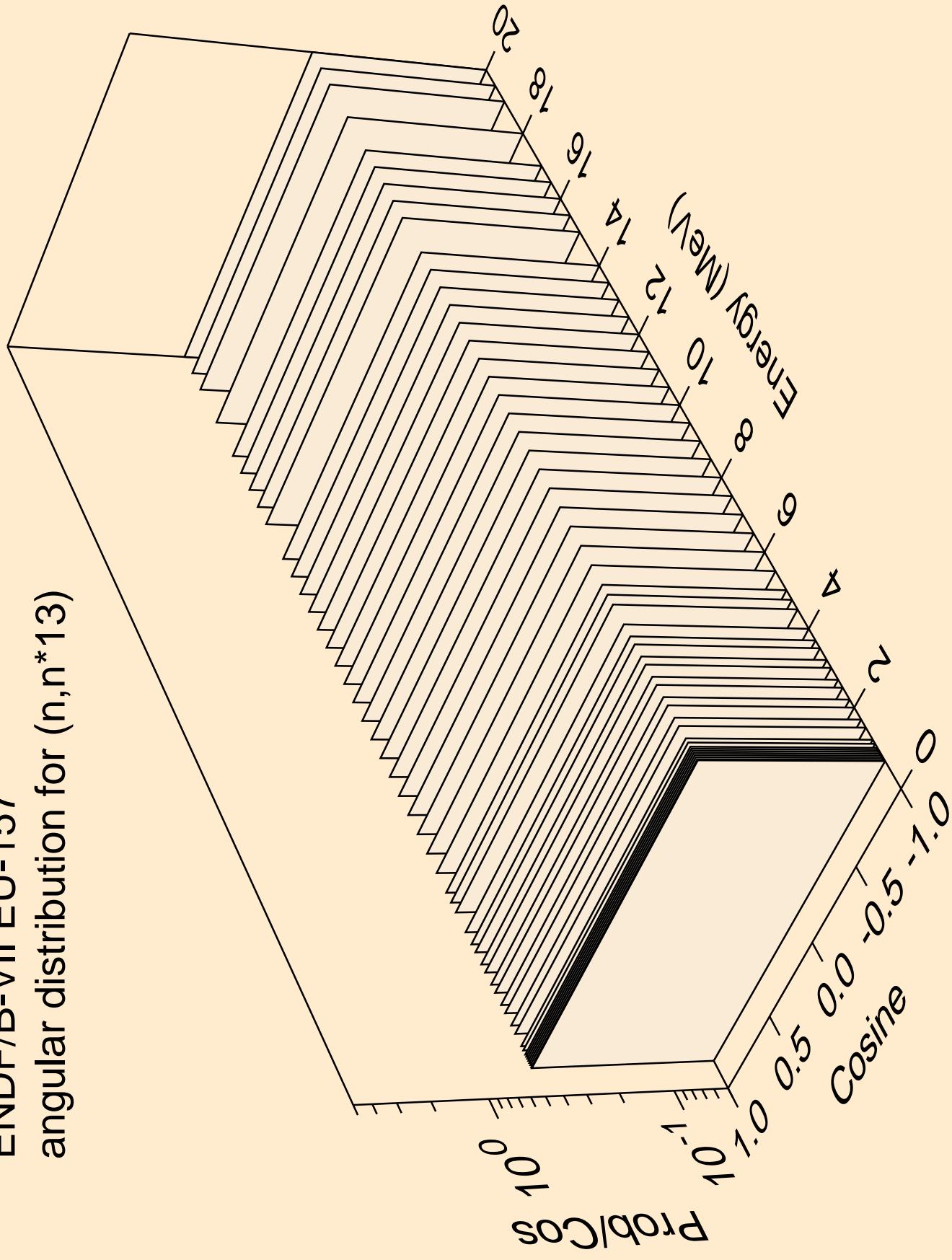

ENDF/B-VII EU-157
angular distribution for (n,n*14)

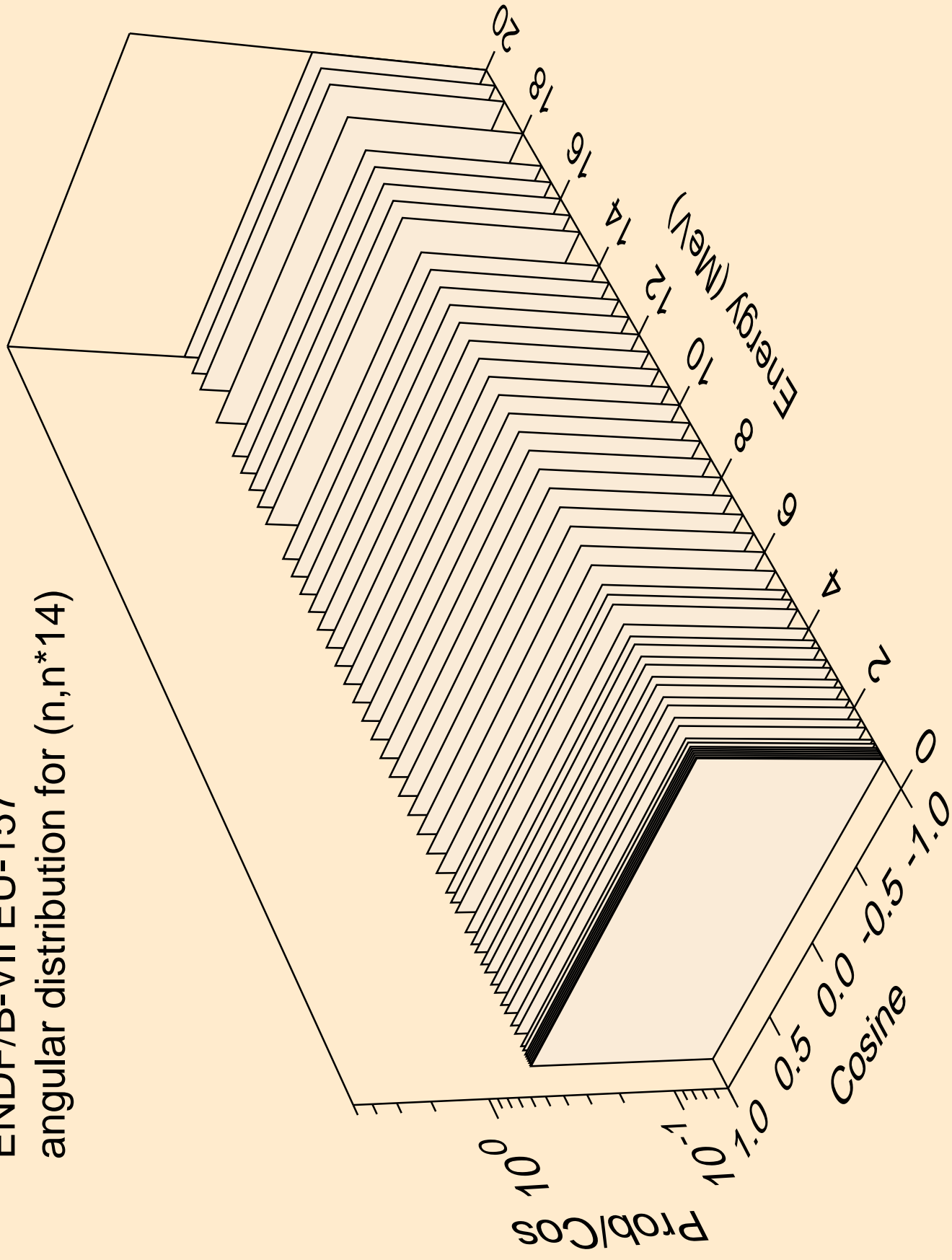

ENDF/B-VII EU-157
angular distribution for (n,n*15)

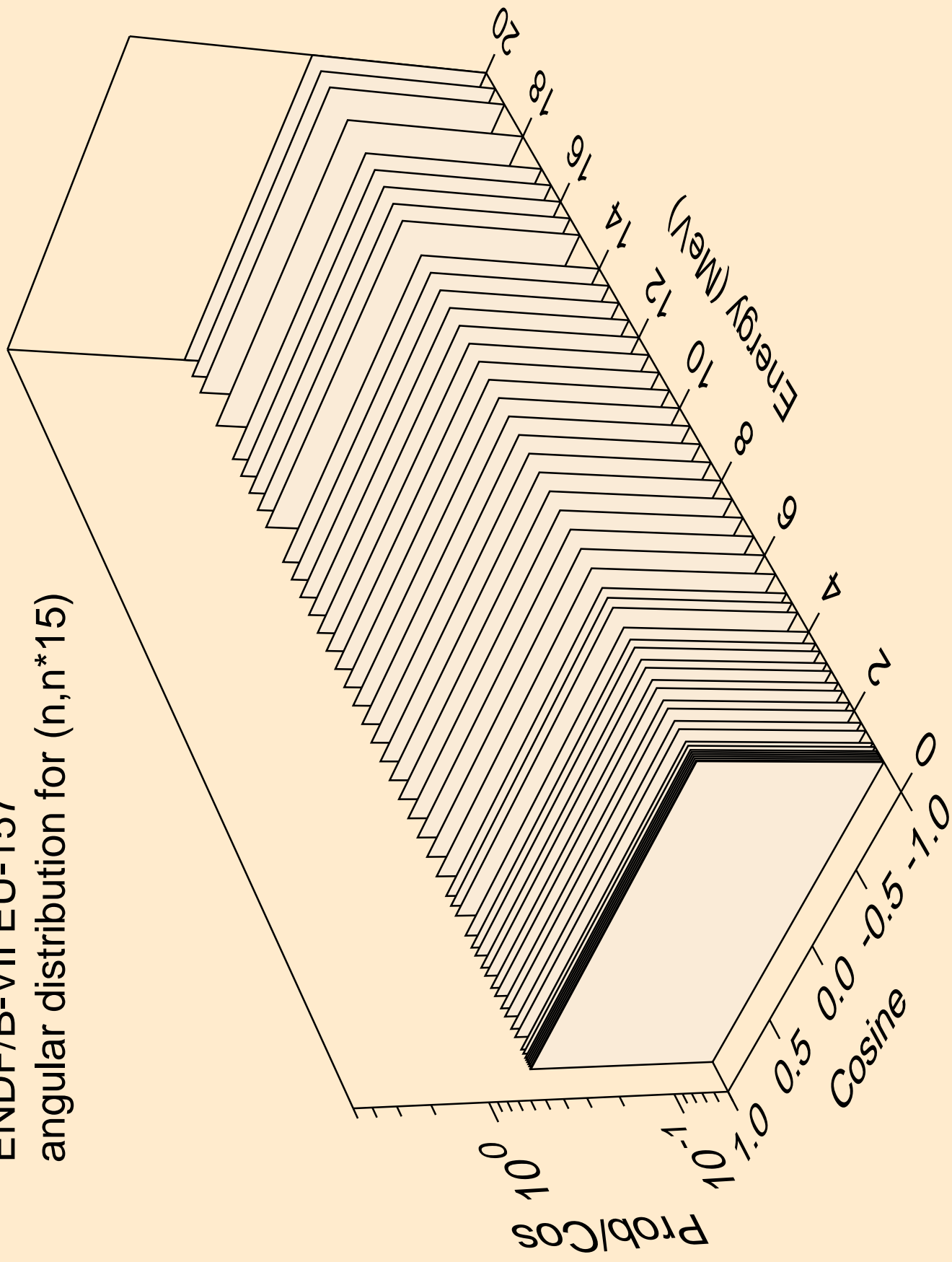

ENDF/B-VII EU-157
angular distribution for (n,n*16)

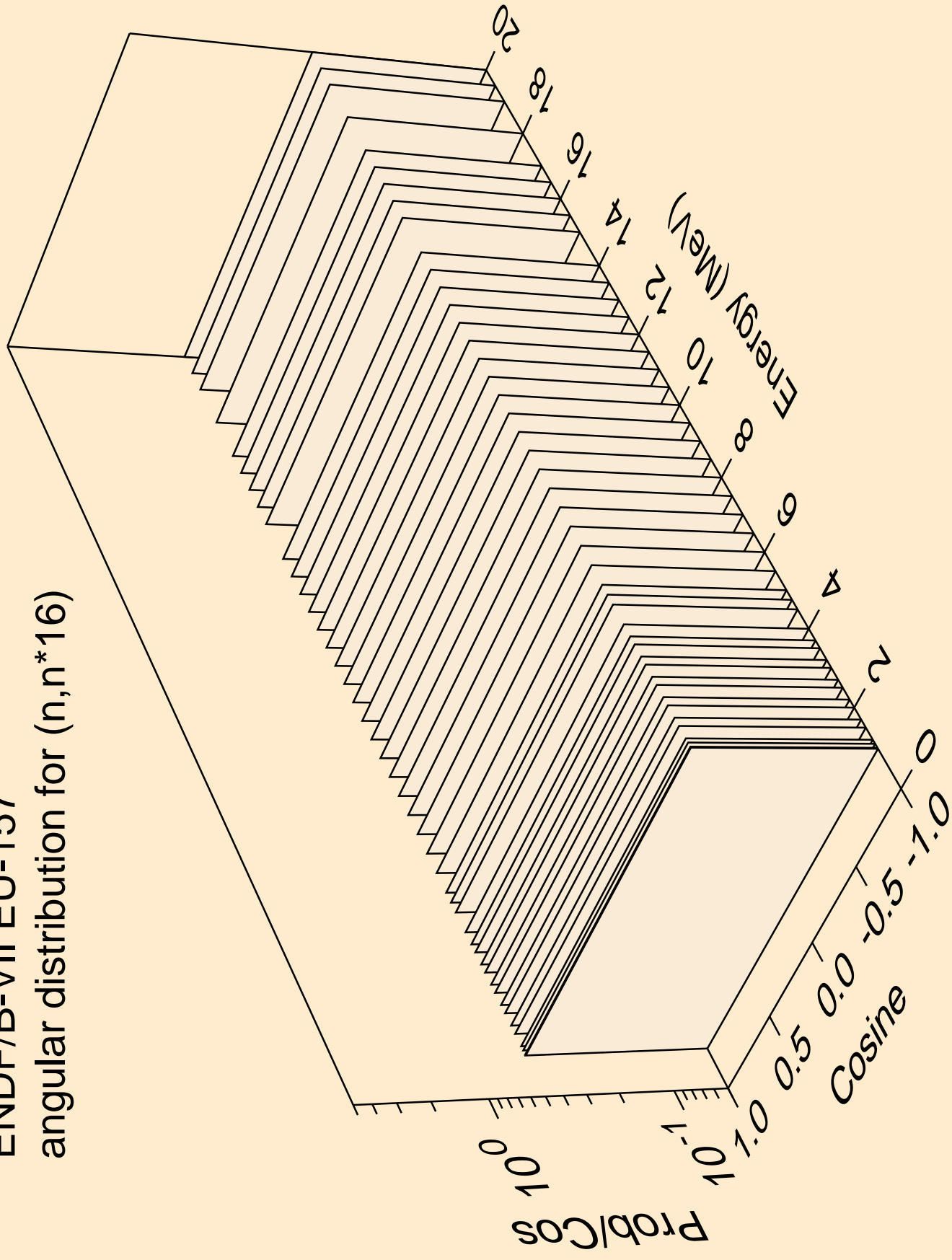

ENDF/B-VII EU-157
angular distribution for (n,n*17)

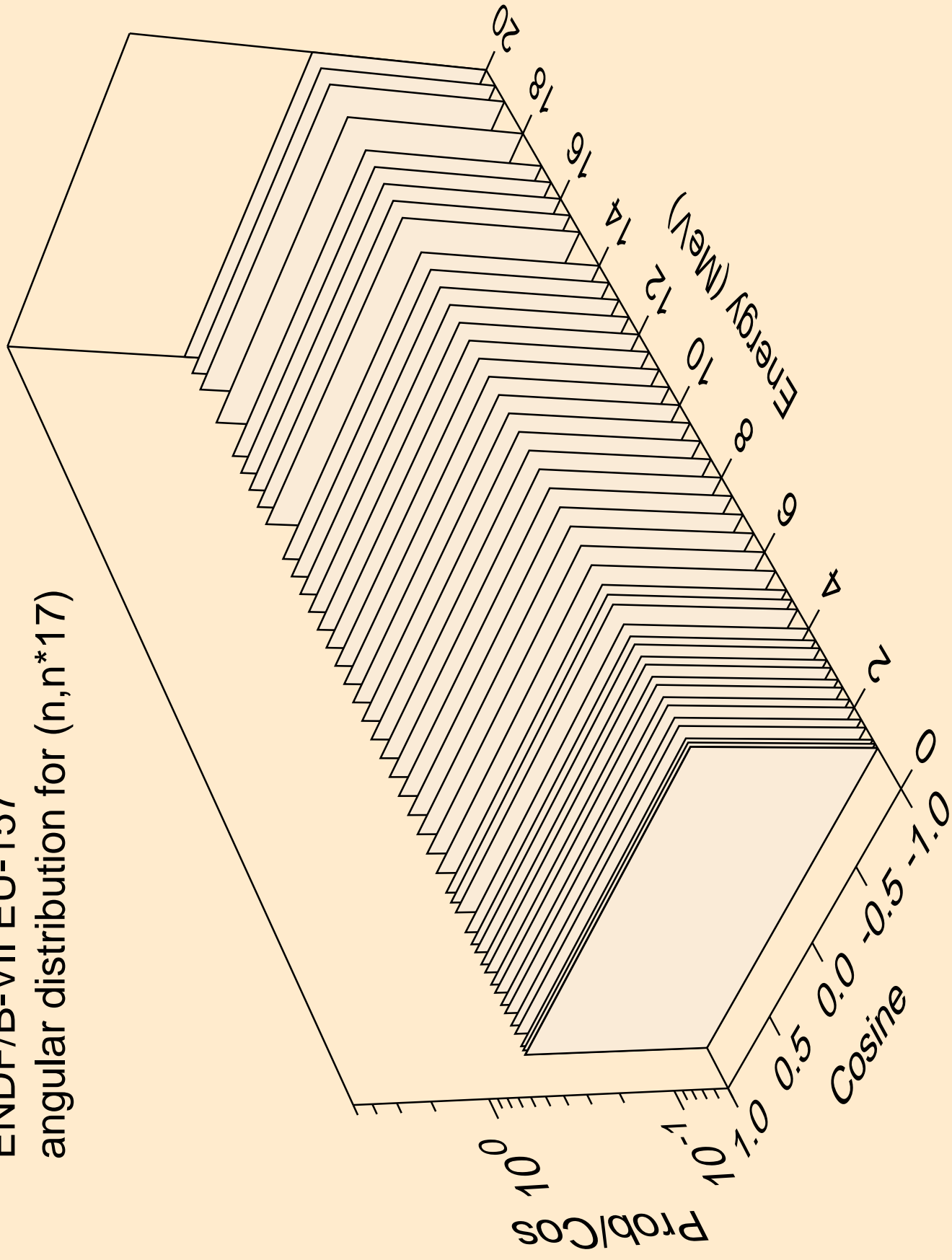

ENDF/B-VII EU-157
angular distribution for (n,n*18)

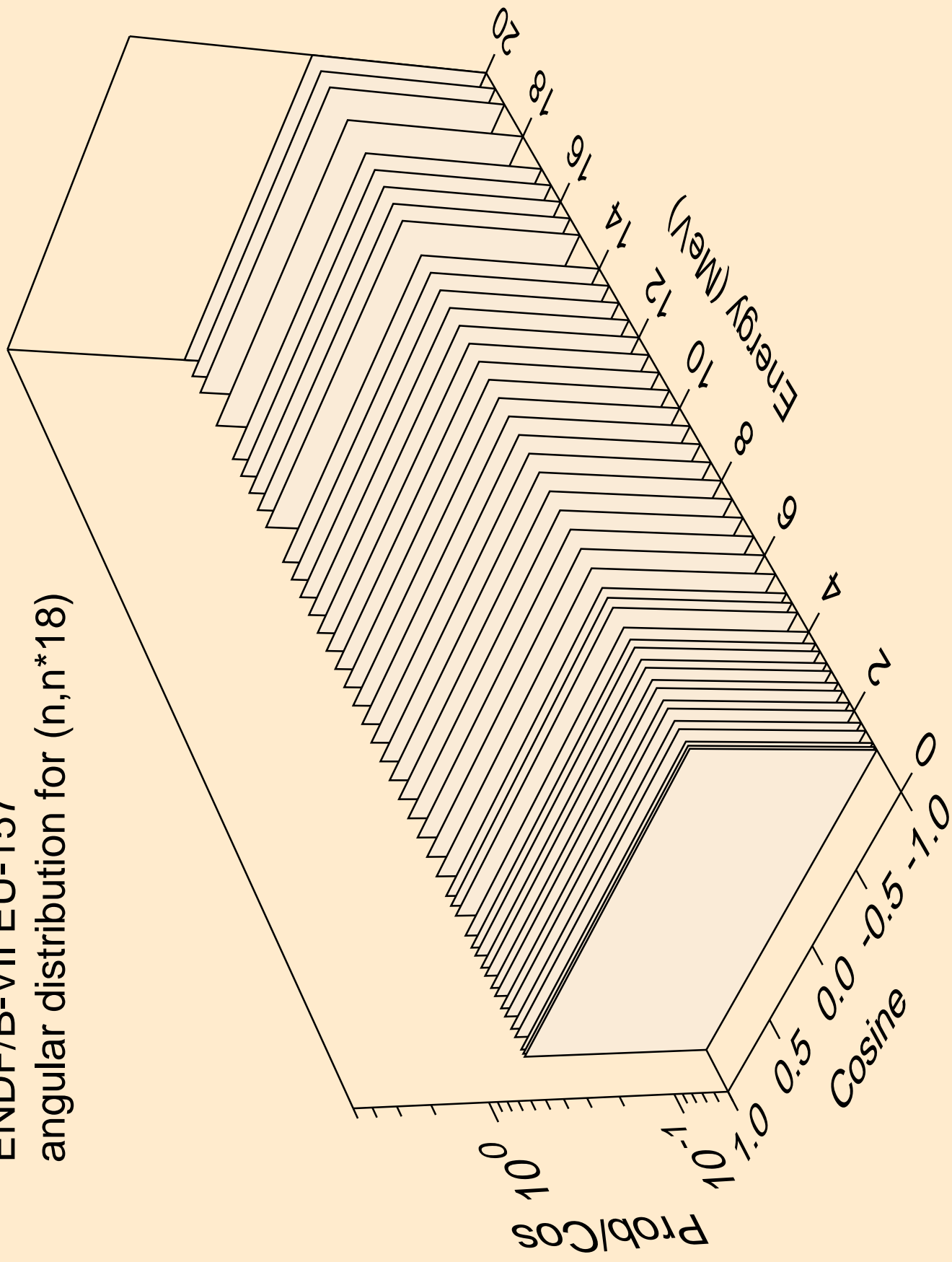

ENDF/B-VII EU-157
angular distribution for (n,n*19)

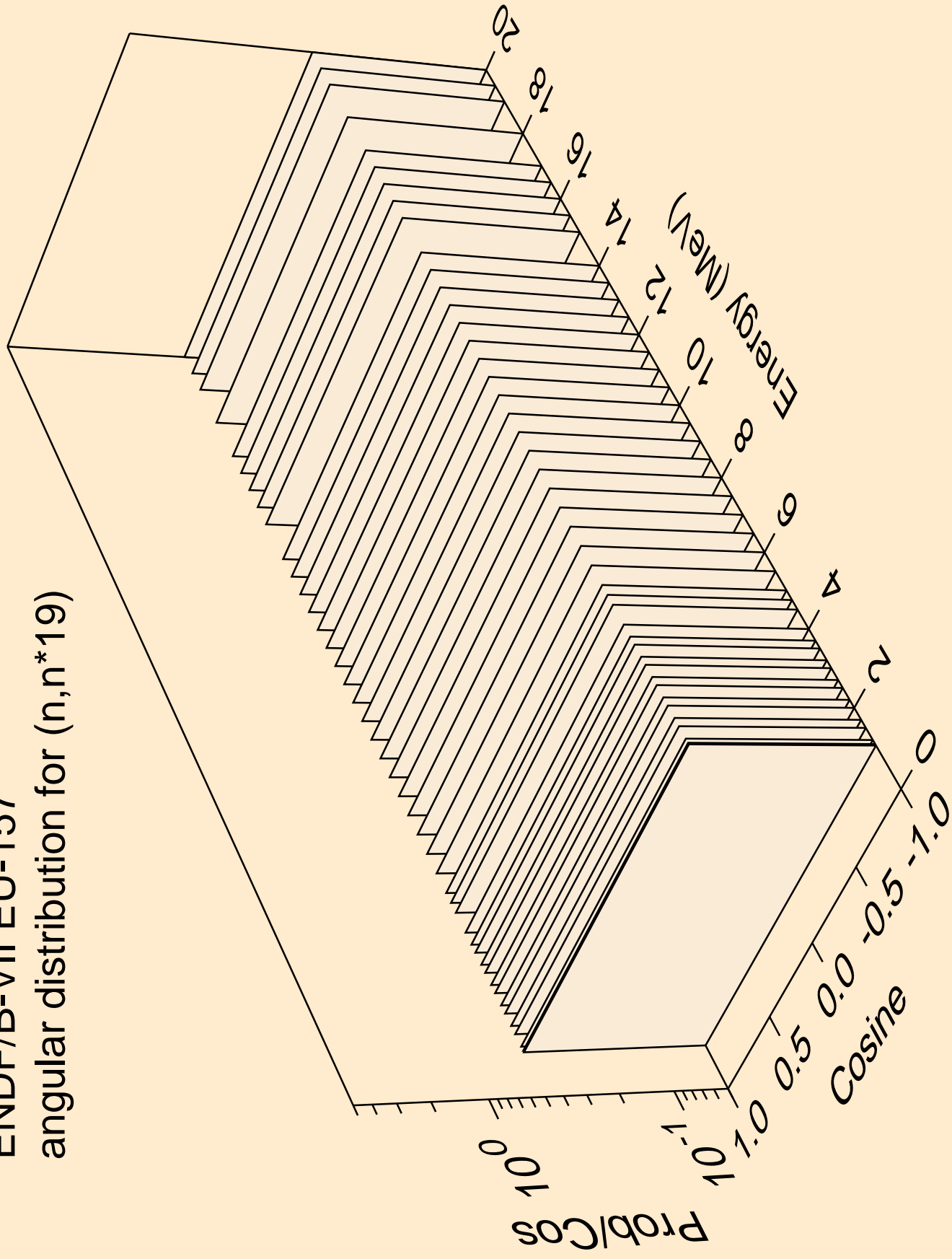

ENDF/B-VII EU-157
angular distribution for (n,n*20)

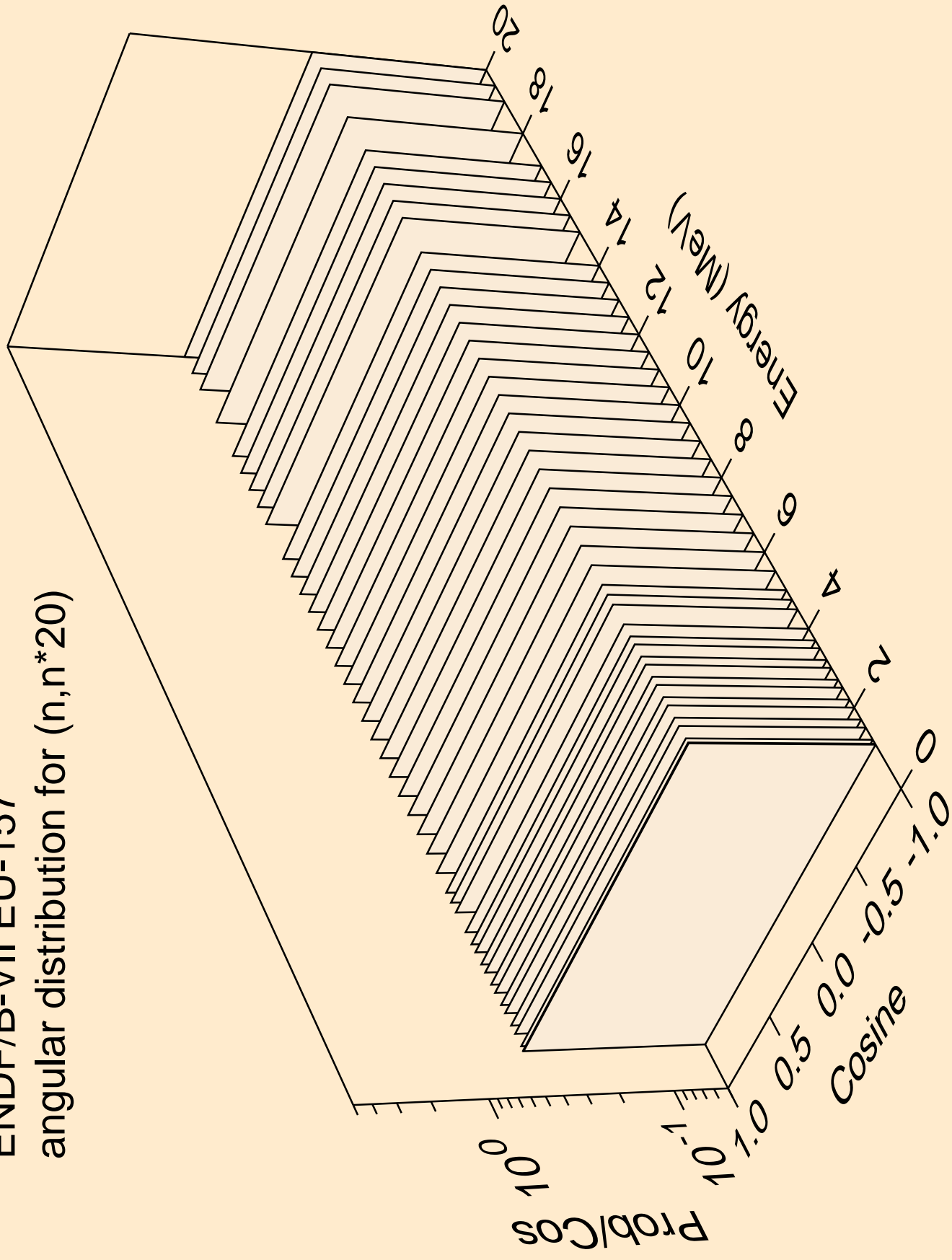

ENDF/B-VII EU-157
angular distribution for (n,n*21)

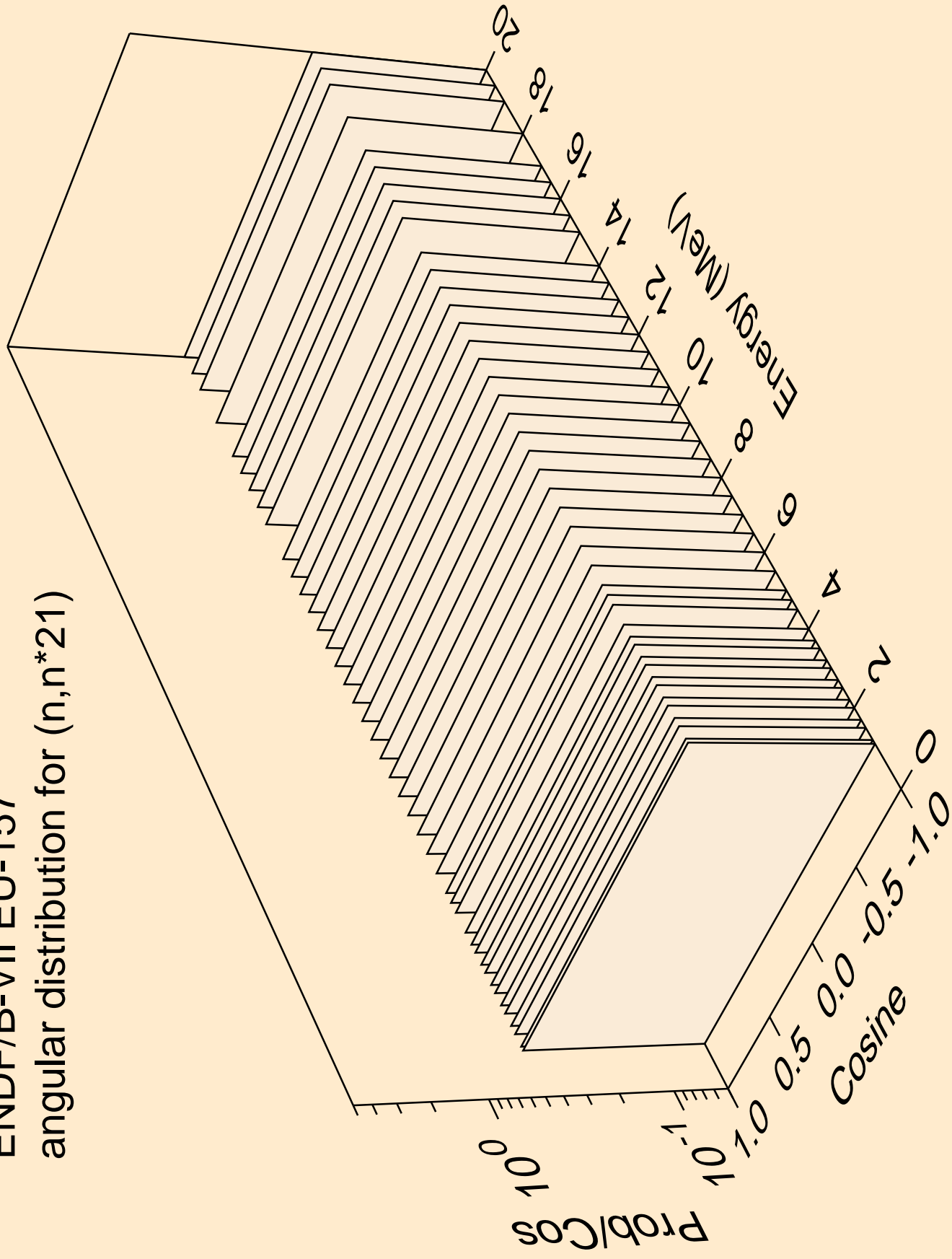

ENDF/B-VII EU-157
angular distribution for (n,n*22)

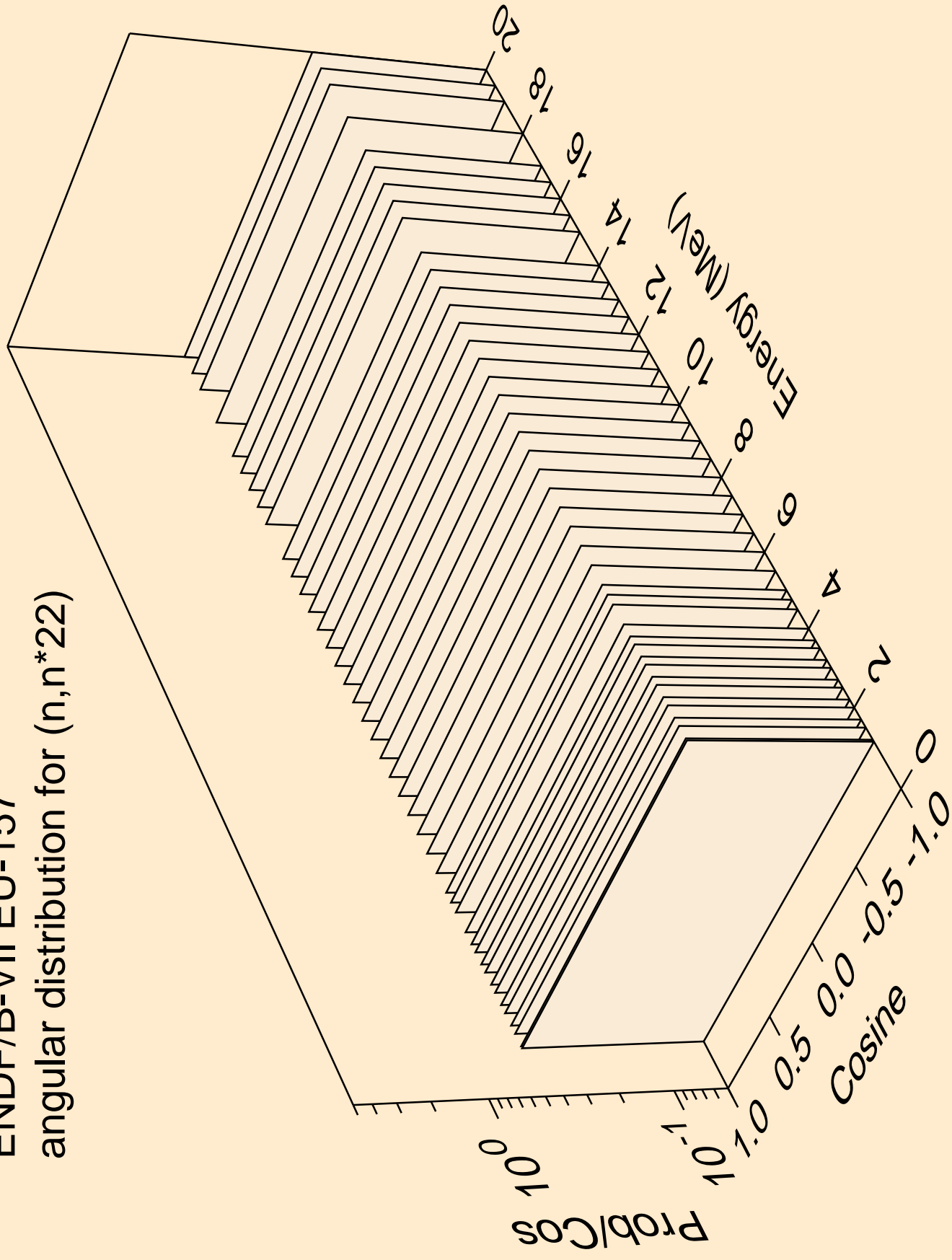

ENDF/B-VII EU-157
angular distribution for (n,n*23)

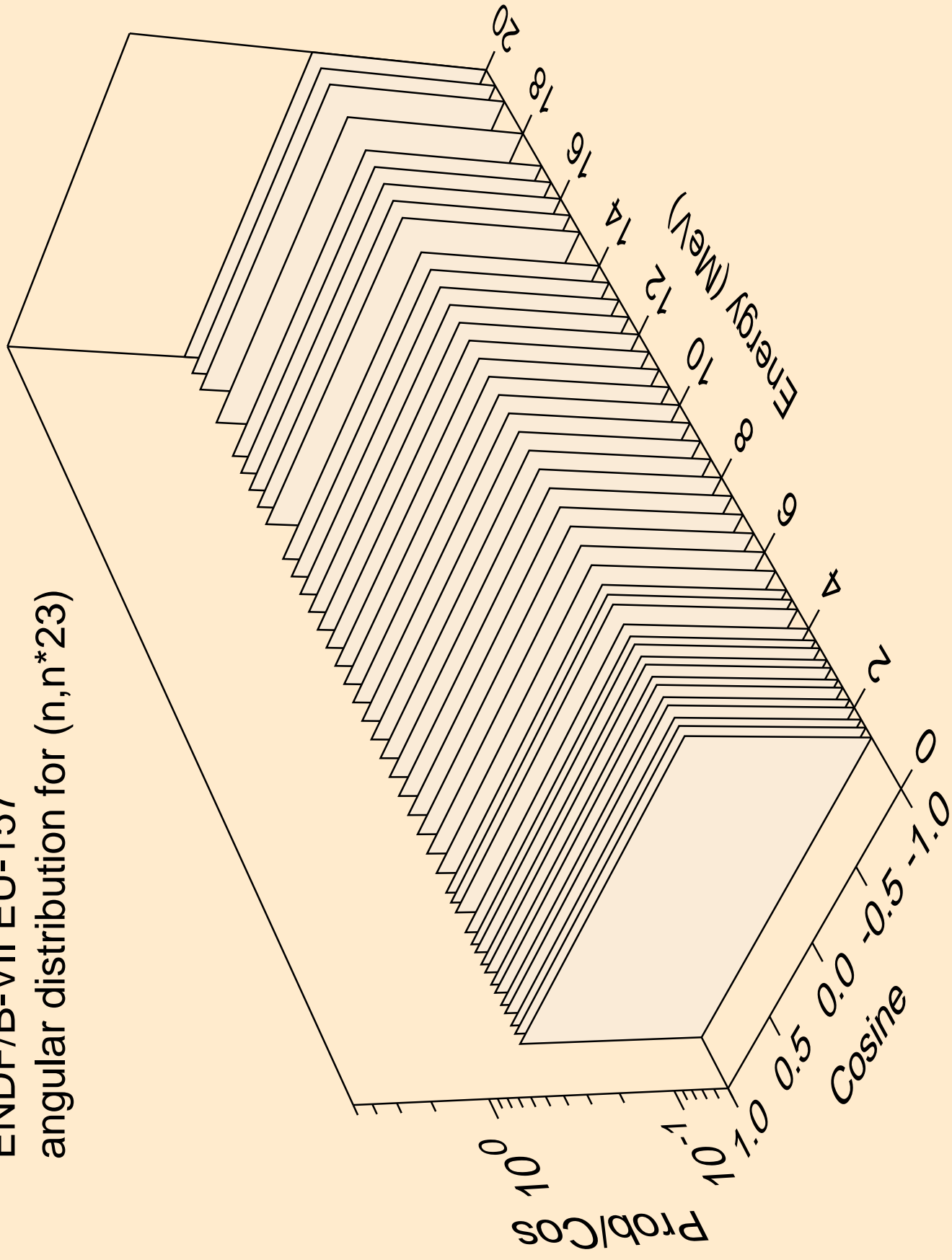

ENDF/B-VII EU-157
angular distribution for (n,n*24)

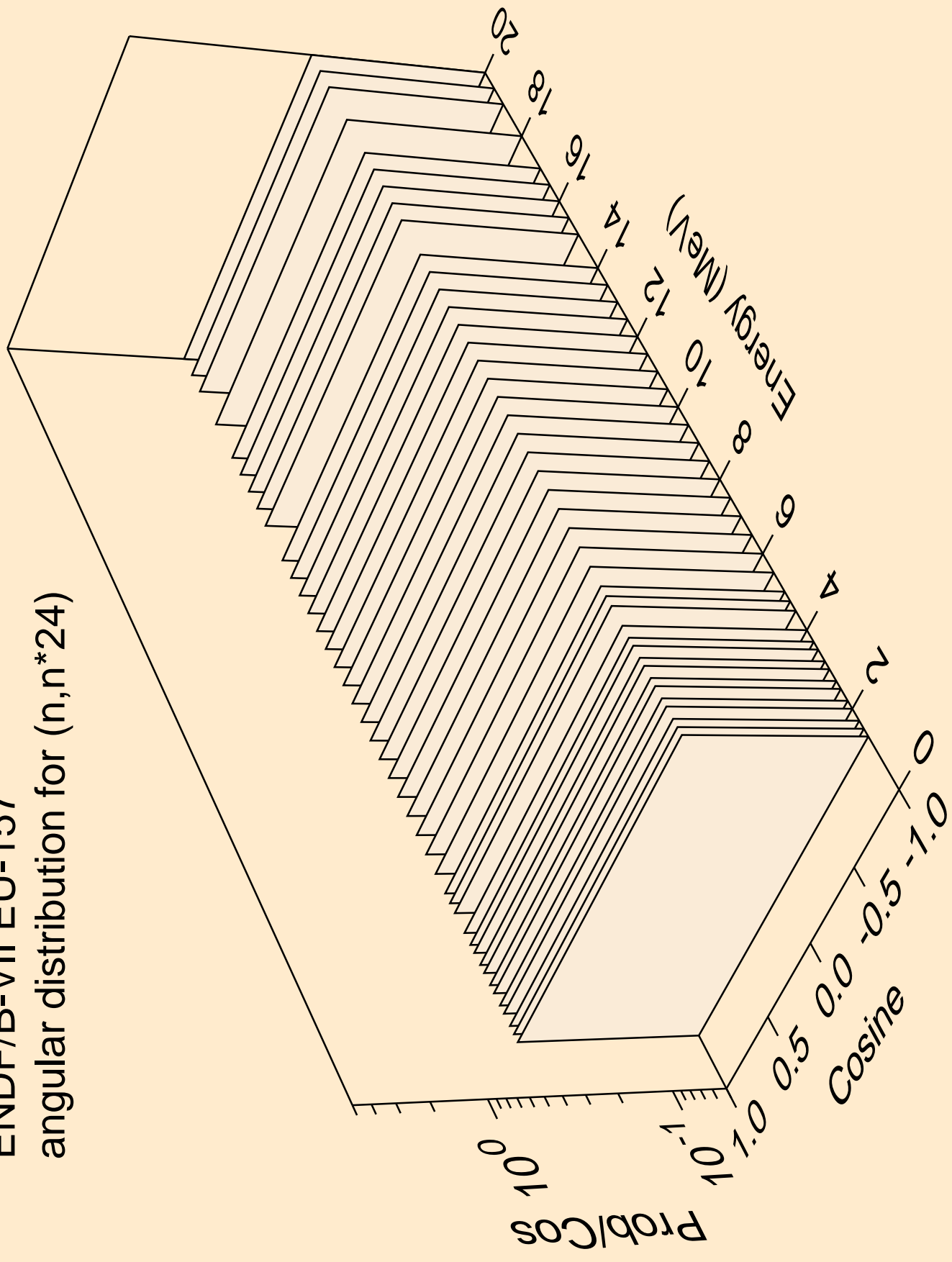

ENDF/B-VII EU-157
angular distribution for (n,n*25)

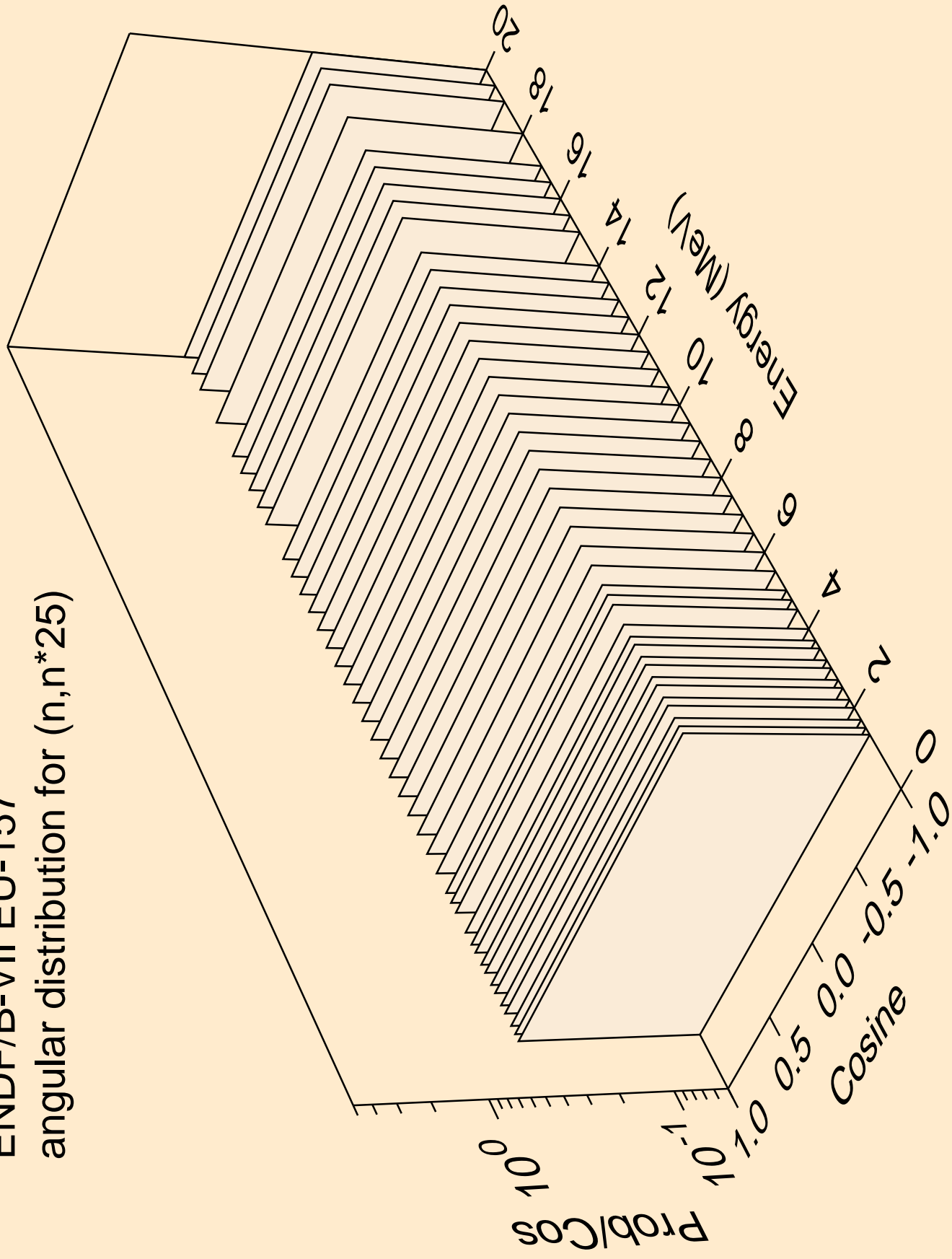

ENDF/B-VII EU-157
angular distribution for (n,n*26)

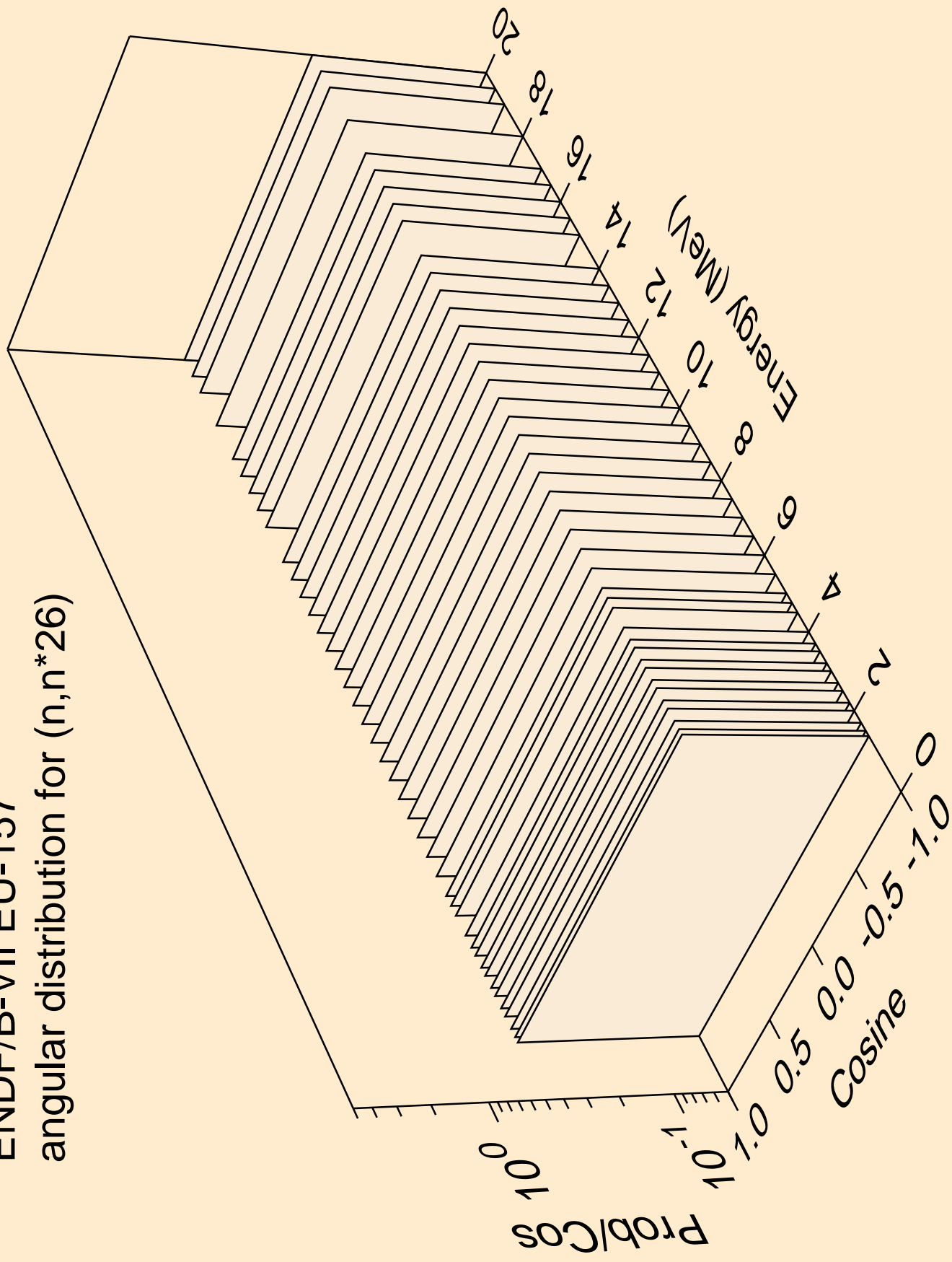

ENDF/B-VII EU-157
angular distribution for (n,n*27)

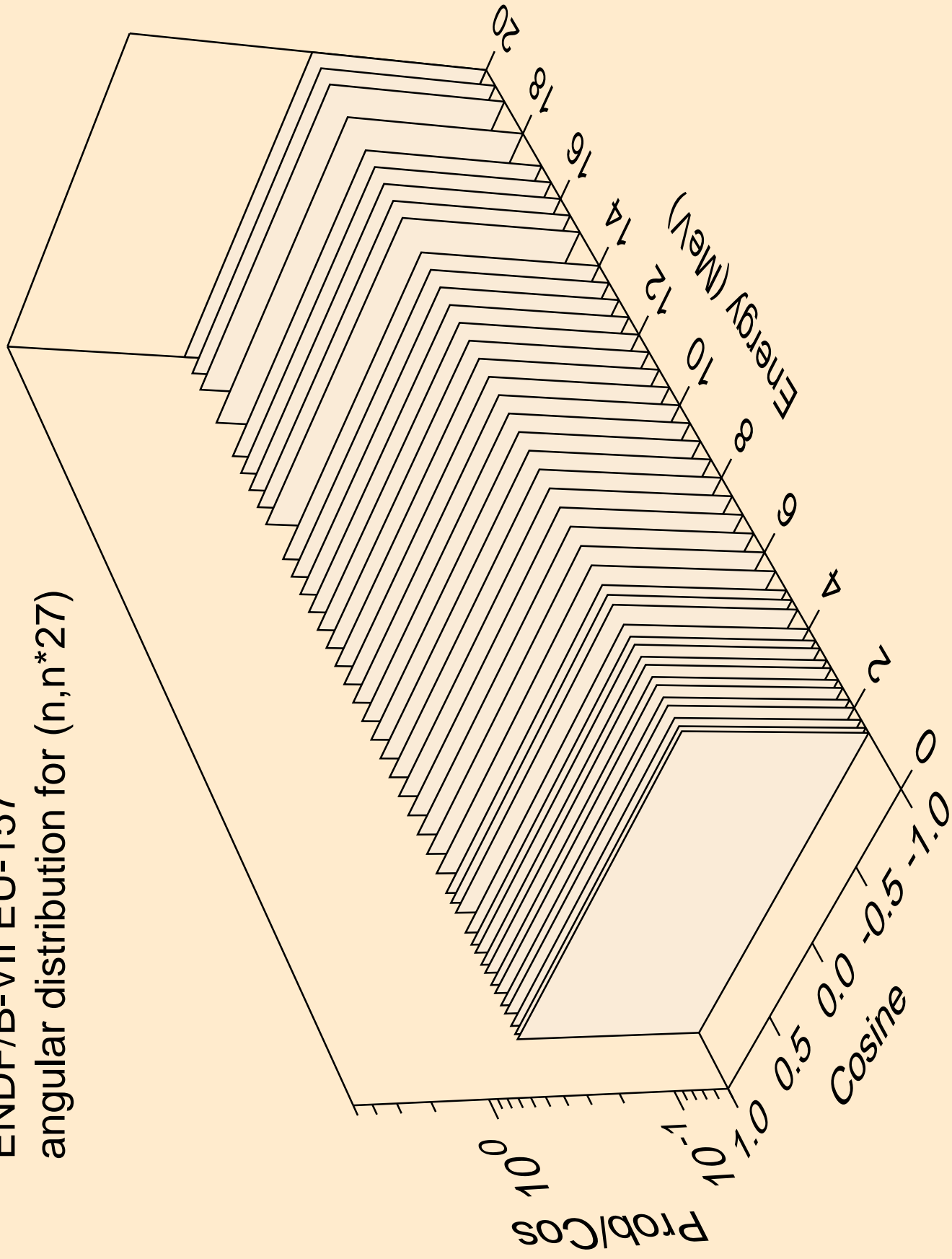

ENDF/B-VII EU-157
angular distribution for (n,n*28)

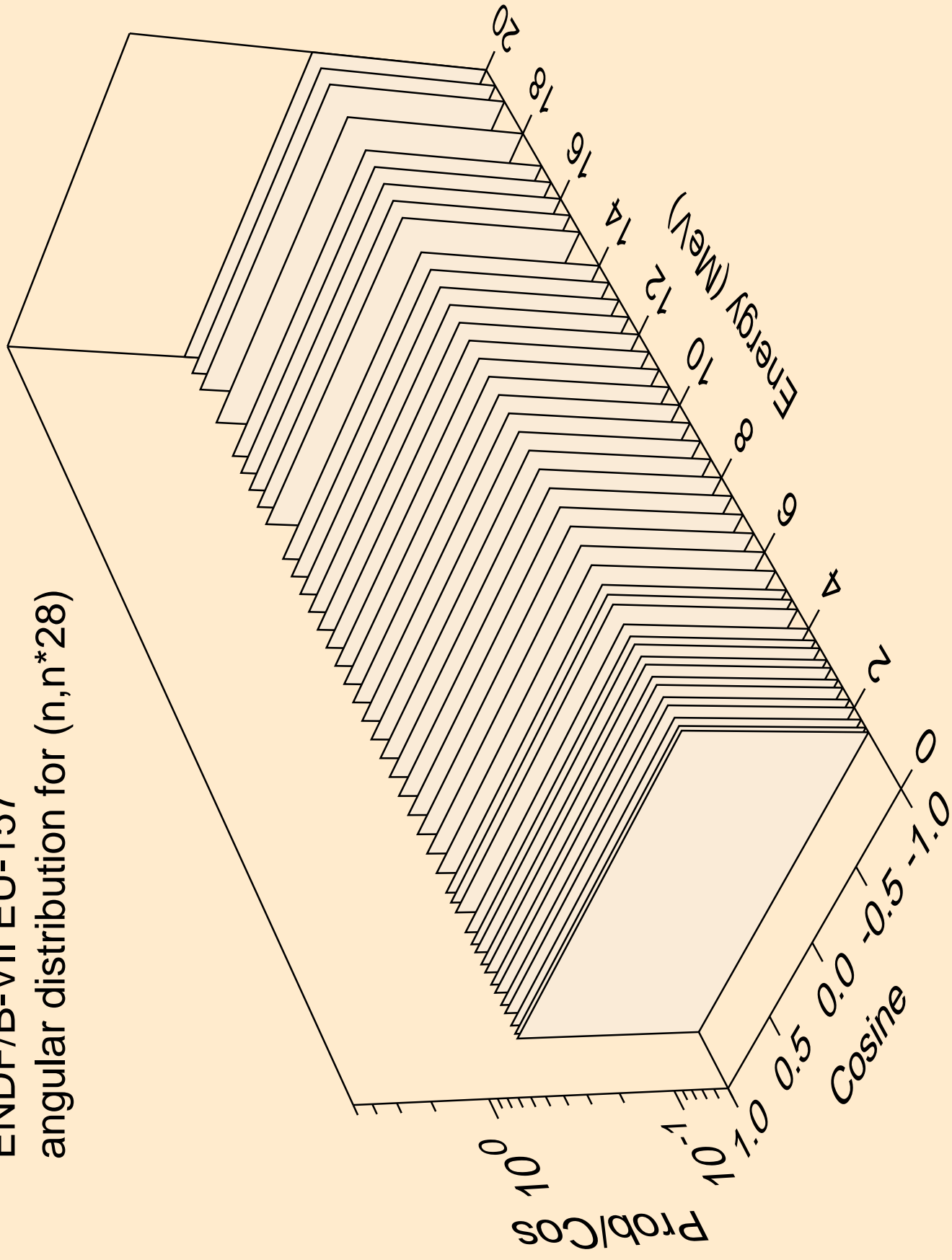

ENDF/B-VII EU-157
angular distribution for (n,n*29)

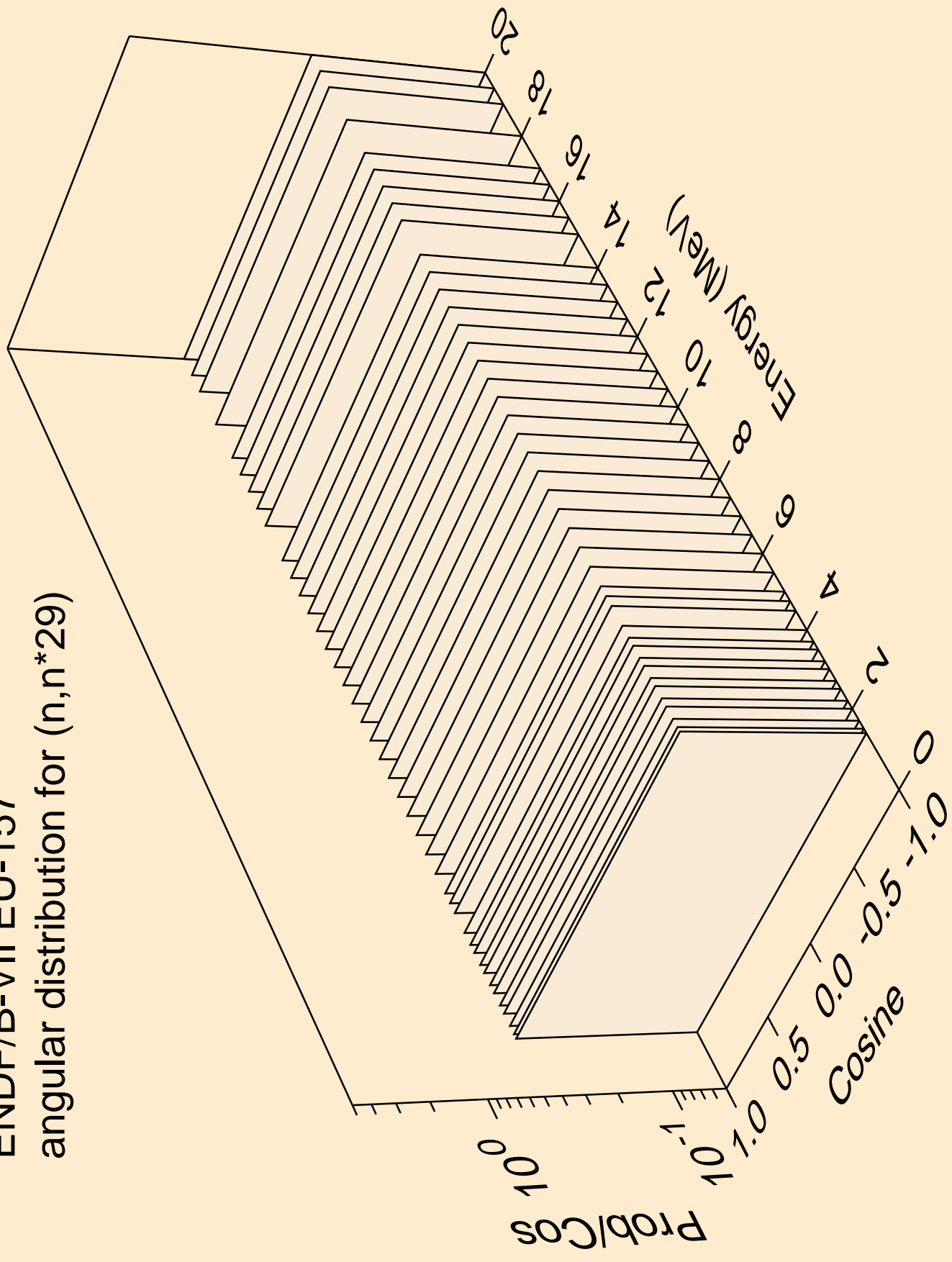

ENDF/B-VII EU-157
angular distribution for (n,n*30)

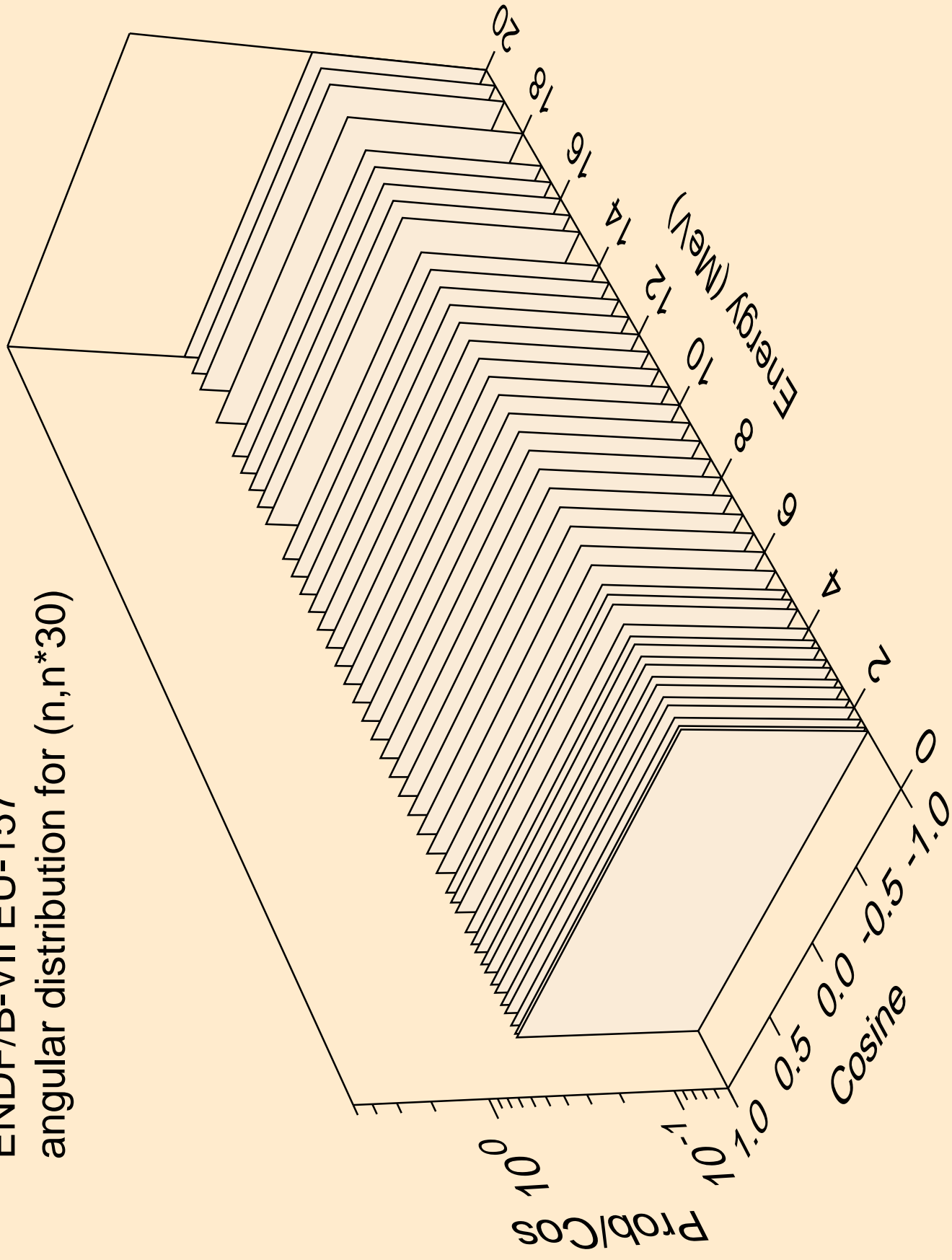

ENDF/B-VII EU-157
angular distribution for (n,n*31)

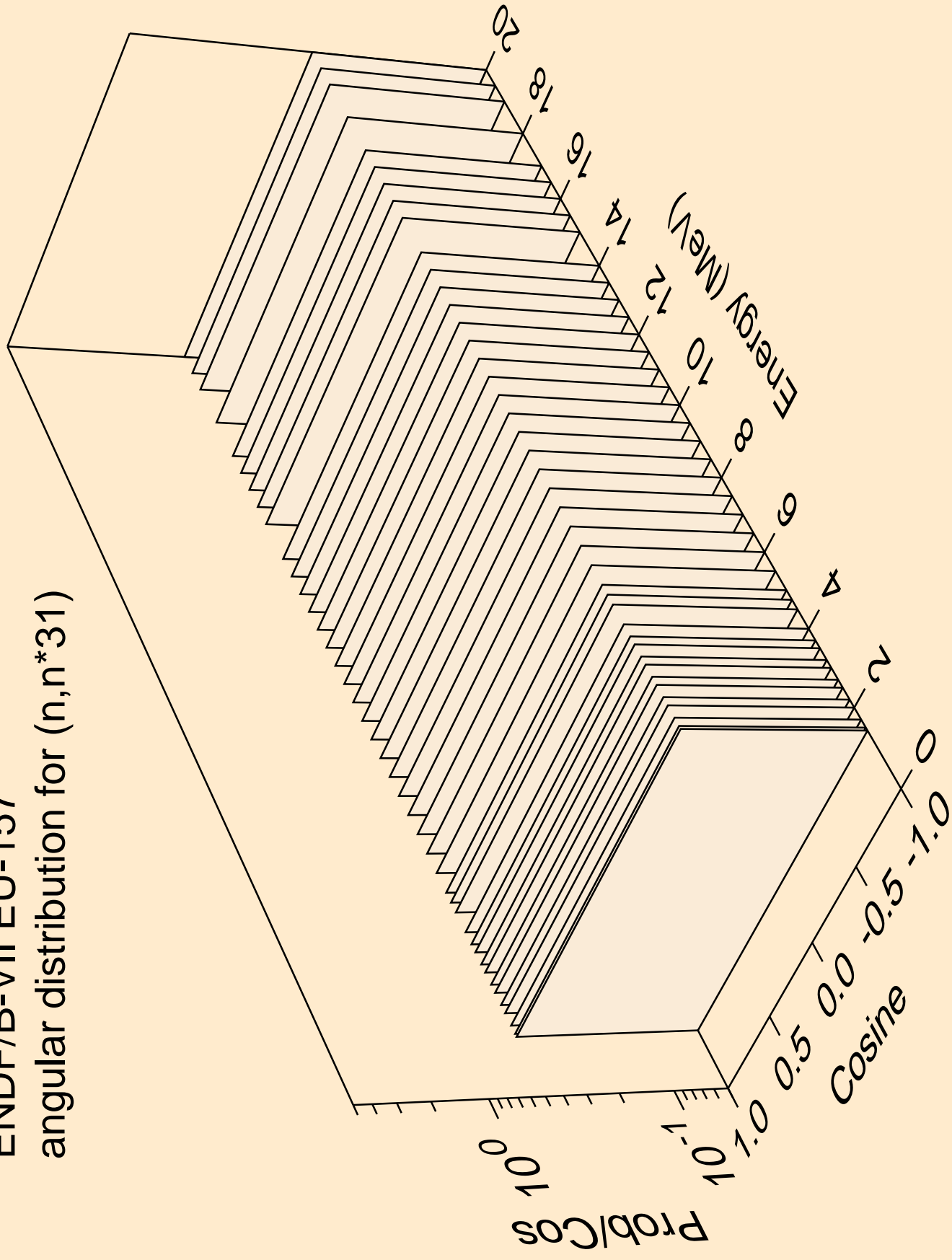

ENDF/B-VII EU-157
angular distribution for (n,n*32)

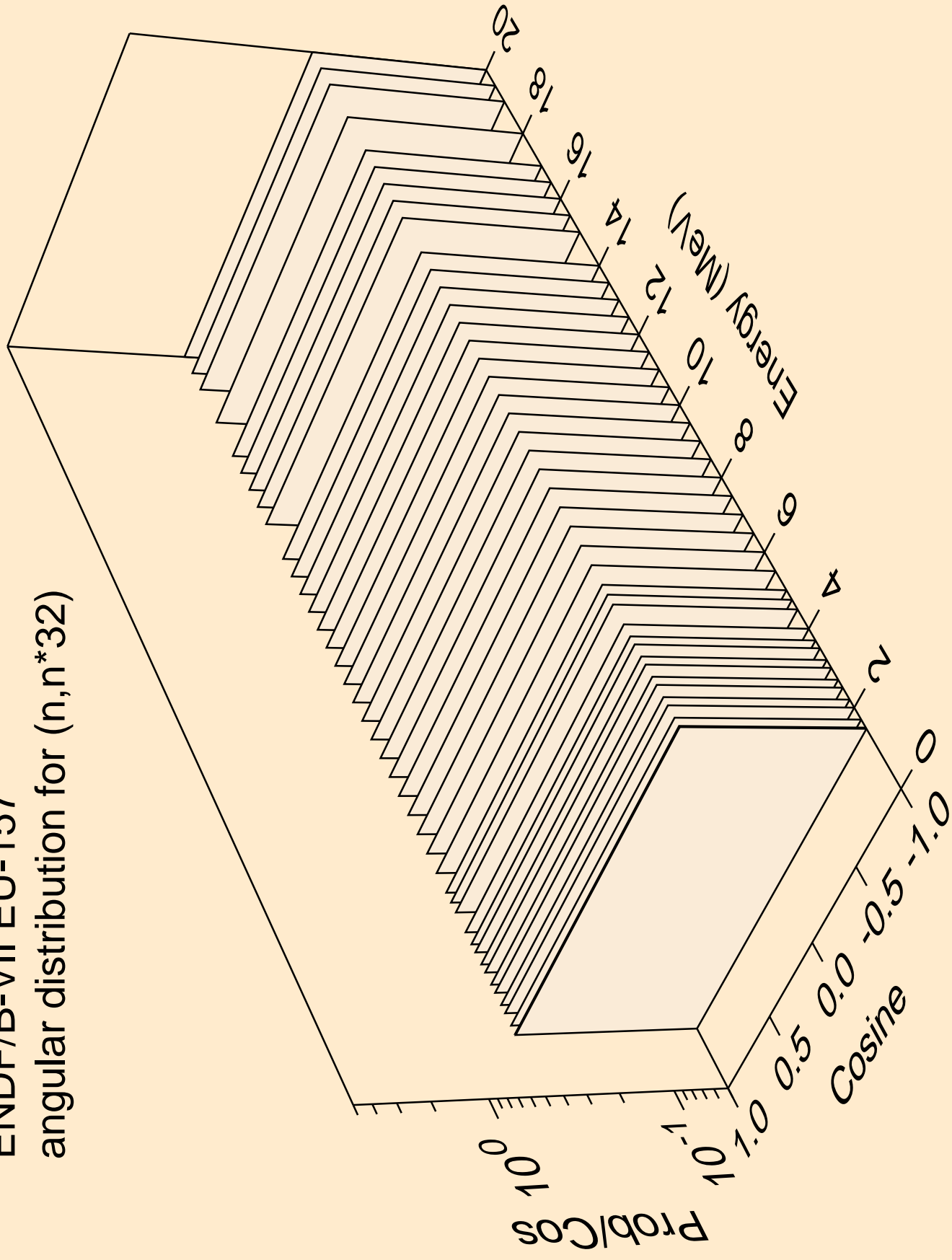

ENDF/B-VII EU-157
angular distribution for (n,n*33)

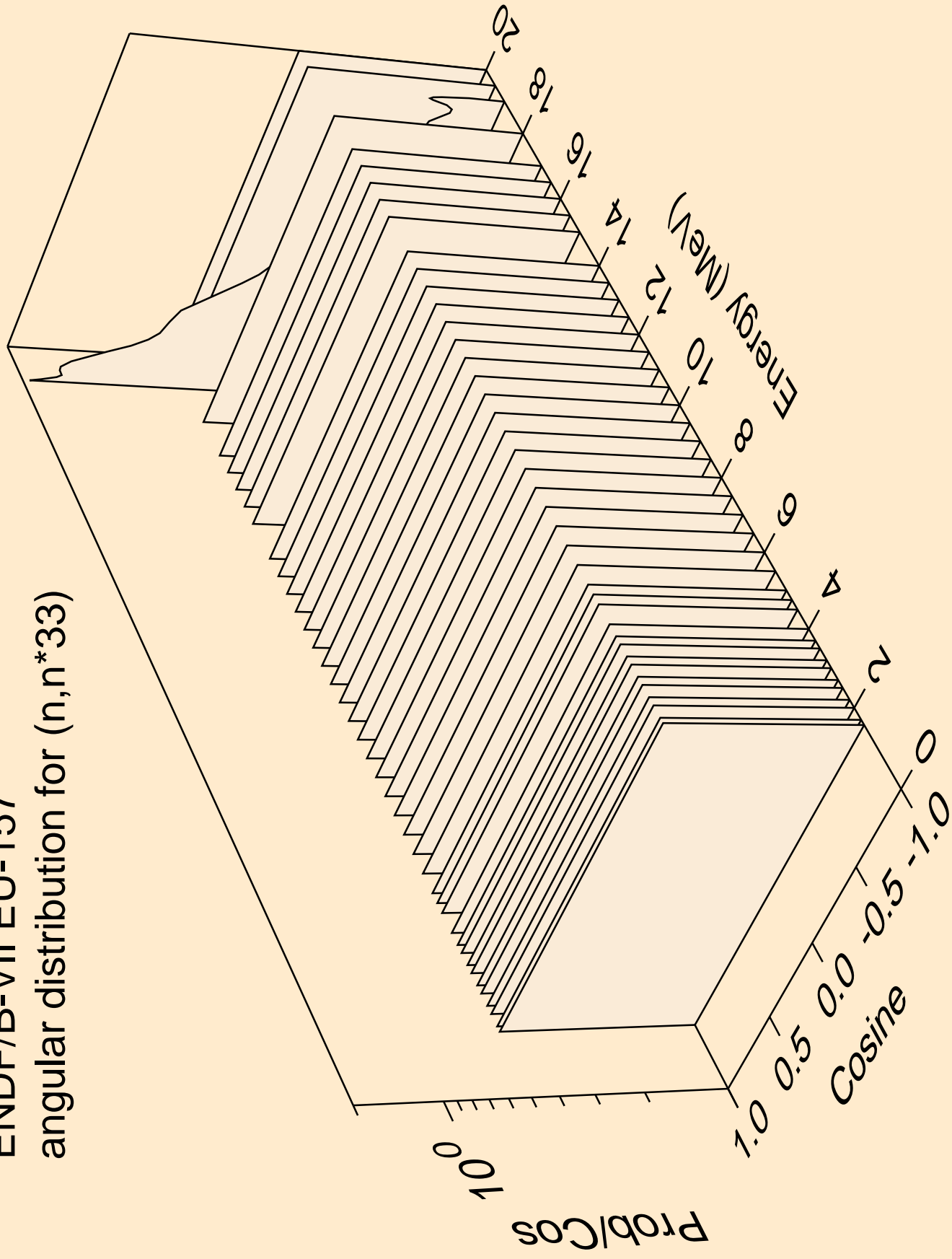

ENDF/B-VII EU-157
angular distribution for (n,n*34)

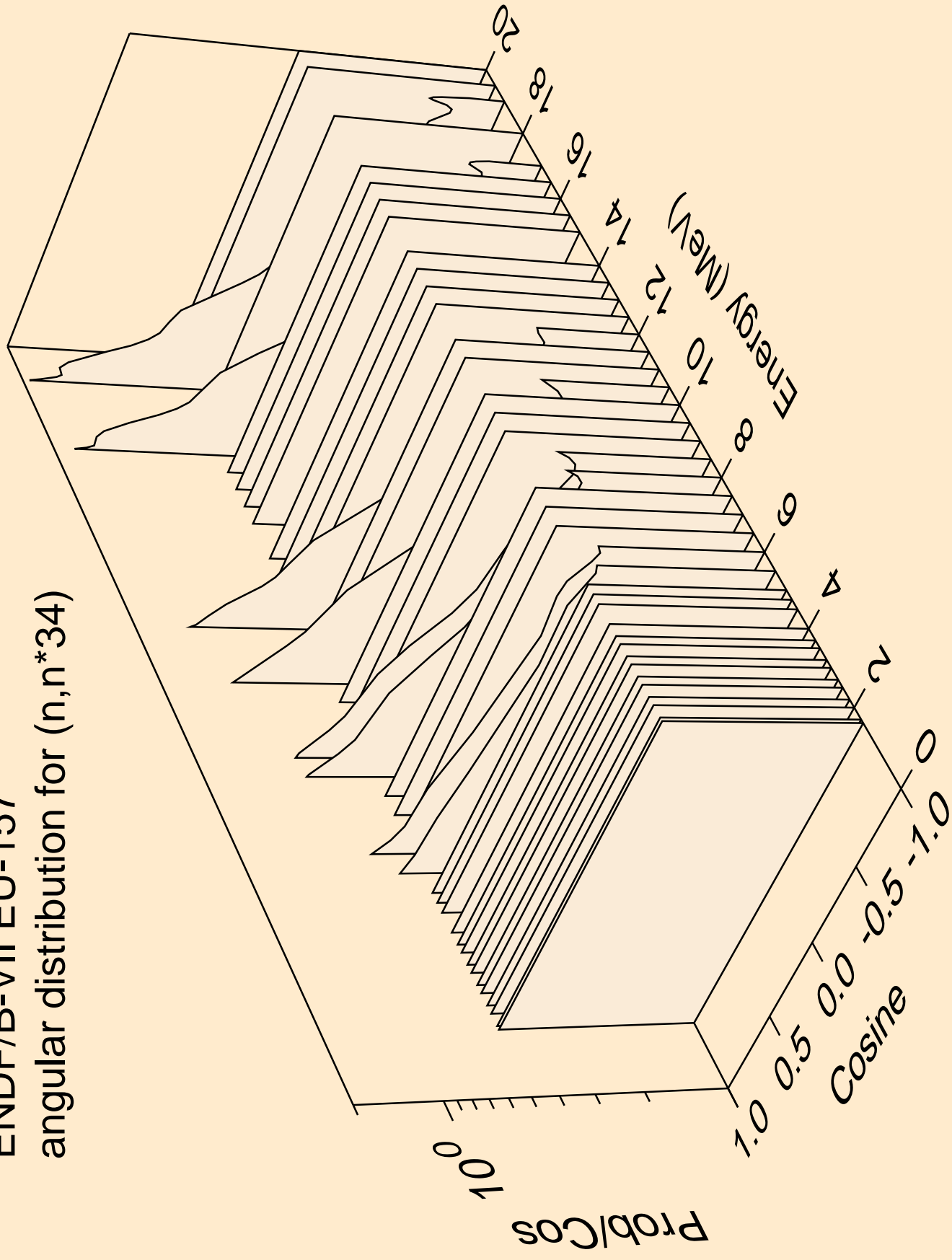

ENDF/B-VII EU-157
angular distribution for (n,n*35)

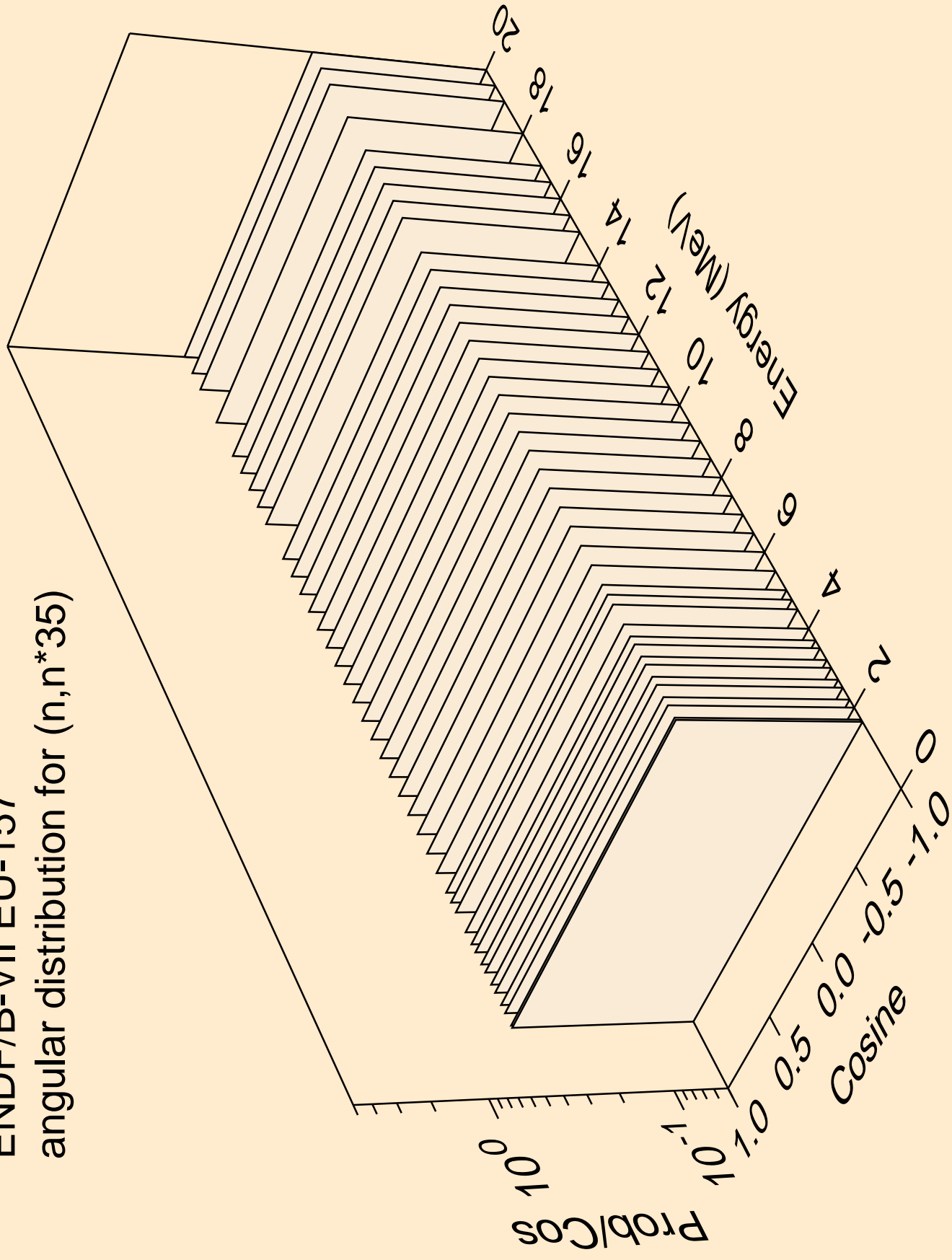

ENDF/B-VII EU-157
Neutron emission for (n,2n)

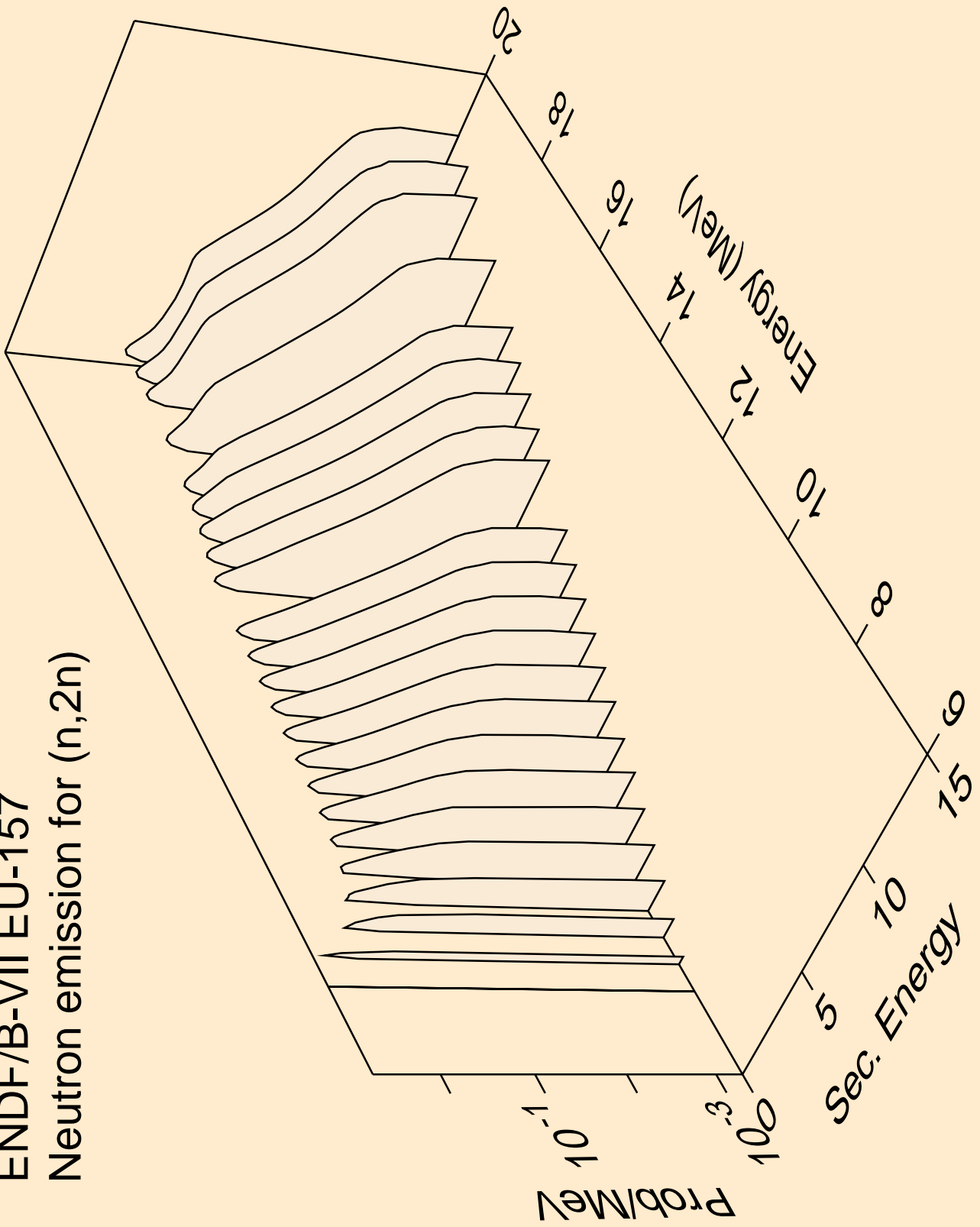

ENDF/B-VII EU-157
Neutron emission for (n,3n)

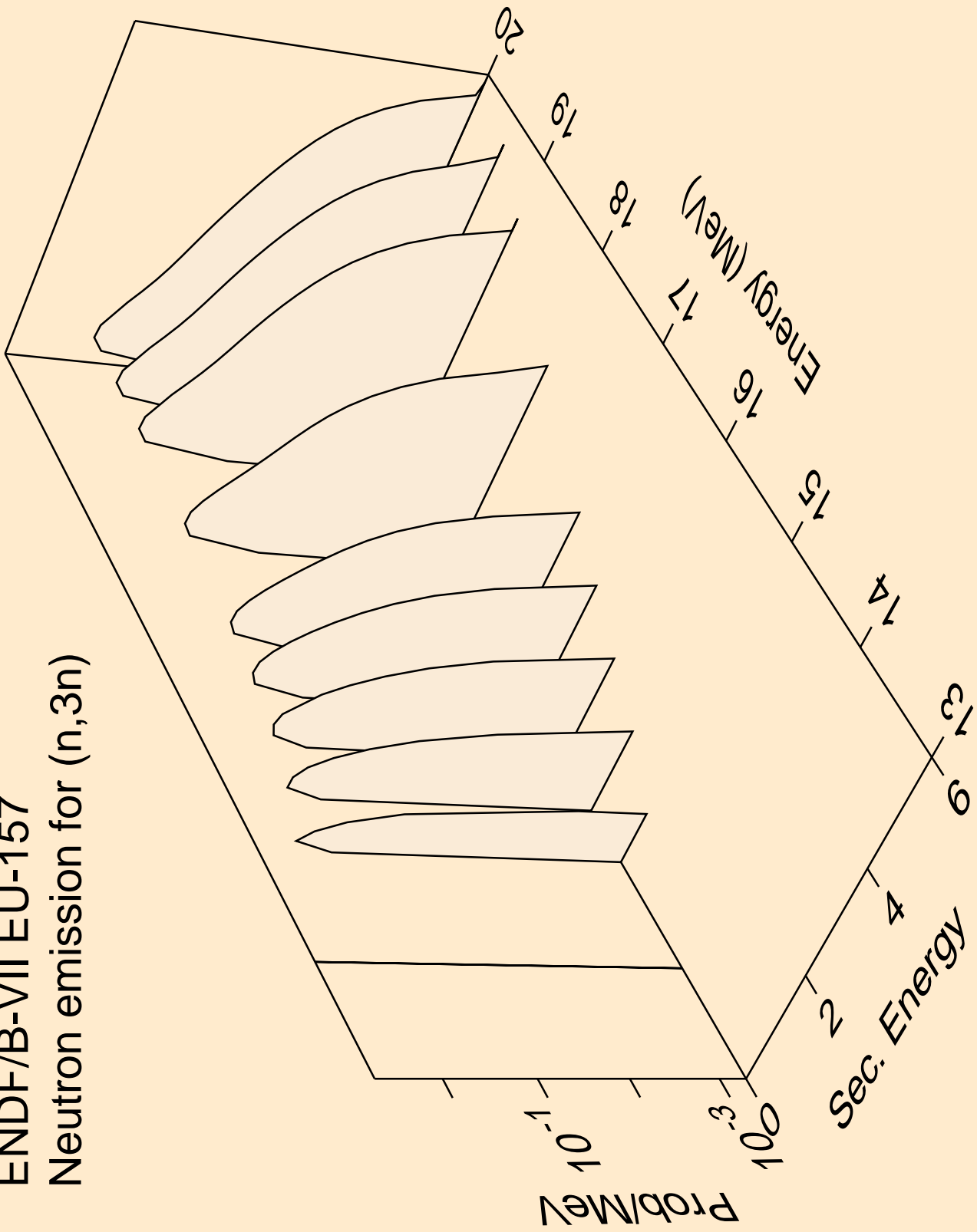

ENDF/B-VII EU-157
Neutron emission for (n,n*)a

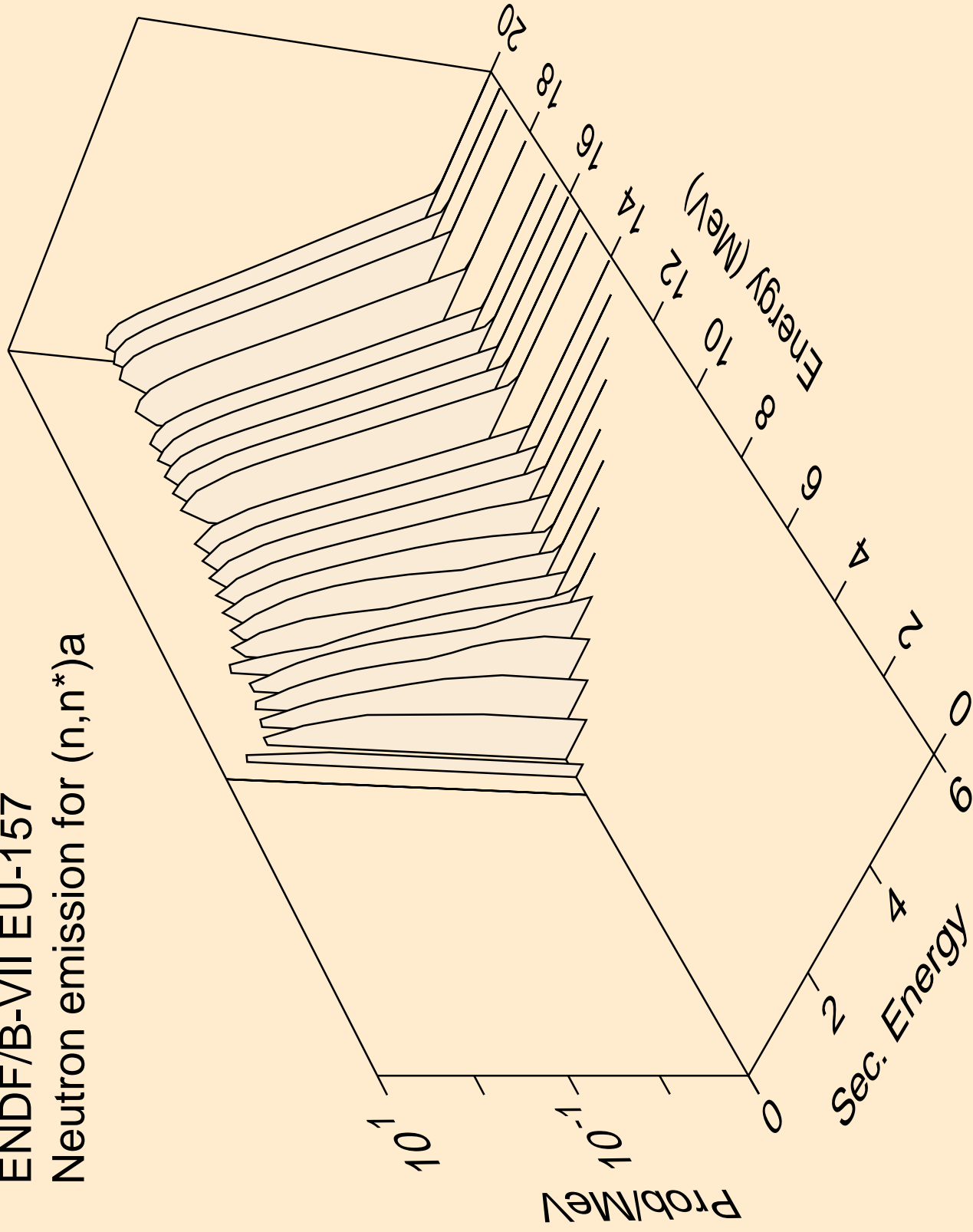

ENDF/B-VII EU-157
Neutron emission for (n,2n)a

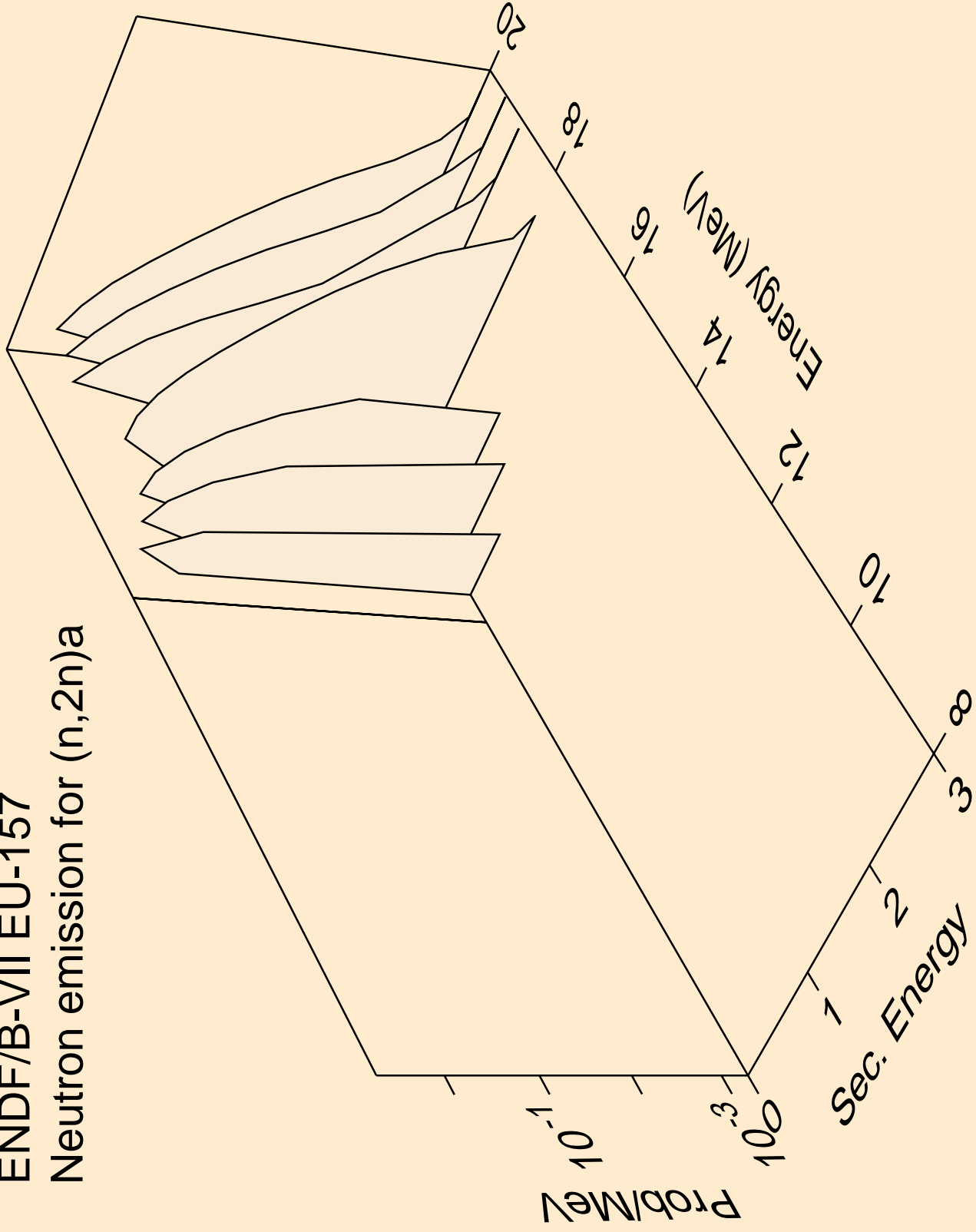

ENDF/B-VII EU-157
Neutron emission for (n,n*)p

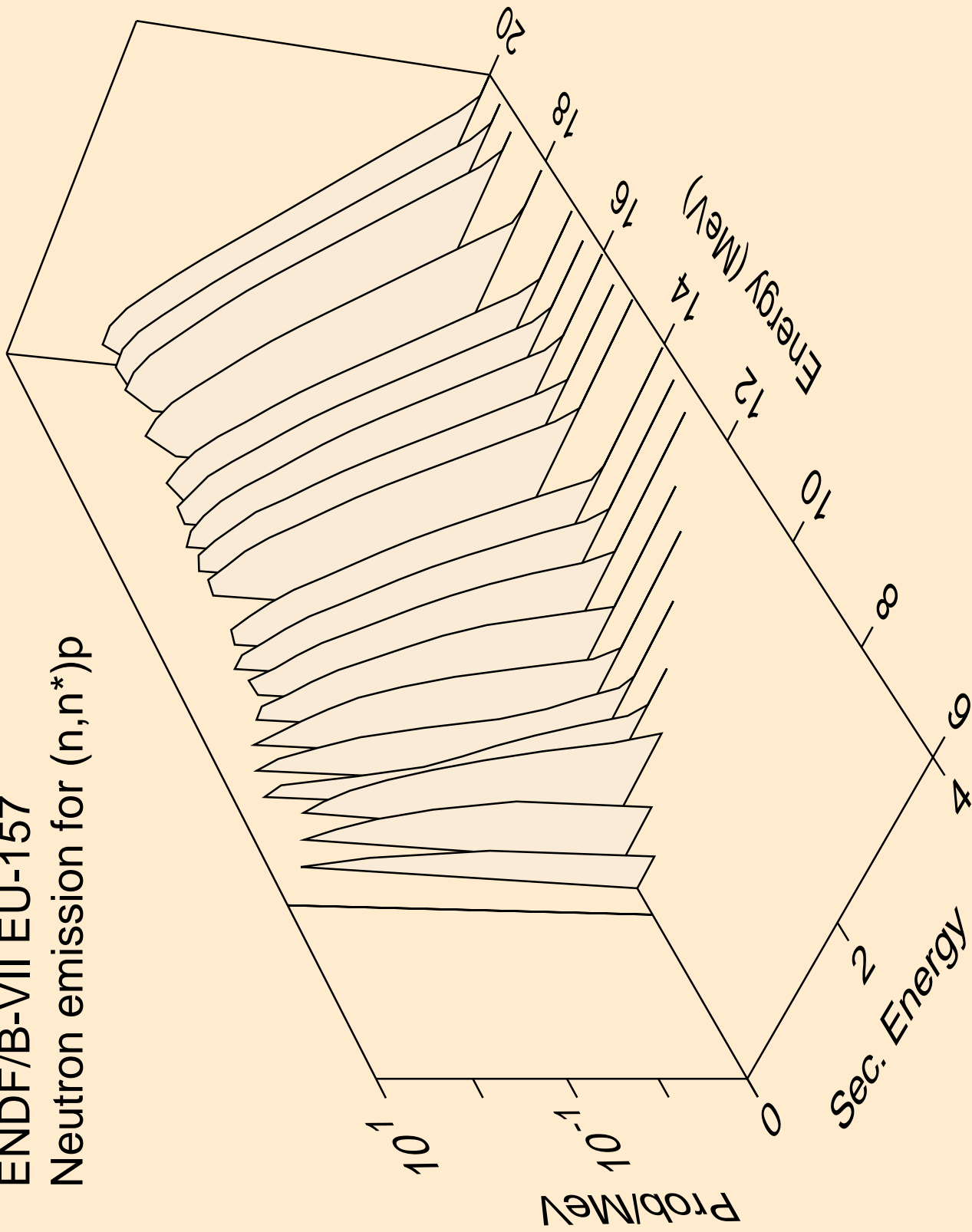

ENDF/B-VII EU-157
Neutron emission for (n,2np)

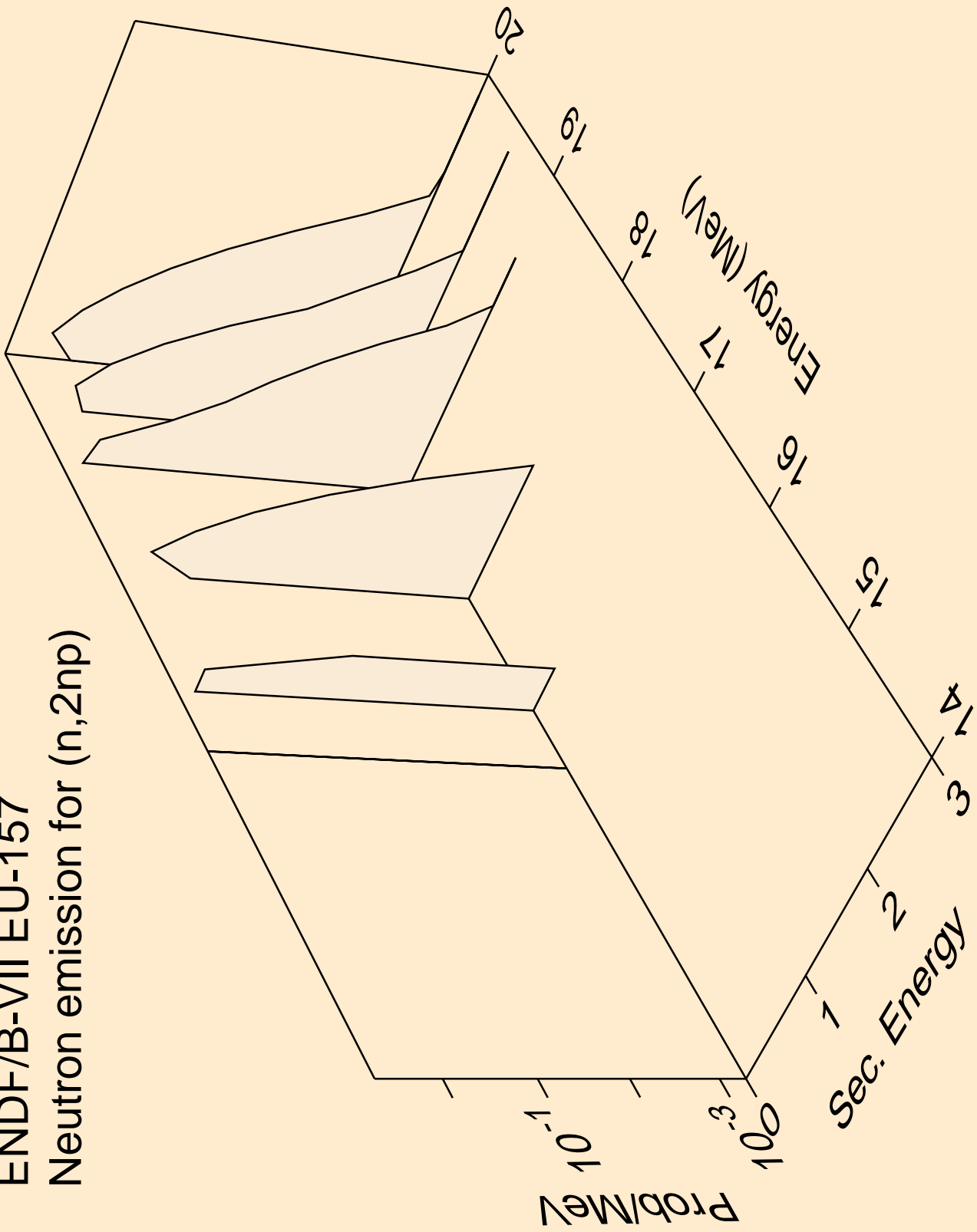

ENDF/B-VII EU-157
Neutron emission for (n,n*c)

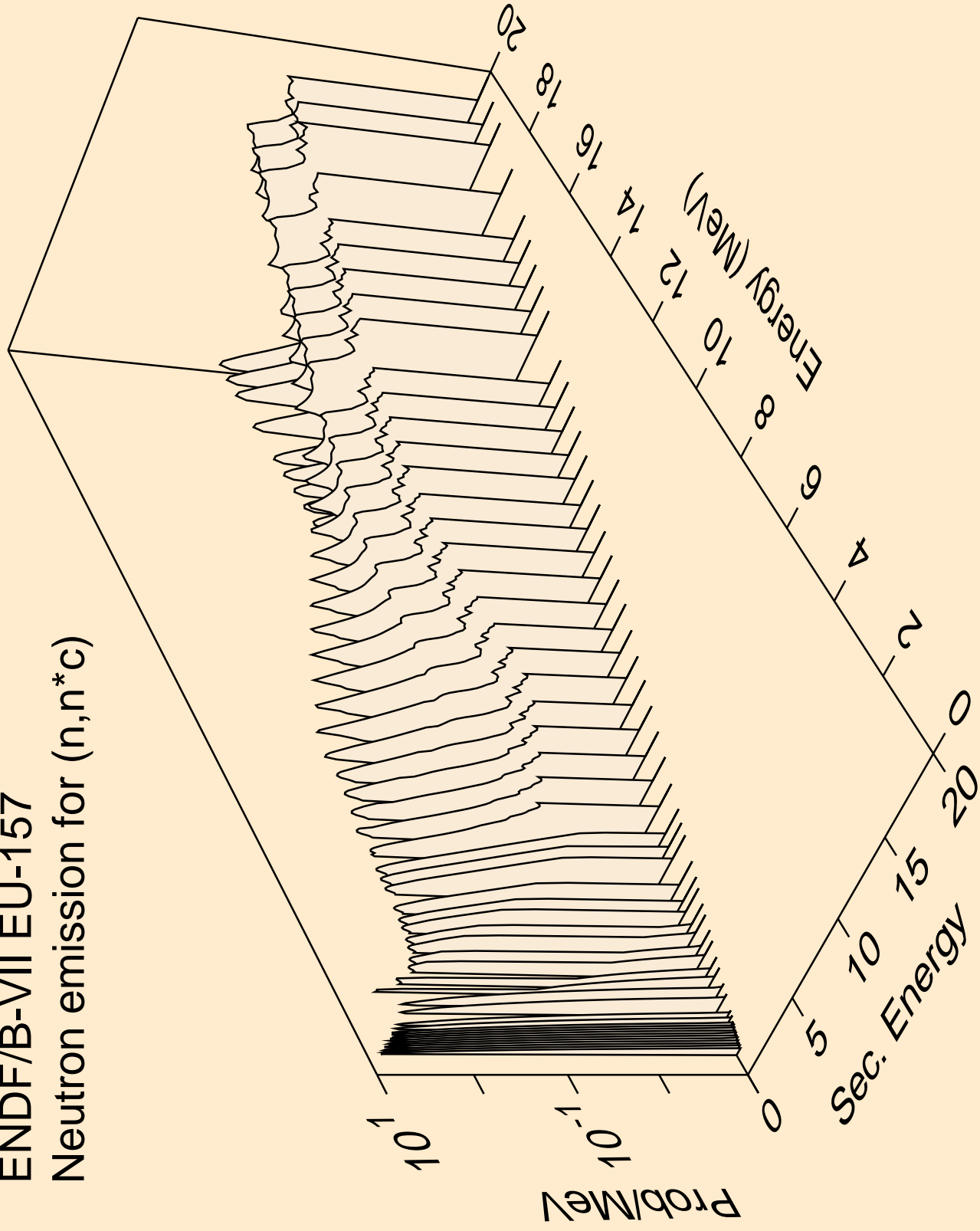

ENDF/B-VII EU-157
Photon emission for (n,2n)

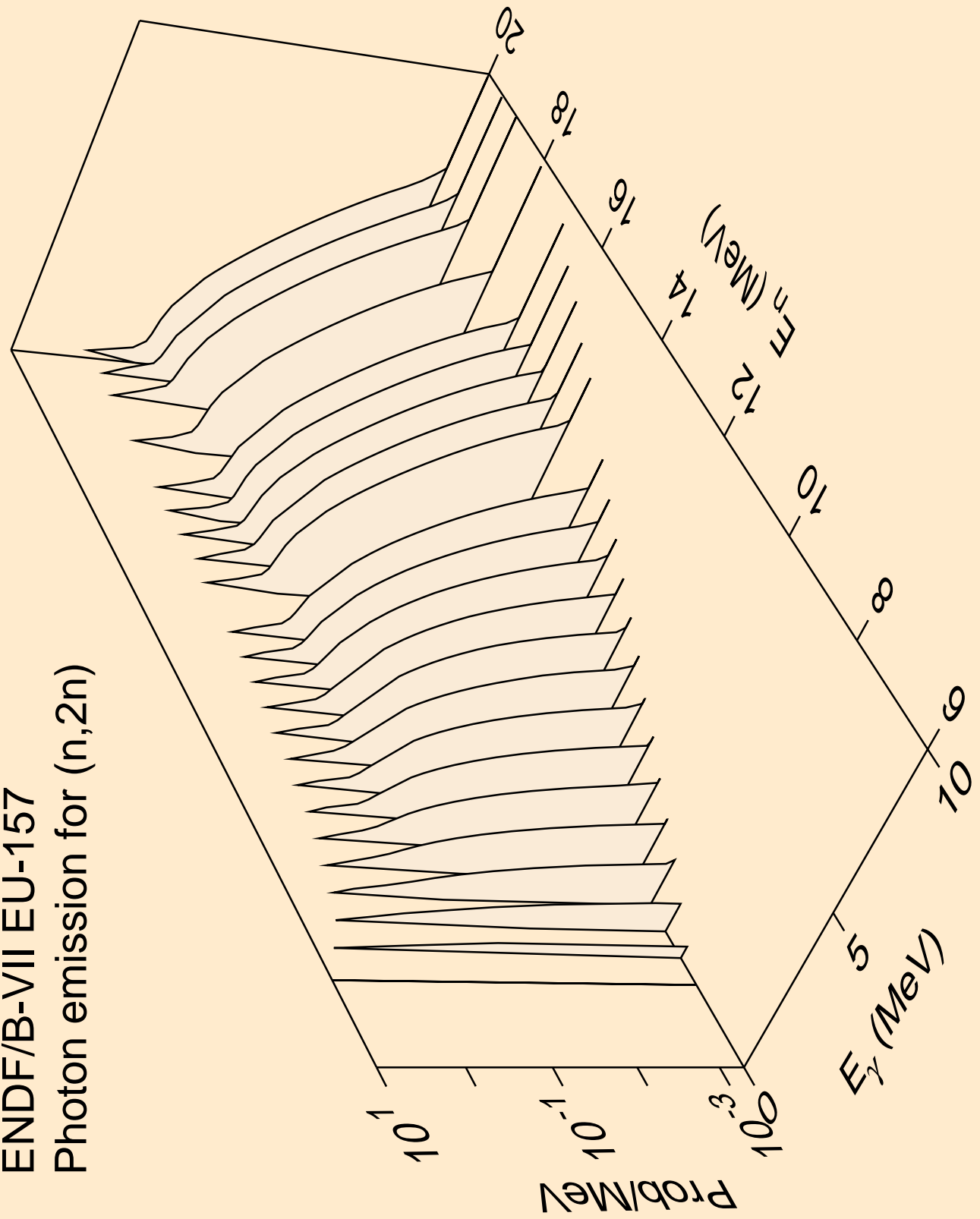

ENDF/B-VII EU-157
Photon emission for (n,3n)

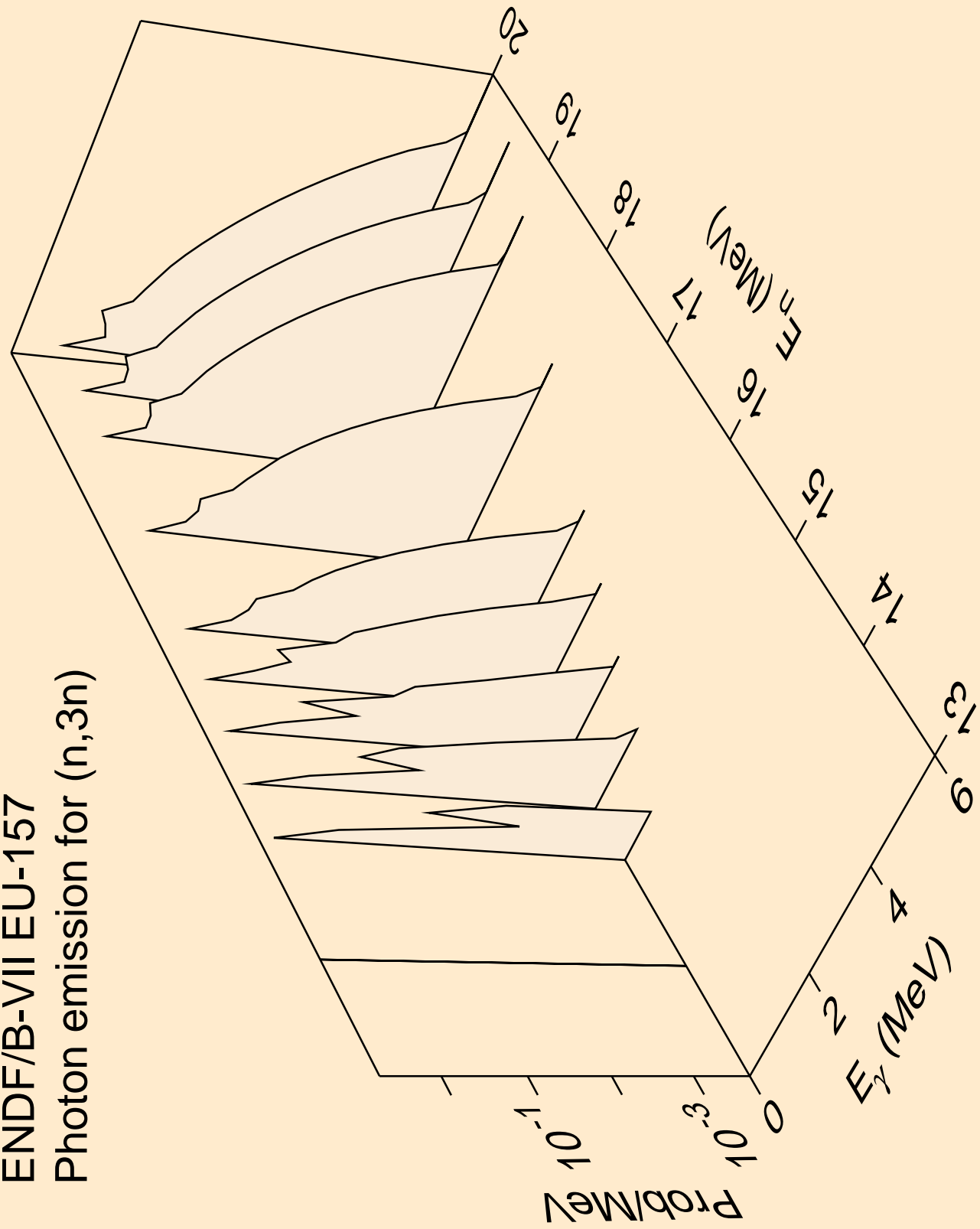

ENDF/B-VII EU-157
Photon emission for (n,n*)a

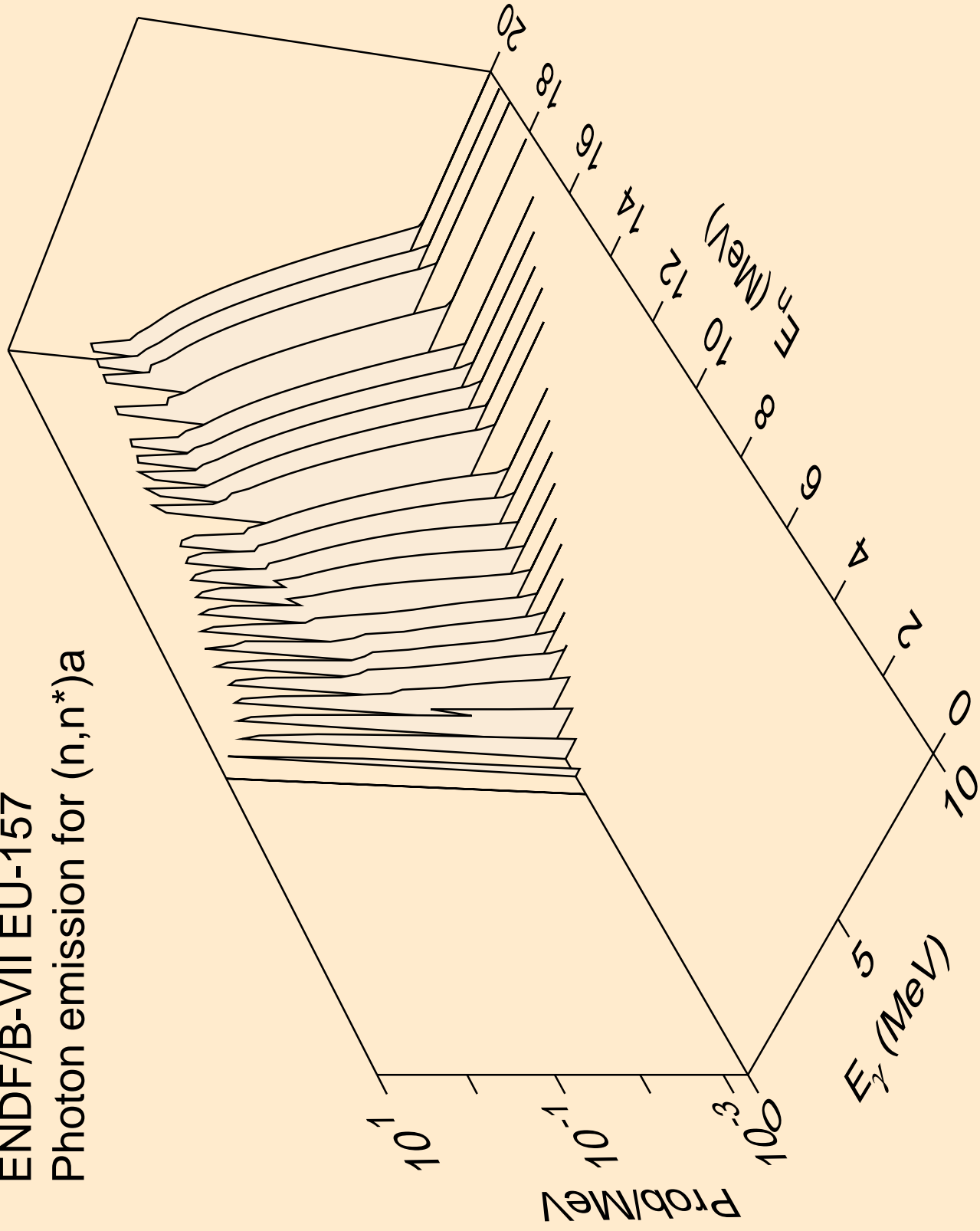

ENDF/B-VII EU-157
Photon emission for (n,2n)a

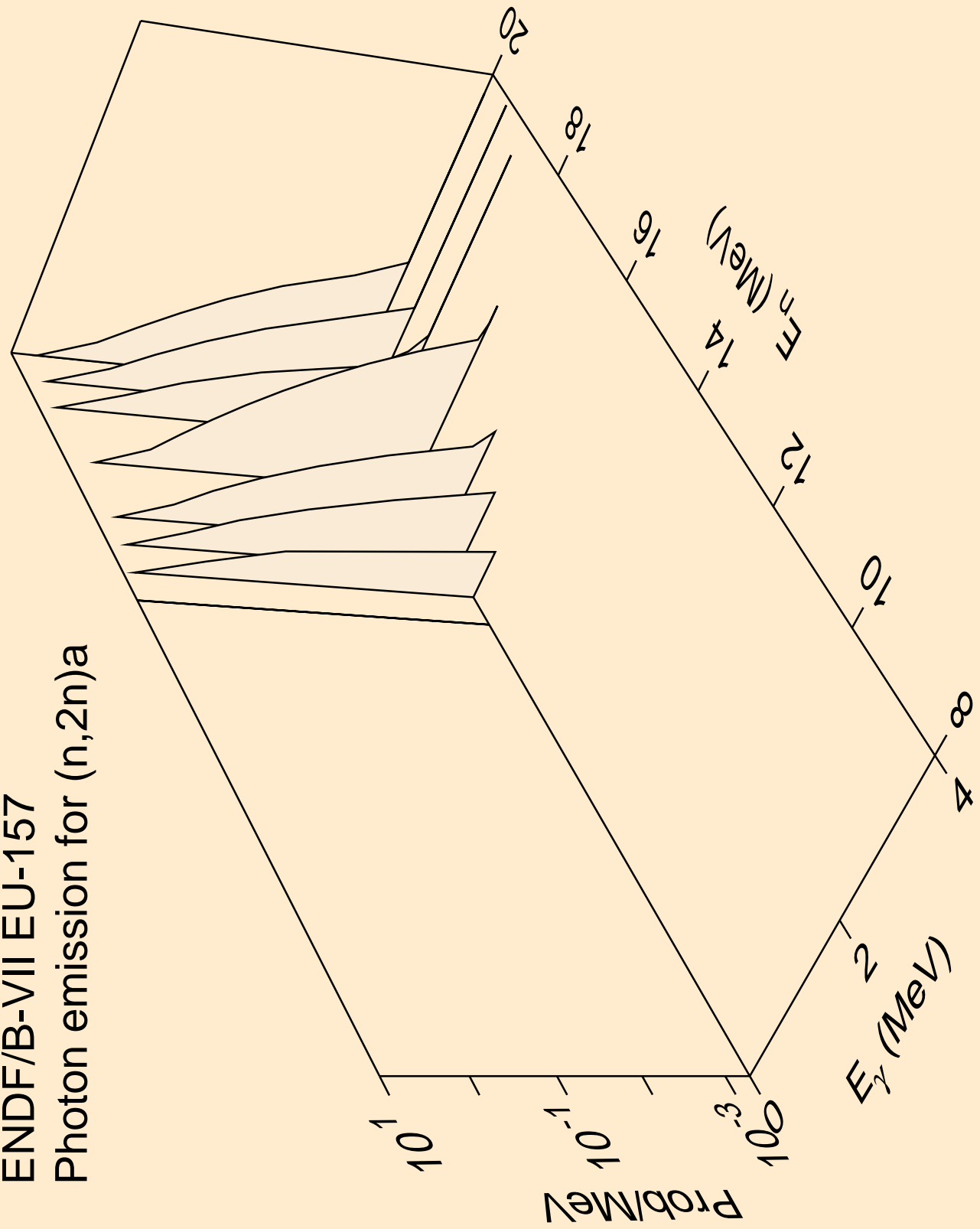

ENDF/B-VII EU-157
Photon emission for (n,n*)p

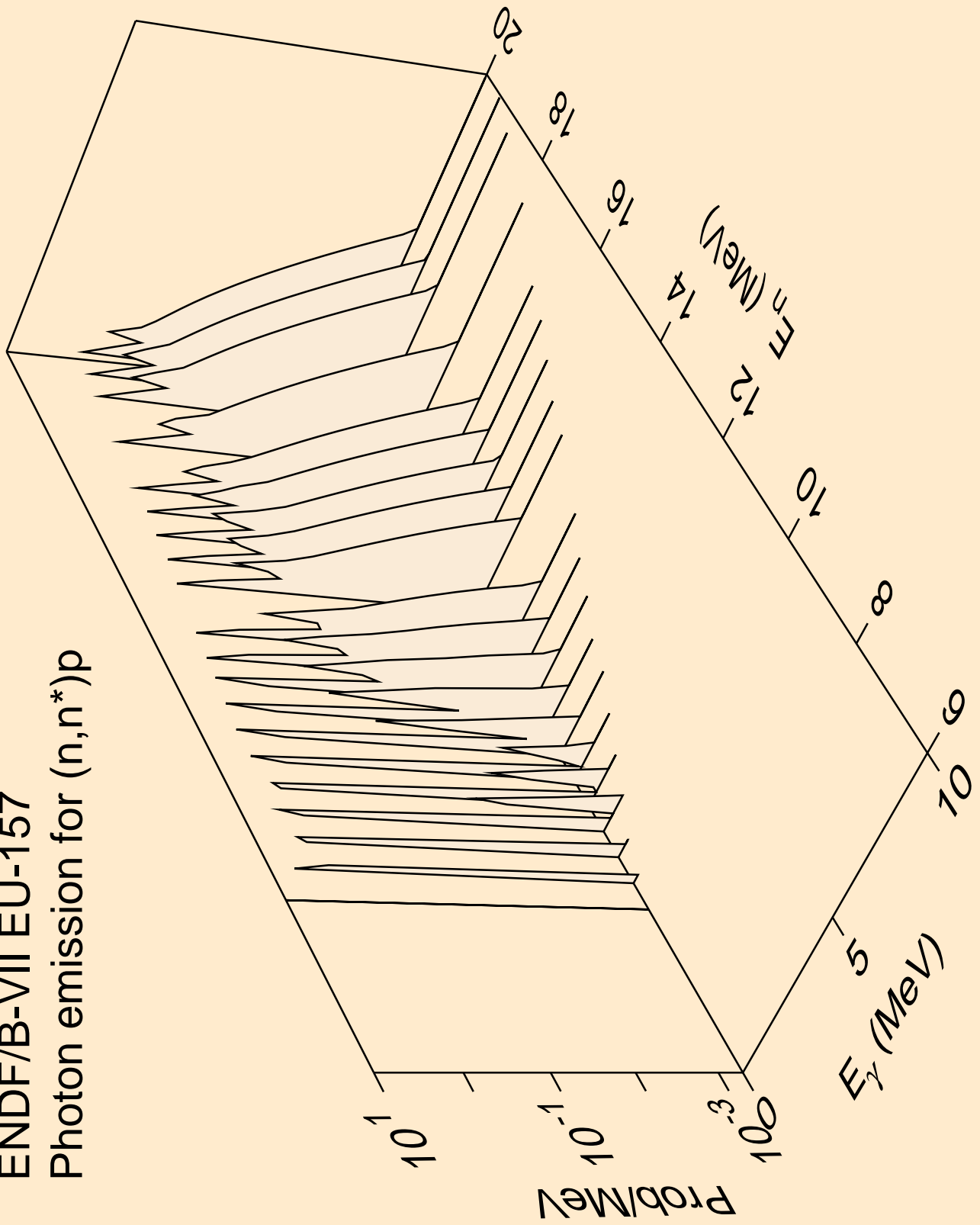

ENDF/B-VII EU-157
Photon emission for (n,2np)

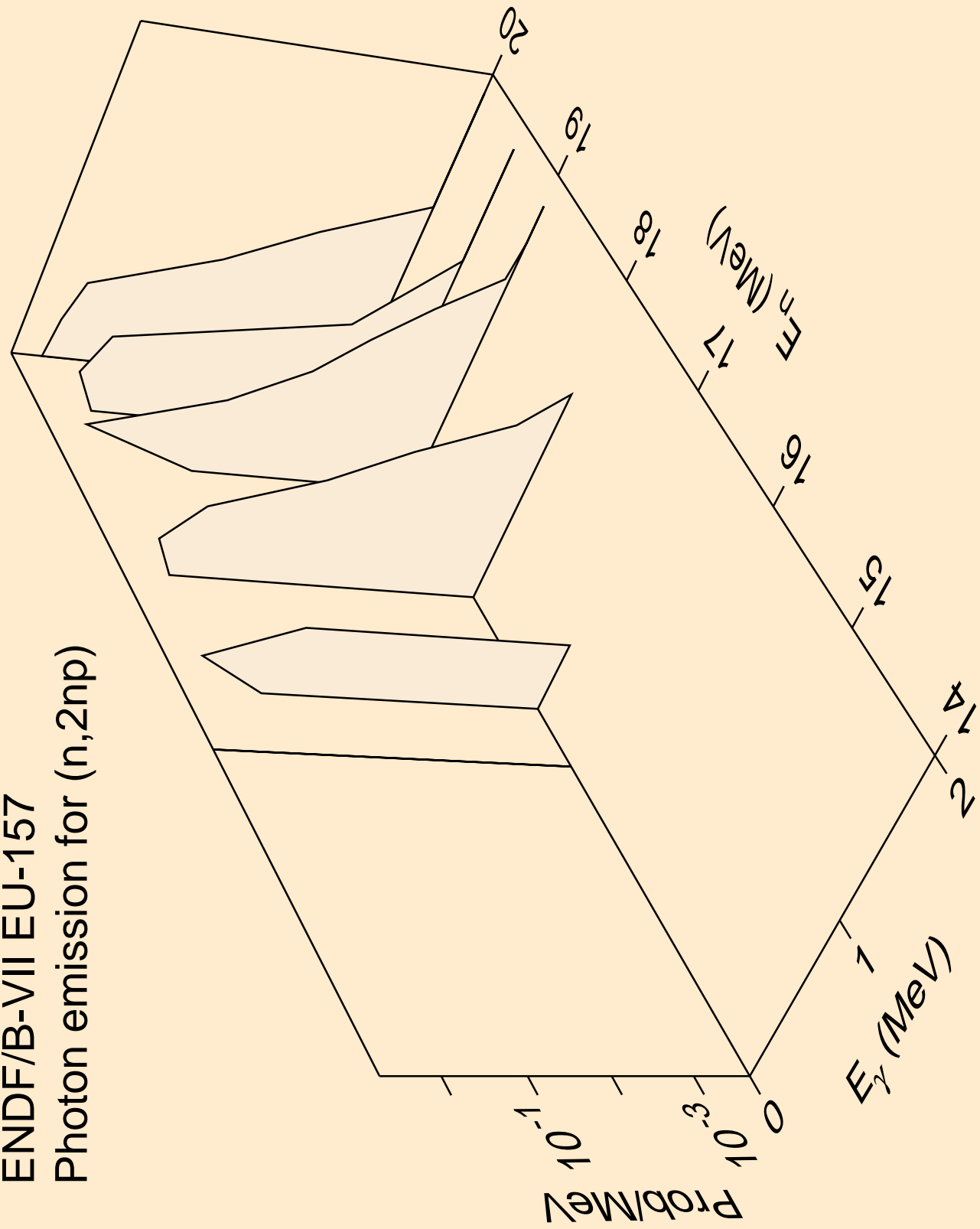

ENDF/B-VII EU-157
Photon emission for (n,n*c)

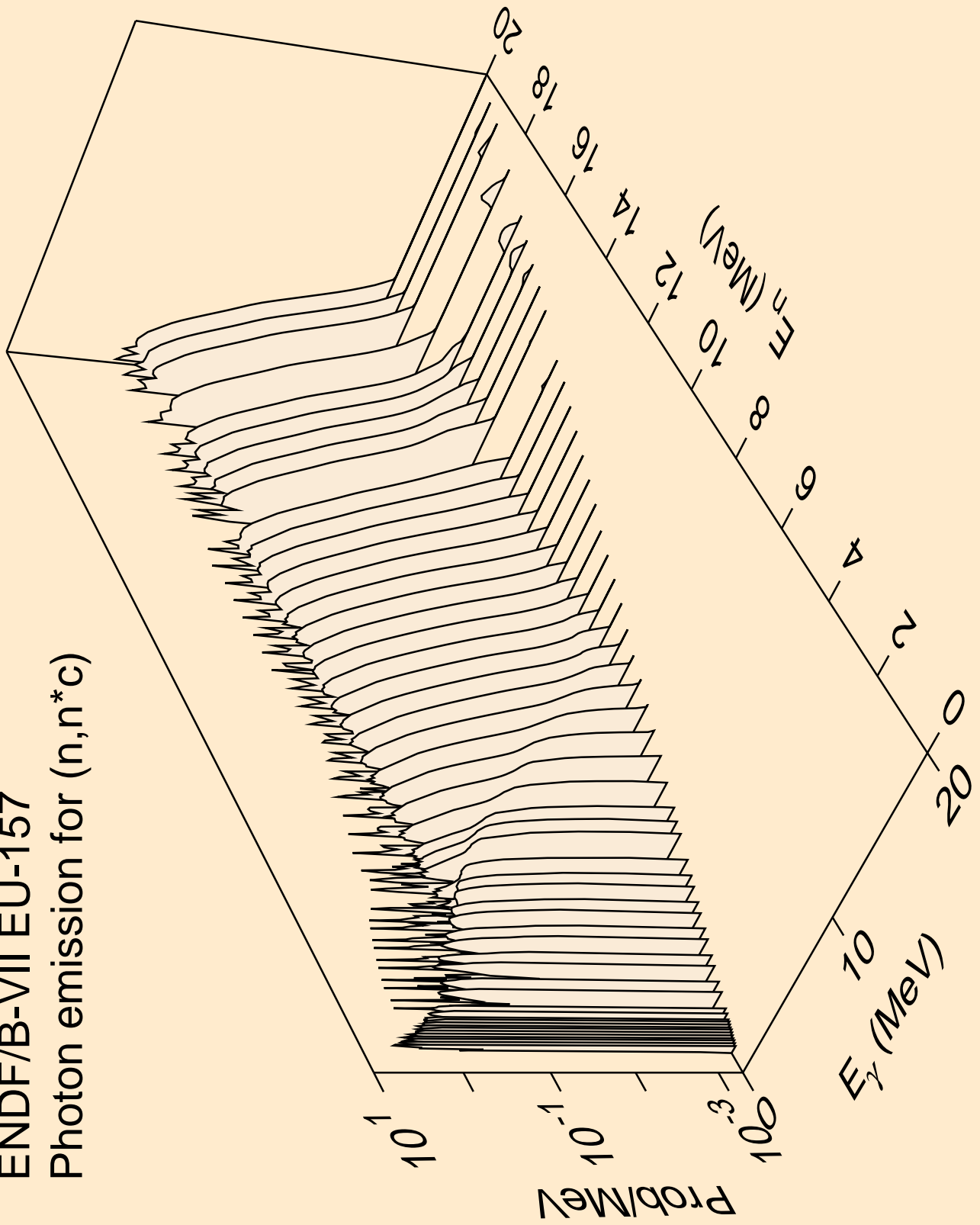

ENDF/B-VII EU-157
Photon emission for (n,gma)

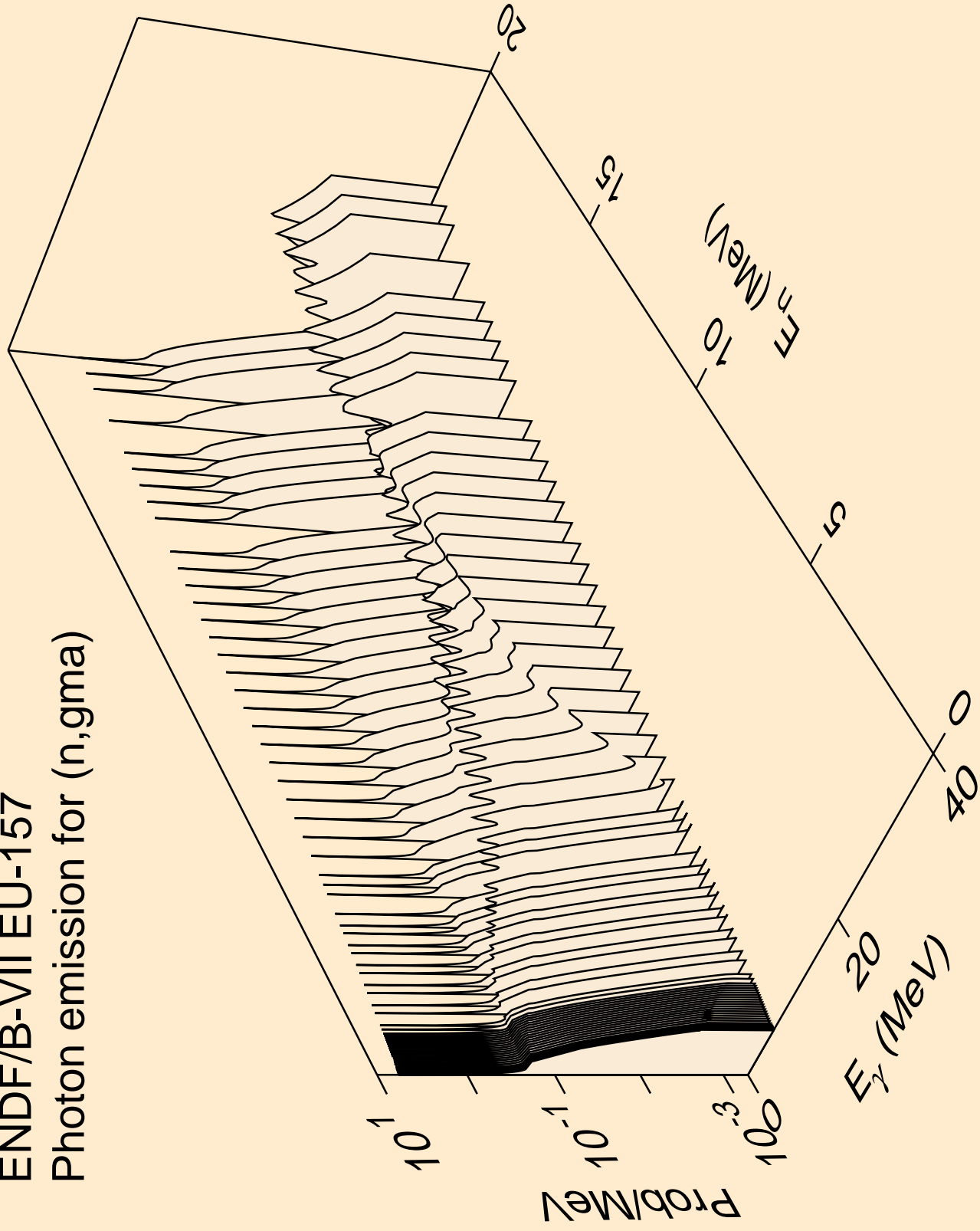

ENDF/B-VII EU-157
Photon emission for (n,p*c)

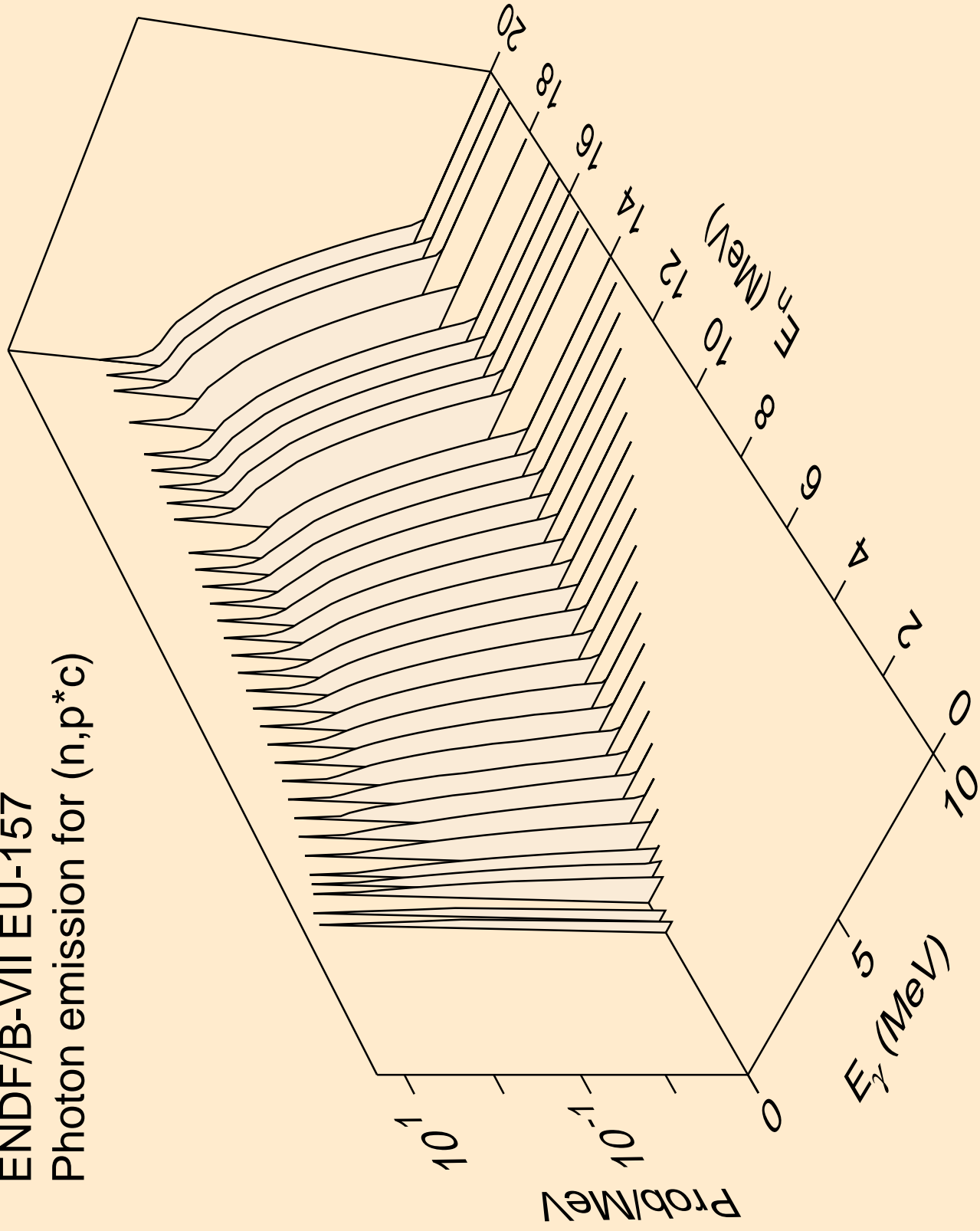

ENDF/B-VII EU-157
Photon emission for (n,a*c)

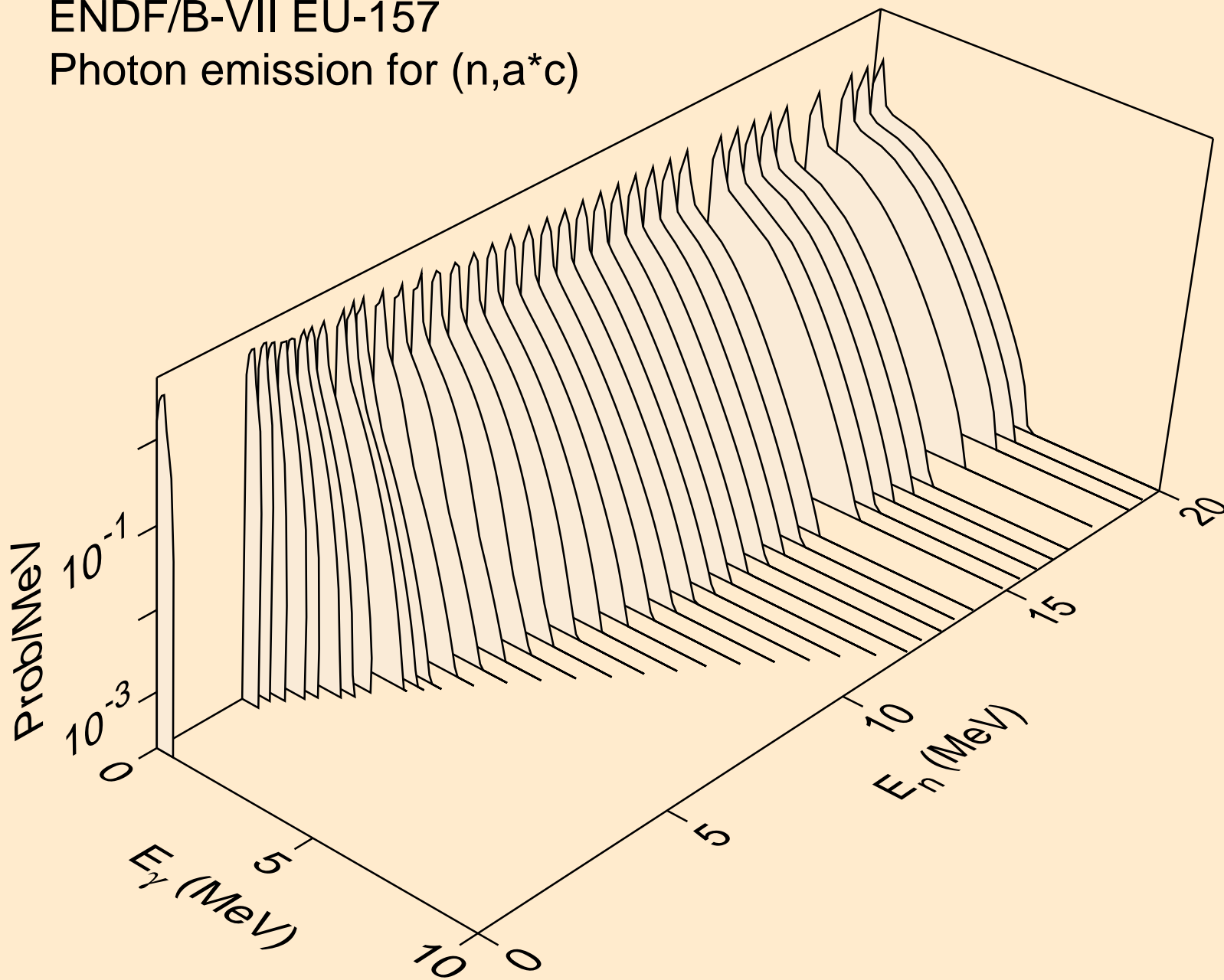

ENDF/B-VII EU-157
thermal capture photon spectrum

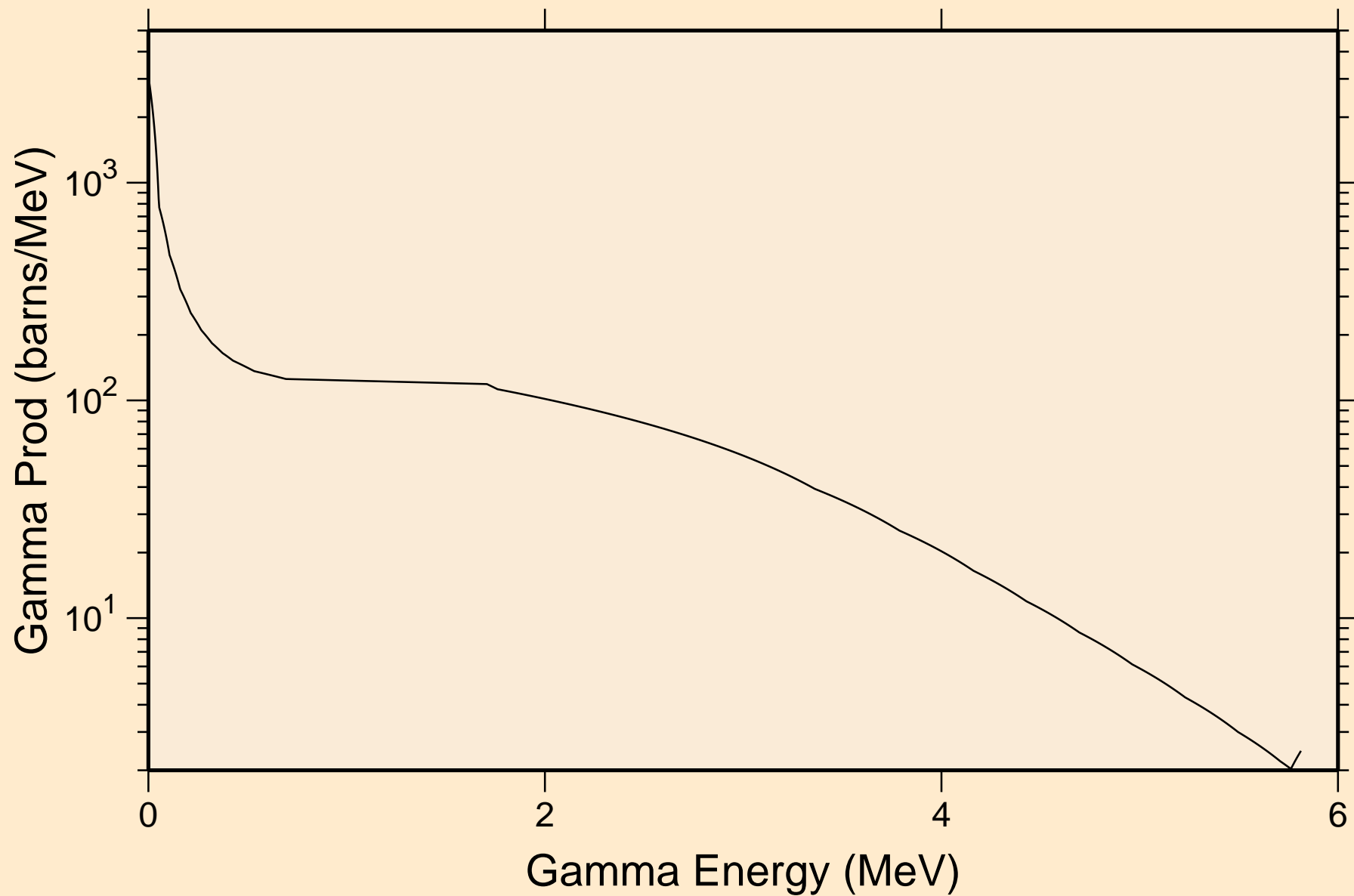

ENDF/B-VII EU-157
14 MeV photon spectrum

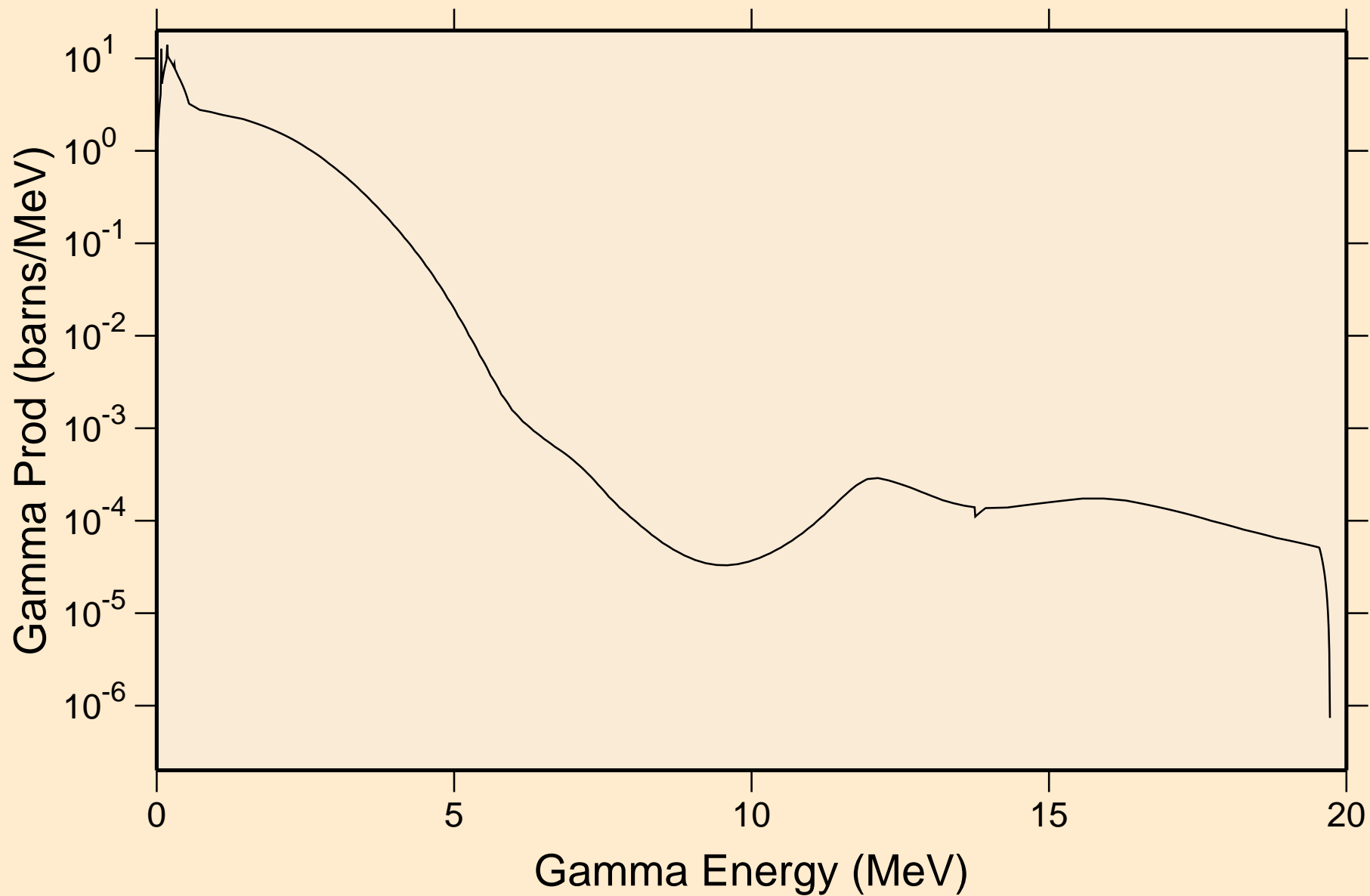

ENDF/B-VII EU-157

Particle heating contributions

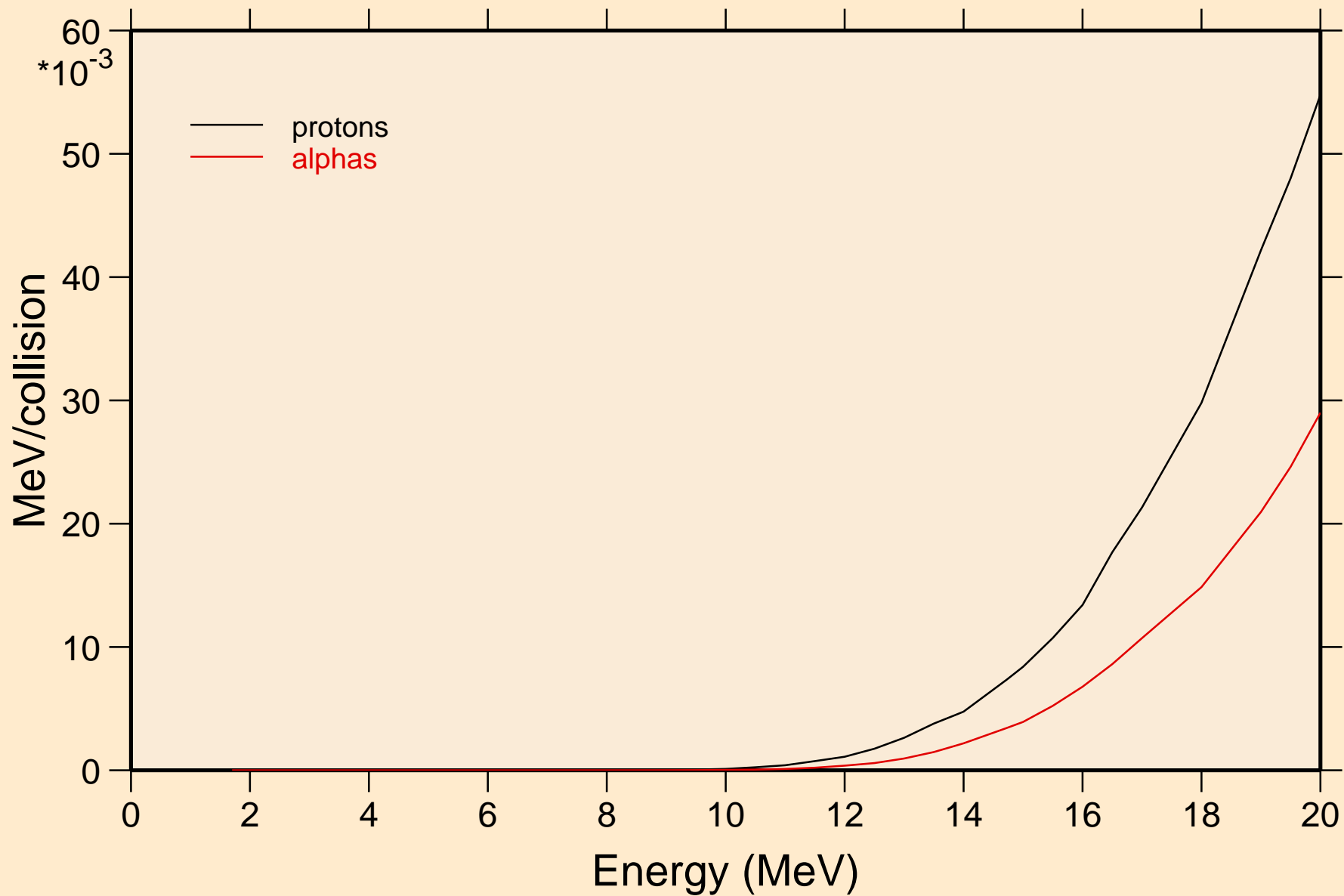

ENDF/B-VII EU-157

Recoil Heating

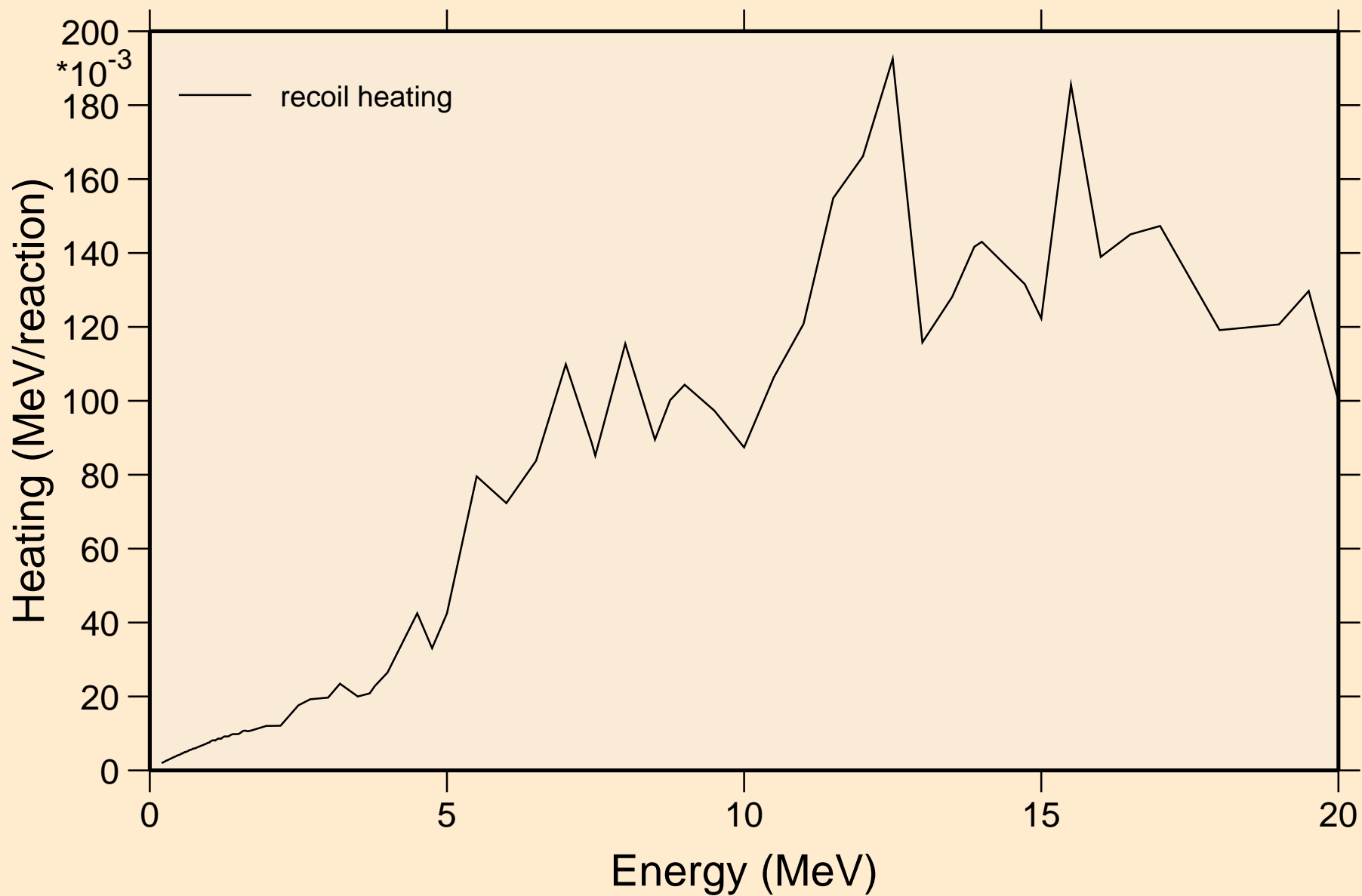

ENDF/B-VII EU-157

Particle production cross sections

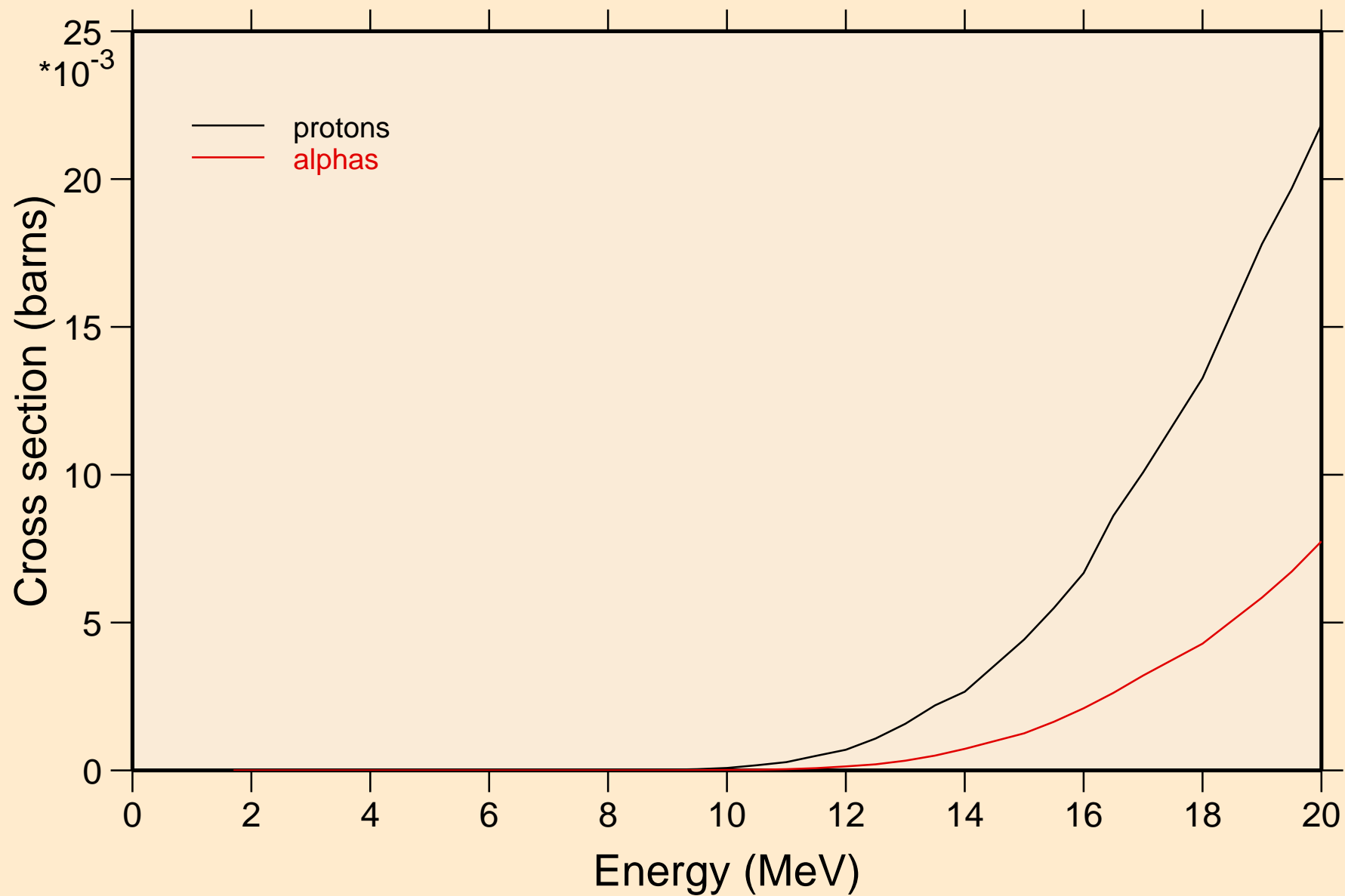

ENDF/B-VII EU-157
protons from (n,n*)p

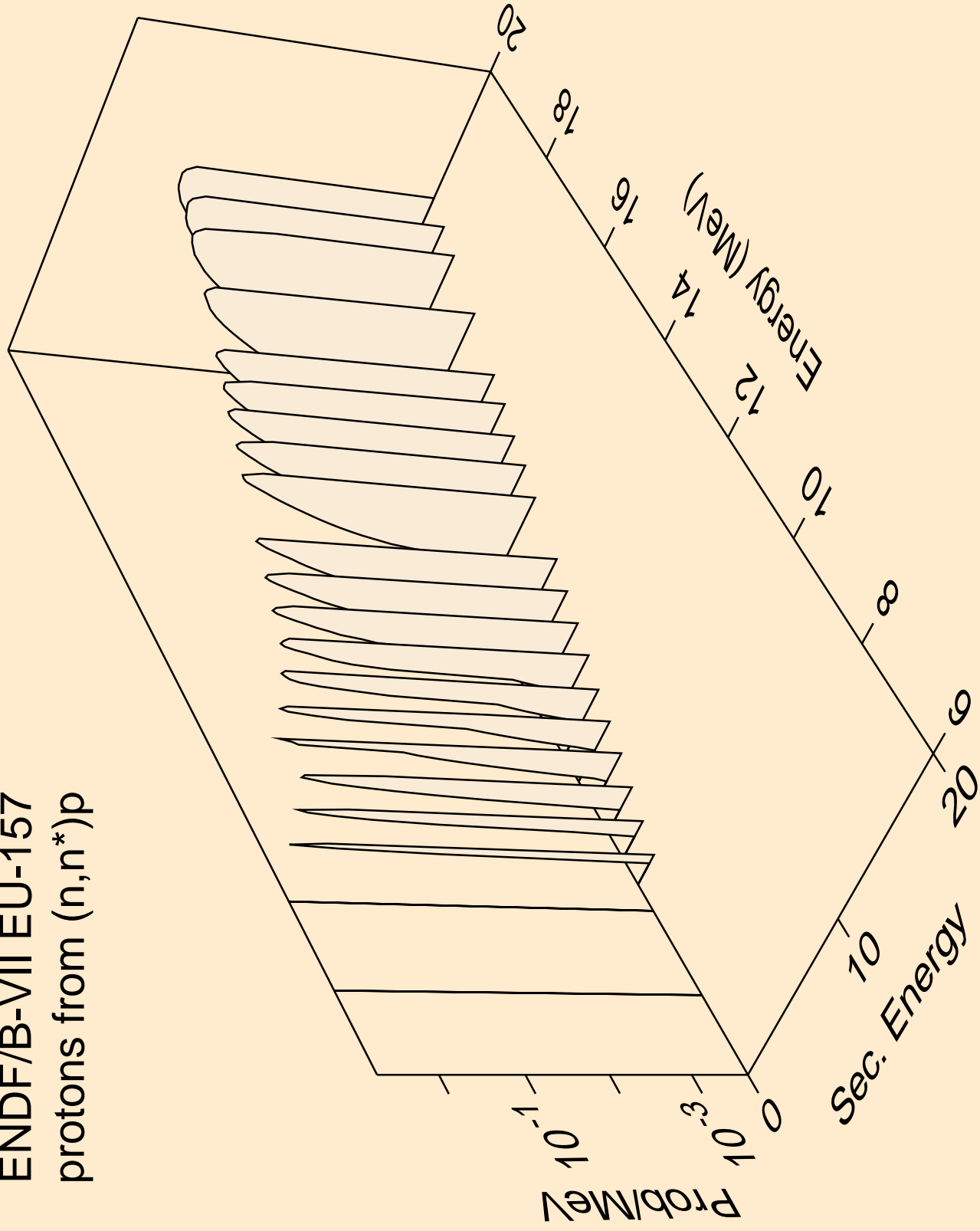

ENDF/B-VII EU-157
protons from (n,2np)

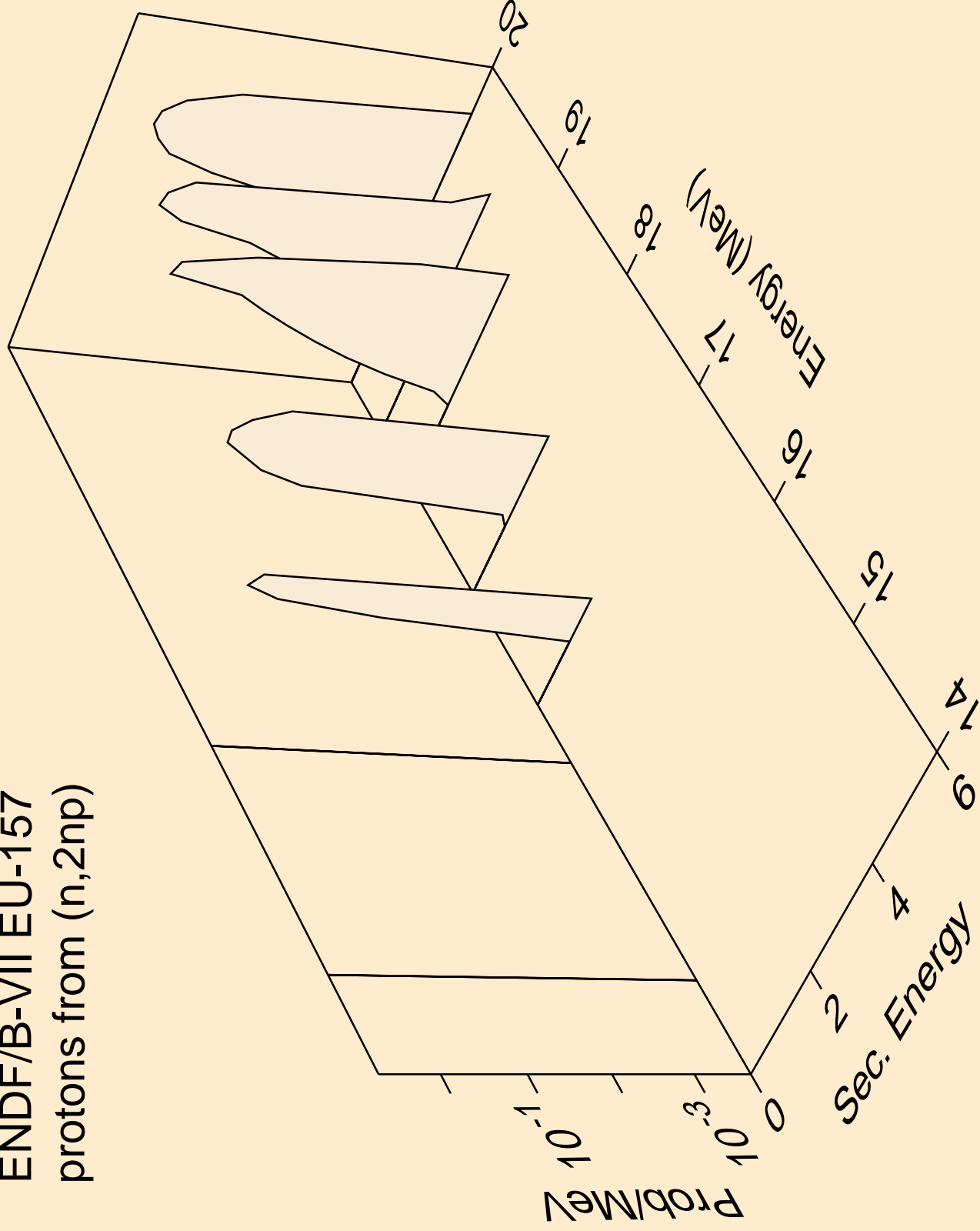

ENDF/B-VII EU-157
angular distribution for (n,p*0) proton

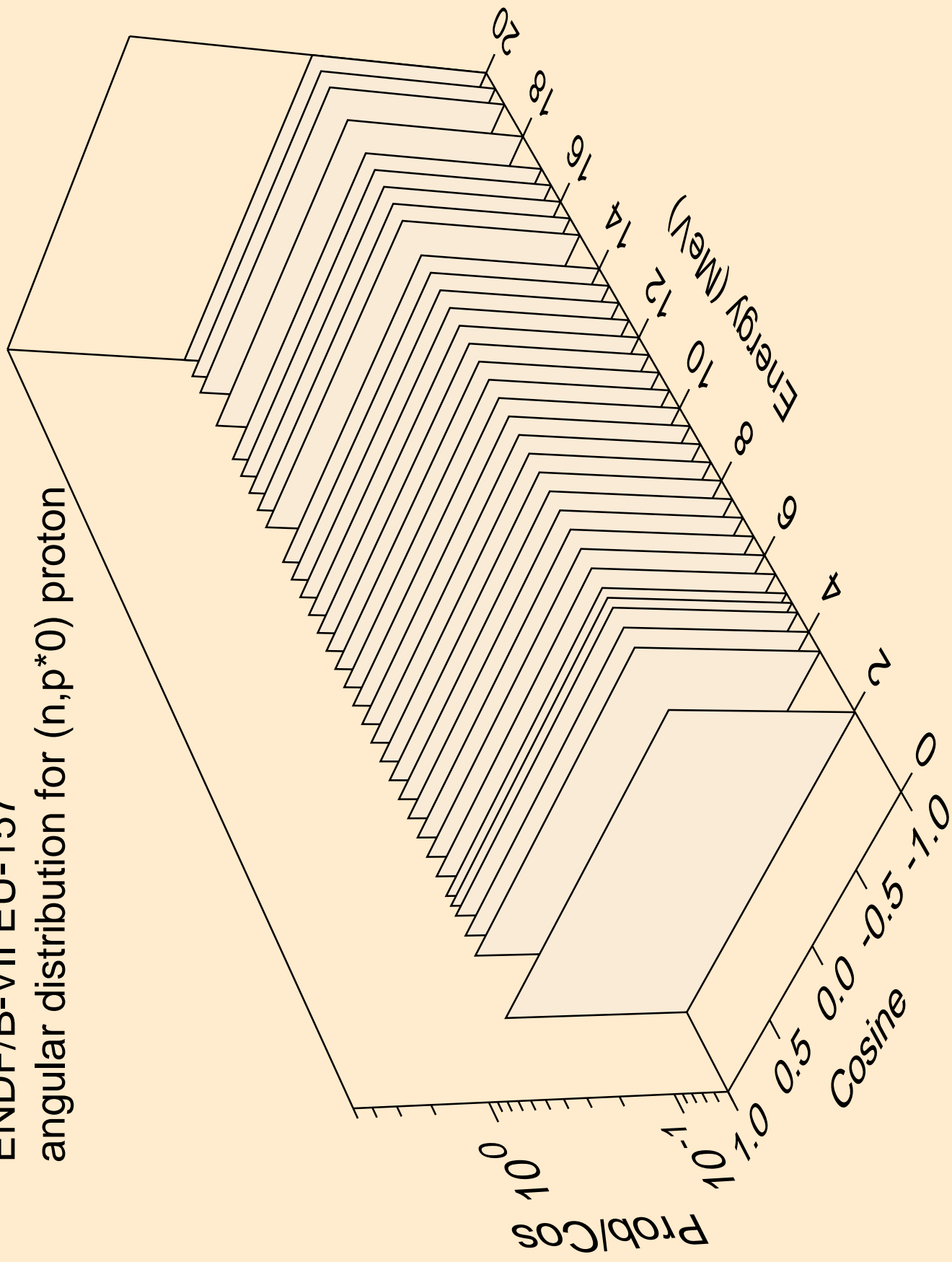

ENDF/B-VII EU-157
protons from (n,p*c)

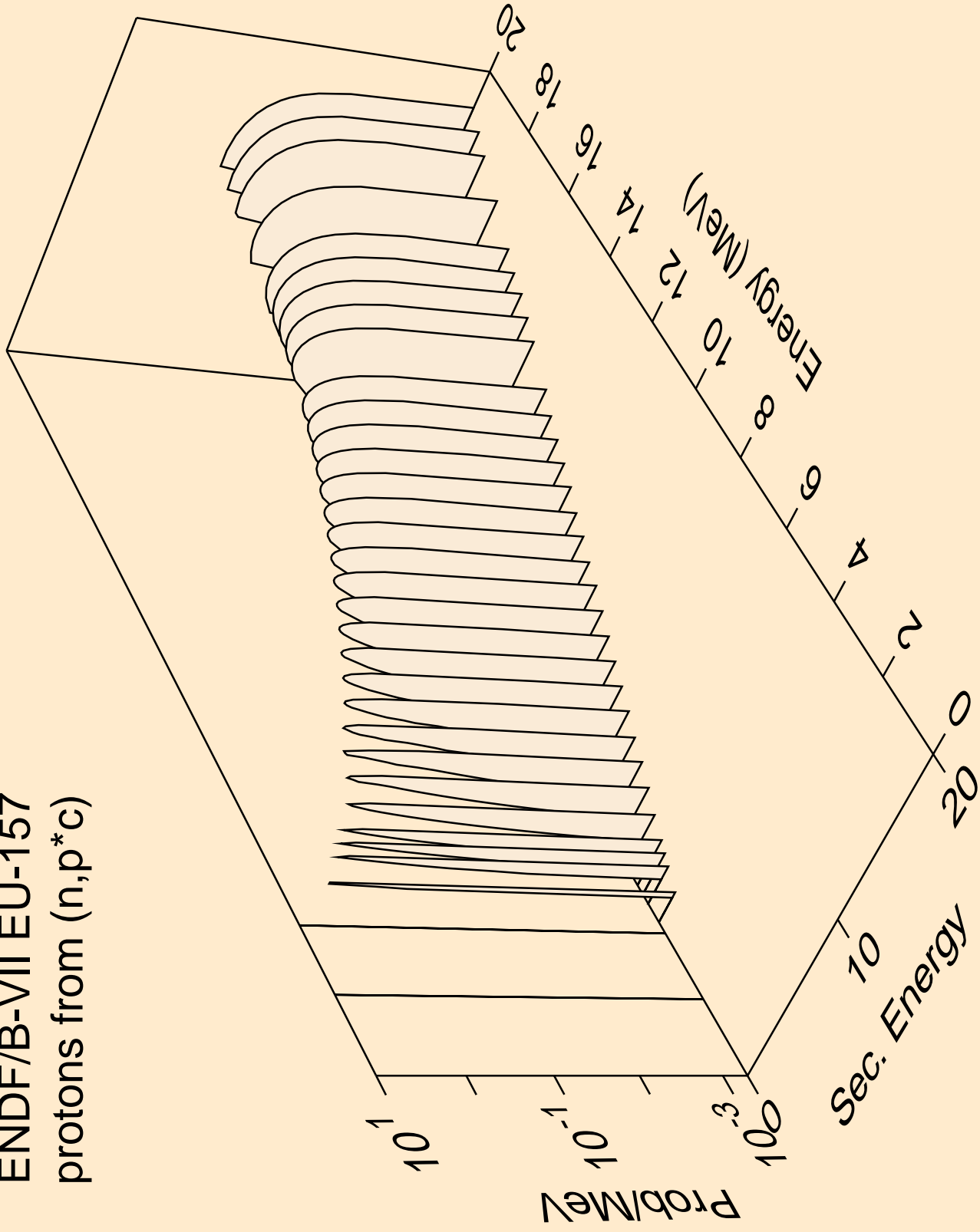

ENDF/B-VII EU-157
alphas from (n,n*)a

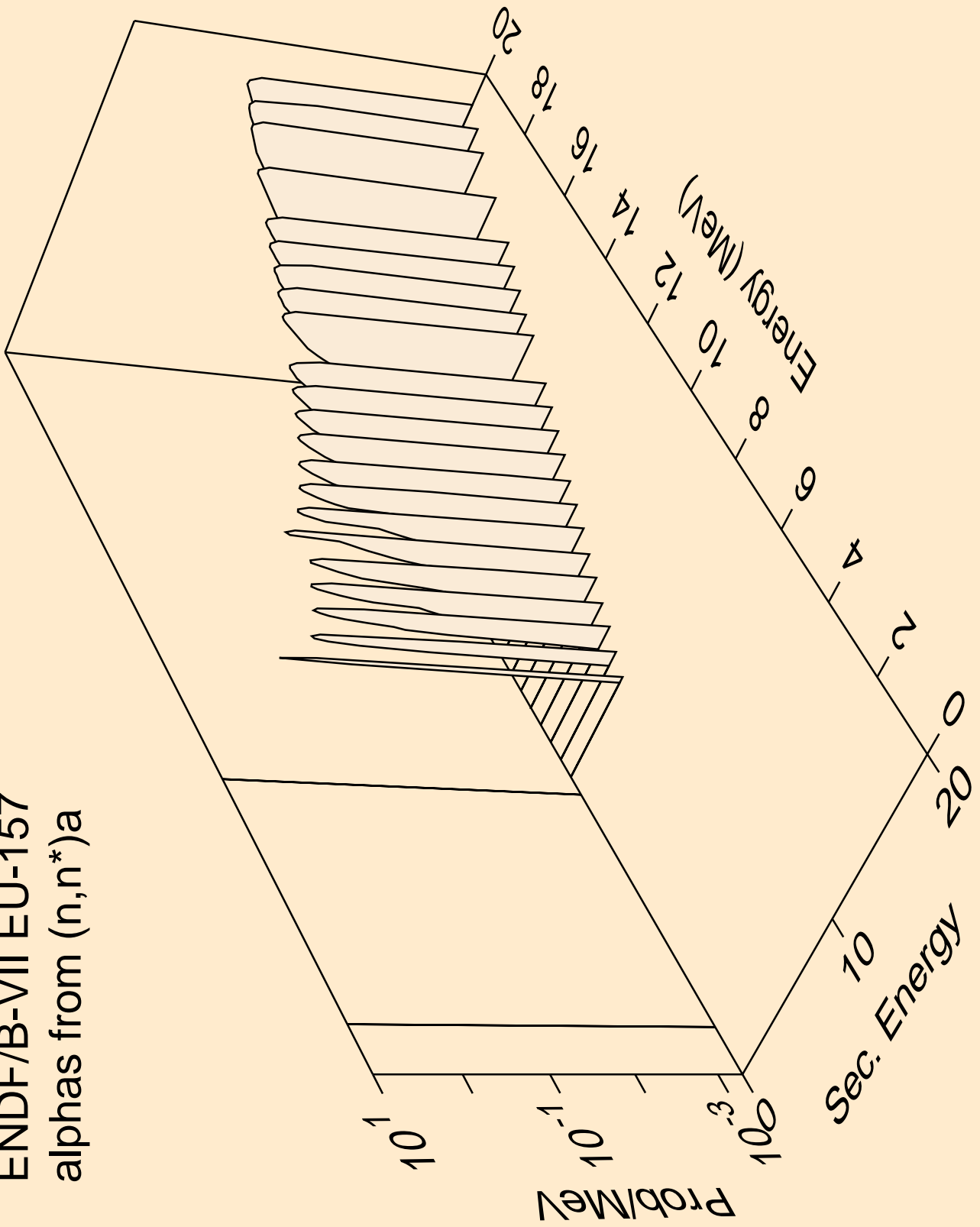

ENDF/B-VII EU-157
alphas from (n,2n)a

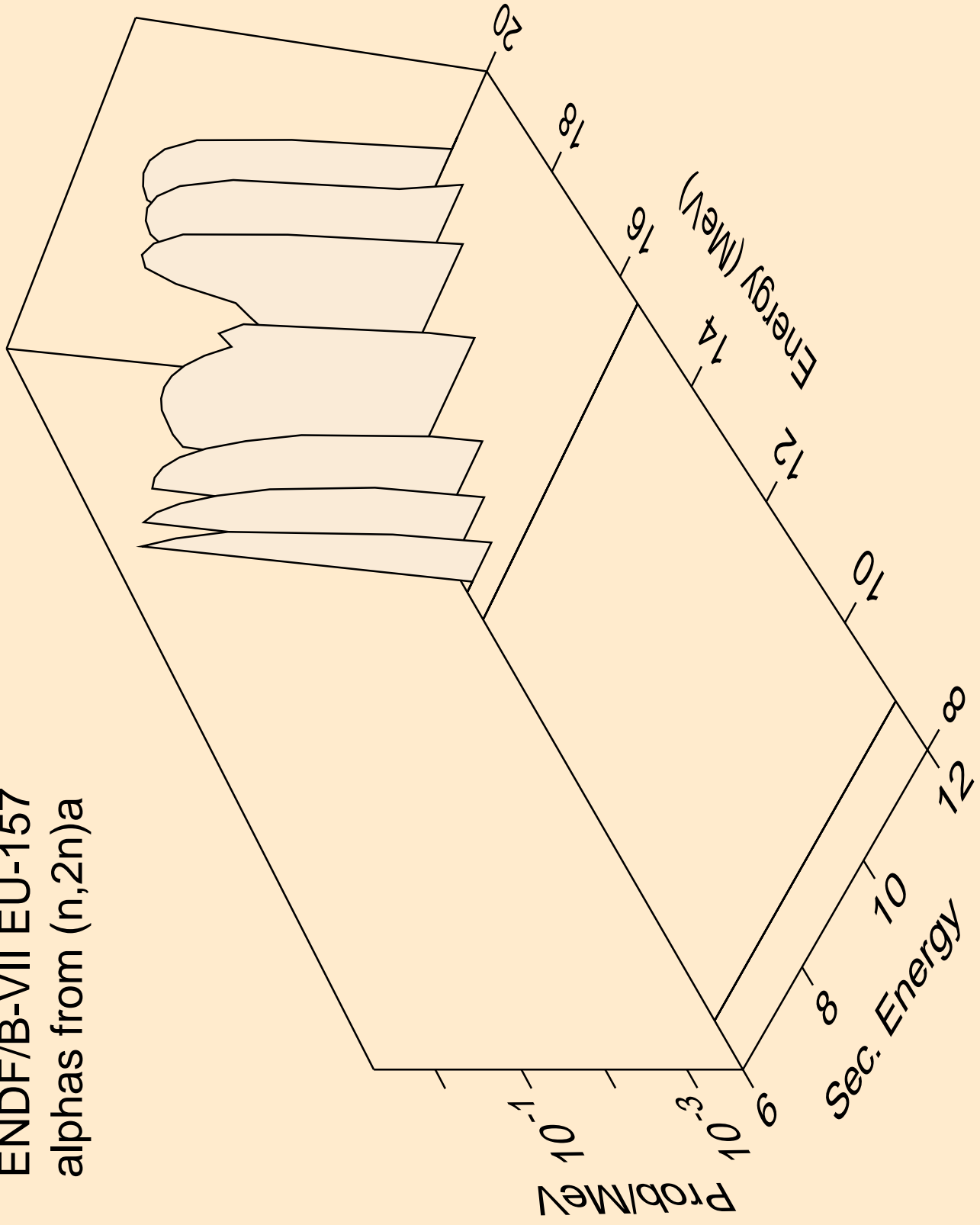

ENDF/B-VII EU-157
angular distribution for (n,a*0) alpha

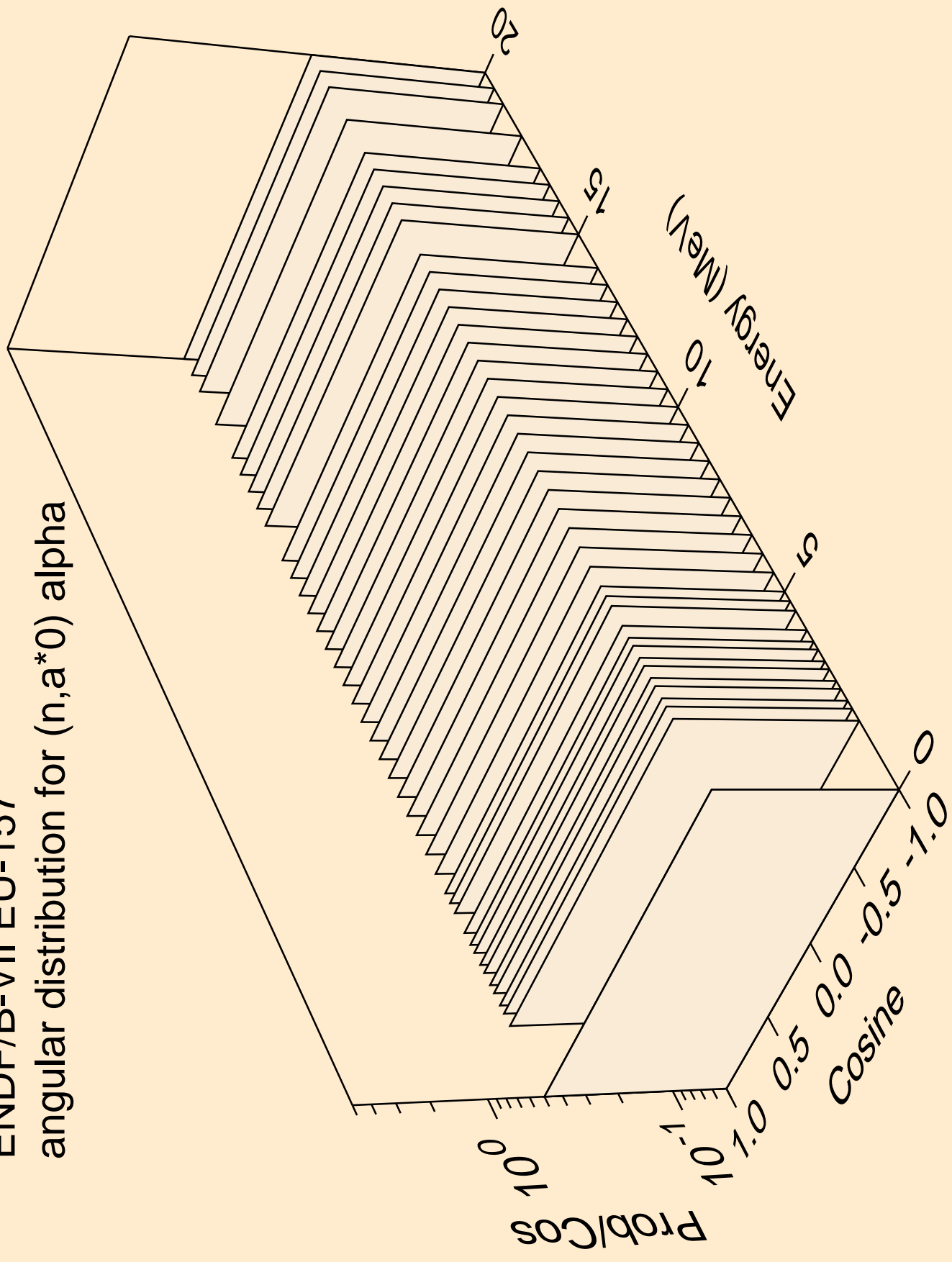

ENDF/B-VII EU-157
angular distribution for (n,a*1) alpha

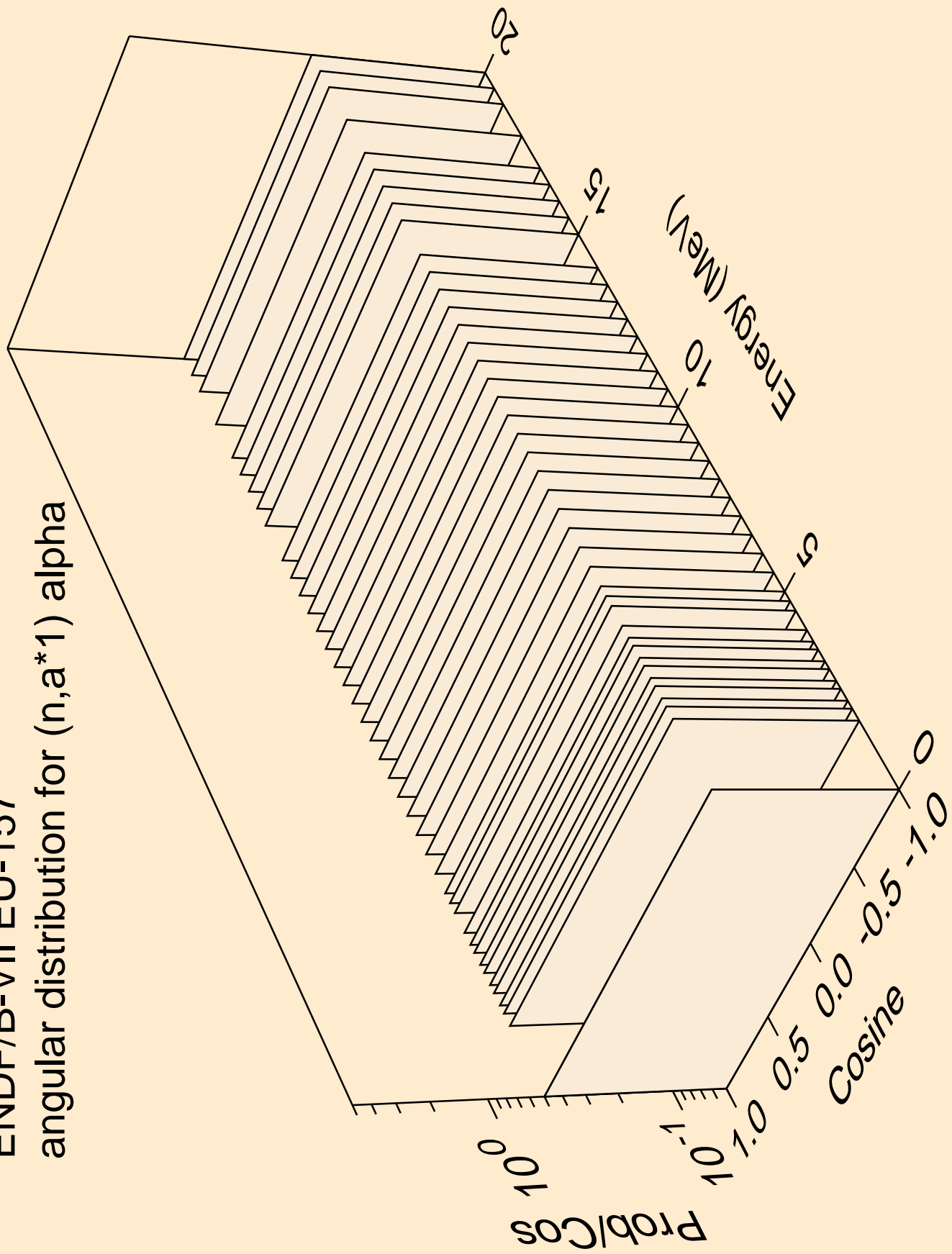

ENDF/B-VII EU-157
angular distribution for (n,a*2) alpha

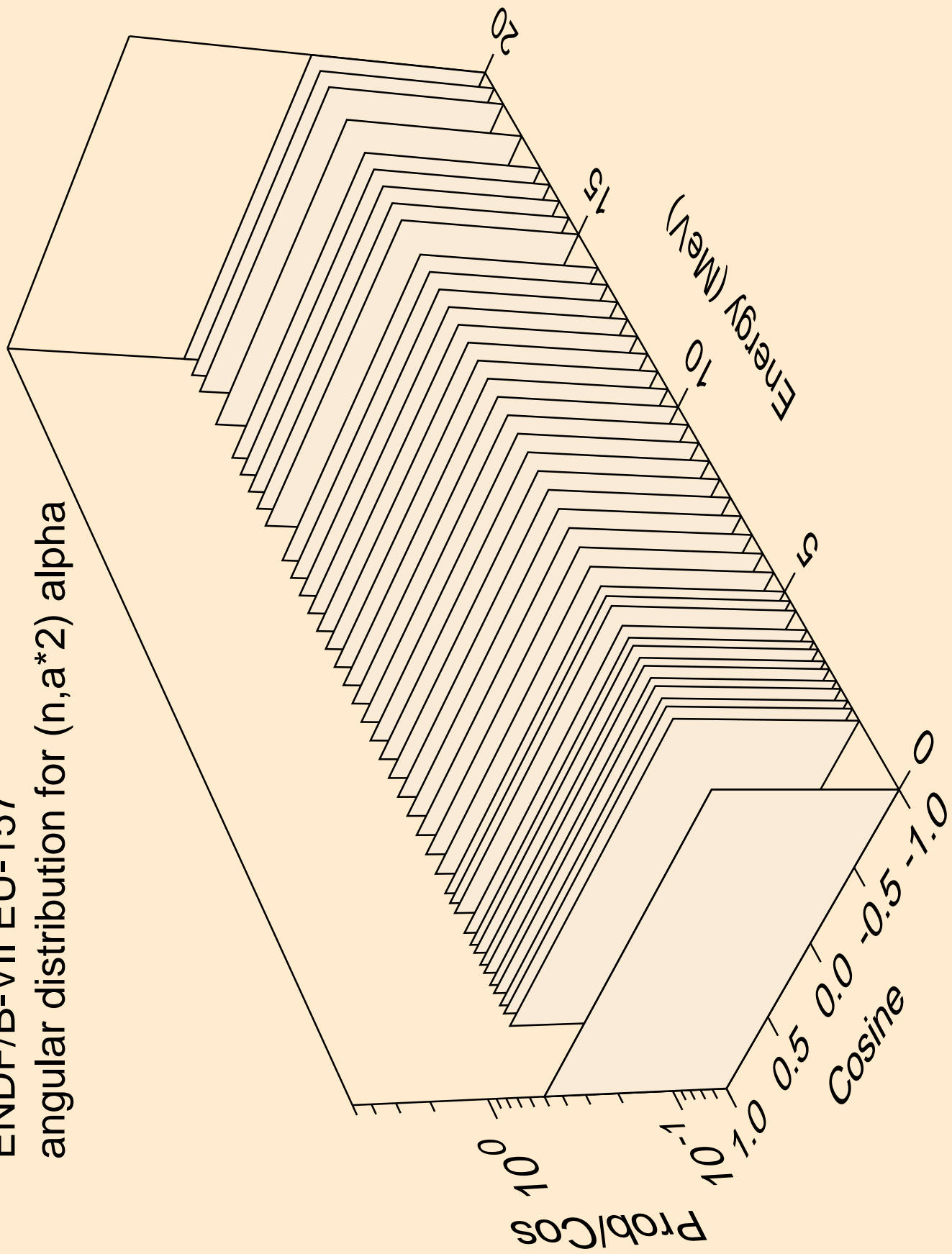

ENDF/B-VII EU-157
angular distribution for (n,a*3) alpha

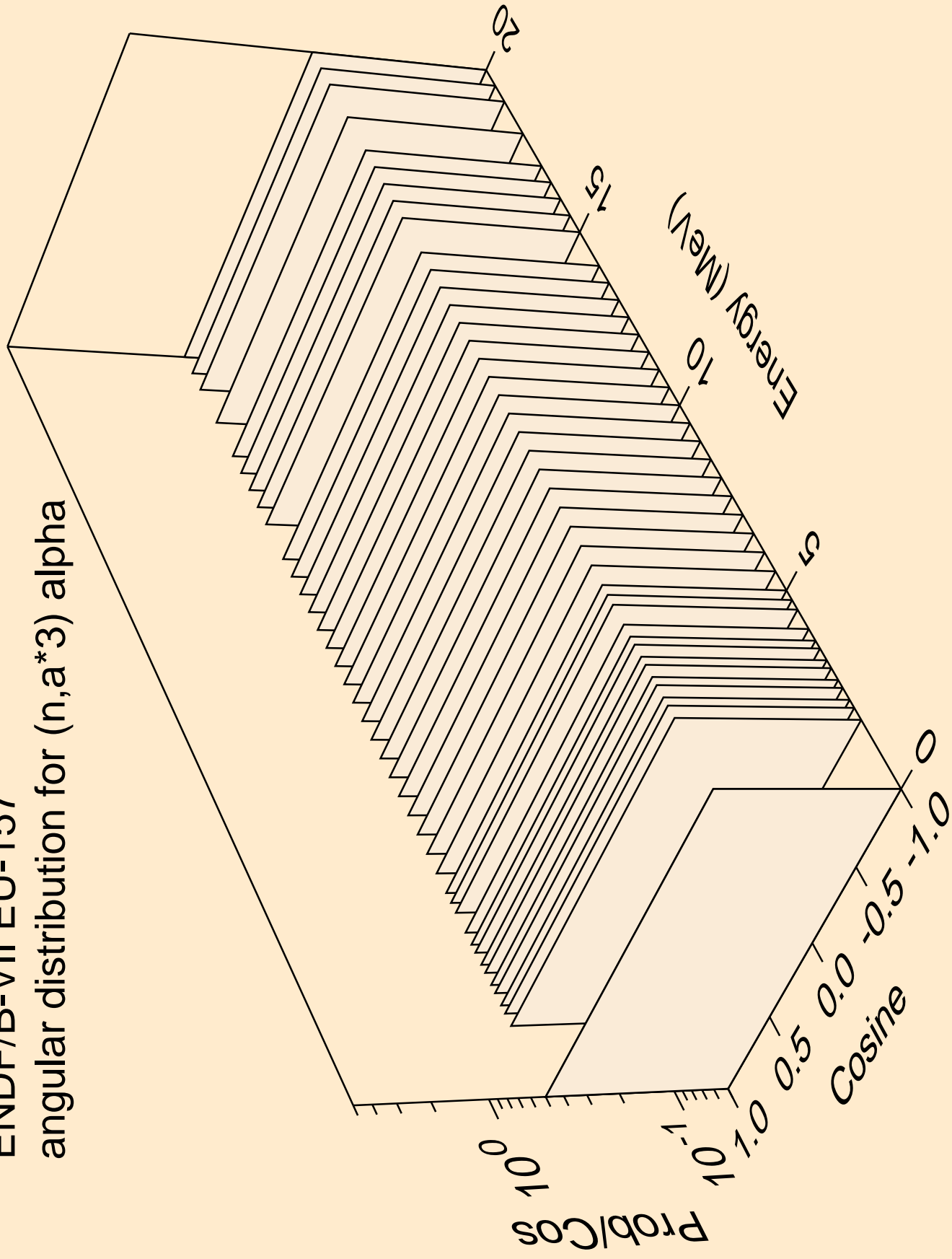

ENDF/B-VII EU-157
angular distribution for (n,a*4) alpha

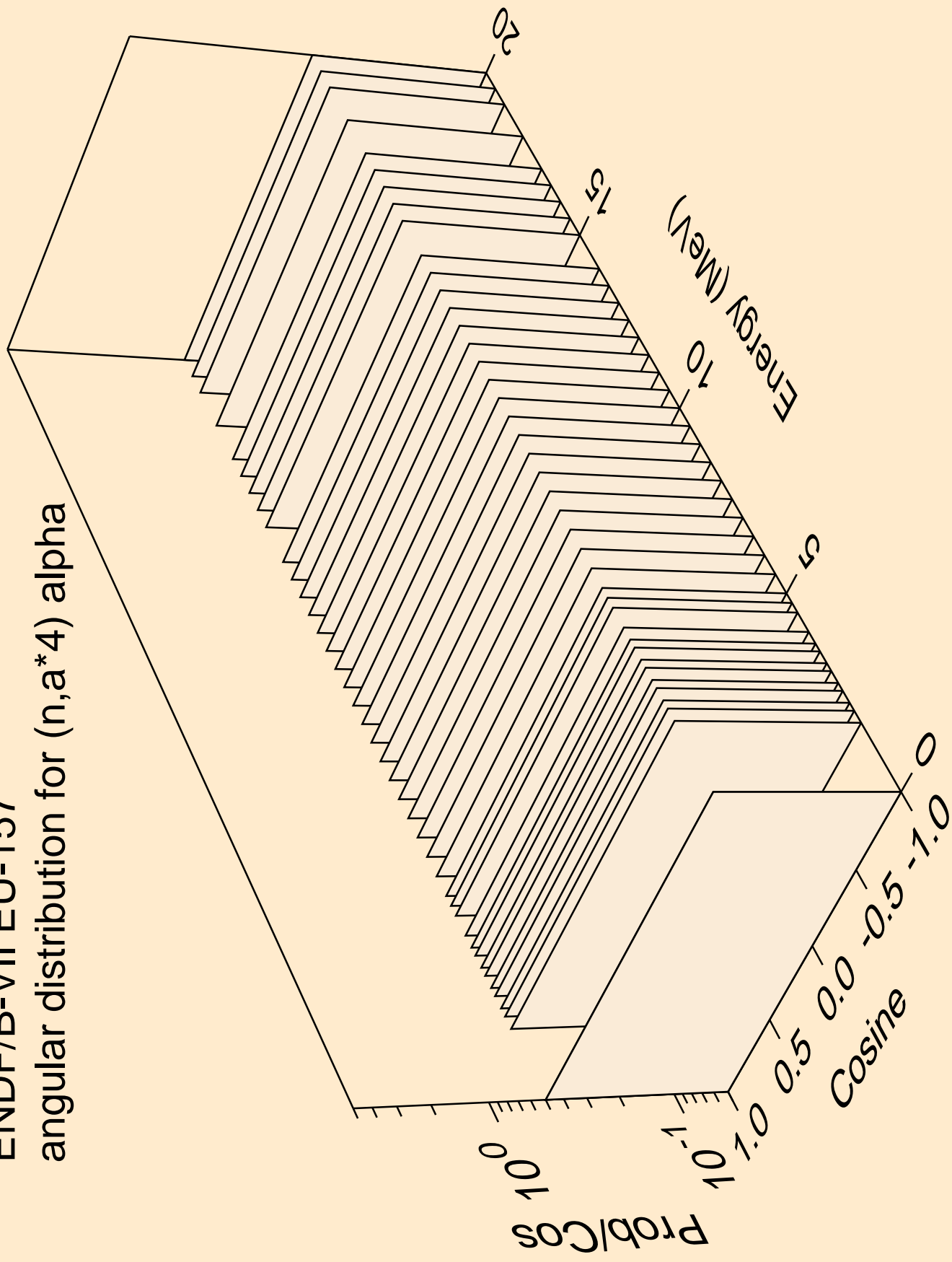

ENDF/B-VII EU-157
angular distribution for (n,a*5) alpha

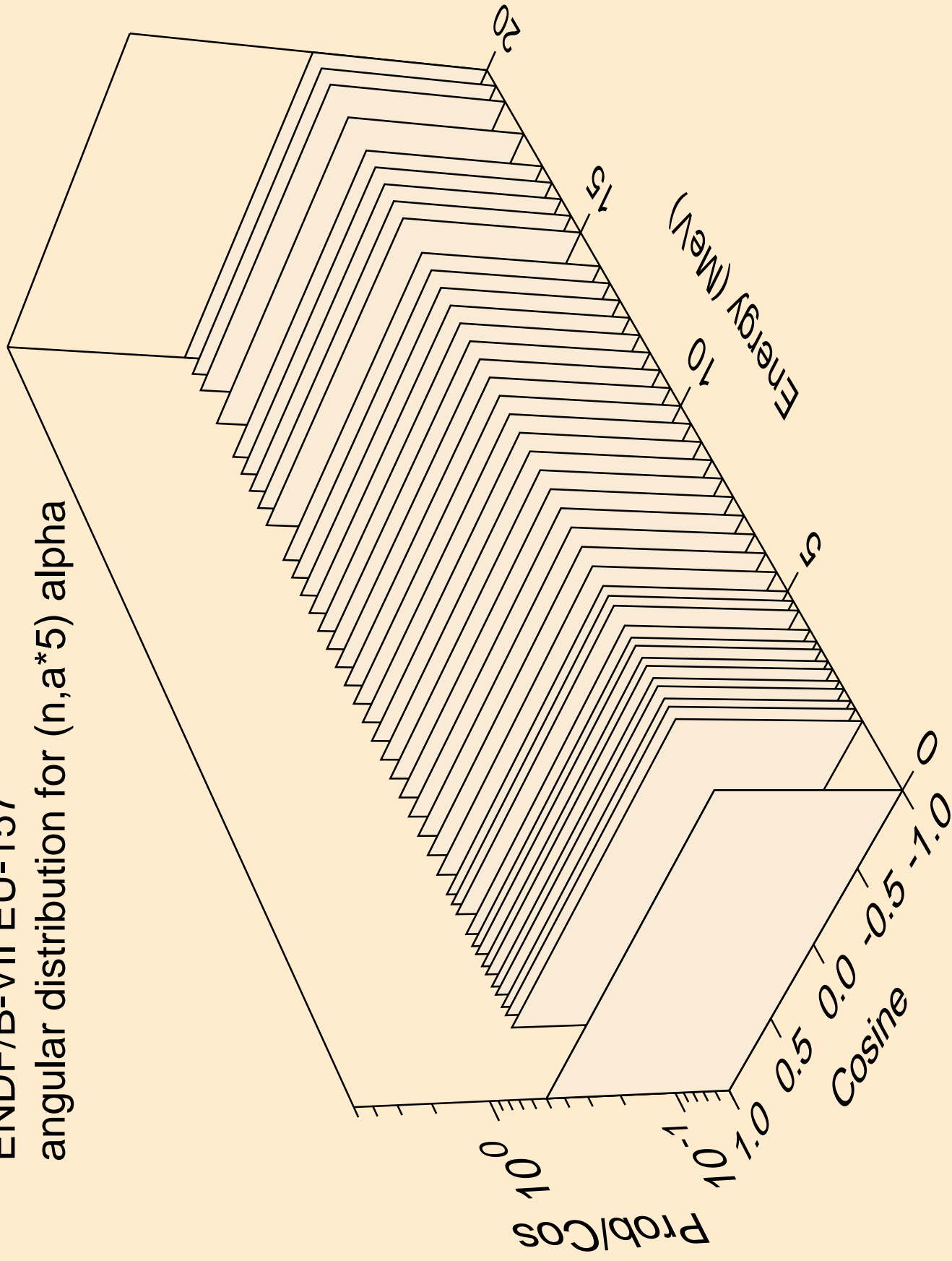

ENDF/B-VII EU-157
angular distribution for (n,a*6) alpha

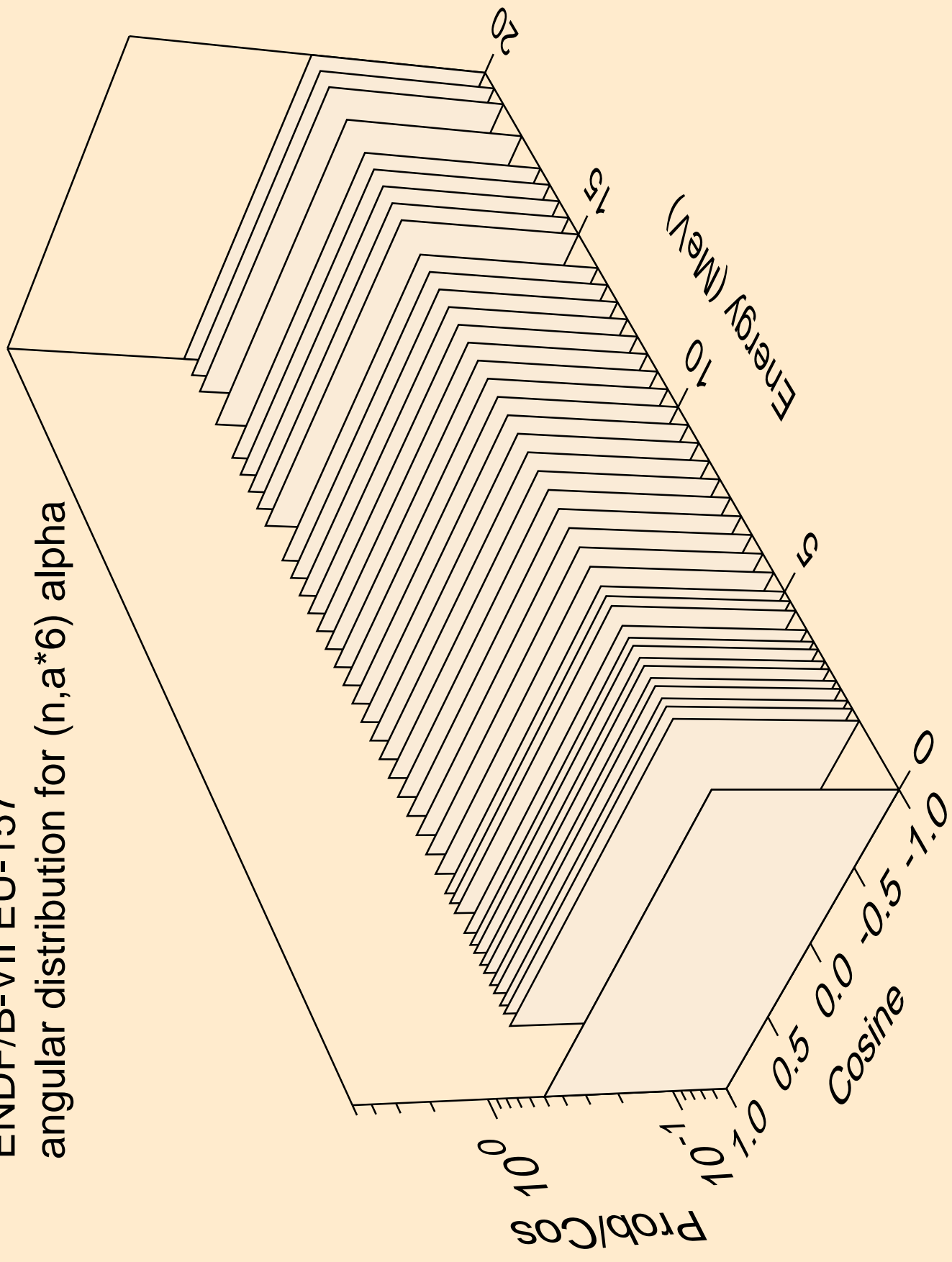

ENDF/B-VII EU-157
angular distribution for (n,a*7) alpha

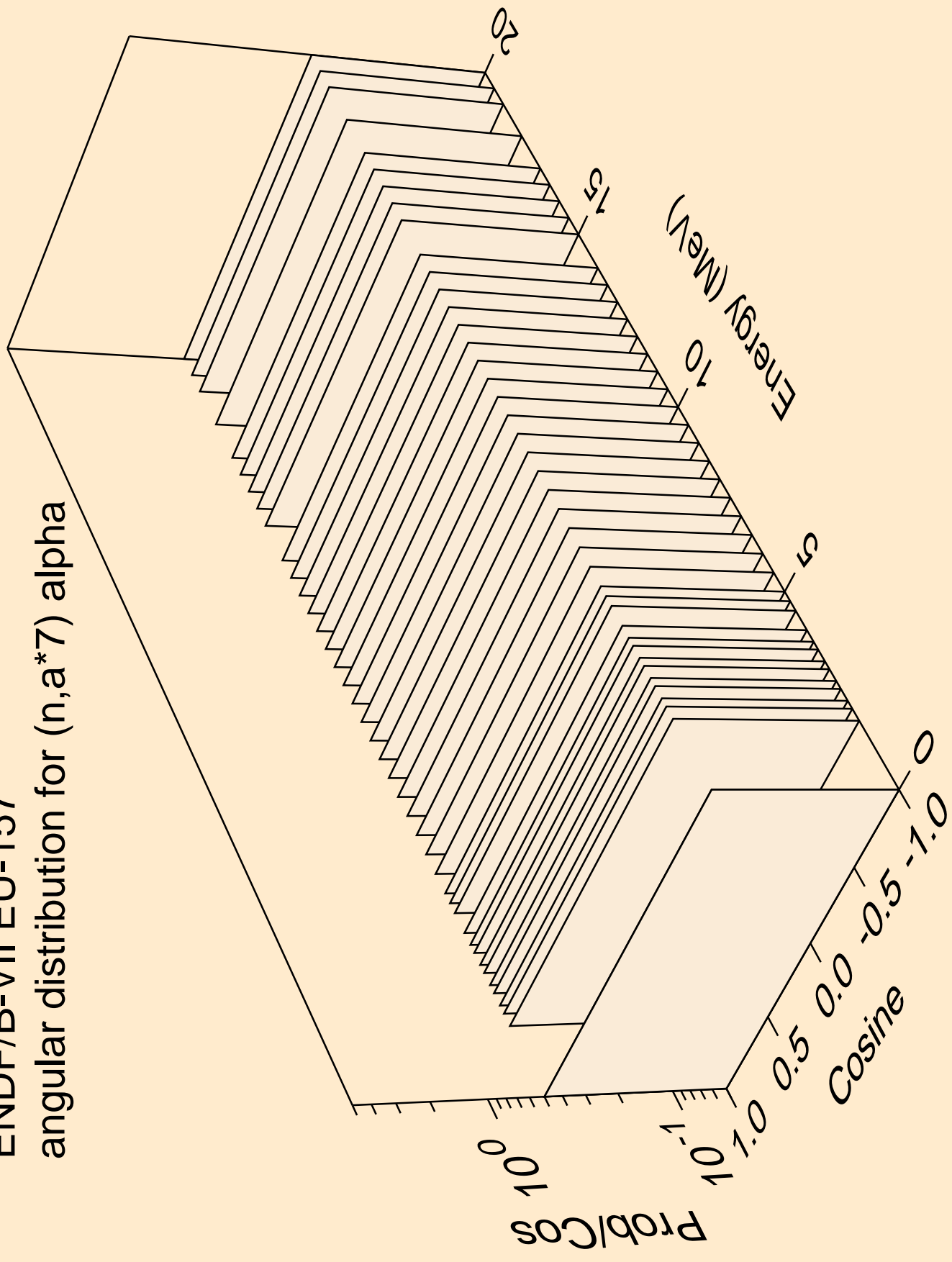

ENDF/B-VII EU-157
angular distribution for (n,a*8) alpha

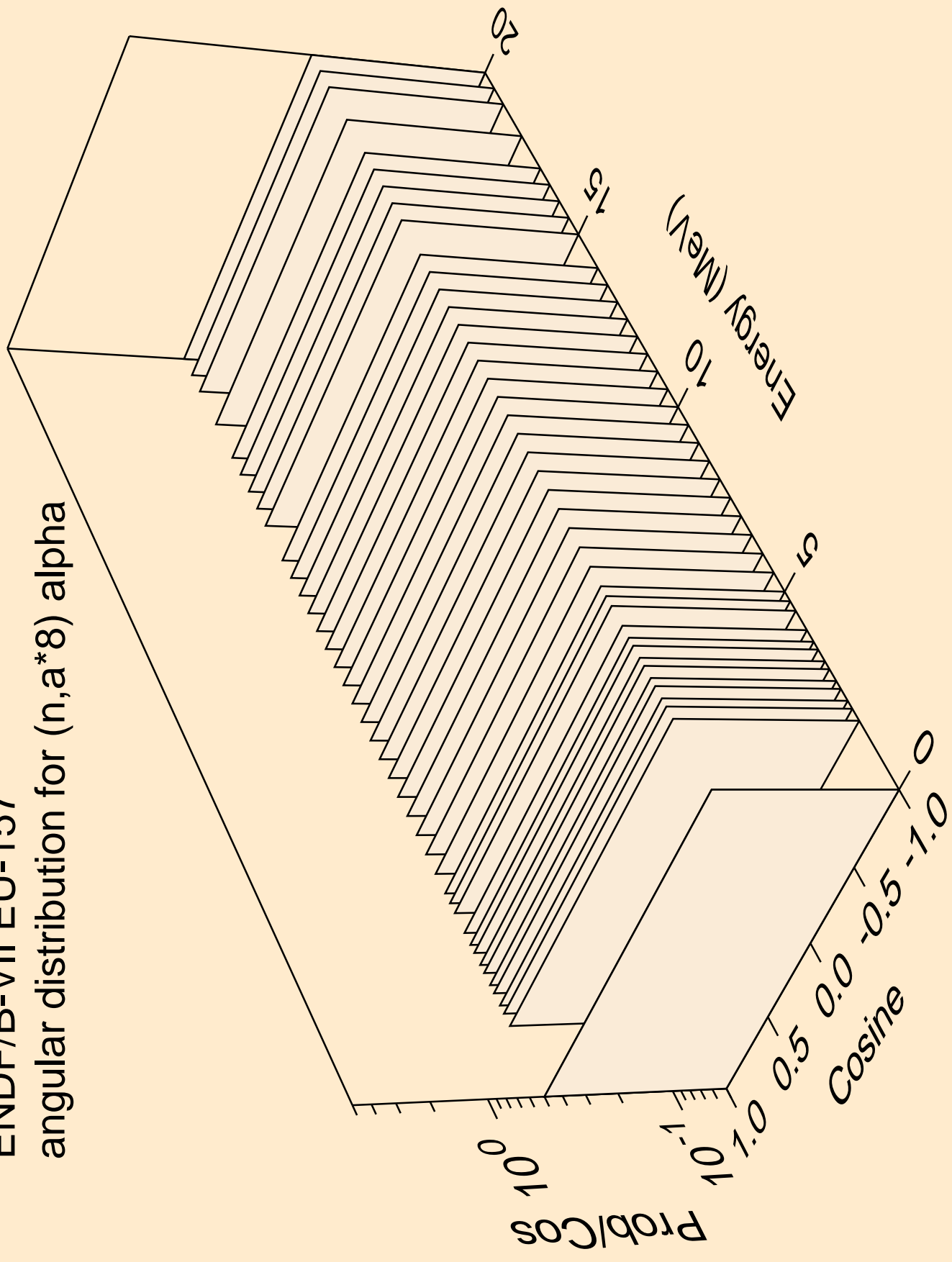

ENDF/B-VII EU-157
angular distribution for (n,a*9) alpha

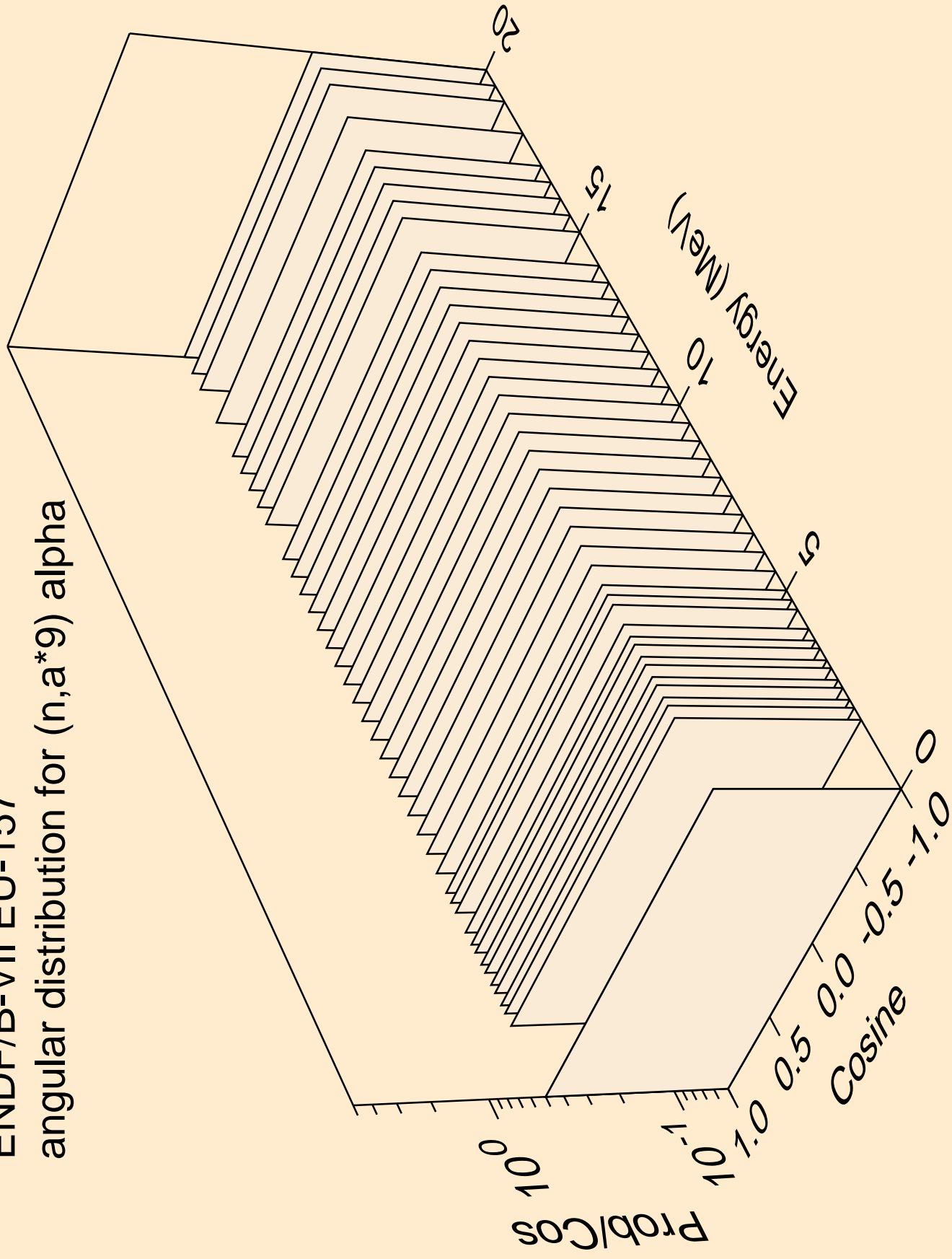

ENDF/B-VII EU-157
angular distribution for (n,a*10) alpha

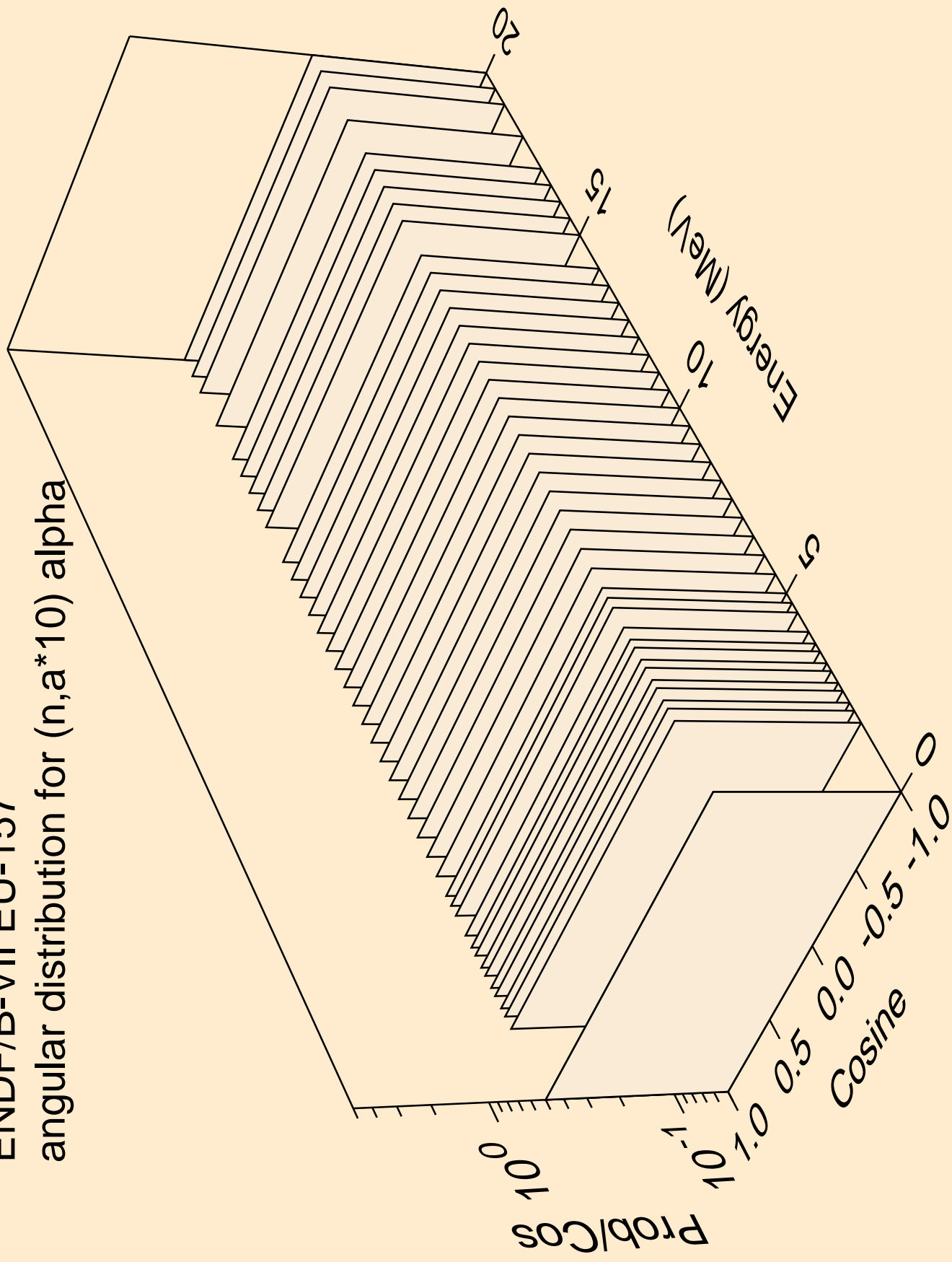

ENDF/B-VII EU-157
angular distribution for (n,a*11) alpha

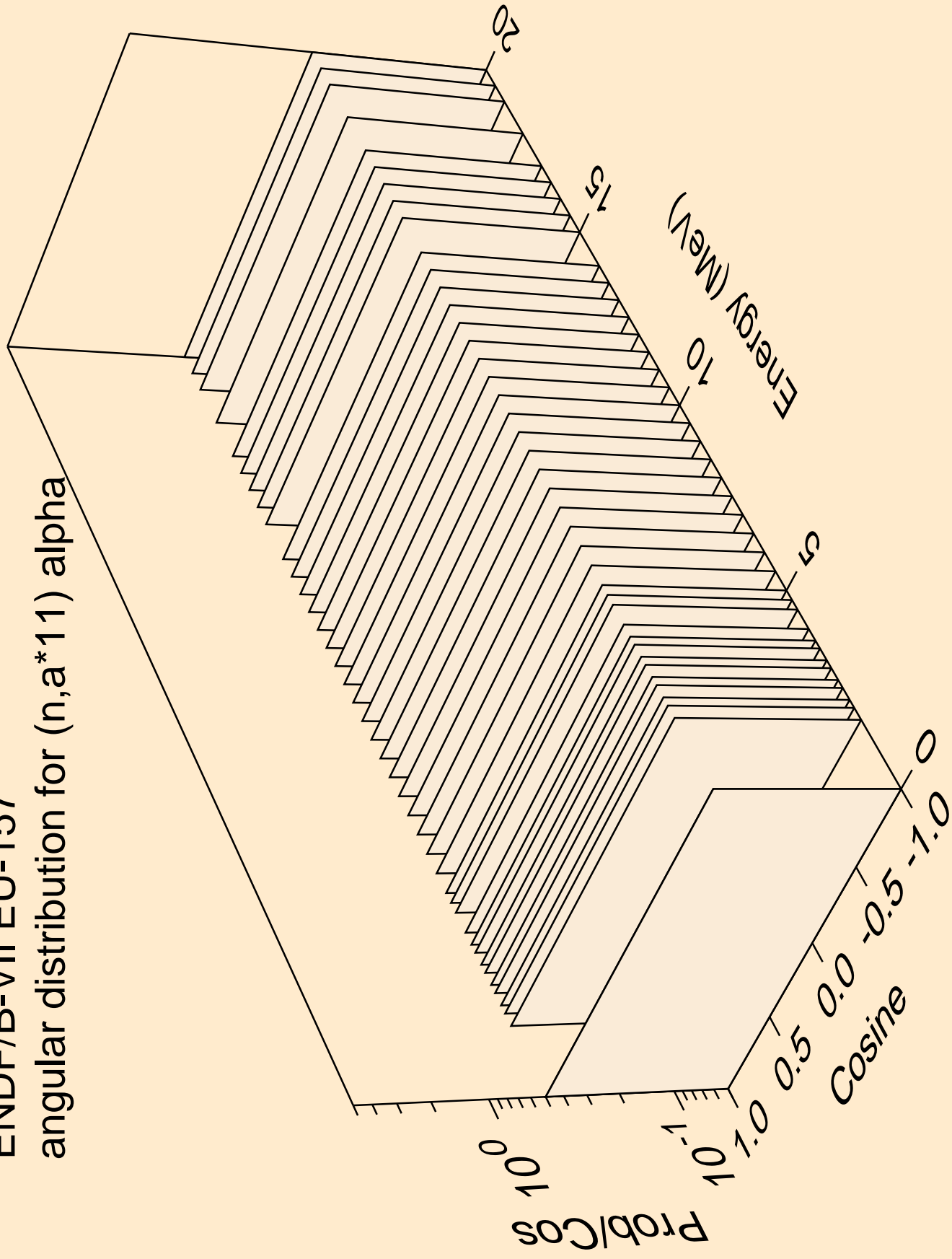

ENDF/B-VII EU-157
angular distribution for (n,a*12) alpha

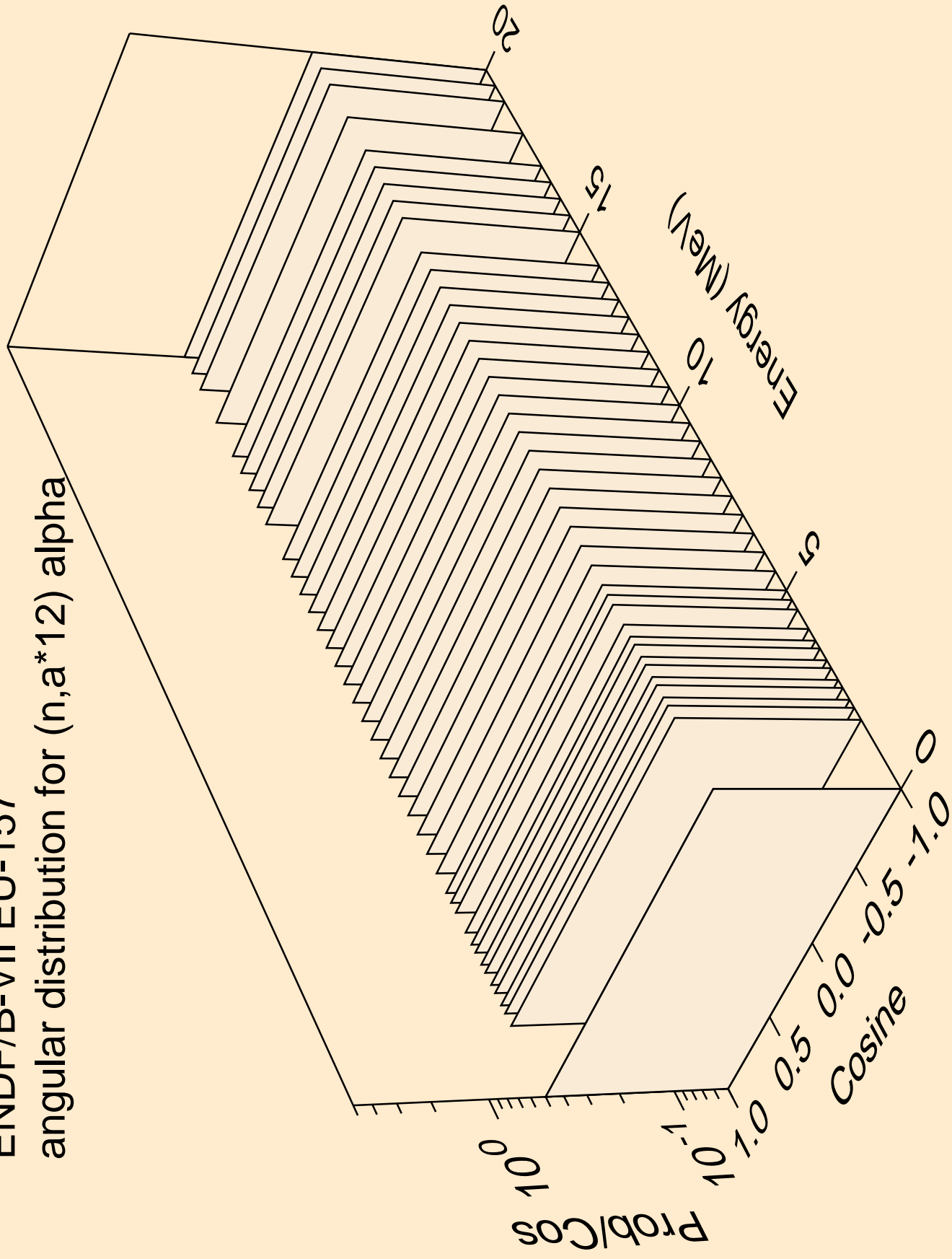

ENDF/B-VII EU-157
angular distribution for (n,a*13) alpha

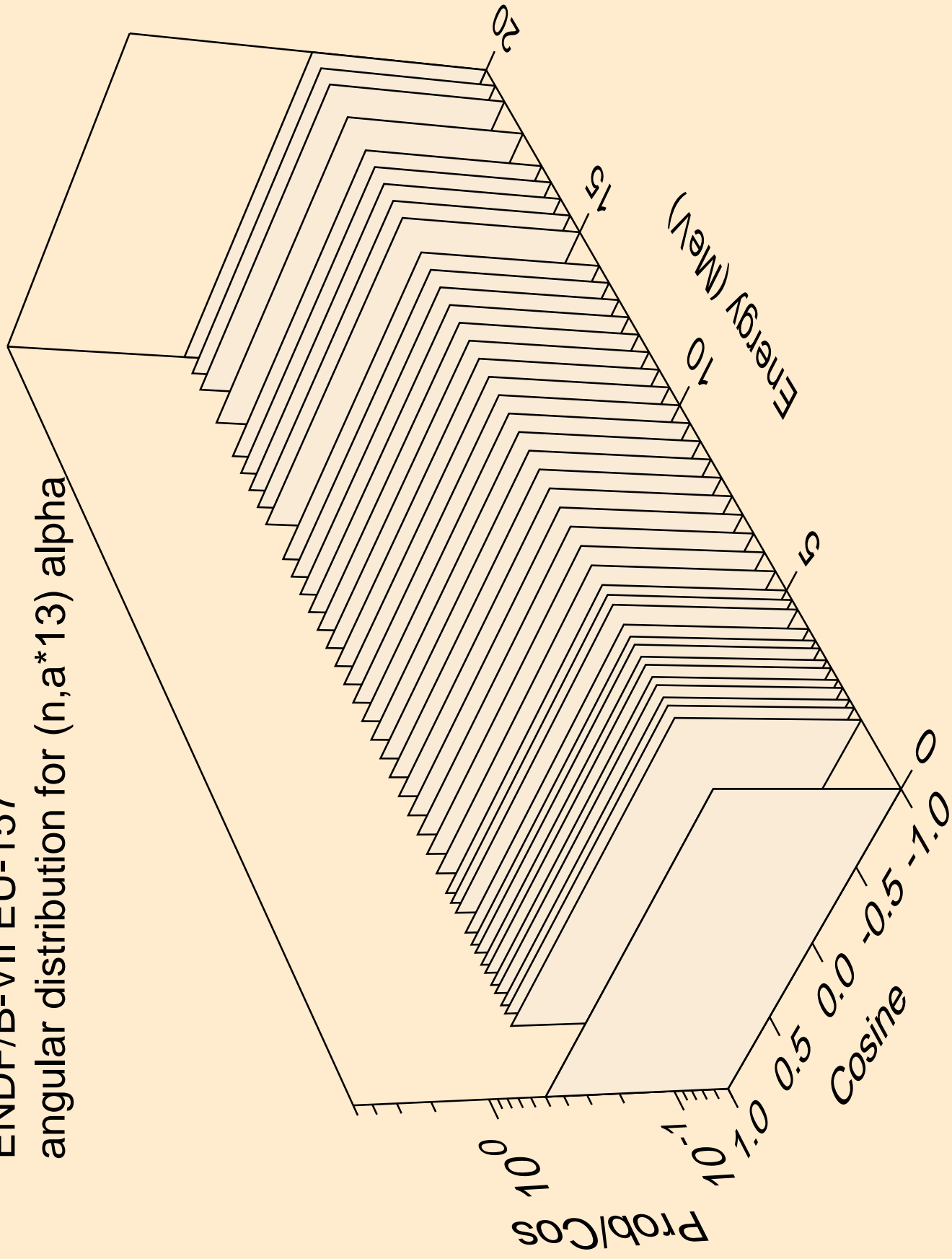

ENDF/B-VII EU-157
alphas from (n,a*c)

