

ENDF/B-VII I-127

Principal cross sections

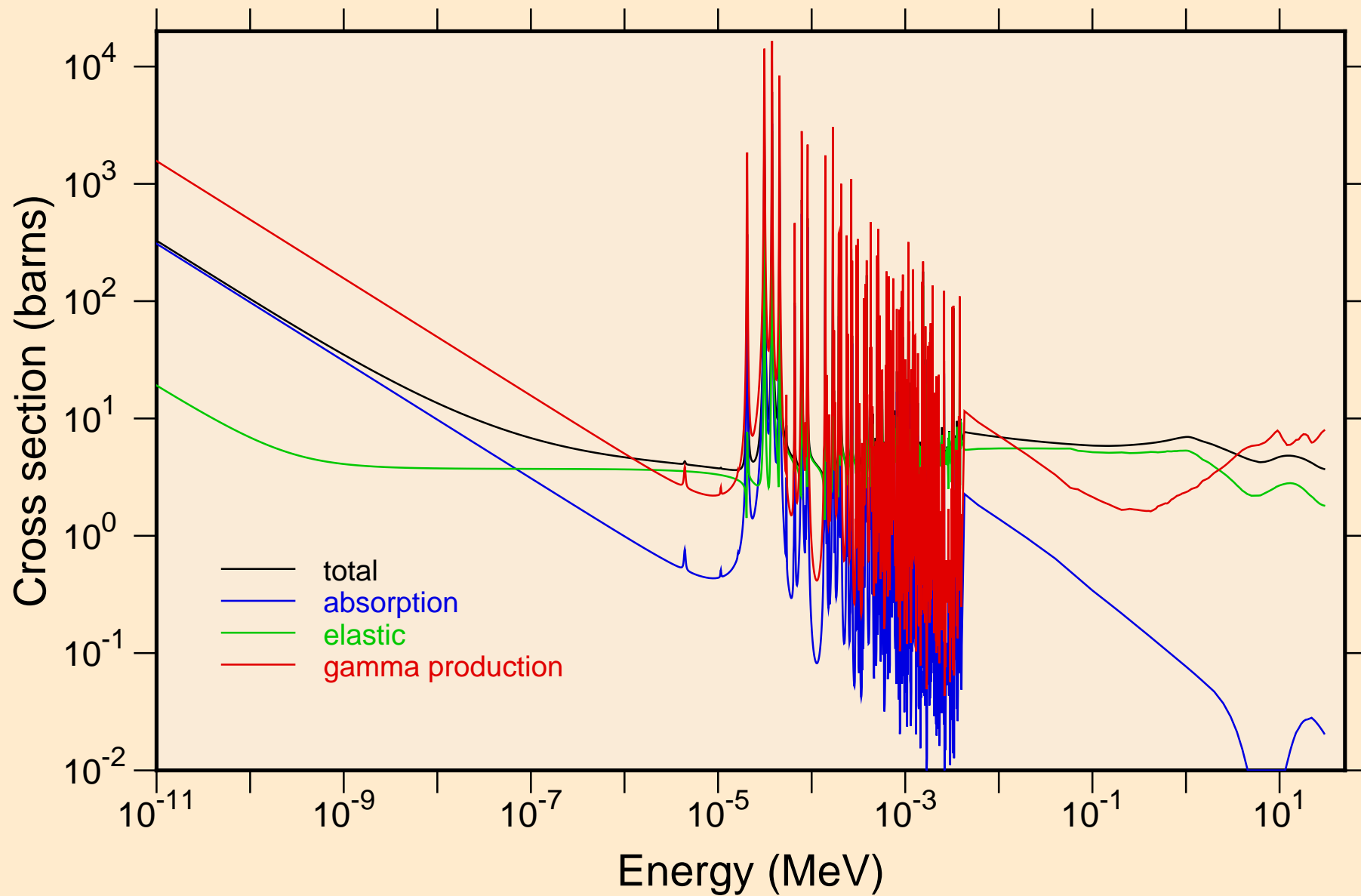

ENDF/B-VII I-127
resonance total cross section

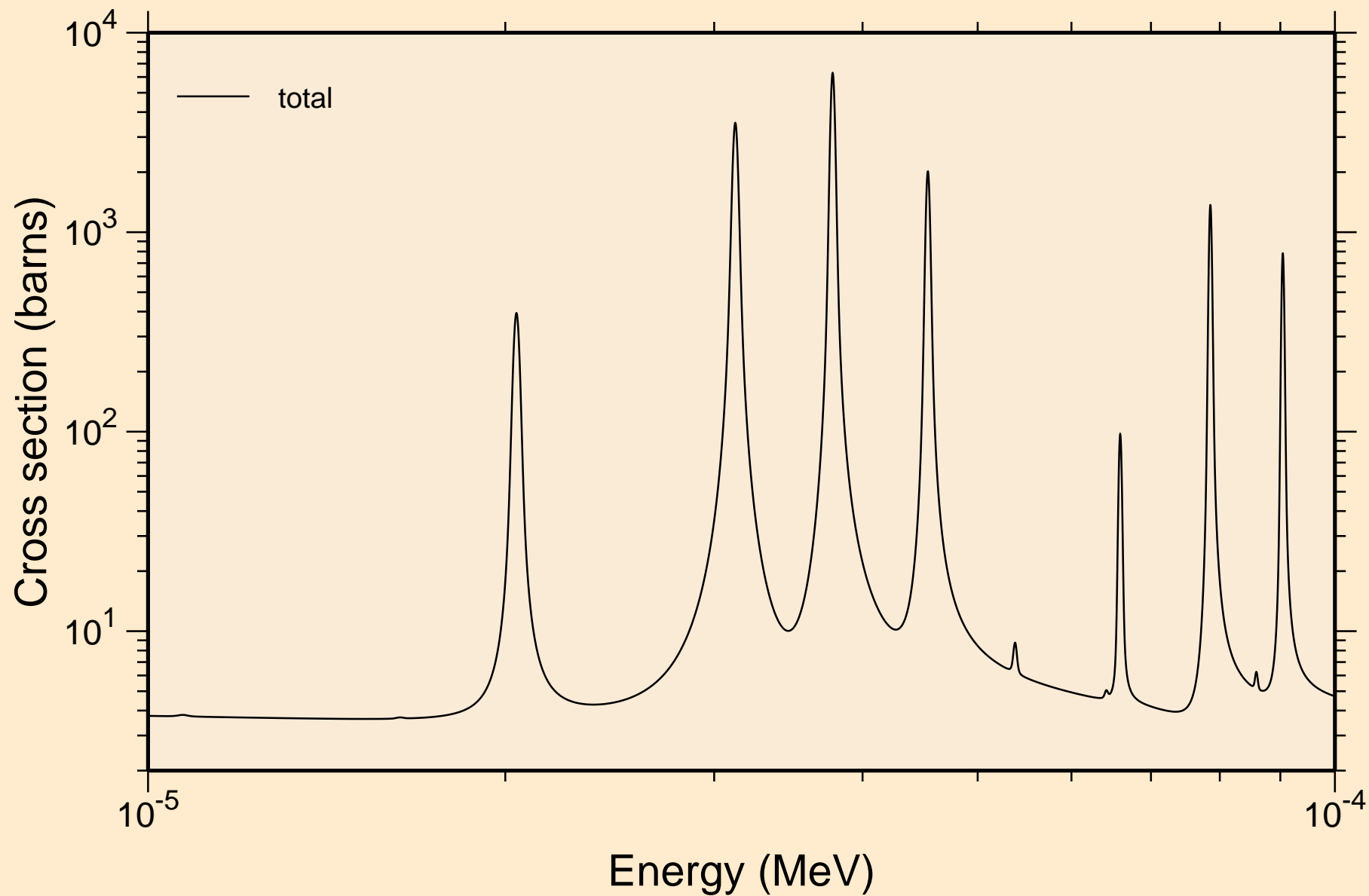

ENDF/B-VII I-127
resonance total cross section

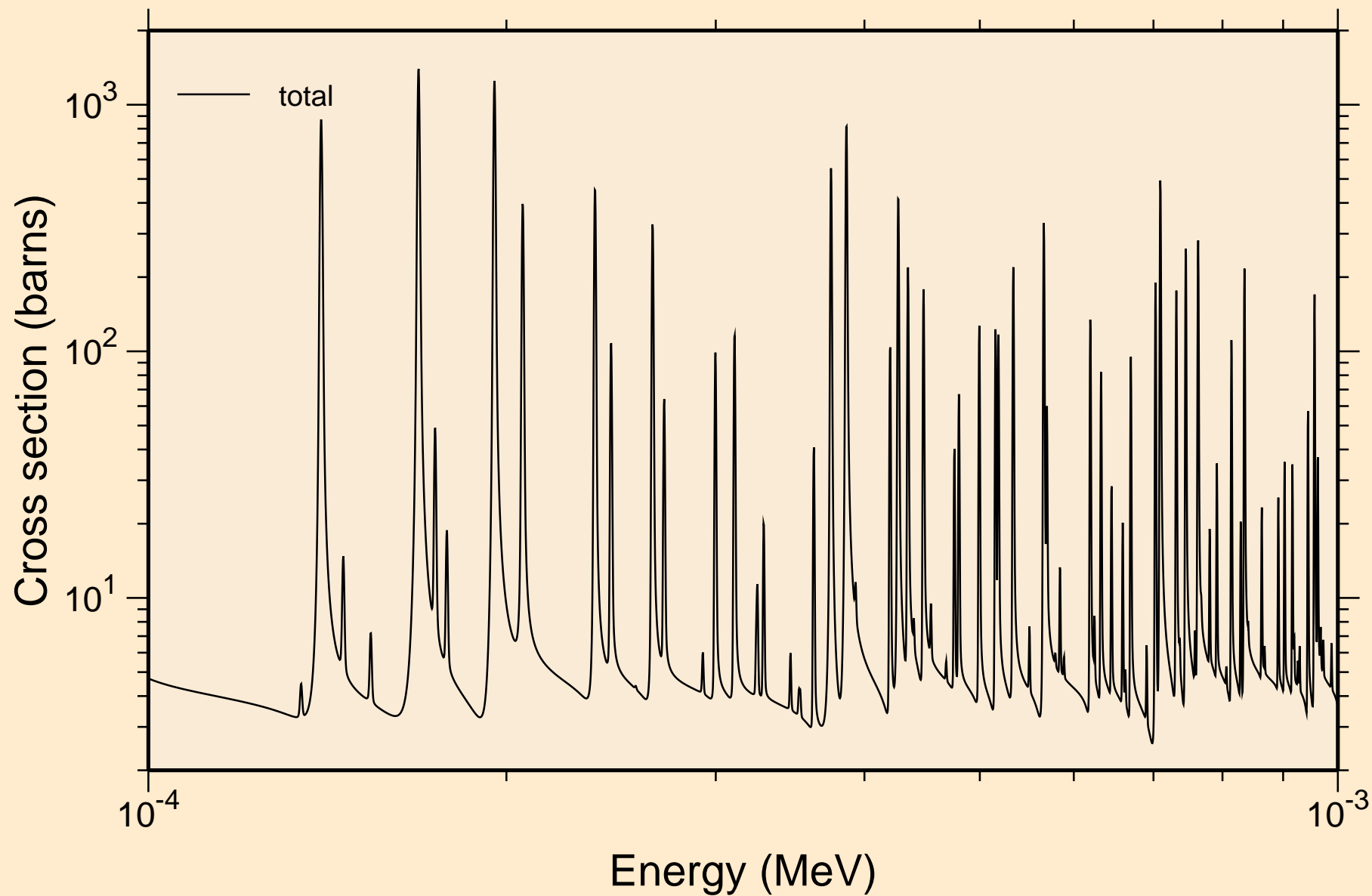

ENDF/B-VII I-127
resonance total cross section

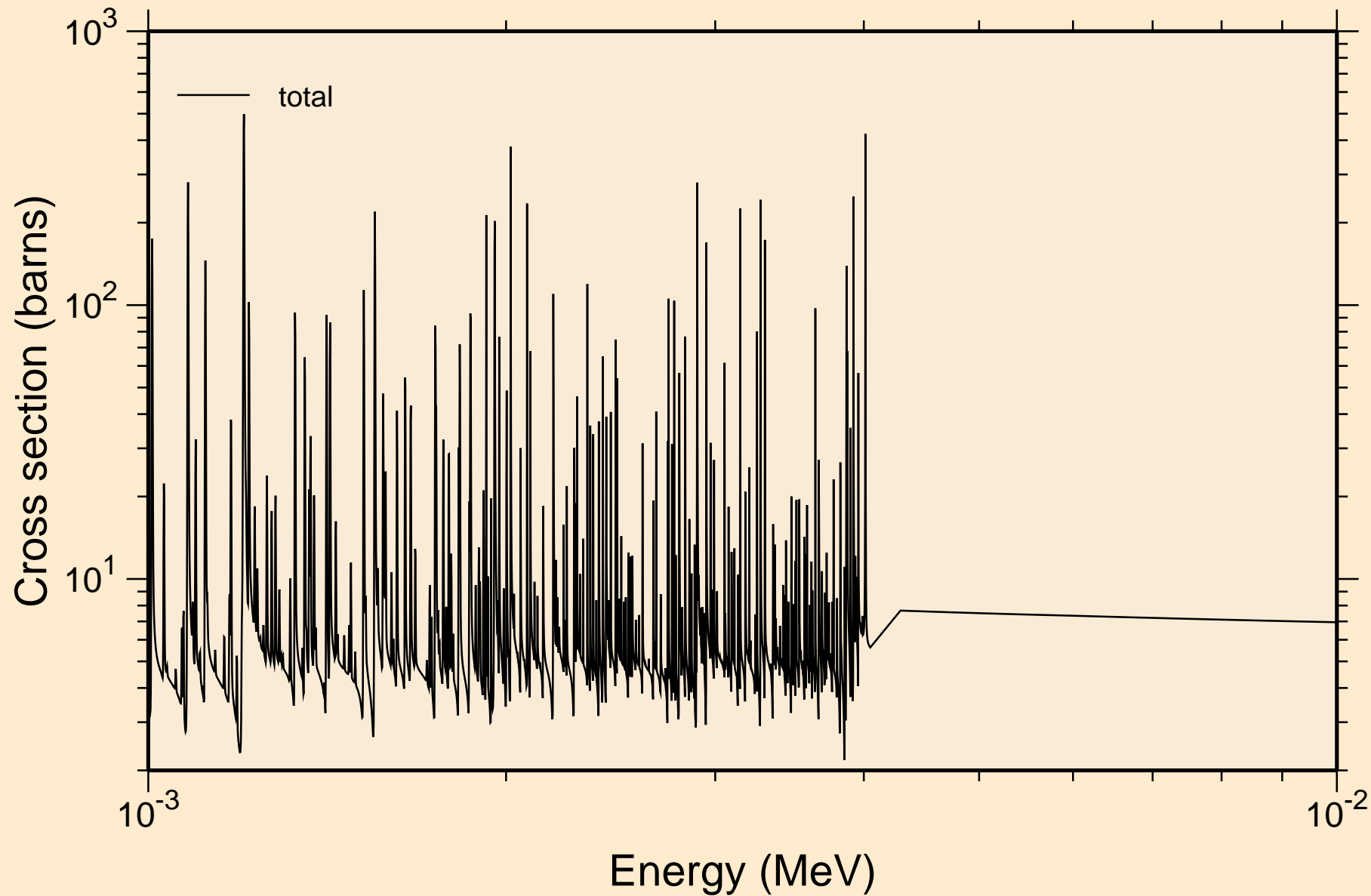

ENDF/B-VII I-127

resonance absorption cross sections

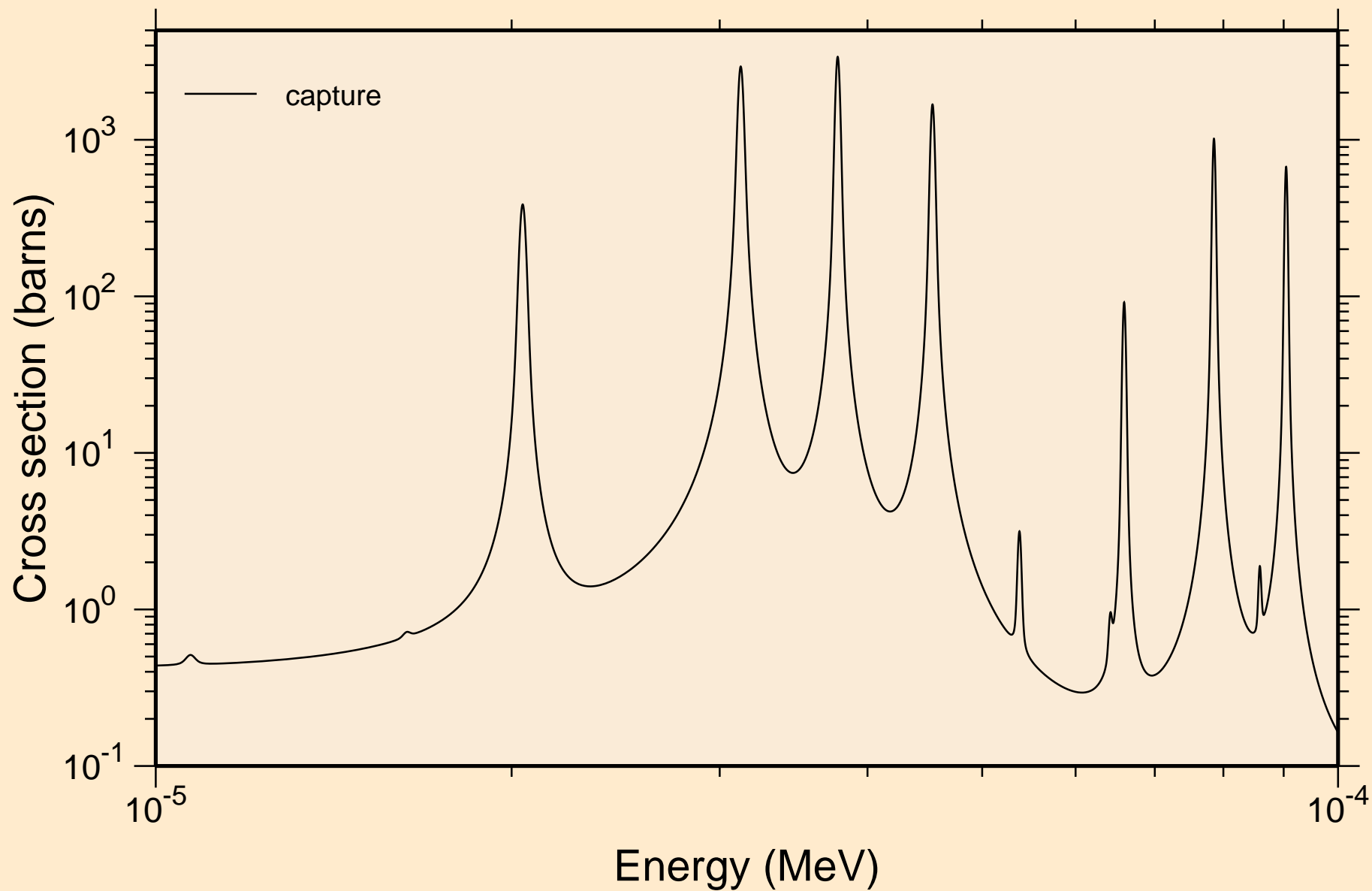

ENDF/B-VII I-127

resonance absorption cross sections

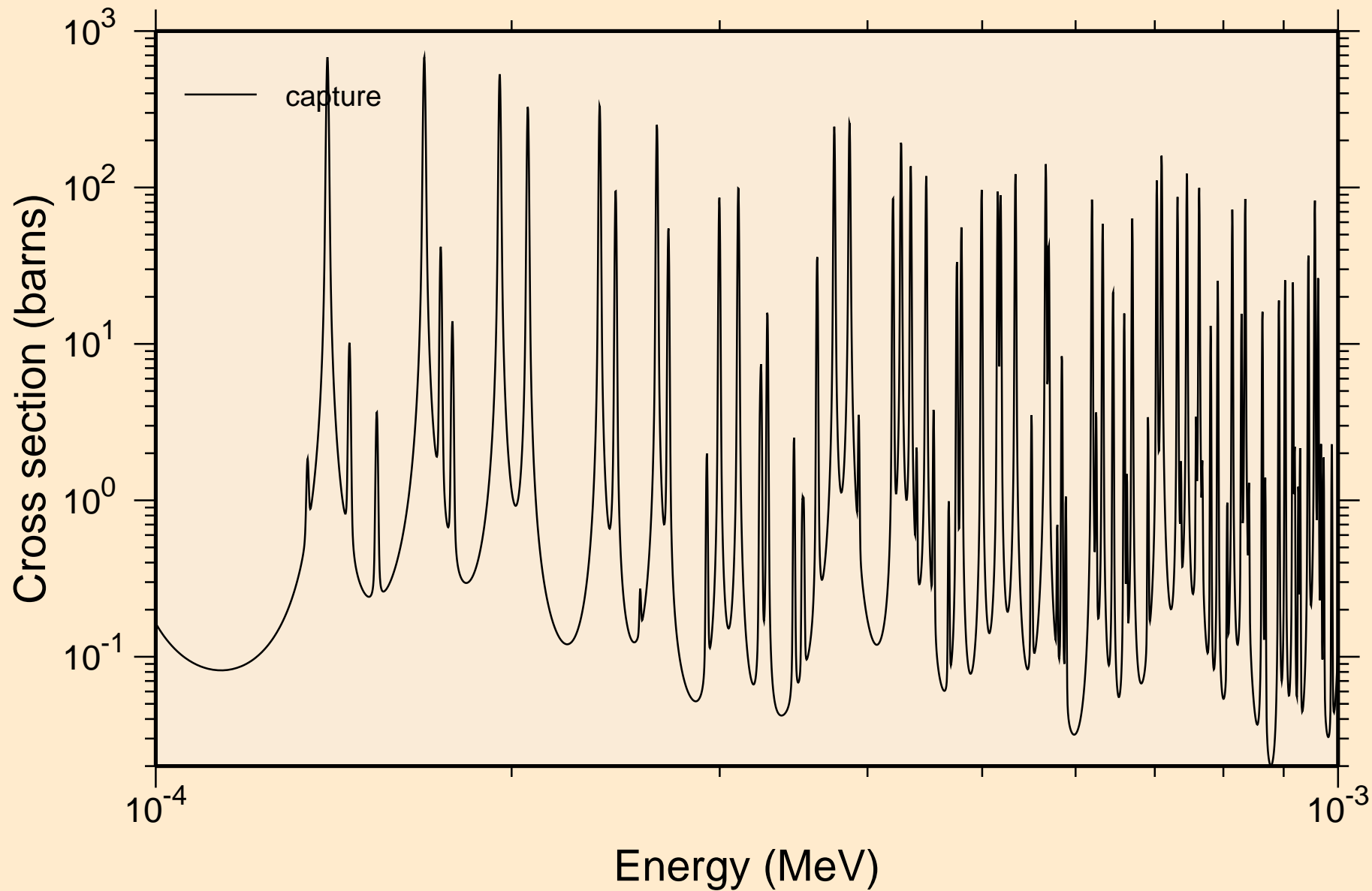

ENDF/B-VII I-127

resonance absorption cross sections

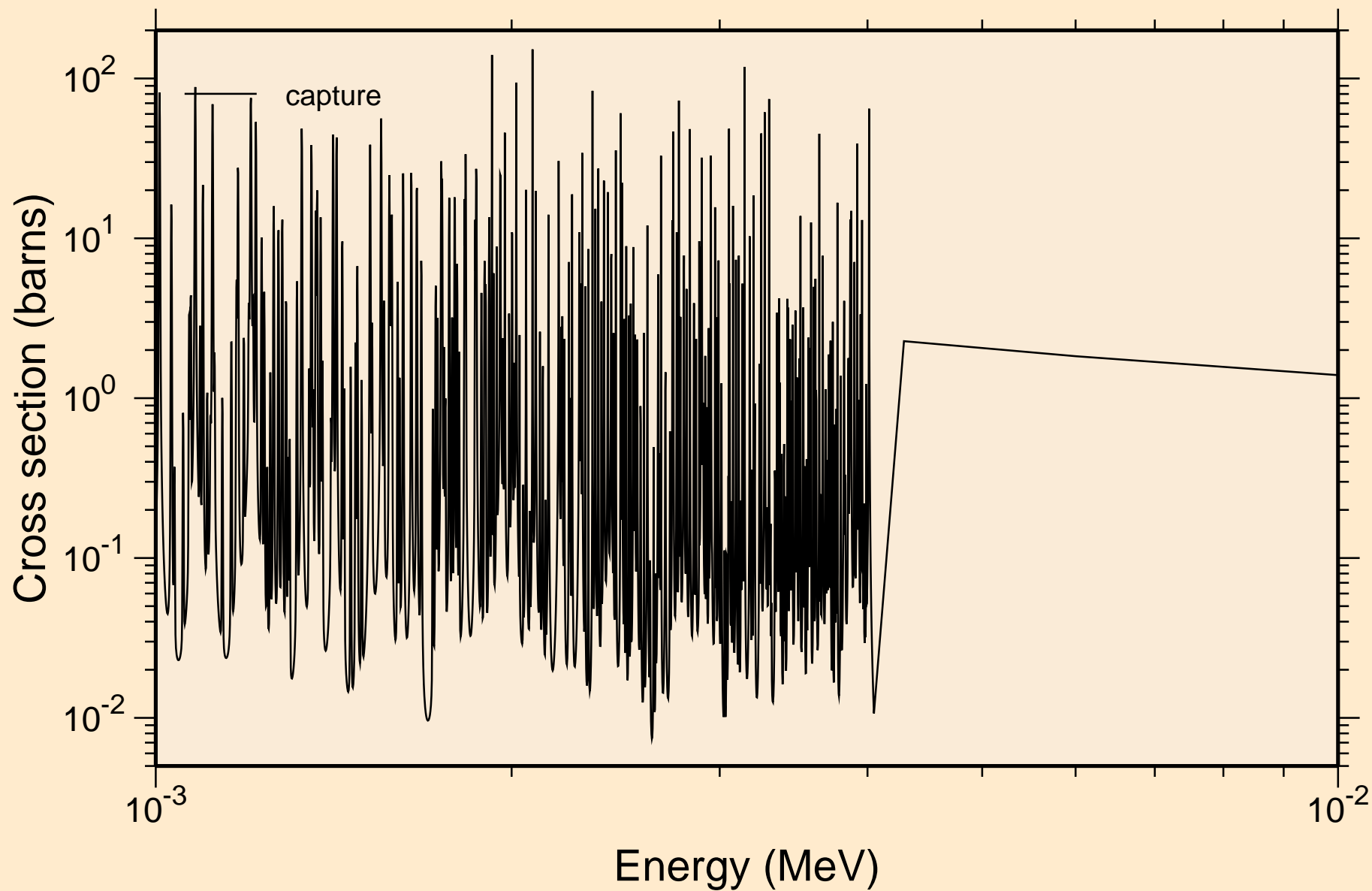

ENDF/B-VII I-127
resonance absorption cross sections

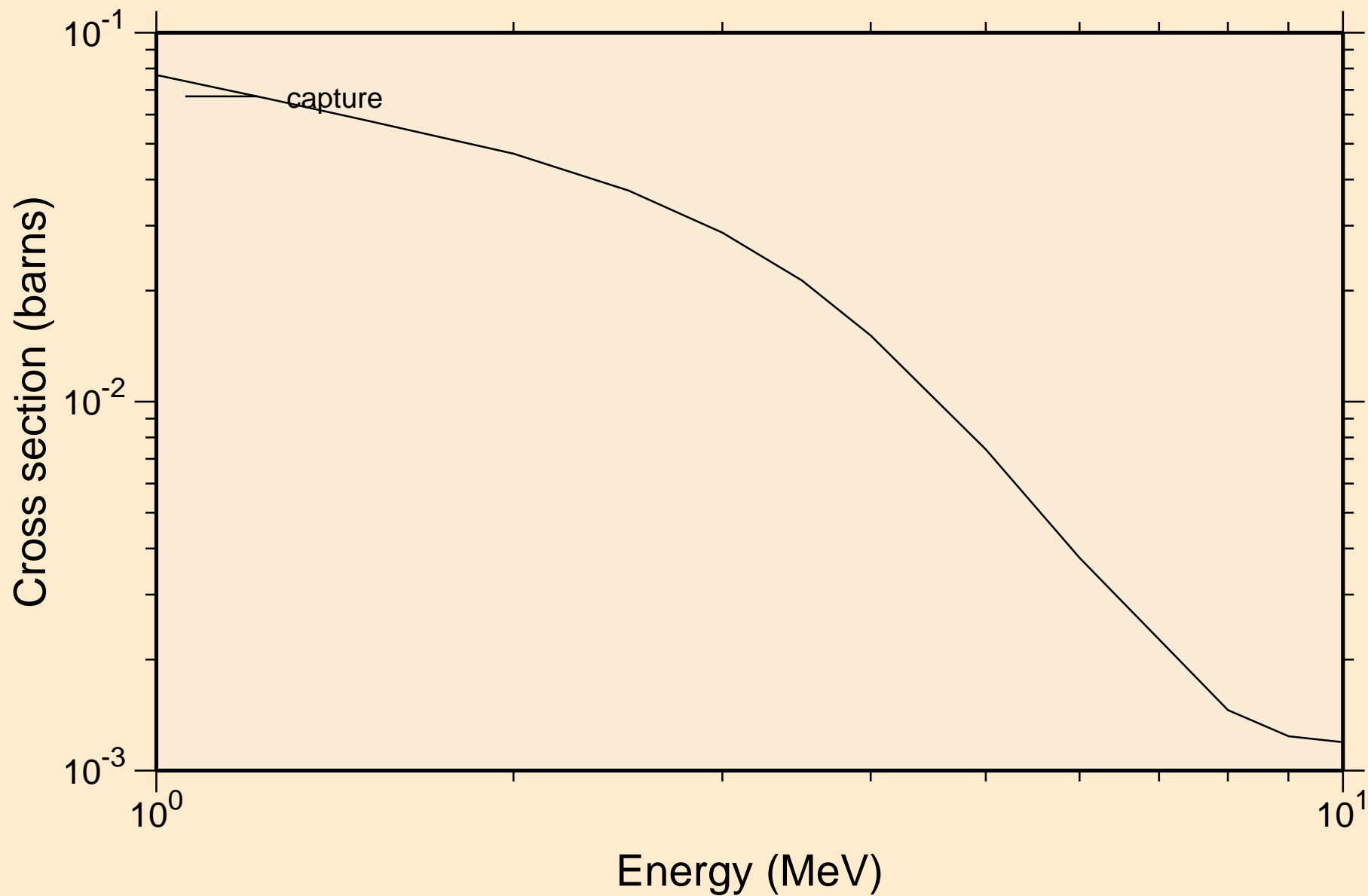

ENDF/B-VII I-127

Heating

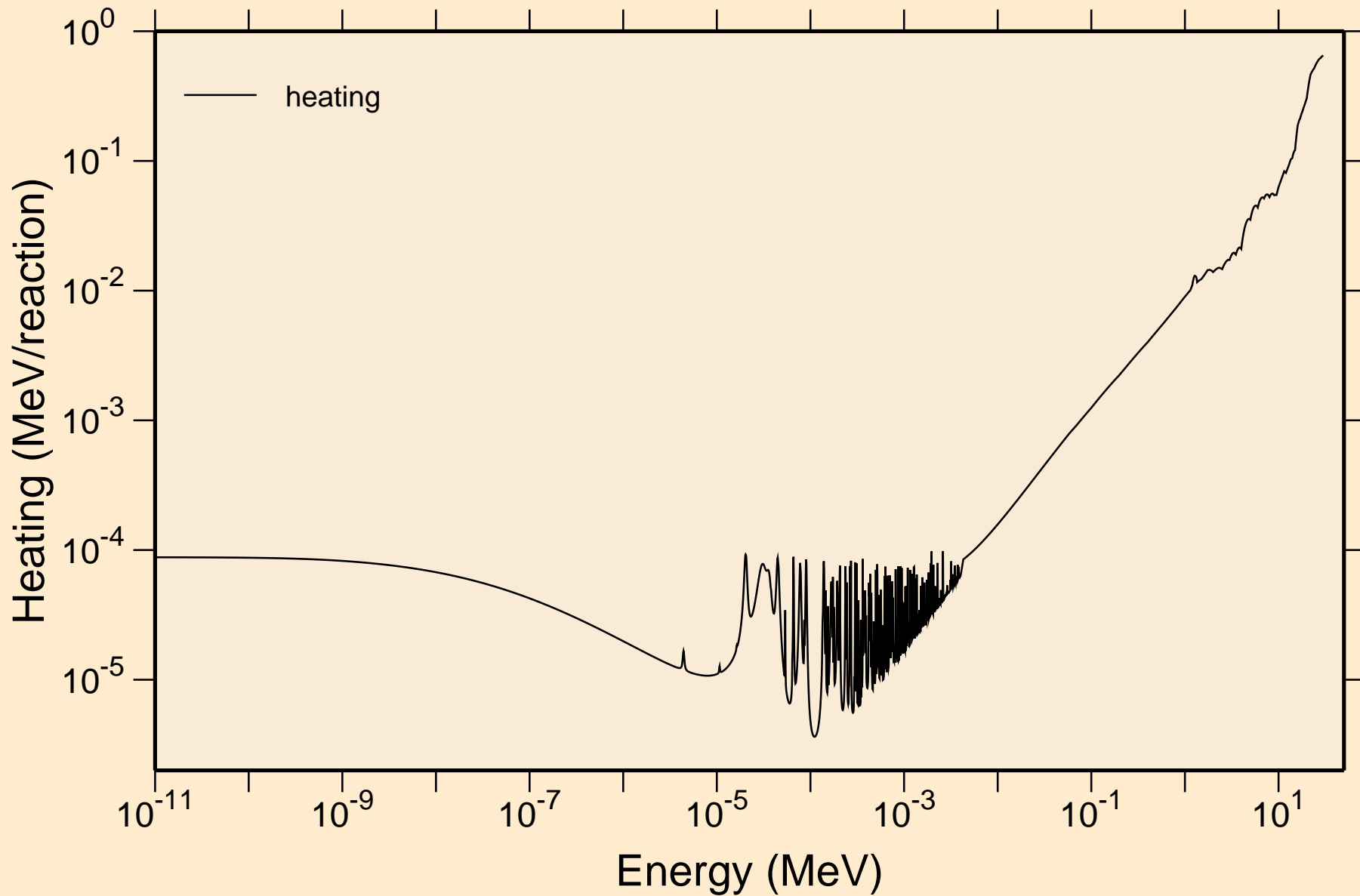

ENDF/B-VII I-127

Damage

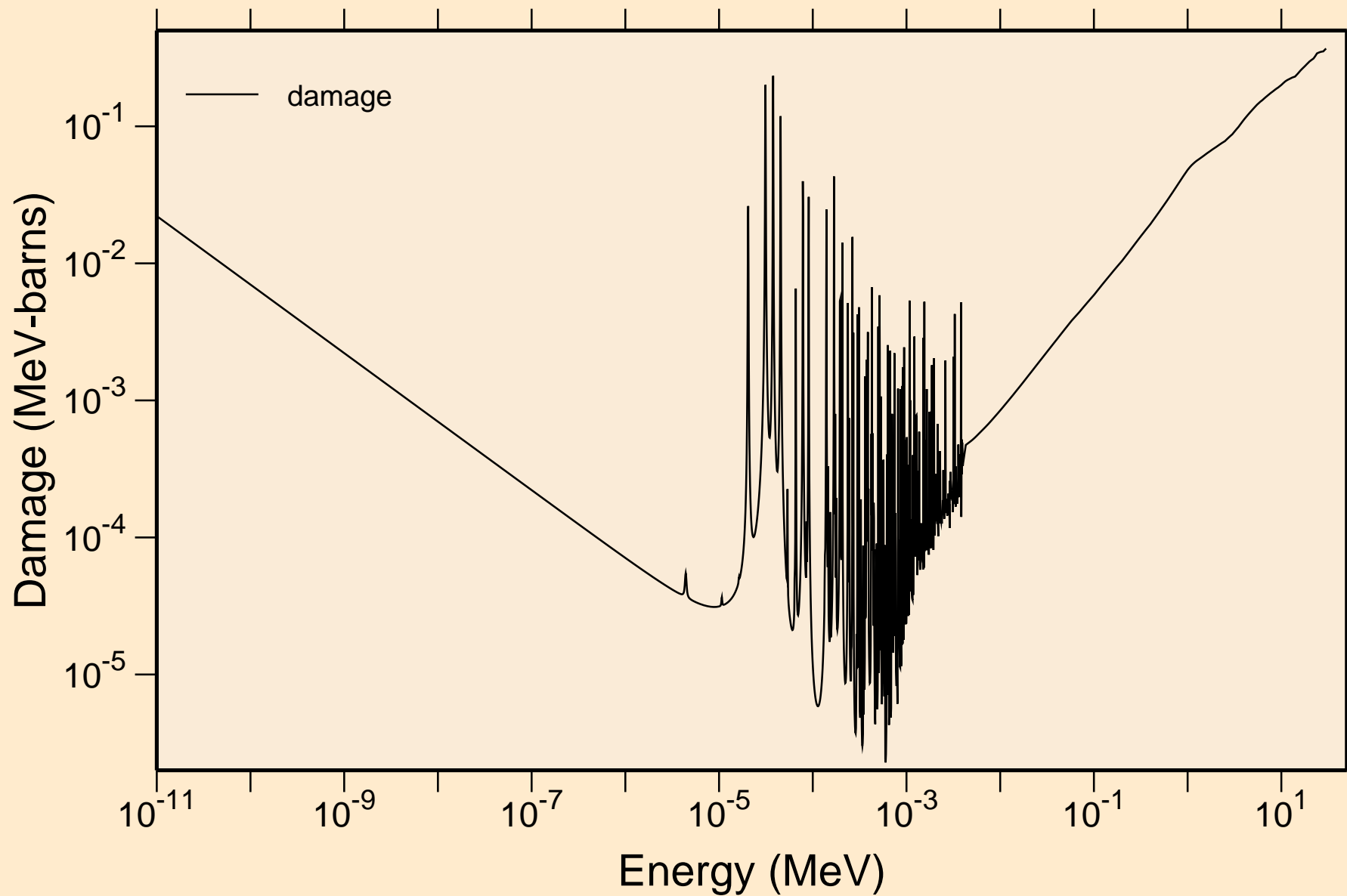

ENDF/B-VII I-127

Non-threshold reactions

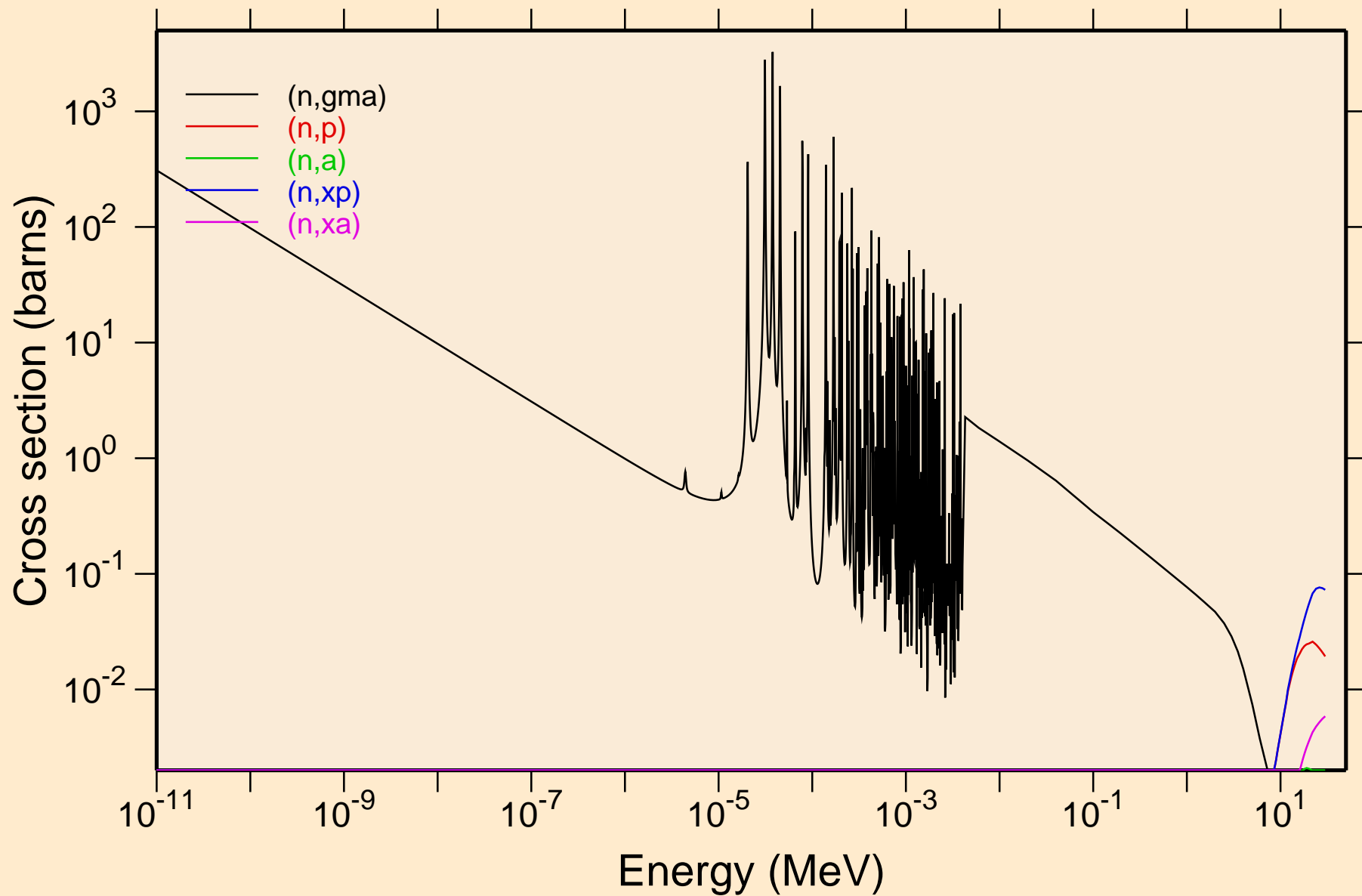

ENDF/B-VII I-127

Principal cross sections

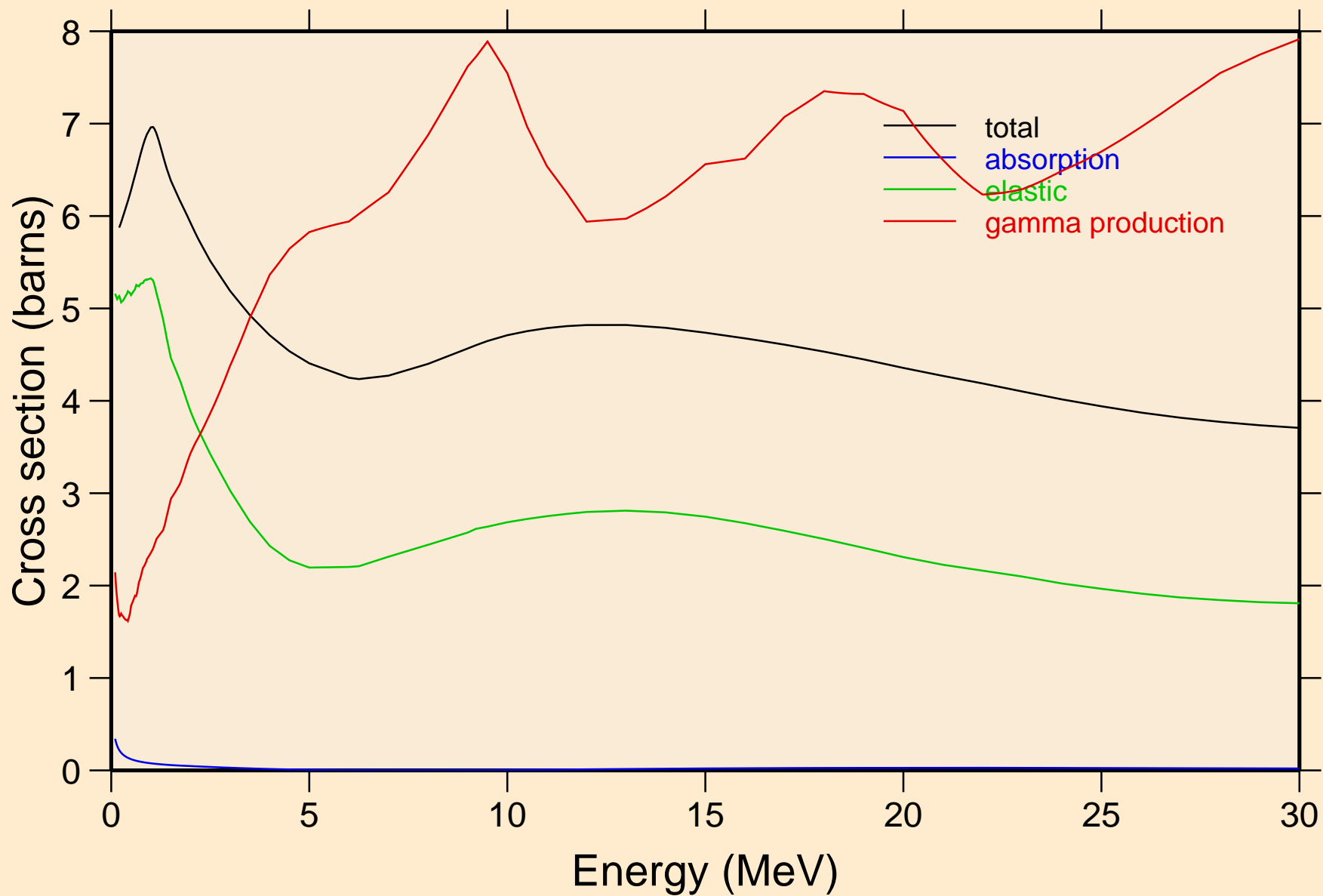

ENDF/B-VII I-127

Heating

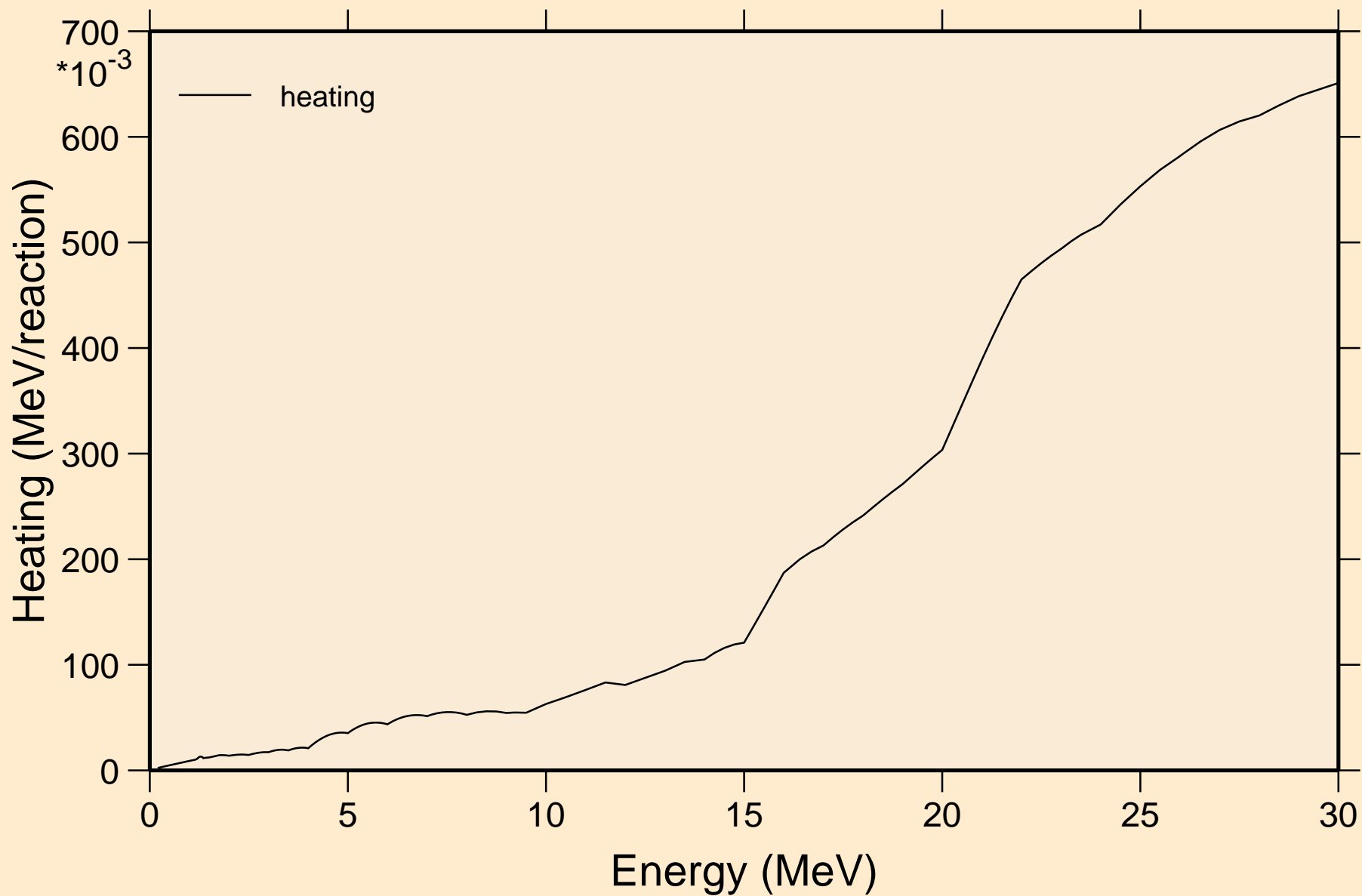

ENDF/B-VII I-127

Damage

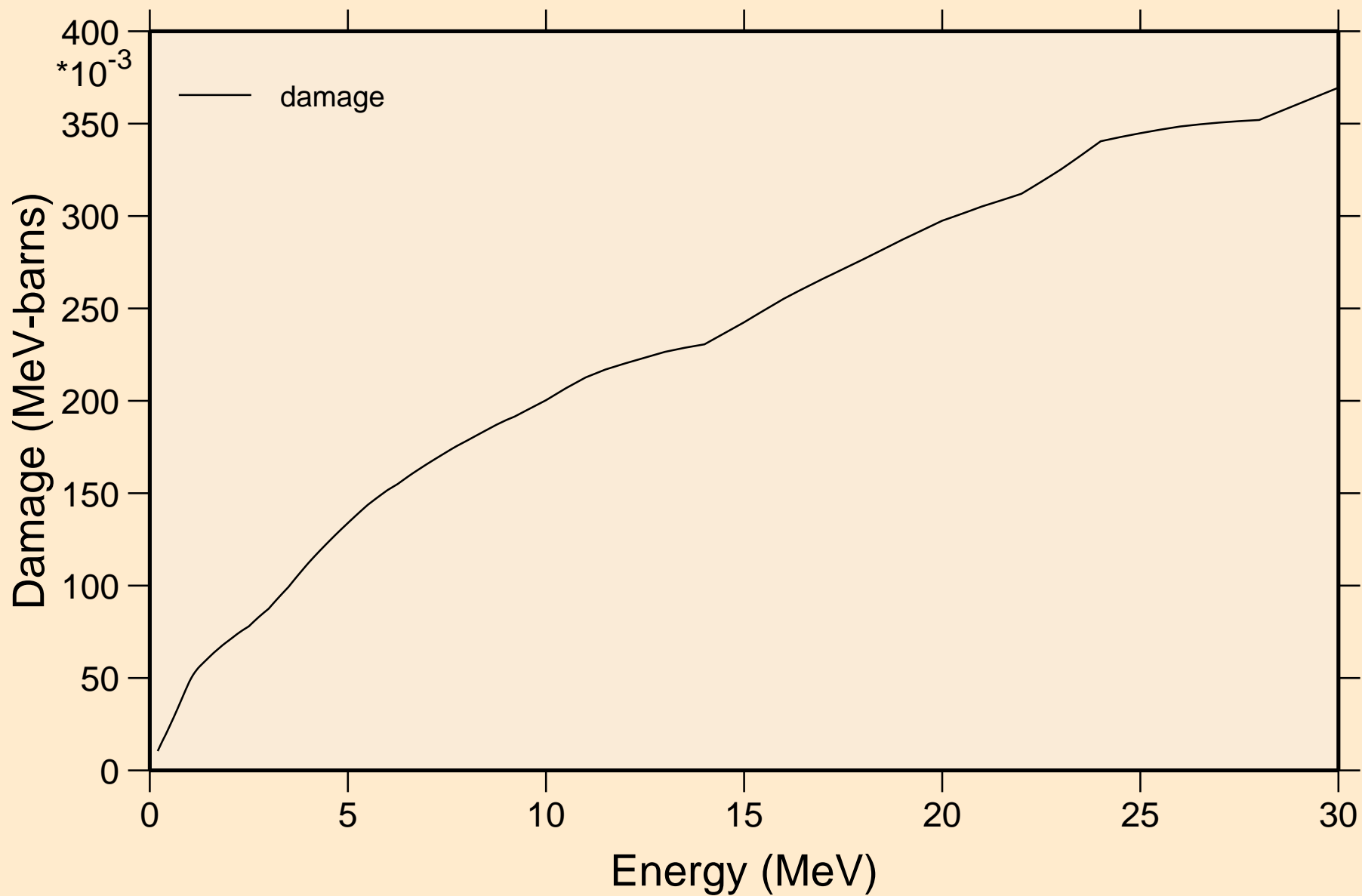

ENDF/B-VII I-127

Non-threshold reactions

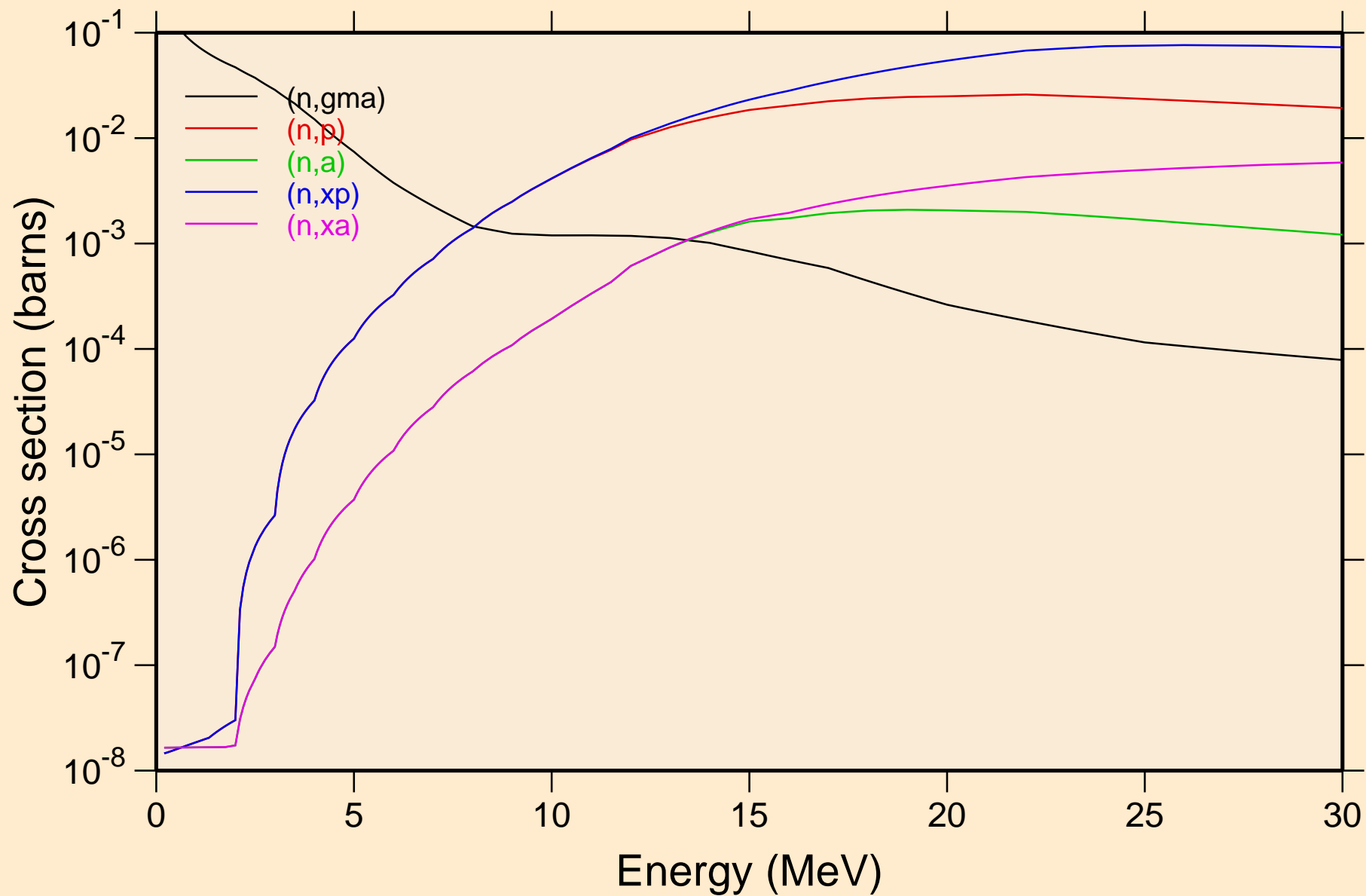

ENDF/B-VII I-127

Inelastic levels

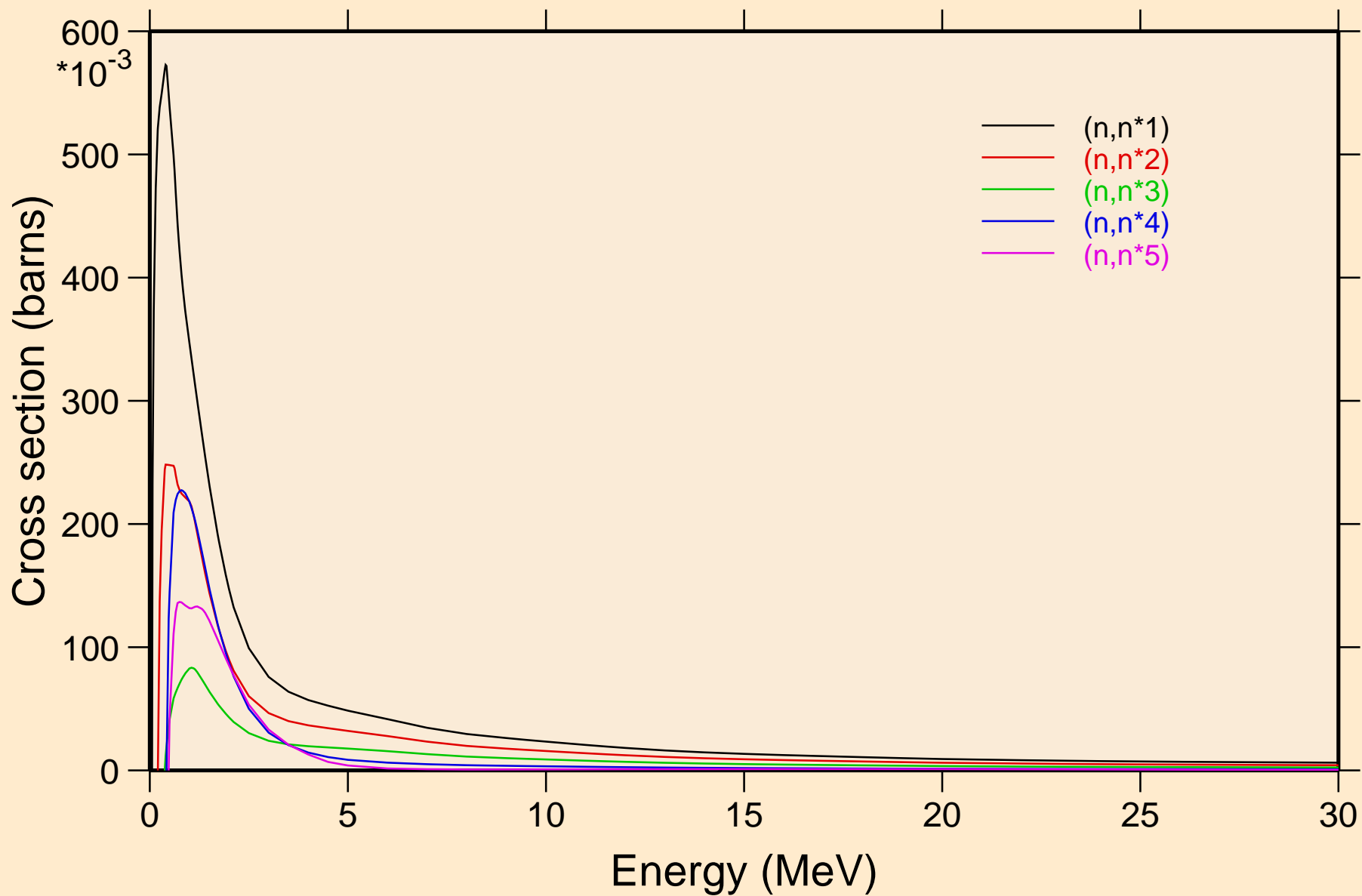

ENDF/B-VII I-127

Inelastic levels

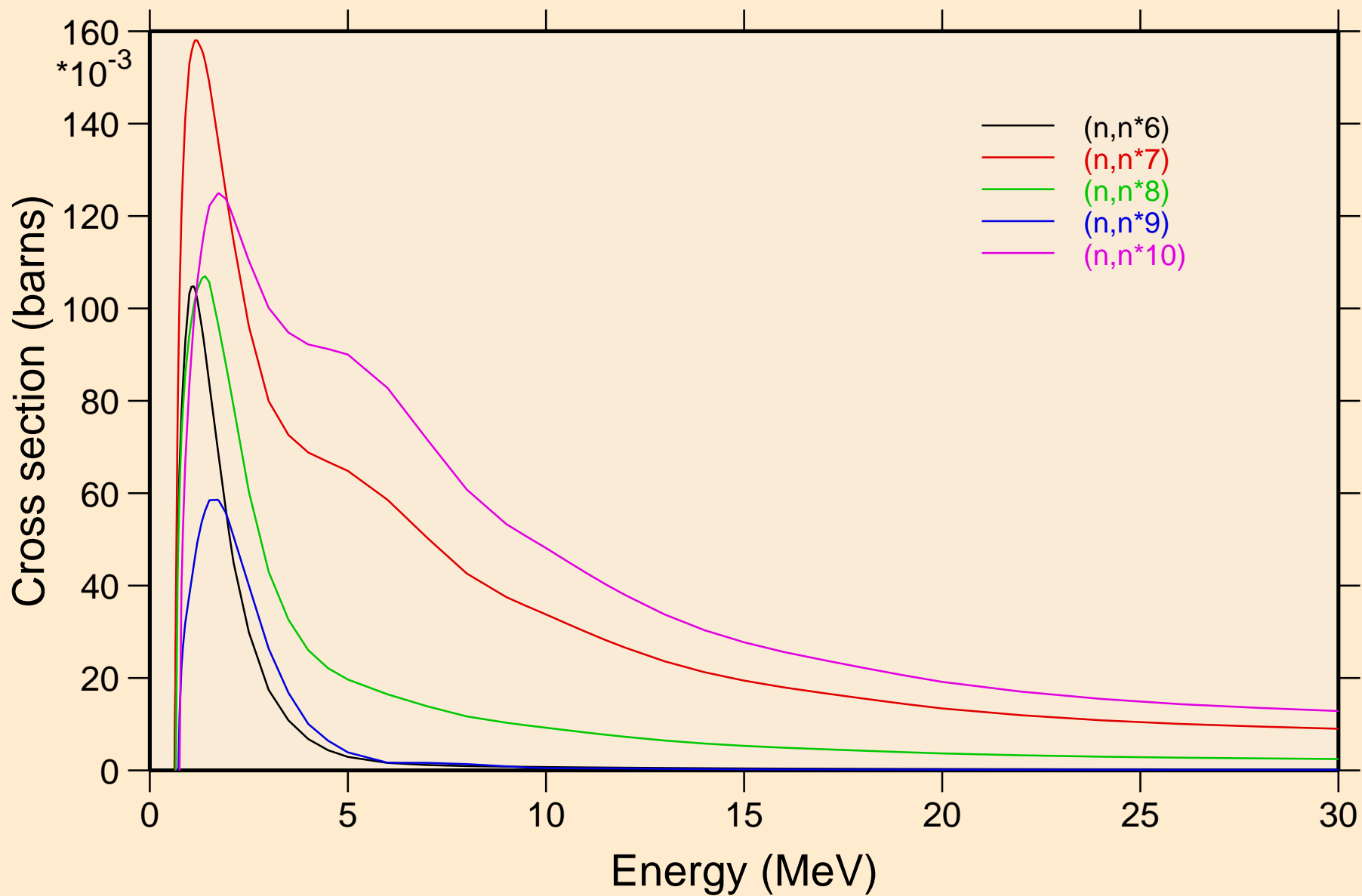

ENDF/B-VII I-127

Inelastic levels

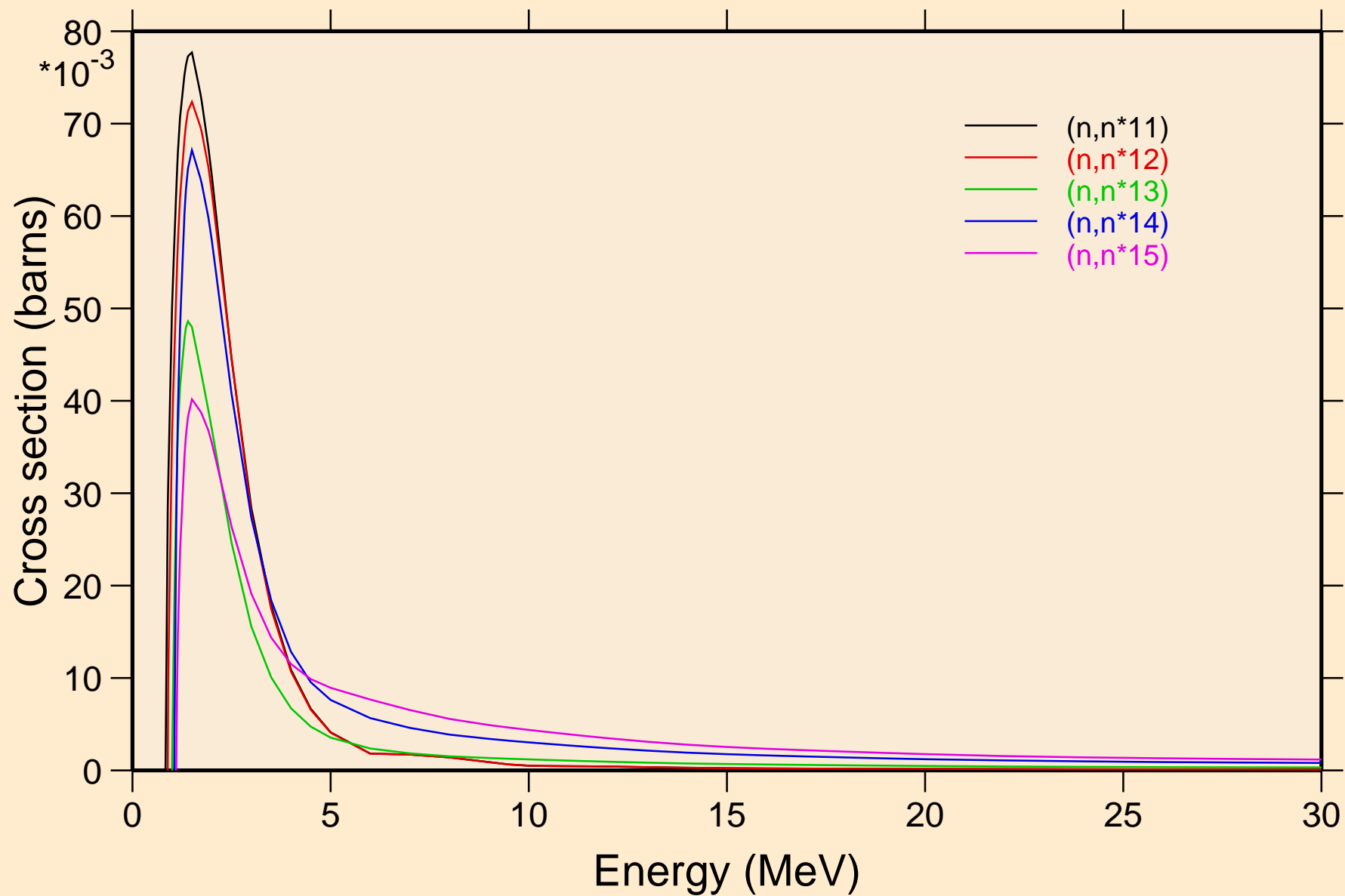

ENDF/B-VII I-127

Inelastic levels

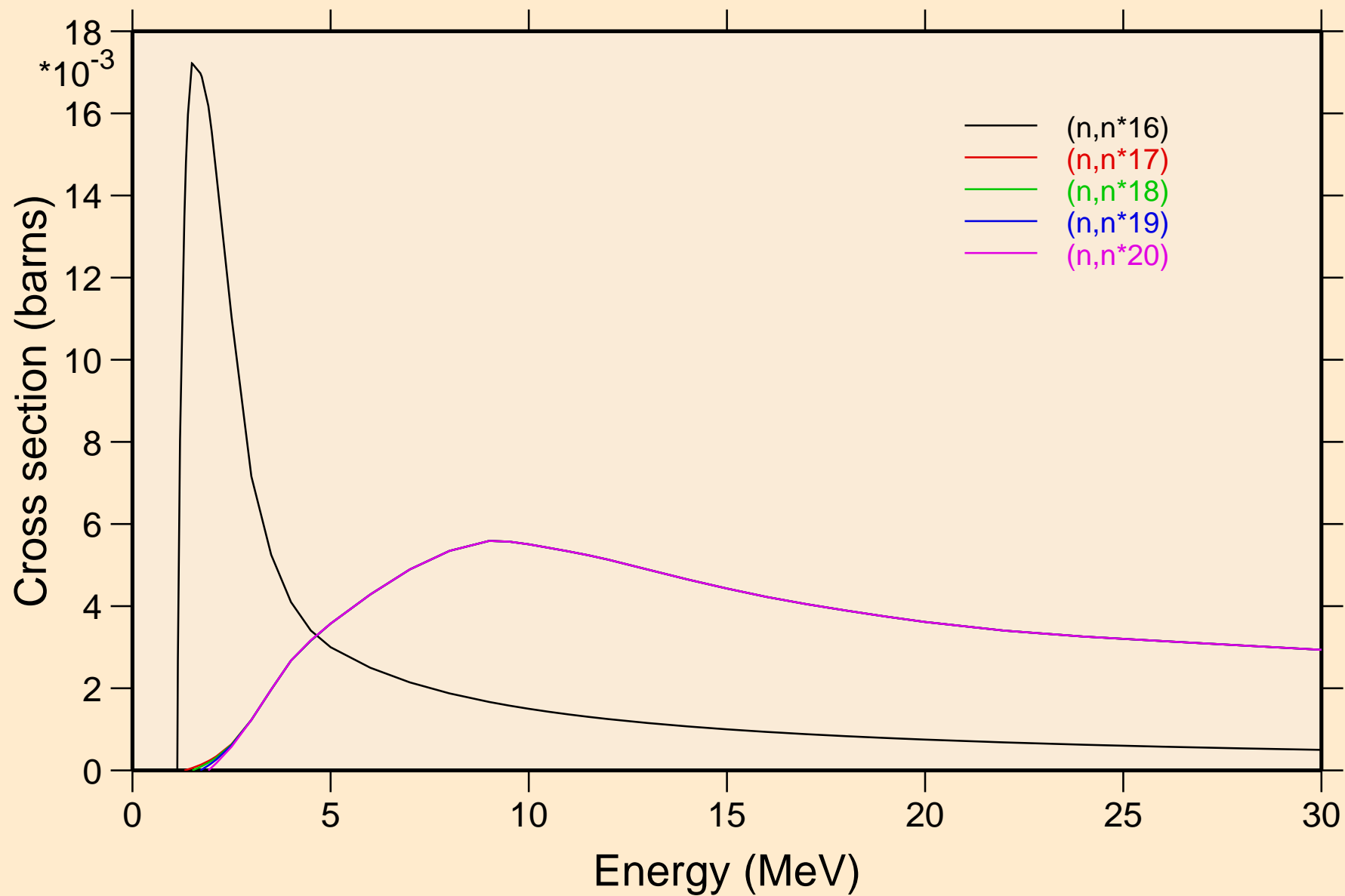

ENDF/B-VII I-127

Inelastic levels

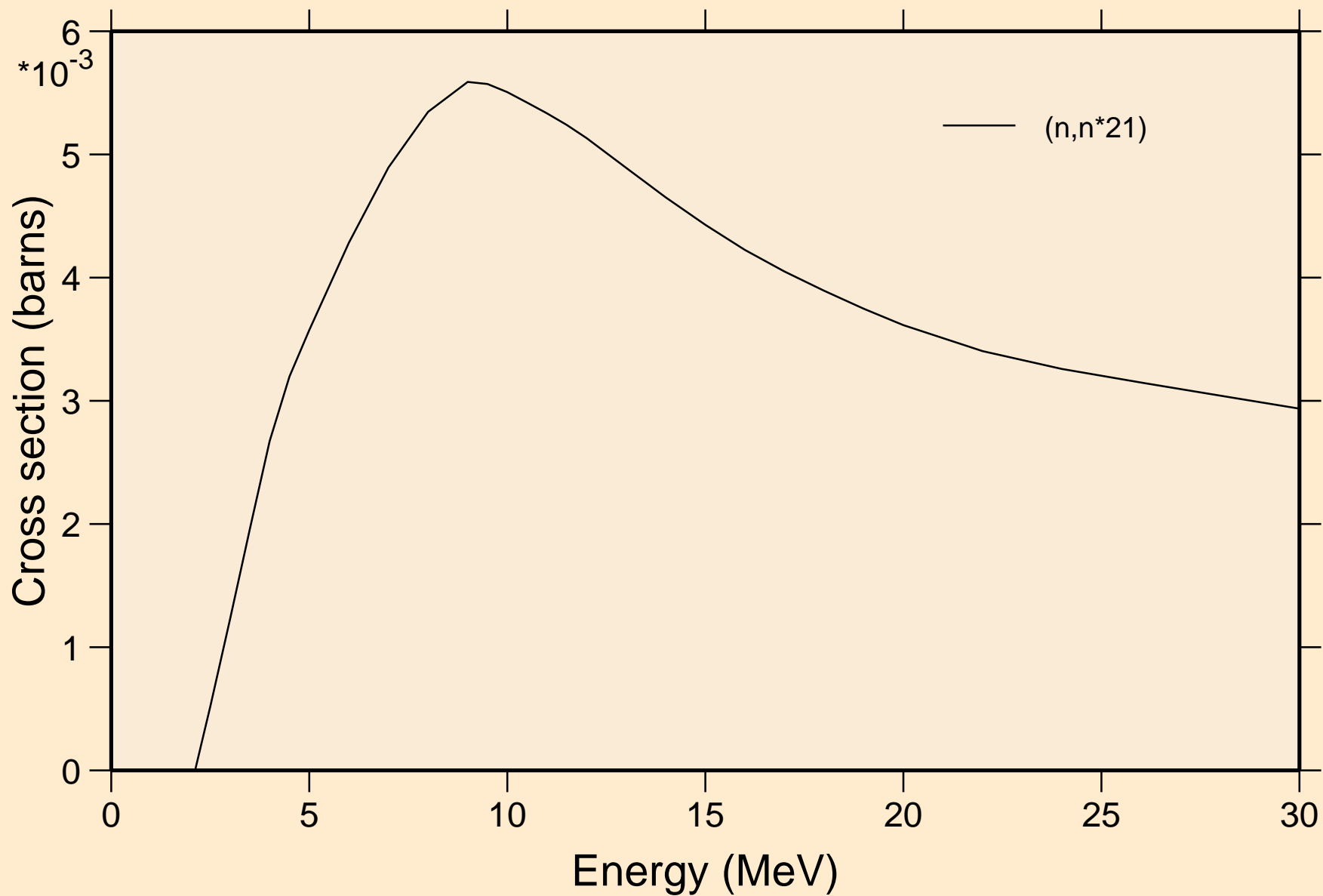

ENDF/B-VII I-127

Threshold reactions

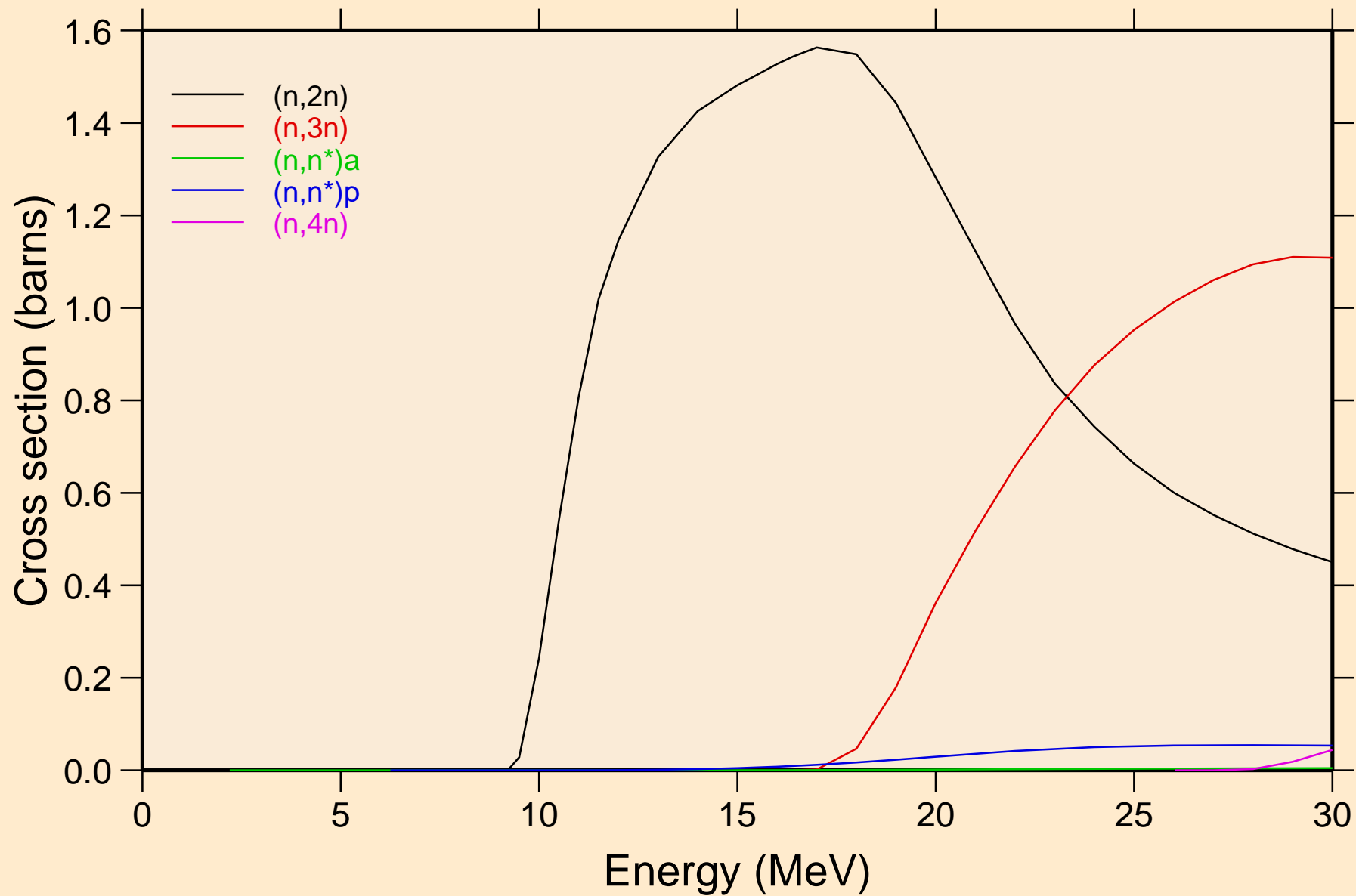

ENDF/B-VII I-127

Threshold reactions

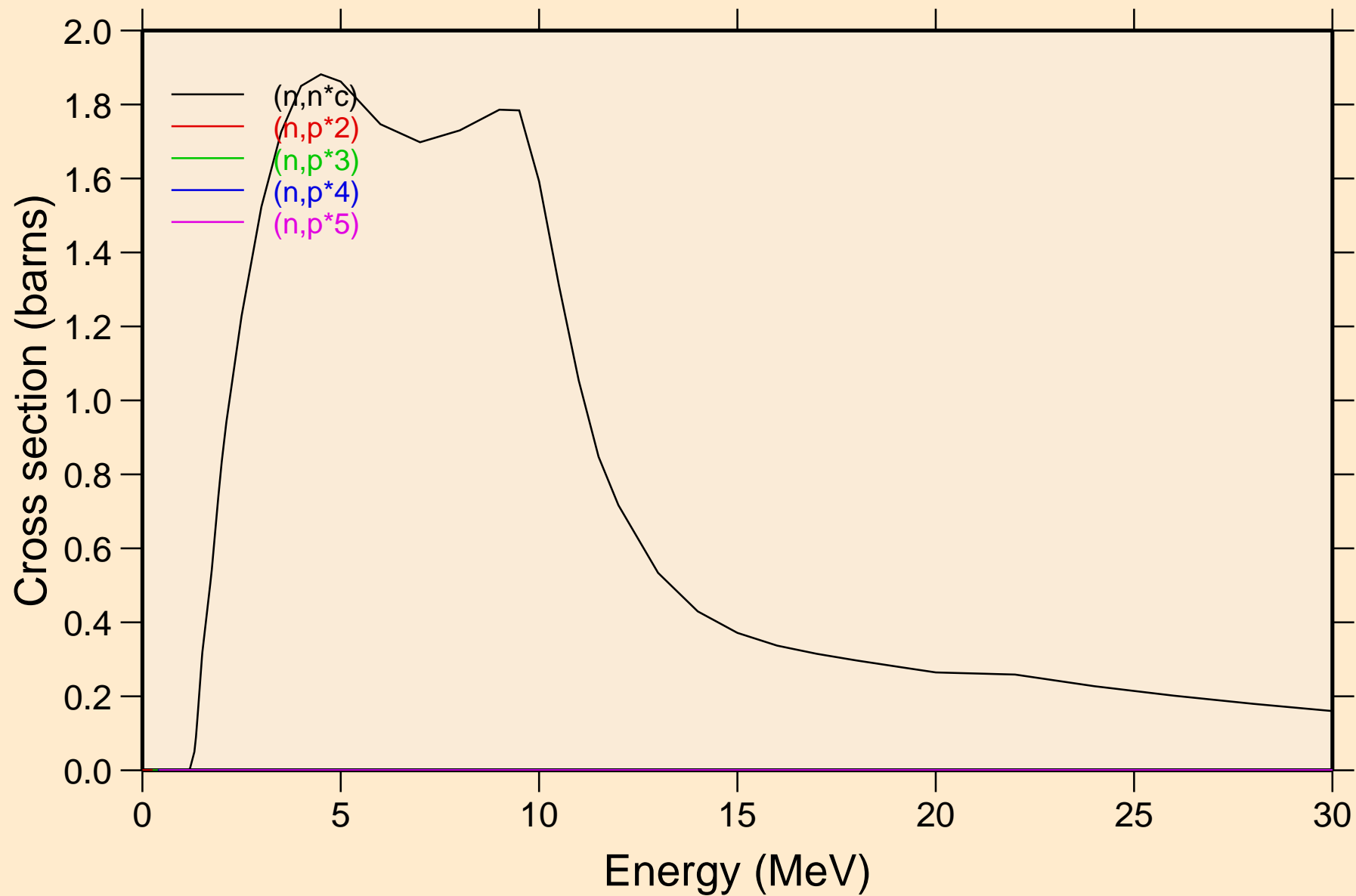

ENDF/B-VII I-127

Threshold reactions

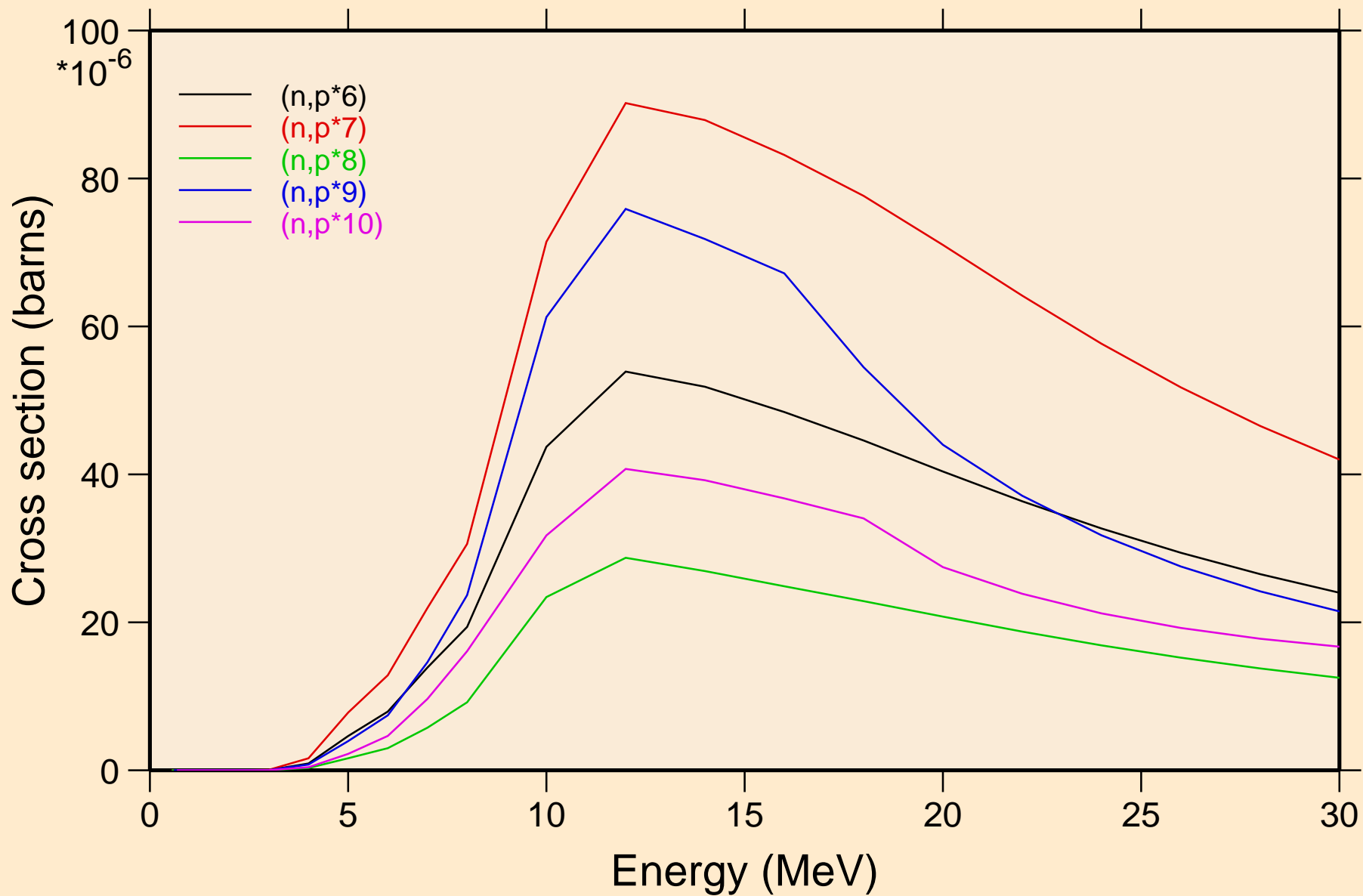

ENDF/B-VII I-127

Threshold reactions

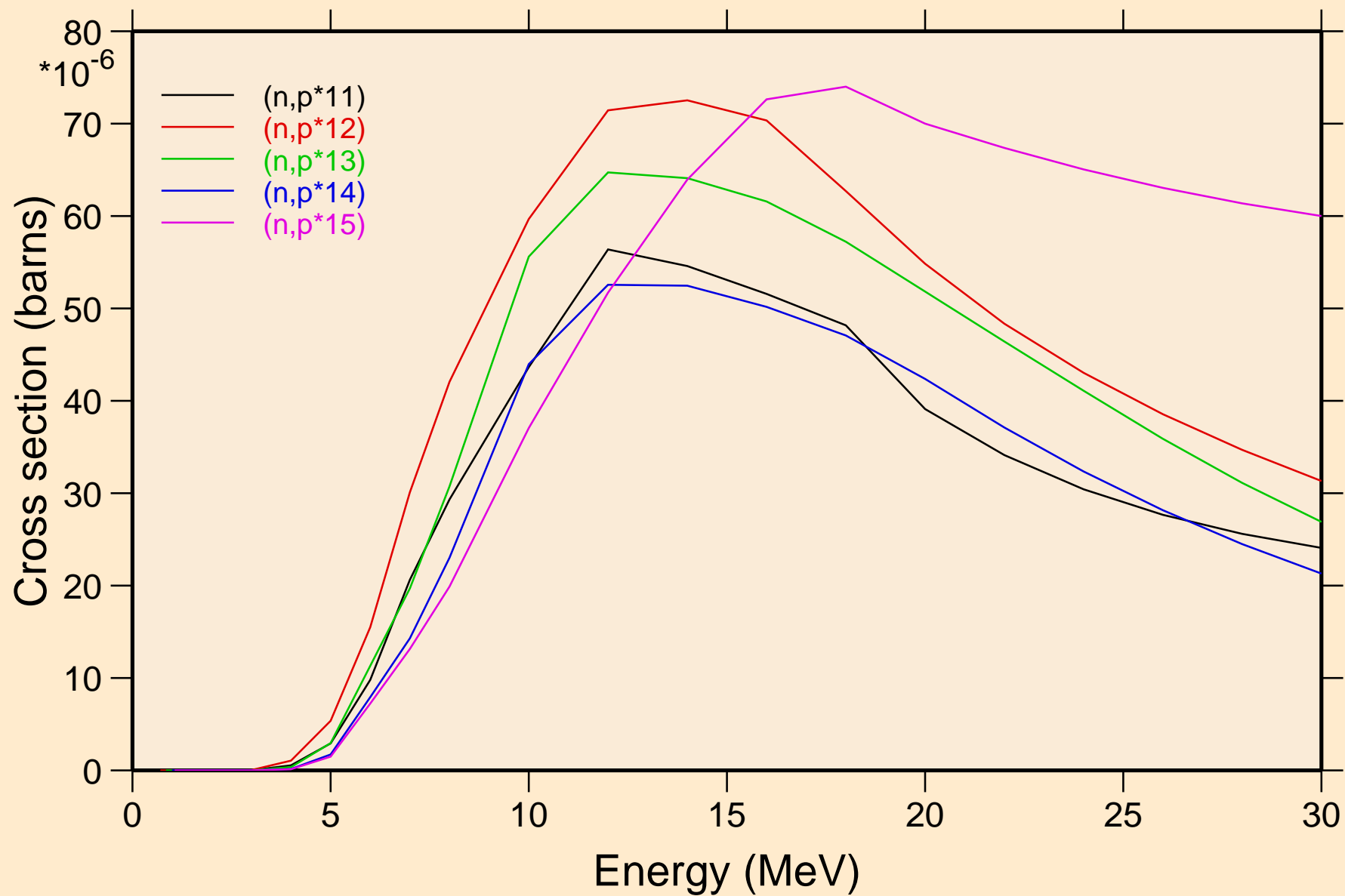

ENDF/B-VII I-127

Threshold reactions

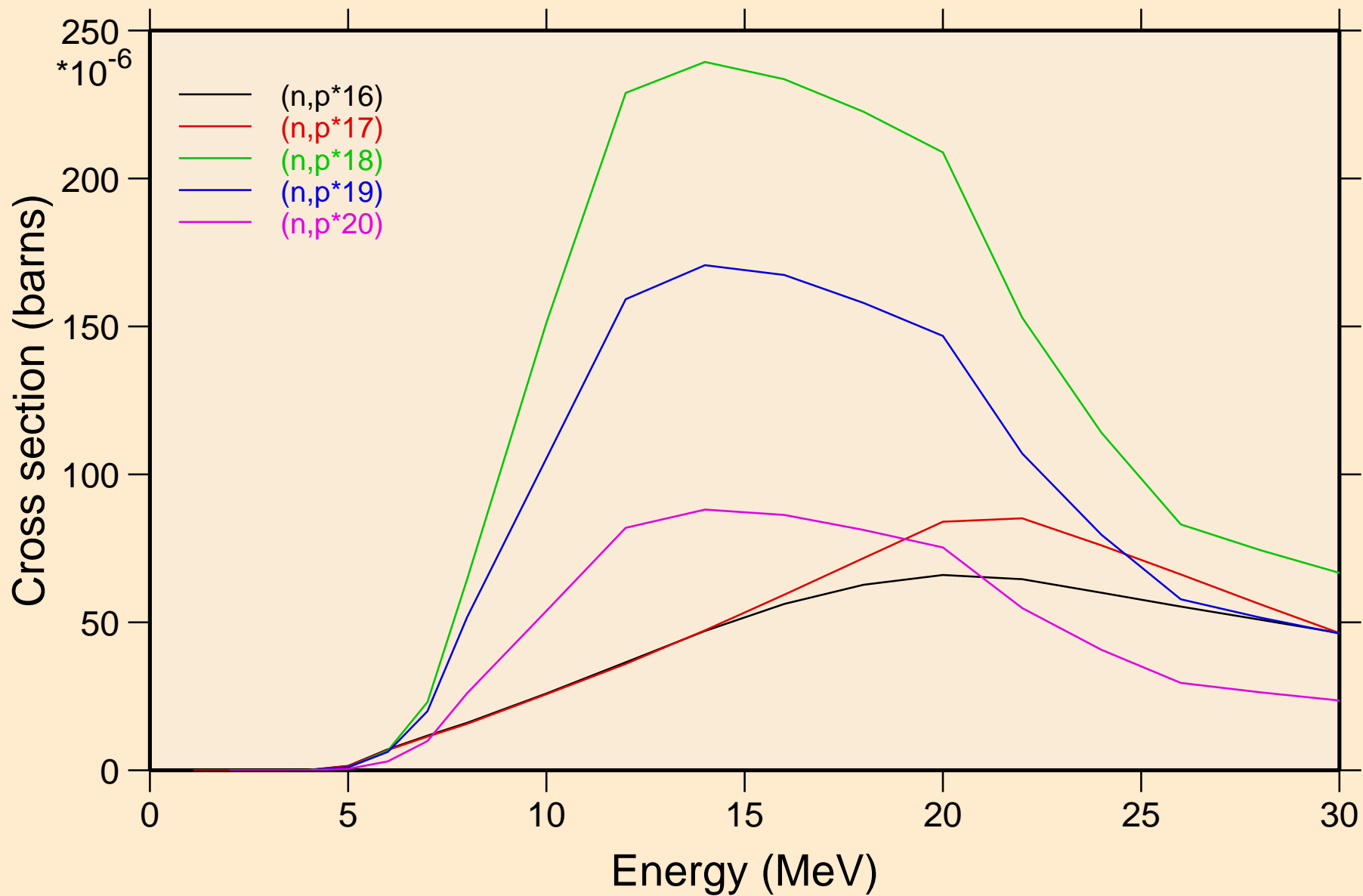

ENDF/B-VII I-127

Threshold reactions

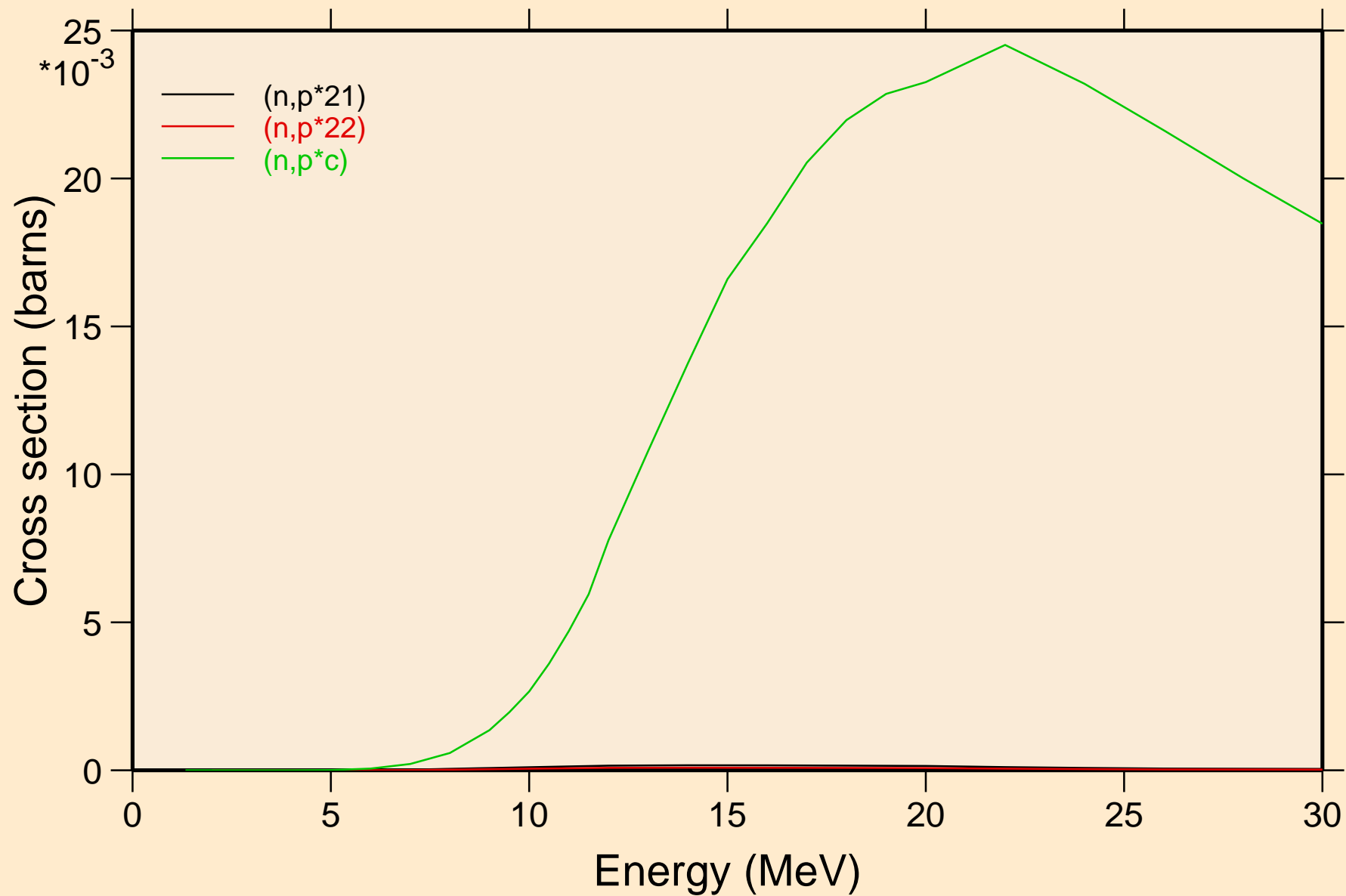

ENDF/B-VII I-127
angular distribution for elastic

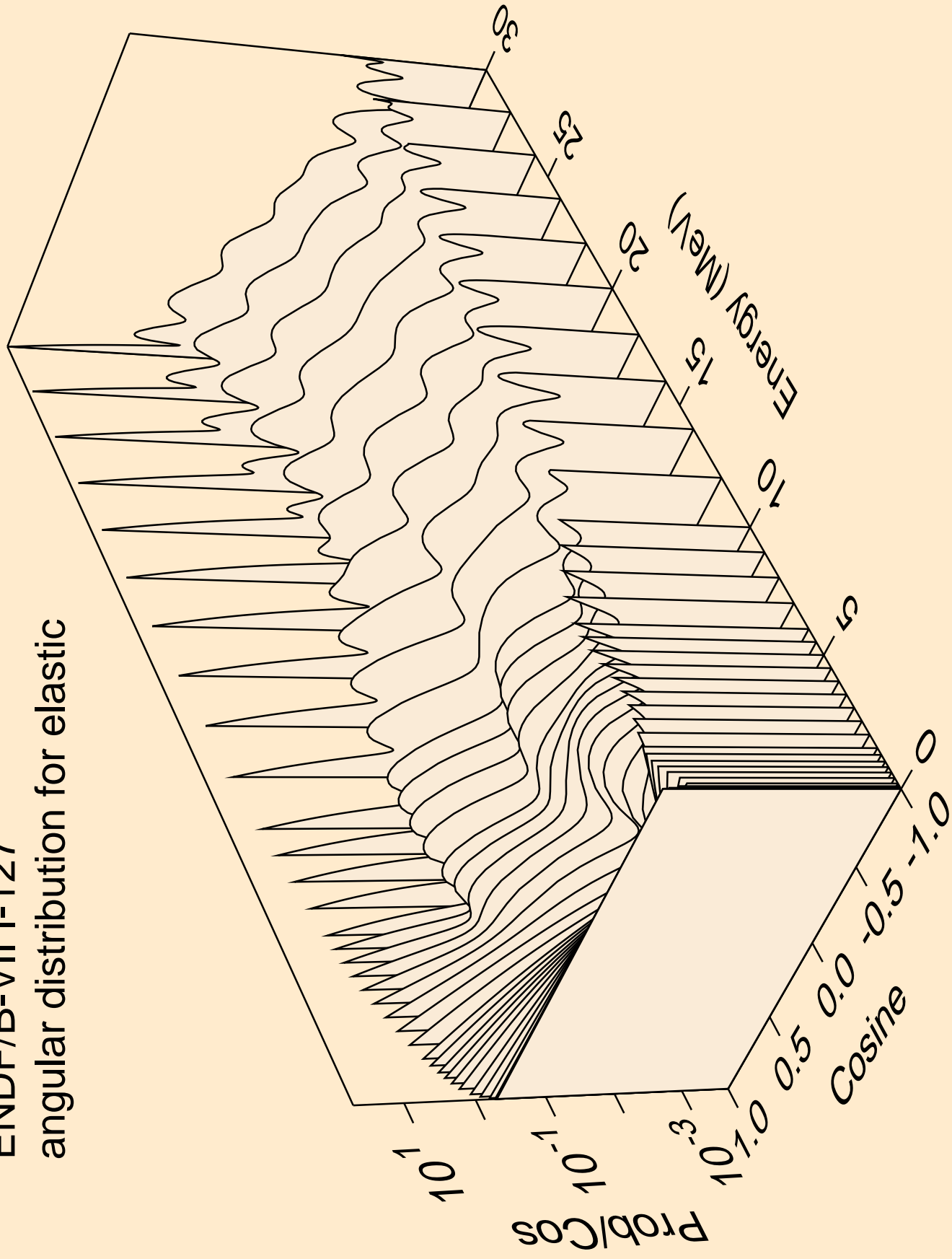

ENDF/B-VII I-127
angular distribution for (n,n*1)

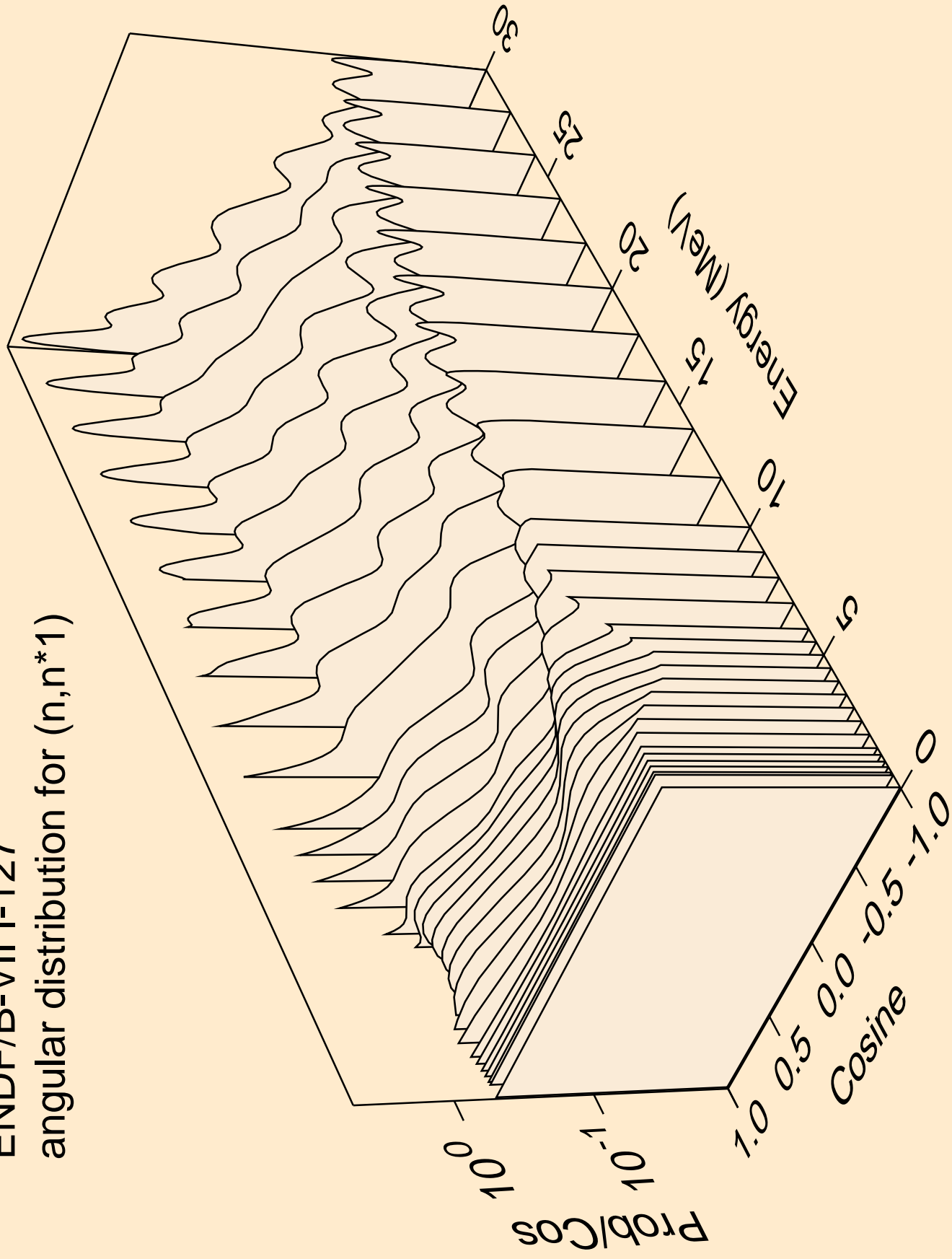

ENDF/B-VII I-127
angular distribution for (n,n*2)

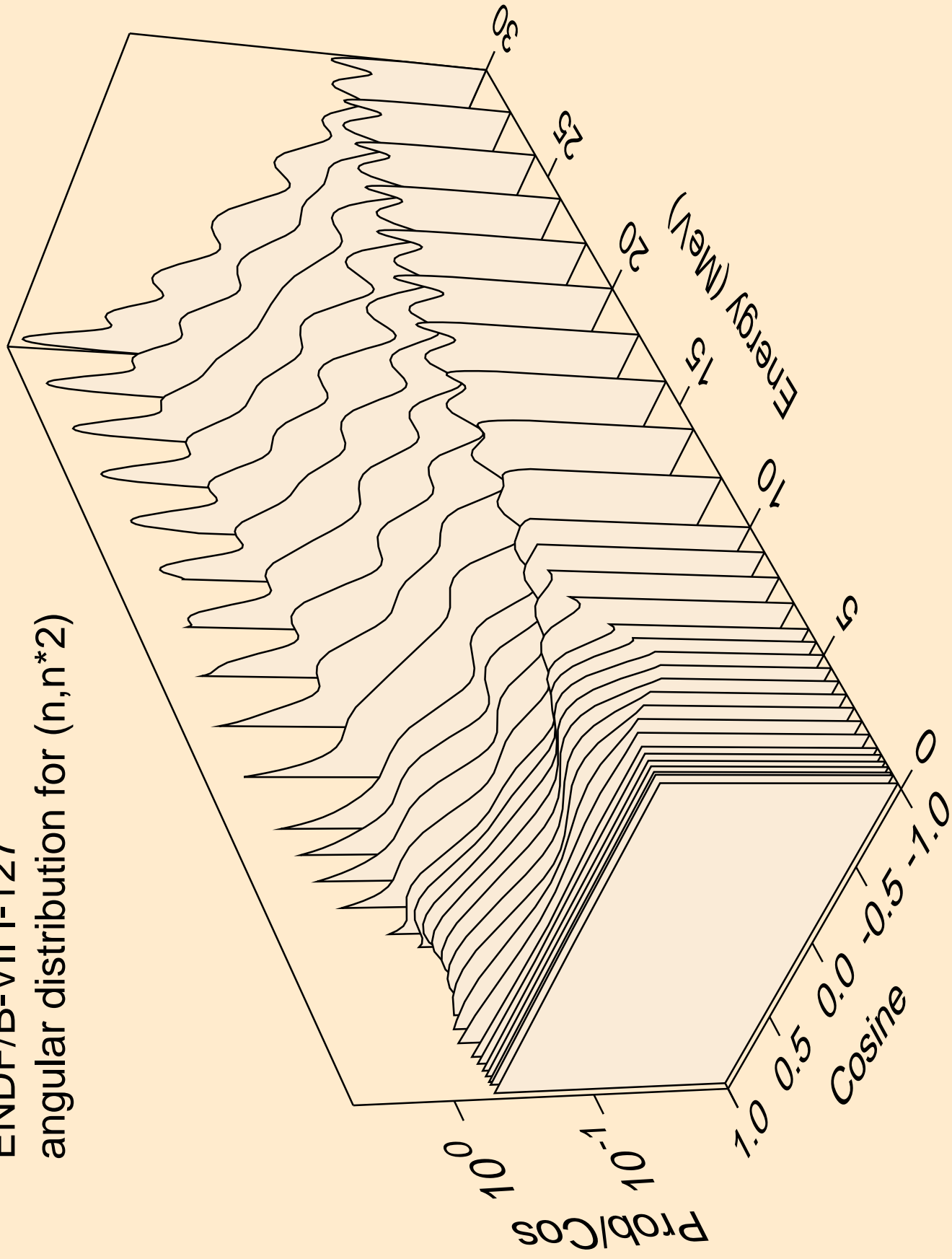

ENDF/B-VII I-127
angular distribution for (n,n*3)

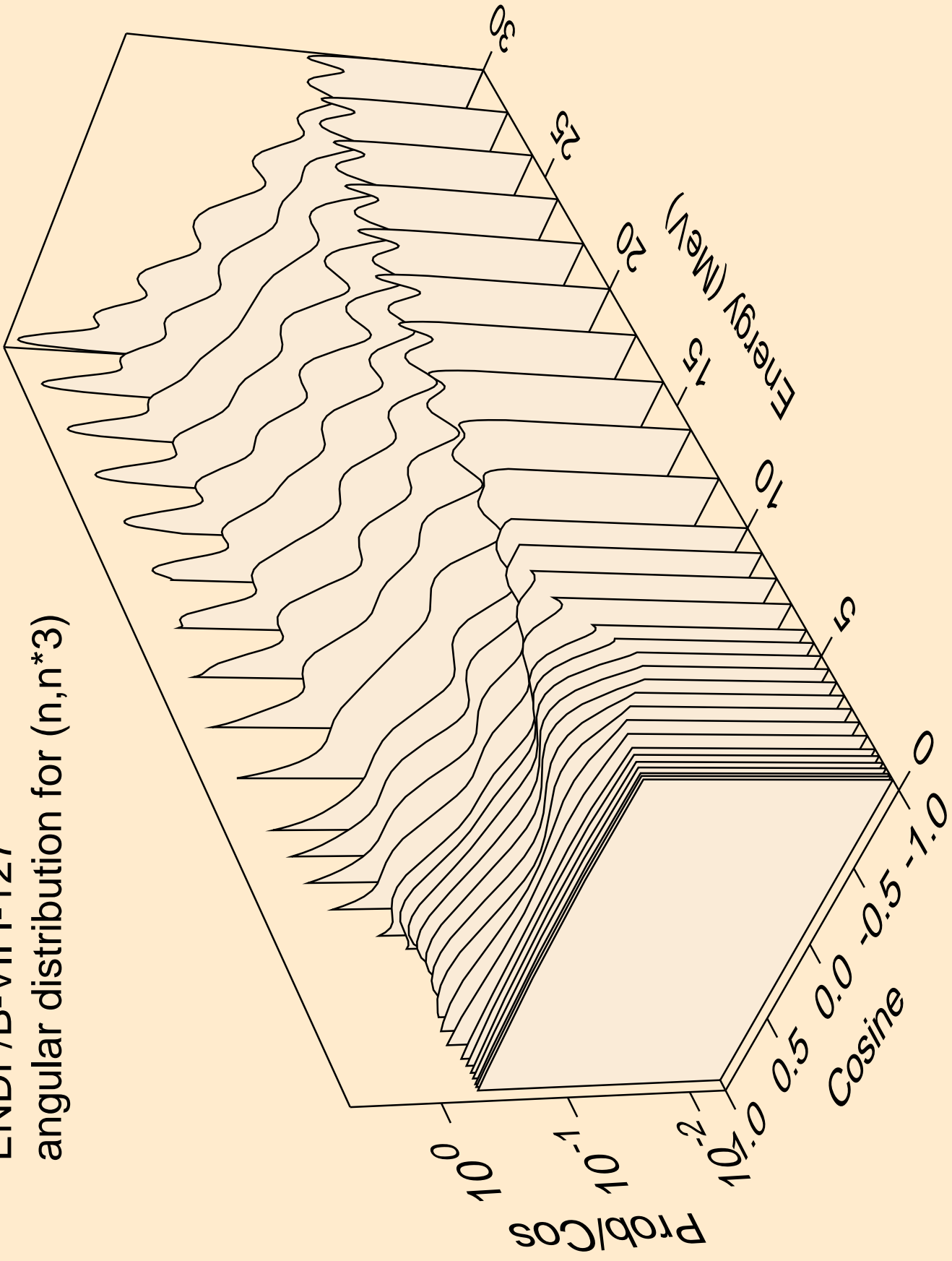

ENDF/B-VII I-127
angular distribution for (n,n*4)

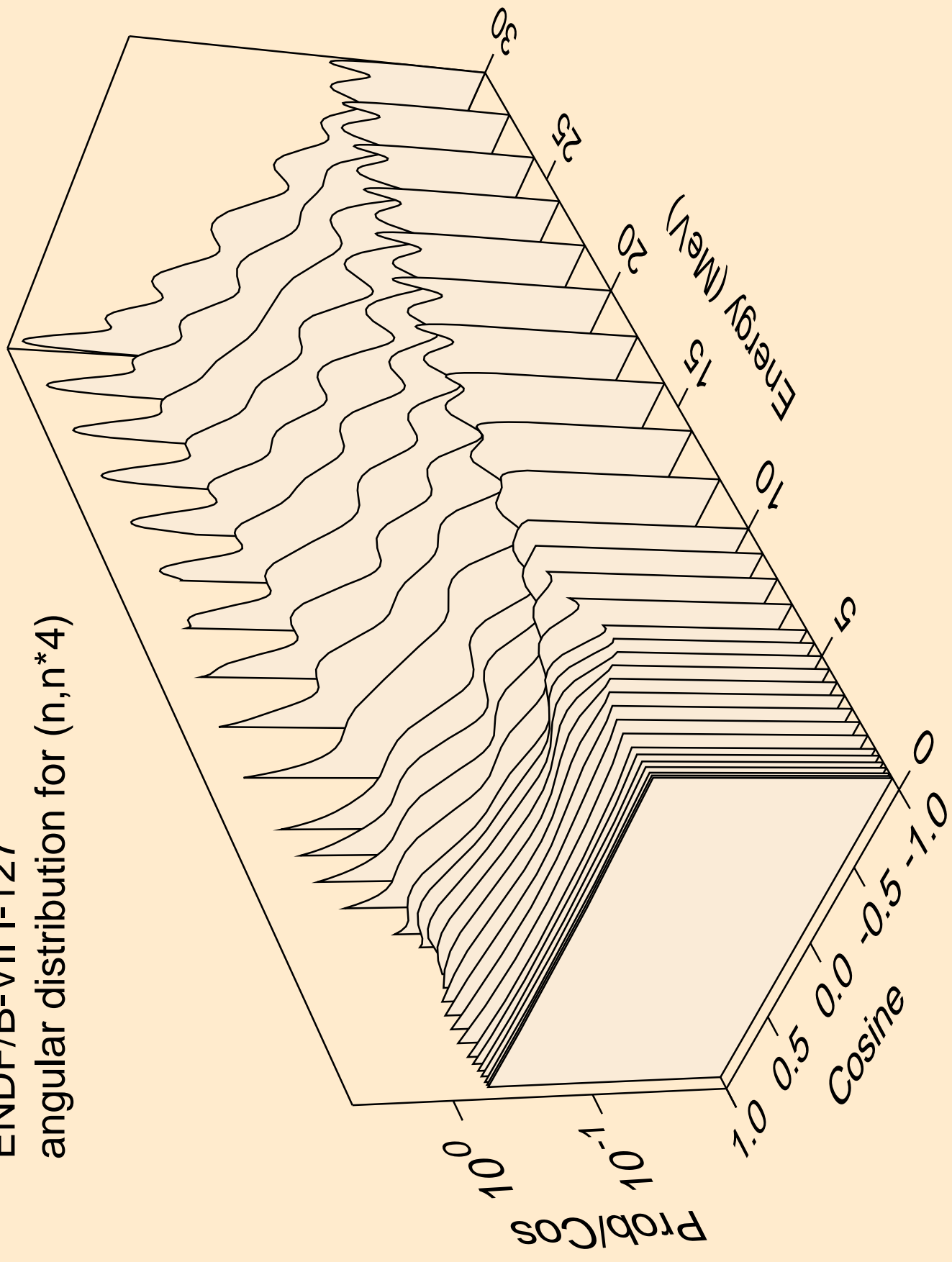

ENDF/B-VII I-127
angular distribution for (n,n*5)

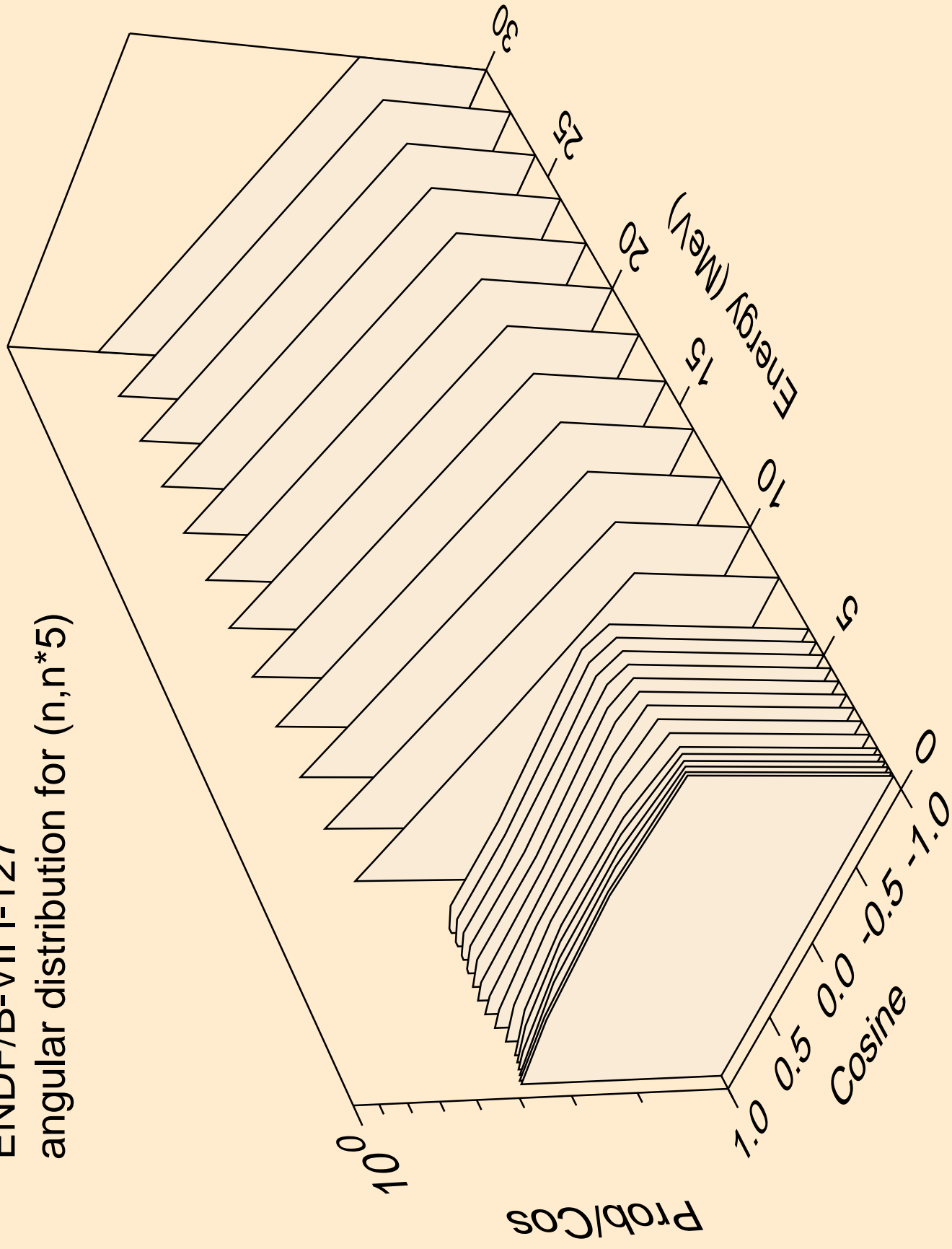

ENDF/B-VII I-127
angular distribution for (n,n*6)

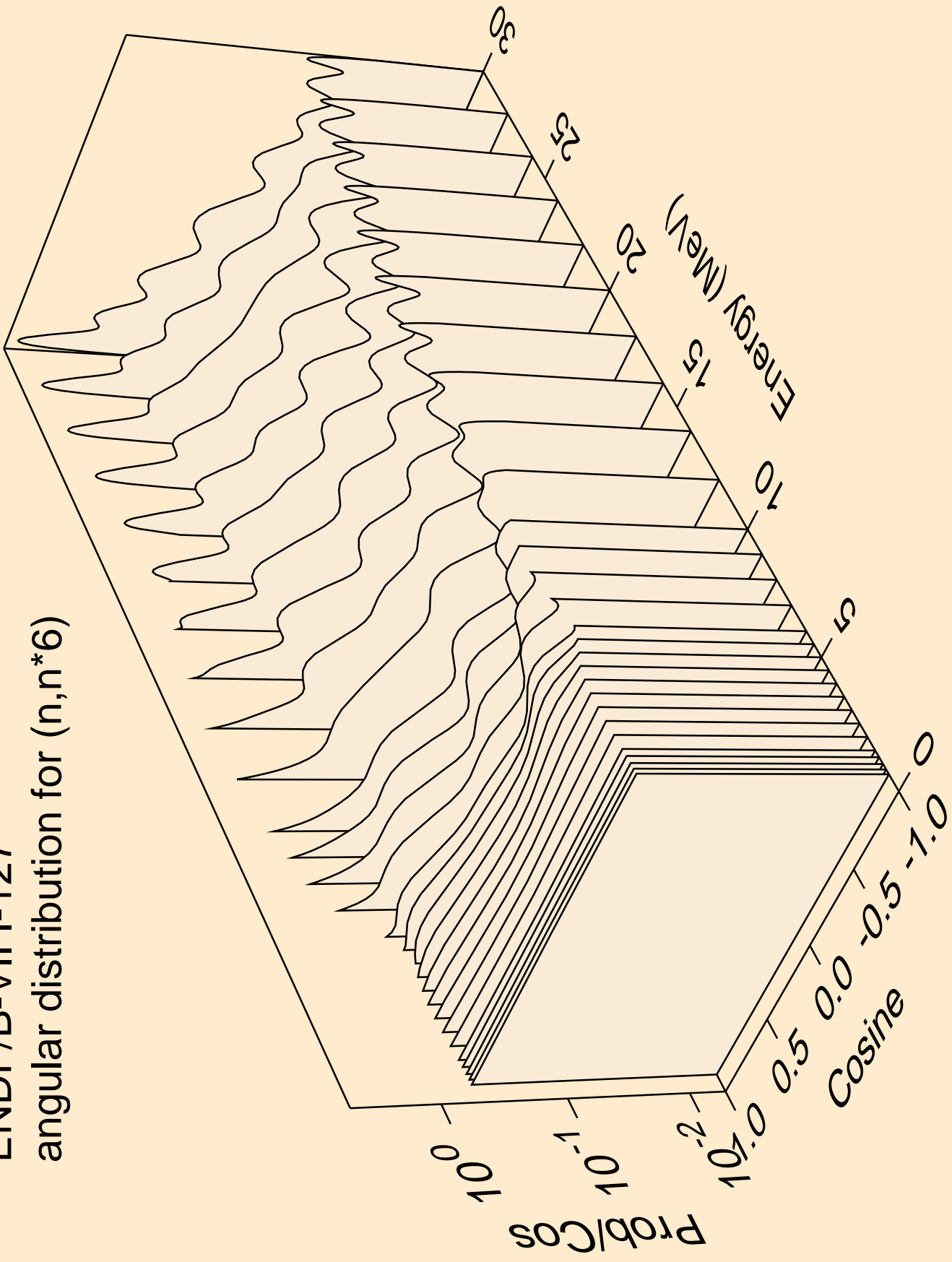

ENDF/B-VII I-127
angular distribution for (n,n*7)

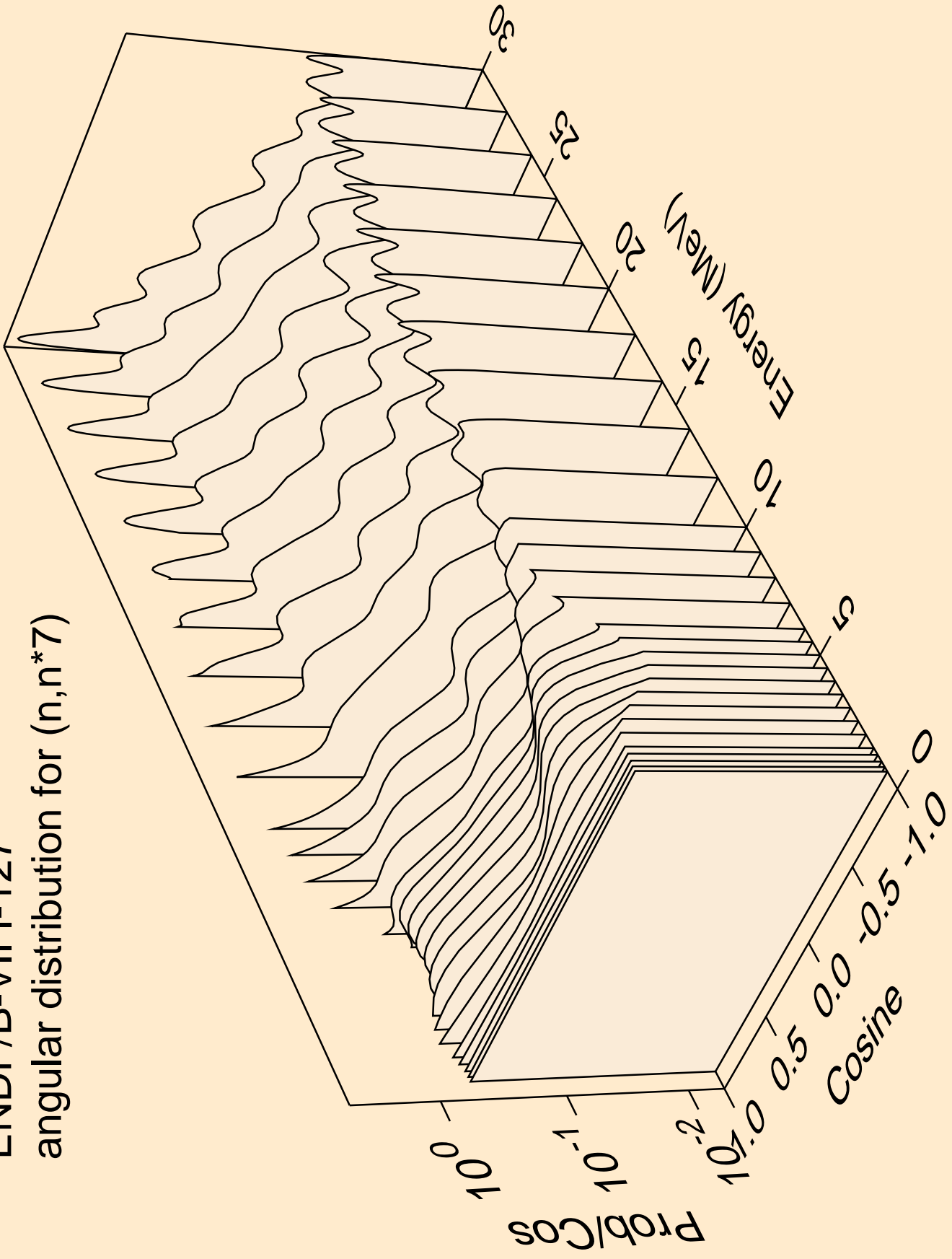

ENDF/B-VII I-127
angular distribution for (n,n*8)

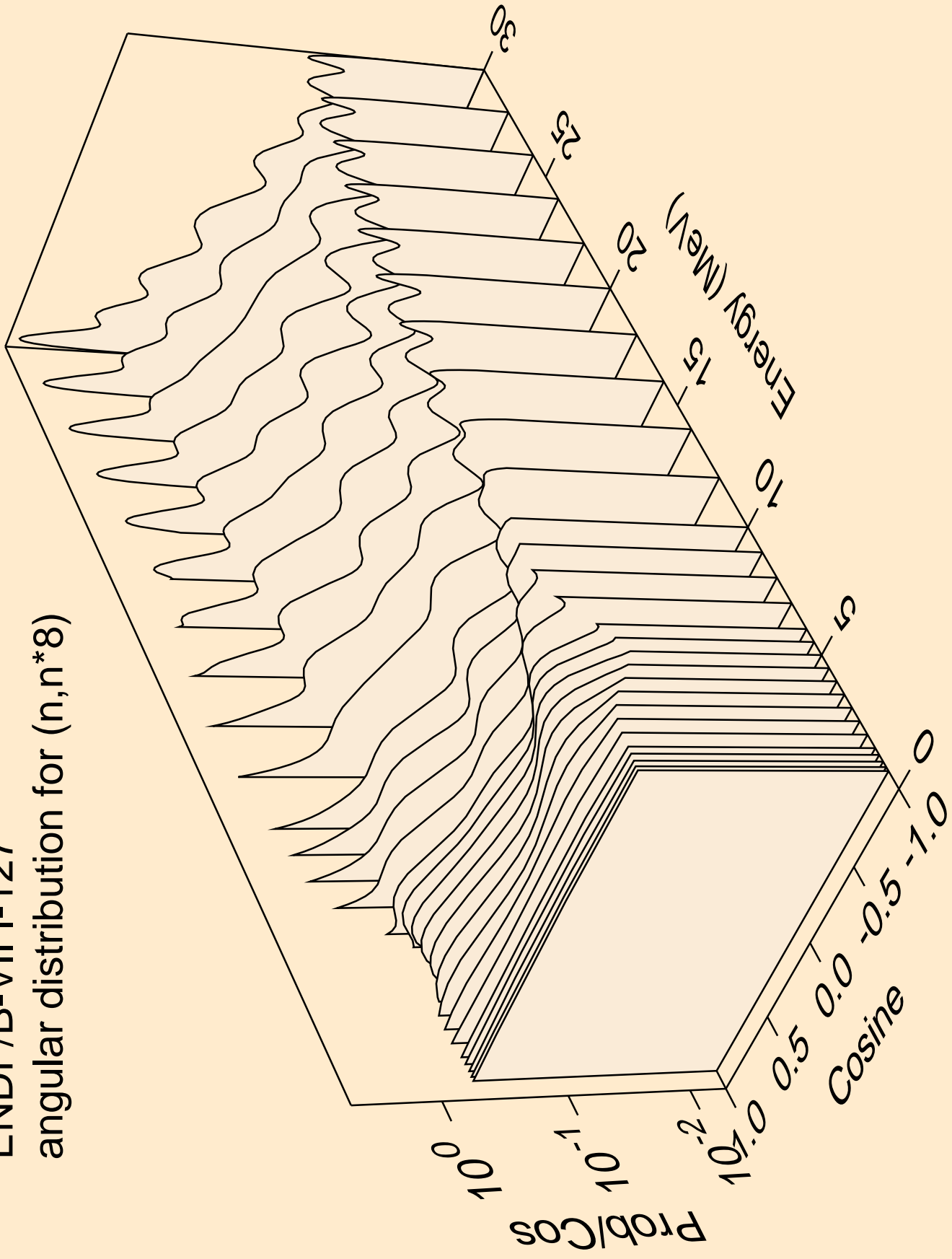

ENDF/B-VII I-127
angular distribution for (n,n*9)

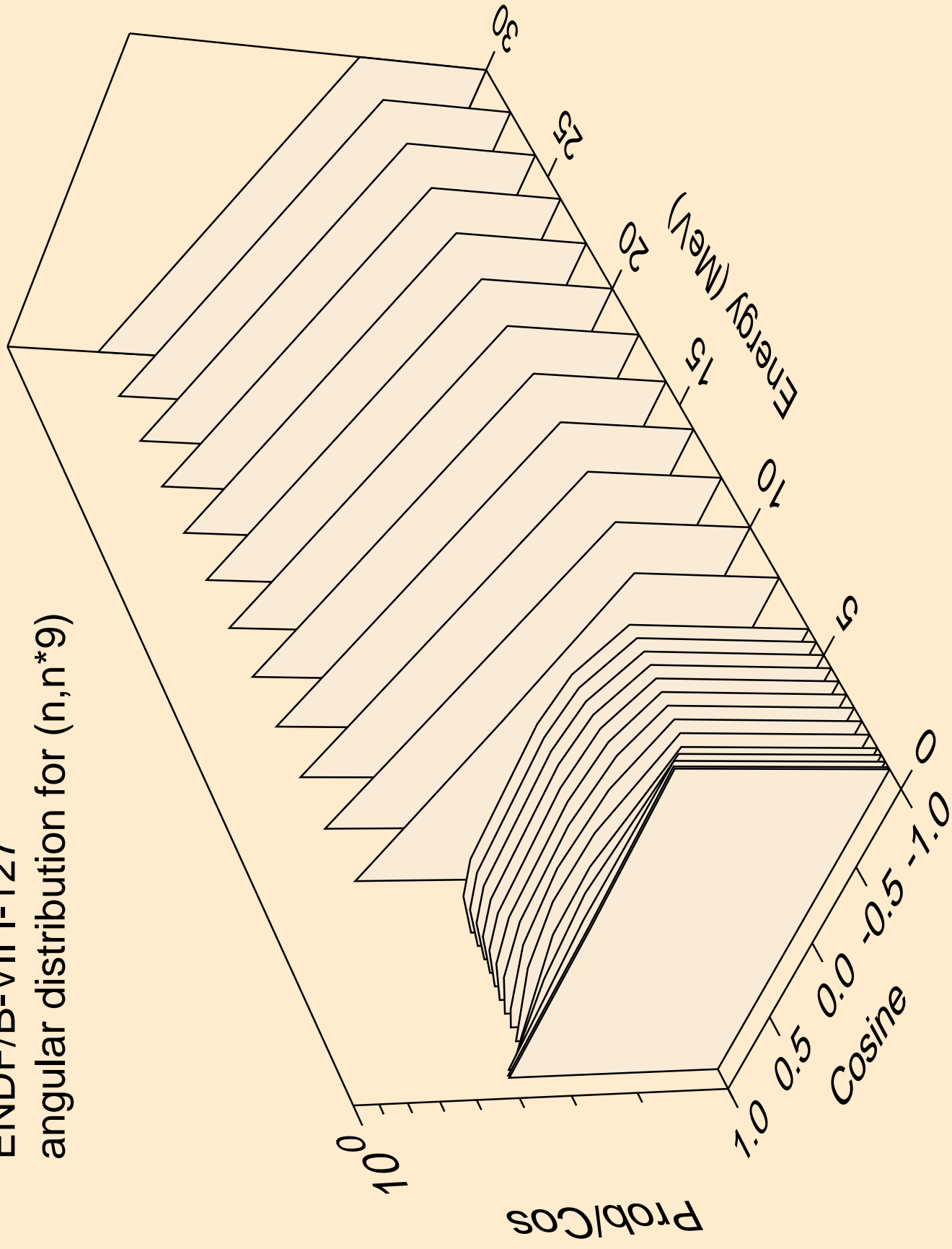

ENDF/B-VII I-127
angular distribution for (n,n*10)

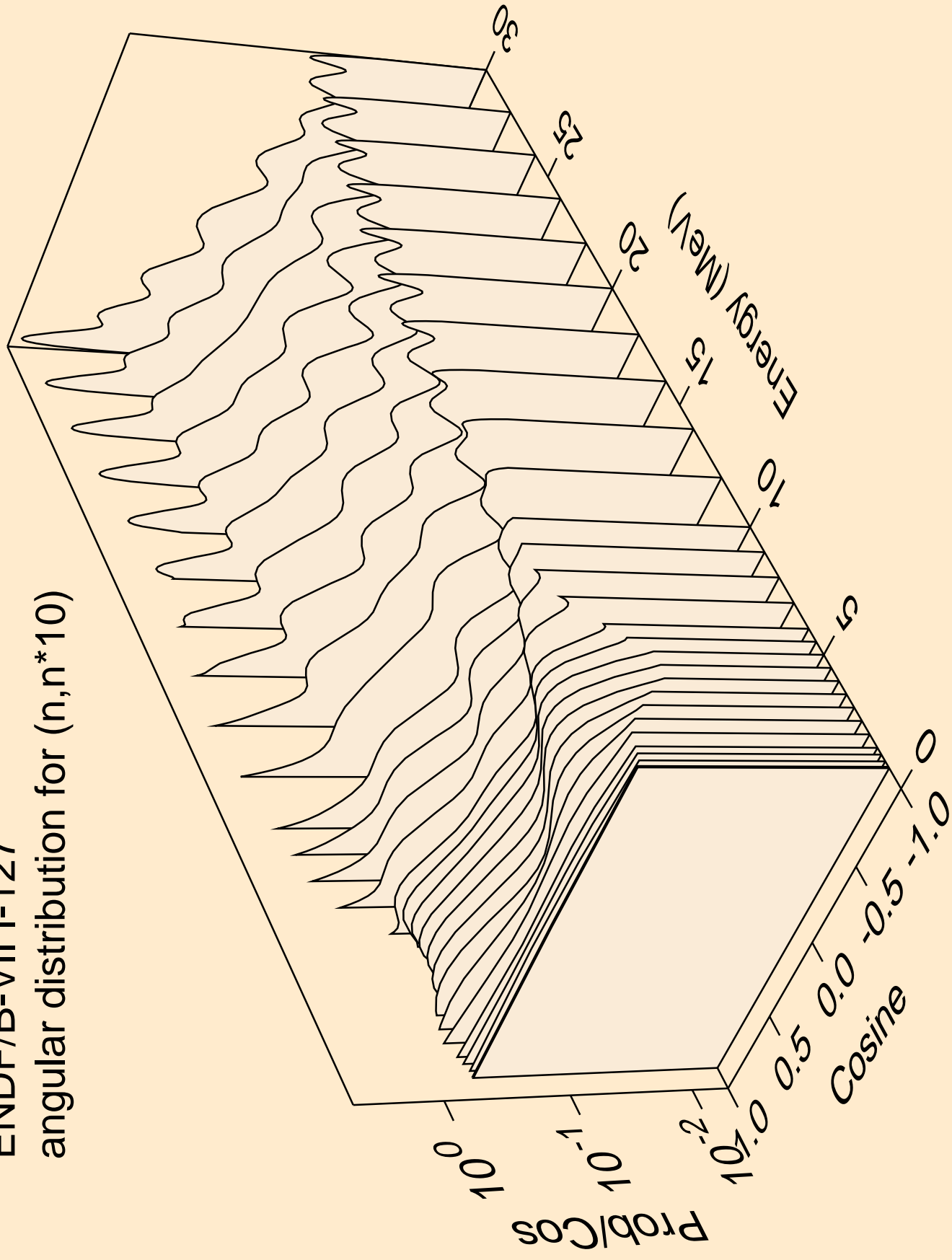

ENDF/B-VII I-127
angular distribution for (n,n*11)

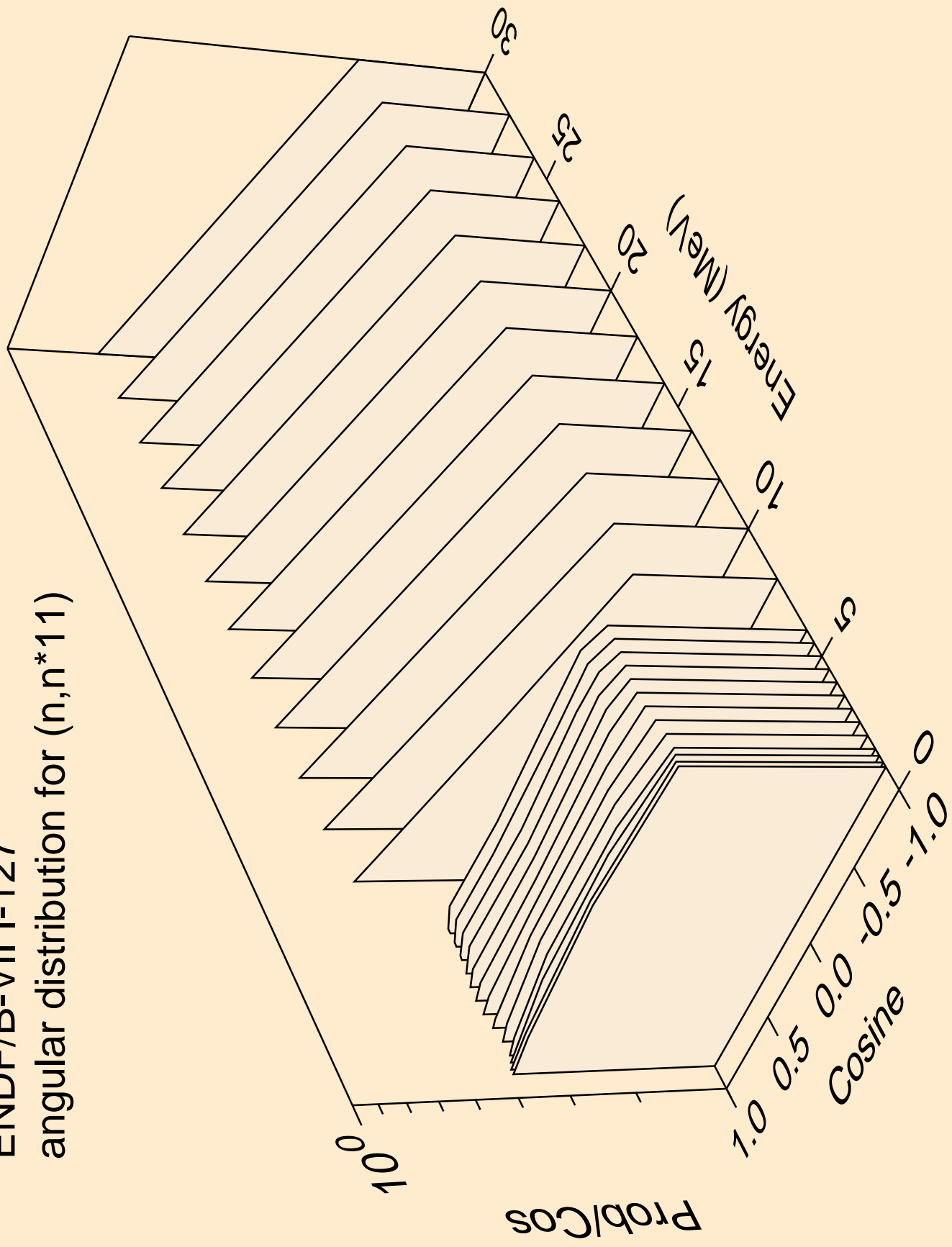

ENDF/B-VII I-127
angular distribution for (n,n*12)

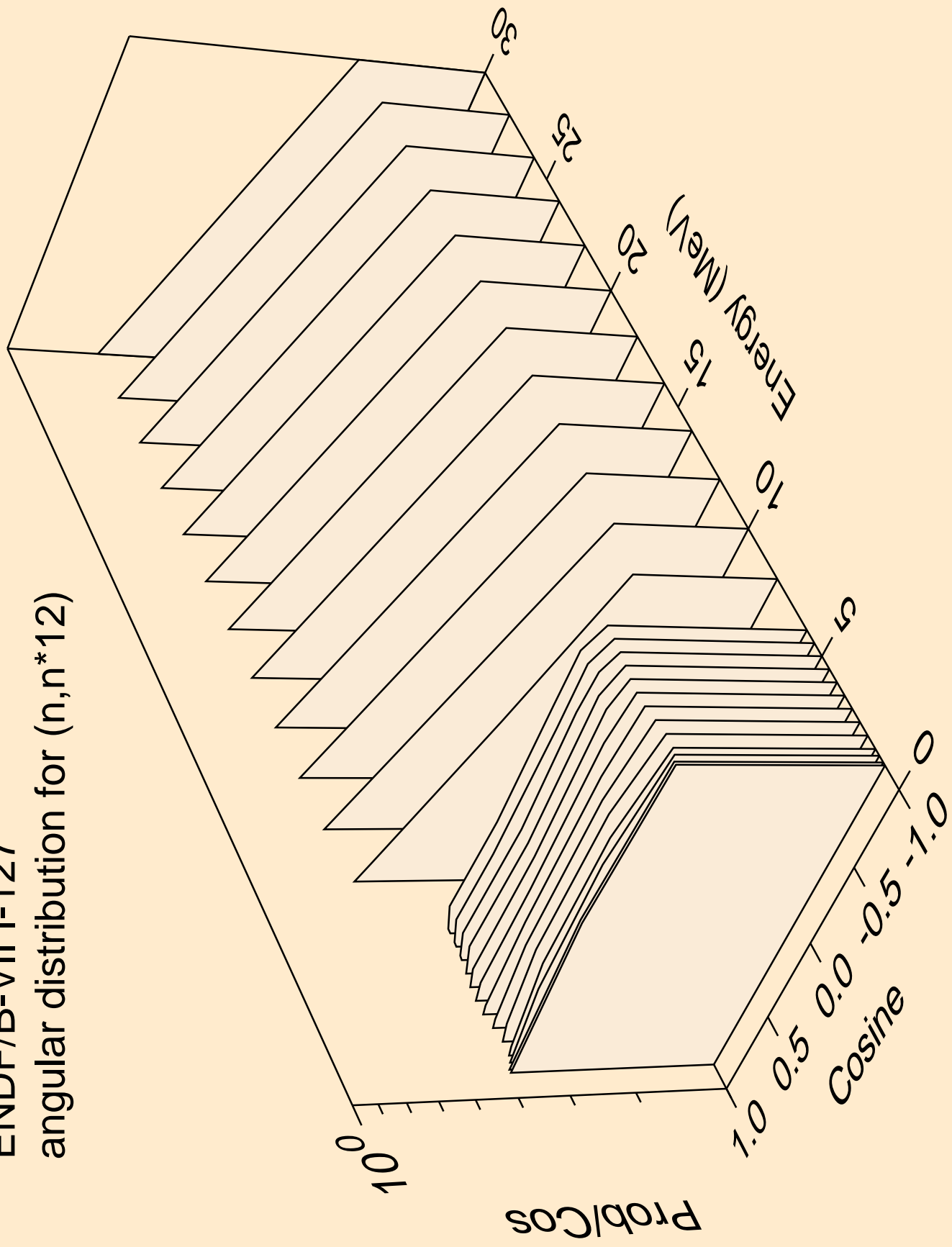

ENDF/B-VII I-127
angular distribution for (n,n*13)

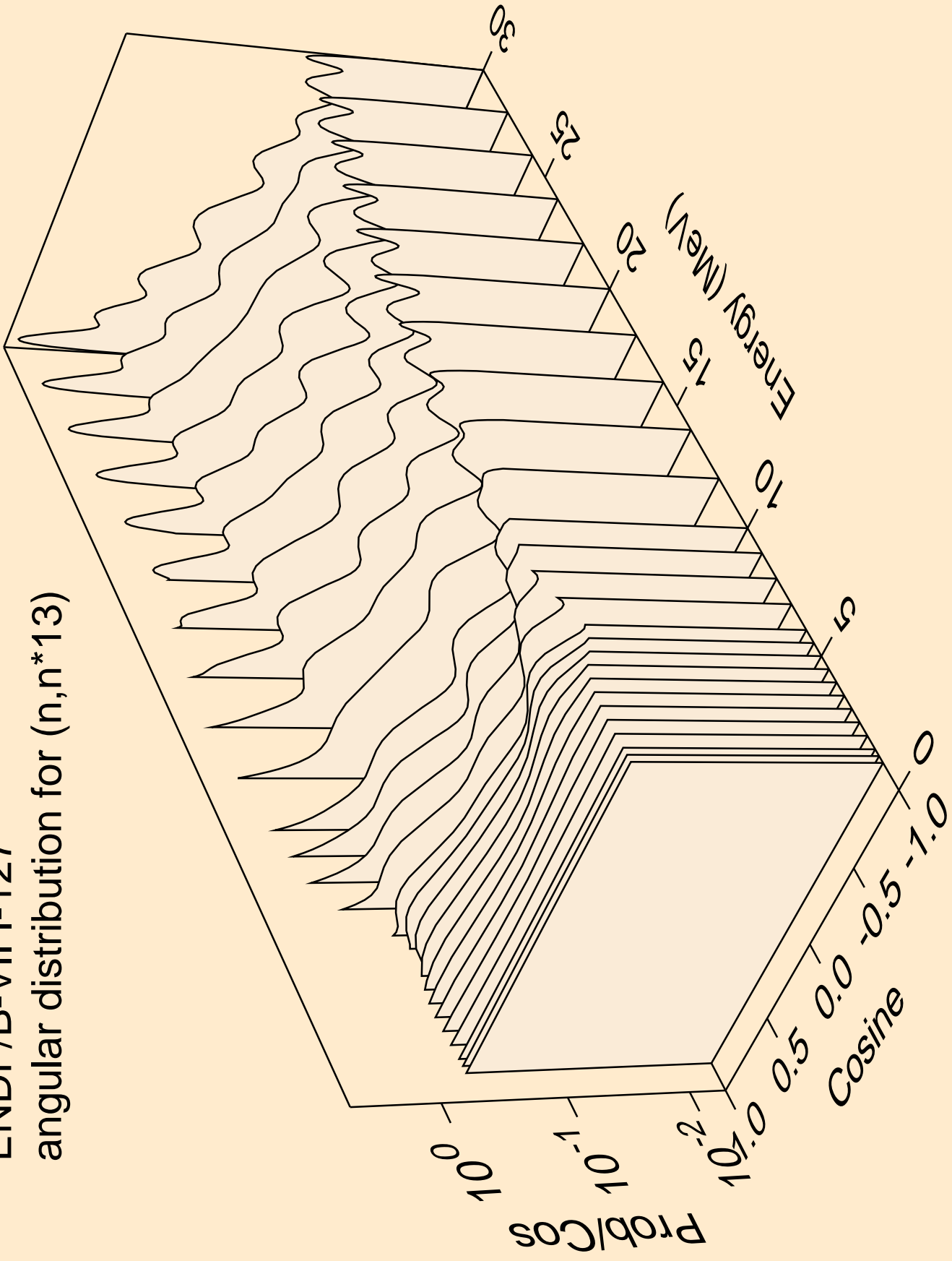

ENDF/B-VII I-127
angular distribution for (n,n*14)

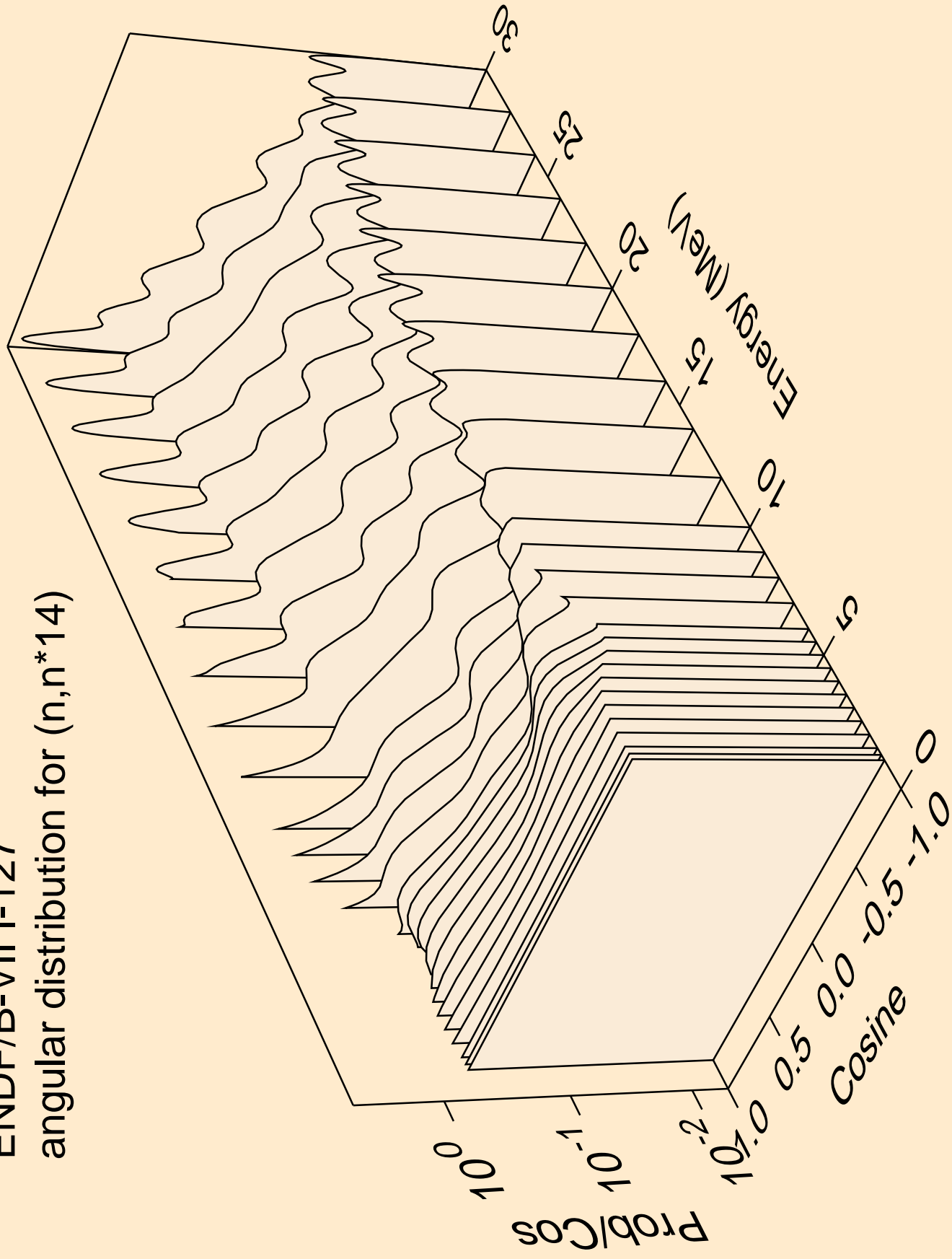

ENDF/B-VII I-127
angular distribution for (n,n*15)

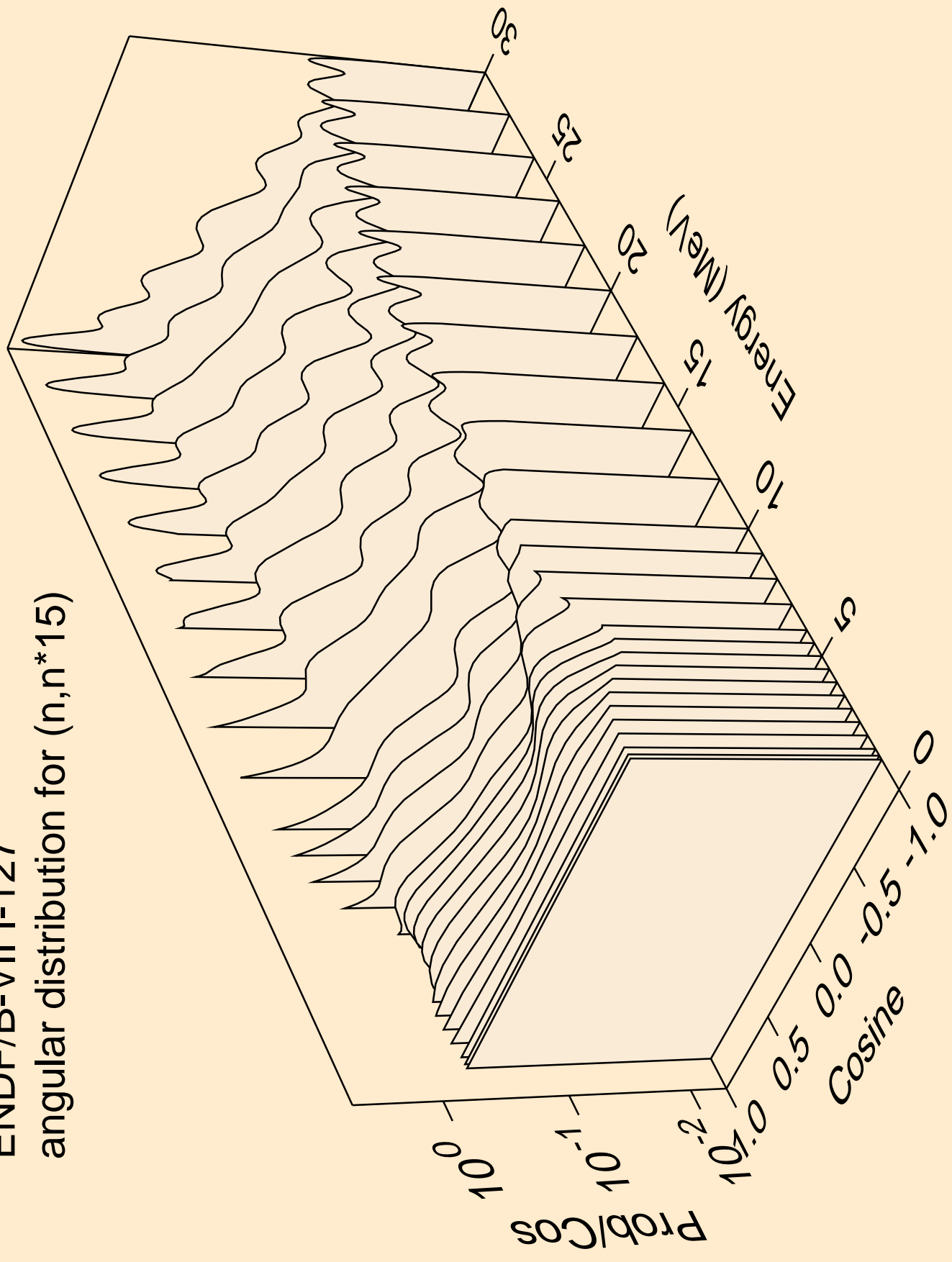

ENDF/B-VII I-127
angular distribution for (n,n*16)

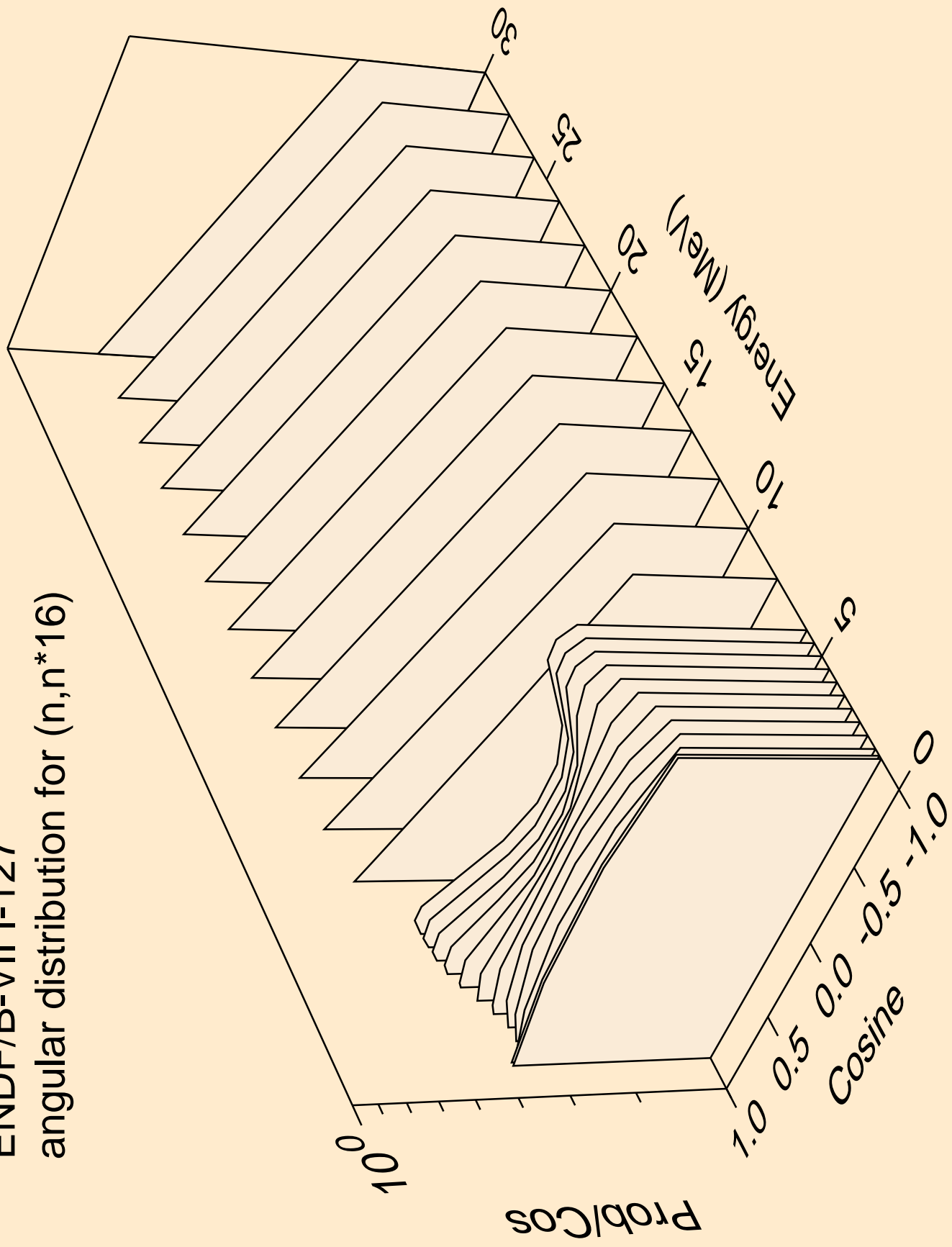

ENDF/B-VII I-127
angular distribution for (n,n*17)

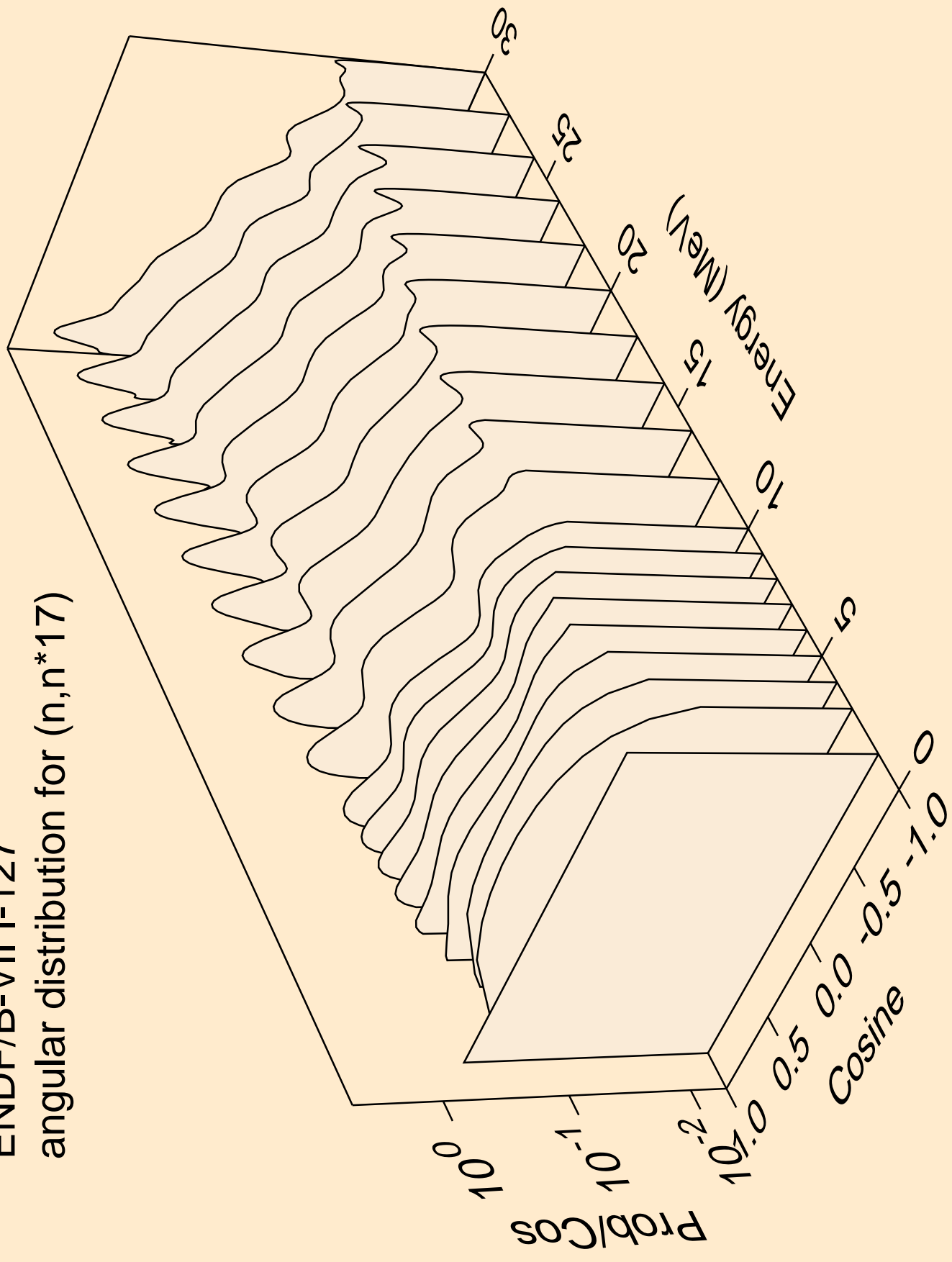

ENDF/B-VII I-127
angular distribution for (n,n*18)

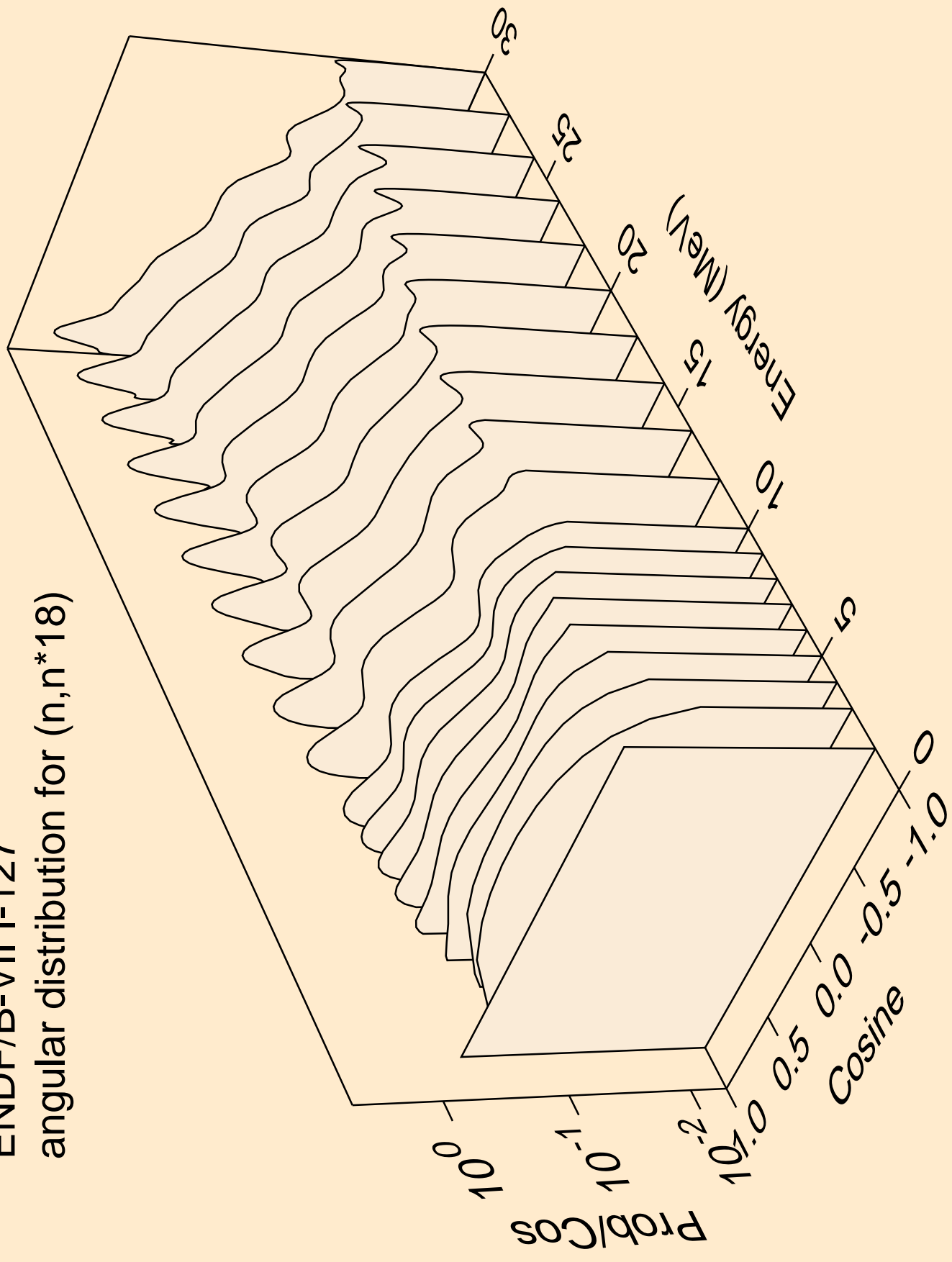

ENDF/B-VII I-127
angular distribution for (n,n*19)

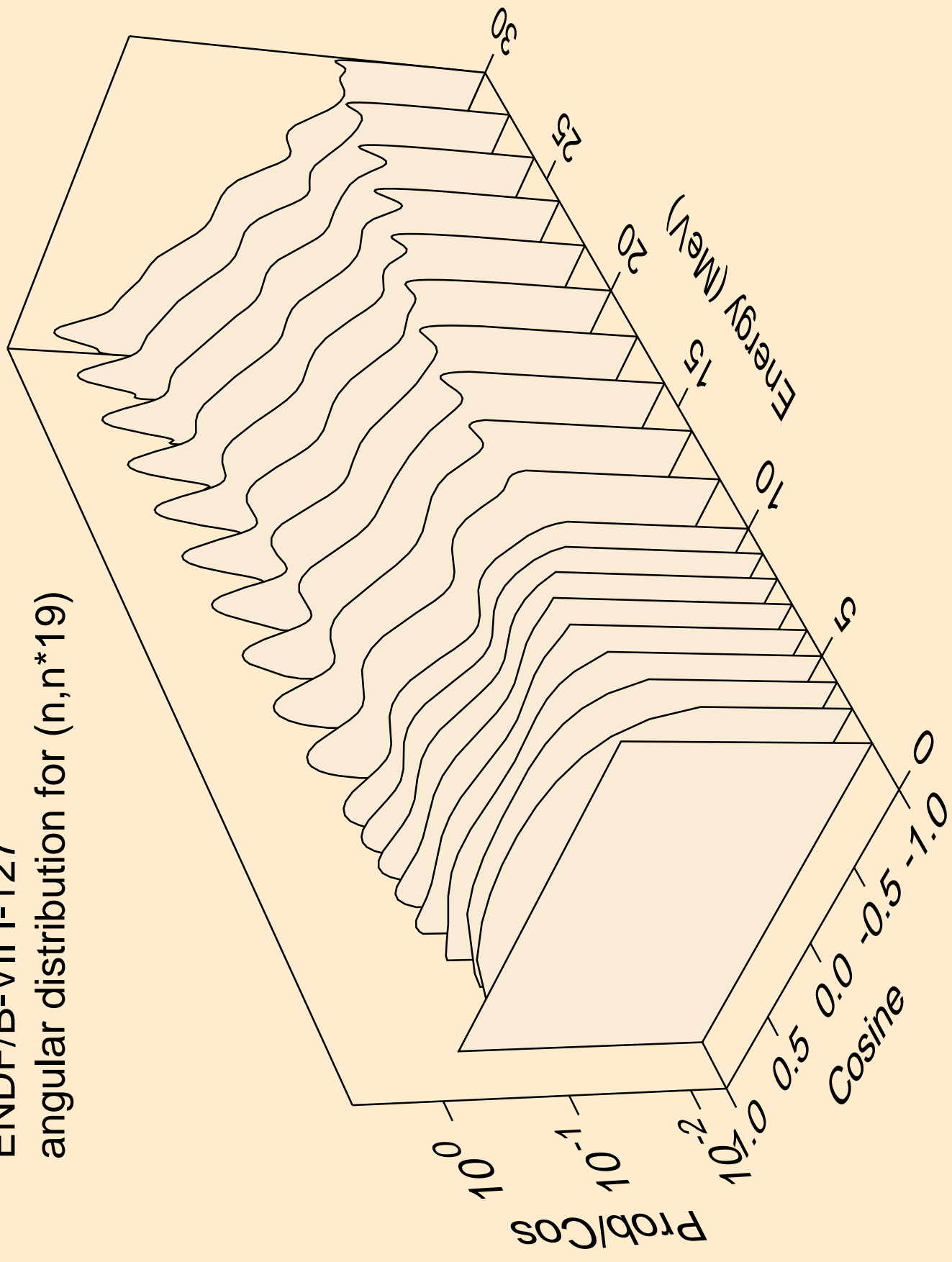

ENDF/B-VII I-127
angular distribution for (n,n*20)

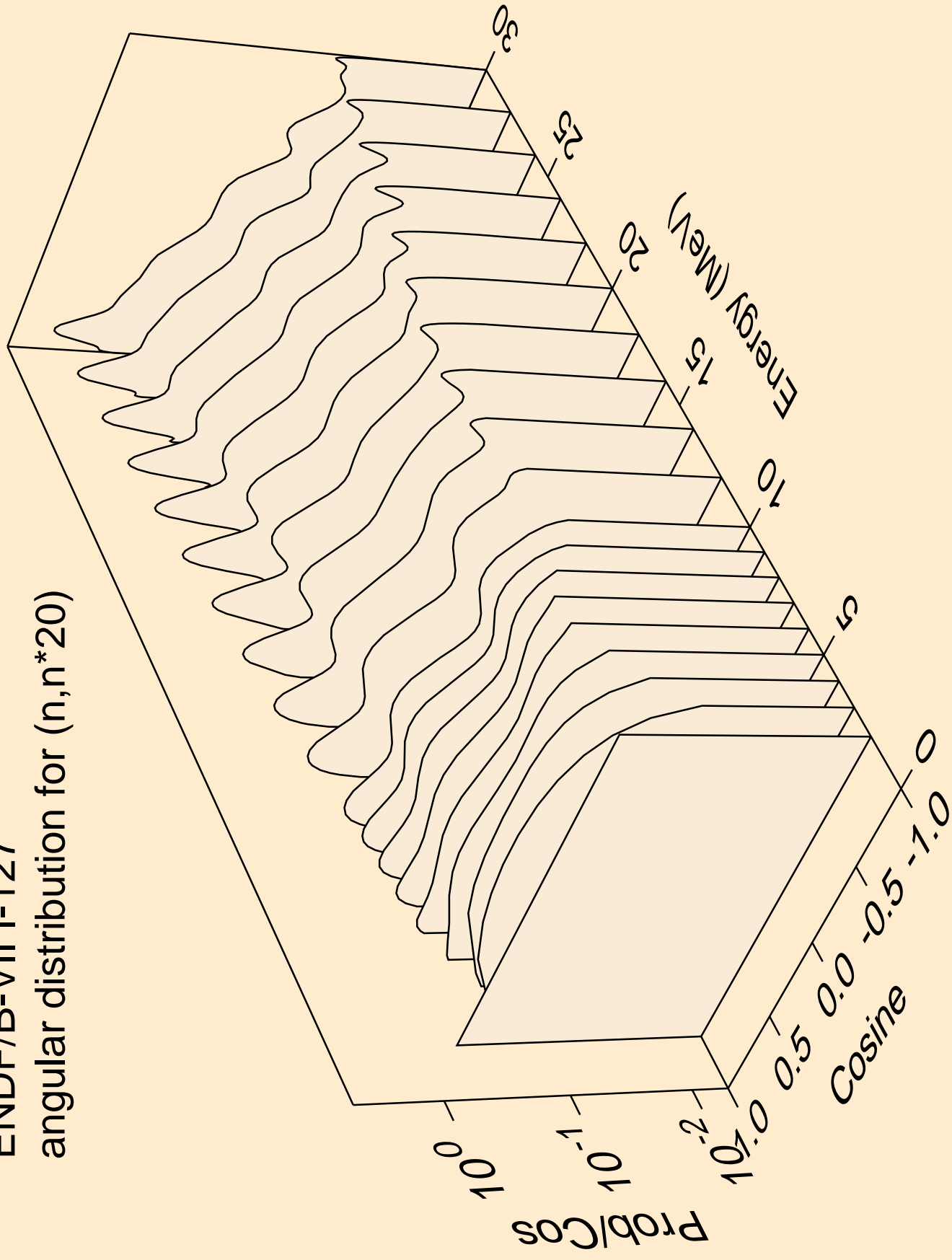

ENDF/B-VII I-127
angular distribution for (n,n*21)

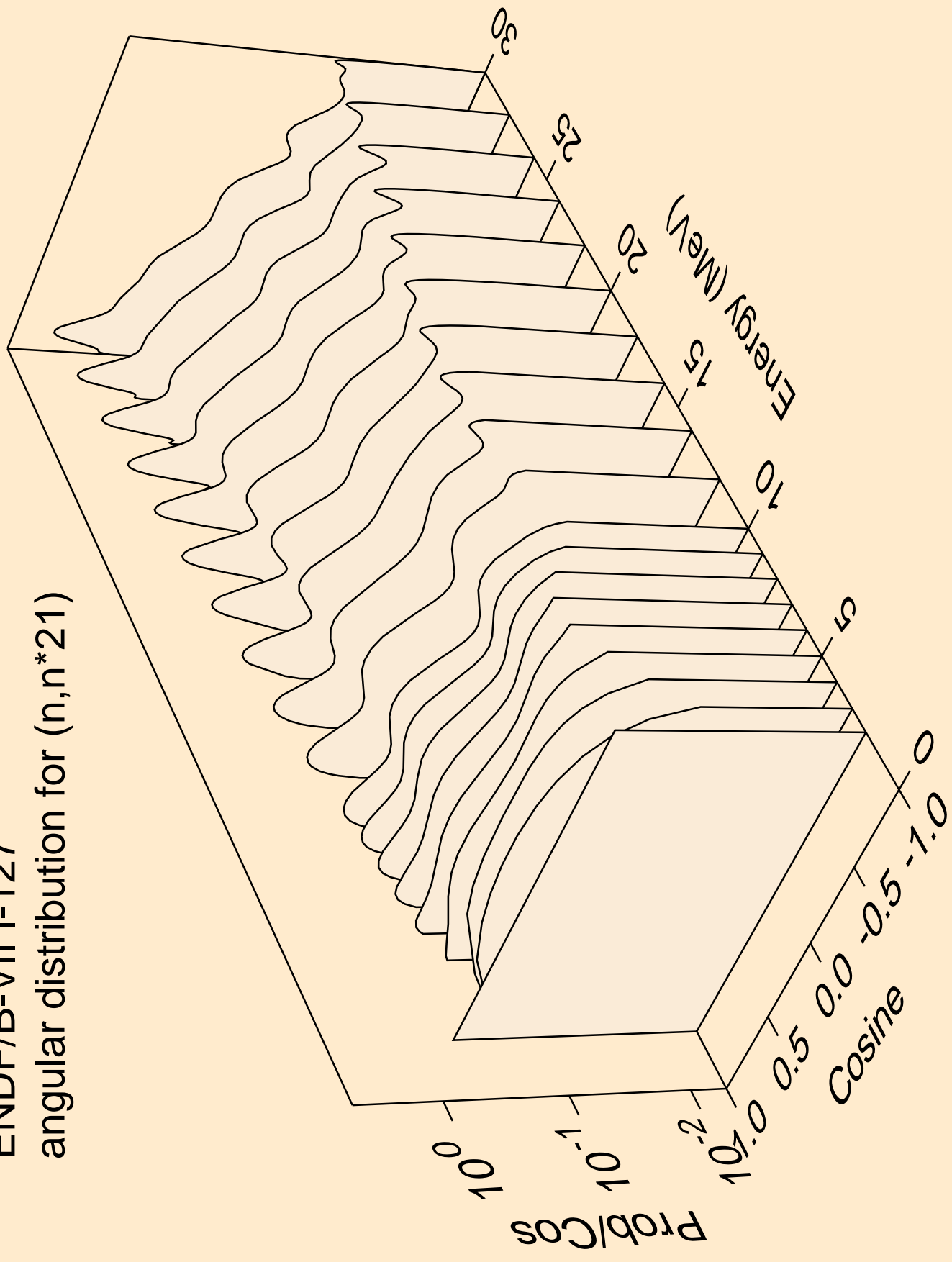

ENDF/B-VII I-127
Neutron emission for (n,2n)

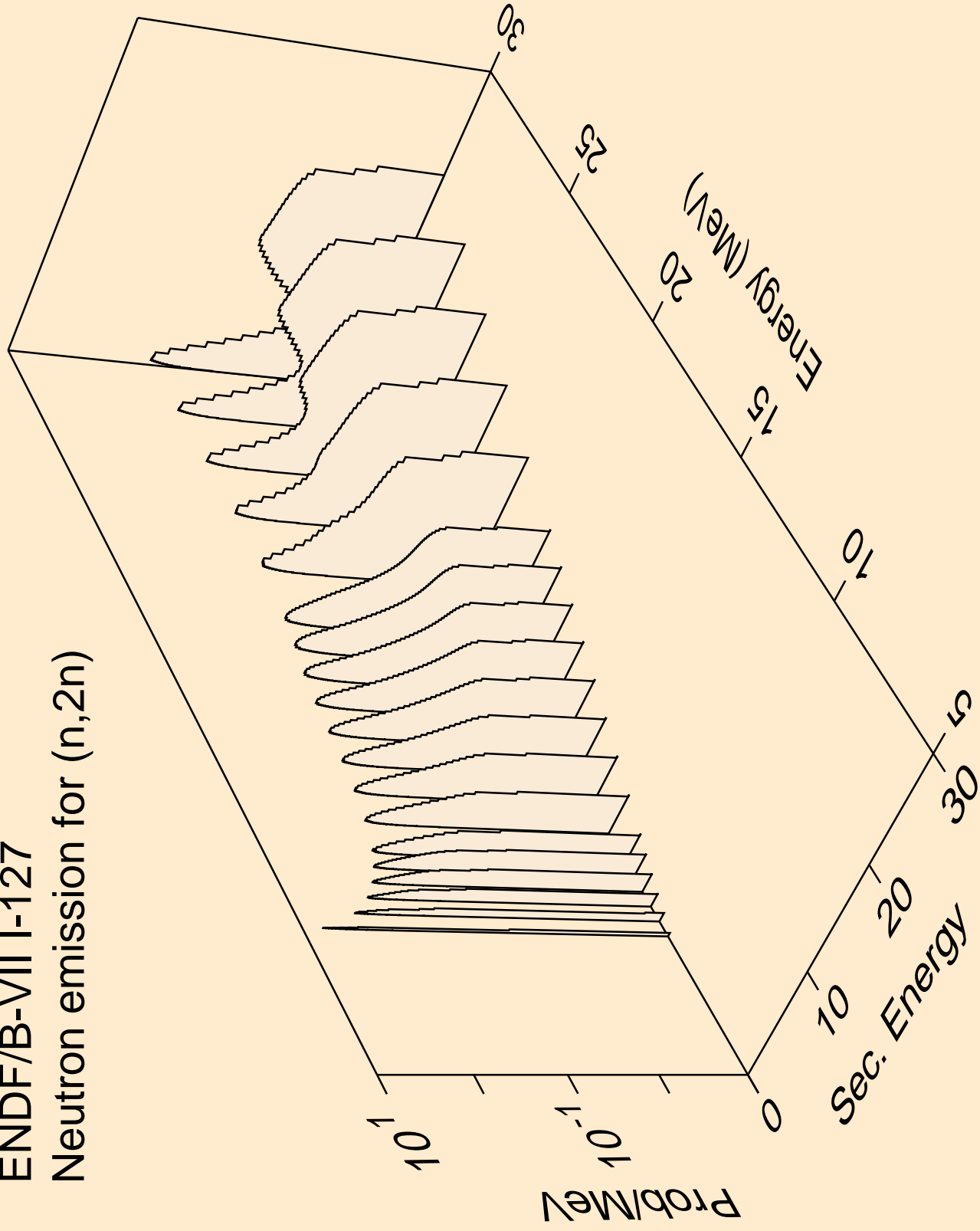

ENDF/B-VII I-127
Neutron emission for (n,3n)

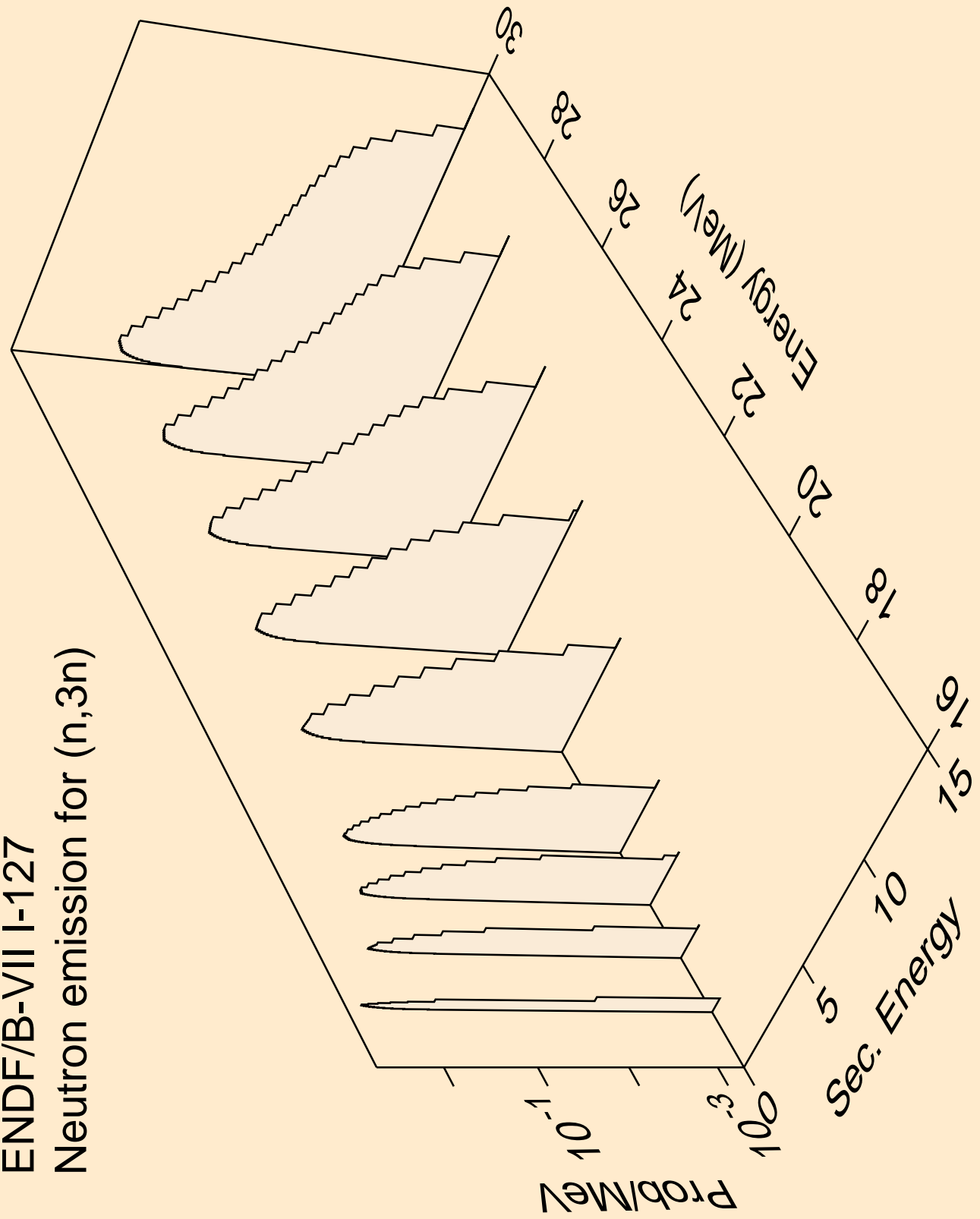

ENDF/B-VII I-127
Neutron emission for (n,n*)a

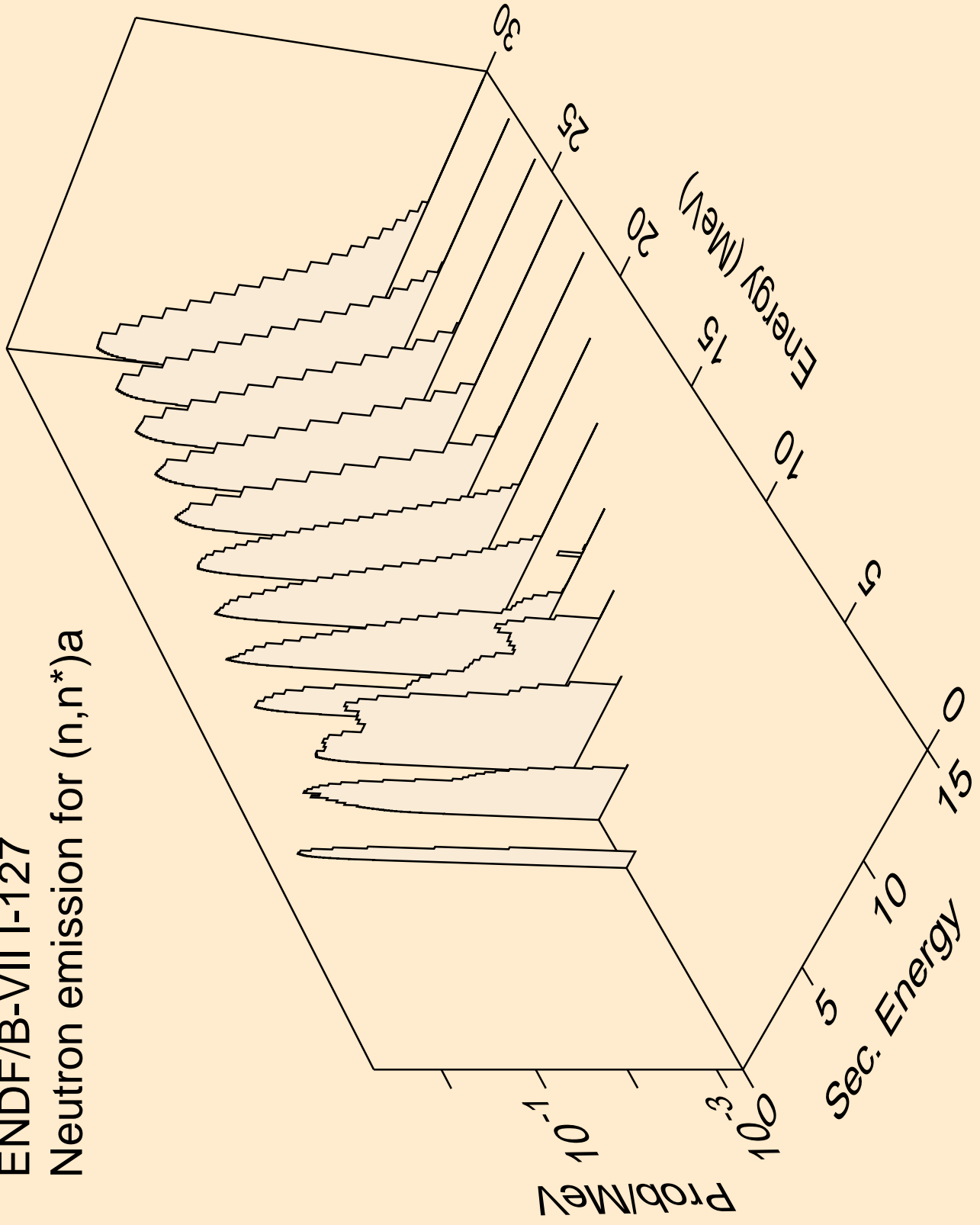

ENDF/B-VII I-127
Neutron emission for (n,n*)p

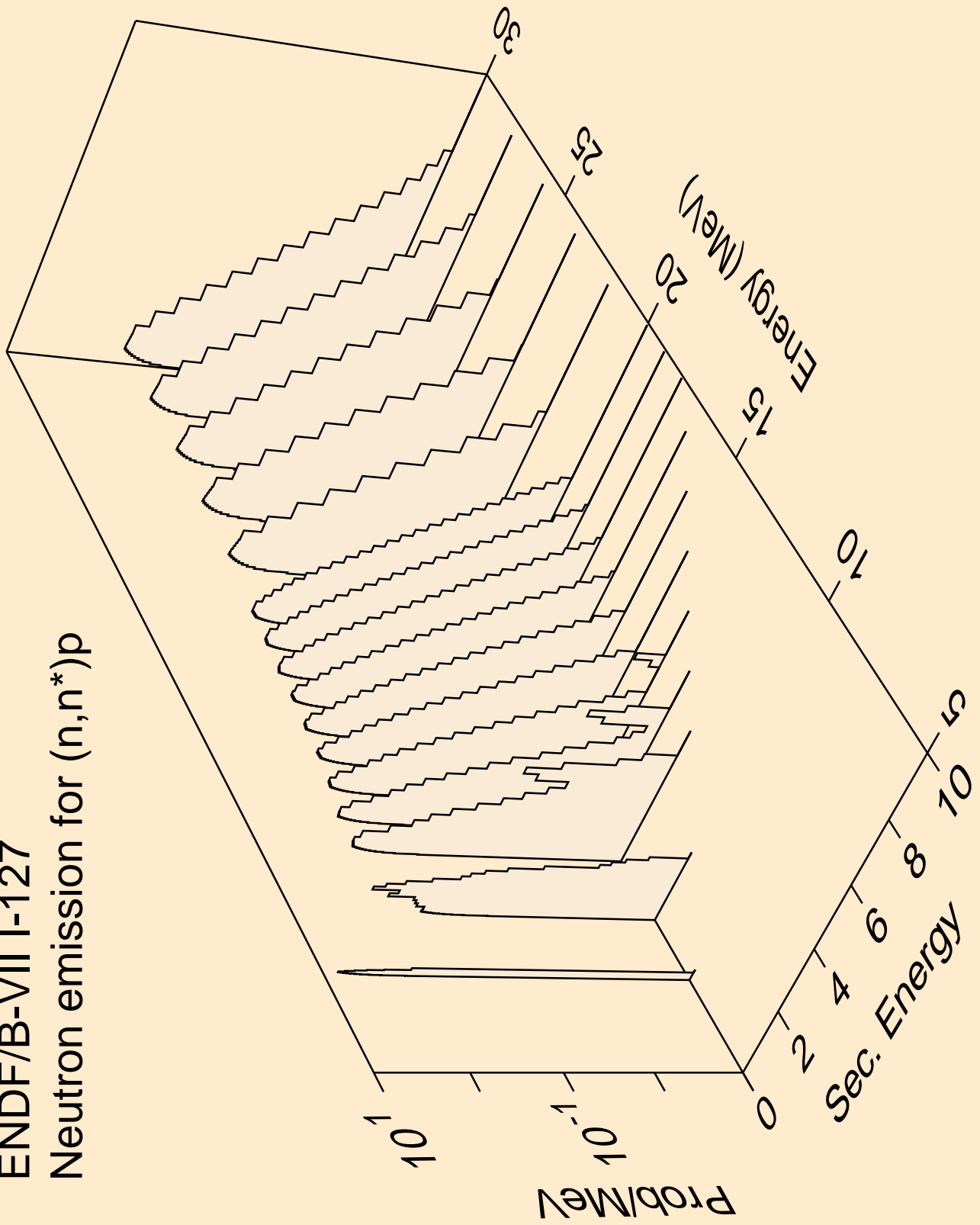

ENDF/B-VII I-127

Neutron emission for (n,4n)

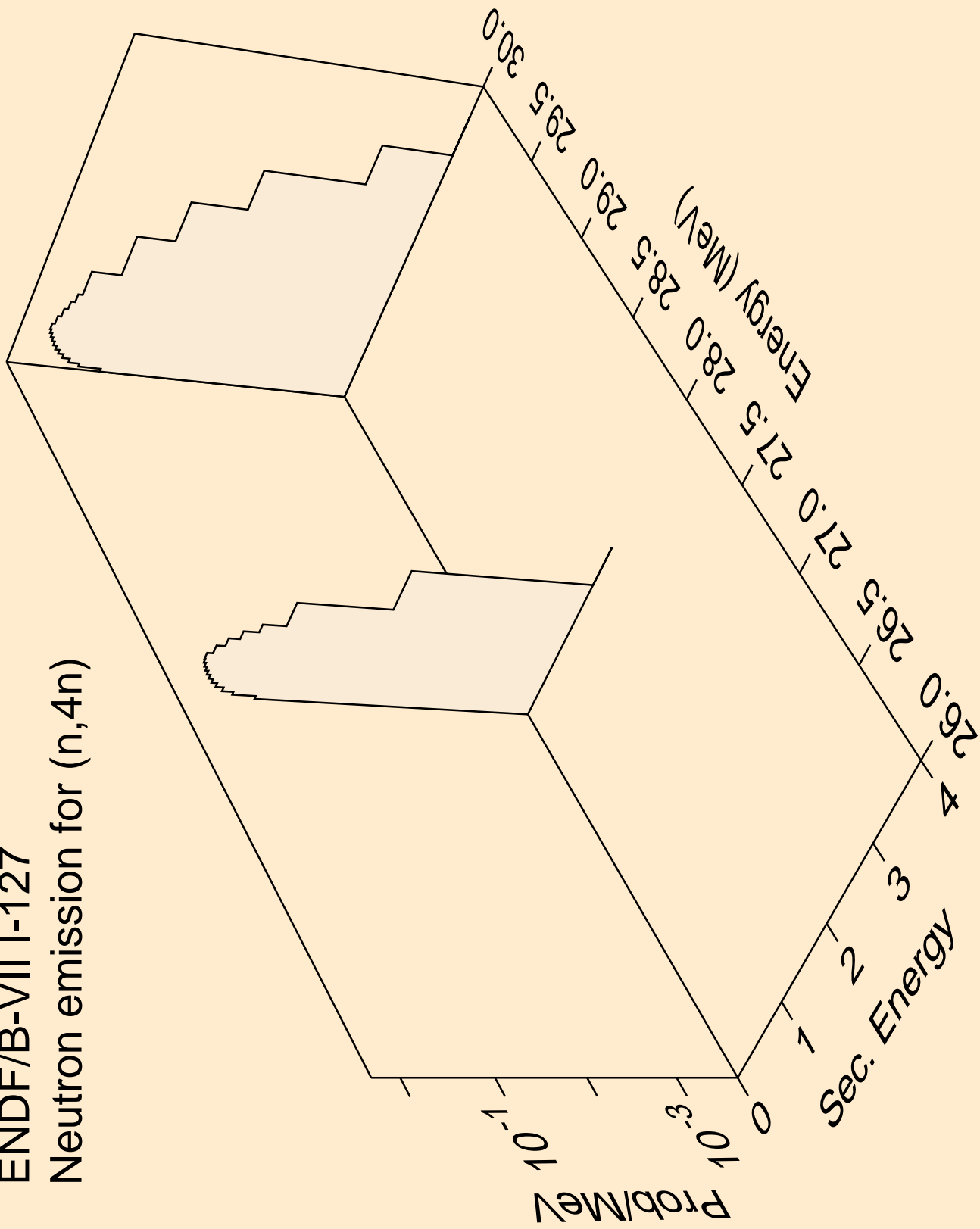

ENDF/B-VII I-127
Neutron emission for (n,n*c)

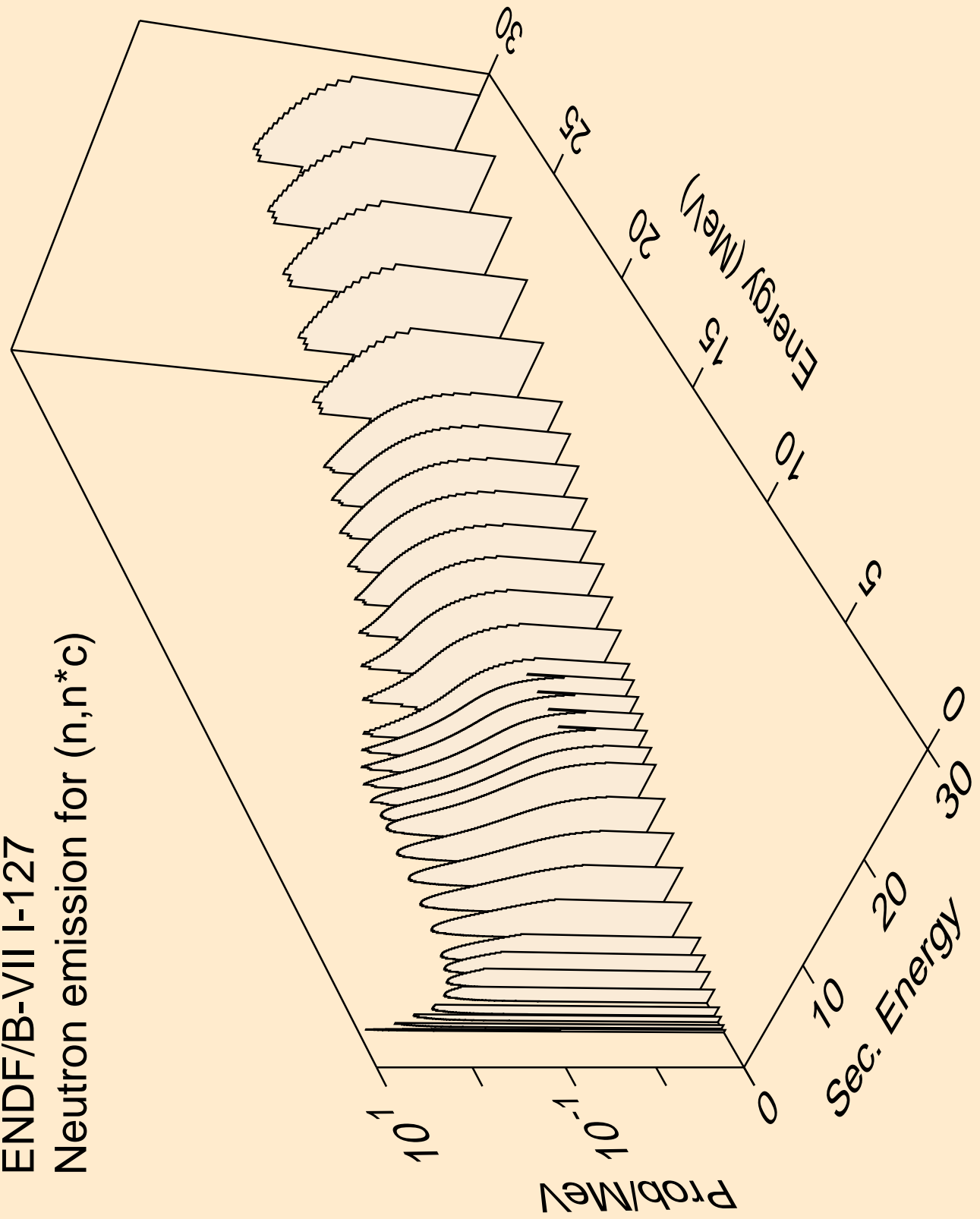

ENDF/B-VII I-127
Photon emission for (n,gma)

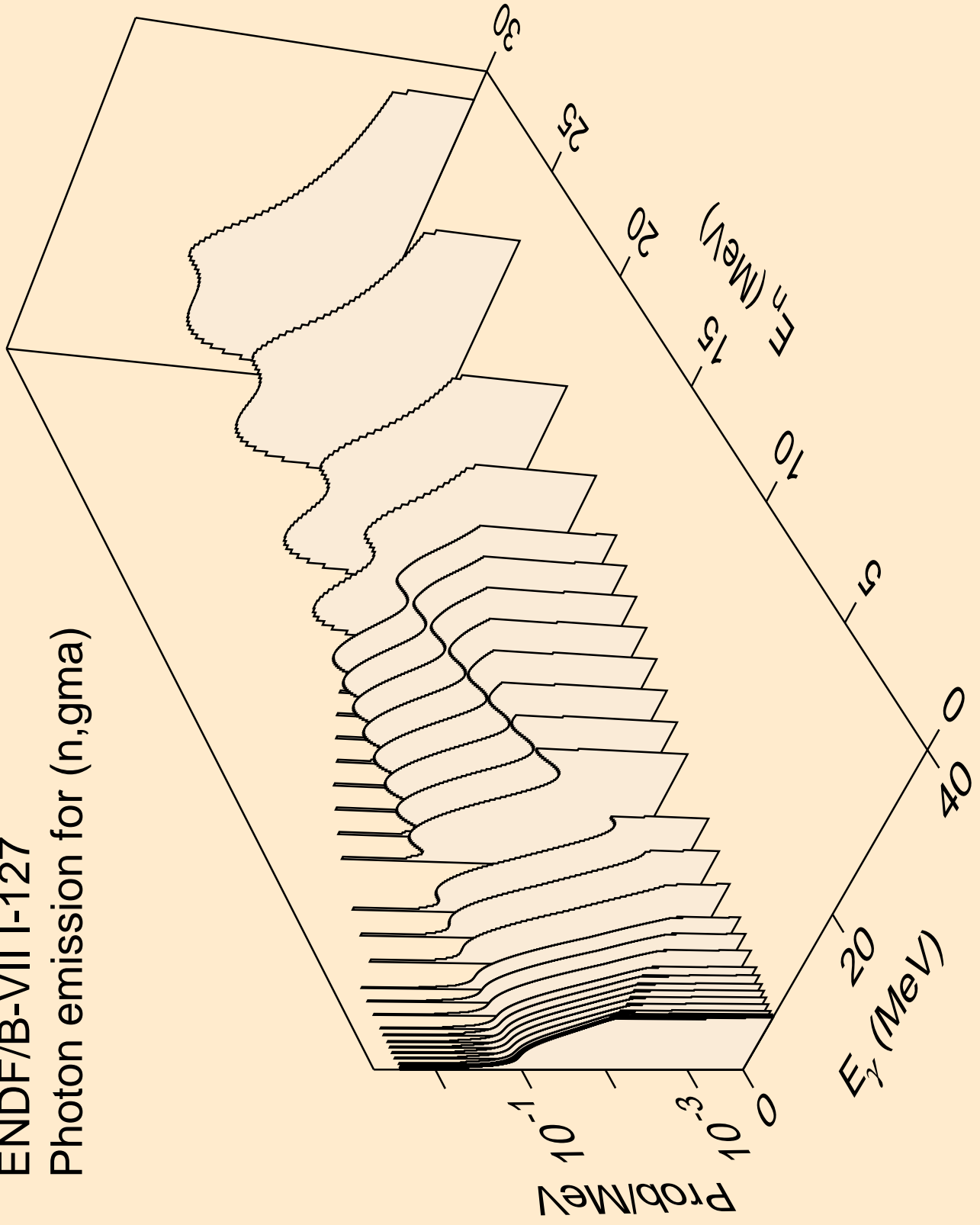

ENDF/B-VII I-127
Photon emission for (n,2n)

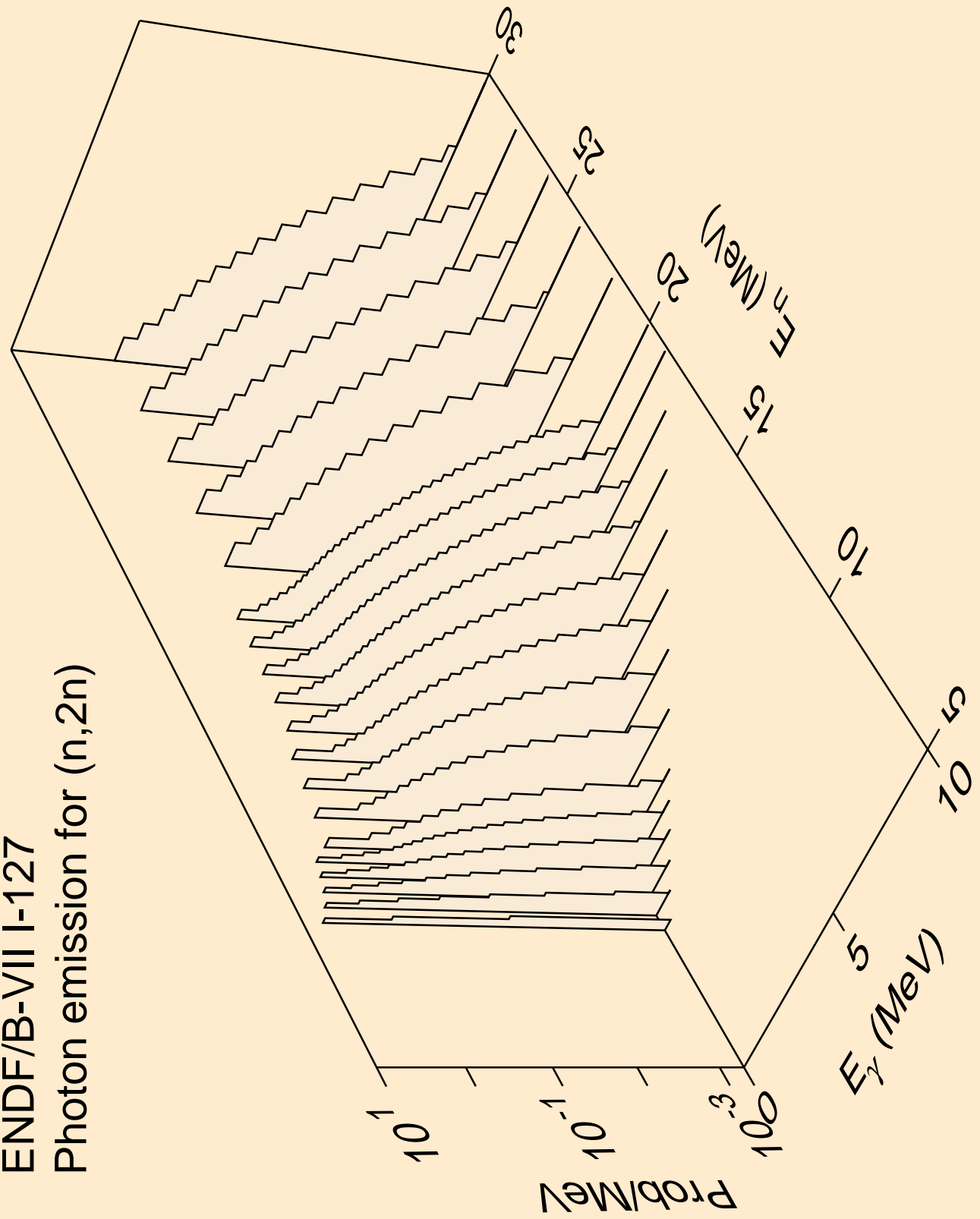

ENDF/B-VII I-127
Photon emission for (n,3n)

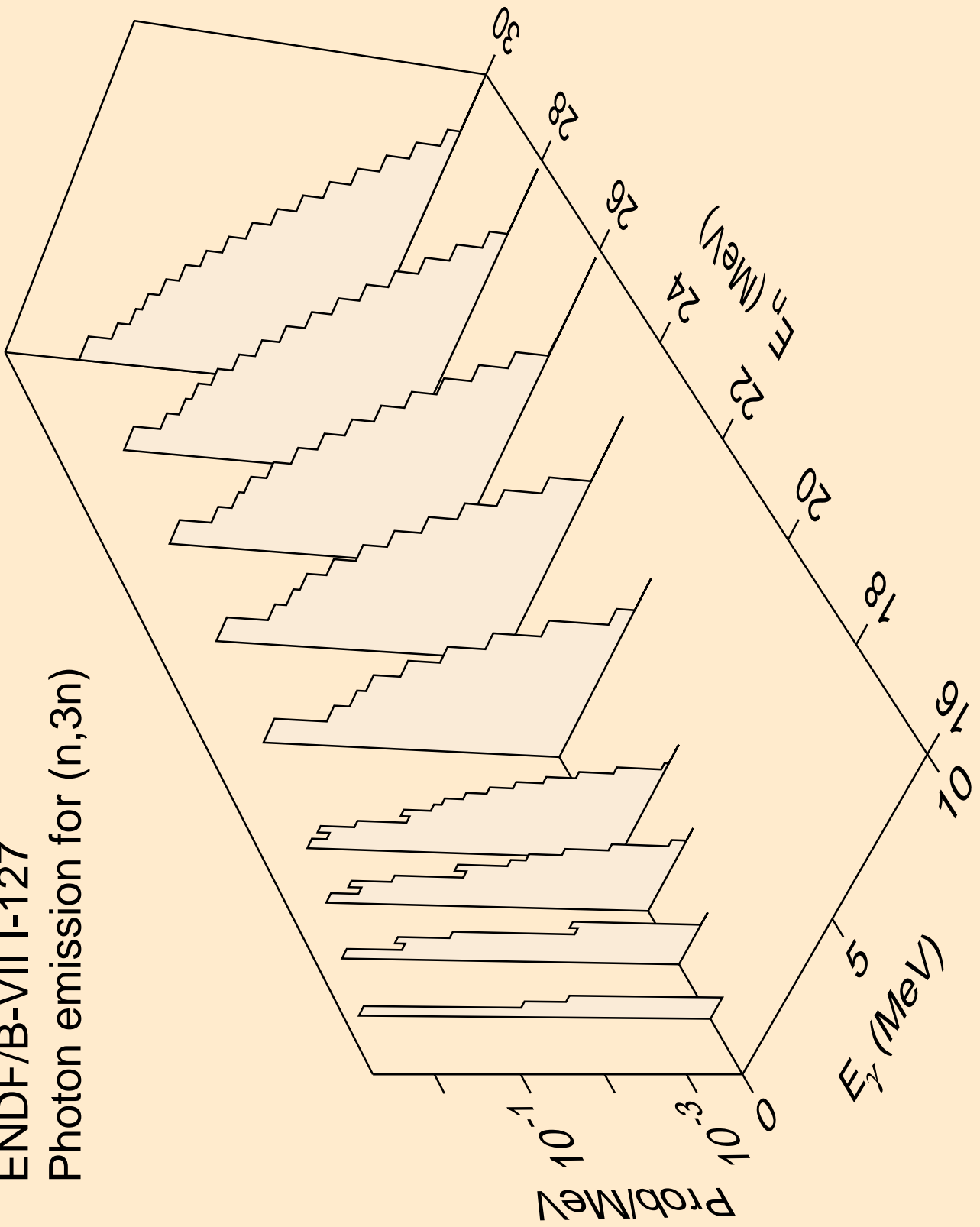

ENDF/B-VII I-127
Photon emission for (n,n*)a

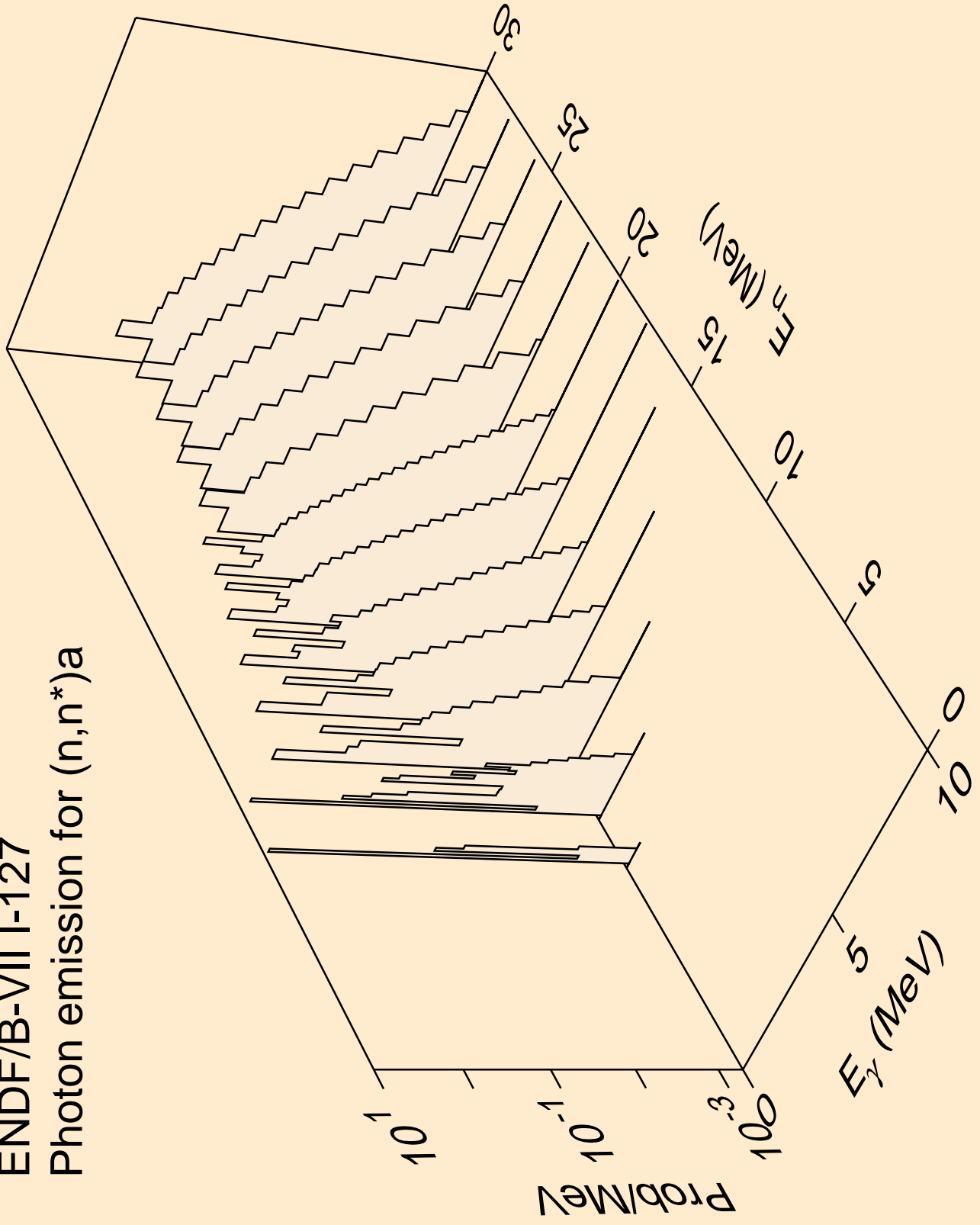

ENDF/B-VII I-127
Photon emission for (n,n*)p

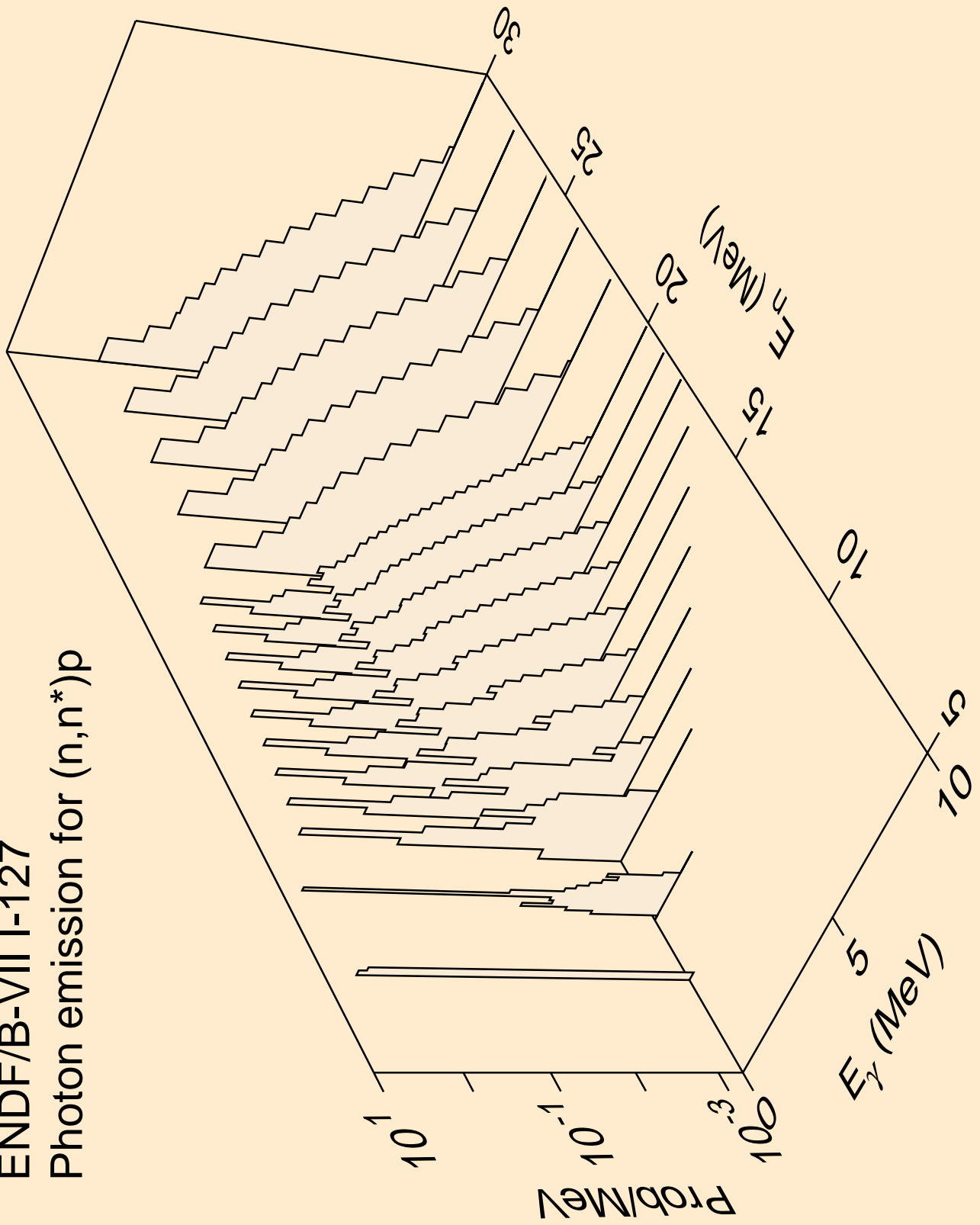

ENDF/B-VII I-127
Photon emission for (n,4n)

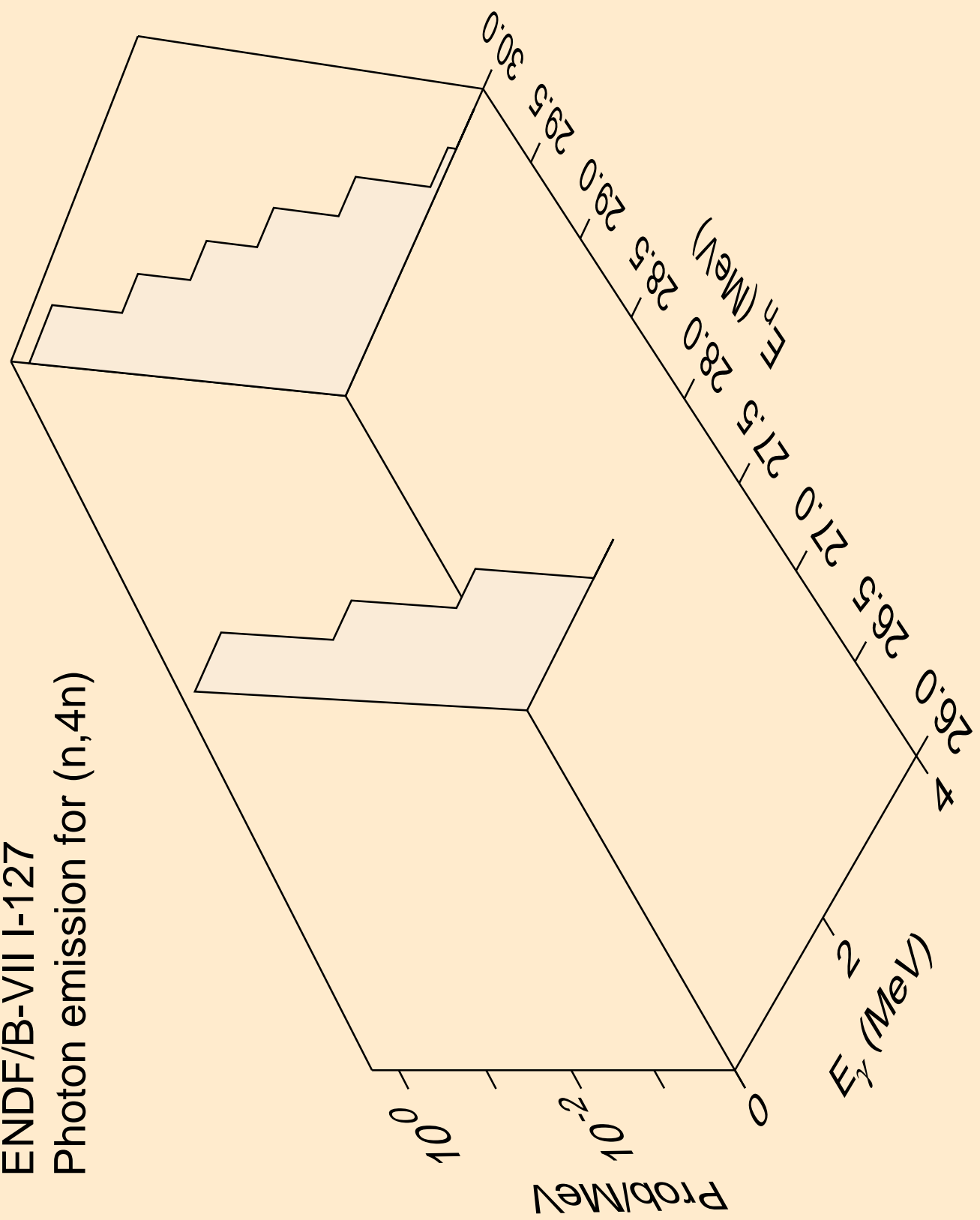

ENDF/B-VII I-127
Photon emission for (n,n*1)

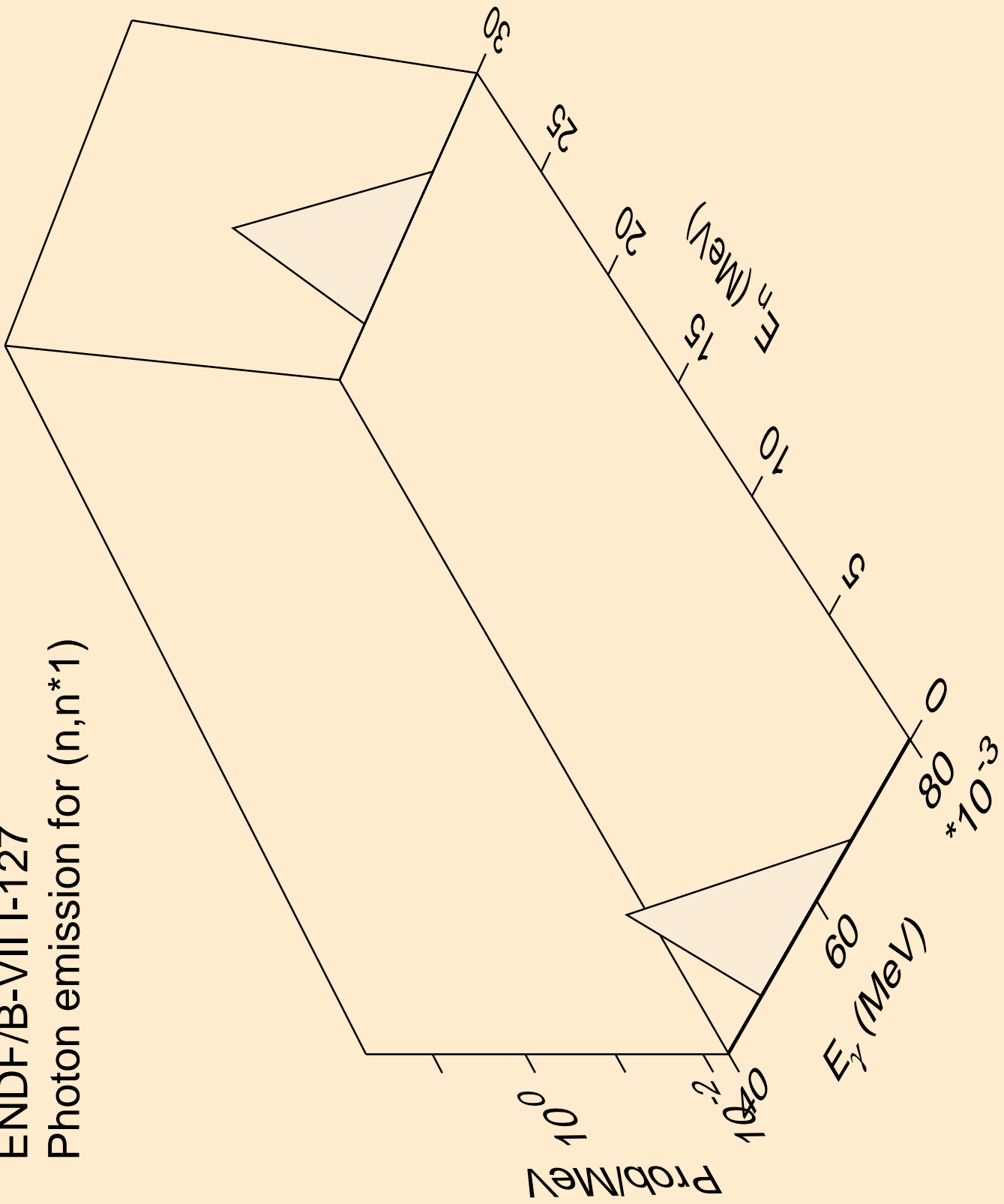

ENDF/B-VII I-127
Photon emission for (n,n*2)

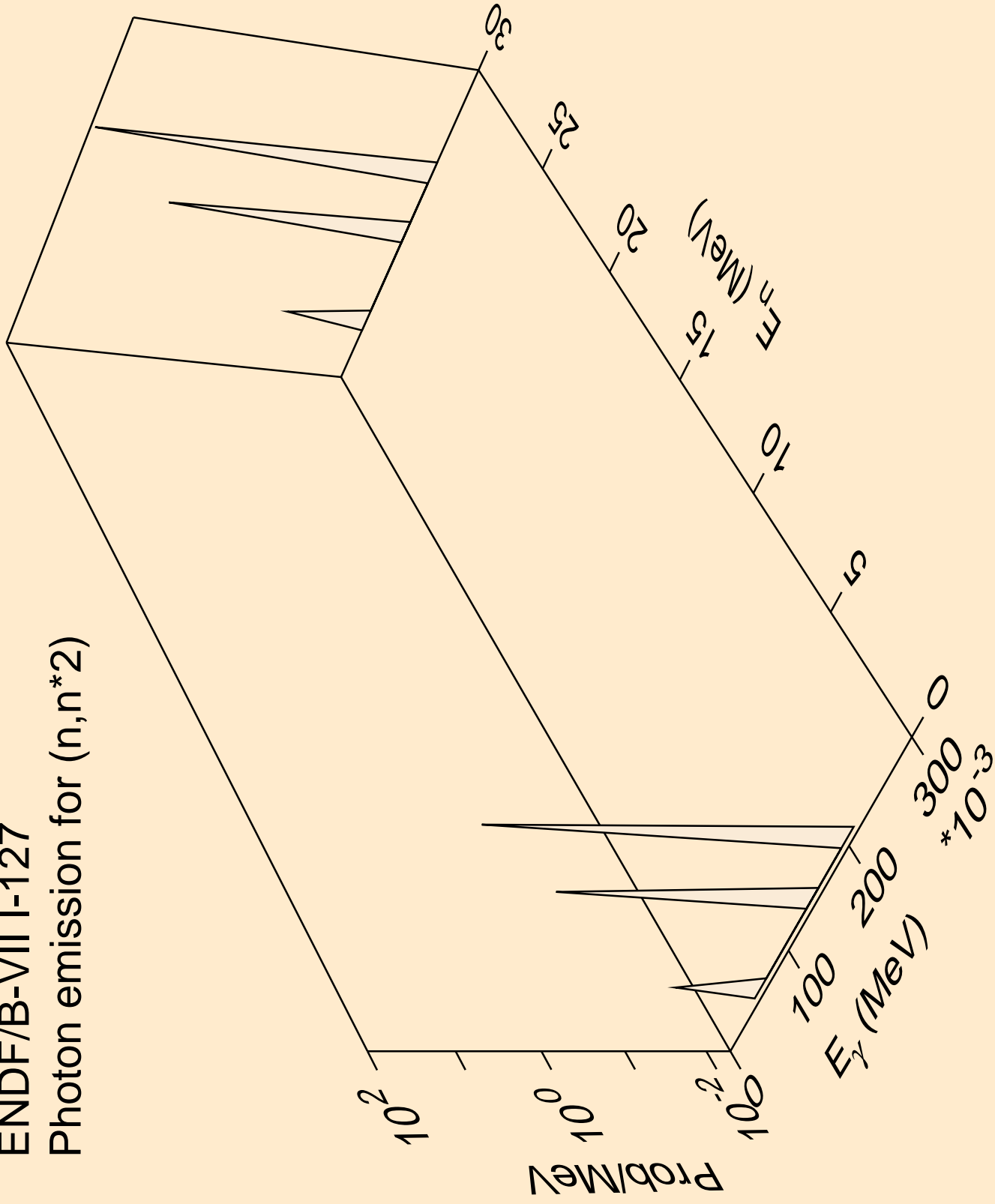

ENDF/B-VII I-127
Photon emission for (n,n*3)

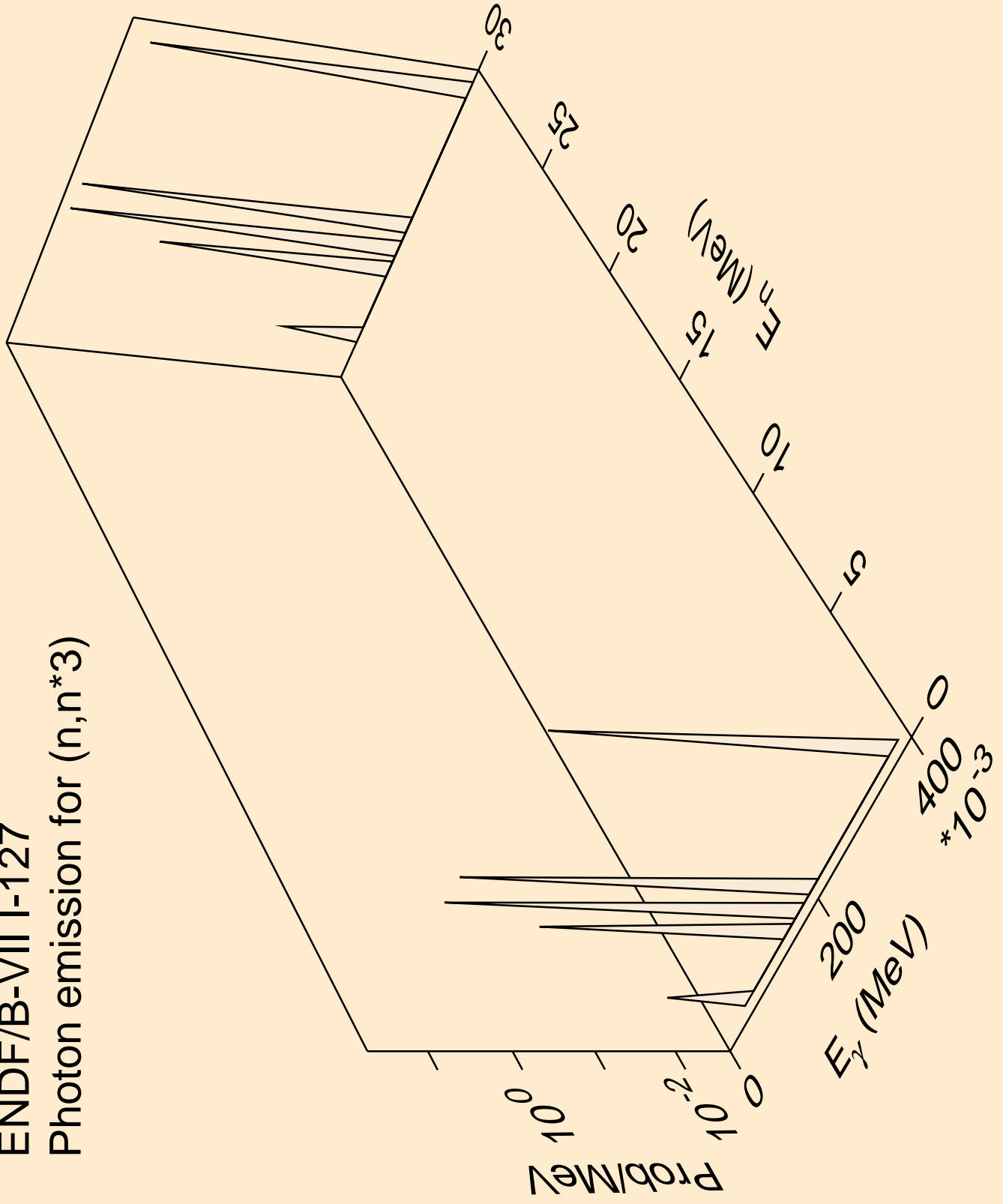

ENDF/B-VII I-127
Photon emission for (n,n*4)

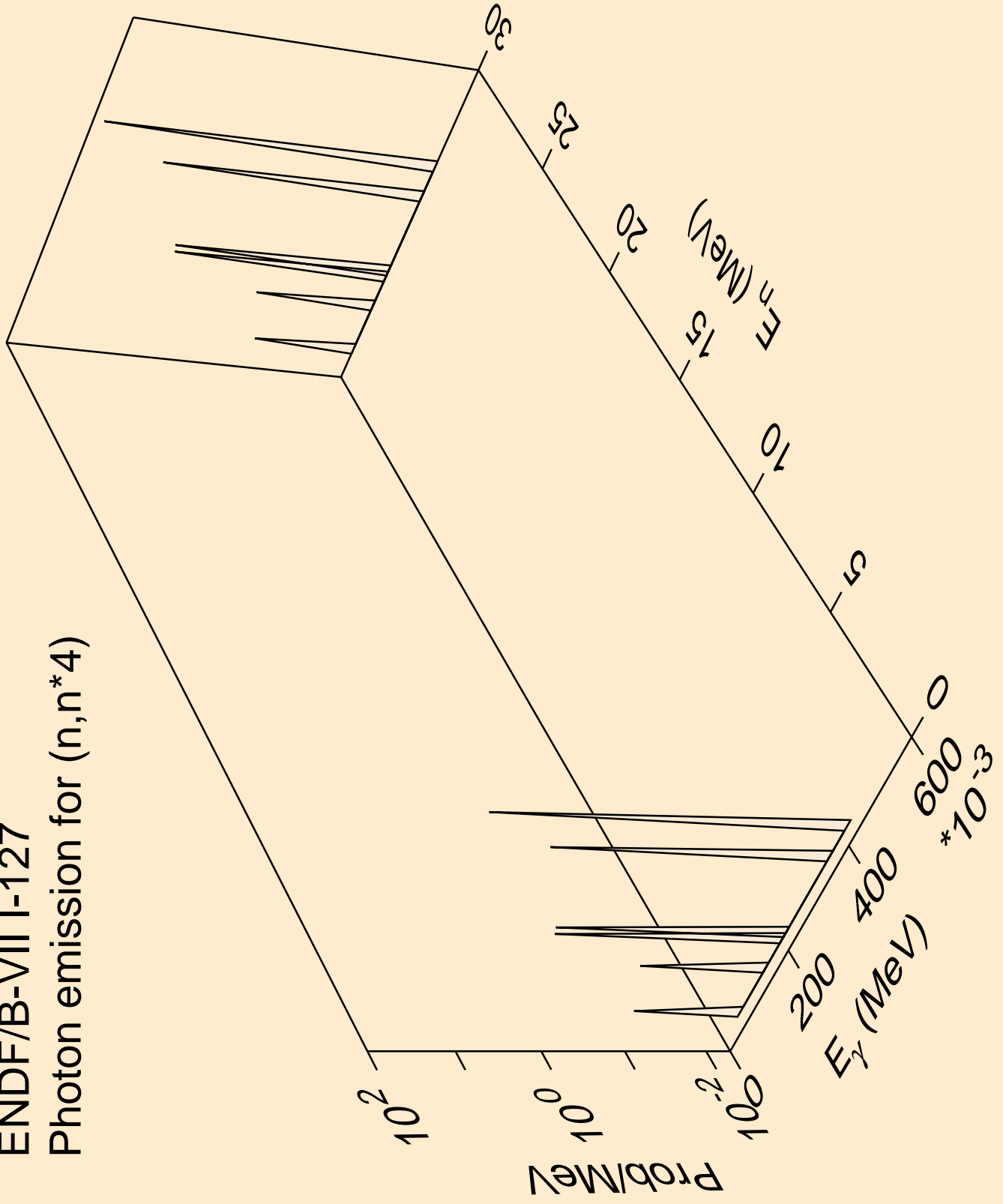

ENDF/B-VII I-127
Photon emission for (n,n*5)

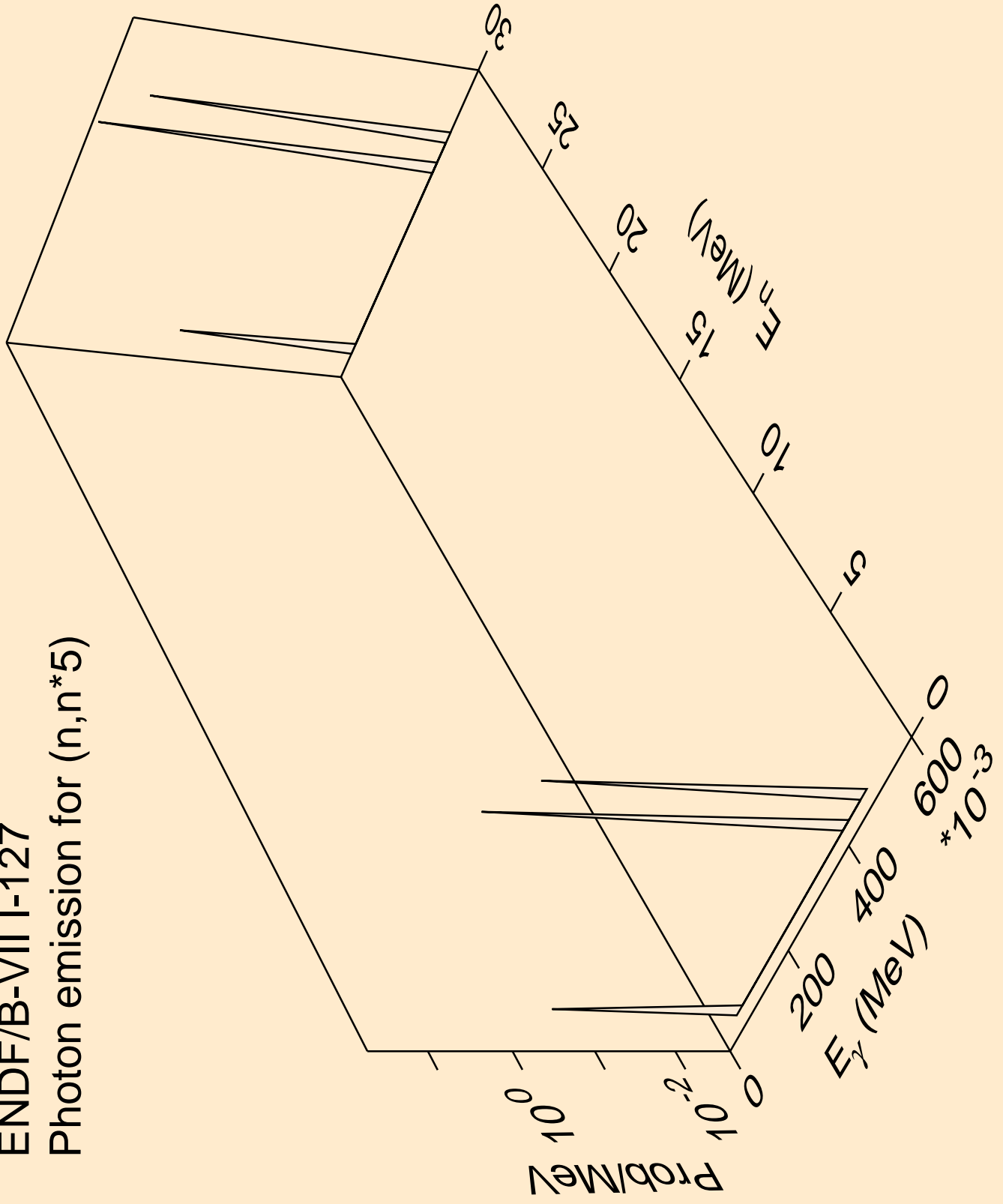

ENDF/B-VII I-127
Photon emission for (n,n*6)

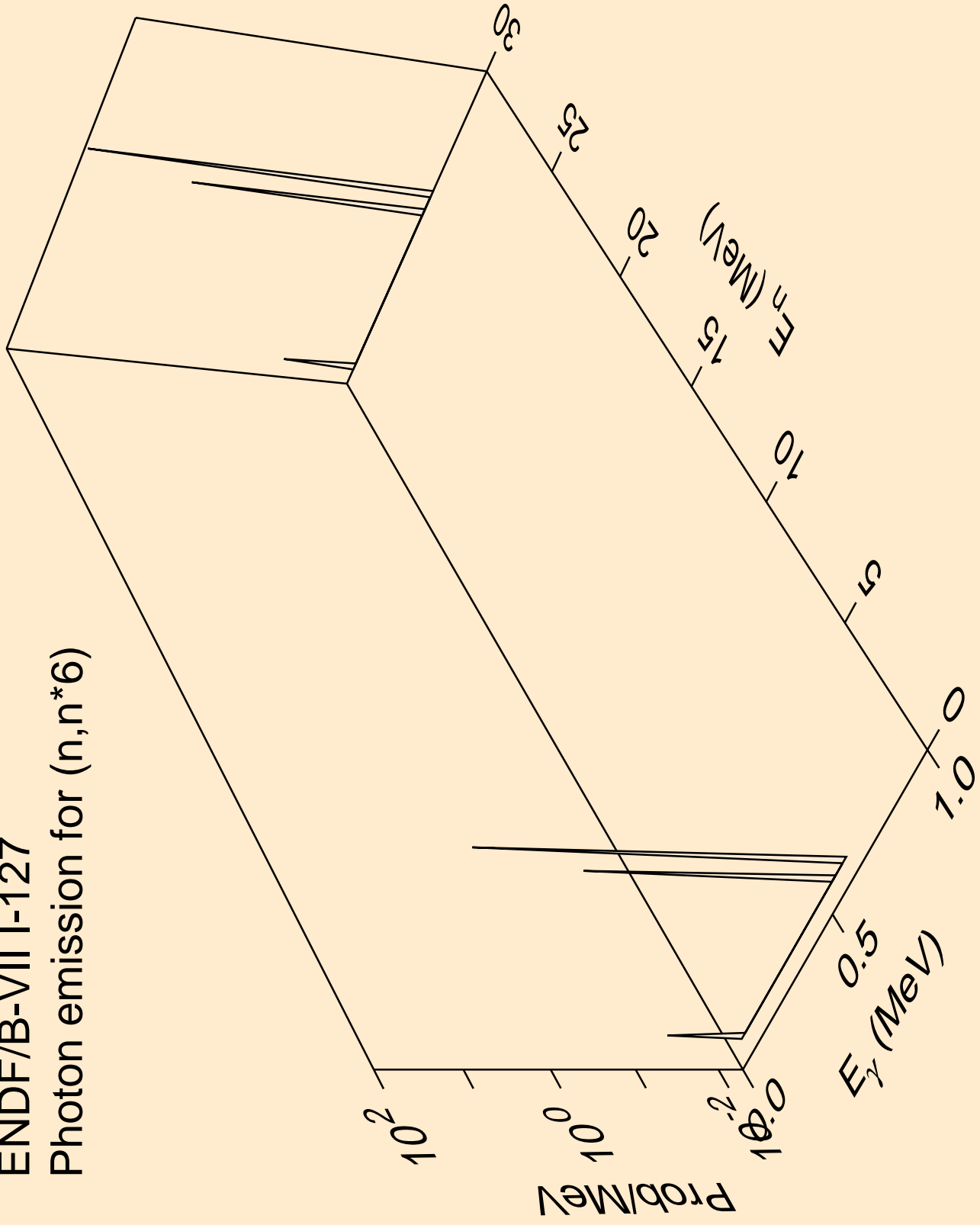

ENDF/B-VII I-127
Photon emission for (n,n*7)

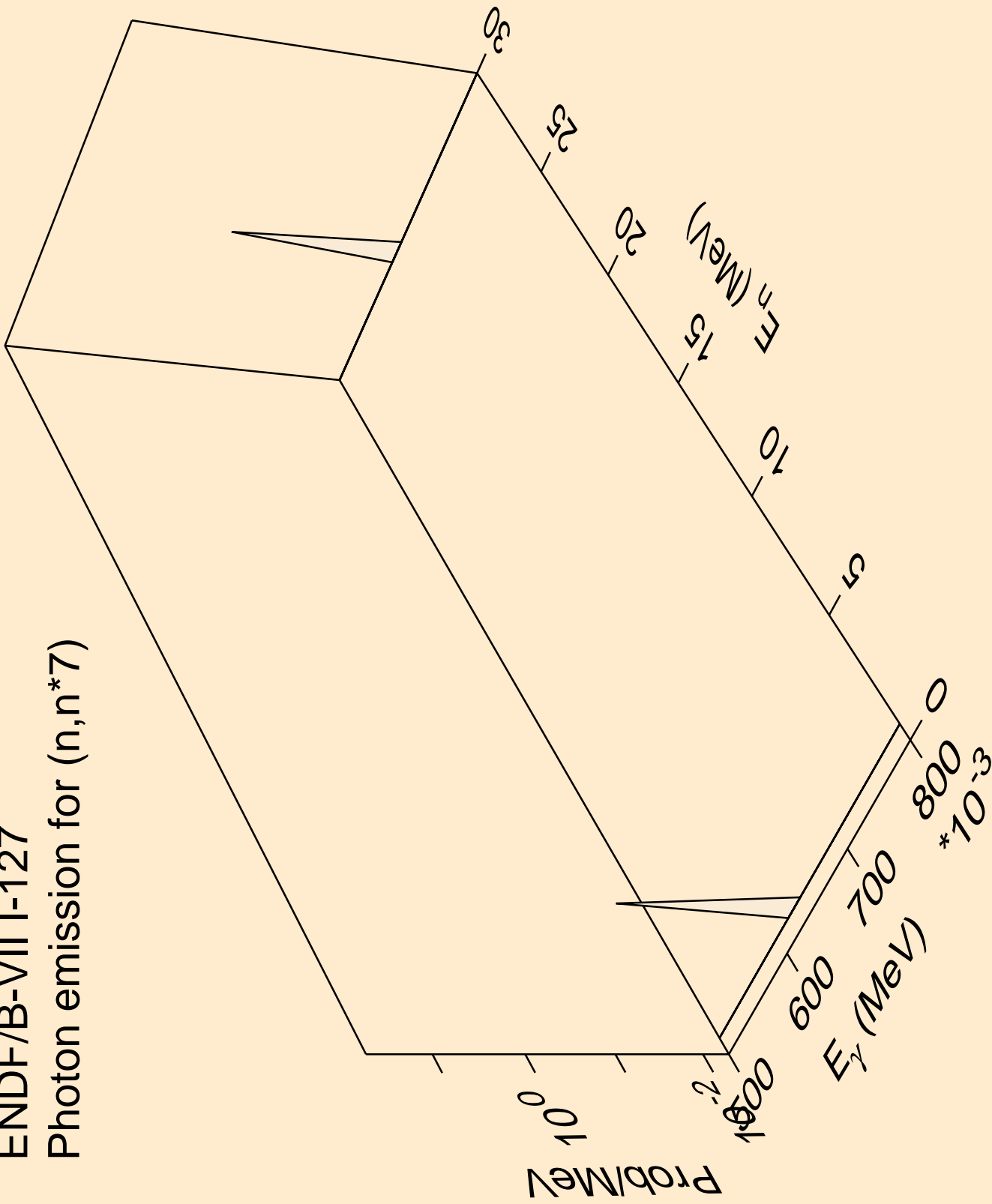

ENDF/B-VII I-127
Photon emission for (n,n*8)

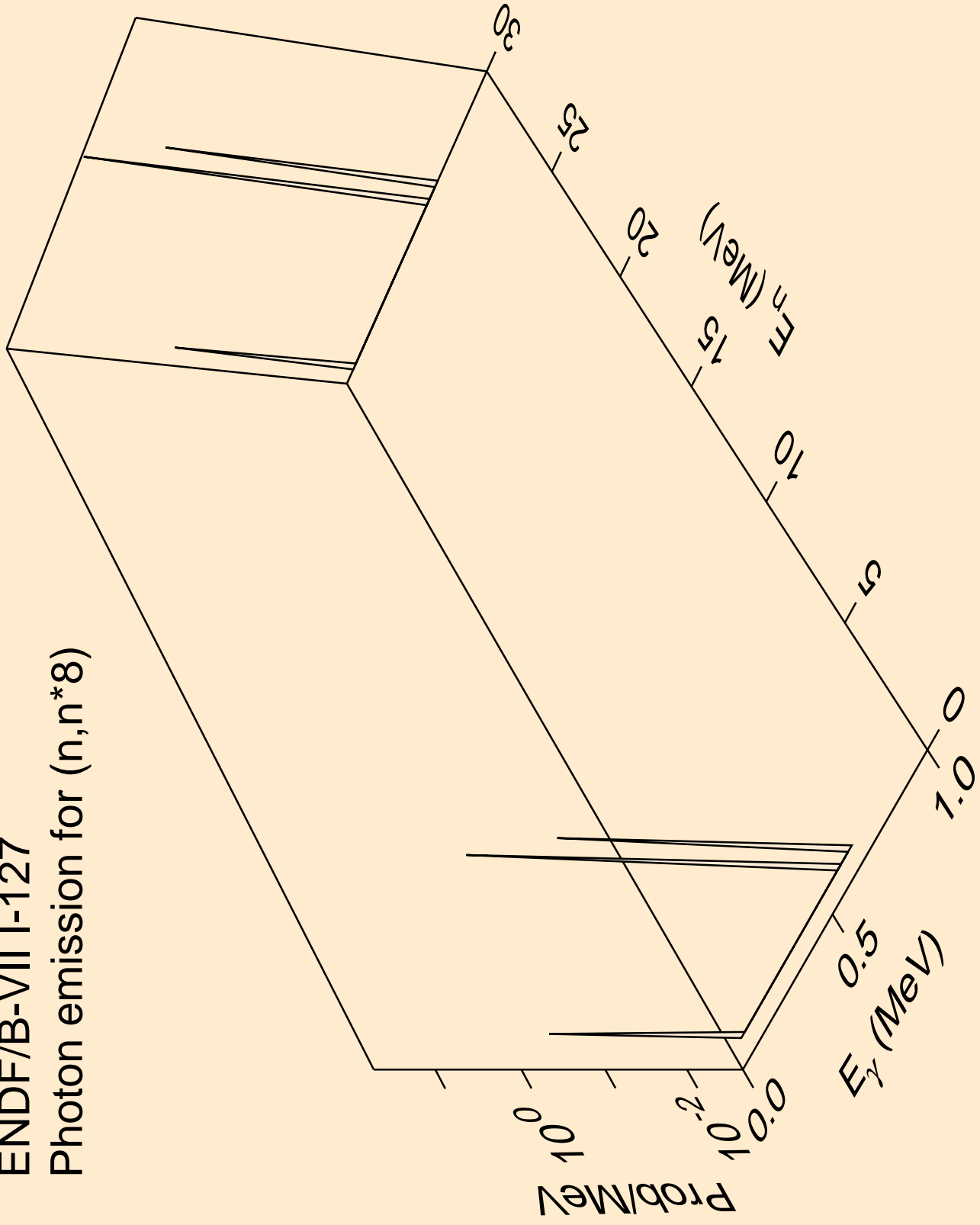

ENDF/B-VII I-127
Photon emission for (n,n*9)

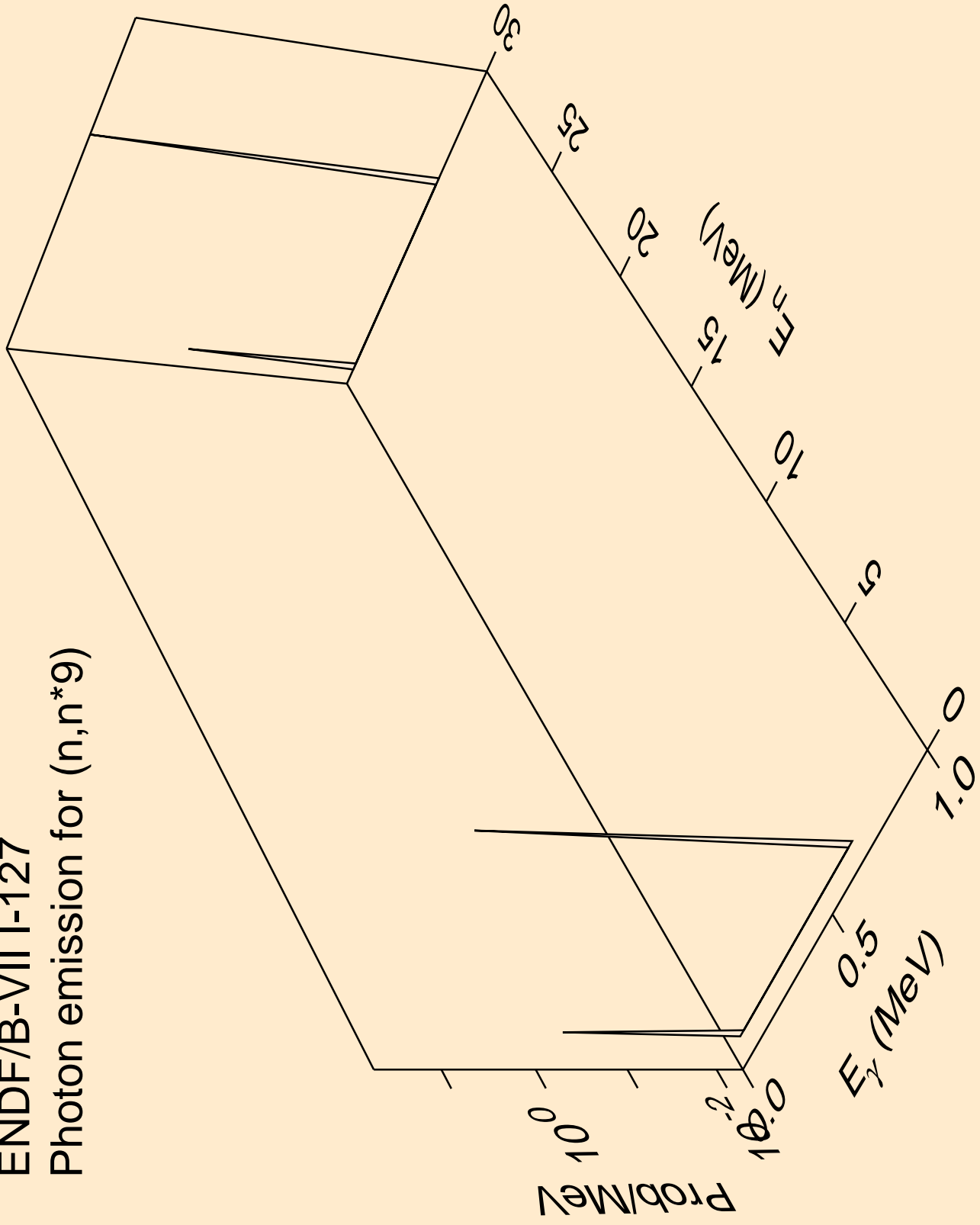

ENDF/B-VII I-127
Photon emission for (n,n*10)

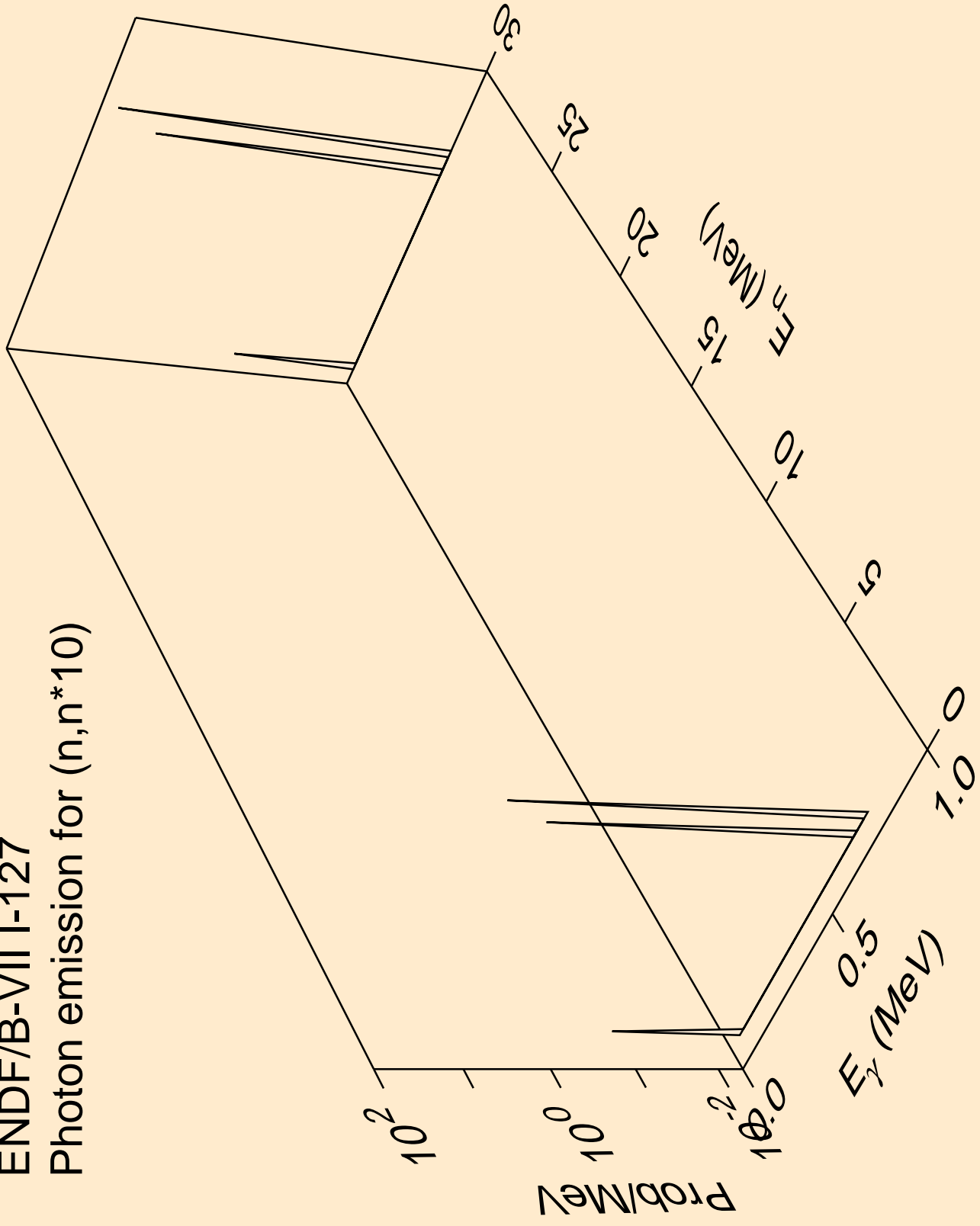

ENDF/B-VII I-127
Photon emission for (n,n*11)

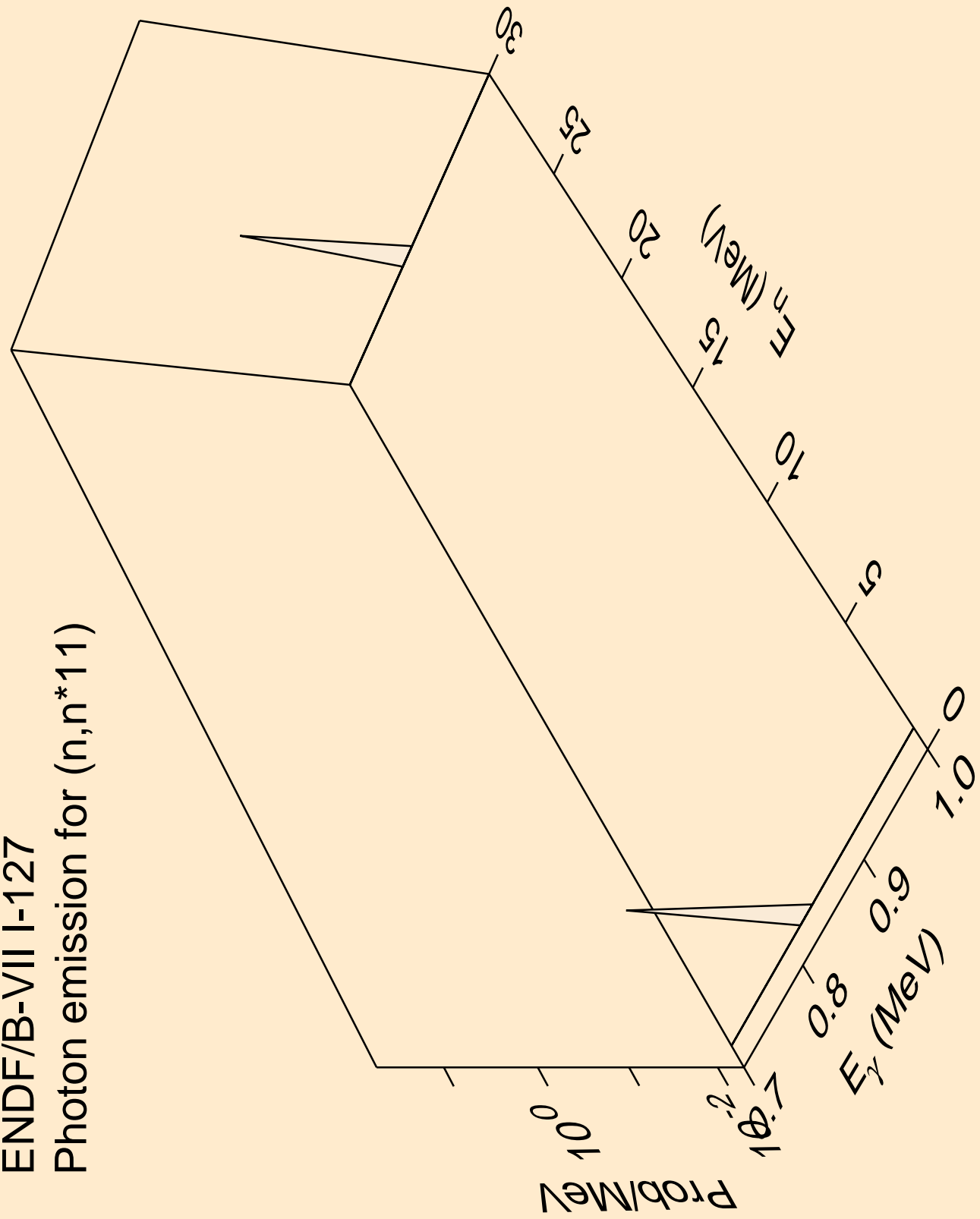

ENDF/B-VII I-127
Photon emission for (n,n*12)

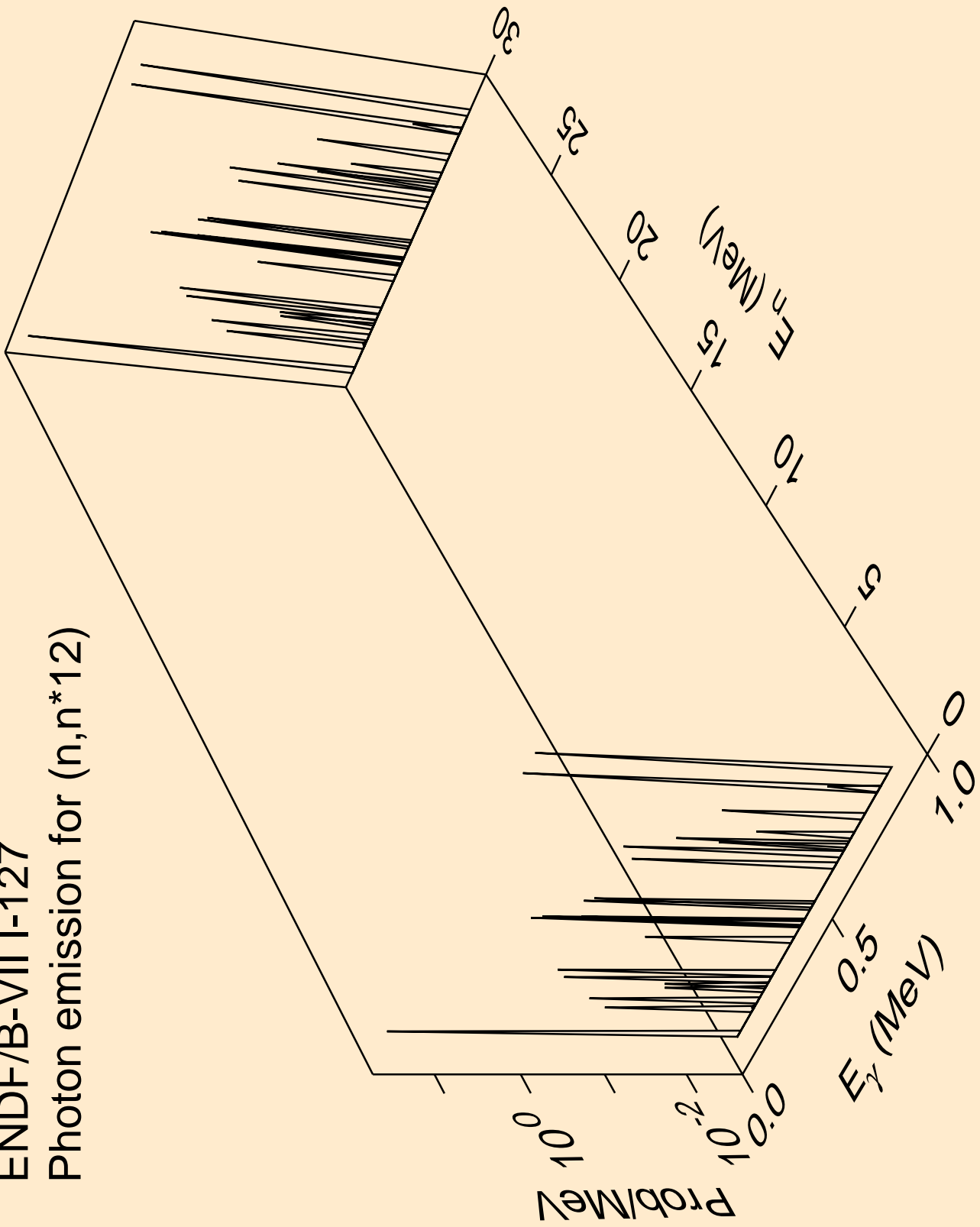

ENDF/B-VII I-127
Photon emission for (n,n*13)

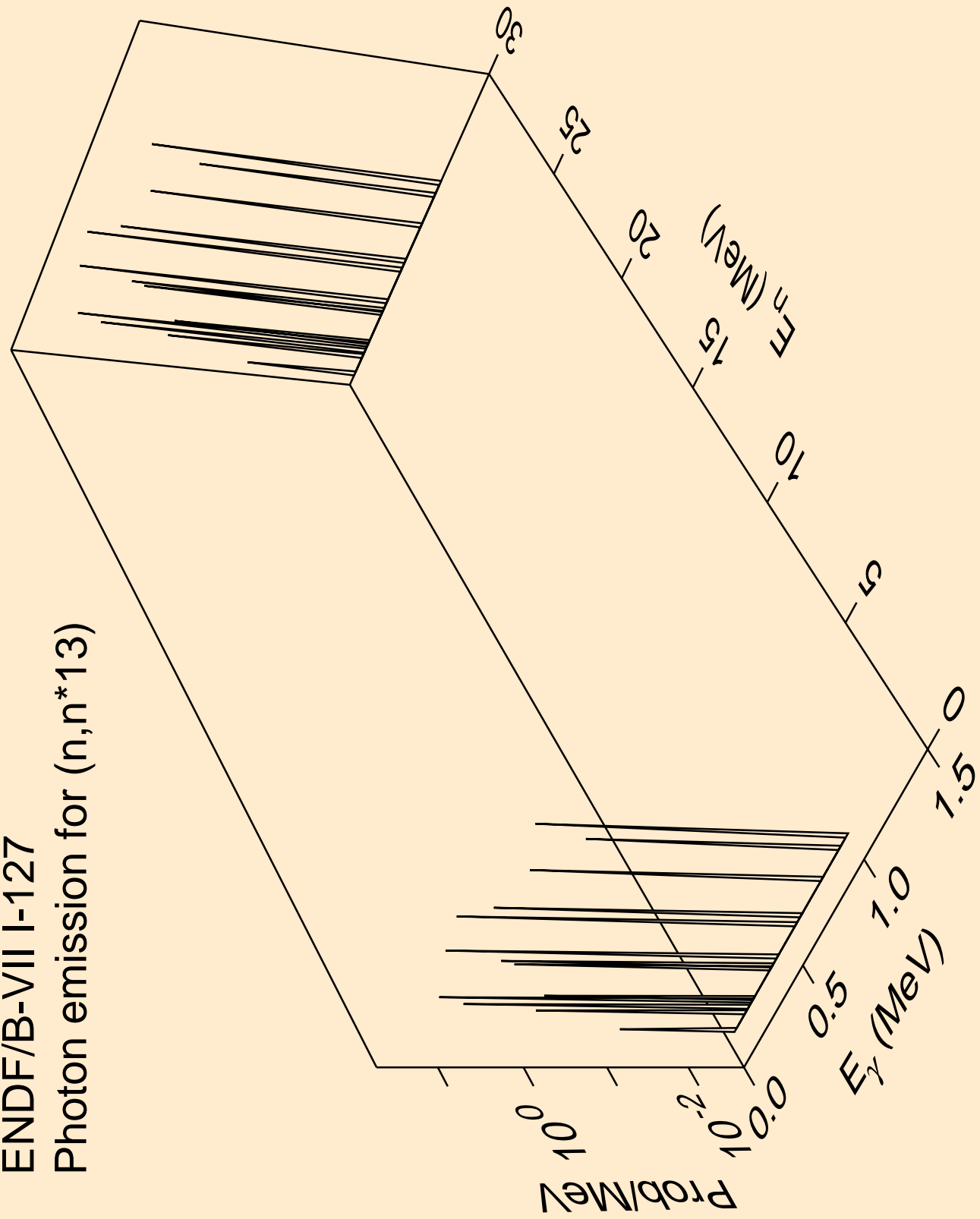

ENDF/B-VII I-127
Photon emission for (n,n*14)

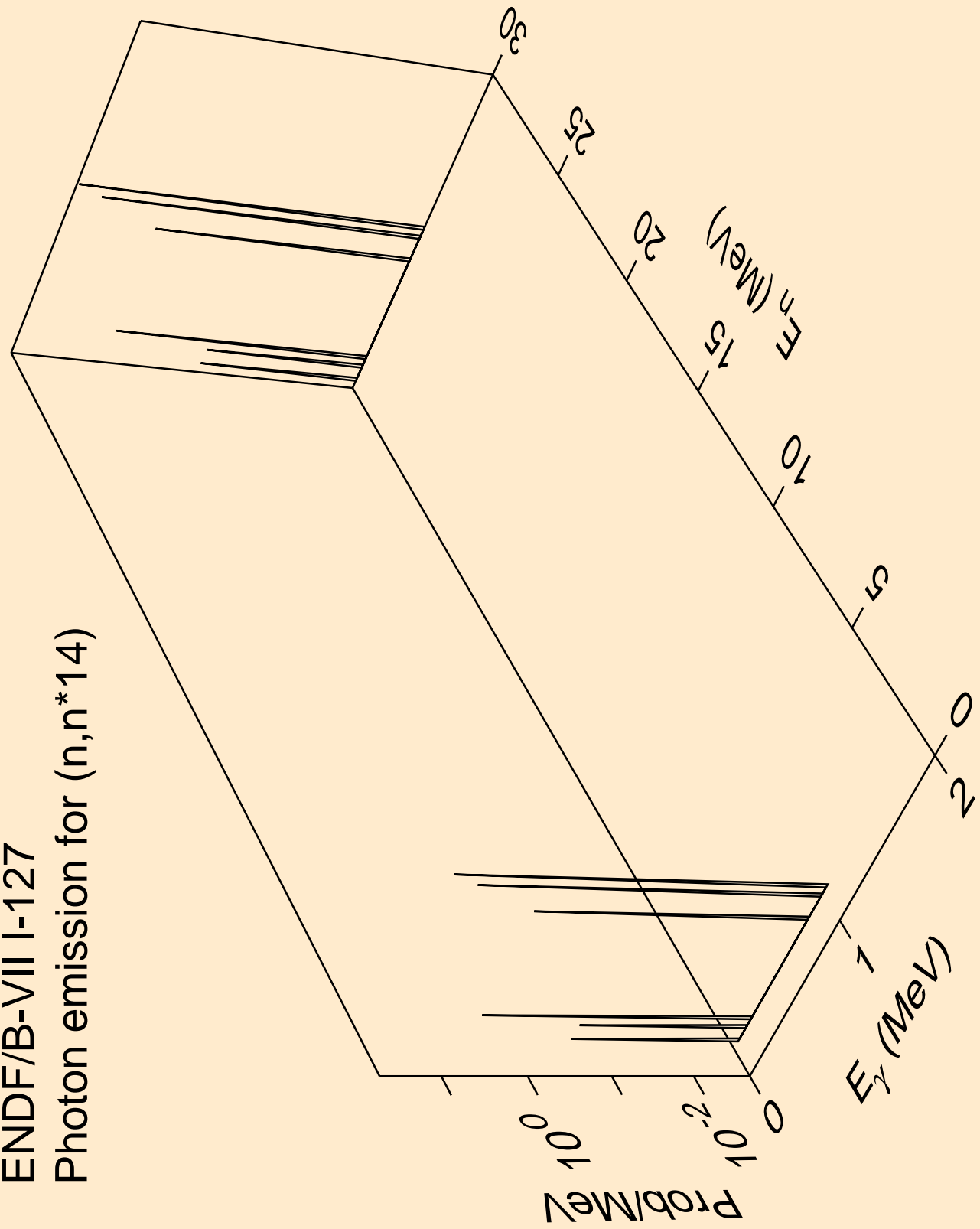

ENDF/B-VII I-127
Photon emission for (n,n*15)

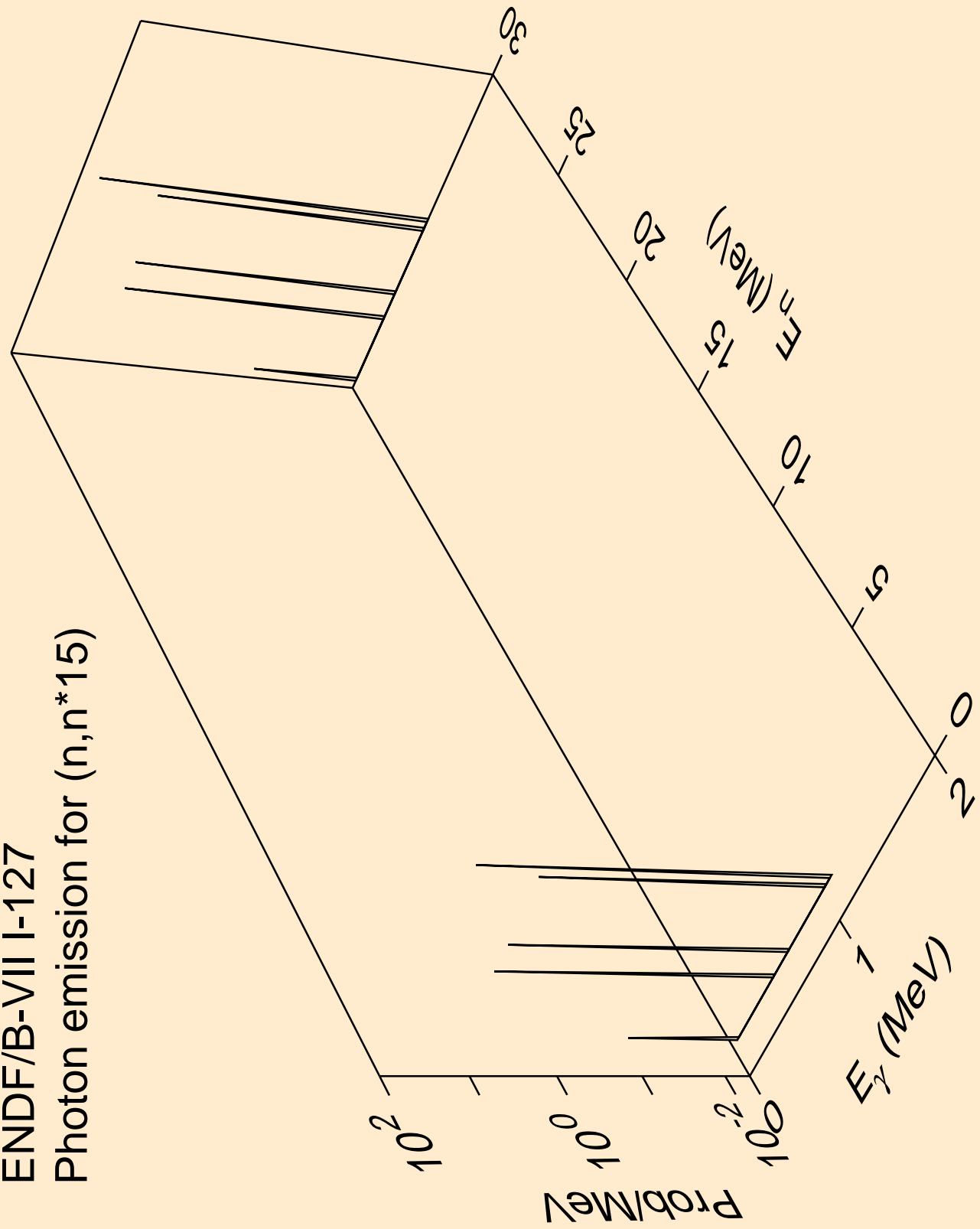

ENDF/B-VII I-127
Photon emission for (n,n*16)

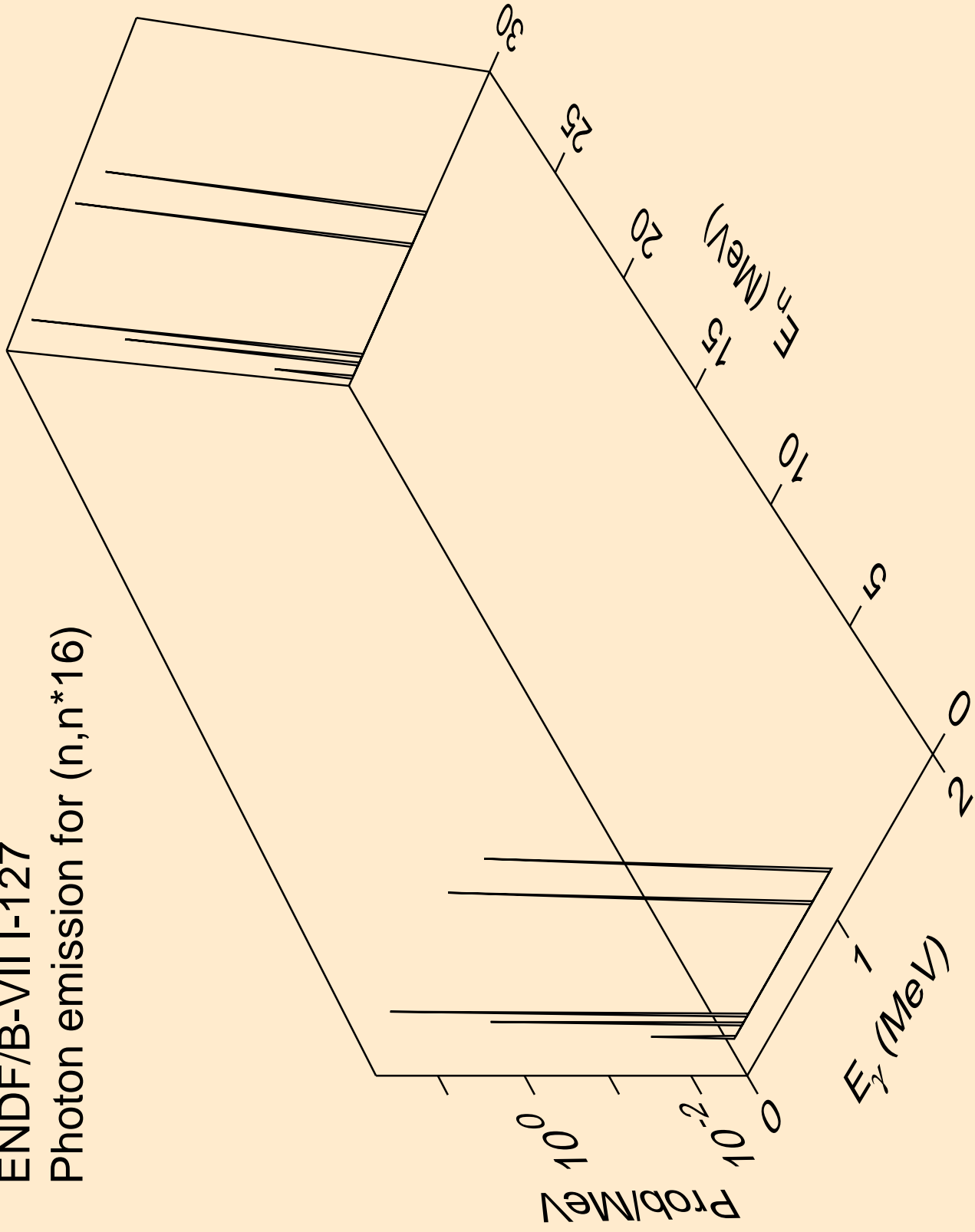

ENDF/B-VII I-127
Photon emission for (n,n*17)

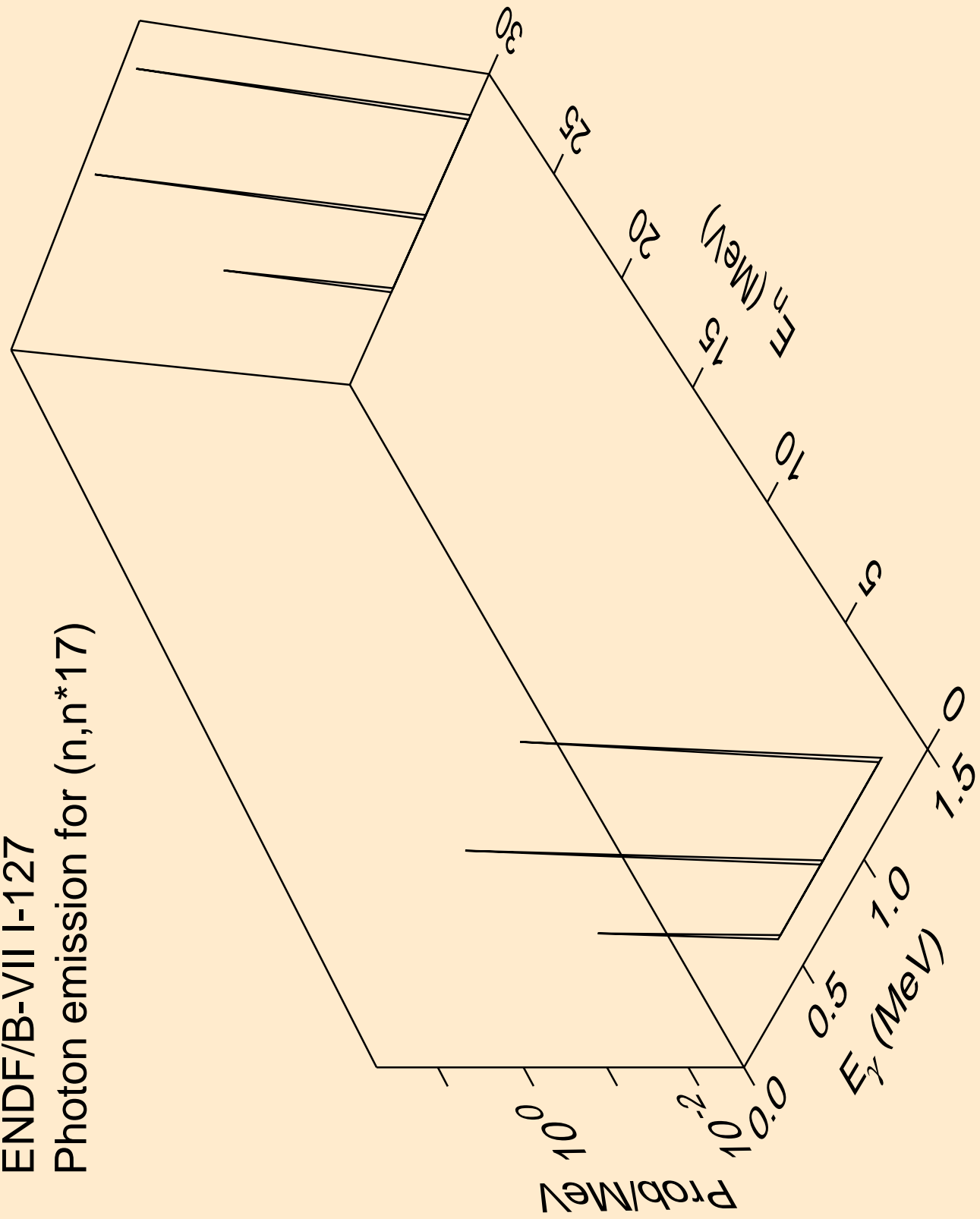

ENDF/B-VII I-127
Photon emission for (n,n*18)

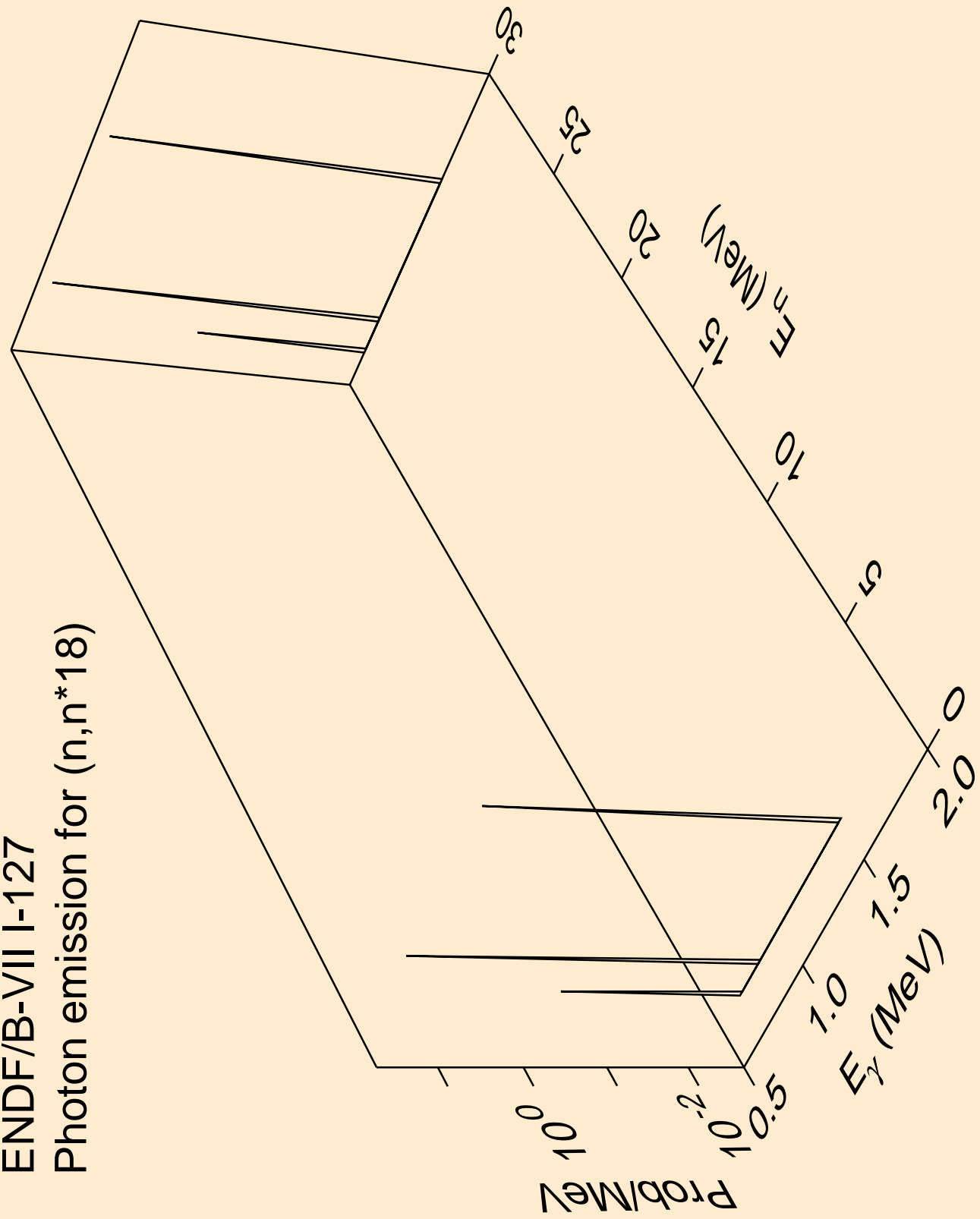

ENDF/B-VII I-127
Photon emission for (n,n*19)

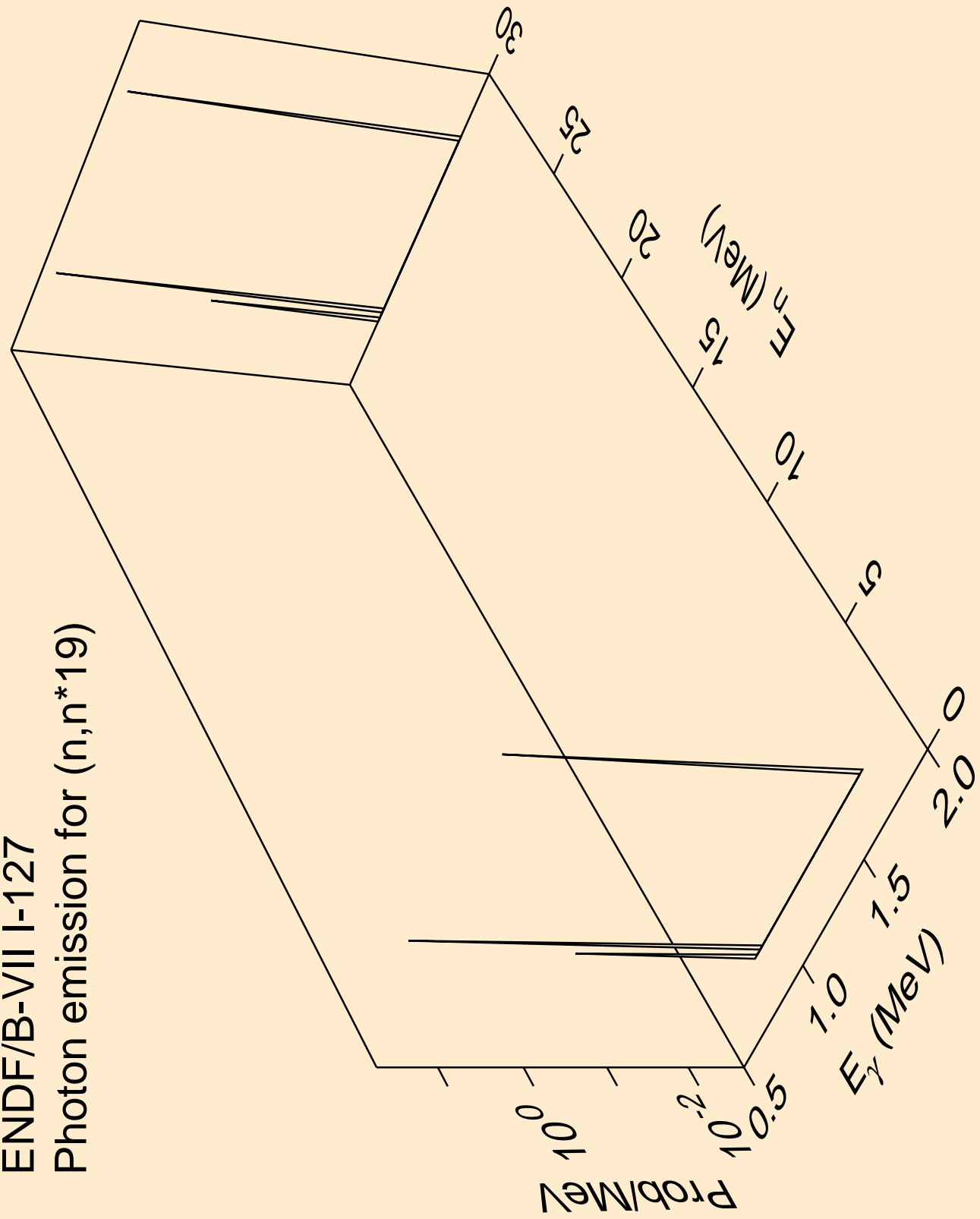

ENDF/B-VII I-127
Photon emission for (n,n*20)

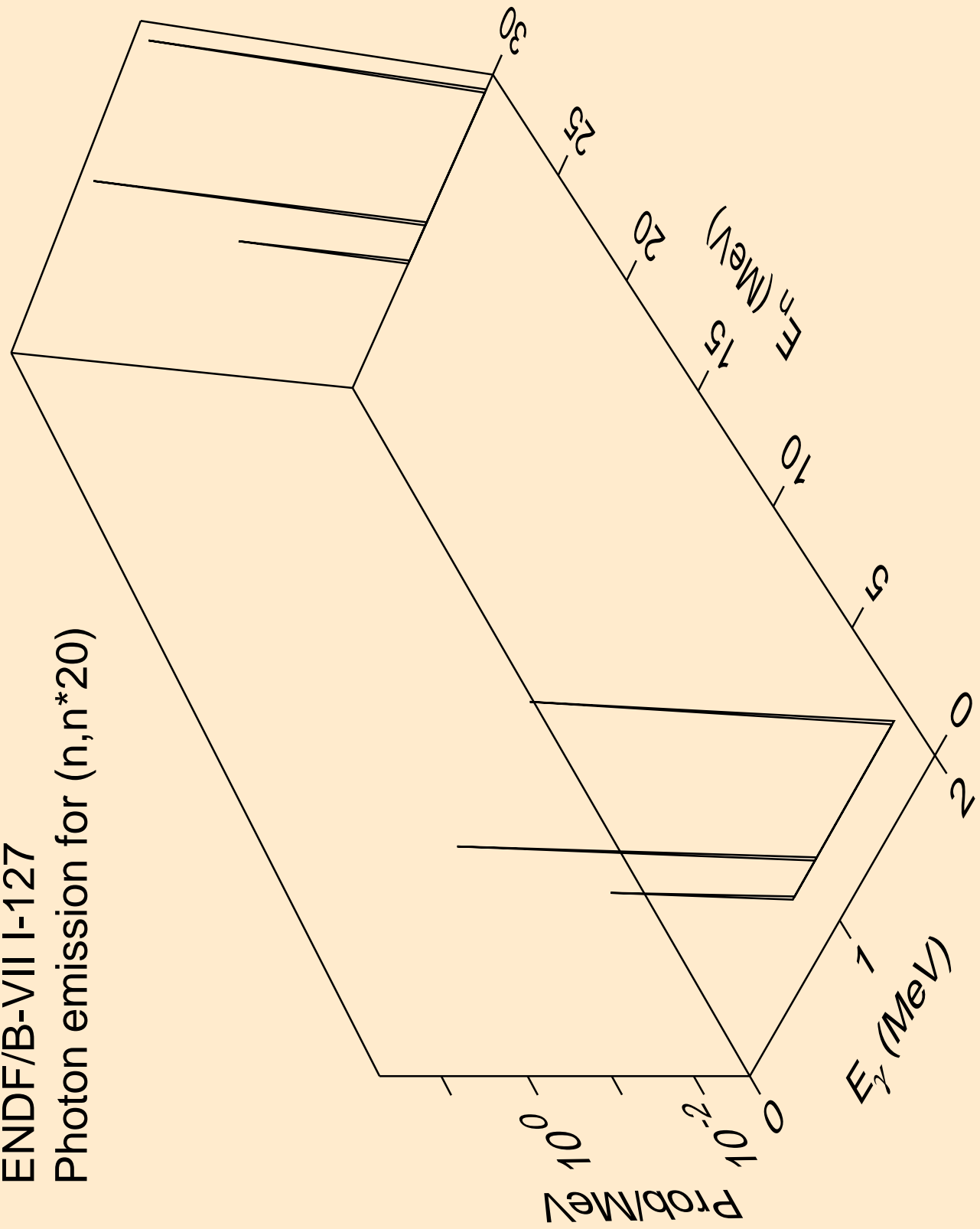

ENDF/B-VII I-127
Photon emission for (n,n*21)

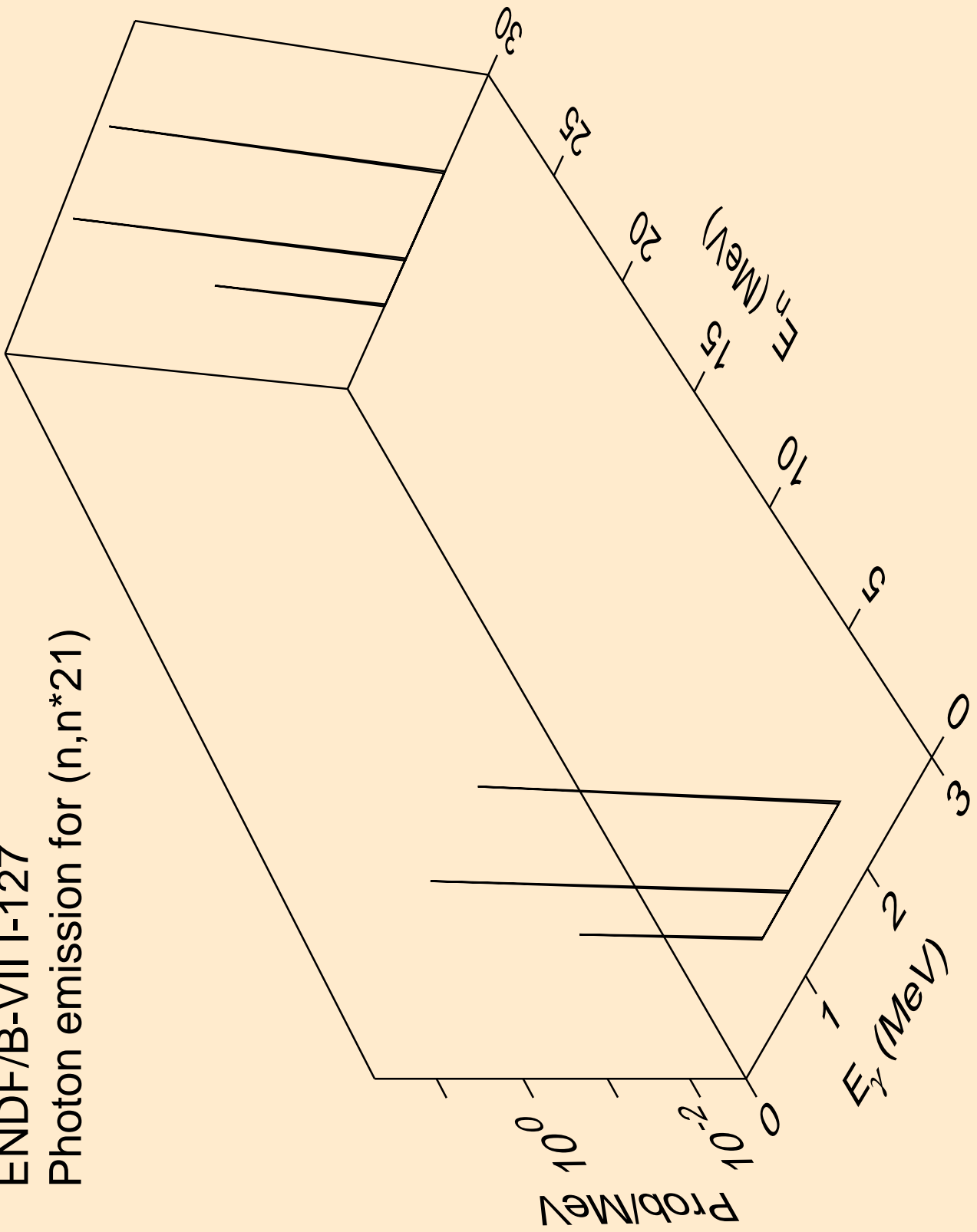

ENDF/B-VII I-127
Photon emission for (n,n*c)

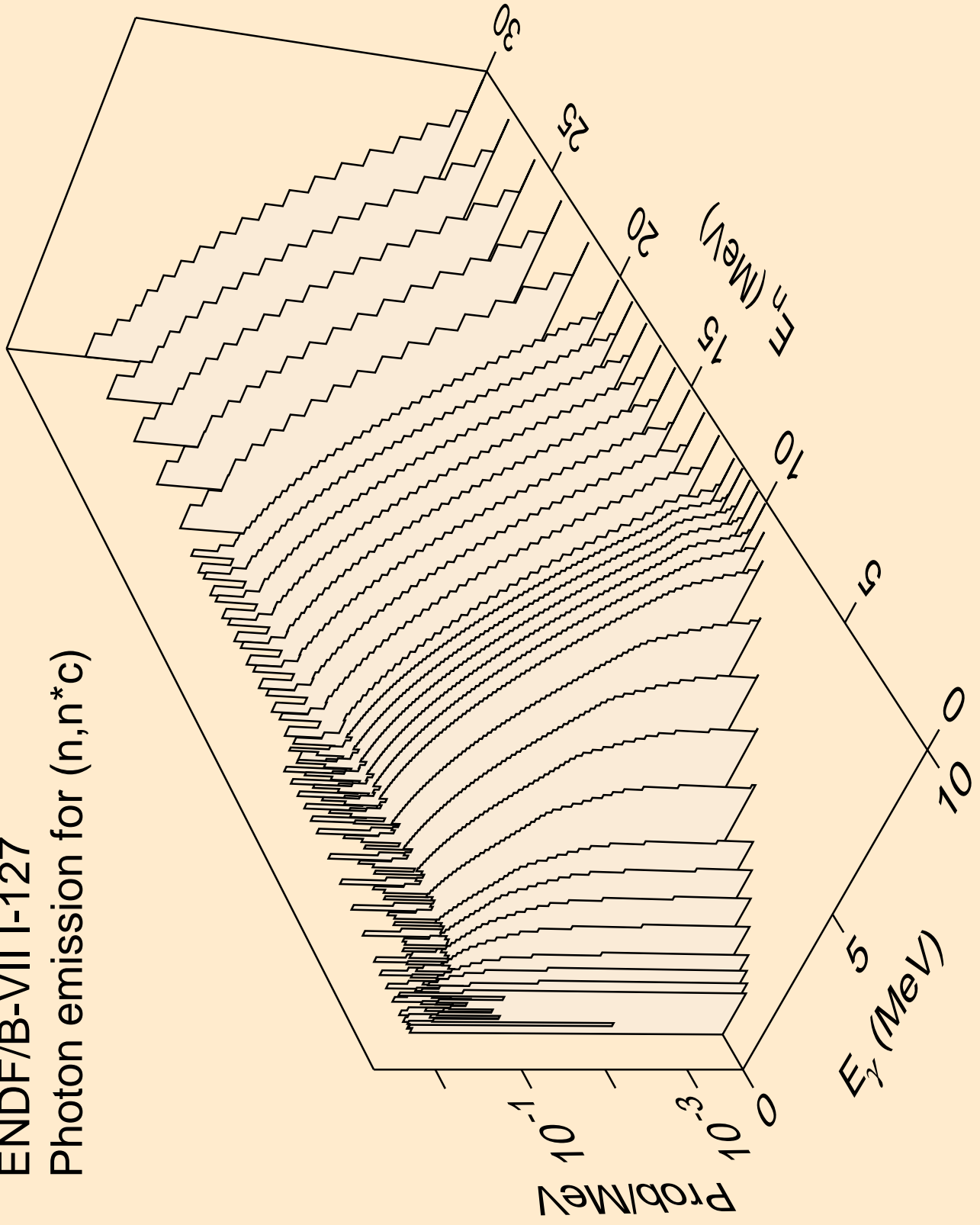

ENDF/B-VII I-127
Photon emission for (n,p*1)

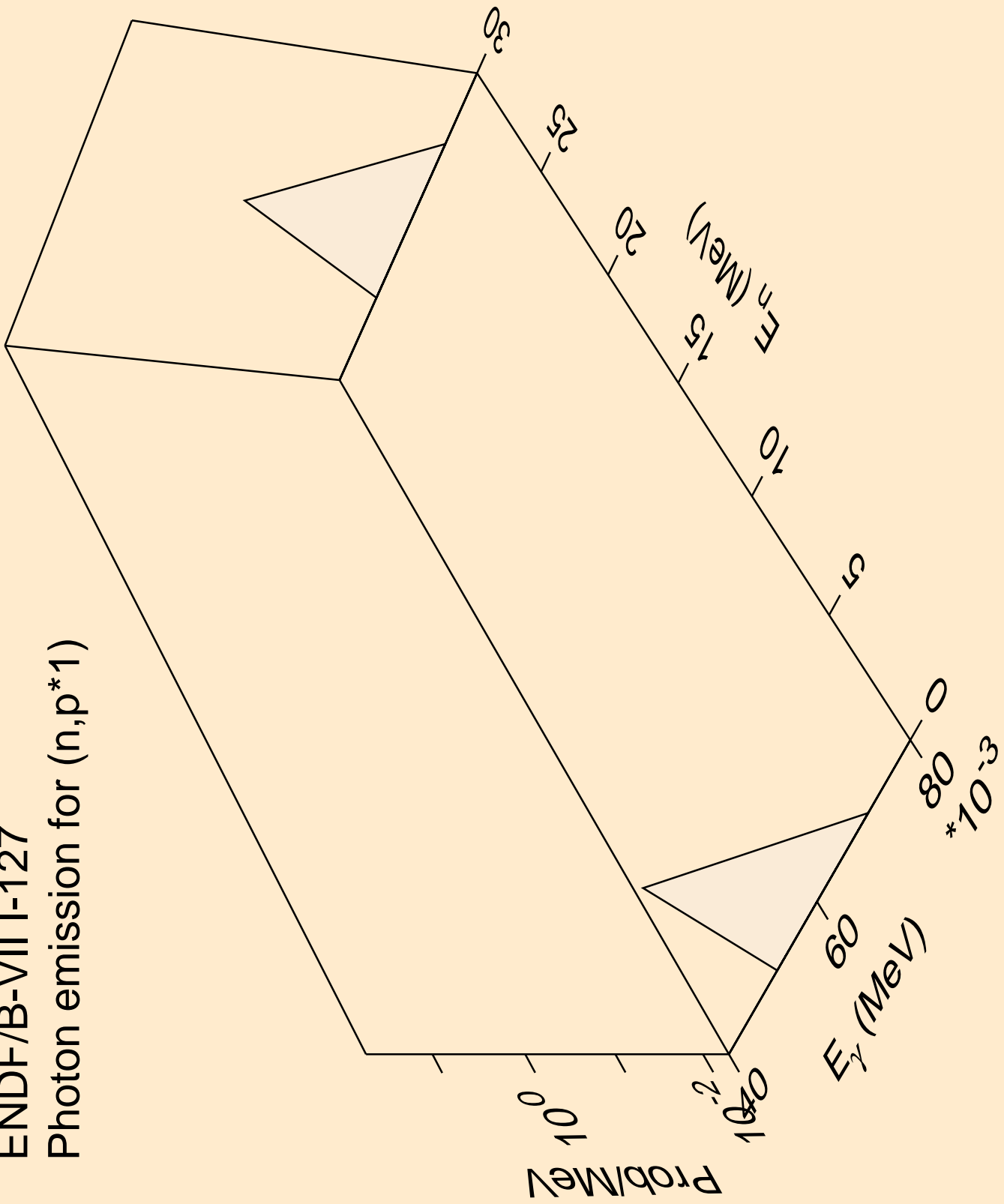

ENDF/B-VII I-127
Photon emission for (n,p*2)

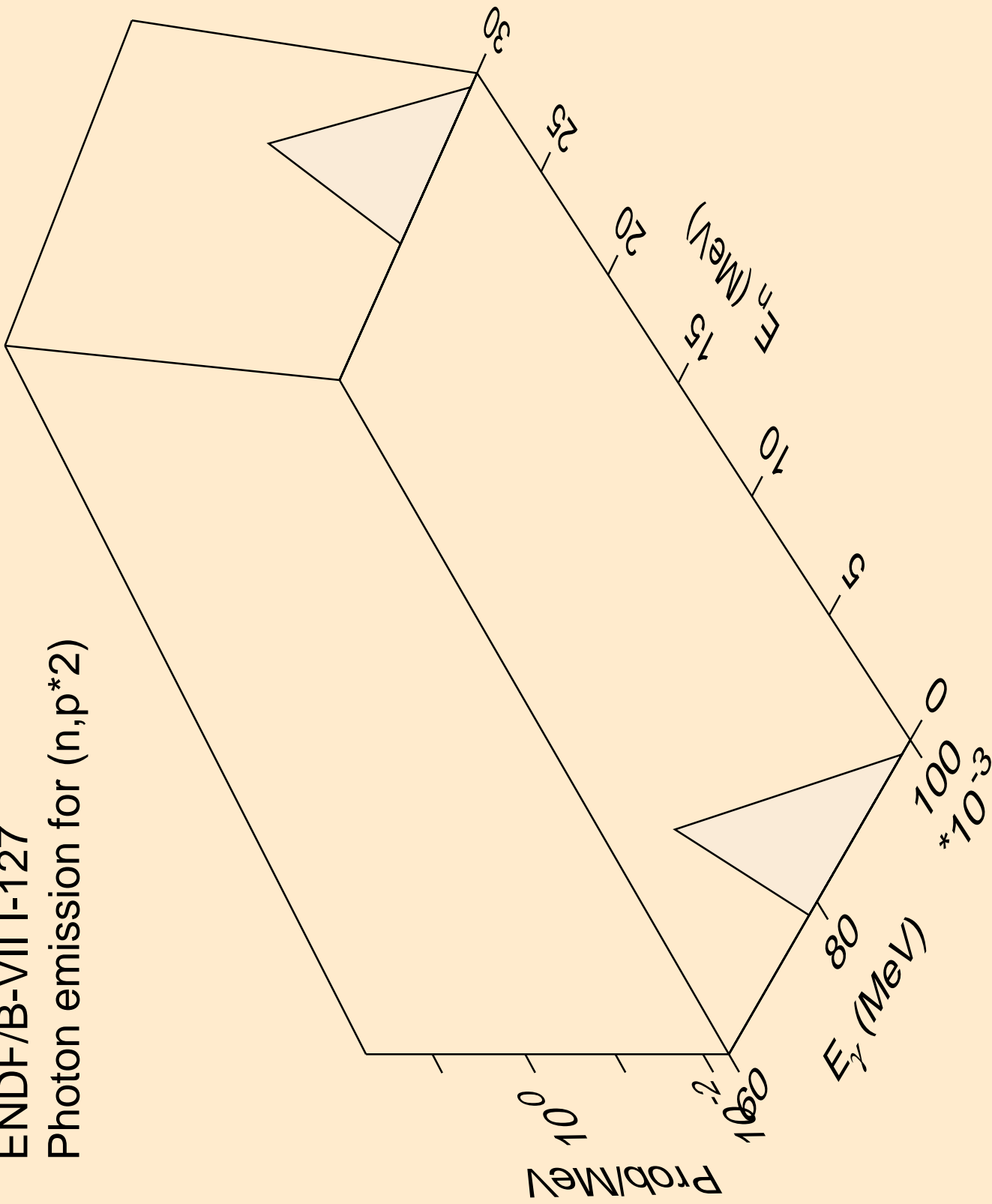

ENDF/B-VII I-127
Photon emission for (n,p*3)

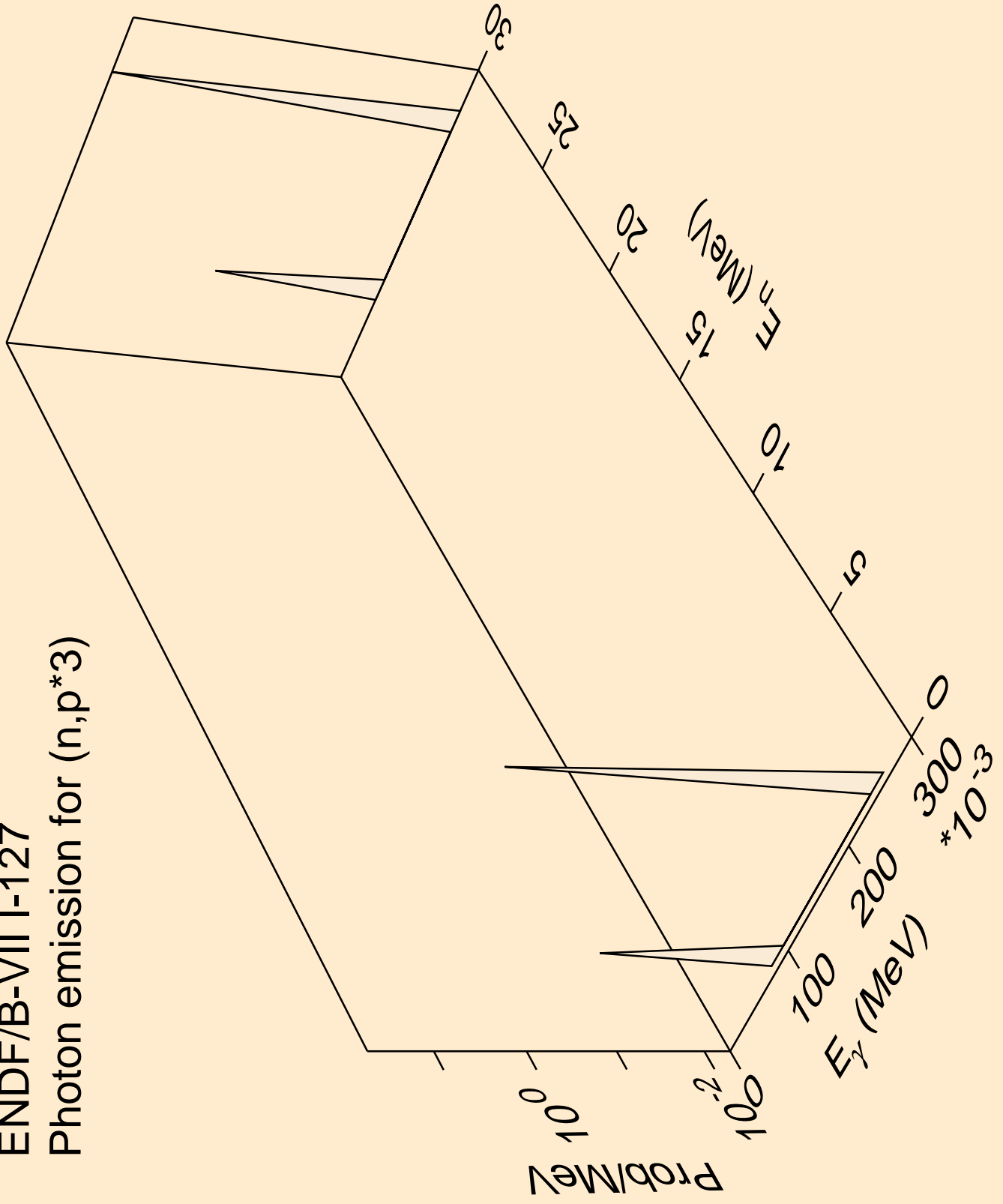

ENDF/B-VII I-127
Photon emission for (n,p*4)

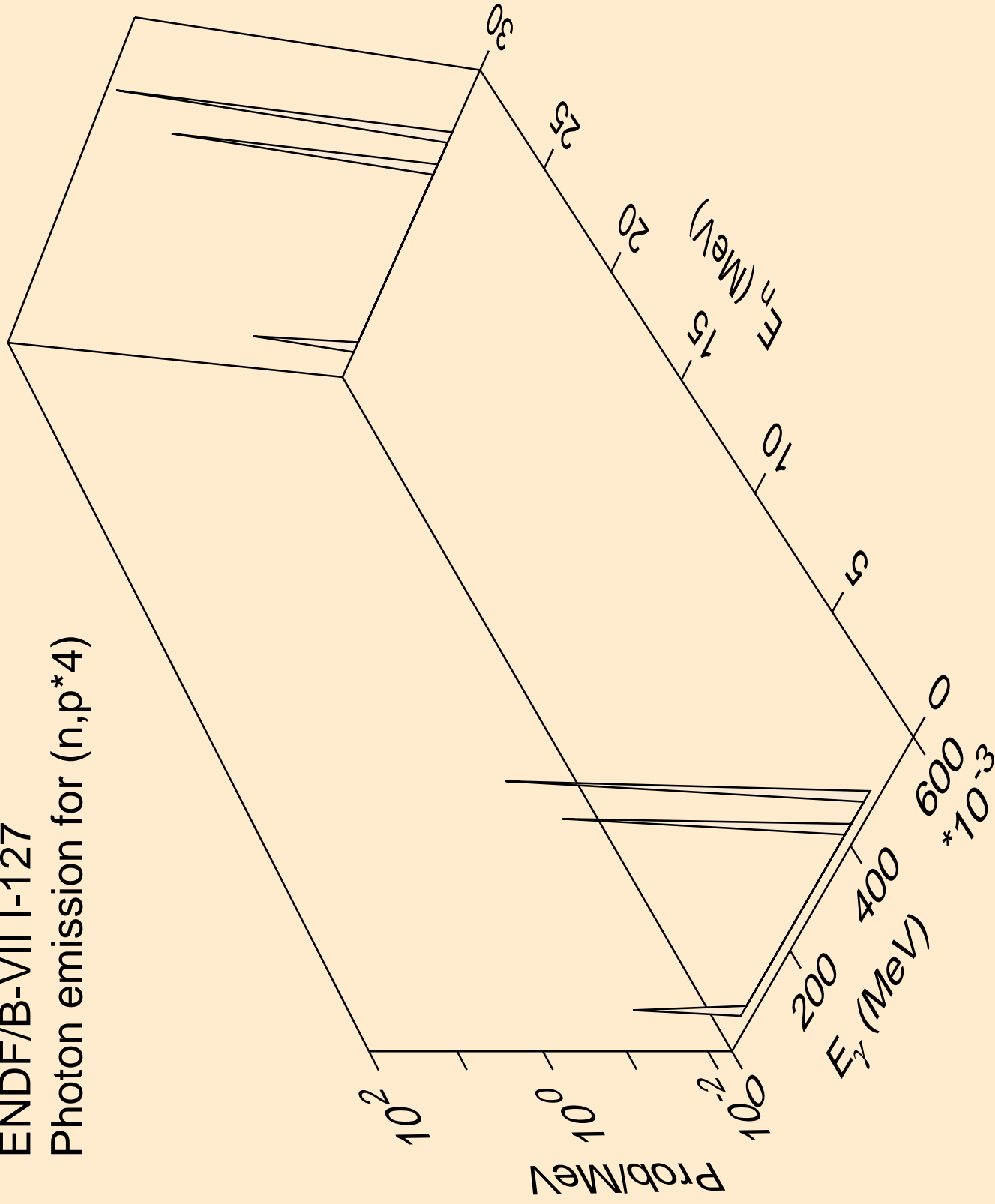

ENDF/B-VII I-127
Photon emission for (n,p*5)

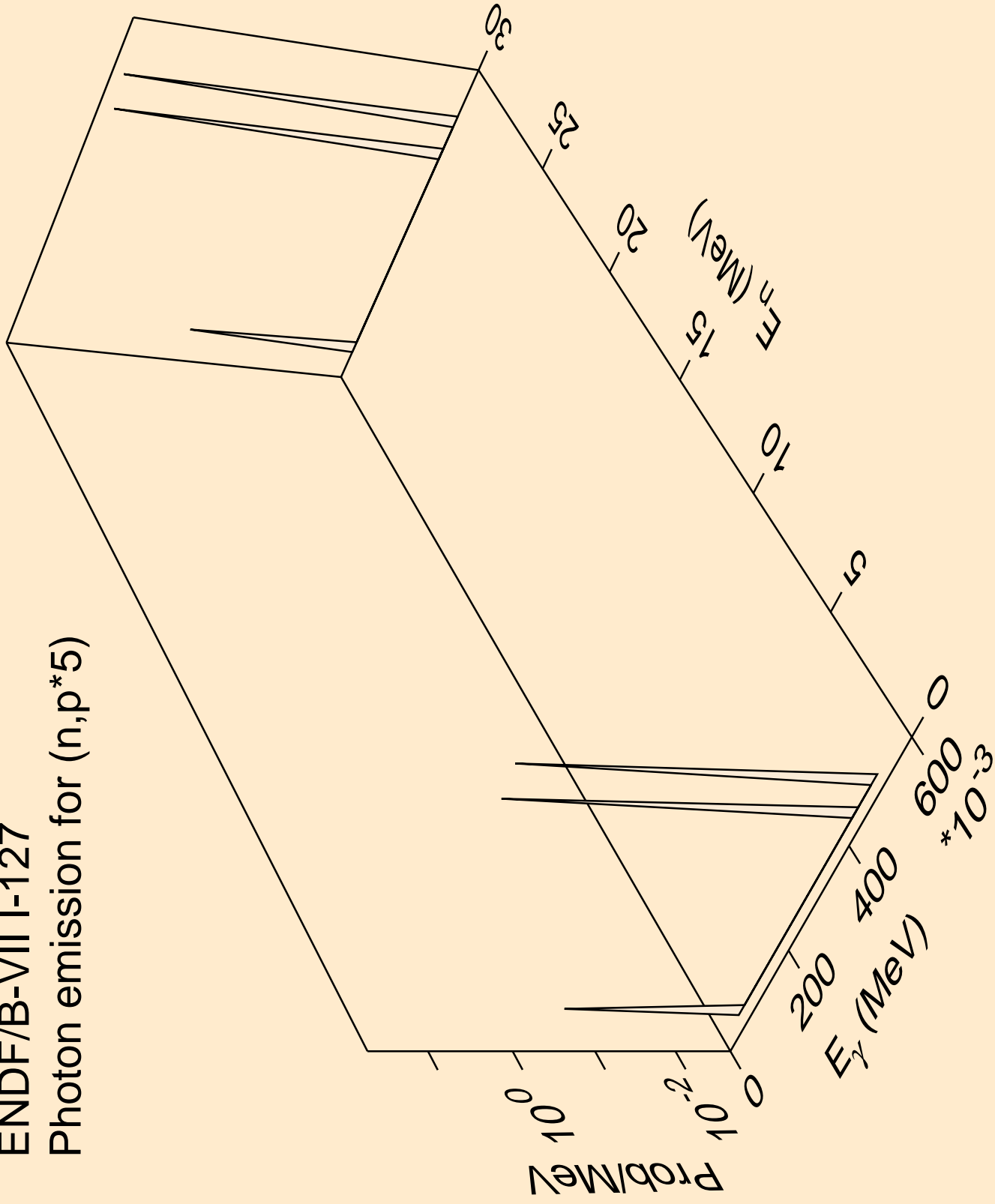

ENDF/B-VII I-127
Photon emission for (n,p*6)

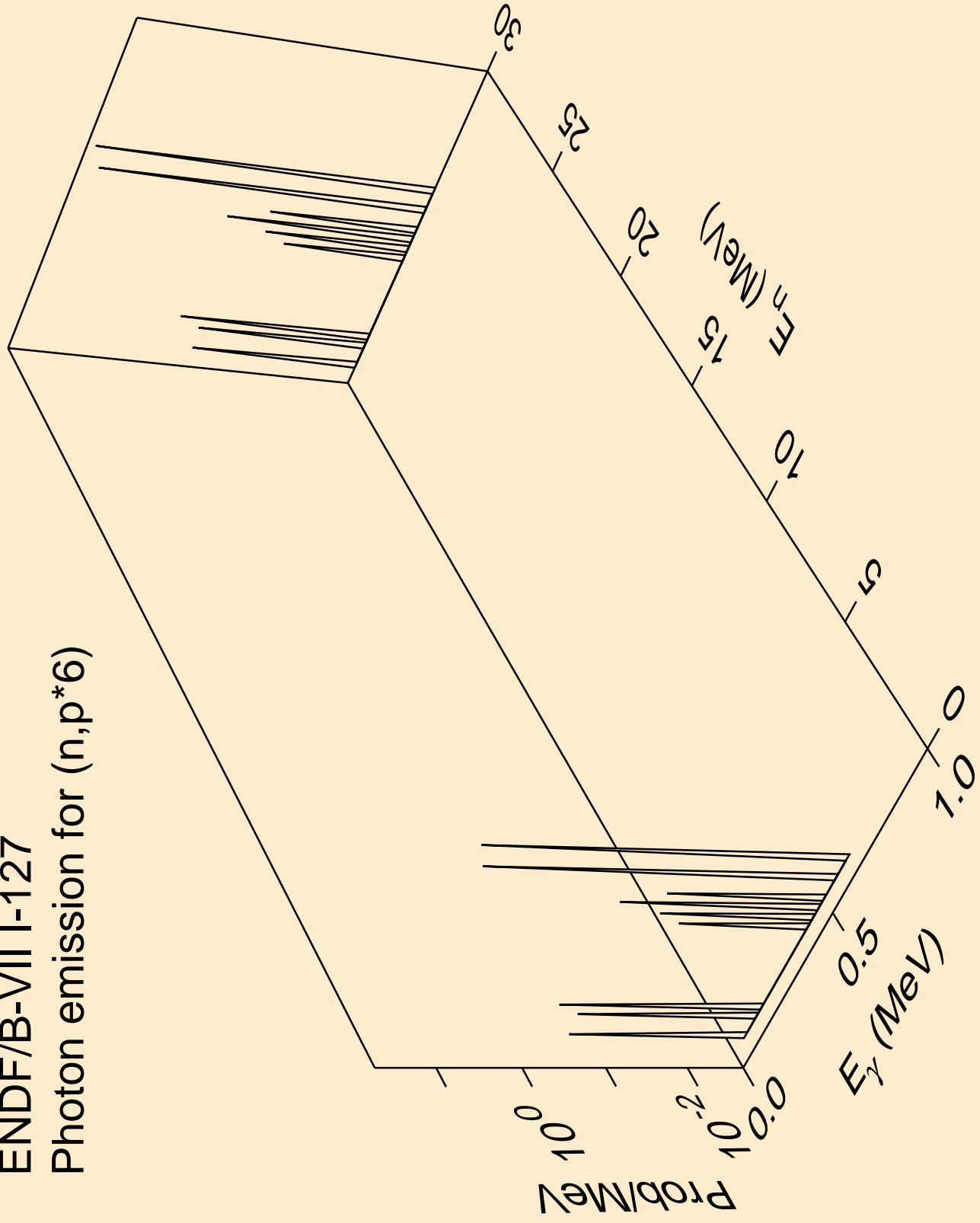

ENDF/B-VII I-127
Photon emission for (n,p*7)

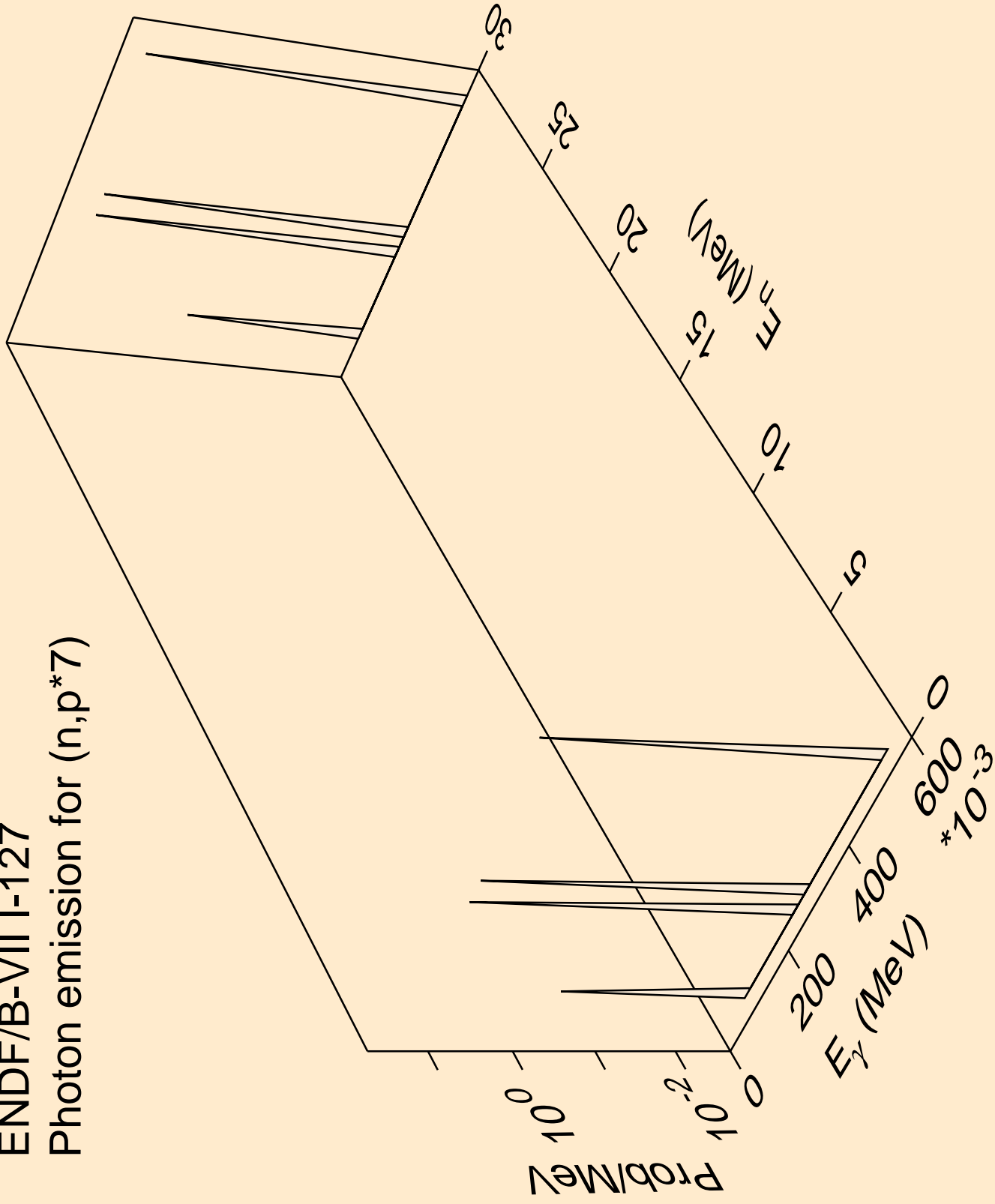

ENDF/B-VII I-127
Photon emission for (n,p*8)

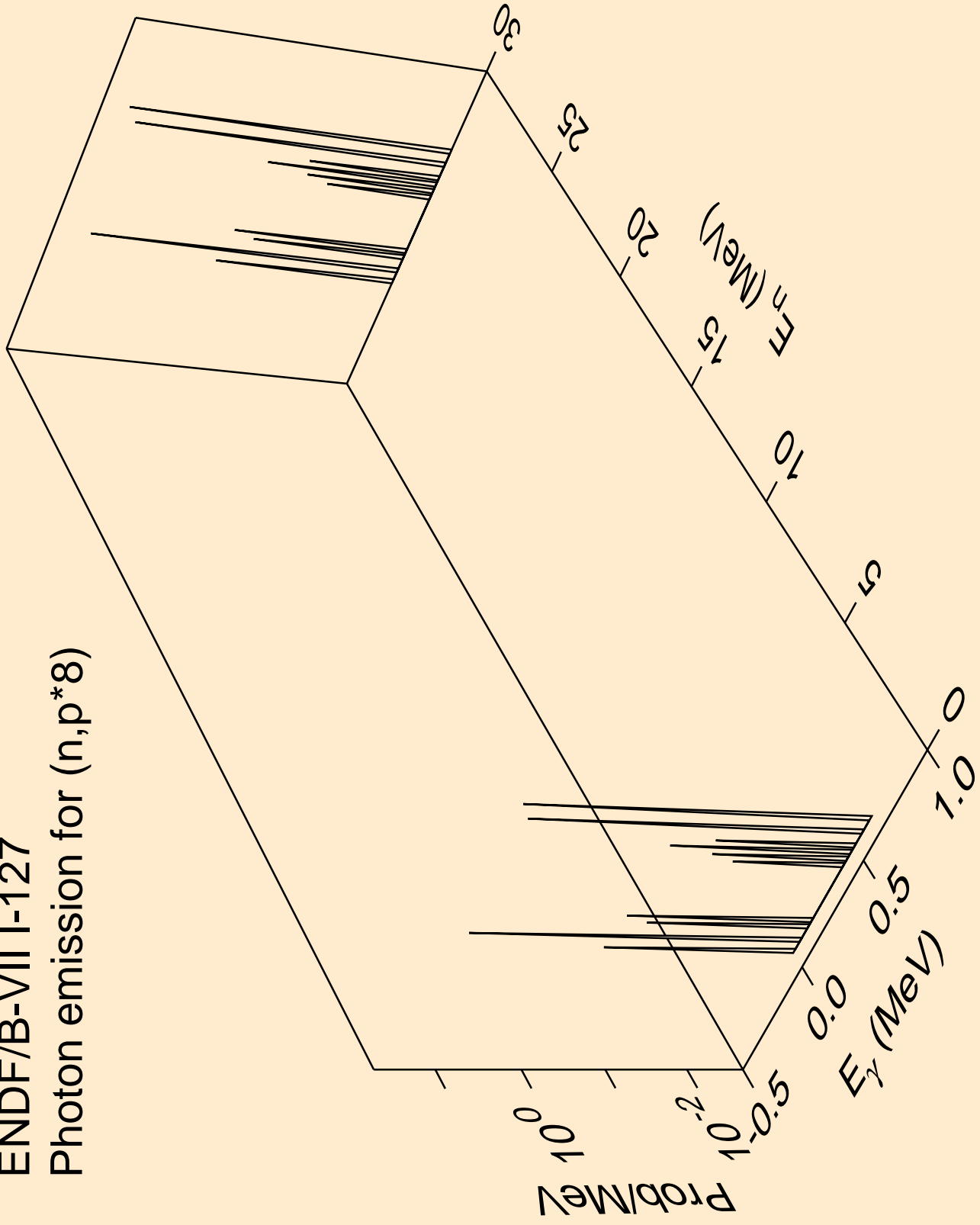

ENDF/B-VII I-127
Photon emission for (n,p*9)

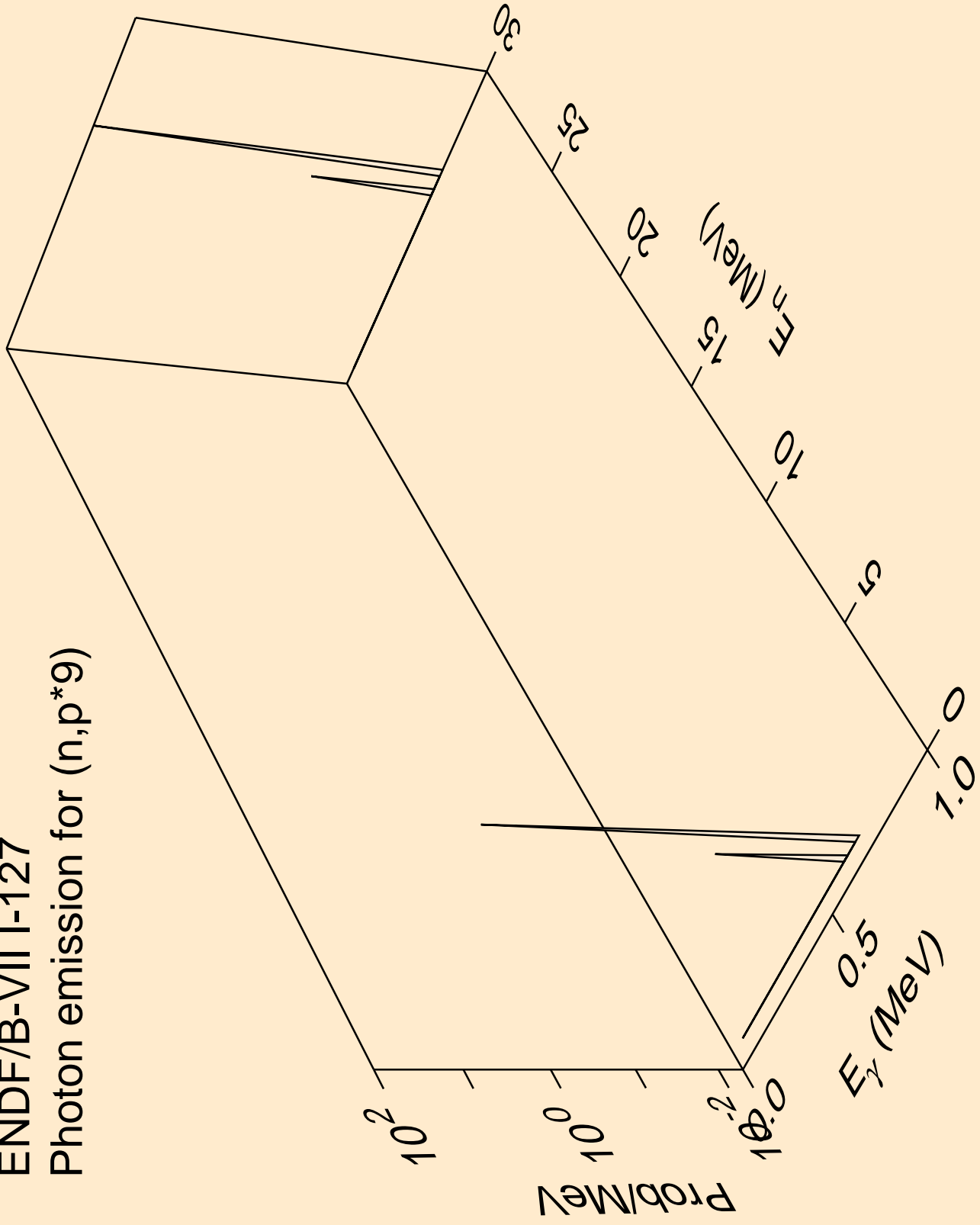

ENDF/B-VII I-127
Photon emission for (n,p*10)

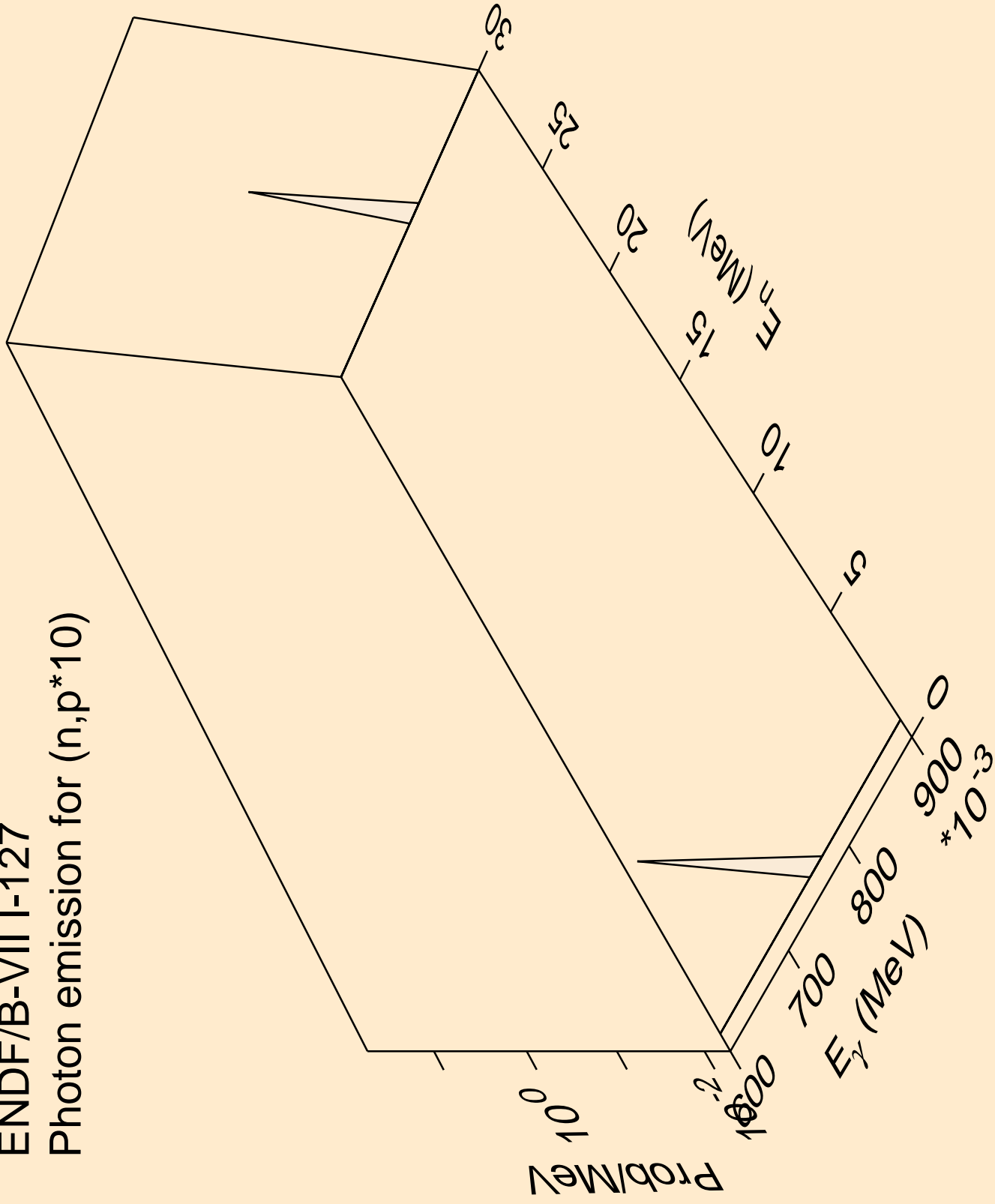

ENDF/B-VII I-127
Photon emission for (n,p*11)

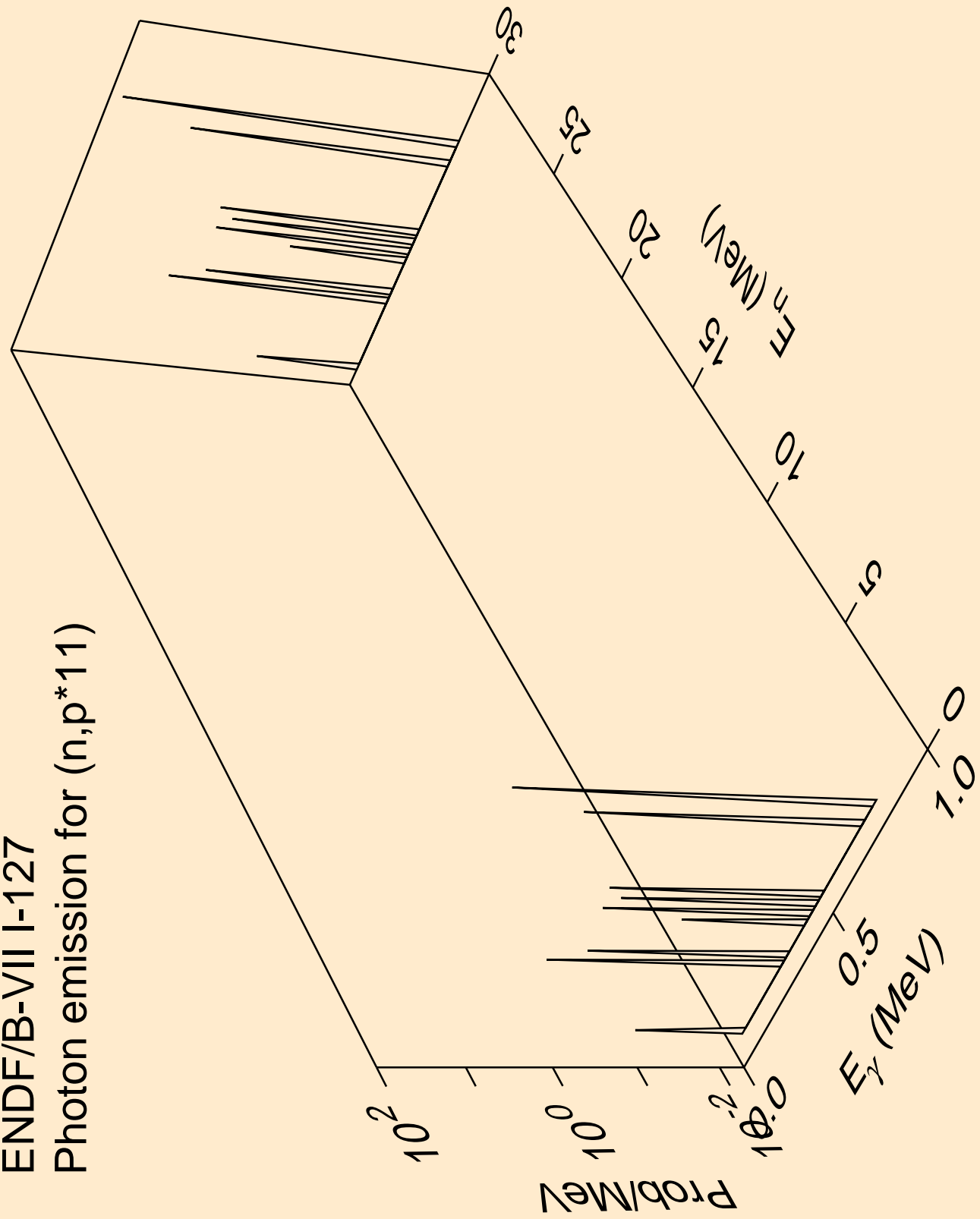

ENDF/B-VII I-127
Photon emission for (n,p*12)

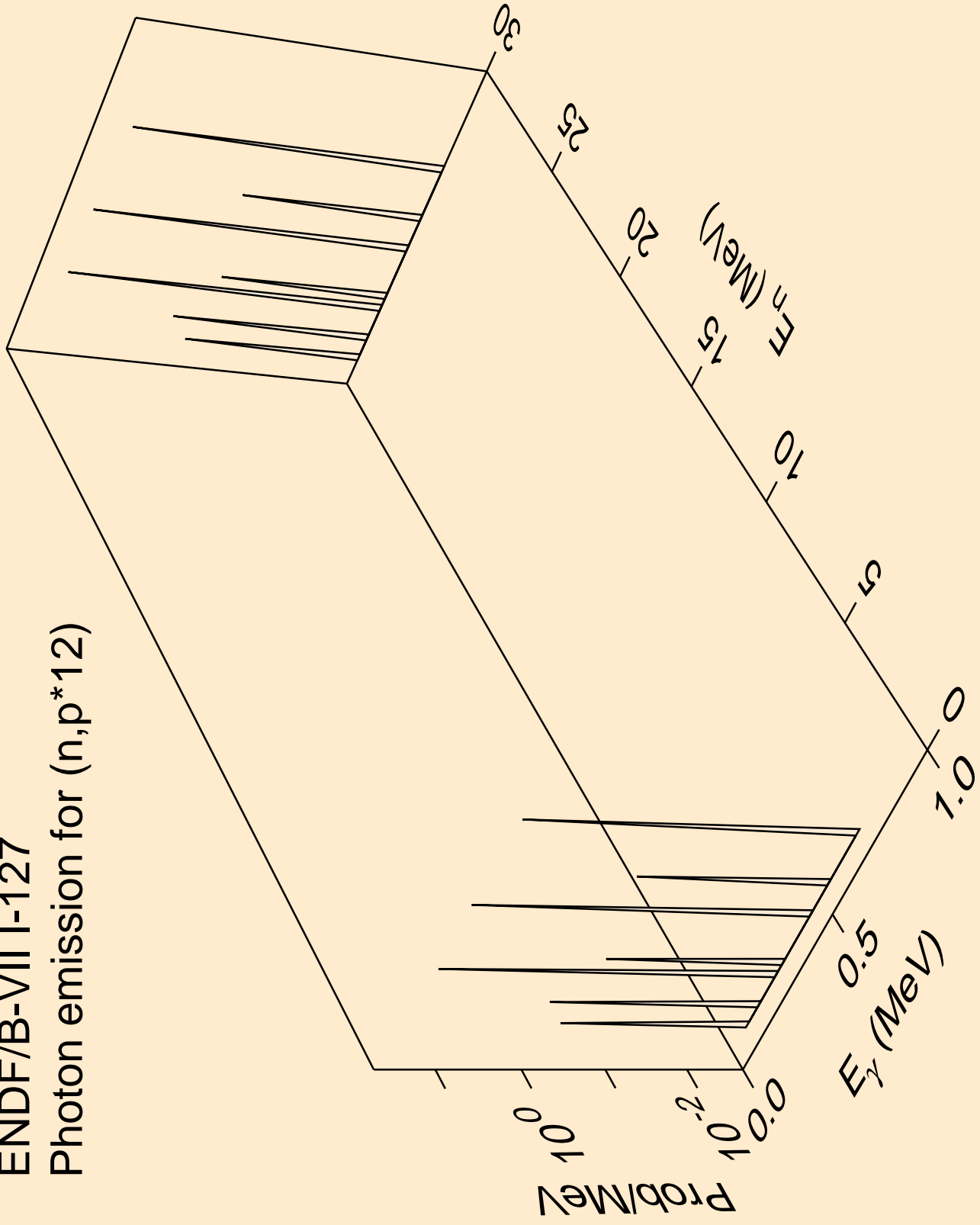

ENDF/B-VII I-127
Photon emission for (n,p*13)

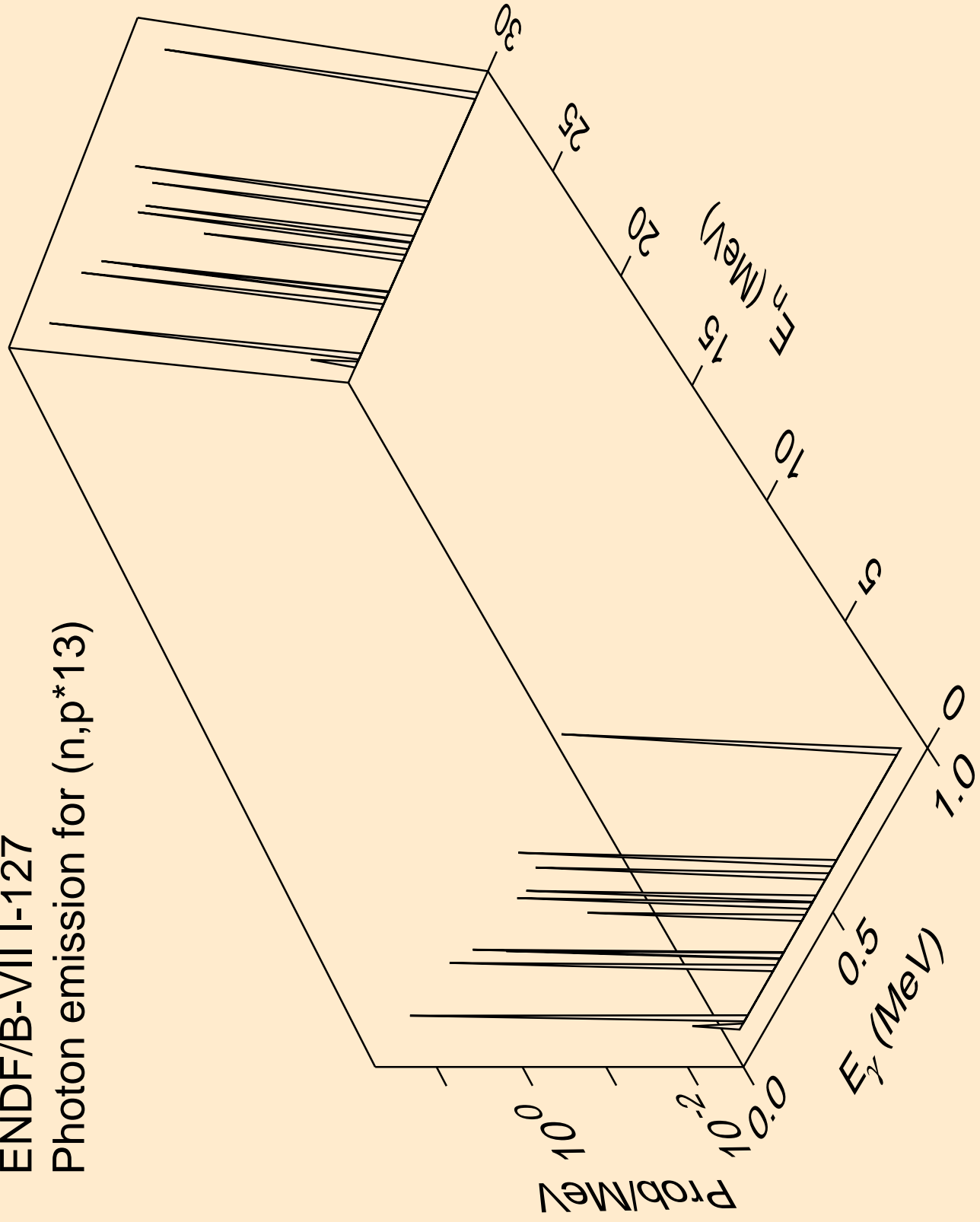

ENDF/B-VII I-127
Photon emission for (n,p*14)

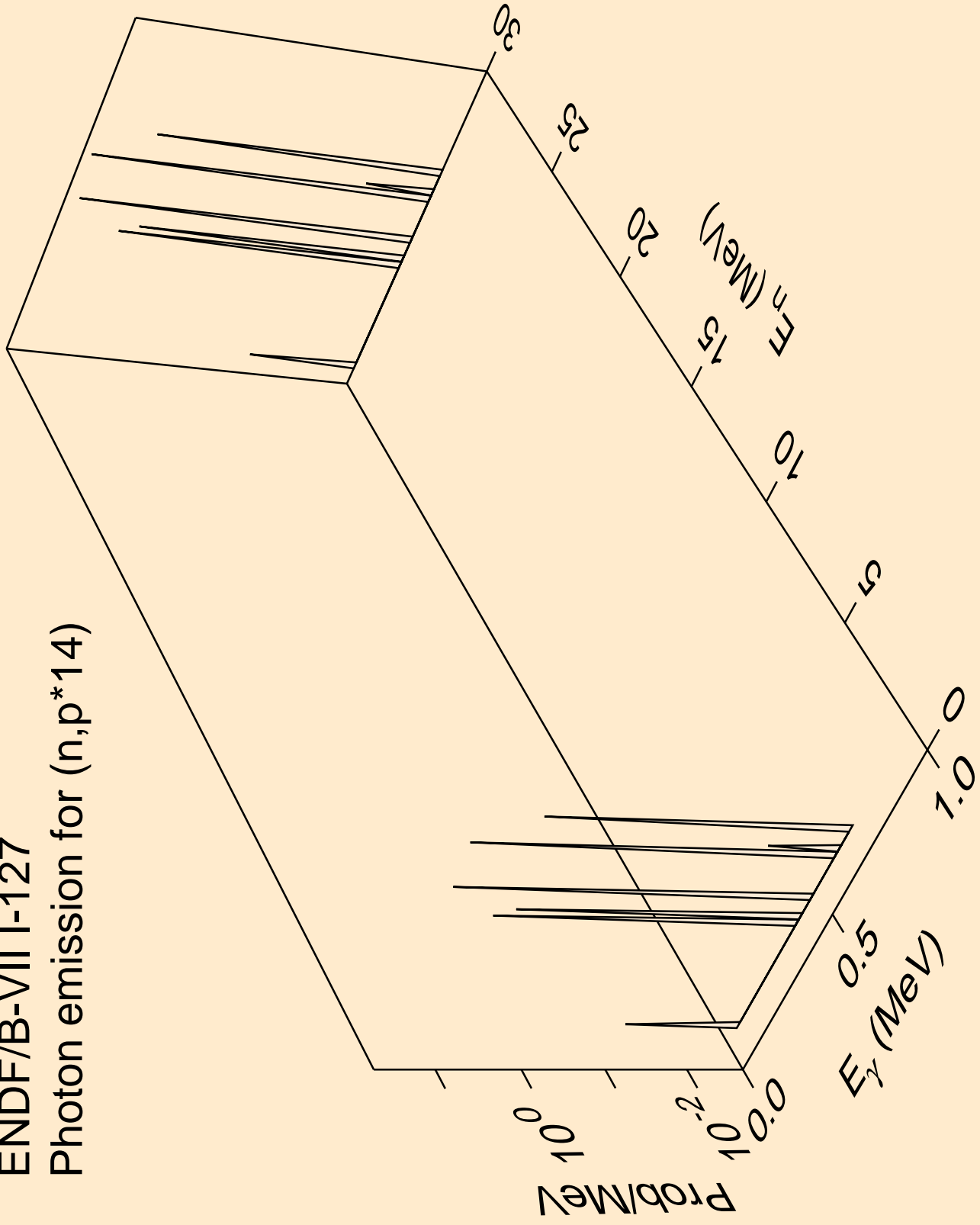

ENDF/B-VII I-127
Photon emission for (n,p*15)

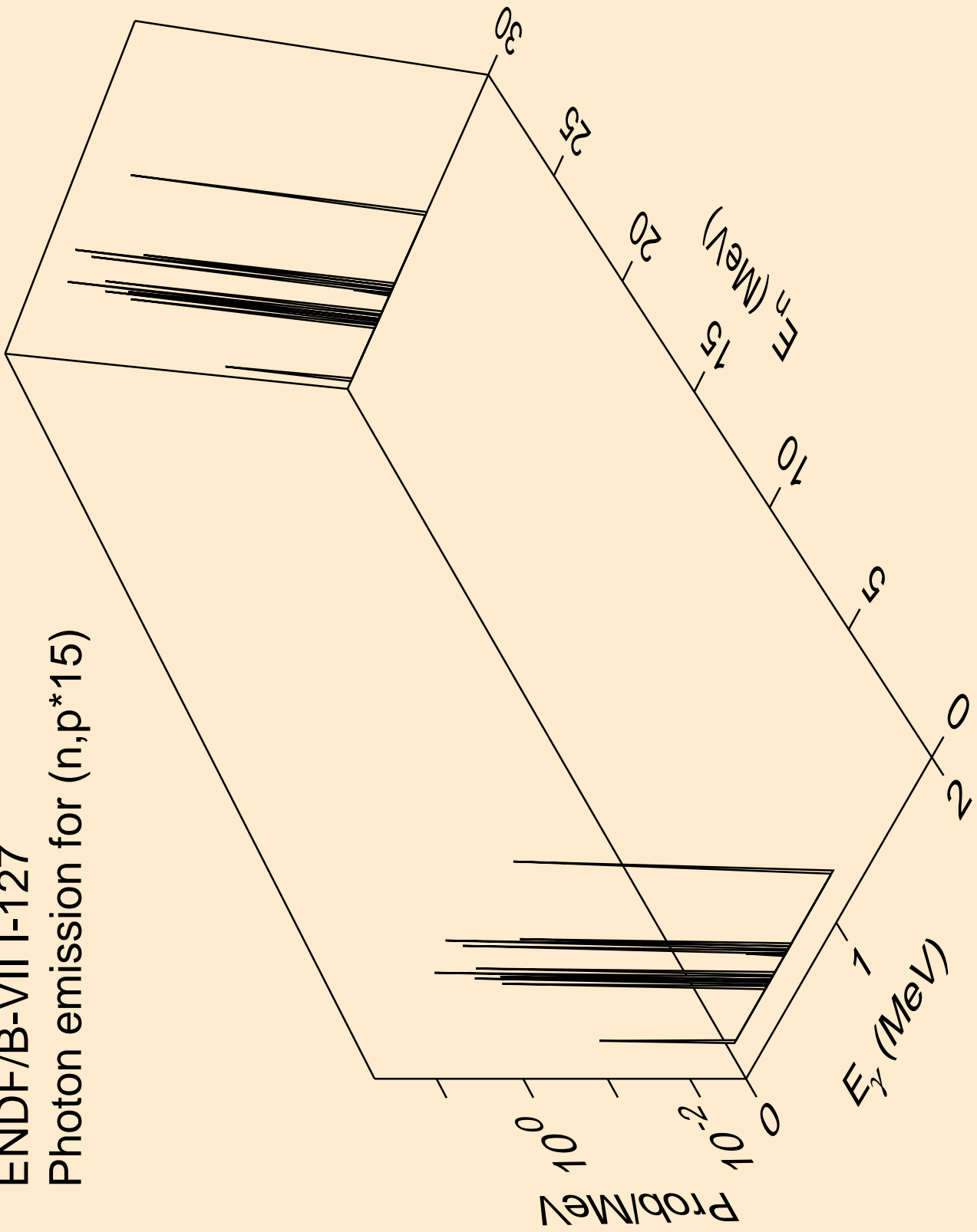

ENDF/B-VII I-127
Photon emission for (n,p*16)

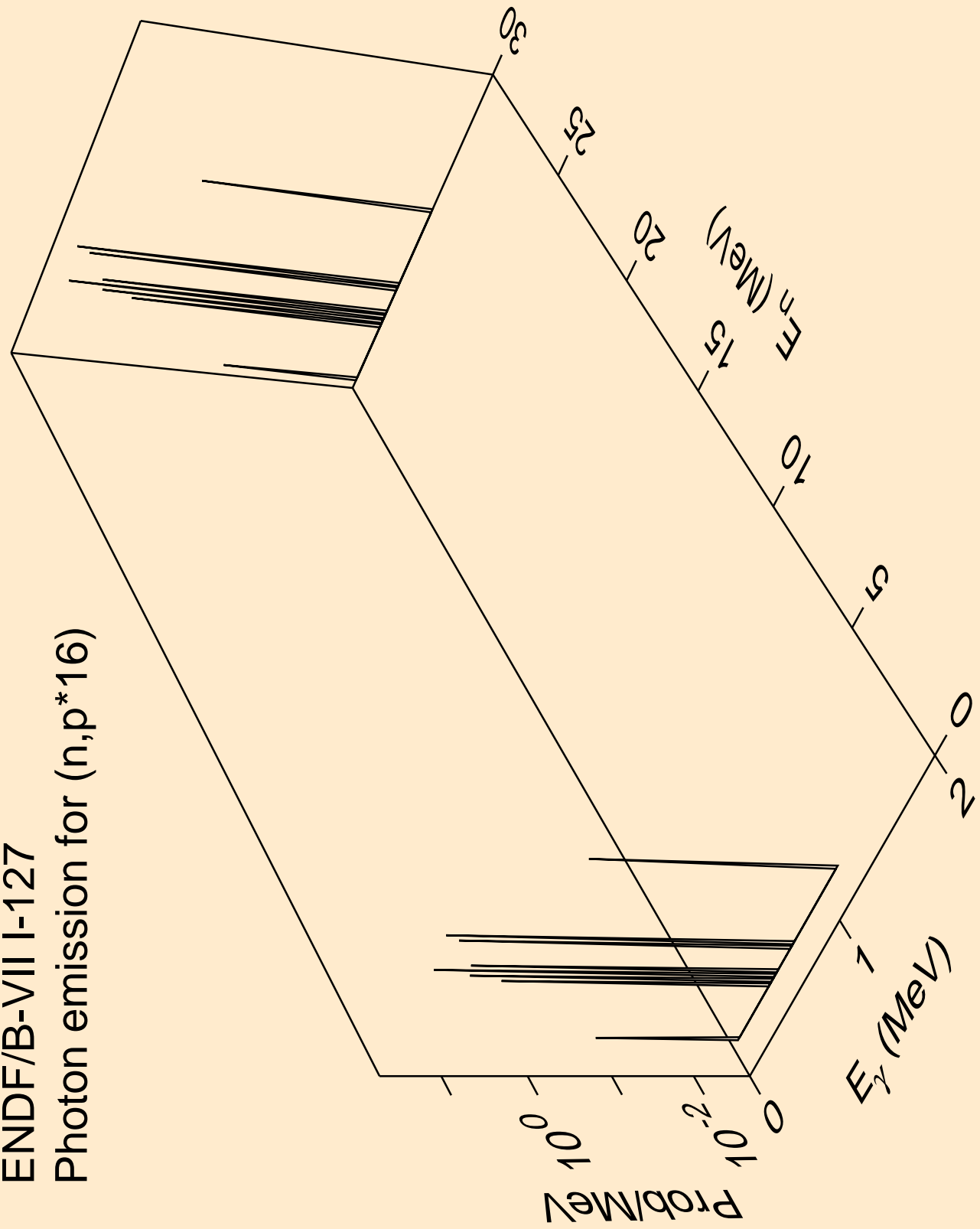

ENDF/B-VII I-127
Photon emission for (n,p*17)

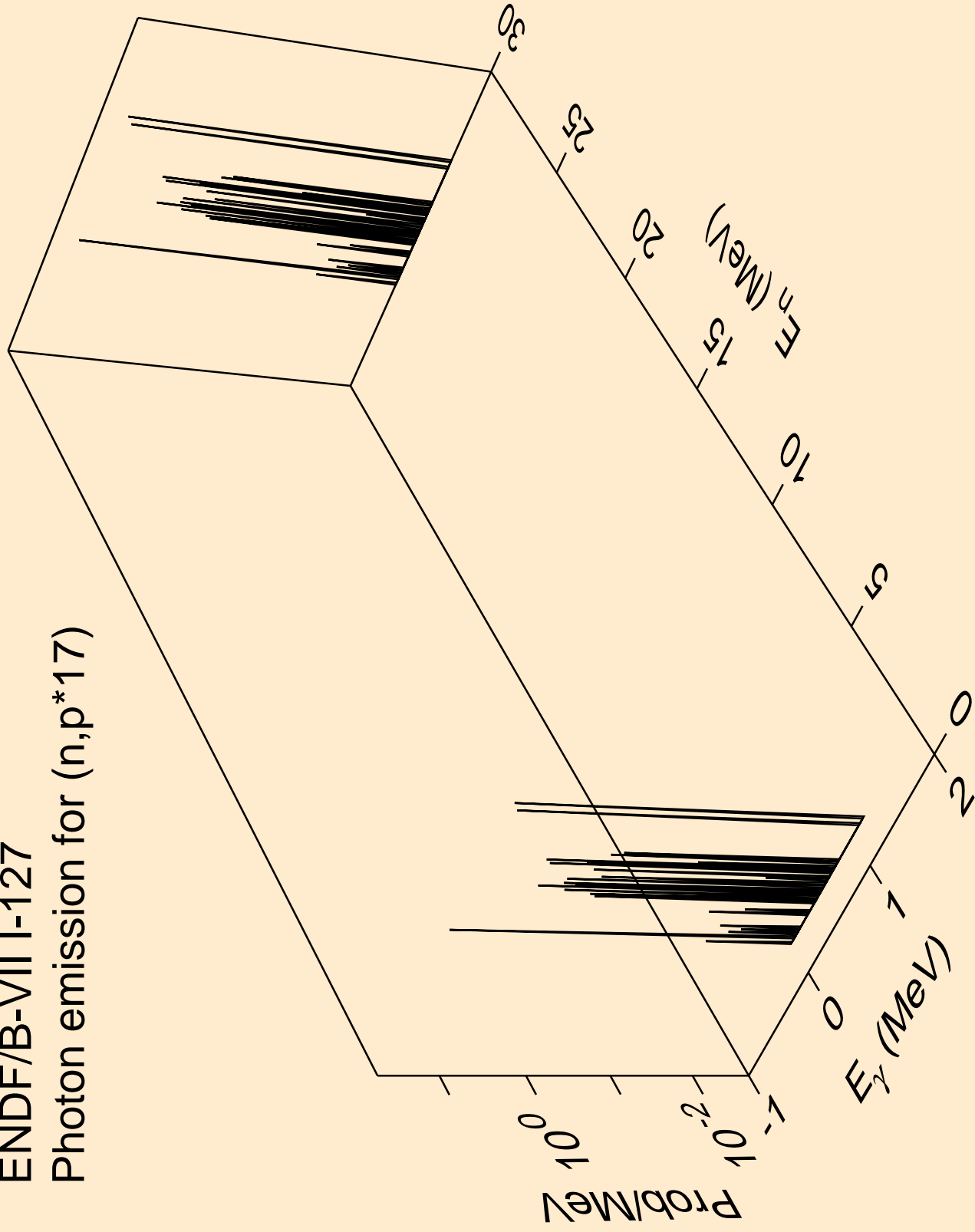

ENDF/B-VII I-127
Photon emission for (n,p*18)

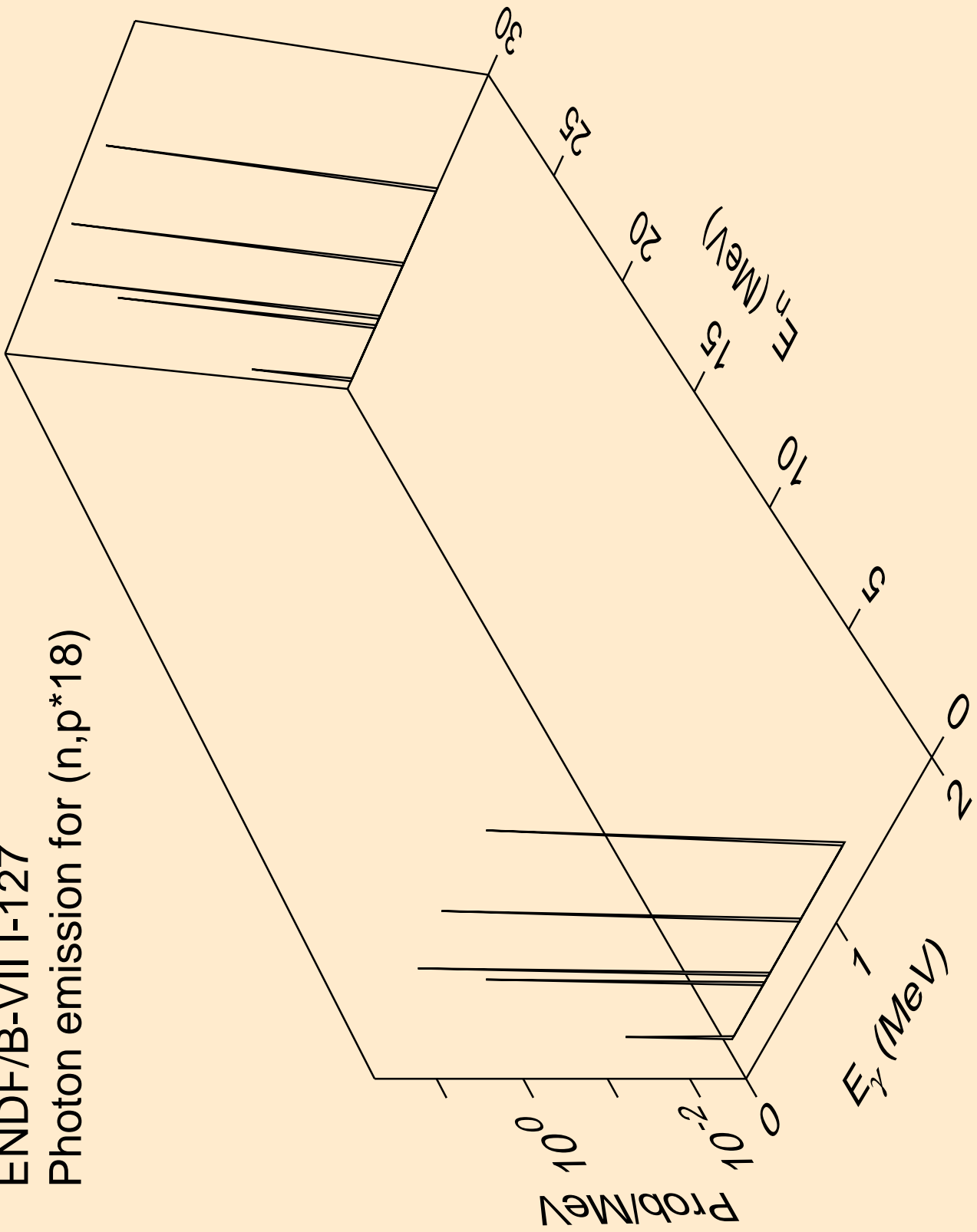

ENDF/B-VII I-127
Photon emission for (n,p*19)

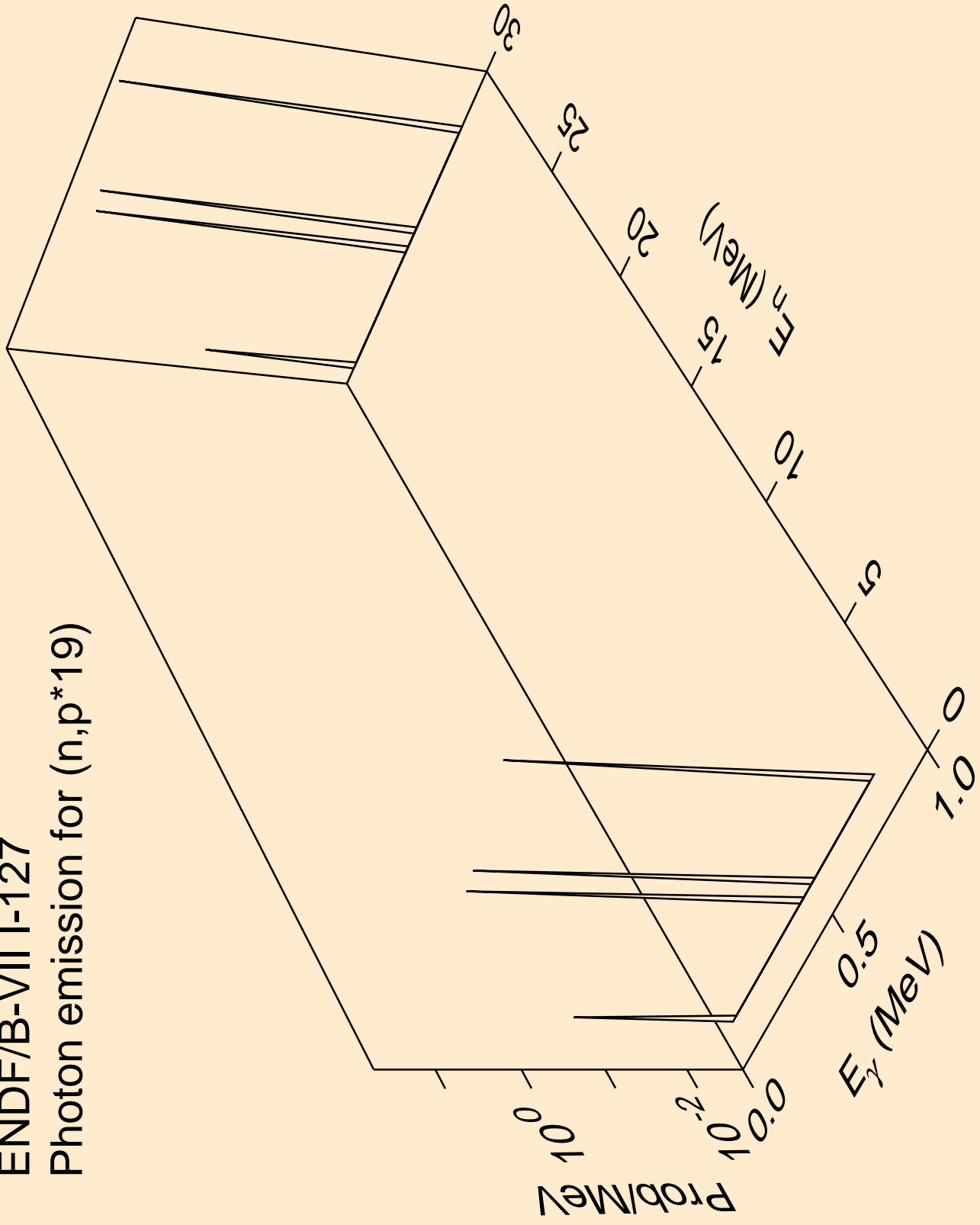

ENDF/B-VII I-127
Photon emission for (n,p*20)

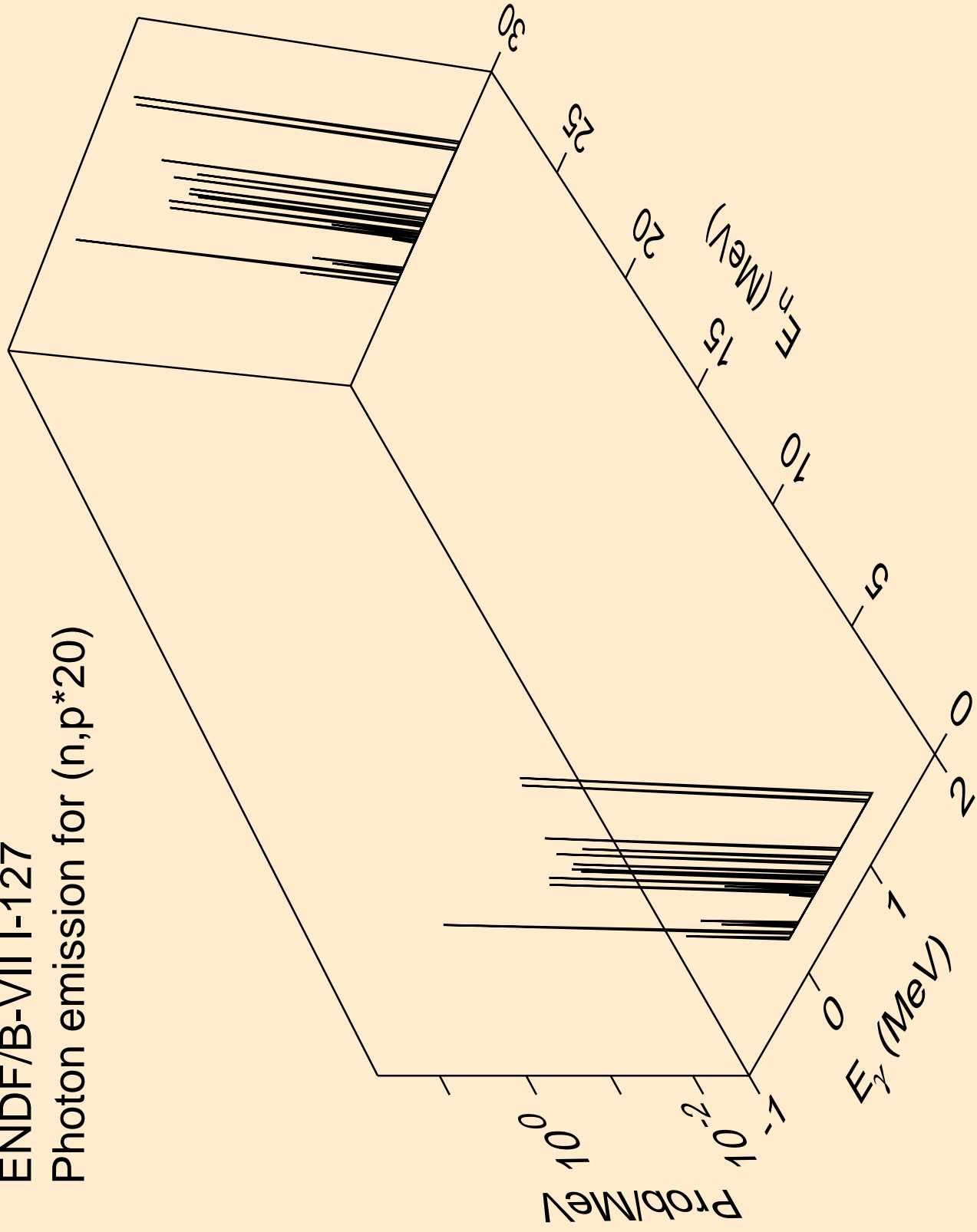

ENDF/B-VII I-127
Photon emission for (n,p*21)

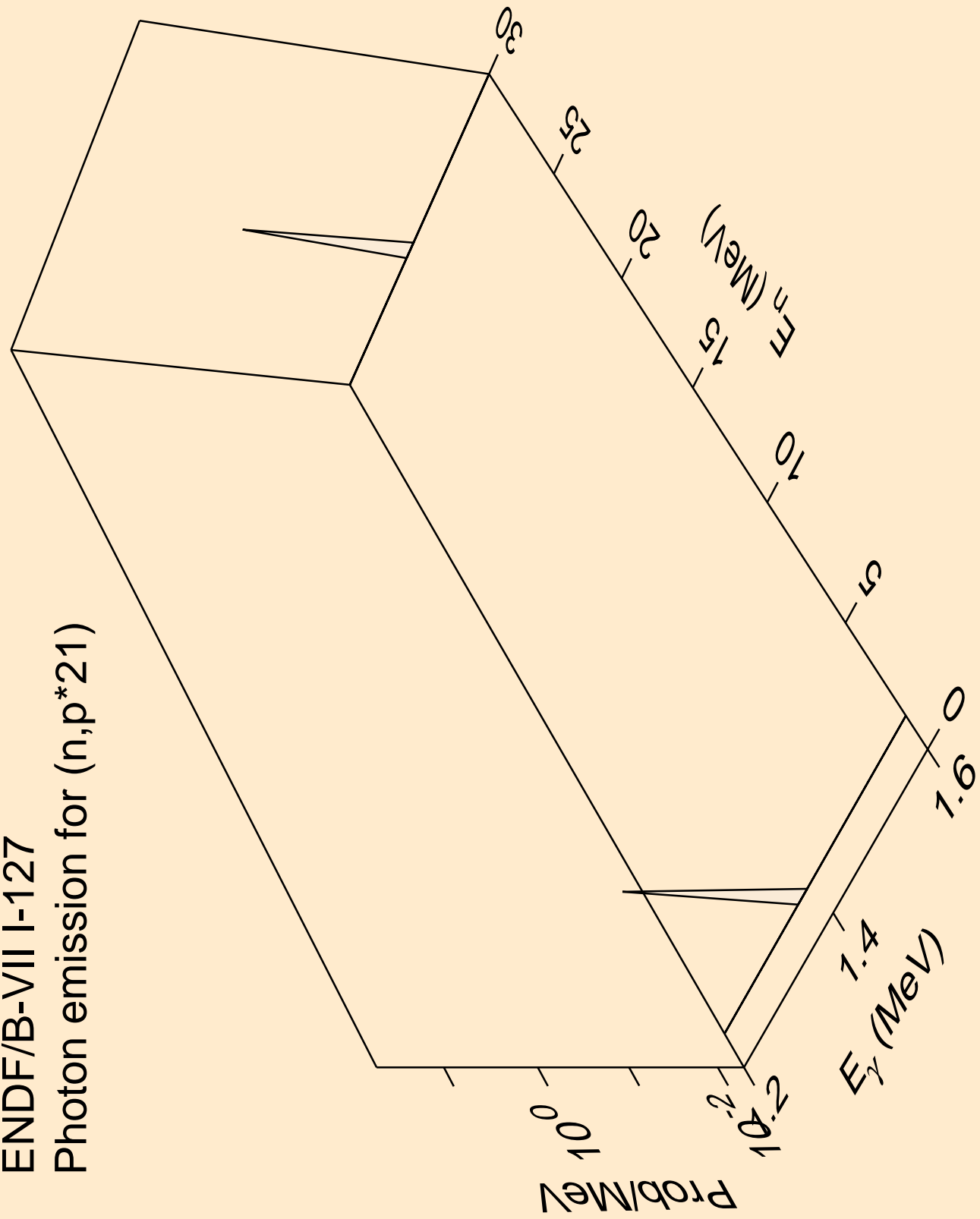

ENDF/B-VII I-127
Photon emission for (n,p*22)

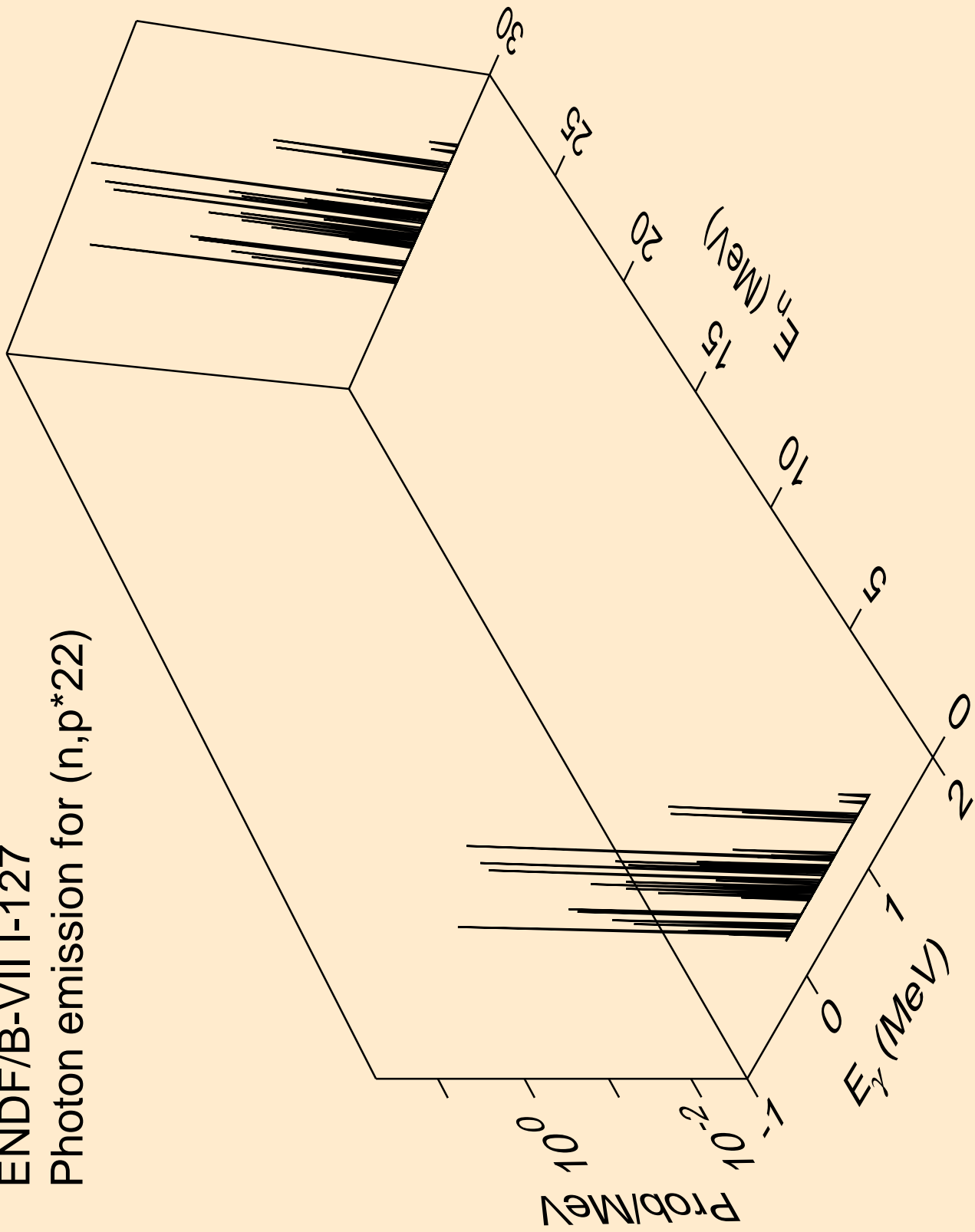

ENDF/B-VII I-127
Photon emission for (n,p*c)

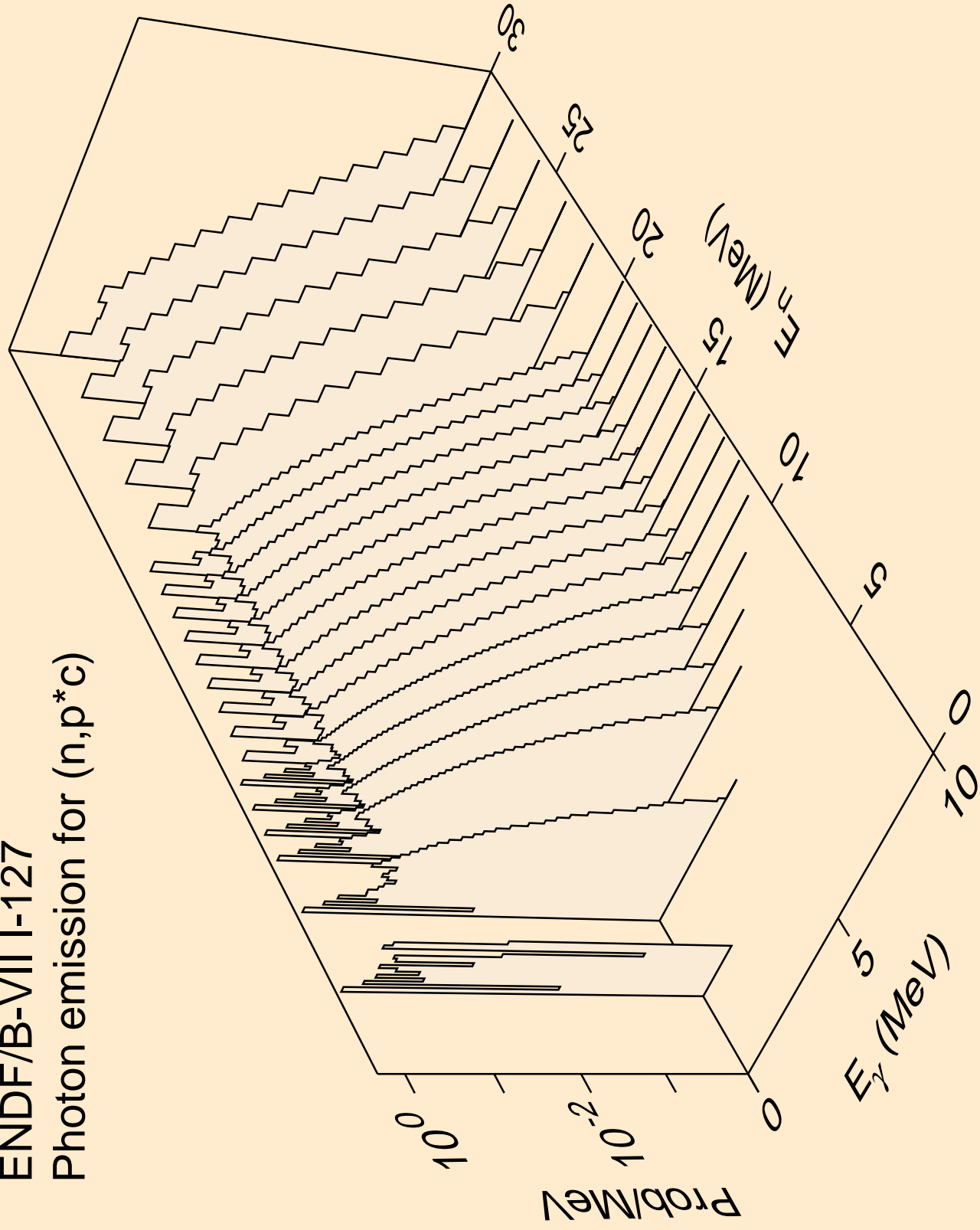

ENDF/B-VII I-127
Photon emission for (n,a*1)

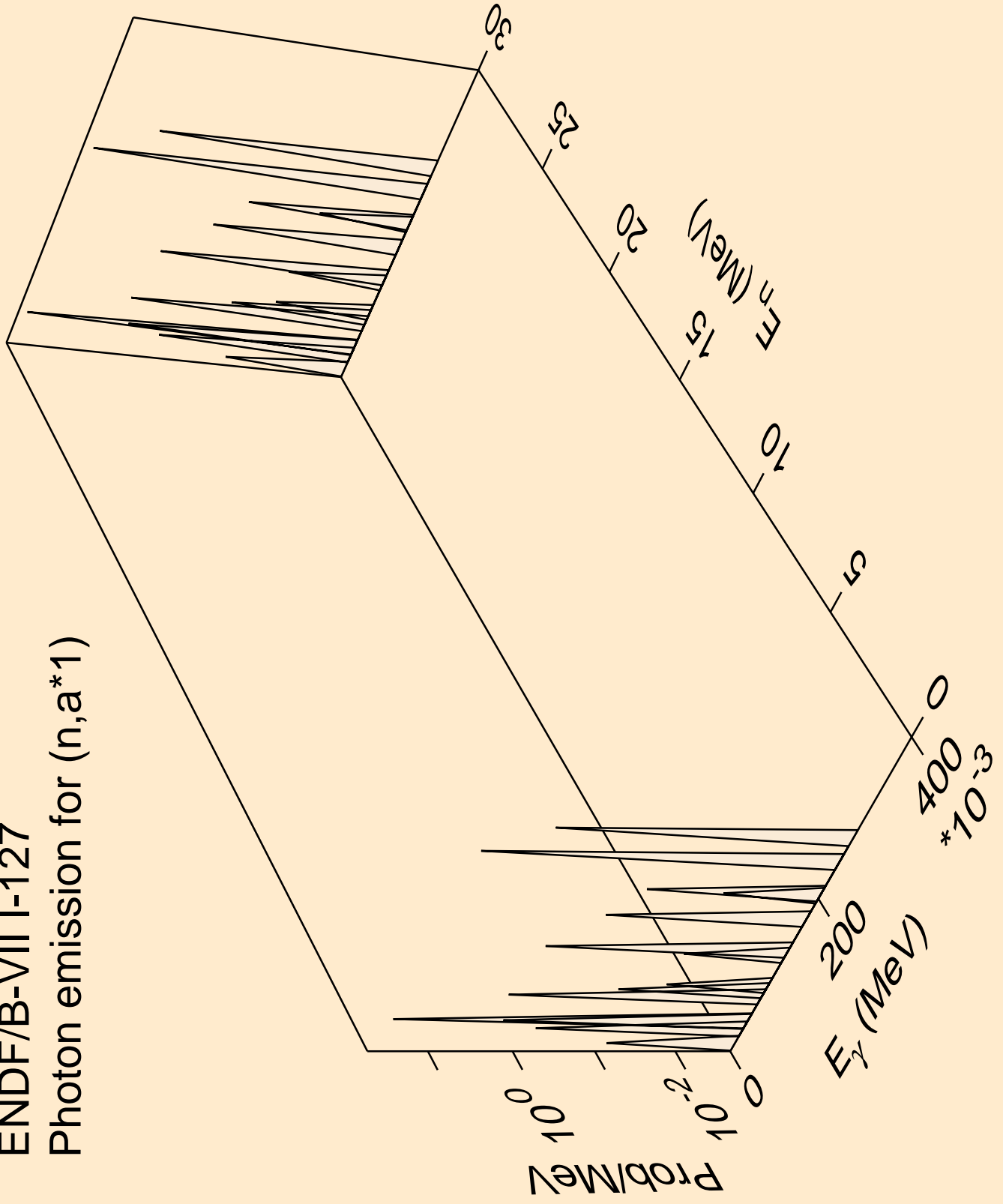

ENDF/B-VII I-127
Photon emission for (n,a*c)

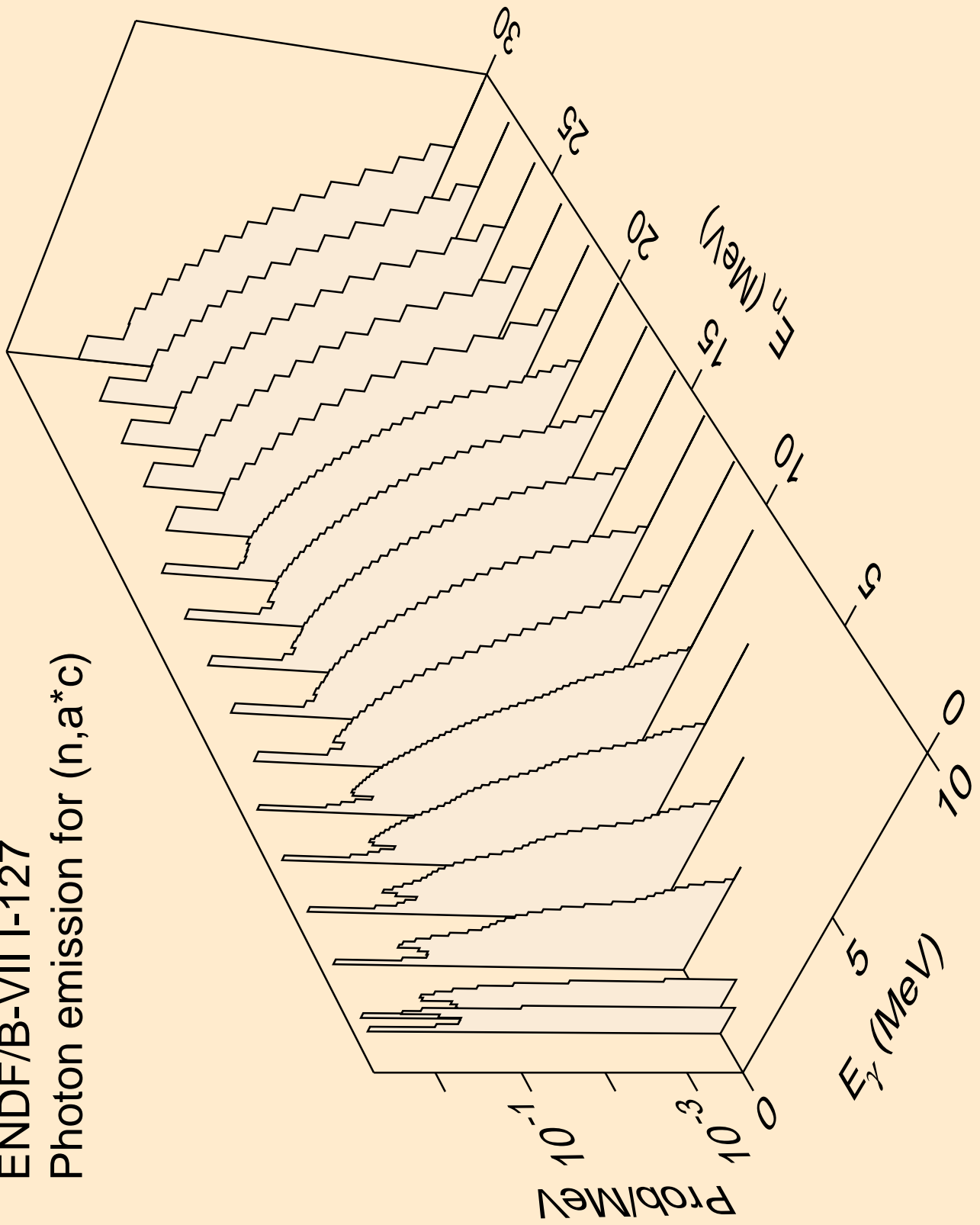

ENDF/B-VII I-127
thermal capture photon spectrum

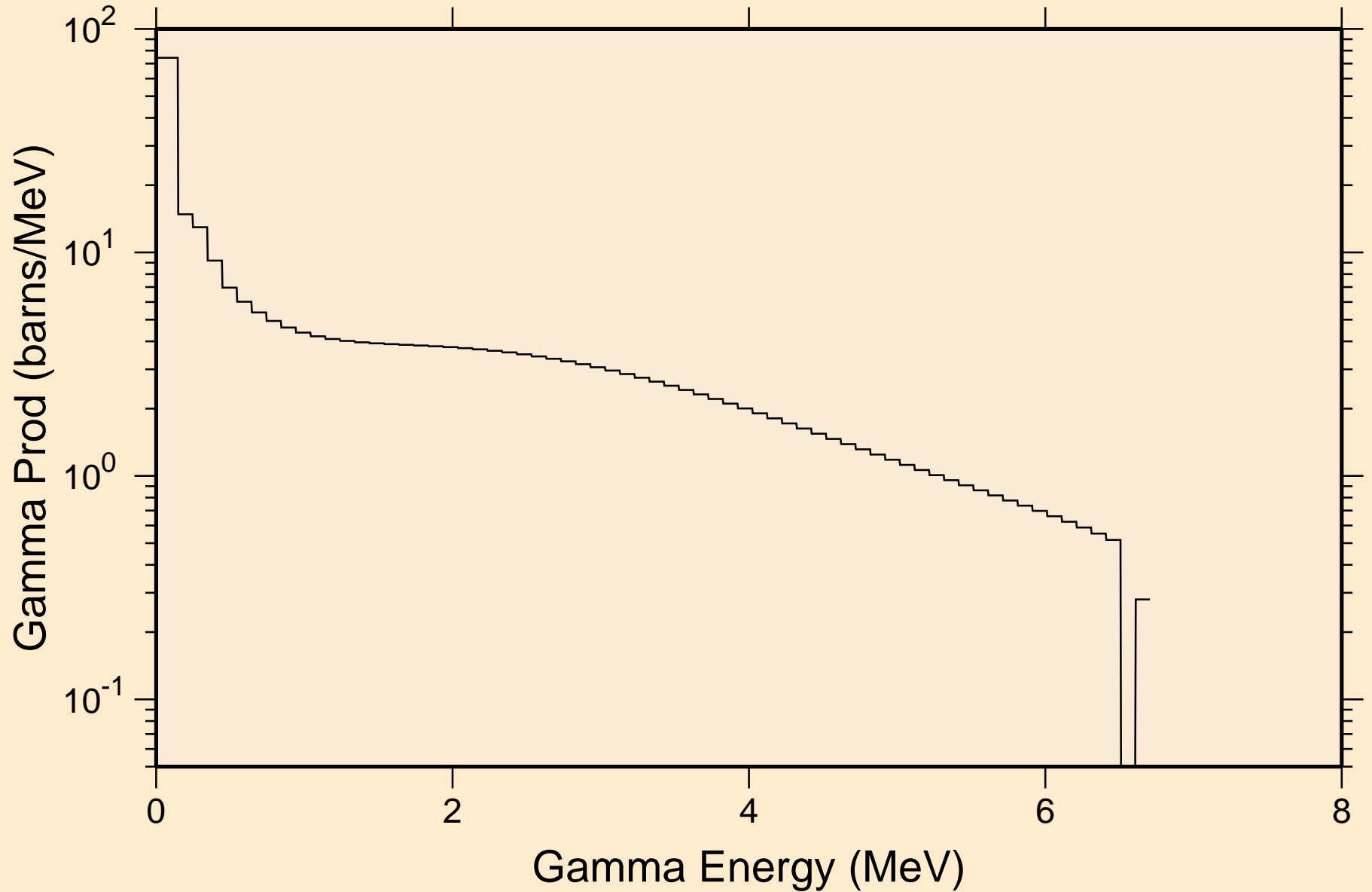

ENDF/B-VII I-127
14 MeV photon spectrum

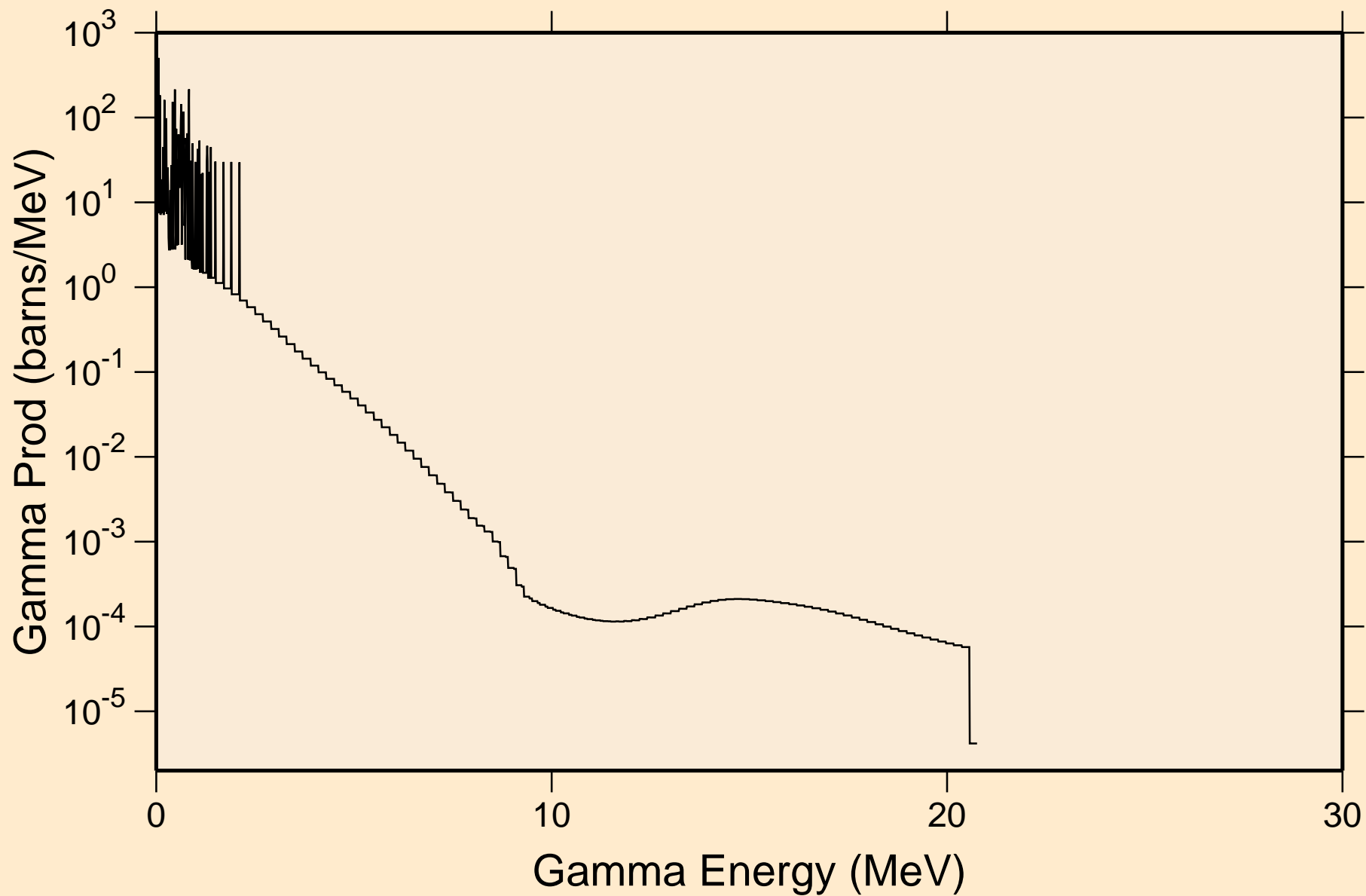

ENDF/B-VII I-127

Particle heating contributions

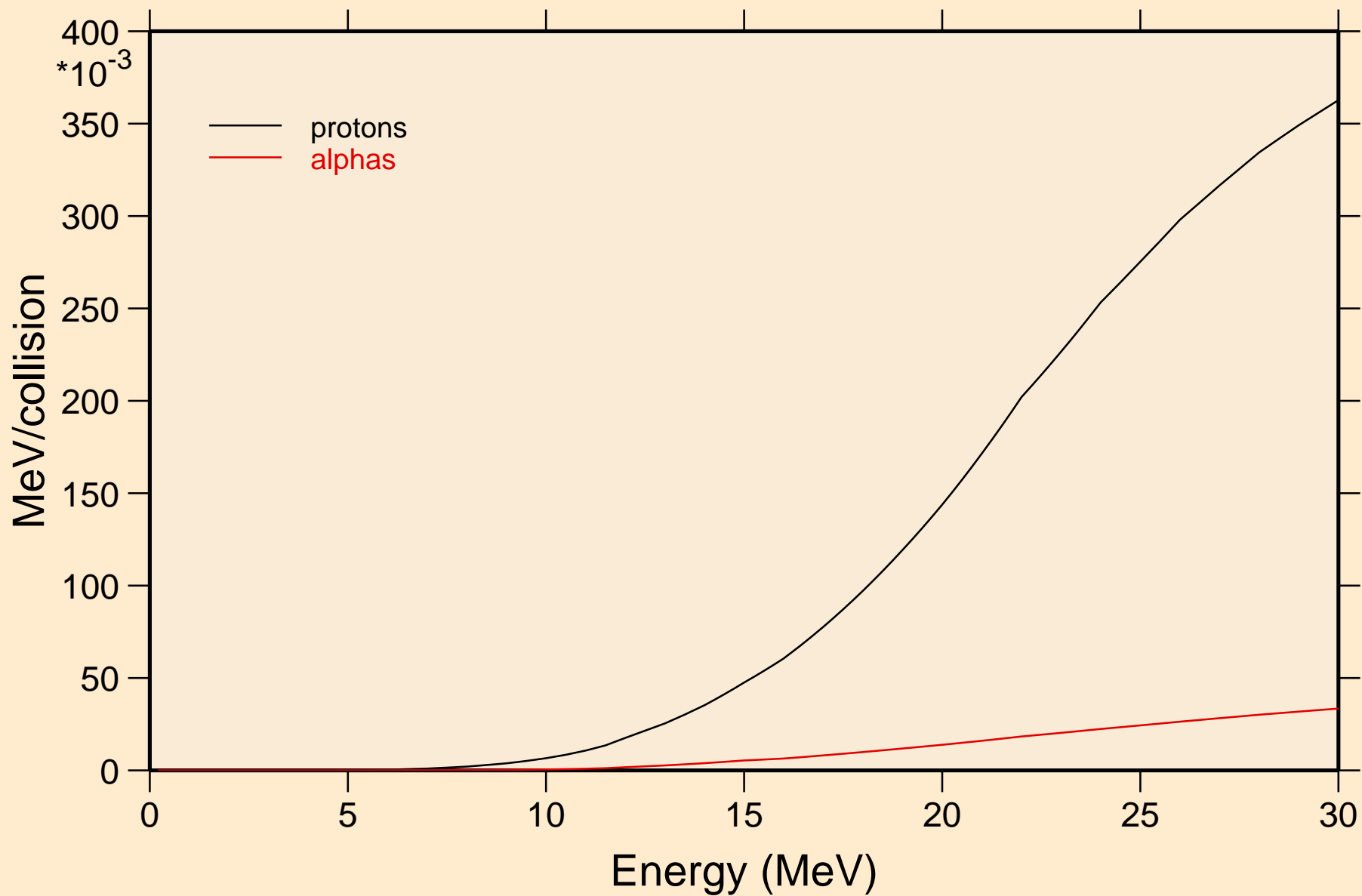

ENDF/B-VII I-127 Recoil Heating

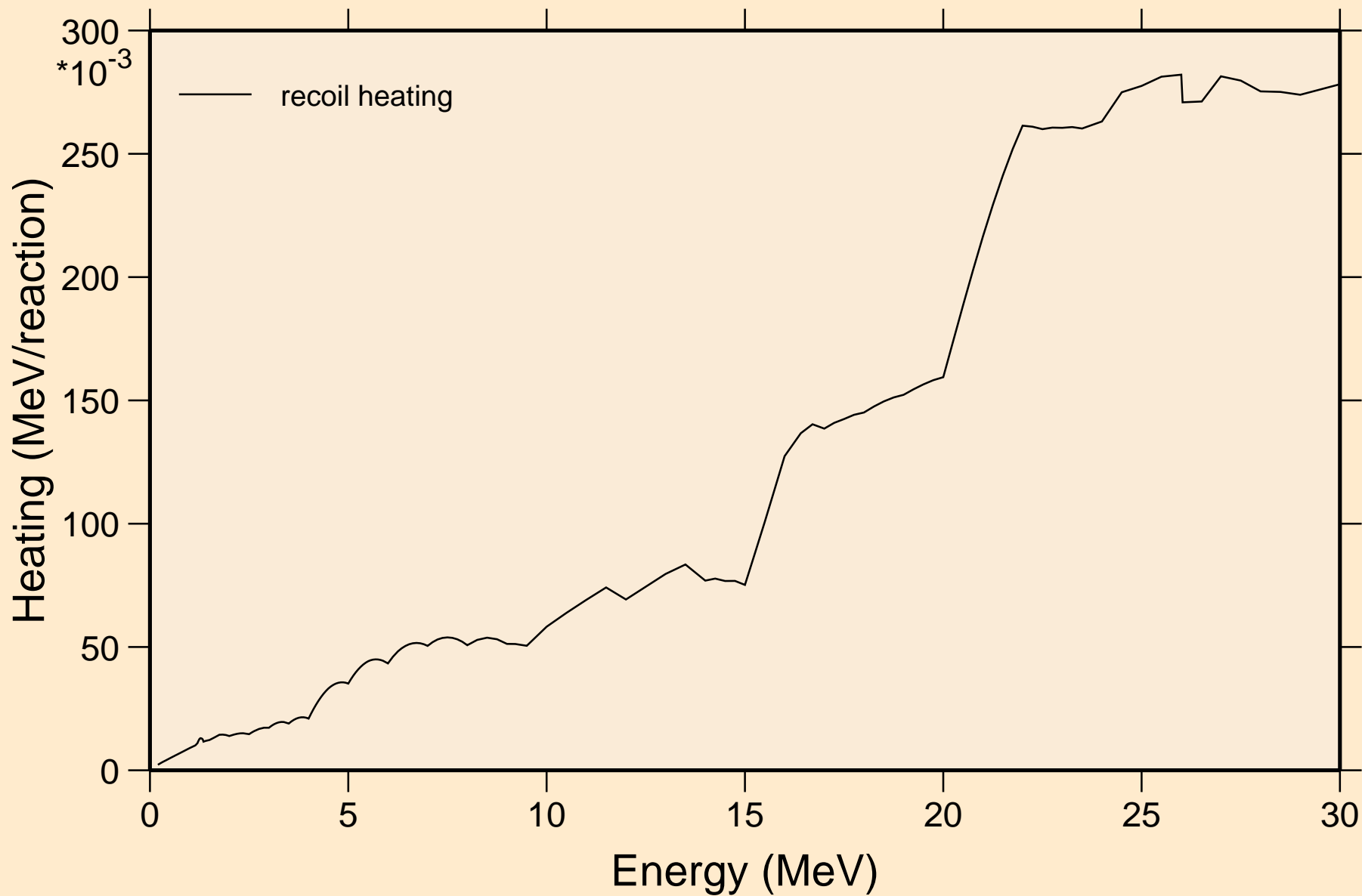

ENDF/B-VII I-127

Particle production cross sections

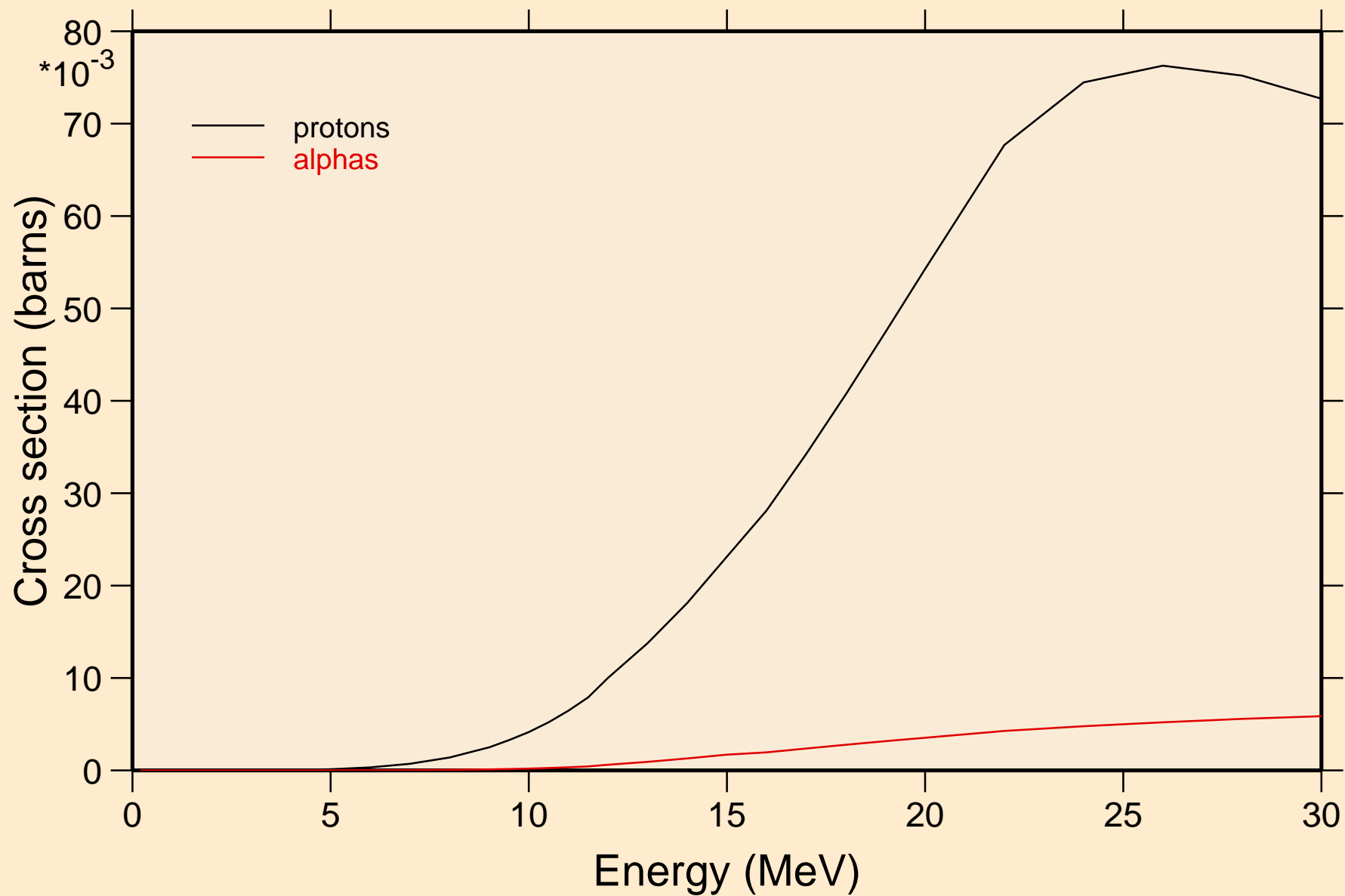

ENDF/B-VII I-127
protons from (n,n*)p

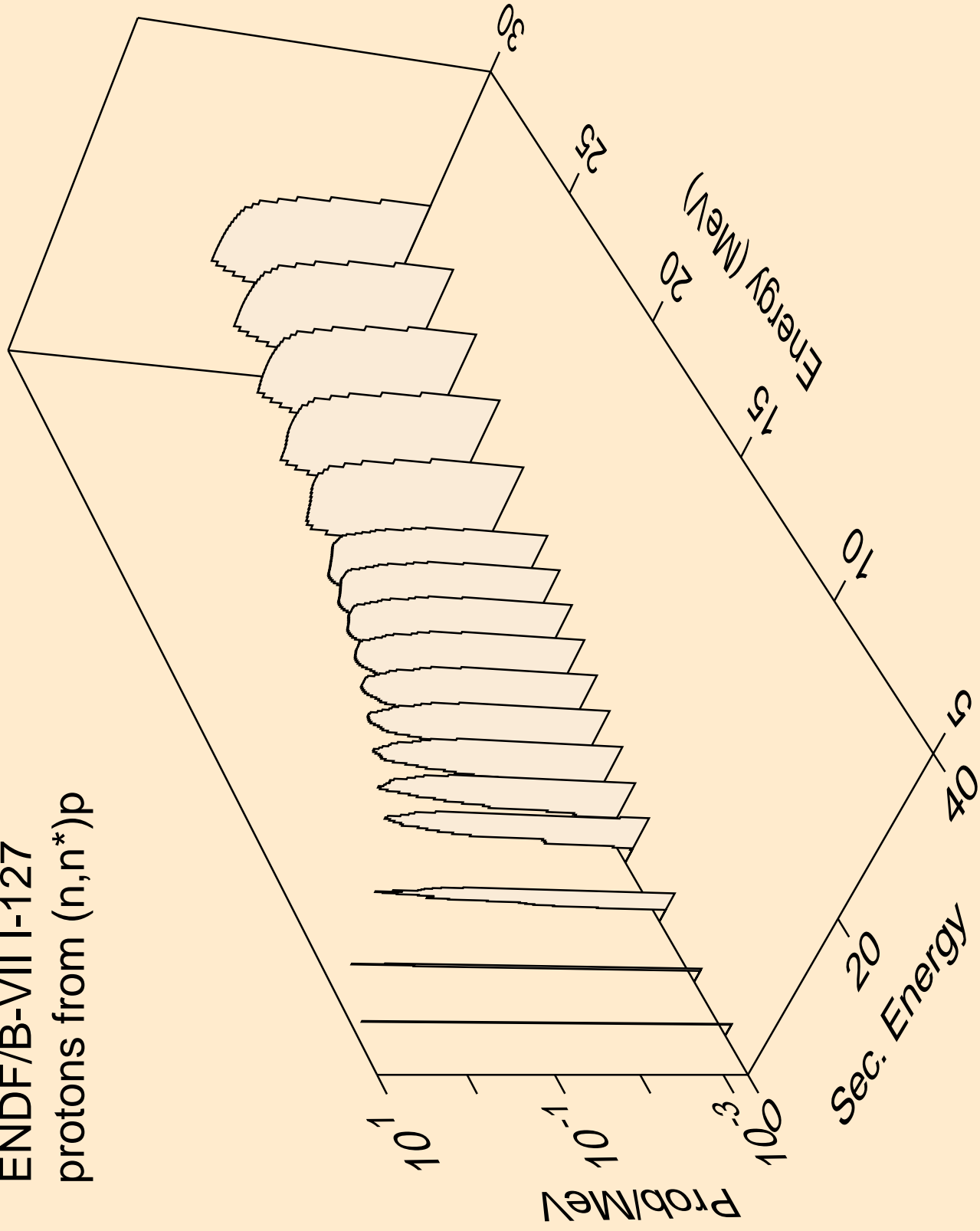

ENDF/B-VII I-127
angular distribution for (n,p*0) proton

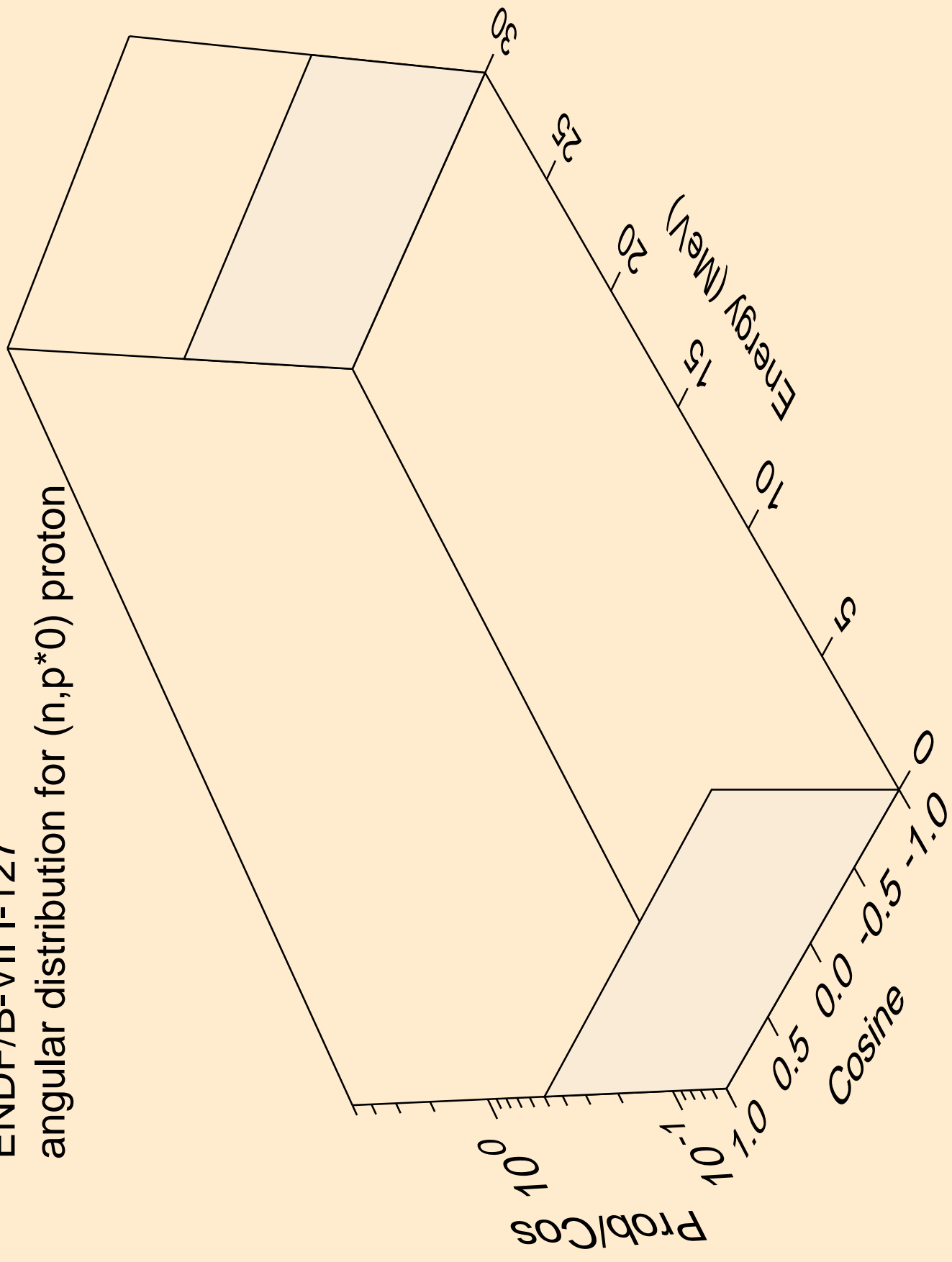

ENDF/B-VII I-127
angular distribution for (n,p*1) proton

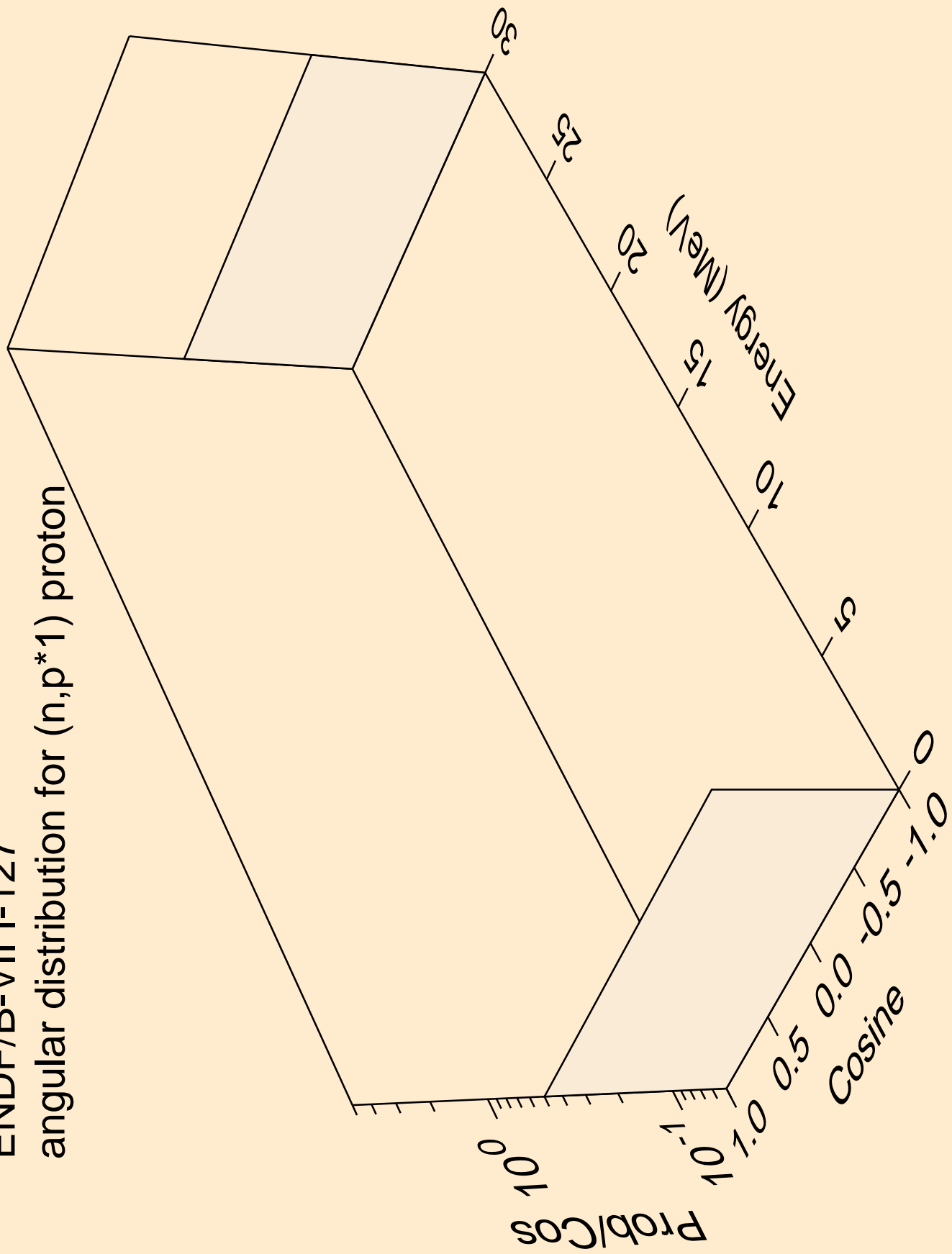

ENDF/B-VII I-127
angular distribution for (n,p*2) proton

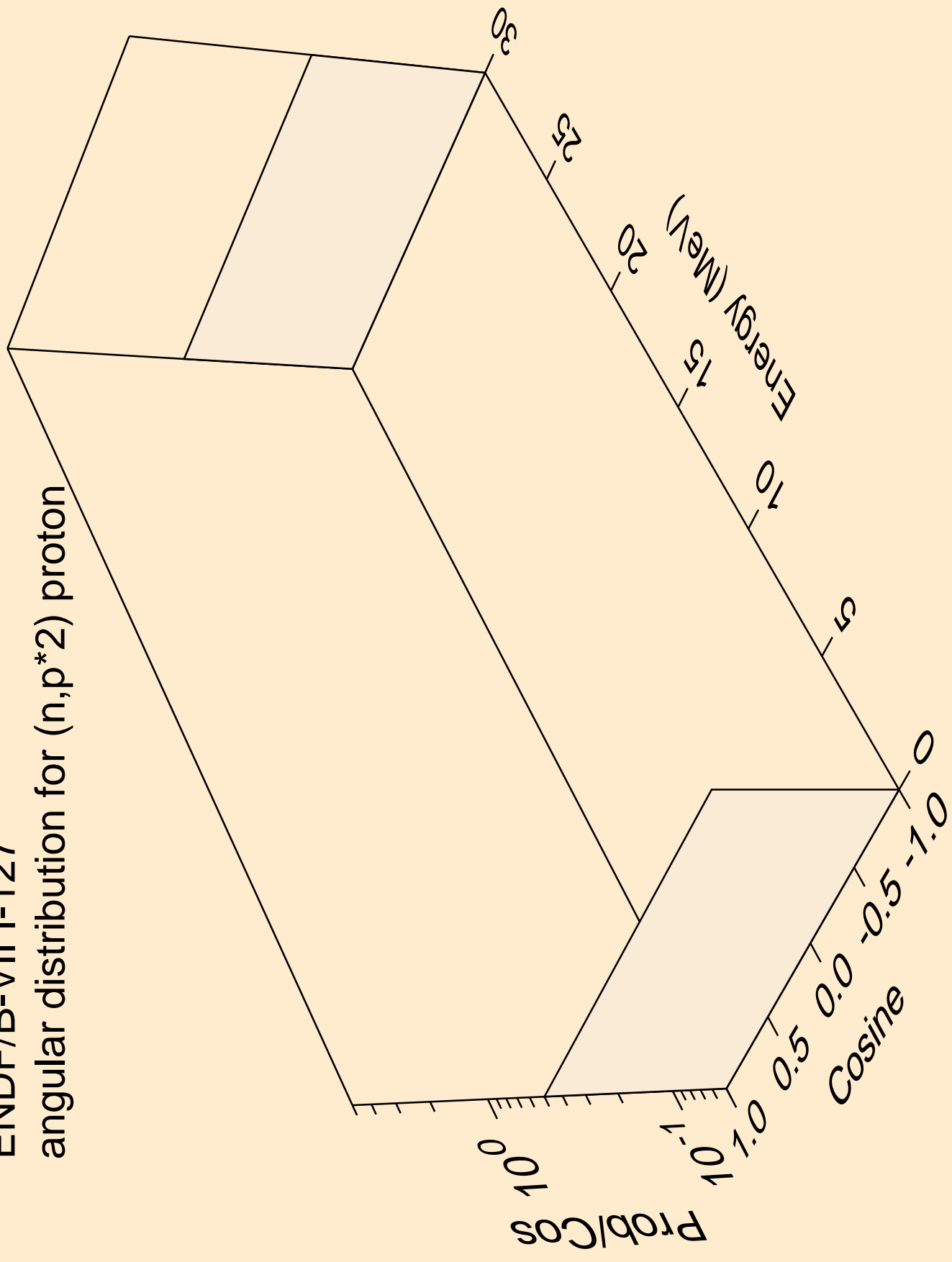

ENDF/B-VII I-127
angular distribution for (n,p*3) proton

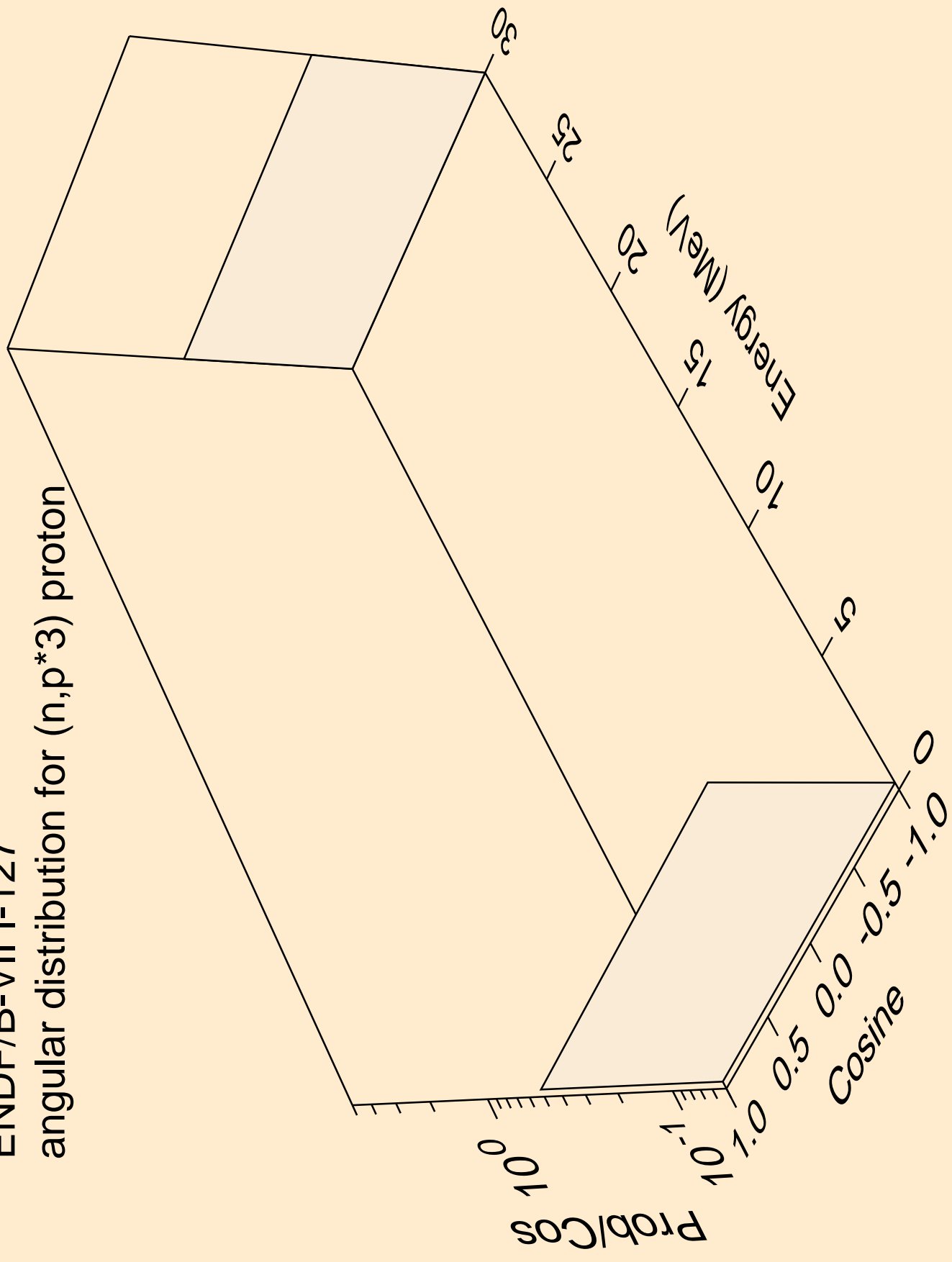

ENDF/B-VII I-127
angular distribution for (n,p*4) proton

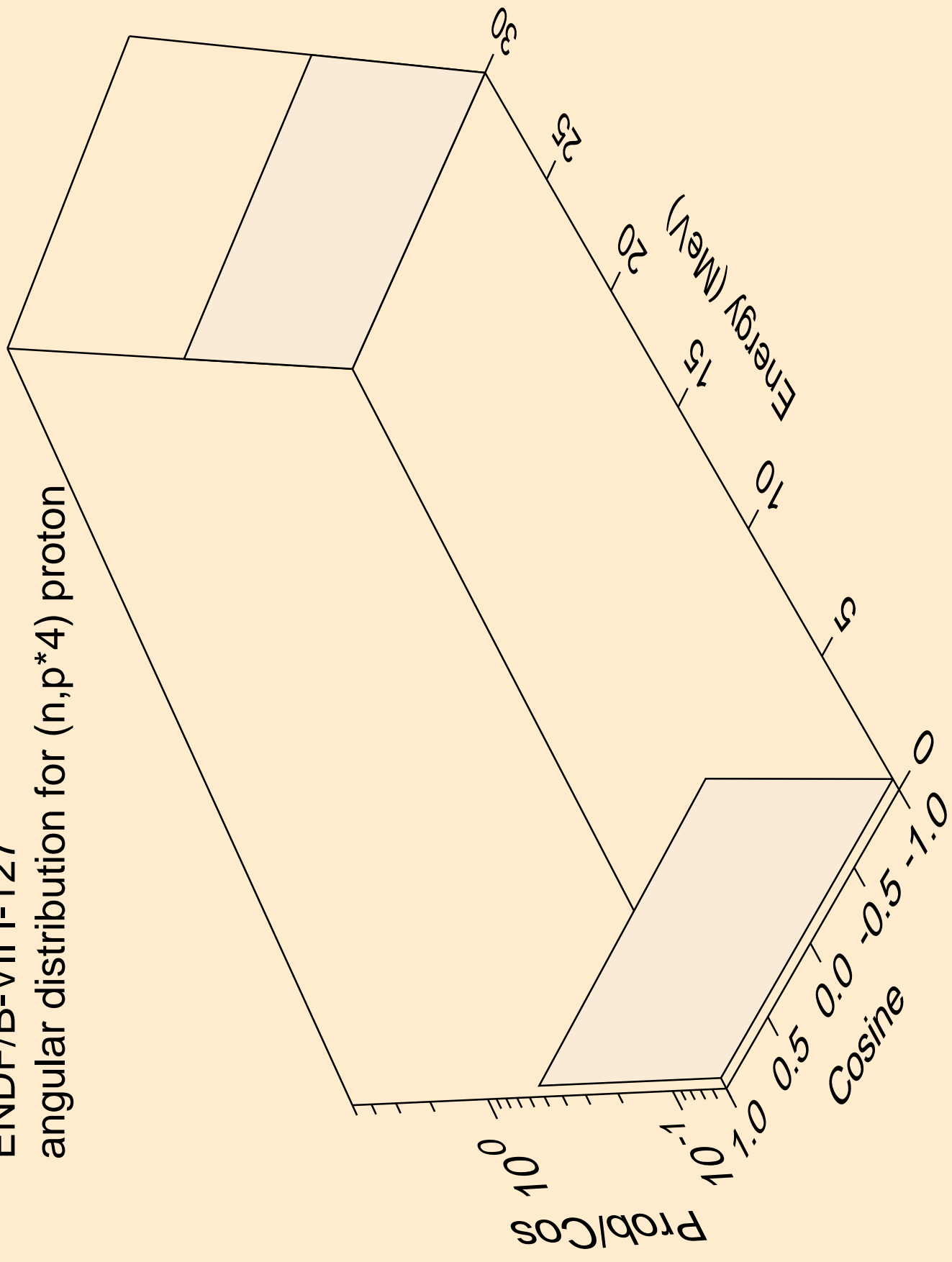

ENDF/B-VII I-127
angular distribution for (n,p*5) proton

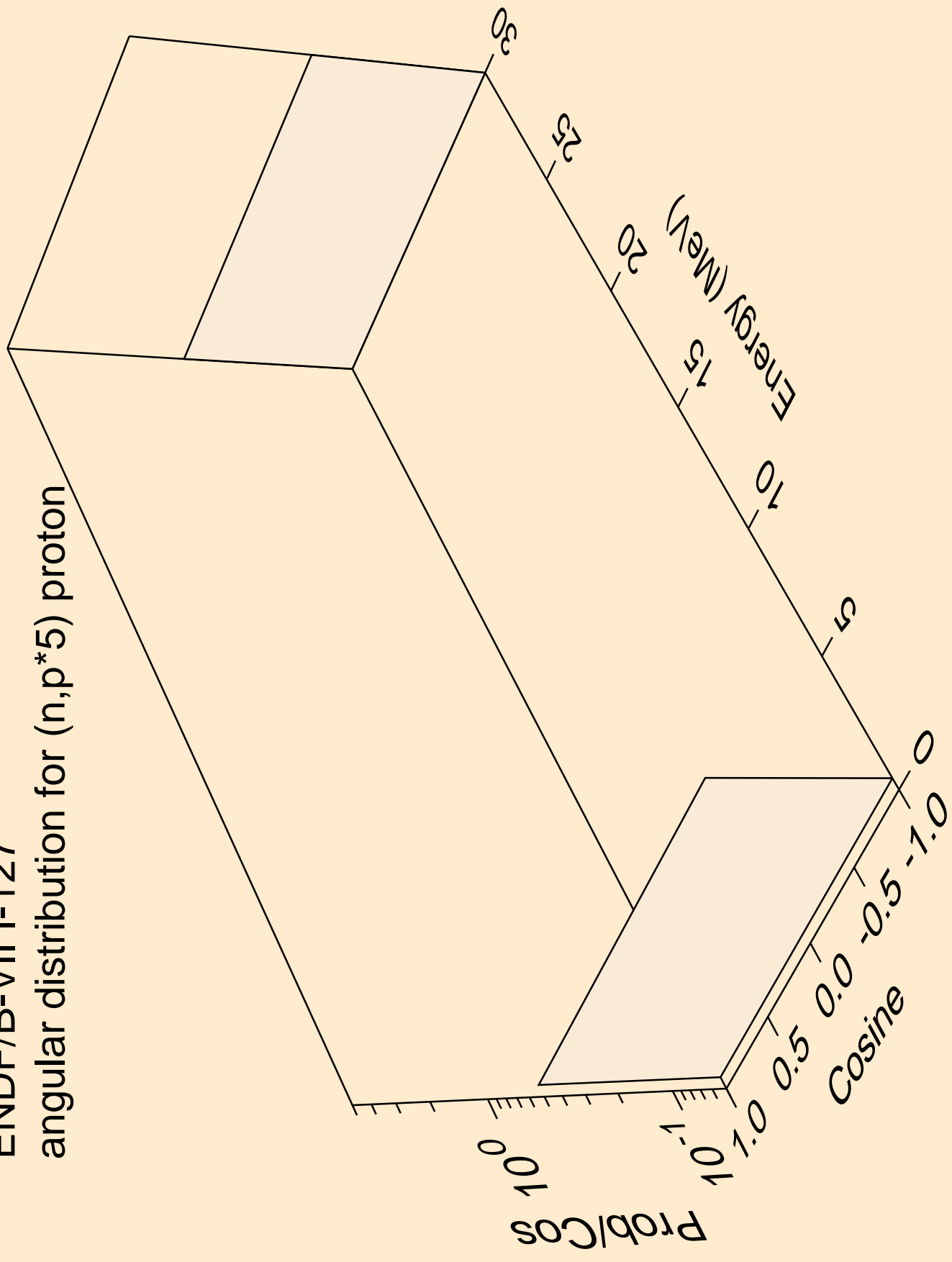

ENDF/B-VII I-127
angular distribution for (n,p*6) proton

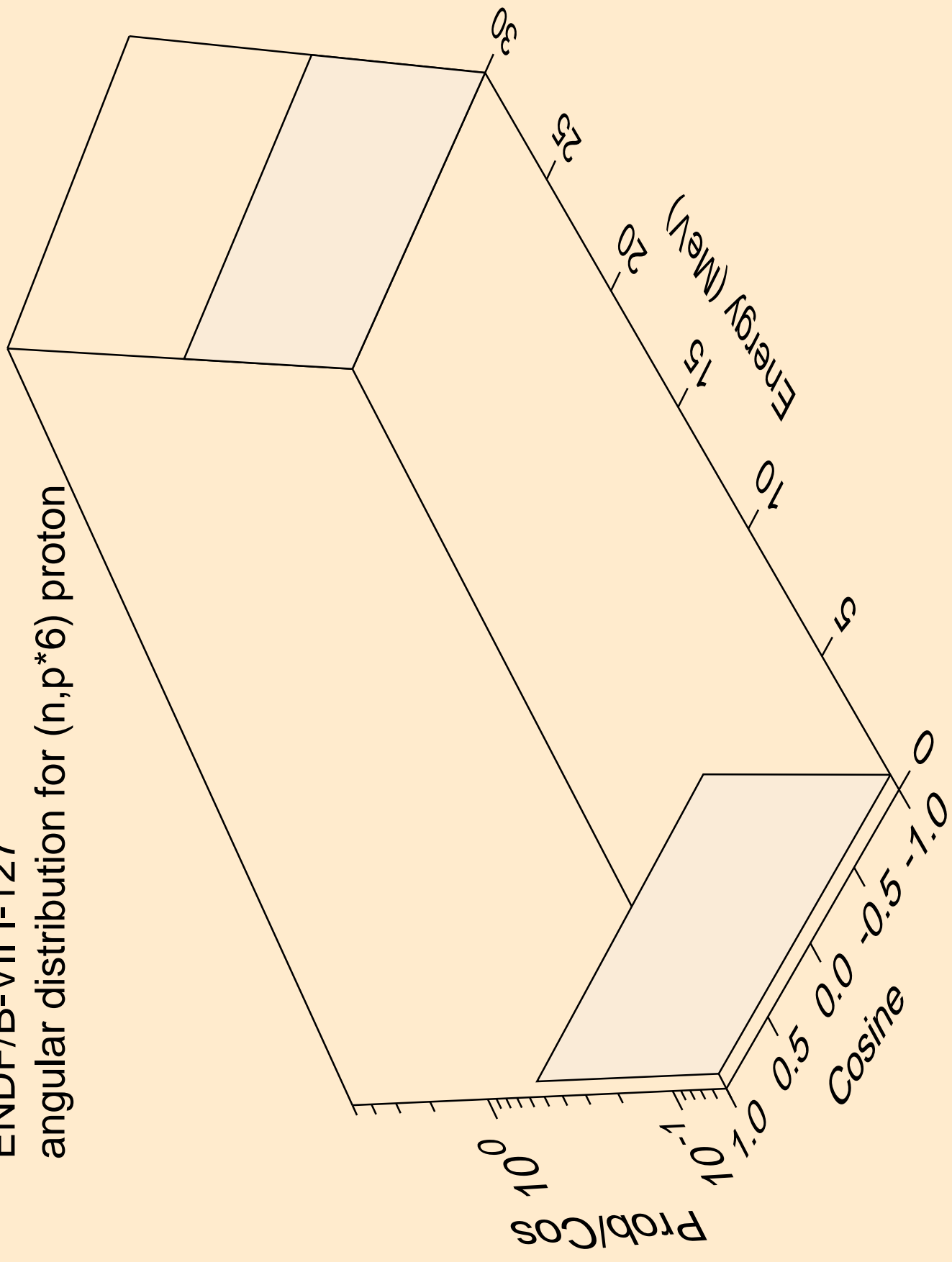

ENDF/B-VII I-127
angular distribution for (n,p*7) proton

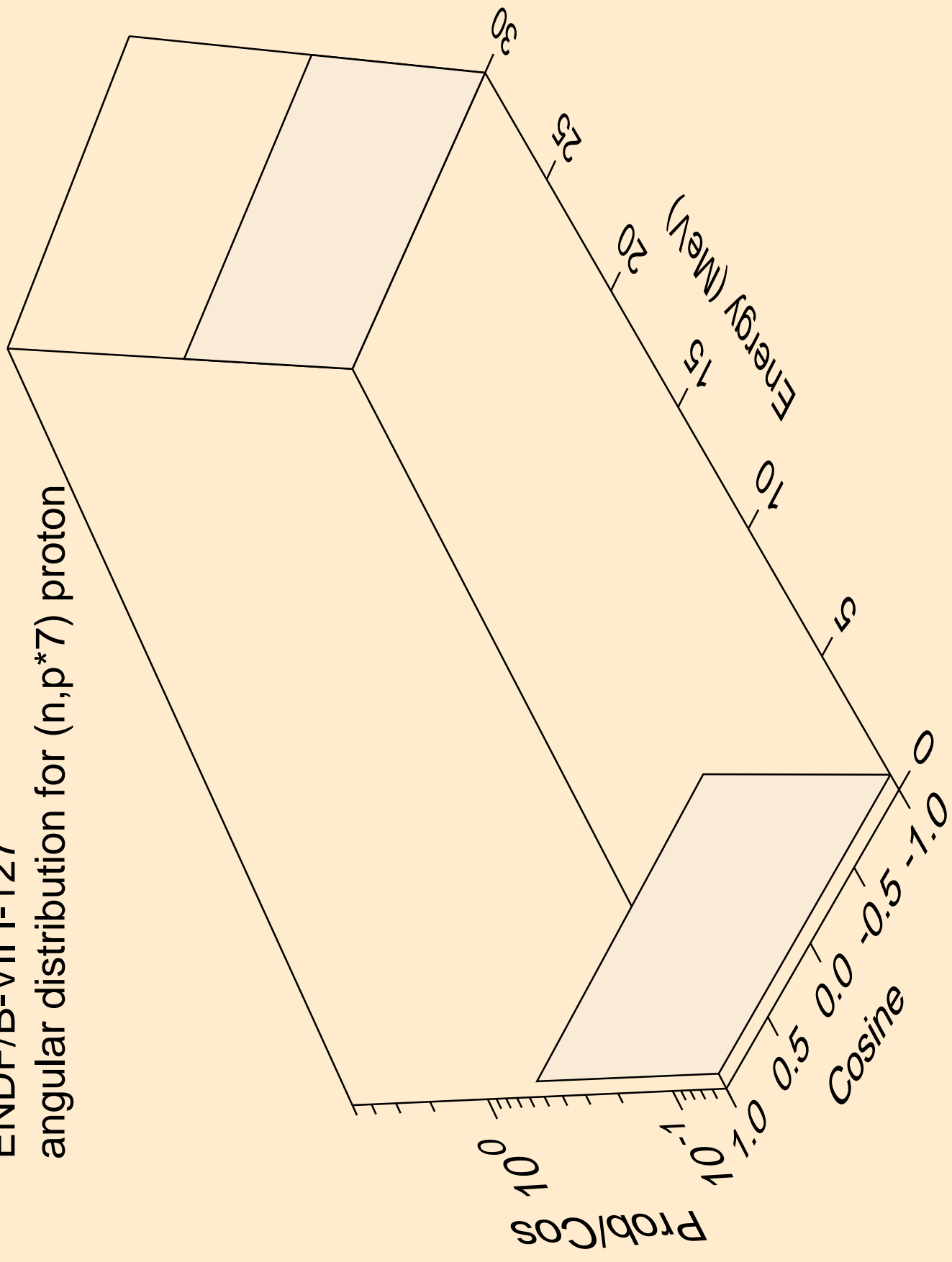

ENDF/B-VII I-127
angular distribution for (n,p*8) proton

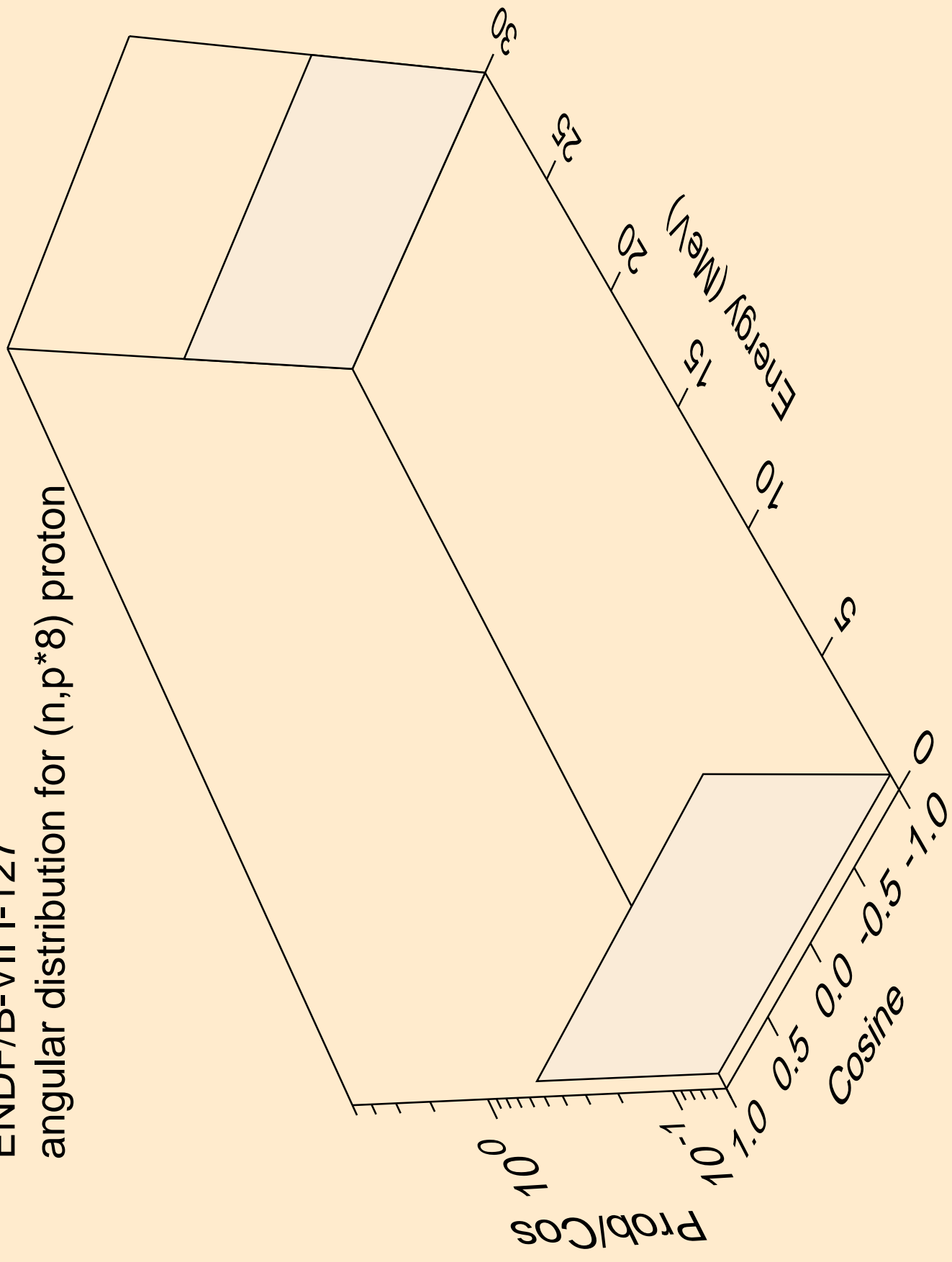

ENDF/B-VII I-127
angular distribution for (n,p*9) proton

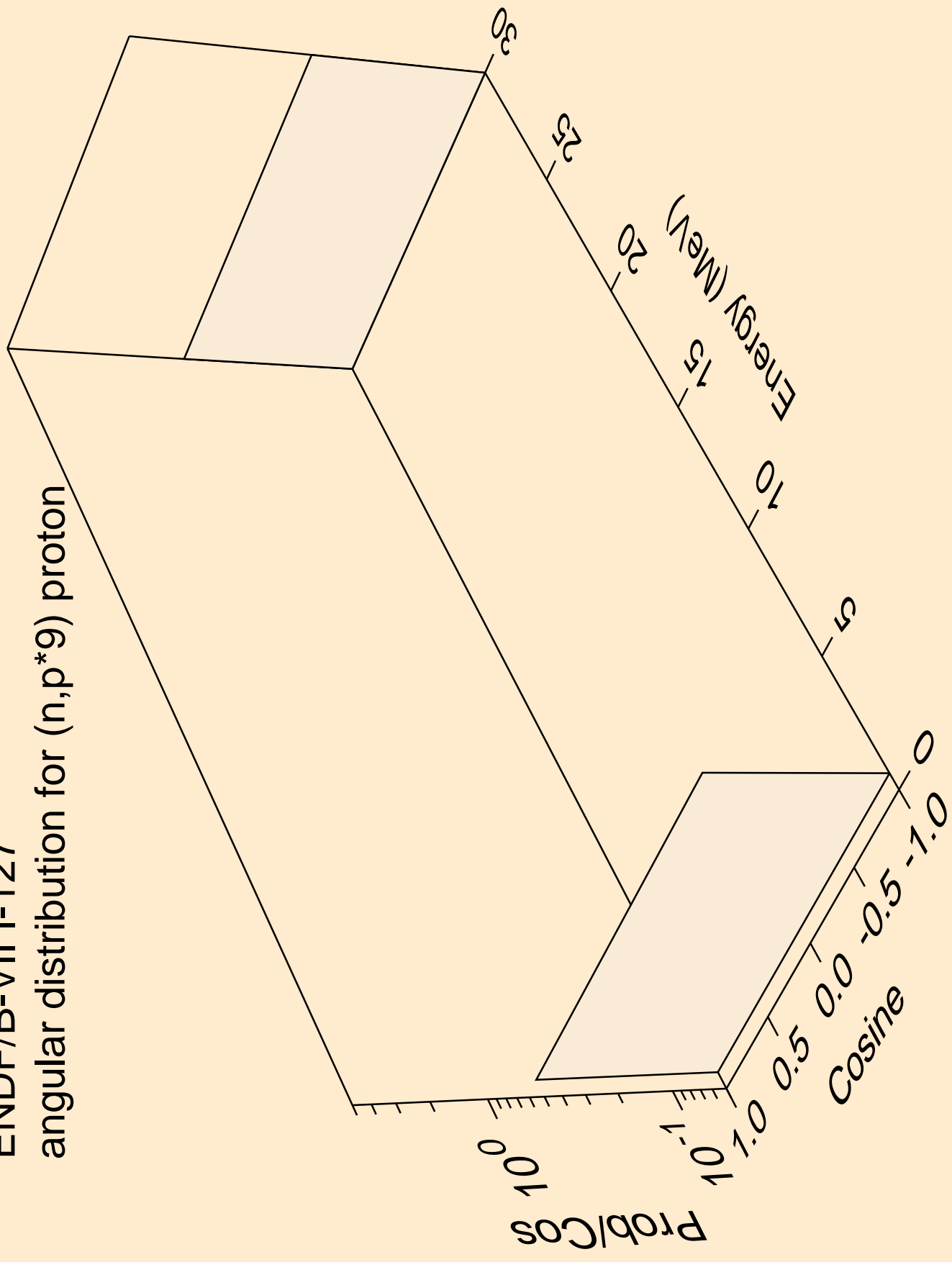

ENDF/B-VII I-127
angular distribution for (n,p*10) proton

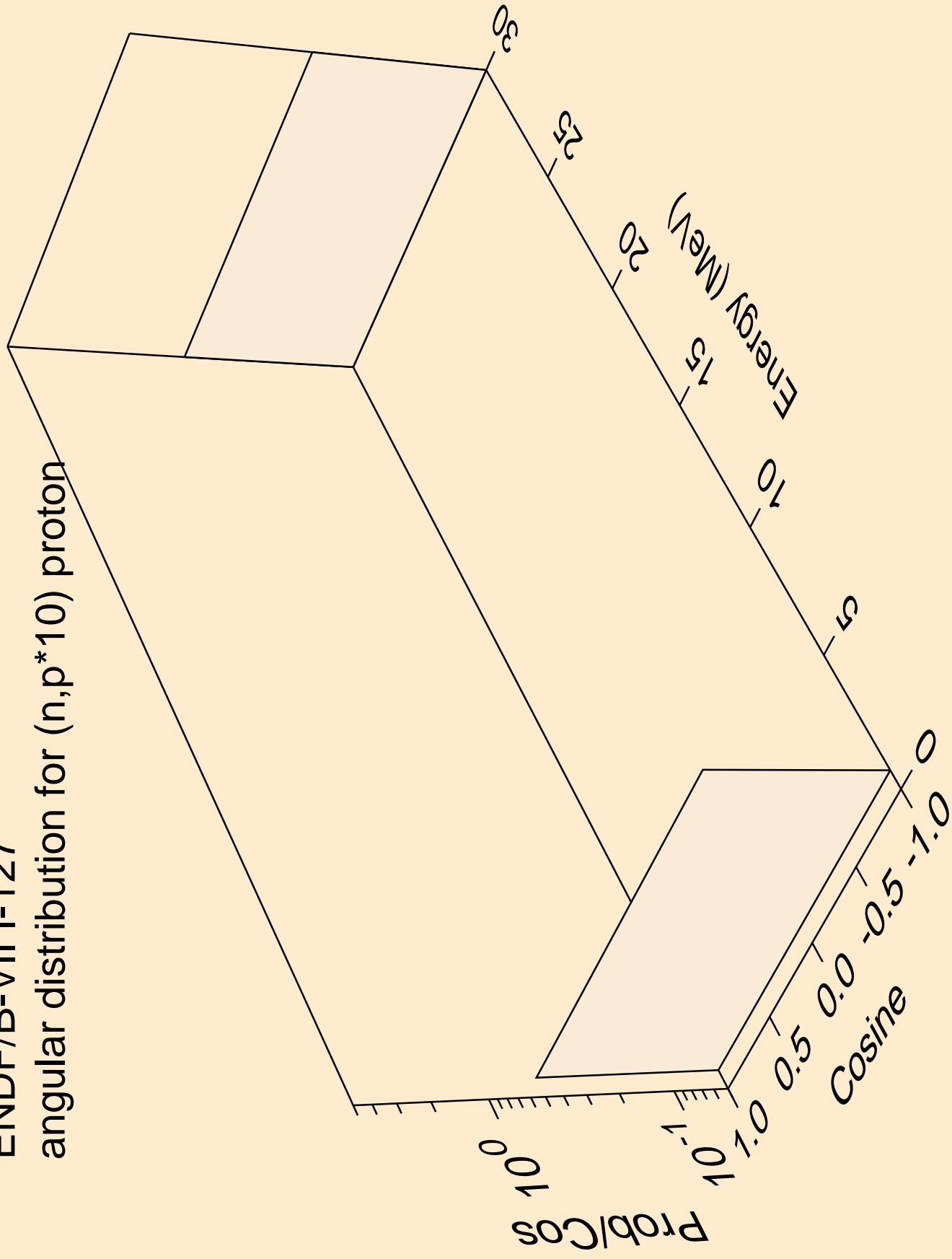

ENDF/B-VII I-127
angular distribution for (n,p*11) proton

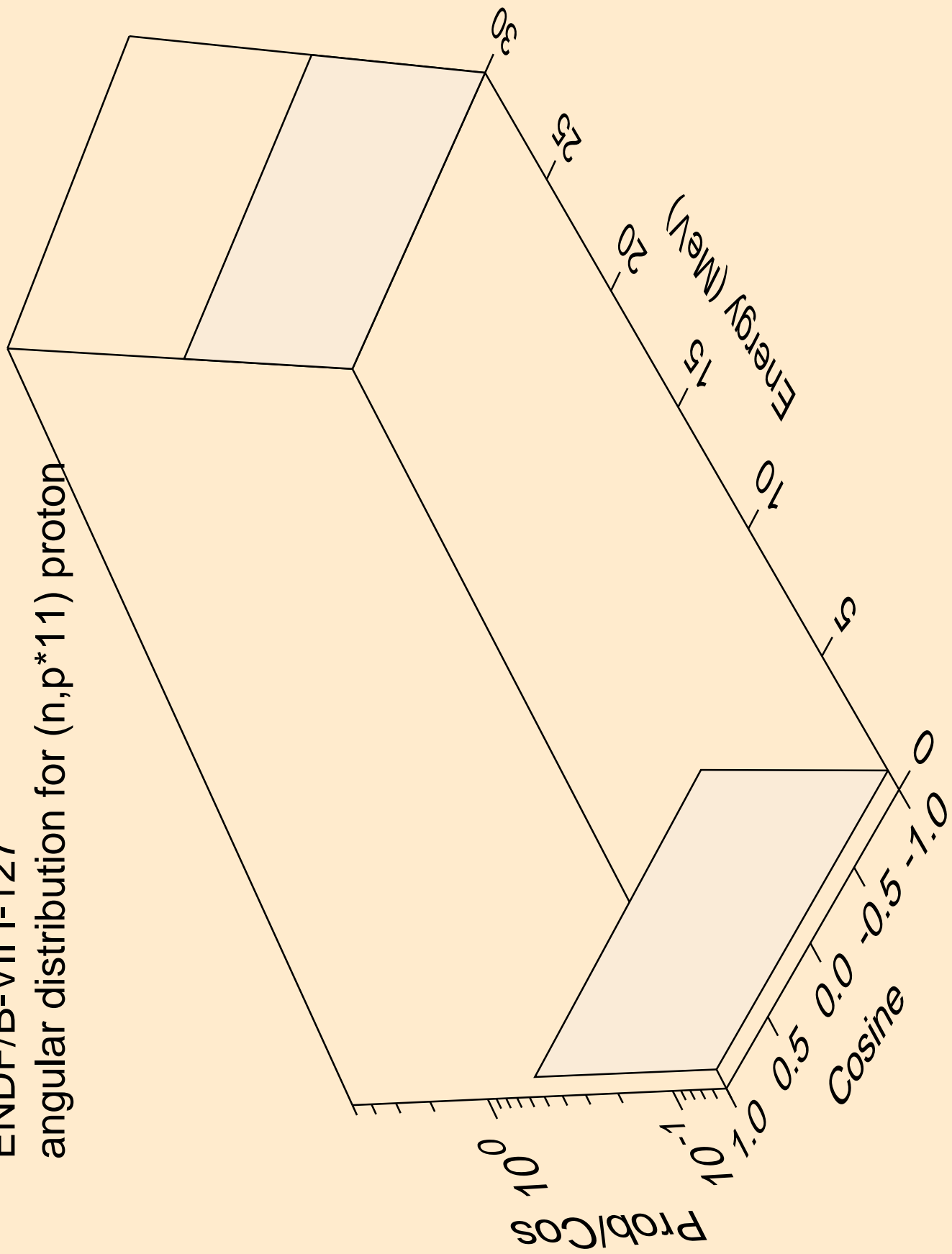

ENDF/B-VII I-127
angular distribution for (n,p*12) proton

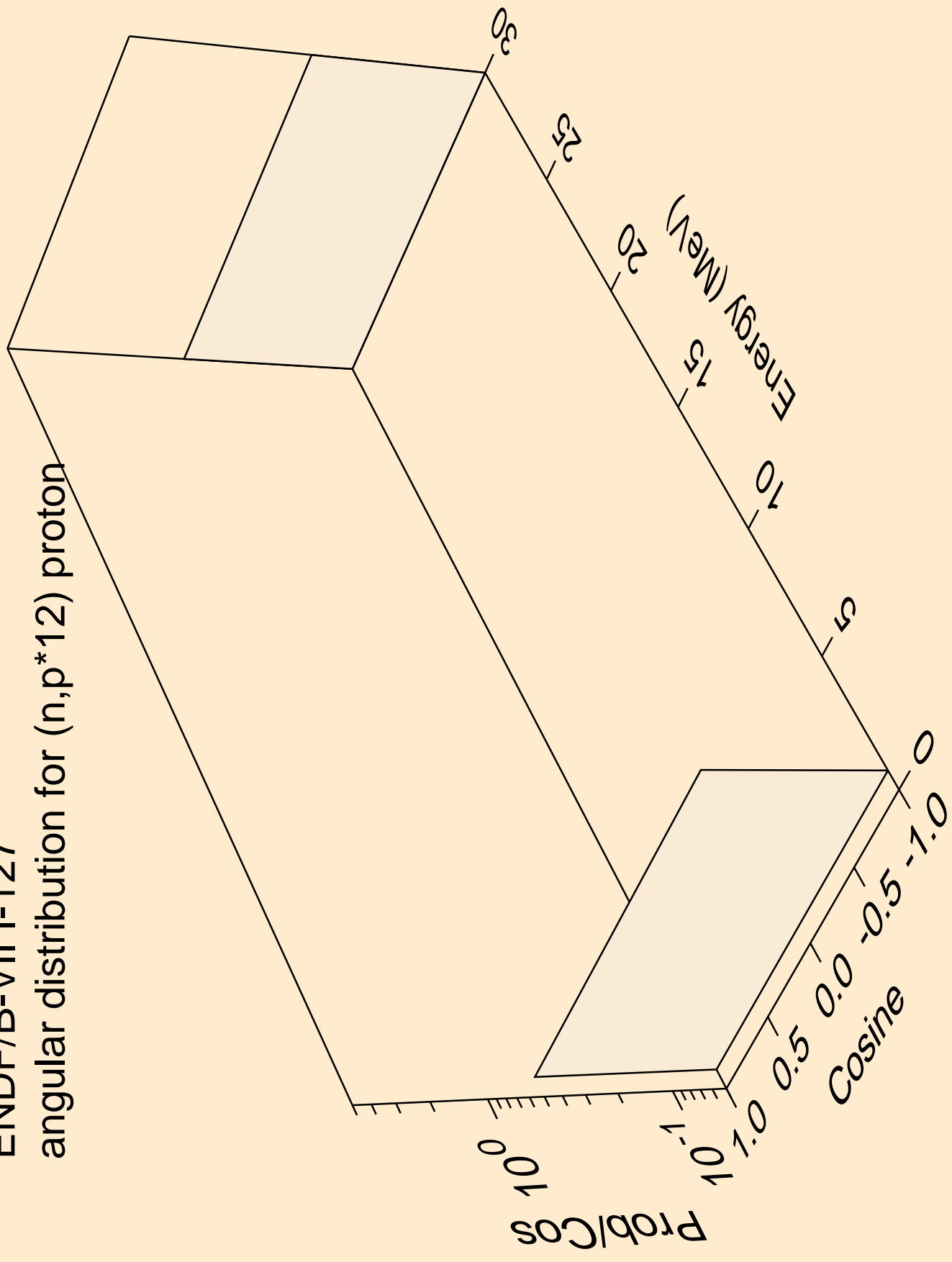

ENDF/B-VII I-127
angular distribution for (n,p*13) proton

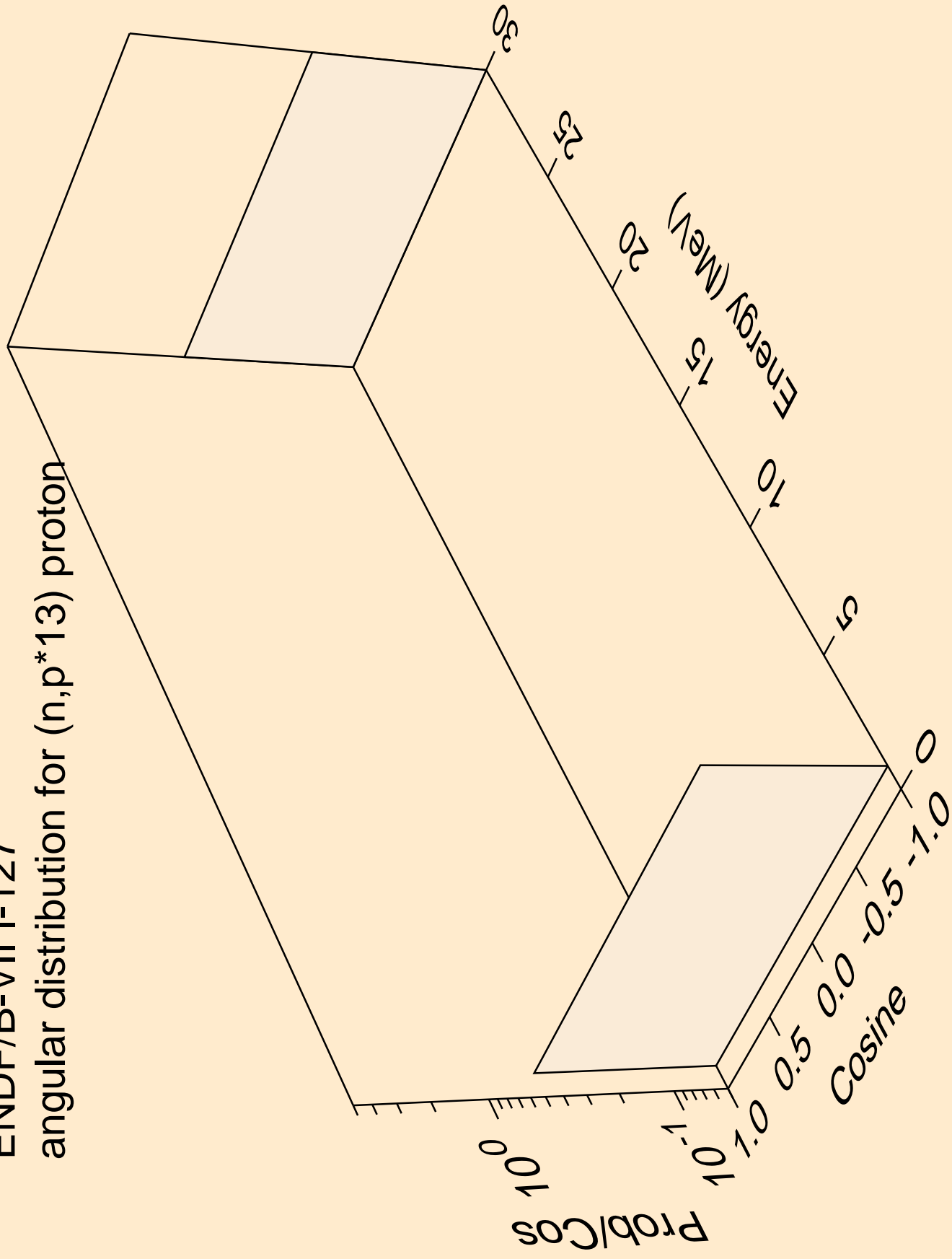

ENDF/B-VII I-127
angular distribution for (n,p*14) proton

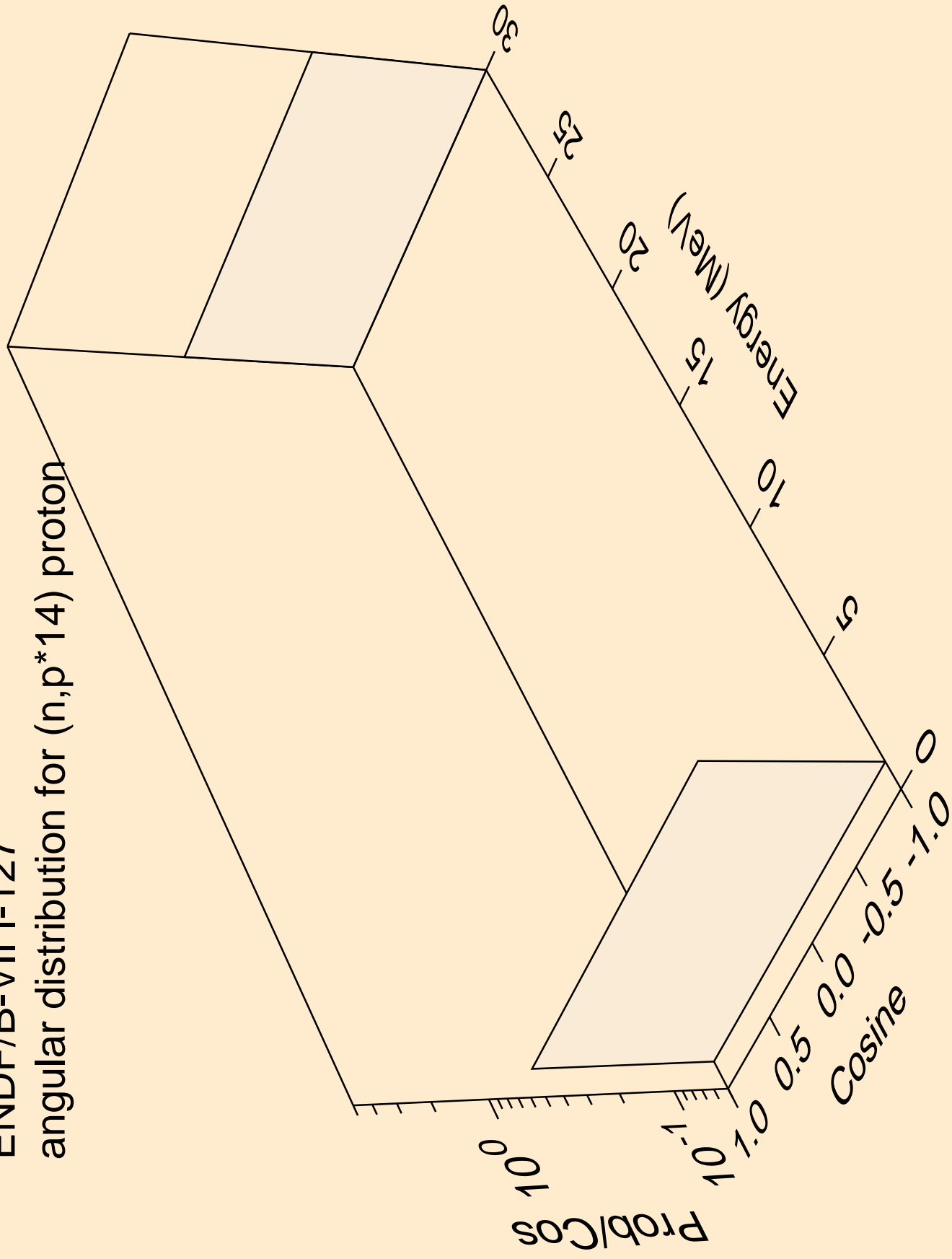

ENDF/B-VII I-127
angular distribution for (n,p*15) proton

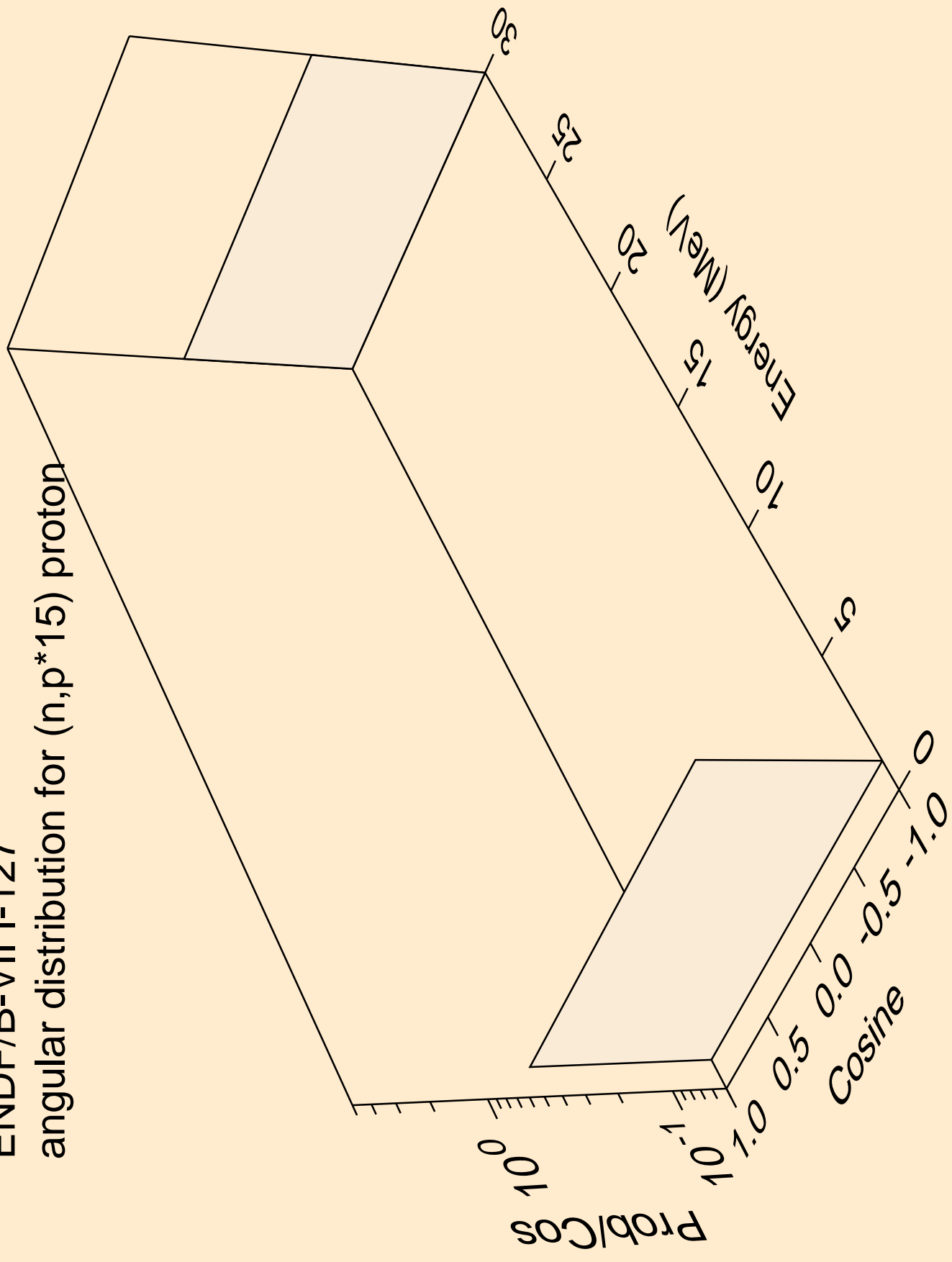

ENDF/B-VII I-127
angular distribution for (n,p*16) proton

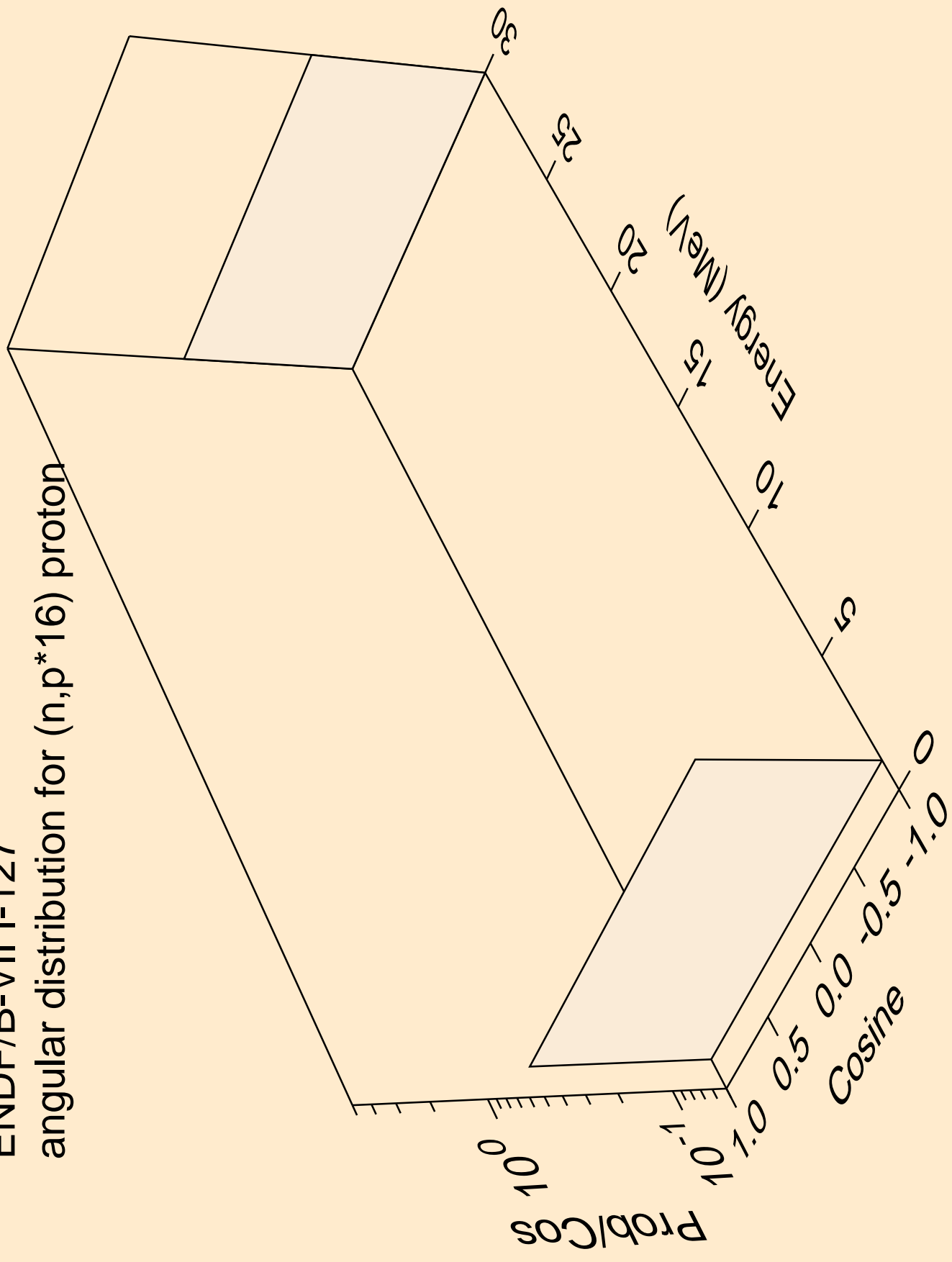

ENDF/B-VII I-127
angular distribution for (n,p*17) proton

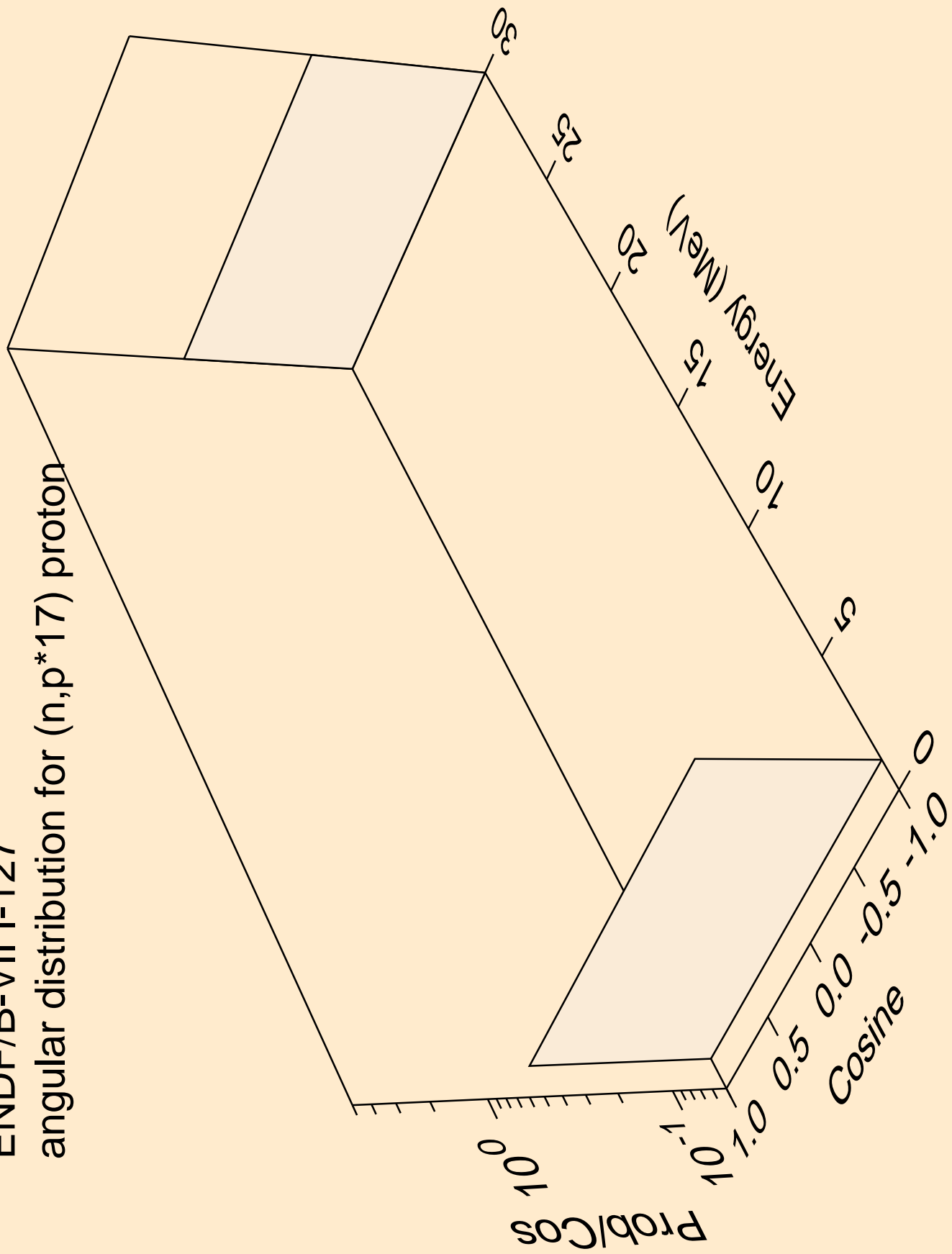

ENDF/B-VII I-127
angular distribution for (n,p*18) proton

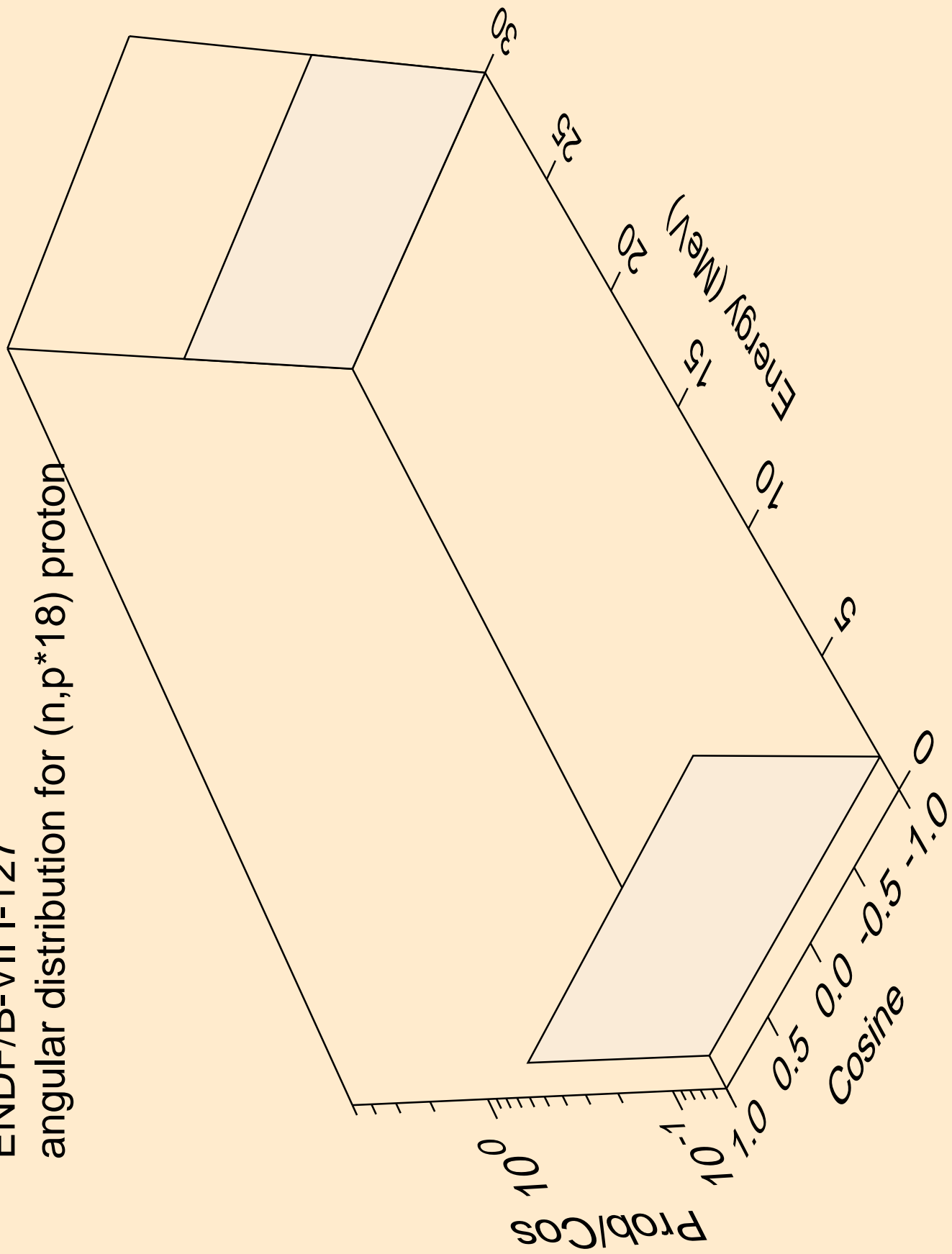

ENDF/B-VII I-127
angular distribution for (n,p*19) proton

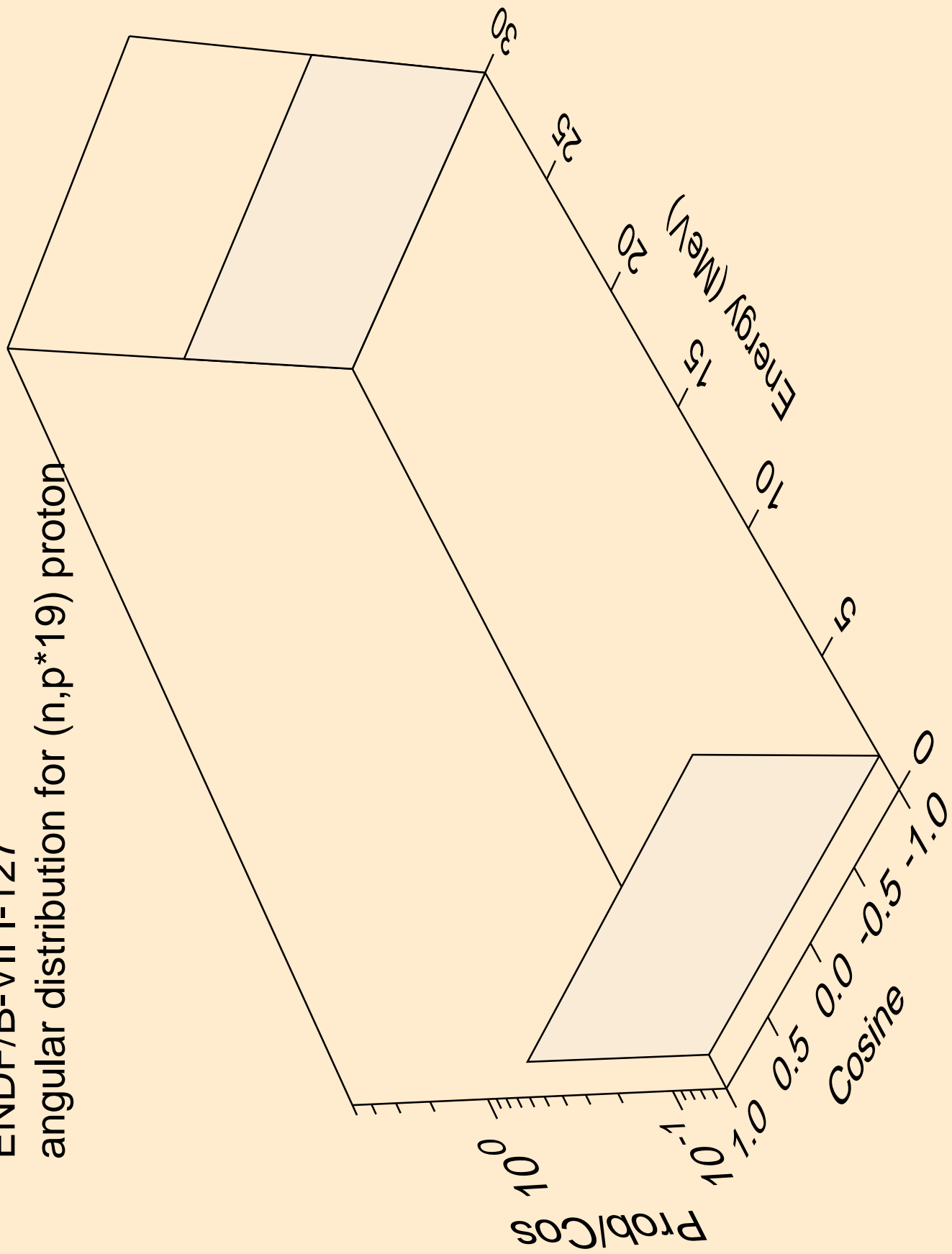

ENDF/B-VII I-127
angular distribution for (n,p*20) proton

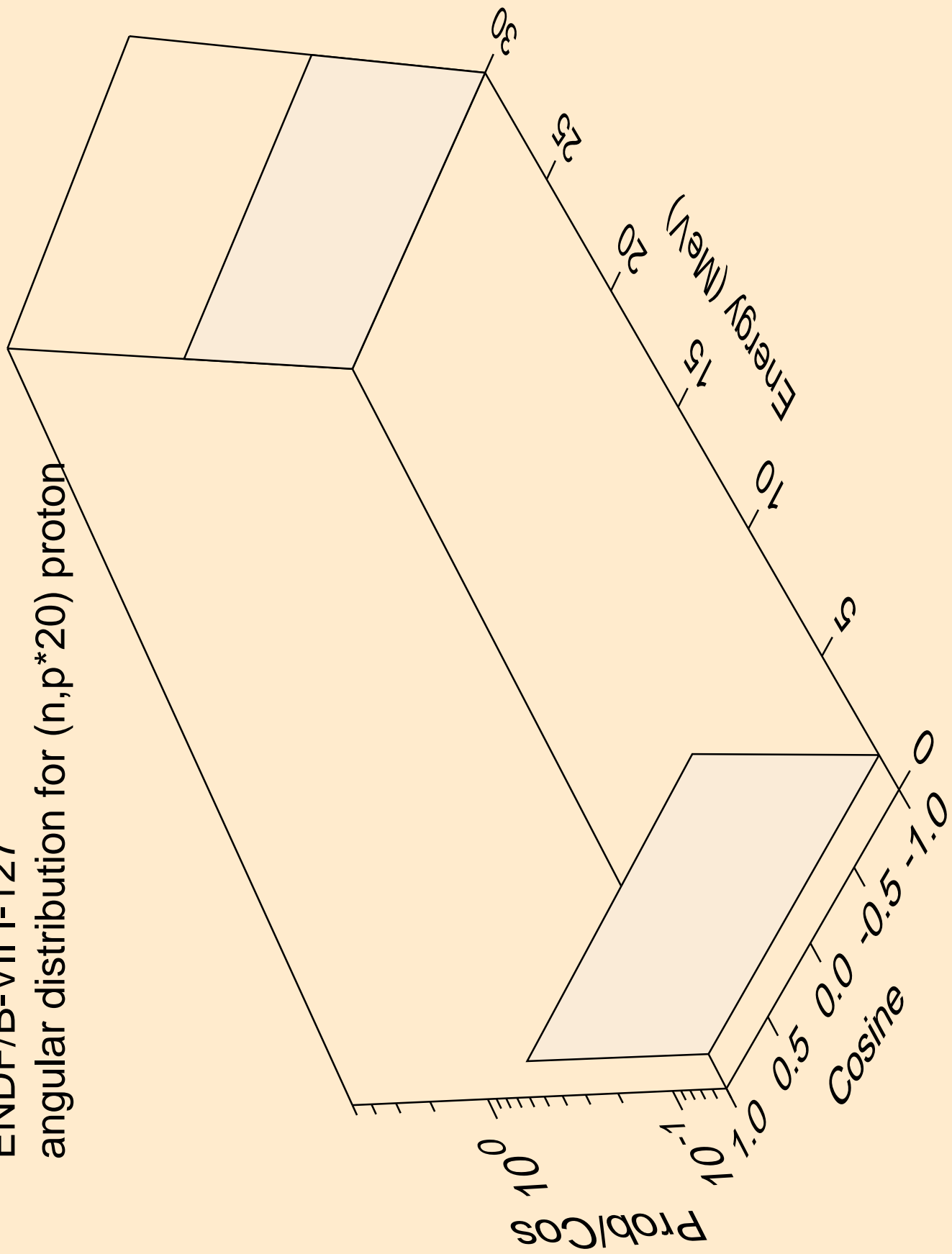

ENDF/B-VII I-127
angular distribution for (n,p*21) proton

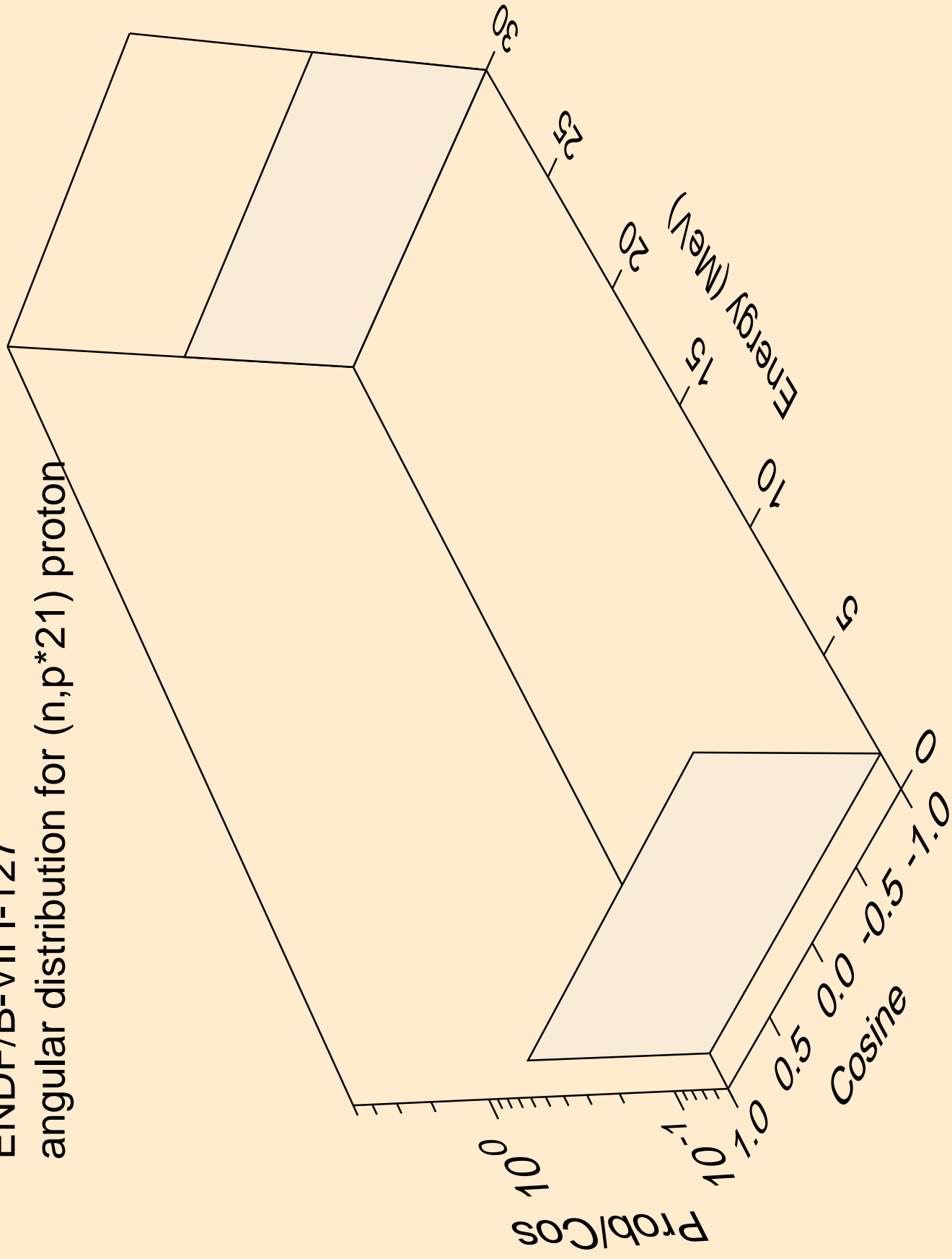

ENDF/B-VII I-127
angular distribution for (n,p*22) proton

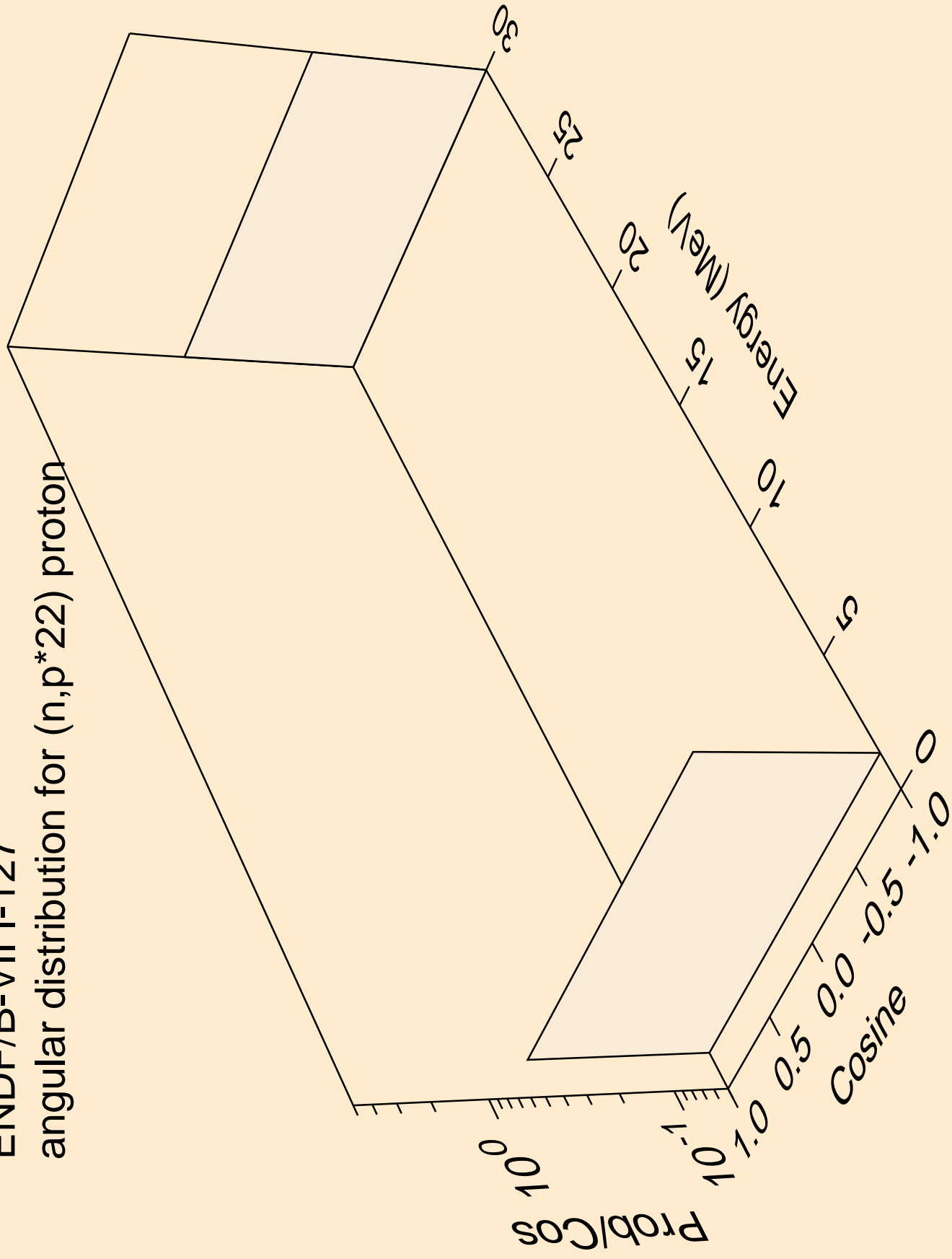

ENDF/B-VII I-127
protons from (n,p*c)

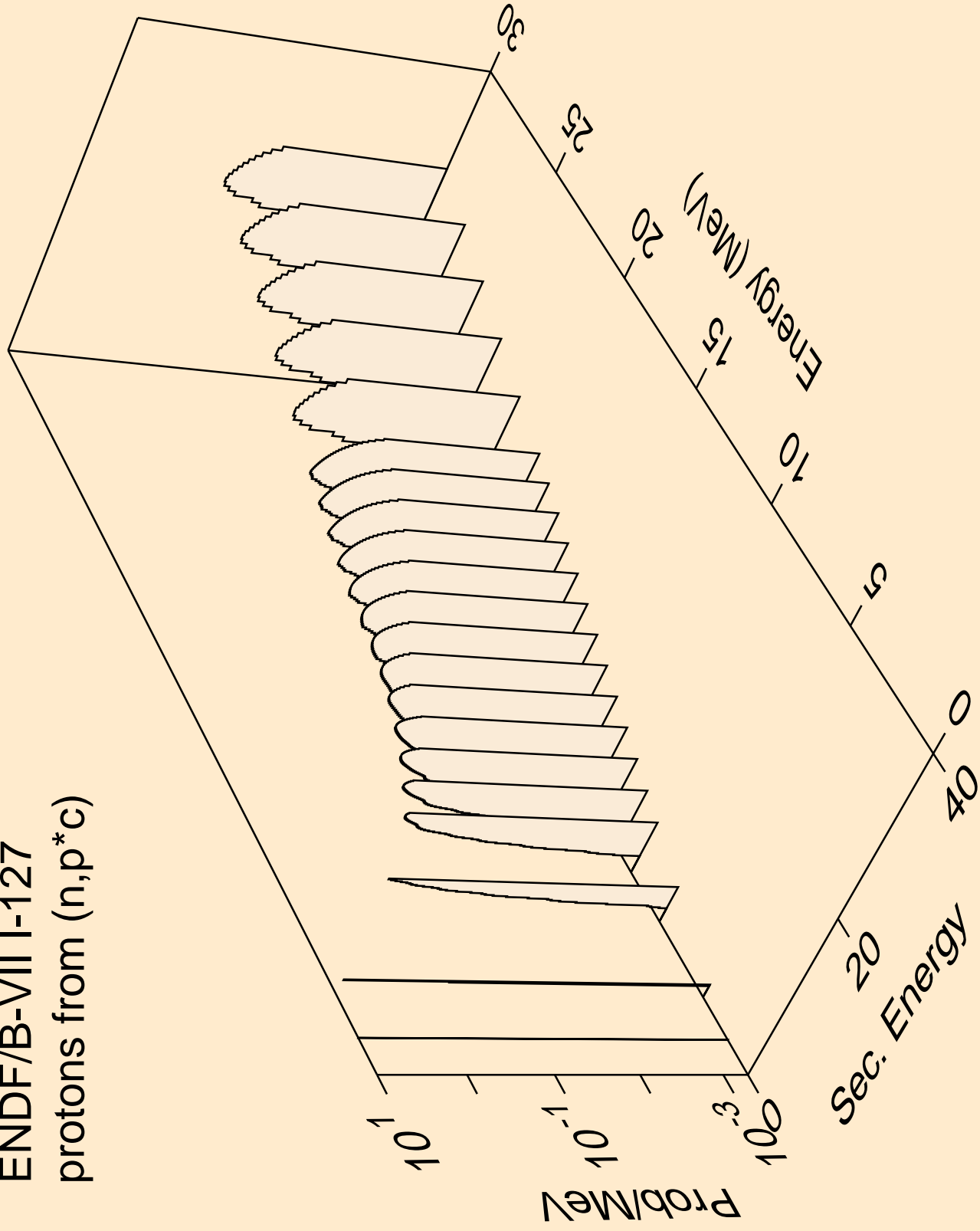

ENDF/B-VII I-127
alphas from (n,n*)a

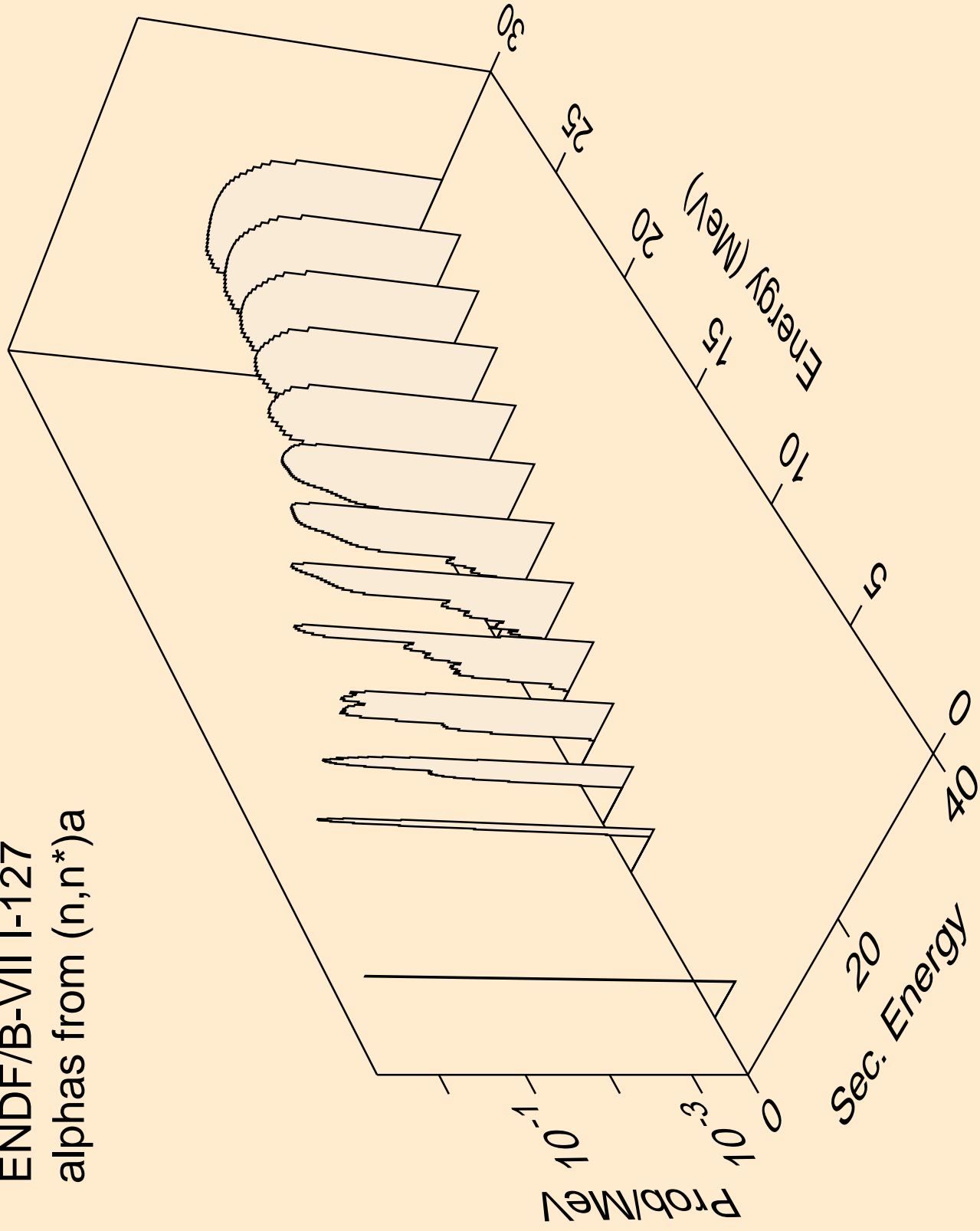

ENDF/B-VII I-127
angular distribution for (n,a*0) alpha

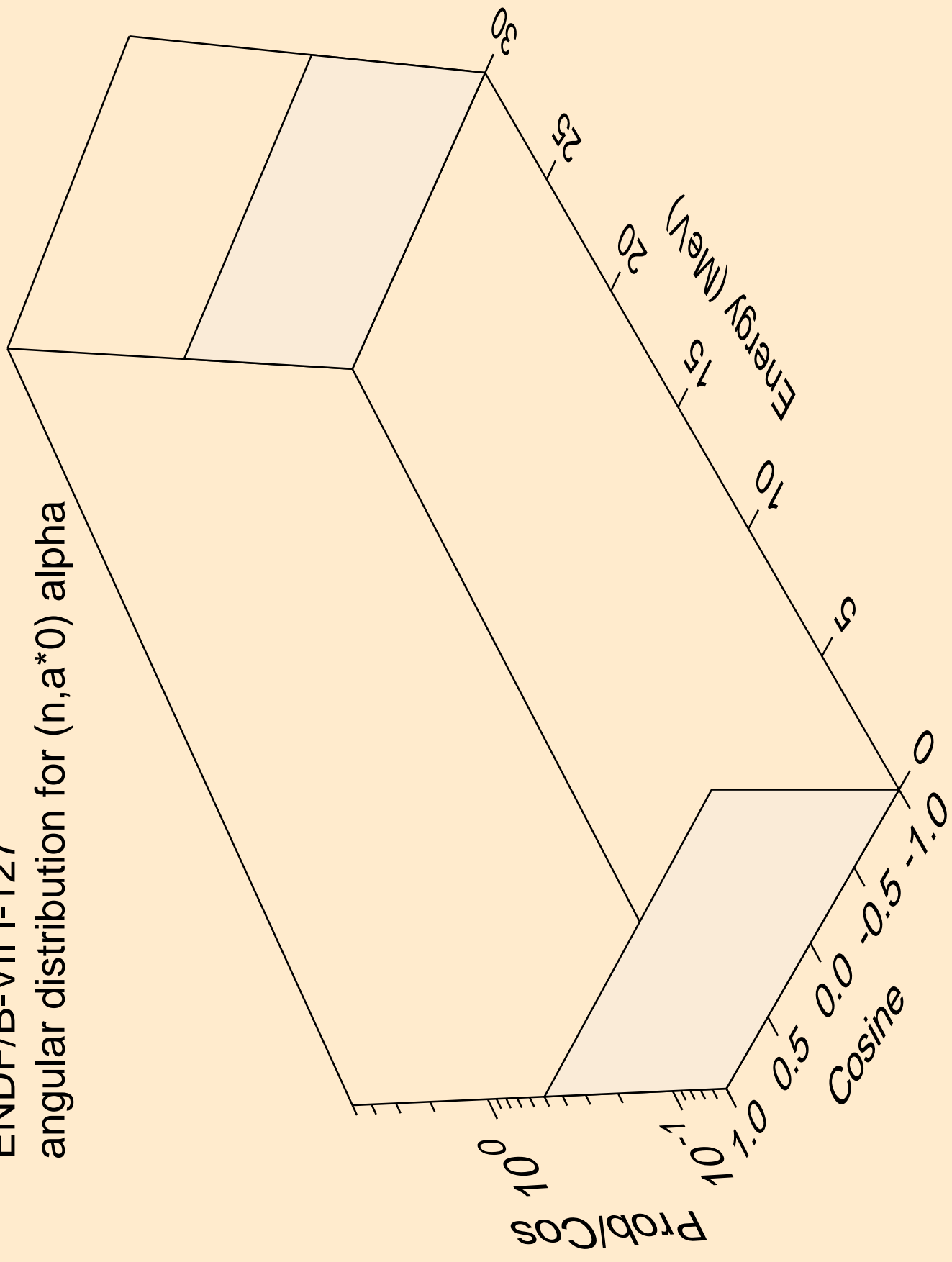

ENDF/B-VII I-127
angular distribution for (n,a*1) alpha

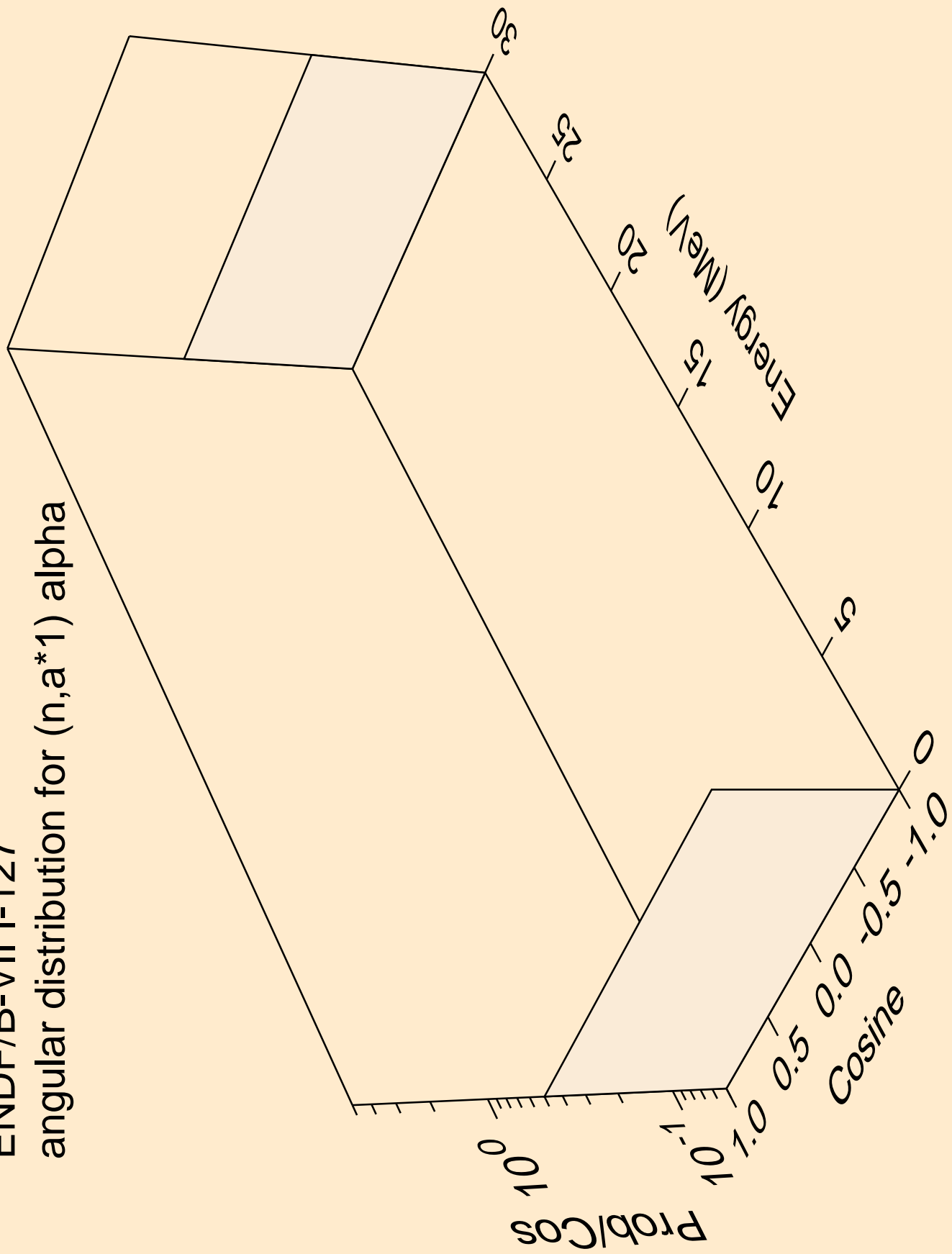

ENDF/B-VII I-127
alphas from (n,a*c)

