

031004-510873-(02)

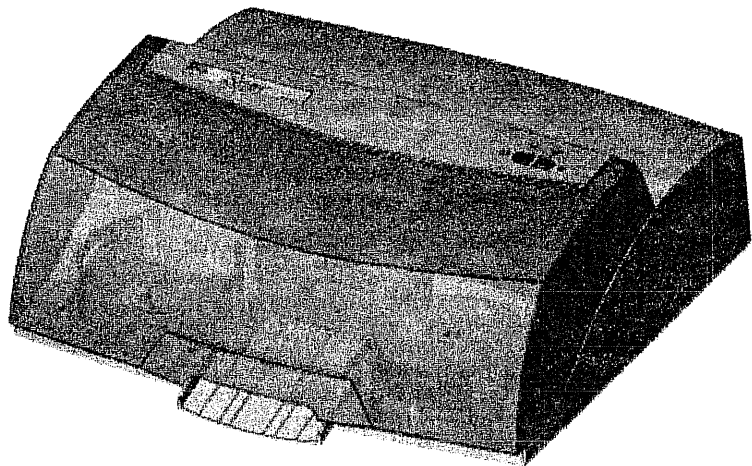

Bravo™ II
DISC PUBLISHER

**Automated Optical Disc
Duplication & Printing System**



USER'S MANUAL

PRIMERA

© 2003 All rights reserved.

Notices: The information in this document is subject to change without notice. NO WARRANTY OF ANY KIND IS MADE WITH REGARD TO THIS MATERIAL, INCLUDING, BUT NOT LIMITED TO, THE IMPLIED WARRANTIES OF MERCHANTABILITY AND FITNESS FOR A PARTICULAR PURPOSE. No liability is assumed for errors contained herein or for incidental or consequential damages in connection with the furnishing, performance, or use of this material. This document contains proprietary information that is protected by copyright. All rights are reserved. No part of this document may be photocopied, reproduced, or translated into another language without prior written consent.

Trademark Acknowledgments: Windows is a registered trademark of Microsoft Corporation. All other trademarks are the property of their respective owners.

Printing History

Edition 2.0, #031004, ©Copyright 2003, All rights reserved.

FCC Compliance Statement: This device complies with part 15 of the FCC rules. Operation is subject to the following two conditions: (1) this device may not cause harmful interference, and (2) this device must accept any interference received, including interference that may cause undesired operation.

For Users in the United States: This product is intended to be supplied by a UL listed Direct Plug-In Power Supply marked "Class 2" or a UL listed ITE Power Supply marked "LPS" with output rated 12VDC, 4.5A or higher. This equipment has been tested and found to comply with the limits for a Class B digital device, pursuant to Part 15 of the FCC Rules. These limits are designed to provide reasonable protection against harmful interference in a residential installation. This equipment generates, uses, and can radiate radio frequency energy and, if not installed and used in accordance with the instructions, may cause harmful interference to radio communications. However, there is no guarantee that interference will not occur in a particular installation. If this equipment does cause harmful interference to radio or television reception, which can be determined by turning the equipment off and on, the user is encouraged to try to correct the interference by one or more of the following measures:

- Re-orient or relocate the receiving antenna.
- Increase the separation between the equipment and receiver.
- Connect the equipment into an outlet on a circuit different from that to which the receiver is connected.
- Consult the dealer or an experienced radio/TV technician for help.

Use of shielded cables is required to comply with the Class B limits of Part 15 of the FCC Rules. You are cautioned that any changes or modifications not expressly approved in this manual could void your authority to operate and/or obtain warranty service for this equipment.

For Users in Canada: This digital apparatus does not exceed the Class B limits for radio noise for digital apparatus set out on the Radio Interference Regulations of the Canadian Department of Communications. Le present appareil numerique n'emet pas de bruits radioelectriques dépassant les limites applicables aux appareils numeriques de la class B prescrites dans le Reglement sur le brouillage radioelectrique edicte par le ministere des Communications du Canada.

CAUTION!

TO PREVENT FIRE OR SHOCK HAZARD, DO NOT EXPOSE THE UNIT TO RAIN OR MOISTURE. TO REDUCE THE RISK OF ELECTRIC SHOCK, DO NOT REMOVE EXTERIOR PANELS NO USER-SERVICEABLE PARTS INSIDE. REFER SERVICING TO QUALIFIED SERVICE PERSONNEL. OPERATE THE UNIT WITH ONLY THE PROPER ELECTRICAL SPECIFICATIONS AS LABELED ON THE PRINTER AND AC ADAPTER.

CAUTION!

THIS PRODUCT CONTAINS A LASER DIODE OF A HIGHER CLASS THAN I. TO ENSURE CONTINUED SAFETY, DO NOT REMOVE ANY COVERS OR ATTEMPT TO GAIN ACCESS TO THE INSIDE OF THIS PRODUCT. REFER ALL SERVICING TO QUALIFIED PERSONNEL. THE FOLLOWING LABEL APPEARS INSIDE YOUR UNIT:
CLASS I LASER PRODUCT
LASER KLASSE I

CAUTION!

USE OF CONTROLS OR ADJUSTMENTS OR PERFORMANCE OF PROCEDURES OTHER THAN THOSE SPECIFIED HEREIN MAY RESULT IN HAZARDOUS RADIATION.

Table of Contents

Section 1: Getting Started	1
A. Choosing a Good Location.....	1
B. Unpacking and Inspection.....	2
C. Identifying the Parts.....	2
D. System Requirements.....	4
E. Overview of Operation.....	5
Section 2: Hardware and Software Set-Up	8
QuickStart Installer.....	8
Step 1: Applying Power.....	8
Step 2: Loading Media.....	9
Step 3: Installing Ink Cartridges.....	10
Step 4: Connecting the USB Cable.....	11
Step 5: Installing the Software Suite.....	12
Step 6: Publishing Discs.....	12
Section 3: Creating Discs	17
A. Setting up the Publisher's Printer Driver.....	17
B. Using SureThing.....	24
C. Using Other Graphics Programs.....	26
D. Using PrimoDVD to Create Your Discs.....	27
E. Using Kiosk Mode.....	30
F. Copying an Audio Disc.....	31
Section 4: Interpreting the Publisher's Indicator Lights	34
Section 5: Maintenance and Troubleshooting	35
A. Cleaning the Publisher.....	35
B. Performing a Robotic Self-Test.....	35
C. Software Test.....	36
D. Recording Errors.....	38
E. Cleaning the Ink Cartridges.....	40
F. Clearing a Media Jam.....	40
G. Technical Support.....	40
Section 6: Technical Specifications	41
Index	42

Section 1: Getting Started

THANK YOU...

...for purchasing the Bravo™ Disc Publisher. Bravo is the perfect all-in-one solution for producing professional looking CD-R and DVD-R discs. A wide variety of disc formats are supported, including audio CDs, Video CDs, data discs and more. Operation is simple and completely automatic once a job has been started.

To begin using your Disc Publisher, please read this manual carefully. This Operator's Manual is a complete step-by-step guide to quickly and easily create discs with your new Optical Disc Publisher.

A separate Online User's Guide is provided with your Publisher that explains the operation of the PrimoDVD Software. This is accessible under Primo's Help Menu.

NOTE ON TERMS AND CONVENTIONS:

From this point forward, the following terms and conventions will apply:

The Bravo Disc Publisher will be abbreviated simply as the Publisher.

Optical discs, which can include many different types of discs including CD-Rs, CD-RWs, DVD-Rs and more are all referred to as CDs or discs. Please note that in order to copy and record DVDs, you will need to have purchased the DVD-R version of the Publisher.

A. CHOOSING A GOOD LOCATION

- Place the Publisher in a location with adequate air circulation to prevent internal heat build up. You will need at least 24" (61 cm) of overhead space to allow the top cover to open freely.
- Do not place the Publisher near heat sources such as radiators or air ducts, or in a place subject to direct sunlight, excessive dust, mechanical vibration or shock.

B. UNPACKING AND INSPECTION

While unpacking your Publisher, inspect the carton to ensure that no damage has occurred during shipping. Make sure that all supplied accessories are included with your unit.

The following items should be included:

- Optical Disc Publisher
- Gray Plastic Input and Output Bins
- Switching Power Supply with Power Cord
- One Three-Color (CMY) Ink Cartridge
- One Monochrome Black Ink Cartridge
- QuickStart Installer Disc (for use with both CD-R and DVD-R models)
- USB 2 Interface Cable (Beige)
- Warranty Card
- This Operator's Manual, Quick Start Guide and Other Printed Information

Save the carton and packing materials. They will come in handy later if you ever need to transport the Publisher and/or any of its parts and accessories.

C. IDENTIFYING THE PARTS

Front Panel and Top

This illustration shows the Publisher, its Control Panel, Buttons, LED indicator lights, Input and Output Bins and other components.

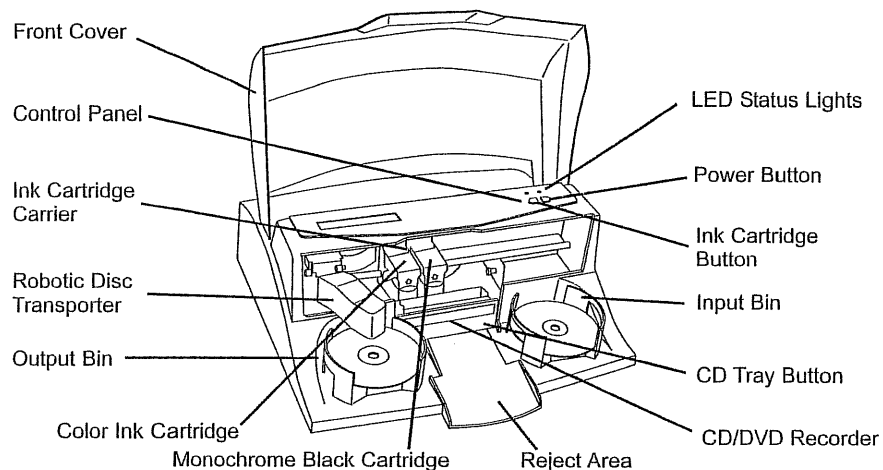

The **Robotic Disc Transporter** moves discs from the Input Bin, to a CD/DVD Recorder, to the printer, and finally to the Output Bin.

The **CD/DVD Recorder** is automatically loaded and unloaded by the Publisher's Robotic Disc Transporter.

The **Recorder Tray Button** manually opens or closes the Recorder Tray. In normal operation, the in/out movement of the Recorder Tray is controlled automatically and this button is not used.

The **Control Panel** contains LED Status Lights and Buttons to control the Publisher.

The **LED Status Lights** indicate that Power is ON. They also blink in certain patterns to indicate an error or other condition of the Publisher. See Section 4 for a full explanation of the LED Status Light conditions.

The **Power Button** turns the Publisher's power ON and OFF.

When the front cover is opened, the **Ink Cartridge Button** is used to position the Cartridge Carrier for easy ink cartridge replacement. When the front cover is closed, pressing the Ink Cartridge button will open or close the Printer Tray.

The **Input/Output Bins** are situated under the top cover of the Publisher. The bins will hold up to 25 discs. The right-side bin is the Input Bin for blank media; the left-side bin is the Output Bin for finished discs.

The **Reject Area** is where discs are dropped if they do not pass a software verification test. The discs slide down the ramp out in front of your Publisher.

The **Front Cover** is a durable plastic cover that will protect the Publisher from dust and interference.

The **Ink Cartridge Carrier** holds both a color ink cartridge (left-side pen) and a monochrome ink cartridge (right-side pen).

Rear Panel

This illustration shows the input ports found on the rear panel of the Publisher:

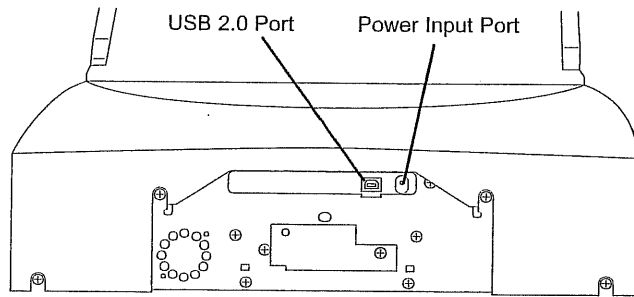

The USB 2.0 Interface is connected to an open USB 2.0 port on your PC with the USB 2.0 cable, included with your Publisher.

The **Power Input Port** connects to the included 100V~240V 12V switching power supply.

D. SYSTEM REQUIREMENTS

Before getting started, it is important for you to verify that your PC meets the minimum system requirements. Here's what you need in order to successfully copy discs at 8x or above with the PrimoDVD 2.0 software:

- 700 MHz or faster Pentium III/IV processor running Windows 2000 or XP.
- 512 MB or greater RAM
- Free hard drive space of at least 10 GB.
- Available USB 2.0 Port.

If your PC does not have at least these minimum system requirements, system performance may not be acceptable.

E. OVERVIEW OF OPERATION

Your new Publisher is an automated, precision device intended for continuous-duty publishing of discs. The following is a description of the complete process of duplicating and printing a CD/DVD job on your Publisher:

1. Up to 25 blank discs may be loaded at one time into the Input Bin.

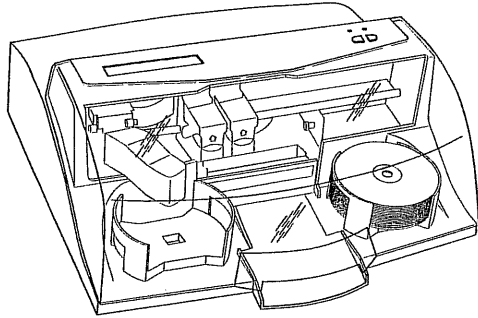

2. The Publisher's integrated Robotic Disc Transporter will first check your recorder drive for a disc by attempting to "pick" from the recorder. Then, the Robotic Disc Transporter will pick a disc from the Input Bin.
3. The Recorder Tray opens automatically and the Robotic Disc Transporter places a disc into the recorder.

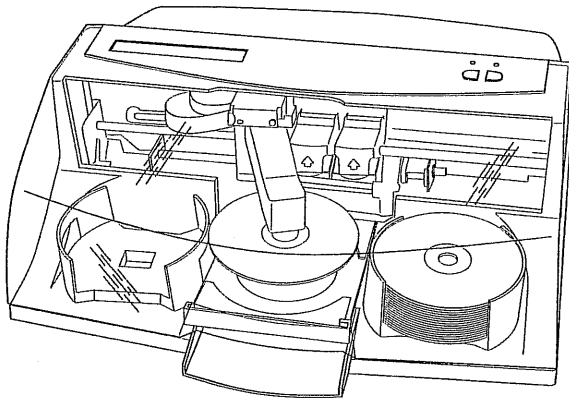

4. The Recorder Tray then automatically shuts. Robotic Disc Transporter will automatically check the Input Bin to make certain that only one disc was picked.

Through software control, you can perform a test on each disc before recording. If a disc does not pass (meaning that all or part of that disc is not recordable), the Robotic Disc Transporter picks it out of the CD Tray and sends it to the Reject Area.

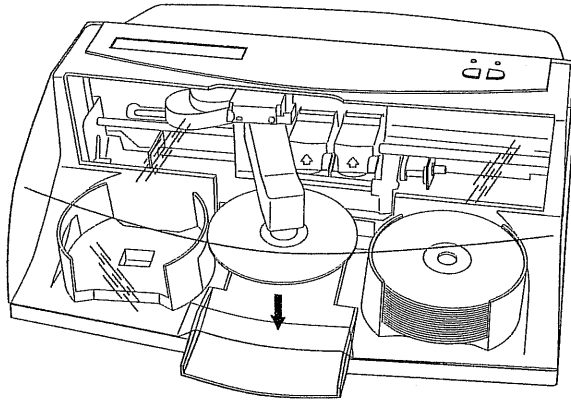

5. The Recorder is now writing to the disc. If you were to fully record a CD with data, audio, video or music (650 MB), recording time is about 3 ½ minutes each. A full DVD records in about 30 minutes. Most jobs don't fill the entire disc, so recording time is usually less than this. After recording, the Recorder Tray opens automatically. The Robotic Disc Transporter will lift the disc out of the Recorder Tray. The Recorder Tray will close, and the Printer Tray will open. The Robotic Disc Transporter will lower the disc into the Printer Tray, and the Printer Tray will then automatically close.
6. If publishing more than one disc, the Robotic Disc Transporter will load the Recording Drive with a blank disc from the Input Bin to start recording the next round.
7. Once recording has started on the next round, printing will start with the recorded disc from the previous round. This simultaneous printing and recording greatly increases the throughput of your Publisher.

8. Print time varies according to which print mode has been selected (section 3-A). In most cases, print time takes no more than 2 minutes. After printing the first disc, the Publisher's Printer Disc Tray opens automatically. The Robotic Disc Transporter moves the finished disc to the Output Bin.

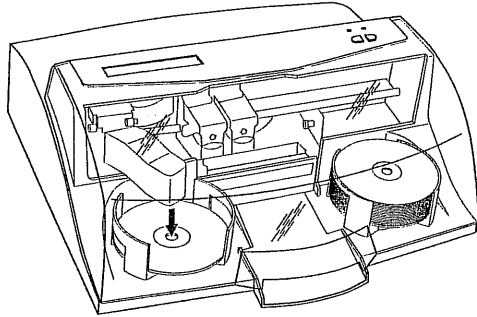

9. The process starts over and repeats until all blank discs are gone or the number you have specified via software are copied and printed.
10. Now that you understand the order of operation, it is time to set up your Publisher.

Section 2, Hardware and Software Set-Up

This section will describe the step-by-step process of setting up your Publisher. This includes information on how to load the supplies (ink and disc media) necessary to start producing discs.

QUICKSTART INSTALLER

The Installer Disc has a QuickStart menu that will guide you through the process of setting up your duplicator. Please refer to the following for more information on each step:

1. Place the Optical Disc Publisher Installer CD in your CD-Rom Drive. The Installer application should automatically launch in a few moments. If it does, proceed to Step 2. If it does not automatically launch, follow these steps:
 - Double-click the **My Computer** Icon, then double-click the icon of the appropriate CD drive containing the Software Installer disc
 - Double-click **INSTALL.exe**
2. In the Installer Application, click the **QuickStart Install** button. The QuickStart Install will guide you step-by-step through the installation process. As you complete each step, click **Next**. Steps 1-4 are shown below as well as on the monitor. You may follow either to complete the setup.

Step 1: Applying Power

- Locate the power adapter supplied with your Publisher.
- Plug the adapter into a surge protected outlet, and plug the 1/8" power plug into the power port on the rear panel of the Publisher.

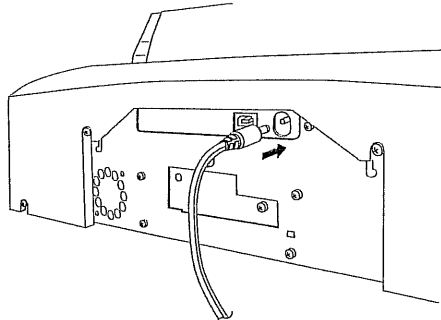

Step 2: Loading Media (Discs)

NOTE: Your Publisher can print directly onto virtually any brand of printable-surface CD/DVD media. However, different brands of discs have different printable coatings. Because of this, you may need to adjust the printer driver settings to accommodate your specific brand of CD/DVD media. Refer to Section 3 for further printer driver information.

Due to the wide variety of printable-surface CD/DVD media, you may find that certain brands of discs provide higher print quality than others. For maximum print quality, use CD/DVD media authorized by Primera.

Refer to the following steps when loading discs in to the Publisher:

- Open the front cover of the Publisher

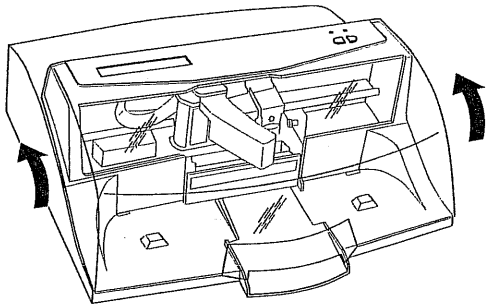

- The Publisher will automatically position the cartridge carrier and Robotic Disc Transporter to the center position allowing for easy access to the bins.

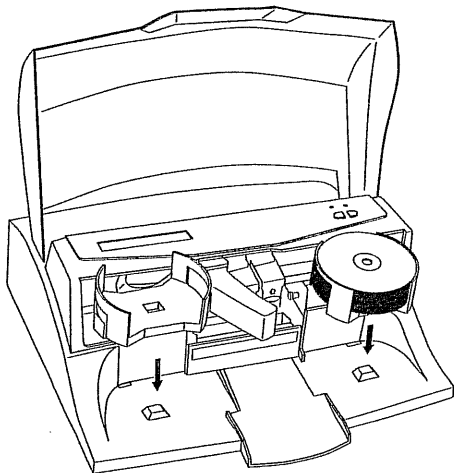

- Load the Input Bin (the bin located on the right-hand side of the Publisher) with 25 blank discs and place the bins on the mounting pegs.

Step 3: Installing Ink Cartridges

- Press the Ink Cartridge Button  to move the Ink Cartridge Carrier to the load position and open the ink cartridge covers
- Remove each ink cartridge from its packaging
- Slowly remove the tape covering the cartridge's print head, being careful to avoid damaging the barcode label on the underside of the cartridge.

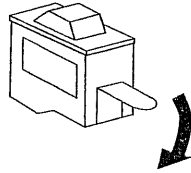

DO NOT TOUCH THE COPPER AREA!

- Insert the ink cartridges into the carrier, copper end first and snap the cartridge cover in place. Insert the color in the left holder, monochrome black in the right cartridge holder.

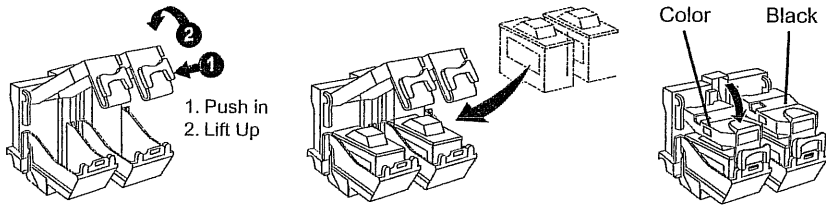

- Close the Publisher's front cover.

Step 4: Connecting the USB 2.0 Cable

Connect the Publisher to your PC with your beige USB 2.0 Cable. After a few moments, Windows will tell you it has found new hardware and is looking for software to install it.

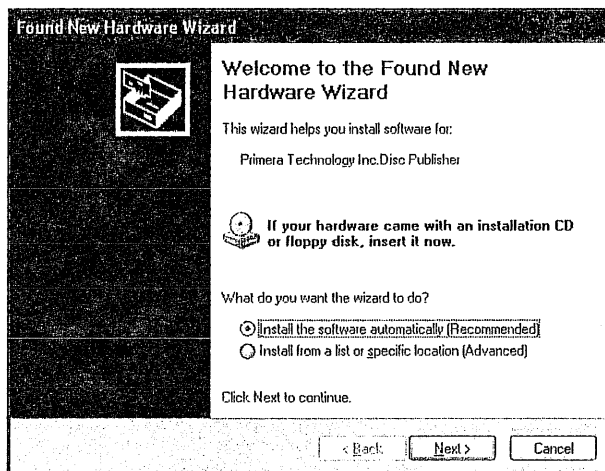
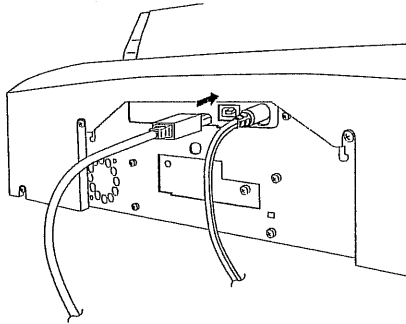

Select "**Install the software automatically**" and click Next.

You may see a notice like the one shown here stating that the Optical Disc has not passed Windows Logo Testing. Click **Install Anyway** to continue installing the printer driver for your Publisher.

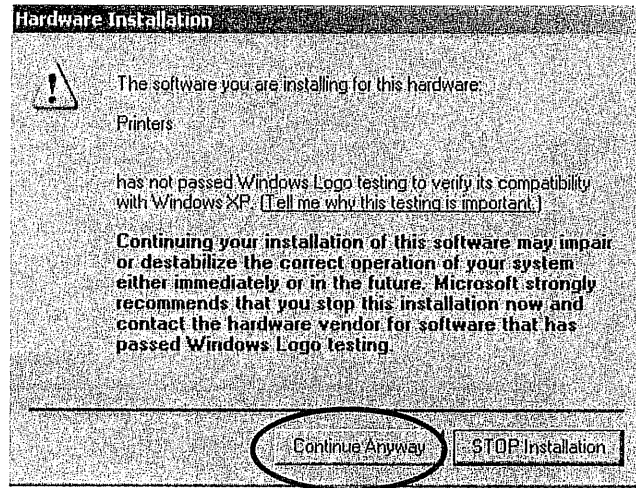

Step 5: Installing the Software Suite

After the printer driver software for the Publisher has installed, click Next and you will see a screen to select the language for the software. Select a language and you will be guided through installing both SureThing CD Labeler and PrimoDVD 2.0. Once installation has completed, reboot your computer.

Congratulations, your Publisher has been successfully installed!

Step 6: Publishing Discs

This step is a walk-through of how to create a basic data disc with your Publisher. More detailed information on the applications that are used to operate your Publisher is available in Section 3.

A. Launch PrimoDVD 2.0

Primo DVD 2.0 can be launched from your Start menu. If you have more than one external recordable drive attached to your PC, the following screen will appear when you launch Primo:

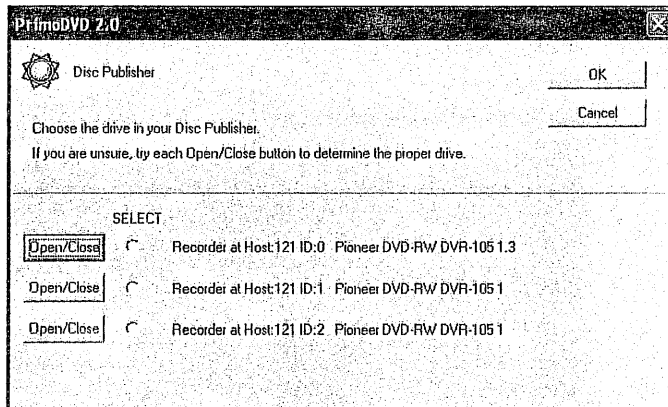

Clicking the **Open/Close** button will help you identify the drive installed in your Publisher. Select this drive from the list and click **OK**.

- B. Once Primo DVD 2.0 is opened, you will see a dialog box allowing you to launch SureThing CD Labeler. Click the **YES** button to design a label for your disc.

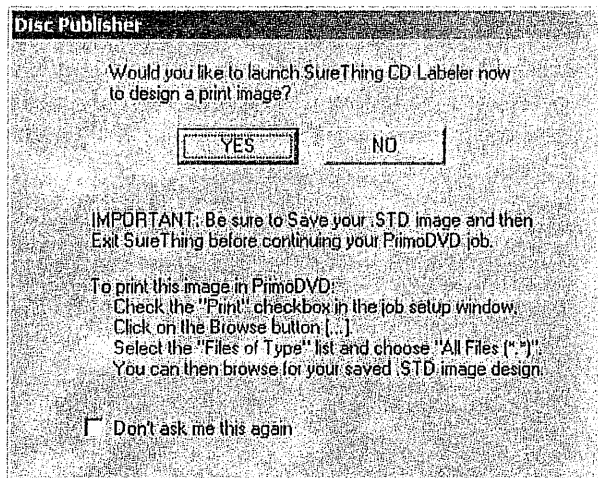

The SureThing Disc Labeler software included with your Publisher is a great tool for creating professional looking discs. You can use SureThing's Smart Designs to quickly label a disc, or easily import your own design in many popular file formats. The On-Line Help section will provide complete instructions on all the features in this package. The following is a tutorial on creating a basic disc design:

1. Click New...

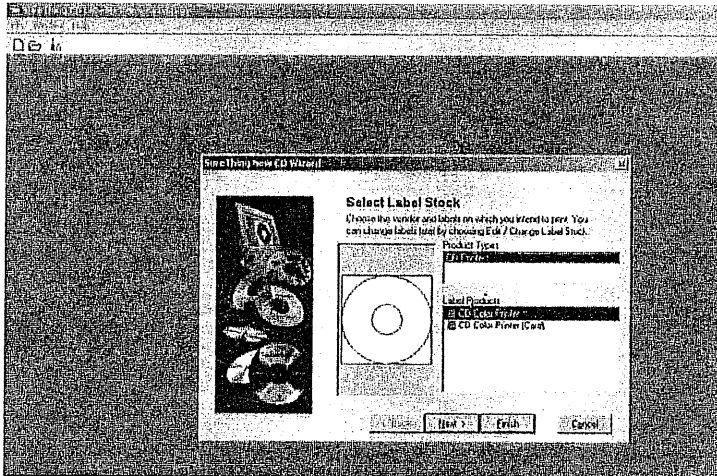

2. Select **CD Color Printer** under Label Products and click **Next**.
3. Click **Browse** to look through the many built-in backgrounds included with SureThing, or click **Clear** if you would like to import your own background or design. Click **Next**.

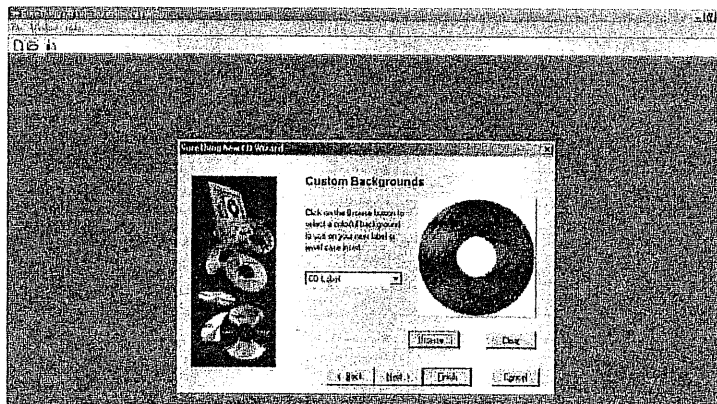

4. Check **Use Smart Designs** to browse through different built-in designs. Deselect this option if you would like to create your own layout. When finished, click **Next**.
5. Click **Finish**. You should now see your basic layout. Simply double click on text boxes to modify the standard text with your information. If you want to import your own graphics, click **Photos/Clipart** to browse for images. Many standard clipart symbols are included with your software.

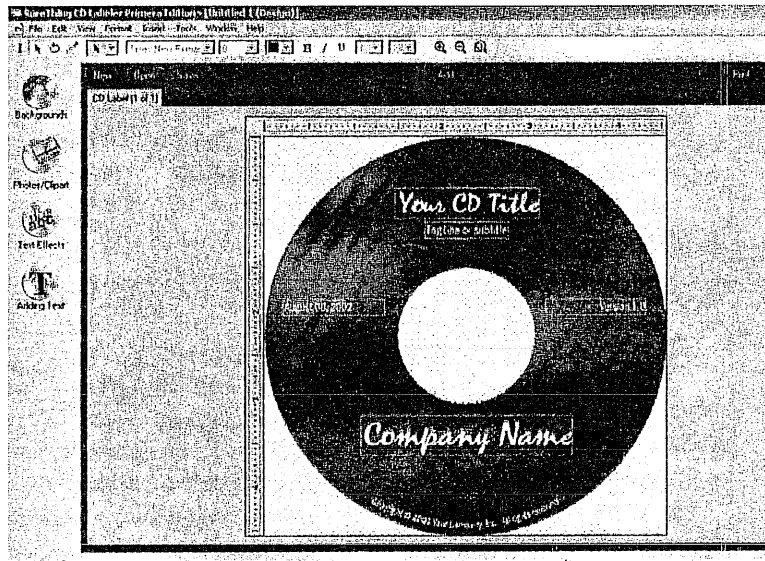

6. Once you are happy with your design, save it as a SureThing Design (*.STD) file format.
 7. Close SureThing CD Labeler. For optimal performance, SureThing CD Labeler must not be running when you are publishing discs in Primo DVD 2.0.
- C. Now that you have designed the label to be printed on your disc, it is time to select the information you wish to write to your disc. In Primo DVD 2.0 click **File**, then **New Job**, then **Data Disc**. The Data Disc option will allow you to select files on your hard drive for recording. If you are recording a disc image or audio disc, refer to Section 3 for more information on those types of recording jobs. For this tutorial we are focusing on the Data Disc.

NOTE: Most applications allow you to change these same printer driver options from their "Print" and/or "Printer Setup" screens. This means that you don't have to go back to the main printer setup window each time you want to change a setting or option in the printer driver. These applications will usually give you the same choices and options, but in a slightly altered format. Some applications do not save your printer driver option changes, but instead only use your changes for the current image.

Paper Size

The paper size option will be set to CD for printing onto printable surface CDs and DVDs.

Resolution

Select the appropriate print quality option for your image. Keep in mind that Normal 600 provides the lowest quality but fastest print, and that Ultra Photo 4800 provides the highest quality but slowest print. You may wish to experiment with these options to see which one is best for your particular CD media and print quality requirements.

Cartridge Type

The **Print Black with Black Cartridge** setting will print discs using both the color and black cartridges. This saves color ink by using just the black cartridge for the black areas of your design. When using this setting, be sure to perform the Alignment Calibration print described later in this section. Please note that the Calibration Alignment will need to be done after installing a new cartridge as alignment may vary from one cartridge to the next. Select **Color** to print using only the color cartridge. The **Monochrome Black** setting prints using the **Monochrome Black** cartridge only.

Color Matching

Click on the Color Matching down arrow and choose the color matching option that's right for you. Select **None** if you are more interested in print speed rather than color accuracy, if you have already color corrected your image for printing, or if you are using some other third party color matching software.

Select **Algebraic** if you would like the printer driver to make very simple color balance adjustments based on an RGB color model. This option gives you more natural looking images without actually utilizing any specific color matching software.

Select **PrimaColor** to enable color-matching profiles written specifically for the Publisher by Candela Color Management System. This setting automatically adjusts the color of your image according to predetermined printer profiles and default system profiles. This results in a very precise color match when attempting to print photographic images.

Ink Saturation

This option controls the ink saturation of the printed image. When printing onto the printer manufacturer's TuffCoat CD media, this option can be left at its default setting of 50%. When printing onto other brands of printable CD media, you may need to adjust this control in order to optimize the ink saturation for the printable surface of your specific CD media. Click on the up and down arrows to change the ink saturation setting. Lower numbers reduce the overall ink saturation, while higher numbers increase it. Please note that higher ink saturation results in higher ink usage. This will reduce the amount of discs produced per cartridge.

Inner Diameter

This value changes the size of the non-printed center. Larger numbers cause the non-printed center to be larger and smaller numbers make the non-printed center smaller. This number is incremented by 0.1mm so a change of 10 for inner diameter changes the diameter by 1mm.

Inner Diameter	Non-Printed Diameter
440	1.733" (44mm) (Default)
383	1.507" (38.3mm) (TuffCoat™)
150	0.591" (15mm) (Physical Center)

Centering Test Print

NOTE: *Your printer comes from the factory pre-calibrated to print the image in the center of the CD. You can use this adjustment if you need to fine-tune this location.*

If you ever wish to verify your factory-calibrated Vertical and Horizontal calibration settings, you can run a simple calibration procedure to assure that your images will be centered when printed on a CD. To do this, refer to the following steps:

1. Verify that a disc and a color ink cartridge are installed in the Publisher. It is important to use the same disc you

normally use for your publishing because different brands of discs may vary slightly in size. Also, verify that the Publisher is powered **ON** and that it is connected to your computer.

2. Click on the **Centering Properties Test Print** button. The printer will begin printing the calibration test print.
3. When the print is complete, rotate disc 180° and put the disc back in the input bin and repeat step 2 using the same disc.
4. When the second run of the print is complete, you should have a test print that looks something like the following:

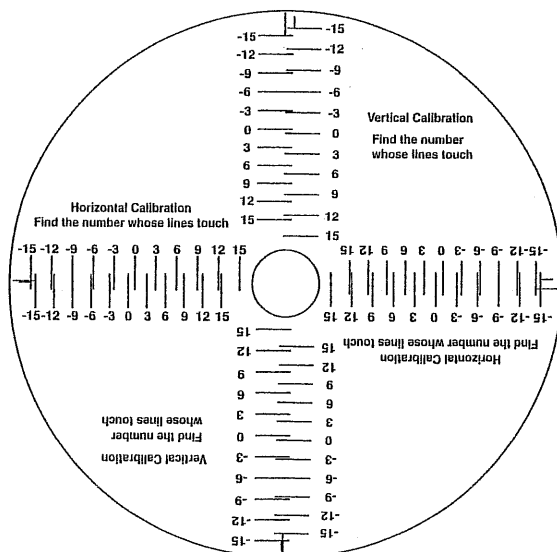
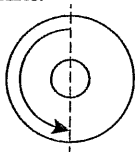

5. Along the Vertical axis of the printed disc, find the number whose lines touch. For example, in the above illustration, the number would be -6 Enter that number into the Vertical box of the Calibration window and -9 would be entered for the Horizontal axis.
6. Select the **OK** button. Your images should now be centered when printed on a disc.

After your selections have been made, close out of the printer setup window. You are now ready to go to an application program and print. All printer driver selections will stay the same until you change them.

Enable Ink Low Warning

This setting lets you enable or disable the warning from the printer to tell you when the ink cartridges are getting low.

Ink Levels and Cartridge Maintenance

Select this button to display the current ink levels as well as options for cleaning and changing cartridges.

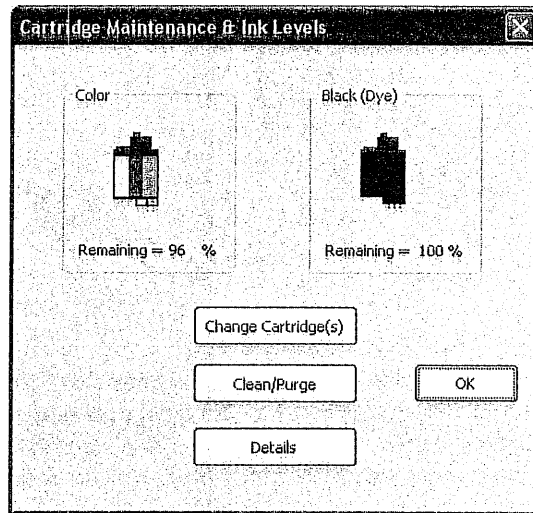

Select **Clean** button to send a simple test pattern to the printer. Be sure to have a disc in the Bravo's input bin and the front cover closed. The test pattern, shown below, purges ink through nozzles of your ink cartridge to clear any blockages. The test pattern will show if the nozzles require any further cleaning.

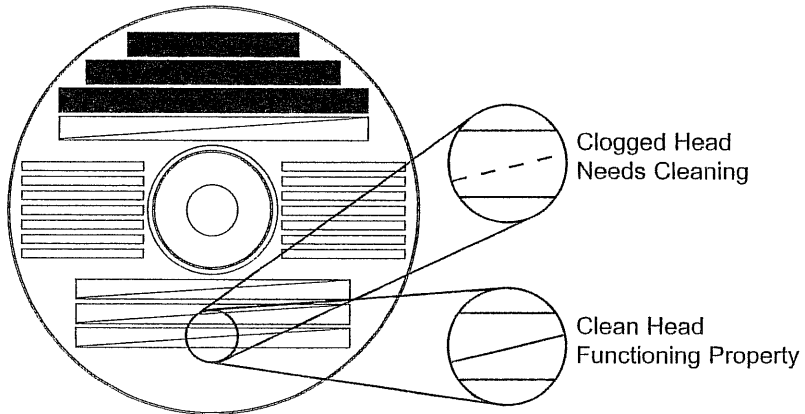

If the Yellow, Magenta, Cyan or Black diagonal lines printed on the disc show breaks, repeat the cleaning procedure. If nozzles still appear to be clogged, remove the cartridge and gently wipe the nozzle area sideways with a clean water-dampened cloth. If after several cleanings a color still does not appear on the test print, the cartridge may be damaged or empty and may need to be replaced.

Select the **Change** button to install a fresh, new ink cartridge or to switch back and forth between previously used cartridges. After the cartridge has been replaced according to the instructions on page 10, Step 3: Installing Ink Cartridges, select either the **New Cartridge Installed** button or the **Old Cartridge Installed** button accordingly. These selections are necessary for the printer to accurately keep track of ink cartridge ink levels.

Select the **Details** button for information on the drivers, firmware, alignment and number of discs printed with your Publisher.

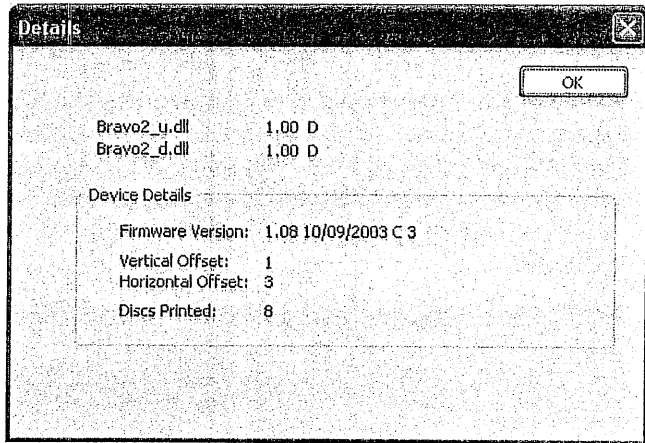

Disc Output Location

This can be set either Normal (Left Bin acts as output), or Kiosk (finished discs deposited out the Front Exit). The default is Normal (Left Bin). Note that this will only have an effect when doing printing only – this will have no affect when recording and printing through PrimoDVD. In PrimoDVD, click **Robotics** then **Options** and select **Kiosk Mode** check box.

Enable Bi-di Printing

When enabled the Bravo will print bi-directional for faster printing. The default is uni-directional printing. When you enable bi-directional printing, you should perform the Alignment Calibration described later in this section. Please note that the calibration is stored on your computer, so if you move to a new computer you must repeat the calibration.

4. Check **Use Smart Designs** to browse through different built-in designs. Deselect this option if you would like to create your own layout. When finished, click **Next**.
5. Click **Finish**. You should now see your basic layout. Simply double click on text boxes to modify the standard text with your information. If you want to import your own graphics, click **Photos/Clipart** to browse for images. Many standard clipart symbols are included with your software.

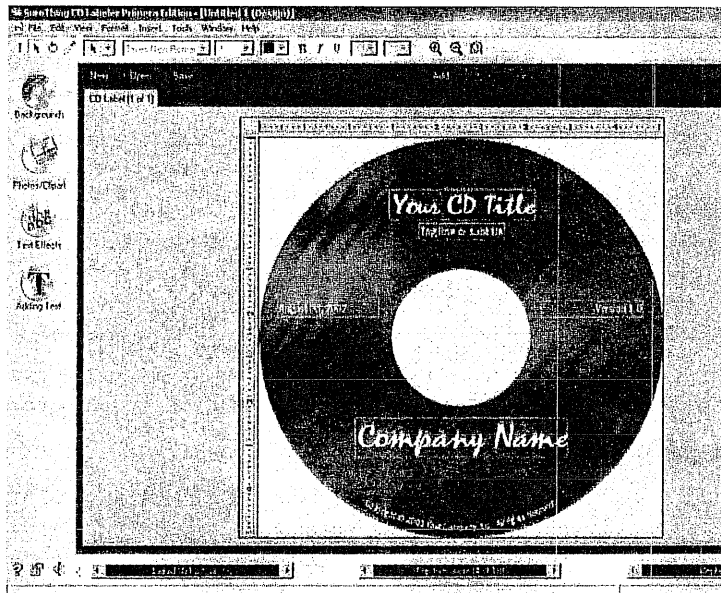

6. Once you are happy with your design, save it as a SureThing Design (*.STD) format.
7. Close SureThing CD Labeler. For optimal performance, SureThing CD Labeler must not be running when you are publishing discs in Primo DVD 2.0.

C. USING OTHER GRAPHICS PROGRAMS

While SureThing will handle most labeling needs, some people prefer to use other graphic programs. Because of this we offer the flexibility to create print files (*.PRN) from any application.

Your Publisher will support two types of print files in PrimoDVD 2.0:

- *.STD - SureThing CD Labeler
- *.PRN - Print files created through the Publisher Printer Driver

***.STD files**

As described earlier, these are files created in SureThing CD Labeler. This is the recommended file type for printing as it offers the most flexibility.

.PRN files

These are files created from virtually any Windows graphics application. Instead of printing to a printer, you print to file. In some programs, you can print directly from that software's Print screen, through the correct printer driver software for the brand and model of printer you've installed on your Publisher, to a *.prn file. Adobe Illustrator and CorelDRAW! are examples of such programs. Most of the popular, higher-end graphics applications give you this option of printing directly to a file.

If your graphics software does not allow a direct print to a file, you will need to go into your Windows Control Panel, Printers where you will be able to select File from your list of available printer ports. This will enable the driver to print to a PRN file from any application.

Note: *You must change the port back to the USB port before you can print.*

D. USING PRIMODVD TO CREATE YOUR DISCS

Now that you have a design for your disc, you are ready to publish.

The example given in this chapter is for a simple audio CD copying job using PrimoDVD software. Please refer to the Software User's Guide accessible from Primo's Help Menu for further information on recording discs.

Operating Screens

To keep things simple, there is really only one main operating screen you'll need to know about in order to run the PrimoDVD Software. It is called the **Application Window** and it looks like this:

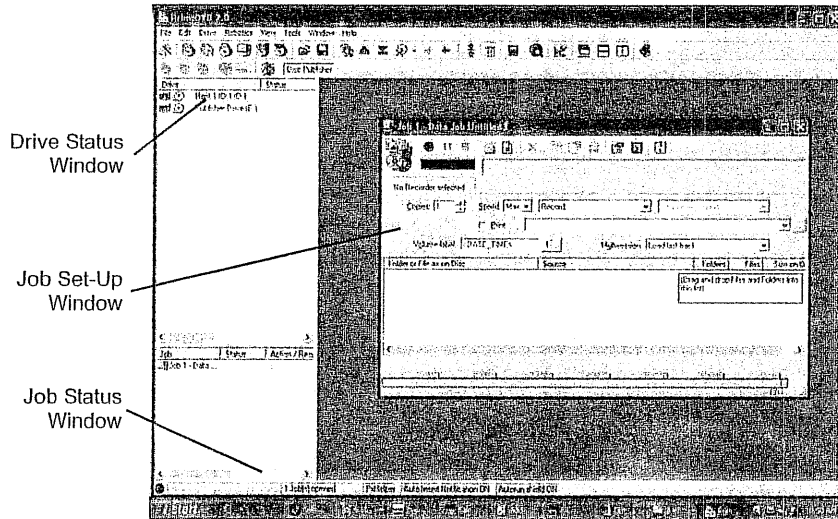

Under this window there are several adjustable-size windows that indicate what you've set-up and what's happening: the **Drive Status Window**, the **Job Status Window**, and the **Job Setup Window**. A sub-Window called the **Activity Log** is also available, but it is hidden upon initial boot-up of the software. Here's a short explanation of each Window:

- **Drive Status Window.** Lists all of the available drives for your computer. Usually, your configuration has just two drives: the internal drive in your PC and the CD Recorder installed in your Publisher.
- **Job Set-Up Window.** This is the space where the Job Setup Panel for each job is displayed. When you select a job by clicking on File: New from the File pull-down menu, a different type of Job Panel will appear in the Job Set-Up Window depending upon the type of job selected. Each Job Panel contains all of the necessary information to run that job, including source file name, number of copies to make, etc. In addition, the Job Panels report status information during the running of the job.

- **Job Status Window.** As each Job Panel is formed, an entry is made in the Job Status Window at the lower left side of the main Application Window. When jobs are started, this list displays the status of each job, including the number of discs copied and the number remaining. This window may be hidden by clicking on the Show Job List Panel under the View menu.

One other sub-window available is called the **Activity Log Panel**. It records all user actions and system responses during the recording process by time of occurrence. If a problem occurs while you're not present in front of the computer, you can browse the log to find out details that may no longer be present on the main screen. The Log may be viewed by clicking on **View: Show Log**. The log may be saved (this happens automatically every time you exit the software). Emptying the log will delete all entries permanently.

Overview of Recording

Three basic recording operations are available: (1) actual recording, (2) test recording, and (3) verifying.

Actual recording is self-explanatory. Discs will be recorded without any testing beforehand. If you have used the Publisher successfully before with a particular brand of media that is highly reliable, you may choose to record without testing or verifying. This will deliver the highest throughput rate of finished discs.

Test recording performs all of the operations of recording with the drive's laser turned on to reading power. A test recording run will determine if the data source will keep up with the recorder's demand.

Verifying will compare the data recorded to the original data. This ensures that the recorded data exactly matches the original. Note that it will take about twice as long to Record and Verify as compared to just Record. All discs that do not verify properly will be rejected.

Please note that if Verify is not enabled, Primo will still reject discs that record improperly. The Verify feature simply double checks the record job to compare that the copy and master contain the same information.

After your job(s) have been set up, each one may be started by clicking on the red "Record" button at the top of the Job Setup Panel. Here's what the **Job Setup Panel** looks like:

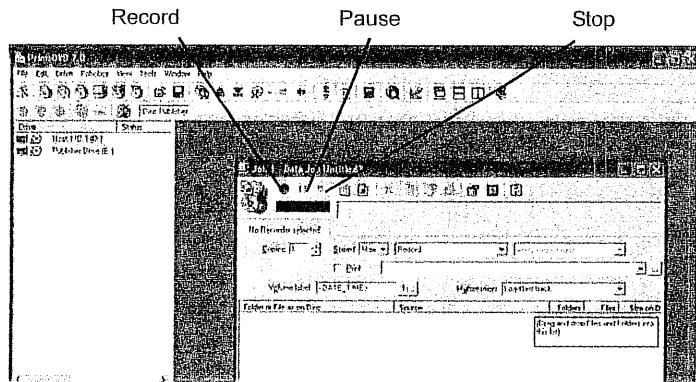

While jobs are running, they may be paused or stopped by clicking on the appropriate buttons on the Job Setup Panel. The Pause Button will allow the current recording to finish, then suspends operations on that job. Recording is resumed by clicking the Pause Button again.

The Stop Button will abort any recording in progress and cause the Publisher to transport the disc to the Reject Area. It will also terminate that job.

Record, Stop and Pause actions for the currently selected (highlighted) job may also be selected from the Toolbar at the top of the main Application Screen.

Once a job is started by pressing the Record button, other subsequent jobs can be created in the same manner and queued by pressing the Record Button. These jobs will appear in a queue in the Job Status Window. Primo can queue up to 64 unique jobs.

E. USING KIOSK MODE

Kiosk Mode allows you to use both of Bravo's Bins as input, doubling your disc capacity from 25 discs to 50 discs. In this mode, the finished discs will be deposited out through the front "reject area" of the Bravo. In Kiosk mode all discs would be ejected in this manner. Rejects can be identified in the stack because they will not be printed in the same manner as successfully recorded discs. Primera Technology offers an optional Kiosk Mode Kit that contains a third output bin to collect the discs. This optional bin hangs off of the edge of a

table and attaches just under the front lip of the Bravo. This kit is available through your reseller. Kiosk mode is enabled as follows:

1. In PrimoDVD 2.0 click **Robotics** then **Options** from the main menu.

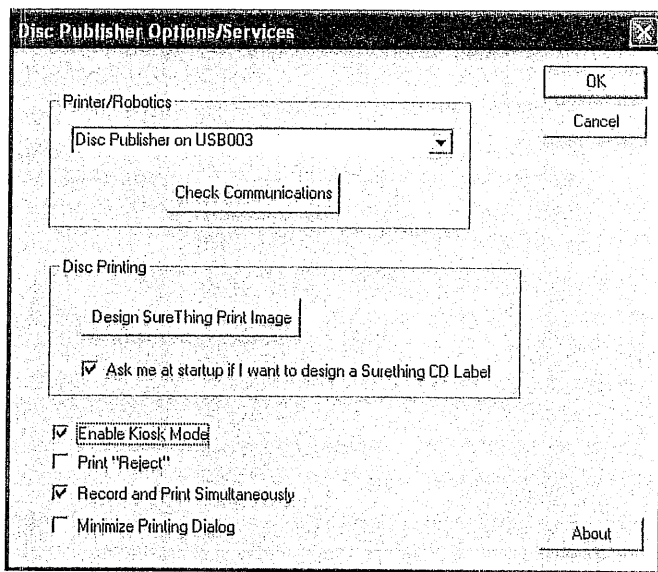

2. In the **Options** dialog box, check the option labeled Enable Kiosk Mode.
3. If you would like the Bravo to physically print the word "Reject" on rejected discs, select the Print "Reject" option. Otherwise, rejected discs will simply be ejected with no printing at all.

F. COPYING AN AUDIO DISC

Now, you're ready to start an actual recording job. In this example, we'll perform a simple audio disc copy. More detailed information regarding other types of jobs (data discs, Video CD, etc.) can be found in the Primo DVD's User's Guide and in the Help files included on the main Application Screen Toolbar.

Follow these steps to set-up and perform an audio CD copy job:

1. Launch the PrimoDVD Software from your Windows Desktop or program files.

2. Insert the master disc into your PC's CD drive. In the drive list on the left of the screen, select the PC's CD drive by clicking on it. Press F4 or, click the **Disc Explorer** button.
3. The Disc Explorer Window will be displayed. Check in the Disc Explorer that the source disc is correctly read. (Click on the **Force Refresh** button if the Auto Refresh checkbox is not checked).
4. To copy the entire CD, press the **Global-Image** button. In the panel that appears at the bottom of the Disc Explorer enter the file name that will contain the disc image. (uses a .GI extension). Then press **Build**.

Please note that this method of building a disc image creates a saved file on your computer's hard drive. These files can be very large, up to 700MB for a CD and 4.7GB for a DVD. You may want to create only a temporary image that is automatically deleted after your copy job is done. To do this instead, build your job image file using the Disc-to-Disc option from the main File: New Job drop-down menu.

Be sure to click the checkbox that reads Make a Temporary Image on the Hard Disc and Copy From There. The job will build automatically, make the number of copies you've specified, and delete the disc image afterwards.

To copy specific tracks from the CD, highlight the desired tracks then click the **Extract Track** button. This will allow you to take the individual tracks from the disc and convert them to Wave files. This is useful for making a compilation disc of tracks from different CDs. When creating an Audio Job from the Application Window, WAV files are converted to CD Audio on the fly.

Wait until the image is completely built and then close the Disc Explorer dialog.

From the Menu bar, select **File: New Job: Global-Image or Other Image Job**. A Job Window will now open in the right side of the application.

In the Image Job dialog box, enter the name of the .GI file you just created into the Image field name. A drop-down box will contain all the recent images you created and you can easily select from this list if you choose.

Also in the Image Job dialog box, check the box labeled Print if you have a printer installed and wish to print a print image onto each disc after it has been recorded. There are two types of files supported:

- *.prn files you've previously created using almost any Windows graphics application,

- *.std files created using SureThing CD labeler.

In the drop down box to the right of the Print checkbox, you can select any recently used *.prn or *.std files. Or, click the box next to the print dialog box to browse for saved .std or .prn files. Find the file you wish to print, highlight it, and click Open. Or, double-click on it. The file appears in the Image Job Window print dialog box with its path. To select a *.STD file, click **Browse** and change Files of Type to All Files and browse to the desired *.std file.

In the Drive List, highlight the recorder icon. This is where the software will send the job for recording. Right click on the icon and select **Select/Deselect as Recorder**.



In the Image Job dialog box, set the number of copies, the speed (if you select a speed that the recorder does not support, it will default to the immediate lower one), and the action you desire: Test, Test and Record, Record, Verify and Record, etc.

Press the red **Record** button to start recording your copies.

If everything was set up properly, the Publisher should now be recording and printing your discs.

Section 4: Interpreting the Publisher's Indicator Lights

The Power and Busy LED indicator lights located on the top of the Publisher can tell you a lot about what is happening inside the Publisher. To accurately interpret what it means when these lights are on, off, or flashing, please refer to the following:

Power LED 	Ink Cartridge LED 	Publisher
on solid	off	Is ready to receive job
on solid	on solid	Has received a job and is waiting for the Robotic Disc Transporter to load a disc
both lights are blinking alternately with one another		Waiting for a cartridge to be installed and the lid to be closed. (See section 2-A).
on solid	flashing rapidly	The printer tray or ink cartridge carrier has stalled. Press the Ink button to retry the operation.
flashing rapidly	on solid	The Publisher has a cartridge problem. Check to make certain that the cartridges are installed correctly and that the bar code labels on the underside of the cartridge are not damaged.
repeating pattern of both lights flashing in unison, then one light momentarily on solid.		This indicates low ink warning. If the left light stays solid after the flash, the Color cartridge is low. If the right light stays on after the flash, the Black Monochrome cartridge should be replaced.

Section 5: Maintenance and Troubleshooting

The Publisher is designed to operate for extended periods of time with very little attention. In fact, no regular maintenance is recommended other than cleaning the outside case.

NOTE: Do NOT attempt to oil or grease the Publisher's Robotic Arm shaft or other components. You will likely cause more harm than good! Any moving parts are designed to operate for the life of the machine with no additional lubrication required.



A. CLEANING THE PUBLISHER

Use a clean, lint-free rag with a small amount of ammonia window cleaner to clean the Publisher's outside case and trays. This type of cleaner is very effective on inks that may accumulate on the printer tray. Stronger cleaning solutions are NOT recommended because they may damage the paint and plastic materials from which the parts are manufactured.

Always disconnect your Publisher's power cords before cleaning. Resume operation only after the surfaces are completely dry.

B. PERFORMING A ROBOTIC SELF-TEST

To ensure that everything is working properly, a Self-Test feature is built in to your Publisher. In this mode, the Robotic Disc Transporter will go through the motions of picking and placing a disc to ensure proper working order. This test may be performed without connecting the Publisher to the PC. Perform the test by doing the following steps:

- Load some discs into the Input Bin
- Make sure the Publisher's front cover is closed
- With the Publisher turned on, press the Cartridge Button 
- While holding the Cartridge Button, press the Power Button  until the robotics start to move.
- Release both buttons
- To stop the test, wait until the disc has moved to the Output Bin and press the Power Button.

C. SOFTWARE TEST

This will confirm that the hardware, software and your PC are all communicating properly with each other properly. Follow the procedures listed on the following pages.

1. Launch the software from your Windows Desktop or program menu. The main Application Window will appear. Select the Publisher Drive by clicking on its icon on the left hand side of the screen.

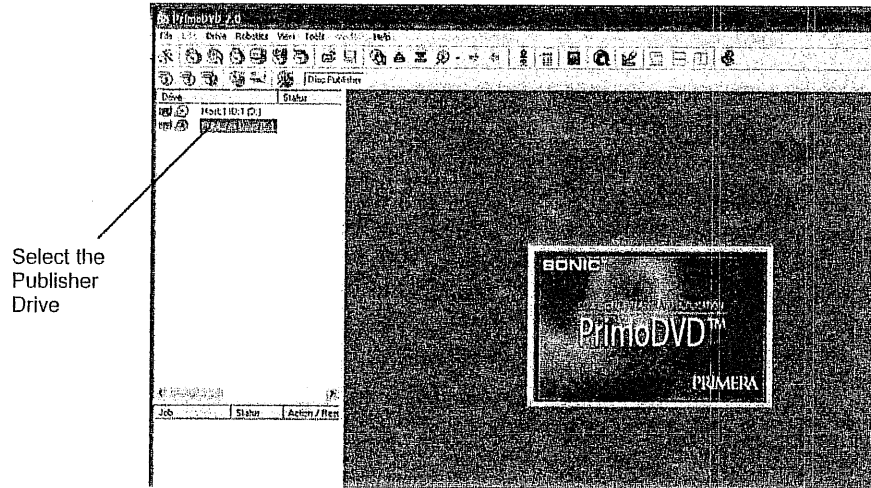

2. From the main Application Window, click on **Robotics**.

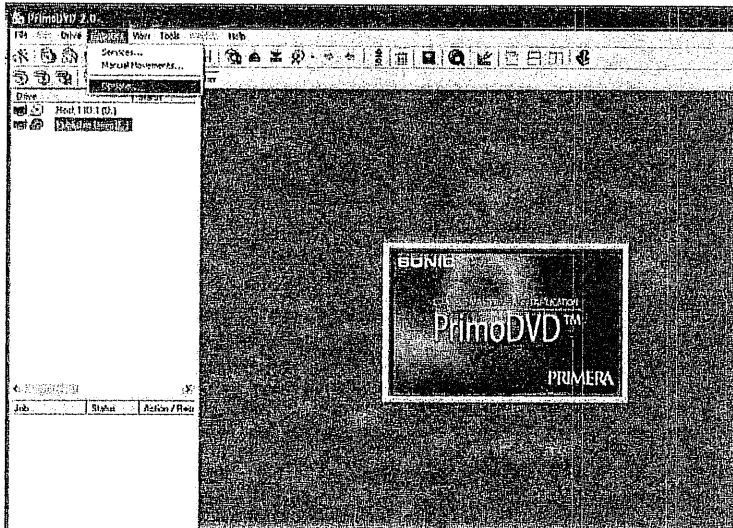

3. In the drop-down menu, go to **Services**.
4. Click on **Check Communications**. You will see a dialog box stating, "Communication OK. System Idle." If you do not see this, make sure that all cables are connected securely.

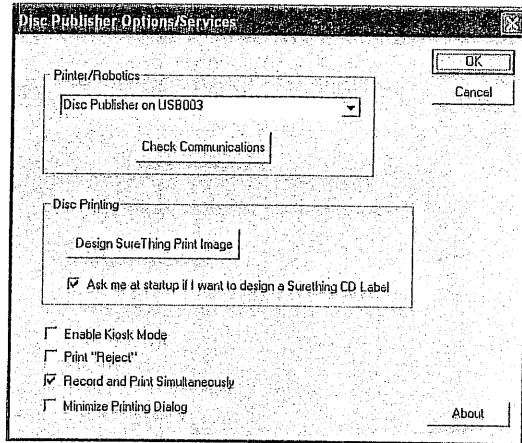

5. Click **OK** to get back to the main screen.
6. Click on **Robotics** again.

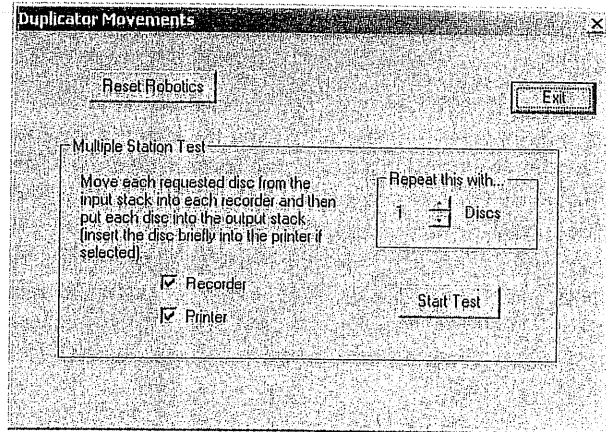

7. Select **Manual Movements**.
8. Load at least 4-5 discs into the Input Bin.
9. Click on **Start Test**. The robotic arm will move through its entire sequence automatically. If you specified more than one disc, it will continue until the number you specified is completed or it runs out of discs.

D. RECORDING ERRORS

If discs are not being recorded properly or are not passing verification, you will want to consult the error log. This is available in PrimoDVD by clicking **View, Activity Log** then selecting the option to **Show At Top** or **Show at Right** from the drop-down Menu.

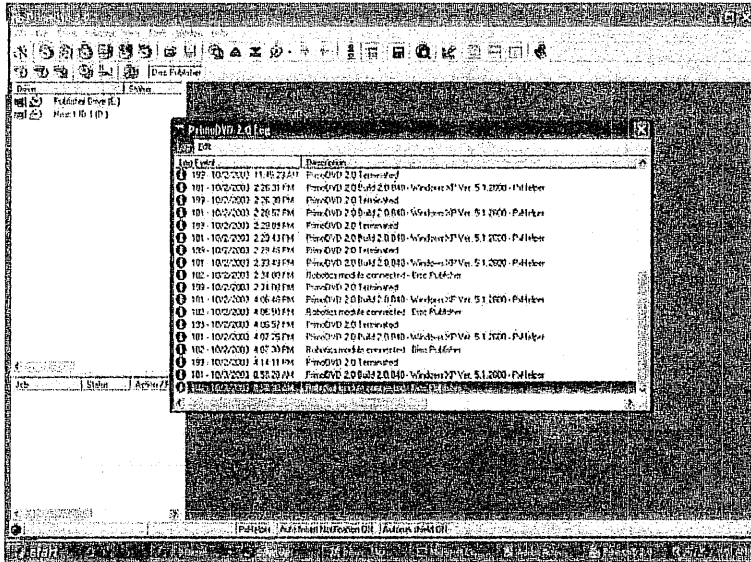

This will show a history of tasks performed by PrimoDVD. If there are errors, you will see them in this list. For more information on recording errors, you can consult the PrimoDVD manual included with the Publisher. The most common error is Buffer Under run. This occurs when data cannot be sent fast enough to keep up with the recording drive. Try the following steps if you are receiving buffer under run errors.

Click **Tools**, **Options** and check the box labeled **Enable Burn Proof**. This option enables the drive to slow down its recording speed to match the data.

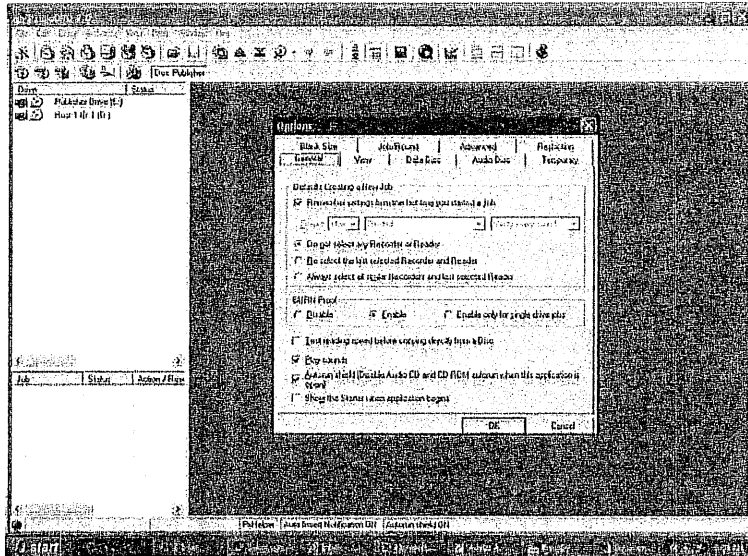

Click **Robotics**, **Options** and deselect **Record and Print Simultaneously**. This will cause your jobs to take longer, but will free more computer resources for recording.

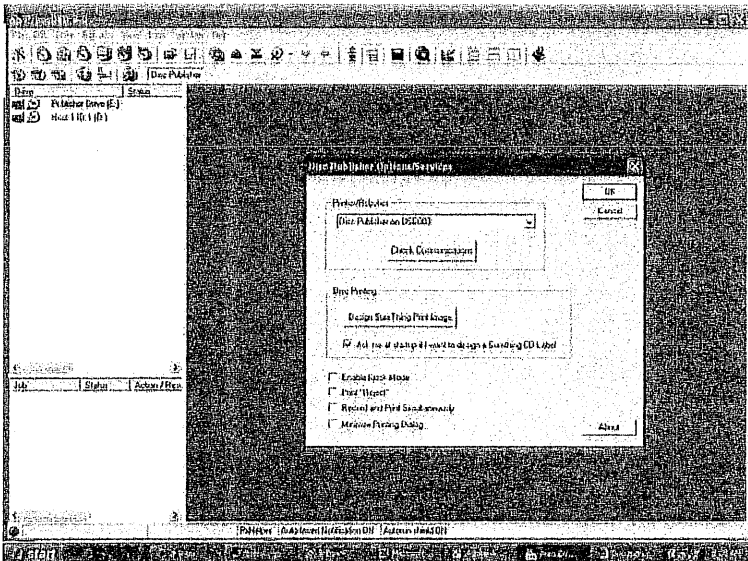

Examine the type of recording job you attempting. If you're attempting to record directly from a CD Reader to the Publisher, the reader or the bus inside your computer may not be able to keep up with recording at 16x speed. Try creating a global image (GI) of the disc as described earlier in this manual and you will most likely have greater success.

E. CLEANING THE INK CARTRIDGES

It may be necessary to clean the ink cartridge nozzles if you notice reduced print quality, or if you suspect an cartridge nozzle has become slightly dried out or clogged. Refer to Section 3 for more information on performing a clean function through the Publisher's printer driver.

F. CLEARING A MEDIA JAM

If a disc should become jammed inside the printing area of the Publisher, with the lid closed press the Cartridge Button. This will eject the Printer Tray. Then open the lid. The Cartridge Carrier will move to the center position automatically.
WAIT FOR THE CARTRIDGE CARRIER TO STOP MOVING!
Then carefully move the cartridge carrier assembly to the left to gain access to the printer tray.

G. TECHNICAL SUPPORT

If you have difficulties in operating your Publisher, the procedures in this manual and the PrimoDVD software User's Guide should, in most cases, solve the problem. If you still have difficulty, contact the technical support number listed on the insert included in the supply pack that came with your Publisher.

Section 6: Technical Specifications

Model	Optical Disc Publisher
Configurations	CD-R Publisher DVD-R Publisher
Printing Method	Ink-Jet
Printing Resolution	4800 x 1200 dpi, 2400 x 1200 dpi, 1200 x 1200 dpi, 600 x 600 dpi
Ink Types	Dual Cartridges: One 3-color (CMY) cartridge, and one Black Monochrome (K)
Media Types	Printable Surface CD-R, CD-RW, DVD-R, DVD RAM
Maximum print width	4.724" (120mm)
Minimum System	Intel® Processor III/IV 750 MHz or higher, 256MB RAM minimum, 512 MB recommended, available PCI slot, one free USB 2.0 port
Disc Capacity	25 disc input, 25 disc output (default) 50 disc input, 50 disc output (Kiosk Mode)
Recordable Formats	CD-R: CD-Audio (CD-DA), CD-ROM, CD-I, Video-CD, MP3 to CD-Audio (on the fly, no hard drive overhead required)
Operating Systems	Windows XP and Windows 2000
Interface	USB 2.0 port
Power Requirement	100-240 VAC, 50/60 Hz, 60 watts
Weight	18 lbs. (8.2kg)
Dimensions	17.25"W x 7.25"H x 16"D (438mmW x 184mmH x 406mmD)
Certifications	Emissions: FCC Class B, CE
Safety	UL, UL-C, CE
Warranty	One year return-to-depot

Index

Activity Log	28, 29, 38
Algebraic.....	18
Alignment Calibration	18, 23, 24
Application Window	28, 29, 32, 36
Audio Job, Running	31
Buffer Under run.....	38
Cartridge Type.....	18, 24
CD Tray.....	6
Centering Test Print	19
Color Matching.....	18
Connections, Rear Panel.....	4
Controls, Front Panel	2
Disc Output Location	23
Drive Status Window	28
Enable Ink Low Warning.....	21
Identifying the Parts	2
Ink Levels and Cartridge Maintenance	21
Ink Saturation	19
Input Bin	2, 3, 5, 6, 10, 20, 22, 35, 37
Inner Diameter.....	19
Job Queueing	30
Job Set-Up Window	28
Job Status Window.....	29
LED Status Lights.....	3
Output Bin	2, 3, 7, 30, 35
Overview of Operation	5
Paper Size	18
Power Input.....	4
PrimoDVD Software.....	1, 27, 31, 40
Print Files.....	26, 27
Printer Driver Software.....	12, 27
PRN Files	27, 33
Reject Area	3, 6, 30
Resolution.....	18, 41
Specifications	41
STD File	16, 27, 33
System Requirements	4
Technical Support.....	40
Troubleshooting.....	35

Printed in the United States of America
P/N 510873

