

High Level Assembler
for MVS & VM & VSE



Toolkit Feature Interactive Debug Facility Reference Summary

Release 5

High Level Assembler
for MVS & VM & VSE



Toolkit Feature Interactive Debug Facility Reference Summary

Release 5

Note!

Before using this information and the product it supports, be sure to read the general information under "Notices" on page 74.

Fifth Edition (June 2004)

This edition applies to IBM High Level Assembler for MVS & VM & VSE, Release 5, Program Number 5696-234 and to any subsequent releases until otherwise indicated in new editions. Make sure you are using the correct edition for the level of the product.

Order publications through your IBM representative or the IBM branch office serving your locality. Publications are not stocked at the address below.

A form for reader's comments is provided at the back of this publication. If the form has been removed, address your comments to:

IBM Corporation
J87/D325
555 Bailey Avenue
SAN JOSE, CA 95141-1003
United States of America

When you send information to IBM, you grant IBM a nonexclusive right to use or distribute the information in any way it believes appropriate without incurring any obligation to you.

© Copyright International Business Machines Corporation 1995, 2004. All rights reserved.

US Government Users Restricted Rights – Use, duplication or disclosure restricted by GSA ADP Schedule Contract with IBM Corp.

Contents

About This Book	x
Syntax Notation	xi
Chapter 1. IDF Basics	1
Introduction	1
Windows	1
IDF Address Expressions	4
Addresses Displayed by IDF	4
Cursor Addressing	5
PF Keys	5
Typeover Storage Modification	6
Chapter 2. IDF Commands	7
ABEND (CMS and MVS)	7
ADSTOP (CMS only)	7
ADSTOPS (CMS only)	7
AFPR	7
ALARM	7
ALET	8
APROGMSG (CMS only)	8
AREGS	8
ARRAY	8
AUDIT	8
BACK	9
BASE	9
BINARY	9
BIT	9
BOTTOM	9
BREAK	9
BRIEF	10
CALLERS	10
CHARACTER	10
CHECK	11
CLOSE	11
COLORS	11
COMMAND	11
COMPACT	12
CREGS (CMS only)	12
CURSOR	12
DBREAK	12
DETAIL	13
DISASM	13

DOWN	13
DROP GLOBAL	13
DROP MODULE	13
DROP SYMBOLS	13
DUMP	14
DUMPMODE	14
EPNAMES	14
EPOFFSET	14
EXITEXEC	14
EXLIMIT	15
FIND	15
FIRST	16
FIXED	16
FLOAT	16
FMT	16
FOLLOW	16
FORMAT	17
FPC	17
FPR	17
GLOBALS	17
GOTO	18
GPACK	18
GPR	18
GPRG (MVS only)	18
GPRH (MVS only)	18
GSTATUS	18
HIDE	19
HISTORY	19
ICOUNT	19
KWDSYN	20
LANGUAGE +	20
LANGUAGE COLOR	20
LANGUAGE COMMENTS	20
LANGUAGE DEBUG	20
LANGUAGE DECLARES	21
LANGUAGE DROP	21
LANGUAGE LOAD	21
LANGUAGE MACROS	21
LANGUAGE OPTIONS	22
LANGUAGE SCROLL	22
LANGUAGE STATUS	22
LANGUAGE STEM	22
LANGUAGE VERSION	23
LANGUAGE XPATH (CMS and MVS)	23

LAST	23
LASTMSG	23
LEFT	24
LIBE (CMS and MVS)	24
LOAD	24
LOCATE	25
LOCATION	25
LOCATION ALET	25
MACRO	25
MAJOR	25
MAP	26
MAXIMIZE	26
MINIMIZE	26
MODE (CMS only)	26
MODULE	27
MODULE	27
MODULE BASE	27
MODULE SIZE	27
MOVE	28
MPACK	28
MRUN	28
MSG	28
MSGID (CMS and MVS)	29
MSGMODE	29
MSTATUS	29
MSTEP	29
NAMES	30
NEXT	30
OFFSET	30
OPEN	31
OPTIONS	31
ORDER	31
OREGS	31
PACKED	31
PARMS	32
PAUSE	32
PER (CMS only)	32
PFK	32
PFKDISP	32
PLOCATES	33
PRESERVE	33
PREVIOUS	33
PROGCK (CMS only)	33
PSW	33

PSWSTEAL (CMS only)	33
QUALIFY	34
QUIET	34
QUIETLY	34
QUIT	34
RCQUIT	34
REFRESH	34
REGS	35
REGS64 (MVS only)	35
REGSTOPS (CMS only)	35
RESTORE	35
RETRIEVE	35
RIGHT	35
RLOG	36
RUN	36
RUNEXIT	36
R0-R15	36
SALIMIT	36
SAREGS	37
SAVE	37
SEARCH	37
SELFNUCX (CMS only)	37
SET ADSTOP (CMS only)	37
SET AREG	37
SET BREAK	38
SET COMMAND	38
SET EXITEXEC	38
SET GLOBAL STEM	38
SET GLOBAL TEXT	38
SET ICOUNT	38
SET OFFSET	39
SET OPTION	39
SET PSW	39
SET REGSTOP (CMS only)	39
SET SIZE	39
SHOW	40
SIZE	41
SKIPSTEP	41
SPACE	41
STATUS	41
STEP	42
STMTSTEP	42
STOKEY	42
STOREMAP	42

STRUCTURE	42
SUBSET (CMS only)	43
SVC (CMS only)	43
SWAP	43
SYMBOL	43
TASKS (TSO only)	43
TITLE	44
TOP	44
TRIGGER LOAD	44
TYPE	44
UNION	44
UNTIL	44
UP	45
VALUE	45
VARIABLE	45
VCHANGE	45
VERSION	45
VS	45
VSEP	46
WATCH	46
WHERE	46
XEDEXIT (CMS only)	46
ZONED	47
Chapter 3. ASMIDF EXTRACT Command	48
ADSTOPS (CMS only)	48
ALET	48
AREGS	48
ARGUMENT	48
ARRAY	49
BREAK	49
CALLERS	49
CMDMSG	49
COLORS	50
CURSOR	50
DISASM	50
EVENT	50
EXITEXEC	50
GLOBAL	51
GLOBAL STEM	51
GLOBAL STEMS	51
GSTATUS	51
ICOUNT	51
LANGUAGE ARGUMENTS	52

LANGUAGE COMMANDS	52
LANGUAGE OPTIONS	52
LANGUAGE STATUS	52
LANGUAGE STEM	52
LANGUAGE VERSION	53
LASTMSG	53
LOAD	53
LOCATION	53
LOCATION ALET	53
MAP	54
MODE (CMS only)	54
MODULES	54
MSTATUS	54
NAMES	54
OPTIONS	55
PER (CMS only)	55
PFK	55
PLIST	55
PLOCATES	55
QUALIFY	56
QUERY SETTING	56
REGS	56
REGSTOPS (CMS only)	56
SCOPE	56
SCRVAR	57
SELFNUCX	57
SKIPSTEP	57
SOURCE	57
STOREMAP	57
STRUCTURE	58
SVC (CMS only)	58
SYMBOLS	58
TASKS	58
TYPE	58
VALUE	59
VARIABLE	59
VDECLARE	59
VERSION	59
VLOC	59
VVALUE	60
WINDOWS	60
Chapter 4. ASMIDF Options	61

Chapter 5. ASMIDF Language Support	64
Introduction	64
A Word about Variables	64
Invocation	64
Options	65
Displaying Source	65
Displaying Variables	66
Displaying Structures	66
Displaying Array Elements	66
Altering Variables	67
Displaying Type Attributes	67
LANGUAGE Command Aliases	68
Hints and Tips	69
Chapter 6. Using ASMLANGX	70
Invocation	70
Options	72
Examples	73
Notices	74
Trademarks	75

About This Book

This book is intended to be used as a quick reference for the High Level Assembler Toolkit Feature Interactive Debug Facility (ASMIDF) User's Guide.

The Interactive Debug Facility, a feature of the *IBM High Level Assembler Toolkit Feature*, are referred to as "ASMIDF" throughout this publication.



This book is divided into the following sections:



- ASMIDF basics
- ASMIDF commands
- ASMIDF SET command
- ASMIDF EXTRACT command
- ASMIDF options
- ASMIDF language support
- Using ASMLANGX



This book uses format conventions and syntax diagram conventions in describing language and statement elements.

Throughout this book, we use these indicators to identify platform-specific information:

- Prefix the text with platform-specific text (for example, "Under CMS...")
- Add parenthetical qualifications (for example, "(CMS only)")
- Bracket the text with icons. The following are some of the icons that we use:

 Informs you of information specific to MVS™ 

 Informs you of information specific to CMS 

 Informs you of information specific to VSE 

| MVS is used in this manual to refer to Multiple Virtual Storage/Enterprise Systems Architecture (MVS/ESA™), to OS/390®, and to z/OS®.

| CMS is used in this manual to refer to Conversational Monitor System on z/VM®.

| VSE is used in this manual to refer to Virtual Storage Extended/Enterprise Systems Architecture (VSE/ESA™), and z/VSE.

Syntax Notation

Throughout this book, syntax descriptions use the structure defined below.

- Read the syntax diagrams from left to right, from top to bottom, following the path of the line.

The \blacktriangleright — symbol indicates the beginning of a statement.

The — \blacktriangleright symbol indicates that the statement syntax is continued on the next line.

The \blacktriangleright — symbol indicates that a statement is continued from the previous line.

The — $\blacktriangleright\blacktriangleleft$ indicates the end of a statement.

Diagrams of syntactical units other than complete statements start with the \blacktriangleright — symbol and end with the — \blacktriangleright symbol.

- **Keywords** appear in uppercase letters (for example, ASPACE) or upper and lower case (for example, PATHFile). They must be spelled exactly as shown. Lower case letters are optional (for example, you could enter the PATHFile keyword as PATHF, PATHFI, PATHFIL or PATHFILE).

Variables appear in all lowercase letters in a special typeface (for example, *integer*). They represent user-supplied names or values.

- If punctuation marks, parentheses, or such symbols are shown, they must be entered as part of the syntax.
- Required items appear on the horizontal line (the main path).

\blacktriangleright —INSTRUCTION—*required item*— $\blacktriangleright\blacktriangleleft$

- Optional items appear below the main path. If the item is optional and is the default, the item appears above the main path.

\blacktriangleright —INSTRUCTION $\left[\begin{array}{l} \textit{default item} \\ \textit{optional item} \end{array} \right]$ — $\blacktriangleright\blacktriangleleft$

- When you can choose from two or more items, they appear vertically in a stack.

If you **must** choose one of the items, one item of the stack appears on the main path.

\blacktriangleright —INSTRUCTION $\left[\begin{array}{l} \textit{required choice1} \\ \textit{required choice2} \end{array} \right]$ — $\blacktriangleright\blacktriangleleft$

If choosing one of the items is optional, the whole stack appears below the main path.



- An arrow returning to the left above the main line indicates an item that can be repeated. When the repeat arrow contains a separator character, such as a comma, you must separate items with the separator character.



A repeat arrow above a stack indicates that you can make more than one choice from the stacked items, or repeat a single choice.

The following example shows how the syntax is used.

Format

A
B
C

1:

operand choice1
operand choice2 (1)
operand choice3

Note:
¹ *operand choice2* and *operand choice3* must not be specified together

- A** The item is optional, and can be coded or not.
- B** The INSTRUCTION key word must be specified and coded as shown.
- C** The item referred to by **1** is a required operand. Allowable choices for this operand are given in the fragment of the syntax diagram shown below **1** at the bottom of the diagram. The operand can also be repeated. That is, more than one choice can be specified, with each choice separated by a comma.

Chapter 1. IDF Basics

Introduction

On CMS and TSO you can activate IDF with the following command:

```
ASMIDF module_name (idf_options/Module_parameters
```

| On MVS, you can activate IDF:

- | • In TSO batch, with the following command supplied on the DD card
| SYSTSIN:

```
| ASMIDF module_name ( LU vtam_luid idf_options/module_parameters
```

- | • In batch, with the following JCL:

```
| //stepname EXEC PGM=ASMIDFB,  
| //          PARM='module_name ( NOSVC97 LU vtam_luid idf_options /  
| //          module_parameters'
```

On VSE you can activate IDF with the following JCL:

```
// EXEC ASMIDF,PARM='module_name (idf_options/module_parameters'
```

Where:

module_name The name of the module to be debugged.

idf_options Options directed to ASMIDF.

module_parameters The parameters directed to the module to be debugged.

Some command examples are:

```
ASMIDF module_name (COLORS RWGY / in out (abcd  
ASMIDF module_name (PATH / in out (abcd
```

Windows

The types of windows available within IDF are:

- AdStops window (CMS only)
 - Opened by the ADSTOPS and REGSTOPS commands.
 - Closed by the ADSTOPS, REGSTOPS, or CLOSE command.
 - Displays the current PER AdStops and Register Stops.

- Additional Floating-Point Registers window
 - Opened by the AFPR command.
 - Closed by the AFPR or CLOSE command.
 - Displays the current Additional Floating-Point Registers and the Floating-Point Control Register.
- Break window
 - Opened by the BREAK command.
 - Closed by the BREAK or CLOSE command.
 - Displays the active breakpoints and watchpoints.
- Current Registers window
 - Opened by the REGS, REGS64, AREGS, or CREGS command.
 - Closed by the REGS or CLOSE command.
 - Displays the current PSW, GPRs, and FPRs or ARs or CRs.
- Disassembly window
 - Opened by the DISASM or OPEN command.
 - Closed by the DISASM or CLOSE command.
 - Displays disassembled instructions.
- Dump window
 - Opened by the DUMP or OPEN command.
 - Closed by the DUMP or CLOSE command.
 - Displays storage in "dump format".
- Entry Point Names window
 - Opened by the EPNAMES or OPEN command.
 - Closed by the EPNAMES or CLOSE command.
 - Displays information about the entry points in the module.
- Language Support Module information window
 - Opened by the VARIABLE, LANGUAGE, STRUCT, or OPEN command.
 - Closed by the VARIABLE or CLOSE command.
 - Displays information from IDF Language Support commands.
- Minimized Windows Viewer
 - Opened by the MINIMIZE command.
 - Closed by the MAXIMIZE command.
 - Lists the minimized windows.

- Old Registers window
 - Opened by the OREGS command.
 - Closed by the OREGS or CLOSE command.
 - Displays the old ARs, CRs or PSW, GPRs, FPRs, and instruction at PSW.
- Options window
 - Opened by the OPTIONS command.
 - Closed by the OPTIONS or CLOSE command.
 - Displays settings of various options.
- Skipped Subroutines window
 - Opened by the SKIPSTEP command.
 - Closed by the SKIPSTEP or CLOSE command.
 - Displays subroutines "skipped" during single stepping, statement stepping, or the PATH or FASTPATH processing.
- Target Status window
 - Opened by the STATUS command.
 - Closed by the STATUS or CLOSE command.
 - Displays information about the target program.

IDF Address Expressions

IDF Address Expressions are made up of terms separated by plus or minus signs. A term can consist of a program symbol, a hex constant (X'5'), a decimal constant (f'4'), a character constant that is one character in length (c'A'), or an implicit numeric constant (247).

Program symbols are of the form "(module.csect) symbol". If supported by the active LSM, they may also be of the form "(module.csect) STMT#nnnnn". The *csect* in "(module.csect)" is only needed if the symbol occurs in multiple CSECTs. The *module* in "(module.csect)" is only needed if the symbol is not in the currently qualified module. To select the module to be the currently qualified module, use the SET QUALIFY command.

Terms may be followed with a register designator. A register designator consists of the string R0 through R15 or AR0 through AR15, enclosed in parentheses. Using AR0 through AR15 directs the DUMP, SET ALET, and EXTRACT LOCATION commands to use the ALET in the specified AR.

Terms and register designators may be followed by indirection operators (% , :>, ?, =>, ->, &, +>). If an indirection operator follows a term, IDF uses the contents of the word pointed to by the expression evaluated thus far. Similarly, if an indirection operator follows a register designator, IDF is being told how to interpret the contents of the register. The word or register is treated as:

- A 24-bit address if the % or :> operators are used.
- A 31-bit address if the ? or => operators are used.
- A 64-bit address if the & or +> operators are used.
- The appropriate size (24-bit, 31-bit or 64-bit) depending on the AMODE of the PSW if the -> operator is used.

Addresses Displayed by IDF

Whenever appropriate, IDF displays addresses in symbolic form. It is normally of the form "(module.csect) symbol+offset". If the address corresponds to IDF Language extract data, it is of the form "(module.csect) STMT#nnnnn+offset". The module name is omitted if it is the currently qualified module, unless the FULLQUAL option is used.

Cursor Addressing

IDF allows you to specify addresses by placing the cursor in a field on the screen. IDF determines an address in the following ways:

- If the cursor is in a GPR, the contents of that displayed register are used. If the cursor is in an AR, the DUMP and SET ALET commands use the ALET in that AR and the DUMP command uses the address in the associated GPR.
- If the cursor is in the PSW, the address part of the PSW is used.
- If the cursor is in the hex part of a disassembled instruction, then:
 - All commands except DISASM and OPEN DISASM use the address of the halfword containing the cursor.
 - If the field containing the cursor is both the first field disassembled and a branch instruction, the DISASM and OPEN DISASM commands use the effective address of the branch instruction. Otherwise they behave like other commands.
- If the cursor is in a dump field, then:
 - All commands except DUMP and OPEN DUMP use the address of the beginning of the hexadecimal field containing the cursor, or the exact address of the character on which the cursor is positioned if it is in the character portion of the display.
 - If the field is both a fullword field and the first field in the dump display, the DUMP and OPEN DUMP commands use the *contents* of the field. Otherwise they behave like other commands.
- If the cursor is in the protected portion of a disassemble or dump line the starting address of the line is used.

PF Keys

The ENTER key and PF keys 1 through 24 can be set to any IDF command or to any IDF macro by the SET PFK command. When this is done, instead of typing the command, you can press the PF key.

The PF key settings are displayed at the bottom of the screen, unless turned off by the PFKDISP command.

Typeover Storage Modification

- In a Dump window, or a Disassembly window containing storage being dumped, storage may be changed by overtyping the hex or character display of that storage.
- In the current registers window, the PSW, general purpose or access registers, and floating point registers may be changed by overtyping the displayed value.
- In a Disassembly window, the hex values of the instructions may be changed by overtyping them.
- In the Additional Floating-Point Registers window, the floating point registers may be changed by overtyping the displayed values.
- In the Entry Point Names window, the short entry point name may be changed by overtyping the displayed values.

The changes are immediately reflected on the screen as different instruction mnemonics, addresses, and so on.

Chapter 2. IDF Commands

ABEND (CMS and MVS)

Performs IDF cleanup, then issues OS ABEND.

```
▶ ABEND abend-code ▶▶
```

ADSTOP (CMS only)

Sets one end of a PER ADSTOP range.

```
▶ ADSTop expression ▶▶
```

ADSTOPS (CMS only)

Displays the current Address Stops and Register Alteration Stops.

```
▶ ADSTops  
  REGSTops ▶▶
```

AFPR

Displays the Additional Floating-Point Registers and the Floating-Point Control Register.

```
▶ AFPR ▶▶
```

ALARM

Enables or disables the terminal alarm.

```
▶ ALARM  ON  
          OFF ▶▶
```

ALET

Sets the ALET for a dump window.

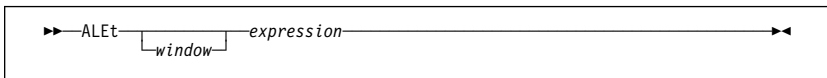

APROGMSG (CMS only)

Enables or disables the trapping of asynchronous program-checks which occur while IDF displays the user interface.

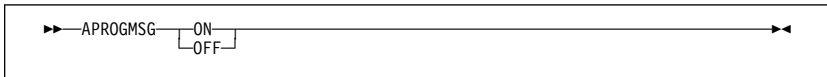

AREGS

Rotates the register display between GPRs and ARs.

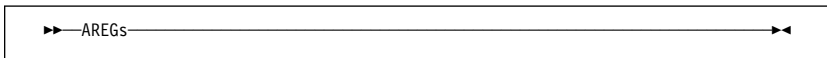

ARRAY

Enables variable display in the array format.

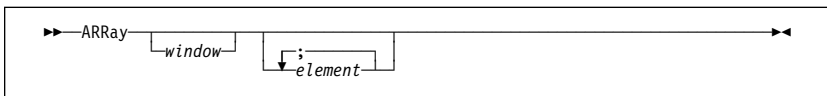

AUDIT

Enables or disables the VAR basing "audit trail".

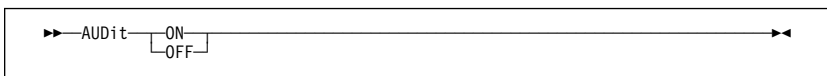

BACK

Displays previously dumped storage (the last 10 dumps can be displayed).

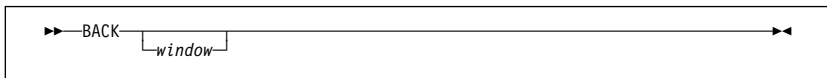

BASE

Sets the base of a target.

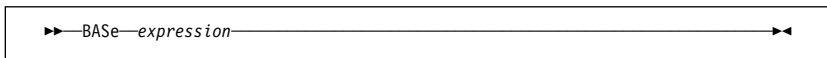

BINARY

A synonym of the FIXED command.

BIT

Sets or queries the VAR display format for BIT variables.

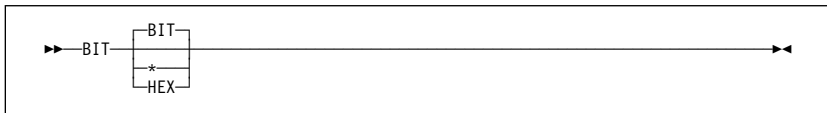

BOTTOM

Displays source code at the highest available address within the current code section.



BREAK

Sets an instruction breakpoint.

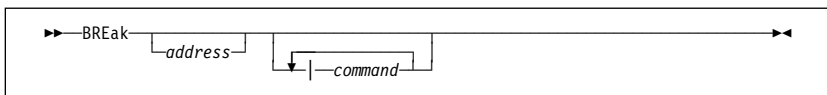

BRIEF

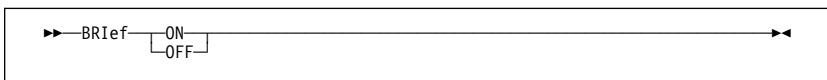

Disables or enables the display of VAR declaration information.

CALLERS

Displays information for each generation in the program caller hierarchy.

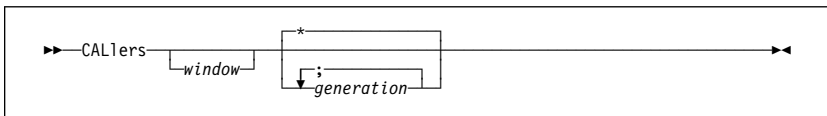

- The information includes:
 - Location as:
 - (mod.sect)stmt#nnnnn+offset
 - program_block_name+offset (if known)
 - Save Area header
 - Save Area register values
- Caller generations are numbered:
 - 0** current program
 - 1** parent (caller)
 - 2** grand parent (caller of caller)
 - ... and so on
- If particular caller generations are specified, only the corresponding information is shown.
- The default is "*", to show *all* caller generations.

Also see the SAREGS and SALIMIT commands.

CHARACTER

Sets or queries display format for CHARACTER variables.

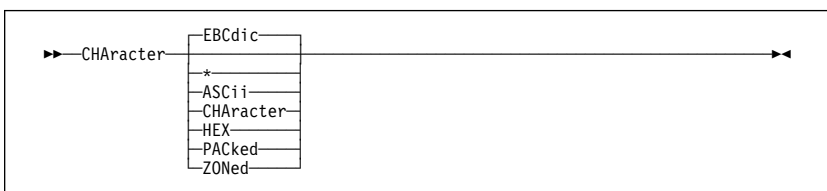

CHECK

Enables or disables the checking of types of input values.

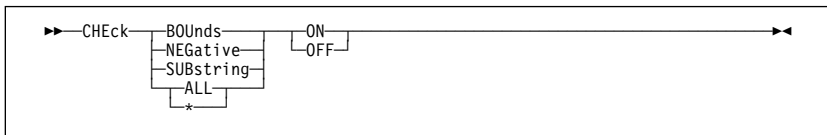

BOUNDS Array index bounds

NEGATIVE Unsigned variable values

SUBSTRING Character or bit string substring limits

ALL | * All of the above

CLOSE

Closes a window.

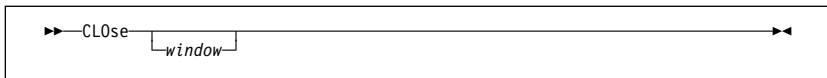

COLORS

Sets display colors.

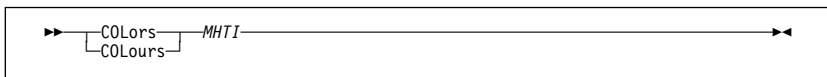

Each value is the first letter of one of the following colors:

Blue, Green, Pink, Red, Turquoise, Yellow, White

For example:

COLORS BGRY

gives blue messages, green headings, red text, and yellow input.

COMMAND

Performs an IDF command.

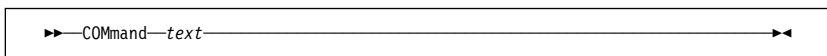

COMPACT

Enables or disables the compact variable display mode.

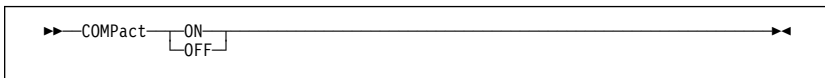

CREGS (CMS only)

Rotates register display between GPRs and CRs.

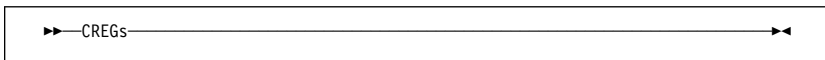

CURSOR

Positions the cursor within a window.

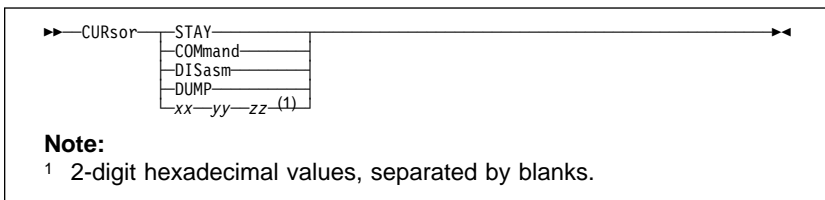

DBREAK

Sets a deferred instruction breakpoint in a module.

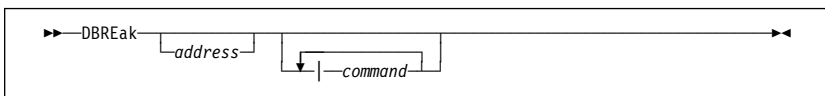

DETAIL

Controls the display of data for Structure or Union components of intermediate depth.

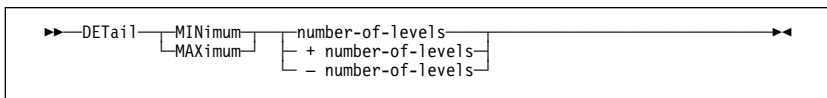

number-of-levels The number of levels of Structure or Union components to be shown.

DISASM

Displays a disassembly listing.

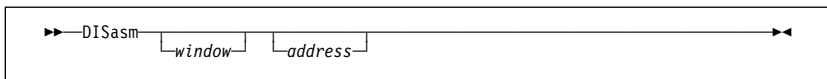

DOWN

A synonym of the NEXT command.

DROP GLOBAL

Discards information for stems from storage.

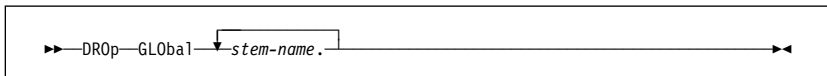

DROP MODULE

Discards information about module *module-name*.

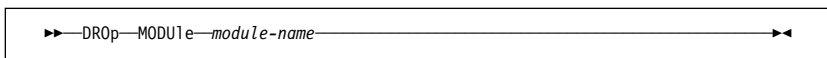

DROP SYMBOLS

Discards IDF symbols.

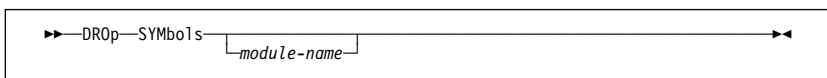

DUMP

Provides Storage Dump in the format HEX ... HEX *char*

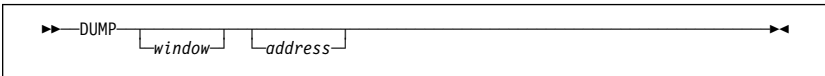

DUMPMODE

Toggles the Dump Format between symbolic and unformatted.

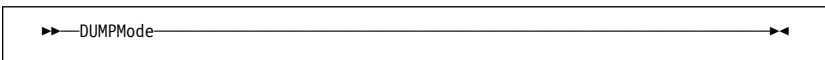

EPNAMES

Toggles the Entry Point Names display.

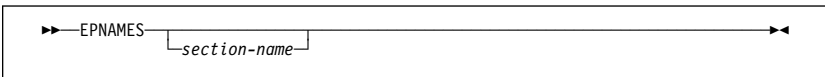

EPOFFSET

Specifies the entry-point-offset.

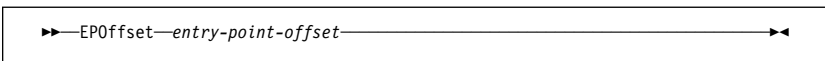

EXITEXEC

Toggles the Exit Routine.

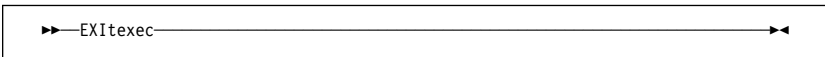

EXLIMIT

Sets the maximum LSM stemmed array index during EXTRACT LANGUAGE commands execution.

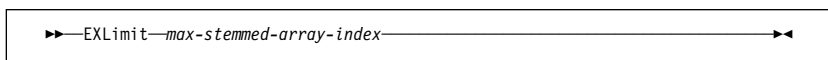

- Prevents "run-away" if data being extracted is unbounded (for example: LANGUAGE EXTRACT VValue for Char(*) or Bit(*) variable).
- The default EXLIMIT is 20000.

FIND

An ISPF-style source text search facility, which locates the string and displays the section of code where it occurs.

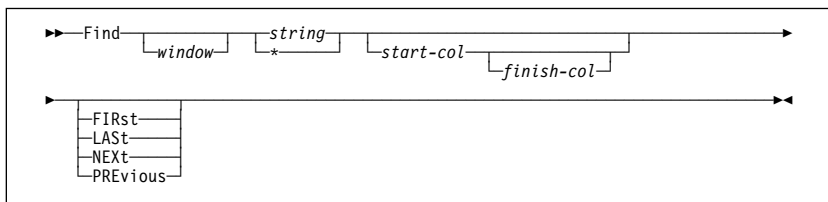

- * Use current search string
- start-col* An integer; the column at which searching starts.
- finish-col* An integer; the column at which searching finishes.
- FIRST** Begin the search at the lowest address, and look for the search string in a forward direction.
- LAST** Begin the search at the highest address, and look for the search string in a reverse direction.
- NEXT** Begin the search at the current address, and look for the search string in a forward direction.
- PREVIOUS** Begin the search at the current address, and look for the search string in a reverse direction.

A search string that is numeric or contains imbedded blanks must be enclosed in quotes. Both "... " and '...' forms are accepted.

Unless otherwise qualified, the search is performed from the current address, in the direction last specified.

FIRST

Displays the source code which corresponds to the lowest address.

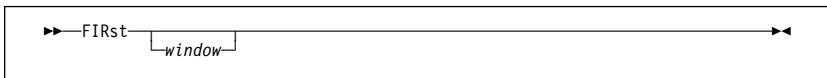

FIXED

Sets or queries the VAR display format for FIXED variables.

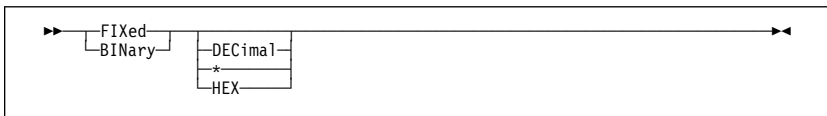

FLOAT

Sets or queries the VAR display format for FLOAT variables.

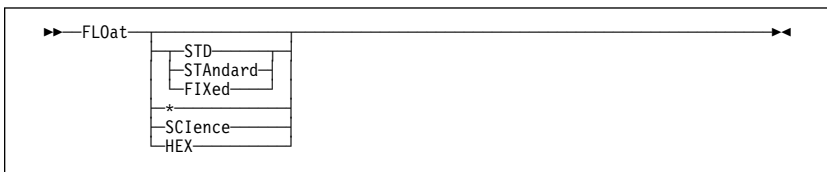

FMT

A synonym of the FORMAT command.

FOLLOW

Directs the DUMP window to “follow” the contents of a register.

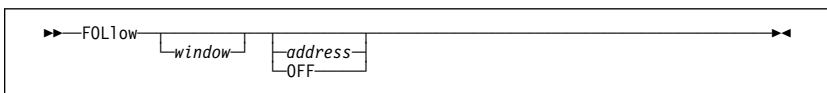

FORMAT

Controls the display format for *individual* variables.

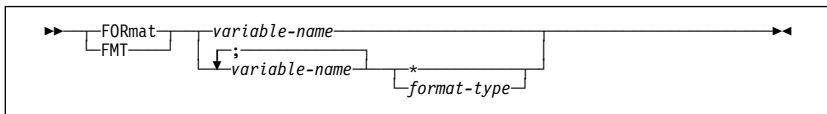

format-type must be appropriate for variable data type:

- * Reset display format to default for variable class.
- Bit** Refer to BIT
- Char** Refer to CHAR
- Fixed** Refer to FIXED
- Float** Refer to FLOAT
- Packed** Refer to PACKED
- Zoned** Refer to ZONED

If the *format-type* is absent, displays the current display format for the variable.

FPC

Sets the Floating Point Control register.

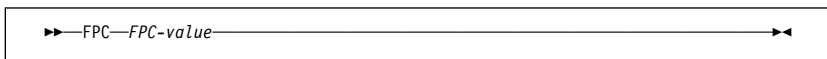

FPR

Sets a floating point register.

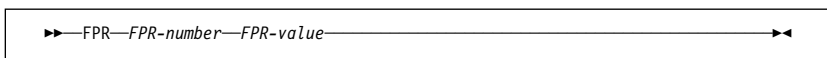

The FPR number is 0, 2, 4, or 6, except for OS/390 systems with binary floating point support, where registers 0 to 15 may be specified.

GLOBALS

Displays information about the Global Storage stems.

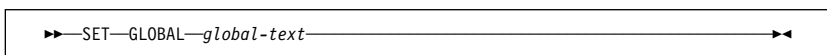

GOTO

Places an evaluated expression in the address portion of the PSW.

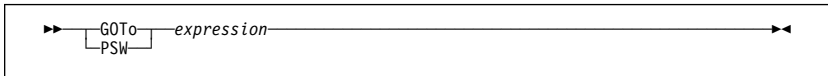

GPACK

Returns the Global Storage data storage areas which no longer contain stem data.

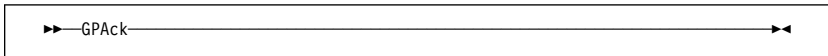

GPR

Sets a general register.

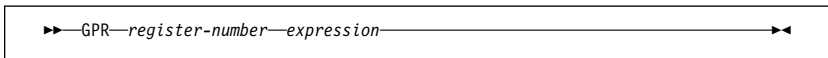

GPRG (MVS only)

Sets a 64-bit general register.

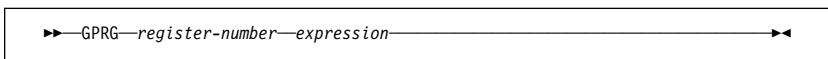

GPRH (MVS only)

Sets the upper 32-bits of a 64-bit general register.

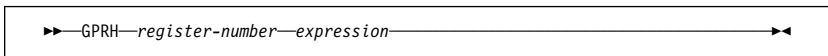

GSTATUS

Displays information about the storage used to contain the Global Storage stem data loaded with SET GLOBAL STEM commands.

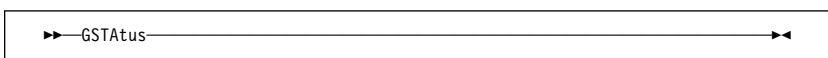

HIDE

Controls the display of source code and disassembly, by hiding information. The SHOW command controls the display by showing information.

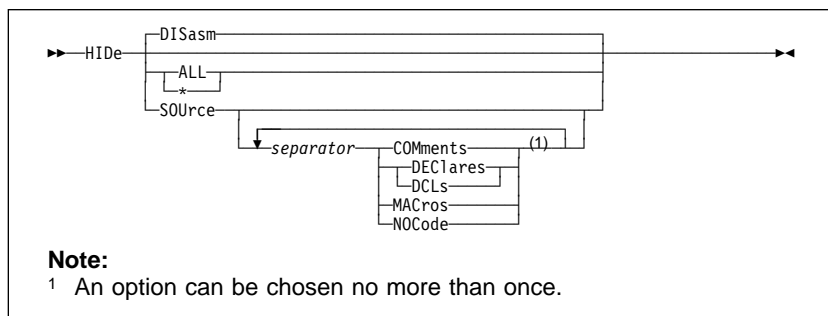

DISASM	Show source code only
ALL *	Show source code only, excluding comments, declarations, macro expansions, and source lines with no corresponding object code
SOURCE	Show disassembly only
COMMENTS	Exclude block comment source code
DECLARES DCL	Exclude declaration source code
MACROS	Exclude macro expansion source code
NOCODE	Exclude source lines with no corresponding object code

HISTORY

Reviews instruction history (PATH).

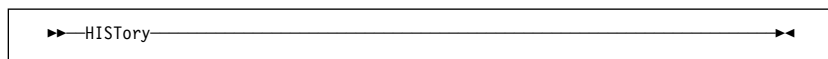

ICOUNT

Displays the number of instructions executed since the last ICOUNT command.

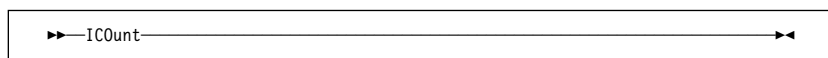

KWDSYN

Defines a synonym of an IDF keyword.

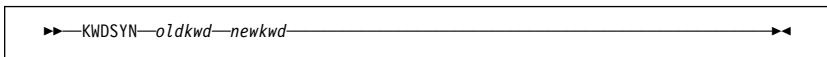

LANGUAGE +

Scrolls the LSM window.

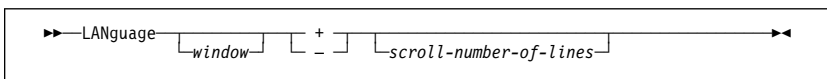

LANGUAGE COLOR

Selects the color used to display source code.

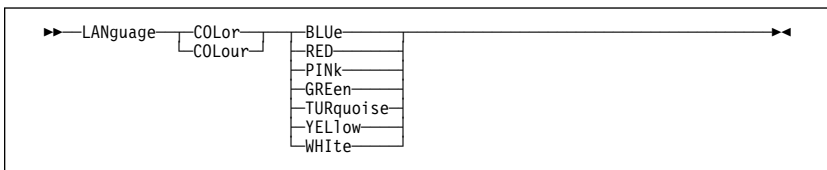

The default is the color used by IDF for text display.

LANGUAGE COMMENTS

Enables or disables the block comment display.

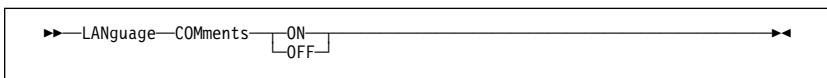

LANGUAGE DEBUG

Enables or disables the display of IDF LSM interface debug information.

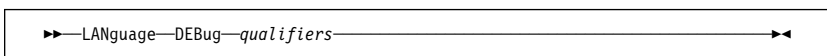

Should only be used as directed by IBM support.

LANGUAGE DECLARES

Enables or disables the declare display.

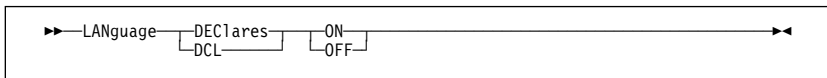

LANGUAGE DROP

Removes one or more language extract files from memory.

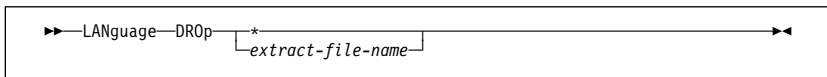

* All currently loaded extract files are removed.
extract-file-name This extract file is removed.

LANGUAGE LOAD

Loads an extract file, optionally associating it with a specific MODULE.

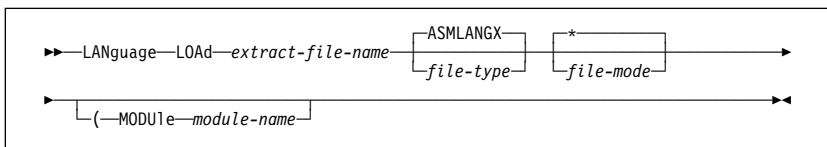

extract-file-name MVS PDS member name
file-type (CMS only) MVS DD name.

Specifying this option eliminates the search using the XPATH file types. The default XPATH is "ASMLANGX".

MODULE *module-name* Associates an extract file with a module. See section "Options" on page 65.

LANGUAGE MACROS

Enables or disables the display of assembler source generated by macros.

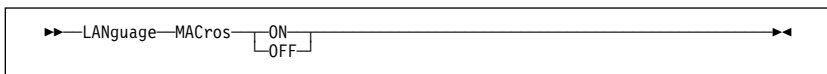

LANGUAGE OPTIONS

Displays the current value of ASMLANG settings and the Options save stack nesting level.

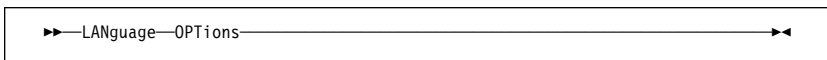

LANGUAGE SCROLL

Sets the default scroll amount.

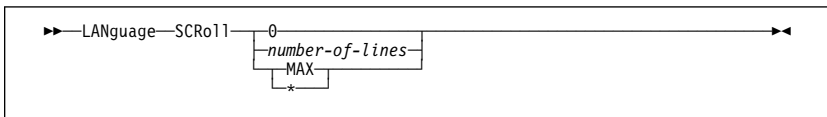

- 0** Disable scrolling
- 1-254** Scroll by this number of lines
- MAX | *** Scroll by maximum amount (current size of LSM window)

LANGUAGE STATUS

Displays information about extract files currently loaded.

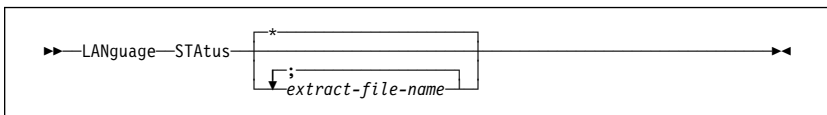

- *** Show all extract files.
- extract-file-name** The name of the extract file to display information about.

LANGUAGE STEM

Alters the name of the REXX stemmed array variable for the EXTRACT LANGUAGE commands, and other EXTRACT commands.



LANGUAGE VERSION

Displays the ASMLANG version identifier.

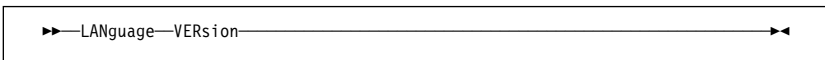

LANGUAGE XPATH (CMS and MVS)

Defines the extract file search path file type (MVS DD name) information.

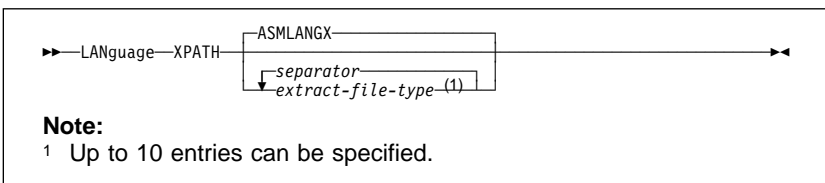

- Used to locate extract files for which the extract file type (MVS DD name) has not been explicitly specified.
- XPATH entries are searched in the order specified.
- If parameters are specified, then sets XPATH as specified, with up to 10 entries.
- If parameters are *not* specified, then resets XPATH to the default of "ASMLANGX".

LANGUAGE STATUS displays the current XPATH.

LAST

Displays source code at the highest address.

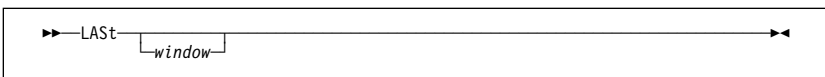

LASTMSG

Displays last two messages.

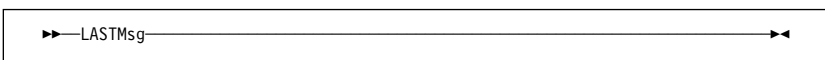

LEFT

Scrolls a window left.

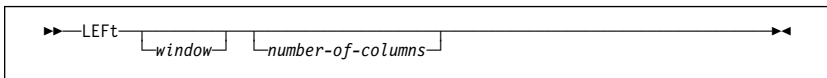

LIBE (CMS and MVS)

Nominates the source of the target program which IDF is to load.



LOAD

Loads a target module and associated symbols.

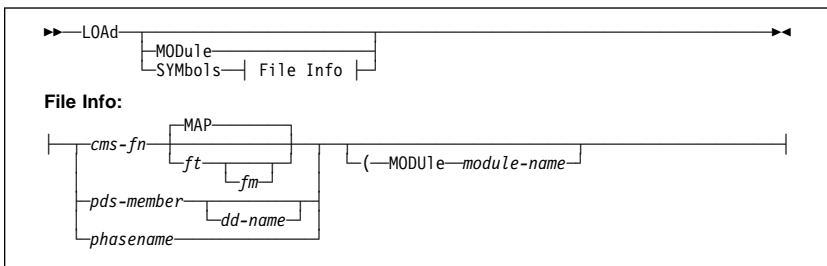

- LOAD loads a target module and symbols.
- LOAD MODULE loads a module.
- LOAD SYMBOLS loads symbols for a module.

LOCATE

XEDIT-style source text search facility which locates the string and displays the section of code where it occurs. The search begins at first source line on screen.

```
▶ [Locate] [window] [ _ ] /-string [ /- ]▶
```

If "-" is specified, the search is performed towards the beginning of the source information.

The trailing delimiter is only required if the string contains trailing blanks.

LOCATION

Sets the main storage to MEMAREA (MEMAREA is a REXX variable).

```
▶-LOCation-storage-start-address▶
```

LOCATION ALET

Sets storage in a dataspace to MEMAREA (MEMAREA is a REXX variable).

```
▶-LOCation-ALEt-access-link-entry-token-storage-start-address▶
```

MACRO

Issues an IDF macro.

```
▶-MACro-macro-name [macro-parameters]▶
```

MAJOR

Disables or enables display of data for Structure or Union major component.

```
▶-MAJor [ON] [OFF]▶
```

MAP

Displays information about modules.

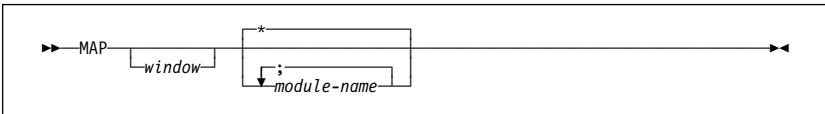

* Information shown for all modules.
_ module-name Information shown for this module.

The information includes:

- Module location
- CSECT location
- Extract file associated with each CSECT

MAXIMIZE

Maximizes a window.

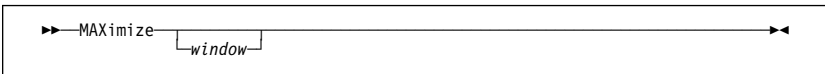

MINIMIZE

Minimizes a window.

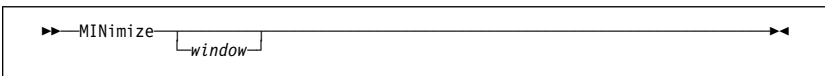

MODE (CMS only)

Sets the file mode for command and macro logging and play back.

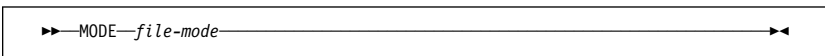

MODULE

Prevents IDF from loading a target module. (Use only within a macro.)

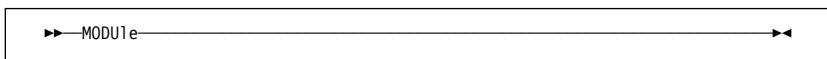

MODULE

Sets the base and size of a module from system control blocks.

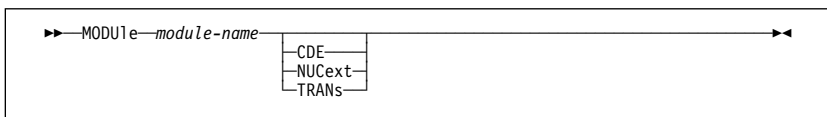

MODULE BASE

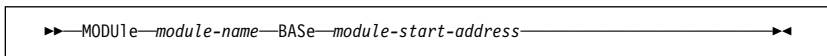

Sets the base of module *modname*.

MODULE SIZE

Sets the size of module *modname*.

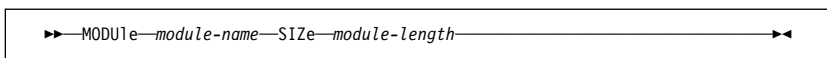

MOVE

Moves a window around on the screen.

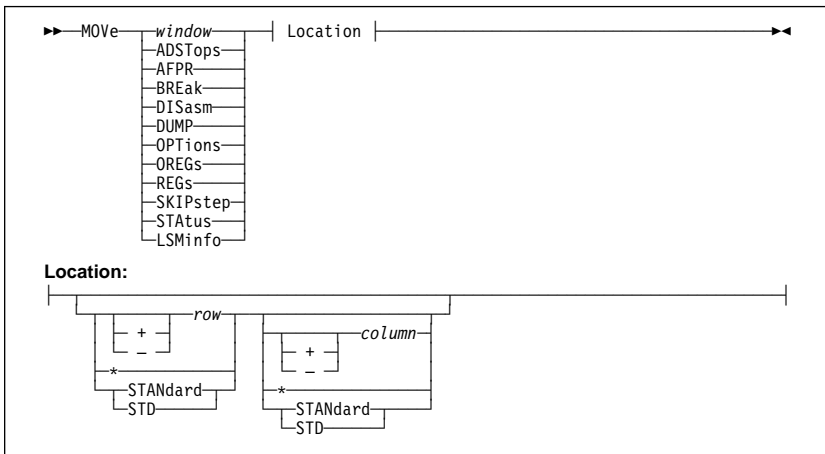

MPACK

Returns unused areas in the extract data storage pool to allow use by other programs.

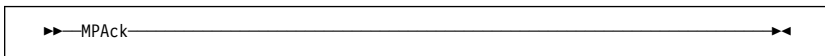

MRUN

Execute program until next event. (Use only within a macro.)

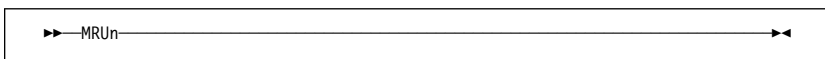

MSG

Sets the next message.

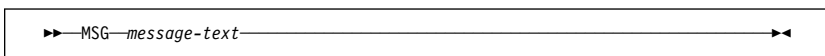

MSGID (CMS and MVS)

Toggles the display of the message identifier.

▶▶MSGID <input type="checkbox"/> ON <input type="checkbox"/> OFF	▶▶
---------------------------------------------------------------------	----

MSGMODE

Displays status and informational messages when various IDF commands have been issued via PF keys.

▶▶MSGMODE <input type="checkbox"/> ON <input type="checkbox"/> OFF	▶▶
-----------------------------------------------------------------------	----

MSTATUS

▶▶MSTATUS	▶▶
-----------	----

Displays extract data memory status:

- number of compile areas
- extract data storage consumption (total, direct, pooled)
- extract data storage pool utilization, including number of AREAs in the pool which are unused

MSTEP

Executes the next program instruction. (Use only within a macro.)

▶▶MSTEP	▶▶
---------	----

NAMES

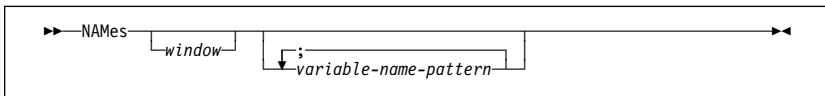

- If name patterns are specified, displays the symbol names associated with those patterns.
- Otherwise, displays all symbol names.
- All eligible symbols are shown:
 - within the current extract file with valid scoping
 - within the External Symbols List for other extract files which are loaded
- special pattern match meta-characters:
 - ? matches a single arbitrary character
 - % matches zero or more arbitrary characters
 - \ A backslash (\) followed by any character matches that character. Most useful when you need to match a real "?", "%", or "\".

NEXT

Scrolls a window forward.

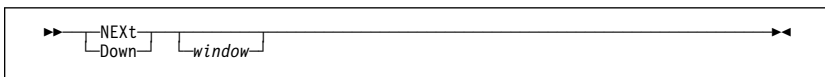

OFFSET

Sets or queries the current offset.

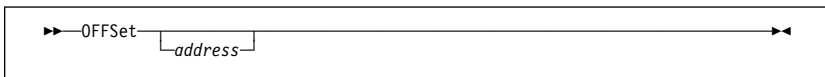

OPEN

Opens a window.

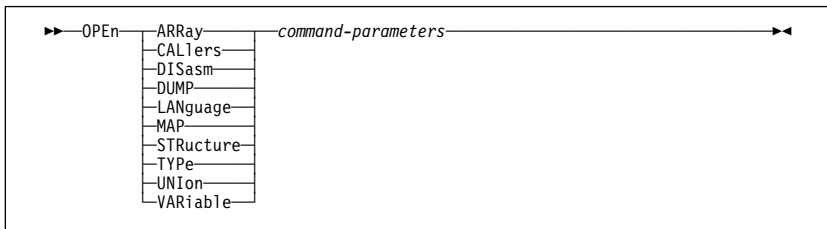

OPTIONS

Toggles the options window.

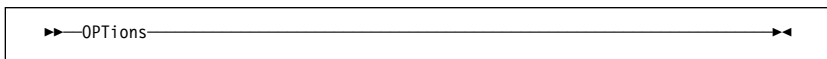

ORDER

Makes a window the first displayed.

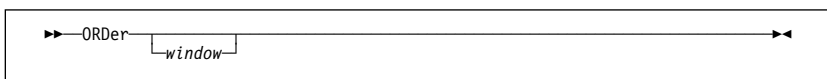

OREGS

Toggles the old registers window.

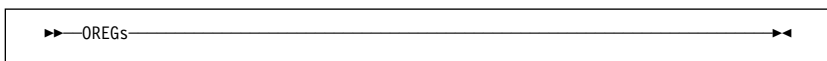

PACKED

Selects the default VAR display format for Packed Decimal variables.

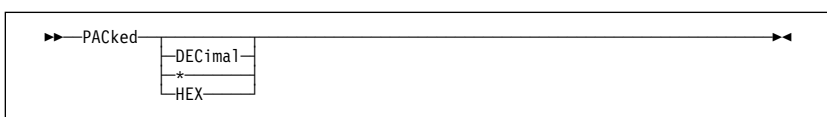

PARMS

Displays the Parameter List for module names.

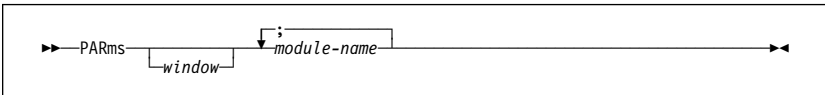

PAUSE

Delays the execution of IDF for a number of seconds.

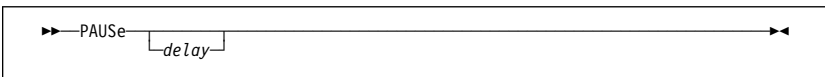

PER (CMS only)

Enables or disables PER.

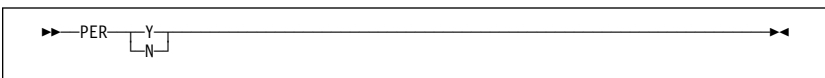

PFK

Assigns a command to a PF key.

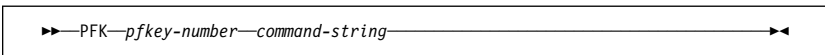

PFKDISP

Toggles the display of the PF keys settings.

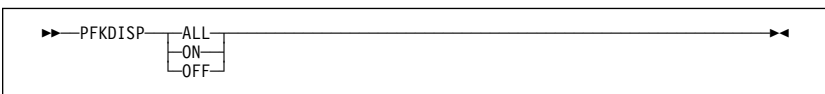

PLOCATES

Displays Pointer Locates information for variables.

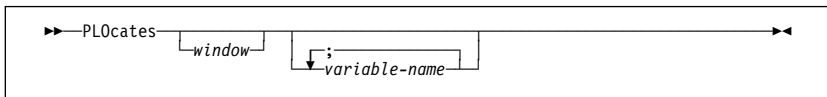

PLOCATES is a command alias which is active *after* ASMLANG has been activated.

PRESERVE

Saves LSM Options and Settings in a 32 element stack.

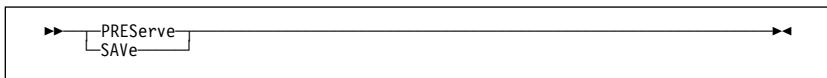

PREVIOUS

Scrolls a window backward.

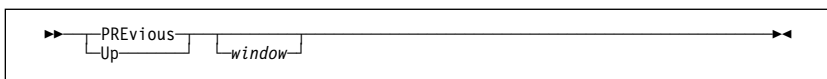

PROGCK (CMS only)

Simulates program check "nn".

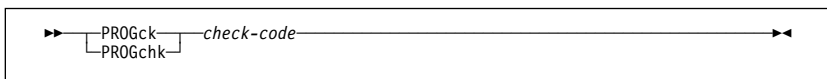

PSW

A synonym of the GOTO command.

PSWSTEAL (CMS only)

Declares a PSW "stealing" location.

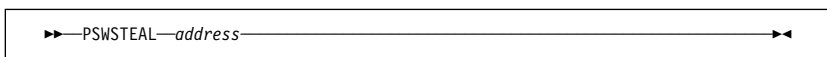

QUALIFY

Sets the currently qualified module.

```
►—QUALify—default-module-name—◄◄
```

QUIET

Disables or enables display of informational messages.

```
►—QUIET—

|     |
|-----|
| ON  |
| OFF |

—◄◄
```

QUIETLY

Temporarily suppresses the display of I, W and E messages during execution of a command.

```
►—QUIETLY—command-name—command-parameters—◄◄
```

QUIT

Returns to MVS, TSO, CMS, or VSE.

```
►—

|      |
|------|
| QUIT |
| QUIT |

—◄◄
```

RCQUIT

Returns to MVS, TSO, CMS, or VSE with a return code.

```
►—RCQuit—

|                    |
|--------------------|
| <i>return-code</i> |
|--------------------|

—◄◄
```

REFRESH

Refreshes windows.

```
►—REFresh—

|        |
|--------|
| DISP   |
| NODISP |

—◄◄
```

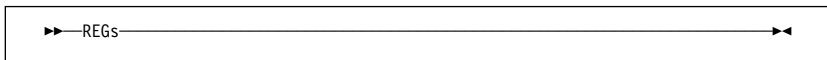

REGS

Toggles the Register display.

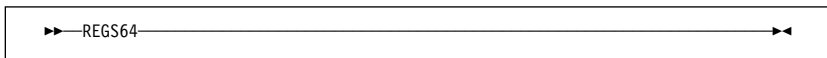

REGS64 (MVS only)

Toggles the Current Registers and Old Registers windows between displaying 31-bit and 64-bit registers.



REGSTOPS (CMS only)

A synonym of the ADSTOPS command.

RESTORE

Restores LSM Options and Settings from a 32 element stack.

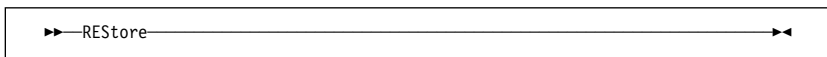

RETRIEVE

Puts the previous command in the command area.

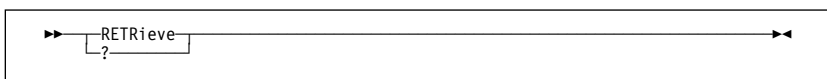

RIGHT

Scrolls a window to the right.

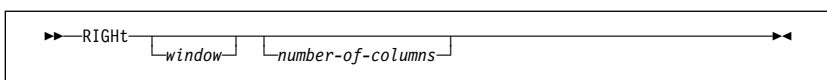

RLOG

Executes commands stored in the command log.

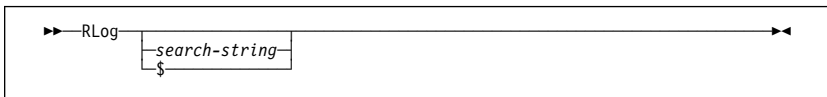

RUN

Runs the program until the next event.

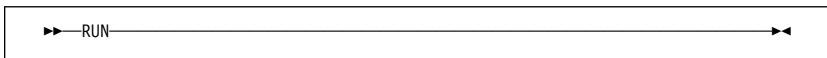

RUNEXIT

Executes the current exit routine (PFKey).



R0-R15

Sets a General Purpose register.

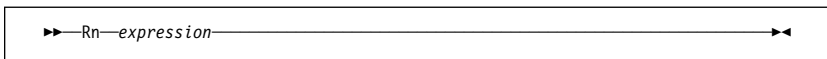

SALIMIT

Sets the maximum Program Caller hierarchy depth for the CALLERS command.

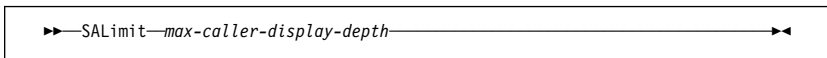

The default value is 100, the range is 1 to 999999.

SAREGS

Enables or disables the display of Save Area header and registers for the CALLERS command.

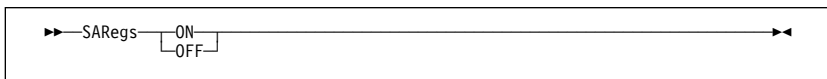

SAVE

A synonym of the PRESERVE command.

SEARCH

Searches for a string in storage.

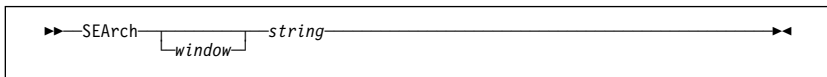

SELFNUCX (CMS only)

Sets the offset in module of nucleus extension.

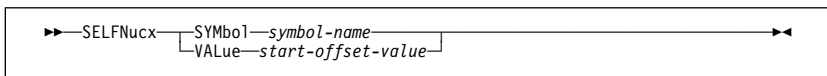

SET ADSTOP (CMS only)

Sets or clears one end of a PER ADSTOP range.

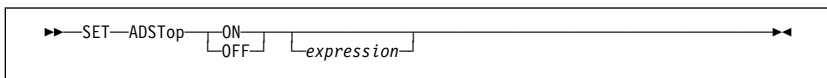

SET AREG

Sets ARn.

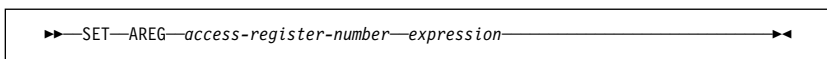

SET BREAK

Sets or clears a breakpoint at an address.

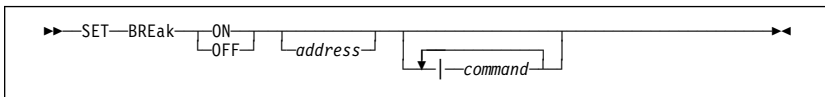

SET COMMAND

Places text on the command line.

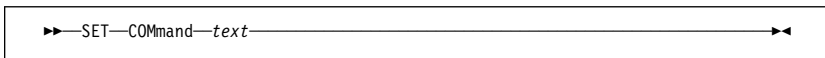

SET EXITEXEC

IDF-exit-exec is the current exit.

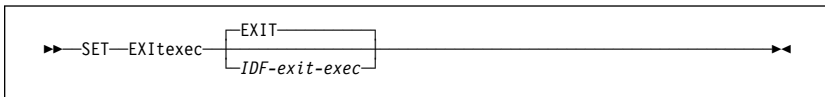

SET GLOBAL STEM

Writes data in a REXX stemmed array.

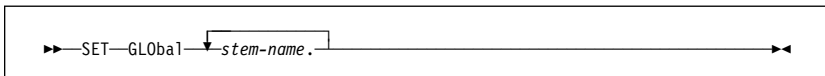

SET GLOBAL TEXT

Sets the IDF global area to text.

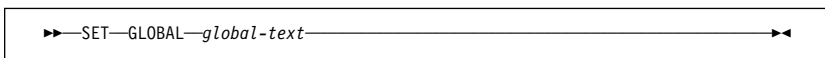

SET ICOUNT

Sets the instructions counted.

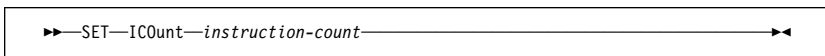

SET OFFSET

Toggles the display of addresses using offsets.

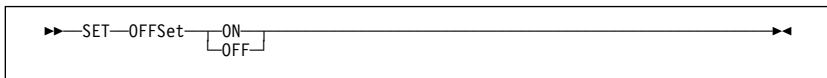

SET OPTION

Enables or disables an IDF option.

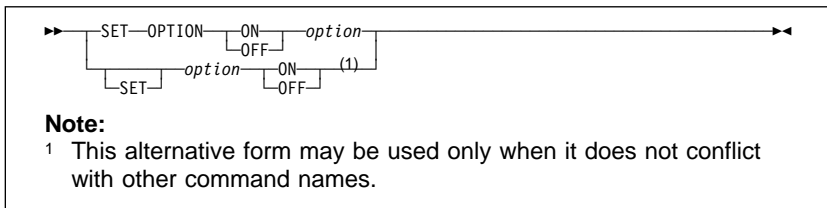

SET PSW

Sets the current PSW to a value.

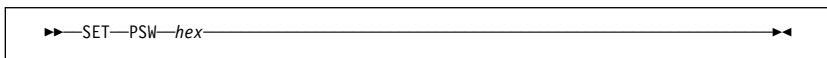

SET REGSTOP (CMS only)

Toggles PER monitoring of General Purpose Register (GPR) contents.

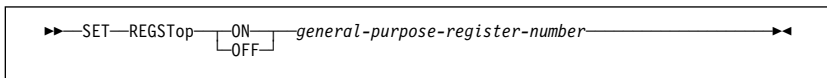

SET SIZE

Sets the size of the program.

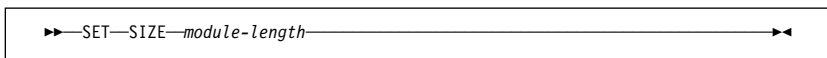

SHOW

Controls source code and disassembly display, by showing information. The HIDE command controls the display by hiding information.

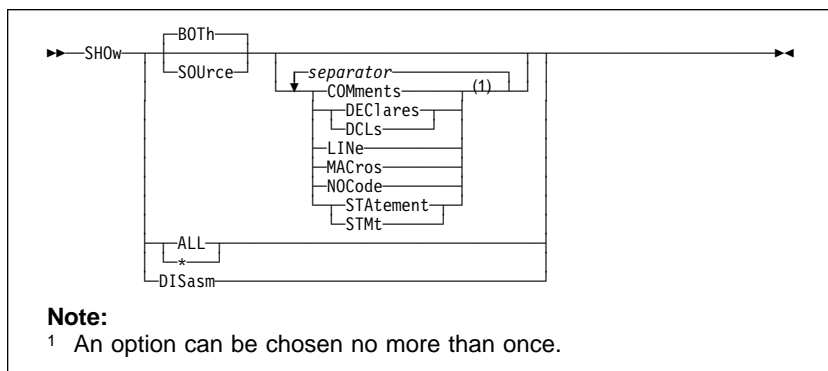

BOTH	Show both source code and disassembly
SOURCE	Show source code only
<i>separator</i>	A comma, blank, or semicolon
COMMENTS	Show block comment source code
DECLARES DCL	Show declaration source code
LINE	Show source line number with source text
MACROS	Show macro expansion source code
NOCODE	Show source lines with no corresponding object code
STATEMENT STMT	Show source statement number with source text
ALL *	Show all source code and disassembly
DISASM	Show disassembly only

Initial settings: BOTH, COMMENTS, DCL, MACROS, NOCODE, STMT

SIZE

Resizes a window.

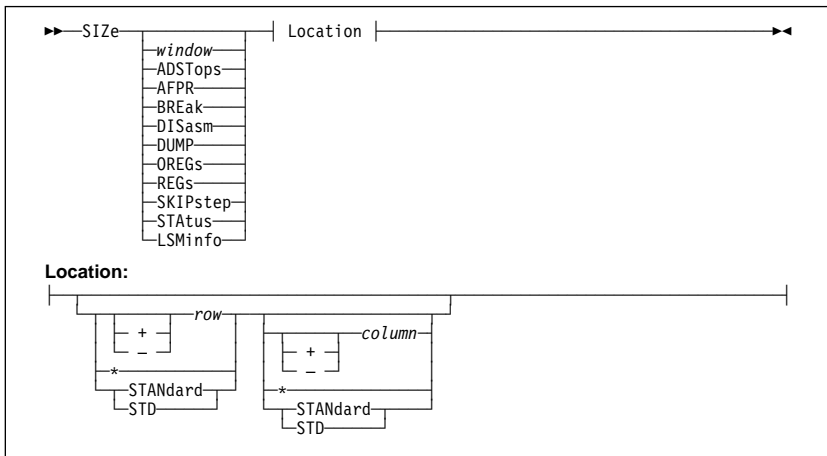

SKIPSTEP

Sets a subroutine to be skipped.

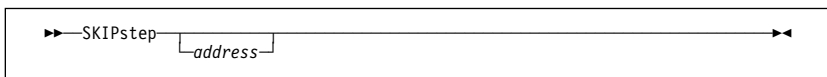

SPACE

Toggles the insertion of a blank line between variables or sets of components.

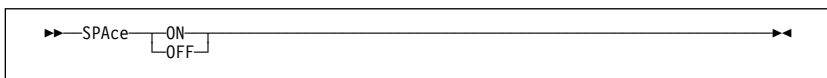

STATUS

Toggles the program status window.



STEP

Steps to the next instruction in the program.

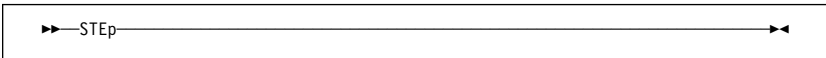

STMTSTEP

Steps to the next statement in the target program.

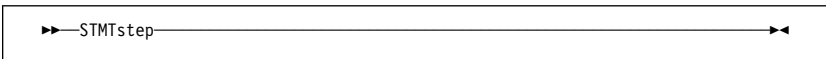

STOKEY

Displays the Storage Key.

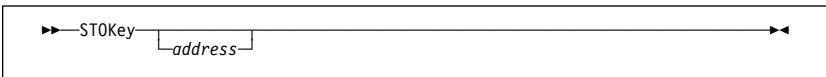

STOREMAP

Displays information about storage allocation.

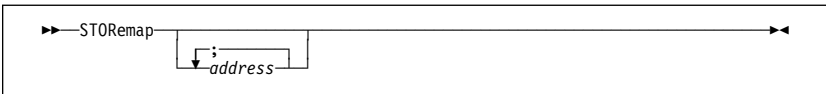

STRUCTURE

Enables variable display in a structure format.

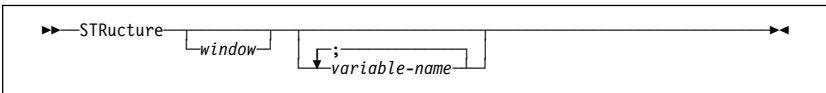

SUBSET (CMS only)

Enters a CMS Subset.

```
▶—SUBset————▶
```

SVC (CMS only)

Monitors SVCs.

```
▶—SVC—

|   |
|---|
| Y |
| N |

————▶
```

SWAP

Displays the application screen.

```
▶—SWAp————▶
```

SYMBOL

Adds a symbol to the symbol table.

```
▶—SYMBOL—(

|                   |
|-------------------|
| code-section-name |
|-------------------|

)—symbol-name————▶  
▶—code-section-offset—module-offset—symbol-length—

|   |
|---|
| I |
| E |

—

|   |
|---|
| F |
| U |

————▶  
▶—symbol-type————▶
```

TASKS (TSO only)

Display information about currently executing tasks

```
▶—TASKs————▶
```

TITLE

Sets the value of the title text.

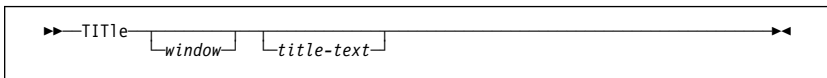

TOP

Displays source code at the lowest address within the current code section.

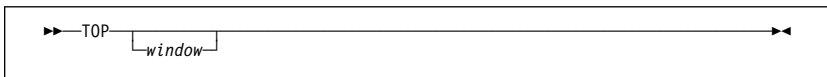

TRIGGER LOAD

Installs deferred breakpoints in a loaded module.

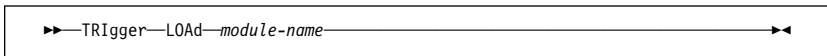

TYPE

Displays type attributes for variables.

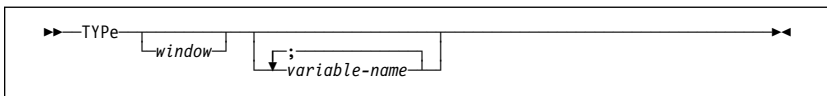

UNION

A synonym of the STRUCTURE command.

UNTIL

Executes a program until an address (not including the address).

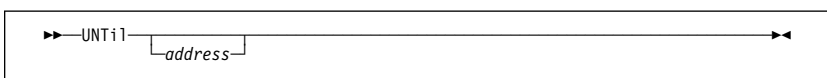

UP

This is a synonym of the PREVIOUS command.

VALUE

Evaluates an expression and displays it.

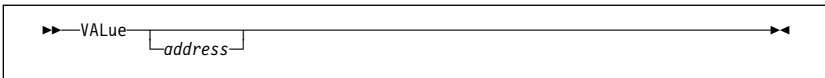

VARIABLE

Enables variable display.

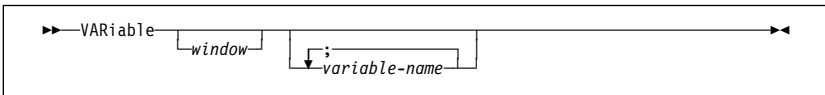

VCHANGE

Logs commands (special purpose).

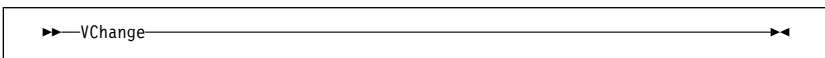

VERSION

Displays the IDF Version.

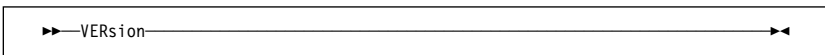

VS

Special command logging.

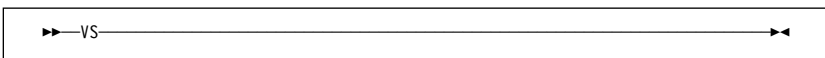

VSEP

Enables or disables the blank line separating multiple variables.

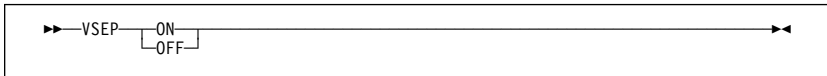

WATCH

Sets a "watchpoint" condition that must be true before a particular breakpoint takes effect.

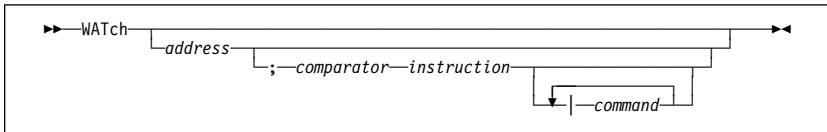

- address* Address of the breakpoint.
- comparator* The condition being checked, for example = or LT.
- instruction* An S/370™ comparison instruction.
- command* A command that is issued when the breakpoint is taken.

WHERE

Displays the symbolic name for an address.

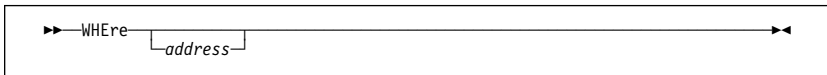

XEDEXIT (CMS only)

Xedit exit macro (EXIT ASM).

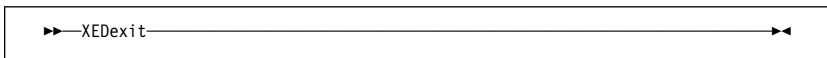

ZONED

Selects the default VAR display format for Zoned Decimal variables.

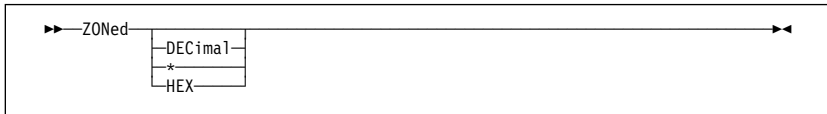

Chapter 3. ASMIDF EXTRACT Command

ADSTOPS (CMS only)

All storage modification stops.

```
▶▶—EXTRACT—ADSTops—————▶▶
```

Sets ADSTOP.n

ALET

The ALET used to qualify the dataspace to be displayed in a Dump window.

```
▶▶—EXTRACT—ALET—number-of-bytes—————▶▶
```

Sets ALET

AREGS

The Access Registers

```
▶▶—EXTRACT—AREGs—————▶▶
```

Sets AR.n, OAR.n

ARGUMENT

An address argument from the command line or cursor position.

```
▶▶—EXTRACT—

|          |
|----------|
| ARGument |
| ARGs     |

—argument—————▶▶
```

Sets SOURCE, FIELD, EXACT, INDIRECT

ARRAY

Returns information about array elements.

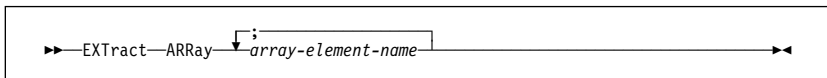

Sets stemname.0, stemname.n

BREAK

One or all breakpoints.

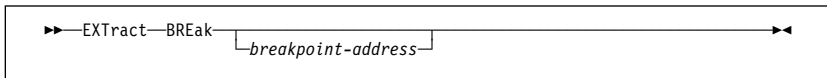

Sets BREAK.n, PBREAK.n

CALLERS

Returns information for each generation in the program caller hierarchy.

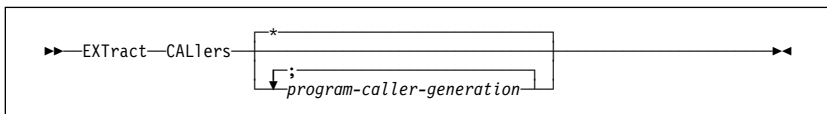

Sets stemname.0, stemname.n

CMDMSG

Contents of the command line and message lines.

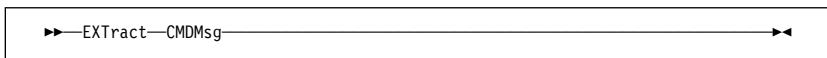

Sets COMMAND, MSG1, MSG2

COLORS

Color settings.

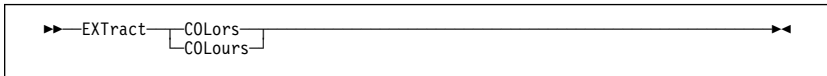

Sets COLORS

CURSOR

Current position of the cursor.

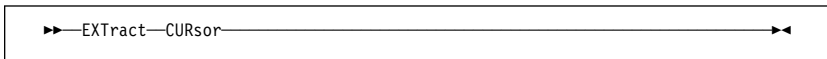

Sets DISPLAY, SOURCE, FIELD, EXACT, INDIRECT, HEXCURSR, CPDISASM, CPDUMP, NPDISASM, NPDUMP

DISASM

Data about an instruction.

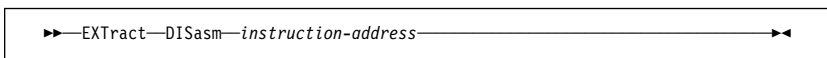

Sets INSTR, NINSTR, CSECT

EVENT

Data about the last event

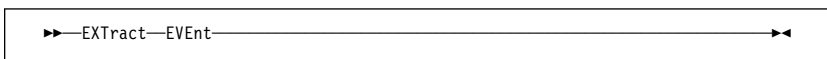

Sets EVENT, COMMAND

EXITEXEC

The name of the currently assigned exit routine.

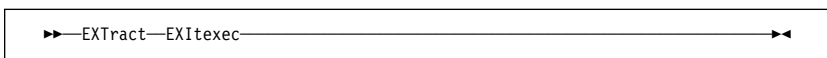

Sets EXITEXEC

GLOBAL

Return the current setting of the ASMIDF global variable.

```
▶▶—EXTRACT—GLObal————▶▶
```

Sets GLOBAL

GLOBAL STEM

Return the data of the Global Storage stems.

```
▶▶—EXTRACT—GLObal—stem-name.————▶▶
```

GLOBAL STEMS

Return the names of all currently defined Global Storage stems.

```
▶▶—EXTRACT—GLObal—STEMs————▶▶
```

Sets GLOBALS.0 , GLOBALS.n

GSTATUS

Returns information about the storage used to contain the Global Storage data.

```
▶▶—EXTRACT—GStAtus————▶▶
```

ICOUNT

Number of instructions executed since the last ICOUNT command.

```
▶▶—EXTRACT—ICount————▶▶
```

Sets ICOUNT

LANGUAGE ARGUMENTS

Returns the current command arguments for each LSM information window

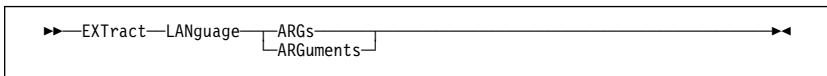

LANGUAGE COMMANDS

Returns the current command for each LSM information window

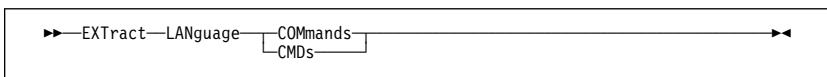

LANGUAGE OPTIONS

Returns information about the current value of the various ASMIDF Language Support settings.

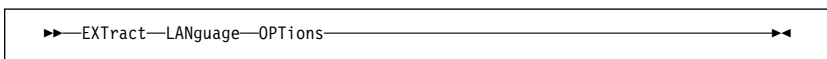

LANGUAGE STATUS

Returns information about the extract files that have been loaded

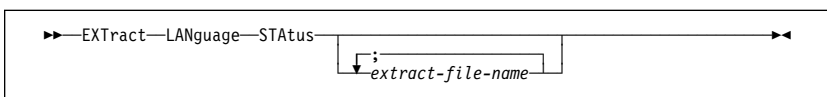

LANGUAGE STEM

Returns the name of the REXX stemmed variable array

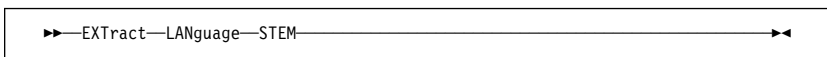

LANGUAGE VERSION

Returns the ASMIDF Language Support version

```
▶▶—EXTRACT—LANGUAge—VERsion————▶▶
```

LASTMSG

Returns the last ten messages issued by SET MSG

```
▶▶—EXTRACT—LASTMsg————▶▶
```

Returns LASTMSG.n and LASTMSGM.n

LOAD

Obtain information about the target program

```
▶▶—EXTRACT—LOAD————▶▶
```

Sets NAME, AREA, SYMBOL, ORIGIN, EPOFFSET, OFFSET, SIZE, LSM, LOADLIB

LOCATION

Extracts bytes of main memory

```
▶▶—EXTRACT—LOCATIOn—number-of-bytes—start-address————▶▶
```

Sets MEMAREA

LOCATION ALET

Storage from a dataspace

```
▶▶—EXTRACT—ALEt—number-of-bytes————▶▶
```

Sets MEMAREA

MAP

Returns information about the location of all modules and code sections known to ASMIDF.

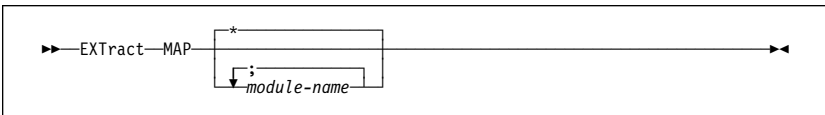

MODE (CMS only)

Current file mode

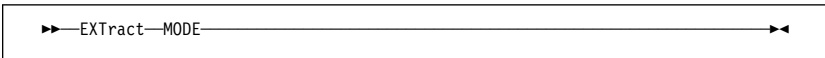

Sets MODE

MODULES

Information about defined modules

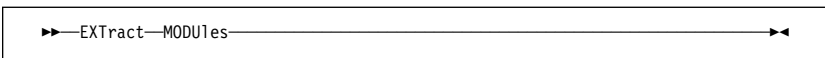

Sets MODULES.n

MSTATUS

Returns information about the storage used to contain extract data information



NAMES

Returns information about symbol names.

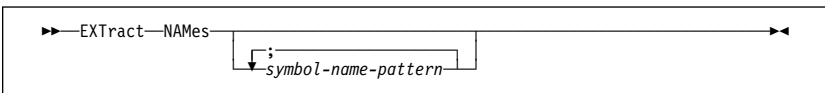

OPTIONS

A list of all ASMIDF options and their current settings.

```
▶▶—EXTRACT—OPTions————▶▶
```

Sets OPTION

PER (CMS only)

Value of the PER setting.

```
▶▶—EXTRACT—PER————▶▶
```

Sets PER

PFK

Current PFK definitions.

```
▶▶—EXTRACT—PFK————▶▶
```

Sets PFK.n

PLIST

Arguments at the time of ASMIDF invocation.

```
▶▶—EXTRACT—PLIST————▶▶
```

Sets PLIST

PLOCATES

Returns information about the variables that may be located with Locator (pointer) variables.

```
▶▶—EXTRACT—PLOCates—↓; locator-variable-name————▶▶
```

QUALIFY

Name of the currently qualified module

▶—EXTRACT—QUALIFY—▶▶

Sets QUALIFY

QUERY SETTING

Returns the current value of an indicator or option item

▶—EXTRACT—QUERY—*argument*—▶▶

Sets QUERY.n

REGS

The GPRs, FPRs, and PSW

▶—EXTRACT—REGS—▶▶

Sets GPR.n, OGPR.n, FPR.n, OFPR.n, PSW, OPSW, FPC

REGSTOPS (CMS only)

List of registers that are being monitoring.

▶—EXTRACT—REGSTOPS—▶▶

Sets GPR.0 - GPR.15

SCOPE

Returns information about the statement scope block that corresponds to a memory address.

▶—EXTRACT—SCOPE—*address*—▶▶

SCRVAR

Returns the contents of an LSM information window

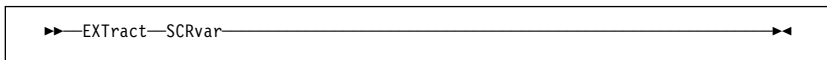

SELFNUCX

Current value of the self-load offset

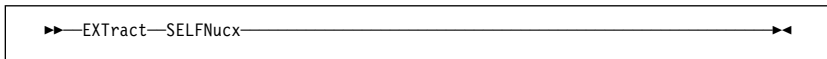

Sets SELFNUCX

SKIPSTEP

One or all currently skipped subroutines.

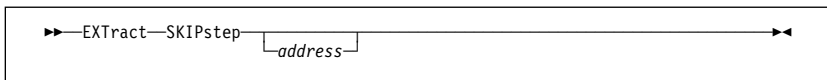

Sets SKIP.n

SOURCE

Returns the source records that correspond to a memory address

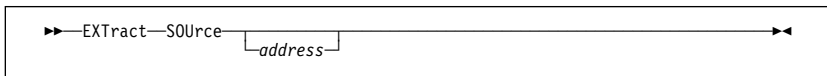

STOREMAP

Return Storage Allocation Map information.

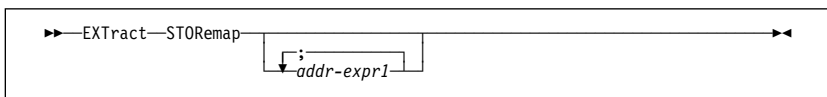

STRUCTURE

Returns information about structure and union components

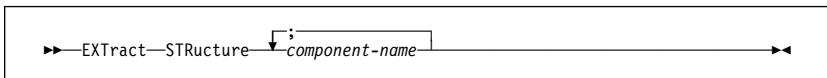

SVC (CMS only)

Current SVC tracing state.

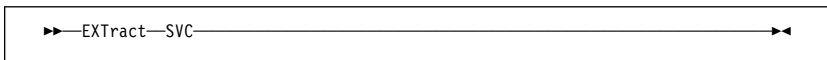

Sets SVC

SYMBOLS

Information about symbols known to ASMIDF

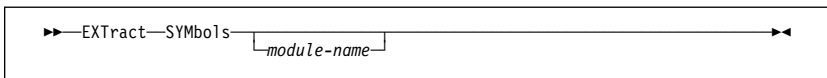

Sets SYMBOL.n

TASKS

Returns information about the currently executing tasks

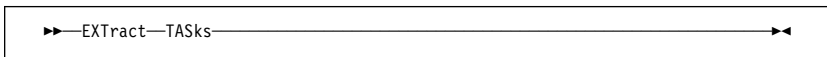

TYPE

Returns information about the type attributes for variables.



VALUE

Value of an expression.

```
▶▶EXTRACT—VALue—address————▶▶
```

Sets EXPR

VARIABLE

Returns information about variables

```
▶▶EXTRACT—VARIABLE—↓;variable-name————▶▶
```

VDECLARE

Returns attribute information about variables

```
▶▶EXTRACT—VDECLare—↓;variable-name————▶▶  
      VDC1
```

VERSION

ASMIDF Version message

```
▶▶EXTRACT—LANGuage—VERsion————▶▶
```

Sets VERSION

VLOC

Returns location information about variables

```
▶▶EXTRACT—VLOC—↓;variable-name————▶▶
```

VVALUE

Returns data value information about variables

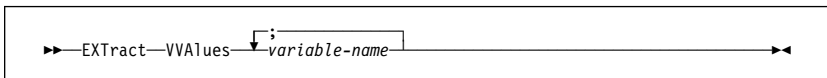

WINDOWS

Information about the screen and open windows

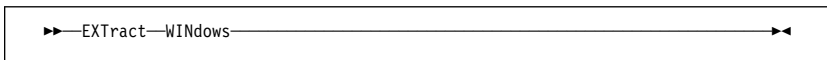

Sets WINDOW.n

Chapter 4. ASMIDF Options

Options may be turned on by:

```
<option> ON  
SET <option> ON  
SET OPT ON <option>
```

Options may be turned off by:

```
<option> OFF  
SET <option> OFF  
SET OPT OFF <option>
```

1ADSTop (CMS)	When PER is enabled, treats the four address ranges as a single address range.
AMODE24	Forces the target program to run in AMODE-24.
AMODE31	Forces the target program to run in AMODE-31.
AMODE64 (MVS)	Forces the target program to run in AMODE-64.
ASCII	Displays a dump in ASCII.
AUTOLoad	ASMIDF should/should not automatically try to load LSM extract files when Statement stepping.
AUTOSize	ASMIDF should/should not resize window.
BCX	Displays branches in extended mnemonics.
CKSubcm	Insures ASMIDF's Subcom is valid before running macros.
CMDLog	Logs user entered commands.
CMPExit	Indicates Exit is written in compiled code.
COLors mhti	msg/head/text/input Blue/Green/Pink/Red/Turquoise/Yellow/White
COMmand	PLIST for target is actually a command to invoke.
DMS0 (CMS)	Loads symbols that start with "DMS0".
EXItexec execname	Specifies the name of the EXIT EXEC that should be used to determine breakpoint applicability.
FASTPath	Uses fast version of PATH.
FULLQual	Symbolic addresses should always be fully qualified.
HEXDisp	Displays offset in hexadecimal.

HEXInput	Numbers without explicit base are hexadecimal.
IMPMacro	Permits implicit macros from command line.
INVPsw	Accepts invalid PSWs on a SET PSW command.
ISA address (CMS)	Defines the address of a 16-byte double-aligned interrupt save area.
LIBE fn/\$ (CMS and MVS)	Loads from specified DDname.
LINE X'nnn' (CMS)	Uses a terminal other than the virtual console.
LSMDebug	Displays LSM debugging information.
LUname lu_unit (VSE and MVS)	Defines the VTAM® logical unit name of the terminal used by IDF.
MACROLog	Logs commands entered from macros.
MODE xx (CMS)	The CMDLOG and PATHDATA files are read from, or written to, the minidisk at the specified filemode.
MODMap (CMS)	Uses fn MAP before LOAD MAP for symbol information.
NOAUTOLd	Do not automatically try to load LSM extract files when Statement stepping.
NOAUTOSz	Do not automatically resize windows.
NOBcx	Do not display branches in extended mnemonics.
NODSects	Do not load symbols in DSECTs.
NOIMPMac	Disallows the implied execution of macros from the command line.
NOINVPsw	Does not accept invalid PSWs on a SET PSW command.
NOMODMap (CMS)	Prefers the "LOAD MAP" file to the "modname MAP" file.
NOProfil	Do not run a profile macro.
NOSTOPnp	Do not put internal breakpoints at a NOP(R) after a BAL(R).
NOSTOPSt	Do not stop statement stepping when not in a statement.

NOSVC97 (MVS)	Do not use SVC 97 for events.
NUCext (CMS)	Runs the program as a CMS nucleus extension.
OFFSet	Displays address in offset format.
OLDBREAK	Uses the old operation of the Break command.
PASspgm	Passes program interrupts to the target.
PATH	Displays the number of times each instruction has executed.
PATHFile	Writes the number of times each instruction has executed to a file.
PROfile name	Runs REXX procedure 'name' as the profile.
QWDump	Forces unformatted Dump display to begin on a fullword.
RISk	Ignores as many "errors" as possible.
RLog	Replays all previously logged user commands.
ROWstyle	Uses row style for display of registers.
SBORder	Uses simple border characters.
SCDactiv	Collapses ASMIDF Subcom before running target.
SELFNucx <i>symbol</i> (CMS)	The code is self-nucxloading.
STOPNOP	Places internal breakpoints at a NOP(R) after a BAL(R).
STOPStmt	Stops statement stepping when not in a statement.
SVC97 (TSO)	Uses SVC 97 for events.
SWAp	Enables the capture of a target program's screen image.
SYStem (CMS)	Runs the program in system key (key=0).
TRACeall	All instructions are traced in single stepped mode.
TRANs (CMS)	Runs the program as a transient.
UNFtdump	Displays Dump in unformatted mode.

Chapter 5. ASMIDF Language Support

Some examples in this section use the < > characters as follows:

- < **item** > Item (such as parameter or word) is optional
-> Represents the based-pointer notation

Introduction

ASMLANG is a Language Support Module (LSM) subsystem which acts as an extension to ASMIDF and provides source-level debugging capabilities for assembler programs. ASMLANG uses extract files which contain the language source and variable information. The extract files are created by the ASMLANGX utility using the SYSADATA files provided by the IBM High Level Assembler (HLASM).

A Word about Variables

Information for all variables in the user's program is extracted into a common format by ASMLANGX.

ASMLANG displays variables using terminology similar to PL/I. Where necessary, extensions have been made - for example, FLOAT, PACKED DECIMAL and ZONED DECIMAL are terms used by ASMLANGX.

Invocation

ASMLANG is integrated with the base debugger module, ASMIDF, and the LSM support is activated during ASMIDF initialization.

To *explicitly* load ASMLANG extract files from the ASMIDF command line or via a macro, you can issue the following command:

```
LOAd LANguage efn eft efm (options
```

To *implicitly* load ASMLANG extract files you can use an LSM command such as STMTSTEP.

Parameters:

- | | |
|------------|-------------------|
| EFN | Extract file name |
|------------|-------------------|
- On MVS, the PDS member name of the extract file created by ASMLANGX.
 - On CMS, the file name of the extract file created by ASMLANGX.

- On VSE, the file name of the extract file created by ASMLANGX.

EFT

Extract file type

- On MVS, the DD name allocated to the extract file created by ASMLANGX.
- On CMS, the file type of the extract file created by ASMLANGX.
- On VSE, not used.
- Specifying this option eliminates the search using the XPATH file types (DD names).
- The default XPATH is "ASMLANGX".

EFM

Optional

- On CMS, the FM of the extract file created by ASMLANGX.
- On MVS, not used, ignored if specified.
- On VSE, not used, ignored if specified.

Options

MODULE modname Module with which to associate the extract file.

If this option is *not* specified:

- If extract file contains information which requires load-time resolution it defaults to the qualified target module.
- Otherwise, the extract file is "generic" where it is freely associated with any relevant CSECTs in all MODULEs.

Displaying Source

Use the ASMIDF DISASM command:

```
DISASM (module.csect)stmt#nnn
DISASM 0(PSW)
```

Displaying Variables

Use the VAR command:

```
VAR var
```

Multiple variables may be displayed:

```
VAR var1<;var2<;var3;...;varn>>
```

Locating expressions may be used:

```
VAR ptr1->ptr2->based_var
```

```
VAR array_var(1,3,4)
```

```
VAR struct_var.member[1,3]
```

```
VAR triglyphs.too??(1,3??)
```

Substring specification may be used:

```
VAR chrstr(1);chrstr(2:3);chrstr(1::4)
```

```
VAR cstring[0::4]
```

ADDR() function can be used:

```
VAR Addr(buff(1))->based_var
```

Displaying Structures

Use the STRUCT command:

```
STR strname
```

```
STR strname.substructure
```

The expression syntax is the same as for the VAR command.

Displaying Array Elements

Use the ARRAY command:

```
Arr arrayvar1(2);array2[3,55]
```

The expression syntax is the same as for the VAR command.

When the display is scrolled, the array indexing is also scrolled.

Altering Variables

1. Display variables using any of the previous commands.
2. Type over the current variable contents
3. Press the Enter key

Displaying Type Attributes

Use the TYPE command:

```
TYPE var
```

Type attribute information includes:

- Fundamental data type
- User defined data type
- Type hierarchy

Type attributes for multiple variables may be displayed:

```
TYPE var1<;var2<;var3;...;varn>>
```

LANGUAGE Command Aliases

With ASMIDF a facility called "Command Alias" is available which allows ASMLANG to add additional commands *without* the LANGUAGE prefix.

Command Alias is an ASMIDF facility that enables:

Alias	Equivalent ASMLANG command
/	LANGUAGE LOCATE /
-/	LANGUAGE LOCATE -/
BOTtom	LANGUAGE BOTTOM
CALlers	LANGUAGE CALLERS
F	LANGUAGE FIND
FIRst	LANGUAGE FIRST
GOTo	PSW
HIDe	LANGUAGE HIDE
LASt	LANGUAGE LAST
LLocate	LANGUAGE LOCATE
Locate	LANGUAGE LOCATE
MAP	LANGUAGE MAP
MPAck	LANGUAGE MPACK
MStatus	LANGUAGE MSTATUS
NAMes	LANGUAGE NAMES
PARms	LANGUAGE PARMS
PLOcates	LANGUAGE PLOCATES
SHOw	LANGUAGE SHOW
TOP	LANGUAGE TOP
TYPe	LANGUAGE TYPE
UNIon	STRuct

Hints and Tips

1. Maximum LSM window display lines

When displaying multiple variables use the LANGUAGE VSEP OFF command. This increases the number of screen lines available to display the variable information.

2. MVS Dataset Conventions

On MVS, ASMIDF and ASMLANGX commands do not change. The CMS conventions are used, with the following mapping of the CMS file conventions to MVS:

CMS MVS Equivalent

fn PDS member name (ignored if using sequential file)

ft DDNAME, which in turn points to the MVS dataset name

fm not used on MVS

You must allocate the DDs using ALLOC (CLIST or EXEC) or DD (JCL).

3. VSE Dataset Conventions

On VSE, ASMIDF and ASMLANGX are invoked from JCL, with the following mapping of the CMS file conventions to VSE:

CMS VSE Equivalent

fn VSE librarian member name.

ft DLBL name, which in turn points to the VSE file name.

fm not used on VSE

Chapter 6. Using ASMLANGX

Invocation

ASMLANGX CMS and TSO syntax

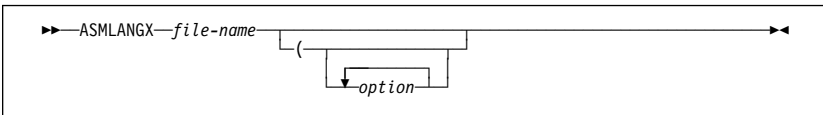

ASMLANGX MVS EXEC syntax

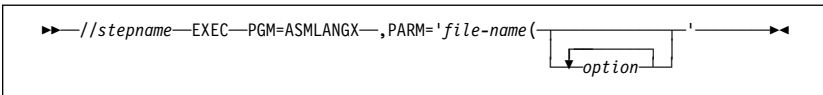

ASMLANGX VSE EXEC syntax

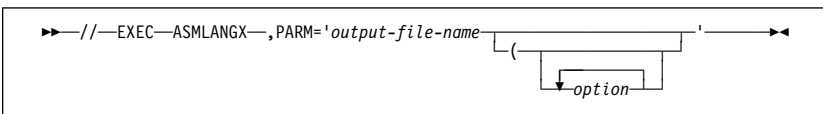

Parameters:

- input_file_name** Input file name
- On TSO, the PDS member name of the SYSADATA input file.
 - On CMS, the file name (FN) of the SYSADATA input file.
 - On MVS in batch, this defaults to the SYSADATA file created by the High Level Assembler.
 - On VSE, this defaults to the SYSADATA file created by the High Level Assembler.
 - Dummy token required *only* if the extract file name is to be modified.
- output_file_name** Output file name.
- On TSO, or CMS, this is optional and defaults to the same name as the input file with a file type

(CMS) of ASMLANGX, or the PDS name of the ASMLANGX DD (TSO) name.

- On MVS, this must be specified with PARM='output_file_name' .
- On VSE, this must be specified with PARM='output_file_name' .

Options

General Options:

ASM	Extract is for Assembler.
CONDASM	Include conditional assembly statements.
DCL	Suppress source for declarations. This is the default option.
DEBUG	Log standard and internal diagnostic messages. To be used as directed by IBM service personnel.
ERROR	List invalid or incomplete extract records.
IFM filemode	input file mode <ul style="list-style-type: none">• On CMS, the file mode to search for the input files. Standard search order used if not found.• On MVS, not used.• On VSE, not used.
INCL	Extract source from INCLUDE files. This is the default option.
LOUD	Issue progress or error messages.
MACDEF	Include inline macro definitions.
NOCONDASM	Exclude conditional assembly statements.
NOINCL	Suppress source from INCLUDE files. Variable information is still extracted.
NOMACDEF	Exclude inline macro definitions.
NOPACK	Disables packing of source statement text
NODCL	Suppress source for declarations (including associated block comments). Variable information is still extracted.
NOSEQ	Suppress source record sequence numbers.
OFM filemode	Output file mode <ul style="list-style-type: none">• On CMS, the file mode of the output file, default "A1."• On MVS, not used.• On VSE, not used.
OFN filename	Output file name <ul style="list-style-type: none">• On CMS, the file name of the output file.• On MVS, the PDS member name of the output file.

	<ul style="list-style-type: none"> • On VSE, the librarian member name of the output member.
OFT filetype	Output file type <ul style="list-style-type: none"> • On CMS, the file type of the output file. • On MVS, the DD name of the output file. • On VSE, not used.
PACK	Compress redundant characters in source statement text
PFM filemode	Primary input file mode <ul style="list-style-type: none"> • On CMS, the initial file mode to search for the primary input file. Standard search order used if not found. Overrides IFM • On MVS, not used. • On VSE, not used.
PFT filetype	Primary input file type <ul style="list-style-type: none"> • On CMS, the file type (FT) of the input file. • On MVS, the DD name of the input file. • On VSE, the DLBL name of the input file.
QUIET	Suppress display of progress and error messages.
SEQ	Retain source record sequence numbers.

Default Options:

- ASM
- PFT SYSADATA
- OFT ASMLANGX
- PACK
- NOSEQ
- DCL
- INCL

Examples

Here is a sample CMS ASMLANGX invocation.

- using "*fn* SYSADATA"
ASMLANGX *fn* (ASM LOUD ERROR

Notices

Notices

This information was developed for products and services offered in the U.S.A.

IBM may not offer the products, services, or features discussed in this document in other countries. Consult your local IBM representative for information on the products and services currently available in your area. Any reference to an IBM product, program, or service is not intended to state or imply that only that IBM product, program, or service may be used. Any functionally equivalent product, program, or service that does not infringe any IBM intellectual property right may be used instead. However, it is the user's responsibility to evaluate and verify the operation of any non-IBM product, program, or service.

IBM may have patents or pending patent applications covering subject matter described in this document. The furnishing of this document does not give you any license to these patents. You can send license inquiries, in writing, to:

IBM Director of Licensing
IBM Corporation
North Castle Drive
Armonk, NY 10504-1785
U.S.A.

Licensees of this program who wish to have information about it for the purpose of enabling: (i) the exchange of information between independently created programs and

other programs (including this one) and (ii) the mutual use of the information which has been exchanged, should contact:

IBM Corporation
Mail Station P300
2455 South Road
Poughkeepsie New York
12601-5400
U.S.A.

Such information may be available, subject to appropriate terms and conditions, including in some cases, payment of a fee.

The licensed program described in this document and all licensed material available for it are provided by IBM under terms of the IBM Customer Agreement, IBM International Program License Agreement or any equivalent agreement between us.

For license inquiries regarding double-byte (DBCS) information, contact the IBM Intellectual Property Department in your country or send inquiries, in writing, to:

IBM World Trade Asia
Corporation
Licensing
2-31 Roppongi 3-chome,
Minato-ku
Tokyo 106-0032, Japan

The following paragraph does not apply to the United Kingdom or any other country where such provisions are inconsistent with local law:
INTERNATIONAL BUSINESS

Notices

MACHINES CORPORATION PROVIDES THIS PUBLICATION "AS IS" WITHOUT WARRANTY OF ANY KIND, EITHER EXPRESS OR IMPLIED, INCLUDING, BUT NOT LIMITED TO, THE IMPLIED WARRANTIES OF NON-INFRINGEMENT, MERCHANTABILITY OR FITNESS FOR A PARTICULAR PURPOSE.

Some states do not allow disclaimer of express or implied warranties in certain transactions, therefore, this statement may not apply to you.

This information could include technical inaccuracies or typographical errors. Changes are periodically made to the information herein; these changes will be

incorporated in new editions of the publication. IBM may make improvements and/or changes in the product(s) and/or the program(s) described in this publication at any time without notice.

Any references in this information to non-IBM Web sites are provided for convenience only and do not in any manner serve as an endorsement of those Web sites. The materials at those Web sites are not part of the materials for this IBM product and use of those Web sites is at your own risk.

If you are viewing this information softcopy, the photographs and color illustrations may not appear.

Trademarks

The following are trademarks of International Business Machines Corporation in the United States, or other countries, or both:

IBM	VSE/ESA
MVS/ESA	VTAM
OS/390	z/Architecture
S/370	z/OS
VM/ESA	

We'd Like to Hear from You

High Level Assembler
for MVS & VM & VSE
Toolkit Feature
Interactive Debug Facility
Reference Summary
Release 5

Publication No. GC26-8712-04

Please use one of the following ways to send us your comments about this book:

- Mail—Use the Readers' Comments form on the next page. If you are sending the form from a country other than the United States, give it to your local IBM branch office or IBM representative for mailing.
- Electronic mail—Use this Internet ID:
 - Internet: comments@us.ibm.com

Be sure to include the following with your comments:

- Title and publication number of this book
- Your name, address, and telephone number if you would like a reply

Your comments should pertain only to the information in this book and the way the information is presented. To request additional publications, or to comment on other IBM information or the function of IBM products, please give your comments to your IBM representative or to your IBM authorized remarketer.

IBM may use or distribute your comments without obligation.

Readers' Comments

**High Level Assembler
for MVS & VM & VSE
Toolkit Feature
Interactive Debug Facility
Reference Summary
Release 5**

Publication No. GC26-8712-04

How satisfied are you with the information in this book?

	Very Satisfied	Satisfied	Neutral	Dissatisfied	Very Dissatisfied
Technically accurate	<input type="checkbox"/>	<input type="checkbox"/>	<input type="checkbox"/>	<input type="checkbox"/>	<input type="checkbox"/>
Complete	<input type="checkbox"/>	<input type="checkbox"/>	<input type="checkbox"/>	<input type="checkbox"/>	<input type="checkbox"/>
Easy to find	<input type="checkbox"/>	<input type="checkbox"/>	<input type="checkbox"/>	<input type="checkbox"/>	<input type="checkbox"/>
Easy to understand	<input type="checkbox"/>	<input type="checkbox"/>	<input type="checkbox"/>	<input type="checkbox"/>	<input type="checkbox"/>
Well organized	<input type="checkbox"/>	<input type="checkbox"/>	<input type="checkbox"/>	<input type="checkbox"/>	<input type="checkbox"/>
Applicable to your tasks	<input type="checkbox"/>	<input type="checkbox"/>	<input type="checkbox"/>	<input type="checkbox"/>	<input type="checkbox"/>
Grammatically correct and consistent	<input type="checkbox"/>	<input type="checkbox"/>	<input type="checkbox"/>	<input type="checkbox"/>	<input type="checkbox"/>
Graphically well designed	<input type="checkbox"/>	<input type="checkbox"/>	<input type="checkbox"/>	<input type="checkbox"/>	<input type="checkbox"/>
Overall satisfaction	<input type="checkbox"/>	<input type="checkbox"/>	<input type="checkbox"/>	<input type="checkbox"/>	<input type="checkbox"/>

Please tell us how we can improve this book:

May we contact you to discuss your comments? Yes No

Name

Address

Company or Organization

Phone No.



NO POSTAGE
NECESSARY
IF MAILED IN THE
UNITED STATES

BUSINESS REPLY MAIL

FIRST-CLASS MAIL PERMIT NO. 40 ARMONK, NEW YORK

POSTAGE WILL BE PAID BY ADDRESSEE

IBM Corporation
J87/D325
555 Bailey Avenue
SAN JOSE, CA 95141-9989

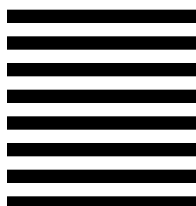

Fold and Tape

Please do not staple

Fold and Tape

Readers' Comments
GC26-8712-04





Program Number: 5696-234



Printed in the United States of America
on recycled paper containing 10%
recovered post-consumer fiber.

High Level Assembler Publications

SC26-4941 *HLASM Programmer's Guide.*
GC26-4943 *HLASM General Information.*
GC26-4944 *HLASM Licensed Program Specifications.*
SC26-4940 *HLASM Language Reference.*
SC26-3494 *HLASM Installation and Customization Guide.*

High Level Assembler Toolkit Feature Publications

GC26-8709 *HLASM Toolkit Feature Interactive Debug Facility User's Guide.*
GC26-8710 *HLASM Toolkit Feature User's Guide.*
GC26-8711 *HLASM Toolkit Feature Installation and Customization Guide.*
GC26-8712 *HLASM Toolkit Feature Debug Reference Summary.*

GC26-8712-04



Spine information:



HLASM

IDF Reference Summary

Release 5