

Kristian Harder, DESY/Hamburg University

Overall Track Reconstruction at TESLA



Basic ideas



From ideas to a real detector (simulation)



Simulation status



Track reconstruction



Performance



Missing parts



Conclusions and acknowledgments

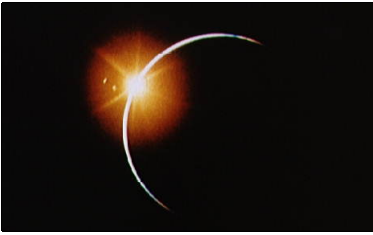

Design goals for TESLA tracking detectors:

- **momentum resolution**

$$\sigma_p/p^2 = 6 \times 10^{-5} (\text{GeV}/c)^{-1}$$

- e.g. Z peak smeared by less than 10% of intrinsic Z width

- **impact parameter resolution**

$$5\mu\text{m} \oplus \frac{10\mu\text{m GeV}/c}{p \sin(3/2\Theta)}$$

- b/c separation performance

- **large angular coverage**

- (down to about 7 deg from the beam pipe)

- missing energy signatures, bhabha spectrum

- **redundancy**

- high reconstruction efficiency

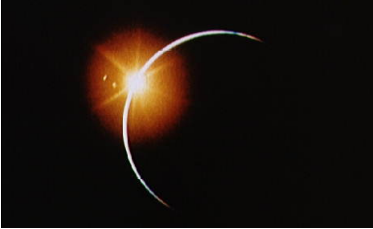

Introduction: basic ideas

Require much better detectors than at LEP:
Momentum resolution must be improved by one order of magnitude!

Important concept for TESLA tracking detector:

(Mostly) all subdetectors have to provide full 3d track information

- redundancy
- better control over systematics (internal alignment)



From ideas to a real detector (simulation)

Silicon Intermediate Tracker (SIT)

momentum resolution

Vertex Detector (VTX)

vertex reconstruction,
impact parameter
resolution

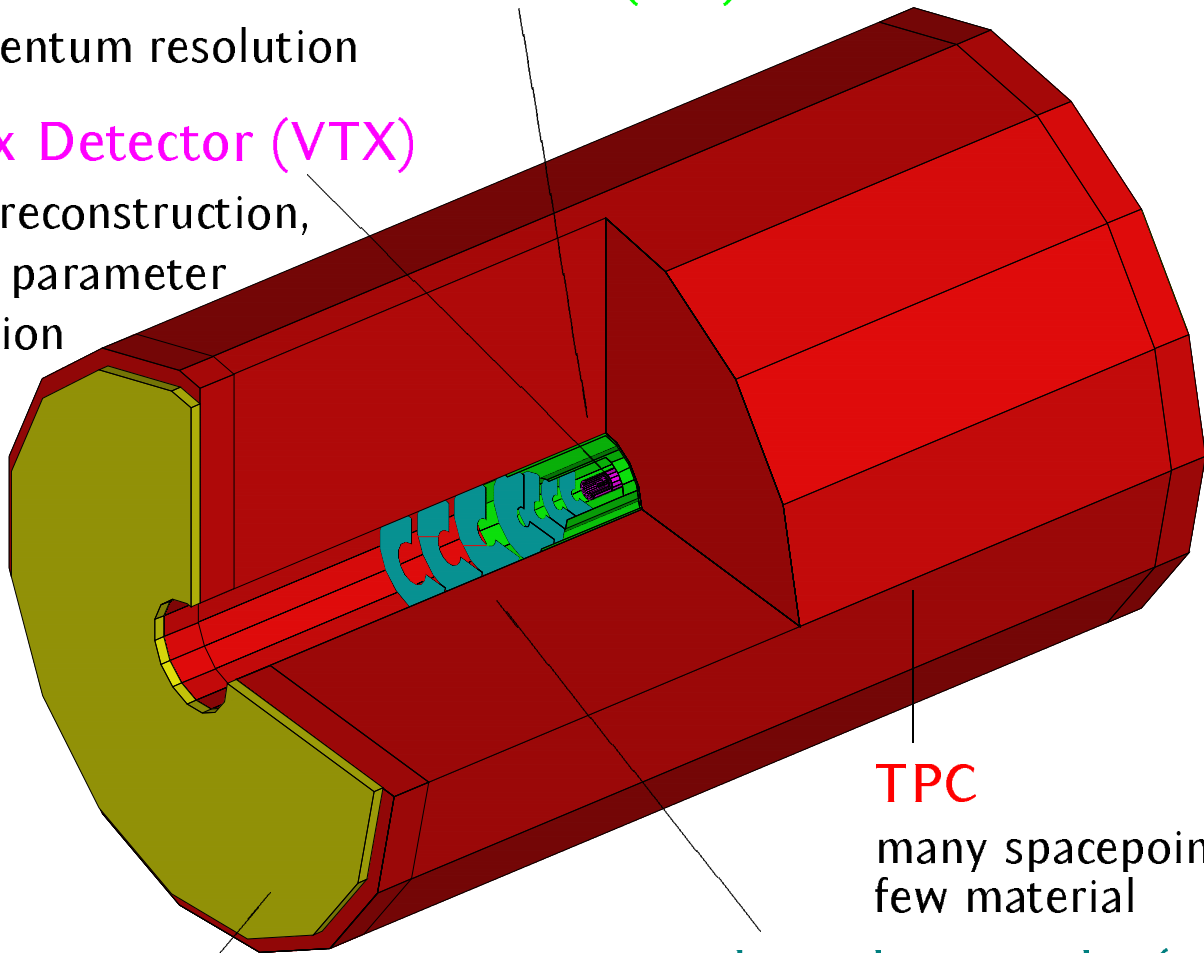

TPC

many spacepoints
few material

Forward Tracking Disks (FTD)

extend good precision into forward
region (bhabha spectrum!)

Forward Chambers (FCH)

improve TPC in forward direction



From ideas to a real detector (simulation)

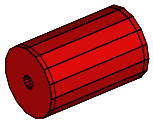
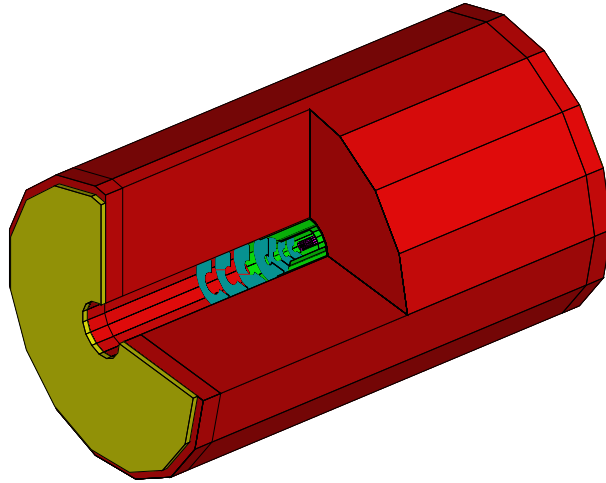

TPC

- Radial coverage of active region 38..160 cm
- Length of active region 500 cm
- 118 pad rows
- Single hit resolution $160\mu\text{m}$ ($r\phi$), 1mm (z)
- Double track resolution 3.3mm ($r\phi$), 1.4cm (z)

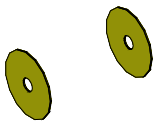

FCH

- 12 straw tube layers (3 orientations) on each side
- resolution perpendicular to straw direction: $120\mu\text{m}$



From ideas to a real detector (simulation)

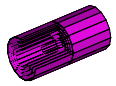
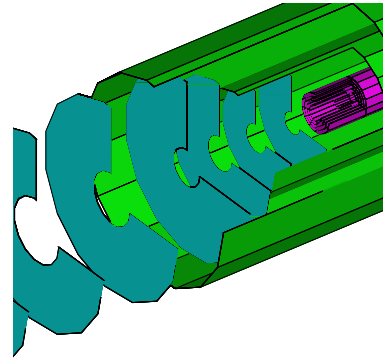
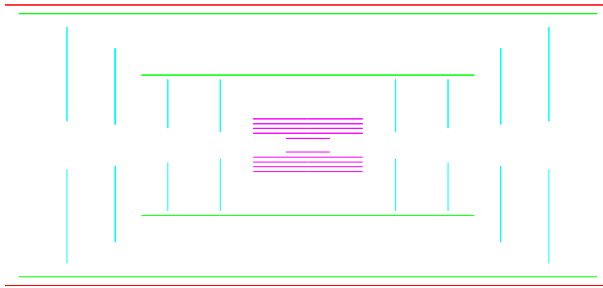

VTX

	APS	CCD
layers	3 + 1 conical endcap	5
radial coverage	1.55, 3.75, 10cm	1.55..6cm
point resolution	7 μ m	3.5 μ m

(third option: CMOS sensors)

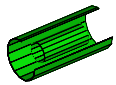

SIT

- 2 barrels at radii 16,30cm
- inner barrel length 76cm, outer barrel length 132cm
- double sided strip detectors, resolution 10 μ m



FTD

- 6 (APS), 7 (CCD) disks per side, $z < 130$ cm
- 2..3 pixel layers: resolution 15 μ m ($r\phi$), 60 μ m (r)
- 4 double sided strip layers: resolution 25 μ m



Status of the simulation

The GEANT3 simulation of a TESLA detector (BRAHMS) contains a full description of all proposed tracking subdetectors.

It includes:

- Full material description, including support and cables
- Event display
- Fully realistic track reconstruction software

Not yet correct:

- FCH simulated with two pixel instead of 12 strip layers
- SIT and outer FTD disks simulated as pixel instead of double sided strip detectors



Track reconstruction

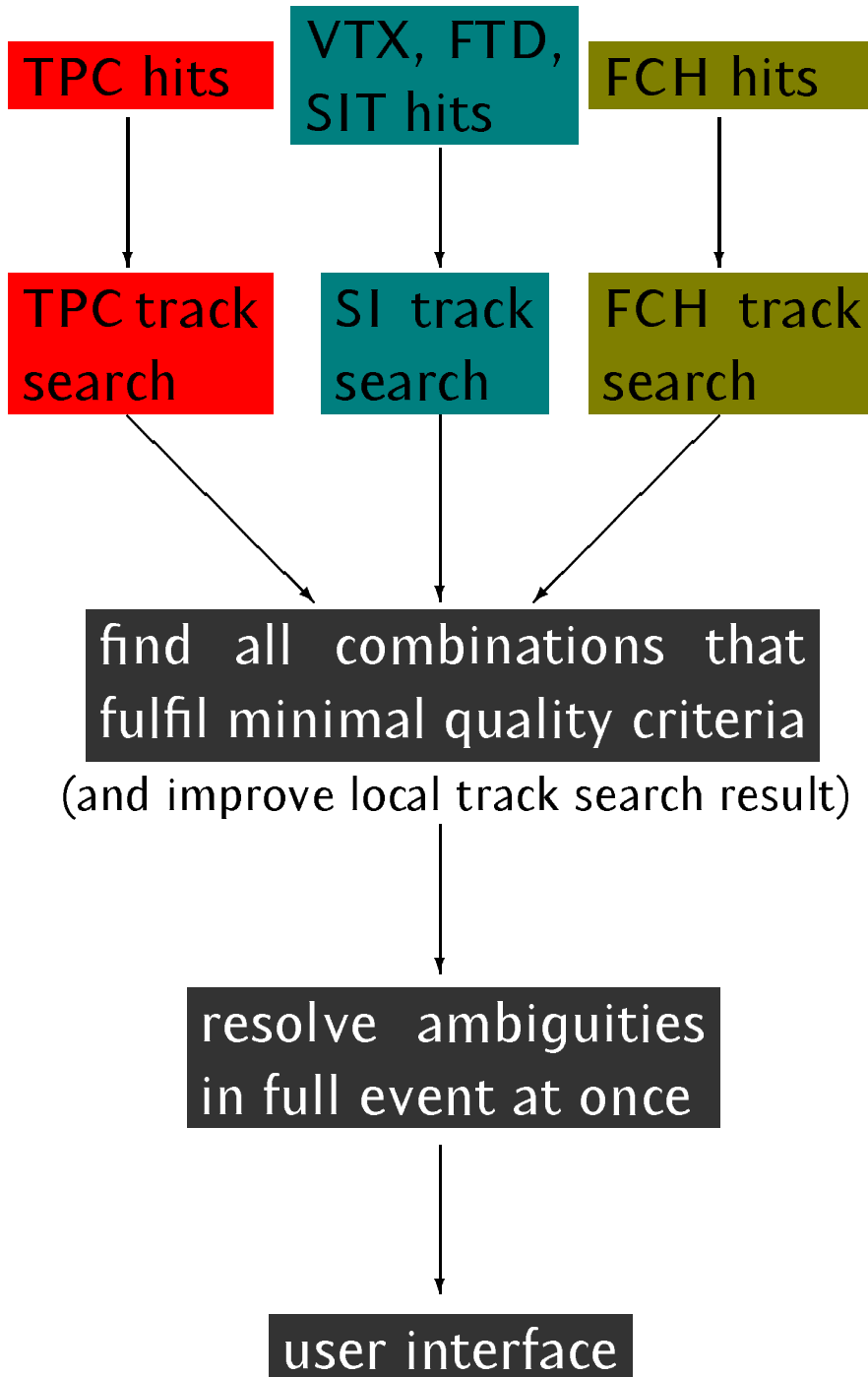

1. local track search with Kalman filters based on software from ALEPH, OPAL
2. connect pieces to ambiguous track candidates using DELPHI software
3. optimise assignment of hits to tracks on global event basis (DELPHI ambiguity resolver)



Tracking Performance

Reference sample for performance measurement:

$e^+e^- \rightarrow Z^0 \rightarrow d\bar{d}$ events at 500 GeV without ISR;
3T magnetic field (4T foreseen in TDR)
→ see example event:

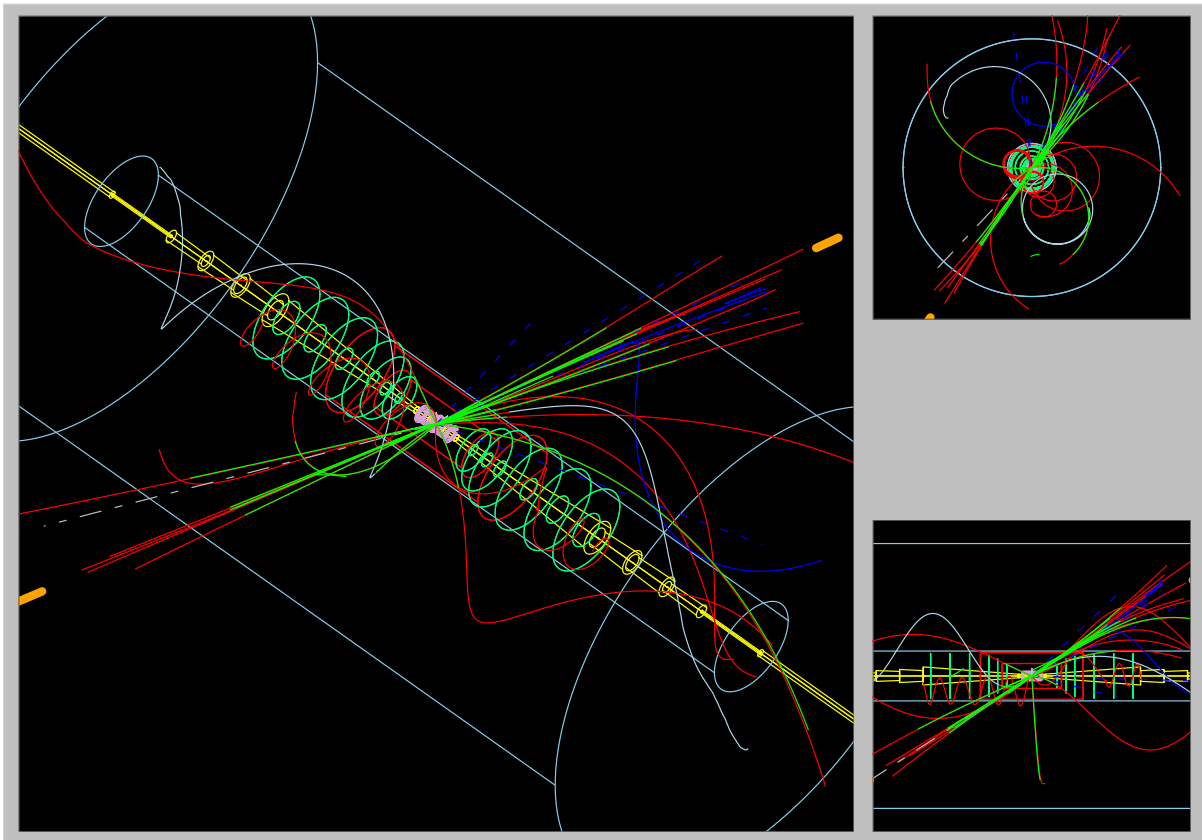

second sample (even worse):

$e^+e^- \rightarrow Z^0 \rightarrow \tau^+\tau^-$ events at 800 GeV without ISR;
only τ decays to three charged particles;
3T magnetic field

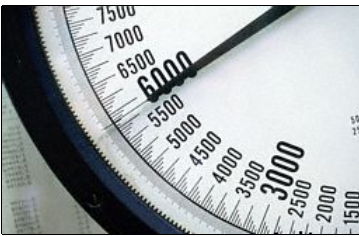

Tracking Performance

local track search
performance (SI)

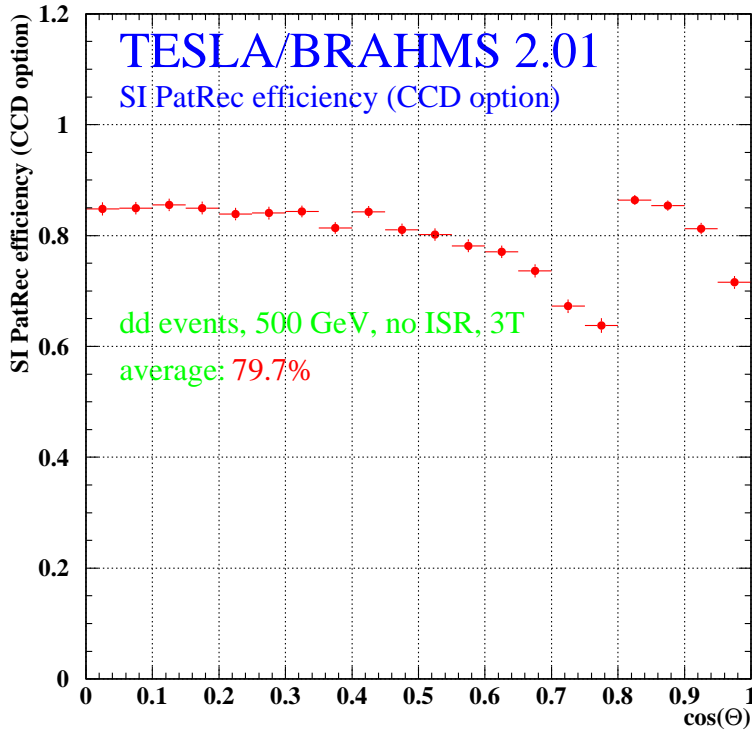

efficiency
over $\cos \Theta$

CCD option 79.7% ($\tau\tau$: 78.4%)

APS option 81.3% ($\tau\tau$: 76.3%)

previous version: $\approx 95\%$

→ room for improvement!

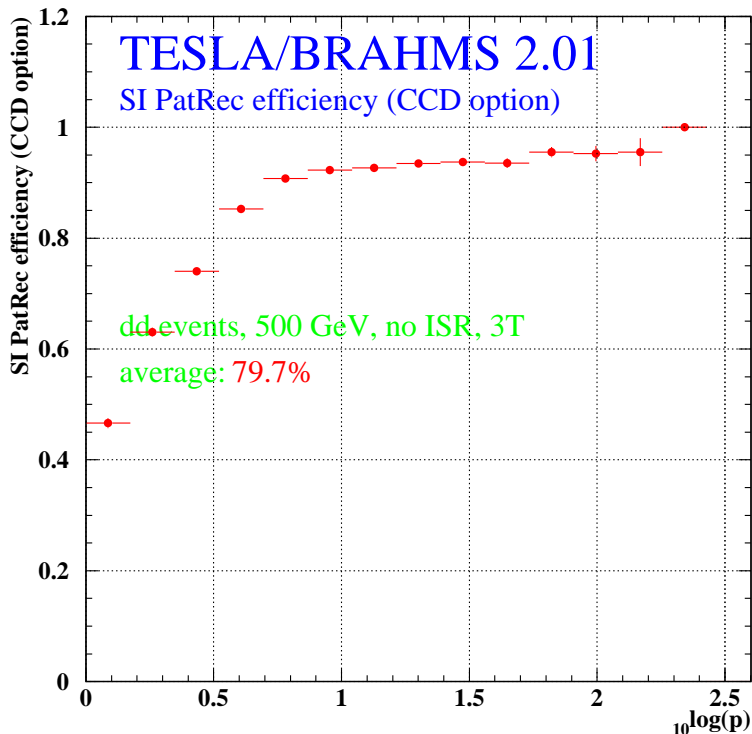

efficiency
over $10 \log p$



Tracking Performance

local track search
performance (TPC)

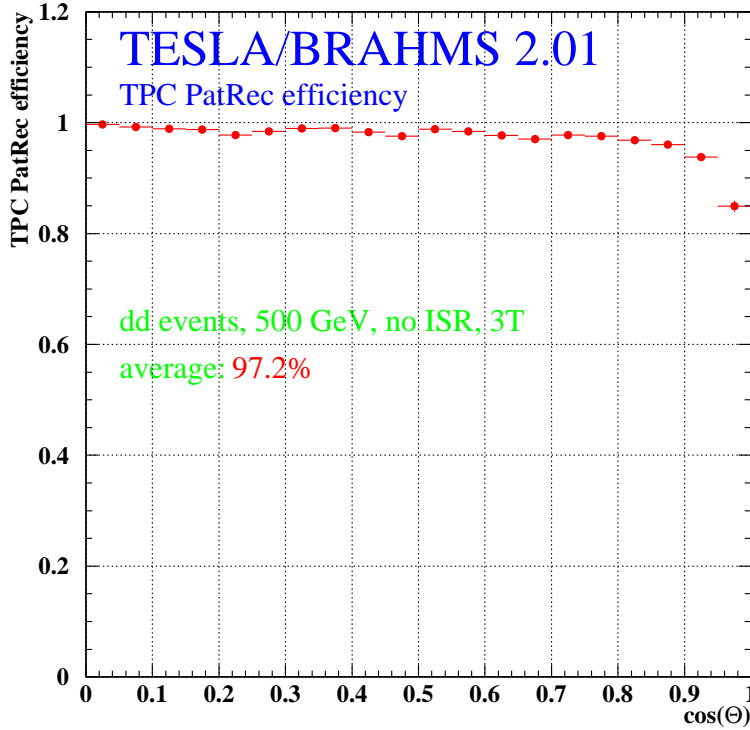

efficiency
over $\cos \Theta$

efficiency 97.2% ($\tau\tau$: 96.9%)

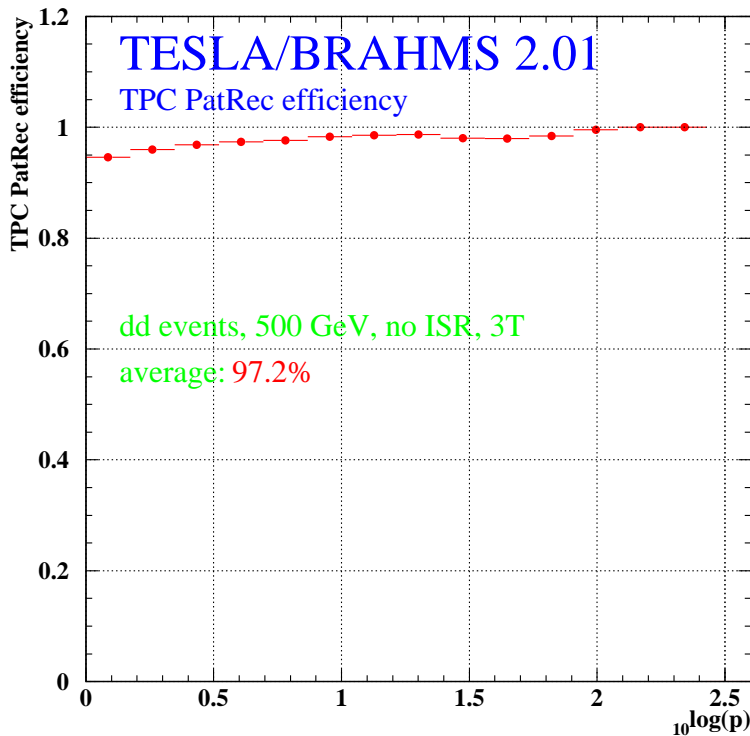

efficiency
over $10 \log p$



Tracking Performance

global
track search
efficiency

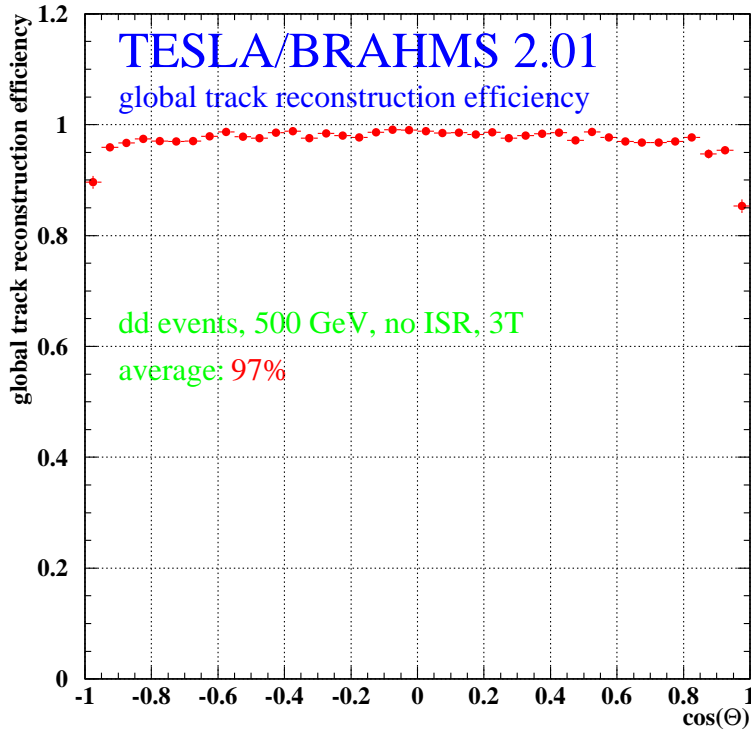

CCD option: 97.0% ($\tau\tau$: 97.5%)
APS option: 97.9% ($\tau\tau$: 98.5%)

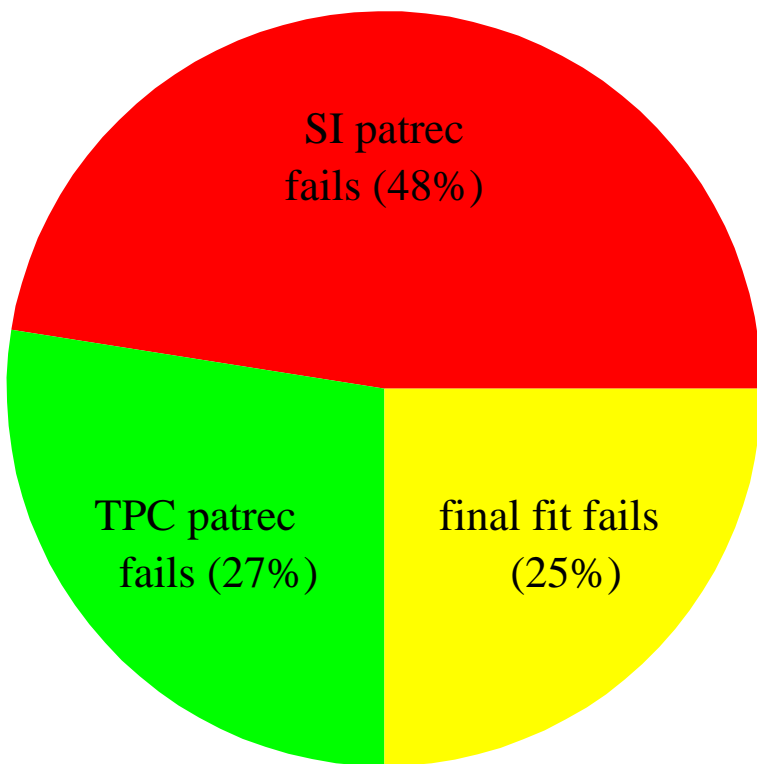

contributions
to inefficiency

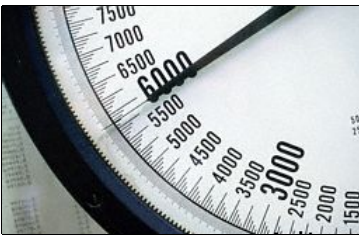

Tracking Performance

global
fake track
fraction

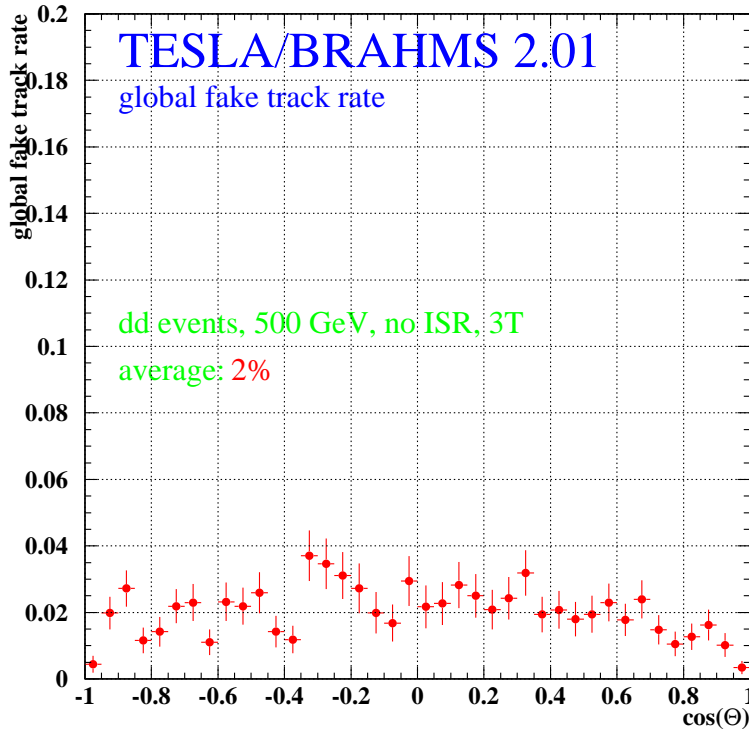

CCD option: 2.0% ($\tau\tau$: 6.9%)
APS option: 1.3% ($\tau\tau$: 4.5%)

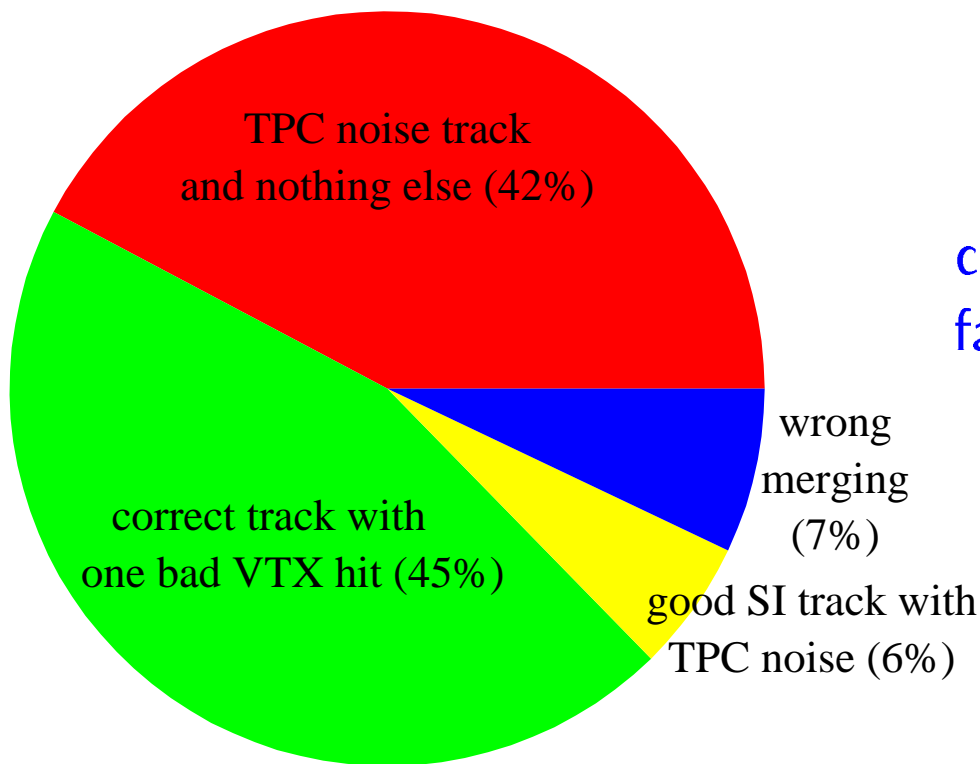



Tracking Performance

Tracks that are reconstructed in more than one piece (currently roughly 10% of all tracks)

($d\bar{d}$ events at 500 GeV, 3T, CCD option)

97.0% extra TPC track segments (kink finder paranoia)

0.8% between TPC and SIT/FTD

0.0% between SIT and VTX

2.3% between FTD and VTX

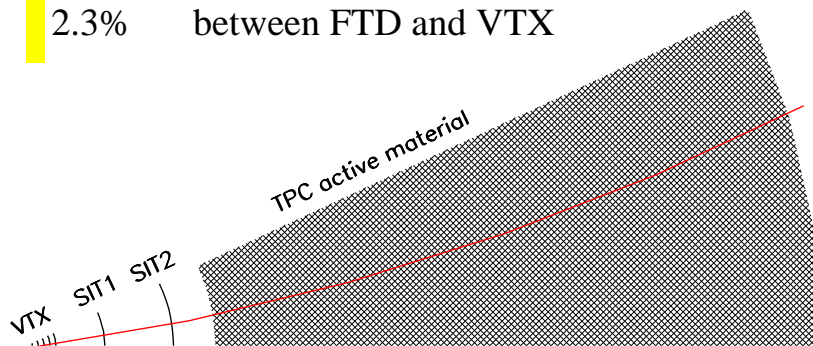



Tracking Performance

Momentum resolution

Design goal for (transverse) momentum resolution:
 $\sigma_p/p^2 = 6 \times 10^{-5}(\text{GeV}/c)^{-1}$

Actual resolution achieved with BRAHMS 2.01:
 $8 \times 10^{-5}(\text{GeV}/c)^{-1}$

Polar angle dependence:

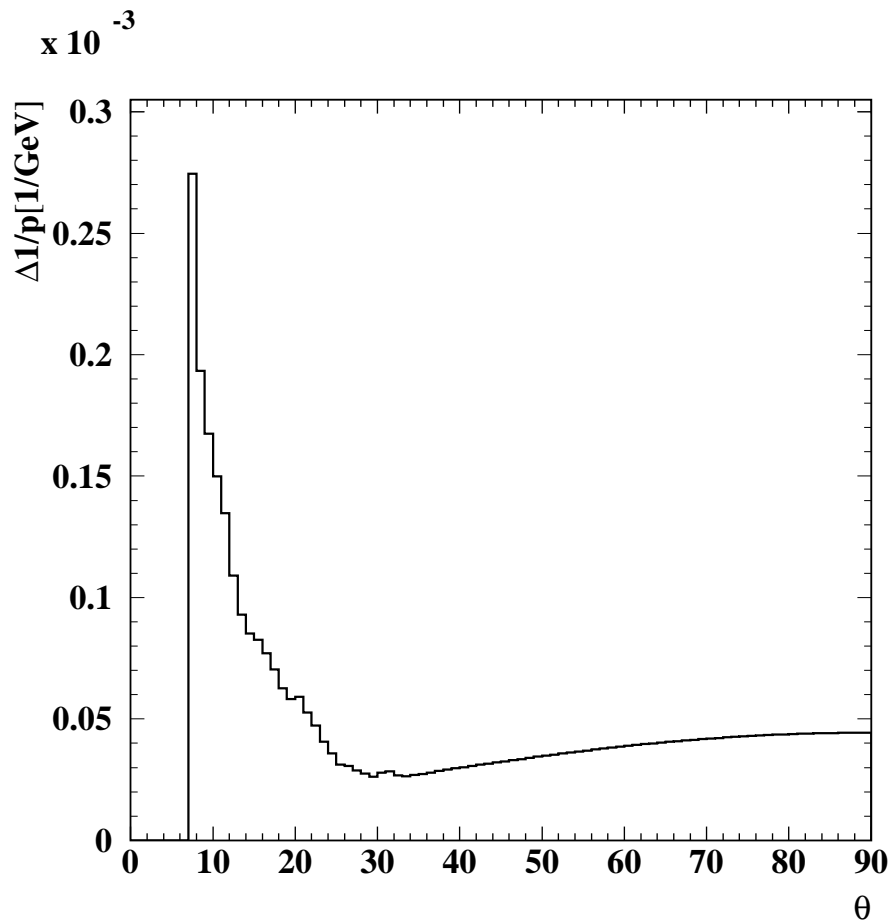

(K. Mönig)



Tracking Performance

Flavour tag performance

Desired impact parameter resolution: $5\mu\text{m} \oplus \frac{10\mu\text{m GeV}/c}{p \sin(3/2\Theta)}$

Actual resolution achieved with BRAHMS 2.01:
 $2.8\mu\text{m}$ (CCD option), $4.9\mu\text{m}$ (APS option)

Charm tag performance
(BRAHMS 1.02, to be updated soon):

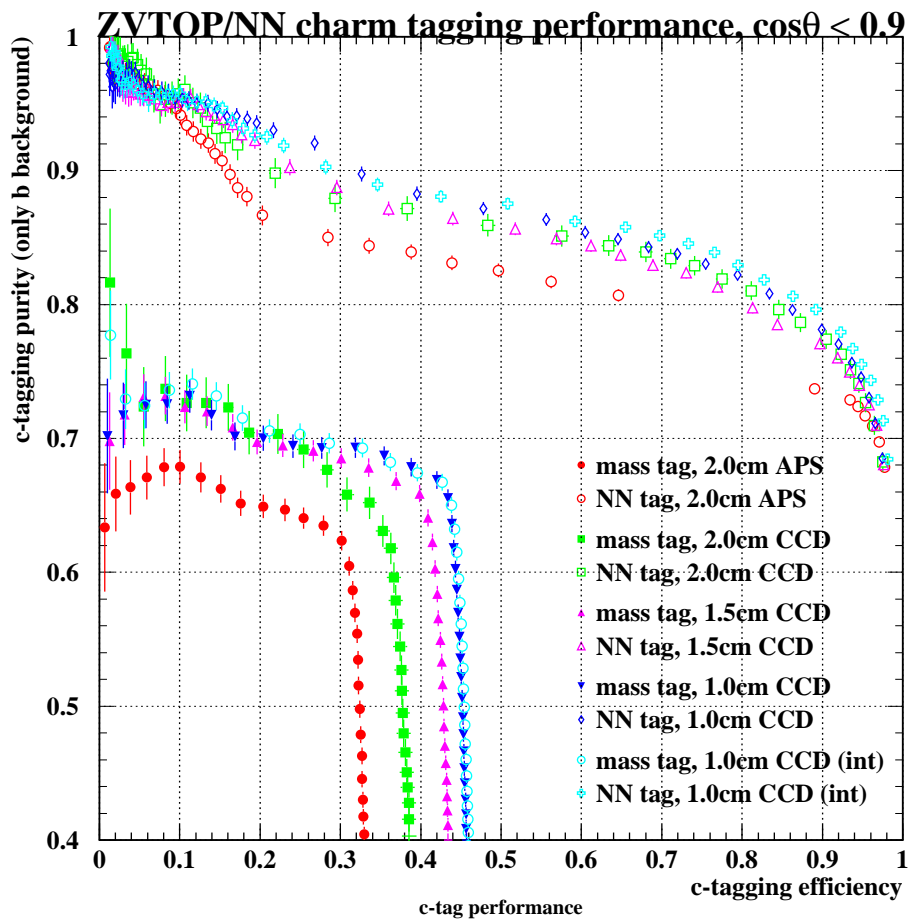

(R. Hawkings)



Tracking Performance

Reconstruction of vertices close to the IP works very well.

Ensure that this is also the case for vertices in the almost 'empty space' between TPC and VTX (e.g. K^0 decays to charged pions, CCD option):

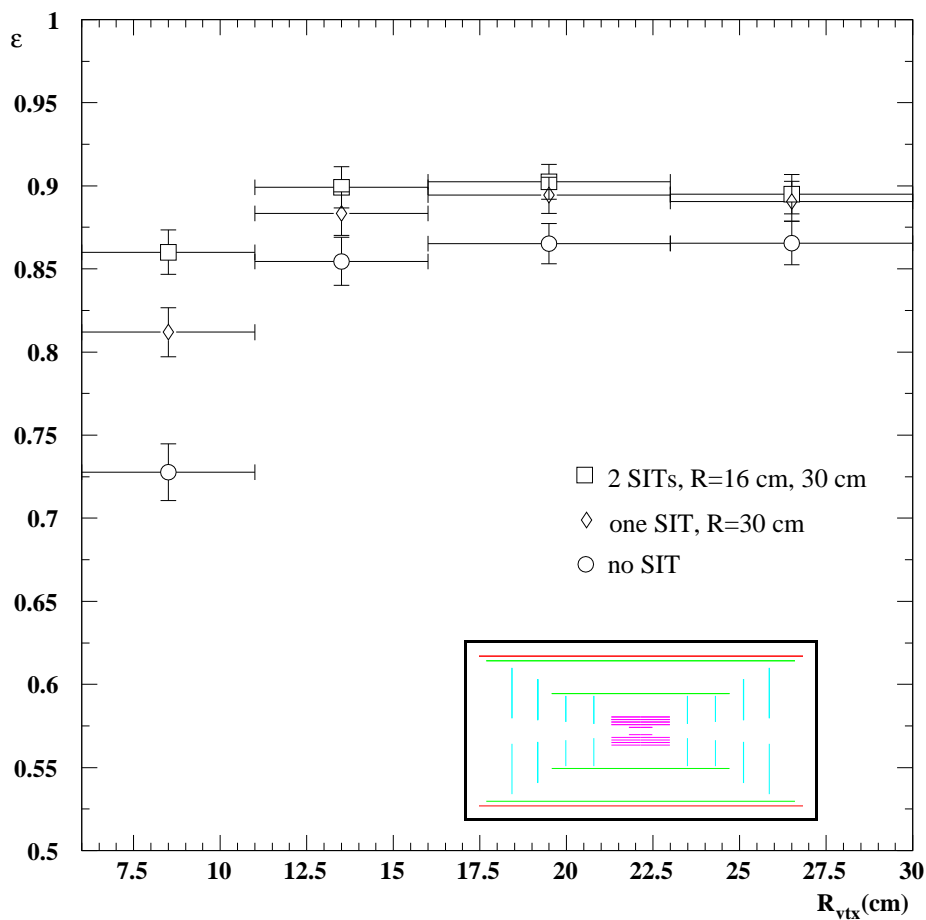

(J. Hauschildt)



Missing parts

Things that remain to be done:

- strip detector simulation*
- background in all detectors except TPC*
- ZVTOP vertex finder interface for new BRAHMS version*
- alignment studies
- feed tracking results into energy flow algorithm

* almost ready; software currently being tested

Summary

- realistic TESLA detector tracking simulation is in good shape
- performance is good, currently only limited by software problems
 - track reconstruction efficiency 97.2%,
fake rate 2.0% in pessimistic scenario
- missing parts will appear soon

Acknowledgements

Many people contributed software, studies, and ideas. Thanks especially to

Ties Behnke, Grahame Blair, Markus Elsing, Jakob Hauschildt, Richard Hawkins, Klaus Mönig, Harald Vogt, Daniel Wicke