

SANDIA REPORT

SAND2006-1324

Unlimited Release

Printed March 2006

Pilot Test Specific Test Plan For the Removal of Arsenic Socorro, New Mexico

Malcolm Siegel, Justin Marbury, Randy Everett, Brian Dwyer, Susan Collins,
Malynda Aragon, Alicia Aragon

Prepared by
Sandia National Laboratories
Albuquerque, New Mexico 87185 and Livermore, California 94550

Sandia is a multiprogram laboratory operated by Sandia Corporation,
a Lockheed Martin Company, for the United States Department of Energy's
National Nuclear Security Administration under Contract DE-AC04-94AL85000.

Approved for public release; further dissemination unlimited.



Issued by Sandia National Laboratories, operated for the United States Department of Energy by Sandia Corporation.

NOTICE: This report was prepared as an account of work sponsored by an agency of the United States Government. Neither the United States Government, nor any agency thereof, nor any of their employees, nor any of their contractors, subcontractors, or their employees, make any warranty, express or implied, or assume any legal liability or responsibility for the accuracy, completeness, or usefulness of any information, apparatus, product, or process disclosed, or represent that its use would not infringe privately owned rights. Reference herein to any specific commercial product, process, or service by trade name, trademark, manufacturer, or otherwise, does not necessarily constitute or imply its endorsement, recommendation, or favoring by the United States Government, any agency thereof, or any of their contractors or subcontractors. The views and opinions expressed herein do not necessarily state or reflect those of the United States Government, any agency thereof, or any of their contractors.

Printed in the United States of America. This report has been reproduced directly from the best available copy.

Available to DOE and DOE contractors from
U.S. Department of Energy
Office of Scientific and Technical Information
P.O. Box 62
Oak Ridge, TN 37831

Telephone: (865)576-8401
Facsimile: (865)576-5728
E-Mail: reports@adonis.osti.gov
Online ordering: <http://www.osti.gov/bridge>

Available to the public from
U.S. Department of Commerce
National Technical Information Service
5285 Port Royal Rd
Springfield, VA 22161

Telephone: (800)553-6847
Facsimile: (703)605-6900
E-Mail: orders@ntis.fedworld.gov
Online order: <http://www.ntis.gov/help/ordermethods.asp?loc=7-4-0#online>



SAND2006-1324
Unlimited Release
Printed March 2006

Pilot Test Specific Test Plan For the Removal of Arsenic Socorro, New Mexico

**Malcolm Siegel, Justin Marbury, Randy Everett, Brian Dwyer,
Susan Collins, Malynda Aragon, Alicia Aragon
Geochemistry Department
Sandia National Laboratories
Albuquerque, NM 87185**

March 2006

Abstract

Sandia National Laboratories (SNL) is conducting pilot scale evaluations of the performance and cost of innovative drinking water treatment technologies designed to meet the new arsenic maximum contaminant level (MCL) of 10 $\mu\text{g/L}$ (effective January 2006). As currently envisioned, pilots tests may include multiple phases. Phase I tests will involve side-by-side comparisons of several commercial technologies primarily using design parameters suggested by the Vendors. Subsequent tests (Phase II) may involve repeating some of the original tests, testing the same commercial technologies under different conditions and testing experimental technologies or additional commercial technologies. This Pilot Test Specific Test Plan (PTSTP) was written for Phase I of the Socorro Springs Pilot. The objectives of Phase I include evaluation of the treatment performance of five adsorptive media under ambient pH conditions (approximately 8.0) and assessment of the effect of contact time on the performance of one of the media. Addenda to the PTSTP may be written to cover Phase II studies and supporting laboratory studies.

The Phase I demonstration began in the winter of 2004 and will last approximately 9 months. The information from the test will help the City of Socorro choose the best arsenic treatment technology for the Socorro Springs well. The pilot demonstration is a project of the Arsenic Water Technology Partnership program, a partnership between the American Water Works Association (AWWA) Research Foundation, SNL, and WERC (A Consortium for Environmental Education and Technology Development).

Acknowledgements

This test plan required the work of a large number of people, each of whom made essential contributions. For this reason, the list of authors is given in reverse alphabetical order. The contributions of several other coworkers are also gratefully acknowledged. These include: Charlotte Casaus, Carolyn Kirby, Katherine North, Pamela Puissant, and Emily Wright, (Sandia National Laboratories), Bruce Bartley, Dale Scherger, and Kristie Wilhelm (NSF, International) and Judy Campbell (GRAM, Inc.). The management support and encouragement of Tom Hinkebein (Department 06118, Sandia National Laboratories) is also appreciated. Sandia is a multiprogram laboratory operated by Sandia Corporation, a Lockheed Martin Company, for the United States Department of Energy's National Nuclear Security Administration under contract DE-AC04-94AL85000.

TABLE OF CONTENTS

	Page
1. INTRODUCTION.....	13
1.1. PURPOSE	13
1.2. PARTICIPATION	14
1.2.1. <i>Manufacturers (joint venture)</i>	14
1.2.2. <i>Field Testing Organization</i>	14
1.2.3. <i>NSF International</i>	15
1.2.4. <i>Water Company</i>	16
1.2.5. <i>Sample Management Office</i>	16
1.2.6. <i>WERC</i>	16
2. ROLES AND RESPONSIBILITIES.....	17
2.1. WATER UTILITIES	17
2.1.1. <i>Site Description</i>	17
2.1.2. <i>Utility Responsibility</i>	17
2.2. MANUFACTURERS.....	18
2.3. FIELD TESTING ORGANIZATION	18
2.4. NSF INTERNATIONAL	19
2.5. SAMPLE MANAGEMENT OFFICE CONTRACT LABORATORIES	19
3. TEST DESIGN.....	21
3.1. INTRODUCTION	21
3.1.1. <i>Objectives</i>	21
3.1.2. <i>Arsenic Removal Using Adsorptive Media</i>	21
3.2. WATER QUALITY	22
3.3. DESCRIPTION OF TEST MEDIA.....	23
3.3.1. <i>Arsenic Adsorption Media</i>	23
3.3.2. <i>Performance Prediction</i>	23
3.3.3. <i>Media Handling Requirements</i>	25
3.4. EQUIPMENT CHARACTERISTICS	27
3.4.1. <i>System Components</i>	27
3.4.2. <i>System Schematics and Equipment Specifications</i>	28
3.4.3. <i>Equipment Photographs</i>	28
3.4.4. <i>Data Plate</i>	31
3.4.5. <i>Design Criteria</i>	31
4. FIELD TEST DESIGN.....	37
4.1. OBJECTIVES	37
4.2. QUANTITATIVE FACTORS.....	37
4.3. PRINCIPLES OF OPERATION	38
4.3.1. <i>Operator Requirements</i>	38
4.3.2. <i>Required Consumables</i>	39
4.3.3. <i>Rates of Waste Production</i>	39
4.3.4. <i>Equipment Performance Range</i>	39
4.3.5. <i>Licensing Requirements Associated with Equipment Operation</i>	39

5.	FIELD OPERATIONS PROCEDURES	41
5.1.	TASK 1: DOCUMENTATION OF OPERATING CONDITIONS AND TREATMENT EQUIPMENT PERFORMANCE.....	41
5.1.1.	<i>Experimental Objectives</i>	41
5.1.2.	<i>Work Plan</i>	41
5.1.3.	<i>Schedule</i>	41
5.1.4.	<i>Recording Data</i>	42
5.1.5.	<i>Verification Testing Schedule</i>	42
5.1.6.	<i>Water Quality Sampling Protocol and Testing Equipment</i>	42
5.1.7.	<i>Communications, Documentation, Logistics, and Equipment</i>	44
5.2.	TASK 2: SYSTEM INTEGRITY VERIFICATION TESTING	45
5.2.1.	<i>Introduction</i>	45
5.2.2.	<i>Experimental Objectives</i>	45
5.2.3.	<i>Work Plan</i>	45
5.2.4.	<i>Analytical Schedule</i>	46
5.2.5.	<i>Evaluation Criteria and Minimum Reporting Requirements</i>	49
5.3.	TASK 3: ADSORPTIVE CAPACITY VERIFICATION TESTING.....	49
5.3.1.	<i>Introduction</i>	49
5.3.2.	<i>Experimental Objectives</i>	49
5.3.3.	<i>Work Plan</i>	50
5.3.4.	<i>Analytical Schedule</i>	50
5.3.5.	<i>Evaluation Criteria and Minimum Reporting Requirements</i>	53
5.4.	TASK 4: DATA MANAGEMENT	53
5.4.1.	<i>Introduction</i>	53
5.4.2.	<i>Experimental Objectives</i>	53
5.4.3.	<i>Work Plan</i>	54
5.5.	TASK 5: QUALITY ASSURANCE/QUALITY CONTROL (QA/QC)	55
5.5.1.	<i>Introduction</i>	55
5.5.2.	<i>Experimental Objectives</i>	55
5.5.3.	<i>Work Plan</i>	55
5.5.4.	<i>Analytical Methods</i>	55
5.5.5.	<i>Samples Shipped Off-Site for Analysis</i>	58
6.	QUALITY ASSURANCE PROJECT PLAN (QAPP)	59
6.1.	PURPOSE AND SCOPE	59
6.2.	QUALITY ASSURANCE RESPONSIBILITIES	59
6.3.	DATA QUALITY INDICATORS	60
6.3.1.	<i>Representativeness</i>	60
6.3.2.	<i>Accuracy</i>	60
6.3.3.	<i>Precision</i>	63
6.4.	METHOD BLANKS	65
6.5.	LABORATORY METHOD DETECTION LIMITS	66
6.6.	QUALITY CONTROL CHECKS.....	67
6.7.	DATA REDUCTION, VALIDATION, AND REPORTING.....	68
6.7.1.	<i>Data Reduction</i>	68
6.7.2.	<i>Data Validation</i>	68

6.7.3. <i>Data Reporting</i>	68
6.8. SYSTEM INSPECTIONS	69
6.9. REPORTS	69
6.9.1. <i>Final Report</i>	69
6.10. CORRECTIVE ACTION.....	69
7. DATA MANAGEMENT AND ANALYSIS, AND REPORTING	71
7.1. DATA MANAGEMENT AND ANALYSIS	71
7.2. REPORT OF EQUIPMENT TESTING.....	71
8. SAFETY AND ENVIRONMENTAL ISSUES.....	73
8.1. ENVIRONMENTAL SAFETY AND HEALTH CONTROL DOCUMENTS AND TRAINING	73
8.2. CITY OF SOCORRO WATER UTILITY DEPARTMENT	73
9. REFERENCES.....	75
APPENDIX A: SYSTEM SCHEMATICS AND EQUIPMENT SPECIFICATIONS.....	77
APPENDIX B: DESIGN CALCULATIONS	85
APPENDIX C: OPERATIONS AND MAINTENANCE MANUAL.....	103
APPENDIX D: ARSENIC SPECIATION PROCEDURE WITH DISPOSABLE CARTRIDGES.....	117
APPENDIX F. SITE-SPECIFIC SAFETY PLAN.....	127
APPENDIX G: NSF REVIEW COMMENTS	133

Figures

	Page
Figure 3-1. Socorro Springs Pilot Skid Unit.....	29
Figure 3-2. Socorro Springs Adsorptive Media Column, Close-Up.....	30

Tables

Table 3-1. Socorro Water Quality Data collected January 13, 2005	22
Table 3-2. Adsorptive Media Specifications.	24
Table 3-3. Predictions of Media Performance	24
Table 3-4. Comparison of Design Parameters for Pilot-Scale and Small-Scale Column Studies for Socorro, NM.....	25
Table 3-5. Handling Procedures Specific to MEI Isolux 302M Adsorptive Media.	26
Table 3-6. Handling Procedures Specific to Purolite ArsenX ^{np} Adsorptive Media	26
Table 3-7. Handling Procedures Specific to Hydroglobe Metsorb Adsorptive Media.....	26
Table 3-8. Handling Procedures Specific to Engelhard ARM 200 Adsorptive Media.....	27
Table 3-9. Handling Procedures Specific to Adedge AD-33 Adsorptive Media.....	27
Table 3-10. Summary of Design Basis	31
Table 3-11. MetSorb (Media #1) Treatment Design and Operating Parameters	32
Table 3-12. AD33 (Media #2) Treatment Design and Operating Parameters	33
Table 3-13. Isolux 302M (Media #3) Treatment Design and Operating Parameters	34
Table 3-14. ARM 200 (Media #4) Treatment Design and Operating Parameters.....	35
Table 3-15. ArsenX ^{np} (Media #5) Treatment Design and Operating Parameters	36
Table 4-1. Backwash Volumes.	39
Table 5-1. Schedule for Observing and Recording Equipment Operation and Performance Data.....	41
Table 5-2. Water Quality Sampling Protocol	43
Table 5-3. Field Analytical and Calibration Equipment.....	44
Table 5-4. On-site Equipment Operating Parameter Monitoring and Data Collection Schedule	46
Table 5-5. Water Quality Sampling Schedule for System Integrity Verification Testing.....	47
Table 5-6. Arsenic Sampling Plan Laboratory Analyses – SMOCL and WQL	48
Table 5-7. Water Quality Sampling Schedule Media Adsorption Capacity Verification Testing	50
Table 5-8. Backwash Wastewater, and Purge Water Monitoring, Sampling and Analyses	52
Table 6-1. Laboratory Water Quality Indicators.....	62
Table 6-2. On-site Water Quality Indicators	62
Table 6-3. Field Instrument Calibration Schedule.....	63
Table 6-4. Schedule of Field Duplicates, Method Blanks and Analytical Splits for Laboratory Analyses.....	65
Table 6-5. Method Detection Limits (MDL) and Laboratory Reporting Limits - SMOCL.....	66
Table 6-6. Method Detection and Reporting Limits – WQL.....	67
Table 6-7: Corrective Action Plan	70

FOREWORD

The Arsenic Water Technology Partnership (AWTP) program is a multi-year program funded by a congressional appropriation through the Department of Energy to develop and test innovative technologies that have the potential to reduce the costs of arsenic removal from drinking water. The AWTP members include Sandia National Laboratories, the American Water Works Association (AWWA) Research Foundation and WERC (A Consortium for Environmental Education and Technology Development). The program is designed to move technologies from bench-scale tests to field demonstrations. The AWWA Research Foundation is managing bench-scale research programs; Sandia National Laboratories is conducting the pilot demonstration program and WERC will evaluate the economic feasibility of the technologies investigated and conduct technology transfer activities.

The objective of the Sandia Arsenic Treatment Technology Demonstration project (SATTD) is the field demonstration testing of both commercial and innovative technologies. The scope for this work includes 1) identification of sites for pilot demonstrations; 2) accelerated identification of candidate technologies through Vendor Forums, proof-of-principle laboratory and local pilot-scale studies, collaboration with the AWWA Research Foundation bench-scale research program and consultation with relevant advisory panels; and 3) pilot testing multiple technologies at several sites throughout the country.

The primary deliverables of the SATTD project are engineering analyses of candidate technologies. The analyses will consider such questions as:

1. How effective is the technology at achieving and maintaining sub-MCL arsenic outflows;
2. How sensitive is performance to feed water solution chemistry;
3. What operational aspects are critical to performance;
4. What is the impact on other aspects of O&M (e.g., sludge accumulation, fluoride levels, etc.)?

The engineering analysis for each pilot test will be contained in several reports: a Pilot Test Specific Test Plan (PTSTP), a yearly status report and a final analysis report. The PTSTP describes test procedures planned for the study and is based on protocols developed by the NSF International Environmental Technology Verification (NSF-ETV) Program. The PTSTP is based on modifications of the NSF/ETV protocols to reflect the experimental nature of SATTD program and to take into account site-specific conditions. It was developed with the assistance of NSF International, Inc.

This report is the PTSTP for the pilot test at the Socorro Springs Well in Socorro, New Mexico. It describes the plan for the pilot test as of February 2005. Two drafts of the PTSTP were reviewed by NSF International, Inc; a training audit was performed NSF staff in February 2005 and resulted in modifications to the original plan. The NSF review comments are included as Appendix G to this plan and describe the differences between the Socorro Springs PTSTP and the standard NSF Pilot Test Specific Test Plans.

The final report for the pilot test will include analyses of the performance data for each technology and information that could be used to generate projected costs for full-scale deployments. Projected costs will be generated using a cost model provided by WERC or other suitable model.

Abbreviations and Acronyms

µg/L	microgram per liter
°C	degrees Celsius
AA	Activated Alumina
ANSI	American National Standards Institute
AOP	Administrative Operating Procedure
ARCOC	Analytical Request Chain of Custody
AWWA	American Water Works Association
BET	Brunauer, Emmett and Teller
BV	bed volume
CA WET	California Waste Extraction Tests
CD	constant diffusivity
cm	Centimeter
D	diameter
DQO	data quality objectives
EBCT	empty bed contact time
EPA	U. S. Environmental Protection Agency
ETV	Environmental Technology Verification
g	gram
gpm	gallons per minute
HDPE	high density polyethylene
L	liter
lb	pound
m	meter
MCL	maximum contaminant level
MDL	method detection limit
mg/L	milligram per liter
mL	milliliter
mm	millimeter
MSDS	material safety data sheet
N/A	not applicable
NA	not analyzed
ND	not detected
NIST	National Institute of Standards and Technology
NSF	NSF International (formerly known as National Sanitation Foundation)
NTU	nephelometric turbidity units
O&M	Operation and Maintenance
PA	Pennsylvania
pCi/L	picoCuries per liter
PD	proportional diffusivity
PE	performance evaluation
ppb	parts per billion
ppm	parts per million
PRV	pressure reducing valve
psi	pounds per square inch

psig	pounds per square inch gauge
PTSTP	Pilot Test Specific Test Plan
PVC	poly vinyl chloride
QA	Quality Assurance
QA/QC	Quality Assurance/Quality Control
QAPP	Quality Assurance Project Plan
QC	Quality Control
SATTD	Sandia Arsenic Treatment Technology Demonstration
SM	Standard Methods (for the Examination of Water and Wastewater)
SMO	(Sandia National Laboratory's) Sample Management Office
SMOCL	Sample Management Office Contract Lab(s)
SNL	Sandia National Laboratory
SOP	standard operating procedure
SS	stainless steel
TBD	to be determined
TCLP	toxicity characteristic leaching procedure
TOC	total organic carbon
TSS	total suspended solids
WERC	Waste-management, Education and Research Consortium
WQL	Sandia (SNL's) Water Quality Laboratory

1. Introduction

1.1. Purpose

Sandia National Laboratories (SNL) is conducting pilot scale evaluations of the performance and cost of innovative drinking water treatment technologies aimed at meeting the new arsenic maximum contaminant level (MCL) of 10 µg/L (effective January 2006). The first pilot tests in the program are being conducted in New Mexico. The New Mexico Environment Department identified over 90 public water systems that currently exceed the 10 µg/L MCL for arsenic. From this list, SNL identified ten communities that are being considered for field scale pilot demonstrations. Socorro Springs in Socorro, New Mexico, was the first demonstration site to be selected.

Pilot-scale testing provides a cost effective method to optimize a water treatment methodology prior to full-scale implementation. The final water treatment system can be modeled and tested using a pilot-scale demonstration that considers the communities long-term needs. More specifically, a pilot-scale system is used to vary design process parameters (such as detention time, filtration rate, or mixing energy) and treatment materials (filter media, new chemicals, or chemical doses) to provide the information necessary for the full-scale design. This information or performance criteria include the following areas:

- Performance, as measured by arsenic removal
- Costs, including capital and Operation and Maintenance (O&M) costs
- O&M requirements, including personnel requirements and level of operator training
- Waste residuals generation

As currently envisioned, pilots tests may include multiple phases. Phase I tests will involve side-by-side comparisons of several commercial technologies primarily using design parameters suggested by the Vendors. Subsequent tests (Phase II) may involve repeating some of the original tests, testing the same commercial technologies under different conditions and testing experimental technologies or additional commercial technologies. This Pilot Test Specific Test Plan (PTSTP) was written for Phase I of the Socorro Springs Pilot. Addendums to the PTSTP may be written to cover Phase II studies and supporting laboratory studies.

The Phase I demonstration began in the winter of 2004 and will last approximately 9 months. The information from the test will help the City of Socorro choose the best arsenic treatment technology for the Socorro Springs well. The pilot demonstration is a project of the Arsenic Water Technology Partnership program, a partnership between the American Water Works Association (AWWA) Research Foundation, SNL, and WERC (A Consortium for Environmental Education and Technology Development).

1.2. Participation

1.2.1. Manufacturers (joint venture)

MEI

Jim Knoll, National Sales Manager
500 Point Breeze Road
Flemington, NJ 08822-9111
(908) 782-5800 ext. 1133
(908) 782-9610 (fax)
E-mail: jknoll@meichem.com

Hydroglobe

John H. Schroeder, P.E., President
612 River Street
Hoboken, NJ 07030
(201) 656-2100
(201) 656-3311 (fax)
E-mail: jschroeder@hydroglobe.com

Adedge Technologies, Inc.
3560 Financial Center Way, Suite 5
Buford, Georgia 30519
(866) 8ADEDGE
Email: info@adedge technologies.com

Linda A. Muroski, Business Development Manager
Thomas Shaniuk, Senior Engineer Research & Development
Engelhard Corporation
101 Wood Avenue, P.O. Box 770
Iselin, NJ 08830-0770
(732) 205-5046
(732) 205-5915 (fax)
Linda.muroski@engelhard.com
Thomas.shaniuk@engelhard.com

Jim Sabzali
Francis Boodoo
Purolite
150 Monument Road
Bala Cynwyd, PA 19004
(610) 668-9090
(610) 668-8139 (fax)
JSabzali@aol.com
fboodoo@puroliteusa.com
website: <http://www.puroliteusa.com>

1.2.2. Field Testing Organization

Malcolm Siegel
Sandia National Laboratories
MS 0754
Albuquerque, NM 87185-0754
msiegel@sandia.gov
(505) 845-5426
(505) 844-7354 (fax)
Role: Program Manager

Brian Dwyer
Sandia National Laboratories
MS 0754
Albuquerque, NM 87185-0754
(505) 845-9894
(505) 844-7354 (fax)
bpdwyer@sandia.gov
Role: Project Engineer

Randy Everett
Sandia National Laboratories
MS 0754
Albuquerque, NM 87185-0754
rlevere@sandia.gov
(505) 844-2933
(505) 844-7354 (fax)
Role: Project Technologist

Malynda Aragon
Sandia National Laboratories
MS 0754
Albuquerque, NM 87185-0754
rlevere@sandia.gov
(505) 844-2933
(505) 844-7354 (fax)
Role: Project Engineer

1.2.3. NSF International

Dale Scherger
Scherger Associates
3017 Rumsey Drive
Ann Arbor, MI 48105
734-213-8150 (phone and fax)
734-395-8157 (cell)
Email: daleres@aol.com
Role: NSF auditor

Justin Marbury
Sandia National Laboratories
MS 0754
Albuquerque, NM 87185-0754
jmarbu@sandia.gov
(505) 284-4093
(505) 844-7354 (fax)
Role: Project Technologist

Alicia Aragon
Sandia National Laboratories
MS 0754
Albuquerque, NM 87185-0754
ararag@sandia.gov
(505) 284-5066
(505) 844-7354 (fax)
Role: Laboratory Engineer

Nik Real
Sandia National Laboratories
MS 0754
Albuquerque, NM 87185-0754
nerael@sandia.gov
(505) 284-6789
(505) 844-7354 (fax)
Role: Project Support

Frederick Partey
New Mexico Tech.
801 Leroy Place
Socorro, NM 87810-4796
parteyfk@nmt.edu
(505) 835-5952
(505) 835-6436 (fax)
Role: Project Support

Bruce Bartley, ETV DWS Center Manager
NSF International
789 North Dixboro Road
Ann Arbor, MI 48105
(734) 769- 5148
(734) 769-0109 FAX
E-mail: bartley@nsf.org
Role: NSF Supervision

1.2.4. Water Company

Jay Santillanes, Utilities Director
City of Socorro
P.O. Box K
302 Main St.
Socorro, NM 87801
(505) 835-0240 ext. 533
(505) 838-1607 (fax)
Role: Host Utility

Rick Sanchez
City of Socorro
P.O. Box K
302 Main St.
Socorro, NM 87801
(505) 835-0240 ext. 533
(505) 838-1607 (fax)
Role: Host Utility Contact

Rueben Amaro
City of Socorro
P.O. Box K
302 Main St.
Socorro, NM 87801
(505) 835-0240 ext. 533
(505) 838-1607 (fax)
Role: Host Utility Contact

1.2.5. Sample Management Office

Pamela Puissant
Sandia National Laboratories
PO Box 5800
MS 0756
Albuquerque, NM 87185-0756
Role: Program Manager for Off Site Contract Laboratories

1.2.6. WERC

Abbas Ghassemi, Ph.D.
Executive Director, WERC
New Mexico State University
PO Box 30001 MSC WERC
Las Cruces, NM 88003-8001
Phone: 505.646.2357
Fax: 505.646.5474
Role: WERC representative

2. Roles and Responsibilities

2.1. Water Utilities

2.1.1. Site Description

The verification test site is the “Springs Site,” located off Evergreen Road in Socorro, NM. The Springs Site has a permitted capacity of 550 gallons per minute (gpm). The sources of the supply are Socorro and Sedillo Springs located in the foothills west of the City of Socorro. Existing treatment consists of gas chlorination prior to storage in the Springs Site Water Tank.

During this testing a portion of the Springs Site water (post chlorination) will be diverted to the arsenic adsorption media filters. The arsenic adsorption media filters are located inside the Springs Site chlorination building. The treated water and backwash wastewater from the arsenic adsorption media filters will be discharged to an on-site subterranean infiltration gallery via a 2-inch polyethylene pipe.

The pilot equipment is housed within a framed stucco building. The building and power drop, the Springs water tank, and the treated water disposal infiltration gallery are secured within a seven-foot chain link fence. The building is heated by residual heat from the eight-inch water supply line (water temperature is approximately 90 °F), and the chlorine pumps. Socorro personnel state that the inside building temperature remains at 50 °F or above year-round.

The two springs, Socorro and Sedillo, supplying continuous water to the Springs Site are composed of spring boxes located in the foothills approximately three-quarters of a mile to the southwest at an elevation approximately fifty feet above the Springs Site. Water from both springs is mixed slightly down gradient of the spring boxes, followed by a shut off valve. Below the shut off valve an eight-inch subsurface carbon steel line delivers via gravity the approximately 540 gpm, 90 °F water to the chlorination building where the water is disinfected and oxidized using chlorine gas injection just prior to storage in the Springs Site Storage Tank. Overflow from the Springs Site Storage Tank flows via gravity to a second storage tank located approximately one mile to the east.

2.1.2. Utility Responsibility

The City of Socorro will provide assistance with on-site logistics, daily operation and maintenance, and sample collection on an as-needed basis after appropriate training. In addition, the utility is providing water, electricity, and site security.

None of the spent media will be retained by the City of Socorro. Sandia National Laboratories will evaluate all spent media for hazardous characteristics using the toxicity characteristic leaching procedure (TCLP) and California Waste Extraction Tests (CA WET) at the conclusion of the pilot test.

Treated effluent from the tests will be discharged on site via surface release; **none of the treated water will be returned to the drinking water distribution system.** Treated water released will

be drained through a subsurface two-inch poly line to an existing infiltration gallery within the security fence. The total discharge will be limited to 3 gpm or less. A permit is not required for this discharge. The discharge has been coordinated with the City of Socorro Water Utility Department.

The pilot equipment used for this testing will be removed from the site and returned to SNL at test completion.

2.2. Manufacturers

As the technology providers, MEI, Purolite, Engelhard Corporation, Hydroglobe, and Adedge are responsible for providing quality controlled media and information regarding suggested pilot system design and operational parameters. In addition the technology providers will provide technical assistance to SNL during operation and monitoring of their respective arsenic adsorptive filter media.

2.3. Field Testing Organization

As the testing organization, Sandia National Laboratories is responsible for conducting verification testing of the arsenic adsorption media filters. As part of the verification testing, SNL is responsible for:

- Defining the roles and responsibilities of appropriate verification testing participants.
- Providing needed logistical support, establishing a communications network, and scheduling and coordinating the activities of all verification testing participants.
- Verifying that the location selected as the test site has feed water quality consistent with the objectives of the verification testing.
- Managing, evaluating, interpreting and reporting on data generated by the verification testing.
- Preparing this PTSTP for the verification testing.
- Overseeing testing activities, obtaining test samples and delivering those samples to the laboratory for analysis, tabulating and analyzing the testing data and preparing the final report.
- Properly disposing of spent media in accordance with classification based on the TCLP and CA WET.

The pilot equipment used for this testing will be removed from the site and returned to SNL at test completion.

2.4. NSF International

NSF International (NSF) is an independent, not-for-profit organization founded in 1944 for the purpose of developing standards and third-party conformity assessment services to government, manufacturers and consumers of products and systems related to public health, safety, and environmental quality.

NSF entered into an agreement on October 1, 2000 with the United States Environmental Protection Agency (EPA) to create a Drinking Water Systems Center dedicated to technology verifications. NSF manages an Environmental Technology Verification (ETV) Program within the Drinking Water Systems Center for the purpose of providing independent performance evaluations of drinking water technologies. Evaluations are conducted using protocols developed with stakeholder involvement. Verified results of product evaluations presented in reports from ETV tests should accelerate a technology's entrance into the commercial marketplace.

NSF, International is providing support to SNL under a technical assistance contract. The following are specific NSF roles and responsibilities:

- PTSTP review to insure compliance with the general requirements of the EPA/NSF ETV Protocol for Equipment Verification Testing for Arsenic Removal and specific requirements of EPA/NSF Equipment Verification Testing Plan for Adsorptive Media Processes for the Removal of Arsenic,
- Test site audit to confirm testing follows the PTSTP, and
- Interim and final report review including technical, format and QA/QC.

2.5. Sample Management Office Contract Laboratories

Sandia National Laboratories will team with the Sample Management Office (SMO) and use Sample Management Office Contract Laboratories (SMOCLs). The Sample Management Office supports SNL with Analytical Request Chain of Custody (ARCOC), sample handling and shipping, technical and contractual coordination, data validation and management, etc. Sample Management Office Contract Laboratories are NELAP (National Environmental Laboratory Accreditation Program) accredited and hold applicable certifications.

This page intentionally left blank.

3. Test Design

3.1. Introduction

3.1.1. Objectives

The objectives of the Socorro Pilot include evaluation of:

- The treatment performance of five adsorptive media using the same water source;
- The effects of pH adjustment and contact time on the performance of selected media; and
- Limited assessment of maintenance and operational requirements for all media.

The treatment performance will measure the arsenic removal capacity of all five media under ambient pH conditions (approximately 7.7). Simultaneously, additional columns using the Isolux 302M, Metsorb, and AD33 media will be evaluated at an adjusted pH of 6.8 to determine the effect on arsenic removal capacity as a function of pH. The pH will be lowered using a CO₂ injection system, which does not require the use of mineral acids. A second parameter, empty bed contact time (EBCT), will be varied for the AD33 media to determine the correlation between treatment contact time and arsenic removal. The results of this last test will help design future, potentially shorter, pilot tests.

The pilot-scale columns were designed based on full-scale design parameters to minimize scaling effects, thereby improving confidence in the results. It is understood that pilot-scale columns are sub-optimal for representation of full-scale maintenance and operational requirements; however, efforts will be directed at collection of some operational parameters. These include the pressure drop across the media and the corresponding backwash requirements (frequency and volume), as well as the adsorptive capacity of media to breakthrough (defined as 10 µg/L). In addition, media handling characteristics and the potential corrosivity and scale formation by effluent water from each of the media will be evaluated through the use of corrosion coupons and saturation index calculations.

Pilot-scale operational parameters for each media are based upon full-scale operating conditions as provided by the respective vendors. Section 3.3 provides a summary of the basis for design of the pilot columns for all five media.

3.1.2. Arsenic Removal Using Adsorptive Media

The conceptual treatment process for all five arsenic adsorption media filters is based on passing arsenic-contaminated feed water through a fixed bed of media that has a strong affinity for arsenic.

The chemical controls over arsenic uptake by metal (hydr) oxides in the subsurface are broadly similar to those that determine arsenic removal by metal (hydr) oxide filter media and coagulants in engineered settings. The arsenic is removed in fixed bed filtration via adsorption, the physical attachment of the adsorbate (arsenic) to the surface of the adsorbent media grains. The removal capacity and effectiveness of the arsenic removal media is dependent on a number of factors, of which surface area is of primary importance. The surface area is a function of the accessibility

of the porosity of the media grains. Adsorbent media contains a large quantity of very small pores throughout the media grains. Other factors that determine the capacity and effectiveness of adsorbent media are accessibility of the pore sites for arsenic ions, time available for arsenic ions to migrate to pore sites, competing ions for pore sites, concentration of arsenic in the feed water, pH of the feed water, and flow characteristics of the feed water that conveys the arsenic into the bed of adsorbent media.

As water passes down through a filter vessel containing fixed bed media, the arsenic concentration declines until it is no longer detectable. As the upper portion of the media becomes saturated, the treatment region (mass transfer zone) progresses downward until all adsorptive capacity is used and arsenic breakthrough occurs.

3.2. Water Quality

A "snapshot" of the Springs Site raw water quality is presented on Table 3-1. The water is generally of good quality except for arsenic, which exceeds the new MCL effective in January 2006. The water has moderate levels of silica, sulfate, and hardness and is near neutral in pH. The arsenic level is four times the January 2006 MCL of 10 µg/L.

Purolite, Engelhard Corporation, Adedge, and Hydroglobe have indicated that no pretreatment is required for their respective arsenic adsorption media; however, MEI utilizes a 5-µm pleated pre-filter cartridge to minimize potential plugging of the media cartridge.

Table 3-1. Socorro Water Quality Data collected 1/13/2005 or 1/27/2005*.

Parameter	Unchlorinated Feed Water	Chlorinated Feed Water
Conductivity (µS)	356-360	356-360
Temperature (degrees Celsius)	30.1-30.5	30.1-30.5
pH	8.03-8.07	7.89-7.91
Free Chlorine (as ppm Cl ₂)		0.74*
Iron (ppb)	43.3	38.2
Turbidity	ND	NA
Total Arsenic (ppb)	42.4	42.9
<i>Speciated Arsenic</i>		
Particulate Arsenic (ppb)	ND	1.9
As(III) (ppb)	ND (0.530)	2.04
As(V) (ppb)	42.4	39.0
Titanium (ppb)	ND (0.381)	ND (0.381)
Zirconium (ppb)	(ND)0.216	ND (0.216)
Alkalinity (ppm)	123	125
Total Suspended Solids	ND	ND
Nitrate (ppm)	0.479	0.4
Calcium (ppm)	17.5	17.4
Magnesium (ppm)	4.09	4.05

Table 3-1. Socorro Water Quality Data collected 1/13/2005 or 1/27/2005*. (continued)

Parameter	Unchlorinated Feed Water	Chlorinated Feed Water
Sodium (ppm)	57.0	57.1
Silica (ppm)	25.0	24.9
Aluminum (ppb)	24.2	23.2
Vanadium (ppb)	11.4	11.3
Gross Alpha/Beta (pCi/L)	Alpha-6.50, Beta-3.52	Alpha-6.07*, Beta-2.68*
Chloride (ppm)	11.5	12.7*
Fluoride (ppm)	0.619	0.52*
Sulfate (ppm)	28.7	30.1*
Total Organic Carbon (TOC)	0.608*	0.364*

3.3. Description of Test Media

3.3.1. Arsenic Adsorption Media

The Socorro pilot study will test five media:

- Four metal oxides and
- One ion exchange/metal oxide combination.

Table 3-2 presents the physical properties of the arsenic adsorption media being tested. Unless stated otherwise, media property values were supplied by the vendors. Brunauer, Emmett and Teller (BET) surface area and pore size distribution were measured at Sandia National Laboratories using a QuantaChrome Autosorb-6B Analyzer (Quantachrome Corporation). The samples were degassed at 120°C for ~ 12 hours (or 30°C, ~24 hours for ArsenX^{np}). Surface areas were determined using the BET equation on a 5-point N₂ gas adsorption isotherms, and the pore-size distributions were obtained from the desorption branches using the standard Barrett-Joyner-Halenda (BJH) method without further correction.

3.3.2. Performance Prediction

The data quality objectives (DQO) for this test plan are based in part on comparison of predicted and observed performance of the media. If the adsorbent media perform as expected, then no arsenic will be detected in the treated water for at least 4 to 6 months. (The lower limit of detection for arsenic using the Inductively Coupled-Mass Spectrometer at the SNL's Water Quality Laboratory (WQL) is less than 2 µg/L (2 ppb).) Eventually, as the adsorbent capacity of an adsorbent medium is exhausted, detectable amounts of arsenic will appear in the treated water. The concentration of arsenic will gradually increase, and when the capacity of the medium is completely exhausted, the arsenic concentrations in the untreated and treated water will be the same.

Ideally, each column will be run until the arsenic concentration in the treated water is about 10 µg/L. However, for media that have very high capacities, a year or more may be required before breakthrough, and limitations in project resources may require termination of the test.

Capacity calculations will be attempted as early as possible and compared to predictions from batch tests and/or rapid small-scale column test (RSSCT) results as described below.

Table 3-2. Adsorptive Media Specifications.

Media	Isolux 302M	Metsorb	ARM 200	ArsenX^{np}	AD-33
Chemical Constituents	Amorphous inorganic zirconium oxide, 60-95%; balance is water	Nano-crystalline titanium dioxide	Iron oxide/hydroxide	Resin with iron oxide coatings as the functional group	Iron oxide/hydroxide
Bulk density (lbs/cuft) [gm/cc]	56 0.90	50 0.80	30 – 45 0.48-0.72	49 – 52 0.79-0.83	30 0.48
BET Area (m ² /g)	300 (per vendor) 499 (SNL measurement)	211 (SNL)	262 (SNL)	120 (SNL)	147 (SNL)
Average pore diameter (Å) (SNL)	23	64	99	174	245
Total pore volume (SNL) (cc/gm)	0.29	0.34	0.65	0.05	0.90
Moisture	5-40% by volume	N/A	N/A	N/A	N/A
Sieve Sizes, US std.	N/A	16 X 60	12 x 40	16 x 50	10 x 35
Particle size	< 5 μ m	1.18 x 0.25 mm	1.40 x 0.425 mm	1.18 x 0.3 mm	0.5 x 2.0 mm
Particle appearance	White powder	White granular beads	Black grains	Brown beads	Amber grains
Approvals	NSF Section 61 certified	NSF Section 61 certified	Pending NSF Section 61 certification	NSF Section 61 certified	NSF Section 61 certified
MSDS available	Yes	Yes	Yes	Yes	Yes

Predictions of Performance by Vendors

Vendors were asked to provide estimates of the media performance in the Socorro Springs waters based on their previous studies. These predictions are summarized in Table 3-3.

Table 3-3. Predictions of Media Performance.

Media/company	Anticipated Treatment Capacity	Anticipated Cost/ 1000 gallon
Isolux 302M media/ MEI	> 85,000 bed volumes	Returnable cartridge model ~\$0.70 Stationary Model ~\$0.50
ArsenX ^{np} / Purolite	> 60,000 bed volumes (50% breakthrough)	~\$0.25 to \$0.35 (@\$350/cu ft media)

Engelhard Corporation, AdEdge, and Hydroglobe did not supply specific performance and cost information.

Rapid Small Scale Column Tests

Laboratory studies to predict media performance of pilot-scale adsorption columns are being conducted using RSSCTs. RSSCTs are scaled-down columns packed with smaller diameter adsorption media that receive higher hydraulic loading rates to significantly reduce the duration of experiments. Results for RSSCTs can be obtained in a matter of days to a few weeks, whereas pilot tests can take a number of months to over a year.

This method uses scaling relationships that allow correlation of lab-scale column results operated at accelerated flow rates to full-scale column performance. The RSSCT concept is based upon a theoretical analysis of the adsorption processes that govern performance including solution and surface mass transport and adsorption kinetics. Mass transfer models have been used to determine dimensionless parameters that establish similitude between the small- and large-scale columns.

For support of the Socorro, NM Pilot Demonstration Project, RSSCTs were scaled down from pilot scale and designed using proportional diffusivity (PD) and constant diffusivity (CD) scaling equations. Design parameters for both the pilot scale and the PD small scale tests (which were done initially) are shown in Table 3-4. The theory and procedures for all the RSSCT experiments carried out in support of the Socorro Springs Pilot are described in a separate test plan (Aragon 2006)

Table 3-4. Comparison of Design Parameters for Pilot-Scale and Small-Scale Column Studies for Socorro, NM.

Parameter	Pilot Scale	RSSCT	Units
Column Diameter	7.6 (3)	1.0 (0.4)	cm (in)
Particle Diameter	0.25-2.0	0.15-0.18	mm
EBCT	2-5	0.05-0.9	min
Bed Height	50-130 (20-50)	8-30 (3-12)	cm (in)
Flow Rate	1100-1900 (0.3-0.5)	20-120 (0.005-0.03)	ml/min (gpm)
Hydraulic Loading Rate	24-32 (6-8)	15-125 (3-32)	cm/min (gpm/ft ²)

3.3.3. Media Handling Requirements

Vendors provided instructions for storage and handling requirements for their respective media. These are described in Table 3-5 through 3-9 below.

Table 3-5. Handling Procedures Specific to MEI Isolux 302M Adsorptive Media.

Item	Manufacturing/Procedures
Material description	Amorphous inorganic zirconium oxide media
Method of manufacture	Proprietary
Preconditioning procedure	N/A – media supplied in cartridge form. No backwashing requirements.
Regeneration procedure	Media is regenerable; however, N/A for this project
Column filling procedure per vendor	N/A

Table 3-6. Handling Procedures Specific to Purolite ArsenX^{np} Adsorptive Media.

Item	Manufacturing/Procedures
Material description	Amorphous inorganic zirconium oxide media
Method of manufacture	Proprietary
Preconditioning procedure	Media is delivered moist – do not attempt to dry out media. Backwash column at design backwash flow rate for 15 minutes prior to startup.
Regeneration procedure	Media is regenerable; however, N/A for this project.
Column filling procedure per vendor	<ul style="list-style-type: none"> • Determine volume of bed. • Spoon a little bit of dry media at a time into column using a funnel scoop. • Use DI water in squirt jar to hose down sides. • Rinse with DI water to pack bed and get some air out. • Backwash gently to remove rest of air and fines (minor).

Table 3-7. Handling Procedures Specific to Hydroglobe Metsorb Adsorptive Media.

Item	Manufacturing/Procedures
Material description	Nanocrystalline titanium dioxide (granular form)
Method of manufacture	Proprietary
Preconditioning procedure	Backwash column at design backwash flow rate for 15 minutes prior to startup.
Regeneration procedure	N/A for this project
Column filling procedure	<ul style="list-style-type: none"> • Fill column with dry media into standing column of water. • Backwash column for ½ hr. After ½ hour water may not be clear but don't worry, the media will filter out residual fines during normal operation.

Table 3-8. Handling Procedures Specific to Engelhard ARM 200 Adsorptive Media.

Item	Manufacturing/Procedures
Material description	Iron oxide/hydroxide
Method of manufacture	Proprietary
Preconditioning procedure	Backwash column at design backwash flow rate for 15 minutes prior to startup.
Regeneration procedure	N/A
Column filling procedure per vendor	<ul style="list-style-type: none"> • Fill column with dry media with or without standing column. • Media is already screened for fines so no need to sieve or backwash.

Table 3-9. Handling Procedures Specific to Adedge AD-33 Adsorptive Media.

Item	Manufacturing/Procedures
Material description	iron oxide/hydroxide
Method of manufacture	Proprietary
Preconditioning procedure	Backwash column at design backwash flow rate for 15 minutes prior to startup.
Regeneration procedure	N/A
Column filling procedure	<ul style="list-style-type: none"> • Fill column with dry media; make sure bottom screen retains media. • Backwash to remove fine. <p>They use a spun cartridge to capture fines during backwash; the backwash water is clear and can be recycled.</p>

3.4. Equipment Characteristics

3.4.1. System Components

The Socorro pilot system is made up of the following modular components:

1. Raw water makeup system
 - a. Polyethylene tank (also acts as chlorine contact tank),
 - b. Pump, and
 - c. Pressure control and relief;
2. Carbon dioxide injection system (pH adjustment method);
3. Column skid;
4. Backwash collection tank; and
5. Corrosion coupons.

The raw water at Socorro Springs is chlorinated in the pipeline by the utility in a small building at the site, which is the location on the pilot unit. The chlorinated raw water is delivered to the pilot unit raw water makeup system using the normal pressure of the Socorro water system. The raw water makeup system contains an 80-gallon linear polyethylene opaque tank supplying prime/suction water for the feed water pump. The storage tank has level controllers that maintain the water level in the tank and will shut off the supply pump to the pilot unit if the tank level drops to low to maintain feed water pump prime. The feed water pump is a vertical, non-self priming, multistage, in-line, centrifugal pump mounted on the tank foundation. The pump supplies feed water to the carbon dioxide system and the column skid at design pressures using pressure control valves and a pressure relief valve to avoid potential pump deadheading. The pump is protected against running dry or loosing prime by a level float control in the makeup tank designed to shut off the pump at a low-level checkpoint. (Refer to Drawing SOC-01 in Appendix A.)

The carbon dioxide injection system provides pH adjusted raw water to three of the ten columns per design. A split stream of raw water (~ 1.2 gpm) is diverted from the raw water supply (~ 3.5 gpm) to the pH system at a pressure approximately 50 psi (pounds per square inch) above the system feed pressure. The system lowers the pH by the formation of carbonic acid during the injection of carbon dioxide under pressure into the water stream. (Refer to Drawing SOC-01 in Appendix A.)

The pilot test skid contains ten columns, each designed as independent arsenic adsorption media filters operating in parallel. Each column is modular in design consisting of the following components: (1) rotameter, (2) three-way valve (for service or backwash mode), (3) upgradient pressure gauge, (4) column with adsorptive media, (5) down gradient pressure gauge, (6) another three-way valve (service or backwash mode), (7) sample tap, (8) totalizing flow meter, (9) check valve, and (10) all associated piping. (Refer to Drawings SOC-01 and SOC-02 in Appendix A.)

The backwash collection tank serves to collect backwash water. Columns will be backwashed independently to avoid backwash water from different media mixing. The collection tank and backwash manifold will be cleaned prior to backwash of a different media.

3.4.2. System Schematics and Equipment Specifications

See Appendix A for system schematics and equipment specifications.

3.4.3. Equipment Photographs

Photographs were taken of the equipment used in the pilot. Figure 3-1 shows the pilot skid unit, and Figure 3-2 shows a close up of the adsorptive media column.



Figure 3-1. Socorro Springs Pilot Skid Unit.

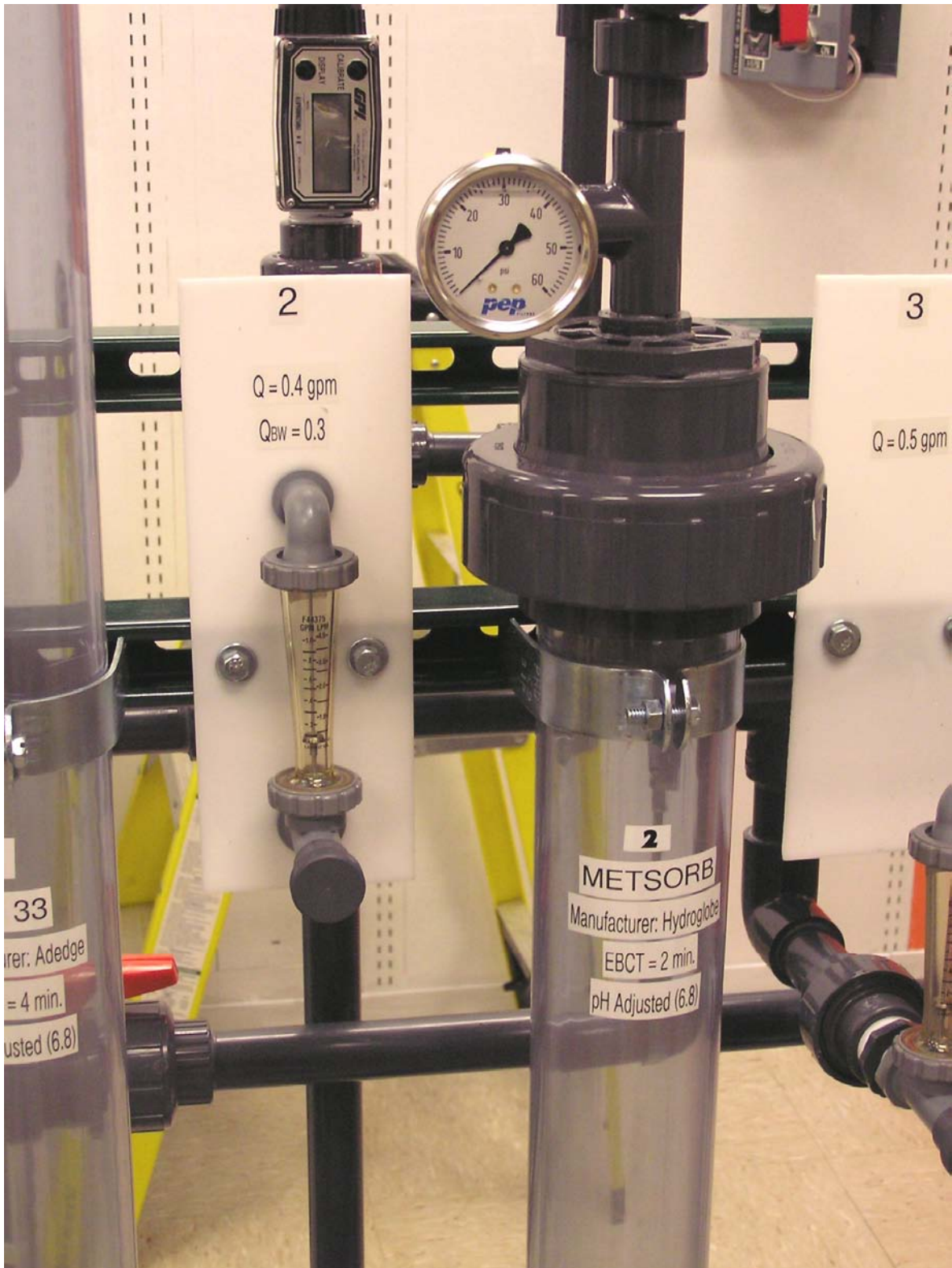

Figure 3-2. Socorro Springs Adsorptive Media Column, Close-Up.

3.4.4. Data Plate

A data plate is installed on each arsenic adsorption media filter column providing the following information:

- Manufacturers' Name
- Additional Information
- Service and Backflow rates
- Warning and Caution Statements.

3.4.5. Design Criteria

Table 3-10 presents a comparative summary of the design basis for the ten arsenic adsorptive columns. The 10 columns are designed based on information on particle size, desired hydraulic loading rate, and optimum EBCTs supplied by the vendors. Design data for each media are found in Tables 3-11 through 3-15 below; the design calculations are included in Appendix B. Columns 1-3 are reserved for Phase II studies in which the pH will be adjusted to 6.8. Conditions for those tests are shown in italics in those tables and other tables in this report.

Table 3-10. Summary of Design Basis.

Vendor Media	MetSorb		AD-33				Isolux 302M		ARM 200	ArsenX ^{np}
Number of Pilot Scale Columns	2		4				2		1	1
Hydraulic Loading Rate (HLR), gpm/ft ²	8		6				23		6	8.1487
Column Number (Drawing SOC-01)	6	2	8	9	10	1	7	3	4	5
Empty Bed Contact Time (EBCT), min	2	2	2	4	5	4	0.20	0.20	4	3
Pre-filtration requirements	No	No	No	No	No	No	Yes (0.5um)	Yes (0.5um)	No	No
Influent pH	7.7	7.7	7.7	7.7	7.7	7.7	7.7	7.7	7.7	7.7
Adjusted pH		6.8				6.8		6.8		
pH adjustment chemical and dose		< 0.5 lbs CO ₂				< 0.5 lbs CO ₂		< 0.5 lbs CO ₂		
Column Height (Hc), inches	39	39	39	60	60	60	10	10	60	60
Column Diameter (D), inches	3	3	3	3	3	3	1	1	3	3
Media Depth (Hm), inches	25.7	25.7	19.3	38.5	48.12	38.5	10	10	38.5	39.2
Media Volume (V), liters	2.97	2.97	2.2294	4.46	5.57	4.46	0.3861	0.3861	4.46	4.74
Water Flowrate (Q), gpm	0.4	0.4	0.3	0.3	0.3	0.3	0.5	0.5	0.3	0.4
Face Velocity (v), ft/s	0.0178		0.0134				0.20		0.0134	0.0182
Backwash Flowrate (Q _{BW}), gpm	0.3		0.3				N/A		0.3	0.2

Table 3-11 contains specific design basis information for the MetSorb pilot columns. MetSorb is a nano-crystalline titanium dioxide adsorption media. The media is loaded into the column in dry granular form.

Table 3-11. MetSorb (Media #1) Treatment Design and Operating Parameters.

Parameter	RSSCT Columns (PD)	MetSorb Pilot Columns		MetSorb Full Scale Systems
Bulk Density (lbs/ft ³)	50	50		50
Particle mesh size	100 x 200	US Std Mesh 16 x 60		US Std Mesh 16 x 60
Particle diameter (mm)	0.15 x 0.075	1.18 x 0.25		1.18 x 0.25
<i>Column Layers</i>				
Distributor Configuration	n/a	Fritted disc		Hub & Spoke
Underbedding Configuration	n/a	1/16" gravel		1/16" gravel
Column Number (Drawing SOC-01)	N/A	6	2	N/A
Underbedding Height (Hug) (ft)	N/A	3	3	N/A
Freeboard (Hf), inches	14.6	10.3	10.3	40-50% of Hm
Media Depth (Hm), in.	5.1	25.7	25.7	24 - 48
Media Volume (Vm), Liters	0.005	2.97	2.97	Function of Q, EBCT
Column Diameter (D), inches	0.28	3	3	1-12 ft
Column Height (Hc), inches	19.7	39	39	24 - 60
<i>Operating Conditions</i>				
Hydraulic Loading Rate (HLR), gpm/ft ²	8.28	8	8	8 - 10
EBCT (min)	0.39	2	2	1.6-2.5
pH	7.7	7.7	6.8	Site specific
Down Flow Pressure Drop (psi)	Not meas	1.7	1.7	< 5
Flow Rate (Q), gpm	0.00337	0.4	0.4	Site specific
Face Velocity (v), (ft/s)	0.018	0.178	0.178	
<i>Backwash Conditions</i>				
Backwash Flux (G _{BW}) (gpm/ft ²)	n/a	6		10-12
Backwash Flow Rate (Q _{bw}), gpm	n/a	0.3		Function of vessel diameter and HLR
Backwash Duration (min)	n/a	≤15		15
Backwash Frequency (per month)	n/a	Backwash only if Δ p > 2 x initial pressure drop across media bed		1 x (dependent on raw water quality)

Table 3-12 contains specific design basis information for the AD33 pilot columns. AD33 is an iron oxide/hydroxide granular adsorption media. The media is loaded into the column in dry granular form.

Table 3-12. AD33 (Media #2) Treatment Design and Operating Parameters.

Parameter	RSSCT Columns			AD33 Pilot Columns				AD33 Full Scale Systems
Bulk Density (lbs/ft ³)	30			30				30
Particle mesh size	100 x 200			US Std Mesh 10 x 35				US Std Mesh 10 x 35
Particle diameter (mm)	0.15 x 0.075			2 x 0.5				2 x 0.5
<i>Column Layers</i>								
Distributor Configuration	n/a			Fritted disc				Hub & Spoke
Underbedding Configuration	n/a			gravel				1/8" x 1/16" gravel
Column Number (Drawing SOC-01)	N/A			8	9	10	1	N/A
Underbedding Height (Hug) (ft)	N/A			3	3	3	3	N/A
Freeboard (Hf), inches	17.65	15.57	14.54	16.75	18.5	8.9	18.5	40-50% of Hm
Media Depth (Hm), in.	2.05	4.13	5.16	19.25	38.5	48.12	38.5	24 - 48
Media Volume (Vm), Liters	0.002	0.004	0.005	2.2294	4.5	5.57	4.5	Function of Q, EBCT
Column Diameter (D), inches	0.28			3	3	3	3	1-12 ft
Column Height (Hc), inches	19.7			39	60	60	60	N/A
<i>Operating Conditions</i>								
Hydraulic Loading Rate (HLR), gpm/ft ²	6.18			6	6	6	6	6 - 10
EBCT (min)	0.21	0.42	0.53	2	4	5	4	3 - 5
pH	7.7			~7.7	~7.7	~7.7	6.8	Site specific
Down Flow Pressure Drop (psi)	Not meas			1.6	3.2	4.0	3.2	< 5
Flow Rate (Q), gpm	0.0025			0.3	0.3	0.3	0.3	Site specific
Face Velocity (v), (ft/s)	0.0135			0.134	0.134	0.134	0.134	
<i>Backwash Conditions</i>								
Backwash Flux (G _{BW}) (gpm/ft ²)	N/A			6				10-12
Backwash Flow Rate ((Q _{bw}), gpm)	N/A			0.3				Function of vessel diameter and HLR
Backwash Duration (min)	N/A			≤15				15
Backwash Frequency (per month)	N/A			Backwash only if Δ p > 1.5 x initial pressure drop across media bed				1 x (dependent on raw water quality)

Table 3-13 contains specific design basis information for the Isolux columns. Isolux 302M is an amorphous inorganic zirconium oxide adsorption media. MEI provides the media in pre-packaged radial flow cartridges. Cartridges in series are used for higher flow rates.

Table 3-13. Isolux 302M (Media #3) Treatment Design and Operating Parameters.

Parameter	Isolux Pilot Columns	Isolux Full Scale Systems
Bulk Density (lb/ft ³)	54	54
Particle mesh size	< 400	< 400
Particle diameter (mm)	0.02	0.02
<i>Column Layers</i>		
Distributor Configuration	Radial flow cartridge with 5 um pre-filter	Radial flow cartridges in series with 5 um pre-filter
Under bedding Configuration	N/A	N/A
Under bedding Height (in)	N/A	N/A
Freeboard Height (in)	N/A	N/A
Media Depth (in)	42	42
Media Volume (ft ³)	Based on cartridge dimensions	Based on cartridge dimensions
Column Diameter (in)	Based on cartridge dimensions	Based on cartridge dimensions
Column Height (in)	42	42
<i>Operating Conditions</i>		
Hydraulic Loading Rate (gpm/ft ²)	Based on cartridge dimensions	Based on cartridge dimensions
EBCT (min)	0.5	Based on cartridge dimensions
pH	8.04	Site specific
Down Flow Pressure Drop (psi)	TBD	N/A
Flow Rate (gpm)	0.3	Site specific
Face Velocity (ft/min)	Based on cartridge dimensions	Based on cartridge dimensions
<i>Backwash Conditions</i>		
Backwash Flux (gpm/ft ²)	N/A	N/A
Backwash Flow Rate (gpm)	N/A	N/A
Backwash Duration (min)	N/A	N/A
Backwash Frequency (per month)	N/A	N/A

Table 3-14 contains specific design basis information for the ARM 200 pilot columns. ARM 200 is an iron oxide/hydroxide granular adsorption media. The media is loaded into the column in dry granular form.

Table 3-14. ARM 200 (Media #4) Treatment Design and Operating Parameters.

Parameter	RSSCT Columns	ARM 200 Pilot Column	ARM 200 Full Scale Systems
Bulk Density (lbs/ft ³)	30-45	30 - 45	30 - 45
Particle mesh size	100 x 200	12 x 40	Any US Std Mesh size
Particle diameter (mm)	0.15 x 0.075	1.40 x 0.425	Any size
<i>Column Layers</i>			
Distributor Configuration	N/A	N/A	Hub & Spoke
Underbedding Configuration	N/A	gravel	gravel
Column Number (Drawing SOC-01)	N/A	4	N/A
Underbedding Height (Hug), Inches	n/a	3	
Freeboard (Hf), inches	14.35	18.5	40-50% of Hm
Media Depth (Hm), inches	5.35	38.5	24 - 48
Media Volume (Vm), Liters	0.0052	4.46	Function of Q, EBCT
Column Diameter (D), inches	0.28	3	1-12 ft
Column Height (Hc), inches	19.7	60	
<i>Operating Conditions</i>			
Pilot Column Number	1	1	
Hydraulic Loading Rate (HLR), gpm/ft ²	6.18	6	6 - 10
EBCT (min)	0.55	4	3 - 5
pH	7.7	Ambient ~ 7.7	Site specific
Down Flow Pressure Drop (psi)	Not meas	1/ft	1/ft
Maximum Differential Pressure (psi)	Not meas	3.3	N/A
Flow Rate (Q), gpm	0.0025	0.3	Site specific
Face Velocity (v), (ft/s)	0.0135	0.0134	
<i>Backwash Conditions</i>			
Backwash Flux (GBW) (gpm/ft ²)	n/a	6	10 - 12
Backwash Flow Rate ((Q _{bw}), gpm	n/a	0.3	Function of vessel diameter and HLR
Backwash Duration (min)	n/a	TBD	15
Backwash Frequency (per month)	n/a	TBD	Site specific

Table 3-15 contains specific design basis information for the ArsenX^{np} column. ArsenX^{np} is a traditional ion exchange resin matrix with an iron oxyhydroxide surface coating.

Table 3-15. ArsenX^{np} (Media #5) Treatment Design and Operating Parameters.

Parameter	ArsenX ^{np} Pilot Column	ArsenX ^{np} Full Scale Systems
Bulk Density (lbs/ft ²)	49-52	49-52
Particle mesh size	US Std Mesh 16 x 50	US Std Mesh 16 x 50
Particle diameter (mm)	1.18 x 0.3	1.18 x 0.3
Distributor Configuration	N/A	Hub & Spoke
Underbedding Configuration	gravel	gravel
Column Number (Drawing SOC-01)	5	N/A
Underbedding Height (Hug), Inches	3	
Freeboard (Hf), inches	17.8	50% of Hm
Media Depth (Hm), inches	39.2	30 – 48
Media Volume (Vm), Liters	4.74	Function of Q, EBCT
Column Diameter (D), inches	3	1-8 ft
Column Height (Hc), inches	60	
Hydraulic Loading Rate (HLR), gpm/ft ²	8.1487	4 – 16 (typical 8 – 12)
EBCT (min)	3	3 - 5
pH	Ambient ~ 7.7	Site specific
Down Flow Pressure Drop (psi)	6.5 across entire media length	≤ 2 psi/ft
Maximum Differential Pressure (psi)	N/A	N/A
Flow Rate (Q), gpm	0.4	Site specific
Face Velocity (v), (ft/s)	0.0182	
<i>Backwash Conditions</i>		
Backwash Flux (GBW) (gpm/ft ²)	4	N/A
Backwash Flow Rate ((Q _{bw}), gpm	0.2	Function of vessel diameter and HLR
Backwash Duration (min)	10 - 15	≤ 15
Backwash Frequency (per month)	TBD	N/A

4. Field Test Design

4.1. Objectives

The objectives of the Socorro Pilot include evaluation of:

1. The comparative treatment performance of five adsorptive media using chlorinated water from the Socorro Springs;
2. Comparison of media performance to predictions based on vendor data and results of laboratory studies carried out at Sandia National Laboratories (RSSCT and supporting experiments).
3. Limited assessment of maintenance and operational requirements for all media.
4. The effect of contact time on the performance of one of the media;
5. The effects of pH adjustment on the performance of selected media;
6. The corrosivity and scale-forming potential of treated water.

The pilot test is being conducted in two stages. In Stage 1, objectives 1 through 4 will be evaluated. Stage 2 will include evaluation of all the above objectives (1-6). An addendum to this test plan will be written to describe design and operation procedures during Stage 2.

The treatment performance will measure the arsenic removal capacity of all five media under ambient pH conditions (approximately 7.7). Empty bed contact time (EBCT) will be varied for the AD33 media to determine the correlation between treatment contact time and arsenic removal. The results of this last test will help design future, potentially shorter, pilot tests. In Stage 2, additional columns using the Isolux 302M, MetSorb, and AD33 media will be evaluated at an adjusted pH of 6.8 to determine the effect on arsenic removal capacity as a function of pH. The pH will be lowered using a CO₂ injection system, which does not require the use of mineral acids. Saturation indices (Langelier and others) will be calculated for the composition of the treated water from these columns to determine their scaling tendencies. In addition, corrosivity of several of the effluent streams will be evaluated with corrosion coupons.

4.2. Quantitative Factors

The following factors will be quantified for site specific conditions based upon data collected during this testing program:

- Concentration of arsenic and other solutes as a function of bed volume and time
- Total number of bed volumes of raw water passed through column until arsenic breakthrough (10 µg/L) or until an estimate of the breakthrough can be reasonably made
- Backwash water quantity and quality
- Backwash and purge duration and frequency
- Estimated labor hours for operation and maintenance of the pilot test plant.

4.3. Principles of Operation

The unistrut skid frame is modular in construction and contains a single bank of ten independent columns for parallel operation in the downflow mode. The filter bank itself does not require electricity to operate. Each of the ten filter columns can be in the service, off line, or backwash mode regardless of the other columns operational mode. Each filter column can operate either intermittently or continuously. All modes of operation are manually controlled using ball valves.

In the operational mode the flow rate of each column is controlled by that column's rotameter. When backwashing, only one column is backwashed at a time using a common manifold for all columns. Backwashing is manually initiated based on differential pressure across a column. A portion of the service water is diverted via a tee-and-ball valve to the backwash rotameter to control the backwash flow rate for the specific column designated for backwash. Backwash is in an upflow mode. Backwash water is collected in a designated backwash tank. Prior to backwashing of a column, a minimum of two times the volume of the backwash manifold is purged prior to initiation of the backwash.

To facilitate a volumetric balance of the Springs Site pilot system, a flow meter measures total flow (volume in gallons) from the Springs main line pipe to the pilot pumping system; each column has a rotameter and totalizing flow/secondary flow rate measurement, the treated water manifold has a flow meter, and the backwash system has a flow meter to measure all backwash flow.

Flow rates for each column are controlled with rotameters. The difference in feed water and treated water pressure readings (each column has a treated water gauge) will provide loss of head across each filter.

Grab samples for on-site and laboratory analyses will be collected from the feed water and treated water sample taps, located upstream and immediately downstream of the adsorption media filter columns. Samples from these taps will be collected following the opening of their respective ball valves and a flush period of five seconds.

As arsenic-contaminated feed water passes down through each filter vessel containing the respective arsenic adsorption media, the arsenic concentration declines until it is no longer detectable. As the upper portion of the adsorption media becomes saturated, the treatment band progresses downward until all adsorptive capacity is used.

The MEI- Isolux 302M and Purolite ArsenX^{np} media are potentially regenerable; however, regeneration is not a part of this pilot project. All media will be evaluated with no regeneration or replacement.

4.3.1. Operator Requirements

The arsenic adsorption media filters are scheduled for continuous operation during the integrity verification test and during the capacity test with the exception of the potential for an occasional backwash (as required by unacceptable head loss across a filter bed). This is in concert with the Springs Site constant operation.

4.3.2. Required Consumables

Isolux 302M: two 5um pleated filter cartridges, two media cartridges
ArsenXnp: 4.74 liters of media
Metsorb: 5.94 liters of media
ARM 200: 4.46 liters of media
AD-33: 16.72 liters of media
Treated water: 3–4.5 gallons per backwash (depending on which column is backwashed – refer to Table 4-1 below)

4.3.3. Rates of Waste Production

Table 4-1 shows approximate volumes of filter backwash for each column.

Table 4-1. Backwash Volumes.

Column	Media	Backwash volume (gallons)
1	AD-33	4.5 (Phase II)
2	METSORB	4.5 (Phase II)
3	ISOLUX 302M	N/A (Phase II)
4	ARM 200	4.5
5	ArsenXnp	3
6	METSORB	4.5
7	ISOLUX 302M	N/A
8	AD-33	4.5
9	AD-33	4.5
10	AD-33	4.5

At the conclusion of the Adsorption Capacity Verification Testing for each media, TCLP and CA WET analyses will be performed by the SMOCL. All media will be removed from each column and returned to SNL for evaluation and final disposal.

4.3.4. Equipment Performance Range

Each manufacturer has stated that their arsenic adsorption media system may exhibit reduced performance when treating feed water containing high levels of potentially interfering ions such as sulfate, silica, fluoride, and phosphate, depending on pH.

4.3.5. Licensing Requirements Associated with Equipment Operation

States generally require a specific grade of waterworks operator permit in order to operate a filter process on a public water supply. However, this requirement does not apply for the Socorro Spring Site pilot since all of the treated water will be discharged to waste.

This page intentionally left blank.

5. Field Operations Procedures

5.1. Task 1: Documentation of Operating Conditions and Treatment Equipment Performance

During each day of verification testing, arsenic adsorption media filter operating conditions will be documented, including the rate of head loss gain. The volumetric flow rate through an adsorptive media vessel is a critical parameter and will be monitored and documented. Adsorptive media performance is affected by the EBCT, which varies directly with the volumetric flow rate through the vessel. Field operation procedures are described in Appendix C to this test plan. The following sections apply specifically to Stage 1 of this test; an addendum to this test plan will be written to describe Stage 2 (effect of pH adjustment and corrosivity/scaling potential).

5.1.1. Experimental Objectives

The objective of this task is to accurately and fully document the operating conditions and performance of the equipment. The task will be performed in conjunction with both the System Integrity Verification Testing and the Adsorption Capacity Verification Testing.

5.1.2. Work Plan

During each day of verification testing, both System Integrity Testing and Adsorption Capacity Testing, treatment equipment operating parameters will be monitored and recorded on a routine basis. This will include a complete description of all applicable data. Field operation and maintenance procedures and log forms are described in Appendix C to this test plan. Table C-3 in Appendix C will be used to record applicable operating data.

5.1.3. Schedule

Table 5-1 presents the schedule for observing and recording equipment operation and performance data. The schedule applies to both System Integrity Verification Testing and Adsorption Capacity Verification Testing.

Table 5-1. Schedule for Observing and Recording Equipment Operation and Performance Data.

Operational Parameter	Action
Treated water flow rate	Check and record in logbook once per day; adjust when >5% above or below target. Record before and after adjustment.
Feed water and treated water pressures	Record in logbook initial clean bed feed water and treated water pressure at the start of the run, and thereafter record once per day.
Tasks performed	Record in logbook tasks performed.
Number of hours per day operator attends to all tasks related to the treatment process	Record number of hours required by operator to accomplish all tasks.
Totalizer meter readings	Record totalizer meter reading once daily.

5.1.4. Recording Data

The following information will be recorded on-site on forms shown in Appendix C:

- Date
- Column Number
- Experimental run number
- Water type (feed, treated, waste type)
- Hours of operation
- Feed (service) Water flow rate
- Treated water flow rate
- Feed water production
- Treated water production
- Feed water pressure
- Treated water pressure
- Feed water temperature
- Feed water turbidity
- Treated water turbidity
- Feed water pH
- Treated water pH
- Feed and treated water free chlorine
- Occurrence of a backwash
- Backwash water flow rate (backwash manually initiated by field engineer)
- Backwash duration

5.1.5. Verification Testing Schedule

Verification testing activities include equipment set up and shakedown, equipment integrity and adsorptive capacity verification tests, and water quality sampling and analysis. The test schedule includes all of these activities.

The test is scheduled to begin on January 26, 2005. The integrity and adsorptive capacity verification tests will be initiated simultaneously. The integrity verification test will run for a 2-week (13 full days plus 8 hours) period. The adsorptive capacity verification test will run until approximately 10 µg/L of arsenic is detected in the treated water or until the capacity can be reasonably estimated.

5.1.6. Water Quality Sampling Protocol and Testing Equipment

Sample collection and management will be in accordance with the SNL SMO Procedure for Sample Management and custody, AOP 95-16. SMO Procedures incorporate methods and specified requirements for sample preservation and holding times. These requirements are presented in Table 5-2 for each water quality parameter. The analytical methods to be used by the SMOCL (contract lab) and WQL (SNL's Water Quality Lab) are described in Section 5.5.4. ARCOG(s) will accompany all samples collected and analyzed by the SMOCL and WQL.

Table 5-2. Water Quality Sampling Protocol.

Parameter	Sample Bottle	Sample Volume	Sample Preservation ⁷	Sample Hold Time
On-site analyses ¹	1 L HDPE	1 L	None	N/A
Nitrate ²	250mL HDPE	250mL	None, cool to 4° C for SMOCL	48 hours
Metals ³	500mL HDPE	500mL	Optima Nitric Acid, pH<2	6 months
Alkalinity, chloride, fluoride, Sulfate ⁴	1 L HDPE	1 L	None, cool to 4° C for SMOCL	28 days; Alkalinity - 14 days for for SMOCL
Total Suspended Solids (TSS) ⁵	1 L HDPE	1 L	None, cool to 4° C for SMOCL	7 days
Arsenic Speciation ⁶	1- 1L HDPE, 3- 250mL HDPE	1 at 1L and 3 at 250mL	None in the 1 L, Optima Nitric Acid in the 250 mL, pH<2	6 months
Total Organic Carbon (TOC) ⁵	250mL amber glass	250mL	Ultrapure Sulfuric acid, pH<2, cool to 4° C for SMOCL	28 days
Gross Alpha/Beta ⁵	1 L HDPE	1 L	Optima Nitric Acid, pH<2	6 months
Radium 226/228 ⁵	1 L HDPE	2 L	Optima Nitric Acid, pH<2	6 months

1. On-site analyses include conductivity, temperature, pH, free chlorine, apparent color, turbidity, and dissolved oxygen. Separation of As(III) from As(V) for speciation will be done on site by aluminosilicate adsorbent cartridge
2. These analyses will be carried out by the SMOCL and/or the WQL
3. Metals include arsenic, calcium, magnesium, sodium, aluminum, titanium, vanadium, zirconium, and silica.
4. These analyses will be carried out by the SMOCL and/or the WQL
5. Analyses will be carried out by the SMOCL
6. Separation of As(III) from As(V) for speciation will be done on site by aluminosilicate adsorbent cartridge. See Appendix D for details. The 1-L HDPE bottle is for taking initial untreated sample; from this initial sample, the three 250-mL samples will be made and sent for analysis.
7. Samples sent to WQL not stored at 4° C

Table 5-3 presents the analytical and calibration equipment that will be used on-site.

Table 5-3. Field Analytical and Calibration Equipment.

Equipment	Manufacturer/Model/Specs
Spectrophotometer	Hach Model DR2400
Turbidimeter	Hach Model 2100P
pH Meter	Hach Senslon 1
Thermometer	H-B Instrument Company (range, -10/70C) NIST Traceable)
Liquid Dissolved Oxygen Meter	Hach Model HQ10
Conductivity Meter	Hach Senslon 5
Stopwatch and "bucket"	Digital stopwatch and 2.0 L graduated cylinder with 10 mL increments for rotameter, totalizer and backwash meters calibration checks. Fifty-gallon container for backwash wastewater flow calibration
Mass Balance (kept in the WQL)	Mettler Toledo 3 kg balance

5.1.7. Communications, Documentation, Logistics, and Equipment

It is the responsibility of SNL to coordinate communication between all verification testing participants.

All field activities will be thoroughly documented using the following forms of record:

- Field Logbook
- Field Data Sheets
- Photographs
- ARCOCs

SNL is responsible for maintaining all field documentation. A bound field logbook will be used to record all water treatment equipment operating data. Each page will be sequentially numbered and labeled with the project name (SS-Socorro Springs), and the page number. Completed pages will be signed and dated by the individual responsible for the entries. Errors will have one line drawn through them and this line will be initialed and dated.

All photographs taken, when necessary, will be inserted in the field logbook. The time, date, direction, subject of the photograph and identity of the photographer will be included with each entry. Any deviations from the approved final PTSTP will be thoroughly documented in the field logbook.

Copies of ARCOC documentation, shippers, condition on receipt forms and laboratory data reports will be filed for reference.

During routine operation, the following will be documented:

- The number of hours working at the pilot site related to operation and sampling
- Description of tasks performed during arsenic adsorption media filter maintenance and sampling.

5.2. Task 2: System Integrity Verification Testing

5.2.1. Introduction

During Task 2, SNL will evaluate the reliability of equipment operation under the environmental and hydraulic conditions at the Socorro Springs pilot site and determine whether performance objectives can be achieved for arsenic removal at the design operating parameters for the arsenic adsorption media system. The adsorption media filter will be operated for integrity testing purposes within the operational range presented in the equipment design. The following sections apply specifically to Stage I of this test; an addendum to this Test Plan will be written to describe the System Integrity Verification testing for Stage 2 (pH and corrosivity/scaling evaluations).

5.2.2. Experimental Objectives

- Establish equipment operational reliability under field conditions.
- Document feed water quality
- Collect operational and water quality data under field conditions that can be related to the operating time, throughput and water quality objectives.

5.2.3. Work Plan

A balance will be used to weigh the media prior to installation into each column. The weight of the media will be reported as well as the measurement of “freeboard” from the top of the media to the top of the unit (top of the opening in each filter tank where the media is added).

The feed water and treated water sample taps will be flushed for at least five seconds prior to sample collection.

Feed water and treated water samples will be collected on three separate days to speciate arsenic. The protocol for arsenic speciation is presented in Appendix D.

If any of the columns requires backwashing during the System Integrity Verification Test, the field engineer will manually initiate the backwash procedure. Backwash water flow, duration, and volume will be monitored volumetrically and recorded and the water quality will be analyzed.

Table 5-4 describes the monitoring frequency and method for on-site equipment operating parameters.

Table 5-4. On-site Equipment Operating Parameter Monitoring and Data Collection Schedule.

Parameter	Monitoring Frequency	Monitoring Method
Treated water flow rate	Check and Record once daily (adjust when 5% above or below target; record before and after adjustment)	Rotameter
Feed water and treated water production	Check and record once daily	Feed and treated totalizer
Feed water pressure	Check and record once daily	Feed water pressure gauge
Treated water pressure	Check and record once daily	Treated water pressure gauge

5.2.4. Analytical Schedule

Operational Data Collection

- Treated water flow rate will be monitored at least once per day and adjusted, as needed, with the rotameter and diaphragm valve located on the treated water pipe. Flow rate will be recorded. Flow rates will be set in accordance with the recommended rates shown for each media in Tables 3-11 through 3-15.
- Feed water and treated water production will be monitored at least once per day at the totalizer meters located on the feed water and treated water pipes.
- Feed water pressure will be monitored at the pressure gauge located on the feed water pipe on the top of each media column.
- Treated water pressure will be monitored at the pressure gauge located on the treated water pipe at the bottom of each column. This will be performed at the same time as the feed water pressure measurement. The difference between these valves will represent head loss through the media.

Water Quality Data Collection

The water quality of the feed water and treated water will be characterized by analysis of the water quality parameters listed on Table 5-5.

Temperature, pH, turbidity, conductivity, apparent color, dissolved oxygen and free chlorine will be analyzed on-site.

Arsenic will be analyzed by the WQL within 48 hrs as an alternative to field qualitative testing (Table 5-6).

Table 5-5. Water Quality Sampling Schedule for System Integrity Verification Testing

Parameter	Sampling Frequency	Test Streams	Method Used ⁽⁵⁾	Comments
<i>On-Site Analyses</i>				
Conductivity	Daily	Feed and Treated	HACH 8160B (Direct Measurement Method)	Equivalent to EPA 120.1, Std Mtd 2510B
Temperature	Daily	Feed and Treated	Std Mtd 2550B	Utilized digital thermometer on HACH conductivity meter
pH	Daily	Feed and Treated	Std Mtd 4500-H ⁺	
Free Chlorine	Daily	Treated	HACH 8021 (DPD)	Equivalent to Std Mtd 4500-Cl G
Turbidity	Daily	Feed and Treated	Std Mtd 2130 B	
Apparent Color	Daily	Feed and Treated	2120 C	Not done
Dissolved Oxygen	Daily	Feed and Treated	4500-O G	Nor done
<i>Laboratory Analyses</i>				
Total Arsenic ⁽¹⁾	Daily	Feed and Treated	EPA 200.8	
Speciated Arsenic ⁽²⁾	Three times during the 14 days	Feed and Treated	EPA 200.8	
Iron	Daily	Feed and Treated	EPA 200.7 – SMOCL AA Spectroscopy – WQL	
Titanium ⁽³⁾	Daily	Treated	EPA 200.7, 200.8	
Zirconium ⁽⁴⁾	Daily	Treated	EPA 200.7, 200.8	
Alkalinity	Daily	Feed and Treated	2320B/310.1 – SMOCL HACH 8203 – WQL	
Total Suspended Solids	Daily	Treated	Std Mtd 2540-D	SMOCL Only
Nitrate	Weekly	Feed and Treated	EPA 300.0	SMOCL Only
Calcium	Weekly	Feed and Treated	EPA 200.7 – SMOCL AA Spectroscopy – WQL	
Magnesium	Weekly	Feed and Treated	EPA 200.7 – SMOCL AA Spectroscopy – WQL	
Sodium	Weekly	Feed and Treated	EPA 200.7 – SMOCL AA Spectroscopy – WQL	

Table 5-5. Water Quality Sampling Schedule for System Integrity Verification Testing (continued)

Parameter	Sampling Frequency	Test Streams	Method Used ⁽⁵⁾	Comments
Silica	Weekly	Feed and Treated	EPA 200.7 – SMOCL HACH 8185 – WQL	HACH method is the Silicomolybdate Method
Aluminum	Weekly	Feed and Treated	EPA 200.7, 200.8	
Vanadium	Weekly	Feed and Treated	EPA 200.7, 200.8	
Gross Alpha/Beta	Weekly	Feed and Treated	EPA 900	SMOCL Only
Radium 226/228	Weekly	Feed and Treated	EPA 903.1, 904	SMOCL Only
Chloride	Weekly	Feed and Treated	EPA 300.0	
Fluoride	Weekly	Feed and Treated	EPA 300.0	
Phosphate	Weekly	Feed and Treated	EPA 300.0	SMOCL Only
Sulfate	Weekly	Feed and Treated	EPA 300.0	
Total Organic Carbon (TOC)	Weekly	Feed and Treated	SW 846 9060	SMOCL Only

1. Total arsenic will be measured within 48 hours of sampling by ICP-MS in the WQL in lieu of on-site qualitative analysis. The SMOCL will also analyze for total arsenic.
2. Separation of As(III) from As(V) for speciation will be done by aluminosilicate adsorbent cartridge. See Appendix D for details.
3. Analyses only for Hydroglobe Columns.
4. Analyses only for MEI cartridges.
5. Reference for the Standards Methods is APHA 1998; reference for EPA Methods is USEPA 2005.

Table 5-6. Arsenic Sampling Plan Laboratory Analyses – SMOCL and WQL ⁽¹⁾

Test Period	Sample Sources	Sample Frequency	Sampling Period	No. of Days Samples Speciated	Hold Samples
Integrity Verification	Feed, treated	Daily	14 days	3	None
Adsorption Capacity Verification	Feed, treated	2 times per week	Until total arsenic > 2 µg/L	At least 3	None
Adsorption Capacity Verification	Feed, treated	3 times per week	Until total arsenic > 10 µg/L		2/week ⁽²⁾

1. Either WQL or SMOCL or both laboratories will perform analyses for arsenic. Initially, SMOCL will perform all analyses until WQL has completed all quality control checks and comparisons. WQL will then analyze all arsenic samples, and SMOCL will perform a “split sample analysis” at least once per month for a quality check.
2. Once total arsenic in the treated water is > 6 µg/L, three samples for arsenic will be collected each week. The “normal” weekly samples will be analyzed. If arsenic is rapidly rising since the previous week (> 2 µg/L increase), then the third sample will be analyzed for arsenic. Otherwise, the third sample will be discarded.

5.2.5. Evaluation Criteria and Minimum Reporting Requirements

Operational performance evaluation

A table and time series plot will be produced to present all feed water (chlorinated and unchlorinated) and treated water arsenic laboratory data from the System Integrity Verification testing. The System Integrity Verification testing demonstrates the initial ability of the adsorptive media to remove the feed water arsenic concentration to below detectable levels in the treated water.

Tables of water flow rates will include:

- Treated water flow rates
- Backwash waste stream and control module discharge flow rates
- Backwash waste stream and control module flow rates

A plot of feed and treated water pressure and system head loss will be presented.

5.3. Task 3: Adsorptive Capacity Verification Testing

5.3.1. Introduction

The objectives of this task are to produce quality operational and water quality data up through and including the defined breakthrough arsenic level (10 µg/L or less) for each sorptive media. The performance of the adsorptive media will be a function of the feed water quality, EBCT, rest time, and type of adsorptive media used. Arsenic breakthrough is highly dependent on the arsenic concentration and adsorptive characteristics (isotherm) of the adsorptive media.

5.3.2. Experimental Objectives

The objectives of Stage I the Socorro Pilot include evaluation of:

- The comparative treatment performance of five adsorptive media using chlorinated water at the ambient pH from the Socorro Springs by measuring the total number of bed volumes of raw water passed through column until arsenic breakthrough (10 µg/L) or until an estimate of the breakthrough can be reasonably made;
- Comparison of media performance to predictions based on vendor data and results of laboratory studies carried out at SNL (RSSCT and supporting experiments);
- The effect of contact time on the performance (bed volume [BV] until breakthrough) of the AD33 granular ferric oxide media (AdEdge);
- Required backwash water quantity and quality for each media over an extended time period;
- Required backwash and purge duration and frequency for each media over an extended time period; and
- Limited assessment of maintenance and operational requirements for all media over an extended time period.

5.3.3. Work Plan

Stage 1 Task 2 Adsorption Capacity Verification Testing will begin simultaneously with Stage 1 Task 1 System Integrity Verification Testing. The operating conditions will be as stated under 5.2.3 Work Plan for Task 1: System Integrity Verification Testing. Log sheets for operations and water quality sampling are found in Appendix C.

5.3.4. Analytical Schedule

Operational Data Collection

- Treated water flow rate will be monitored once per day at the rotameter located on the treated water pipe.
- Feed and treated water production will be monitored once per day at the totalizer meters located on the feed and treated water pipes.
- Feed water pressure will be monitored once per day at the pressure gauge located on the feed water pipe to each column.
- Treated water pressure will be monitored once per day at the pressure gauge located on the treated water pipe on each column.

Sample Holding

As indicated on Table 5-6, samples for laboratory arsenic will be collected on a weekly basis (staggered from standard samples) and held (approximately 2 weeks) pending the results of the standard arsenic samples. This is done in the event that arsenic breakthrough is missed with the standard sampling. If a breakthrough should happen to be missed, the hold samples will be submitted for analysis. The first detection of arsenic at a level of 6 ppb or higher in the treated water (and all previous treated water lab results for arsenic were non-detects) will also trigger more frequent (triweekly to daily) sample collection for laboratory arsenic analysis and/or submittal of any recently collected samples being held for future arsenic analysis.

Water Quality Data Collection

The adsorptive media feed water quality, treated water quality and wastewater quality will be characterized by the analysis of the water quality parameters listed in Tables 5-7 and 5-8. The sampling frequency is described in Tables 5-6, 5-7, and 5-8. This frequency is intended to provide sufficient water quality data to effectively characterize the breakthrough profile of arsenic and to develop a representative wastewater quality profile. The exact sampling interval and duration will depend on the length of the verification testing. The verification test and sampling plan will continue until breakthrough as defined above occurs.

Grab samples of backwash wastewater will be collected for the water quality analyses at the frequency presented on Table 5-8. The backwash and purge collection procedure is for all columns where backwash is necessary. The samples will be mixed to maintain a relatively homogenous suspension during sample collection.

Table 5-7. Water Quality Sampling Schedule Media Adsorption Capacity Verification Testing

Parameter	Sampling Frequency	Test Streams	Method Used ⁽⁵⁾	Comments
<i>On-Site Analyses</i>				
Conductivity	Bi-weekly	Feed and Treated	HACH 8160B (Direct Measurement Method)	Equivalent to EPA 120.1, Std Mtd 2510B
Temperature	Bi-weekly	Feed and Treated	Std Mtd 2550B	Utilized digital thermometer on HACH conductivity meter
pH	Bi-weekly	Feed and Treated	Std Mtd 4500-H ⁺	
Free Chlorine	Bi-weekly	Treated	HACH 8021 (DPD)	Equivalent to Std Mtd 4500-Cl G
Turbidity	Bi-weekly	Feed and Treated	Std Mtd 2130 B	
Apparent Color	Bi-weekly	Feed and Treated	2120 C	Not done
Dissolved Oxygen	Bi-weekly	Feed and Treated	4500-O G	Not done
<i>Laboratory Analyses</i>				
Total Arsenic ⁽¹⁾	Weekly	Feed and Treated	EPA 200.8	
Speciated Arsenic ⁽²⁾	Minimum 3X during test	Feed and Treated	EPA 200.8	
Iron	Weekly	Feed and Treated	EPA 200.8	
Titanium ⁽³⁾	Weekly	Treated	EPA 200.8	
Zirconium ⁽⁴⁾	Weekly	Treated	EPA 200.7 – SMOCL AA Spectroscopy – WQL	
Alkalinity	Weekly	Feed and Treated	EPA 200.7, 200.8	
Total Suspended Solids	Weekly	Treated	EPA 200.7, 200.8	
Nitrate	Weekly	Feed and Treated	2320B/310.1 – SMOCL HACH 8203 – WQL	
Calcium	Weekly	Feed and Treated	Std Mtd 2540-D	SMOCL Only
Magnesium	Weekly	Feed and Treated	EPA 300.0	SMOCL Only
Sodium	Weekly	Feed and Treated	EPA 200.7 – SMOCL AA Spectroscopy – WQL	
Silica	Weekly	Feed and Treated	EPA 200.7 – SMOCL AA Spectroscopy – WQL	
Aluminum	Weekly	Feed and Treated	EPA 200.7 – SMOCL AA Spectroscopy – WQL	
Vanadium	Weekly	Feed and Treated	EPA 200.7 – SMOCL HACH 8185 – WQL	HACH method is the Silicomolybdate Method

Table 5-7. Water Quality Sampling Schedule Media Adsorption Capacity Verification Testing (continued)

Parameter	Sampling Frequency	Test Streams	Method Used ⁽⁵⁾	Comments
Gross Alpha/Beta	Monthly	Feed and Treated	EPA 200.7, 200.8	
Radium 226/228	Monthly	Feed and Treated	EPA 200.7, 200.8	
Chloride	Weekly	Feed and Treated	EPA 900	SMOCL Only
Fluoride	Weekly	Feed and Treated	EPA 903.1, 904	SMOCL Only
Phosphate	Weekly	Feed and Treated	EPA 300.0	
Sulfate	Weekly	Feed and Treated	EPA 300.0	
Total Organic Carbon (TOC)	Weekly	Feed and Treated	EPA 300.0	SMOCL Only

1. Total Arsenic will be measured within 48 hours of sampling by ICP-MS in the WQL in lieu of on-site qualitative analysis. The SMOCL will also analyze for total arsenic.
2. Separation of As(III) from As(V) for speciation will be done by aluminosilicate adsorbent cartridge. See Appendix E for details.
3. Analyses only for Hydroglobe columns.
4. Analyses only for MEI cartridges.
5. Reference for the Standards Methods is APHA 1998; reference for EPA Methods is USEPA 2005.

Table 5-8. Backwash Wastewater, and Purge Water Monitoring, Sampling and Analyses.

Parameter	Sample type	Frequency	Method ³
Flow rate	Manual reading	with every backwash	Bucket and stopwatch
Volume	Manual reading	with every backwash	2L Graduated Cylinder
Duration	Manual reading	with every backwash	Stopwatch
Turbidity	Grab ⁽¹⁾	with every backwash	EPA 180.1
pH	Grab ⁽¹⁾	with every backwash	SM 4500-H ⁺
Arsenic	Grab ⁽¹⁾	with every backwash	EPA 200.8
Iron	Grab ⁽¹⁾	with every backwash	EPA 200.7
Titanium ²	Grab ⁽¹⁾	with every backwash	EPA 200.8
Conductivity	Grab ⁽¹⁾	with every backwash	SM 2510B
Alkalinity	Grab ⁽¹⁾	with every backwash	2320B/8203
Calcium	Grab ⁽¹⁾	with every backwash	EPA 200.7
Magnesium	Grab ⁽¹⁾	with every backwash	EPA 200.7
Silica	Grab ⁽¹⁾	with every backwash	EPA 200.7
TSS	Grab ⁽¹⁾	with every backwash	SM 2540D

1. Entire backwash volume will be collected in a container and a grab sample collected from the container.
2. Titanium will be measured in Columns 2 and 6 backwash.
3. Reference for the Standards Methods is APHA 1998; reference for EPA Methods is USEPA 2005.

Arsenic Speciation

The minimum frequency for arsenic speciation is presented on Table 5-6. If arsenic is detected in a treated water sample as determined by the SMOCL or WQL analysis, follow-up samples of feed and treated water will be speciated. In addition, if the WQL detects arsenic above 2 µg/L in the treated water, then the next sample collected for laboratory arsenic analysis should be speciated.

Analyses of Spent Media

- Samples of spent media will be taken from the columns at the end of the test as described in Appendix E. The physical condition of the spent media will be noted and reported. Each sample will be collected in a separate sample bag and marked with appropriate information indicating its source and required laboratory tracking information. One sample will be used for TCLP. The second sample will be used for CA WET.
- TCLP and CA WET will be performed on spent media. Where appropriate, other tests may be carried out on spent media to characterize the extent of media physical degradation, if any.

5.3.5. Evaluation Criteria and Minimum Reporting Requirements

Record of Arsenic Removal

- An arsenic breakthrough curve showing adsorptive media treated water concentrations versus volumes treated will be plotted. Feed water arsenic concentrations will be included on the same plot.
- A spreadsheet table will tabulate arsenic feed water concentrations and calculate the average feed water arsenic concentration.
- A laboratory data plot comparing analyzed by WQL and SMOCL will be maintained. The plot will include the acceptable relative percent deviation range for the data.

Process Control

Adsorptive media feed water and treated water pressure water production will be recorded on forms from Appendix C, which will be used to calculate incremental feed and treated water production and differential pressure. Included will be the adsorptive media feed water average, standard deviation and percent standard deviation for each parameter.

5.4. Task 4: Data Management

5.4.1. Introduction

The data management system that will be used in this verification involves the use of computer spreadsheet software and manual recording of system operating parameters.

5.4.2. Experimental Objectives

The objective of this task is to establish a viable structure for the recording and transmission of field testing data and sufficient and reliable data for verification purposes.

5.4.3. Work Plan

The following outline is for onsite data handling and data verification by SNL.

SNL will record operating and water quality data and calculations as follows:

- Daily measurements will be recorded on specially prepared data log sheets (see example in Appendix B).
- The data log sheets will be dated and initialed by the field engineer.
- A field logbook will be used to record observations, calculations, maintenance activities, and other pertinent information on the system operation.
- The logbook will be permanently bound with consecutively numbered pages.
- The logbook will indicate the starting and ending dates that apply to entries in the logbook.
- All pages will have appropriate headings to avoid entry omissions.
- All logbook entries will be made in black water-insoluble ink.
- All corrections in the logbook will be made by placing one line through the erroneous information and initialed by the field technician.
- Pilot operating logs will include a description of the adsorptive media equipment, description of test run(s), names of visitors, description of any problems or issues, etc; such descriptions will be provided in addition to experimental calculations and other items.

The original logbook and field data sheets will be stored with sampling and analysis kit. The original logbook and field data sheets will be photocopied at least once per week and copies filed at SNL. This protocol will not only ease referencing the original data, but offer protection of the original record of results.

The database for this verification testing program will be set up in the form of custom-designed spreadsheets. The spreadsheets will be capable of storing and manipulating each monitored water quality and operational parameter from each task, each sampling location, and each sampling time. All data from the laboratory notebooks and data log sheets will be entered into the appropriate spreadsheets. Data entry will be conducted off-site by the designated individual. All recorded calculations will also be checked at this time. Following data entry, the spreadsheet will be printed out and another individual will check the printout against the handwritten data sheet. Any corrections will be noted on the hard copies and corrected on the screen, and then a corrected version of the spreadsheet will be printed out. The individual performing the entry or verification step will initial each step of the verification process.

Each experiment (i.e., each test run) will be assigned a run number that will then be tied to the data from the experiment through each step of data entry and analysis. As samples are collected and sent to the SMOCL and WQL, the data will be tracked using unique sample identification numbers, ARCO numbers, and experiment run numbers. Sample collection information will be captured on the ARCO and tracked in the SMO tracking database for samples sent to the SMOCL. WQL samples will be tracked in a similar manner by the WQL. The analytical data will be reviewed by the SMO and designated SNL team members assigned to the project. All data will be peer reviewed for completeness and accuracy.

5.5. Task 5: Quality Assurance/Quality Control (QA/QC)

5.5.1. Introduction

Quality assurance and quality control for the operation of the arsenic adsorption media filter and the measured water quality parameters will be maintained during the Pilot Study.

5.5.2. Experimental Objectives

The objective of this task is to maintain strict QA/QC methods and procedures during this verification. Maintenance of strict QA/QC procedures is important so that it will be possible to verify exact conditions at the time of testing if a question arises when analyzing or interpreting data collected for the arsenic adsorption media filter.

5.5.3. Work Plan

Equipment flow rates will be verified and verification recorded on a routine basis. A routine daily walk-through during testing will be established to verify that each piece of equipment or instrumentation is operating properly. The items listed below are in addition to any specified checks outlined in the analytical methods.

It is extremely important that system flow rates are maintained at set values and monitored frequently. Doing so allows a constant and known EBCT to be maintained in the adsorptive media. Adsorptive media performance is directly affected by the EBCT, which in turn is proportional to the volumetric flow rate through the media. Therefore, an important QA/QC objective will be the maintenance of a constant volumetric flow rate through the adsorptive media by frequent monitoring and documentation. Documentation will include an average and standard deviation of recorded flow rates through the adsorptive media.

Weekly QA/QC Verifications will include:

- In-line rotameter (clean any foulant buildup as needed and verify flow rate volumetrically)
- In-line totalizer meters (clean any foulant buildup as needed and verify flow volume)
- Tubing (verify good condition of all tubing and connections, replace as necessary)

5.5.4. Analytical Methods

The analytical methods utilized in this study for both on-site and laboratory analyses of water quality parameters are listed below. Reference for the Standards Methods is APHA 1998; reference for EPA Methods is USEPA 2005.

Arsenic

Arsenic analyses will be performed by the SMOCL using EPA Method 200.8. These analyses are the most critical for the pilot test. Accelerated analytical turnaround time is required to achieve optimum process control. Samples will be preserved with ultrapure optimum grade nitric acid.

Arsenic analyses will also be performed in the WQL at SNL in lieu of on-site analyses. These analyses will use Perkin Elmer Elan 6100 ICP-MS and EPA Method 200.8.

pH

Analyses for pH will be performed on-site according to Standard Method 4500-H+ B (Electrometric Method). A three-point calibration of the pH meter used in this study will be performed once per day when the instrument is in use. Certified pH buffers 4.0, 7.0, and 10.0 will be used. The pH electrode will be stored in the appropriate solution defined in the instrument manual.

Alkalinity

Analyses for alkalinity will be performed by the SMOCL according to Method 310.1 and at the WQL using Hach Method 8203 (Titrametric) or SM 3320-B.

Fluoride

Analyses for fluoride will be performed by the SMOCL according to EPA method 300.0 and at the WQL using Hach method 4500-F-C (Ion-Selective Electrode Method) or EPA 300.0.

Chloride

Analyses for chloride will be performed by the SMOCL according to EPA Method 300.0. The WQL will use EPA 300.0 or Hach method 8207.

Sulfate

Analyses for sulfate will be performed by the SMOCL according to EPA Method 300.0. The WQL will use EPA 300.0 or Hach method 8051.

Silica

Analyses for silica will be performed by the SMOCL according to EPA Method 200.7. The WQL will use 200.7 or Hach method 8185.

Aluminum

Analyses for aluminum will be performed by the SMOCL according to EPA Method 200.7. The WQL will use Perkin Elmer AAnalyst 200 Atomic Absorption Spectroscopy.

Calcium

Analyses for calcium will be performed by the SMOCL according to EPA Method 200.7. The WQL will use EPA 200.7. The WQL will use Perkin Elmer AAnalyst 200 Atomic Absorption Spectroscopy.

Hardness

Analyses for total hardness will be performed by the SMOCL using EPA Method 130.2. The WQL will use SM 2340-C (calculation).

Magnesium

Analyses for magnesium will be performed by the SMOCL according to EPA Method 200.7. The WQL will use The WQL will use Perkin Elmer AAnalyst 200 Atomic Absorption Spectroscopy.

Iron

Analyses for iron will be performed by the SMOCL and WQL according to EPA Method 200.7. The WQL will use The WQL will use Perkin Elmer AAnalyst 200 Atomic Absorption Spectroscopy.

Turbidity

Turbidity analyses will be performed on-site according to Standard Method 2130 B using a portable turbidimeter.

Temperature

Temperature will be analyzed on-site according to Standard Method 2550 B.

Zirconium

Analyses for zirconium will be performed by the SMOCL and the WQL using EPA Method 200.8.

Titanium

Analyses for titanium will be performed by the SMOCL and the WQL using EPA Method 200.7 or 200.8

Sodium

Analyses for sodium will be performed by the SMOCL using EPA Method 200.7. The WQL will use Perkin Elmer AAnalyst 200 Atomic Absorption Spectroscopy.

Vanadium

Analyses for vanadium will be performed by the SMOCL and the WQL using EPA Method 200.7.

Nitrate

Analyses for nitrate will be performed by the SMOCL and WQL using EPA Method 300.0. WQL may use SM4500-NO3-D or Hach 8039.

Corrosivity

Corrosivity will be calculated using SM 2330B.

Total Suspended Solids (TSS)

Analyses for TSS will be performed by the SMOCL according to standard method 2540-D.

Free Chlorine

Analyses for free chlorine will be performed on-site according to SM 4500-Cl-G or Hach method 8021.

Conductivity

Conductivity will be determined on-site according to Hach method 8160 or SM 2510 B.

Total Organic Carbon (TOC)

Analyses for TOC will be performed by the SMOCL according to EPA method SW-846 9060.

Gross Alpha/Beta

Analyses for gross alpha/beta will be performed by the SMOCL according to EPA method 900.

Radium 226/228

Analysis for both Radium 226 and 228 will be performed by the SMOCL according to EPA method 903.1 and 904.

TCLP

Toxicity Characteristic Leaching Procedures will be performed on spent media by the SMOCL or WQL using EPA SW-846 Method 1311. The SMOCL or WQL will use EPA SW-846 Method 6010B for metals analyses on the leachate generated by 1311 including As, Ba, Cd, Cr, Cu, Ni, Pb, Se, Ag, and Zn; and Method SW-846 7470A for Hg.

CA WET

California Waste Extraction Test will be performed on spent media by the SMOCL or WQL using EPA procedures EPA SW-846 Method 6010B for metals analyses on the leachate generated by the CA WET.

5.5.5. Samples Shipped Off-Site for Analysis

Samples will be cooled and maintained at method-specified temperature (4 degrees Celsius +/- 2 Degrees) until analysis by the SMOCL and WQL. Section 5.1.6 presents the sampling protocol that will be followed.

6. Quality Assurance Project Plan (QAPP)

The QAPP for this verification testing specifies procedures that will be used to ensure data quality and integrity. Careful adherence to these procedures will ensure that data generated from the Pilot Study will provide sound analytical results that can serve as the basis for the performance verification. It is recognized that this PTSTP is the first plan written for the Sandia Arsenic Treatment Technology Demonstration project (SATTD). Because this program is a research program involving first attempts at this kind of test, the procedures may require modification as a result of the initial results. Deviations from the procedures and controls described in this PTSTP will be documented in the final report for the pilot test.

6.1. Purpose and Scope

The purpose of this section is to outline steps that will be taken by SNL and by SMOCL/WQL to ensure that data resulting from the pilot test is of known quality and that a sufficient number of critical measurements are taken.

6.2. Quality Assurance Responsibilities

A number of individuals will be responsible for monitoring equipment-operating parameters and for sampling and analysis QA/QC throughout the verification testing. Primary responsibility for ensuring that both equipment operation and sampling and analysis activities comply with the QA/QC requirements of this PTSTP rests with SNL.

The SMO is responsible for QA/QC of the SMOCL that will analyze samples sent off-site. If problems arise or any data appear unusual, they will be thoroughly documented, and corrective actions will be implemented as specified in this section. The QC measurements made by the SMOCL will be in accordance with the SMO Statement of Work and reported with the sample data and as described in the following sections.

The SMOCL is responsible for performing work in accordance to their procedures and the SMO Statement of Work. Data packages will include sample data, QC, calibration, and other documentation that support data defensibility. Data will be provided in both hard copy and electronic format.

SNL will review all data records to ensure compliance to test plan requirements.

WQL is responsible for performing analysis according to WQL procedures and analytical manufacturers' specifications. WQL will maintain data plots comparing sample splits between WQL and the SMOCL.

SMOCL will retain and will not discard the arsenic and metals samples for 90 days to ensure that the data is valid and the samples can be discarded. Samples with short holding times can be discarded by the SMOCL using their normal procedures.

This procedure will reduce the risk that data quality problems could jeopardize the test program. If problems are detected, SNL will be notified immediately by the SMO and appropriate corrective action will be taken. This procedure does not release the SMOCL from having the primary responsibility to produce analytical results that meet the QA requirements and follow the specified EPA procedures.

6.3. Data Quality Indicators

The data obtained during the verification testing must be of sound quality for conclusions to be drawn on the media. For all measurement and monitoring activities conducted for equipment verification, we will be using data quality parameters that were established based on the proposed end uses of the data. Data quality parameters include: representativeness, accuracy and precision.

Treatment results generated by the equipment and by the laboratory analyses must be verifiable for the purposes of this program to be fulfilled. High quality, well-documented analytical laboratory results are essential for meeting the purpose and objectives of this verification testing. Therefore, the following indicators of data quality will be closely evaluated to determine the performance of the equipment when measured against data generated by the analytical laboratory.

6.3.1. Representativeness

Representativeness refers to the degree to which the data accurately and precisely represent the conditions or characteristics of the parameter represented by the data. In this verification testing, representativeness will be ensured by executing consistent sample collection protocol, including sample locations, timing of sample collection, sampling procedures, sample preservation, sample packaging, and sample shipping. Representativeness also will be ensured by using each method at its optimum capability to provide results that represent the most accurate and precise measurement it is capable of achieving. For equipment-operating data, representativeness entails collecting a sufficient quantity of data during operation to be able to detect a change in operations. For most water treatment processes involving arsenic removal, detecting a +/- 10% change in an operating parameter (i.e., head loss, pressure) is sufficient. Flow rates will be adjusted if they deviate by more than $\pm 5\%$ of the targeted flow rate for each media.

6.3.2. Accuracy

The definition of accuracy depends on the context and is defined as the following:

Water quality analyses – difference between a sample result and the reference or true value for the sample. Loss of accuracy can be caused by:

- Errors in standards preparation
- Equipment calibrations
- Loss of target analyte in the extraction process
- Chemical interferences
- Systematic or carryover of contamination from one sample to the next

Arsenic speciation columns QA check – each lot of the arsenic speciation columns will be checked once against samples with known concentrations of As(III) and As(V) by the field engineer who will be performing the speciation procedure onsite. This QC check will assure that the column was properly prepared by the manufacturer, is performing as expected, and is being used correctly. The samples will be sent to SMOCL or the WQL after speciation for analysis.

pH QA – checks will consist of conducting a 3-point calibration of the pH meter, before each use, with certified pH buffers 4.0, 7.0 and 10.0. If the accuracy of the pH electrode falls outside 95% to 105%, the electrode will be rehabilitated according to manufacturer's recommendations or discarded.

Temperature QA checks – readings will be made using a digital thermometer that is part of the field equipment (conductivity and dissolved oxygen meters). The field thermometer will be checked for accuracy against an NIST-traceable certified reference thermometer on a monthly basis.

Turbidimeter QA checks – the portable turbidimeter will be calibrated according to the manufacturer's instructions before each set of measurements using primary turbidity standards (i.e., at least every three months.)

Accuracy of analytical readings is measured through the use of spiked samples, that is, a known quantity of a target analyte is added to a sample. The percent recovery is calculated as a measure of the accuracy. Acceptance limits for percent recovery are analyte and concentration specific. Tables 6-1 and 6-2 present the frequency and the acceptable accuracy limits for the laboratory and on-site spiked samples, respectively.

The calibration procedures for the analyses of samples for parameters shown in Table 6-1 will be as follows:

A calibration check standard is analyzed at a frequency of 10% with acceptable criteria of +15% for arsenic, titanium, zirconium, and vanadium, and +10% for calcium, magnesium, iron, aluminum and silica. A calibration check standard is analyzed at a frequency of 10% with acceptable criteria of +10% for chloride, fluoride, nitrate, sulfate, and TOC. If a spiked sample is not within acceptable criteria, the sample and spike are either reanalyzed or re-spiked and reanalyzed. If still not within acceptable criteria, a comment is placed on the report indicating possible matrix interference. The same procedure applies to duplicates. A comment in that case may be that the sample may not be homogenous. If a calibration check standard does not meet the acceptable criteria, the samples following the last acceptable calibration check standard must be reanalyzed.

Table 6-1. Laboratory Water Quality Indicators

Parameter	Lab Spike Frequency	Acceptable Accuracy (% Recovery)	Lab Duplicate Frequency	Acceptable Precision*
Arsenic	10%	90-110%	10%	25%
Titanium	10%	80-120%	10%	25%
Zirconium	10%	80-120%	10%	30%
Iron	10%	80-120%	10%	25%
Calcium	10%	80-120%	10%	25%
Magnesium	10%	80-120%	10%	25%
Sodium	10%	80-120%	10%	25%
Silica	10%	80-120%	10%	25%
Aluminum	10%	80-120%	10%	25%
Vanadium	10%	80-120%	10%	25%
Alkalinity	N/A	N/A	10%	25%
Chloride	10%	85-115%	10%	25%
Fluoride	10%	85-115%	10%	25%
Sulfate	10%	85-115%	10%	25%
Nitrate	10%	85-115%	10%	25%
TSS	N/A	N/A	10%	25%
TOC	10%	70-130%	10%	30%

*All precision limits are based on Relative Percent Standard Deviation as shown in Section 6.3.3. For all laboratory duplicate analyses, the first analysis is considered the sample, and that result is reported. The duplicate analysis is used for calculating precision per Section 6.3.3.

Table 6-2. On-site Water Quality Indicators

Parameter	Spike Frequency	Acceptable Accuracy (% Recovery)	Duplicate Frequency	Acceptable Precision*
pH	N/A	N/A	10%	± 0.2 S.U.
Temperature	N/A	N/A	10%	± 25%
Conductivity	N/A	N/A		± 25%
Free Chlorine	10%		10%	± 25%
Turbidity	N/A	N/A	10%	± 25%
Dissolved Oxygen	N/A	N/A	10%	± 25%
Apparent Color	N/A	N/A	10%	± 2 S.U.

*All precision limits are based on Relative Percent Standard Deviation as shown in Section 6.3.3. For all on-site duplicate analyses, the first analysis is considered the sample, and that result is reported. The duplicate analysis is used for calculating precision per Section 6.3.3.

On-site analyses for pH, temperature, apparent color, conductivity, dissolved oxygen, and turbidity do not lend themselves to spike samples and percent recovery or blank analyses. The accuracy for these analyses is ensured by proper meter calibration for pH and turbidity using

three point curves (buffers and turbidity standards). Temperature will be calibrated using a NIST traceable thermometer. Dissolved oxygen meter and conductivity meters are calibrated using manufacturer's recommended procedures.

Methods used to quantify the differences between the reported operating conditions and the actual operating conditions for flow and head loss are listed below:

- Water flow – difference between the reported flow indicated by a flow meter and the flow as actually measured on the basis of known volumes of water and carefully defined times as practiced in hydraulics laboratories or water meter calibration shops. The "bucket and stopwatch" technique will be used to determine the accuracy of the rotameter and accessory totalizer meters.
- Headloss measurement – accuracy will be determined by using a dead weight pressure tester to check the calibration of the pressure gauges.

Meters and gauges will be checked at the frequencies presented on Table 6-3 for accuracy, and when proven to be dependable over time, the time interval between accuracy checks will be increased. Inaccurate pressure gauges and meters will be replaced.

Table 6-3. Field Instrument Calibration Schedule.

Instrument	Calibration Method	Frequency	Acceptable Accuracy
Rotameter	Volumetric "bucket and stopwatch"	Weekly	+/- 10%
Totalizer Meters	Volumetric "bucket and stopwatch"	Weekly	+/- 10%
Pressure Gauges	Dead weight pressure tester	Beginning and end of test	+/- 10%
Portable Turbidimeter	Primary turbidity standards	Every use	Calibration curve set by standard
Portable pH Meter	Three-point calibration using 4.0, 7.0 and 10.0 buffers	Every use	Calibration by standards
Thermometer	Calibration against NIST certified thermometer	Monthly	+/- 5%
Portable Conductivity Meter	Calibration to primary conductivity standards	Every Use	+/- 10%
Dissolved Oxygen Meter	Calibration per manufacturer procedure	Every Use	Calibration set per manufacturer procedure
Free Chlorine Analyzer	Blank and Known standard	Weekly	+/- 10% for known standard.

6.3.3. Precision

Precision refers to the degree of mutual agreement among individual measurements and provides an estimate of random error. Analytical precision is a measure of how far an individual measurement may be from the mean of replicate measurements. The standard deviation and the relative standard deviation will be reported as a means to quantify sample precision. The percent relative standard deviation will be calculated in the following manner:

$$\text{Percent Relative Standard Deviation} = S(100) / X_{\text{average}}$$

where: S = standard deviation
X_{average} = the arithmetic mean of the duplicate values

Standard Deviation is calculated as follows:

$$\text{Standard Deviation} = \sqrt{\frac{\sum_{i=1}^n (X_i - X)^2}{(n - 1)}}$$

where: X_i = the individual recovery values
X = the arithmetic mean of the recovery values
n = the number of determinations

Tables 6-1 and 6-2 present the frequency of laboratory and on-site duplicates, respectively, and the acceptable percent relative standard deviation for each analyte where applicable.

In addition to the regular laboratory duplicates used by the laboratory to establish the precision of the laboratory measurements, field duplicate and analytical split samples will be collected and analyzed to determine the precision of the overall sampling and analysis procedures. Field duplicate samples will be collected and analyzed for all onsite and laboratory analysis for every ninth sample collected. Analytical split samples will be collected and analyzed for all laboratory analysis at least monthly for every sample collected. For analytical split samples, one large sample will be collected and subsequently split into two aliquots, representing the regular sample and the analytical split sample. The frequency of the duplicate and analytical split sampling is presented in Table 6-4.

Table 6-4. Schedule of Field Duplicates, Method Blanks and Analytical Splits for Laboratory Analyses

Parameter	Field Duplicates Frequency	Method Blanks Frequency	Analytical Splits Frequency
Conductivity	1/10	N/A	N/A
pH	1/10	N/A	N/A
Free Chlorine	1/10	1/Analytical Batch	N/A
Turbidity	1/10	1/Analytical Batch	N/A
Dissolved Oxygen	1/10	N/A	N/A
Alkalinity	1/10	N/A	≥ 1/month
Arsenic	1/10	1/Analytical Batch	≥ 1/month
Calcium	1/10	1/Analytical Batch	≥ 1/month
Magnesium	1/10	1/Analytical Batch	≥ 1/month
Sodium	1/10	1/Analytical Batch	≥ 1/month
Silica	1/10	1/Analytical Batch	≥ 1/month
Aluminum	1/10	1/Analytical Batch	≥ 1/month
Iron	1/10	1/Analytical Batch	≥ 1/month
Titanium	1/10	1/Analytical Batch	≥ 1/month
Zirconium	1/10	1/Analytical Batch	≥ 1/month
Vanadium	1/10	1/Analytical Batch	≥ 1/month
Nitrate	1/10	1/Analytical Batch	≥ 1/month
Chloride	1/10	1/Analytical Batch	≥ 1/month
Sulfate	1/10	1/Analytical Batch	≥ 1/month
Fluoride	1/10	1/Analytical Batch	≥ 1/month
TSS	1/10	1/Analytical Batch	≥ 1/month
Total Organic Carbon	1/10	1/Analytical Batch	≥ 1/month
Gross Alpha/Beta	1/10	1/Analytical Batch	≥ 1/month

6.4. Method Blanks

The analytical laboratory will use method blanks as part of all analytical procedures. Method blanks are used as part of the calibration process and to ensure the analytical process does not contaminate the samples. Table 6-4 shows the frequency for method blank use in the laboratory.

The onsite field tests will also use method blanks where appropriate for the procedure. Method blank frequency and use for the on site field test is shown in Table 6-4.

6.5. Laboratory Method Detection Limits

The methods selected for this PTSTP are EPA approved methods and other field methods that have detection limits and reporting limits appropriate to the evaluation. The arsenic method, EPA 200.8, provides a low detection limit as needed to properly evaluate the performance of the media. Table 6-5 and 6-6 show the method detection limit and reporting limits for the SMOCL and WQL selected for use. Method references are provided in Tables 5-5 and 5-7.

Table 6-5. Method Detection Limits (MDL) and Laboratory Reporting Limits – SMOCL.

	Analytical Method	MDL (µg/L)	Laboratory Report Limit (µg/L)
Arsenic	EPA 200.8	1.5	5
Aluminum	EPA 200.7	68	200
Calcium	EPA 200.7	36	100
Magnesium	EPA 200.7	85	300
Sodium	EPA 200.7	45	150
Iron	EPA 200.8	10	25
Titanium	EPA 200.7	1	5
Vanadium	EPA 200.7	1	5
Zirconium	EPA 200.8	0.5	2
Silica	EPA 200.7	32	213
Fluoride	EPA 300.0	30	100
Chloride	EPA 300.0	53	200
Sulfate	EPA 300.0	57	400
Nitrate	EPA 300.0	54	100
TOC	EPA 9060	74	1000
TSS	SM 2540D	1140	5000
Alkalinity	SM 2320B	1450	2000
Gross Alpha/Beta	EPA 900	2 pCi/L	2 pCi/L
Radium 226/228	EPA 903.1, 904	1 pCi/L	1 pCi/L

Table 6-6. Method Detection and Reporting Limits – WQL.

	Location	Method Detection Limit	Laboratory/Field Reporting Limit
Field Tests ⁽¹⁾			
pH	On-site	N/A	N/A
Apparent Color	On-site	1.0 Color Units	1.0 Color Units
Turbidity	On-site	0.05 NTU	0.10 NTU
Temperature	On-site	N/A	N/A
Dissolved oxygen	On-site	0.5 mg/L	0.5 mg/L
Chlorine free	On-site	0.05 mg/L	0.05 mg/L
Conductivity	On-site	N/A	N/A
WQL Lab Tests ⁽²⁾		mg/L	mg/L
Arsenic (Total)	Laboratory	0.0005	0.002
Arsenic (As ⁺³ and dissolved)	Laboratory	0.0005	0.002
Calcium	Laboratory	0.2	0.5
Magnesium	Laboratory	0.1	0.2
Iron	Laboratory	0.1	0.2
Silica	Laboratory	1	1.0
Chloride	Laboratory	0.5	0.2
Sulfate	Laboratory	0.5	0.2
Fluoride	Laboratory	0.1	0.1
Alkalinity	Laboratory	10	10

(1) The actual detection limit of the field test equipment will be confirmed once the equipment is setup and calibrated. It is expected that the equipment will achieve these typical target detection limits.

(2) WQL is in the process of establishing the MDL for these parameters (TBD) using the EPA MDL procedure. Once complete the laboratory reporting limits will be adjusted as needed. It is expected that the reporting limits listed here will be verified by the MDL study.

6.6. Quality Control Checks

In addition to the standard laboratory QA/QC procedures described in the previous sections, additional checks will be used to ensure accuracy of the analytical procedures. These additional checks will include inter-laboratory splits samples between SMOCL and WQL and the use of performance evaluation (PE) samples.

Analytical Splits. Analytical splits will be made in order to have verification of WQL results. Once per month, as a minimum, the samples will be split and analyzed at both the WQL and the SMOCL. A correlation between the results of the two analytical laboratories will be established in tabular and graphical form.

Performance Evaluation Samples. SMOCL and WQL will use PE samples to evaluate their analytical procedures. SMOCL anticipates in annual and semiannual PE programs and will provide the data to SMO and SNL. WQL will run PE samples for analyses at least twice during the duration of the test program. WQL is also using PE samples in conjunction with the MDL studies to establish the performance of their analytical procedures.

6.7. Data Reduction, Validation, and Reporting

To maintain good data quality, specific procedures will be followed during data reduction, validation, and reporting. These procedures are detailed below.

6.7.1. Data Reduction

Data reduction refers to the process of converting the raw results from the equipment into concentration or other data in a form to be used in the comparison. The purpose of this step is to provide quality data that will be presented in a form that is useful for all stakeholders. These data will be obtained from logbooks, instrument outputs, and computer outputs.

6.7.2. Data Validation

There are two types of data validation that need to be addressed, field data and laboratory data. For the field data (including data collected from the WQL):

- The operator will verify the correctness of data acquisition and reduction.
- SNL will review calculations and inspect laboratory logbooks and data sheets to verify accuracy of data recording and sampling.
- Calibration and QC data will be examined by the individual operators and the field team supervisor.
- Project managers will verify that all instrument systems are in control and that QA objectives for accuracy, precision, and method detection limits have been met.

For the data produced from the SMOCL:

- Calibration and QC data are reviewed by the SMOCL analyst and the SMO in accordance with the SMO data review and validation procedures.
- Section supervisors in the laboratory verify that all instrument systems are in control and that QA objectives for accuracy, precision, and method detection limits have been met.
- Method detection limits are presented on Table 6-5.

Analytical outlier data are defined as those QC data lying outside a specific QC objective window for precision and accuracy for a given analytical method. Should QC data be outside of control limits:

- The SMOCL, the SMO and SNL will investigate the cause of the problem.
- If the problem involves an analytical problem, the sample will be reanalyzed.
- If the problem can be attributed to the sample matrix, the result will be flagged with a data qualifier.
- The data qualifier will be included and explained in the final analytical report.

6.7.3. Data Reporting

This section contains a list of the water quality and equipment operation data to be reported. The data tabulation will list the results for feed water and treated water quality analyses and equipment operating data. All QC information such as calibrations, blanks and reference samples will be included in an appendix. All raw analytical data will also be reported in an appendix. All data will be reported in hardcopy and electronically in a spreadsheet.

The SMOCL will provide data packages including the appropriate documentation to the SMO within contractual turn around times.

The SMO will review the data packages for compliance to the Statement of Work according to the contract re-verification review procedure. This review is performed within 5 days of data receipt.

Additionally 10% of the data will be validated according to the SMO Data Validation Procedure. During validation data will be qualified if necessary. These qualifiers will be included in the final report.

This procedure will reduce the risk that data quality problems could jeopardize the test program. If problems are detected, SNL will be notified immediately and will take the appropriate corrective action. This procedure does not release SMOCL and the WQL from having the primary responsibility to produce analytical results that meet the QA requirements and follow the specified QA/QC procedures.

6.8. System Inspections

On-site system inspections and audits for sampling activities, field operations, and laboratories will be conducted as least quarterly by the SNL program manager or his/her designee. These inspections will focus on the key elements of the test program and confirm that the requirements of the pilot test specific test plan are being followed. SNL will arrange at least one third party audit by either NSF, an NSF technical consultant or other properly qualified person to conduct an on-site audit to determine if this PTSTP is being implemented as intended. An inspection report will be completed after the inspection and provided to the participating parties.

6.9. Reports

6.9.1. Final Report

A final report on all testing activities will be prepared as outlined in Section 7.

6.10. Corrective Action

If, during the course of the verification testing, established equipment operation acceptance limits are exceeded, SNL will take corrective action. Acceptance limits are discussed in the appropriate sections of this document. If corrective action is necessary, SNL will document the required action, the party responsible and the results of the action. Any suspect data gathered during or before the implementation of the corrective action will be discarded or where possible reanalyzed. Table 6-7 shows some of the typical acceptance criteria and the corrective approach that will be used.

Table 6-7. Corrective Action Plan.

Parameter	Acceptance Criteria	Sequence of Steps for Corrective Action
Any Spike, Duplicate, or lab control sample	Limits established in separate tables	<ul style="list-style-type: none"> • Re-sample duplicates • Check instrument calibration; re-calibrate instrument
Any Method Blank	Must be below the reporting limit	<ul style="list-style-type: none"> • Investigate source of contamination • Rerun samples
Any Performance Evaluation (PE) or Proficiency Sample	Within recovery specified for each PE or proficiency sample	<ul style="list-style-type: none"> • Check and verify all steps in sample collection and analysis • Re-do PE or proficiency sampling and analysis
pH	≤10% difference from previous day- bullet one; Outside precision window of 30% - bullets two and three	<ul style="list-style-type: none"> • Check for change in feed water source or supply • Check instrument calibration • Re-calibrate instrument
Temperature	≤20% difference from previous day	<ul style="list-style-type: none"> • Check for change in feed water source or supply
Turbidity, Conductivity	Secondary standard or primary standard must be inside established limit.	<ul style="list-style-type: none"> • Check/verify system operating conditions • Verify turbidity meter performance and status of sampling tap, verify no fogging of sample cell had occurred, • Perform routine maintenance/cleaning of instrument • Verify calibration using secondary standards • Re-calibrate using primary standards

7. Data Management and Analysis, and Reporting

7.1. Data Management and Analysis

All operational and analytical data will be gathered and included in the final Sandia National Laboratories report for the pilot test. The data will consist of results of analyses and measurements that are detailed in the Tasks section of this PTSTP. The data will be entered into computer spreadsheets and submitted in electronic and hard copies. In addition, all QA/QC summary forms, field notebooks, and photographs will be provided.

7.2. Report of Equipment Testing

The testing report will be issued at the conclusion of the Capacity Test. The report will be issued in draft form for review prior to final publication.

The reports will be prepared by SNL. The reports will consist of:

- Introduction
- Forward
- Description and Identification of products tested
- Procedures and methods used in testing especially identifying deviations from the procedures described in this PTSTP
- Results and Discussion: (Integrity Test and Capacity Test)
- References
- QA/QC Results
- Laboratory raw data and validated data (hard copy or electronic spreadsheets)
- Field notebooks (hard copy or electronic media copy)
- Photographs

This report will be prepared in Microsoft Word[®] with data and graphics presented using Microsoft Excel[®] spreadsheets.

This page intentionally left blank.

8. Safety and Environmental Issues

8.1. Environmental Safety and Health Control Documents and Training

There are five safety management functions, which are documented in SNL's Management and Operating Contract, Clause I-71, "DEAR 970.5204-2 Integration of Environment, Safety, and Health into Work Planning and Execution (Jun 1997)":

- Plan work
- Analyze hazards
- Control hazards
- Perform work
- Feedback & improve

As such, a Preliminary Hazard Assessment was performed (PHS SNL3A103-002). The assessment stipulated some HAZCOM and site specific training requirements. These training requirements are found in PHS SNL3A103-002 and the site-specific safety plan for this test (Appendix F).

Some of the site-specific resources are:

- Description of chemical and physical hazards
- Material safety data sheets (MSDSs)
- Local urgent care contact information and driving directions

As work is performed, feedback and improvement can occur via updates to the resource notebook and other corporate processes that are applicable.

8.2. City of Socorro Water Utility Department

The test equipment and some analytical equipment will be housed within the existing Springs Site chlorination building. Prior to starting the test, the field engineer will become familiarized with the facilities via training provided by City of Socorro Water Utility Department. This training will include:

- A facility tour
- Presentation of the chlorination safety manual
- A review of the chlorination facilities
- A review of the electrical facilities

This page intentionally left blank.

9. References

APHA, 1998, *Standard Methods for the Examination of Water and Wastewater*, 20th Edition. American Public Health Association, Washington, DC.

Aragon, A., 2006, *Test Plan for Rapid Small Scale Tests in Support of the Arsenic Treatment Pilot Test at Socorro Springs, Socorro, New Mexico, SAND 2006-xxxx*. Sandia National Laboratories, Albuquerque, NM.

USEPA, 2005, *Water Test Methods*. NTIS National Technical Information Service, Dept. of Commerce, Springfield, VA or <http://www.ntis.gov/> (last accessed January 9, 2006).

This page intentionally left blank.

Appendix A: System Schematics and Equipment Specifications

This page intentionally left blank.

SOCORRO SPRINGS FLOW DIAGRAM

LEGEND:

- Manual Ball Valve
- Pressure Gauge
- Rotameter
- Totalizing Water Meter
- Sample Point
- Check Valve
- Pressure Reducing Valve
- Pressure Relief Valve
- 3-Way Valve

pH ADJUSTED COLUMNS - SETPOINT @ 6.8								
COL#	MEDIA	MANUFACTURER	COLUMN DIMENSION	HLR (GPM/FT ²)	FLOW RATE (GPM)	MEDIA VOLUME (L)	BW FLOW RATE (GPM)	EBCT (MIN)
1	AD-33	AEDGE	3"x60"	6	0.3	4.46	0.3	4
2	METSORB	HYDROGLOBE	3"x39"	8	0.4	2.97	0.3	2
3	ISOLUX 302M	MEI	1"x10"	23	0.5	0.48	N/A	15 sec

AMBIENT pH COLUMNS ~ 7.7								
COL#	MEDIA	MANUFACTURER	COLUMN DIMENSION	HLR (GPM/FT ²)	FLOW RATE (GPM)	MEDIA VOLUME (L)	BW FLOW RATE (GPM)	EBCT (MIN)
4	ARM200	ENGELHARD	3"x60"	6	0.3	4.46	0.3	4
5	ARSENXNP	PUROLITE	3"x60"	8.15	0.4	4.74	0.2	3
6	METSORB	HYDROGLOBE	3"x39"	8	0.4	2.97	0.3	2
7	ISOLUX 302M	MEI	1"x10"	23	0.5	0.48	N/A	15 sec
8	AD-33	AEDGE	3"x29"	6	0.3	2.23	0.3	2
9	AD-33	AEDGE	3"x60"	6	0.3	4.46	0.3	4
10	AD-33	AEDGE	3"x60"	6	0.3	5.57	0.3	5

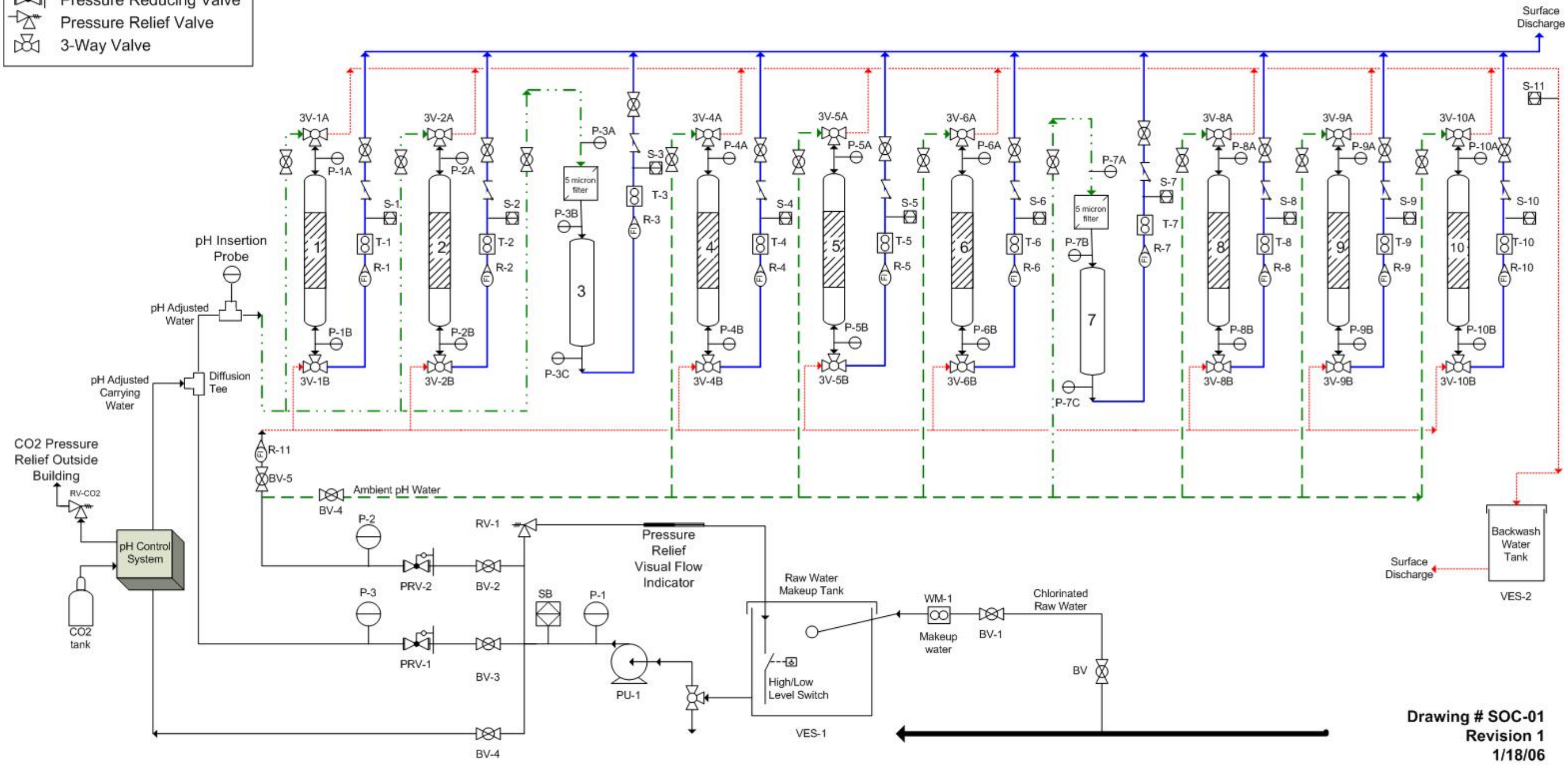

Drawing # SOC-01
Revision 1
1/18/06

SERVICE MODE
(BOLD LINES INDICATE FLOW DIRECTION)

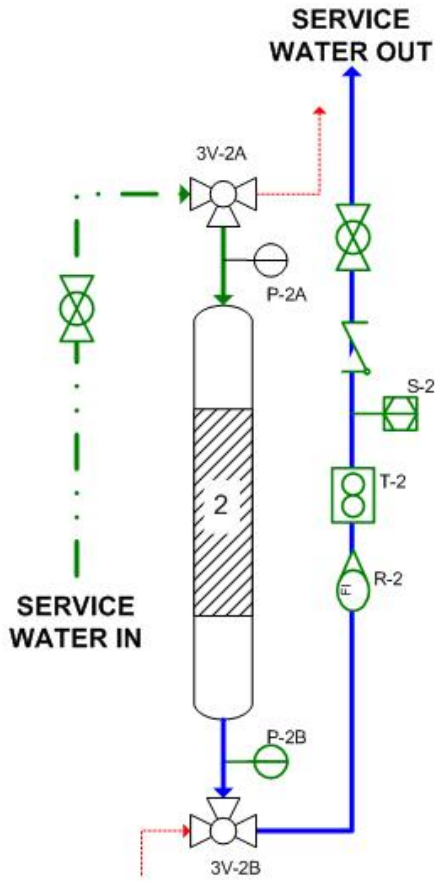

BACKWASH MODE
(BOLD LINES INDICATE FLOW DIRECTION)

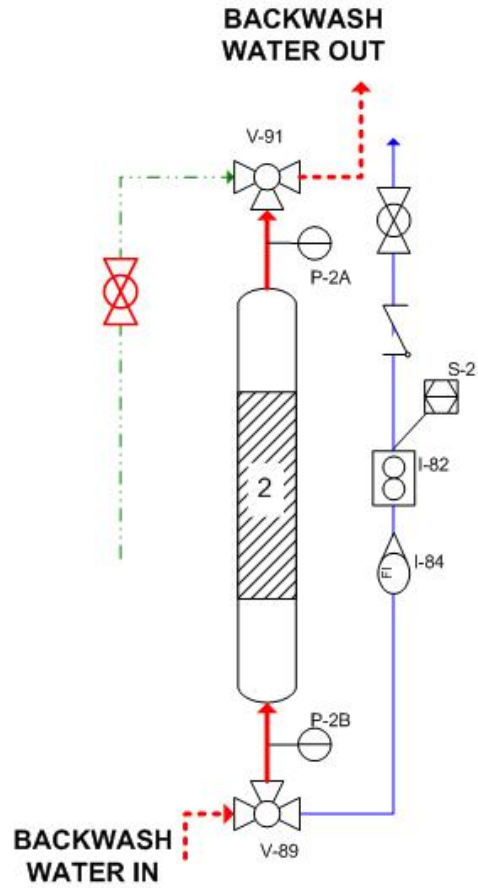

LEGEND:

	Manual Ball Valve
	Pressure Gauge
	Rotameter
	Totalizing Water Meter
	Sample Point
	Check Valve
	Pressure Reducing Valve
	Pressure Relief Valve
	3-Way Valve

Drawing # SOC-02
Revision 1
1/18/06

Equipment Specifications

Equipment Item	Drawing SOC-01 I.D.	Manufacturer/ Model	Material/ Description	Pressure Rating	Certification
Water meter	WM-1, WM-2	Master Meter 1-800-765-6518/ Multi-jet, Cole-Parmer, pg. 601	Bronze, sapphire glass-filled Noryl/ 1-20 gpm, 8 psi max. pressure drop, 1.5% reading accuracy, repeatability $\pm 1/4\%$	150 psi at 194 °F	ISO 9002 of AWWA C-708 standards
Ball valve	BV-1, BV-2, BV-3, BV-4, BV-5, BV-6	Chemtrol by NIBCO 1-800-343-5455/ True-Bloc, True Union	PVC/ 1 PVC ball valves with positive shut off	150 psi at 100 °F	N/A
Three-way-valve	3V-0, 3V-1A, 3V-1B, 3V-2A, 3V-2B 3V-3B 3V-4A, 3V-4B, 3V-5A, 3V-5B, 3V-6A, 3V-6B, 3V-7B, 3V-8A, 3V-8B, 3V-9A, 3V-9B, 3V-10A, 3V-10B	SPEARS/ 2000 Industrial 3-Way ball	PVC/ 1" and 1/2" PVC three-way valves	N/A	N/A
Universal Stopcock (sample valves)	S-A, S-B, S-1, S-2, S-3, S-4, S-5, S-6, S-7, S-8, S-9, S-10, S-11, S-12	Hayward Industrial Products/ Universal Stopcock	PVC/ 1/4" NPT threaded pvc stopcock valve	95 psi at 100 °F	ASTM D2464-88
Float valve	FV-1	WATTS Regulator (supplied by Granger)/ ST-750	Bronze valve assembly, with adjustable float, plastic float/ 3/4" valve inlet, 40 gpm @ 50 psi, 60 gpm @ 100 psi.	> 100 psi	N/A
Low-level float switch	FS-1	SJE-Rhombus Controls/ SJE Pumpmaster	Mechanically activated pump switch/ Wide angle pump switch providing automatic shut off of pump at low level mark	N/A	NSF Standard 61, ANSI/NFPA 70
Pump	PU-1	Grundfos supplied by TP Pump & Pipe 247-4036/ CR15 11 U-A-A-E-HQQE	Cast iron pump, 3/4 HP, single phase (only one rotational direction) 115/230V, 9.6/4.8 Amps, 3450 rpm, Frame 56CZ/ Vertical multi-stage centrifugal pump	5.01 gpm at 194 ft head Max. Pressure = 363 psi at 104 °F	

Equipment Item	Drawing SOC-01 I.D.	Manufacturer/ Model	Material/ Description	Pressure Rating	Certification
Pressure gauges	PI-1, PI-2, P1-A, P1-B, P2-A, P2-B, P3-A, P3-B, P4-A, P4-B, P5-A, P5-B, P6-A, P6-B, P7-A, P7-B, P8-A, P8-B, P9-A, P9-B, P10-A, P10-B	Ryan Herco/ 5337-060	Stainless steel-bronze-brass/ 2-1/2" premium gauge, steel case, glycerin filled, accuracy \pm 1.5%, 1/4" brass connection, bronze bourdon tube, brass movement	0-60 psi	N/A
Water tank, tank cover	VES-1, VES-2	Supplier: Ryan Herco/ 7110.016, 7172.022, 7173.011	Linear Polyethylene/ Heavy wall tank with excellent chemical resistance, self supporting	Operating temp. - 180°F	N/A
Pressure control valve	PCV-1, PCV-2	Plast-O-Matic Valves, Inc. Supplier: Ryan Herco, 1-973-256-3000/ 5416.010	PVC/ 1" pressure regulator valve	100 psi at 105 °F	N/A
Pressure Relief Valve	PRV-1	Plast-O-Matic Valves, Inc. Supplier: Ryan Herco 1-973-256-3000/ RVDT Series 5423.510	PVC / 1" pressure relief valve	100 psi at 105 °F, pressure setting range = 5-100 psi	N/A
Piping, fittings	All piping, bushings, nipples, ells, tees	Supplier: Albuquerque Windustrial/ True Blue Schedule 80	PVC/ 1/2", 1" PVC schedule 80 gray pipe	150 psi	ASTM-D-1784
column	Column 1,2,4,5,6,8,9, and 10	Supplier: Ryan Herco 1-973-256-3000/ 4005H-030	Clear rigid PVC/ 3" clear PVC	190 max. working pressure at 70°F	N/A
rotameter	R-1, R-2, R-3, R-4, R-5, R-6, R-7, R-8, R-9, R-10, R-11	Blue-White Industries, Supplier: Ryan Herco/ Model F-440EA	Polysulfone Body, 316 SS float, #316 Stainless guide rod, o-rings are viton/ Adjustable flow control meter	150 psi at 70°F,	
Braided tubing		Supplier: Ryan Herco/ 0512.110	Clear PVC reinforced with polyester/ 1" I.D. standard duty K3155-16 x 50	125 psi, service temp. +25 - 150°F	NSF 51

Equipment Item	Drawing SOC-01 I.D.	Manufacturer/ Model	Material/ Description	Pressure Rating	Certification
Electronic flow meters	T-1, T-2, T-3, T-4, T-5, T-6, T-7, T-8, T-9, T-10	Great Plains Industries, Inc., Supplier: Ryan Herco/ Model 09, turbine housing – model A025	Nylon housing, ceramic journal bearings, 1” NPT for use with non-aggressive, non-flammable liquids/ 1” low flow electronic flow meter, rotor turbine that spins generating electrical signal to pickup coil providing input to computer	Pressure rating – 150 psig; temperature range - +14 to 250°F 0.3 – 3 gpm, (1 –10 lpm), max. pressure drop = 8 psi	N/A
pH Adjustment System	CO ₂ panel	TOMCO Equipment, Inc./ CO ₂ /H ₂ O pressure solution feed system	See Appendix C		
PH data logger	In conjunction with CO ₂ panel				
Liquid CO ₂ bottle/ regulator	Connected to CO ₂ panel				

Appendix B: Design Calculations

Brian Dwyer and Randy Everret
Geochemistry Department
Sandia National Laboratories

This page intentionally left blank.

MEDIA #1 MetSorb (supplied by Hydroglobe)

MetSorb is a non regenerable sorption media

Manufacturer: Hydroglobe Treatment mechanism: adsorption

Media Properties: $\rho_b = 50 \text{ lbs/ft}^3$

Vendor estimated arsenic adsorptive capacity = 220 mg-As/g-media

Optimal pH ~ 6.0 However since pH = 7.7 < 8.5 no need for pH adjustment
(per John Schroeder, President Hydroglobe)

No pre-oxidation or filtration requirements

Residuals to sanitary landfill

PROCESS FLOW DIAGRAM

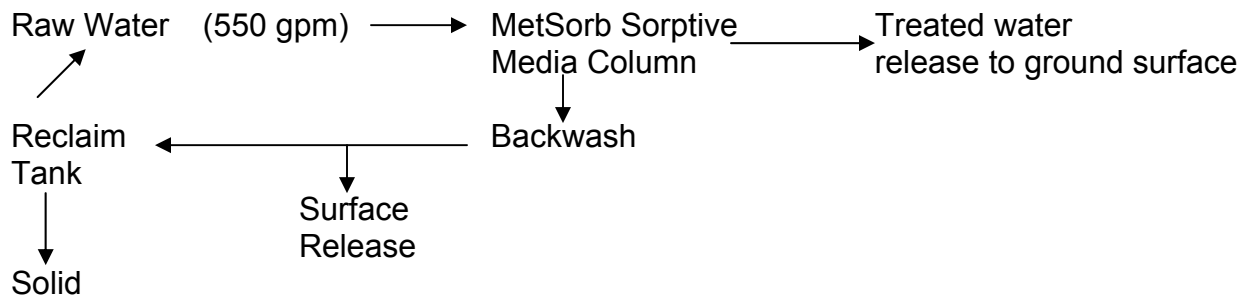

COLUMN DESIGN BASIS

Column Material: PVC or polycarbonate (lexan)

Column diameter (ft) = (D)

Number of parallel treatment = n_p

Particle Diameter = D_p

Design Flow rate (gpm) = Q

hydraulic loading rate (gpm/ft²) = HLR

$$D = [(4 \times Q) \div (\pi \times n_p \times \text{HLR})]^{1/2}$$

HLR \propto linear face velocity

Column Diameter

Determine column diameter (D) based on 50:1 or > aspect ratio of D to D_p

D_p Particle size = 16 x 50 US Std. Mesh

Use largest particle size of 1.18 mm

$$D = 1.18 \text{ mm} \times 50 = 59 \text{ mm} \times 1 \text{ cm}/10 \text{ mm} \times 1 \text{ in}/2.54 \text{ cm} = 2.3228 \text{ in}$$

Use D = 3 in

Calculate Q

Assumptions:

HLR = 8 gpm/ft² (per John Schroeder/President Hydroglobe)

$$Q = [D^2 \times \pi \times n_p \times \text{HLR}] / 4 \quad \rightarrow \quad = [(3/12)^2 \times \pi \times 1 \times 8] / 4 = 0.3927 \text{ gpm}$$

$$0.3927 \text{ gpm} \times 60 \text{ min/hr} \times 24 \text{ hrs/day} = 565 \text{ gal/day}$$

NOTE: the lower the HLR – the better the media is utilized and vice-versa \rightarrow
 directly affects the MTZ profile

Column Height (Hc)

Media depth (ft) = Hm

freeboard height (ft) = Hf

Empty bed contact time (Min) = EBCT

V = volume of media

$$Hm \geq \text{HLR} \times \text{EBCT} \times (1 \text{ ft}^3 / 7.48 \text{ gal})$$

MANUFACTURERS SUGGESTED EBCT RANGE - 1.6 – 2.5

EBCT = 2 min

$$Hm = 8 \text{ gpm/ft}^2 \times 2 \text{ min} \times (1 \text{ cu ft} / 7.48 \text{ gal}) = 2.1390 \text{ ft} \times 12 \text{ in/1 ft} = 25.6684 \text{ in}$$

$$\text{Check: } D = 3 \text{ in, EBCT} = V/Q \quad V = \text{EBCT}(Q) \rightarrow V = \pi \times r^2 \times h \text{ where } h = Hm$$

$$Hm = [\text{EBCT} \times Q] / [\pi \times r^2]$$

$$= [(2 \text{ min}) \times (0.3927 \text{ gpm}) / \pi \times (1.5 \text{ in})^2] \times (1 \text{ cu ft} / 7.48 \text{ gal}) \times (144 \text{ in}^2 / \text{ft}^2) = 2.1390 \text{ ft} \times 12 = 25.668 \text{ in}$$

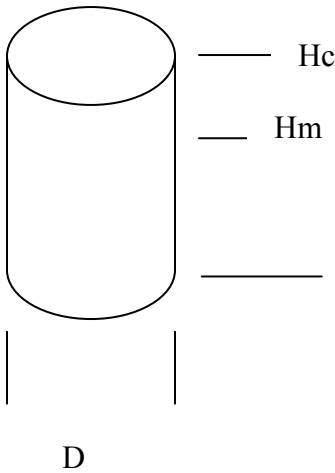

$$Hc = Hm + Hf$$

Hc = column height (ft)

Hf = freeboard height (ft)

Hm = media height (ft)

Hug = height of gravel underbed (ft)

Assume freeboard = 40%

$$Hc = Hm + 0.4 Hm + Hug = 1.4 Hm + Hug$$

$$Hc = 2.1390 \text{ ft} \times 1.4 = 2.9946 \text{ ft} \times (12 \text{ in/1 ft}) = 35.9352 \text{ in}$$

$$Hf = 0.8556 \text{ ft} \times 12 = 10.2672 \text{ in}$$

Assume Hug = 0.1 x Hm

$$\text{Use } Hc = 36 \text{ in} + Hug = 39 \text{ in}$$

Check aspect ratio Hm:D $2.1390 \text{ ft} \gg 0.25 \text{ ft}$ OK

Check pressure drop across media bed (Hm)

Assumptions: head loss/ft of media = 0.8 psi/ft (per manufacturer)

$$0.8 \text{ psi} \times 2.1390 \text{ ft} = 1.7 \text{ psi across column 6}$$

Calculate Volume of media (V)

$$D = 3 \text{ in, EBCT} = V/Q \quad V = \text{EBCT}(Q) \quad V = \pi \times r^2 \times h \text{ where } h = Hm$$

$$V = \pi (1.5 \text{ in})^2 \times 2.1390 \text{ ft} = 0.1050 \text{ ft}^3 = 0.7854 \text{ gal} = 2.9727 \text{ liters}$$

Estimate of Media Exhaustion

Column 6 EBCT = 2 min

$$\tau = BV_{ex} \times \text{EBCT} \times (1 \text{ hr} / 60 \text{ min})$$

where: τ = optimal filter run time (hrs) EBCT = empty bed contact time (min)

BV_{ex} = # of bed volumes to exhaustion

Assumptions: exhaustion is point where inlet and outlet concentrations are equal
 Socorro Springs well operates in continuous mode

$BV_{ex} = 20,000$	$\tau = 667$ hrs	=	28 days
$BV_{ex} = 40,000$	$\tau = 1333.3$ hrs	=	56 days
$BV_{ex} = 60,000$	$\tau = 2000$ hrs	=	84 days
$BV_{ex} = 80,000$	$\tau = 2667$ hrs	=	112 days

BACKWASH CALCULATIONS

NOTE: *** Backwashing will only occur when an unacceptable pressure loss due to precipitants or bed compaction – it will not be done as a maintenance item.

Media Weight = W_m (lbs)

H_m = media height (ft)

ρ_b = bulk density of media (lbs/ft³) = 50

D = column diameter (ft)

ρ_{SG} = bulk density of support gravel (lbs/ft³) = 100

$$W_m = [\pi \times (D^2) \times (H_m) \times (\rho_b)] / 4$$

$$W_{SG} = [\pi \times (D^2) \times (H_{SG}) \times (\rho_{SG})] / 4$$

V_{ug} = gravel underbed volume (liters)

H_{ug} = height of gravel underbed (ft)

Calculate Volume and weight of gravel under bed (V_{ug})

$$D = 3 \text{ in} \quad V = \pi \times r^2 \times h \text{ where } h=H_{ug} \quad V_{ug} = 10\% \text{ of } V_m = (.1) \times (0.1050 \text{ ft}^3) = 0.0105 \text{ ft}^3$$

$$H_{ug} = V_{ug} / \pi \times r^2 = 0.0105 / [(\pi) \times (1.5/12)^2] = 0.2139 \text{ ft} \times (12 \text{ in}/1 \text{ ft}) = 2.5669 \text{ in}$$

$$W_m = [\pi \times (3/12)^2 \times (1.0695 \text{ ft}) \times (50)] / 4 = 2.6249 \text{ lbs}$$

$$W_{SG} = [\pi \times (3/12)^2 \times (0.2139 \text{ ft}) \times (100)] / 4 = 1.050 \text{ lbs}$$

Calculate Backwash Flowrate

Where: Q_{BW} = Backwash Flowrate (gpm)

V_{WW} = volume of waste water (gal)

G_{BW} = Backwash Flux (gpm/ft²)

D = column diameter (ft)

t_{BW} = backwash duration (min)

Q = design flowrate (gpm)

n_p = number of parallel treatment trains

t_{FTW} = filter-to-waste duration (min)

Assume: $G_{BW} = 6$ gpm/ft²

$$Q_{BW} = \pi / 4 \times (D^2) \times (G_{BW}) = \pi / 4 \times (3/12)^2 \times (6 \text{ gpm/ft}^2) = 0.2945 \text{ gpm}$$

$$V_{WW} = Q_{BW} \times (t_{BW}) + (Q/n_p) (t_{FTW})$$

t_{BW} - the backwash duration – TBD in the field, and t_{FTW} also TBD in the field; consequently

V_{WW} will also be determined in the field.

CALCULATE SAMPLING FREQUENCY

Minimum of 20 points required to define curve. Use 20.

Assume: fastest completion to project – $BV = 60,000$ means 126 days

$$126/20 = 6.3 \text{ days} \longrightarrow \text{Sample Frequency} = 1x/\text{week}$$

MEDIA #2 AD33 (Supplied by Adedge)

Design Basis Calculations

AD33 is a non-regenerable sorption media

Manufacturer: Adedge Treatment mechanism: adsorption

Media Properties: $\rho_b = 30 \text{ lbs/ft}^3$ As adsorptive capacity not estimated

Optimal pH ~ 6.0 However since pH = 7.7 < 8.5 no need for pH adjustment (per Greg Gilles, VP Adedge)

No pre-oxidation or filtration requirements

Residuals to Landfill

PROCESS FLOW DIAGRAM

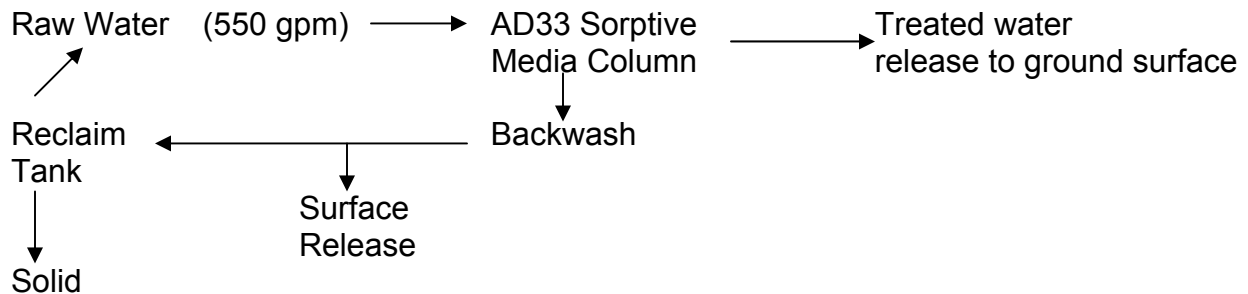

COLUMN DESIGN

Column Material: PVC or polycarbonate (lexan)

Column diameter (ft) = (D)

Design Flowrate (gpm) = Q

Number of parallel treatment = n_p

hydraulic loading rate (gpm/ft²) = HLR

Particle Diameter = D_p

$$D = [(4 \times Q) \div (\pi \times n_p \times \text{HLR})]^{1/2} \quad \text{HLR} \propto \text{linear face velocity} = v$$

Check Velocity (ft/s) = v

$$v = Q/A = 0.2945 \text{ gpm} / (\pi \times (1.5 \text{ in}/12)^2) \times (1 \text{ ft}^3/7.48 \text{ gal})$$

$$= 0.8021 \text{ ft/min} \times (1 \text{ min}/60 \text{ sec}) = 0.0134 \text{ ft/s} \times 12 \times 2.54 = 0.4075 \text{ cm/s}$$

Column Diameter

Determine column diameter based on 50:1 or > aspect ratio of D to D_p

Particle size = 10 (2 mm) x 35 (0.5 mm) US Std. Mesh

use 1.5 mm particle size for column diameter calculation

$$D = 1.5 \text{ mm} \times 50 = 75 \text{ mm} \times 1 \text{ cm}/10 \text{ mm} \times 1 \text{ in}/2.54 \text{ cm} = 2.9528 \text{ in}$$

Use D = 3 in

Manufacturers suggested EBCT range - 3 – 5 min

Calculate Q

Assumptions: HLR = 6 gpm/ft², EBCTs = 2, 4, & 5 min

$$Q = [D^2 \times \pi \times n_p \times \text{HLR}] / 4 \quad \rightarrow \quad = [(3/12)^2 \times \pi \times 1 \times 6] / 4 = 0.2945 \text{ gpm}$$

$$0.2945 \text{ gpm} \times 60 \text{ min/hr} \times 24 \text{ hrs/day} = 424 \text{ gal/day}$$

* the lower the HLR – the better the media is utilized and vice-versa \rightarrow directly affects the MTZ profile

Column Height (Hc)

Media depth (ft) = Hm

freeboard height (ft) = Hf

Empty bed contact time (Min) = EBCT

V = volume of media

$$Hm \geq \text{HLR} \times \text{EBCT} \quad (1 \text{ ft}^3 / 7.48 \text{ gal})$$

Manufacturers suggested EBCT range - 3 – 5 min

Column # 8 EBCT = 2.0 min

$$Hm = 6 \text{ gpm/ft}^2 \times 2 \text{ min} \times (1 \text{ cu ft} / 7.48 \text{ gal}) = 1.6043 \text{ ft} \times 12 \text{ in/1 ft} = 19.25 \text{ in}$$

Check: D = 3 in, EBCT = V/Q \rightarrow V = EBCT x Q \rightarrow V = $\pi \times r^2 \times h$ where h=Hm
 $Hm = [EBCT \times Q] / [\pi \times r^2] = [(2 \text{ min}) (0.2945 \text{ gpm}) / \pi \times (1.5 \text{ in})^2] \times (1 \text{ cu ft} / 7.48 \text{ gal}) \times (144 \text{ in}^2 / \text{ft}^2) = 1.6041 \text{ ft} (12/1) = 19.25 \text{ in}$

Calculate Volume of media (V)

$$D = 3 \text{ in}, \text{EBCT} = V/Q \quad V = \text{EBCT} \times Q \quad V = \pi \times r^2 \times h \text{ where } h=Hm$$

$$V = \pi (1.5 \text{ in}/12)^2 \times 2.8074 \text{ ft} = 0.1378 \text{ ft}^3 = 1.0308 \text{ gal} = 3.9016 \text{ liters}$$

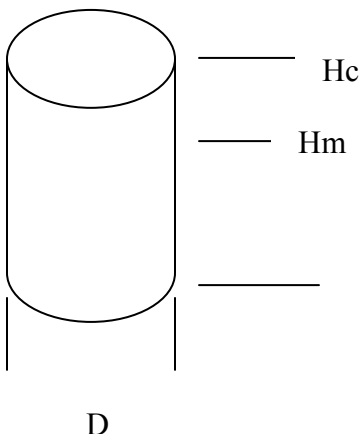

$$Hc = Hm + Hf$$

Hc = column height (ft)

Hf = freeboard height (ft)

Hm = media height (ft)

Assume freeboard = 40%

$$Hc = Hm + 0.4 Hm = 1.4 Hm$$

$$Hc = 1.6041 \text{ ft} \times 1.4 = 2.2458 \text{ ft} \times (12 \text{ in/1 ft}) = 26.9496 = 27 \text{ in}$$

$$Hf = \{2.2458 - 1.6041 \text{ ft}\} \times (12) = 7.7 \text{ in}$$

Use Hc = 27 in + 2 in (Hug) = 29 in

Check aspect ratio Hm:D 1.6041 ft >> 0.25 ft OK

Check pressure drop across media bed (Hm)

Assumptions: head loss/ft of media = 1 psi/ ft (per manufacturer)

$$1 \text{ psi/ft} \times 1.6041 \text{ ft} = 1.6 \text{ psi across column}$$

Column # 9 EBCT =4.0 min

$$H_m = 6 \text{ gpm/ft}^2 \times 4 \text{ min} \times (1 \text{ cu ft/ 7.48 gal}) = 3.2086 \text{ ft} \times 12 \text{ in/1 ft} = 38.5 \text{ in}$$

Check: $D = 3 \text{ in}$, $EBCT = V/Q \rightarrow V = EBCT(Q) \rightarrow V = \pi \times r^2 \times h$ where $h=H_m$

$$H_m = [EBCT \times Q] / [\pi \times r^2]$$

$$= [(4 \text{ min}) \times (0.2945 \text{ gpm}) / \pi \times (1.5 \text{ in})^2] \times (1 \text{ cu ft/ 7.48 gal}) \times (144 \text{ in/ ft}^2)$$

$$= 3.2083 \text{ ft} \times (12/1) = 38.5 \text{ in}$$

Calculate Volume of media (V)

$$D = 3 \text{ in}, EBCT = V/Q \quad V = EBCT(Q) \quad V = \pi \cdot r^2 \cdot h \text{ where } h=H_m$$

$$V = \pi \times (1.5 \text{ in}/12)^2 \times 3.2083 \text{ ft} = 0.1575 \text{ ft}^3 = 11780 \text{ gal} = 4.4587 \text{ liters}$$

$$H_c = H_m + H_f$$

H_c = column height (ft)

H_f = freeboard height (ft)

H_m = media height (ft/)

Assume freeboard = 40%

$$H_c = H_m + 0.4 H_m = 1.4 H_m$$

$$H_c = 3.2083 \text{ ft} \times 1.4 = 4.4916 \text{ (12 in/1 ft)} = 53.9 =$$

$$H_f = (4.4916 - 3.2083 \text{ ft}) \times (12) = 1.2833 \times 12 = 15.3 \text{ in}$$

$$\text{Use } H_c = 53.9 \text{ in} + 2 \text{ (Hug)} = 56$$

$$\text{Check aspect ratio } H_m:D \quad 3.2083 \text{ ft} > > 0.25 \text{ ft} \quad \text{OK}$$

Check pressure drop across media bed (H_m)

Assumptions: head loss/ft of media = 1 psi/ ft (per manufacturer)

$$1 \text{ psi/ft} \times 3.2083 \text{ ft} = 3.2 \text{ psi across column}$$

Column # 10 EBCT =5.0 min

$$H_m = 6 \text{ gpm/ft}^2 \cdot 5 \text{ min} \cdot (1 \text{ cu ft/ 7.48 gal}) = 4.0107 \text{ ft} \times 12 \text{ in/1 ft} = 48.1283 \text{ in.}$$

Check: $D = 3 \text{ in}$, $EBCT = V/Q \rightarrow V = EBCT(Q) \rightarrow V = \pi \cdot r^2 \cdot h$ where $h=H_m$

$$H_m = [EBCT \times Q] / [\pi \cdot r^2]$$

$$= [(5 \text{ min}) \times (0.2945 \text{ gpm}) / \pi \times (1.5 \text{ in})^2] \times (1 \text{ cu ft/ 7.48 gal}) \times (144 \text{ in/ ft}^2)$$

$$= 4.0104 \text{ ft} \times (12/1) = 48.12 \text{ in}$$

Calculate Volume of media (V)

$$D = 3 \text{ in}, EBCT = V/Q \quad V = EBCT(Q) \quad V = \pi \times r^2 \times h \text{ where } h=H_m$$

$$V = \pi (1.5 \text{ in}/12)^2 \times 4.0107 \text{ ft} = 0.1969 \text{ ft}^3 = 1.4726 \text{ gal} = 5.5739 \text{ liters}$$

$$H_c = H_m + H_f$$

H_c = column height (ft)

H_f = freeboard height (ft)

H_m = media height (ft)

Use freeboard (Hf) = 6.25 in
 Hc= Hm + Hf = Hug
 Hc = 48.12 in + 6.25 in + 2 = 56 in
 Check aspect ratio Hm:D 4.0107 ft >> 0.25 ft OK

Check pressure drop across media bed (Hm)
 Assumptions: head loss/ft of media = 1 psi/ ft (per manufacturer)
 1 psi/ft x 4.0107 ft = 4.0 psi across column 3B

BACKWASH CALCULATIONS

NOTE: *** Backwashing will only occur when an unacceptable pressure loss due to precipitants or bed compaction – it will not be done as a maintenance item.

Column #9 EBCT = 4 min
 Media Weight = W_m (lbs) $W_m = [\pi (D^2) (Hm) (\rho_b)] / 4$
 Hm = media height (ft) $W_{SG} = [\pi (D^2) (H_{SG}) (\rho_{SG})] / 4$
 ρ_b = bulk density of media (lbs/ft³) = 30 V_{ug} = gravel underbed volume (liters)
 D = column diameter (ft) Hug = height of gravel underbed (ft)
 ρ_{SG} = bulk density of support gravel (lbs/ft³) = 100

Calculate Volume of gravel underbed (V_{ug})
 D = 3 in $V = \pi \times r^2 \times h$ where h=Hug $V_{ug} = 10\% \text{ of } V_m = (0.1) (0.2297 \text{ft}^3)$
 = 0.02297 ft³
 $Hug = V_{ug} / \pi \times r^2 = 0.02297 / [(\pi) \times (1.5/12)^2] = 0.4679 \text{ ft} \times (12 \text{ in}/1 \text{ ft}) = 5.6 \text{ in}$
 $W_m = [\pi (3/12)^2 \times (3.7433 \text{ ft}) \times (30)] / 4 = 5.5 \text{ lbs}$
 $W_{SG} = [\pi (3/12)^2 \times (0.4679 \text{ ft}) \times (100)] / 4 = 2.3 \text{ lbs}$

Calculate Backwash Flowrate

Where: Q_{BW} = Backwash Flowrate (gpm) V_{WW} = volume of waste water (gal)
 G_{BW} = Backwash Flux (gpm/ft²) D = column diameter (ft)
 t_{BW} = backwash duration (min)
 Q = design flowrate (gpm) n_p = number of parallel treatment trains
 t_{FTW} = filter-to-waste duration (min)

Assume: $G_{BW} = 6 \text{ gpm}/\text{ft}^2$
 $Q_{BW} = \pi / 4 (D^2) \times (G_{BW}) = \pi / 4 (3/12)^2 \times (6 \text{ gpm}/\text{ft}^2) = 0.2945 \text{ gpm}$

$V_{WW} = Q_{BW} (t_{BW}) + (Q/n_p) (t_{FTW})$
 t_{BW} - the backwash duration – TBD in the field, and t_{FTW} also TBD in the field; consequently V_{WW} will also be determined in the field.

PILOT SCALE SITE: SOCORRO SPRINGS, SOCORRO, NM

MEDIA # 3 Isolux 302M (Supplied by MEI)

Design Basis Calculations

Isolux 302M is an optional regenerable sorption media; however, for the purposes of this project, i.e., pilot scale testing, the media will not be regenerated.

Manufacturer: MEI Treatment mechanism: adsorption

Media Properties: $\rho_b = 57 \text{ lbs/ft}^3$ As adsorptive capacity = 9 – 13 mg/g

Surface Area = 300 m²/g

Media particle size: D50 = 18 μm (powder form)

No backwashing requirements

pH range: 4 – 9 (lower is better)

Since pH = 7.7 < 9 no need for pH adjustment (per Jim Knoll, Sales Manager, MEI)

Pre filtration requirements: 5 μm pre-filter or other as needed dependent on water quality

Residuals To Landfill

MEI has a patent pending treatment column design; consequently, MEI will supply their media in a 10 in flow through cartridge with a flow design of $\leq 1 \text{ gpm}$.

PROCESS FLOW DIAGRAM

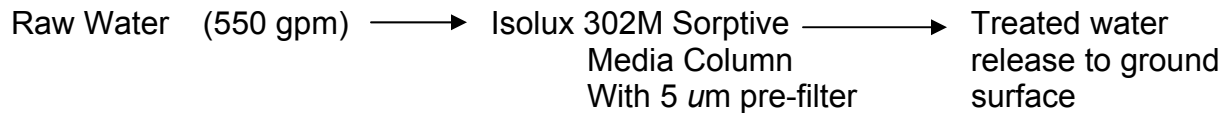

1 in x 10 in radial flow (patented design) cartridge

$$V_m = 0.0168 \text{ ft}^3 = 0.4768 \text{ liters}$$

Mass of media = 0.96 lbs/cartridge

Q range = 0.3 – 0.85 gpm

$$A = \pi (r^2) = \pi (1/12)^2 = 0.0218 \text{ ft}^2$$

$$\text{EBCT} = V/Q$$

Column 3

$$Q = 0.5 \text{ gpm} \quad \text{EBCT} = 15 \text{ sec}$$

$$\text{HLR}_2 = 0.5/0.0218 = 22.9 \text{ gpm/ft}^2$$

Column 3

Check velocity (ft/s) = v

$$v = Q/A = [0.5 \text{ gpm} / (\pi \times (0.5 \text{ in}/12)^2)] \times (1 \text{ ft}^3/7.48 \text{ gal}) = 12.2558 \text{ ft/min} \times (1 \text{ min}/60 \text{ sec}) = 0.2043 \text{ ft/s}$$

$$= 6.2259 \text{ cm/s}$$

Backwash Calculations

No backwashing required for these columns.

Estimate of Media Exhaustion Column 3 EBCT = 15 sec

$$\tau = BV_{ex} \times EBCT \text{ (1hr/60 min) (1 min/60 sec)}$$

where: τ = optimal filter run time (hrs) EBCT = empty bed contact time (min)

BV_{ex} = # of bed volumes to exhaustion

Assumptions: exhaustion is point where inlet and outlet concentrations are equal
Socorro Springs well operates in continuous mode

$$BV_{ex} = 20,000 \quad \tau = 83 \text{ hrs} = 3.5 \text{ days}$$

$$BV_{ex} = 40,000 \quad \tau = 167 \text{ hrs} = 7 \text{ days}$$

$$BV_{ex} = 60,000 \quad \tau = 250 \text{ hrs} = 10.4 \text{ days}$$

$$BV_{ex} = 80,000 \quad \tau = 333 \text{ hrs} = 14 \text{ days}$$

MEDIA #4 ARM 200 (Supplied by Engelhard)

Design Basis Calculations

ARM 200 is a non regenerable sorption media

Manufacturer: Engelhard Treatment mechanism: adsorption

Media Properties: $\rho_b = 30 - 45 \text{ lbs/ft}^3$ As adsorptive capacity not supplied by vendor

Optimal pH ~ 6.0 However since pH = 7.7 < 8.5 no need for pH adjustment (per Tom Shaniuk,)

No pre-oxidation or filtration requirements

Residuals To Landfill

PROCESS FLOW DIAGRAM

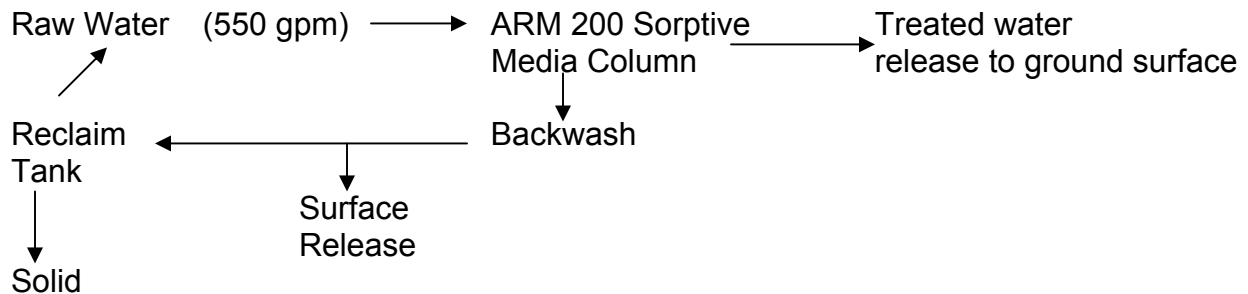

COLUMN DESIGN

Column Material: PVC

Column diameter (ft) = (D) Design Flowrate (gpm) = Q

Number of parallel treatment = n_p hydraulic loading rate (gpm/ft²) = HLR

Particle Diameter = D_p

$$D = [(4 \times Q) \div (\pi \times n_p \times \text{HLR})]^{1/2} \qquad \text{HLR} \propto \text{linear face velocity}$$

Column Diameter

Determine column diameter based on 50:1 or > aspect ratio of D to D_p

Particle size = 10 (2 mm) x 35 (0.5 mm) US Std. MESH

Assume $D = 1.5 \text{ mm} \times 50 = 75 \text{ mm} \times 1\text{cm}/10\text{mm} \times 1 \text{ in}/2.54\text{cm} = 2.9528 \text{ in}$

Use $D = 3 \text{ in}$

Calculate Q

Assumptions: HLR = 6 gpm/ft², EBCT = 4 min (per verbal agreement with Tom Shaniuk)

$$Q = [D^2 \times \pi \times n_p \times \text{HLR}] / 4 \quad \rightarrow \quad = [(3/12)^2 \times \pi \times 1 \times 6] / 4 = 0.2945 \text{ gpm}$$

$$0.2945 \text{ gpm} \times 60 \text{ min/hr} \times 24 \text{ hrs/day} = 424 \text{ gal/day}$$

* the lower the HLR – the better the media is utilized and vice-versa \longrightarrow directly affects the MTZ profile

Column Height (Hc)

Media depth (ft) = Hm

freeboard height (ft) = Hf

Empty bed contact time (Min) = EBCT

V = volume of media

$$Hm \geq \text{HLR} \times \text{EBCT} \quad (1 \text{ ft}^3/7.48 \text{ gal})$$

Column #4 EBCT = 4 min

$$Hm = 6 \text{ gpm/ft}^2 \times 4 \text{ min} \times (1 \text{ cu ft} / 7.48 \text{ gal}) = 3.2086 \text{ ft} \times 12 \text{ in/1 ft} = 38.5027 \text{ in}$$

Check: $D = 3 \text{ in}$, $\text{EBCT} = V/Q \longrightarrow V = \text{EBCT}(Q) \longrightarrow V = \pi \times r^2 \times h$ where $h=Hm$

$$Hm = [\text{EBCT} \times Q] / [\pi \times r^2] = [(4 \text{ min}) (0.2945 \text{ gpm}) / \pi \times (1.5 \text{ in})^2] \times (1 \text{ cu ft} / 7.48 \text{ gal}) \times (144 \text{ in}^2 / \text{ft}^2) = 3.2083 \text{ ft}$$

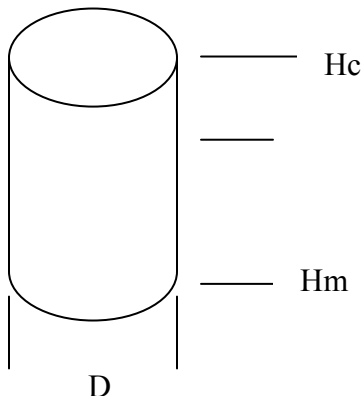

$$Hc = Hm + Hf$$

Hc = column height (ft)

Hf = freeboard height (ft)

Hm = media height (ft)

Assume freeboard = 40%

$$Hc = Hm + 0.4 Hm = 1.4 Hm$$

$$Hc = 3.2083 \text{ ft} \times 1.4 = 4.4916 \text{ ft} \times (12 \text{ in/1 ft}) = 53.8993 \text{ in}$$

$$Hf = 1.2833 \text{ ft}$$

$$\text{Use } Hc = 54 \text{ in} + \text{Hug} (5 \text{ in}) = 59 \text{ in}$$

Check aspect ratio $Hm:D \quad 3.2083 \text{ ft} \gg 0.25 \text{ ft} \quad \text{OK}$

Calculate Volume of media (V)

$$D = 3 \text{ in}, \text{EBCT} = V/Q \quad V = \text{EBCT}(Q) \quad V = \pi \times r^2 \times h \text{ where } h=Hm$$

$$V = \pi \times (1.5 \text{ in}/12)^2 \times 3.2083 \text{ ft} = 0.1575 \text{ ft}^3 = 1.1780 \text{ gal} = 4.4587 \text{ liters}$$

$$\text{Mass} = \rho_b \times V = 35 \text{ lbs/cu ft} \times 0.1575 = 5.5125 \text{ lbs}$$

Check pressure drop across media bed (Hm)

Assumptions: head loss/ft of media = 0.8 psi/ft (per manufacturer)

$$0.8 \text{ psi} \times 3.2083 \text{ ft} = 2.6 \text{ psi across column 4}$$

Check Velocity (ft/s) = v

$$V = Q/A = 0.2945 \text{ gpm} / (\pi \times (1.5 \text{ in}/12)^2) \times (1 \text{ ft}^3/7.48 \text{ gal}) = 0.8021 \text{ ft/min} \times (1 \text{ min}/60 \text{ sec}) = 0.0134 \text{ ft/s} \times 12 \times 2.54 = 0.4075 \text{ cm/s}$$

Estimate of Media Exhaustion

$$\tau = BV_{\text{ex}} \times \text{EBCT} \quad (1 \text{ hr}/60 \text{ min})$$

where: τ = optimal filter run time (hrs) EBCT = empty bed contact time (min)

BV_{ex} = # of bed volumes to exhaustion

Assumptions: exhaustion is point where inlet and outlet concentrations are equal
 Socorro Springs well operates in continuous mode
 EBCT = 4 min

BV _{ex} = 20,000	τ = 1333.3 hrs	= 56 days
BV _{ex} = 40,000	τ = 2667 hrs	= 111 days
BV _{ex} = 60,000	τ = 4000 hrs	= 167 days
BV _{ex} = 80,000	τ = 5333.3 hrs	= 222 days

BACKWASH CALCULATIONS

NOTE: *** Backwashing will only occur when an unacceptable pressure loss due to precipitants or bed compaction – it will not be done as a maintenance item.

Column #4 EBCT = 4 min

Media Weight = W_m (lbs)

H_m = media height (ft)

ρ_b = bulk density of media (lbs/ft³) = 30

D = column diameter (ft)

ρ_{SG} = bulk density of support gravel (lbs/ft³) = 100

$$W_m = [\pi \times (D^2) \times (H_m) \times (\rho_b)] / 4$$

$$W_{SG} = [\pi \times (D^2) \times (H_{SG}) \times (\rho_{SG})] / 4$$

V_{ug} = gravel underbed volume (liters)

Hug = height of gravel underbed (ft)

Calculate Volume of underbedding gravel (V_g)

$$D = 3 \text{ in} \quad V = \pi \times r^2 \times h \text{ where } h = \text{Hug} \quad V_{ug} = 10\% \text{ of } V_m = (0.1) \times (0.2297 \text{ ft}^3) = 0.02297 \text{ ft}^3$$

$$\text{Hug} = V_{ug} / \pi \times r^2 = 0.02297 / [(\pi) \times (1.5/12)^2] = 0.4679 \text{ ft} \times (12 \text{ in}/1 \text{ ft}) = 5.6 \text{ in}$$

$$W_m = [\pi \times (3/12)^2 \times (3.7433 \text{ ft}) \times (30)] / 4 = 5.5 \text{ lbs}$$

$$W_{SG} = [\pi \times (3/12)^2 \times (0.4679 \text{ ft}) \times (100)] / 4 = 2.3 \text{ lbs}$$

Calculate Backwash Flowrate

Where: Q_{BW} = Backwash Flowrate (gpm)

V_{WW} = volume of waste water (gal)

G_{BW} = Backwash Flux (gpm/ft²)

D = column diameter (ft)

t_{BW} = backwash duration (min)

Q = design flowrate (gpm)

n_p = number of parallel treatment trains

t_{FTW} = filter-to-waste duration (min)

Assume: G_{BW} = 6 gpm/ft²

$$Q_{BW} = \pi / 4 \times (D^2) \times (G_{BW}) = \pi / 4 \times (3/12)^2 \times (6 \text{ gpm}/\text{ft}^2) = 0.2945 \text{ gpm}$$

$$V_{WW} = Q_{BW} (t_{BW}) + (Q/n_p) \times (t_{FTW})$$

t_{BW} - the backwash duration – TBD in the field, and t_{FTW} also TBD in the field; consequently V_{WW} will also be determined in the field.

PILOT SCALE SITE: SOCORRO SPRINGS, SOCORRO, NM

MEDIA #5 ArsenX^{np} (Supplied by Purolite)

Design Basis Calculations

ArsenX^{np} is regenerable iron hydroxide based media built on a traditional ion exchange resin matrix.

Supplier: Purolite

Treatment mechanism: ion exchange/adsorption

Media Properties:

$\rho_b =$ lbs/ft³

As adsorptive capacity = no estimate available

Delivery State: wet

Particle size: 16 x 50 US Std. Mesh (1.18mm x 0.30mm)

Optimal pH ~ However since pH = 7.7 < 9 no need for pH adjustment (per Jim Sabzali)

No pre oxidation or filtration requirements

Residuals To Landfill

PROCESS FLOW DIAGRAM

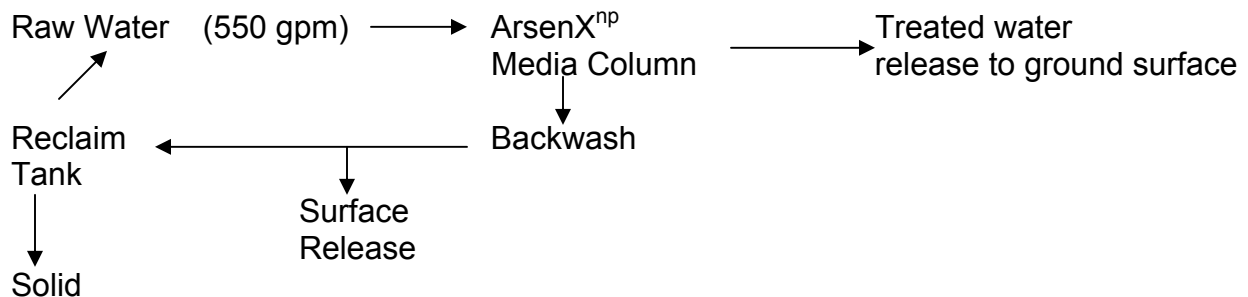

COLUMN DESIGN

Column Material: PVC

Column diameter (ft) = (D)

Number of parallel treatment = n_p

Particle Diameter = D_p

Design Flowrate (gpm) = Q

hydraulic loading rate (gpm/ft²) = HLR

$$D = [(4 \times Q) \div (\pi \times n_p \times HLR)]^{1/2}$$

HLR \propto linear face velocity

Column Diameter

Determine column diameter based on 50:1 or > aspect ratio of D to D_p

Particle size = 16 (1.18 mm) x 50 (0.3 mm) US Std. MESH

Check $C_u = D_{60} / D_{10} \longrightarrow 1.18 / 0.3 = 3.93 \leq 5$ therefore consider uniform particle size - use 1.18 mm particle size for column diameter calculation

$D = 1.18 \text{ mm} \times 50 = 59 \text{ mm} \times 1 \text{ cm} / 10 \text{ mm} \times 1 \text{ in} / 2.54 \text{ cm} = 2.3228 \text{ in}$

Use D = 3 in

Calculate Q

Assumptions: HLR = 8 gpm/ft² (Purolite suggested HLR range – 8-12), EBCT = 2 - 3 min (Purolite suggested) Use EBCT = 2.5 min

$$Q = [D^2 \times \pi \times n_p \times \text{HLR}] / 4 \rightarrow = [(3/12)^2 \times \pi \times 1 \times 8] / 4 = 0.3927 \text{ gpm} \text{ Use } 0.4 \text{ gpm} \rightarrow \text{actual HLR} = 8.1487 \text{ gpm/ft}^2$$

$$0.4 \text{ gpm} \times 60 \text{ min/hr} \times 24 \text{ hrs/day} = 576 \text{ gal/day}$$

Column Height (Hc)

Media depth (ft) = Hm

freeboard height (ft) = Hf

Empty bed contact time (Min) = EBCT

V = volume of media

$$Hm \geq \text{HLR} \times \text{EBCT} \text{ (1 ft}^3\text{/7.48 gal)}$$

Column #5 EBCT = 3 min

$$Hm = 8.1487 \text{ gpm/ft}^2 \times 3 \text{ min} \times (1 \text{ cu ft/ } 7.48 \text{ gal}) = 3.2682 \text{ ft} \times 12 \text{ in/1 ft} = 39.2185 \text{ in}$$

Check: D = 3 in, EBCT = V/Q → V = EBCT(Q) → V = π × r² × h where h=Hm

$$Hm = [\text{EBCT} \times Q] / [\pi \times r^2] = [(3 \text{ min}) (0.4 \text{ gpm}) / \pi \times (1.5 \text{ in})^2] \times (1 \text{ cu ft/ } 7.48 \text{ gal}) \times (144 \text{ in}^2\text{/ft}^2) = 3.2682 \text{ ft}$$

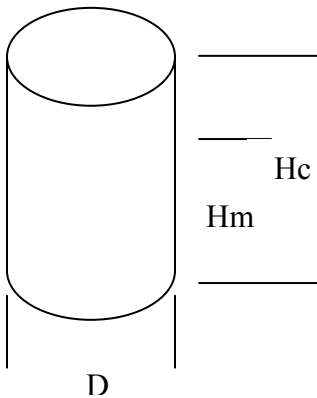

$$Hc = Hm + Hf$$

Hc = column height (ft)

Hf = freeboard height (ft)

Hm = media height (ft)

Assume freeboard = 50% (per Purolite)

$$Hc = Hm + 0.4 Hm = 1.4 Hm$$

$$Hc = 3.2682 \text{ ft} \times 1.5 = 4.9023 \text{ (12 in/1 ft)} = 58.8278 \text{ in}$$

$$Hf = 1.6341 \text{ ft}$$

$$\text{Use } Hc = 59 \text{ in} + \text{Hug (5 in)} = 64 \text{ in}$$

$$\text{Check aspect ratio } Hm:D \text{ } 3.2682 \text{ ft} \gg 0.25 \text{ft OK}$$

Calculate Volume of media (V)

$$D = 3 \text{ in, EBCT} = V/Q \quad V = \text{EBCT}(Q) \quad V = \pi \times r^2 \times h \text{ where } h=Hm$$

$$V = \pi (1.5 \text{ in}/12)^2 3.2682 \text{ ft} = 0.1604 \text{ ft}^3 = 1.2513 \text{ gal} = 4.7363 \text{ liters}$$

$$\text{Mass} = \rho_b \times V = 50 \text{ lbs/cu ft} \times 0.1604 = 8.02 \text{ lbs}$$

Check pressure drop across media bed (Hm)

Assumptions: head loss/ft of media = 2 psi/ft (per manufacturer)

$$2 \text{ psi} \times 3.2682 \text{ ft} = 6.5 \text{ psi across column 1}$$

Check Velocity (ft/s) = v

$$V = Q/A = 0.4 \text{ gpm} / (\pi \times (1.5 \text{ in}/12)^2) \times (1 \text{ ft}^3/7.48 \text{ gal}) = 1.0894 \text{ ft/min (1min/60 sec)} = 0.0182 \text{ ft/s} \times 12 \times 2.54 = 0.5534 \text{ cm/s}$$

Estimate of Media Exhaustion Column 5

$$\tau = BV_{ex} \times EBCT \text{ (1hr/60 min)}$$

where: τ = optimal filter run time (hrs) EBCT = empty bed contact time (min)

BV_{ex} = # of bed volumes to exhaustion

Assumptions: exhaustion is point where inlet and outlet concentrations are equal

Socorro Springs well operates in continuous mode

$$EBCT = 4 \text{ min}$$

$BV_{ex} = 20,000$	$\tau = 1333.3 \text{ hrs}$	$= 56 \text{ days}$
$BV_{ex} = 40,000$	$\tau = 2667 \text{ hrs}$	$= 111 \text{ days}$
$BV_{ex} = 60,000$	$\tau = 4000 \text{ hrs}$	$= 167 \text{ days}$
$BV_{ex} = 80,000$	$\tau = 5333.3 \text{ hrs}$	$= 222 \text{ days}$

BACKWASH CALCULATIONS

NOTE: *** Backwashing will only occur when an unacceptable pressure loss due to precipitants or bed compaction – it will not be done as a maintenance item.

Column #5 EBCT = 3 min

Media Weight = W_m (lbs)

$$W_m = [\pi (D^2) \times (H_m) \times (\rho_b)] / 4$$

H_m = media height (ft)

$$W_{SG} = [\pi (D^2) \times (H_{SG}) \times (\rho_{SG})] / 4$$

ρ_b = bulk density of media (lbs/ft³) = 30

V_{ug} = gravel underbed volume (liters)

D = column diameter (ft)

H_{ug} = height of gravel underbed (ft)

ρ_{SG} = bulk density of support gravel (lbs/ft³) = 100

Calculate Volume of underbedding gravel (V_{ug})

$$D = 3 \text{ in} \quad V = \pi \times r^2 \times h \text{ where } h = H_{ug} \quad V_{ug} = 10\% \text{ of } V_m = (.1) (0.2297 \text{ ft}^3) = 0.02297 \text{ ft}^3$$

$$H_{ug} = V_{ug} / \pi \times r^2 = 0.02297 / [(\pi) \times (1.5/12)^2] = 0.4679 \text{ ft (12 in/1 ft)} = 5.6 \text{ in}$$

$$W_m = [\pi \times (3/12)^2 \times (3.7433 \text{ ft}) \times (30)] / 4 = 5.5 \text{ lbs}$$

$$W_{SG} = [\pi \times (3/12)^2 \times (0.4679 \text{ ft}) \times (100)] / 4 = 2.3 \text{ lbs}$$

Calculate Backwash Flowrate

Where: Q_{BW} = Backwash Flowrate (gpm)

V_{WW} = volume of waste water (gal)

G_{BW} = Backwash Flux (gpm/ft²)

D = column diameter (ft)

t_{BW} = backwash duration (min)

Q = design flowrate (gpm)

n_p = number of parallel treatment trains

t_{FTW} = filter-to-waste duration (min)

Assume: $G_{BW} = 4 \text{ gpm/ft}^2$ (per Purolite)

$$Q_{BW} = \pi / 4 (D^2) \times (G_{BW}) = \pi / 4 \times (3/12)^2 \times (4 \text{ gpm/ft}^2) = 0.1963 \text{ gpm use } 0.2 \text{ gpm}$$

$$V_{WW} = Q_{BW} (t_{BW}) + (Q/n_p) (t_{FTW})$$

t_{BW} - the backwash duration – TBD in the field, and t_{FTW} also TBD in the field; consequently V_{WW} will also be determined in the field.

Appendix C: Operations and Maintenance Manual

This page intentionally left blank.

APPENDIX C. OPERATIONS AND MAINTENANCE MANUAL

Randy Everett and Brian Dwyer
Geochemistry Department
Sandia National Laboratories

There are two basic modes of operation for each of the ten columns (adsorptive media) within the Socorro Springs Pilot skid:

- Service mode
- Backwash mode

The mode of operation for each column is independent of the others; however, only one column will be operated in the backwash mode at a time, ensuring that backwash waste water represents the column being backwashed. If more than one column was backwashed simultaneously, the backwash waste waters would mix because they have a common backwash waste water discharge manifold.

Prior to the Integrity Validation testing period, all eight columns (the two MEI-Isolux 302M columns contain cartridge designs where backwash is not an option) were backwashed in accordance with the manufacturer's specifications.

SERVICE MODE

Columns 1-3 operate using pH adjusted raw water, and columns 4-10 operate using ambient pH raw water. Procedures for columns 4-10 were planned at the beginning of the test and may be modified during the conduct of the test. Procedures for operation of the pH adjusted columns may be modified after Phase I of the pilot test is completed, reflecting "lessons learned".

Columns 1-3 (pH adjusted columns -may be modified after Phase I is completed)

A three-quarter-inch tap in the eight-inch Socorro Springs main water line directs chlorinated raw water through a 1" shut off ball valve (BV-1; open when in service mode), through the makeup water meter (WM-1), and into the makeup water tank (VES-1). VES-1 is an 80-gallon linear polyethylene opaque tank with a float valve (FV-1) for filling.

A three-quarter HP multi-stage vertical centrifugal pump (PU-1) draws suction water (low pressure) from the bottom of VES-1 through a 1" bulkhead fitting and a three-way valve (3V-0; flow to pump in service mode, and flow to drain in drain mode). VES-1 contains a low level switch (FS-1) that shuts off power to the pump in the event the tank water level reaches the low level mark. This protects the pump from losing suction and potential running dry.

The pump produces 5 gallons per minute (gpm) of service/backwash water at approximately 90 psi. When any or all of columns 1 –3 are in the service mode, BV-3 is open and PCV-2 and PRV-1 are set to achieve the desired feed pressure in Line 1 supplying the CO₂ panel (~55 psi

over service pressure for columns 1-3). PRV-1 is a pressure relief valve that provides pressure relief to the system to avoid the possibility of deadheading the pump (PU-1).

Raw water flows through Line 1 (yellow) to the CO₂ panel, exits the panel as pH adjusted raw water at the desired pressure, and continues through Line 1 to the manifold supplying Columns 1–3.

Column 1

A tee from the Line 1 (manifold) directs pH adjusted raw water to R-1 (column 1 rotameter) where the operational flow rate is controlled. Three-way valves 3V-1A and 3V-1B are placed in the service position, allowing water to flow via gravity and slight system pressure downward through the AD-33 media. The differential pressure (head loss) across the media can be measured as the difference between pressure gauges P-1A and P-1B. Treated water exits Column 1 entering Line 6 (Green). Treated water is sampled at S-1, located immediately downgradient of 3V-1B. Additional treated water flows out to the designated surface discharge point (atmospheric pressure) through Line 6.

Column 2

A tee from the Line 1 (manifold) directs pH adjusted raw water to R-2 (Column 2 rotameter) where the operational flow rate is controlled. Three-way valves 3V-2A and 3V-2B are placed in the service position, allowing water to flow via gravity and slight system pressure downward through the Metsorb media. The differential pressure (head loss) across the media can be measured as the difference between pressure gauges P-2A and P-2B. Treated water exits Column 2 entering Line 6 (Green). Treated water is sampled at S-2, located immediately downgradient of 3V-2B. Additional treated water flows out to the designated surface discharge point (atmospheric pressure) through Line 6.

Column 3

A tee from the Line 1 (manifold) directs pH adjusted raw water to R-3 (Column 3 rotameter) where the operational flow rate is controlled. Water flows via gravity and slight system pressure downward through the Isolux 302M pre-filter and media cartridges. The differential pressure (head loss) across the pre-filter and media cartridges can be measured as the difference between pressure gauges P-2A and P-3B. The differential pressure (head loss) across the media cartridge alone can be measured as the difference between pressure gauges P-3A and P-3B. Treated water exits Column 3 entering Line 6 (Green). Treated water is sampled at S-3. Additional treated water flows out to the designated surface discharge point (atmospheric pressure) through Line 6.

Columns 4–10 (Ambient pH columns)

When any or all of Columns 4–10 are in the service mode, BV-2 is open and PCV-1 and PRV-1 are set to achieve the desired feed pressure in Line 2 (blue). PRV-1 is a pressure relief valve that provides pressure relief to the system to avoid the possibility of deadheading the pump (PU-1). Line 2 is the service water supply line and manifold for Columns 4–10.

Column 4

A tee from the Line 2 manifold directs ambient pH raw water to R-4 (Column 4 rotameter) where the operational flow rate is controlled. Three-way valves 3V-4A and 3V-4B are placed in the service position, allowing water to flow via gravity and slight system pressure downward through the ARM 200 media. The differential pressure (head loss) across the media can be measured as the difference between pressure gauges P-4A and P-4B. Treated water exits Column 4 entering Line 6 (Green). Treated water is sampled at S-4, located immediately downgradient of 3V-4B. Additional treated water flows out to the designated surface discharge point (atmospheric pressure) through Line 6.

Column 5

A tee from the Line 2 manifold directs ambient pH raw water to R-5 (Column 5 rotameter) where the operational flow rate is controlled. Three-way valves 3V-5A and 3V-5B are placed in the service position, allowing water to flow via gravity and slight system pressure downward through the ArsenX^{np} media. The differential pressure (head loss) across the media can be measured as the difference between pressure gauges P-5A and P-5B. Treated water exits Column 5 entering Line 6 (Green). Treated water is sampled at S-5, located immediately downgradient of 3V-5B. Additional treated water flows out to the designated surface discharge point (atmospheric pressure) through Line 6.

Column 6

A tee from the Line 2 manifold directs ambient raw water to R-6 (Column 6 rotameter) where the operational flow rate is controlled. Three-way valves 3V-6A and 3V-6B are placed in the service position, allowing water to flow via gravity and slight system pressure downward through the Metsorb media. The differential pressure (head loss) across the media can be measured as the difference between pressure gauges P-6A and P-6B. Treated water exits Column 6 entering Line 6 (Green). Treated water is sampled at S-6, located immediately downgradient of 3V-6B. Additional treated water flows out to the designated surface discharge point (atmospheric pressure) through Line 6.

Column 7

A tee from the Line 1 (manifold) directs ambient pH raw water to R-7 (Column 7 rotameter) where the operational flow rate is controlled. Water flows via gravity and slight system pressure downward through the Isolux 302M pre-filter and media cartridges. The differential pressure (head loss) across the pre-filter and media cartridges can be measured as the difference between pressure gauges P-6A and P-7B. The differential pressure (head loss) across the media cartridge alone can be measured as the difference between pressure gauges P-7A and P-7B. Treated water exits Column 7 entering Line 6 (Green). Treated water is sampled at S-7. Additional treated water flows out to the designated surface discharge point (atmospheric pressure) through Line 6.

Column 8

A tee from the Line 2 manifold directs ambient pH raw water to R-8 (Column 8 rotameter) where the operational flow rate is controlled. Three-way valves 3V-8A and 3V-8B are placed in the service position, allowing water to flow via gravity and slight system pressure downward through the AD-33 media. The differential pressure (head loss) across the media can be measured as the difference between pressure gauges P-8A and P-8B. Treated water exits Column 8 entering Line 6 (Green). Treated water is sampled at S-8, located immediately downgradient of 3V-8B. Additional treated water flows out to the designated surface discharge point (atmospheric pressure) through Line 6.

Column 9

A tee from the Line 2 manifold directs ambient pH raw water to R-9 (Column 9 rotameter) where the operational flow rate is controlled. Three-way valves 3V-9A and 3V-9B are placed in the service position, allowing water to flow via gravity and slight system pressure downward through the AD-33 media. The differential pressure (head loss) across the media can be measured as the difference between pressure gauges P-9A and P-9B. Treated water exits Column 9 entering Line 6 (Green). Treated water is sampled at S-9, located immediately downgradient of 3V-9B. Additional treated water flows out to the designated surface discharge point (atmospheric pressure) through Line 6.

Column 10

A tee from the Line 2 manifold directs ambient pH raw water to R-10 (Column 10 rotameter) where the operational flow rate is controlled. Three-way valves 3V-10A and 3V-10A are placed in the service position, allowing water to flow via gravity and slight system pressure downward through the AD-33 media. The differential pressure (head loss) across the media can be measured as the difference between pressure gauges P-10A and P-10B. Treated water exits Column 10 entering Line 6 (Green). Treated water is sampled at S-10, located immediately downgradient of 3V-10B. Additional treated water flows out to the designated surface discharge point (atmospheric pressure) through Line 6.

BACKWASH MODE

Columns will not be backwashed as a maintenance item; instead, backwashing will only be used to restore flow to a column that has plugged due to filtered solids resulting in out of tolerance head loss. The initial criteria for when to backwash are shown in Tables 3-11 to 3-15. Table C-1 summarizes the backwash duration and flow rates for the columns.

In the backwash mode all columns (except 3 and 7 where backwashing is not an option) use ambient pH water for backwash supply water. Line 3 (red) is the backwash water supply manifold. NOTE: All columns are independent of each other with respect to mode of operation (service vs. backwash); however, only one column can be backwashed at a time.

Table C-1. Backwash Procedures

Column No.	Manufacturer/Media	Backwash Duration (min)	Backwash Flowrate (gpm)
1	Aledge/AD-33	<15	0.3
2	Hydroglobe/Metsorb	<15	0.3
3	MEI/Isolux 302M	N/A	N/A
4	Engelhard/ARM 200	TBD	0.3
5	Purolite/ArsenXnp	10-14	0.2
6	Hydroglobe/Metsorb	<15	0.3
7	MEI/Isolux 302M	N/A	N/A
8	Aledge/AD-33	<15	0.3
9	Aledge/AD-33	<15	0.3
10	Aledge/AD-33	<15	0.3

Column 1

- Step 1 Record the pressure readings on P-1A and P-1B.
- Step 2 Record WM-2 reading.
- Step 3 A tee in Line 2 directs ambient raw water to Line 3 (red). Make sure R-11 is in the fully closed position. Open ball valve BV-4 supplying raw water to R-11 (backwash rotameter) where the backwash flow rate is controlled. Open sample port 12 (S-12), then open R-11 to the desired flow rate of 0.3 gpm for Column 1. Allow water to flush backwash manifold via S-12 for 1 minute purging 0.3 gallons. Close S-12.
- Step 4 Record purge volume.
- Step 5 Place 3V-1B and 3V-1A in the backwash position. Backwash water travels upward through Column 1 cleaning the AD-33 media bed by removing filtered solids. Backwash water exits Column 1 through 3V-1A and enters Line 5 (pink) the backwash water out manifold flowing to the backwash water meter (WM-2) and into VES-2.
- Step 6 Backwash the column for 15 minutes at 0.3 gpm.
- Step 7 Record backwash procedure and note observations.
- Step 8 Close R-11, close BV-4, return 3V-1A and 3V-1B to the service position.
- Step 9 Record the new pressure readings on P-1A and P-1B. If the differential (P-1A – P-1B) is not within the desired range, repeat Steps 2 through 8 for Column 1.
- Step 10 Record final WM-2 reading.

Column 2

- Step 1 Record the pressure readings on P-2A and P-2B.
- Step 2 Record WM-2 reading.
- Step 3 A tee in Line 2 directs ambient raw water to Line 3 (red). Make sure R-11 is in the fully closed position. Open ball valve BV-4 supplying raw water to R-11 (backwash rotameter) where the backwash flow rate is controlled. Open sample port 12 (S-12), then open R-11 to the desired flow rate of 0.3 gpm for Column 2.

Allow water to flush backwash manifold via S-12 for 1 minute purging 0.3 gallons. Close S-12.

- Step 4 Record purge volume.
- Step 5 Place 3V-2B and 3V-2A in the backwash position. Backwash water travels upward through Column 2 cleaning the Metsorb media bed by removing filtered solids. Backwash water exits Column 2 through 3V-2A and enters Line 5 (pink) the backwash water out manifold, flowing to the backwash water meter (WM-2) and into VES-2.
- Step 6 Backwash the column for 15 minutes at 0.3 gpm.
- Step 7 Record backwash procedure and note observations.
- Step 8 Close R-11, close BV-4, return 3V-2A and 3V-2B to the service position.
- Step 9 Record the new pressure readings on P-2A and P-2B. If the differential (P-2A – P-2B) is not within the desired range, repeat Steps 2 through 8 for Column 2.
- Step 10 Record final WM-2 reading.

Column 3

Not Applicable. Column 3 cannot be backwashed.

Column 4

- Step 1 Record the pressure readings on P-4A and P-4B.
- Step 2 Record WM-2 reading.
- Step 3 A tee in Line 2 directs ambient raw water to Line 3 (red). Make sure R-11 is in the fully closed position. Open ball valve BV-4 supplying raw water to R-11 (backwash rotameter) where the backwash flow rate is controlled. Open sample port 12 (S-12), then open R-11 to the desired flow rate of 0.3 gpm for Column 4. Allow water to flush backwash manifold via S-12 for 1 minute purging 0.3 gallons. Close S-12.
- Step 4 Record purge volume.
- Step 5 Place 3V-4B and 3V-4A in the backwash position. Backwash water travels upward through Column 4 cleaning the ARM 200 media bed by removing filtered solids. Backwash water exits Column 4 through 3V-4A and enters Line 5 (pink) the backwash water out manifold, flowing to the backwash water meter (WM-2) and into VES-2.
- Step 6 Backwash the column for 15 minutes at 0.3 gpm.
- Step 7 Record backwash procedure and note observations.
- Step 8 Close R-11, close BV-4, return 3V-4A and 3V-4B to the service position.
- Step 9 Record the new pressure readings on P-4A and P-4B. If the differential (P-4A – P-4B) is not within the desired range, repeat Steps 2 through 8 for Column 4.
- Step 10 Record final WM-2 reading.

Column 5

- Step 1 Record the pressure readings on P-5A and P-5B.
- Step 2 Record WM-2 reading.

- Step 3 A tee in Line 2 directs ambient raw water to Line 3 (red). Make sure R-11 is in the fully closed position. Open ball valve BV-4 supplying raw water to R-11 (backwash rotameter) where the backwash flow rate is controlled. Open sample port 12 (S-12), then open R-11 to the desired flow rate of 0.2 gpm for Column 5. Allow water to flush backwash manifold via S-12 for 1 minute purging 0.2 gallons. Close S-12.
- Step 4 Record purge volume.
- Step 5 Place 3V-5B and 3V-5A in the backwash position. Backwash water travels upward through Column 5 cleaning the ArsenX^{np} media bed by removing filtered solids. Backwash water exits Column 5 through 3V-5A and enters Line 5 (pink) the backwash water out manifold, flowing to the backwash water meter (WM-2) and into VES-2.
- Step 6 Backwash the column for 15 minutes at 0.2 gpm.
- Step 7 Record backwash procedure and note observations.
- Step 8 Close R-11, close BV-4, return 3V-5A and 3V-5B to the service position.
- Step 9 Record the new pressure readings on P-5A and P-5B. If the differential (P-5A – P-5B) is not within the desired range, repeat Steps 2 through 8 for Column 5.
- Step 10 Record final WM-2 reading.

Column 6

- Step 1 Record the pressure readings on P-6A and P-6B.
- Step 2 Record WM-2 reading.
- Step 3 A tee in Line 2 directs ambient raw water to Line 3 (red). Make sure R-11 is in the fully closed position. Open ball valve BV-4 supplying raw water to R-11 (backwash rotameter) where the backwash flow rate is controlled. Open sample port 12 (S-12), then open R-11 to the desired flow rate of 0.3 gpm for Column 6. Allow water to flush backwash manifold via S-12 for 1 minute purging 0.3 gallons. Close S-12.
- Step 4 Record purge volume.
- Step 5 Place 3V-6B and 3V-6A in the backwash position. Backwash water travels upward through Column 6 cleaning the Metsorb media bed by removing filtered solids. Backwash water exits Column 6 through 3V-6A and enters Line 5 (pink) the backwash water out manifold, flowing to the backwash water meter (WM-2) and into VES-2.
- Step 6 Backwash the column for 15 minutes at 0.3 gpm.
- Step 7 Record backwash procedure and note observations.
- Step 8 Close R-11, close BV-4, return 3V-6A and 3V-6B to the service position.
- Step 9 Record the new pressure readings on P-6A and P-6B. If the differential (P-6A – P-6B) is not within the desired range, repeat Steps 2 through 8 for Column 6.
- Step 10 Record final WM-2 reading.

Column 7

Not Applicable. Column 7 cannot be backwashed.

Column 8

- Step 1 Record the pressure readings on P-8A and P-8B.
- Step 2 Record WM-2 reading.
- Step 3 A tee in Line 2 directs ambient raw water to Line 3 (red). Make sure R-11 is in the fully closed position. Open ball valve BV-4 supplying raw water to R-11 (backwash rotameter) where the backwash flow rate is controlled. Open sample port 12 (S-12), then open R-11 to the desired flow rate of 0.3 gpm for Column 8. Allow water to flush backwash manifold via S-12 for 1 minute purging 0.3 gallons. Close S-12.
- Step 4 Record purge volume.
- Step 5 Place 3V-8B and 3V-8A in the backwash position. Backwash water travels upward through Column 8 cleaning the AD-33 media bed by removing filtered solids. Backwash water exits column 8 through 3V-4A and enters Line 5 (pink) the backwash water out manifold flowing to the backwash water meter (WM-2) and into VES-2.
- Step 6 Backwash the column for 15 minutes at 0.3 gpm.
- Step 7 Record backwash procedure and note observations.
- Step 8 Close R-11, close BV-4, return 3V-4A and 3V-4B to the service position.
- Step 9 Record the new pressure readings on P-4A and P-4B. If the differential (P-4A – P-4B) is not within the desired range, repeat Steps 2 through 8 for Column 8.
- Step 10 Record final WM-2 reading.

Column 9

- Step 1 Record the pressure readings on P-9A and P-9B.
- Step 2 Record WM-2 reading.
- Step 3 A tee in Line 2 directs ambient raw water to Line 3 (red). Make sure R-11 is in the fully closed position. Open ball valve BV-4 supplying raw water to R-11 (backwash rotameter) where the backwash flow rate is controlled. Open sample port 12 (S-12), then open R-11 to the desired flow rate of 0.3 gpm for Column 9. Allow water to flush backwash manifold via S-12 for 1 minute purging 0.3 gallons. Close S-12.
- Step 4 Record purge volume.
- Step 5 Place 3V-9B and 3V-9A in the backwash position. Backwash water travels upward through Column 9 cleaning the AD-33 media bed by removing filtered solids. Backwash water exits Column 9 through 3V-9A and enters Line 5 (pink) the backwash water out manifold, flowing to the backwash water meter (WM-2) and into VES-2.
- Step 6 Backwash the column for 15 minutes at 0.3 gpm.
- Step 7 Record backwash procedure and note observations.
- Step 8 Close R-11, close BV-4, return 3V-9A and 3V-9B to the service position.
- Step 9 Record the new pressure readings on P-9A and P-9B. If the differential (P-9A – P-9B) is not within the desired range, repeat Steps 2 through 8 for Column 9.
- Step 10 Record final WM-2 reading.

Column 10

- Step 1 Record the pressure readings on P-10A and P-10B.
- Step 2 Record WM-2 reading.
- Step 3 A tee in Line 2 directs ambient raw water to Line 3 (red). Make sure R-11 is in the fully closed position. Open ball valve BV-4 supplying raw water to R-11 (backwash rotameter) where the backwash flow rate is controlled. Open sample port 12 (S-12), then open R-11 to the desired flow rate of 0.3 gpm for Column 10. Allow water to flush backwash manifold via S-12 for 1 minute purging 0.3 gallons. Close S-12.
- Step 4 Record purge volume.
- Step 5 Place 3V-10B and 3V-10A in the backwash position. Backwash water travels upward through Column 10 cleaning the AD-33 media bed by removing filtered solids. Backwash water exits column 10 through 3V-10A and enters Line 5 (pink) the backwash water out manifold, flowing to the backwash water meter (WM-2) and into VES-2.
- Step 6 Backwash the column for 15 minutes at 0.3 gpm.
- Step 7 Record backwash procedure and note observations.
- Step 8 Close R-11, close BV-4, return 3V-10A and 3V-10B to the service position.
- Step 9 Record the new pressure readings on P-10A and P-10B. If the differential (P-10A – P-10B) is not within the desired range, repeat Steps 2 through 8 for Column 10.
- Step 10 Record final WM-2 reading.

MAINTENANCE

Table C-2 lists spare parts that will be available at the pilot site.

Table C-2. Spare Parts List.

Equipment Item	Number of Spares Parts
Water meter	1
Ball valve	3
Three-way-valve	4
Universal Stopcock (sample valves)	4
Float valve	1
Low-level float switch	-
Pump	-
Pressure gauges	5
Water tank, tank cover	-
Pressure control valve	1
Pressure Relief Valve	1
Piping, fittings	
column	-
rotameter	3
Braided tubing	20 ft
Electronic flow meters	3
pH Adjustment System	-
pH data logger	-
Liquid CO ₂ bottle/regulator	2

Table C-3. Socorro Springs Pilot – Operations Log

SOCCORO SPRINGS PILOT - OPERATIONS LOG

DATE:		RAW WATER		time:		CO2 PANEL		time:		BACKWASH		Comments							
FT - Signature	MU - PUMP		ON - OFF		FUTURE - Phase II		WM-2 GAL.												
	P @ MU METER						TODAY												
	PI-1						WM-2 GAL.												
	PI-2						PREVIOUS												
Total Hours on Site	PI-3						WM-2 GAL.												
Tasks Performed	WM-1 GAL.						USED												
	TODAY																		
	WM-1 GAL.																		
PREVIOUS										* If column pressure drop exceeds 15 psi, then proceed with SOP for Backwashing. Log in work performed.									
WM-1 GAL.																			
USED																			
COLUMN #1 - AD - 33		time:		COLUMN #2 - Metsorb		time:		COLUMN #3 - Isolux 302M		time:		COLUMN #4 - ARM 200		time:		COLUMN #5 - ArsenX		time:	
R-1 (0.3gpm)				R-2 (0.4gpm)				R-3 (0.5gpm)				R-4 (0.3gpm)				R-5 (0.4gpm)			
3V-1A		service/backwash		3V-2A		service/backwash		3V-3A		service/backwash		3V-4A		service/backwash		3V-5A		service/backwash	
3V-1B		service/backwash		3V-2B		service/backwash		3V-3B		service/backwash		3V-4B		service/backwash		3V-5B		service/backwash	
P-1A				P-2A				P-3A				P-4A				P-5A			
P-1B				P-2B				P-3B				P-4B				P-5B			
psi drop P1(A-B) *				psi drop P2(A-B) *				psi drop P3(A-B) *				psi drop P4(A-B) *				psi drop P5(A-B) *			
T-1, gpm				T-2, gpm				T-3, gpm				T-4, gpm				T-5, gpm			
T-1, GAL.				T-2, GAL.				T-3, GAL.				T-4, GAL.				T-5, GAL.			
TODAY				TODAY				TODAY				TODAY				TODAY			
T-1, GAL.				T-2, GAL.				T-3, GAL.				T-4, GAL.				T-5, GAL.			
PREVIOUS				PREVIOUS				PREVIOUS				PREVIOUS				PREVIOUS			
T-1, GAL.				T-2, GAL.				T-3, GAL.				T-4, GAL.				T-5, GAL.			
USED				USED				USED				USED				USED			
Comments				Comments				Comments				Comments				Comments			
COLUMN #6 - Metsorb		time:		COLUMN #7 - Isolux 302M		time:		COLUMN #8 - AD - 33		time:		COLUMN #9 - AD - 33		time:		COLUMN #10 - AD - 33		time:	
R-6 (0.4gpm)				R-7 (0.5gpm)				R-8 (0.3gpm)				R-9 (0.3gpm)				R-10 (0.3gpm)			
3V-6A		service/backwash		3V-7A		service/backwash		3V-8A		service/backwash		3V-9A		service/backwash		3V-10A		service/backwash	
3V-6B		service/backwash		3V-7B		service/backwash		3V-8B		service/backwash		3V-9B		service/backwash		3V-10B		service/backwash	
T-6A				P-7A				P-8A				P-9A				P-10A			
T-6B				P-7B				P-8B				P-9B				P-10B			
psi drop P6(A-B) *				psi drop P7(A-B) *				psi drop P8(A-B) *				psi drop P9(A-B) *				psi drop P10(A-B) *			
T-6, gpm				T-7, gpm				T-8, gpm				T-9, gpm				T-10, gpm			
T-6, GAL.				T-7, GAL.				T-8, GAL.				T-9, GAL.				T-10, GAL.			
TODAY				TODAY				TODAY				TODAY				TODAY			
T-6, GAL.				T-7, GAL.				T-8, GAL.				T-9, GAL.				T-10, GAL.			
PREVIOUS				PREVIOUS				PREVIOUS				PREVIOUS				PREVIOUS			
T-6, GAL.				T-7, GAL.				T-8, GAL.				T-9, GAL.				T-10, GAL.			
USED				USED				USED				USED				USED			
Comments				Comments				Comments				Comments				Comments			

Table C-4. Socorro Springs Arsenic Removal Pilot - Sample Log

SOCORRO SPRINGS ARSENIC REMOVAL PILOT - SAMPLE LOG

DATE:																									
TIME:																									
FT - SIGNATURE		ANALYSIS	RAW WATER			COLUMN EFFLUENT										S - 11									
HOLD TIME:	SAMPLE BOTTLE		S-A	S-B	S-C	S-1	S-2	S-3	S-4	S-5	S-6	S-7	S-8	S-9	S-10	C-1	C-2	C-4	C-5	C-6	C-8	C-9	C-10		
Field Tests																									
N/A	1 - Liter Un-Preserved Immediate Testing	Conductivity																							
		Temperature																							
		pH																							
		Free Chlorine																							
		Iron																							
		True Color																							
		Turbidity																							
		Dissolved Oxygen																							
Water Quality Lab Tests and/or SMOCL - Hall Laboratory																									
48 hours	1 - 250 mL UNP	Nitrate																							
SMO Contract Labs - GEL																									
6 months	1 - 500 mL Nitric	Arsenic																							
		Total Hardness - calculation																							
		Calcium Hardness																							
		Magnesium Hardness																							
		Sodium																							
		Aluminum																							
		Iron																							
		Silica																							
		Titanium																							
		Vanadium																							
Zirconium																									
28 days	1 - Liter Un-Preserved	P & MO Alkalinity																							
		Chloride																							
		Fluoride																							
		Silica																							
7 days	1 - Liter - UNP	Sulfate																							
		Total Suspended Solids																							
6 months	250mL - Nitric	Arsenic - Total - Particulate																							
6 months	250mL - Nitric	Arsenic - (III)																							
6 months	250mL - Nitric	Arsenic - Total																							
	1-Liter - Nitric	Radium																							
28 days	1-250mL Amber Glass	TOC																							
		Corrosivity - calculation																							

This page intentionally left blank.

Appendix D: Arsenic Speciation Procedure with Disposable Cartridges

This page intentionally left blank.

Appendix D

Arsenic Speciation Procedure with Disposable Cartridges

Principles

Disposable cartridges packed with selective aluminosilicate adsorbent are used to separate arsenate As(V) and arsenite As(III) in water samples. The cartridges are used for separation of inorganic arsenic species only.

Product Name: Aluminosilicate adsorbent

<u>Component</u>	<u>% by Weight</u>
Alumina	0.1 – 10
Aluminum silicate	5 – 50
Silica	20 - 80

The adsorbent in the cartridges removes arsenate [As(V)] and does not adsorb arsenite [As(III)]. The difference between the total arsenic concentrations in the raw water and the As(III) concentration in the filtered water through the cartridges is equal to the concentration of As(V) in the sample.

Conditions for Accurate Speciation of As

1. Sample pH values: 4-9
2. Arsenic concentration: for freshwater samples with As concentration <500 µg/L, use one cartridge; for samples with As concentrations 500 – 5000 µg/L, use two cartridges in series or dilute the samples
3. Sample volume: approximately 50 mL
4. Filtration rate: 60 +/- mL/min

Procedure for Speciation of Arsenic in Samples

1. Collect a water sample and filter it through a 0.4 µm filter to remove particulate As. (This step can be eliminated if particulate arsenic concentration in the samples is low or is not a concern. Avoid oxidation of Fe(II) in water samples and filter the samples as soon as possible.)
2. Analyze soluble or total As concentration (Ts) in the filtered or raw water sample.
3. Pass 30 to 50 mL of the water sample through a disposable cartridge using a syringe (luer slip tip). Discard the first 5 mL of filtrate. Collect the filtered solution for analysis of As concentration (As(III)).
4. Calculation of As(III) and As(V) concentrations
 - a. As(III) concentration = total As in cartridge-filtered water
 - b. As(V) concentration = total As in raw or 0.4-µm filtered water – As(III)

Reference

Meng, X. G. and Wang, W. (1998) "Speciation of Arsenic by Disposable Cartridges" In Book of Posters of the Third International Conference on Arsenic Exposure and Health Effects: Society of Environmental Geochemistry and Health, University of Colorado at Denver.

Appendix E: Sampling Plan for Spent Media Columns

This page intentionally left blank.

Appendix E

Sampling Plan for Spent Media Columns

Post-test characterization of the media in the columns is divided into two phases. In the first phase, the column containing MetSorb (#6) and one of the columns containing AD-33 (#9) will be returned to Sandia National Laboratories, where pore water will be sampled, the columns will be split, and samples of media will be taken. When the columns (#s 6 and 9) are removed from the Socorro Pilot, flow will be restarted in the remaining columns (#s 4, 5, 8, and 10) and will continue for approximately one week to re-establish the steady-state mass transfer zone profile. Samples of composite influent and a sample of effluent for each column will be taken daily for analysis of the solutes as described in Table E-1.

Table E-1. Sampling and Analysis Plan for Columns 4, 5, 8 and 10 (August 25 – ?)

Location	Sampling Frequency	Solutes	Total # Lab Samples
Influent	daily	Field: pH, Lab: total As	NA 7
Effluent Columns #4,5,8,10	daily	Field: pH Lab: total As	NA 28

Supplies for field sampling of influent and effluent: 35 pre-acidified __-mL bottles

After one week or a to-be-determined period, flow will be stopped, and pore water samples will be extracted from each column in place immediately after flow ceases. This will be repeated for all of the columns. All of the columns will be returned to Sandia National Laboratories for sampling of the solids. The following plan applies to sampling of all columns, whether they are sampled on site (pore waters only) or at Sandia National Laboratories (solids).

Sampling of Pore Waters and Solid Media

Supplies for pore water and media sampling (numbers represent maximums) are listed below. Table E-2 shows the number of samples that will be taken for pore water and solid analyses.

- PPE (gloves, glasses, lab coat, pants, shoes, etc.)
- Electric saw
- PVC hand saw
- Electric drill
- Drill bit (unspecified size – currently located in the box with syringes)
- Yellow duct tape
- pH paper (range 6.8 – 8.4)
- 71 12-mL syringes to take water samples
- 353 plastic scintillation vials for samples (media and water)
- Permanent markers/Sharpies
- Nylon line
- Spatulas for sampling media

- DI water to rinse; small wastewater beakers
- Tape measure
- Disposal materials (multiple large plastic garbage bags)
- Dust pan and brush
- Digital camera

Table E-2. Number of Samples for ICP-MS (pore water) and Extraction (solid) Analysis.

Media Length in Column (in)	Number of Water Samples*	Number of Media Samples*
25.7	9	18
19	7	13
38	13	26
48	16	32
38	13	26
39	13	26
Total	71	141
* Sample estimates are rounded up.		

An additional 141 vials for solid samples may be needed to hold samples for locating the mass transfer zone.

Procedure

- Before opening the column, label each vial to be used for water and media samples with an ID for the column and at what height the sample was taken from (i.e., “SC9 M 3,” meaning a media (M) sample from 3 inches down on column SC9).

Sampling of pore fluids in the field

- Mark three-inch intervals on all columns starting at the top of the media.
- Shut off water flow to the column. Ensure that water cannot drain through the base of the column.
- With the column in the vertical position, drill a hole right above the media to drain any standing non-pore water. When this water is drained, drill another hole three inches down.
- Once a hole is drilled within the media-filled portion of the column, immediately insert a 12-mL syringe into the hole and draw out the pore water. Draw enough water to obtain a >15-mL sample for the ICP-MS. Wet a strip of pH paper by squirting out water from the syringe (don’t dip the paper in the vial). Determine pH and record result. If greater than 15 mL of water is available, allow the remaining water to drain out from the hole before drilling the next. These holes do not need to be plugged unless media oozes out.

Sampling of media in the lab

- Place garbage bags along the length of the bench and secure with tape. This will greatly ease cleaning the bench later. Make sure the empty vials are not sitting on the bench where PVC shavings can get in them.
- Draw a straight line along the side of the column that directly opposes where the drill holes were made for water extraction. Place the column on a table and use an electric

saw to split the column lengthwise. If the column will not hold together while turning it over to make the second cut or if the media starts oozing out, tape the first cut along its entire length.

- After both vertical cuts are made, cut off the top and bottom of the column (this may be easier with the PVC hand saw, especially at the bottom of the column). Then finish the vertical cuts to the end of the column.
- (Remove any tape.) Split the column in half by pulling nylon cord through the media using the two cuts in the PVC pipe as guides. Try to minimize any sawing action as it will diminish any visible features in the media. Separate the two halves of the column.
- Lay out a piece of tape along the length of the column and mark off every 1½ inches using the tape measure (this will also serve as scale in the photographs).
- Photograph the column at sufficient resolution from top to bottom. Take additional photos to distinguish any indications of flow channeling or interesting features.
- The two halves of the column should now be lying open on the table. Using a spatula, take samples of media in the center of one half of the column every three inches and at the edge of the column every three inches, but in between the center samples.
- Fill the vial with sample, but don't pack the media in. Ensure that ~20 g of sample is taken (you may want to weigh the first one or two vials to check).

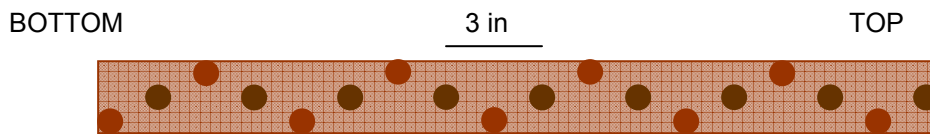

- After taking all samples, dispose of the media in double garbage bags until proper disposal methods are determined. Rinse media off PVC pipe and dispose of it in the trash. Clean up all the material spilled and add to the garbage bags.

This page intentionally left blank.

Appendix F. Site-Specific Safety Plan

This page intentionally left blank.

Appendix F

Socorro Site-Specific Safety Plan

This is a Site-Specific training document for Socorro Arsenic treatment site to be used in addition with PHS SNL3A103-002, umbrella document for the Arsenic Project.

Introduction

This document is designed to provide individuals with information that will help protect them from potential hazards at the Socorro Arsenic Treatment Site. This document is required reading for all regular workers and all visitors performing work at this site. To be in compliance with regulations set for this site, this document must be read initially upon entering the site and once annually thereafter for as long as work is being performed on this site. The “Statement of Understanding” at the end of this document must be signed, detached and returned to Emily Wright (MS 0754, Dept 6118) for record keeping purposes. The remaining portion of this document is to be kept.

Communication Policy

It is required that all field test personnel carry a cell phone in case of an emergency. Other ES&H information pertinent to this activity are described in PHS 7A 00405-010.

Chlorine and CO₂ Gases Hazard

A chlorine gas line is present at this site. In case of leak, return immediately to vehicle, drive to an area up-wind at least 100 meters (330 feet) away from the site, and report any injuries or illness, and leak to 911. Do not try to locate or repair the leak. When logical, remain in your vehicle until emergency response arrives and warn anyone approaching the site of the danger. Material safety data sheets (MSDSs) for this chemical are located at the end of this section or can be downloaded from www-irn.sandia.gov/CIS/MSDS/ohsbk665.htm.

CO₂ gas (Carbon Dioxide Gas) is used as part of a pH adjustment system. MSDS sheets for this chemical are located at the end of this section, or can be downloaded from www-irn.sandia.gov/CIS/MSDS/ohs04260.htm.

Natural Habitat Hazards

Being that this site is in a rural area, there are different types of wildlife that you may encounter. Snakes, particularly Rattle Snakes are seen regularly in this area. Always consider that a snake may be present when approaching the site, and proceed with caution. If a snake is encountered, slowly walk backwards away from the snake, return to your vehicle, and phone 505-440-6119. Within 15 minutes, someone from the City of Socorro will arrive to assist in removing the snake. Coyotes also raise a slight concern. By nature, coyotes fear humans and will stay away, but if you feel threatened, make loud noises and walk backwards slowly to your vehicle. Once inside your vehicle, call 505-440-6119 for assistance. Do not run from a pack of coyotes; this may show fear and provoke an attack.

Accidents

Accidental injuries that may occur at this site, such as, slip and falls or cuts and scrapes, that do not require emergency treatment but need urgent medical care should be treated at Socorro General Hospital. Only if the injured person is conscious, self-mobile, and any bleeding is limited, should the victim transport themselves to Socorro General Hospital for urgent care; all other cases should be reported to 911 and treated by emergency response individuals. The following map in Figure F-1 shows the address of the hospital and driving directions.

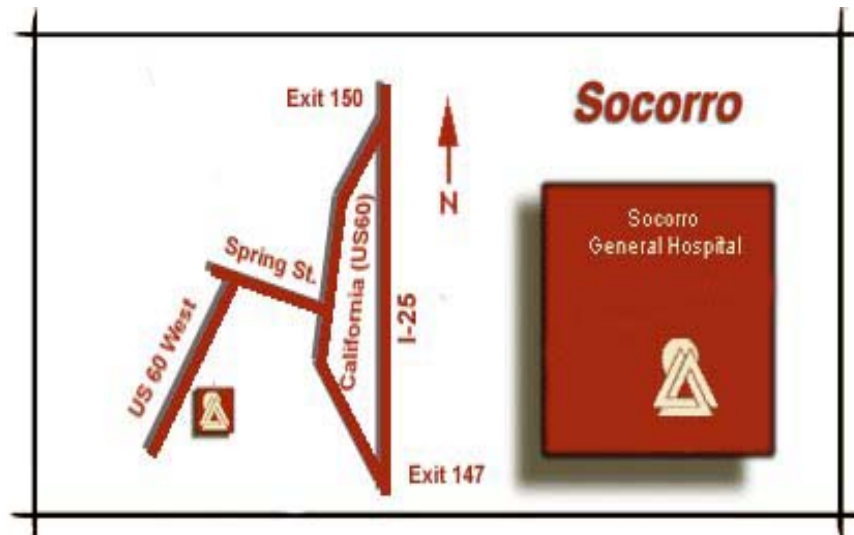

**1202 Highway 60 West
P.O. Box 1009
Socorro, NM 87801**

Figure F-1. Hospital Location

Visitor Policy

Visitors maybe visiting this site for non-work related reasons. All visitors should be escorted and be made aware of the potential hazards at this site. It is the responsibility of the escort to inform visitors that will not be performing work duties at this site of the hazards. The following Section 1.2 should be read out loud to visitors by escort before entering the site.

1.2 “This site has potential hazards that must be addressed. The hazards at this site are, but are not limited to, chlorine gas, carbon dioxide gas, slips and falls, and wildlife encounters. For your protection, there is a first aid kit on site and located close to the entrance. Your escort has been briefed and understands how to handle emergency situations that could happen at this site; in case of an emergency, follow the direction given by your escort. If no directions are given in a situation, evacuate to your vehicle. If you do not understand anything that was just explained to you, or if you have any questions, please feel free to ask your escort at anytime during your visit.”

Once this is read and all questions have been answered, visitors must sign a “Statement of Understanding signature log” that will be kept onsite for record-keeping purposes.

(Detach this page and return for filing)

“Statement of Understanding”

I have read the “Socorro Site Specific Document” and understand all of the information provided. I understand that I have the right to ask any questions about this or any other safety documents. I understand that I have the right to refuse to work at this site due to unsafe conditions without consequence. I understand by signing below I agree to this statement.

Printed Name _____

Signature _____

Date _____

This page intentionally left blank.

Appendix G: NSF Review Comments

This page intentionally left blank.

APPENDIX G

Review of Socorro Springs Pilot Test Specific Test Plan by NSF, International

- Sandia Plan and ETV Protocols Comparisons
- Audit/Inspection Report of the Socorro Springs Arsenic Test Program, Sandia National Laboratory, February 1 and 2, 2005

Dale Scherger, P.E,
Scherger and Associates
February 2005

Sandia Test Plan and ETV Protocol Comparisons

Tables follow that show comparisons between the ETV Protocol and Sandia Test Plan. There are some differences between the NSF/EPA ETV Protocol and the Sandia Test Program. NSF and its technical consultant have reviewed the differences and found most to be acceptable changes given the objectives of the Sandia program. There are a couple of recommendations included with the comparison tables, where differences can be eliminated easily within the Sandia program. The tables on methods and analytical frequency have notes and comments at the bottom, in addition to comments in the Table. Two other differences that are not included in the attached Tables are:

Statistics

Confidence Interval

Sandia dropped the confidence interval calculation from their plan. They feel it is not needed for their work. Since the mean and standard deviation will be known, anyone can calculate the value if they want. Confidence intervals do not apply to capacity studies since the treated water should be increasing with time and therefore do not follow a normal distribution. Feed water should follow a normal distribution.

Bruce Bartley, Kristie Wilhelm, and Dale Scherger agree this change is acceptable.

Completeness

Sandia does not plan to use completeness as a measure or QA objective/quality indicator. DOE projects do not appear to require this as a DQO. This is not critical to the program, but of course if large amounts of data are missing, the findings will be in jeopardy. EPA projects require this parameter, but it is often not included in QA programs for other agencies.

Bruce Bartley, Kristie Wilhelm, and Dale Scherger agree this change is acceptable.

OPERATING PARAMETERS, INFORMATION, AND CALIBRATIONS

Operational Parameters	ETV Protocol	Sandia Test Plan	Comments/Decision
Flow rate measurements	Record every 4 hours when on site; adjust when >5% above or below	Record once per day; adjust when >5% above or below	Once a day acceptable; they are only on site once a day during Integrity Test; once a week for Capacity test; daily readings by utility operators.
Total flow	Record every 4 hours when on site; adjust when >5% above or below	Record once per day; adjust when >5% above or below	See above; Meters have been consistent; changes are gradual over longer than 4 hr periods.
Pressure readings	Record every 4 hours when on site	Record once per day	See above; pressure changes even more gradual than flow.
Electrical Power	Record meter daily	Not recorded	Acceptable - This is pilot test equipment, not commercial units; power not really applicable.
Chemical use	Check and record once per day; record refill volumes and times; Record name and strength	Currently not in plan; will be added to pH adjustment addendum; same as ETV	They will update with addendum for pH adjustment part of the test.
Hours of operation	Record once per day; beginning or end of day	Record once per day; when on site	Same as ETV
Flow meter calibrations checks	Once per week	Once per week	Test plan inconsistencies will be fixed. Once per week same as ETV.
Flow totalizer calibrations checks	Once per week	Once per week	Test plan inconsistencies will be fixed. Once per week same as ETV.
Pressure gauge calibrations	Once per week	Once per test (NSF is requesting calibration check also at end of test.)	Acceptable with modification - Pressure gauge calibration should be at a minimum at the beginning of testing and end of test to document no change during the test. Pressure gauges are usually very consistent and reliable once checked so less frequent than ETV is acceptable.
Qualitative factors (Kristie #2)	Requires these factors	Not included	Acceptable - This is pilot test equipment, not commercial units; qualitative factors not really applicable.
Applicable range of arsenic concentrations (Kristie #3)	Requires vendors to supply claims and guidance	Not required, media vendors uncertain	Acceptable - Media vendors have not been knowledgeable or forthcoming. Since the tests are not on commercially sold units, claims are not part of their program. It would be helpful to have this information, but vendors do not seem to know.

INTEGRITY TEST SAMPLING FREQUENCY AND PARAMETER LIST

ETV PROTOCOL			SANDIA TEST PLAN		Comments
Parameter	Frequency	Location	Frequency	Location	
Adsorptive Media Influent and Effluent					SMOCL – Contract lab WQL – Sandia Water Quality Lab
Arsenic	Daily	Lab	Daily	WQL and SMOCL Lab	
Arsenic Speciation	Three times during this task	On-Site Prep, Lab analyses	Three times, Prep on site SMOCL lab	On-Site Prep WQL and SMOCL Lab	
Arsenic Test Kit	Optional by FTO	On-Site	No test kit, Daily to lab with fast turn around	WQL lab	
pH	Daily	On-Site	Daily	On site	
Alkalinity	Daily	On-Site	Daily	WQL and SMOCL Lab	
Fluoride	Daily	On-Site or Lab	Weekly	WQL and SMOCL Lab	Weekly acceptable See notes (1)
Chloride	Weekly	Lab	Weekly	WQL and SMOCL Lab	
Sulfate	Weekly	Lab	Weekly	WQL and SMOCL Lab	
Silica	Daily	Lab	Weekly	WQL and SMOCL Lab	Weekly acceptable See notes (1)
Aluminum	Daily	Lab	Weekly	WQL and SMOCL Lab	Weekly acceptable See notes (1)
Sodium (optional)	Weekly	Lab	Weekly	WQL and SMOCL Lab	
Calcium	Weekly	On-Site or Lab	Weekly	WQL and SMOCL Lab	
Hardness	Weekly	On-Site or Lab	Weekly	By calculation	
Magnesium	Weekly	On-Site or Lab	Weekly	WQL and SMOCL Lab	
Iron	Weekly	Lab	Daily	On site	Acceptable more frequent See Note (1)
Manganese	Weekly	Lab	Not included		Questionable See note (2)
Turbidity	Daily	On-Site	Daily	On site	
Temperature	Daily	On-Site	Daily	On site	
Conductivity	Not required		Daily	On site	
TCLP	Once	Lab	Not included		Acceptable, See Note (3)
CA WET	Once	Lab	Not included		Acceptable See Note (3)

Parameter	ETV PROTOCOL		SANDIA TEST PLAN		Comments
	Frequency	Location	Frequency	Location	
Free Chlorine	Not required		Daily	On site	
Apparent Color	Not required		Daily	On site	
Dissolved Oxygen	Not required		Daily	On site	
Titanium	Not required		Daily	SMOCL lab	
Zirconium	Not required		Daily	SMOCL lab	
TSS	Not required		Daily	SMOCL lab	
Nitrate	Not required		Weekly	SMOCL lab	
Vanadium	Not required		Weekly	SMOCL lab	
Gross Alpha/Beta	Not required		Weekly	SMOCL lab	
Total Organic Carbon (TOC)	Not required		Weekly	SMOCL lab	

Note 1: Silica, aluminum, and fluoride analyses were emphasized in the ETV protocol based on activated alumina media technology. Other media are not as susceptible to changes in these parameters. Titanium and Zirconium have been added for media in this test that are based on using these metals in the media. Other media are iron based so iron is performed daily.

Note 2: Sandia does not include manganese as they say manganese in the raw water is low. Data not in test plan. Removing manganese does remove a parameter often looked at by agencies. In this case probably acceptable assuming manganese is low in the raw water. Still recommend it be considered.

Note 3: TCLP and CA WET not part of the Integrity Test. The columns will not be backwashed as part of the Integrity Test, since these pilot columns of media, not actual commercial equipment. Waste will not be generated. These tests will be part of the capacity test at the end of the entire run.

CAPACITY VERIFICATION TEST SAMPLING FREQUENCY AND PARAMETER LIST

Parameter	ETV Protocol		Sandia Test Plan		Comments
	Frequency	Location	Frequency	Location	
					SMOCL – Contract Lab WQL – Sandia Lab
Arsenic	Weekly & More Frequent Near Breakthrough	Lab	Weekly & More Frequent Near Breakthrough	SMOCL Lab	
Arsenic Speciation	Minimum of three times during this task	On-Site Prep, Lab analyses	Three times, Prep on site SMOCL lab	On-Site Prep SMOCL lab	
Arsenic Test Kit	Optional by FTO	On-Site	No test kit, WQL Fast turnaround	WQL lab	
pH	Daily	On-Site	Daily	On site	
Alkalinity	Daily	On-Site	Weekly	SMOCL lab	Acceptable; See Note 3
Fluoride	Daily	On-Site, Lab	Weekly	SMOCL lab	Acceptable; see Note 1
Chloride	Weekly	Lab	Weekly	SMOCL lab	
Sulfate	Weekly	Lab	Weekly	SMOCL lab	
Silica	Daily	Lab	Weekly	SMOCL lab	Acceptable; see Note 1
Aluminum	Daily	Lab	Weekly	SMOCL lab	Acceptable; see Note 1
Sodium (optional)	Weekly	Lab	Weekly	SMOCL lab	
Calcium	Weekly	On-Site, Lab	Weekly	SMOCL lab	
Hardness	Weekly	On-Site, Lab	Weekly	By calculation	
Magnesium	Weekly	On-Site, Lab	Weekly	SMOCL lab	
Iron	Weekly	Lab	Weekly	On site	
Manganese	Weekly	Lab	Not included		Questionable, see Note 2
Turbidity	Daily	On-Site	Weekly	On site	Acceptable; this a staffing issue –See Note 3
Temperature	Daily	On-Site	Daily	On site	
TCLP	Once	Lab	Once	WQL or SMOCL	
CA WET	Once	Lab	Once	WQL or SMOCL	

Parameter	ETV Protocol		Sandia Test Plan		Comments
	Frequency	Location	Frequency	Location	
Conductivity	Not required		Daily	On site	
Free Chlorine	Not required		Weekly	On site	
Apparent Color	Not required		Weekly	On site	Sandia decided on apparent color for color test Acceptable for these tests
Dissolved Oxygen	Not required		Weekly	On site	
Titanium	Not required		Weekly	SMOCL lab	
Zirconium	Not required		Weekly	SMOCL lab	
TSS	Not required		Weekly	SMOCL lab	
Nitrate	Not required		Weekly	SMOCL lab	
Vanadium	Not required		Weekly	SMOCL lab	
Gross Alpha/Beta	Not required		Weekly	SMOCL lab	
Total Organic Carbon (TOC)	Not required		Weekly	SMOCL lab	

Note 1: Silica, aluminum, and fluoride analyses were emphasized in the ETV protocol based on activated alumina media technology. Other media are not as susceptible to changes in these parameters. Titanium and Zirconium have been added for media in this test that are based on using these metals in the media. Other media are iron based so iron is performed daily.

Note 2: Sandia does not include manganese as they say manganese in the raw water is low. Data not in test plan. Removing manganese does remove a parameter often looked at by agencies. In this case probably acceptable assuming manganese is low in the raw water. **Still recommend it be considered.**

Note 3: Turbidity and Alkalinity are reduced to once per week, as Sandia will only have staff on site once per week. The utility operators will monitor the system on the remaining days. It was felt the utilities operators could do pH. Temperature, conductivity, but it was too much to ask and train them to do turbidity and alkalinity. Assuming these parameters are stable during the Integrity test this should be acceptable. Once concern is alkalinity for the pH adjustment tests. Sandia will monitor alkalinity more frequently during the pH control loop startup to ensure things are stable.

Sandia Test Plan Analytical Methods (per Section 5.5.4 and Tables 5-5 and 5-7)

Evaluation of Proposed Methods and Comparison to EPA Approved Drinking Water Methods

Parameter	On-site	WQL	SMOCL	Drinking Water Methods Per Web Site and Regulations	Method Acceptable Or Not - Comments
Arsenic		200.8	200.8	200.8	YES
Arsenic Speciation	Aluminosilcate cartridge prep	200.8	200.8	200.8	Yes
Arsenic Test Kit	N/A				
pH	4500-H+ B			150.1, 4500-H+ B	Yes
Alkalinity		310.1; 8203	310.1	2320 B	Yes –methods are equivalent See note 1
Fluoride		4500-F-C	300.0	300.0, 4500-F-B, C, D	Yes
Chloride		4500D; 8207	300.0	300.0, 4500-Cl-B, D	Yes
Sulfate		8051; 4500 SO4 E	300.0	300.0, 4500- SO4 C, D, E, F	Yes
Silica		6010B; 8185; 4500-SiO2 C	200.7	200.7, 3120 B, 4500-SiO2 D,E,F	Yes
Aluminum			200.7	200.7, 3120B	Yes
Sodium (optional)			200.7	200.7, 3111 B	Yes
Calcium		8204; 2340- C	200.7	200.7, 3120 B, 3500-Ca-B, D	Yes – See note 2
Hardness		2340-C	130.2	None found	Yes
Magnesium		2340-B	200.7	200.7, 3120 B, 3500-Mg-E	Yes – See note 2
Iron	8008; 3500-Fe B		200.7	200.7, 3120 B	Yes – See note 3
Manganese				200.7, 3120 B	Not in current plan
Turbidity	2130B; 180.1			180.1, 2130B	Yes
Temperature	2550			2550	Yes
Conductivity	2510 B; 8160			2510 B	Yes
TCLP		1311/6010B/ 7470A	1311/6010B/ 7470A	None	Yes
CA WET		WET/6010B/ 7470A	WET/6010B/ 7470A	None	Yes
Free Chlorine	4500-CL-G; 8021			4500-Cl-D, F, G, H	Yes
Apparent Color					
Dissolved Oxygen	4500-O-G			None	Yes

Evaluation of Proposed Methods and Comparison to EPA Approved Drinking Water Methods

Parameter	On-site	WQL	SMOCL	Drinking Water Methods Per Web Site and Regulations	Method Acceptable Or Not - Comments
Titanium			200.7	None	Yes
Zirconium			200.8	None	Yes
TSS		2540- D	160.2	None (2540-D approved for waste water)	Yes - methods are equivalent
Nitrate		4500-NO3-D; 8039	300.0	300.0, 4500-NO3-D, E, F	Yes
Vanadium			200.7	None	Yes
Gross Alpha/Beta			903	900	Yes
Total Organic Carbon (TOC)			9060	Method 5310 B approved for wastewater	Yes - methods are equivalent

Note 1: Alkalinity is non-critical parameter but will be of interest, especially when using CO₂ for pH adjustment. The Hach method is the same procedure as the EPA approved method, but uses a different indicator. Suggest the WQL setup the approved method and use the Hach method only when on site for quick checks.

Note 2: Calcium and Magnesium approved methods are by ICP or AA. The titration methods sited are long proven methods, but suggest that they only be used for quick checks. Since samples are being analyzed by 200.7 (ICP) for other parameters suggest including calcium and magnesium be included by method 200.7 on these daily or weekly samples.

Note 3: Using the Hach kit or wet chemistry to give quick checks on site or in the WQL lab is acceptable for screening tests and providing a quick indicator of iron levels. Suggest the daily/weekly normal samples be run by ICP (200.7) along with the other ICP parameters. This will provide EPA approved methodology and lower detection limits.

This page intentionally left blank.

DRAFT – NOT FOR GENERAL DISTRIBUTION

**Audit/Inspection Report
Of The
Socorro Springs Arsenic Test Program
Sandia National Laboratory
February 1 and 2, 2005**

**By
Dale Scherger P.E.**

Introduction

An operational and laboratory audit was conducted on February 1 and 2, 2005 by Dale Scherger (consultant) representing NSF International. The test site is located at the Socorro, New Mexico, at the water utility chlorination site, known as the “Springs” site. The Water Quality Laboratory (WQL) and Rapid Small Scale Column Test (RSSCT) Laboratory are located at the Sandia National Laboratory in Albuquerque, New Mexico. The site visit to the Springs was the morning of February 1, followed by review of the WQL in the afternoon. The RSSCT lab was visited the morning of February 2. A closing meeting was held with Malcolm Siegel, the project manager, on February 2.

The purpose of the audit was to review the procedures and approach being used at the site and in the laboratories, and evaluate them for sound quality practices and in relation to the specifications outlined in the Draft Pilot Specific Test Plan (PSTP) developed by SNL and protocol requirements of the NSF ETV Drinking Water Center for adsorptive media. Since the PSTP was still in review and development, the audit provided an opportunity to discuss changes that might benefit the Springs test program and also could be incorporated in future test programs. The site operational audit was conducted to review the procedures being used in the field, including sample collection procedures, field data collection records, log books, field laboratory methods and records, and to review the data management system in use to summarize all of the information collected to date. The purpose of the laboratory audits was to examine the operational aspects of the laboratory procedures being used for the specific tests being analyzed for the SNL program. The audit also served as a time to discuss laboratory procedures that were under development, analytical methods and QA/QC requirements for drinking water, and to observe the operation of the RSSCT lab with columns in operation. The PSTP and ETV Protocol requirements were used as the basis for the audit.

The project manager, Dr. Malcolm Siegel, and several members of the SNL team were available for the entire visit. Mr. Randy Everett, project technologist, and Mr. Brian Dwyer, project engineer, who designed the site test equipment, were present and available during the site visit. The field visit coincided with a routine sampling event for the pilot program. Therefore, it was possible to observe the sampling procedures and recording of the operational data. Mr. Justin Marbury, project technologist, conducted the WQL laboratory visit and discussed the planned implementation of sample analysis procedures in the WQL laboratory. Ms. Pamela Puissant,

Program manager for Off Site Contract Laboratories, was available to discuss the Sample Management Office program. An outside contract lab is being used for analytical work until the WQL is fully operational. Ms. Alicia Aragon, Laboratory Engineer, conducted the RSSCT visit and is operating all of the equipment for the RSSCT program.

This audit report is divided into three sections, the site operational and field test activities, the WQL laboratory, and the RSSCT facility. The audit results are divided between findings and observations/recommendations. Findings are audit items that require action to either meet the PSTP or good QA/QC practice as described in the EPA and equivalent analytical methods, sampling procedures, and QA manuals. Observations/Recommendations are items that in the opinion of this auditor should be considered for implementation to strength the overall pilot test program.

TEST SITE – SOCORRO SPRINGS

The project manager and the entire on site staff were found to be knowledgeable of the technologies being tested and were familiar with the test plan and the ETV program. The audit of the field records and procedures found that in general the information was in order and the basic test plan was being followed. The field data was being recorded on custom made field logs (from a spreadsheet) and in a field logbook. The sampling procedures were observed to be excellent with the sample lines being purged prior to each sample collection time. Bottle labels were pre-prepared and legible. Proper preservations was being used for all samples collected. The field analysis was being preformed with the Hach and Standard Methods procedures described in the test plan.

The site test equipment was well constructed and the placement of flow meters, pressure gauges, etc. allowed easy access for taking daily readings. The columns and piping were secured on a unistrut system that provided a secure and safe method for holding the equipment. The system had been operating for several days, and except for some flow rate fluctuations (discussed later), appeared of a robust design that could operate on a continuous basis with minimal operator attention.

There were several issues that were discussed that could improve the QA/QC, the clarity of record keeping, and there were some tasks that could be improved. These findings are summarized below.

FINDINGS

1. Duplicate Field Samples

The test plan and standard QC practice call for one field duplicate to be collected and analyzed for every ten samples collected in the field. In the first week of operation, NO field duplicates were collected for either the onsite analyses or the laboratory. The field operators and laboratory need to coordinate and begin to collect field duplicates for analysis. These duplicate samples should be collected for all parameters being performed onsite or in the laboratory. This includes parameters such as pH, temperature, turbidity, conductivity, etc. It was discussed that since

approximately eight to nine samples are being collected during each sampling event (raw water, feed water, 7 columns) it would be easiest to collect one duplicate each time a set of samples was collected. This duplicate should rotate between the inlet (feed) water and the column effluent (treated) water. It was suggested the duplicate could be added to the sampling and analysis work sheet being used in the field to ensure all samples were collected.

2. Calibration of field chemical test equipment

The pH meter, turbidity, chlorine, conductivity, and dissolved oxygen meters were being calibrated by the site operator based on conversation with him regarding the methods being used. It was clear that the need to calibrate the meters was understood and being done. However, there is no record being kept of the calibrations performed, when it was performed, and by whom. Calibration data for the pH meter (3 buffers) and turbidity meter (primary or secondary standards) should be recorded in the calibration log with a date, time, and analyst's initials. The same should also be done for the chlorine analysis, which should include showing that a "blank water" was used to set the zero point or confirm the chlorine reading is zero. For the DO and conductivity meters, since these are meter specific operations, it should be logged with a time, date and operator initials that "the DO meter was calicbrated on XXX date, at XXX time, by XXX" and that "the conductivity meter was calibrated on XXX date, at XXX time, by XXX.

The temperature measurements were being done with an NIST certified thermometer. Therefore, additional calibration is not needed. However, it was discussed that using the digital meters was significantly easier and was the preference of the field staff. The use of the digital thermometer is acceptable, but it must be calibrated against an NIST certified traceable thermometer on a monthly basis. If the change is made top the digital thermometer, this calibration needs to be incorporated into the field operating requirements.

3. Pressure Gauge Calibration

There are several pressure gauges on the test unit to monitor head loss across the columns, which is the indicator that backwashing may be needed. The pressure gauges did not have a certification of calibration by the manufacturer and had not been calibrated using a dead weight test device. The pressure gauges need to be calibrated at least at the beginning and possibly at the end of the test to ensure accuracy [proposed change to PSTP]. It was agreed that a set of pressure gauges would be calibrated at SNL and then installed in place of the current gauges. Pressure readings from the current gauges would be read just prior to removal from the system, and then the new gauges would be installed and read immediately after installation. This will provide a record and comparison between the gauges when the change is made. The current gauges after removal will be calibrated at SNL, the calibration information placed in the operating log, and then they can be used in the future in the next test rig.

Observations/ Recommendations

1.. Flow Rate Records

The flow rates are read once per day and then adjusted if they deviate by more than +/- 5%. The flow rate before and after adjustment must be recorded in the operating log sheet. This was being done by making a note on the bottom of the sheet. It is recommended that an actual row be placed in the log sheet for the before and after readings, so that there is no confusion when the data is entered into spreadsheets at a later date. Experience shows that these types of measurements can be easily missed or misinterpreted at data entry. It will also be easier for the utility operators when they take over the readings during the capacity test to remember to record any flow rate changes. Otherwise, all flow readings, if only recorded after adjustment, will show a steady flow, since only adjusted readings will be shown,

2. Flow Meter Calibrations

The flow meters, flow rate and volume, are being calibrated with a bucket and stop watch method as called for in the PSTP. However, the current method is to shut off all the columns except the one being checked, and then collect the water from the main drain line. It was discussed and recommended that individual sample locations could be used on the outlet end of the columns to allow easier collection of calibration data and not require shutting down the other columns.

3. Flow Fluctuation –

Following startup the flow rates were still showing some significant change over 24 hour periods. This may be due to changing pressure on the common header feeding the columns. The entire flow control and pressure drop is being taken by the rotameter on the inlet side of each column. It was recommended that if the flow fluctuation continues, pressure regulators on the inlet of each column should be installed to maintain a steady inlet pressure on each column. This will stabilize the inlet pressure even if one column develops a large backpressure. SNL was planning to try this approach. It is important that flow rate fluctuations be minimized to ensure consistent empty bed contact time is achieved in each column.

4. Feed Water Sample Location

The feed water is being sampled near the feed water tank. It is suggested that the sample point be moved to the common header near the columns. This new point will be easier to sample, and will give a better sample of the feed water.

5. Operating Log and Training for the Utility Operators

At the end of the Integrity Test and start of the Capacity Test, the Socorro utility operators will begin to record the daily operating parameters, and the SNL staff will only be on site about once per week to perform the weekly analyses and calibration checks. While the current operating log sheets are good with a lot of detail, it is recommended that simplified operating record log be developed for the utility operators. They only need to make a few readings and a simple “fill in” the box approach for their readings should be easier to follow.

It is also recommended that training of the utility operators be performed as soon as possible. SNL indicated they planned to train the utility operators but this has not yet occurred. It is very important that proper training is performed and follow-up review of the records is performed at the beginning of the capacity test.

WATER QUALITY LAB

The WQL has the basic equipment to support the on site field tests that are being performed and to provide fast turn around checks of some parameters. Basic titration and wet chemistry methods can be performed. The lab has an ICP/MS to perform the arsenic analysis and other EPA 200.8 metals parameters. The lab also has an ion chromatograph capable of performing anion analyses (Cl, F, NO₃, SO₄) by EPA 300.0. It was not possible to perform a “standard” lab audit as the WQL is still in the process of developing the analytical methods 200.8 and 300.0. The lab is also in the process of adding technicians to perform some of these analyses. Justin Marbury is in charge of developing the laboratory capabilities and methods. Since the lab was not yet fully operational, part of the audit was used to discuss QA/QC and methods development requirements to meet basic EPA method requirements. Some of the issues discussed will be presented in the Findings section below.

Discussion with Justin indicated he had a good understanding of the basic EPA methods, the equipment, and the QA/QC requirements. He was in the process of developing the procedures for the ICP/MS and the ion chromatograph. Given proper time and support, it is believed that the WQL can perform the analyses scheduled for the lab and perform them with good accuracy and precision. It should be noted that actually performing the methods development work and preparing the necessary documentation to record all needed QA data will take a significant effort.

SNL is using an outside contract lab, General Engineering Laboratory (GEL), to perform all analyses until the WQL is fully operational. WQL is doing quick response arsenic tests and other wet chemistry support for the pilot project at the Springs. However, all samples for regular water quality measurements are being sent to GEL. GEL will also analyze split samples with WQL after WQL has completed the methods development work. GEL was not part of this audit, but typical laboratory reports were reviewed and found to contain needed QC information. The SNL Sample Management Office operates the contract lab program. The SMO specifies QA/QC and methods requirement for the contract laboratories and review all data submitted by the labs. This review includes validating the data. Discussions with Pamela Puissant of the SMO indicated that the contract lab program includes all of the elements of a sound QA/QC program. The data reviewed from GEL [raw water lab report] showed that appropriate spikes, duplicates, blanks, etc. were being performed in proper manner.

FINDINGS

1. Methods Development

The WQL has the needed equipment to perform the EPA methods 200.8 (ICP/MS) and 300.0 (ion chromatograph), but these methods have not been fully developed and documented. The

following activities, at a minimum need to occur for the WQL to perform these analyses on a regular basis:

- a. Establish a run sequence and protocol for the ICP/MS that meets the EPA 200.8 requirements including: method blanks, calibration standards, interference check samples, continuing calibration (ccv), independent source secondary check standard, matrix spike and matrix spike duplicates. The method specifies the sequence and frequency. Matrix spike and matrix spike duplicates for accuracy and precision should be run on a minimum frequency of 5% (one set per every 20 samples). More frequent spikes and spike duplicates may be appropriate until laboratory QC windows are established.
- b. Method Detection Limit Study (MDL) – WQL must run a full MDL study in accordance with EPA methods for each parameter that will be analyzed. This procedure is based on running low level spiked blank water (near the expected detection limit) seven times and then calculating the statistical MDL. Once the MDL is established the laboratory can set reasonable reporting limits above the proven MDL. Note: it is very important that the arsenic MDL be established quickly as the WQL is using the ICP/MS in lieu of an arsenic test kit to give quick feed back on the pilot operation. Since arsenic is expected to be very low at the beginning of the test period (<2 µg/L), it is important for the lab to demonstrate they can see this low level.
- c. Performance Evaluation Check (PE) – Once the method is developed and MDLs are established, WQL needs to run PE samples to verify they can measure independent samples within industry acceptable limits. PE samples can be obtained from various suppliers. When new technicians are trained on a method, a PE sample should be used to confirm they can achieve the needed accuracy and precision.

2. Other Methods

The WQL may perform other methods for the pilot project. These methods must also be documented in accordance with the methods. The procedures should include all of the applicable QC requirements including calibrations, blanks, spike and spike duplicates or duplicates, etc. The procedures should be documented and run sequences setup. MDL studies are needed for all analyses, except for analyses without a detection limit such as pH. PE samples can usually be obtained for these methods as well.

3. Hach Methods Verification

WQL is helping with bottle preparation and sample handling for the field operations. The PSTP states that for HACH methods being used, split samples will be obtained and regular laboratory analysis preformed at least twice to be sure the Hach methods are performing properly. These checks need to be performed, as they had not been performed at the time of the audit.

4. Training –

It appears new technicians will be hired to help with the sample load in the WQL. It is important that each new technician be trained in proper analytical procedures for each analysis being

performed and also demonstrates proficiency in performing the methods. The training should include information on the run sequence and QA/QC requirements. Experienced technicians or supervisors should review the results and ensure that all procedures were followed. A blind PE sample should be included with a sample set to check that the technician is able to achieve acceptable results.

Observations/Recommendations

1. Documentation

Experience indicates that most laboratory analysts can develop and achieve proficiency in the types of analyses being performed at the WQL for the pilot test. However, it is common that setting up and maintaining a documentation system to prove the work was performed properly is more difficult and often the downfall of newly setup laboratories. It is strongly recommended that a documentation system be put in place to collect and archive the run logs, log books and other supporting documents in the lab. The computer systems on the equipment make this easier, as the run information is normally part of the “raw data record and print out”. This information needs to be properly reviewed and archived so auditors and other data reviewers can readily review the information.

RSSCT LAB

The RSSCT lab, a separate lab, was operational during the visit with several columns running preliminary screening tests to determine operating characteristics. The system was setup on a lab bench secured in an appropriate manner. The pump(s) were variable speed peristaltic units that appeared capable handling the needed flow rates for the RSSCT tests. There is a plan to move the location of the lab, which was described as providing more space and making it easier to move the 50-gallon drums of feed water into the lab.

The Laboratory Engineer, Alicia Aragon, is very knowledgeable of the RSSCT procedures having run these types of tests as part of a PhD dissertation. The operating work plan developed for the testing showed good understanding of the fundamental concepts of the RSSCT.

Findings

1. Sampling and Analysis Plan

While the operating work plan was well developed, there is no sampling and analysis plan detailing the specific samples and analyses that will be performed as part of the RSSCT. A plan specifying the types of samples, the number of duplicates, etc. must be developed and placed in writing as part of the operating procedure. The analyses that will be run need to be specified. Once the parameters are identified, the methods and QA/QC specified in the Pilot Specific Test Plan for the Socorro field tests can be used or referenced. This will simplify the development of the sampling and analysis plan. It is expected that the WQL will perform many of the analyses for the RSSCT so it is important that the WQL complete their method development and associated QA/QC information in order to support the RSSCT lab.

The sampling and analysis plan should also clearly identify which analyses are to run by the WQL and which analyses, if any, will run by the RSSCT lab. In the field test plan, it is clearly identified which parameters are performed by the field personnel. As an example, it might be expected that pH, temperature, free chlorine, and turbidity would be done in the RSSCT lab, whereas the WQL or Contract Lab would perform arsenic, iron, and other similar parameters.

An example sampling and analysis plan with QA information was provided as a guide for the development of the plan.

2. Operating Logs

The lab had not yet setup an operating log sheet to record and document the column operating conditions. Flow rates, pressures, and observations on column conditions is important information that needs to be recorded on a frequent basis. The lab needs to establish an operating log sheet similar to the field operating logs being used at the field test site or in the model plan document..

3. Sample Handling and Delivery to the WQL

Written procedures for the storage and transfer of samples to the WQL have not been developed. It was not clear if a chain of custody or similar detailed sample transfer form will be used to transfer the samples to the WQL. A procedure should be developed to provide a written record of the samples collected, the analyses requested, and the number of bottles transferred to the laboratory.

Observation/ Recommendations

1. Sample Collection

An automated sample collection system is planned for the sampling of the RSSCT columns. Given the 24-hour operation of the column and the need to collect aliquots on a frequent basis the use of this type equipment is common practice. The sampler had not yet been specified and ordered at the time of the audit. It is important that the sampler is purchased and time be allowed to operate it prior to the actual testing. This type of equipment often takes a few days to setup and establish the proper operating procedures and to obtain the proper sample amounts for the analyses.

Report prepared by:

Dale A. Scherger P.E.

Date:

Distribution:

1 MS 0701 P. Davies, 06100
1 MS 0701 J. Merson, 06110
1 MS 1089 F. Nimick, 06140
1 MS 0754 T. Hinkebein, 06118
5 MS 0754 M. Aragon, 06118
2 MS 0754 A. Aragon, 06118
1 MS 0754 P. Brady, 06118
2 MS 0754 S. Collins, 06118
2 MS 0754 B. Dwyer, 06118
2 MS 0754 R. Everett, 06118
2 MS 0754 W. Holub, 06118
1 MS 0754 C. Kirby, 06116
1 MS 0754 R. Kottenstette, 06118
1 MS 0754 J. Krumhansl, 06118
2 MS 0754 J. Marbury, 06118
1 MS 0754 P. McConnell, 06118
1 MS 0754 T. Meyer, 06118
1 MS 0754 M. Shedd, 06118
30 MS 0754 M. Siegel, 06118
1 MS 0754 E. Wright, 06118

2 MS 9018 Central Tech. Files, 8945-1
2 MS 0899 Tech Library, 4536
1 MS 0123 Donna Chavez, 1011