

# MISSION REQUIREMENTS FOR ULTRALOW-BACKGROUND LARGE-FORMAT BOLOMETER ARRAYS

Dominic J. Benford<sup>†</sup>, S. Harvey Moseley, Jay A. Chervenak  
NASA / Goddard Space Flight Center

## ABSTRACT

In the coming decade, work will commence in earnest on large cryogenic far-infrared telescopes (e.g., SAFIR<sup>1</sup>) and interferometers (SPIRIT, SPECS<sup>2</sup>). These missions require large format, two dimensional arrays of close-packed detectors capable of reaching the fundamental limits imposed by the very low photon backgrounds present in deep space. In the near term, bolometer array architectures which permit 1000 pixels – perhaps sufficient for the next generation of space-based instruments – can be arrayed efficiently. Demonstrating the necessary performance, with Noise Equivalent Powers (NEPs) of order  $10^{-20}$  W/ $\sqrt{\text{Hz}}$ , will be a hurdle in the coming years. Superconducting bolometer arrays are a promising technology for providing both the performance and the array size necessary. We discuss the requirements for future detector arrays in the far-infrared and submillimeter, describe the parameters of superconducting bolometer arrays able to meet these requirements, and detail the present and near future technology of superconducting bolometer arrays. Of particular note is the coming development of large format planar arrays with absorber-coupled and antenna-coupled bolometers.

## BACKGROUND-LIMITED SENSITIVITY

Any future space-based far-infrared mission will likely require that the detector sensitivity be maximized for point source detection. NGST went through this exercise, and decided not to fly an FTS in order to avoid losing sensitivity at the price of eliminating instantaneous broadband imaging/spectroscopic capability.

The ideally sensitive instrument will be limited only by the photon statistics from the natural backgrounds outside of Earth orbit. The background limit is set by the combination of several components (figure above at left), and is particularly low in the 50-500 $\mu\text{m}$  regime. In order to keep below this intensity limit, the telescope must be cold: 4K to get below the sky background.

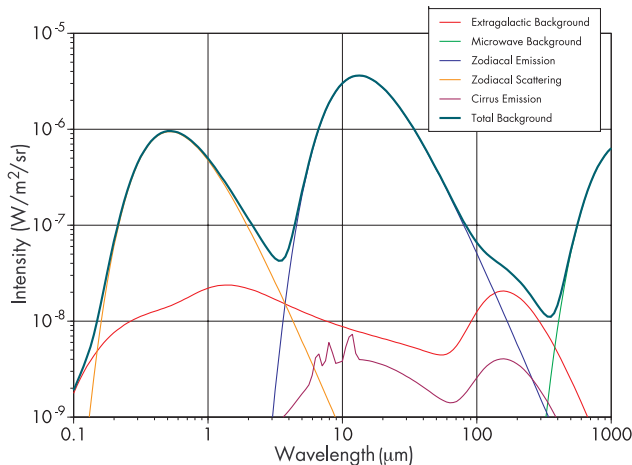

Figure 1. Intensity of natural sky background in a diffraction limited beam of unity bandwidth; the region from 50-500 $\mu\text{m}$  is particularly dark

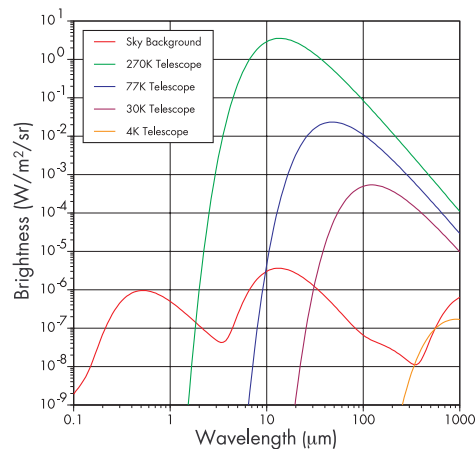

Figure 2. The total sky background with the emission of telescopes of 5% emissivity.

<sup>†</sup> Email address: Dominic.Benford@gssc.nasa.gov

We can calculate the sensitivity required for any strawman instrument from the sky background.

Given that direct detection with bolometers is the most capable currently available option for achieving background-limited broadband imaging in the far-IR to submillimeter, we shall assume detectors of this type. Typically, quantum efficiencies are high ( $>50\%$ ) and system optical efficiency is good ( $\sim 30\%$ ), while bandwidths of  $\lambda/\Delta\lambda\sim 5$  are normal. Figure 3 is a calculation of the background power and corresponding photon shot noise equivalent power (NEP) for a broadband detector as a function of wavelength. Overplotted is the noise equivalent flux density (NEFD) for this detector operating on a 10m-class cryogenic telescope.

Low-resolution spectrographs for studying, e.g., PAH emission will have lower backgrounds, but otherwise be very similar. This is not shown as it can be easily estimated from Figure 3.

High resolution spectroscopy ( $\lambda/\Delta\lambda\sim 3000$ ) can be achieved with large gratings or Fabry-Perots. These will often have lower optical efficiency - we take 10% - and have very low background power. The calculation of background power and noise is shown in Figure 4 at right, with the addition of the quantum noise power for heterodyne systems. In a plot immediately below (Figure 5), we see the NEFD of such a system plotted with estimates of the brightness of various far-IR lines as a function of their redshifted wavelength. By comparison with Figure 4, it is evident that the detection of redshifted lines is challenging with heterodyne systems. A suitable direct detection spectrometer can achieve the necessary sensitivity. At even higher spectral resolutions - ( $\lambda/\Delta\lambda\sim 10^6$ ) - it is conceivable that heterodyne systems may be the most efficient spectrometer implementation<sup>3</sup>.

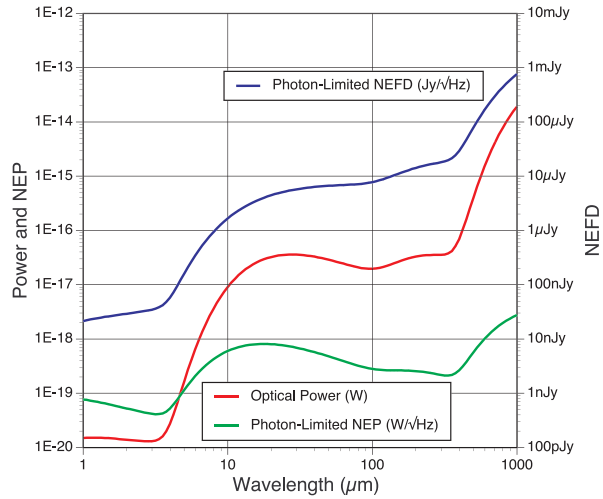

Figure 3. Broadband detector sensitivity.

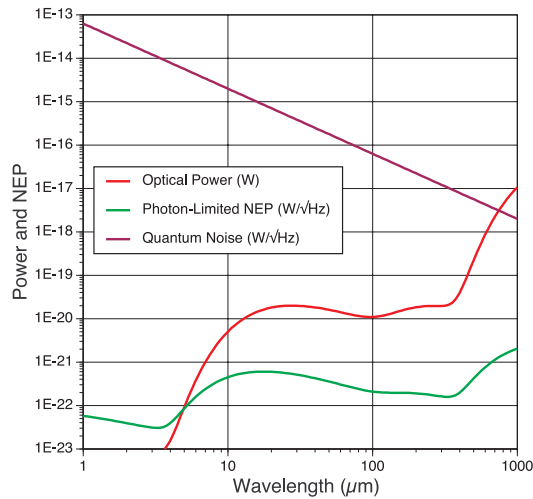

Figure 4. High resolution spectrometer sensitivity.

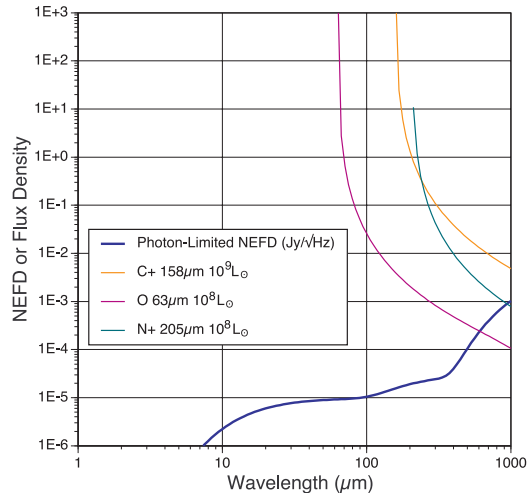

Figure 5. High resolution spectrometer sensitivity compared with line flux density.

## SENSITIVITY SUMMARY

The state-of-the-art detector sensitivity for bolometers is currently at  $\sim 10^{-18}$  W/ $\sqrt{\text{Hz}}$ . This can be reduced by changing operating temperature, materials, and geometries, perhaps improving the sensitivity by one or two orders of magnitude. The next step - sensitivity below  $10^{-21}$  W/ $\sqrt{\text{Hz}}$  - will likely require substantial advancement or new technologies. Will enough effort be made to ensure that these innovations come to pass before SAFIR requires them?

## OTHER PARAMETERS

Yes, sensitivity reigns supreme as the most important characteristic of far-IR and submillimeter detectors. However, we should consider Paul Richards' detector performance criterion: number of detectors divided by sensitivity squared<sup>4</sup>. The size of an array is another important parameter.

### Array Format:

Large numbers of detectors are being planned for the near future. At GSFC, work is underway to manufacture kilopixel-scale detector arrays read out by SQUID multiplexers (see papers by Dominic Benford<sup>5</sup>, Jay Chervenak<sup>6</sup>, Johannes Staguhn<sup>7</sup>, and Rick Shafer<sup>8</sup>). How large an array will we need?

A camera designed for diffraction-limited wide field imaging of the 100 $\mu\text{m}$  sky with a 10m telescope is a reasonable and demanding goal. A wide field might be defined as 2' on a side with detectors Nyquist sampling the 2.5" diffraction spot. This requires a 100x100 element bolometer array, and will detect thousands of galaxies in a single  $\sim$ hour long integration.

If detector arrays containing 10,000 elements are to be operated with low dissipation, it is a virtual necessity that the readout be multiplexed.

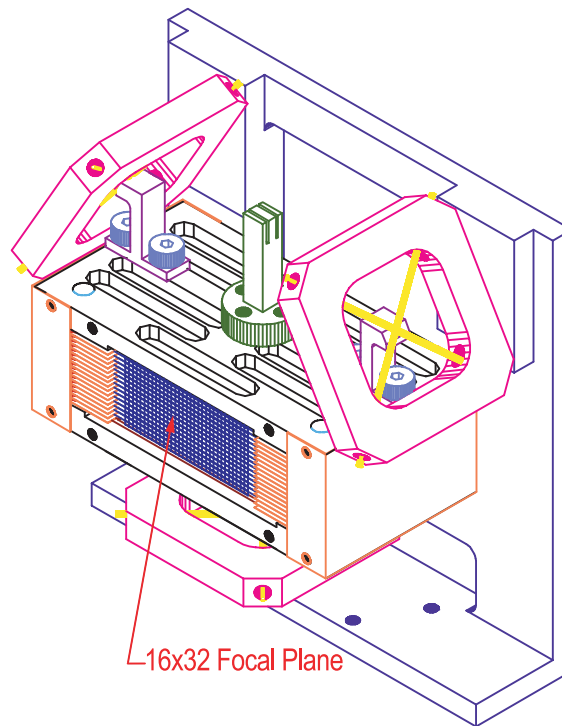

Figure 6. Design for a 16x32 prototype array to demonstrate kilopixel-scale architecture.

### Response Speed and Stability:

Fast surveying would require detectors able to slew with the orbit rate of a spacecraft. For example, a small ( $\sim 2\text{m}$ ) telescope in a polar orbit moves  $\sim 200''/\text{s}$ , or tens of beams per second. A response time of a few milliseconds is necessary. On the other end, a staring-mode observation will take 100s to become confusion limited at 100 $\mu\text{m}$  (see figure at right). Stability on such long timescales would permit absolute staring mode observations with only infrequent dark/flat calibrations.

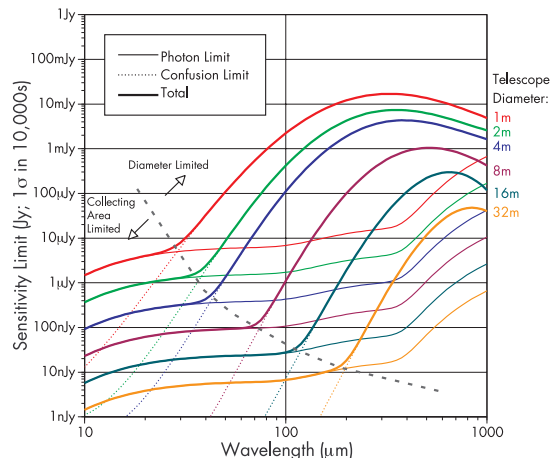

Figure 7. Sensitivity limits including confusion.

### Readout:

The electronics for readout of large-format bolometer arrays must be made simple, compact, and low power so as to be attached to the cold stage. Typically, only about  $1\mu\text{W}$  is permitted, so low power SQUID multiplexers are the most likely current technology<sup>9</sup>. Multiplexed readout with crosstalk of  $-60\text{dB}$  more than a few pixels away will be required to permit high dynamic range imaging of sources such as faint disks around IR-bright stars. The dynamic range of a single element in an array will have to be high enough to reach the chosen maximum background power while remaining background-limited. At  $\sim 100\mu\text{m}$ , 16 bits of precision are required.

### Dynamic Range Limit:

One subtlety of superconducting bolometer arrays is that the detector phonon noise can be derived from the optical photon noise, so a background-limited device can only be made when this has been accounted for.

Consider the phonon noise:  $\text{NEP}_{\text{phonon}}=(4kT^2G)^{1/2}$ , where  $G$  is the thermal conductance at temperature  $T$ . The maximum power seen before saturation is then  $P_{\text{sat}}\approx GT/\eta$ , where  $\eta\sim 10$  is a temperature rise factor. The photon noise in this case is  $\text{NEP}_{\text{photon}}=(2Ph\nu)^{1/2}$ . Rearranging, we find that  $2kT\eta\ll h\nu$  in order to keep phonon noise below photon noise. As an example, the temperature for  $1\text{THz}$  is  $\sim 300\text{mK}$ .

### Mechanical Assembly:

Someday, space flight missions like SAFIR, CMBPOL, and SPECS will need large detector arrays. Simple construction, compact design, and the capability of processing bolometers with as little skilled craftsmanship as possible is ultimately desirable. Planar arrays such as the sketch at right are a goal. In this implementation, a single wafer of detectors and a single wafer of readouts are bump-bonded together to form a hybrid integrated detector array.

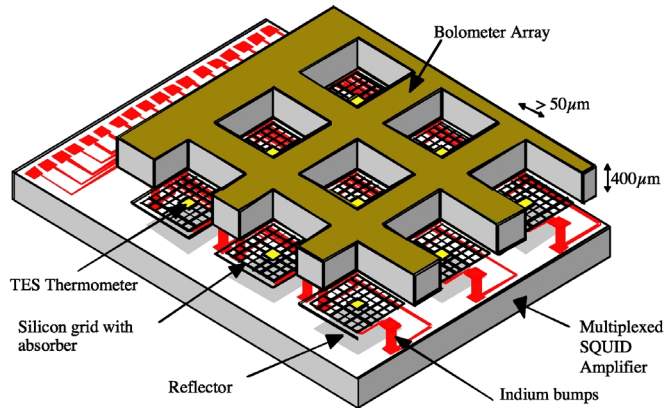

Figure 8. Hybrid planar array with multiplexers.

## CONCLUSION

There are many design requirements on detectors for space-based missions in the far-IR to submillimeter. Most of them will require substantial engineering efforts sustained over the next few years at least. Is NASA up to this?

## REFERENCES

1. G. H. Rieke, D. J. Benford, P. M. Harvey, C. R. Lawrence, D. T. Leisawitz, D. F. Lester, J. C. Mather, G. J. Stacey, M. W. Werner, and H. W. Yorke, "Charting the Winds that Change the Universe, II- The Single Aperture Far Infrared Observatory (SAFIR)", in *New Concepts for Far-Infrared and Submillimeter Space Astronomy*, 2002, in press
2. D.T. Leisawitz et al., "Probing the Invisible Universe: the Case for Far-IR/Submillimeter Interferometry", in *New Concepts for Far-Infrared and Submillimeter Space Astronomy*, 2002, in press
3. J. Zmuidzinas et al. (these proceedings)
4. P.L. Richards, private communication
5. D.J. Benford et al. (these proceedings)
6. J.A. Chervenak et al. (these proceedings)
7. J.G. Staguhn et al. (these proceedings)
8. R.A. Shafer et al. (these proceedings)
9. K.D. Irwin et al. (these proceedings)