

Decoupled Selection of

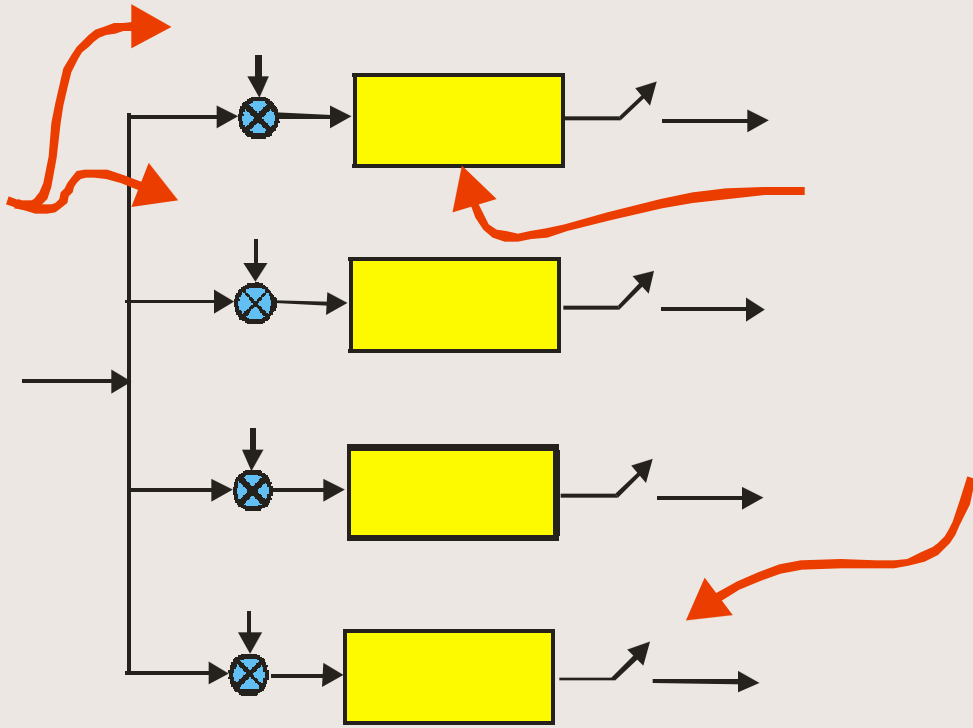

Channel Spectral Characteristics

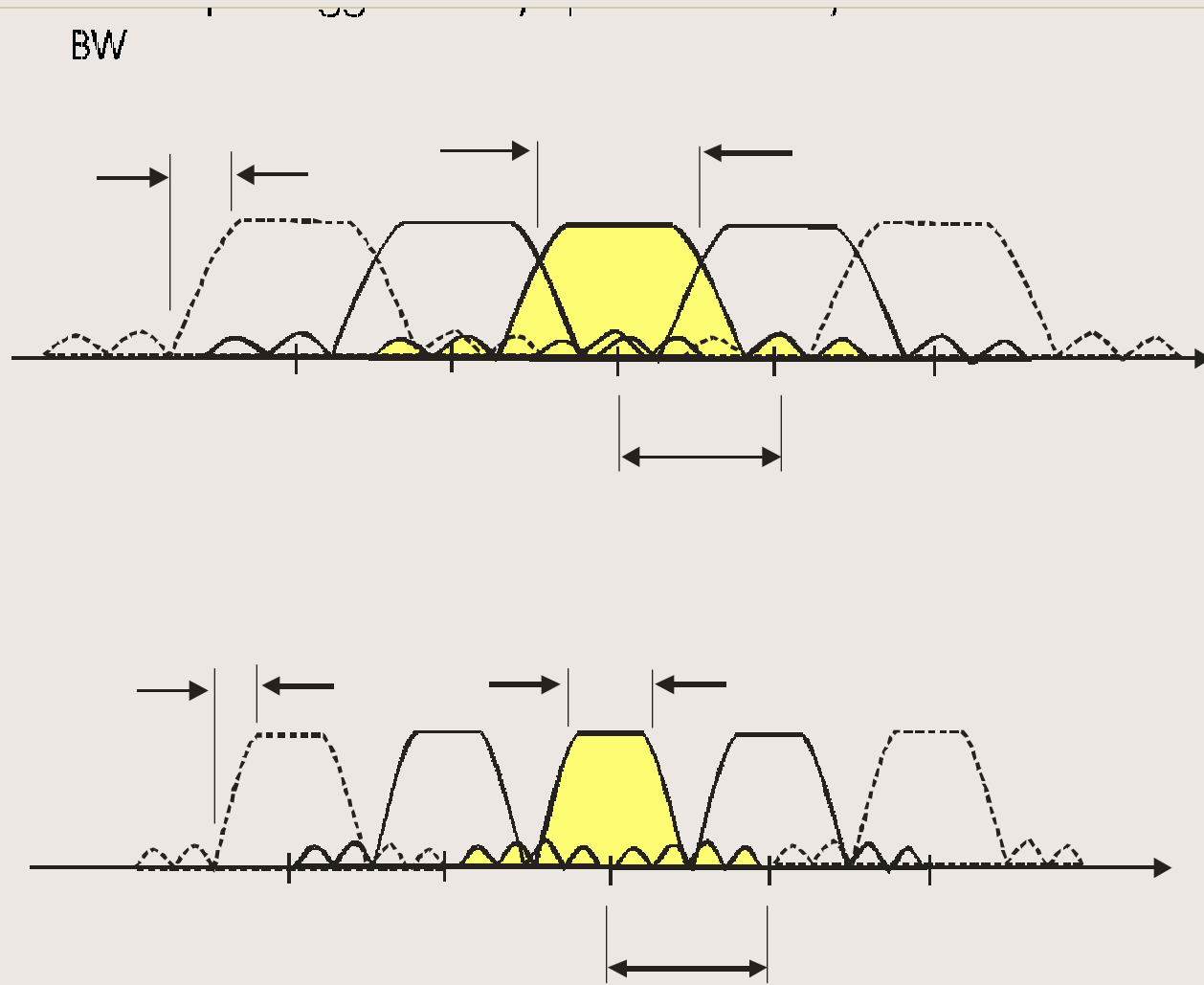

Some Polyphase Filter Options

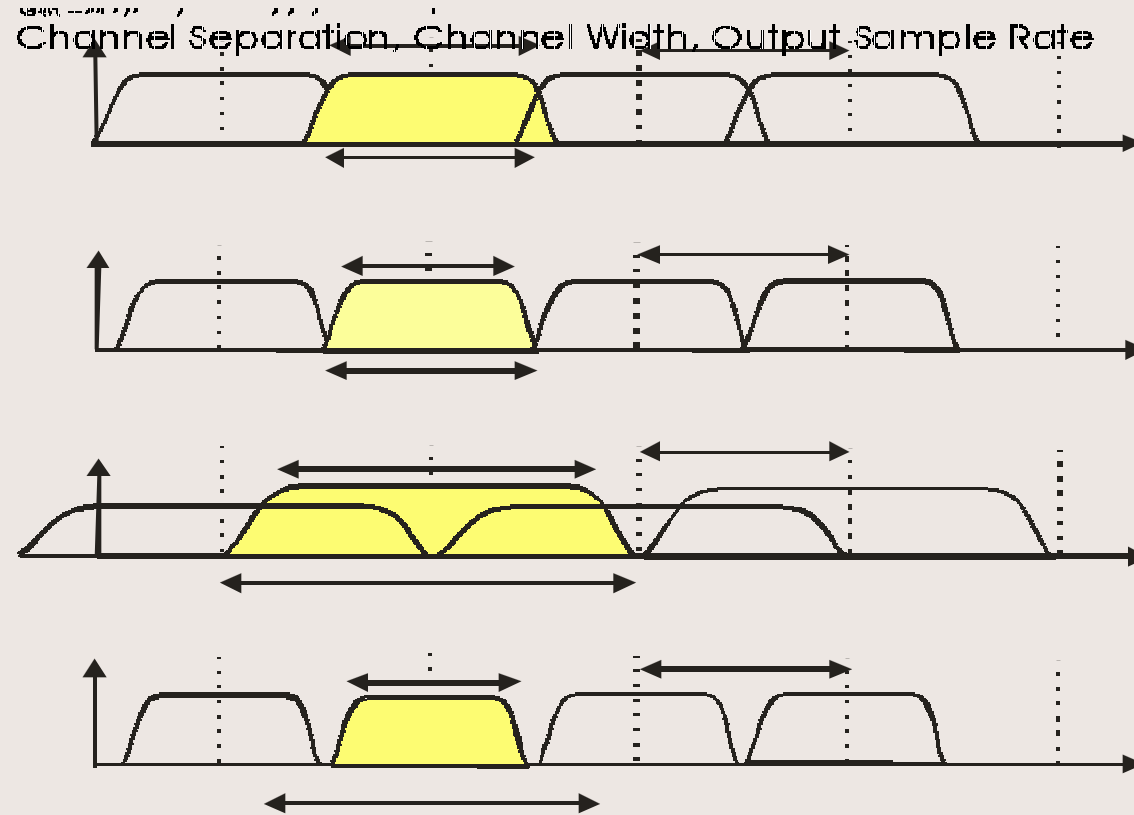

FDM-to TDM Standard Channelizer: Collection of Downconverters

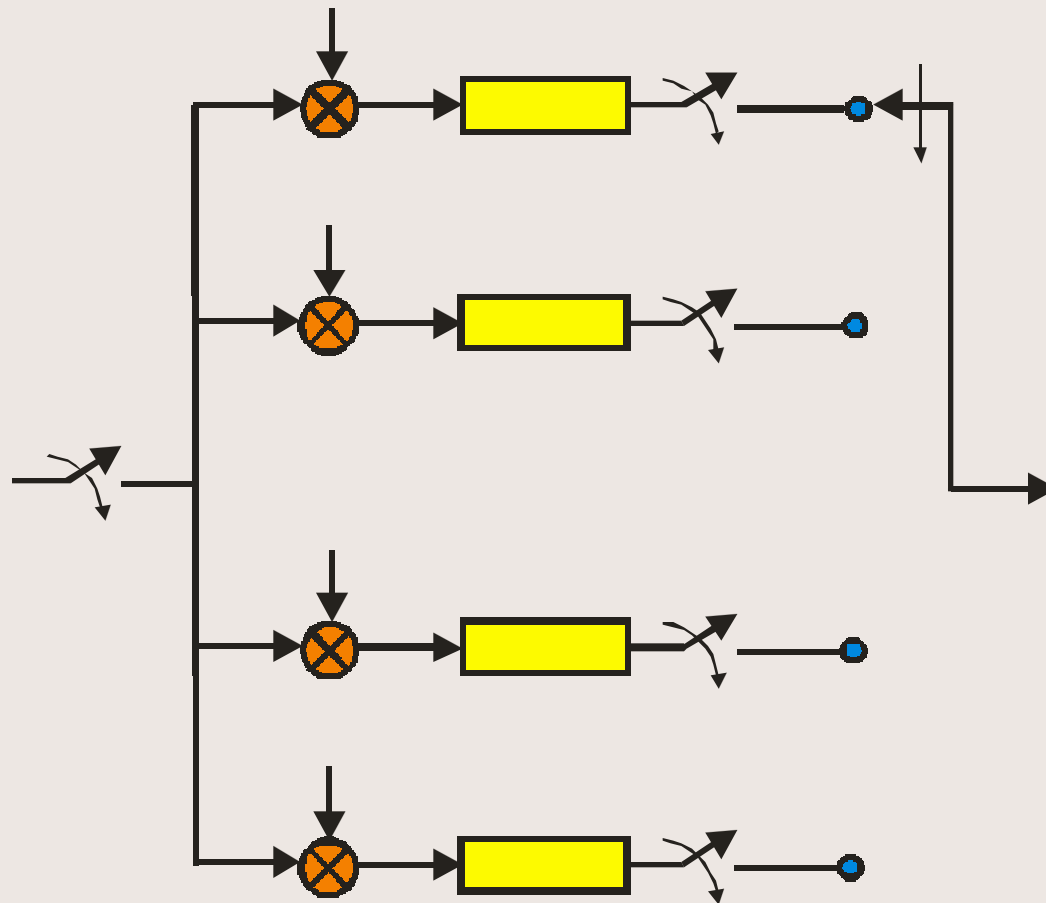

FDM-to TDM Polyphase Channelizer: Input Commutator, M-Path Filter, and FFT

M-Path
Filter

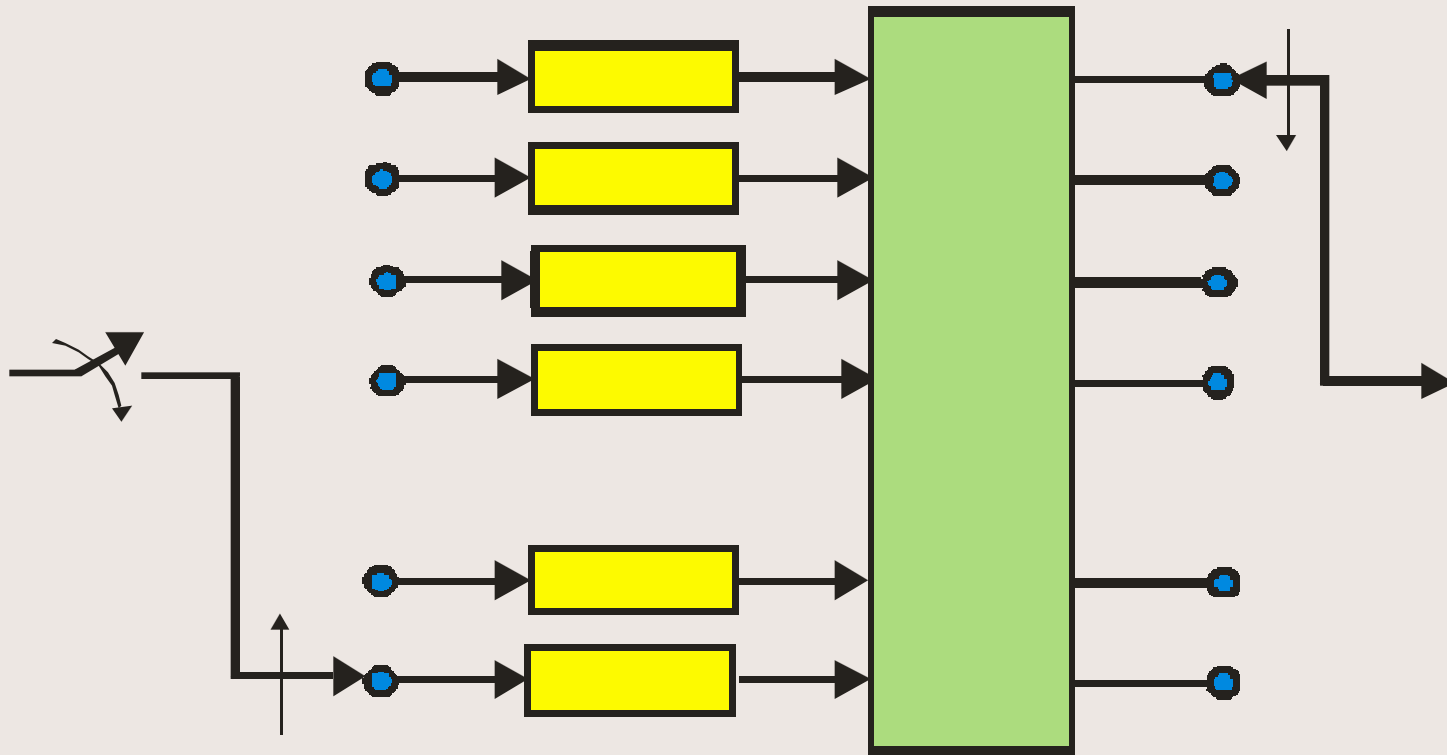

Conventional Channelizer Application

Channelize and Downsample to Nyquist Rate, Interpolate to Two Times Symbol Rate

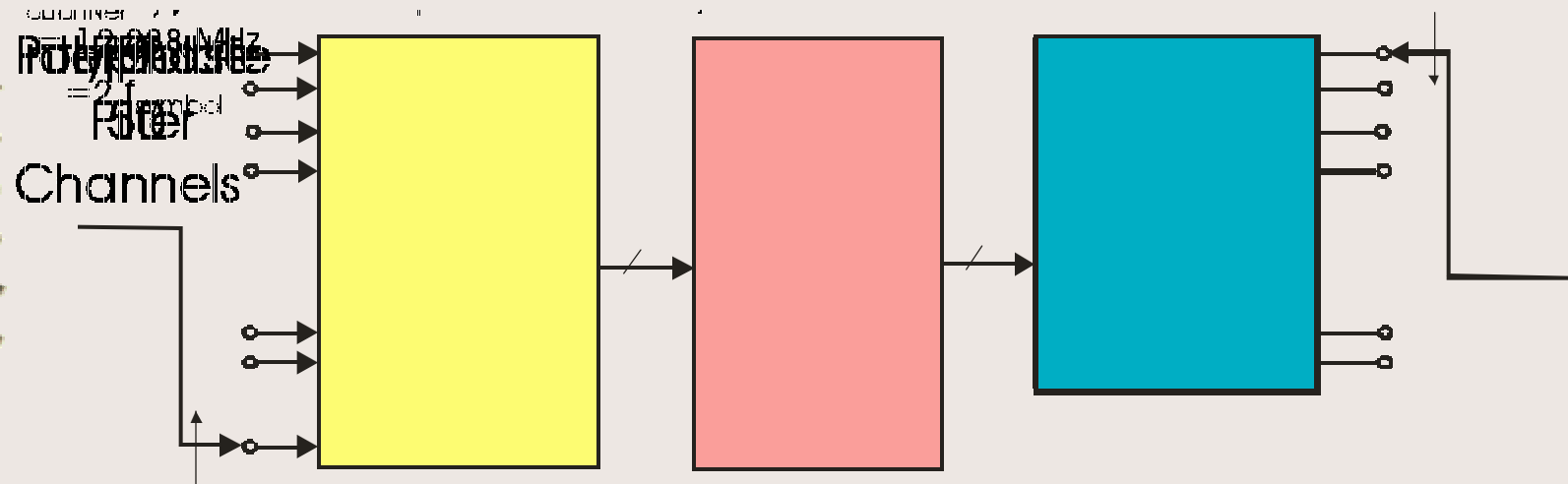

Enhanced Channelizer Solution

Replace Interpolator Function With Buffer Addressing

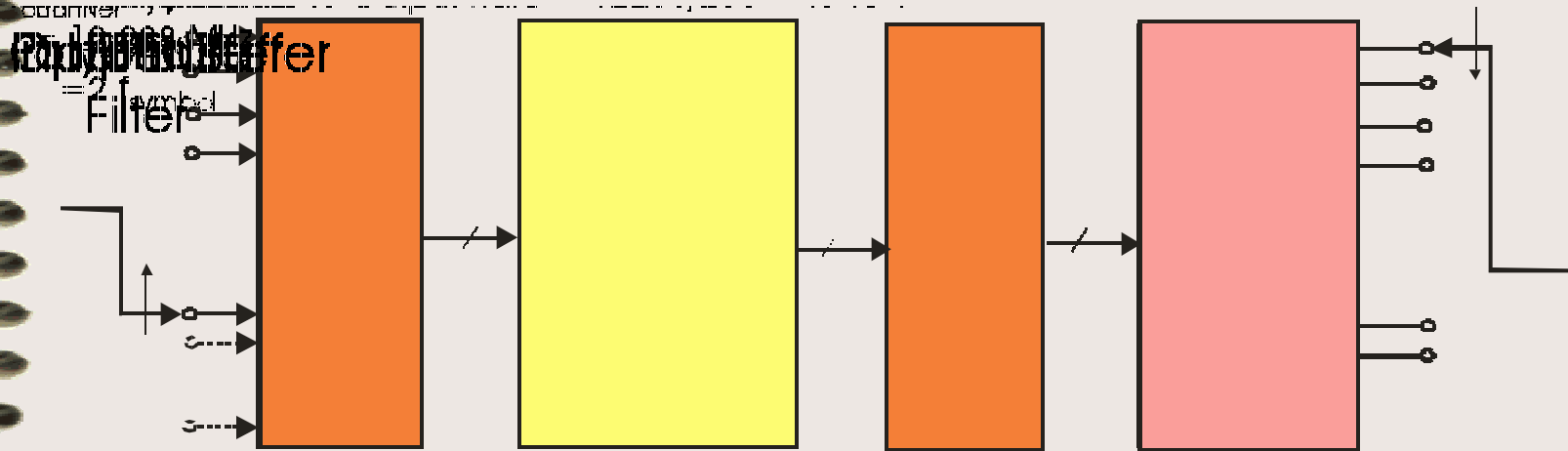

Standard Downconverter: Heterodyne, Filter, Resample

LOW-PASS

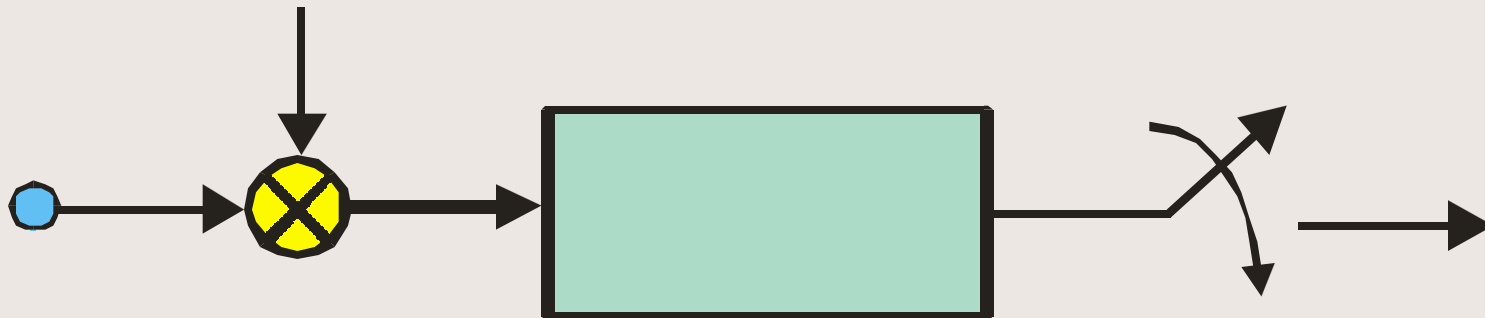

Equivalency Theorem

Heterodyne and Low Pass Filter Same as Band Pass Filter and Heterodyne

$$\begin{aligned}y(n, k) &= [x(n)e^{-j\theta_k n}] * h(n) \\&= \sum_{r=0}^{N-1} x(n-r) e^{-j(n-r)\theta_k} h(r) \\&= \sum_{r=0}^{N-1} x(n-r) e^{-jn\theta_k} h(r) e^{jr\theta_k} \\&= e^{-jn\theta_k} \sum_{r=0}^{N-1} x(n-r) h(r) e^{jr\theta_k}\end{aligned}$$

Slide Heterodyne Through Filter: Convert Low-Pass to Band-Pass

Band-Pass

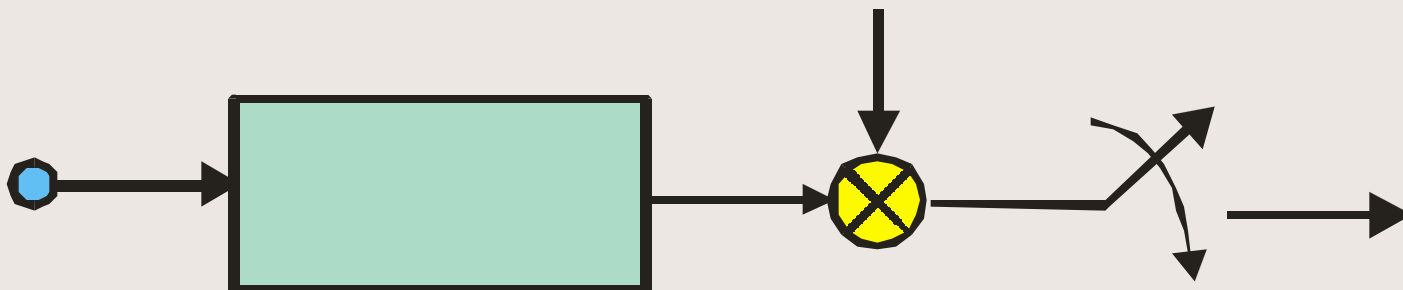

Slide Heterodyne Through Downsampler: Alias Frequency of Heterodyne

Band-Pass

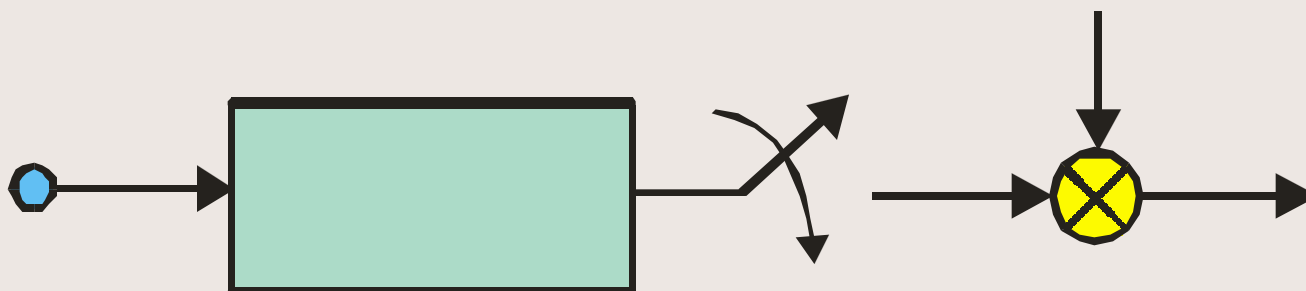

Select Input Center Frequency That Aliases to DC Under Resampling

4-2 101

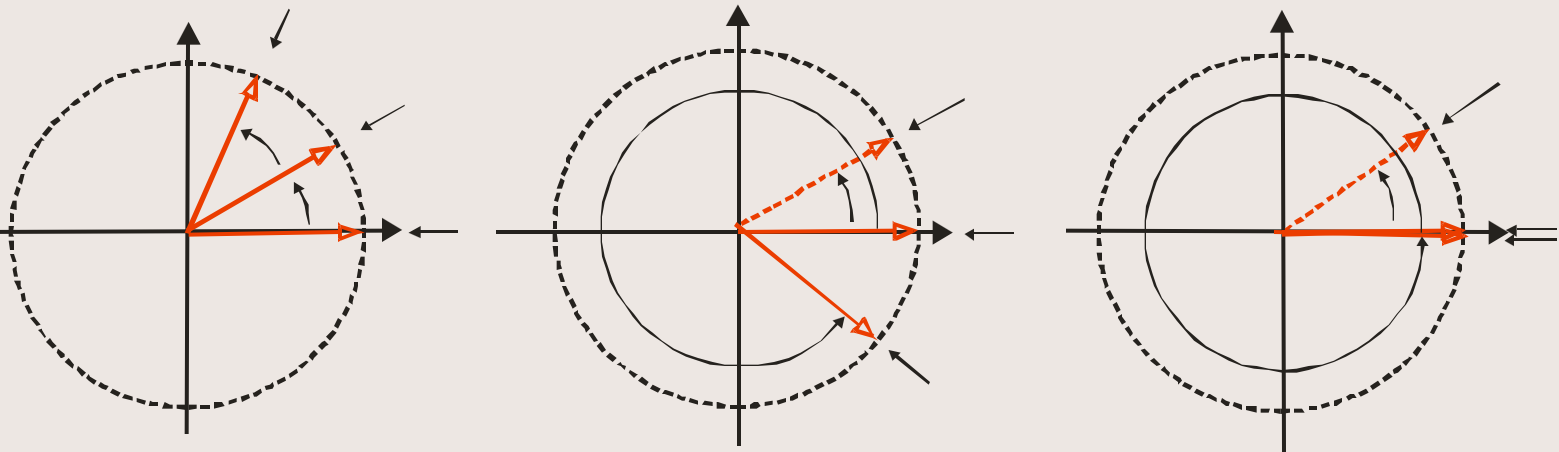

Discard Trivial Heterodyne: Now a Scalar Multiply by Unity

~~RF/IF~~
Band-Pass



Noble Identity

Interchange Order of Filter and Resample

7.5.1.1

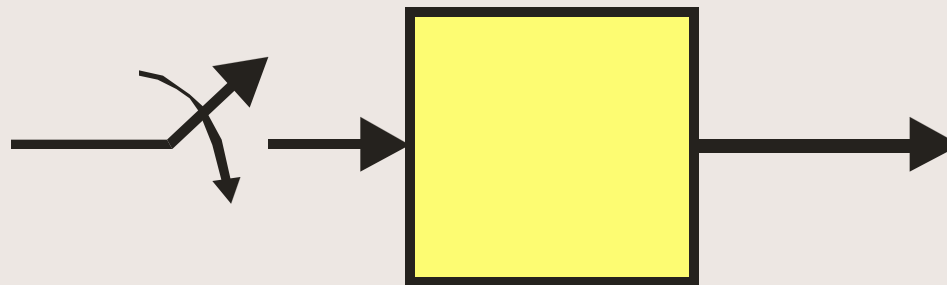
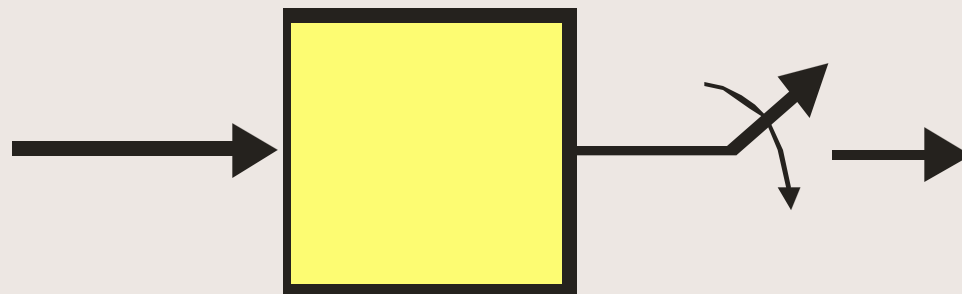

M-Path Partition of FIR Filter

$$\begin{aligned}
 H(Z) &= \sum_{n=0}^{N-1} h(n) Z^{-n} \\
 &= h(0) + h(1)Z^{-1} + h(2)Z^{-2} + h(3)Z^{-3} + \dots + h(N-1)Z^{-(N-1)}
 \end{aligned}$$

$$\begin{aligned}
 H(Z) &= h(0) & + & h(M+0)Z^{-M} & + & h(2M+0)Z^{-(2M+0)} & + \dots \\
 & h(1)Z^{-1} & + & h(M+1)Z^{-(M+1)} & + & h(2M+1)Z^{-(2M+1)} & + \dots \\
 & h(2)Z^{-2} & + & h(M+2)Z^{-(M+2)} & + & h(2M+2)Z^{-(2M+2)} & + \dots \\
 & h(3)Z^{-3} & + & h(M+3)Z^{-(M+3)} & + & h(2M+3)Z^{-(2M+3)} & + \dots \\
 & \vdots & & \vdots & & \vdots & & \vdots \\
 & h(M-1)Z^{-(M-1)} & + & h(2M-1)Z^{-(2M-1)} & + & h(3M-1)Z^{-(3M-1)} & + \dots
 \end{aligned}$$

$$H(Z) = H_0(Z^M) + Z^{-1}H_1(Z^M) + Z^{-2}H_2(Z^M) + \dots + Z^{-(M-1)}H_{(M-1)}(Z^M)$$

$$H(Z) = \sum_{r=0}^{M-1} Z^{-r} H_r(Z^M) = \sum_{r=0}^{M-1} Z^{-r} \sum_{n=0}^{(N/M)-1} h(r+nM)Z^{-Mn}$$

Example of Polyphase (M-Path) Partition

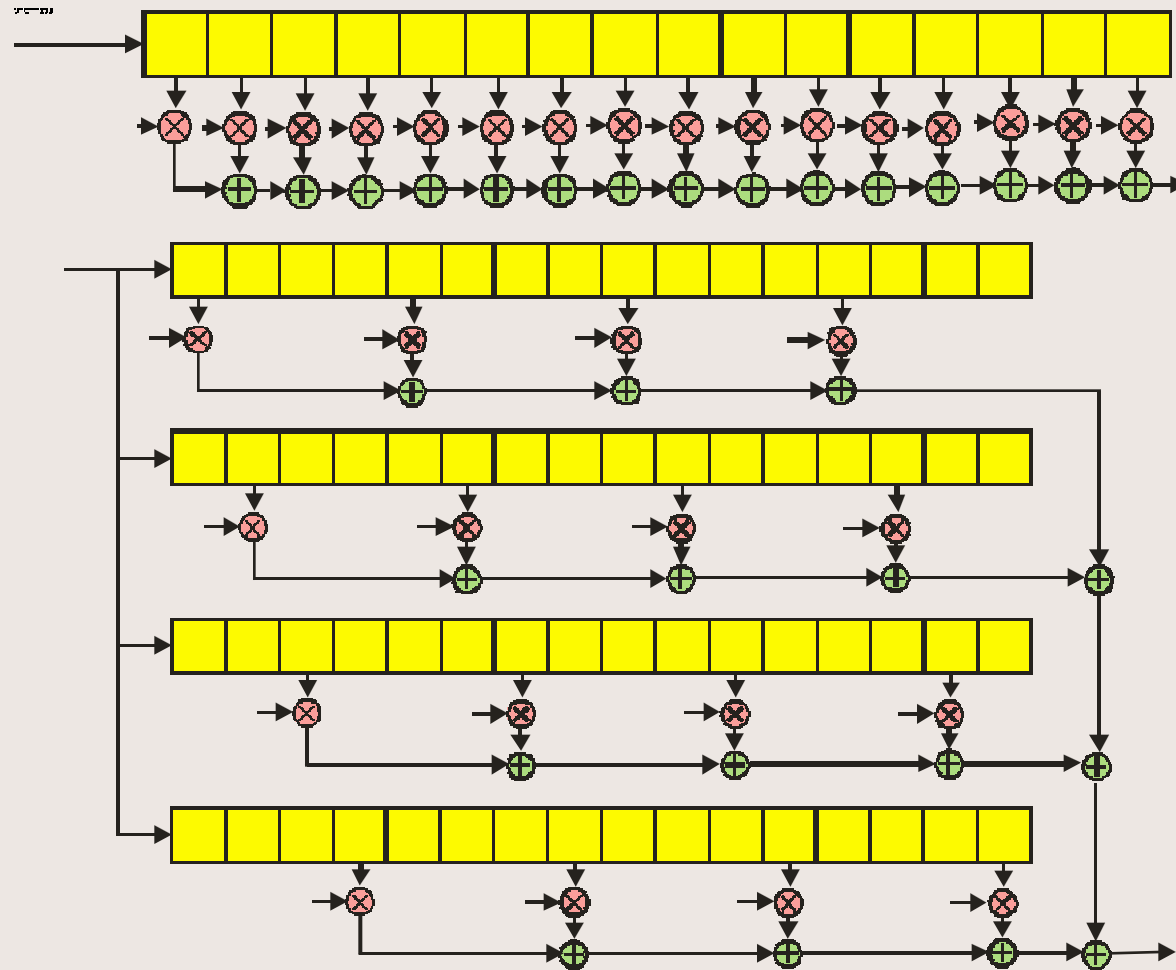

Block Diagram of M-Path Filter

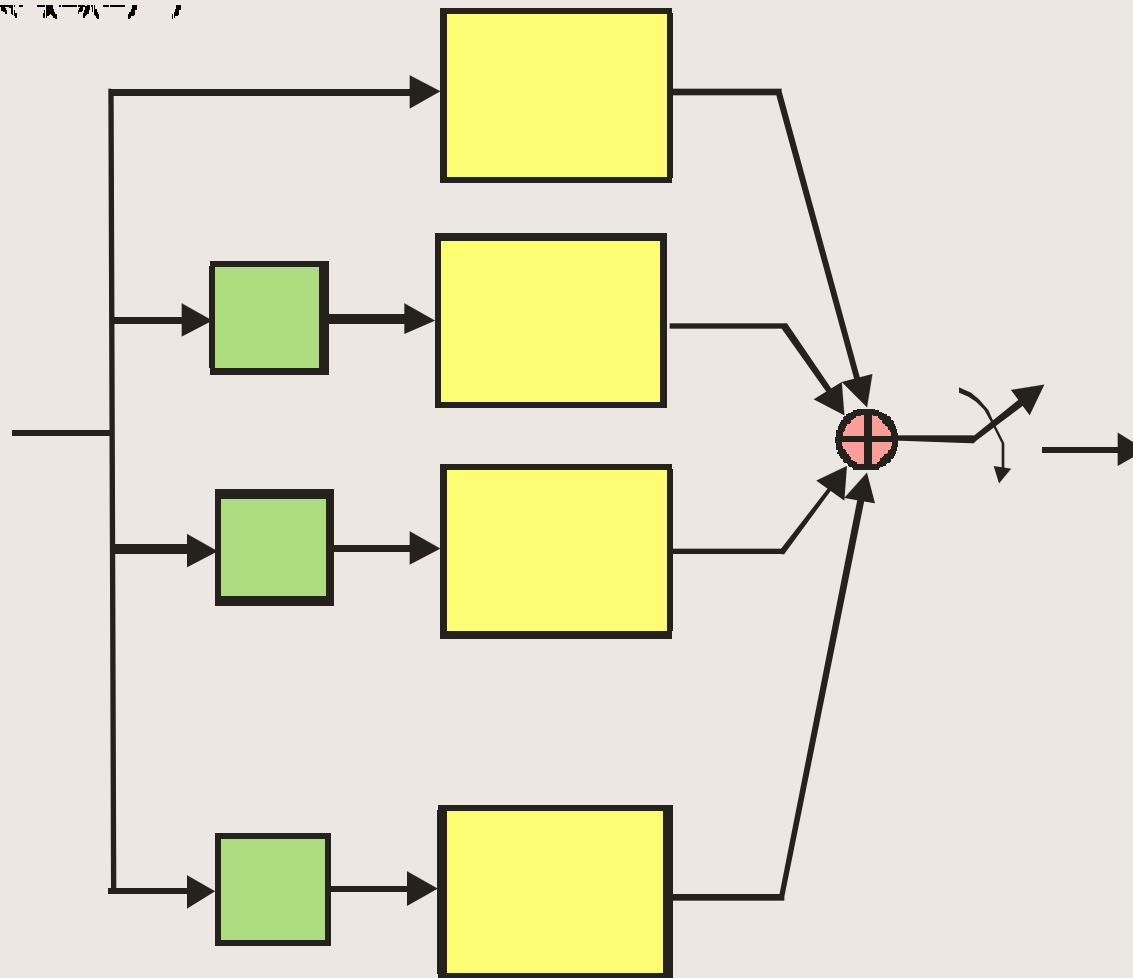

Pull Resamplers Through Filters in Each path

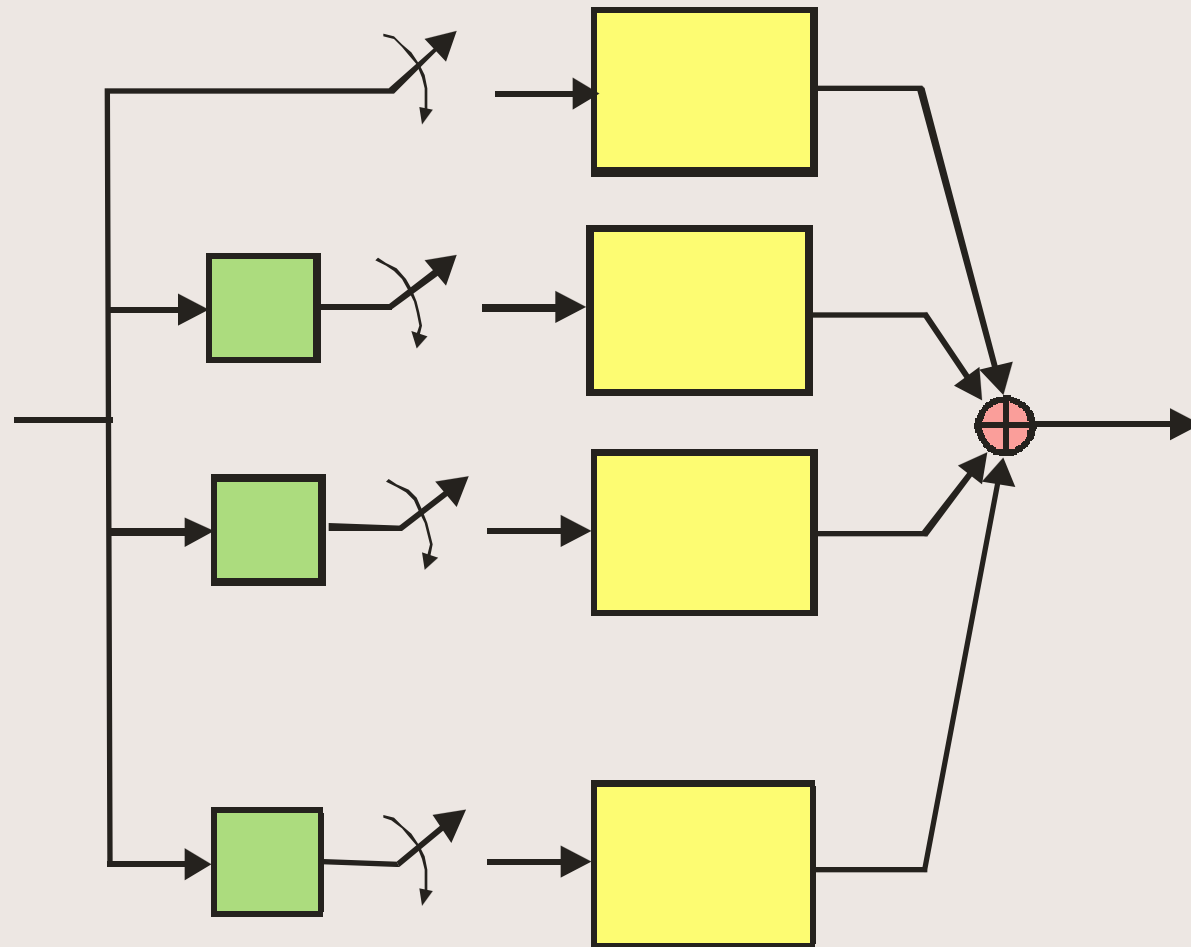

Delays and Synchronous Resamplers are Equivalent to Input Commutator

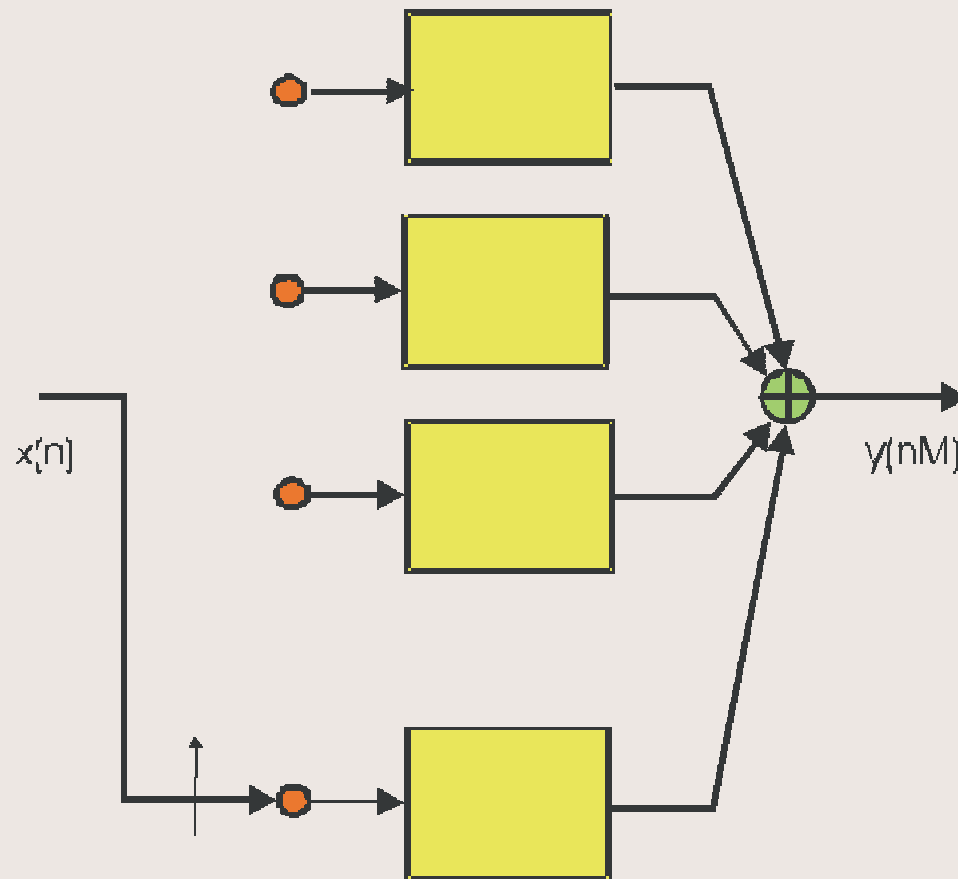

Input Series in Each Path of M-Path Filter have Offset Time Origins

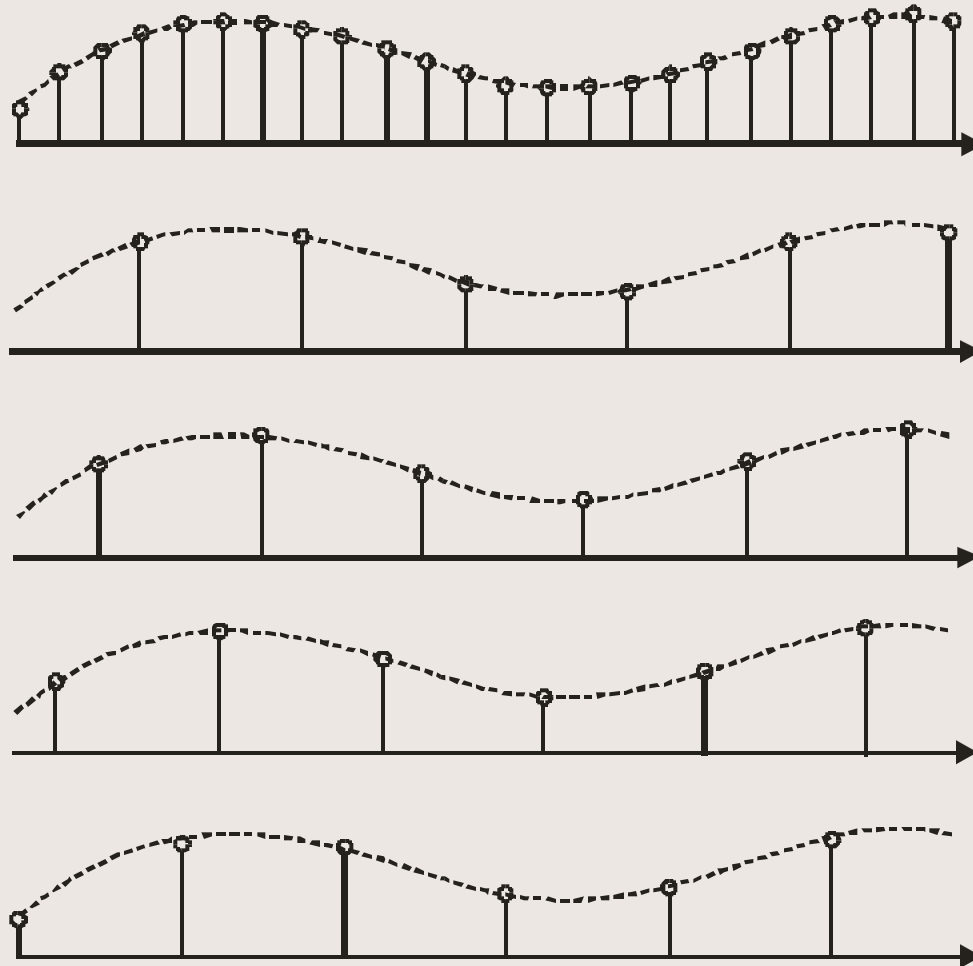

Path Filters are Interpolators: Computing Output Samples with Common Time Origin

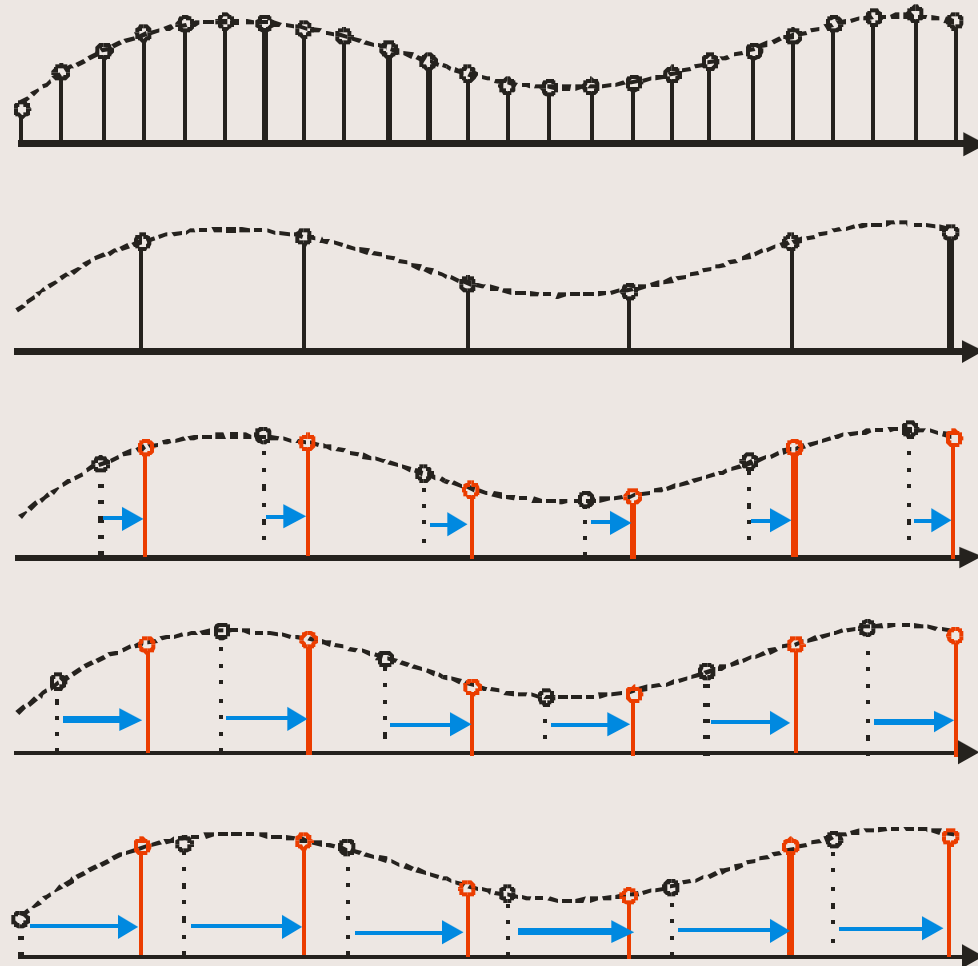

Phase Response of Paths in Ten Stage Polyphase Filter

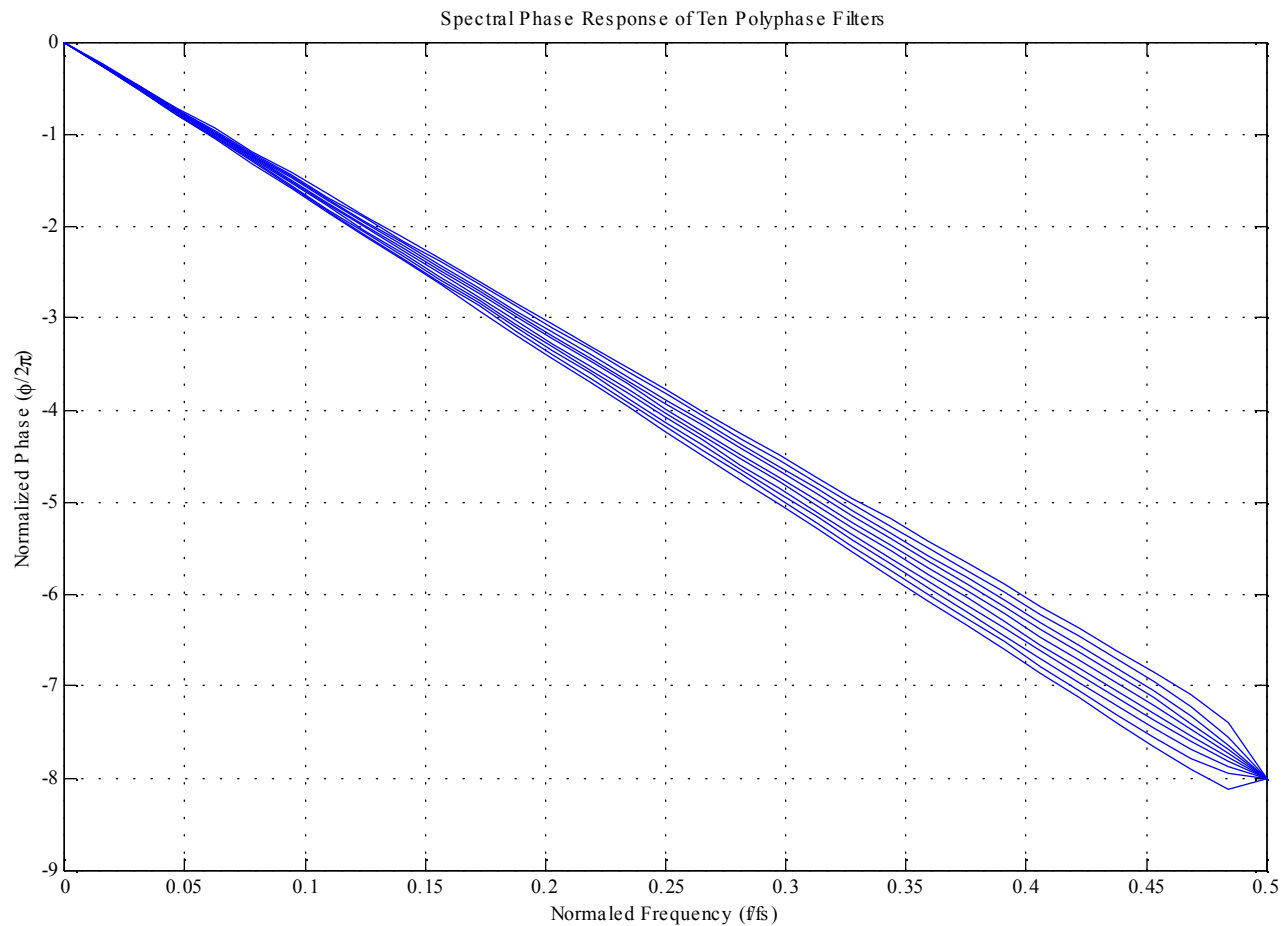

Group Delay of Paths in Ten-Stage Polyphase Filter

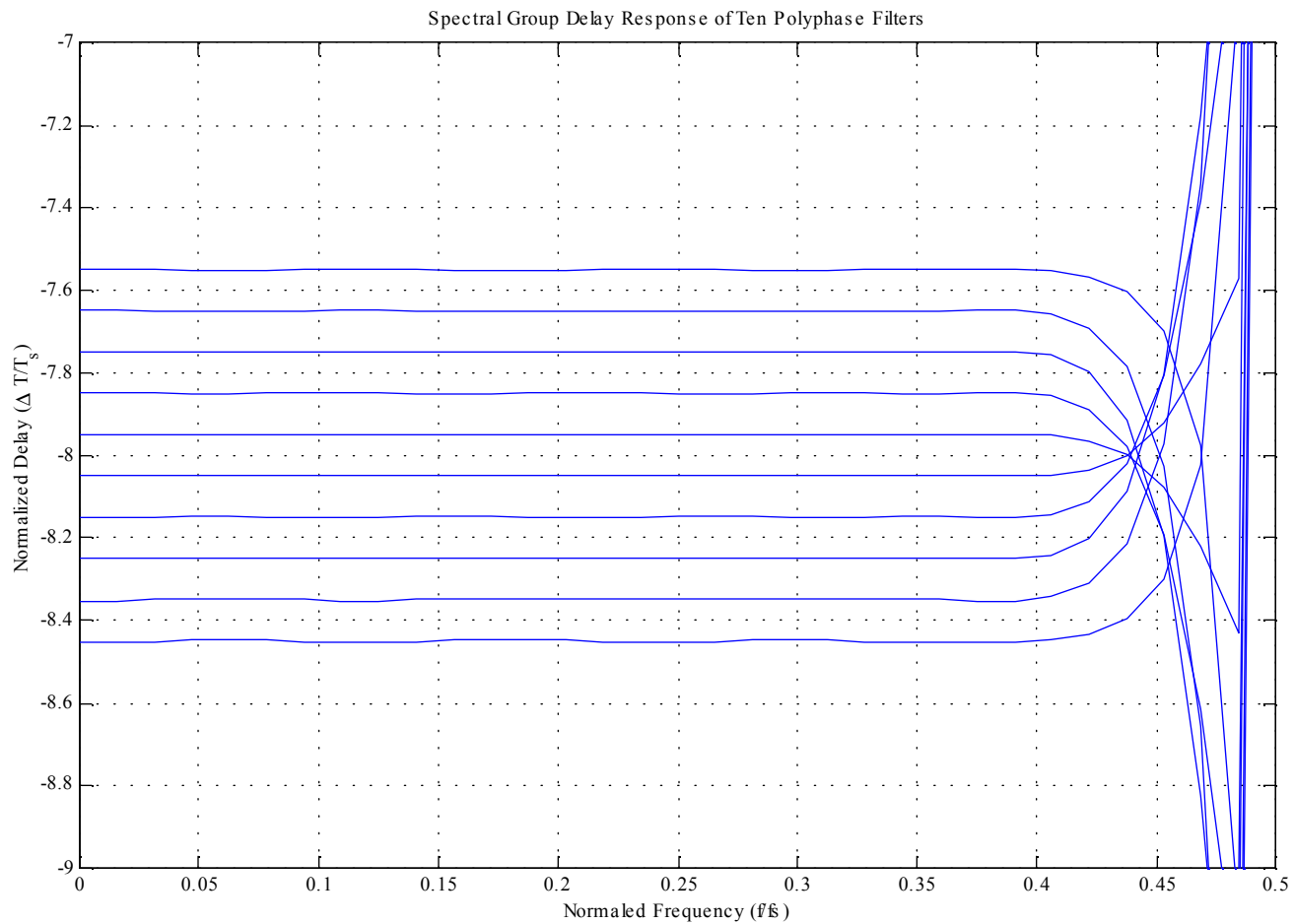

Modulation Property for Z-Transform

if

$$\begin{aligned} H(Z) &= h(0) + h(1)Z^{-1} + h(2)Z^{-2} + \dots + h(N-1)Z^{-(N-1)} \\ &= \sum_{n=0}^{N-1} h(n)Z^{-n} \end{aligned}$$

and

$$\begin{aligned} G(Z) &= h(0) + h(1)e^{j\theta}Z^{-1} + h(2)e^{j2\theta}Z^{-2} + \dots + h(N-1)e^{j(N-1)\theta}Z^{-(N-1)} \\ &= h(0) + h(1)[e^{-j\theta}Z]^{-1} + h(2)[e^{-j2\theta}Z]^{-2} + \dots + h(N-1)[e^{-j(N-1)\theta}Z]^{-(N-1)} \\ &= \sum_{n=0}^{N-1} h(n)[e^{-j\theta}Z]^{-n} \end{aligned}$$

then

$$G(Z) = H(Z) \Big|_{Z=e^{-j\theta}Z} = H(e^{-j\theta}Z)$$

Polyphase Partition of Band-Pass Filter

Figure 7

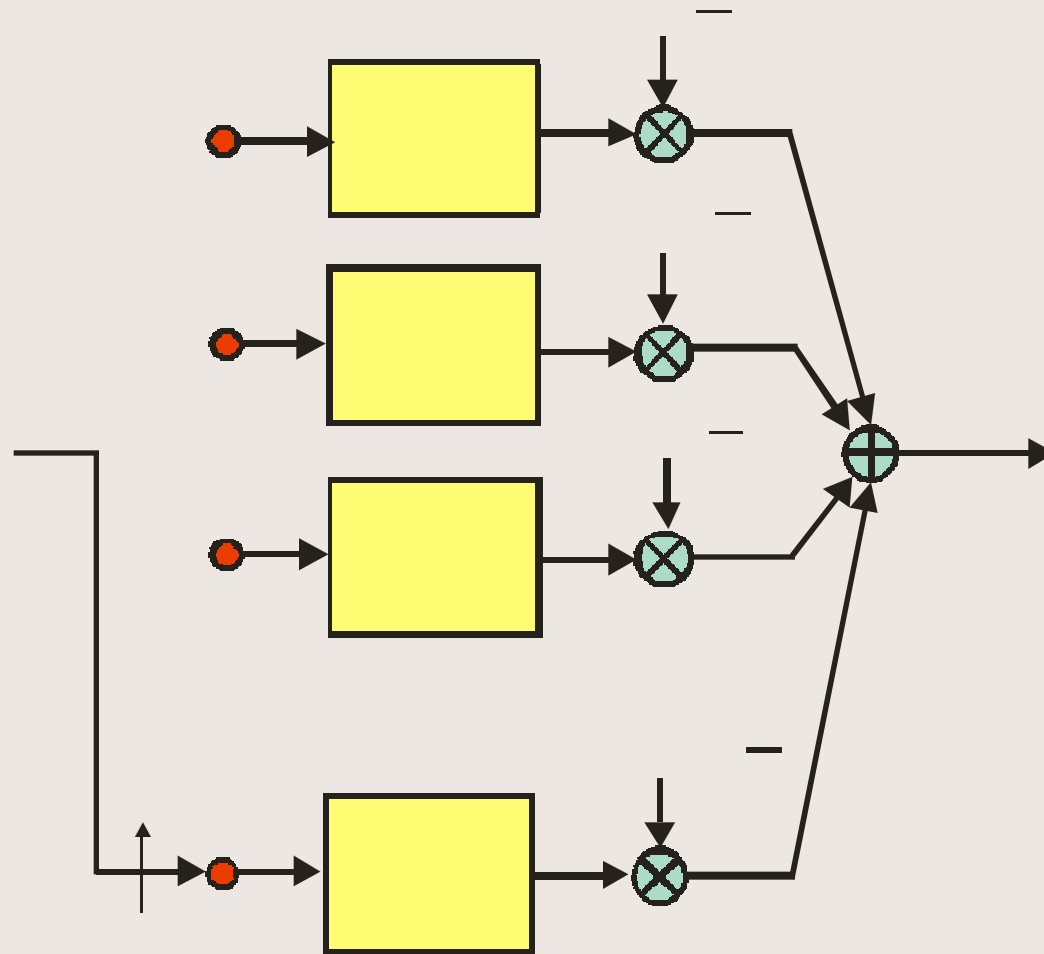

Spectral Response of Signal in Resampled Pass Band Filter

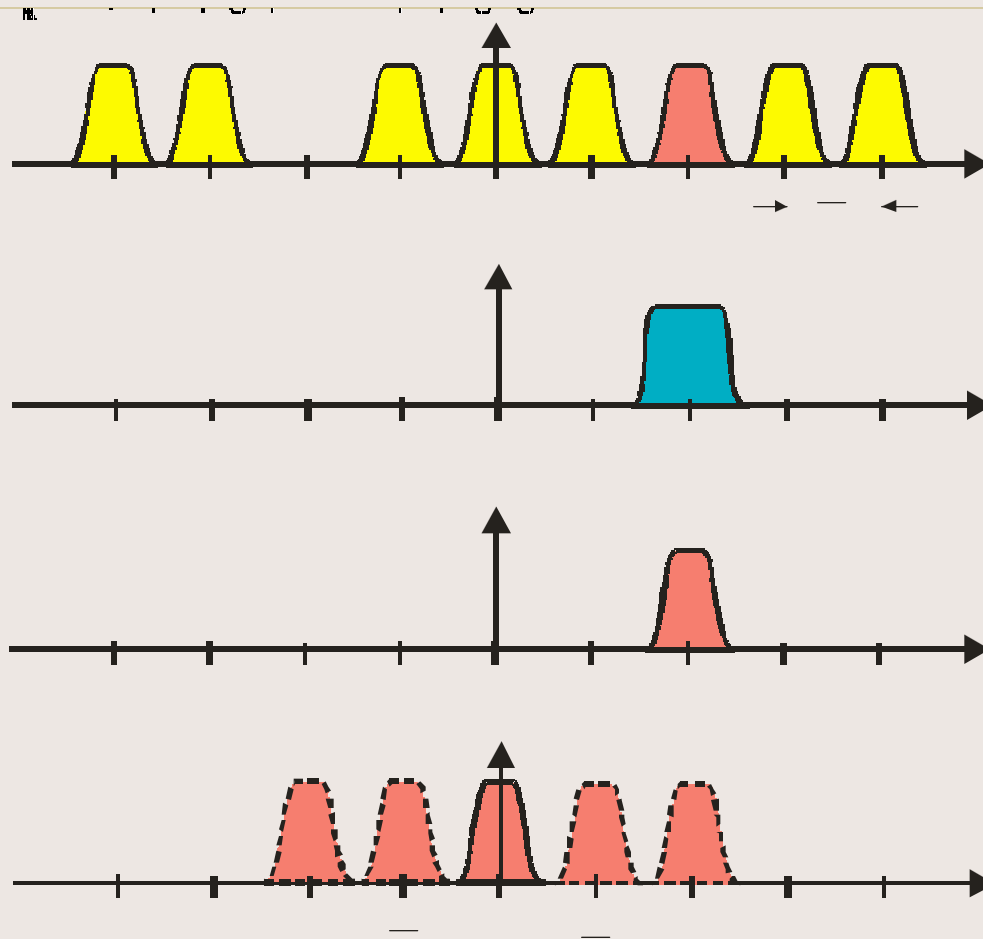

Performance Specifications for 50-Channel Polyphase Channelizer

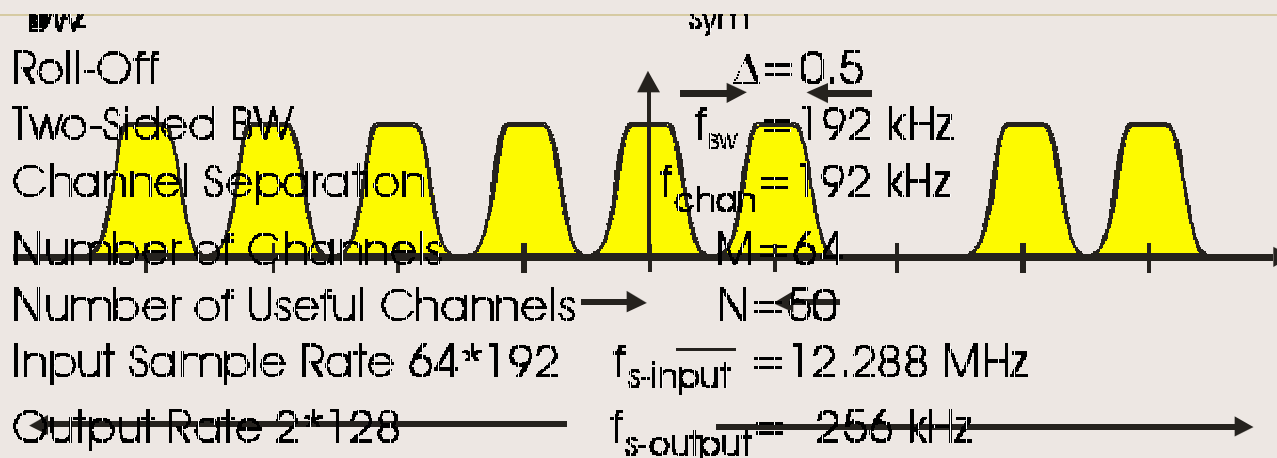

Required Spectral Response of Channel Filter at Output and at Input Rates

BW = 0.40177

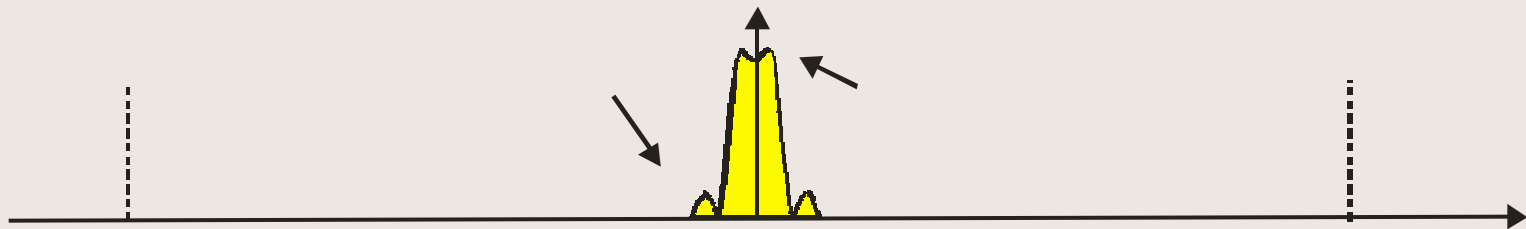
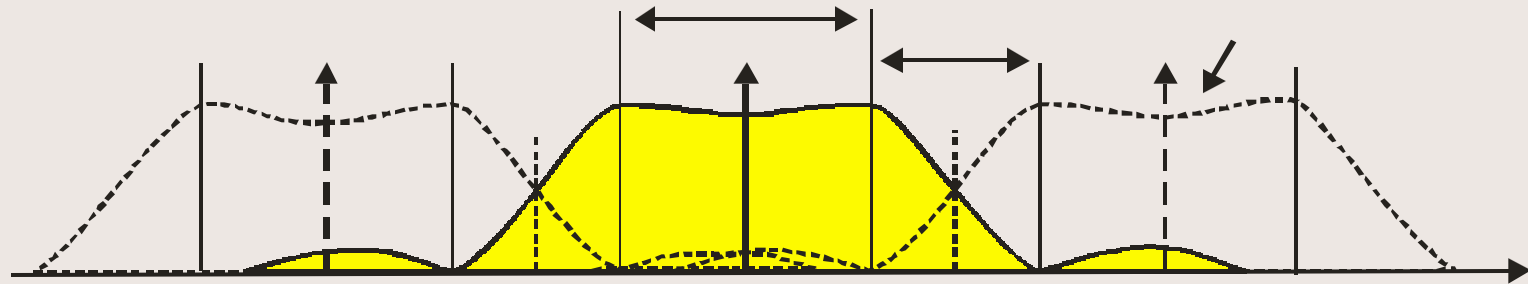

Time and Frequency Response of Remez Filter Design

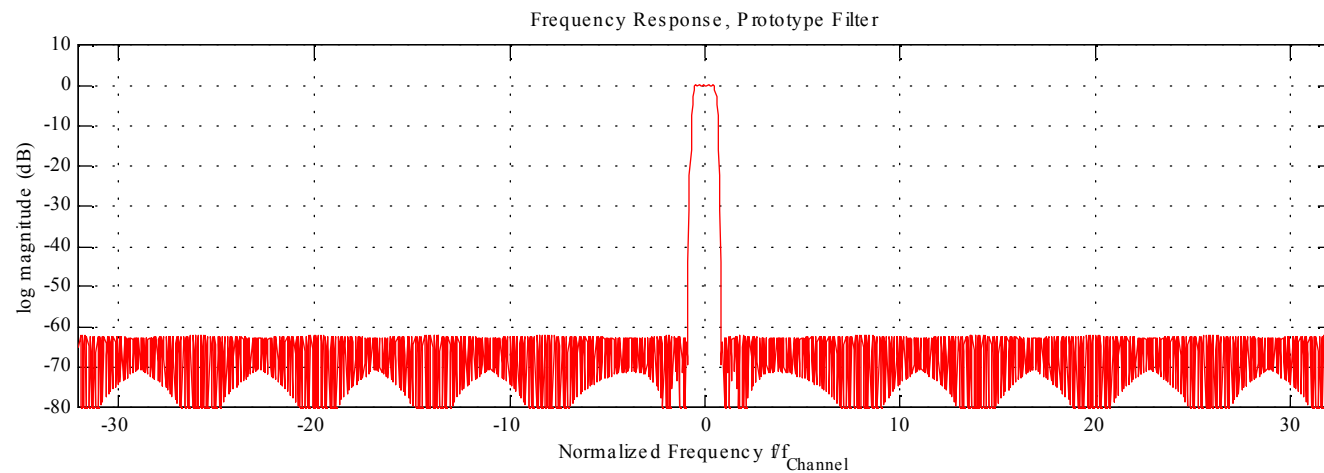
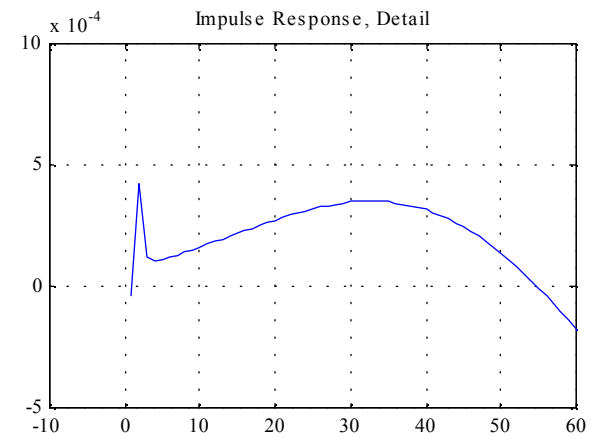
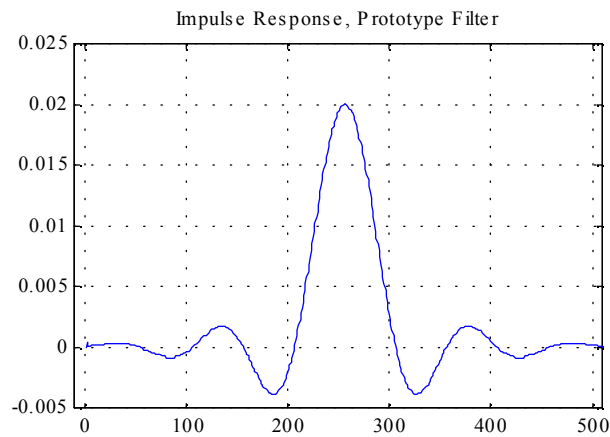

Time and Frequency response of Remez Filter Design with Modified End Points

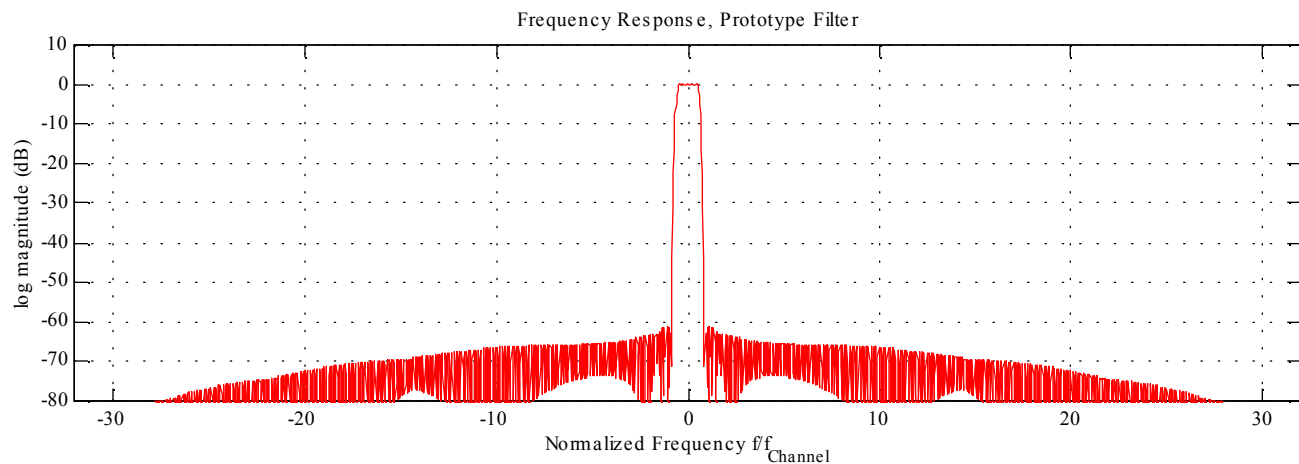
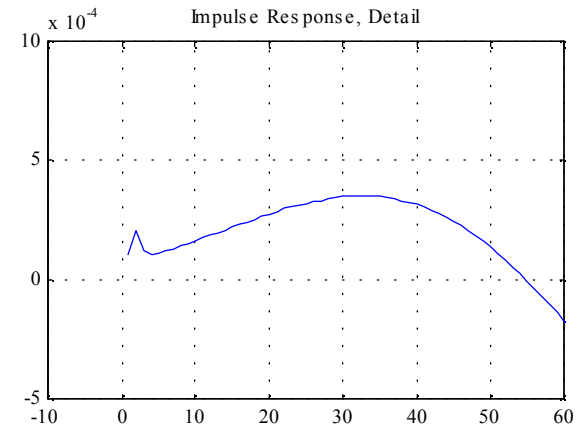
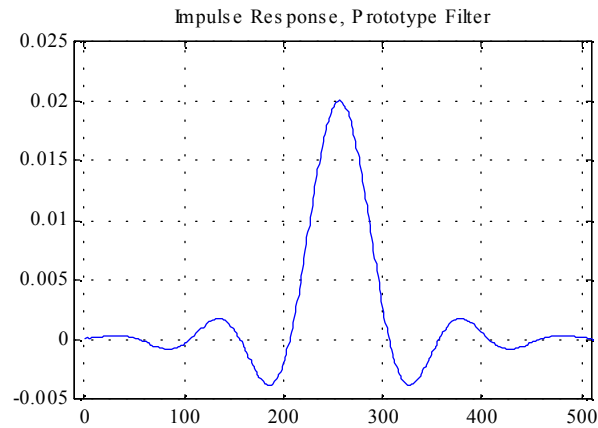

Time and Frequency Response of Prototype Filter at Output Sample Rate

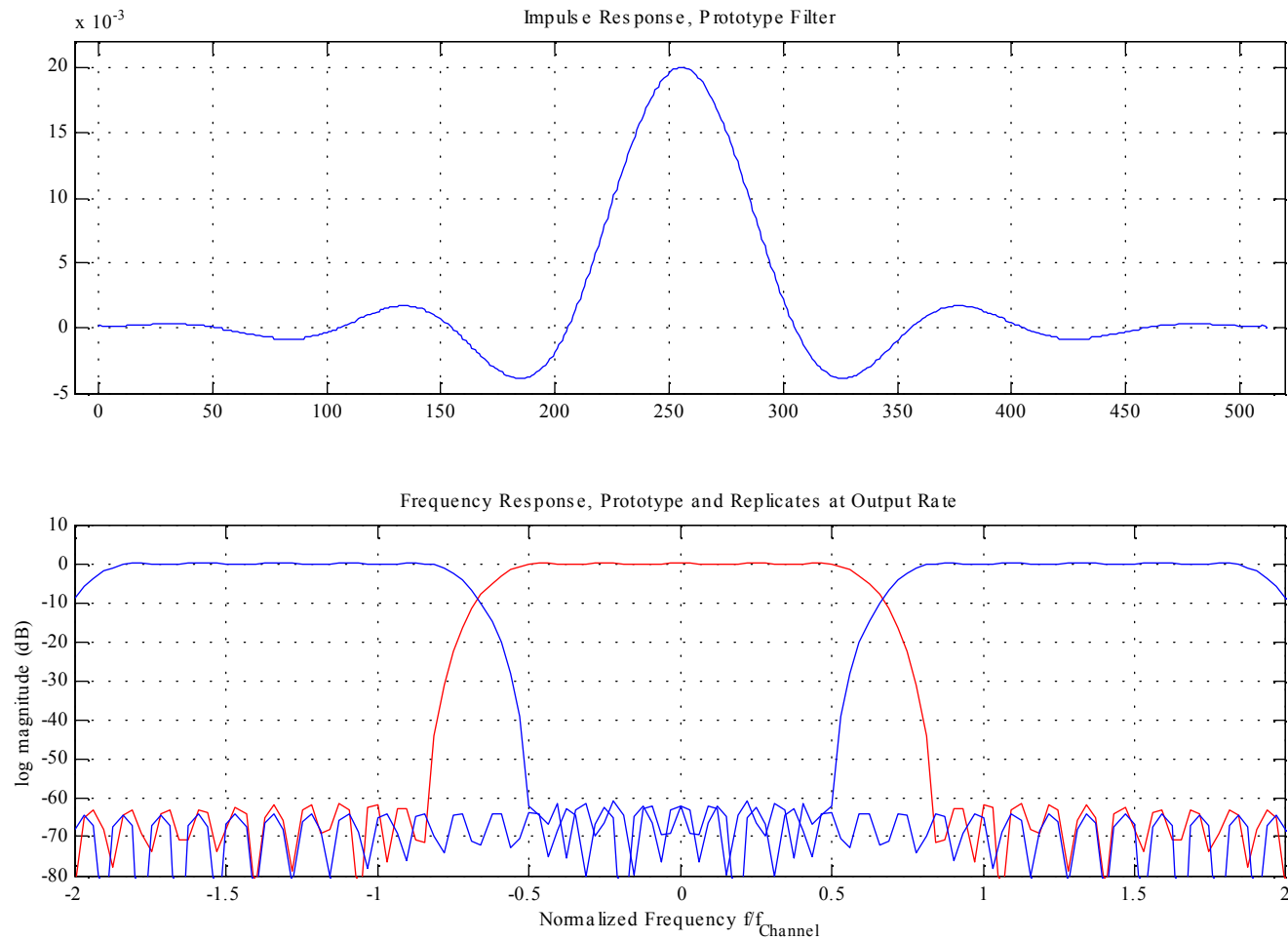

Commutators for Standard Input Buffer and for Circular Input Buffer

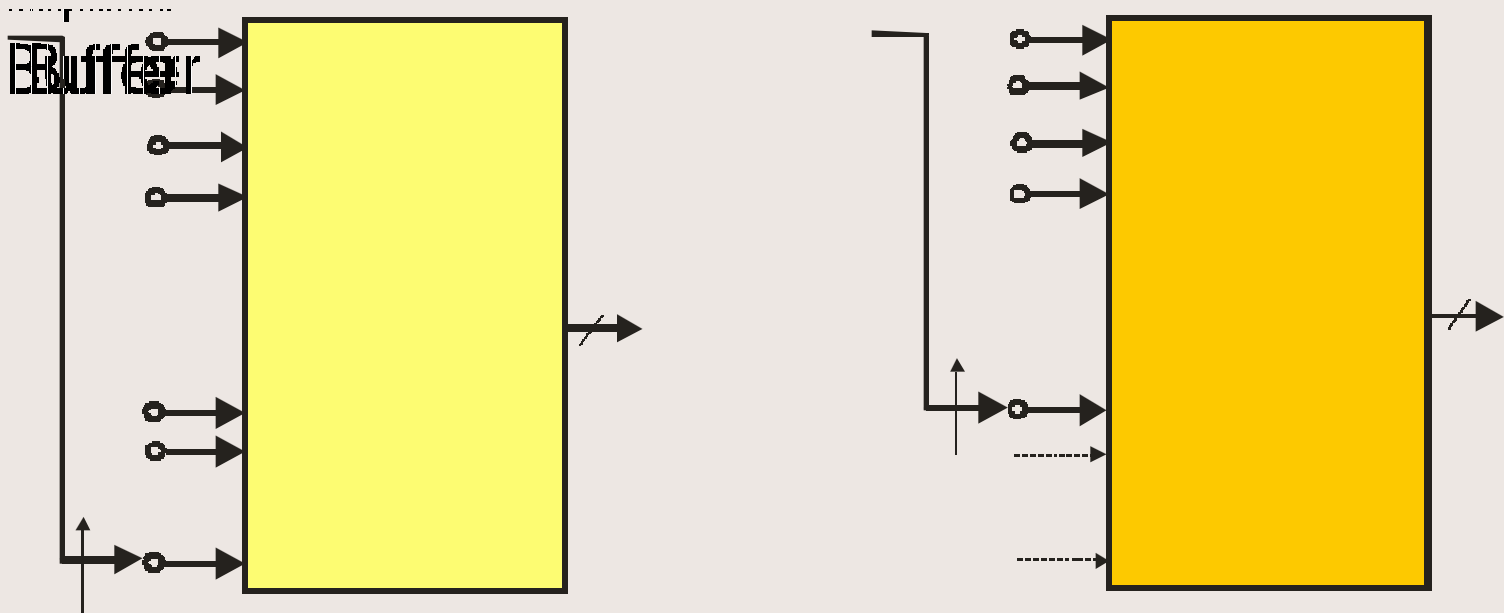

Standard Polyphase Channelizer and Modified Channelizer with Circular Buffers

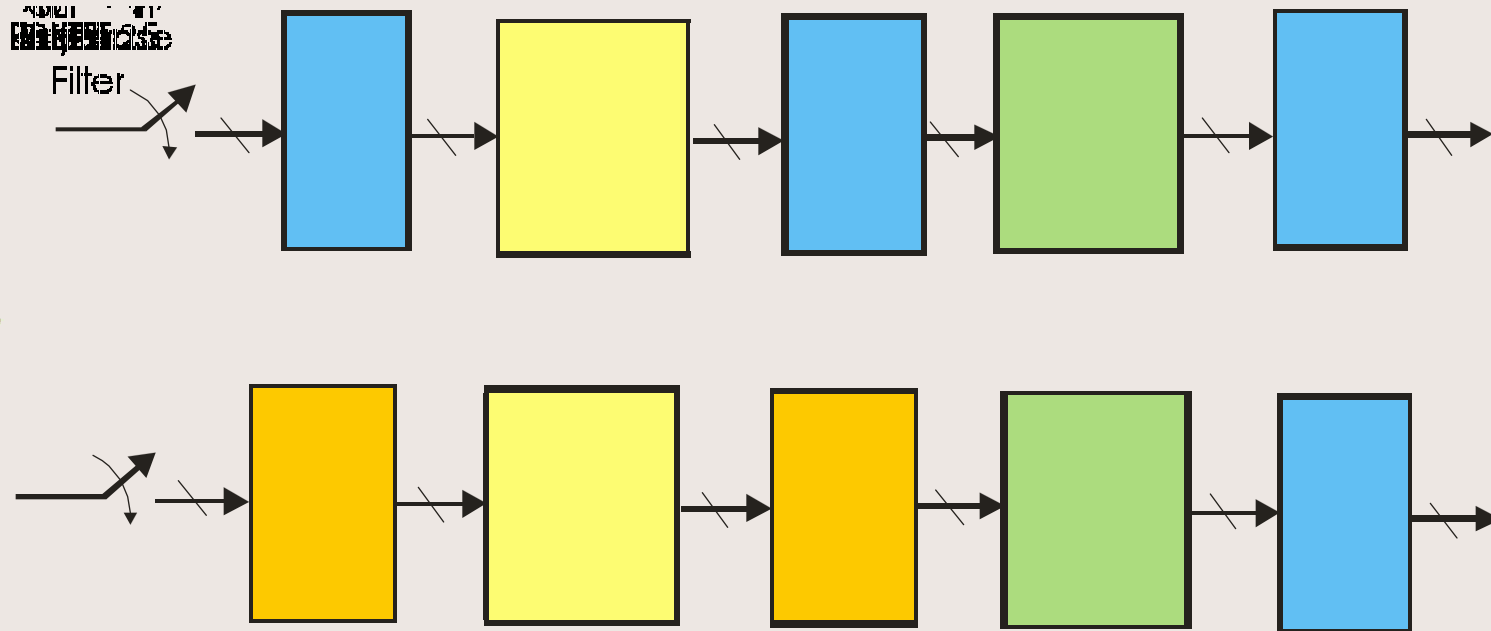

Content of 64-Point Circular Input Buffer for Two Successive 48 Point Input Blocks

Next 48
Input
Samples

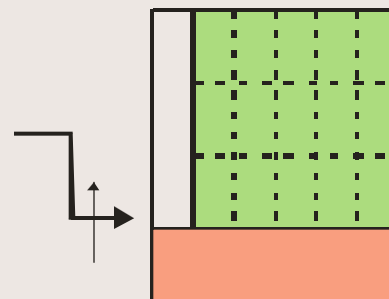
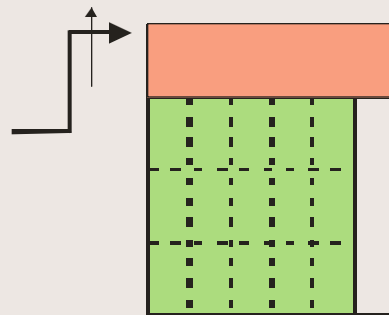
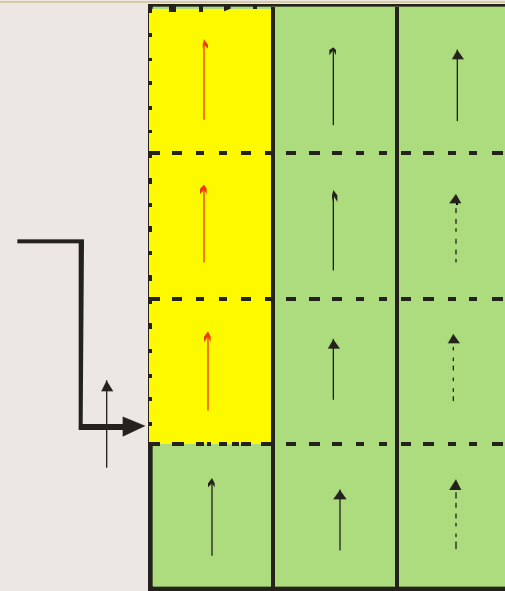
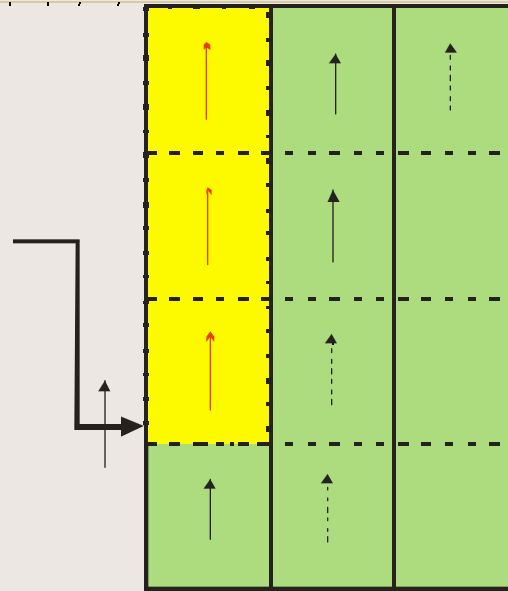

Shifting Time Origin for Input Data of Polyphase Filter and of Resetting FFT

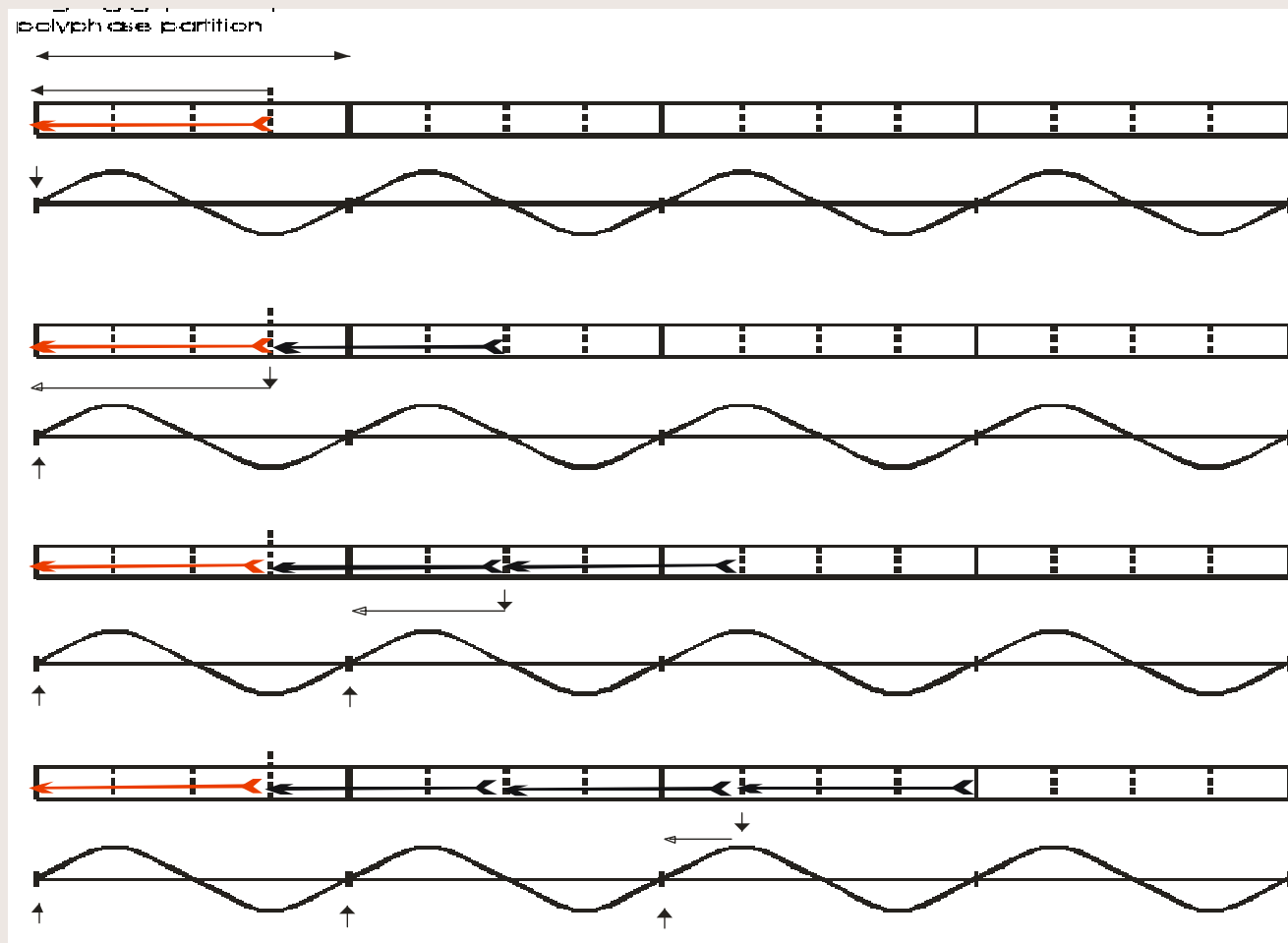

Contents of Transfer Circular Buffer

Aligning Origins for Successive Input Blocks

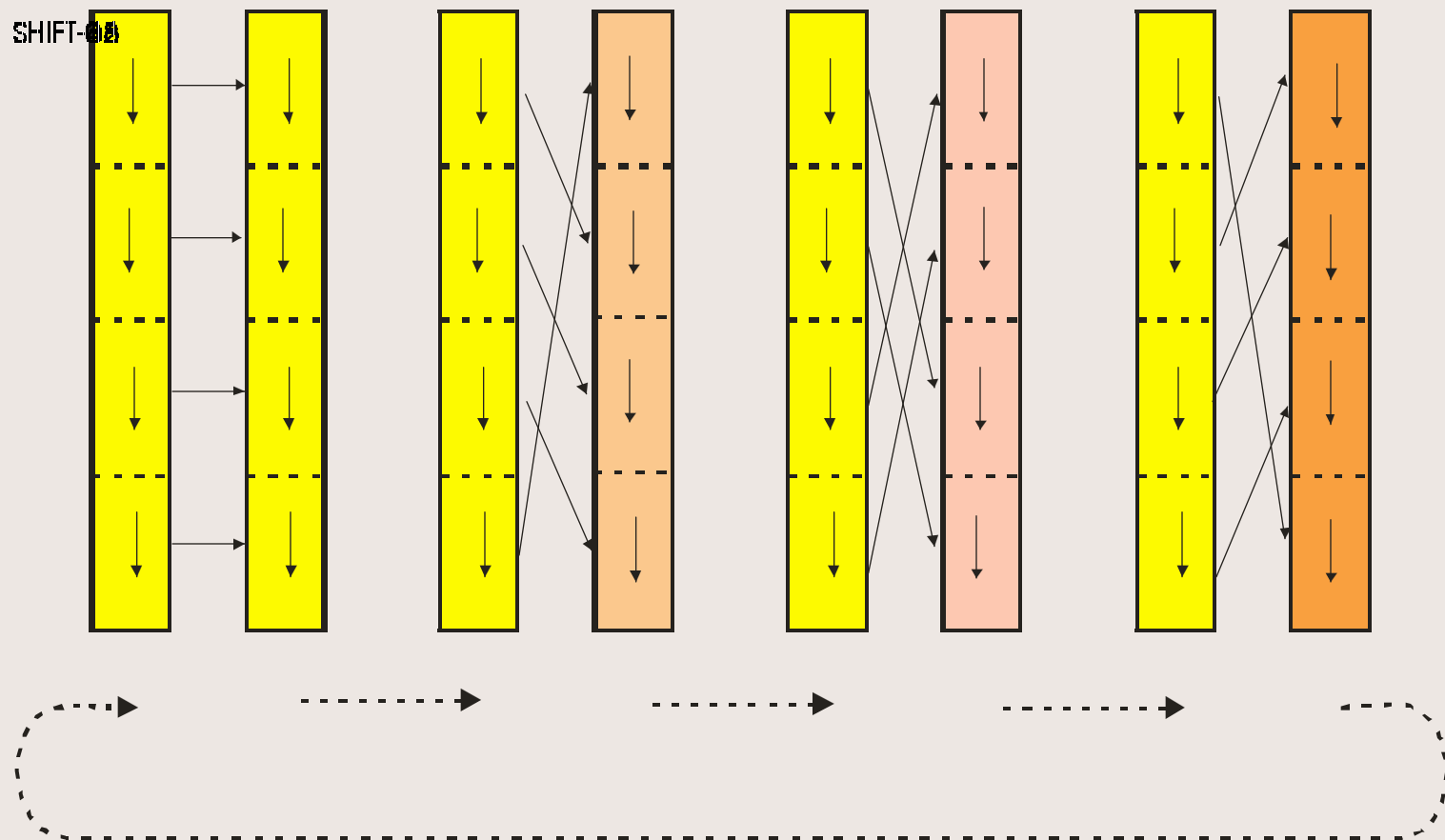

Input Time and Spectrum to 30 Channel, 40 Point FFT Channelizer

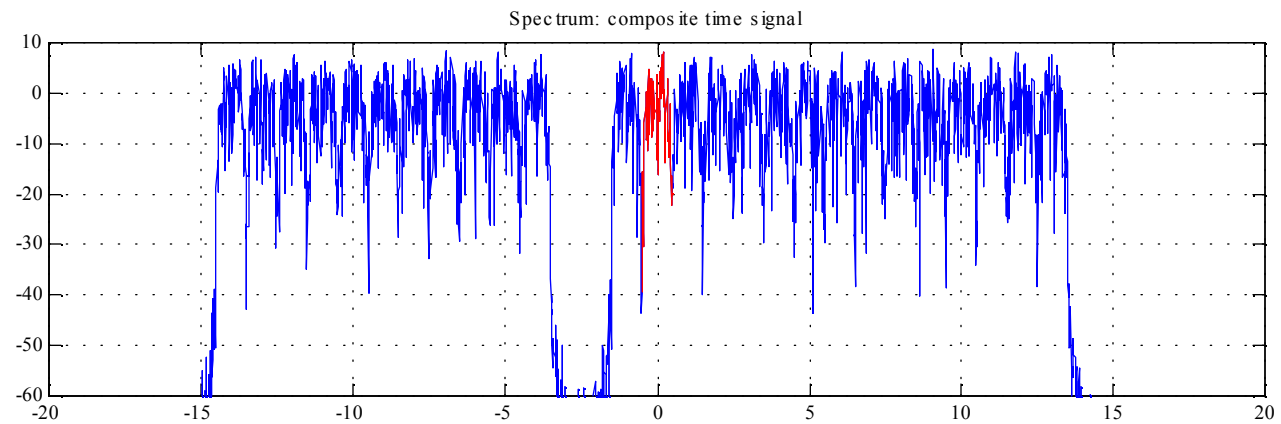
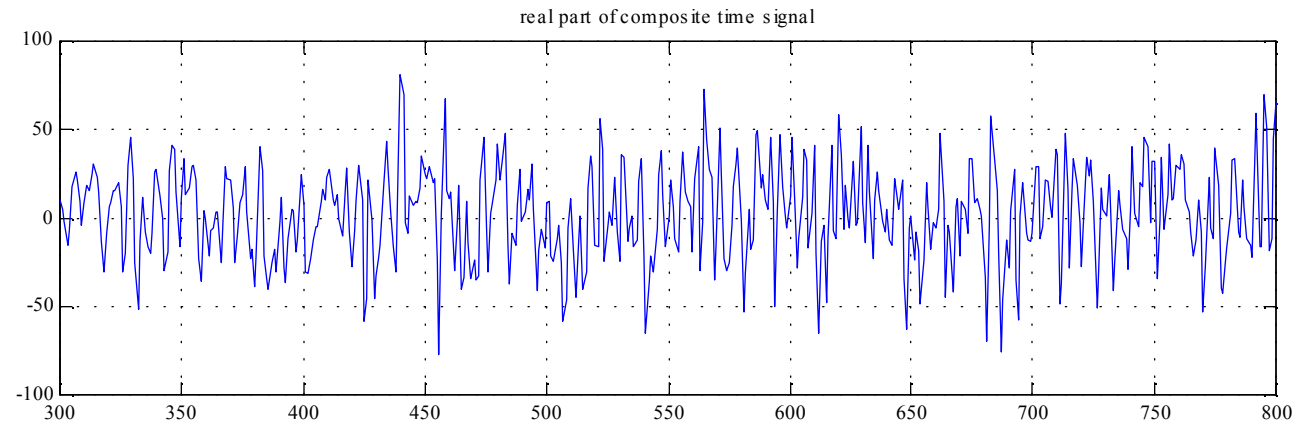

Time Series from 30 Channel Channelizer

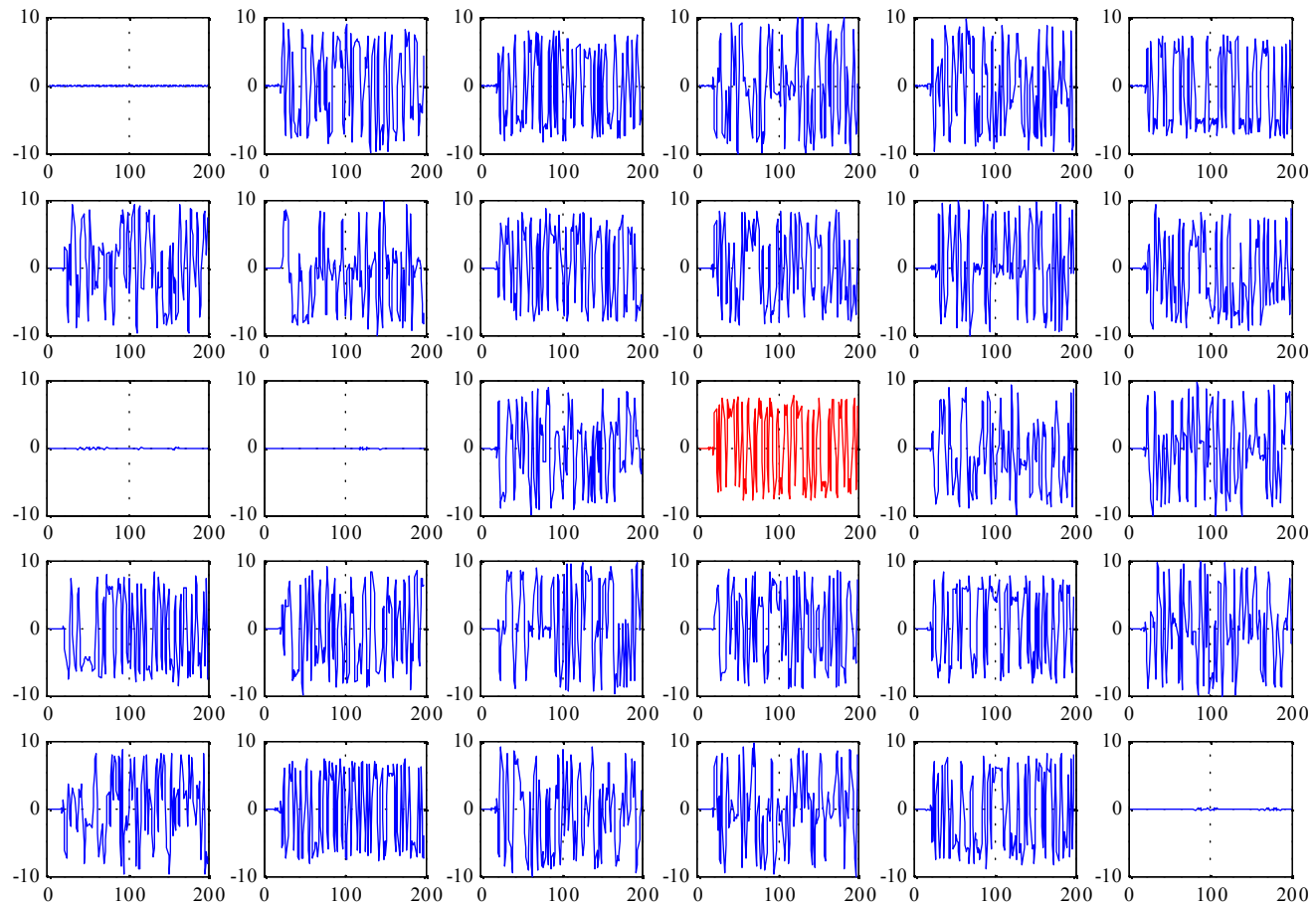

Spectra for 30 Channel Channelizer

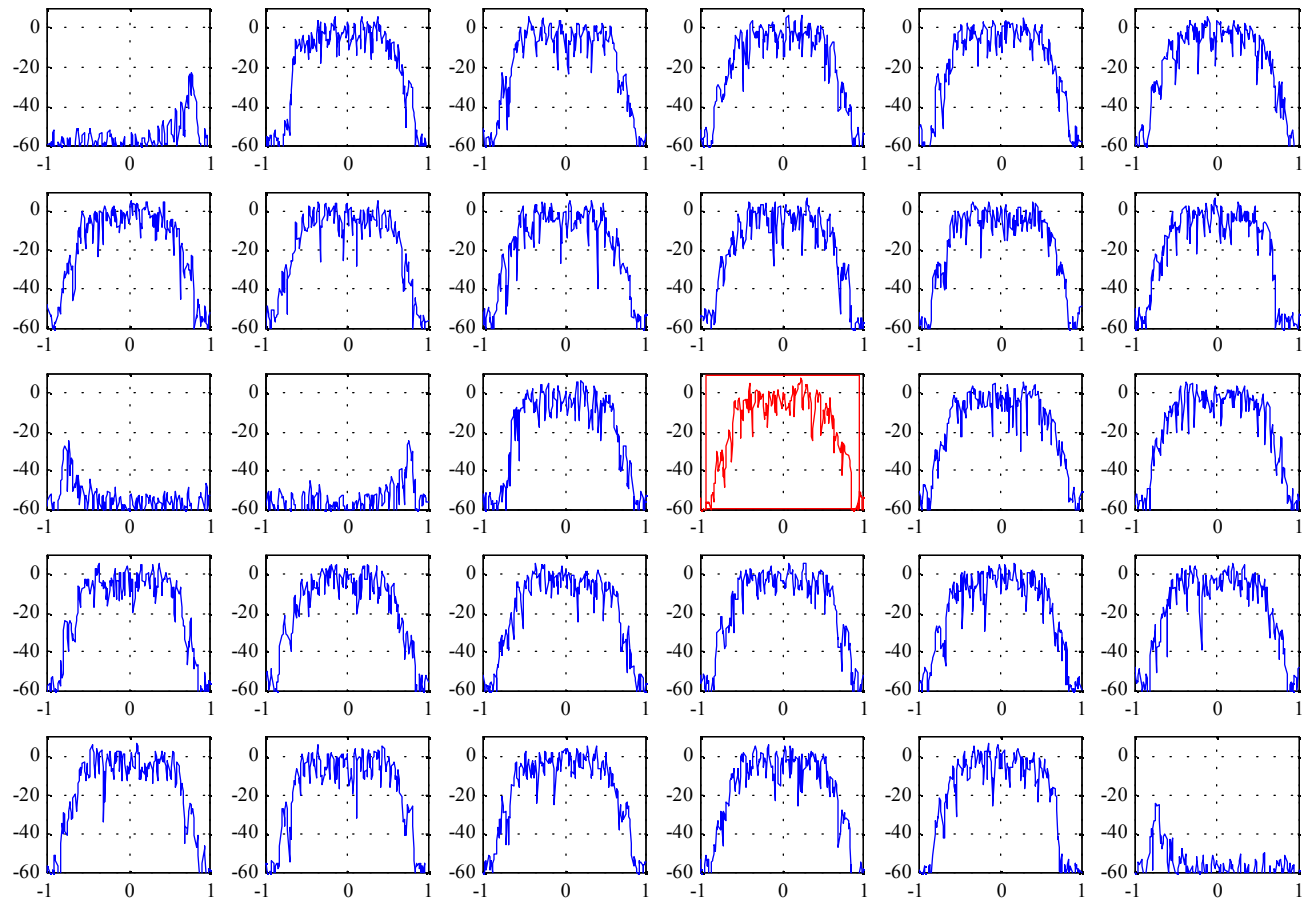

Input Time and Spectrum to 50 Channel, 64 Point FFT Channelizer

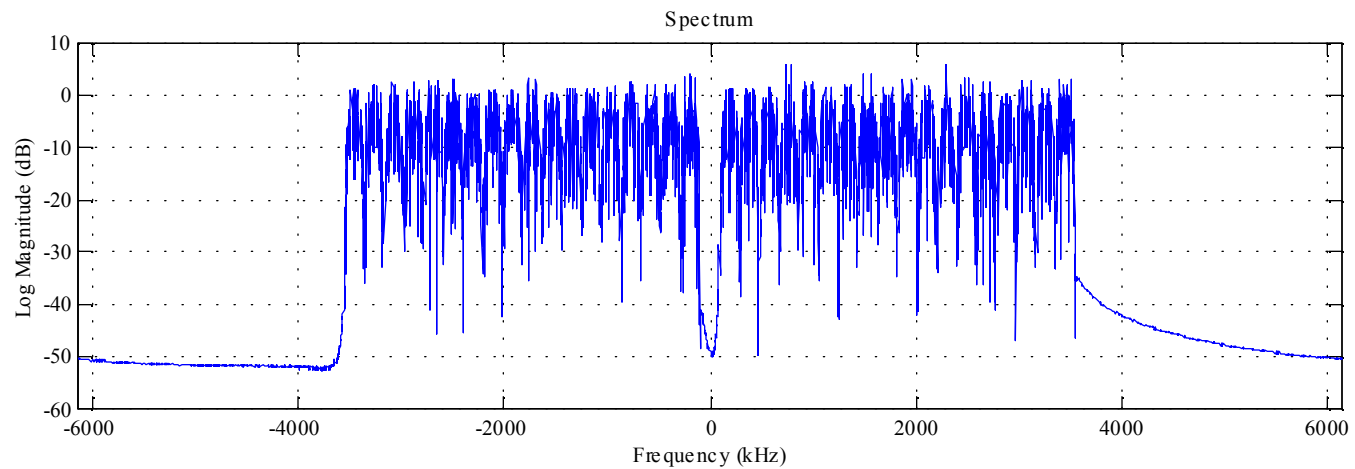
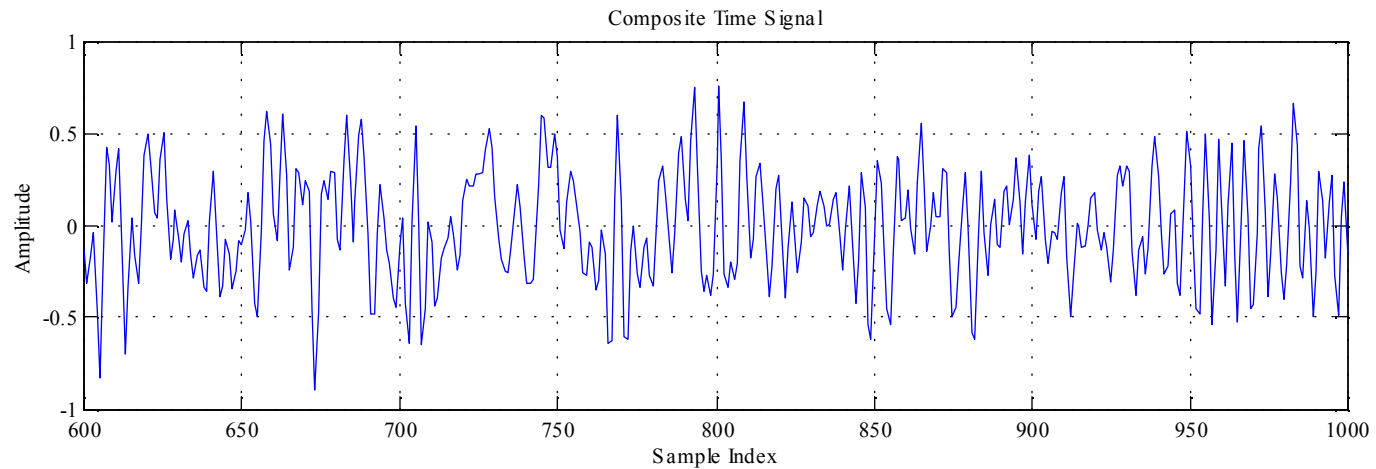

Time Series from 50 Channel Matched Filter Channelizer

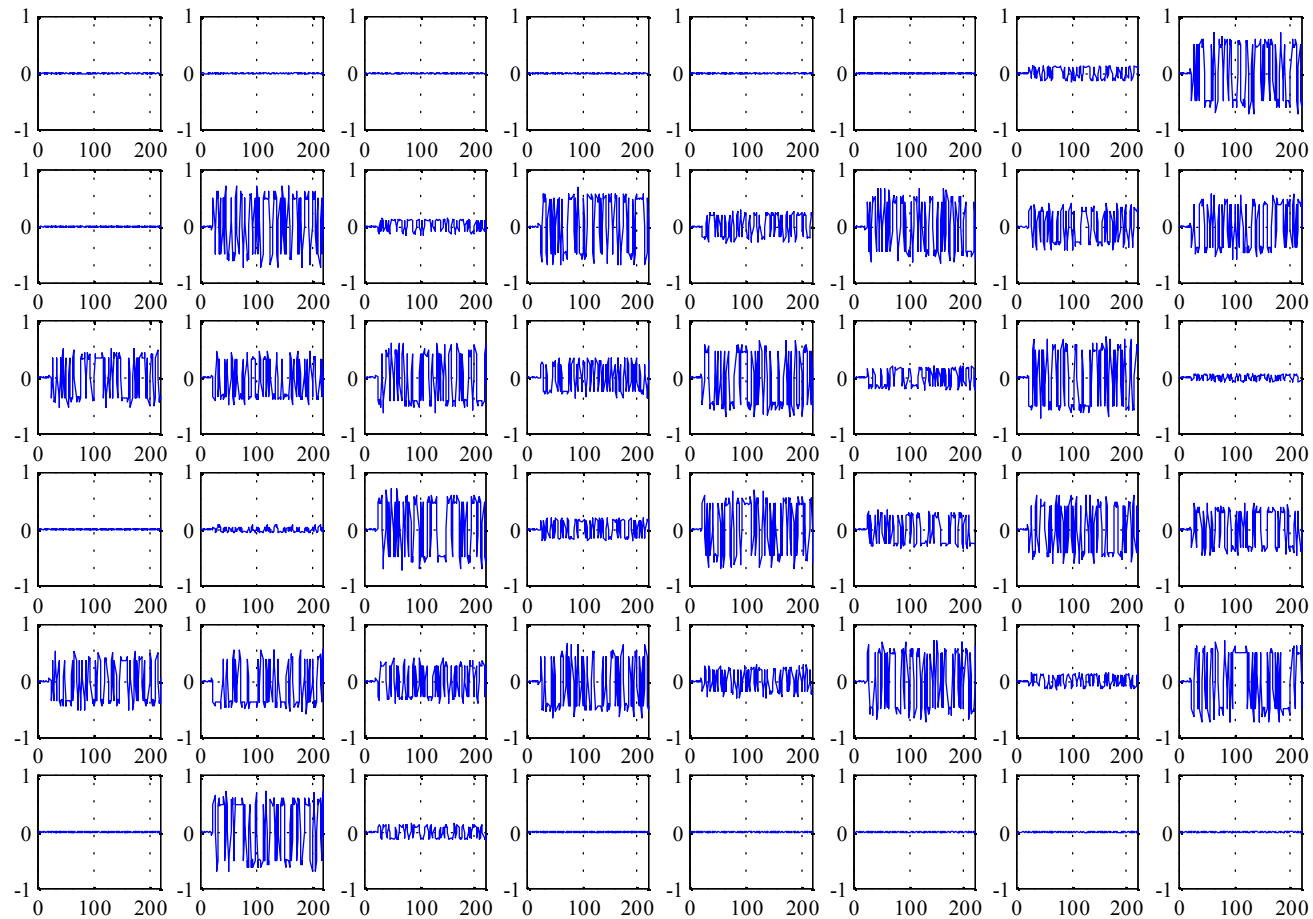

Spectra from 50 Channel Matched Filter Channelizer

