

Power Parks System Simulation

**Andy Lutz, Carl Mas, Elliott Schmitt
Combustion Research Facility
Sandia National Laboratories
Livermore, CA**

TV-2

**Hydrogen Program Annual Review
May 16, 2006**

This presentation does not contain any proprietary or confidential information.

Overview

- **Timeline**

- Started FY03
- Finish: end of FY06
- Percent complete: 85%

- **Budget**

- FY 2006: 250 K\$

- **Barriers addressed**

- Overall performance for stationary H₂ systems
- MYPP defined cost and efficiency targets for distributed H₂ production
- Natural gas:
 - 3 \$/kg (2005) with 4 \$/GJ natural gas
 - Reforming efficiency:
 - 69 % (2005), 80 % (2010)
- Electrolysis:
 - 4.75 \$/kg (2005) and 2.85 \$/kg (2010) from electricity at 0.04 \$/kWh
 - Efficiency: (electrolyzer + BOP)
 - 68 % (2005), 76 % (2010)

Overview (con't)

● Partners

- **Arizona Public Service (APS)**
 - Ray Hobbs
 - Scott McCamman, Dimitri Hochard (ETEC)
- **DTE Energy**
 - Rob Regan, Bruce Whitney
 - Rob Fletcher, Elliott Schmitt (Lawrence Tech.)
- **Energy Resources Group, UC Berkeley**
 - Carl Mas, Tim Lipman
- **Hawaii Natural Energy Institute (HNEI)**
 - Mitch Ewan, Richard Rocheleau, Severine Busquet
- **Stanford's Global Climate & Energy Project**
 - Adam Simpson, A. J. Simon, Chris Edwards



DTE Energy®



HAWAII NATURAL ENERGY INSTITUTE



Objectives and Relevance to H₂ Program

Objectives

- **Develop a flexible system model to simulate distributed power generation in energy systems that use H₂ as an energy carrier**
 - Power parks combine power generation co-located with a business, an industrial energy user, or a domestic village
- **Analyze the performance of demonstration systems to examine the thermal efficiency and cost of both H₂ and power production**

Relevance to the Multi-year Program Plan:

- **Technical Analyses**
 - Analyze H₂ and electricity as energy carriers and evaluate synergies
 - Analyze advanced power parks for production of both H₂ and electricity
 - Determine the economics of H₂ and electricity co-production

Approach

Combine engineering and economic analysis

- Assemble engineering model as system of components
- Component models based on fundamental physics and chemistry
 - ex: Chemkin for thermodynamic properties and chemical equilibrium
- Economic analysis modules linked to components
- Validate simulations with data from DOE demonstration projects
 - Conducted site visits to establish working relationships with engineers
 - Hosted LTU summer student to coordinate data collection & modeling

Software Design

- Create a library of Simulink modules for H₂-specific components
- Library components can be quickly re-configured for new systems
- Generic components can be customized using specific data
- GUI developed for a sample system (Sandia internal funds)

Library of Simulink modules

- **Newly developed components:**
 - **Wind turbine and resource**
 - Wind resource model takes hourly wind data as input
 - Turbine model power map and wind shear
 - **Chiller**
 - Model pump work and refrigerant cycle with coefficient-of-performance
- **Existing components:**
 - **Reformers - steam methane and autothermal (partial oxidation)**
 - **Electrolyzer – balances mass & energy, including phase change and purification**
 - **PEM Fuel cell - uses experimental data for polarization curve**
 - **Compressor – multi-stage with intercooling, isentropic efficiency**
 - **High-pressure storage vessel – real-gas equation-of-state**
 - **Photovoltaic solar collector – solar incidence with location & time of day**
- **Economic analysis modules are consistent with H2A**
 - Levelized cost approach uses H2A parameters for interest, taxes, depreciation, capacity factor

Simulations of DOE demonstration systems

- **DTE Energy Hydrogen Technology Park**
 - PV arrays & grid feed electrolyzer
 - H₂ for PEMFCs (10 at 5 kW each) and vehicle refueling station
- **Hawaii Natural Energy Institute**
 - Wind turbine proposed for Big Island
 - Electrolyzer to produce compressed H₂ for transportation
 - 5 kW PEMFC evaluated in FC testing center
- **Arizona Public Service (APS) refueling facility**
 - H₂ produced by PEM electrolyzer from grid and PV electricity
 - H₂ stored at low-p and used by PEMFC and ICE gen-sets
 - H₂ compressed for vehicle refueling

Projected cost of H₂ from electrolysis at DTE

- H₂ production rate has non-linear effect on cost
- Scale electrolyzer capital cost with production rate to 0.6 power
- Electricity price set to 0.025 \$/kWh for off-peak power

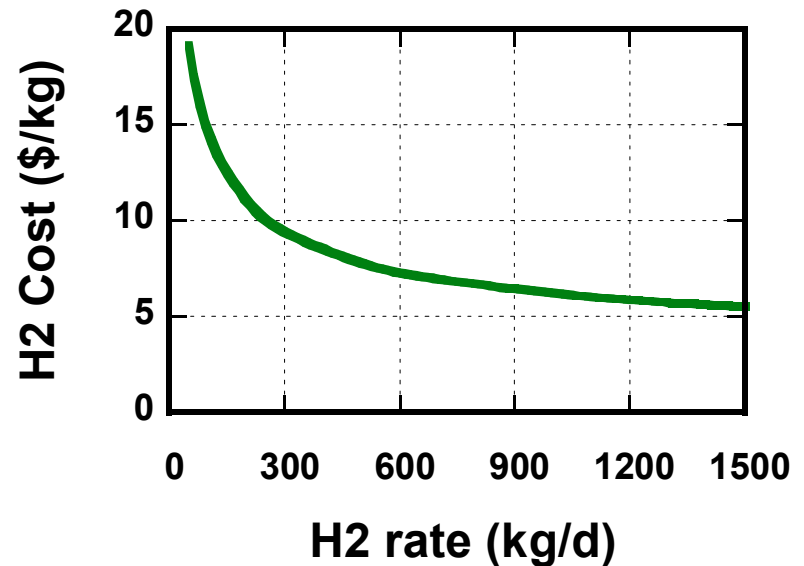
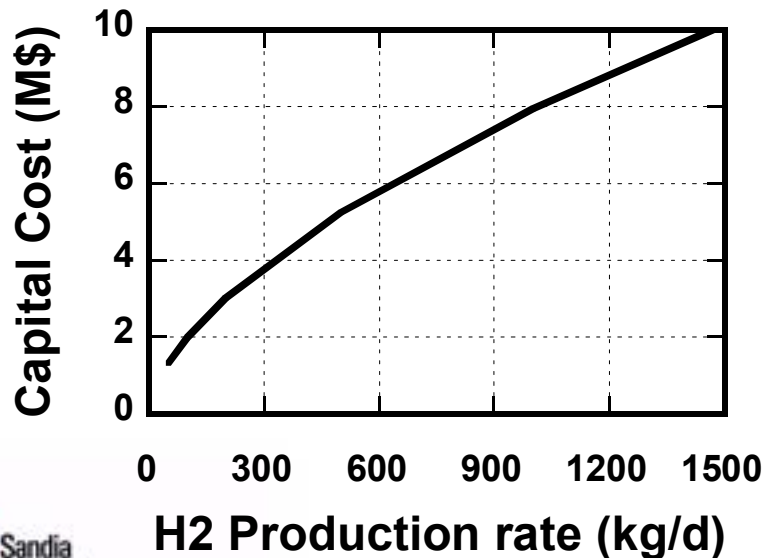

- To meet DOE electrolysis targets
 - 2005: 4.75 \$/kg maybe feasible, depending on scaling to 1500 kg/d
 - 2010: 2.85 \$/kg will need innovation and capital reduction

Simulation of photovoltaic panels at DTE Energy

- **Solar insolation model**
 - Clear-sky algebraic model uses geographic location
 - Adjusted model solar-to-electric efficiency = 9%
 - Correct monthly energy collection for number of cloudy days
- **Data from DTE park**
 - 26.7 kW capacity in 2 arrays: fixed and tracking
 - Peak capacity factor ~ 0.3

Comparison to DTE PV Data

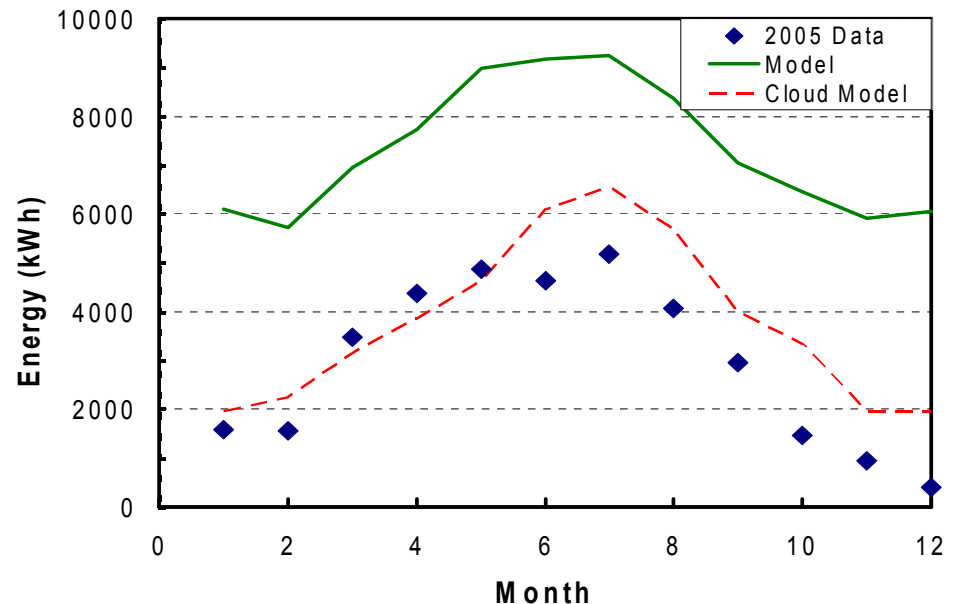

Electrolyzer operation at DTE Energy H₂ park

- Hydrogenics/Stuart unit
 - Rated capacity: 225 kW
 - Operation range: 150 – 180 kW
- Efficiency data
 - Data from DTE Energy website
 - Stack and BOP, not compression
 - Steady operation data collected for runs > 10 hrs
 - Monthly average data includes standby power use
 - Difference emphasizes the influence of duty-cycle
 - Average over 8 months
 - Steady operation = 59 %
 - Operation with standby = 48%

Monthly Electrolyzer Averages

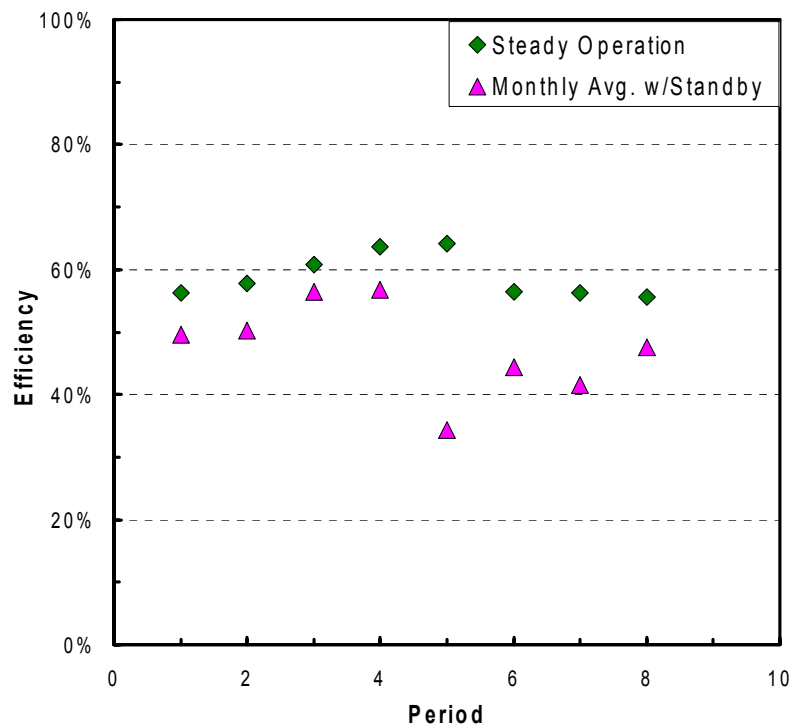

Compressor meets DOE target for the relative work in an electrolyzer system

- Isentropic efficiency definition: $\eta = \frac{W_{\Delta S=0}}{W_{comp}}$
- MYPP specifies 2 groups
- Compressor group is not an efficiency
 - Merely a relative factor between electrolyzer and total system efficiencies

$$\eta_{total} = f \eta_{elect}$$

	DTE Data	2005 Target	2010 Target
Cell & BOP	60%	68	76
Comp, Store, Disp	95%	95	99
Total	57%	64	75

Compressor Efficiency

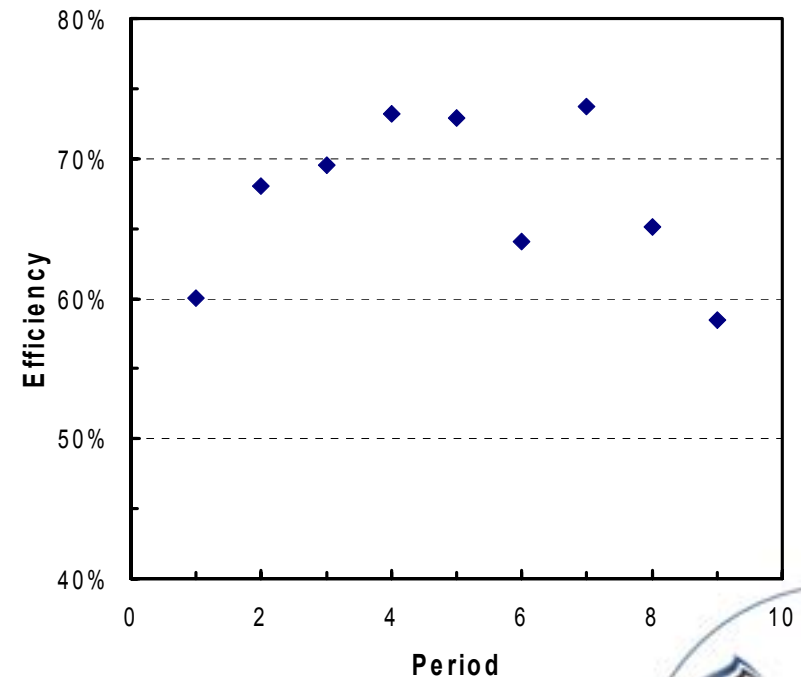

Updated economic analysis of HNEI electrolysis

- **Alkaline electrolyzer data used to set model**
 - 12 kg/d at 43% efficiency (LHV)
 - Compressor: 21 MJ/kg-H₂ at 2000 psi
- **Scale capital cost to 1500 kg/day**
 - Includes compression and 2% O&M
 - Electricity variation:
 - DOE target assumed 0.04 \$/kWh
 - Honolulu: 0.15 \$/kWh
 - Big Island: 0.22 – 0.32 \$/kWh

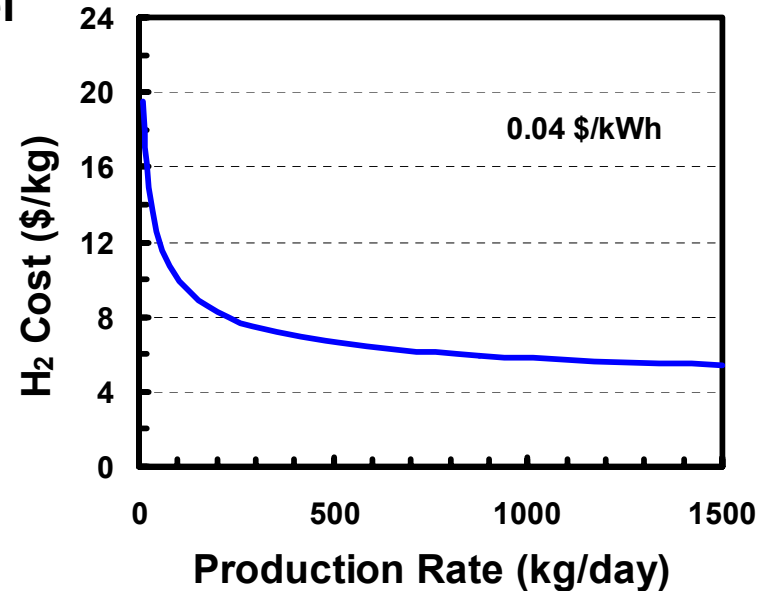
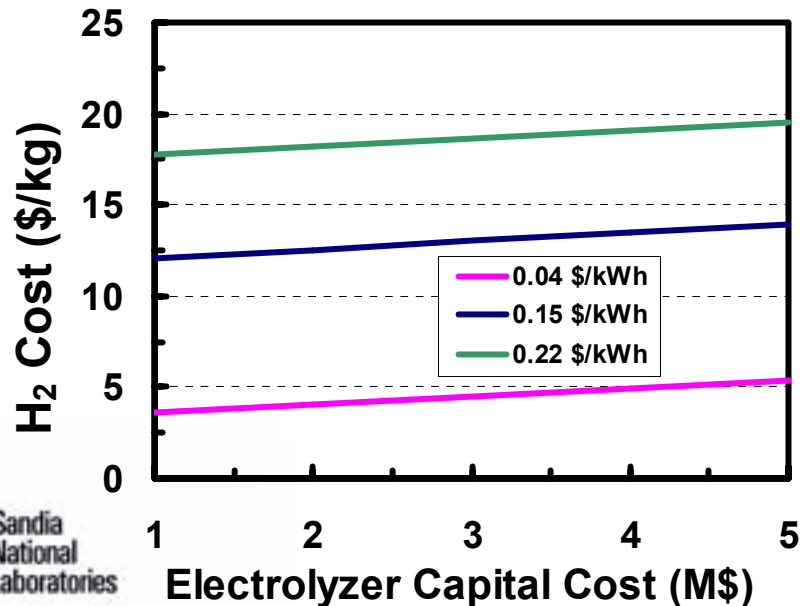

- To meet DOE targets for water electrolysis (0.04 \$/kWh)
 - 2005: 4.75 \$/kg achievable for 1500 kg/day electrolyzer
 - 2010: 2.85 \$/kg will need innovation

Wind resource for proposed HNEI power park

- Wind resource at Kahua Ranch, Big Island, HI
 - Hourly average wind speed data at 27 m in 1993
 - Wind power class: 5
- 500 kW wind turbine
 - Hub height: 30 m
 - Swept area: 866 m²
 - Predicted capacity factor: 0.24
 - Expanded correlation to long-term data, capacity factor: 0.37

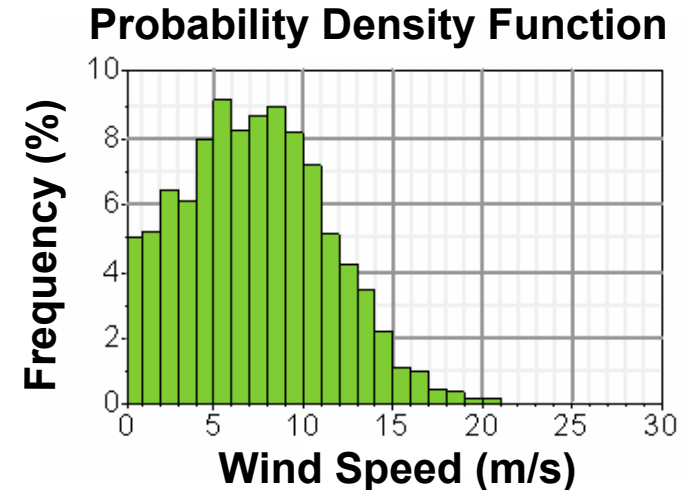

Monthly Average Wind Speed (m/s)

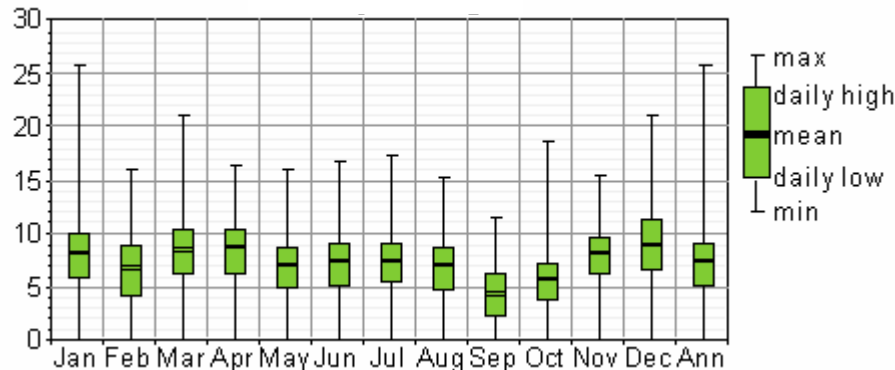

- Modeling approach

- Input hourly average wind speed and air density
- Wind shear characterized using power-law relation
- Wind turbine power map predicts hourly average power output

Projected cost of electricity from HNEI wind turbine

- **Parameter Study:**
 - Vary wind turbine hub height
- **Wind turbine rated at 500 kW**
- **Wind speed data from Kahua Ranch in 1993**
- **Economic analysis uses H2A Parameters**
- **Capital cost includes turbine, tower, and installation**
- **~ 2 / 3 of electricity cost is from capital cost of turbine**

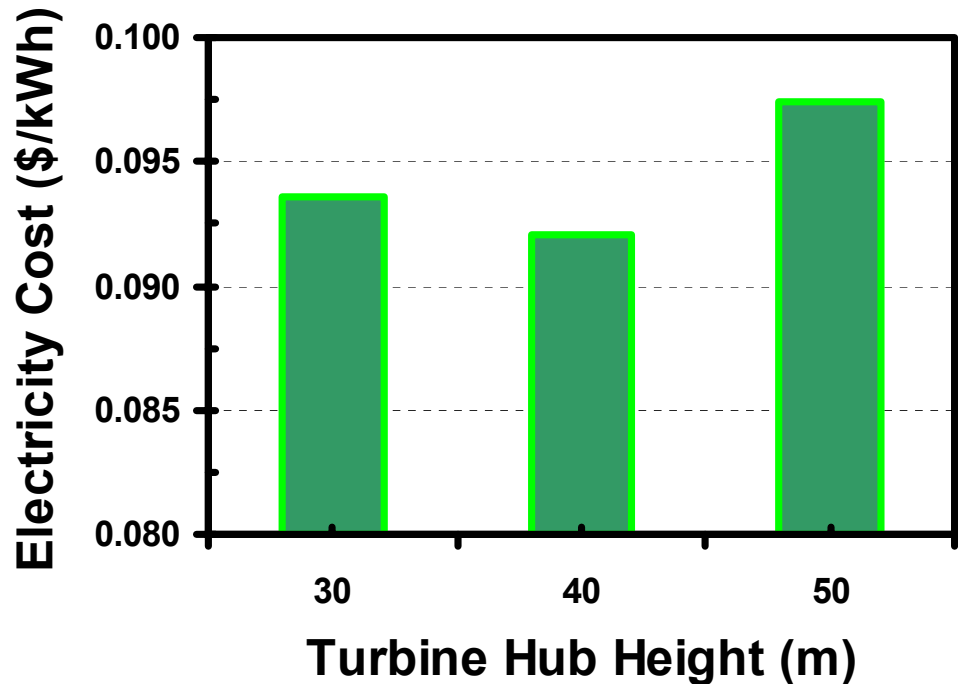

Projected cost of H₂ from proposed HNEI wind turbine

- Turbine rated at 500 kW
- Model assumptions:
 - Electrolyzer output:
 - 50 kg/day
 - 60% efficiency (LHV)
 - Includes compression
 - Parameter study
 - Electrolyzer capital cost
 - Electricity from wind turbine
 - Includes O&M = 2% Capital
- Cost contributions at:
 - 0.06 \$/kWh
 - 7 \$/kg-H₂

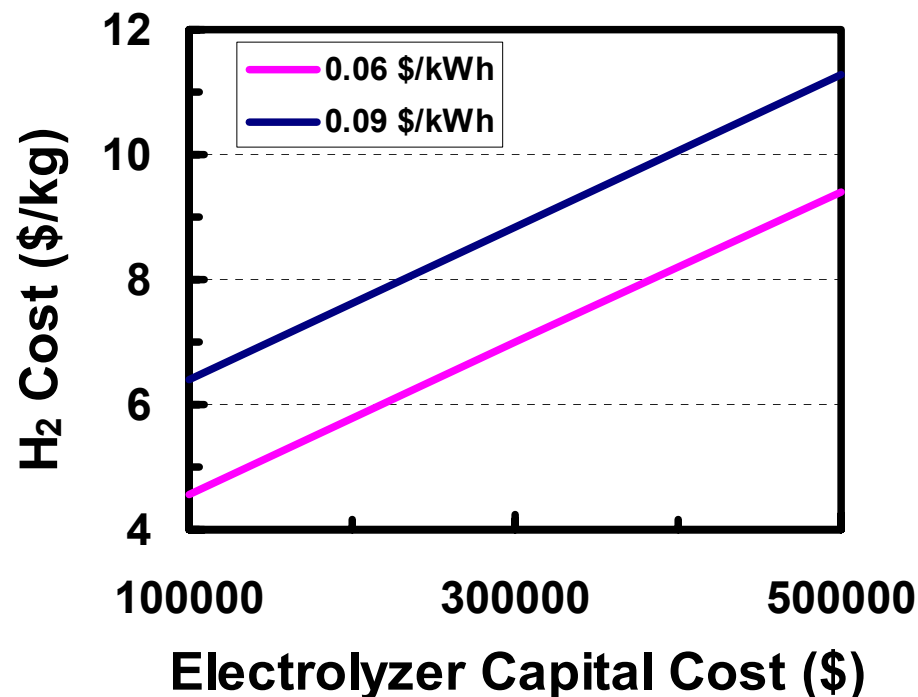

CONTRIBUTION	COH (\$/kg-H ₂)
Electricity Use	3.35
Capital	3.19
O&M	0.46

Economic parameter study: electrolyzer capital cost to meet program targets

- Levelized cost using default H2A values
 - With O&M = 2% of capital
- Variables:
 - cost-of-electricity
 - efficiency
- MYPP target: 2.85 \$/kg
- Shaded regions are range of capital to meet goal at given efficiency

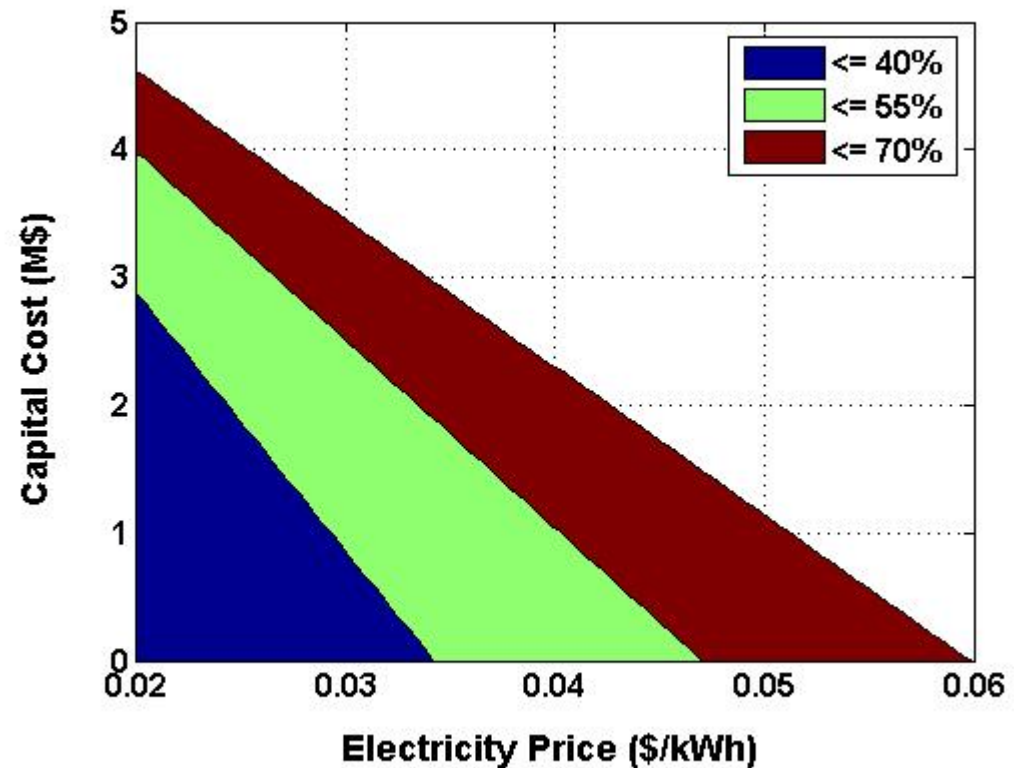

FC stack performance at DTE hydrogen park

- **Polarization data**
 - Stack V-I data averaged over periods of steady-operation
 - Data from 10 stacks grouped by load
 - Averaged data used to fit linear model
 - Error bars show 2 std. dev.
- **V-I data can be used in 2 levels of FC model**
 - Detailed model
 - Simple efficiency vs. power curve-fit

Fuel Cell Polarization Curve

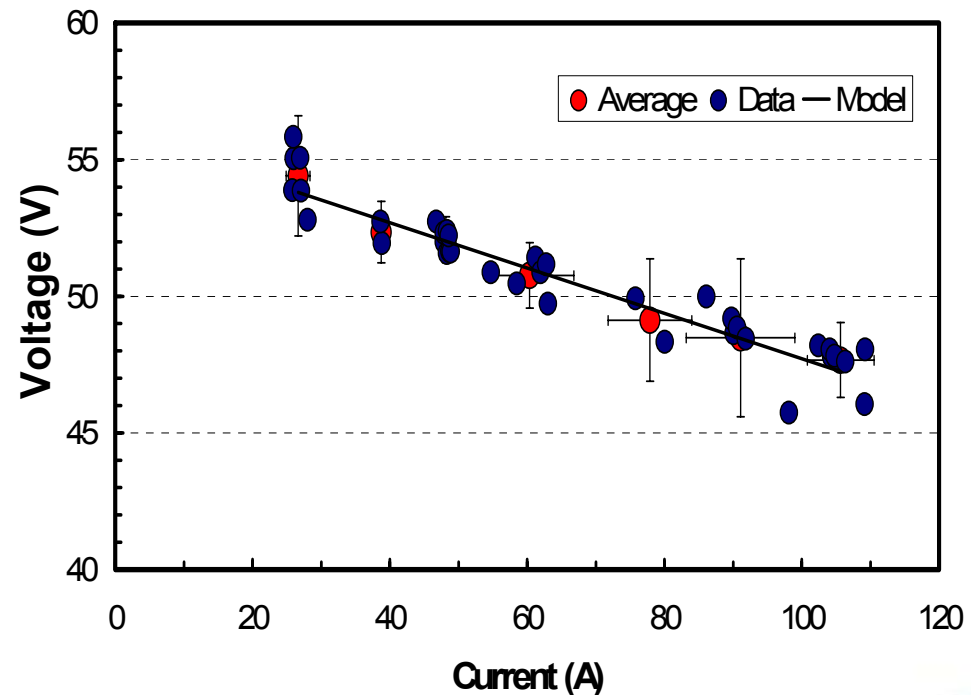

FC polarization data from 3 sites agree, providing model calibration

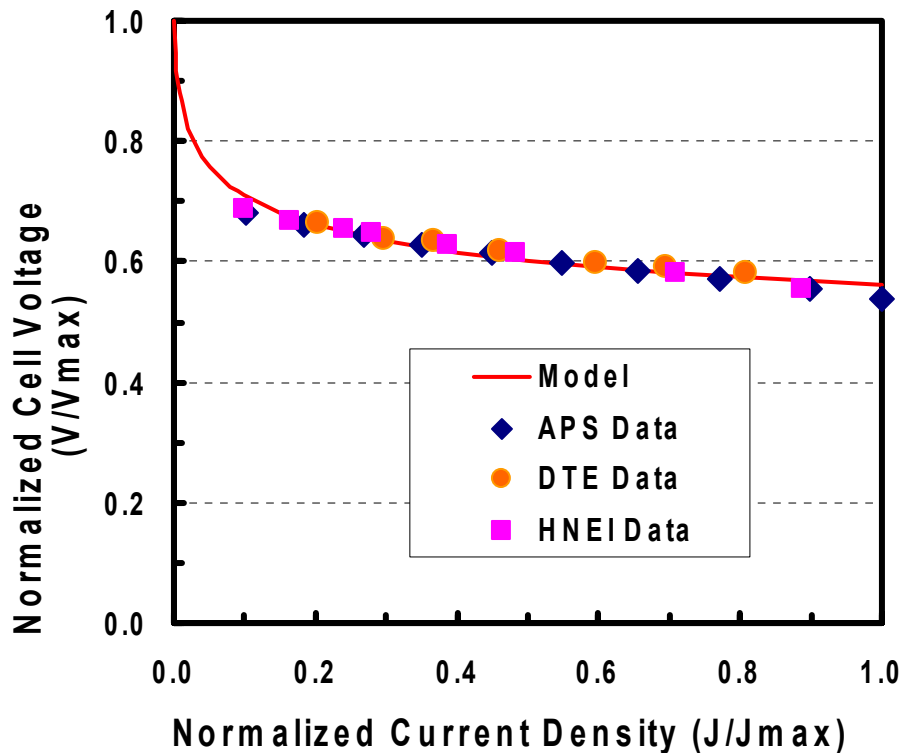

- Model requires V-I curve as input to fuel cell
 - Determines component efficiency versus load
- Adjust polarization curve to fit data provided by Partner
 - Operated Plug Power FC at steady-state
 - Normalized data for use in generalized model

Fuel cell system operating data at 3 sites

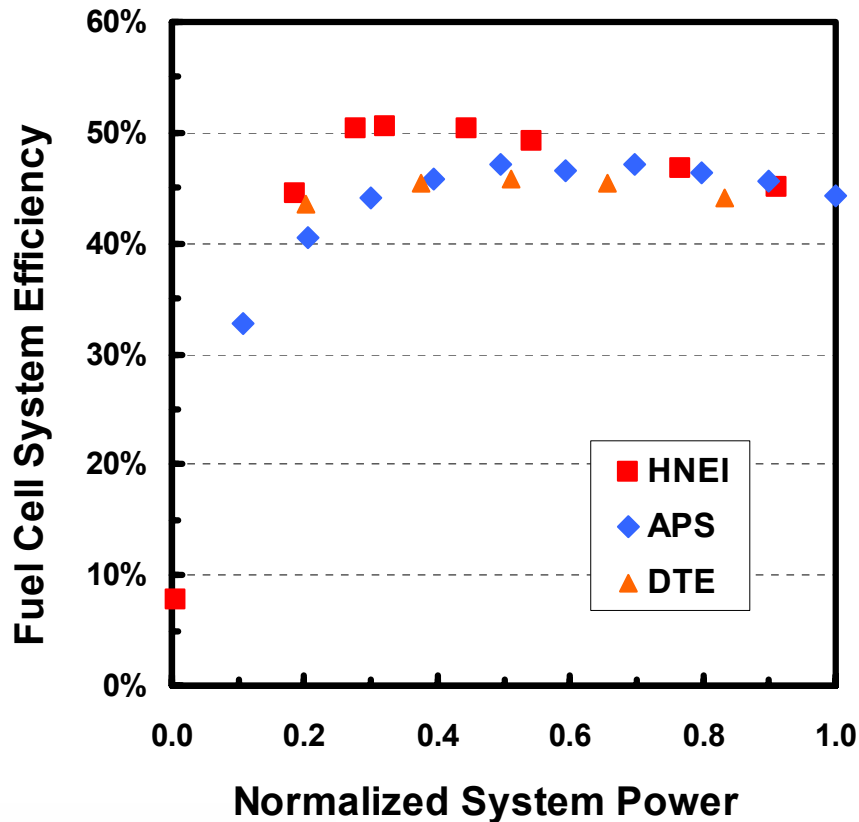

- Hydrogen fuel cell system efficiency (LHV)
 - Based on net DC power out and hydrogen flow
 - Power regulated to 48V
 - System includes fuel cell stack, balance of plant, and DC-DC converter
- Agreement in practical range:
 - 48 % system at half load
 - 45 % at full load
- Model analysis performed in this load range

Projected cost of electricity from HNEI FC

- **Capital cost for 5 kW-DC fuel cell system**
 - 45% efficiency (LHV)
 - Parameter Study:
 - Fuel cell capital cost
 - Vary O&M from 10-30% for stack replacement
 - H₂ at 5.37 \$/kg from electrolyzer at nominal conditions:
 - 1500 kg/day production rate
 - 0.04 \$/kWhr electricity

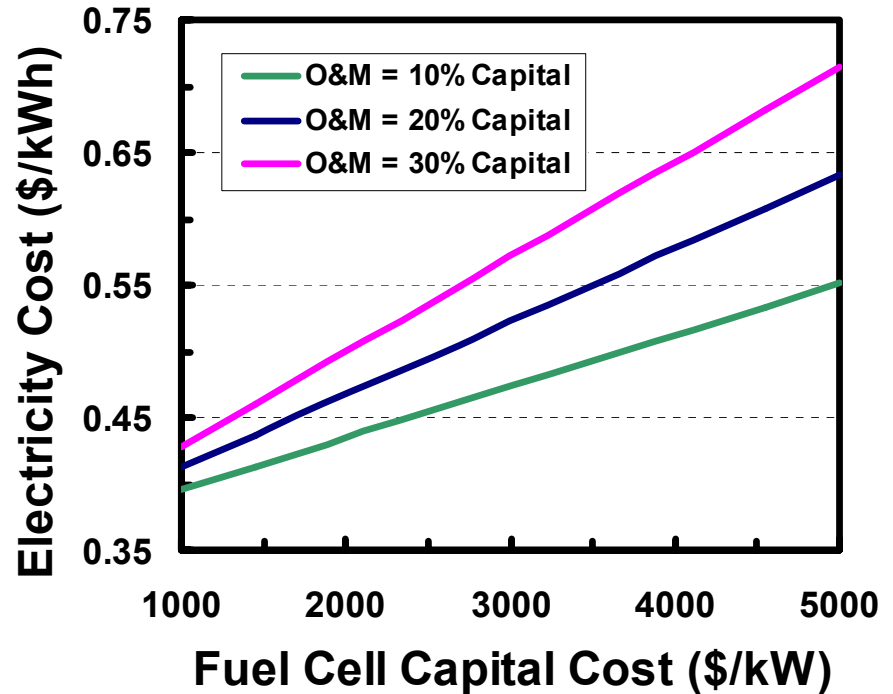

We developed a GUI for non-Simulink users

1st GUI:
Electrolyzer,
H₂ storage
(gaseous),
Compressor,
Fuel cell

Left side:
user inputs

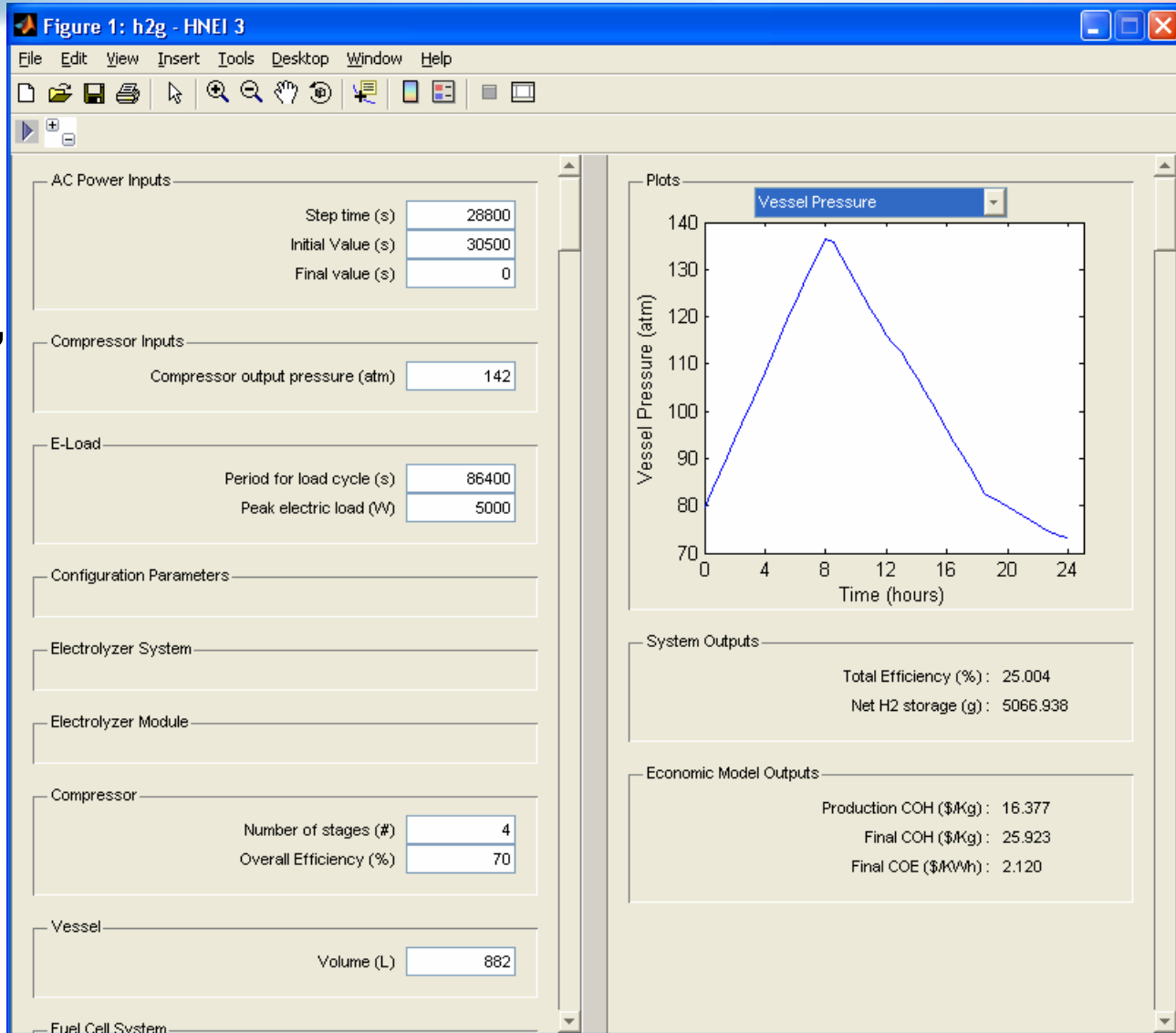

Right side:
model
outputs
and a
choice
of
graphs

Future Work

- **Compare model to data from DOE power parks**
 - **APS:** apply model to new data on HBR electrolyzer
 - **DTE Energy:** evaluate new electrolyzer expected in summer
 - **HNEI:** Compare model predictions with wind turbine data
- **Analysis of biomass pyrolysis**
 - **Analyze data from peanut shell pyrolysis demonstration**
 - Collaborate with EPRIDA, U. of Georgia, NREL
- **Collaborate with Stanford's Global Climate & Energy Project**
 - **Implement 2nd-law exergy analysis to measure efficiency in terms of available energy for a process**

$$A = (E - U_0) + p_0(V - V_0) - T_0(S - S_0)$$

Future Work (con't)

- Collaborate with grad-student visitor in UK/US exchange program
- Emma Stewart (U of Strathclyde)
- Research Interests
 - Modeling of fuel cells for electrical power systems and distributed generation
 - Power electronics modeling for electrical grid network integration
 - Testing methods for analyzing electrical performance in relation to the electrochemical reactions
 - Electro-Impedance Spectroscopy
 - Load and Transient Analysis

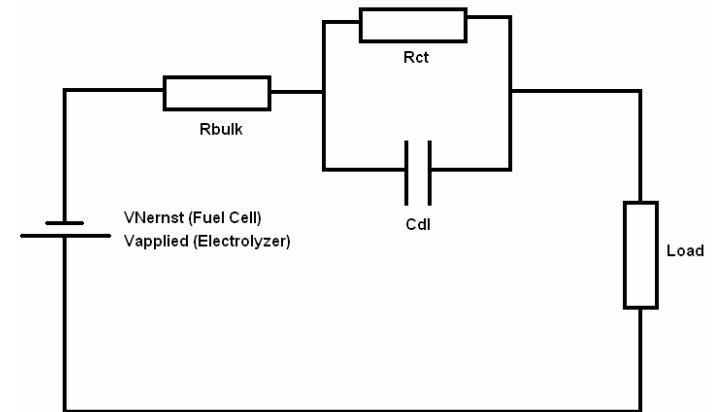

Randles Cell

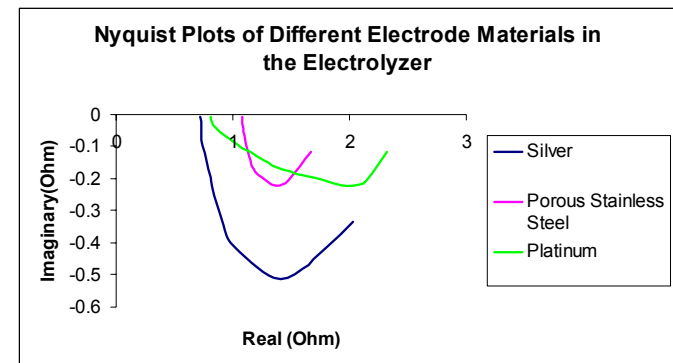

Impedance Analysis

Summary

- **Analysis of electrolysis at 3 power parks: APS, DTE, HNEI**
 - **System efficiency range: 35 to 57 % including BOP & compression**
 - **Best efficiency is about 10 % points short of 2005 target**
 - Standby power and chiller loads are significant
 - **Duty cycle is an issue—as in driving cycle for vehicle mileage**
 - **H2 cost depends on:**
 - **Electricity price – which depends on region and time-of-day**
 - **Capital cost – which depends on scale**
 - **H2 price range:**
 - 20 \$/kg at scale of power parks
 - ~5 \$/kg at 1500 kg/d with optimistic scaling factor
 - **Electricity from fuel cells returned at peak load is not competitive**
 - **except for isolated cases like Big Island at 0.32 \$/kWh**

Supplemental Slides

Response to FY 2005 review

- **Reviewers' major comments:**

1. *Be more proactive with technology validation power park projects to ensure good quality data*
2. *Consider approaches to enable broader dissemination of analytical models*
3. *What is plan for interfacing with HFCIT Systems Analysis & Systems Integration activities?*

- **Response:**

1. **Working directly with engineers at APS, HNEI and DTE**
 - *supporting LTU student to work in data analysis at DTE*
2. **Committed Sandia internal funds (20k\$) to develop GUI so others can perform system simulations**
3. **Sandia is developing the high-level architecture (HLA) for the macro-system model (MSM)**
 - *Can link H2Lib modules in future system analysis activities*

Publications and Presentations

Presentations:

- “Power Park Simulations”, Tech Val working meeting, July (2005).
- “Power Park Simulations”, IEA Task 18 meeting, March (2006).

Publications:

- Lutz, A E, Bradshaw, R W, Bromberg, L and Rabinovich, A, “Thermodynamic Analysis of Hydrogen Production by Partial Oxidation Reforming,” *Int J of Hyd Engy*, 29 (2004) 809-816.
- Lutz, A E, Bradshaw, R W, Keller, J O, and Witmer, D E, “Thermodynamic Analysis of Hydrogen Production by Steam Reforming,” *Int J of Hyd Engy*, 28 (2003) 159-167.
- Lutz, A E, Larson, R S, and Keller, J O, “Thermodynamic Comparison of Fuel Cells to the Carnot Cycle,” *Int J of Hyd Engy*, 27 (2002) 1103-1111.