



EMC Test Report

Product Name: CDMA Mobile Phone

Model Number: C5005

Report No: SYBH (R) 056052008EB-1

Reliability Laboratory of Huawei Technologies Co., Ltd.

Huawei Base, Bantian, Longgang District, Shenzhen 518129, P.R. China

Tel: +86 755 28780808 Fax: +86 755 89652518

Notice 1

1. The laboratory has obtained the accreditation of China National Accreditation Service for Conformity Assessment (CNAS), and accreditation number: L0310.
2. The laboratory has obtained the accreditation of THE AMERICAN ASSOCIATION FOR LABORATORY ACCREDITATION (A2LA), and Accreditation Council Certificate Number: 2174.01.
3. The laboratory has been listed on the US Federal Communications Commission list of test facilities recognized to perform electromagnetic emissions measurements. The site recognition number is 97456.
4. The laboratory has been listed by industry Canada to perform electromagnetic emission measurement. The site recognition number is 6369A-1.
5. The laboratory also has been listed by the VCCI to perform EMC measurements. The accreditation number is R2364, C2583, and T256.
6. The test report is invalid if not marked with "exclusive stamp for the test report".
7. The test report is invalid if not marked with the stamps or the signatures of the persons responsible for performing, revising and approving the test report.
8. The test report is invalid if there is any evidence of erasure and/or falsification.
9. If there is any dissidence for the test report, please file objection to the test centre within 15 days from the date of receiving the test report.
10. Normally, the test report is only responsible for the samples that have undergone the test.
11. Context of the test report cannot be used partially or in full for publicity and/or promotional purposes without previous written approval of the laboratory.

Notice 2

Modification Information:

Table 1 Modification Information

Modification Information	1	
	2	
	3	<i>Not Applicable!</i>
	4	
	5	
	6	
	7	

REPORT ON	EMC Test of CDMA Mobile Phone
	M/N: C5005
REGULATION	FCC CFR47 Part 15: Subpart B; FCC CFR47 Part 22 Subpart H; :
START OF TEST	May. 4 2008
END OF TEST	May. 5, 2008
Final Judgement:	Pass

Approver

2008-05-7
Date

张兴海
Name

Signature



Reviewer

2008-04-7
Date

余 辉
Name

Signature



Operator

2008-04-6
Date

胡 俊
Name

Signature

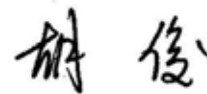

REPORT BODY CONTENT

1	Status.....	6
1.1	Product Information.....	6
1.2	Applied Standard.....	6
1.3	Test Site.....	7
1.4	Test environment condition.....	7
2	Summary of Results.....	8
3	Equipment Specification.....	9
3.1	General Description.....	9
3.2	Sub-Assembly Identity.....	9
4	System Configuration during EMC Test.....	10
4.1	Cables Used during Test.....	10
4.2	Associated Equipment Used during Test.....	10
4.3	Test Configurations and Test Mode.....	10
4.4	Test conditions and test connections.....	10
5	Electromagnetic Interference (EMI).....	12
5.1	Radiated Disturbance 30MHz to 1000MHz.....	12
5.2	Conducted Disturbance 0.15 MHz to 30MHz.....	13
5.3	Radiated Spurious Emissions.....	14
6	Main Test Instruments.....	16
7	System Measurement Uncertainty.....	17
8	Graph and Data of Emission Test.....	18
8.1	Radiated Disturbance.....	18
8.2	Conducted Disturbance.....	19
8.3	Radiated Spurious Emission.....	20

1 **Status**

1.1 **Product Information**

CLIENT: Huawei Technologies Co., Ltd.
ADDRESS: Bantian Longgang District Shenzhen, P.R. China
MANUFACTURING DESCRIPTION CDMA Mobile Station
MANUFACTURERS MODEL NUMBER C5005

1.2 **Applied Standard**

FCC Measurement Specification	FCC Limits Part(s)	Description	Result
-	15.107	Conducted Emission at Power Port	PASS
-	15.109	Radiated Emission of Enclosure in Idle Mode	PASS
2.1051	22.917	Spurious Emission at Antenna Terminals	PASS

1.3 Test Site

Site 1:

EMC LABORATORY OF RELIABILITY LABORATORY OF HUAWEI TECHNOLOGIES CO., LTD

Site 2:

EMC LABORATORY OF AUDIX LABORATORY

Site 3:

EMC LABORATORY OF HUATONGWEI INTERNATIONAL INSPECTION CO, Ltd.

1.4 Test environment condition

Ambient temperature	20~25°C
Relative humidity	40%~52%
Atmospheric pressure	101kPa

2 Summary of Results

Table 2 below shows a brief summary of the results obtained.

Table 2 Summary of results

EUT Classification : Wireless Terminal				
Test Items	Test Configuration & Test Mode	Required Performance Criteria	Result	Site
<u>Radiated Emissions</u> Enclosure Port	TC1/TM2	N/A	Pass	Site1
<u>Conducted Emissions</u>	TC1/TM1	N/A	Pass	Site1
<u>Radiated Spurious Emissions</u> Enclosure Port 30MHz – 18GHz	TC1/TM1	N/A	Pass	Site1

Note:

- 1, Measurement taken is within the measurement uncertainty of measurement system.
- 2, TC = Test configuration
- 3, NT=no test. Because of not containing devices susceptible to magnetic fields, the EUT has been exempt from immunity test of power frequency magnetic field.

3 Equipment Specification

3.1 General Description

Huawei CDMA Mobile Phone C5005 is subscriber equipment in the CDMA system. The frequency band is US Cellular. The Mobile Phone implements such functions as RF signal receiving / Transmitting, CDMA protocol processing, voice and SMS service etc. The Mobile Phone uses QSC6030 single chipset and Zero-IF technologies.





3.1.1 Main Equipment Technical Data

Description:	CDMA 1X Digital Mobile Phone
Model:	C5005
Input Rated Voltage:	 3.7V
Rated Power:	2W ,
Dimensions:	104 mm (W)× 45 mm(L)× 13.6 mm(H)
Weight:	<100g (with battery)

Mode	Band Class	Frequency	
		Transmitt Frequency (MHz)	Receive Frequency (MHz)
CDMA	Band Class 0	824-849	869-894

3.2 Sub-Assembly Identity

Table 3 Sub-Assembly Identity

Board				
Model Name	Qty.	Hardware Version	Serial	Description
HC1C5100M	1	Ver.C	020JTQ7N84000087	Main board of Mobile Phone
Accessory				
Name	Qty.	Manufacture	Serials number	Description
Adapter	1	SHENZHEN HUNTKEY POWER TECHNOLOGY CO., LTD	HKA7C281222	voltage nominal: ~120V Input voltage: ~100-240V ;50/60Hz Output voltage:  +5.0V , 0.4A Rate power: 2W
Adapter	1	SHENZHEN HUNTKEY POWER TECHNOLOGY CO., LTD	HKA7C351242	voltage nominal: ~120V Input voltage: ~100-240V ;50/60Hz Output voltage:  +5.0V , 0.4A Rate power: 2W
Rechargeable Li-ion	1	Harbin Coslight Power Co.,Ltd.	HGY7A1114480	Battery Model: HBC80S Rated capacity: 800mAh Nominal Voltage:  +3.7V Charging Voltage:  +4.2V

4 System Configuration during EMC Test

The Equipment under Test (EUT) was functioning correctly during all tests. The EUT was installed within the test site and was configured to simulate a typical user installation.

4.1 Cables Used during Test

Table 4 Cable Used during Test

Port	Length	Quantity	Type of Cable
AC Power Port	3m	1	Unshielded

4.2 Associated Equipment Used during Test

Table 5 Associated Equipment Used during Test

Name	Model	Manufacturer	S/N	Cal Date	Cal Interval (month)
Radio Communication Tester	CMU200	R&S	3604091211	2007-10-10	12

4.3 Test Configurations and Test Mode

4.3.1 Test Configuration.

The EUT will be connected to test system (Base Station Simulator) in order to simulate normal operating conditions (with reference to the guidance given in the standard for this type of equipment).

Table 6 Configuration table

TC1	TM1~TM2
-----	---------

4.3.2 Test Mode

There were two test Modes. TM1 and TM2 were shown in the diagrams below:

TM1: operate in traffic mode CDMA 800;

TM2: operate in idle mode CDMA 800;

4.4 Test conditions and test connections

4.4.1 Test Conditions

The EUT will be connected to test system (Base Station Simulator) in order to simulate normal operating conditions (with reference to the guidance given in the standard for this type of equipment).

4.4.2 Test connections

Traffic Mode:

The EUT is required to be in the traffic mode, a call is set up according to the generic call set up procedure and enter the EUT into loop back test mode.

For CDMA, the following conditions shall also be met:

- The EUT shall be commanded to operate at maximum transmit power;

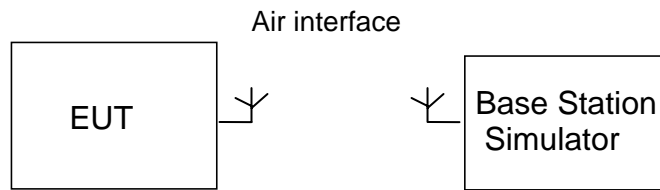

Figure 1. : Test Configuration TC1

Idle Mode:

The EUT will be connected to test system (Base Station Simulator) in order to simulate normal operating conditions (with reference to the guidance given in the standard for this type of equipment).

The EUT is required to be in the idle mode.

For CDMA, the following conditions shall be met:

- UE shall be camped on a cell;
- UE shall perform Location Registration (LR) before the test, but not during the test;
- UE's neighbour cell list shall be empty;

For Cellular, the following conditions shall be met:

When the EUT is required to be in the idle mode, the test system shall simulate a Base Station (BS) with Broadcast Control Channel/Common Control Channel (BCCH/CCCH) on one carrier. The EUT shall be synchronized to the BCCH, listening to the CCCH and able to respond to paging messages. Periodic Location Updating shall be disabled.

5 Electromagnetic Interference (EMI)

5.1 Radiated Disturbance 30MHz to 1000MHz

5.1.1 Test Procedure

The test site semi-anechoic chamber has met the requirement of NSA tolerance 4dB according to the standards: ANSI C63.4 (2003). The test distance was 3m. The EUT was set-up on insulator 80cm above the Ground Plane. The set-up and test methods were according to ANSI C63.4. The Radiated Disturbance measurements were made using a Rohde and Schwarz ESMI Test Receiver and control software ES-K1.

A preliminary scan and a final scan of the emissions were made from 30 MHz to 1GHz by using test script of software; the emissions were measured using a Quasi-Peak Detector. The maximal emission value was acquired by adjusting the antenna height, polarisation and turntable azimuth in accordance with the software setup. Normally, the height range of antenna was 1m to 4m, the azimuth range of turntable was 0° to 360°, The receive antenna has two polarizations V and H.

Huawei Mobile Station was communicated with the BTS simulator through Air interface. The Mobile Station operated on the typical channel and the Mobile Station worked in idle mode, transmitter was not work in this test.

Measurement bandwidth: 30 MHz – 1000 MHz: 120 kHz

Test set up figure:

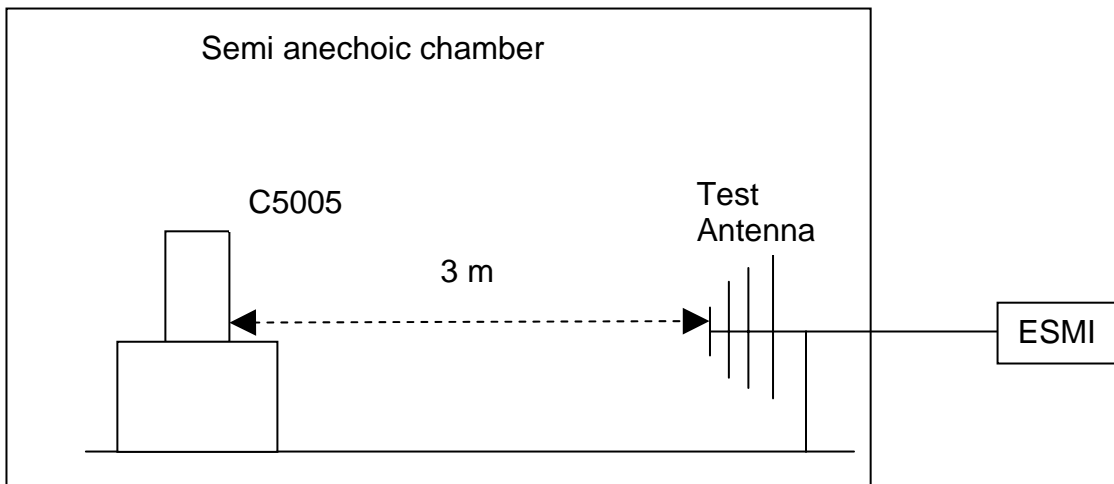

Figure 2. Test set up

5.1.2 Test Results

The EUT has met the requirements for Radiated Emission of enclosure port.

The test data is shown in section 8.1 of the report.

Two adapters are all tested in the EMC test, here the worse result are showed.

Table 7 Test Limits

Frequency of Emission (MHz)	Radiated Limit	
	Unit($\mu\text{V}/\text{m}$)	Unit($\text{dB}\mu\text{V}/\text{m}$)
30-88	100	40
88-216	150	43.5
216-960	200	46
960-1000	500	54

5.2 Conducted Disturbance 0.15 MHz to 30MHz

5.2.1 Test Procedure

The Table-top EUT was placed upon a non-metallic table 0.8 m above the horizontal metal reference ground plane. EUT was connected to LISN and LISN was connected to reference Ground Plane. EUT was 80cm from LISN. The set-up and test methods were according to ANSI C63.4: 2003.

Conducted Disturbance at AC Port measurements were undertaken on the L and N Lines. The emissions were measured using a Quasi-Peak Detector and Average Detector.

Huawei Mobile Station was communicated with the BTS simulator through Air interface, the BTS simulator controls the Mobile Station to transmitter the maximum power which defined in specification of product. The Mobile Station operated on the typical channel.

Measurement bandwidth (RBW) for 150kHz to 30 MHz: 9 kHz;

Test Set-up figure:

The Mobile Station was setup in the screened chamber and operated under nominal conditions.

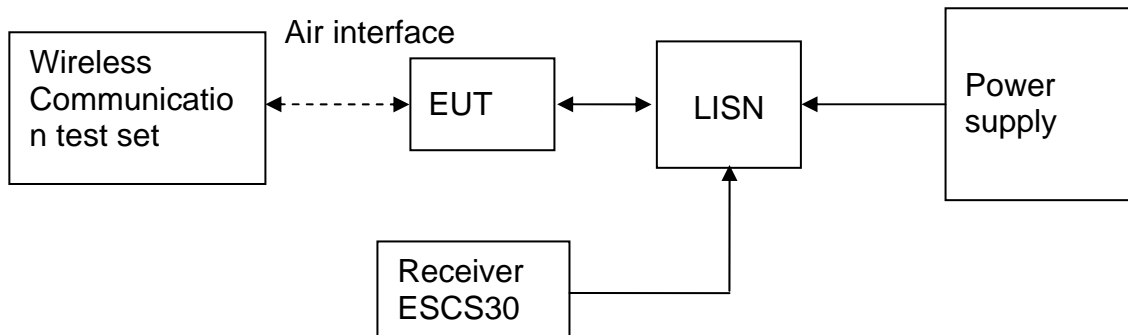

Figure 3. Test Set-up

5.2.2 Test Results

The EUT has met requirements for Conducted disturbance of signal lines.

The test data is shown in section 8.2 of the report.

Two adapters are all tested in the EMC test, here the worse result are showed.

Table 8 Test Limit of DC&AC Power Port

Frequency range	150kHz~ 30MHz	
Classification	Class B	
Limit(Class B)	Voltage limits	
	QP	AV
0.15MHz~0.5MHz	66~56 dB μ V	56~46 dB μ V
0.5MHz~5MHz	56 dB μ V	46 dB μ V
5MHz~30MHz	60 dB μ V	50 dB μ V

5.3 Radiated Spurious Emissions

5.3.1 Test Procedure

A test site fulfilling the requirements of ITU-R Recommendation SM329-10 was used. The EUT was placed on a non-conducting support in the anechoic chamber and was operated from a power source via an RF filter to avoid radiation from the power leads.

Step 1:

For transmitters other than single sideband, independent sideband and controlled carrier radiotelephone, EIRP shall be measured when the transmitter is adjusted in accordance with the tune-up procedure to give the values of current and voltage on the circuit elements specified in 2.1033(c)(8). Connect the EUT to the BTS simulator via the air interface.

Test the Radiated maximum output power by the Rohde and Schwarz ESIB26 Test Receiver from test antenna.

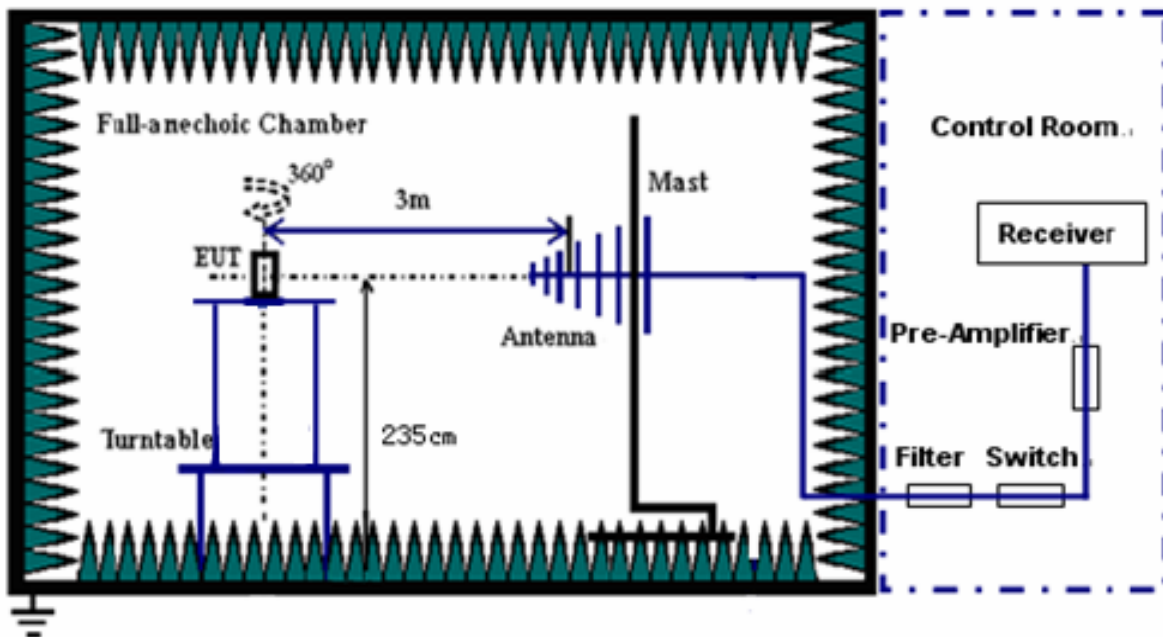

Step 2:

Use substitution method to verify the maximum output power. The EUT is substituted by a dipole antenna. The dipole is connected to a signal generator. And then adjust the output level of the signal generator to get the same received power recorded in step1 on ESIB26 Test Receiver, and record the power level of Signal Generator. Of course, the cable loss at the test frequency should be compensated.

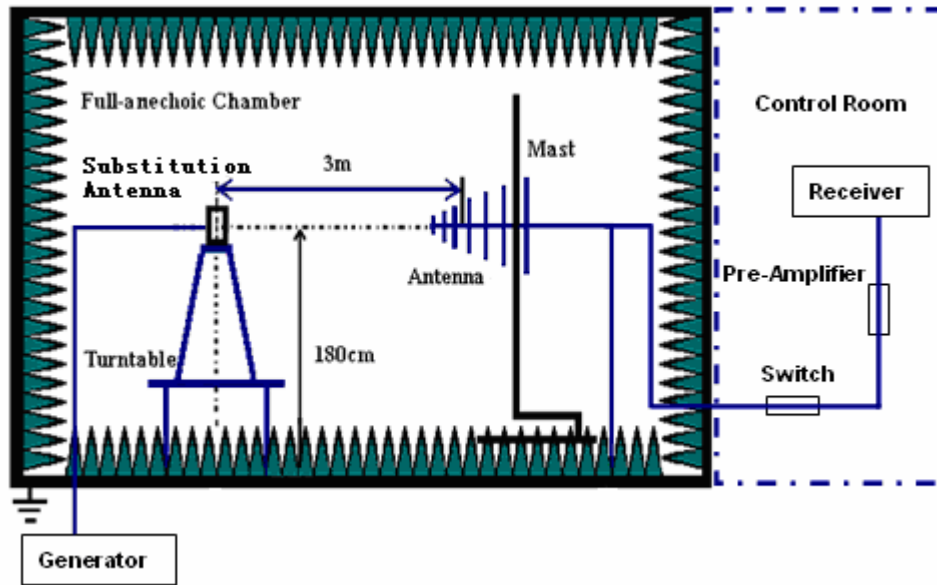

Test should be performed in normal voltage condition.

The received power shall be measured for frequencies within 30MHz~18GHz for CDMA,, shown below, are applicable for frequencies in the spurious domain.

According to part 22.917, the defined measurement bandwidth as following:

22.917(b) Measurement procedure: Compliance with these rules is based on the use of measurement instrumentation employing a resolution bandwidth of 100 kHz or greater.

Measurement bandwidth (RBW) for 9 kHz up to 1 GHz: 100 kHz;
Measurement bandwidth (RBW) for 1GHz up to 18GHz: 1MHz;

Table 9 Radiated Spurious Emissions Limits

Frequency band	Minimum requirement (E.R.P) traffic mode
9KHz~18GHz	-13dBm

5.3.2 Test Results

The EUT has met the requirements of FCC Part22 requirement.

The test data see section 8.5 of this report.

6 Main Test Instruments

Table 10 Main Test Equipments

Test item	Test Instrument	Model	Manufacturer	Cal-Date	Cal Interval (month)
RE	EMI Test receiver	ESMI	R&S	April.22, 2008	12
	Broadband Antenna	CBL 6112B (2536)	SCHAFFNER	Jun.08, 2007	12
CE	EMI Test receiver	ESCS30	R&S	May.29, 2007	12
	Artificial Mains Network	ENV4200	R&S	May.21, 2007	12
RSE	EMI Test receiver	ESIB26	R&S	May.30.2007	12
	Broadband Antenna	CBL6112B (2747)	SCHAFFNER	Oct.17.2007	12
	Horn Antenna	3117	ETS-Lindgren	May.21.2007	12
Software Information					
Test Item	Software Name	Manufacturer		Version	
RE/CE	ES-K1	R&S		1.7.1	
RSE	EMC32	R&S		V5.0	

7 System Measurement Uncertainty

For a 95% confidence level, the measurement expanded uncertainties for defined systems, in accordance with the recommendations of ISO 17025 were:

Table 11 System Measurement Uncertainty

Items		Extended Uncertainty
RE	Field strength (dB μ V/m)	U=4.3dB; k=2(30MHz-1GHz)
		U=3.6dB; k=2(1GHz-18GHz)
RSE	ERP (dBm)	U = 2.2dB ; k = 2
CE	Disturbance Voltage (dB μ V)	U=3.6dB; k=2

8 Graph and Data of Emission Test

8.1 Radiated Disturbance

8.1.1 Radiated Disturbance

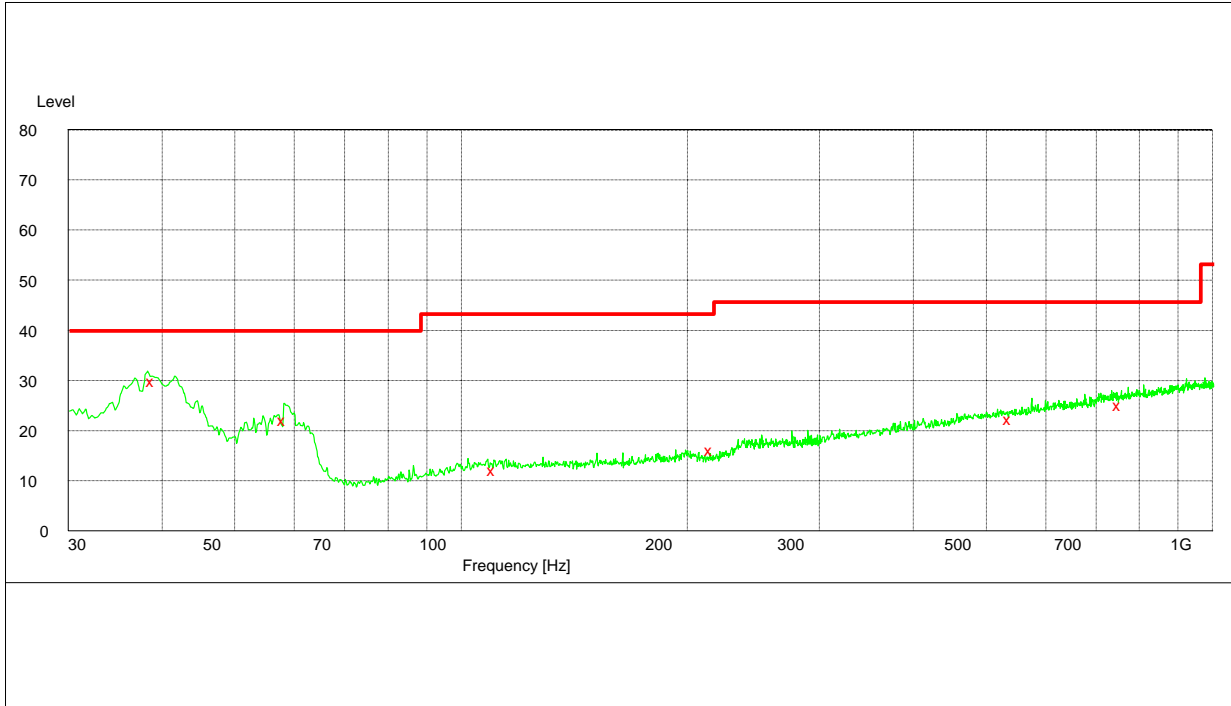

MEASUREMENT RESULT: QP Detector

Frequency MHz	Level dBμV/m	Transd dB	Limit dBμV/m	Margin dB	Height cm	Azimuth deg	Polarisation
38.980000	30.00	-7.1	40	10.0	143.0	304.00	VERTICAL
58.260000	22.10	-18.4	40	17.9	107.0	360.00	VERTICAL
110.700000	12.30	-15.3	43.5	31.2	250.0	14.00	VERTICAL
215.520000	16.20	-13.4	43.5	27.3	124.0	189.00	HORIZONTAL
538.620000	22.40	-5.1	46	23.6	107.0	67.00	VERTICAL
753.780000	25.20	-1.9	46	20.8	124.0	338.00	VERTICAL

8.2 Conducted Disturbance

8.2.1 AC Port Test Data

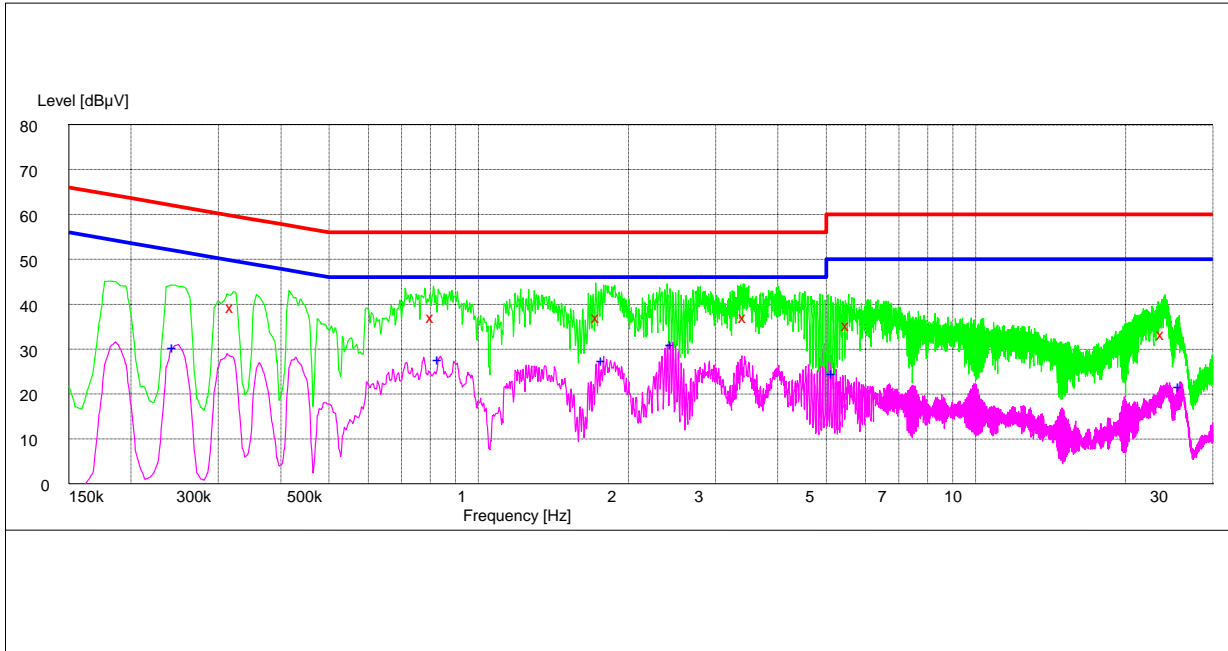

MEASUREMENT RESULT: QP Detector

Frequency MHz	Level <i>dBµV</i>	Transd dB	Limit <i>dBµV</i>	Margin dB	Line	PE
0.321000	39.70	10.1	60	20.3	N	FLO
0.811500	37.50	10.0	56	18.5	L3	FLO
1.747500	37.50	10.0	56	18.5	L3	FLO
3.444000	37.40	10.1	56	18.6	L3	FLO
5.563500	35.70	10.1	60	24.3	L3	FLO
23.883000	33.70	10.4	60	26.3	L3	FLO

MEASUREMENT RESULT: AV Detector

Frequency MHz	Level <i>dBµV</i>	Transd dB	Limit <i>dBµV</i>	Margin dB	Line	PE
0.244500	30.70	10.1	52	21.3	N	FLO
0.838500	28.10	10.0	46	17.9	N	FLO
1.783500	27.80	10.0	46	18.2	L3	FLO
2.458500	31.50	10.1	46	14.5	N	FLO
5.176500	24.90	10.1	50	25.1	L3	FLO
25.867500	22.00	10.4	50	28.0	L3	FLO

8.3 Radiated Spurious Emission

8.3.1 For CDMA800

Traffic Mode (9kHz-30MHz)

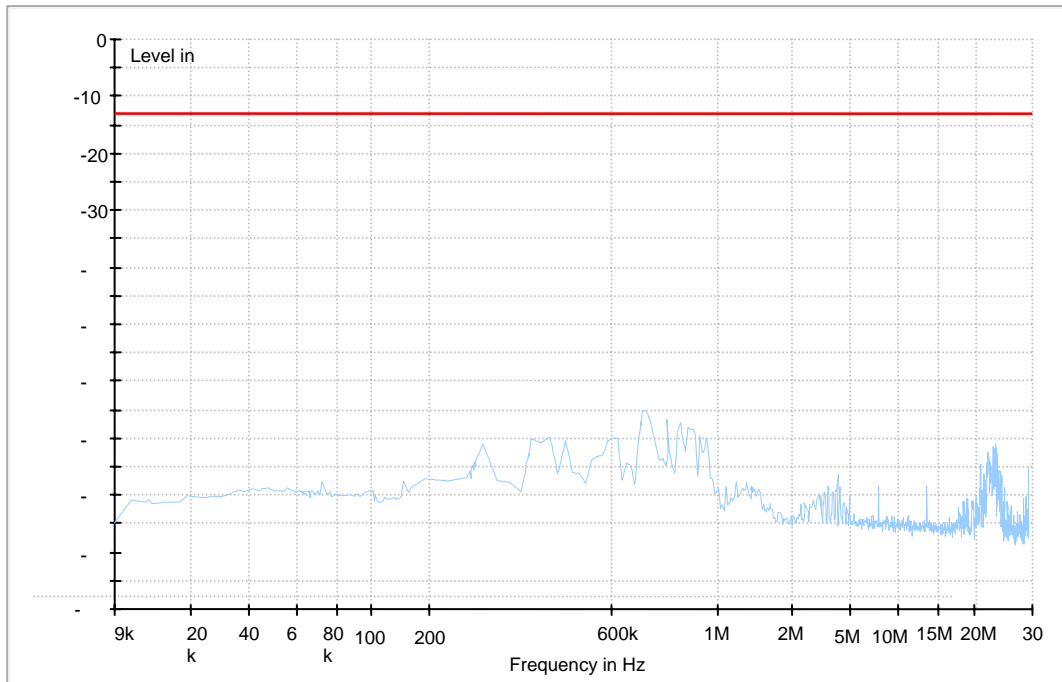

Traffic Mode (30MHz-2GHz)

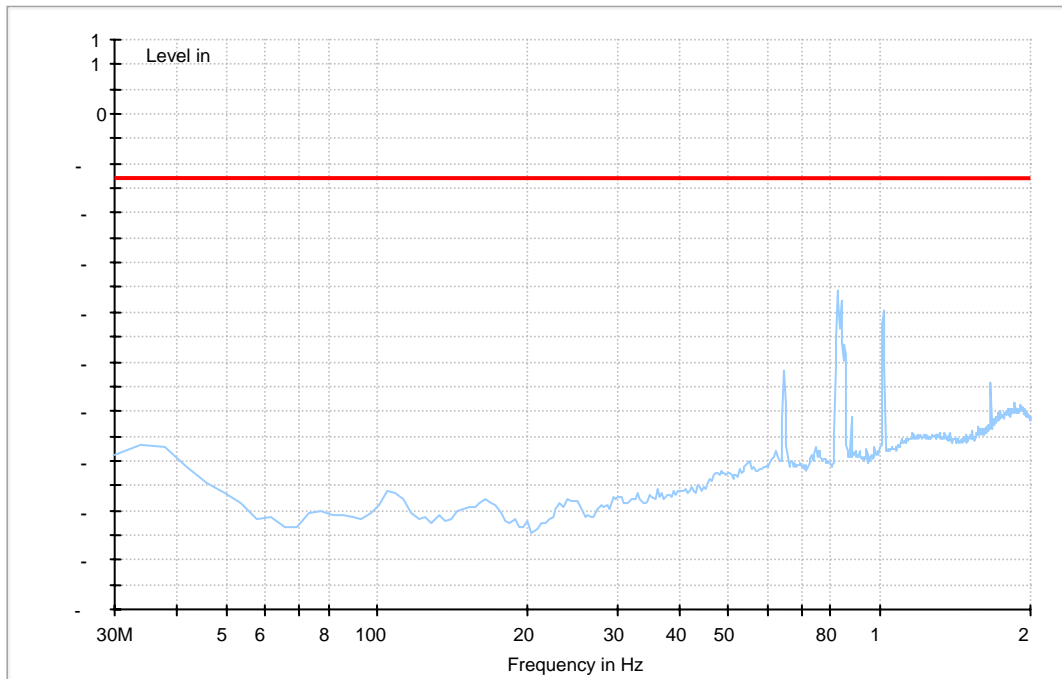

Traffic Mode (2GHz-18GHz)

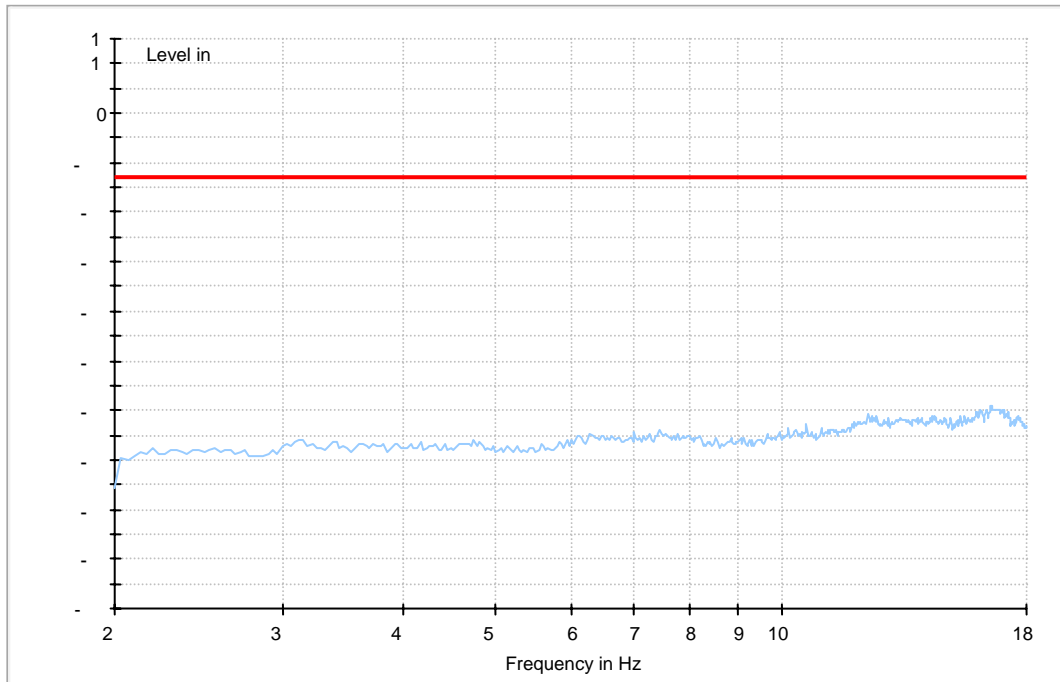

END