



Satellite Delivery of Aviation Weather Data

Robert J. Kerczewski
Glenn Research Center, Cleveland, Ohio

Richard Haendel
Rockwell Collins, Cedar Rapids, Iowa

The NASA STI Program Office . . . in Profile

Since its founding, NASA has been dedicated to the advancement of aeronautics and space science. The NASA Scientific and Technical Information (STI) Program Office plays a key part in helping NASA maintain this important role.

The NASA STI Program Office is operated by Langley Research Center, the Lead Center for NASA's scientific and technical information. The NASA STI Program Office provides access to the NASA STI Database, the largest collection of aeronautical and space science STI in the world. The Program Office is also NASA's institutional mechanism for disseminating the results of its research and development activities. These results are published by NASA in the NASA STI Report Series, which includes the following report types:

- **TECHNICAL PUBLICATION.** Reports of completed research or a major significant phase of research that present the results of NASA programs and include extensive data or theoretical analysis. Includes compilations of significant scientific and technical data and information deemed to be of continuing reference value. NASA's counterpart of peer-reviewed formal professional papers but has less stringent limitations on manuscript length and extent of graphic presentations.
- **TECHNICAL MEMORANDUM.** Scientific and technical findings that are preliminary or of specialized interest, e.g., quick release reports, working papers, and bibliographies that contain minimal annotation. Does not contain extensive analysis.
- **CONTRACTOR REPORT.** Scientific and technical findings by NASA-sponsored contractors and grantees.

- **CONFERENCE PUBLICATION.** Collected papers from scientific and technical conferences, symposia, seminars, or other meetings sponsored or cosponsored by NASA.
- **SPECIAL PUBLICATION.** Scientific, technical, or historical information from NASA programs, projects, and missions, often concerned with subjects having substantial public interest.
- **TECHNICAL TRANSLATION.** English-language translations of foreign scientific and technical material pertinent to NASA's mission.

Specialized services that complement the STI Program Office's diverse offerings include creating custom thesauri, building customized data bases, organizing and publishing research results . . . even providing videos.

For more information about the NASA STI Program Office, see the following:

- Access the NASA STI Program Home Page at <http://www.sti.nasa.gov>
- E-mail your question via the Internet to help@sti.nasa.gov
- Fax your question to the NASA Access Help Desk at 301-621-0134
- Telephone the NASA Access Help Desk at 301-621-0390
- Write to:
NASA Access Help Desk
NASA Center for Aerospace Information
7121 Standard Drive
Hanover, MD 21076

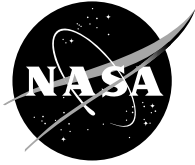

Satellite Delivery of Aviation Weather Data

Robert J. Kerczewski
Glenn Research Center, Cleveland, Ohio

Richard Haendel
Rockwell Collins, Cedar Rapids, Iowa

Prepared for the
19th International Communications Satellite Systems Conference
sponsored by the American Institute of Aeronautics and Astronautics
Toulouse, France, April 17–20, 2001

National Aeronautics and
Space Administration

Glenn Research Center

Trade names or manufacturers' names are used in this report for identification only. This usage does not constitute an official endorsement, either expressed or implied, by the National Aeronautics and Space Administration.

Available from

NASA Center for Aerospace Information
7121 Standard Drive
Hanover, MD 21076

National Technical Information Service
5285 Port Royal Road
Springfield, VA 22100

Available electronically at <http://gltrs.grc.nasa.gov/GLTRS>

SATELLITE DELIVERY OF AVIATION WEATHER DATA

Robert J. Kerczewski
National Aeronautics and Space Administration
Glenn Research Center
Cleveland, Ohio 44135

Richard Haendel
Rockwell Collins
Cedar Rapids, Iowa 52498

ABSTRACT

With aviation traffic continuing to increase worldwide, reducing the aviation accident rate and aviation schedule delays is of critical importance. In the United States, the National Aeronautics and Space Administration (NASA) has established the Aviation Safety Program and the Aviation System Capacity program to develop and test new technologies to increase aviation safety and system capacity. Weather is a significant contributor to aviation accidents and schedule delays. The timely dissemination of weather information to decision makers in the aviation system, particularly to pilots, is essential in reducing system delays and weather related aviation accidents. The NASA Glenn Research Center is investigating improved methods of weather information dissemination through satellite broadcasting directly to aircraft. This paper describes an on-going cooperative research program with NASA, Rockwell Collins, WorldSpace, Jeppesen and American Airlines to evaluate the use of satellite digital audio radio service (SDARS) for low cost broadcast of aviation weather information, called Satellite Weather Information Service (SWIS). The description and results of the completed SWIS Phase I are presented, and the description of the on-going SWIS Phase II is given.

INTRODUCTION

Weather has been identified as a causal factor in 30% of all aviation accidents, and is responsible for up to 65% of domestic US airline schedule delays, resulting in significant loss of life and operating cost increases of \$5 billion annually [1]. The National Aeronautics and Space Administration (NASA) has established research programs in aviation safety and aviation system capacity which have determined that improved collection and dissemination of accurate, up-to-date weather information would have a significant impact in reducing aviation accidents and weather-related delays.

The most significant inadequacy in the current aviation system is the lack of timely and accurate weather information delivered to pilots in the flight decks of operating aircraft. Current methods of transmitting data to the aircraft flight deck, primarily ground-based VHF transmission over 25kHz channels, suffer from low bandwidth, frequency channel congestion, and security issues, as well as significant geographical coverage gaps. The collection of weather information from sensors, especially airborne sensors, to be used in developing better weather models, forecasts, and “nowcasts” is an important secondary issue. In both cases, an inexpensive broadcast solution which can address all classes of aircraft – transport, regional, business, cargo, and general aviation – is desired. The delivery of weather information is not considered “safety-of-flight” critical information, hence mandating the equipage of aircraft with advanced weather information reception equipment is unlikely to occur. Therefore, an economically attractive solution must exist to motivate aircraft owners to equip and achieve the desired result of producing an industry-wide reduction in the weather-related accident rate. The solution must not only be low cost to enable privately owned general aviation aircraft to afford to equip. It must also demonstrate the ability to reduce operating costs for the transport aviation segment to justify the higher equipage costs for the large passenger-bearing aircraft.

NASA's Glenn Research Center is performing research in the area of weather data dissemination as part of NASA's Aviation Safety Program Weather Accident Prevention (WxAP) Project. A number of research efforts are underway, including assessment of ground-based and satellite communications links, development of weather information standards and protocols, future communications architectures for weather data dissemination, and development of improved low cost technologies. Previous NASA efforts under the WxAP's Aviation Weather Information (AWIN) Element at NASA's Langley Research Center have helped to develop a VHF broadcast solution through cooperative research agreements with ARNAV and Honeywell. This solution is now being deployed through the Federal Aviation Administration's Flight Information Services (FIS) policy. Two additional cooperative research agreements, with Honeywell and Boeing, are evaluating cockpit weather data delivery systems using a UHF/VHF telephone link and the COMSAT Aero-H International Maritime Satellite, respectively [1].

The emergence of satellite digital audio radio services (SDARS) satellites broadcasting over 100 channels of digital audio programming and other services presents a significant opportunity to develop a very low cost aviation weather solution. In particular, the SDARS enables reception of up to 128 kbps digital channel using very small passive patch antennas easily mountable on aircraft. In addition, a mass consumer market in SDARS receivers can be exploited to provide very inexpensive receiving equipment. NASA has entered into a cooperative agreement with Rockwell Collins, WorldSpace, Jeppesen and American Airlines to develop and evaluate an experimental SDARS-based aviation weather broadcast system, called Satellite Weather Information Service (SWIS).

Phase I of the SWIS demonstration took place in South Africa in September of 1999. In this feasibility demonstration, a typical set of weather images was broadcast from WorldSpace's AfriStar Satellite to a general aviation aircraft. The demonstration showed the feasibility of receiving satellite broadcast weather information in a flying aircraft using a 64 kbps channel.

Phase II of the SWIS demonstration, now under development, will use the WorldSpace AsiaStar Satellite to broadcast real aviation weather products to two commercial transport aircraft, American Airlines Boeing 777's flying revenue service routes between Chicago and Hong Kong and Chicago and Tokyo/Narita. The SWIS Phase II is scheduled to begin flight demonstrations in April 2001.

This paper will provide background on the aviation weather application requirements, the types of aviation weather products being considered for satellite delivery and their expected benefits, and potential system architectures to deliver weather products to the flight deck by satellite. The technical details of the satellite broadcast link, and a technical description of the SWIS subsystems will be presented. The results of the SWIS Phase I tests in South Africa and the plans for SWIS Phase II flight tests over the North Pacific Region will be described.

AVIATION WEATHER REQUIREMENTS

The National Aviation Weather Program Council Joint Action Group for Aviation Weather has issued a call for national aviation weather initiatives in the United States [2]. This call identified a number of potential high impact research initiatives, including improved communication links for Flight Information Services (FIS, which includes weather information), improved multi-color cockpit displays for FIS, improved weather forecasting, and expanded use of automated pilot reports to provide better current aviation weather information for immediate use and generation of forecasts. The NASA Weather Accident Prevention Project is addressing a number of these issues.

For all aviation users, improved weather information for strategic flight planning and routing decisions and for real-time en route tactical decision-making is desired. The most important atmospheric hazards are turbulence, wind shear, icing conditions, low visibility and ceilings, wake vortices convection, and volcanic ash. The development of more accurate aviation weather forecasts

and nowcasts for all of these hazards is an on-going research topic. The dissemination of current and future weather products resulting from this research will require low cost and easily accessible communications media. While Phase I and II of NASA's SWIS project, described in detail below, both emphasize the performance of the data delivery system and its capabilities in delivering a sufficient volume of weather data with sufficient reliability, Phase II has a particular emphasis on the transport aviation sector and trans-Pacific flights.

New routes are continuing to develop between the USA and the Pacific Rim, especially to Japan and China. Not too long ago, these flights were routed from the West Coast via stops at Anchorage or Honolulu, so flight times enroute were relatively short, < 8 hours. Now non-stop service is provided over such routes as Dallas and New York to Narita, Japan; Detroit to Beijing, China; and Chicago to Hong Kong. Flight legs typically exceed 6000 N miles and some, such as Hong Kong to New York are more than 7500 N. miles using B777 and B747-400 aircraft. These flight legs are up to 15 hours in length. Weather can change significantly during this extended period.

There is currently no means of providing updated graphical weather information to airborne aircraft over these longer routes. To date, flight crews have not been able to obtain high quality updated weather while enroute. Frequently, significant unanticipated weather buildups are detected using on-board radar. These flights must typically reroute and travel parallel to the severe weather and probe for an opening in the weather buildups. On occasions, attempting to pierce the weather front, turbulence is encountered and sometimes injuries occur.

Rerouting delays caused by nearby significant weather causes added fuel burn and sometimes cancelled flights, resulting in an economic impact to the air carriers. Flight crews would prefer to know about significant weather 500-1000 N. miles in advance if possible, so they can divert earlier, maintain their flight schedules and minimize additional fuel burn as well as giving their passengers a smoother ride. Flight crews are insisting on better and more frequently updated graphical weather information while enroute. Especially in the Western Pacific and Southern Caribbean Sea, severe weather can develop within just a few hours.

ARCHITECTURES FOR AVIATION WEATHER DATA DISEMMINATION

NASA is investigating optimal communications system architectures for future delivery of aviation weather information. An architecture for aviation weather delivery that has been proposed consists of a hybrid satellite/terrestrial approach [3]. A satellite broadcast over large geographical regions would provide continental scale weather information, such as satellite imagery, NEXRAD radar composite images, winds, etc. Terrestrial-based broadcasts would deliver local weather, such as airport conditions – ceiling and visibility - local radar, wind shear alerts, etc. The hybrid architecture would enable a relatively low cost, receive-only system providing much greater weather information to the flight deck than is currently available. This architecture is described in Figure 1.

This type of architecture provides a low cost wide area broadcast of major weather data affordable to most users. The use of satellites for high quality graphical weather data dissemination on a national or continental scale also gives nearly complete geographic coverage, including oceanic and remote regions. The terrestrial based broadcasts provide local or regional coverage of high quality weather information crucial for departure and arrival of aircraft. Although such a service would be potentially more costly than a satellite broadcast service, it would also be of most use in high-density terminal areas where transport aircraft are involved.

OVERVIEW OF THE SWIS DEMONSTRATION PROJECT

The SWIS Demonstration Project is intended to develop and evaluate a prototype satellite weather data delivery system based on SDARS satellite broadcast technology. The key advantage of SDARS for aviation weather data dissemination is the potential extremely low cost of the service compared to alternatives currently available or in development. Because the SDARS radio service is intended for a

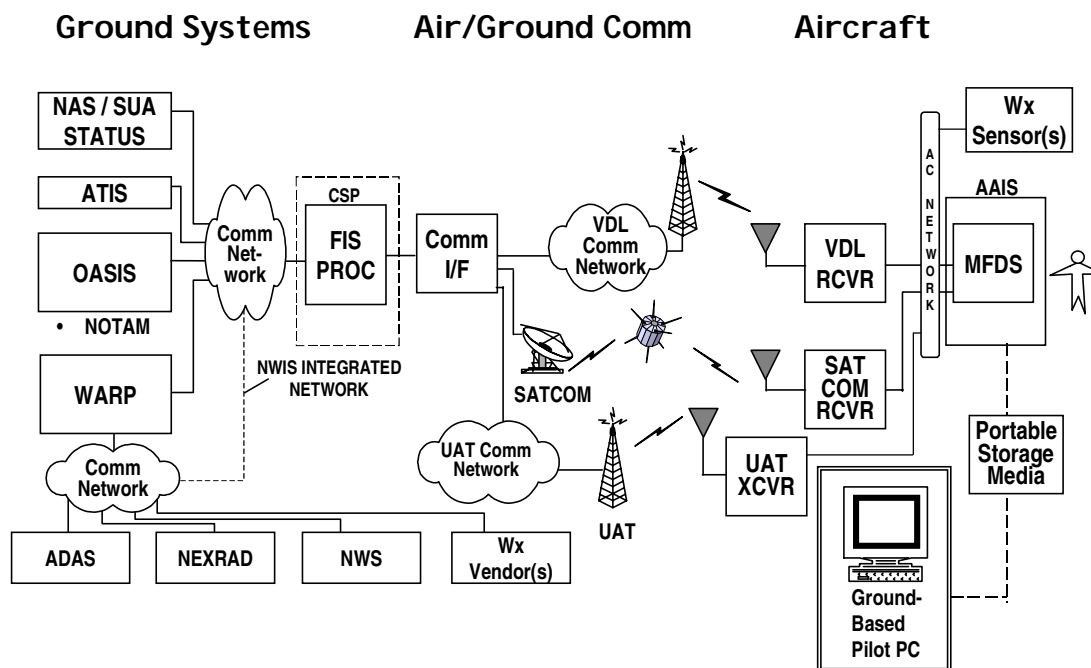

Figure 1 – A possible architecture for national and global delivery of aeronautical flight information services, which includes weather data.

market of perhaps hundreds of millions of users worldwide, the potential for low cost equipment due to economies of mass production is significant. The SDARS satellites broadcast a sufficiently strong signal so that very small passive microstrip patch antennas can be employed. These antennas are approximately 10 cm in diameter and present a flat profile. Hence they are low cost and easily installed on aircraft.

The first phase of the SWIS project was an initial feasibility demonstration to show that graphical weather data broadcast by an SDARS satellite can be reliably received by an airborne receiver. The second phase of SWIS will demonstrate the SWIS system on a transport class aircraft in revenue service, with real, up-to-date weather information being supplied to the flight crew for operational use. Further Phases of SWIS are being considered for future implementation. A demonstration over the Caribbean Sea and Gulf of Mexico for flights between North and South America is being evaluated. Also, a demonstration over North America to evaluate the utility of a satellite-based aviation weather broadcast system for use by general aviation aircraft.

SWIS PHASE I

The primary goal of the SWIS Phase 1 testing was to determine the feasibility of using S-DARS capabilities to transmit complex graphical weather data to an aircraft in flight. Although the capability has been shown on-ground using automobile-mounted equipment, motion characteristics of in-flight maneuvers have the potential to block reception from the satellite to the low-cost patch antenna and, traditionally, a more expensive, beam-steered antenna solution has been required for airborne information transfer. The cost of the beam-steered antenna alone has rendered the equipment inaccessible to a large segment of the aviation community. A low-cost alternative for providing weather information would go far in addressing the current information access inequity.

The proof-of-concept tests verified the feasibility of receiving weather data from an S-DARS satellite using a low-cost, aircraft-mounted non-steered antenna. The test procedures examined signal

reception during aircraft turn and bank maneuvers during reception of data files containing weather information. The WorldSpace AfriStar satellite, being the first and only SDARS satellite in operation at the time of these tests, was used for SWIS Phase I [4].

The equipment used for this test includes a Rockwell Collins designed and built antenna and LNA components. Specifically, the following components were implemented in the test set.

- a) Rockwell Collins flat patch antenna using a mini-Circuits LNA with 1.2db NF and 25db of gain.
- b) A WorldSpace Digital Satellite Receiver KH-WS1 (manufactured by Hitachi) and a WorldSpace Smart PC adapter (SPCA) with firmware ver1.2 were used. This unit receives and converts the data output of the WorldSpace (Hitachi) receiver to RS232 format.
- c) GPS receiver (with NEMA 0183 output) for position and track data.
- d) Laptop Computer (with Windows 95) with software.
- e) WorldSpace SPCA Driver/Data Capture software. This program communicates with the Smart PC adapter via a RS232 serial port on the laptop PC and assembles the individual data packets into a complete file.
- f) WorldSpace UnZIPer/Datacast processing software. The graphical data file uplinked to the aircraft was encapsulated with a CRC32 error detecting code.
- g) Test Data and GPS logging software.

The WorldSpace AfriStar satellite is controlled from a Regional Operations Control Centers (ROCC) located in Johannesburg, South Africa. This AfriStar coverage is shown in Figure 2. The SWIS Phase I tests used the Southern beam.

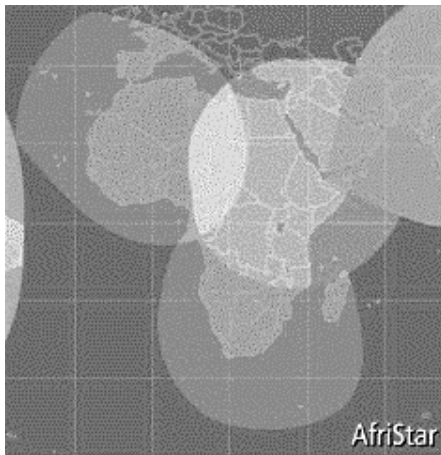

Figure 2 – AfriStar coverage.



Figure 3 - SWIS Patch Antenna Mounted to *Cessna 172*.

The flight tests were performed using a Cessna 172 aircraft. The patch antenna was mounted as shown in Figure 3. All flight tests started and ended at Hanger 24 at the Rand Airport in Johannesburg, South Africa. The AfriStar satellite is located at 21° East longitude. Flight Testing was conducted from September 18-24, 1999 in a 50nm radius of the airport. A typical flight path is shown in Figure 4. Typical weather graphics were broadcast at 64kbits/second by the AfriStar satellite, received and viewed on the laptop computer. These flight tests produced excellent results. Continuous error free data reception was received during normal aircraft maneuvers performed during takeoff, cruise and landing operations. In addition, continuous data reception was observed for bank angles up to and including 45 degrees. In general, 100% reception of the data was received except when the aircraft bank exceeded 45 degrees away from the satellite.

The SWIS Phase I tests demonstrated the feasibility of transmitting graphical weather data through an SDARS satellite to an operating aircraft. The results indicated the next Phase for SWIS, demonstration and evaluation in an air transport environment.

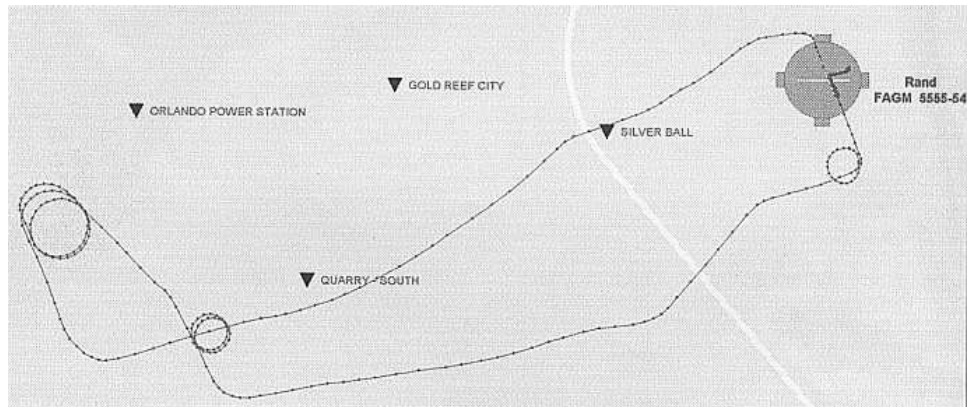

Figure 4 - Typical flight path for SWIS Phase I tests.

SWIS PHASE II

The primary goal of SWIS Phase II is to build upon the feasibility demonstrated in Phase I by developing, demonstrating and evaluating a prototype system capable of delivering real, up-to-date weather information to a transport class aircraft operating revenue service flights. American Airlines is installing the equipment and providing two B777 aircraft operating on routes to the Pacific Rim.

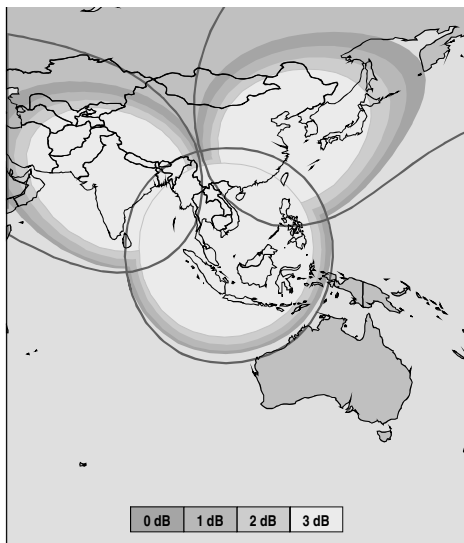

Figure 5 – AsiaStar coverage.

Jeppesen has developed new graphics for the North Pacific routes and is gathering, interpreting and providing timely weather data and an application program. WorldSpace Corporation is providing the Satellite service, Ground Earth Station support and software and Rockwell-Collins is providing the satellite receiver, antenna and other on-board electronics, economic benefit and safety analyses. The NASA Langley Research Center is focusing on the human factors issues and pilot interaction with the weather graphics application. NASA Glenn will evaluate the communications link performance.

Weather satellites are strategically located throughout the world, many in geostationary orbits and some that circle the earth in polar orbits. Data from these satellites using a variety of sensors includes infrared imagery, pinpoint satellite radar (cloud height) and other images are available frequently. Some images are updated as frequently as every 30 minutes. SWIS Phase II will utilize subsets of the available satellite imagery, make

sense of the graphical information and have meteorologists interpret and simplify this vast amount of data to provide meaningful information to pilots in a timely and easily interpreted way.

As in Phase I, the antenna is a simple patch antenna, low cost, low profile, easy to install, very high reliability. It includes a radome qualified for high altitude, high-speed flight. The broadcast data rate is 64 kbits/second. Data rate can be changed dynamically between 16 kbits/second and 128 kbits per second with no system hardware impact. WorldSpace satellites operate in the 1460-1492 MHz band

similar to Inmarsat (1559 MHz), but have a much higher power level than Inmarsat, providing a very robust data link without beam steered antennas. The system is designed to use a broadcast protocol, providing weather information to all aircraft simultaneously, as compared to Inmarsat which is a two-way request-reply protocol. This results in a much lower cost system to use.

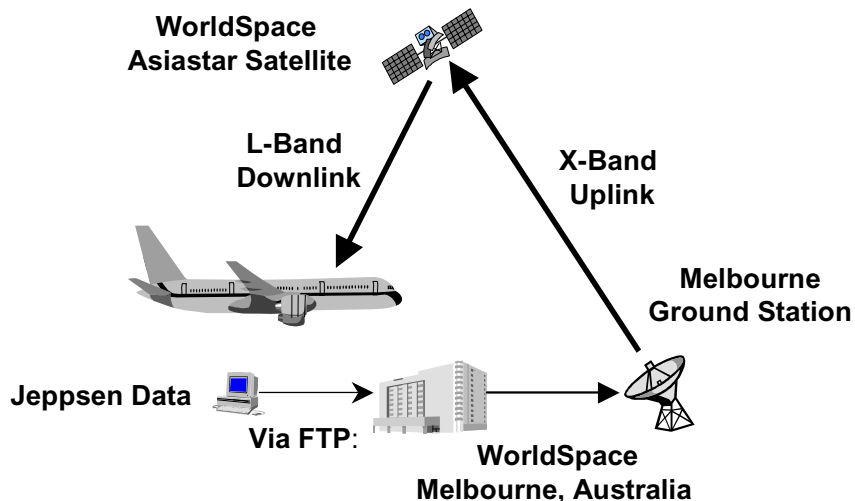

Figure 6 – SWIS Phase II system description

Figure 6 describes the SWIS Phase II system. The weather data developed by Jeppesen is transmitted via Internet file transfer to the WorldSpace AsiaStar ground station in Melbourne, Australia. The data is transmitted via an X-Band uplink to AsiaStar and broadcast over the northeast beam at L-band.

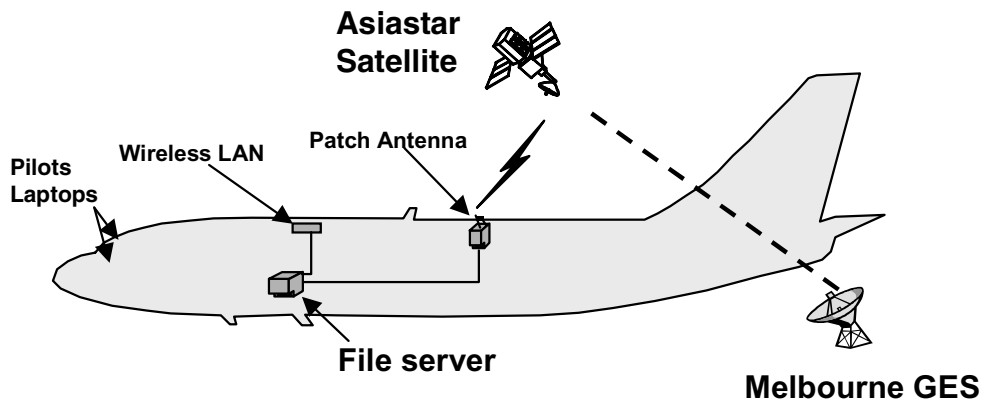

Figure 7 – SWIS Phase II on-board system configuration.

Figure 7 shows deployment of equipment on the aircraft. The patch antenna and receiver send the received weather graphics data to a file server. The data is then distributed to the pilot laptops for display in the cockpit through an on-board wireless LAN.

Typical weather graphics to be provided in SWIS Phase II include winds aloft at 7 altitudes, every 4 hours, infrared imagery every 60 minutes, visible imagery every 60 minutes, Hi-level SIGMETs (significant meteorological warnings), including volcanic ash, as they are detected, surface winds and weather fronts every 1 or 4 hours. Figure 8 shows examples of typical graphical weather products that will be transmitted to the operational aircraft in SWIS Phase II.

Following installation of the on-board equipment in the early spring of 2001, the SWIS Phase II demonstration is scheduled to run from April through September of 2001. Flight crews operating the equipped aircraft on flights from Chicago to Asia will obtain per-flight weather briefings including the SWIS Phase II weather data in Chicago, Hong Kong and Tokyo. During flight, they will have access to updated weather information while the aircraft is within the coverage region of the AsiaStar satellite. Detailed pilot surveys and operational flight data will be used to assess the effectiveness and usefulness of the SWIS Phase II weather data, as well as its impact on operational performance of the flights. Measurement of communications link performance and equipment performance (antenna and receiver) will also be accomplished.

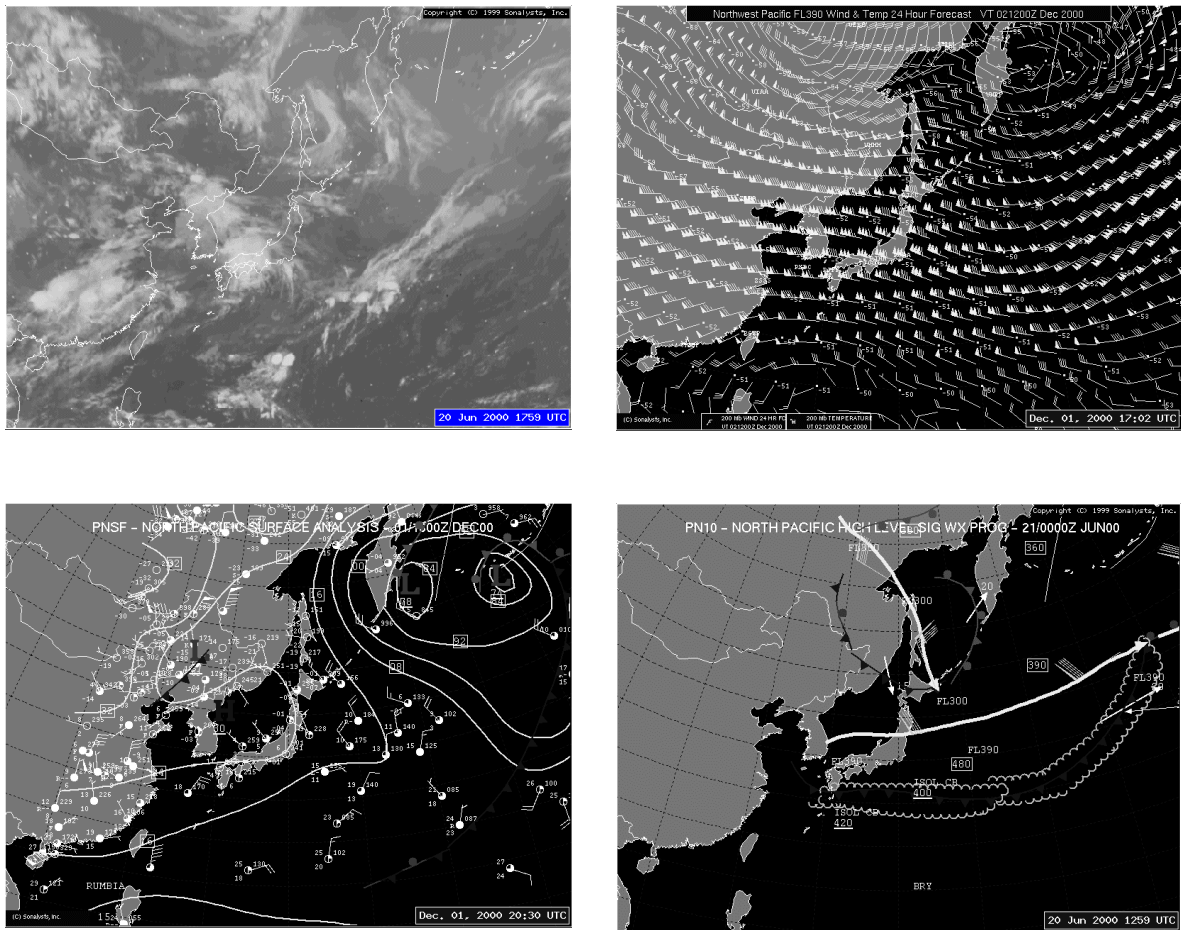

Figure 8 – Examples of SWIS Phase II graphical weather data displays: Infrared satellite imagery, winds aloft, and surface weather presentation.

SUMMARY

The continuing increase in air traffic worldwide puts significant strain on the safety and capacity of the global aviation system. NASA's Aviation Safety and Aviation System Capacity Programs are addressing some of the critical issues in improving system safety and capacity. Weather has a significant impact on both the safety and operational efficiency of the aviation system. A key element of improving safety and capacity, therefore, is the timely dissemination of high quality aviation weather data to users throughout the system, in particular to the flight deck of the aircraft.

The NASA Glenn Research Center is performing research, development and demonstration of technologies for weather data dissemination. Proposed architectures for future aviation weather dissemination emphasize an important role for satellite broadcast of weather data, particularly in providing a low cost solution available and beneficial to all classes of aircraft. The emergence of SDARS provides an opportunity for a very low cost satellite broadcast solution. NASA has entered into cooperative research efforts with Rockwell Collins, WorldSpace, Jeppesen and American Airlines to develop, demonstrate and evaluate prototype SDARS-based satellite aviation weather delivery systems under the SWIS Project. SWIS Phase I successfully demonstrated the basic feasibility of using SDARS to broadcast graphical weather information to operational aircraft using low cost equipment. SWIS Phase II is being designed to demonstrate and evaluate the application of SDARS to transport class aircraft operating trans-Pacific flights. Phase II will involve revenue service transport aircraft and include detailed technical evaluation of the prototype system for satellite delivery of aviation weather information and an assessment of the operational benefits to the airline.

REFERENCES

1. Stough, H. P., Shafer, D. B., Schaffner, P. R. and Martzaklis, K.S., "Reducing Aviation Weather-Related Accidents through High-Fidelity Weather Information Distribution and Presentation", 22nd International Congress of the Aeronautical Sciences, Harrogate, UK, August 2000.
2. National Aviation Weather Program Council Joint Action Group for Aviation Weather: National Aviation Weather Initiatives. Office of the Federal Coordinator for Meteorology, FCM-P34-1999, February 1999.
3. Communications System Architecture Development For Air Traffic Management & Aviation Weather Information Dissemination, NASA Research Task Order 24, Final Report, Science Applications International Corporation, for NASA Glenn Research Center under Contract NAS2-98002, May, 2000.
4. SDARS Phase I Test Report, Rockwell Collins, Inc., 1999.

REPORT DOCUMENTATION PAGE

Form Approved
OMB No. 0704-0188

Public reporting burden for this collection of information is estimated to average 1 hour per response, including the time for reviewing instructions, searching existing data sources, gathering and maintaining the data needed, and completing and reviewing the collection of information. Send comments regarding this burden estimate or any other aspect of this collection of information, including suggestions for reducing this burden, to Washington Headquarters Services, Directorate for Information Operations and Reports, 1215 Jefferson Davis Highway, Suite 1204, Arlington, VA 22202-4302, and to the Office of Management and Budget, Paperwork Reduction Project (0704-0188), Washington, DC 20503.

1. AGENCY USE ONLY (<i>Leave blank</i>)	2. REPORT DATE May 2001	3. REPORT TYPE AND DATES COVERED Technical Memorandum	
4. TITLE AND SUBTITLE Satellite Delivery of Aviation Weather Data		5. FUNDING NUMBERS WU-728-40-20-00	
6. AUTHOR(S) Robert J. Kerczewski and Richard Haendel			
7. PERFORMING ORGANIZATION NAME(S) AND ADDRESS(ES) National Aeronautics and Space Administration John H. Glenn Research Center at Lewis Field Cleveland, Ohio 44135-3191		8. PERFORMING ORGANIZATION REPORT NUMBER E-12762	
9. SPONSORING/MONITORING AGENCY NAME(S) AND ADDRESS(ES) National Aeronautics and Space Administration Washington, DC 20546-0001		10. SPONSORING/MONITORING AGENCY REPORT NUMBER NASA TM-2001-210886 AIAA-2001-057	
11. SUPPLEMENTARY NOTES Prepared for the 19th International Communications Satellite Systems Conference sponsored by the American Institute of Aeronautics and Astronautics, Toulouse, France, April 17-20, 2001. Robert J. Kerczewski, NASA Glenn Research Center and Richard Haendel, Rockwell Collins, Cedar Rapids, Iowa 52498. Responsible person, Robert J. Kerczewski, organization code 6150, 216-433-3434.			
12a. DISTRIBUTION/AVAILABILITY STATEMENT Unclassified - Unlimited Subject Category: 04 Available electronically at http://gltrs.grc.nasa.gov/GLTRS This publication is available from the NASA Center for AeroSpace Information, 301-621-0390.		12b. DISTRIBUTION CODE	
13. ABSTRACT (<i>Maximum 200 words</i>) With aviation traffic continuing to increase worldwide, reducing the aviation accident rate and aviation schedule delays is of critical importance. In the United States, the National Aeronautics and Space Administration (NASA) has established the Aviation Safety Program and the Aviation System Capacity Program to develop and test new technologies to increase aviation safety and system capacity. Weather is a significant contributor to aviation accidents and schedule delays. The timely dissemination of weather information to decision makers in the aviation system, particularly to pilots, is essential in reducing system delays and weather related aviation accidents. The NASA Glenn Research Center is investigating improved methods of weather information dissemination through satellite broadcasting directly to aircraft. This paper describes an on-going cooperative research program with NASA, Rockwell Collins, WorldSpace, Jeppesen and American Airlines to evaluate the use of satellite digital audio radio service (SDARS) for low cost broadcast of aviation weather information, called Satellite Weather Information Service (SWIS). The description and results of the completed SWIS Phase I are presented, and the description of the on-going SWIS Phase II is given.			
14. SUBJECT TERMS Satellite communications; Aeronautical communications; Aviation weather		15. NUMBER OF PAGES 15	
		16. PRICE CODE	
17. SECURITY CLASSIFICATION OF REPORT Unclassified	18. SECURITY CLASSIFICATION OF THIS PAGE Unclassified	19. SECURITY CLASSIFICATION OF ABSTRACT Unclassified	20. LIMITATION OF ABSTRACT