

## CLASS D9, PACKAGES AND CONTAINERS FOR GOODS

### SECTION I - CLASS DEFINITION

This class provides for design patents claiming ornamental designs for:

1. Packages and Containers for Goods with gas propellant means or pump
2. Collapsible tube
3. Sewing kit, needle or button
4. Matchbook type
5. Bag or wrapper type
6. Simulative in form or motif
7. Combined with diverse article
8. Sequential discharge of contents
9. Compartmented or having distinct support
10. Uniform cross-section of periphery around axis (i.e., generated shape)
11. Opposed perimetric beads (e.g., seams, seals, joints, etc.)
12. Shaker type or with plural dispensing apertures
13. Bottle, jug, jar and can
14. Box or packaging container
15. Element or attachment
16. Miscellaneous

(1) Note. This class includes product containers whose acquisition is incidental to the purchase of the contents. Boxes, bottles, jars, etc., in this class are of a disposable or destructible nature. However, perfume bottles without atomizers, returnable bottles, canning jars or similar containers are included.

(2) Note. Containers purchased exclusively for storing or carrying purposes such as jew-

elry boxes, china canister sets, etc. are excluded. Secondary uses of the container are not specifically entertained for purposes of exclusion (e.g., bottle used as a bank, etc.).

(3) Note. Design patents in this class are classified by what is disclosed in full lines only. Broken, hatched or stippled lines are considered as environment only.

(4) Note. Parts of portions of bottles, jugs and jars are classified in subclasses 516 through 575 as they are not considered elements or attachments.

### SECTION II - REFERENCES TO OTHER CLASSES

#### SEE OR SEARCH CLASS:

- D3, Travel Goods and Personal Belongings, subclass 200 for shoeshine kit or container; subclass 202 for canteen for liquid; subclasses 263-268 for storage container for optical equipment; subclass 272 for permanent-type shipping container; subclasses 304-317 for open bin, tray, or carrier.
- D4, Brushware, subclass 114 for fountain brush; subclass 116, nail enamel container combined with brush.
- D5, Textile or Paper Yard Goods; Sheet Material, subclasses 2 through 99 for sheet material or wrapping paper; subclasses 63-66 for cigar band.
- D6, Furnishings, subclasses 515 through 523 for non-disposable dispensers.
- D7, Equipment for Preparing or Serving Food or Drink not Elsewhere Specified, subclasses 300 through 322 for serving type decanter or carafe; subclass 301 for wine cask; subclasses 509-537 for drinking cup; subclasses 510-511 for sports bottle; subclasses 591-597 for shaker type condiment dispenser; subclass 598 for condiment type cruet; subclasses 601-641 for food storage container (e.g., lunch box, vacuum bottle or box, etc.); subclasses 612-615 and 629 for canister.
- D8, Tools and Hardware, subclass 71 for bagging tool; subclasses 300-322 for handle or element; subclasses 349-399 for generic type fastener, clamp, reel or locking device; subclass 399 for washer for storage or canning jar.

- D11, Jewelry, Symbolic Insignia, and Ornaments, subclass 126 for Christmas stocking; subclasses 143-156 for flower container or plant holder; subclass 184 for package ornament or bow.
- D12, Transportation, subclass 411 for cycle mounted bottle combined with cage holder; subclass 607 for tire valve cap.
- D18, Printing and Office Machinery, subclass 43 for container for toner or photographic developing type chemical.
- D19, Office Supplies; Artists' and Teachers' Materials, subclasses 3 through 4 for stationery type envelop; subclasses 70-71 for glue applicator; subclasses 86-92 for office type document holder or tray.
- D20, Sales and Advertising Equipment, subclasses 1 through 10 for vending machine; subclasses 10-44 for display card, sign, label, tag or show card; subclass 40 for calling card holder.
- D21, Games, Toys, and Sports Goods, subclasses 439 through 440 for balloon.
- D23, Environmental Heating and Cooling; Fluid Handling and Sanitary Equipment, subclasses 202 through 206 for tank or element therefore; subclass 211 for lubricating can; subclass 212 for watering can; subclasses 213-230 for spay nozzle; subclasses 223-227 for spray gun.
- D24, Medical and Laboratory Equipment, subclass 110 for atomizer for medical product (e.g., nebulizer, inhaler, etc.); subclass 115 for medical fluid dropper; subclass 119 for medicine applicator; subclasses 197-199 for nursing bottle or holder therefore; subclass 224 for vial, test tube or medication storage container.
- D27, Tobacco and Smokers' Supplies, subclass 101 for cigarette wrapper; subclasses 172-193 for tobacco or reusable match container.
- D28, Cosmetic Products and Toilet Articles, subclass 7 for mascara or lotion applicator or dispenser, subclass 84 for soap bar container or stick type cosmetic container (e.g., lip balm, subclasses 78-84 for compact; subclasses 85-90 for lipstick container; subclass 91 for compact-type face powder box; subclass 91.1 for atomizer for perfume or cologne.
- D32, Washing, Cleaning, or Drying Machine, subclasses 53 through 54 for pail or can attachment (e.g., paint brush support, paint can rim, etc.); subclass 75 for laundry sprinkler.
- D34, Material or Article Handling Equipment, subclass 39 for barrel, case or drum.
- D99, Miscellaneous, subclass 25 for holy water bottle.

## SUBCLASSES

**434 ELEMENT OR ATTACHMENT:**

This subclass is indented under the class definition. Design for an element or attachment for ornamental designs classified in this class.

- (1) Note. Includes shopping bag handle.

## SEE OR SEARCH THIS CLASS, SUBCLASS:

500 through 575, for design patent claiming portion or part of a bottle, container, or can.

## SEE OR SEARCH CLASS:

D7, Equipment for Preparing or Serving Food or Drink Not Elsewhere Specified, subclass 398 for siphon.

**499 MISCELLANEOUS:**

This subclass is indented under the class definition. Design for disposable packaging not elsewhere provided for.

**500 UNIFORM CROSS-SECTION OR PERIPHERY AROUND AXIS:**

This subclass is indented under the class definition. Design wherein the form of the packaging is uniform in cross-section or shows a uniform peripheral configuration around an axis.

- (1) Note. As a container is rotated, the same configuration exists throughout the 360-degree rotation; the container must have a constant profile. For example, an article turned on a lathe has a uniform cross-section around its axis.
- (2) Note. Applied surface ornamentation such as a printed motif, label or a matte or surface texture that is asymmetrical is not considered and does not exclude a design from this classification.
- (3) Note. The closure and bottom surface may or may not conform to the requirement for a uniform-section or periphery.
- (4) Note. Threaded opening with ribs, or surface texture shown on the closure is

not considered and does not exclude a design from this classification.

- (5) Note. Molding seam is not considered and does not exclude a design from this classification.

**506 OPPOSED PERIMETRIC BEADS:**

This subclass is indented under the class definition. Design that includes joined sides or seams spaced on opposite sides around the perimeter.

**516 BOTTLE, JUG, OR JAR:**

This subclass is indented under the class definition. Design for a container with a narrow or wide neck for holding liquid, food or cosmetics or for a tin or can with a chime at the top or bottom.

- (1) Note. Bottle may include stopper.
- (2) Note. Bottle may include measuring information, markings, or indicia.
- (3) Note. Bottle may include pull tab or tear strip opening for packaging.

SEE OR SEARCH THIS CLASS, SUBCLASS:  
505, 544-546, for decanter type.  
547, for bottle with quantitative measurement indicator.

SEE OR SEARCH CLASS:

- D24, Medical and Laboratory Equipment, subclass 110 for atomizer for medical product (e.g., inhaler, etc.); subclass 115 for medical fluid dropper; subclass 119 for medicine applicator; subclasses 197-199 for nursing bottle or holder therefor; subclass 224 for vial, test tube or medication storage container.
- D28, Cosmetic Products and Toilet Articles, subclasses 86 through 90 for lipstick container; subclass 91 for compact-type face powder container; subclass 91.1 for atomizer for perfume or cologne.

**600 SIMULATIVE IN FORM OR MOTIF:**

This subclass is indented under the class definition. Design that shows an ornamental feature or features that simulate the ornamental appearance of another object either as applied ornamentation or in form.

- (1) Note. The search for disposable packaging fan that simulates the appearance of another object should also include the appropriate Design Class and subclass(es) for the actual object simulated.
- (2) Matchbook type excluded since the design for this article usually includes or shows applied ornamentation that is a simulation of another object.

**601 Animate:**

This subclass is indented under subclass 600. Design that simulates the form or appearance of an animal.

SEE OR SEARCH THIS CLASS, SUBCLASS:  
666, for shell.

SEE OR SEARCH CLASS:

- D3, Travel Goods and Personal Belongings, subclass 271.2 for storage container that simulates an animal.
- D11, Jewelry, Symbolic Insignia, and Ornaments, subclasses 49 through 58 for simulative jewelry; subclasses 158 and 159 for sculpture or table ornament that simulates an animal.
- D21, Games, Toys, and Sports Goods, subclasses 585 through 657 for toy animal or stuffed animal.

**602 Bird:**

This subclass is indented under subclass 601. Design that simulates a feathered animal with two wings and two legs.

SEE OR SEARCH CLASS:

- D3, Travel Goods and Personal Belongings, subclass 271.2 for storage container that simulates an animal.
- D11, Jewelry, Symbolic Insignia, and Ornaments, subclasses 57 through 58 for jewelry with bird motif, subclass 107 for symbolic medals or badge with

- bird motif; subclasses 162 for sculpture or table ornament with bird motif.
- D21, Games, Toys, and Sports Goods, subclasses 606 through 609 for toy bird.
- 603 Rooster, hen turkey or chick:**  
This subclass is indented under subclass 602. Design that simulates domestic fowl.
- SEE OR SEARCH CLASS:
- D11, Jewelry, Symbolic Insignia, and Ornaments, subclass 58 for jewelry with bird motif, subclass 107 for symbolic medal or badge with bird motif; subclasses 162 for sculpture or table ornament with bird motif.
- D21, Games, Toys, and Sports Goods, subclass 609 for toy rooster, hen, turkey or chick.
- 604 Web-footed:**  
This subclass is indented under subclass 602. Design that simulates a feathered animal with toes that are joined with a web such as a duck or swan.
- SEE OR SEARCH CLASS:
- D11, Jewelry, Symbolic Insignia, and Ornaments, subclass 58 for jewelry with bird motif, subclass 107 for symbolic medal or badge with bird motif; subclasses 162 for sculpture or table ornament with bird motif.
- D21, Games, Toys, and Sports Goods, subclass 607 for web-footed toy bird.
- 605 Dinosaur or dragon:**  
This subclass is indented under subclass 601. Design that simulates an extinct reptile or mythical reptile monster.
- SEE OR SEARCH CLASS:
- D11, Jewelry, Symbolic Insignia, and Ornaments, subclasses 150 through 163 for simulative sculpture or table ornament.
- D21, Games, Toys, and Sports Goods, subclass 615 for toy dinosaur or dragon.
- 606 Fish:**  
This subclass is indented under subclass 601. Design that simulates a cold-blooded sea or water creature.
- SEE OR SEARCH CLASS:
- D11, Jewelry, Symbolic Insignia, and Ornaments, subclass 50 for jewelry that simulates aquatic animals, subclass 100 for symbolic medal or badge that simulates an animal; subclass 158 for animal simulative sculpture or table ornament.
- D21, Games, Toys, and Sports Goods, subclasses 599 for toy fish; subclass 603 for turtle; subclass 601 for toy octopus.
- 607 Quadraped:**  
This subclass is indented under subclass 601. Design that simulates an animal with four feet.
- SEE OR SEARCH CLASS:
- D3, Travel Goods and Personal Belongings, subclass 271.2 for storage container that simulates an animal.
- D11, Jewelry, Symbolic Insignia, and Ornaments, subclasses 49, 51 and 52 for jewelry that simulates animals with four legs, subclass 100 for symbolic medals or badge showing a four legged animal; subclasses 158-159 for simulative sculpture or table ornament showing a four-legged animal.
- D21, Games, Toys, and Sports Goods, subclasses 596, 603-605, 610-620, 651-656 for four-legged toy animal.
- 608 Bear:**  
This subclass is indented under subclass 607. Design that simulates a large, heavy animal with thick fur and claws.
- SEE OR SEARCH CLASS:
- D11, Jewelry, Symbolic Insignia, and Ornaments, subclasses 49, 51 and 52 for jewelry that simulates animals with four legs, subclass 100 for symbolic medals or badge showing a four legged animal; subclasses 158-159 for simulative sculpture or table ornament showing a four legged animal.
- D21, Games, Toys, and Sports Goods, subclasses 604 through 605 for toy bear.
- 609 Canine:**  
This subclass is indented under subclass 607. Design under subclass that simulates a dog.

## SEE OR SEARCH CLASS:

- D11, Jewelry, Symbolic Insignia, and Ornaments, subclasses 49, 51 and 52 for jewelry that simulates animals with four legs, subclass 100 for symbolic medals or badge showing a four legged animal; subclasses 158-159 for simulative sculpture or table ornament showing a four legged animal.
- D21, Games, Toys, and Sports Goods, subclass 611 for toy dog figure.

**610 Elephant:**

This subclass is indented under subclass 607. Design that simulates the largest living land mammal.

## SEE OR SEARCH CLASS:

- D11, Jewelry, Symbolic Insignia, and Ornaments, subclasses 49, 51 and 52 for jewelry that simulates animals with four legs, subclass 100 for symbolic medals or badge showing a four legged animal; subclasses 158-159 for simulative sculpture or table ornament showing a four-legged animal.
- D21, Games, Toys, and Sports Goods, subclass 616 for toy elephant.

**611 Feline:**

This subclass is indented under subclass 607. Design that simulates a cat or lion figure.

## SEE OR SEARCH CLASS:

- D11, Jewelry, Symbolic Insignia, and Ornaments, subclass 49, 51 and 52 for jewelry that simulates animals with four legs, subclass 100 for symbolic medals or badge showing a four legged animal; subclasses 158-159 for simulative sculpture or table ornament showing a four legged animal.
- D21, Games, Toys, and Sports Goods, subclasses 617 and 618 for toy feline animal.

**612 Horse, mule or zebra:**

This subclass is indented under subclass 607. Design that simulates a four-legged animal with a flowing mane and tail used for transporting loads or for riding.

## SEE OR SEARCH CLASS:

- D11, Jewelry, Symbolic Insignia, and Ornaments, subclasses 49, 51 and 52 for jewelry that simulates animals with four legs, subclass 100 for symbolic medals or badge showing a four legged animal; subclasses 158-159 for simulative sculpture or table ornament showing a four legged animal.
- D21, Games, Toys, and Sports Goods, subclasses 428 and 620 for toy horse, mule or zebra.

**613 Rabbit:**

This subclass is indented under subclass 607. Design that simulates a hare or burrowing animal with long ears and a short fluffy tail.

## SEE OR SEARCH CLASS:

- D11, Jewelry, Symbolic Insignia, and Ornaments, subclasses 49, 51 and 52 for jewelry that simulates animals with four legs, subclass 100 for symbolic medals or badge showing a four legged animal; subclasses 158-159 for simulative sculpture or table ornament showing a four legged animal.
- D21, Games, Toys, and Sports Goods, subclass 655 for toy rabbit.

**614 Humanoid:**

This subclass is indented under subclass 601. Design that simulates or shows a human figure or human type characteristics.

- (1) Note. Includes skeleton and body part.

## SEE OR SEARCH THIS CLASS, SUBCLASS:

- 625 through 628, for packaging the simulates the appearance of a human head or skull.

## SEE OR SEARCH CLASS:

- D3, Travel Goods and Personal Belongings, subclass 271.3 for storage container that simulates the appearance of the human form.
- D11, Jewelry, Symbolic Insignia, and Ornaments, subclasses 53 through 56 for jewelry that simulates the human form, subclass 101 for symbolic medals or badge showing the human form;

subclasses 160-162 for simulative sculpture or table ornament showing a human form.

D21, Games, Toys, and Sports Goods, subclasses 594 and 621-649 for toy doll.

**615 Clown:**

This subclass is indented under subclass 614. Design that simulates or shows a costumed performer suggesting comic tricks or actions.

**SEE OR SEARCH CLASS:**

D21, Games, Toys, and Sports Goods, subclass 632 for toy clown.

**616 Ethnic costume:**

This subclass is indented under subclass 614. Design that simulates a figure with clothing that suggests a particular geographic region or culture.



Example of a design for packaging that simulates an ethnic costume.

**SEE OR SEARCH CLASS:**

D21, Games, Toys, and Sports Goods, subclasses 639 through 642 for toy doll with national, regional or ethnic attire or costume.

**617 Christmas or holiday figure:**

This subclass is indented under subclass 614. Design that simulates a human figure with clothing that suggests a particular holiday such as Christmas, Halloween or the like.



Example of a design for packaging that simulates a Christmas or holiday figure.

(1) Note: Includes snowman.

**SEE OR SEARCH CLASS:**

D21, Games, Toys, and Sports Goods, subclass 638 for Santa type doll figure; subclass 629 for snowman.

**618 Sports attire:**

This subclass is indented under subclass 614. Design that simulates a human figure dressed in clothing that suggests an organized sport activity such as baseball, golf or the like.



Example of a design for packaging that simulates sports attire.

(1) Note: Swimming attire excluded.

**SEE OR SEARCH CLASS:**

D21, Games, Toys, and Sports Goods, subclass 635 for doll with athletic attire.

**619 Uniform:**

This subclass is indented under subclass 614. Design that simulates a human figure dressed in clothing that suggests a particular occupation or type of trade or work.

- (1) Note: Includes royalty or playing card figure, and ballet dancer.

**SEE OR SEARCH CLASS:**

D21, Games, Toys, and Sports Goods, subclass 634 for doll with occupational or vocational uniform; subclass 636 for military type; subclass 637 for astronaut or pilot; subclass 640 for cowboy or cowgirl.

**620 Grotesque:**

This subclass is indented under subclass 614. Design that shows a caricature or representation of a human figure with distorted proportions or body appearance.



Example of a design for packaging that simulates a grotesque figure.

**SEE OR SEARCH THIS CLASS, SUBCLASS:**

625, for representation of a jack-o - lantern or "man in the moon."

**SEE OR SEARCH CLASS:**

D21, Games, Toys, and Sports Goods, subclass 630 for doll with grossly exaggerated head size.

**621 Feminine:**

This subclass is indented under subclass 614. Design that simulates a female human figure.

**SEE OR SEARCH THIS CLASS, SUBCLASS:**

614, for representation of child or infant.

**SEE OR SEARCH CLASS:**

D21, Games, Toys, and Sports Goods, subclasses 645 through 649 for doll with female characteristics.

**622 Dress:**

This subclass is indented under subclass 621. Design that simulates a female human figure and includes a flowing one-piece outer garment.

**SEE OR SEARCH THIS CLASS, SUBCLASS:**

614, for representation or child or infant.

**SEE OR SEARCH CLASS:**

D2, Apparel and Haberdashery, subclasses 756 through 822 for dress.  
D21, Games, Toys, and Sports Goods, subclass 648 for female doll with a dress or skirt; subclass 647 for pinafore or apron.

**623 Masculine:**

This subclass is indented under subclass 614. Design that simulates a mature male human figure.

**SEE OR SEARCH THIS CLASS, SUBCLASS:**

614, for representation or child or infant.

**SEE OR SEARCH CLASS:**

D21, Games, Toys, and Sports Goods, subclasses 621 through 644 for male doll.

- 624 Appendage or body part:**  
This subclass is indented under subclass 614. Design that simulates a part of the human figure such as an arm, leg, hand, head or the like.
- 625 Head:**  
This subclass is indented under subclass 624. Design that simulates the uppermost or forward most part of the human body that includes the brain eyes, nose, mouth and jaws.
- (1) Note. Includes representation of a jack-o-lantern and "man in the moon."
- SEE OR SEARCH CLASS:  
D21, Games, Toys, and Sports Goods, subclass 659 for doll head or mask.
- 626 Skull:**  
This subclass is indented under subclass 625. Design that shows the bones forming the human head.
- SEE OR SEARCH THIS CLASS, SUBCLASS:  
614, for skeleton.
- SEE OR SEARCH CLASS:  
D21, Games, Toys, and Sports Goods, subclass 659 for doll head or mask.
- 627 Feminine figure:**  
This subclass is indented under subclass 625. Design that shows the head of a mature female.
- SEE OR SEARCH CLASS:  
D21, Games, Toys, and Sports Goods, subclass 659 for doll head or mask.
- 628 Masculine figure:**  
This subclass is indented under subclass 625. Design that simulates the head of a mature male.
- SEE OR SEARCH CLASS:  
D21, Games, Toys, and Sports Goods, subclass 659 for doll head or mask.
- 629 Heart:**  
This subclass is indented under subclass 624. Design that simulates the organ of the human body that pumps blood.
- SEE OR SEARCH CLASS:  
D3, Travel Goods and Personal Belongings, subclass 271.3 for storage container that simulates a human heart.
- 630 Insect:**  
This subclass is indented under subclass 601. Design that simulates a small anthropoid animal with six legs, possibly winged and a body divided into three parts.
- (1) Note. Includes beehive.
- SEE OR SEARCH CLASS:  
D21, Games, Toys, and Sports Goods, subclass 650 for toy insect.
- 631 Apparel:**  
This subclass is indented under subclass 600. Design that simulates an article of clothing or garment.
- (1) Note. Includes apparel type accessory such as a fan or umbrella.
- SEE OR SEARCH CLASS:  
D2, Apparel and Haberdashery, subclasses 700 through 864 for designs for apparel.  
D3, Travel Goods and Personal Belongings, subclasses 1 through 17 for fan or umbrella.
- 632 Hat or crown:**  
This subclass is indented under subclass 631. Design that simulates a head covering.
- SEE OR SEARCH CLASS:  
D2, Apparel and Haberdashery, subclasses 865 through 895 for designs hats or headwear.  
D29, Equipment for Safety, Protection, and Rescue, subclasses 102 through 107 for helmet or protective headgear.
- 633 Barrel:**  
This subclass is indented under subclass 600. Design that shows or simulates a cylindrical container, usually constructed of staves bound together with hoops, with a flattop and bottom of equal diameter.



- SEE OR SEARCH CLASS:  
D3, Travel Goods and Personal Belongings, subclass 39 for barrel storage container.
- 634 Book:**  
This subclass is indented under subclass 600. Design that shows or simulates a set of written, printed or blank pages fastened along one side and encased between protective covers.
- SEE OR SEARCH CLASS:  
D3, Travel Goods and Personal Belongings, subclass 39 for barrel, subclass 271.5 for permanent storage container simulating a book.  
D19, Office Supplies; Artists' and Teachers' Materials, subclasses 26 through 31 for design for book.
- 635 Bow:**  
This subclass is indented under subclass 600. Design that shows or simulates a bowknot or at least two loops of material connected with a knot and two ends.
- SEE OR SEARCH THIS CLASS, SUBCLASS:  
670, for textile.
- SEE OR SEARCH CLASS:  
D2, Apparel and Haberdashery, subclass 606 for bow tie.  
D5, Textile or Paper Yard Goods; Sheet Material, subclass 34 for textile or sheet goods, pattern that includes plant life with a ribbon or bow; subclass 40 for ribbon or bow only.  
D11, Jewelry, Symbolic Insignia, and Ornaments, subclass 74 for brooch or earring with bow ornament.
- 636 Building or component:**  
This subclass is indented under subclass 600. Design that shows or simulates a structure or dwelling or part thereof.
- SEE OR SEARCH CLASS:  
D3, Travel Goods and Personal Belongings, subclass 271.6 for permanent storage container simulating a building.
- D21, Games, Toys, and Sports Goods, subclasses 506 through 512 for toy building or structure; subclasses 484 - 505 for toy building block.
- D25, Building Units and Construction Elements, subclasses 1 through 34 for building structure; subclasses 102-164 for architectural stock material.
- 637 Barn or log cabin:**  
This subclass is indented under subclass 636. Design that shows or simulates a structure built to house farm animals and farm equipment or a rough structure fashioned from rough log type materials.
- SEE OR SEARCH CLASS:  
D21, Games, Toys, and Sports Goods, subclass 508 for toy barn or stable.  
D25, Building Units and Construction Elements, subclasses 1 through 34 for building structure; subclasses 22-30 for building structure with angled roof.
- 638 Tower or skyscraper:**  
This subclass is indented under subclass 636. Design that simulates a multi-level tall building type structure of four floors or more.
- SEE OR SEARCH CLASS:  
D21, Games, Toys, and Sports Goods, subclass 510 for toy tower.  
D25, Building Units and Construction Elements, subclass 6 for tower.
- 639 Windmill:**  
This subclass is indented under subclass 638. Design that simulates a structure that includes a projecting sail like members.
- SEE OR SEARCH CLASS:  
D21, Games, Toys, and Sports Goods, subclass 510 for toy windmill.
- 640 Architectural detail:**  
This subclass is indented under subclass 638. Design that simulates a part or element of a building structure.

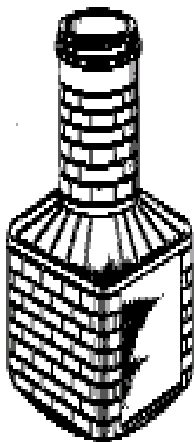

Example of a design for packaging that simulates an architectural detail such as a fire place.

**SEE OR SEARCH CLASS:**

D25, Building Units and Construction Elements, subclasses 102 through 164 for architectural stock material.

- 641 Column:**  
This subclass is indented under subclass 640.  
Design that simulates a support column.

**SEE OR SEARCH CLASS:**

D25, Building Units and Construction Elements, subclasses 126 through 131 for architectural post or beam.

- 642 Furniture:**  
This subclass is indented under subclass 600.  
Design that simulates movable articles in a room that make it fit for living or working such as chair, bed, cabinet or the like.

**SEE OR SEARCH CLASS:**

D3, Travel Goods and Personal Belongings, subclass 271.7 for permanent storage container simulating furniture.  
D6, Furnishings, subclasses 300 through 512 for furniture and furnishings.  
D21, Games, Toys, and Sports Goods, subclasses 519 through 524 for toy furniture.

- 643 Edible food or tobacco product:**  
This subclass is indented under subclass 600.  
Design that simulates a substance for human consumption or an item or device for smoking.

**SEE OR SEARCH CLASS:**

D1, Edible Products, subclasses 100 through 199 for food product.  
D3, Travel Goods and Personal Belongings, subclass 271.8 for permanent storage container simulating a plant or plant part.  
D27, Tobacco and Smokers' Supplies, subclasses 100 and 101 for tobacco product; subclasses 163-169 for pipe.

- 644 Fruit or vegetable:**  
This subclass is indented under subclass 643.  
Design that simulates the edible, fleshy portion of a plant.

- 645 Fruit:**  
This subclass is indented under subclass 643.  
Design that simulates the edible, fleshy portion of a plant usually containing seeds such as a banana, apple, berry or the like.

- 646 Grape:**  
This subclass is indented under subclass 645.  
Design that simulates clusters of small, round, sweet fruit grown on vines.

- 647 Citrus:**  
This subclass is indented under subclass 645.  
Design that shows a semi-tropical fruit having a leathery aromatic skin.

- 648 Tobacco:**  
This subclass is indented under subclass 643.  
Design that simulates a product made from leaves such as a cigarette or cigar for smoking or a device used for smoking them such as a pipe or cigarette holder.

**SEE OR SEARCH CLASS:**

D27, Tobacco and Smokers' Supplies, subclasses 100 and 101 for tobacco product; subclasses 163 -169 for pipe; subclasses 186-192 for storage container for tobacco product.

- 649 Geography:**  
This subclass is indented under subclass 600.  
Design that shows a geographic feature such as a map, shape of a nation, state or the appearance of a urban or rural landscape such as a mountain range or waterfall.

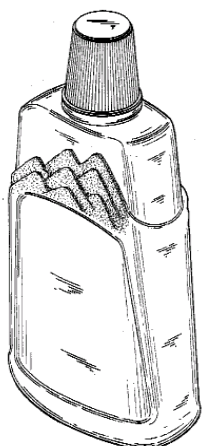

Example of a design for simulates geography.

**650 Horseshoe:**

This subclass is indented under subclass 600. Design that simulates a U-shaped flat plate that may be nailed to a horse hoof or is used as a 'good luck' symbol.

**651 Jewel:**

This subclass is indented under subclass 600. Design that simulates a faceted stone or jewelry.

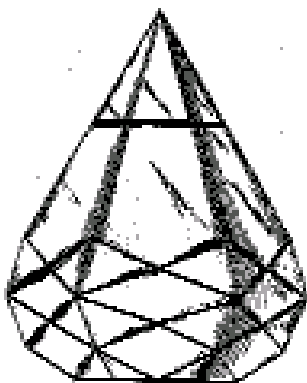

Example of a design for packaging that simulates jewel.

**SEE OR SEARCH CLASS:**

D11, Jewelry, Symbolic Insignia, and Ornaments, subclasses 1 through 94 for jewelry.

**652 Letter or number, embossed or in form only:**

This subclass is indented under subclass 600. Design that is embossed with a letter or number or simulates in form a letter or number.

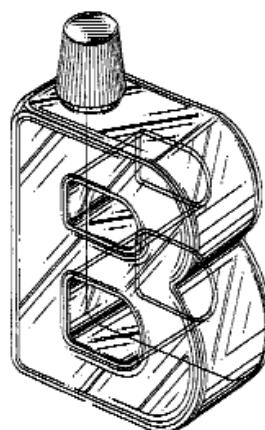

Example of a design for packaging that simulates a letter.

(1) Note. Text or printed matter is not considered in the classification of subject matter in this subclass.

(2) Note. Includes punctuation mark.

**SEE OR SEARCH CLASS:**

D5, Textile or Paper Yard Goods; Sheet Material, subclass 30 for textile that includes a letter, number or punctuation mark.

D18, Printing and Office Machinery, subclasses 24 through 31 for ornamental designs for type and typefonts.

**653 Light source:**

This subclass is indented under subclass 600. Design that simulates a point of light such as a torch, candle, light bulb or light fixture.

**SEE OR SEARCH THIS CLASS, SUBCLASS:**

667, for lightening type symbol.

669, for star.

**SEE OR SEARCH CLASS:**

D26, Lighting, subclasses 1 through 8 for light source, subclasses 9-23 for candle or candle holder, subclasses 24-112 for domestic or industrial light fixture.

**654 Luggage:**

This subclass is indented under subclass 600. Design that simulates personal carrying containers such as a suitcase or cosmetic bag.

**SEE OR SEARCH CLASS:**

D3, Travel Goods and Personal Belongings, subclasses 272 through 302 for trunk or suitcase.



Example of a design for a packaging that simulates a pine cone.

**655 Plant:**

This subclass is indented under subclass 600. Design that simulates or shows an organism of the kingdom of plantae-lacking the power of locomotion.

**SEE OR SEARCH CLASS:**

D3, Travel Goods and Personal Belongings, subclass 271.8 for storage containers that simulate plants.  
D5, Textile or Paper Yard Goods; Sheet Material, subclasses 6, 16, 24, 32-39 for textile or sheet goods with pant motif.  
D11, Jewelry, Symbolic Insignia, and Ornaments, subclass 63 for brooch or earring with plant motif or design; subclasses 117-20 for artificial plant.

**658 Individual leaf or spray:**

This subclass is indented under subclass 655. Design that simulates or shows a single flat plant structure attached to a twig or an individual sprig of leaves.

**659 Tree or shrub:**

This subclass is indented under subclass 655. Design that simulates or shows a perennial woody plant.

**660 Trunk or log:**

This subclass is indented under subclass 659. Design that simulates or shows a woody, bark-covered portion of a tree such a base area or limb.

**656 Wreath:**

This subclass is indented under subclass 655. Design that simulates or shows a circlet of leaves or boughs that may include an open section.

**661 Flower:**

This subclass is indented under subclass 655. Design that simulates or shows a bud or blossom of a plant.

**657 Cone, acorn or the like:**

This subclass is indented under subclass 655. Design that simulates or shows the appearance of a unisexual reproductive structure of plants such a conifers typically consisting of a central axis that develops pollen gearing sacs or seeds or the fruit of the oak tree.

**SEE OR SEARCH CLASS:**

D5, Textile or Paper Yard Goods; Sheet Material, subclass 34 for textile or sheet goods, pattern that includes plant life with a ribbon or bow; subclass 40 for ribbon or bow only.  
D11, Jewelry, Symbolic Insignia, and Ornaments, subclass 74 for brooch or earring with bow design.  
PLT, Plants, appropriate subclasses for brooch or earring with bow design.

**662 Daisy:**

This subclass is indented under subclass 661. Design that simulates or shows a common, naturalized Eurasian plant having a flower head with petals extending as rays.

**663 Rose:**  
 This subclass is indented under subclass 661.  
 Design that simulates or shows a flower from a genus ROSA, having prickly stems, compound petals.

**664 Fleur de lis:**  
 This subclass is indented under subclass 661.  
 Design that simulates or shows a three-petal iris flower often used or associated as a emblem of the kings of France.



Example of a design for packaging that simulates a fleur de lis.

**665 Musical instrument or symbol:**  
 This subclass is indented under subclass 600.  
 Design that simulates or shows a device intended to make music such as a drum, trumpet, violin or clarinet.

SEE OR SEARCH CLASS:  
 D17, Musical Instruments, subclasses 1 through 9 for keyboard type, subclasses 10-13 for wind instrument; subclasses 14-21 for string instrument; subclasses 22-23 for percussion instrument.  
 D21, Games, Toys, and Sports Goods, subclasses 405 through 411 for noise or music making toys.

**666 Shell:**  
 This subclass is indented under subclass 600.  
 Design that simulates or shows the hard outer covering that encases certain organisms such as mollusks insects or the like.

SEE OR SEARCH THIS CLASS, SUBCLASS:  
 657, for nut, acorn or outer covering for a fruit or seed.

**667 Symbol or shield:**  
 This subclass is indented under subclass 600.  
 Design that simulates or shows a representation for another object such as heraldry, weather, religious or money symbols or the like.

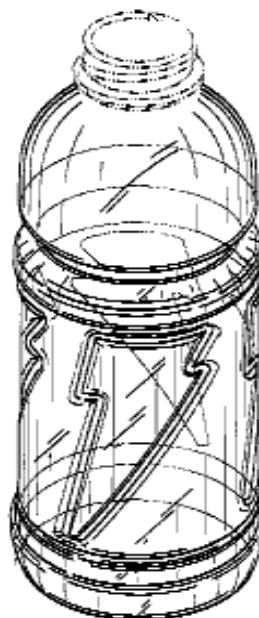

Examples of a design for packaging that simulates a symbol or shield.

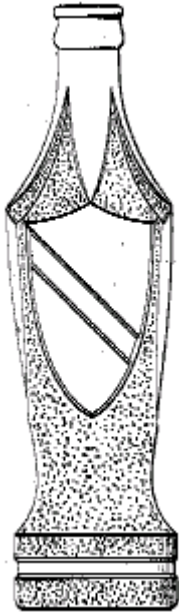

Examples of a design for packaging that simulates a symbol or shield.

- (1) Note. Includes representation of a playing card unless a human figure is shown such as a king, queen, jack or joker.
- (2) Note. Includes arrow.

SEE OR SEARCH THIS CLASS, SUBCLASS:

614 through 623, for figure of a royal person including face card of a playing deck.

**668 Sport goods:**

This subclass is indented under subclass 600. Design that simulates or shows an object used to play organized games such as football, golf, baseball, tennis and the like.



Example of a design for packaging that simulates a sport article.

SEE OR SEARCH THIS CLASS, SUBCLASS:

632, for sports helmet or headware.

SEE OR SEARCH CLASS:

D3, Travel Goods and Personal Belongings, subclass 271.9 for storage container that simulates sport goods.

D21, Games, Toys, and Sports Goods, subclasses 698 through 770 for sports equipment.

**669 Star:**

This subclass is indented under subclass 600. Design that simulates or shows a planetary object such as a planet, point or light, meteor or other heavenly body.

SEE OR SEARCH THIS CLASS, SUBCLASS:

625, for simulation of the "man in the moon".

**670 Textile:**

This subclass is indented under subclass 600. Design that simulates or shows fabric or rope material.

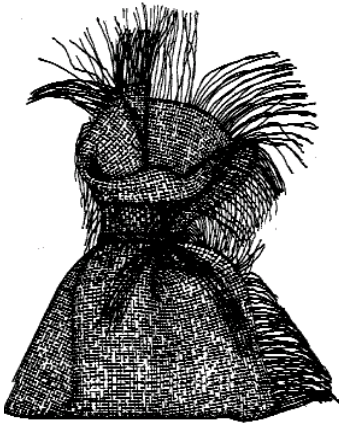

Example of a design for packaging that simulates textile.

**SEE OR SEARCH CLASS:**

D5, Textile or Paper Yard Goods; Sheet Material, subclasses 1 through 62 for textiles or yard goods.

**671 Timepiece:**

This subclass is indented under subclass 600. Design that simulates or shows a clock or watch, sundial or the like.

**SEE OR SEARCH CLASS:**

D10, Measuring, Testing, or Signaling Instruments, subclasses 1 through 45 for clock or clock case, subclasses 30-39 or watch.

**672 Vehicle or component thereof:**

This subclass is indented under subclass 600. Design that simulates or shows a means of transportation.

**SEE OR SEARCH CLASS:**

D3, Travel Goods and Personal Belongings, subclasses 271.11 and 12 for storage container that simulates a vehicle.  
 D12, Transportation, subclasses 16, for golf cart, 17-19 for animal cart; 36-51.  
 D21, Games, Toys, and Sports Goods, subclasses 533 through 560 for toy vehicle.  
 D34, Material or Article Handling Equipment, subclasses 12 through 26 for hand cart or conveying article.

**673 Aircraft or spacecraft:**

This subclass is indented under subclass 672. Design that simulates or shows an airplane or rocket.

**SEE OR SEARCH CLASS:**

D12, Transportation, subclasses 319 through 344 for aircraft, spacecraft or fuselage.  
 D21, Games, Toys, and Sports Goods, subclass 442 for toy helicopter, subclasses 447-452 for toy aircraft or rocket.

**674 Rocket or spaceship:**

This subclass is indented under subclass 673. Design that simulates or shows means for travel in outer space.

**SEE OR SEARCH CLASS:**

D12, Transportation, subclasses 319 through 344 for aircraft, spacecraft or fuselage.  
 D21, Games, Toys, and Sports Goods, subclasses 447 through 452 for toy aircraft or rocket.

**675 Automobile:**

This subclass is indented under subclass 672. Design that simulates or shows a motor car.

**SEE OR SEARCH CLASS:**

D12, Transportation, subclasses 82 through 100 for motorcar, bus or truck.  
 D21, Games, Toys, and Sports Goods, subclasses 548 through 551 for toy automobile.

**676 Truck:**

This subclass is indented under subclass 673. Design that simulates or shows a motor truck.

**SEE OR SEARCH CLASS:**

D12, Transportation, subclasses 82 through 100 for motorcar or truck.  
 D21, Games, Toys, and Sports Goods, subclasses 552 through 560 for toy truck.

**677 Train:**

This subclass is indented under subclass 673. Design that simulates or shows means for rail travel.

**SEE OR SEARCH CLASS:**

- D12, Transportation, subclasses 36 through 42 for train or monorail.  
 D21, Games, Toys, and Sports Goods, subclasses 540 through 541 for toy train.

**678 Ship or boat:**

This subclass is indented under subclass 673.  
 Design that simulates or shows means for travel on water.

**SEE OR SEARCH CLASS:**

- D12, Transportation, subclasses 300 through 316 for watercraft or hull.  
 D21, Games, Toys, and Sports Goods, subclasses 542 through 547 for toy watercraft.

**679 Tool:**

This subclass is indented under subclass 600.  
 Design that simulates or shows a device such as a hammer, used to perform or facilitate manual or mechanical work.

**SEE OR SEARCH CLASS:**

- D8, Tools and Hardware, subclasses 1 through 107 for hand and power tools.  
 D21, Games, Toys, and Sports Goods, subclass 532 for toy tool.

**680 Weapon:**

This subclass is indented under subclass 600.  
 Design that simulates or shows an instrument for defense such as a handgun or sword.

**SEE OR SEARCH CLASS:**

- D21, Games, Toys, and Sports Goods, subclasses 567 through 575 for toy weapon.  
 D22, Arms, Pyrotechnics, Hunting and Fishing Equipment, subclasses 102 through 111 for weapon.

**681 Wickerwork or basket:**

This subclass is indented under subclass 600.  
 Design that simulates or shows wicker-type material or shows a heavy woven texture.

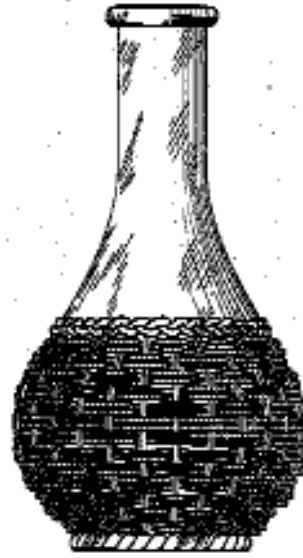

Example of a design for packaging that simulates wickerwork.

**SEE OR SEARCH CLASS:**

- D3, Travel Goods and Personal Belongings, subclass 277 for wicker type enclosed storage or carrying container, subclasses 304-314 for open basket.

**682 WITH GAS PROPELLANT MEANS OR PUMP:**

This subclass is indented under the class definition. Design for aerosol type can or container with means for pump propelled application of contents.



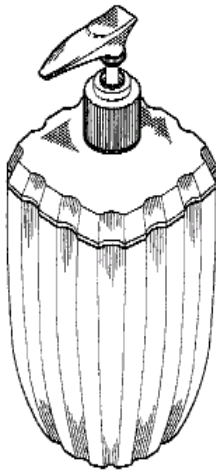

Examples of a design for packaging with gas propellant means or pump.

**SEE OR SEARCH CLASS:**

- D8, Tools and Hardware, subclass 30 for blow torch.
- D24, Medical and Laboratory Equipment, subclass 110 for atomizer for medical product (e.g., inhaler, etc.).
- D28, Cosmetic Products and Toilet Articles, subclass 91.1 for atomizer for perfume or cologne.
- D29, Equipment for Safety, Protection, and Rescue, subclasses 125 through 128 for fire extinguisher.

**683 Bellows:**  
 This subclass is indented under subclass 682. .  
 Design for container that includes a wrinkled

feature that compresses or expands to pump or release contents.

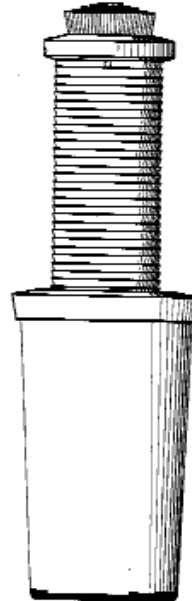

Example of a design for packaging with bellows.

**684 Divided or joined compartments:**  
 This subclass is indented under subclass 682.  
 Design for design with two or more separate areas to hold contents or with plural pump closures.

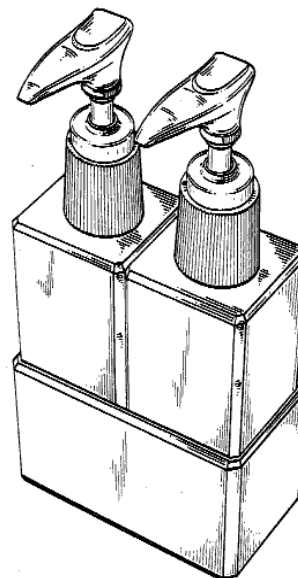

Example of a design for packaging with divided or joined compartments.

**685 Trigger type spray:**

This subclass is indented under subclass 682.  
Design that shows a pump type applicator that is activated by a squeezing motion usually with a finger.

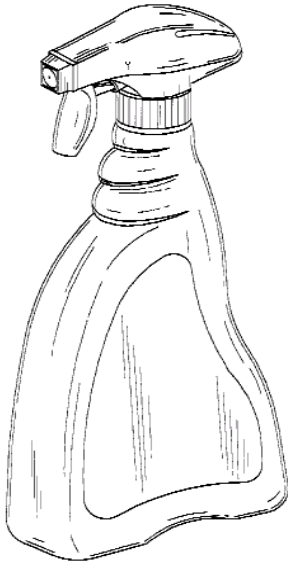

Example of a design for packaging with a trigger type spray.

**686 Top, overcap or closure continues configuration of body:**

This subclass is indented under subclass 682.  
Design that shows a cap or top member appears to be an extension of the form or shape of the basic container.



Example of a design for packaging with a closure that continues configuration of the body.

**687 And flat side or detail:**

This subclass is indented under subclass 686.  
Design that shows at least one side or area on the body of the design that is smooth, even and level.

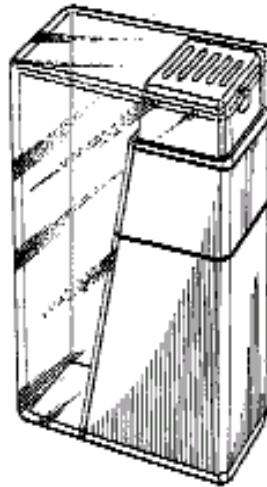

Example of a design for packaging with a closure that continues configuration of the body with a flat side.

**688 Circular in plan:**

This subclass is indented under subclass 686.  
Design that is round with viewed from the top plan aspect.

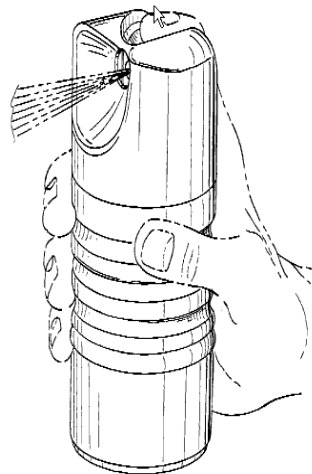

Example of a design for packaging with a closure that continues configuration of the body and is circular in plan.

**689 And tapered or rounded side wall:**  
 This subclass is indented under subclass 688.  
 Design that slopes or becomes gradually narrower or thinner.

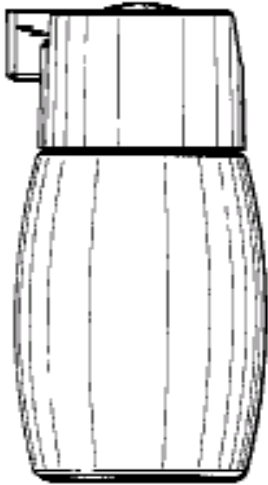

Example of a design for packaging with a closure that continues configuration of the body and circular in plan and tapers.

**690 Substantially circular in plan:**  
 This subclass is indented under subclass 682.  
 Design that is round with viewed from the top.



Example of a design for packaging with gas propellant that is circular in plan.

**691 And tapered sidewall:**  
 This subclass is indented under subclass 690.  
 Design that slopes or becomes gradually narrower or thinner.

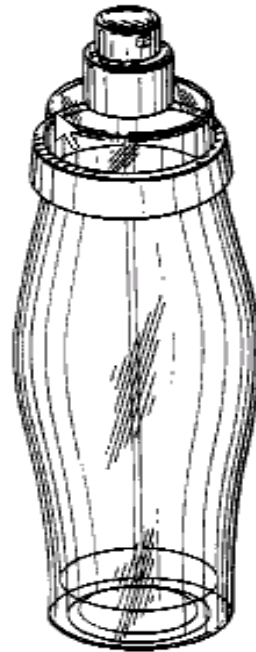

Example of a design for packaging with gas propellant that is circular in plan and tapers.

**692 And vertical or horizontal detail:**  
 This subclass is indented under subclass 691.  
 Design that included vertical or horizontal band or inscribed ornamental line on the body of the design.



Example of a design for packaging with gas propellant that is circular in plan and taper and shows a vertical or horizontal detail.

(1) Note. Closure details not considered.

**693 Asymmetric:**

This subclass is indented under subclass 682. Design under subclass that shows an irregular configuration.

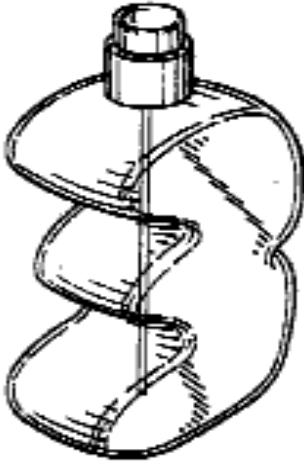

Example of a design for packaging with gas propellant that is asymmetric.

**694 Flat sidewall or detail:**

This subclass is indented under subclass 682. Design under subclass that shows at least one side or area on the body of the design that is smooth, even and level.

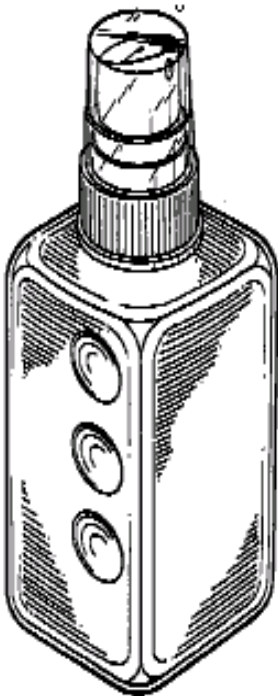

Example of a design for packaging with gas propellant that shows a flat wall or detail.

**695 COLLAPSIBLE TUBE:**

This subclass is indented under the class definition. Design under the class definition for extended, soft cylinder type packaging wherein contents are emptied by squeezing.

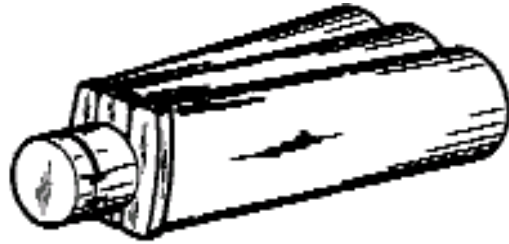

Example of a design for packaging that is a collapsible tube.

- (1) Note. Squeeze type bottle and bottle that stands on the cap end are excluded.

**SEE OR SEARCH THIS CLASS, SUBCLASS:**

- 521, for pointed or downwardly rounded (nonstandable) bottle.  
707, for tear open pouch or bag type container.  
727 through 729, for stick type tube or dispenser.

**SEE OR SEARCH CLASS:**

- D3, Travel Goods and Personal Belongings, subclass 300 for sleeve type tube used for permanent storage.  
D24, Medical and Laboratory Equipment, subclass 110 for medical product.

**696 Liquid capsule type:**

This subclass is indented under subclass 695. Design for small sealed disposable tube for one-time use that cannot be resealed after the closure is removed.

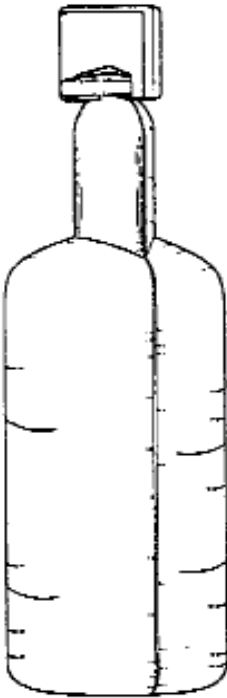

Example of a design for packaging that is a liquid capsule type.

**697 Crimped end:**  
 This subclass is indented under subclass 695.  
 Design that shows one end with a tightly pinched or rolled fold or ridge such as a tooth-paste tube.

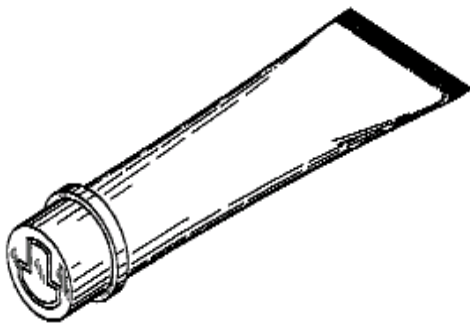

Example of a design for tube a crimped end.

**698 And hanger:**  
 This subclass is indented under subclass 697.  
 Design that includes a member located near the crimped end the permits the tube to be suspended or hung.



Example of a design for packaging a tube with a crimped end with a hanger.

SEE OR SEARCH THIS CLASS, SUB-CLASS:  
 415, for packaging with hanger.

**699 Curved or irregular crimp:**  
 This subclass is indented under subclass 697.  
 Design that shows a crimped end that is bowed, rounded or irregular in shape.

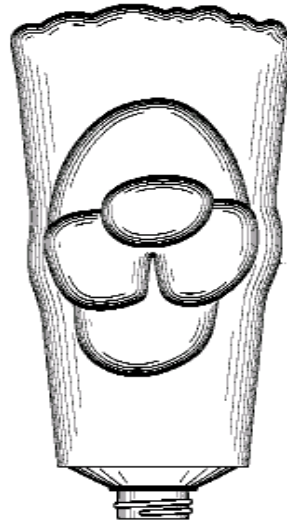

Example of a design for a tube with curved or irregular crimped end.

**700 SEWING KIT, NEEDLE OR BUTTON:**  
 This subclass is indented under the class definition.  
 Design for packaging of articles used to manually connect textiles or for sewing implements or disc shape fastener for textiles.



Example of a design for packaging that is a sewing kit.

- (1) Note. Package may include sewing needles, buttons, thread or the like.

SEE OR SEARCH THIS CLASS, SUBCLASS:

419, for box or packaging container for ribbon, strip or filament.

SEE OR SEARCH CLASS:

D3, Travel Goods and Personal Belongings, subclasses 18 through 29 for hand sewing, knitting and embroidery equipment.

**701 MATCHBOOK TYPE:**

This subclass is indented under the class definition. Design for folding or bending type package configuration used generally for matches.



Example of a design for a matchbook.

- (1) Note. Includes matchbook with simulation.

SEE OR SEARCH CLASS:

D27, Tobacco and Smokers' Supplies, subclasses 172 through 193 for reusable match container.

**702 BAG, POUCH, SLEEVE OR WRAPPER:**

This subclass is indented under the class definition. Design for disposable sack, pocket, or flat piece of package covering material.

SEE OR SEARCH THIS CLASS, SUBCLASS:

444, for sheath or shroud type packaging.

SEE OR SEARCH CLASS:

D3, Travel Goods and Personal Belongings, subclass 303 for pocket type permanent storage container such as a shopping bag or tote; subclasses 304-314 for open top storage container with handle.

D5, Textile or Paper Yard Goods; Sheet Material, subclasses 1 through 62 for printed sheet material.

**703 Bag or sack:**

This subclass is indented under subclass 702.

Design for disposable container of a flexible material with one open end used to carry small items.

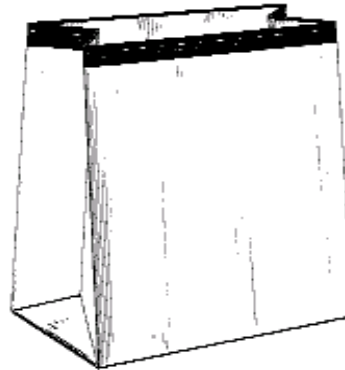

Example of a design for a bag or sack.

SEE OR SEARCH THIS CLASS, SUBCLASS:

720, for bag or sack combined with a diverse article.

SEE OR SEARCH CLASS:

D3, Travel Goods and Personal Belongings, subclass 303 for permanent type shopping bag or tote; subclasses 304-314 for open top storage container with handle.

**704 With bail type handle:**  
 This subclass is indented under subclass 703.  
 Design that includes or provides for a loop-type symmetric holding means.

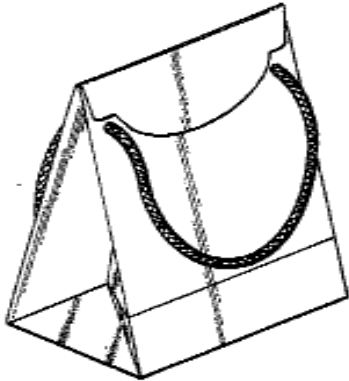

Example of a design for a bag or sack with a bail type handle.

**SEE OR SEARCH CLASS:**  
 D3, Travel Goods and Personal Belongings, subclass 240 for purse of handbag with bail-type handle, subclass 303 for permanent type shopping bag or tote; subclasses 304-314 for open top storage container with handle.

**705 With closure:**  
 This subclass is indented under subclass 703.  
 Design that includes or provides for a provision to cover or close the open end of a bag or sack.

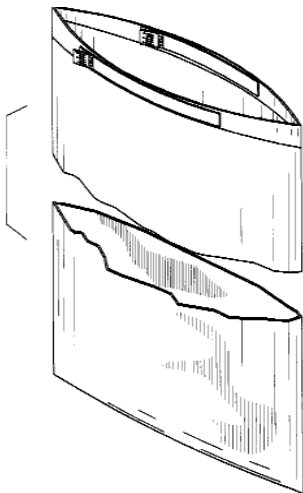

Example of a design for a bag or sack with closure.

**SEE OR SEARCH CLASS:**  
 D3, Travel Goods and Personal Belongings, subclasses 232 through 247 for handbag or purse; subclasses 273-202 for permanent type enclosed storage containers.

**706 Drawstring type:**  
 This subclass is indented under subclass 705.  
 Design that includes or provides for a cinch or pull cord type closure means.



Example of a design for a bag or sack with a drawstring type closure.

**SEE OR SEARCH CLASS:**  
 D3, Travel Goods and Personal Belongings, subclass 244 for purse of handbag with drawstring type closure, subclass 303 for permanent type shopping bag or tote; subclasses 304-314 for open top storage container with handle.

**707 Sealed pouch:**  
 This subclass is indented under subclass 702.  
 Design for sealed, flat, disposable container or bag.

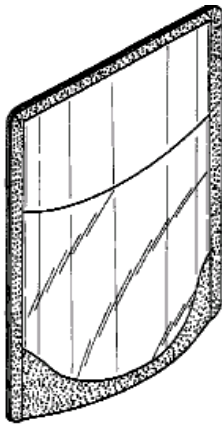

Example of a design for a sealed pouch.

**708 With cap:**

This subclass is indented under subclass 707. Design that includes a seal type closure with a plug type closure that opens to release contents, especially liquids.

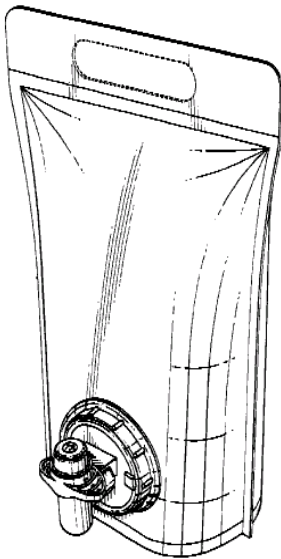

Example of a design for a sealed pouch with a cap.

SEE OR SEARCH THIS CLASS, SUBCLASS:  
435 through 454 , for bottle cap.

**709 Re-sealable type:**

This subclass is indented under subclass 707. Design that shows a provision that permits a subsequent tight seal after the sealed pouch has been opened.

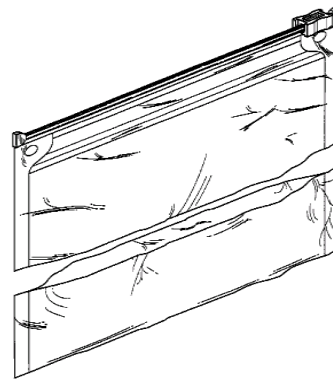

Example of a design for is a sealed pouch that is resealable.

**710 Curved side:**

This subclass is indented under subclass 707. Design for sealed, flat, disposable container that shows a side wall with a sinuous curvature.

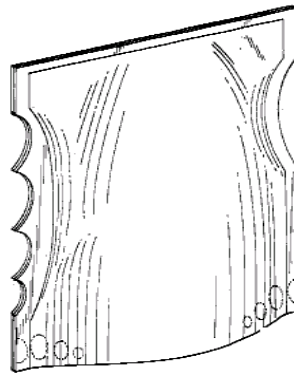

Example of a design for a sealed pouch with a sinuous curvature.

**711 Sleeve or tube:**

This subclass is indented under subclass 702. Design for packaging that fits around an article and is open at both ends such as a coin wrapper or the like.

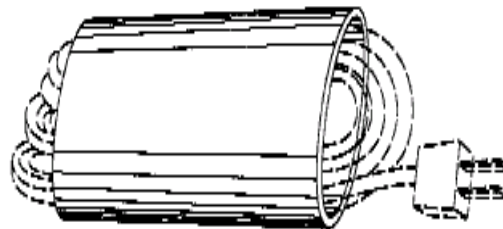

Example of a design for a sleeve type packaging.



- (1) Note. Design may include a handle member.

SEE OR SEARCH THIS CLASS, SUB-CLASS:

- 434, for accessory type handle or carrying member.
- 754, for shroud type compartmented package for bottle, can or cup.

SEE OR SEARCH CLASS:

- D3, Travel Goods and Personal Belongings, subclass 227 for document sleeve.

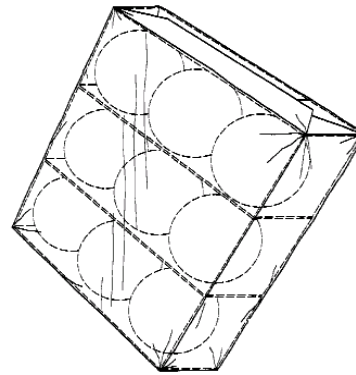

Example of a design for packaging that is a wrapper.

**712 Cone shape:**

This subclass is indented under subclass 710. Design that is triangular in shape when in a flat condition such as a wrapper for flowers, ice cream cone, broom or the like.



Example of a design for packaging that is cone-shaped sleeve.

**713 Wrapper:**

This subclass is indented under subclass 702. Design under subclass for disposable packaging that completely covers or envelops an article or flat sheet material therefore, such as a 'cellophane wrapper.'

SEE OR SEARCH CLASS:

- D5, Textile or Paper Yard Goods; Sheet Material, subclasses 1 through 62 for printed sheet material.
- D19, Office Supplies; Artists' and Teachers' Materials, subclass 3 and 4 for envelop; subclass 5 for safety paper with continuous background.

**714 With twist type closure:**

This subclass is indented under subclass 712. Design that shows a provision for closing a wrapper by turning or twisting both ends.



Example of a design for packaging that shows a twist type closure.

SEE OR SEARCH CLASS:

- D21, Games, Toys, and Sports Goods, subclass 405 for party popper type.

**715 COMBINED WITH DIVERSE ARTICLE:**

This subclass is indented under the class definition. Design that shows or includes a diverse article that, if claimed separately, would be subject matter for classification in another design class.

- (1) Note. Package combined with packaging element in Class D9, such as bottle and cap or package with holder or tear strip,

should be classified in a subsequent subclass class.

- (2) Note. Broken line disclosure is considered.
- (3) Note. Includes articulated packaged in shrink-wrap type wrapper only.

**SEE OR SEARCH THIS CLASS, SUBCLASS:**

- 303, for sewing kit-type packaging.
- 338, for packaging in combination with roller-type applicator or deodorant dispensing means.
- 436, for packaging in combination with applicator.
- 501, for packaging in combination with another packaging container.
- 517, for packaging in combination with bottle, jug, jar or can.
- 737 through 747, for compartmented bottle, jar or can.
- 744, for nested type bottle, jar or can.

**SEE OR SEARCH CLASS:**

- D4, Brushware, subclass 114 for fountain brush; subclass 116 for nail enamel container combined with brush.
- D20, Sales and Advertising Equipment, subclass 40 for calling card holder.
- D24, Medical and Laboratory Equipment, subclass 223 for diagnostic or "test kit."
- D28, Cosmetic Products and Toilet Articles, subclasses 66 through 68 for dental floss dispenser or holder.

**716 With cup:**

This subclass is indented under subclass 715. Design showing disposable packaging and an open type container for a liquid.

- (1) Note: Includes eyecup.

**SEE OR SEARCH THIS CLASS, SUBCLASS:**

- 751 through 755, for compartmented container for bottle or cup only.
- 761 through 762, for compartmented container for food.

**SEE OR SEARCH CLASS:**

- D7, Equipment for Preparing or Serving Food or Drink Not Elsewhere Specified, subclasses 509 through 538 for drinking glass or cup, subclasses 605-608 for thermos type container.
- D16, Photography and Optical Equipment, subclasses 300 through 329 for eye-wear that includes an eyecup.

**716 With cup:**

This subclass is indented under subclass 715. Design showing disposable packaging and an open type container for a liquid.

- (1) Note: Includes eyecup.

**SEE OR SEARCH THIS CLASS, SUBCLASS:**

- 751 through 755, for compartmented container for bottle or cup only.
- 761 through 762, for compartmented container for food.

**SEE OR SEARCH CLASS:**

- D7, Equipment for Preparing or Serving Food or Drink Not Elsewhere Specified, subclasses 509 through 538 for drinking glass or cup, subclasses 605-608 for thermos type container.
- D16, Photography and Optical Equipment, subclasses 300 through 329 for eye-wear that includes an eyecup.

**717 With eating utensil:**

This subclass is indented under subclass 715. Design showing a member used for the purpose of consuming food, such as a spoon, fork or straw.

**SEE OR SEARCH CLASS:**

- D7, Equipment for Preparing or Serving Food or Drink Not Elsewhere Specified, subclasses 642 through 663 for place setting, table service of handle therefore, subclass 300.2 for thermos straw.

**718 With tool:**

This subclass is indented under subclass 715. Design that includes a member used to work or fashion another material.

**SEE OR SEARCH CLASS:**

- D8, Tools and Hardware, subclasses 14 through 106 for hand tool.  
 D28, Cosmetic Products and Toilet Articles, subclasses 10 through 91 for cosmetic type hand tool.

**719 Bottle and diverse article:**

This subclass is indented under subclass 715. Design under subclass that includes a disposable receptacle having a narrow neck, usually without handles and a mouth that can be plugged, corked or capped.

**SEE OR SEARCH THIS CLASS, SUBCLASS:**

- 516 through 575, for designs for bottles, per se.  
 739, for package or bottles or bottle with support or holder.

**720 Bag and diverse article:**

This subclass is indented under subclass 715. Design that includes a disposable receptacle of a flexible material with one open end used to carry small items.

**SEE OR SEARCH THIS CLASS, SUBCLASS:**

- 703, for designs for bag or sack, per se.

**721 Box and diverse article:**

This subclass is indented under subclass 715. Design that includes a disposable carton type receptacle.

**SEE OR SEARCH THIS CLASS, SUBCLASS:**

- 414 through 433, for designs for box or packaging, per se.

**722 Hanger or card and diverse article:**

This subclass is indented under subclass 715. Design that includes a flat type backing or member from which the diverse article may be suspended.

**SEE OR SEARCH THIS CLASS, SUBCLASS:**

- 415, for designs for packaging with hanger, per se.

**723 APPLICATOR TYPE:**

This subclass is indented under the class definition. Design for disposable packaging that includes a distinctive means to apply liquid or semi-liquid.

**SEE OR SEARCH THIS CLASS, SUBCLASS:**

- 516 through 575, for squeeze type bottle.  
 900, for dauber.

**SEE OR SEARCH CLASS:**

- D4, Brushware, subclasses 104 through 113 for toothbrush; subclass 114 for fluid material dispenser such as fountain brush; subclass 16 for nail polish brush and bottle.  
 D19, Office Supplies; Artists' and Teachers' Materials, subclasses 41 through 51 for marking instruments including bingo type dauber or marker.  
 D28, Cosmetic Products and Toilet Articles, subclass 7 and 8 for cosmetic product; subclasses 8.1 and 8.2 for soap; subclass 20 for washing, dying or fluid treatment; subclasses 66-68 for dental floss or pick; subclass 91.1 for perfume type atomizer.

**724 Pointed tip:**

This subclass is indented under subclass 723. Design that includes and shows a tapered opening for applying or dispensing the contents.

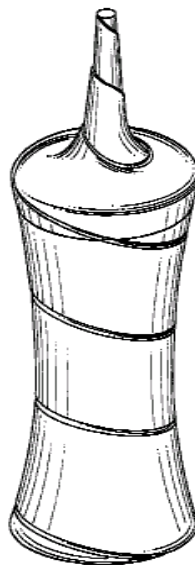

Example of a design for an applicator with a pointed tip.

SEE OR SEARCH THIS CLASS, SUB-CLASS:

695 through 699, for collapsible tube, e.g., toothpaste tube.

**725 Sponge:**

This subclass is indented under subclass 723. Design that includes and shows a porous or cellulose application member.

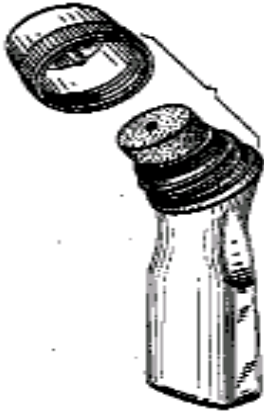

Example of a design for an applicator with a sponge member.

SEE OR SEARCH CLASS:

D28, Cosmetic Products and Toilet Articles, subclass 7 for sponge type cosmetic applicator for products such as lotions or skin care.

D32, Washing Cleaning, or Drying Machine, subclass 40 for sponge.

**726 Ball or roller:**

This subclass is indented under subclass 723. Design that shows a spherical or cylindrical shaped applicator member.

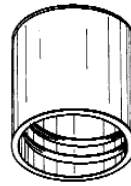

Example of a design for packaging that is an applicator with a ball or roller.

**727 Stick type:**

This subclass is indented under subclass 723. Design that includes and shows or shows a provision for a stick shaped product.



Example of a design for packaging that is an applicator for a stick type product.

- (1) Note. Includes glue stick, deodorant stick, detergent stick, shoe polish stick and the like.

SEE OR SEARCH CLASS:

D28, Cosmetic Products and Toilet Articles, subclasses 7 and 8 for applicator or template type cosmetic product.

**728 With provision for pattern discharge:**

This subclass is indented under subclass 727. Design that includes and shows a provision for applying product in an ornamental pattern.

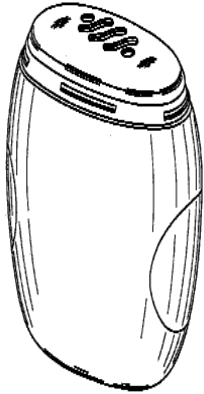

Example of a design for packaging that is an applicator for a stick type product that provides for a pattern discharge.

**729 With knob or dial:**

This subclass is indented under subclass 727. Design that shows a knob or dial used to apply or dispense the product.

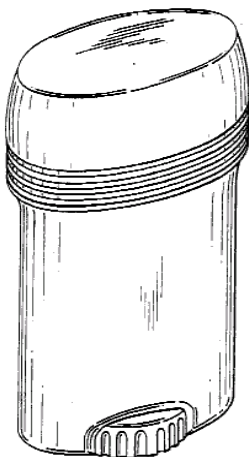

Example of a design for packaging that is an applicator for a stick type product with a knob or a dial.

**730 SEQUENTIAL DISCHARGE OF CONTENTS:**

This subclass is indented under the class definition. Design that shows a provision to dispense articles in particular or set order.

SEE OR SEARCH THIS CLASS, SUBCLASS:

304, for matchbook-type packaging.  
419, for ribbon, strip or filament dispenser.

SEE OR SEARCH CLASS:

- D3, Travel Goods and Personal Belongings, subclasses 203 through 203.2 for medication storage container or pill box.
- D6, Furnishings, subclasses 515 through 523 for sequential article dispenser.
- D7, Equipment for Preparing or Serving Food or Drink Not Elsewhere Specified, subclasses 300 through 322 for beverage or liquid serving or dispenser; subclasses 590-600 for condiment dispenser; subclasses 591-597 for salt or pepper shaker.
- D18, Printing and Office Machinery, subclass 43 for container for toner or photographic developing-type chemical.
- D20, Sales and Advertising Equipment, subclasses 1 through 7 for vending machine.
- D24, Medical and Laboratory Equipment, subclass 223 for diagnostic or "test kit."
- D32, Washing, Cleaning, or Drying Machine, subclass 75 for laundry sprinkler.
- 206, Special Receptacle or Package, subclass 807 for tamper proof packages.

**731 Dial type:**

This subclass is indented under subclass 730. Design for package that turns, twists or swivels to release individual units in a set order or sequence.

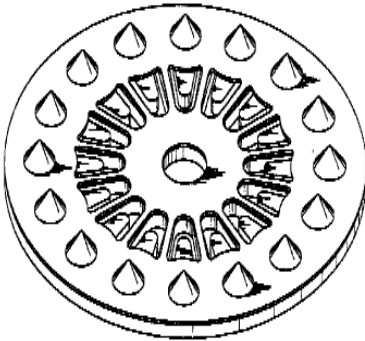

Example of a design for packaging that shows a dial type sequential product discharge.

**SEE OR SEARCH CLASS:**

D3, Travel Goods and Personal Belongings, subclass 203.4 for dial type pill-box.

**732 Blister type:**

This subclass is indented under subclass 730. Design for package showing a rounded or bubble type structure displays and protects contents and breaks to release an individual unit such a tablet, in a set order or sequence.

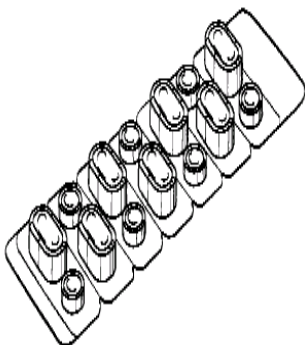

Example of a design for packaging that shows a blister type sequential product discharge.

**SEE OR SEARCH THIS CLASS, SUB-CLASS:**

418, for package with transparent window feature.

**SEE OR SEARCH CLASS:**

206, Special Receptacle or Package, subclass 531 for "press out" of contents; subclass 828 for medicinal contents.

D3, Travel Goods and Personal Belongings, subclasses 203.2 through 203.8 for medication storage container or pill box.

**733 Gravity type:**

This subclass is indented under subclass 730. Design for package that releases an individual unit by dropping or falling in a set order or sequence.

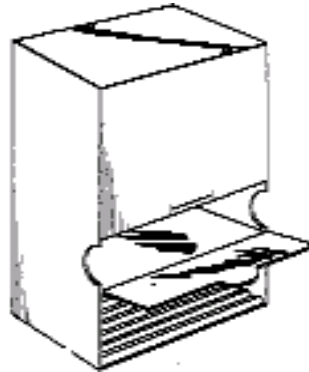

Example of a design for packaging that shows gravity type sequential product discharge.

**734 For tissue or folded sheet material:**

This subclass is indented under subclass 730. Design for package that releases individual sheet type product such as a tissues or cigarette papers in an established order or sequence.



Example of a design for packaging for tissue or folded sheet material.

**SEE OR SEARCH CLASS:**

D5, Textile or Paper Yard Goods; Sheet Material, subclasses 1 through 62 for sheet material.

- D6, Furnishings, subclasses 517 through 523 for interfolded sheet or roll dispenser.
- 206, Special Receptacle or Package, subclass 812 for packaged towel; subclass 823 for cosmetic or toilet article.

**735 For cutting or razor blade:**  
 This subclass is indented under subclass 730. Design for package that sequentially releases razor blades or a dispenser for blade cartridges.

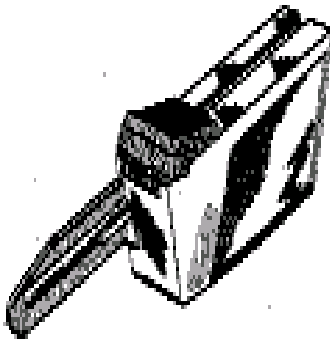

Example of a design for packaging for razor blade discharge.

**736 Open or tray type:**  
 This subclass is indented under subclass 735. Design wherein the razor or cutting blade units are situated side by side in a shallow, flat receptacle.

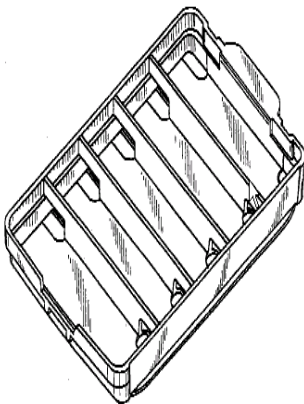

Example of a design for packaging for tray type razor blade discharge.

SEE OR SEARCH THIS CLASS, SUBCLASS:  
 737 through 762, for generic compartmented package.

**737 COMPARTMENTED OR WITH DISTINCT PLURAL SUPPORT AREAS**  
 This subclass is indented under the class definition. Design for disposable packaging showing two or more distinct and separate depressions or surrounds for articles.

(1) Note. Includes single bottle shown with separate support.

SEE OR SEARCH THIS CLASS, SUBCLASS:  
 730 through 734, for with dispensing feature.

- SEE OR SEARCH CLASS:
- D7, Equipment for Preparing or Serving Food or Drink Not Elsewhere Specified, subclasses 553.1 through 555 for compartmented food tray or serving dish.
  - D24, Medical and Laboratory Equipment, subclasses 227 through 230 for diagnostic or compartmented medical type patient tray.
  - D27, Tobacco and Smokers' Supplies, subclasses 186 through 192 for storage container for tobacco product.

**738 Bottle, jar or can:**  
 This subclass is indented under subclass 737. Design for compartmented bottle or set of bottles packaged together.

**739 Includes holder or detachable support:**  
 This subclass is indented under subclass 738. Design that includes a surround or containing device.

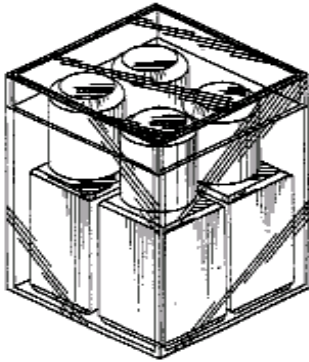

Example of a design for bottles with a holder.

SEE OR SEARCH THIS CLASS, SUB-CLASS:

434, for accessory handle intended to attach to a single bottle.

752, for compartmented device intended to grip plural bottles or cans at the neck area.

**740 Includes integral horizontal connecting member:**

This subclass is indented under subclass 738. . Design for bottles that are attached to one another by a structural member.

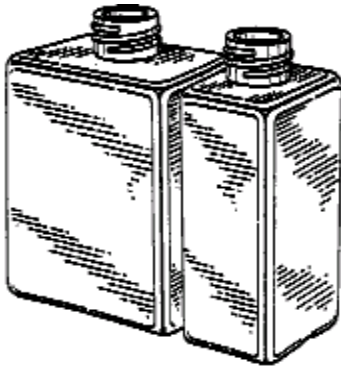

Example of a design for compartmented bottle with an integral horizontal connecting member.

**741 With plural opening or closure:**

This subclass is indented under subclass 738. Design that shows two or more caps, plugs or closure members.

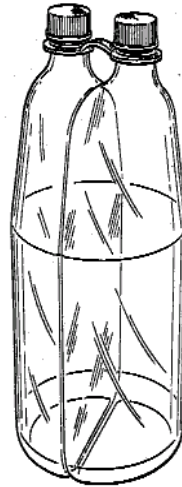

Example of a design for compartmented bottle with plural opening.

**742 And distinct handle:**

This subclass is indented under subclass 741. Design that shows plural bottle, jar or can that includes a carrying member.

**743 Interlocking:**

This subclass is indented under subclass 741. Design that shows plural bottle, jar or can that lock into or connect with one another.

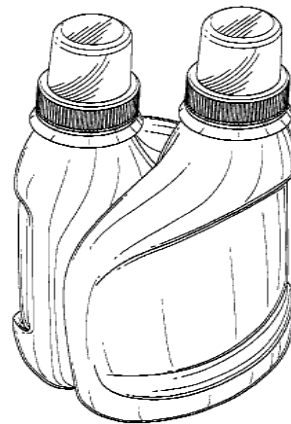

Example of a design for interlocking plural bottle.

**744 Nesting:**

This subclass is indented under subclass 741. Design for plural bottle, jar or can that show a cavity or provision to hold another bottle.





Example of a design for nesting plural bottle.

- 745 Stacking:**  
This subclass is indented under subclass 741. Design that rest on top of one another.
- 746 Visible thread or screw detail:**  
This subclass is indented under subclass 745. Design that shows closure type thread members.



Example of a design for compartmented bottle with visible tread or screw detail.

- 747 Three or more openings:**  
This subclass is indented under subclass 741. Design with three or more openings.
- 748 For razor or shaving accessory:**  
This subclass is indented under subclass 737. Design with plural and separate areas for holding a shaving type razor and or accessories therefore.

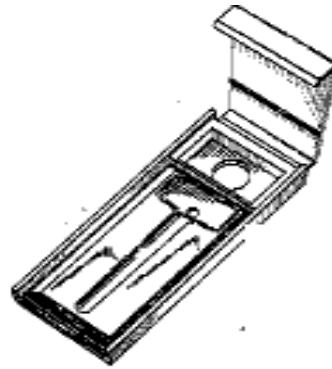

Example of a design for compartmented packaging for razor or shaving accessory.

- SEE OR SEARCH THIS CLASS, SUB-CLASS:  
736, for package sequential dispenser for razor blades.  
737, for tray type sequential dispenser for razor blades.

- SEE OR SEARCH CLASS:  
D3, Travel Goods and Personal Belongings, subclass 205 for storage container for personal grooming article.

- 749 Open tray type:**  
This subclass is indented under subclass 748. Design for shallow receptacle with raised rim for holding razor and or accessories.

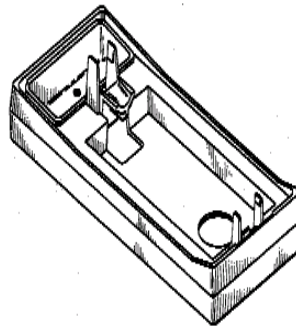

Example of a design for compartmented tray type packaging for razor or shaving accessory.

- SEE OR SEARCH THIS CLASS, SUB-CLASS:  
736, for package sequential dispenser for razor blades.  
737, for tray type sequential dispenser for razor blades.

**SEE OR SEARCH CLASS:**

D3, Travel Goods and Personal Belongings, subclass 205 for storage container for persona grooming article.

**750 For light bulb or light string:**

This subclass is indented under subclass 737. Design for holding device to project incandescent light bulbs or a series of light bulbs connected with cord.

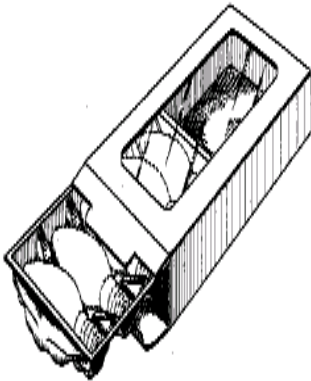

Example of a design for compartmented packaging for light bulb.

**751 For bottle, can or cup only:**

This subclass is indented under subclass 737. Design for holding beverage type containers or containers of liquid only.

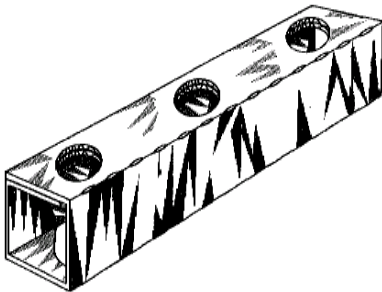

Example of a design for compartmented packaging for bottle, can or cup only.

**SEE OR SEARCH THIS CLASS, SUBCLASS:**

761 through 762, for compartmented packaging for food.

**SEE OR SEARCH CLASS:**

D7, Equipment for Preparing or Serving Food or Drink Not Elsewhere Specified, subclasses 550.1 through 53.8 for tray with provision for beverage container; subclass 596 for holder or caddy for cruet or decanter.

**752 Engages rim, top or neck only:**

This subclass is indented under subclass 751. Design for package that grasps the upper portion or the article it holds or contains.

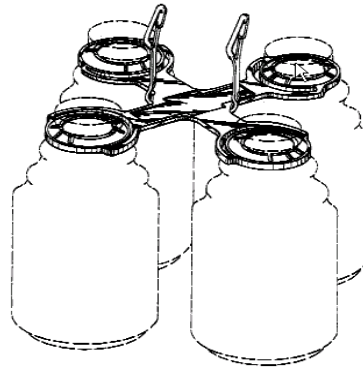

Example of a design for compartmented packaging for bottle, can or cup that engages the rim, top or neck only.

(1) Note. Includes glue stick, deodorant stick, detergent stick, shoe polish stick and the like.

**SEE OR SEARCH THIS CLASS, SUBCLASS:**

434, for accessory handle for carrying a single bottle or package.

**SEE OR SEARCH CLASS:**

D7, Equipment for Preparing or Serving Food or Drink Not Elsewhere Specified, subclasses 701 through 708 for holder for multiple food container.

**753 Includes projecting handle:**

This subclass is indented under subclass 751. Design for holding beverage type containers or containers of liquid that includes a provision or member that permits being held in the hand.

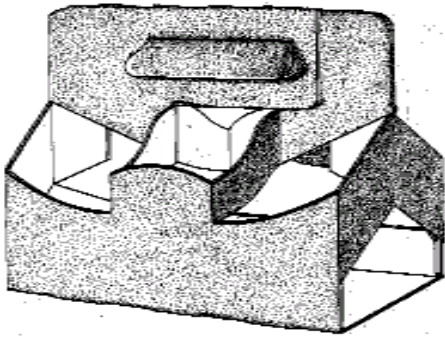

Example of a design for compartmented packaging for bottle, can or cup only with a projecting handle.

**SEE OR SEARCH CLASS:**

- D3, Travel Goods and Personal Belongings, subclasses 315 through 316 for carrier or caddy.
- D7, Equipment for Preparing or Serving Food or Drink Not Elsewhere Specified, subclasses 550.1 through 53.8 for tray with provision for beverage container; subclass 596 for holder or caddy for cruet or decanter.

**754 Shroud type:**

This subclass is indented under subclass 751. Design for holding beverage type containers or containers of liquid that wraps around and surrounds in a sleeve type configuration.

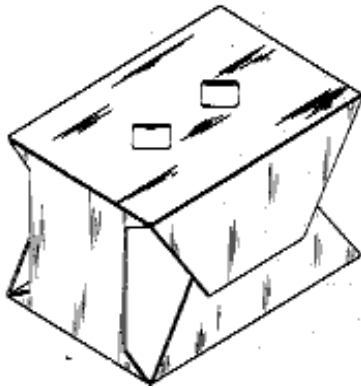

Example of a design for shroud type packaging for bottle, can or cup only.

**SEE OR SEARCH THIS CLASS, SUBCLASS:**

- 711, for sleeve or tube.
- 713, for wrapper, per se.

**755 Open tray type:**

This subclass is indented under subclass 751. Design for holding beverage type containers or containers of liquid in an open or uncovered condition.

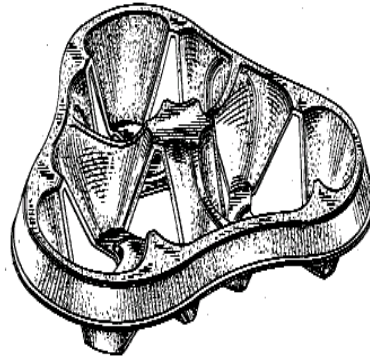

Example of a design for open tray type packaging for bottle, can or cup only.

**756 Repeating identical compartment:**

This subclass is indented under subclass 737. Design that shows plural depressions or areas that are each exactly like.

**757 For egg or ball shape:**

This subclass is indented under subclass 756. Design for holding ovoid or sphere shaped objects.

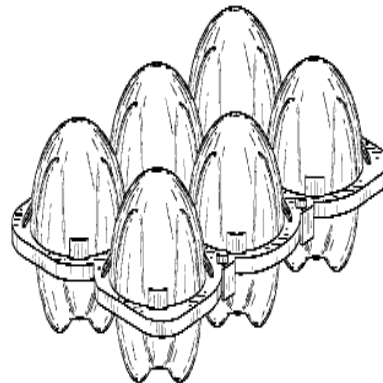

Example of a design for compartmented type packaging for egg or ball shape.

**SEE OR SEARCH THIS CLASS, SUBCLASS:**

- 762, for non-identical depressions that includes provision for egg or the like.

**758 Open tray type:**

This subclass is indented under subclass 757.  
Design for tray that is not covered or without lid.

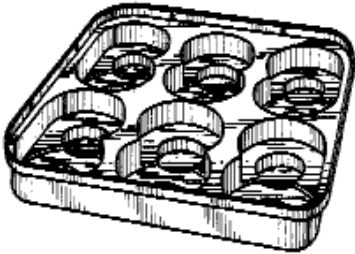

Example of a design for compartmented, open tray type packaging for egg or ball shape.

**759 Rectangular or square depression:**

This subclass is indented under subclass 756.  
Design for holding items that shows four flat perimeter edges.

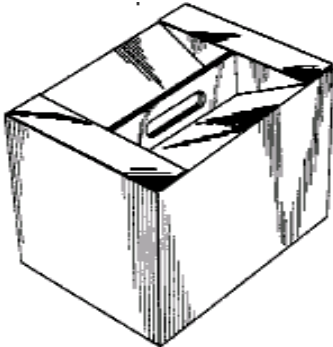

Example of a design for compartmented type packaging with a rectangular or square depression.

**760 Open tray type:**

This subclass is indented under subclass 759.  
Design for holding items that are rectangular or square.

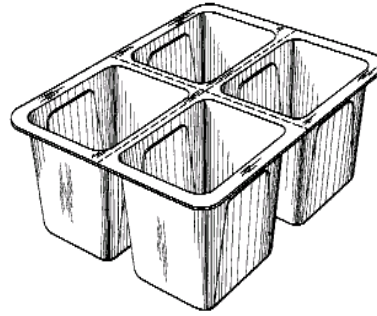

Example of a design for compartmented, open tray type packaging with a rectangular or square depression.

**761 Food specific:**

This subclass is indented under subclass 737.  
Design that for edible food products.

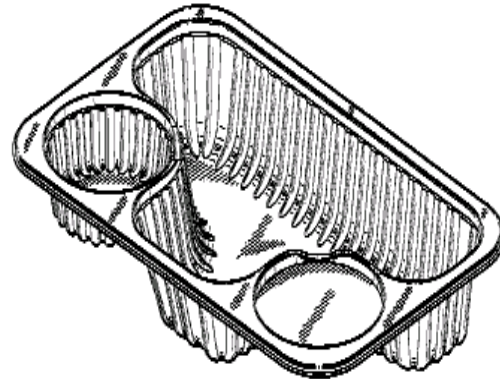

Example of a design for compartmented type packaging that is food specific.

SEE OR SEARCH THIS CLASS, SUB-CLASS:

751 through 754, for beverage bottle, can or cup.

**762 With provision for egg or the like:**

This subclass is indented under subclass 761.  
Design that includes an area or areas to hold ovoid food product such as a hen egg.

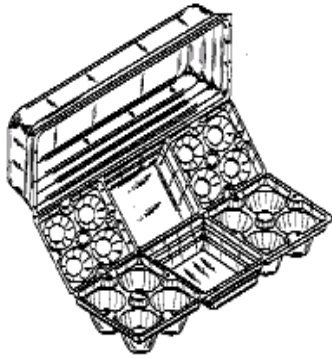

Example of a design for compartmented type packaging that is food specific with provision for egg or the like.

**763 CAN:**

This subclass is indented under the class definition. Design for a disposable container with rigid surfaces that shows at least one chime or welded type seam.

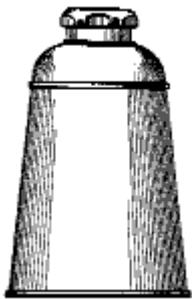

Design for a can.

- (1) Note. Includes body for aerosol can if spray or pump member is not shown.
- (2) Note. Includes part or portion of can body.

**SEE OR SEARCH THIS CLASS, SUBCLASS:**

- 682 through 694 , for aerosol type can or pump type container.
- 715, for can combined with diverse article.
- 738 through 747 , for can with compartments or with distinct support areas.

**SEE OR SEARCH CLASS:**

- D23, Environmental Heating and Cooling; Fluid Handling and Sanitary Equipment, subclasses 211.1 and 211.2 for gasoline or fuel type storage container.
- D32, Washing, Cleaning, or Drying Machine, subclass 29.1 for liquid softener or detergent dispenser for clothes washing machine.

**764 With elongated neck:**

This subclass is indented under subclass 763. Design for a can that includes a substantially extended spout for emptying the contents.



Design for a can with an elongated neck.

**SEE OR SEARCH CLASS:**

- D7, Equipment for preparing or serving food or drink not elsewhere specified, subclass 397 and 398 for spout.
- D23, Environmental Heating and Cooling; Fluid Handling and Sanitary Equipment, subclass 211.1 and 211.2 for gasoline or fuel type storage container.

**765 Vertical chime:**

This subclass is indented under subclass 763. Design for a design that shows a seam member that substantially transverses the height of the can.



Design for a can with a vertical chime.

SEE OR SEARCH THIS CLASS, SUB-CLASS:

666, for container that simulates a shell.

**766 Base shape merges into a different shape at container top:**

This subclass is indented under subclass 763. Design for a design that shows a distinct configuration at the bottom of the design that gradually changes into different configuration near the upper portion of the can.

**767 Circular or oval base:**

This subclass is indented under subclass 766. Design that shows a round or oval configuration at the bottom.

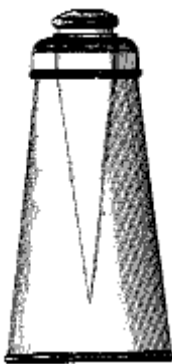

Design for a can with an oval base that merges into a different shape at the top.

**768 Polygon base:**

This subclass is indented under subclass 766. Design that shows a base with substantially flat sides on the bottom.

**769 Triangular:**

This subclass is indented under subclass 768. Design that shows three edges on the bottom.

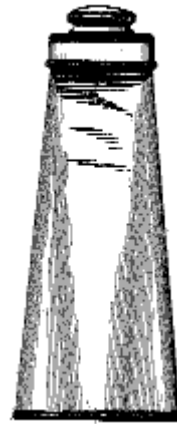

Design for a can with a triangular base that merges into a different shape at the top.

**770 Rectangular or square:**

This subclass is indented under subclass 768. Design that shows four edges on the bottom.

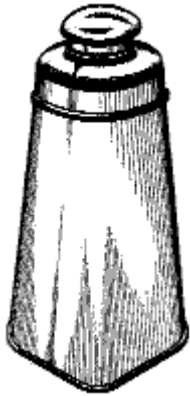

Design for a can with a rectangular or square base that merges into a different shape at the top.

**771 Hexagonal:**  
 This subclass is indented under subclass 768.  
 Design that shows six edges only on the bottom.

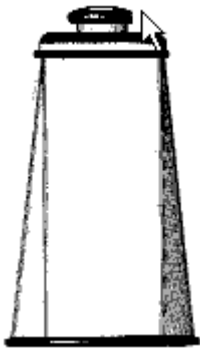

Design for a can with a rectangular base that merges into a different shape at the top.

**772 Circular in plan:**  
 This subclass is indented under subclass 763.  
 Design that shows a round configuration as viewed from the plan aspect.



Design for a can with a circular configuration viewed from the top.

SEE OR SEARCH THIS CLASS, SUBCLASS:  
 688 through 692 , for circular aerosol type can.

**773 With distinct sidewall surface texture or detail:**  
 This subclass is indented under subclass 772.  
 Design that shows ornamental markings or indentations on the side or sides of the can.



Design for a can with a circular configuration viewed from the top with distinct sidewall texture or detail.

**774 Repeating vertical lines or grooves:**  
 This subclass is indented under subclass 773.  
 Design that shows markings or indentations on the side that extend from the bottom area toward the top.

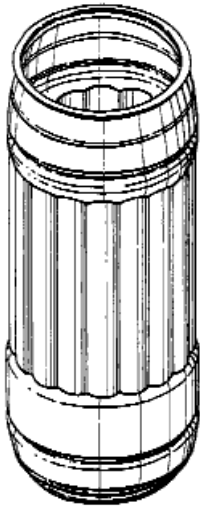

Design for a can with a circular configuration viewed from the top with repeating vertical lines or grooves.

SEE OR SEARCH THIS CLASS, SUB-CLASS:

692, for aerosol can with vertical or horizontal detail.

**775 Repeating helical lines or grooves:**

This subclass is indented under subclass 773. Design that shows spiral marking or indentation that extends from the bottom area toward the top.



Design for a can with a circular configuration viewed from the top with repeating helical lines or grooves.

- 776 Curved or undulating sidewall or detail:**  
This subclass is indented under subclass 772. Design that shows a rounded or wavy side.



Design for a can with a circular configuration viewed from the top with an undulating sidewall.

**777 Having tapered body:**

This subclass is indented under subclass 772. Design with body that narrows from top to bottom or from bottom to top.



Design for a can with a circular configuration viewed from the top with a tapered body.

**778 Wide mouth:**

Design under 777 wherein the opening at the top is substantially the same width as the body of the can.



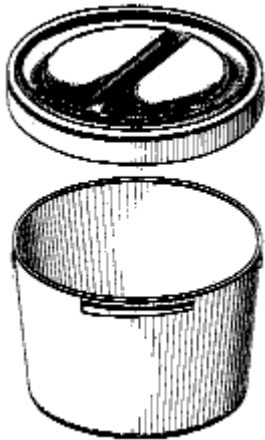

Design for a can with a circular configuration viewed from the top with a tapered body and a wide mouth.

**779 Wide mouth:**

This subclass is indented under subclass 772. Design wherein the opening at the top is substantially the same width as the body of the can.

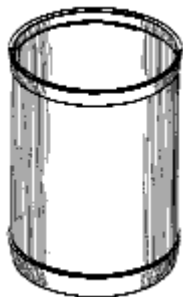

Design for a can with a circular configuration viewed from the top and a wide mouth.

**780 And lid:**

This subclass is indented under subclass 779. Design that includes a cover member.

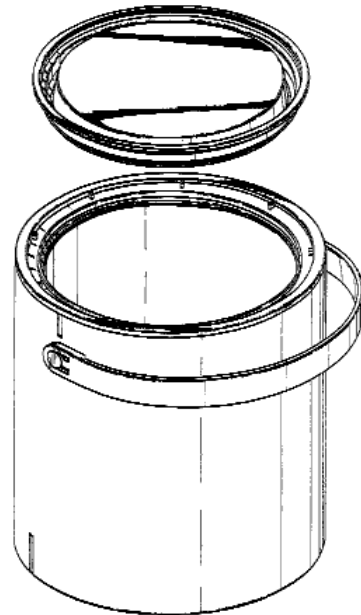

Design for a can with a circular configuration viewed from the top with a tapered body, a wide mouth and a lid.

**781 Oval in plan:**

This subclass is indented under subclass 763. Design that shows an ovoid configuration when viewed from the top or bottom.

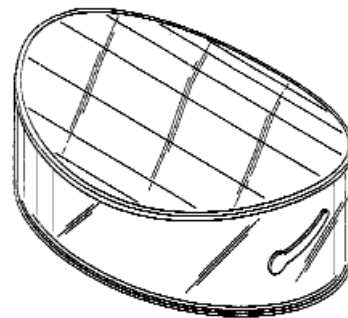

Design for a can with an oval configuration viewed from the top.

**782 Polygon in plan:**

This subclass is indented under subclass 763. Design that shows more than three sides when viewed from the top or bottom.

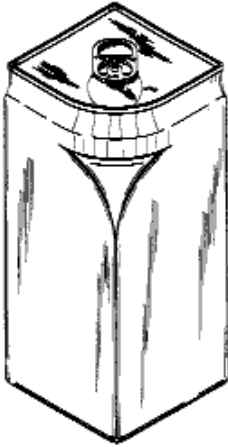

Design for a can with a polygon configuration viewed from the top (and tapered side).

**783 Having tapered sides:**

This subclass is indented under subclass 782. Design that narrows from top to bottom or from bottom to top.

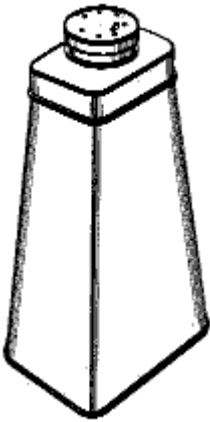

Design for a can with a polygon configuration viewed from the top and tapered sides.

**CROSS-REFERENCE ART COLLECTIONS**

**900 DAUBER:**

This subclass is indented under the class definition. Collections of designs for bottles that include and show a suspended rod type applicator member.

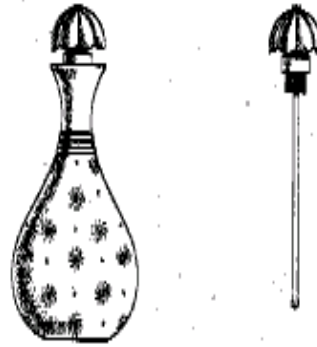

Example of a design for bottle that includes a dauber.

**901 CONTAINER WITH TEAR STRIP OPENING:**

This subclass is indented under the class definition. Collection of designs that show a sealed container that may be opened by pulling a string or filament or narrow slip.

**902 CONTAINER WITH PULL TAB TYPE OPENING:**

This subclass is indented under the class definition. Collection of designs that shows a sealed container that may be opened by pulling a small projecting flap.

**903 CARBONATED BEVERAGE CAN:**

This subclass is indented under the class definition. Collection of designs that cans designed to contain a carbonated type beverage.

**904 CONTAINER WITH DISTINCE BOTTOM SURFACE DETAIL:**

This subclass is indented under the class definition. Collection of designs that show a distinctive configuration or design on the underside of the can.

**905 SHAKER TYPE:**

This subclass is indented under the class definition. Collection of designs with apertures to dispense the contents by agitation.

**906 PAINT CAN:**

This subclass is indented under the class definition. Collection of designs for colorant or sealing material.

(1) Note. Excludes aerosol paint can.

**907 BAIL HANDLE OR PROVISION THERE-  
FOR:**

This subclass is indented under subclass 906.  
Collection of designs indented with loop type  
protrusion for holding or provision therefor.

**SEE OR SEARCH CLASS:**

D3, Travel Goods and Personal Belong-  
ings, subclass 240 for handbag or  
purse with bail handle.

END