

NTIA Report 96-333

# Testing and Evaluation of the Subcarrier Traffic Information Channel

John F. Mastrangelo  
Wayne F. Rust

The logo consists of the letters 'NTIA' in a bold, white, sans-serif font. The letters are set against a solid black rectangular background. The 'N' and 'A' have a slight 3D effect with a shadow on the bottom right.

report series

---

U.S. DEPARTMENT OF COMMERCE • National Telecommunications and information Administration



# Testing and Evaluation of the Subcarrier Traffic Information Channel

**John F. Mastrangelo**  
**Wayne R. Rust**



**U.S. DEPARTMENT OF COMMERCE**  
**Mickey Kantor, Secretary**

Larry Irving, Assistant Secretary  
for Communications and Information

September 1996

## PRODUCTDISCLAIMER

Certain commercial companies, equipment, instruments, and materials are identified in this report to specify adequately the technical aspects of the reported results. In no case does such identification imply recommendation or endorsement by the National Telecommunications and Information Administration, nor does it imply that the material or equipment identified is necessarily the best available for the purpose.

# CONTENTS

	Page
PRODUCTDISCLAIMER .....	iii
ABSTRACT.....	1
1. INTRODUCTION .....	1
2. STIC SYSTEM DESCRIPTION .....	2
3. LABORATORY EVALUATION .....	2
3.1 Laboratory Testing .....	3
3.2 Laboratory Results .....	4
4. STIC FIELD TESTING AND EVALUATION .....	6
4.1 STIC Installation .....	6
4.2 Route Planning .....	8
4.3 STIC Field Evaluation .....	11
5. CONCLUSIONS .....	37
APPENDIX A: DATA COLLECTION SYSTEM .....	41
APPENDIX B: DATA-PROCESSING METHODOLOGY .....	43
APPENDIX C: CONVERSION OF RECEIVED SIGNAL POWER TO ELECTRIC FIELD STRENGTH .....	47
APPENDIX D: COMPARISON OF PREDICTED AND RECEIVED SIGNAL POWER LEVELS .....	49

# TESTING AND EVALUATION OF THE SUBCARRIER TRAFFIC INFORMATION CHANNEL

John F. Mastrangelo and Wayne R. Rust\*

In support of the Federal Highway Administration of the United States Department of Transportation, the Institute for Telecommunication Sciences has completed a laboratory and field test program designed to independently evaluate the performance of an FM subcarrier-based traveler information broadcast system. This system was developed by the MITRE Corporation to investigate the use of FM subcarriers for the broadcast of traffic data to vehicles on highways. The testing and evaluation program measured the Subcarrier Traffic Information Channel (STIC) system performance both in the laboratory and when installed in the subcarrier channel of a commercial FM broadcast station. STIC performance was measured and evaluated in a variety of reception environments in order to assist in the future prediction of STIC coverage in areas of the United States that differ dramatically in terrain and population density.

Key words: Advanced Traffic Information Systems (ATIS); FM broadcast subcarrier; Intelligent Transportation Systems (ITS); propagation measurements; propagation predictions; Subcarrier Traffic Information Channel (STIC) system

## 1. INTRODUCTION

The United States Department of Transportation (DOT) established the Intelligent Transportation System (ITS) program to use advanced computer, electronics, and communications technologies to improve the effectiveness of the nation's highway system. The goals are to provide travel planning and management, traveler information, energy conservation, and advanced vehicle control to highway users. The Federal Highway Administration (FHWA) contracted the MITRE Corporation to investigate the use of FM subcarriers for the broadcast of traffic data to vehicles on highways to support ITS. In response to this contract, MITRE developed the Subcarrier Traffic Information Channel (STIC) waveform and prototype STIC system to evaluate the potential use of the existing FM broadcast infrastructure to broadcast traffic information. The National Telecommunications and Information Administration/Institute for Telecommunication Sciences (NTIA/ITS) was contracted by the FHWA to perform independent analysis and additional laboratory and field testing of the STIC system. NTIA/ITS measured the STIC system performance when installed in the subcarrier channel of a commercial FM broadcast station. STIC performance was evaluated in a variety of reception environments: urban high-rise, urban low-rise, rural mountain, and rural plains.

---

\*The authors were formerly with the Institute for Telecommunication Sciences, National Telecommunications and Information Administration, U.S. Department of Commerce, Boulder, CO 80303-3328.

## 2. STIC SYSTEM DESCRIPTION

The STIC system is a proof-of-concept prototype developed by the MITRE Corporation under the sponsorship of the ITS program. The prototype is intended to demonstrate the ability to broadcast high-speed digital data using the existing commercial FM broadcast radio infrastructure.

The STIC system is an FM subcarrier-based data transmission and reception system. It is designed to achieve reliable communications in the multipath and fading environment associated with very high frequency (VHF) mobile receivers. To achieve that end, the STIC system uses high levels of signal processing and error correction. The key characteristics of the waveform are:

- 72.2-kHz center frequency,
- 20-kHz bandwidth,
- n/4 DQPSK with square root raised cosine filtering,
- %-rate convolutional code (mitigation of random errors),
- Reed-Solomon (228,243) block code (mitigates burst errors and provides error detection),
- convolutional interleaving (to randomize burst errors), and
- 18.05kbps channel data rate, >8-kbps information data rate.

The prototype STIC system consists of a transmitter subsystem and receiver subsystem. The STIC transmitter subsystem consists of the STIC subcarrier generator and a personal computer (PC). The PC is used to control and configure the subcarrier generator and generate messages for transmission. The subcarrier generator is enclosed in a single rack-mounted chassis. It connects directly to the subcarrier input port of an FM broadcast exciter. The STIC receiver subsystem consists of an FM car stereo receiver (modified to demodulate the subcarrier signal), a Global Positioning System (GPS) antenna, the STIC receiver (which also functions as a GPS receiver), a hand-held data terminal, a data collection PC, and the STIC power supply and harness.

## 3. LABORATORY EVALUATION

The goals of the laboratory testing were to familiarize the NTIMTS engineers with the operation of the STIC system before embarking on the field-testing program, verify adjacent subcarrier and entertainment signal compatibility by measuring the occupancy bandwidth of the STIC signal, and determine the baseline performance under the best possible operating conditions in preparation for field testing. Extensive compatibility testing of the STIC waveform with an audio program or other subcarrier systems was not performed due to time and equipment constraints. The primary purpose of the STIC laboratory performance testing was to measure the system error rates vs. received signal power. Error performance for the STIC system consisted of three performance metrics: channel error rate (CER), bit error rate (BER), and packet error rate (PER). Each of these was measured and recorded for a range of received signal power levels.

### 3.1 Laboratory Testing

Laboratory testing was used to characterize the idealized system error performance (CER, BER, and PER) as a function of the received power level. The received power level is a metric closely associated with radio area coverage. The ultimate goal of the field test program was to predict STIC performance in different geographic environments (i.e., system coverage) by using either known or predicted received signal power levels.

The STIC system can operate in message mode and BER mode. In message mode, the STIC transmits a user-specified message. This message can be generated via the keyboard, a previously stored file, a modem, or any other input device. The message mode was not used during the NTIA/ITS testing. In BER mode, the transmitter continuously sends a BER data pattern that is known by the receiver. By comparing the received BER data pattern with the stored BER data pattern, error rate information can be computed. The STIC prototype can also perform convolutional interleaving of the transmitted data. The convolutional interleaver can operate in one of four modes; denoted x1, x2, x4, or x8. Each mode corresponds to an interleaver depth. Two of the four modes, x1 and x2, were evaluated during laboratory testing. Error performance was divided into three categories: CER, which corresponds to the actual channel error rate; BER, which is post-error-correction bit error rate; and PER, which corresponds to the packet error rate. A packet with errors is defined as a packet containing one or more bit errors. A packet consists of 1824 bits. The laboratory evaluation system is shown in Figure 1.

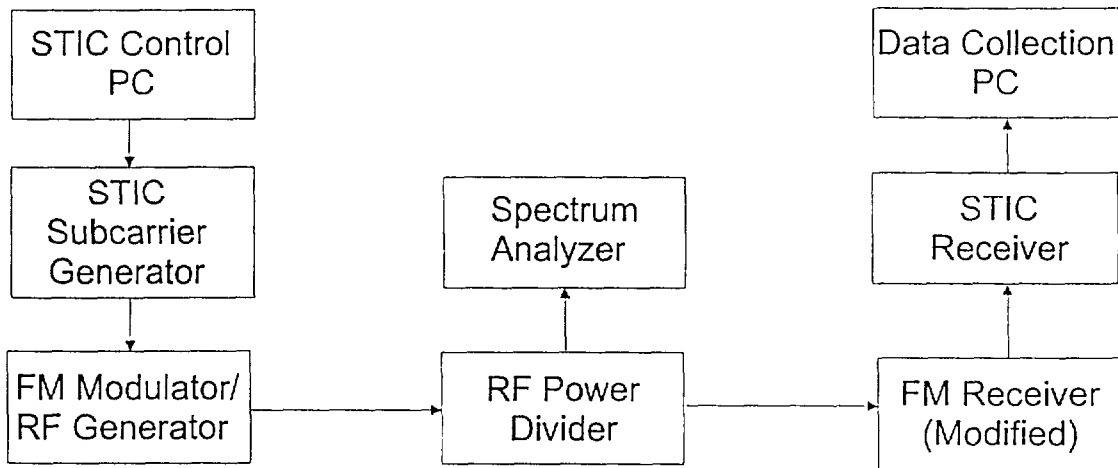

Figure 1. Laboratory test configuration for error rate testing.

In order to simulate the STIC subcarrier signal imposed onto a commercial FM carrier, the STIC signal was modulated using a Fluke 6062A synthesized RF signal generator. The signal generator carrier frequency was set to 100.5 MHz and the FM modulation sensitivity was adjusted for an injection level of 10% for the STIC signal. The carrier frequency was chosen for minimal commercial broadcast energy in the surrounding frequency band. Additionally, the laboratory testing was conducted in the NTIA/ITS screen room to minimize the reception of spurious RF

signals. The RF output of the signal generator was connected to a power divider. The output power of the RF generator was varied using a precision output attenuator contained in the generator. One output of the power divider was routed to a spectrum analyzer for signal power measurements and the other output was routed to the modified FM stereo receiver. The hand-held data terminal and data collection PC were connected to the STIC receiver. The hand-held data terminal was used to configure the STIC receiver and the PC was used to collect and store error information. Laboratory testing of the STIC system consisted of two parts: bandwidth occupancy and error rate testing.

### 3.2 Laboratory Measurement Results

#### 3.2.1 Bandwidth Occupancy Measurements

The STIC waveform was designed to be compatible with the entertainment signal, the 57-kHz Radio Broadcast Data System (RBDS) and the 92-kHz subcarrier channel. This required that the STIC signal power (when injected at 10%) be suppressed by at least 60 dB relative to the carrier level at 62 and 82 kHz. Examination of the STIC signal power spectrum (Figure 2) displayed in the

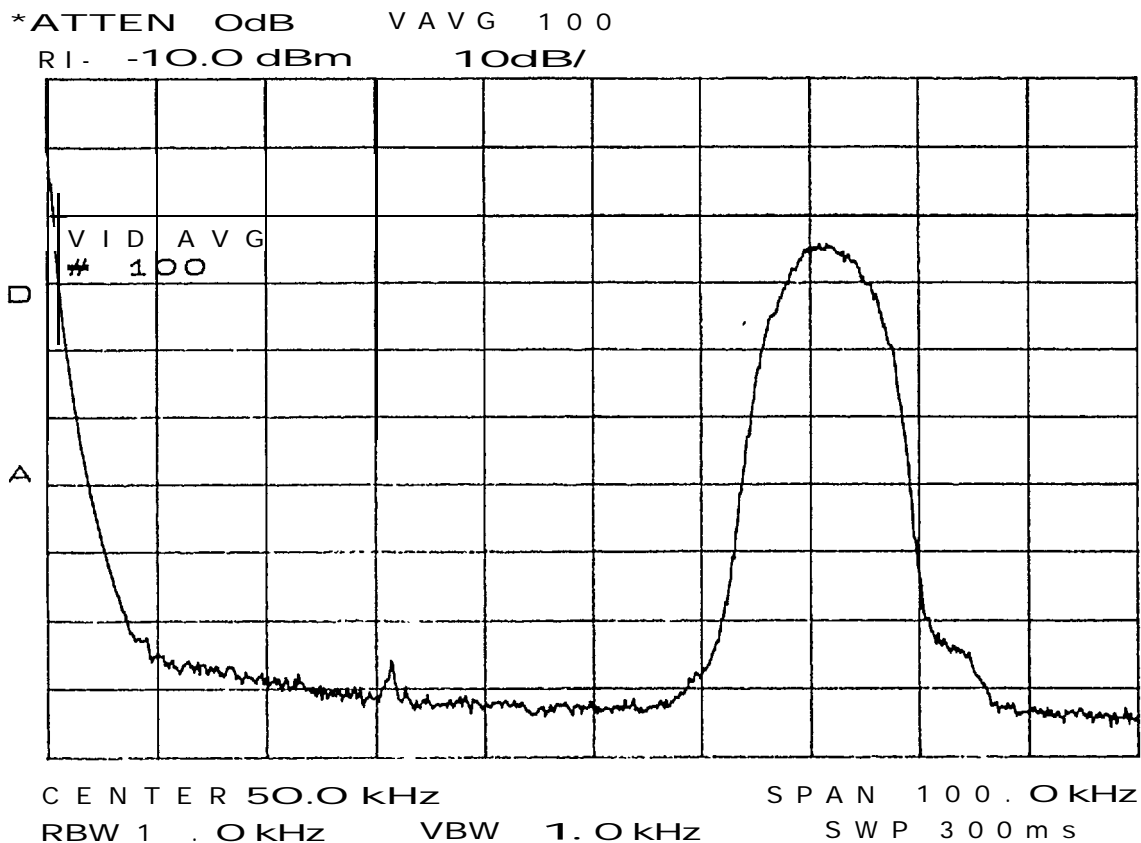

Figure 2. STIC baseband power spectrum.



spectrum analyzer plots supports this assertion, with a 6-dB bandwidth of 10 kHz and a 60-dB bandwidth of approximately 20 kHz. The out-of-band attenuation suggested that the STIC waveform did not interfere with the 57-kHz and 92-kHz subcarriers or the audio program.

### 3.2.2 Error Rate Performance

Error rate vs. received signal power was determined experimentally for three performance metrics and two system configurations.

For the x2 interleaver configuration (Figure 3), channel errors began to appear at power levels less than approximately -84 dBm. For channel error rates less than  $1 \times 10^{-2}$ , the error-correcting codes implemented in the STIC receiver worked well and corrected 100% of the channel errors. Note that for ease of plotting, error rates less than  $1 \times 10^{-6}$  were assigned the value  $1 \times 10^{-6}$ . When the received signal power level was reduced to approximately -95 dBm and the corresponding CER increased to  $4 \times 10^{-2}$ , the post error-correction bit errors began to appear. The corresponding PER at this power level was approximately  $1 \times 10^{-3}$  and the post error-correction BER was  $1 \times 10^{-5}$ . However, when the received power level decreased an additional 1 dB to -96 dBm, performance degraded dramatically. At -96 dBm and at a CER of roughly  $5 \times 10^{-2}$ , the post error-correction BER jumped to  $5 \times 10^{-7}$  and PER increased to 0.2. By decreasing the signal power an additional 1 dB to -97 dBm, the PER increased to effectively 1.

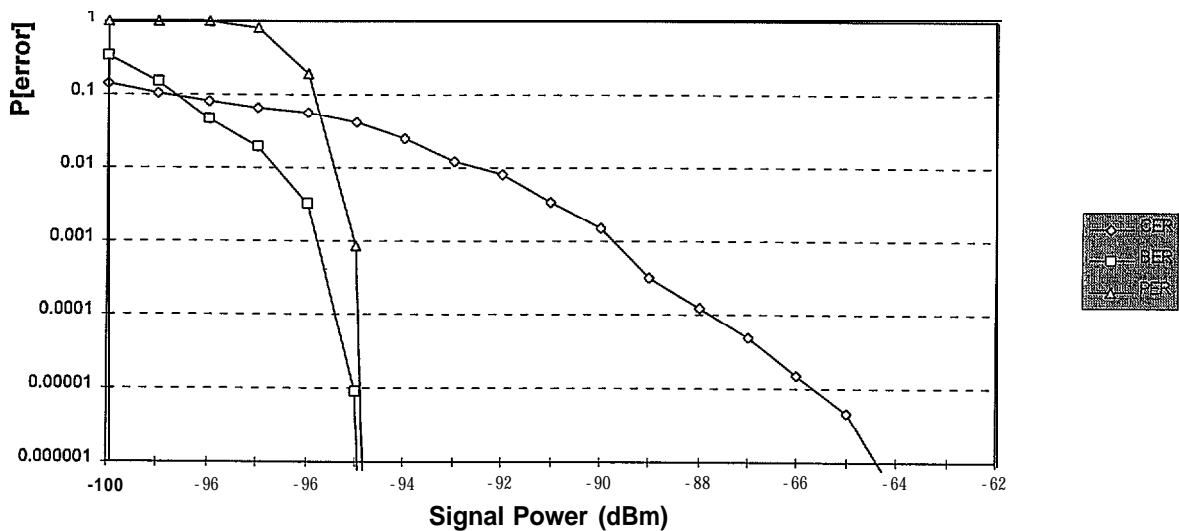

Figure 3. CER, BER, and PER vs. received signal power for x2 interleaver.

Behavior of the system in the x1 interleaver mode (Figure 4) was similar to the x2 mode with one exception. At signal levels of  $-96 \text{ dBm} \pm 0.5 \text{ dB}$ , the STIC receiver would not maintain synchronization. The system would acquire the STIC signal, then immediately lose

synchronization. Increasing or decreasing the power level allowed the system to regain synchronization. At this signal level, switching to the x2 mode would allow the STIC receiver to acquire the signal and maintain synchronization. This behavior did not occur at any power level during the x2 testing. MITRE personnel suggested this behavior was the result of a STIC receiver program error. The direct effects of this error on STIC field performance are unknown. However, the minimum signal power encountered during the field testing was -84 dBm, significantly greater than the -95 dBm power level at which the malfunction occurred.

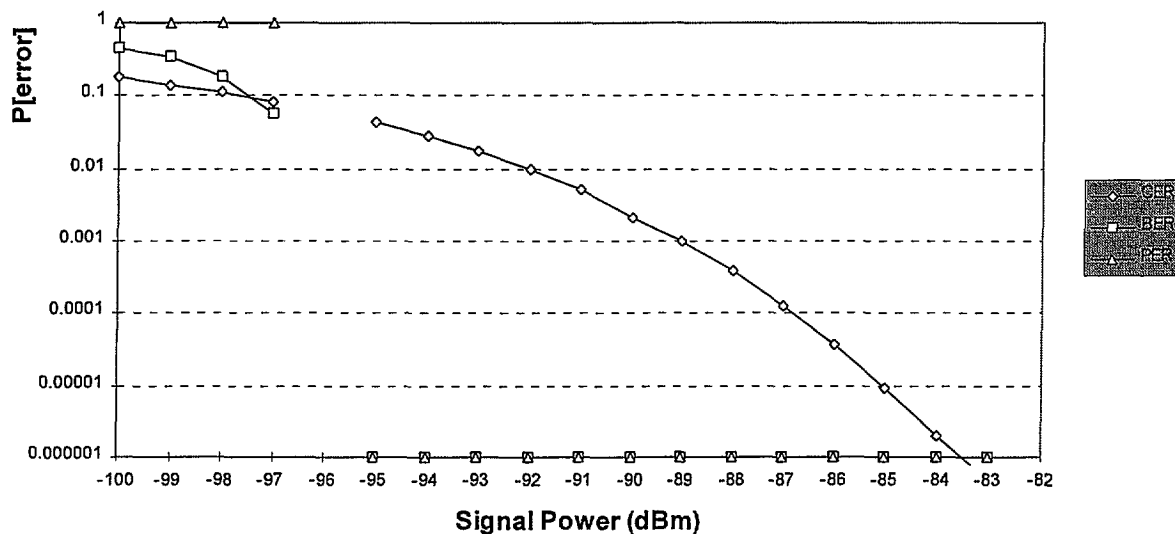

Figure 4. CER, BER, and PER vs. received signal power for x1 interleaver.

#### 4. STIC FIELD TESTING AND EVALUATION

Once the laboratory testing of the STIC system was complete, a field test program was initiated. The primary goal of the field test program was to correlate the STIC performance with received signal level in a variety of reception environments.

##### 4.1 STIC Installation

The following two subsections describe the installation and configuration of the STIC transmitter, STIC receiver, and signal power measurement system (Figure 5).

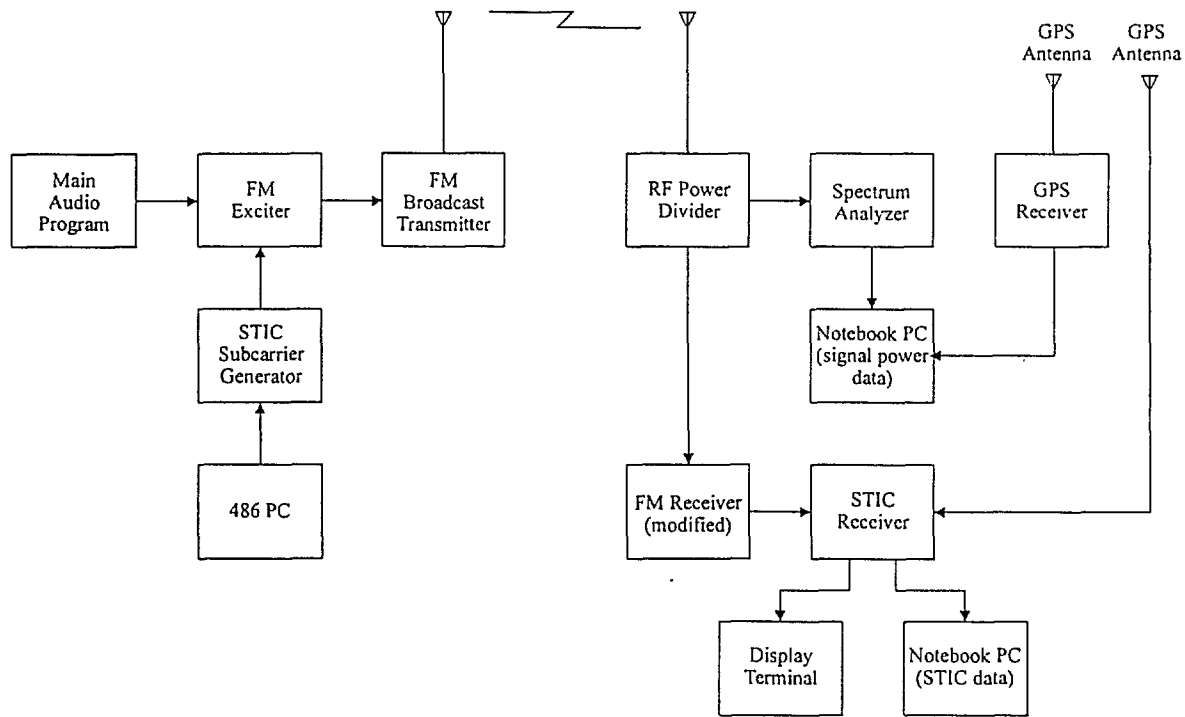

Figure 5. STIC field test configuration.

#### 4.1.1 Transmitter

A local FM radio station agreed to participate in the STIC field testing program. The STIC transmitter was installed at the transmitter site of KYGO-FM, a Denver-area commercial FM radio station broadcasting with an effective radiated power of 100 kW and at a frequency of 98.5 MHz. The KYGO transmitter is located roughly 25 miles west of Denver, Colorado (altitude 5,280 feet), at an altitude of 10,597 feet. The transmitter site provides an unobstructed path into much of the Denver metropolitan area and to the East. The STIC signal was injected into the broadcast signal at a 10% injection level. The subcarrier injection level was set at the transmitter site by momentarily interrupting the entertainment signal and measuring the total modulation on the transmitter's modulation meter. No other subcarriers were carried by the station. The program format is country-western.

The STIC system can operate using a variety of interleaver sizes. At the time of the STIC transmitter installation, NTIA/ITS and MITRE personnel decided to operate the STIC system in the default x1 mode. This mode was chosen because the transmitter site had encountered occasional power outages due to severe weather conditions and in the event of a power cycle, the STIC transmitter would automatically resume operation in the default x1 mode. The transmitter site is a considerable distance from Boulder, Colorado and there were no provisions at the transmitter location for remote configuration of the STIC system.

#### 4.1.2 Receiver

In order to efficiently measure STIC performance over a wide geographical area, a mobile data collection system was employed. The data collection system consisted of a van with both the STIC receiver system and signal power measurement systems (Figure 6). GPS receivers were employed by both systems allowing the simultaneous collection of received signal power, STIC performance, time, and location. The STIC receiver was configured to utilize the xl interleaver. Appendix A provides details of the measurement system and Appendix B details the data-processing methodology.



Figure 6. Mobile data collection van.

This report describes the STIC performance as a function of received signal power. In some cases, electric field strength is a more useful parameter with which to correlate system performance. Appendix C describes the procedure for conversion from received signal power to electric field strength.

## 4.2 Route Planning

The metropolitan Denver area provides a wide variety of natural and man-made reception environments in which to evaluate the STIC performance. Denver, Colorado, is located on the plains of the American Mid-West, 20 miles east of the dramatic rise of the Rocky Mountains. Its location provides four areas in which the STIC system may operate. These areas were defined as: urban high-rise, deep canyons formed by long rows of high-rise buildings; urban low-rise, areas of significant numbers of buildings roughly 1 or 2 stories high; rural plains, great open areas typically devoid of significant structures or dramatic terrain features; and rural mountains, areas dominated by tall mountains and deep natural canyons. The two urban environments encompass typical urban and suburban areas while the two rural categories cover most rural environments.

A series of driving routes was chosen to provide significant time in each environment and to define the boundaries of coverage by increasing the distance from the transmitter. The table below summarizes each environment, lists the number of miles over which data were collected, and provides a color key for each environment that corresponds to the map in Figure 7.

Reception Environment Data and Map Color Key

Environment	Miles	Map Key	Characteristics
Transmitter	N/A	Orange	Mountain-top location.
Urban High-Rise	16.4	Pink	City streets, urban canyons, high-rise corridors.
Urban Low-Rise	117.0	Yellow	Significant man-made obstacles and obstructions, typically no greater than 2 stories tall.
Rural Mountain	130.0	Green	Deep canyons, rugged terrain, significant terrain shadowing.
Rural Plains	330.0	Blue	Few significant natural or man-made obstacles. Typically line-of-sight.



### 4.3 STIC Field Evaluation

For each environment described above, several statistics of performance were computed and analyzed. In a dynamic signal environment, such as experienced by a mobile receiver, the received signal was likely to experience significant degradation and distortion as the mobile receiver changed location. In certain locations, the signal degradation will be so severe that the reception of any data was impossible. It was in these areas that the STIC system would lose synchronization with the transmitter and thereby lost the ability to receive message or BER data. When the receiver was moved to a location more favorable to signal reception, the STIC system would regain synchronization. However, the effect of losing synchronization extended beyond the period of degraded signal reception. Upon moving to a location more favorable to signal reception, the STIC system would re-establish synchronization after an initialization period of approximately 15 seconds (for the x1 interleaver). During this resynchronization period, message or BER data were not being accepted and therefore the error rates (CER, BER, and PER) were assigned their maximum value. Discussions with MITRE personnel suggested that the STIC synchronization performance would have improved if the x2 interleaver were used instead of the x1. Due to time and equipment constraints it was not possible to repeat the field data collection procedure for the x2 interleaver but by filtering the field performance data to remove the data points corresponding to the STIC system “out of sync,” it was possible to evaluate an approximate upper bound on STIC synchronization performance. These figures are labeled as “SYNC Data” in the following sections.

In the following sections, three sets of statistics are presented as a function of received signal power: mean error rate, median error rate, and percentile error rate. Additionally, mean and percentile error rates are presented in the “SYNC Data” form and several other statistics are computed and presented. No one statistical or performance measure can evaluate or quantify the performance of a complex communication system such as the STIC. Each statistical estimation of STIC performance provides unique insight into the system performance.

#### 4.3.1. Rural Plains Environment

Data for the rural plains environment were collected over paths totaling 330 miles. These data were collected at distances between 25 and 103 miles from the transmitter and consisted of 4,127 signal-power and STIC error-rate measurement locations. The propagation environment was typically either line-of-sight or close to line-of-sight. Few significant geographical features or man-made obstacles were present.

Figure 8 displays mean error rates vs. received signal power. The mean error rates for a specific signal power level were calculated by forming the arithmetic mean of channel, bit, and packet error rate measurements for a specific power level ( $\pm 2$  dB) and placing them in the appropriate bin. Figure 9 displays the same data set with the out-of-sync errors removed. The removal of these data points produced an improvement of approximately 8 dB in STIC performance.

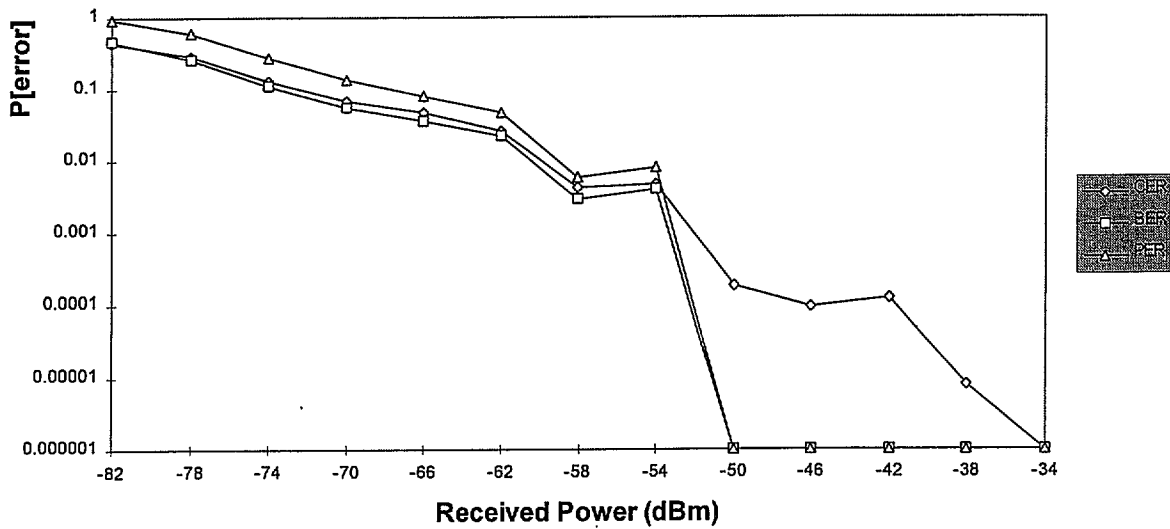

Figure 8. Mean CER, BER, and PER vs. received signal power for rural plains environment.

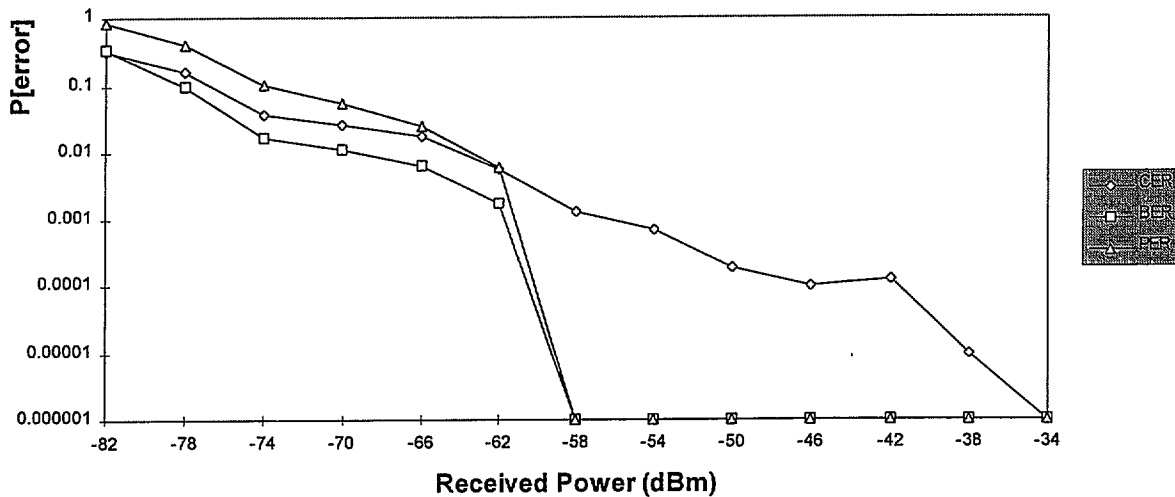

Figure 9. Mean CER, BER, and PER vs. received signal power (SYNC data) for rural plains environment.

Figures 10, 11, and 12 show the STIC performance data using median and percentile error rates vs. signal power. Median and percentile error rates assist in illuminating the almost binary nature of STIC PER performance, where errors typically occur in bursts.



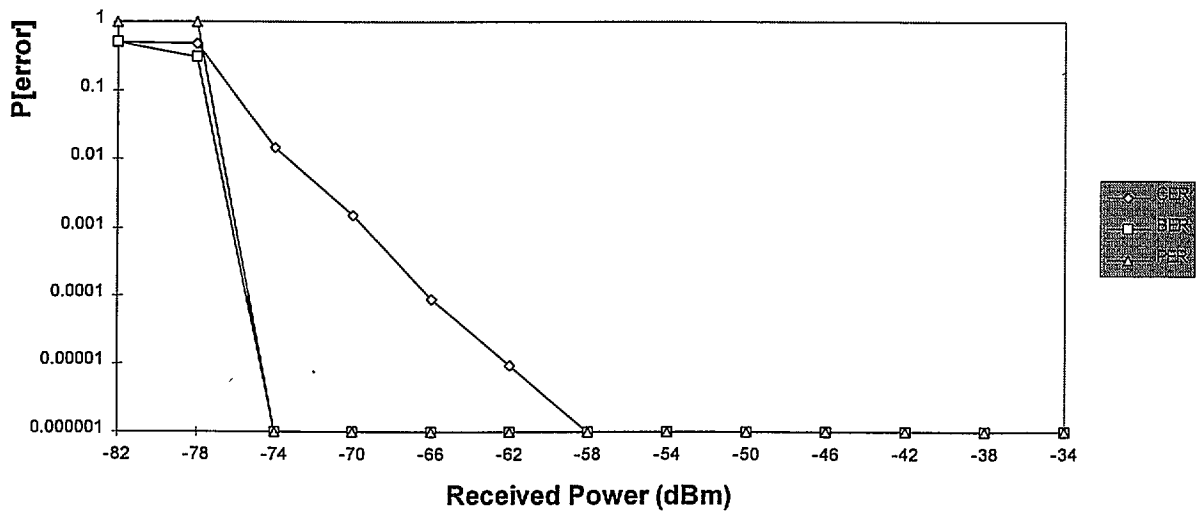

Figure 10. Median CER, BER, and PER vs. received signal power for rural plains environment.

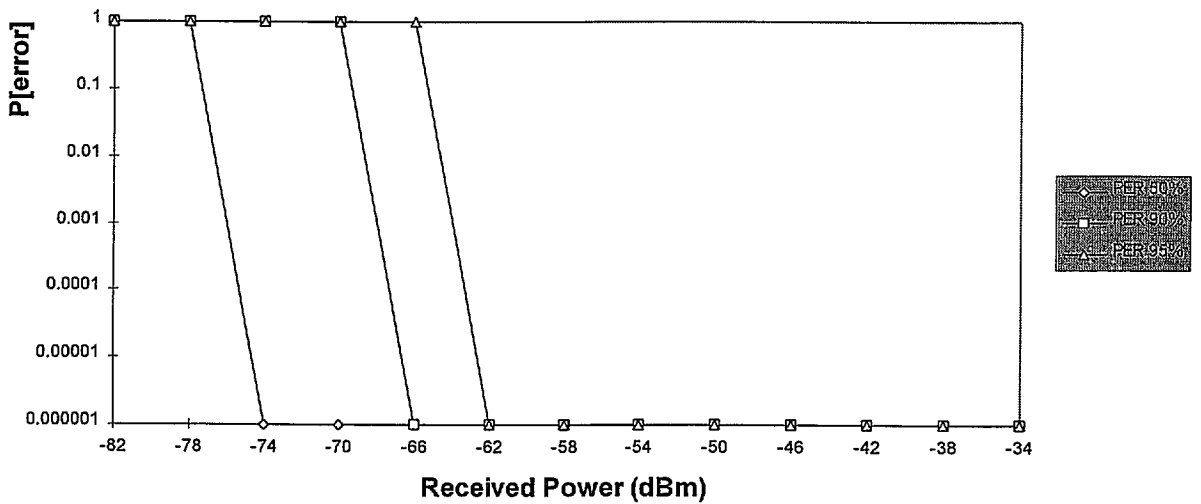

Figure 11. Percentile packet error rates vs. received signal power for rural plains environment.

Figure 13 displays mean error rates vs. distance from the transmitter. The error rates were computed in the same manner as the data in Figure 8 except that error rate measurements were sorted by distance instead of power level. It was interesting to note the dramatic decrease in STIC performance at the ranges of 33 miles, and 43 to 51 miles. Examining the scatter plot of signal power vs. distance (see Figure 17), there were instances of unusually low signal power at 33 miles,

a significant group in the range of 43 to 51 miles, another group in the range of 65 to 77 miles, and above 85 miles. These power levels ( $< -70$  dBm) were consistent with high packet error rates shown in Figures 8 through 12.

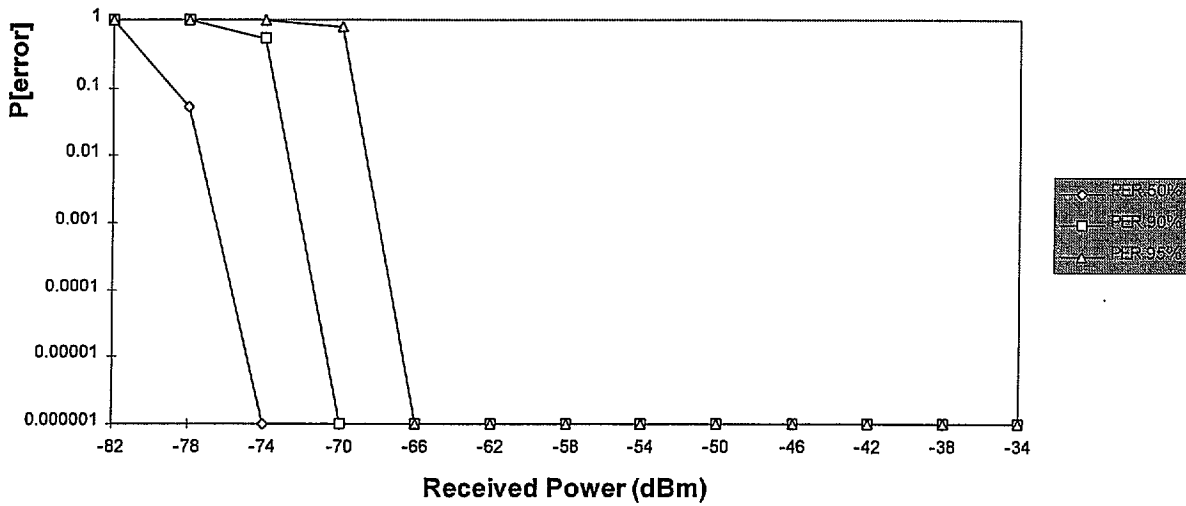

Figure 12. Percentile packet error rates vs. received signal power for rural plains environment.

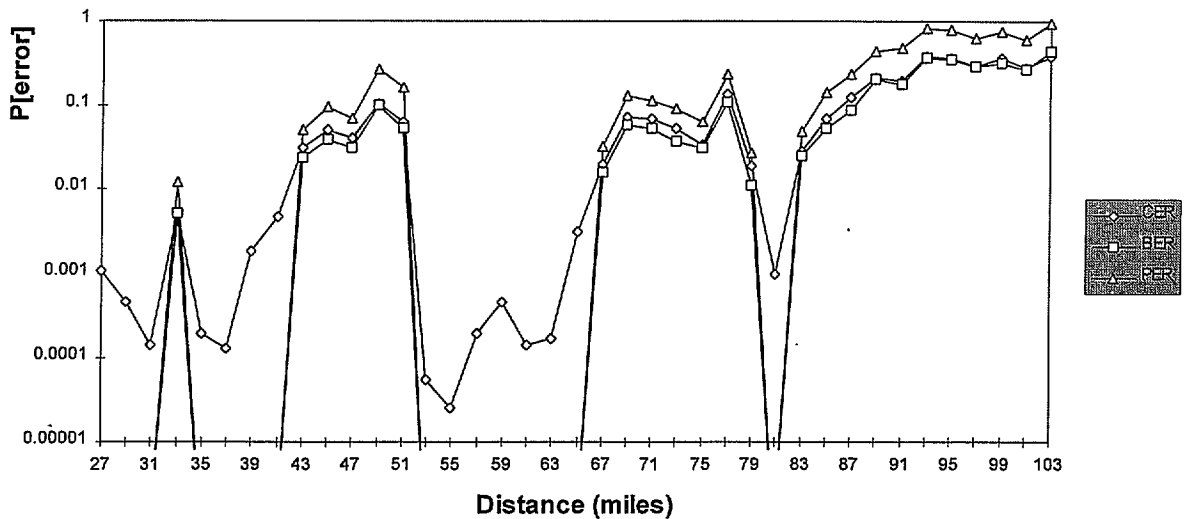

Figure 13. Mean error rates vs. distance from transmitter for rural plains environment.

Figure 14 displays cumulative error rates vs. error rate for the three performance metrics and Figures 15 and 16 display the raw channel and packet error rate data in the form of scatter plots. It was from these scatter plots that the mean, median, and percentile error rate plots were generated.

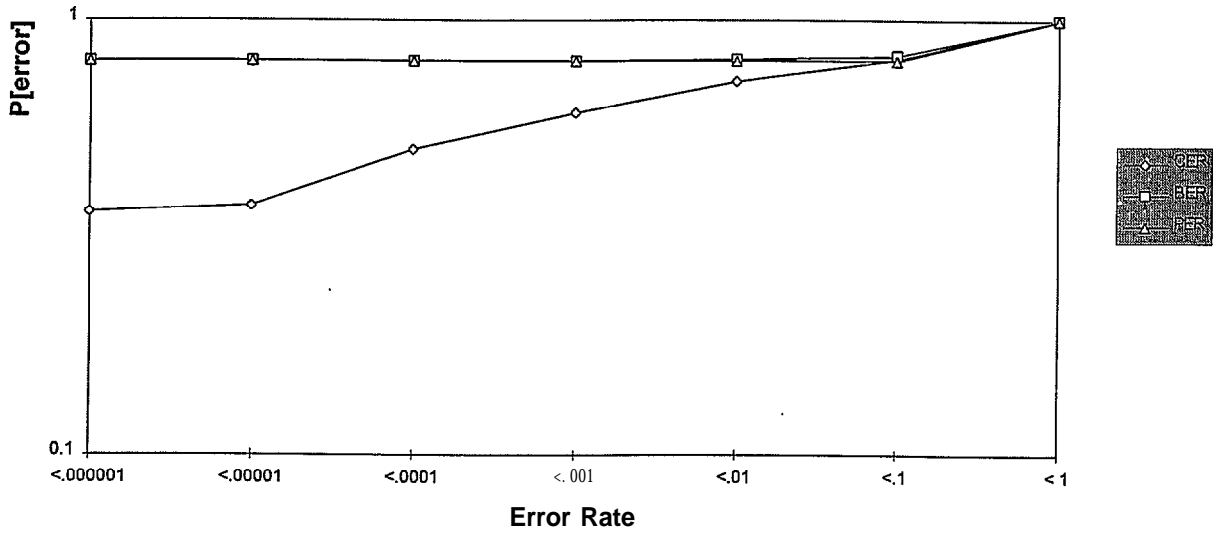

Figure 14. Cumulative error rates vs. error rate for rural plains environment.

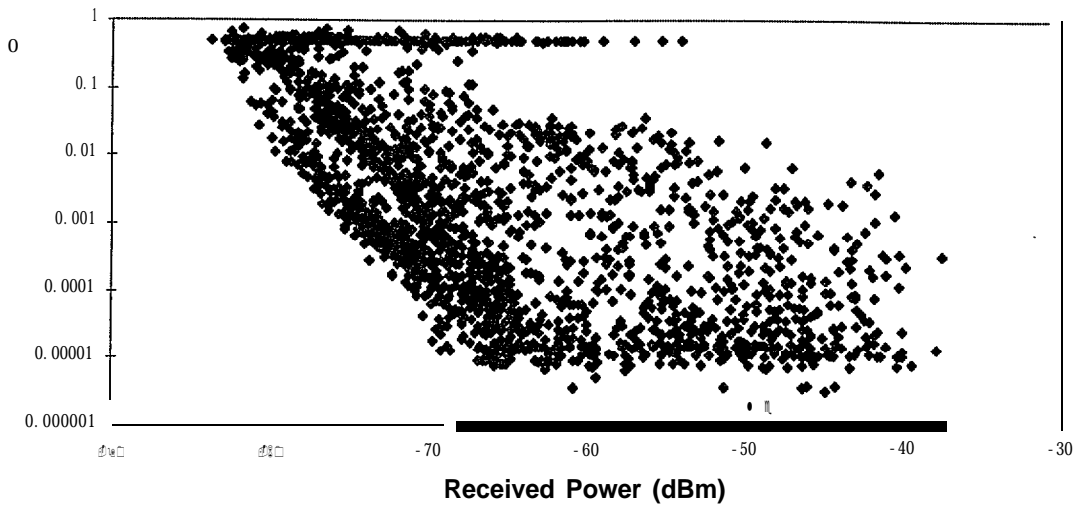

Figure 15. Channel error rates vs. received signal power for rural plains environment.

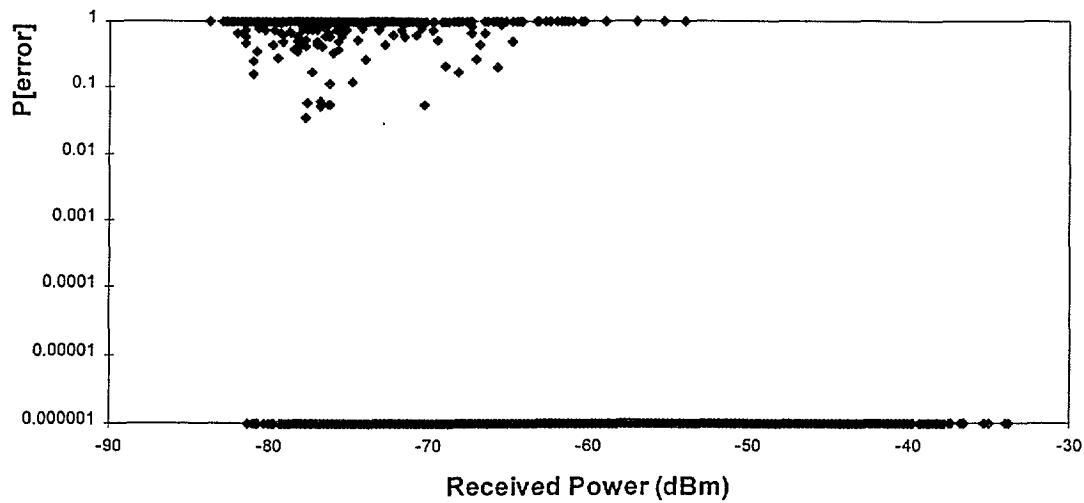

Figure 16. Packet error rates vs. received signal power for rural plains environment.

Figure 17 shows received signal power vs. distance to transmitter in the form of scatter plot. Figures 18 and 19 show the number of measurements used to construct each error rate estimate.

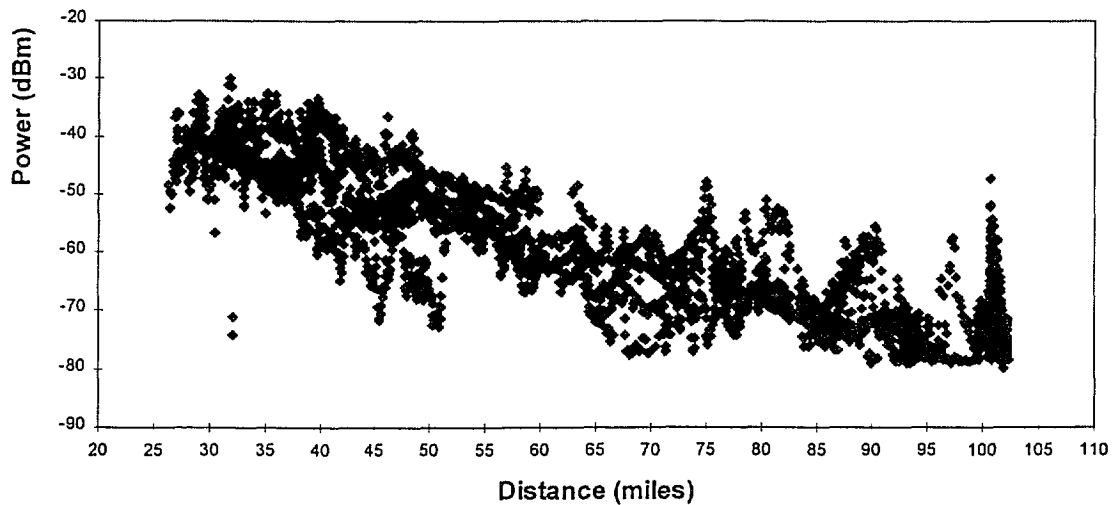

Figure 17. Received signal power vs. distance from transmitter for rural plains environment.

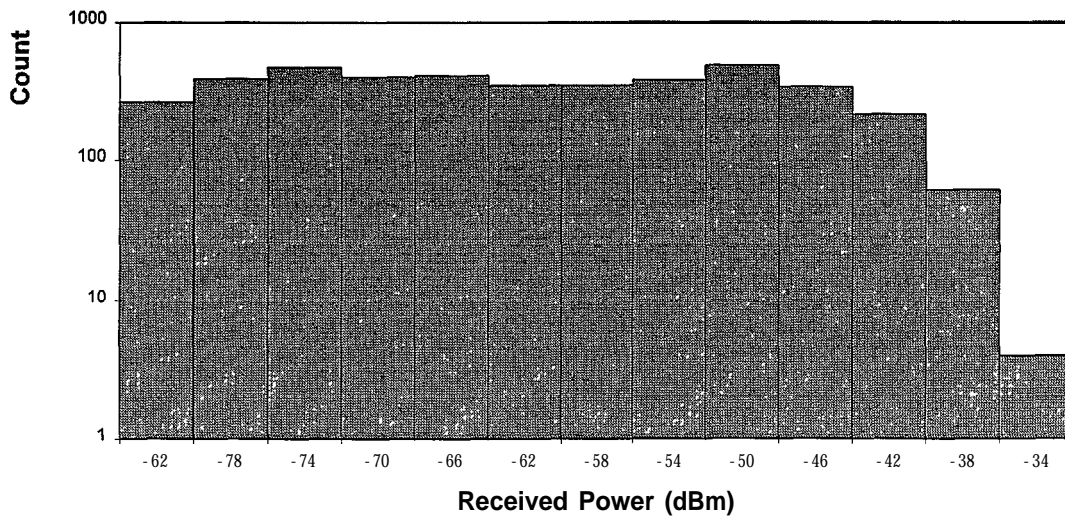

Figure 18. Measurement count vs. received signal power for rural plains environment.

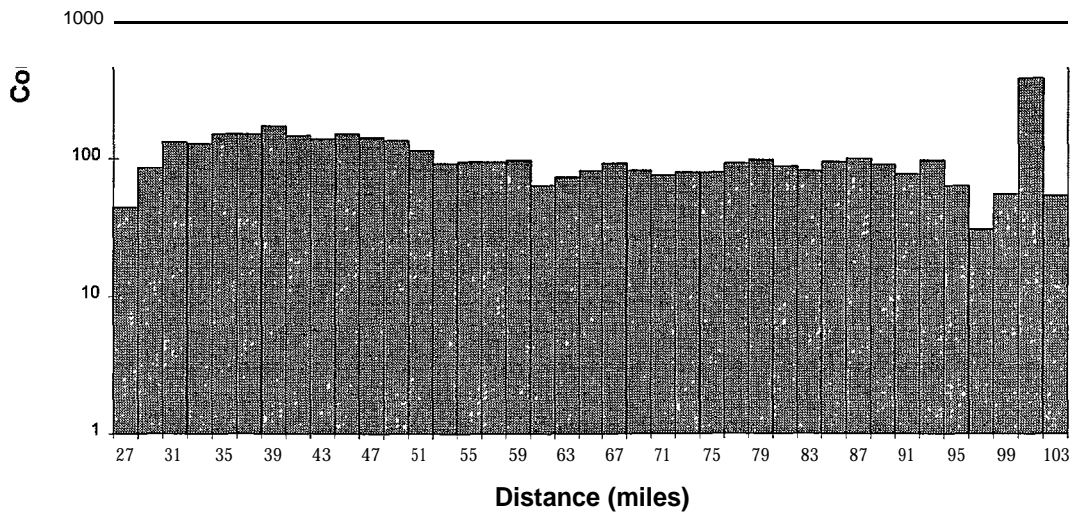

Figure 19. Measurement count vs. distance from transmitter for rural plains environment.

### 4.3.2 Rural Mountain Environment

Data for the rural mountain environment were collected **over** paths totaling 130 miles through the foothills and mountainous regions of the Rocky Mountains west and south of the Denver metropolitan area. The data were collected at distances between 2 and 48 miles from the transmitter and consisted of 1,726 signal-power and STIC error-rate measurements.

Figures 20 through 28 reveal the generally poor performance of the STIC system in the rural mountain environment. Error performance was poor over a wide range of received power levels and distances from the transmitter. This was not surprising considering the severe multipath and shading imposed on the STIC receiver. The severity of the environment was apparent in the scatter plot of received power vs. distance from transmitter (Figure 29). Received power level spreads of 60 dB or more for similar distances were common.

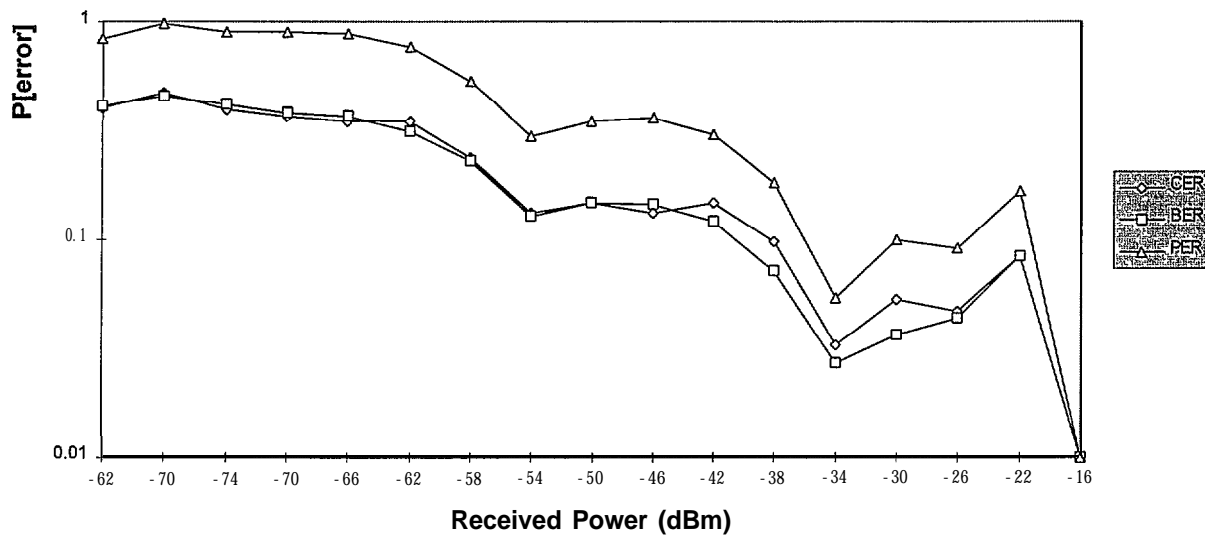

Figure 20. Mean CER, BER, and PER vs. received signal power for rural mountain environment.

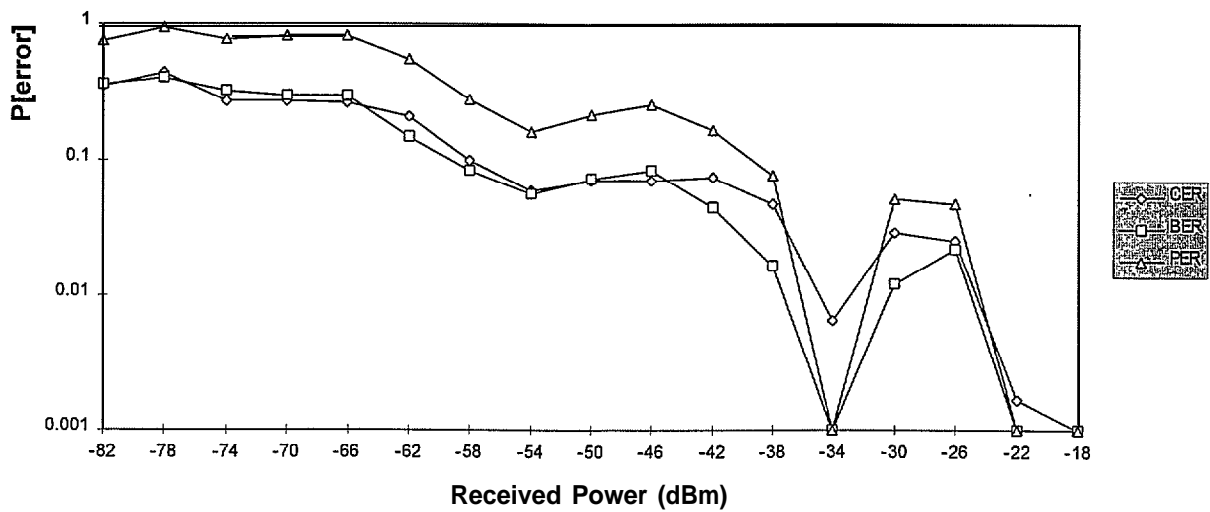

Figure 21. Mean CER, BER, and PER vs. received signal power (SYNC data) for rural mountain environment.

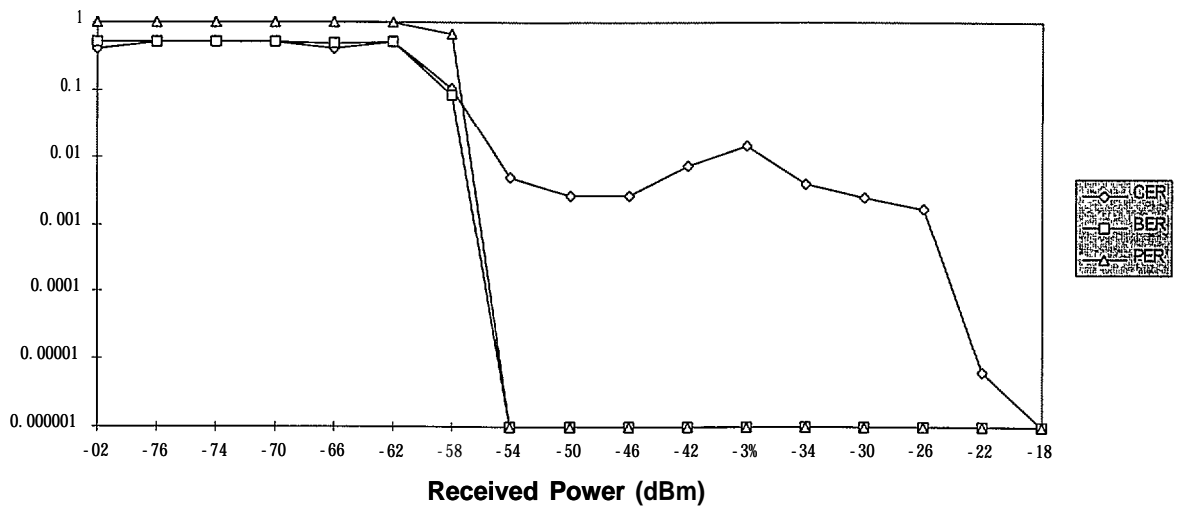

Figure 22. Median CER, BER, and PER vs. received signal power for rural mountain environment.

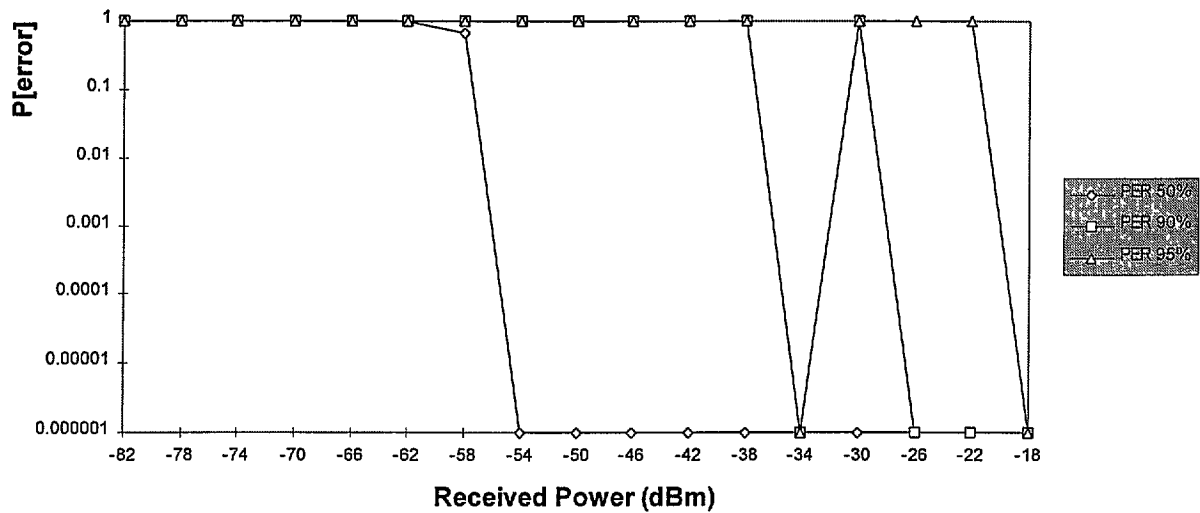

Figure 23. Percentile CER, BER, and PER vs. received signal power for rural mountain environment.

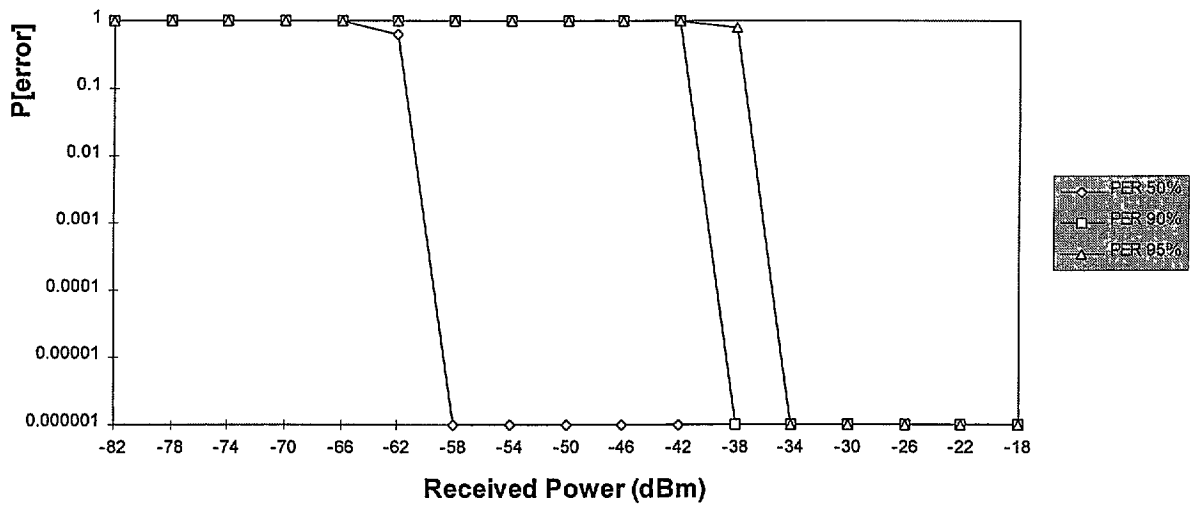

Figure 24. Percentile CER, BER, and PER vs. received signal power (SYNC data) for rural mountain environment.

In Figure 25 (Mean Error Rates vs. Distance from Transmitter) there appeared to be an inconsistency in the STIC error rate performance. At distances between 25 and 34 miles from the



transmitter, the STIC system appeared to be operating error free. This inconsistency was explained by Figures 29 through 31 which show that very little data were collected at that distance.

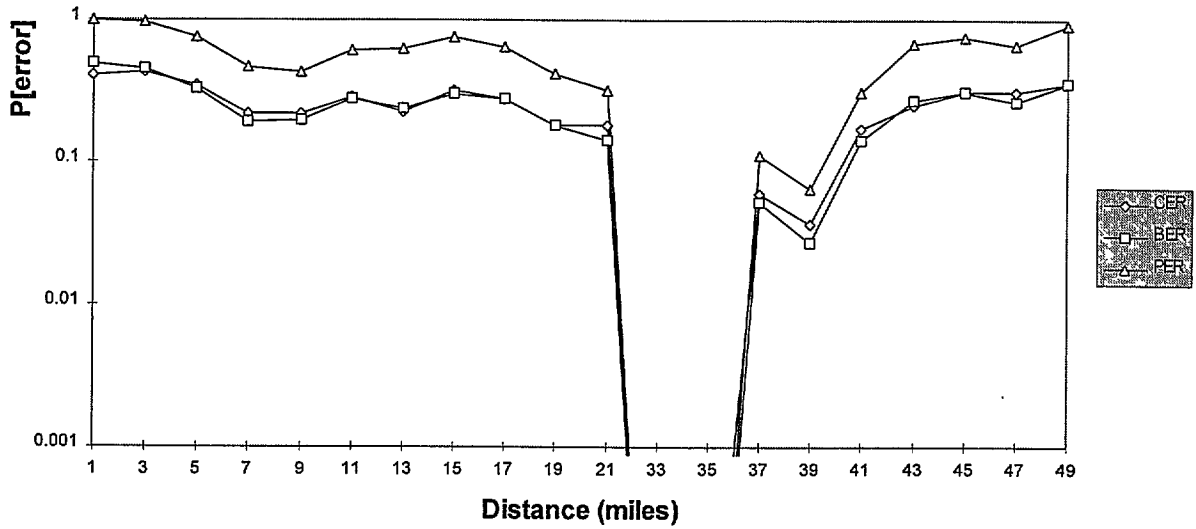

Figure 25. Mean CER, BER, and PER vs. distance from transmitter for rural mountain environment.

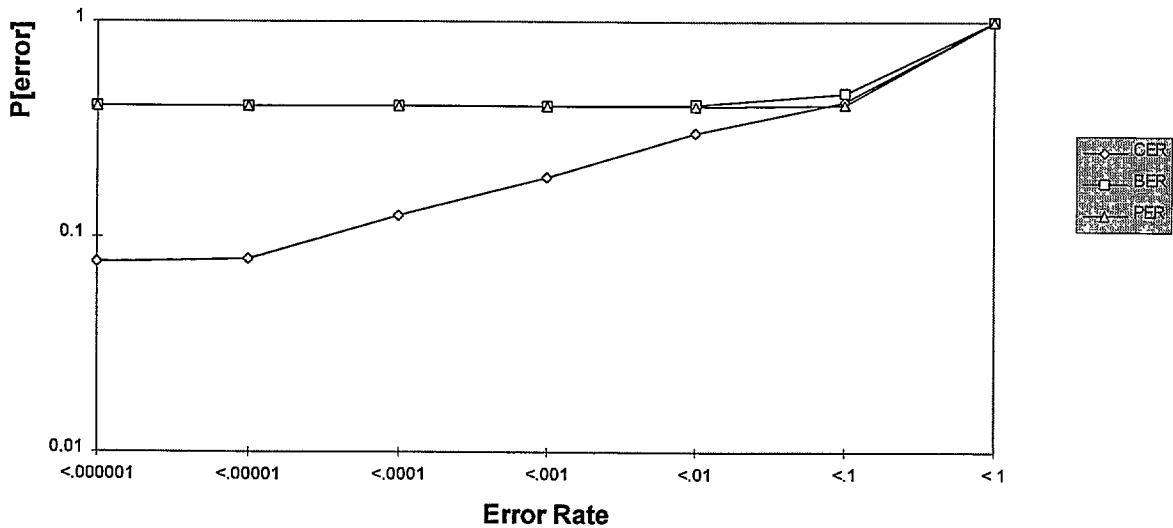

Figure 26. Cumulative error rates vs. error rate for rural mountain environment.

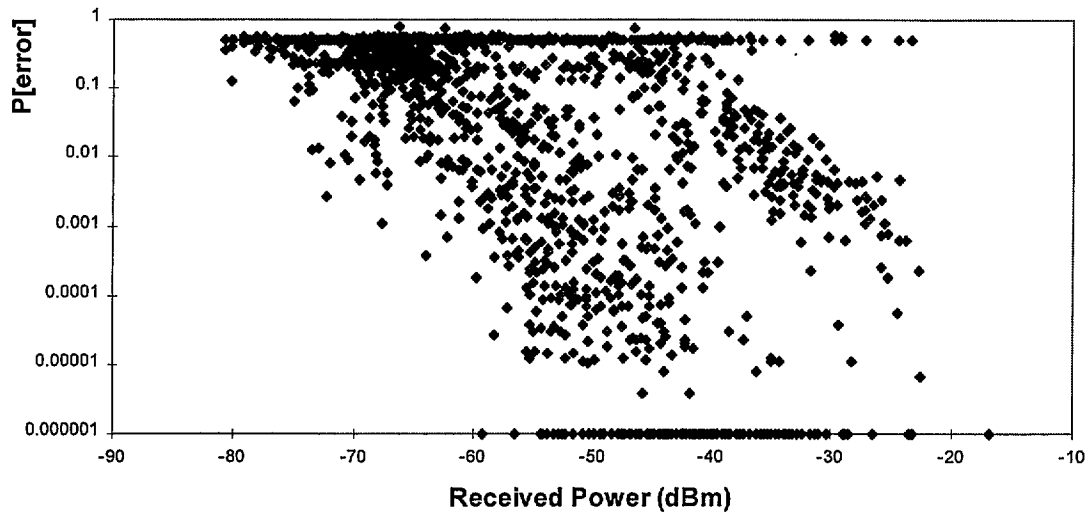

Figure 27. Channel error rates vs. received signal power for rural mountain environment.

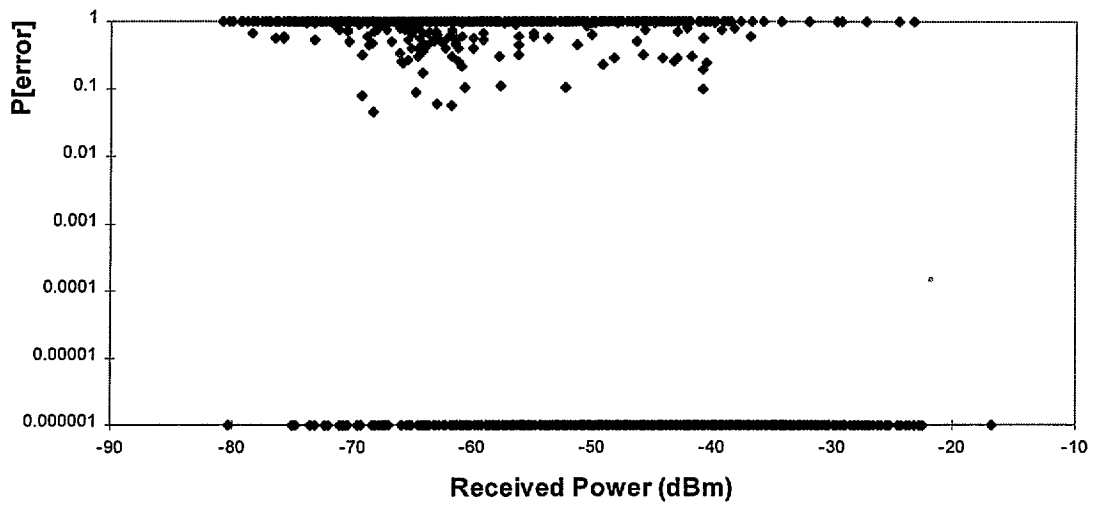

Figure 28. Packet error rates vs. received signal power for rural mountain environment.

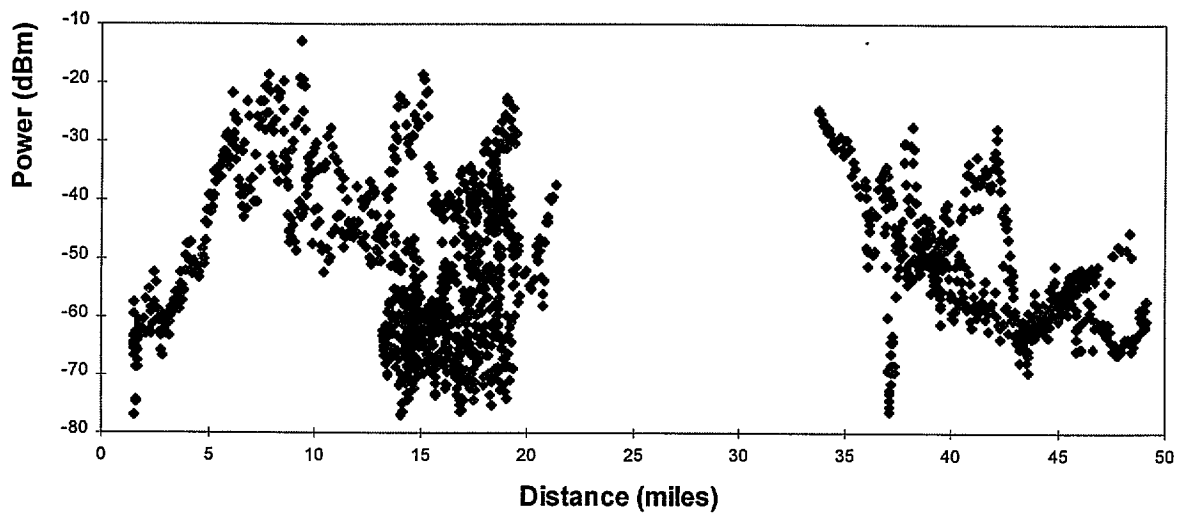

Figure 29. Received signal power vs. distance from transmitter for rural mountain environment.

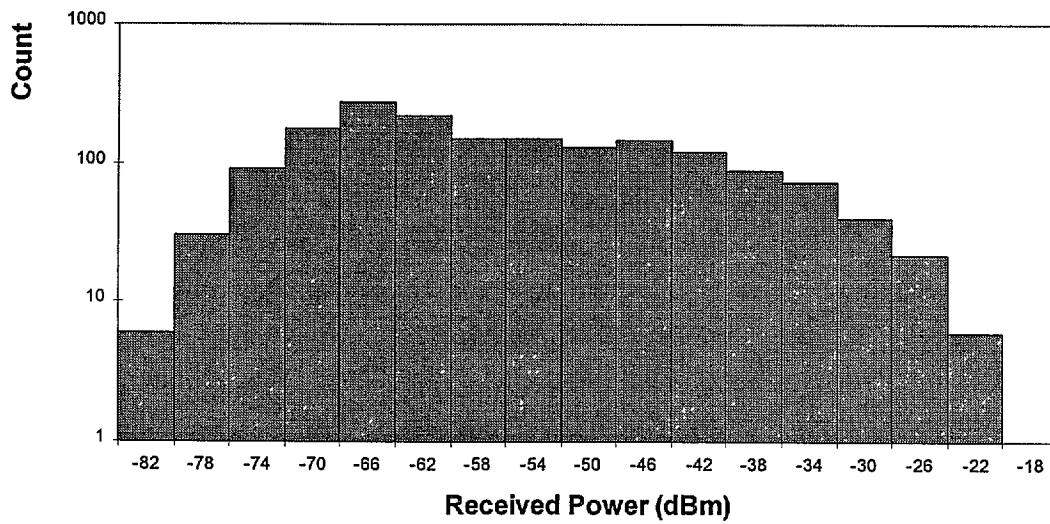

Figure 30. Measurement count vs. received signal power for rural mountain environment.

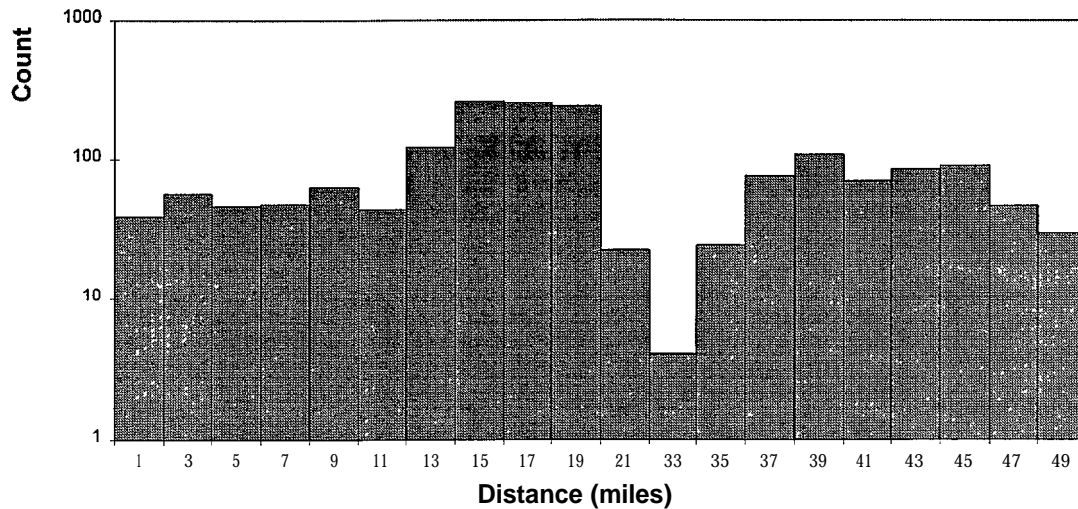

Figure 3.1. Measurement count vs. distance from transmitter for rural mountain environment.

### 4.3.3. Urban Low-rise Environment

The urban low-rise environment was defined as geographical areas where some man-made or geographical obstacles were present. Typical scenarios were suburban areas and city streets populated by primarily 1- and 2-story buildings but lacking significant terrain features that would classify the areas as rural mountain or urban high-rise environments. A total of 117 miles were classified as urban low-rise, and ranged from 17 to 47 miles from the transmitter. The data set consisted of 1,474 signal-power and STIC error-rate measurements.

Performance in the urban low-rise environment remained relatively constant over the range of -34 to -62 dBm (Figure 32). Error rates rose dramatically at power levels of -66 dBm and below (Figures 32 through 36), as they did for the rural plains environment. Removing data points where the STIC was out of sync resulted in a significant improvement in error performance at power levels greater than -66 dBm. This indicated that the primary cause of STIC performance degradation was loss of STIC synchronization. Additional data is shown in Figures 37 through 39. During resynchronization (nominally 15 seconds) CER and BER were defined as 0.5 and PER was defined as 1. This was evident in the scatter plot of PER vs. signal power (Figure 40). A high proportion of data points on the PER = 1 line corresponded to the STIC system being out of synchronization. It was clear that these points dominate the error behavior of the system. It was also interesting that these out-of-sync periods were apparently not highly correlated with received signal power.

Judging from Figure 37, STIC performance in the urban low-rise environment actually *improved* with increasing distance from the transmitter. Figure 37 shows packet errors occurring only at distances between 21 and 27 miles from the transmitter. This was likely due to the categorization of the data. Figure 7 shows that the shorter distance urban low-rise data were collected in an area contiguous with the longer distance rural mountain data. The scatter-plot of received signal power vs. distance (Figure 41) shows a high variability in received signal power vs. distance in the range of 18 to 30 miles. This behavior was consistent with the rural mountain environment (Figure 29). Figure 41 suggests that perhaps the urban low-rise data in the range of 18 to 30 miles may be more accurately described as rural mountain environment.

Other than the inconsistency in the short-distance urban low-rise data, the performance of the STIC system in the urban low-rise environment was very similar to the performance in the rural plains environment.

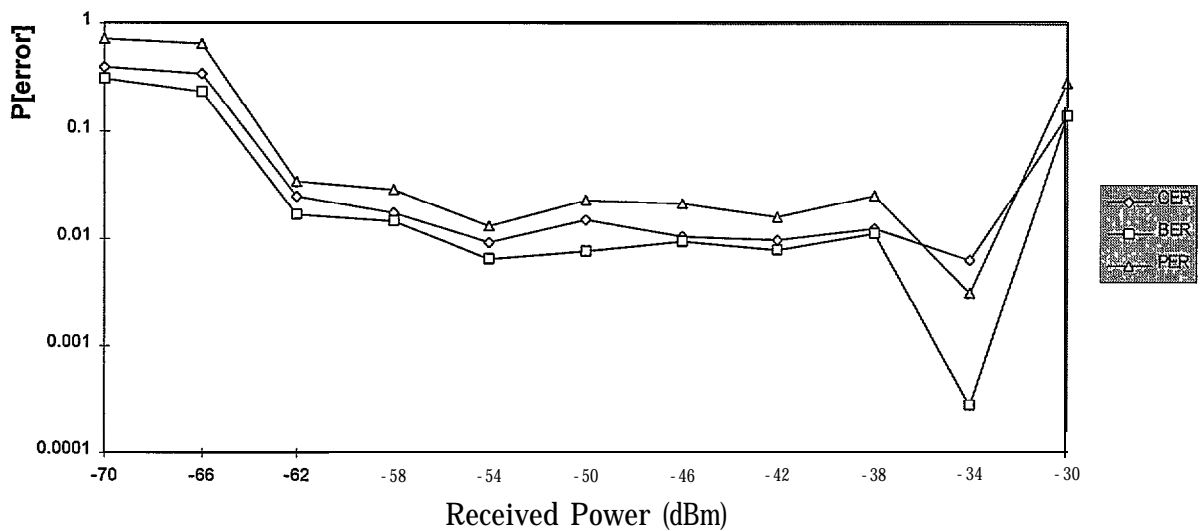

Figure 32. Mean CER, BER, and PER vs. received signal power for urban low-rise environment.

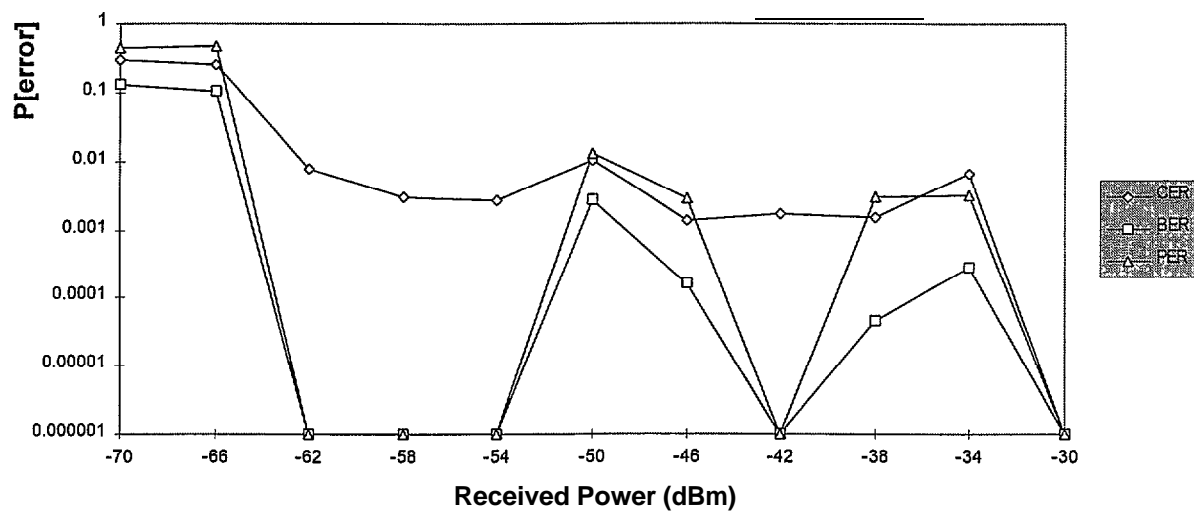

Figure 33. Mean CER, BER, and PER vs. received signal power (SYNC data) for urban low-rise environment.

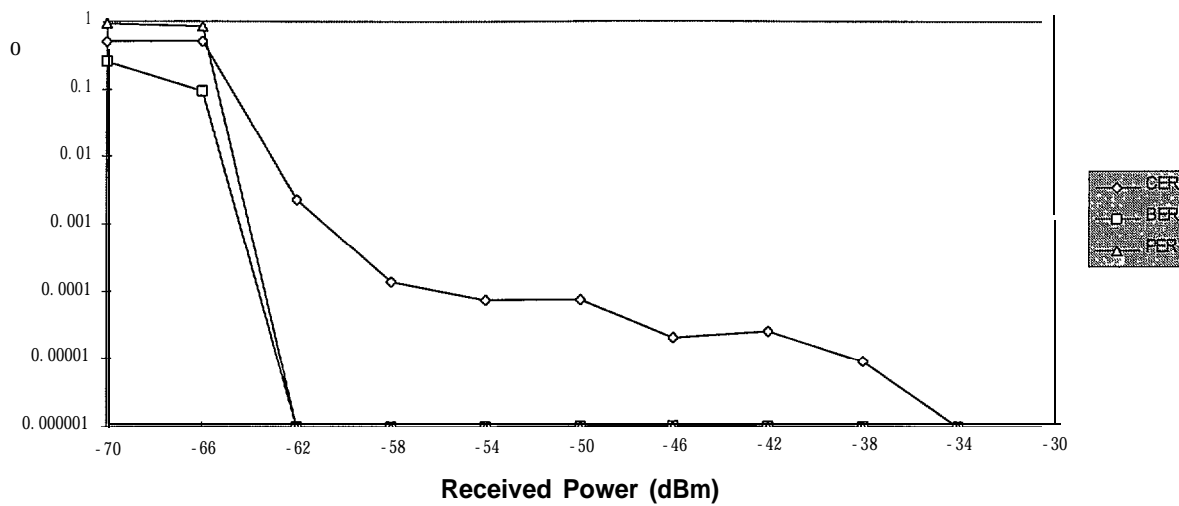

Figure 34. Median CER, BER, and PER vs. received signal power for urban low-rise environment.

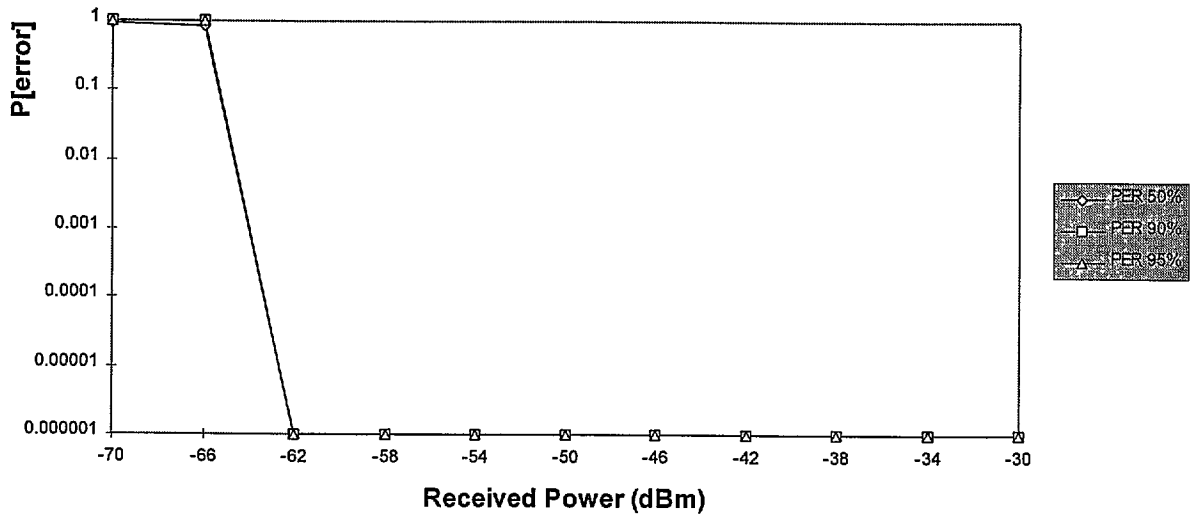

Figure 35. Percentile CER, BER, and PER vs. received signal power for urban low-rise environment.

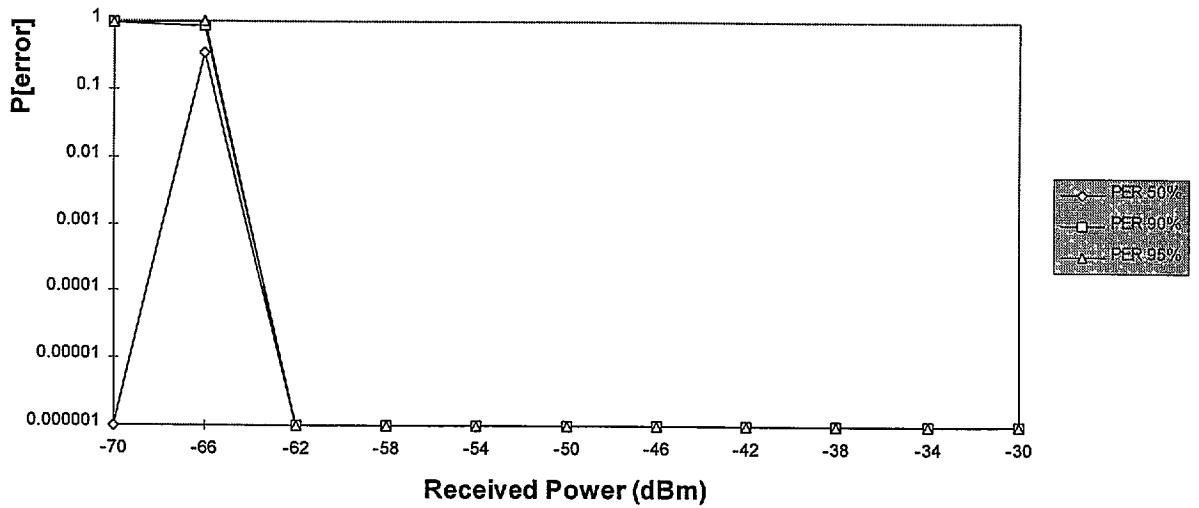

Figure 36. Percentile CER, BER, and PER vs. received signal power (SYNC data) for urban low-rise environment.

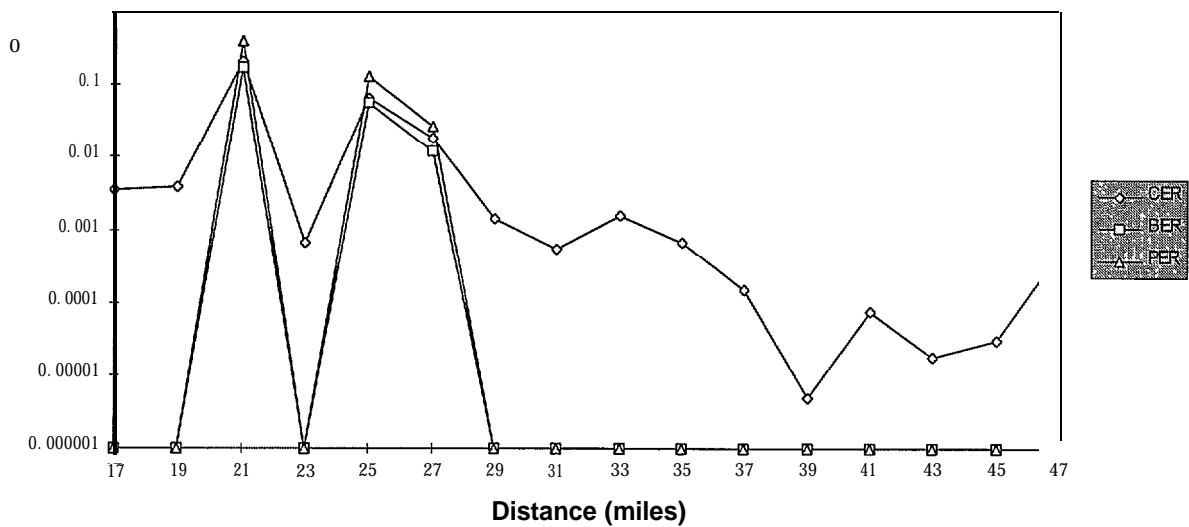

Figure 37. Mean CER, BER, and PER vs. distance from transmitter for urban low-rise environment.

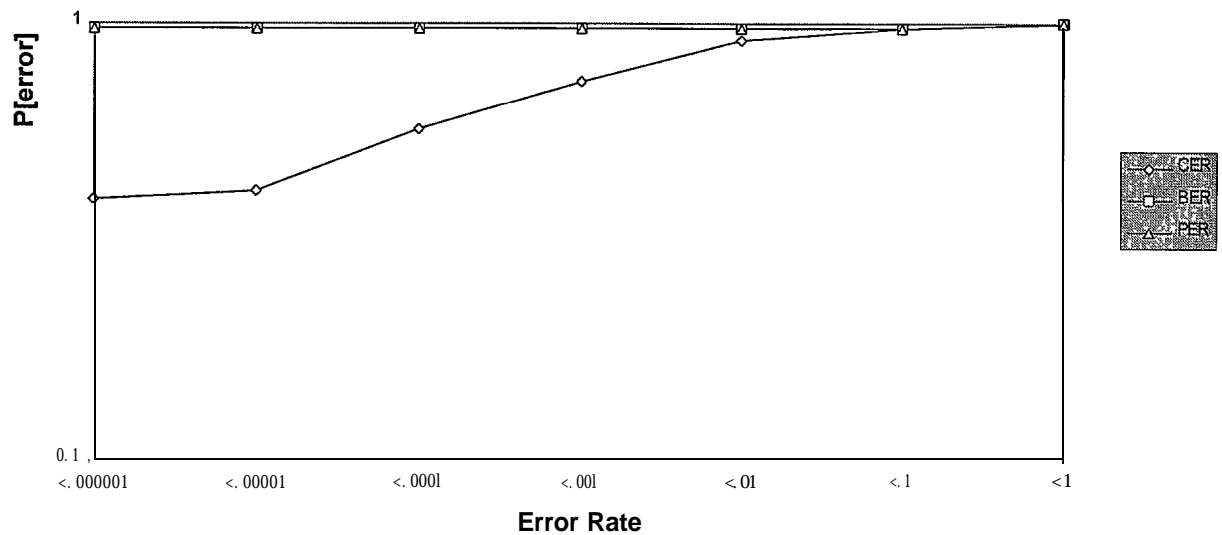

Figure 38. Cumulative CER, BER, and PER vs. error rate for urban low-rise environment.



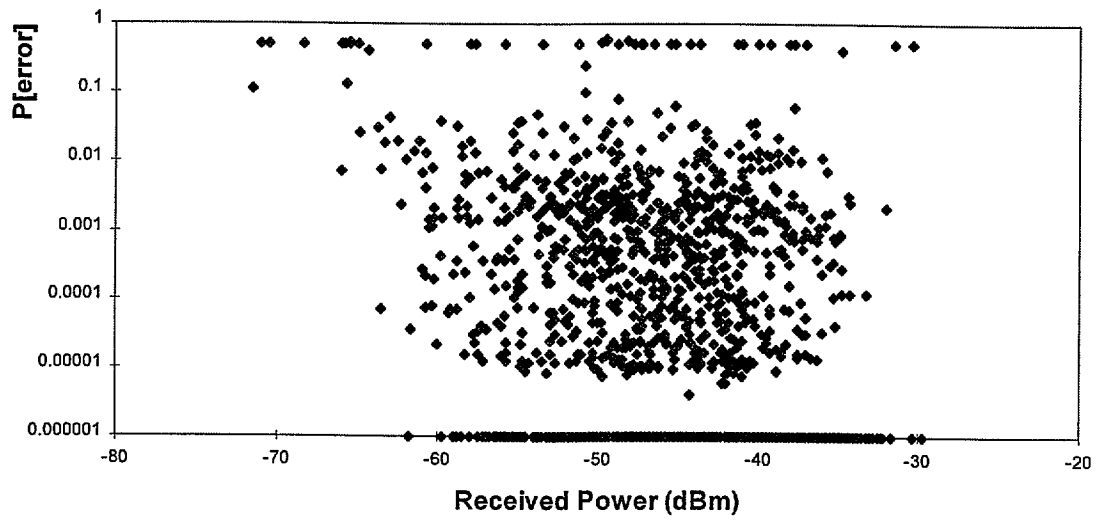

Figure 39. Channel error rates vs. received signal power for urban low-rise environment.

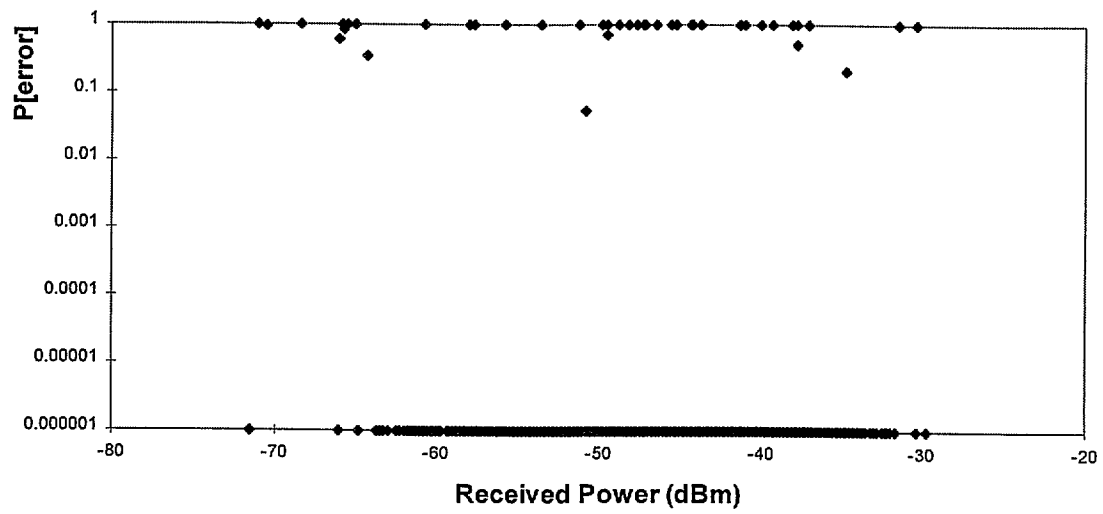

Figure 40. Packet error rates vs. received signal power for urban low-rise environment.

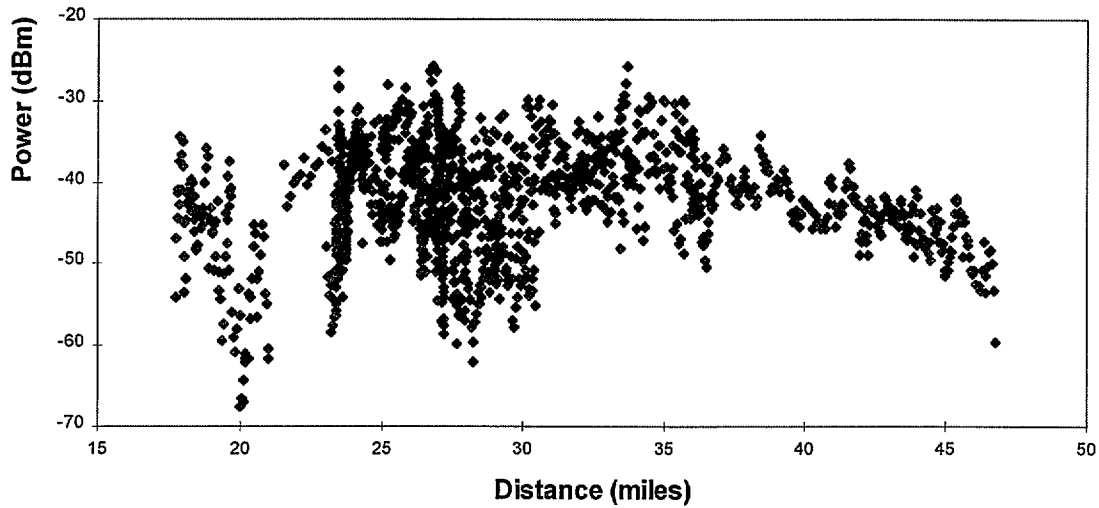

Figure 41. Received signal power vs. distance from transmitter for urban low-rise environment.

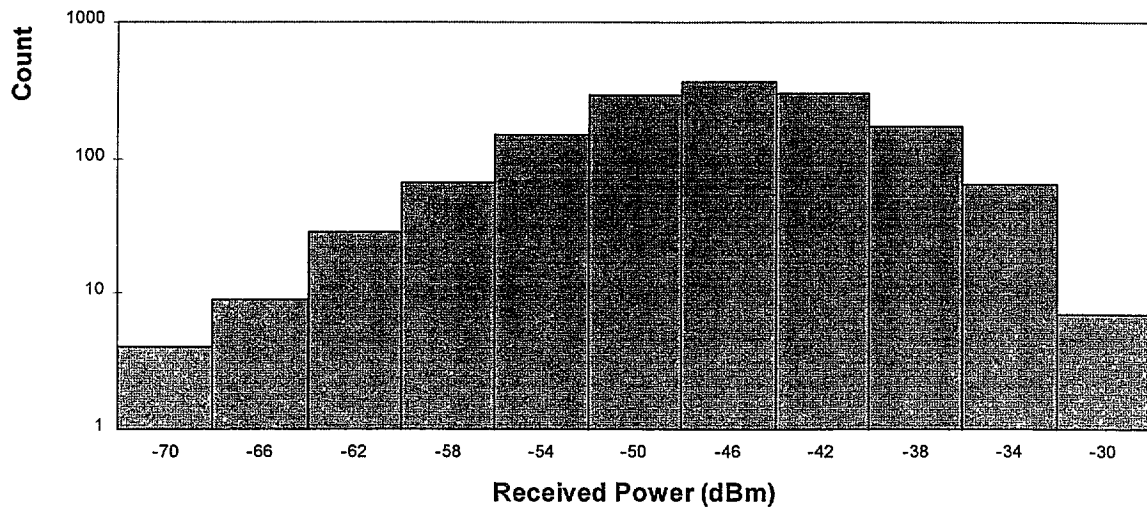

Figure 42. Measurement count vs. received signal power for urban low-rise environment.

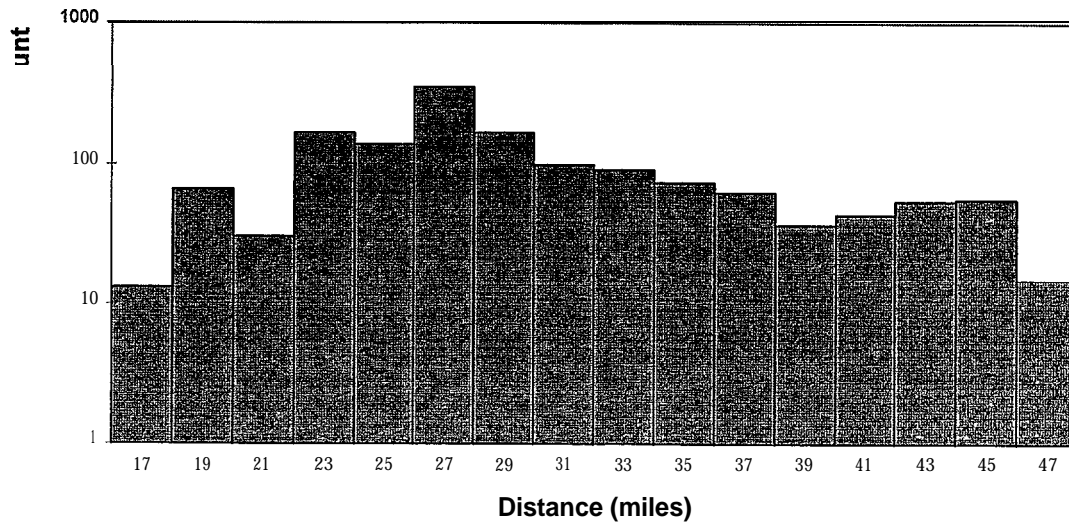

Figure 42. Measurement count vs. distance from transmitter for urban low-rise environment.

#### 4.3.4 Urban High-rise Environment

The urban high-rise environment data set was collected over paths totaling 16.4 miles and at distances between 25.5 and 26.5 miles from the transmitter. The data set consisted of 276 signal-power and STIC error-rate measurements.

The urban high-rise environment data were collected on the streets of downtown Denver, Colorado in the deep canyons formed by the rows of tall buildings. These artificial canyon walls were typically 5 or more stories high and provided a severe multipath and fading environment for the STIC receiver. This section of downtown Denver was a reasonably square area, approximately one-half mile on each side. In order to maintain a consistent environment and not leave the boundaries of the high-rise sector, the measurement van was driven up and down adjacent streets, within the confines of the tall buildings. The path was then reversed, driving on the opposite side of the streets previously driven. When the high-rise area was traversed, the streets perpendicular to the first set were driven and the process was repeated.

The Denver high-rise environment may not be typical of the reception environment of most high-rise areas. A typical FM transmitter, located atop a tall building in a high-rise area, may present a much greater signal level than a transmitter located 26 miles away and produce significantly improved system performance.

As expected, STIC performance degraded in the urban high-rise environment (Figures 43-53). Similar to the rural plains data, removal of the out-of-sync data resulted in an 8- to 10-dB improvement in STIC PER performance. Due to the very small (1 mile) distance over which the data were collected, error rate performance vs. distance plots were not included for this environment.

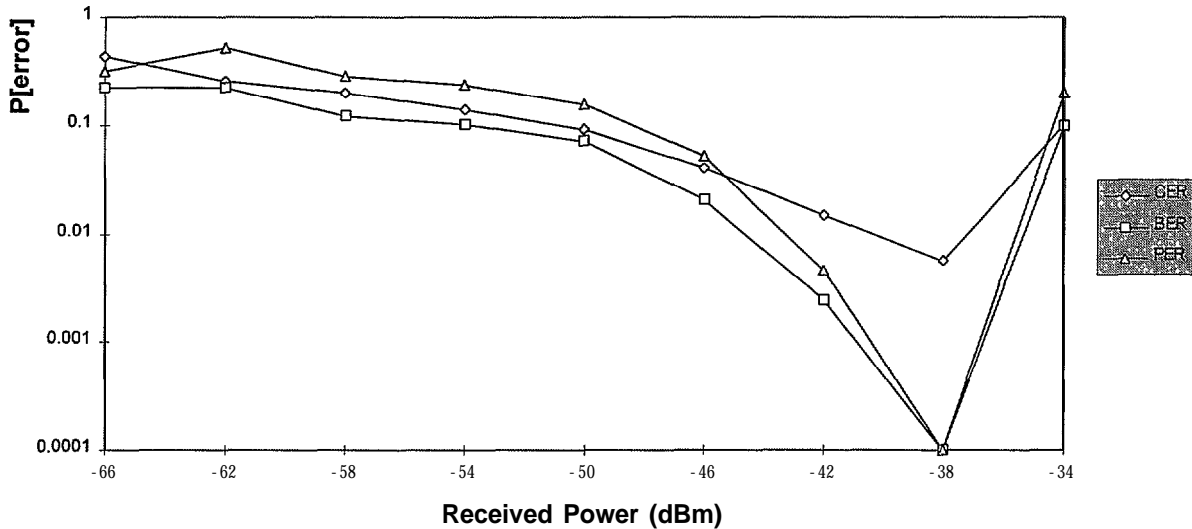

Figure 44. Mean CER, BER, and PER vs. received signal power for urban high-rise environment.

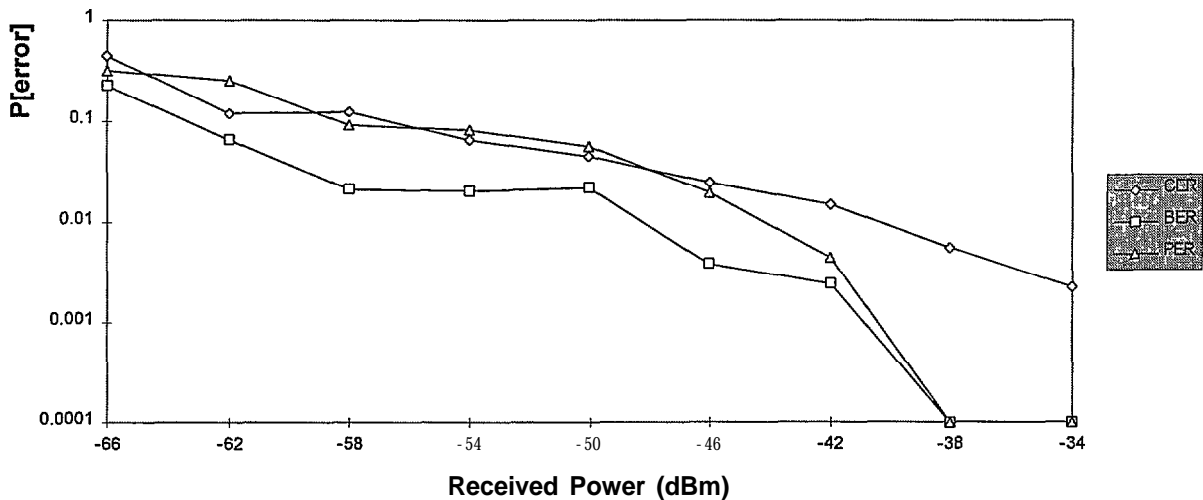

Figure 45. Mean CER, BER, and PER vs. received signal power (SYNC data) for urban high-rise environment.

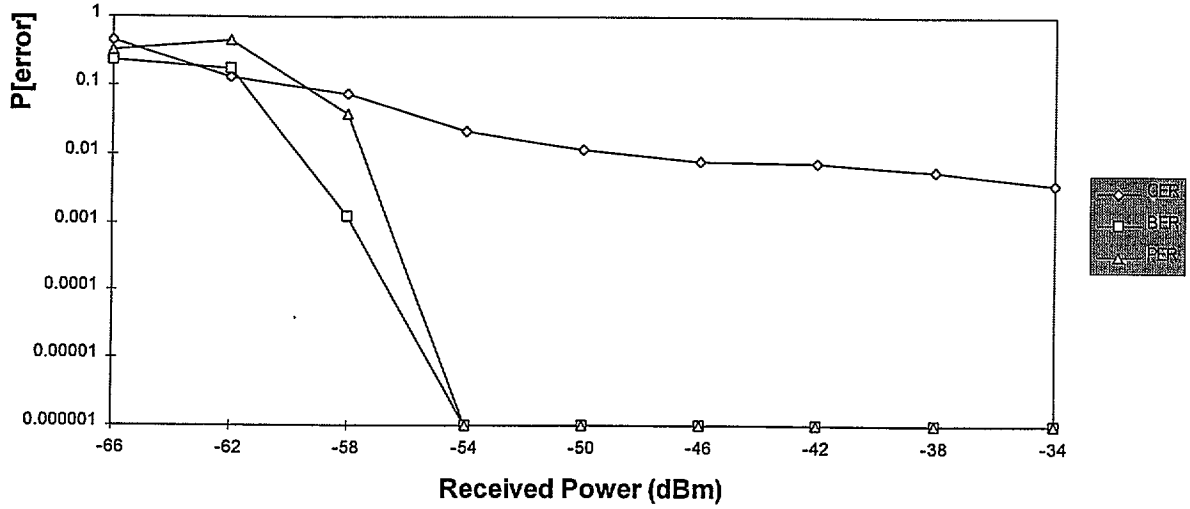

Figure 46. Median CER, BER, and PER vs. received signal power for urban high-rise environment.

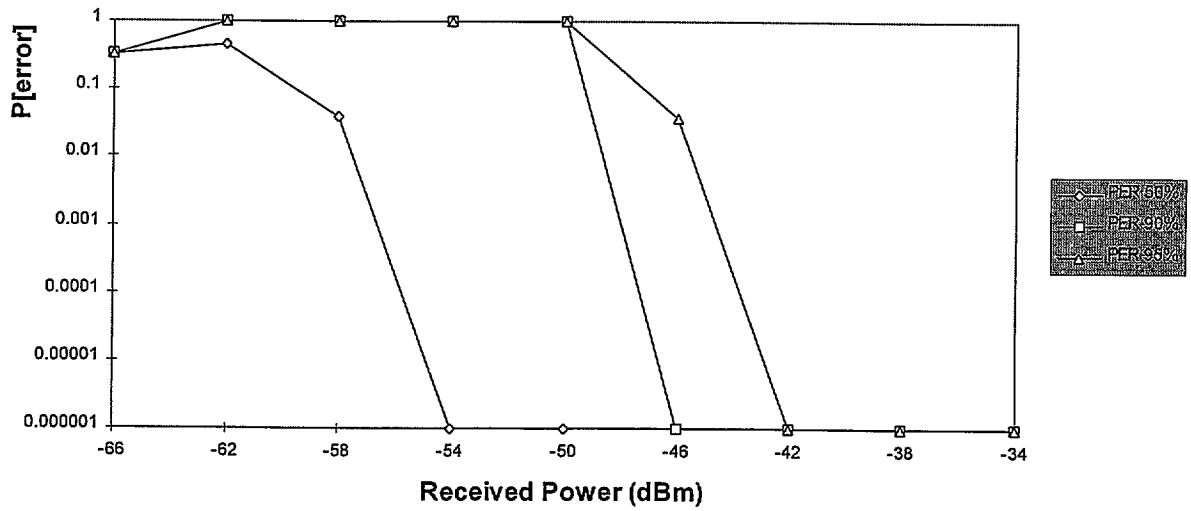

Figure 47. Percentile CER, BER, and PER vs. received signal power for urban high-rise environment.

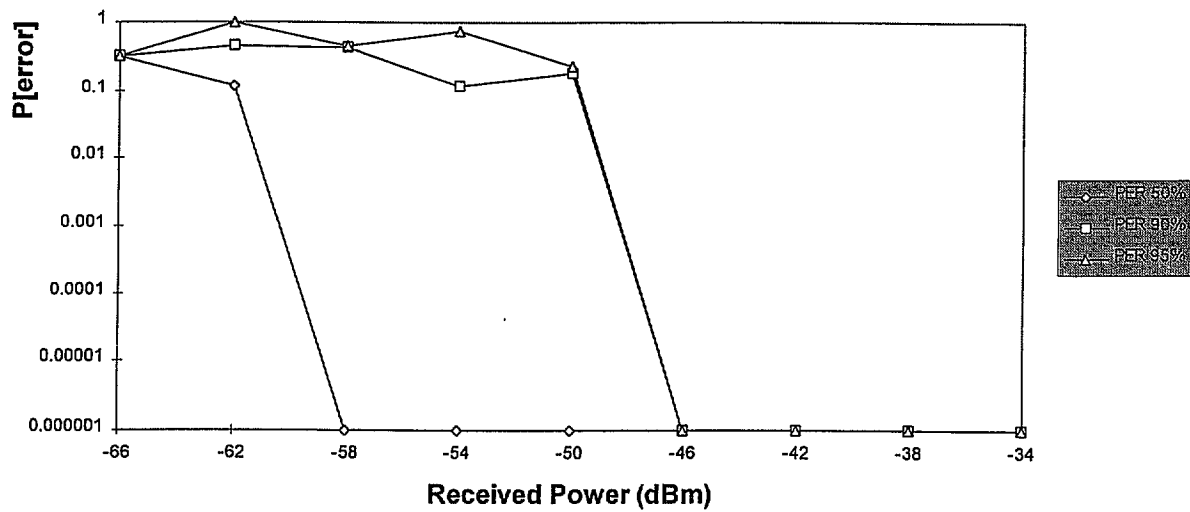

Figure 48. Percentile CER, BER, and PER vs. received signal power (SYNC data) for urban high-rise environment.

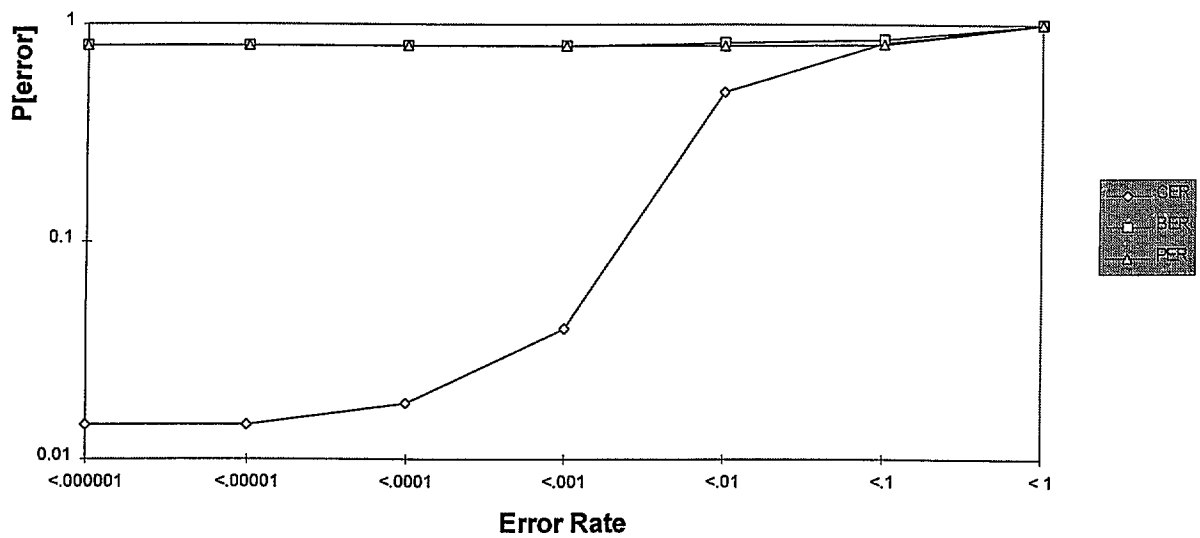

Figure 49. Cumulative CER, BER, and PER vs. received signal power for urban high-rise environment.

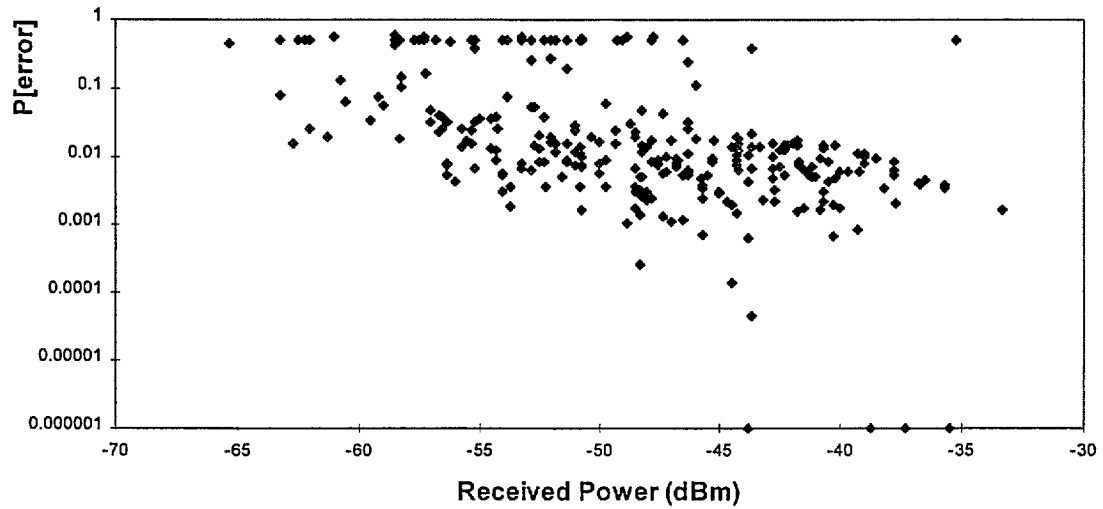

Figure 50. Channel error rates vs. received signal power for urban high-rise environment.

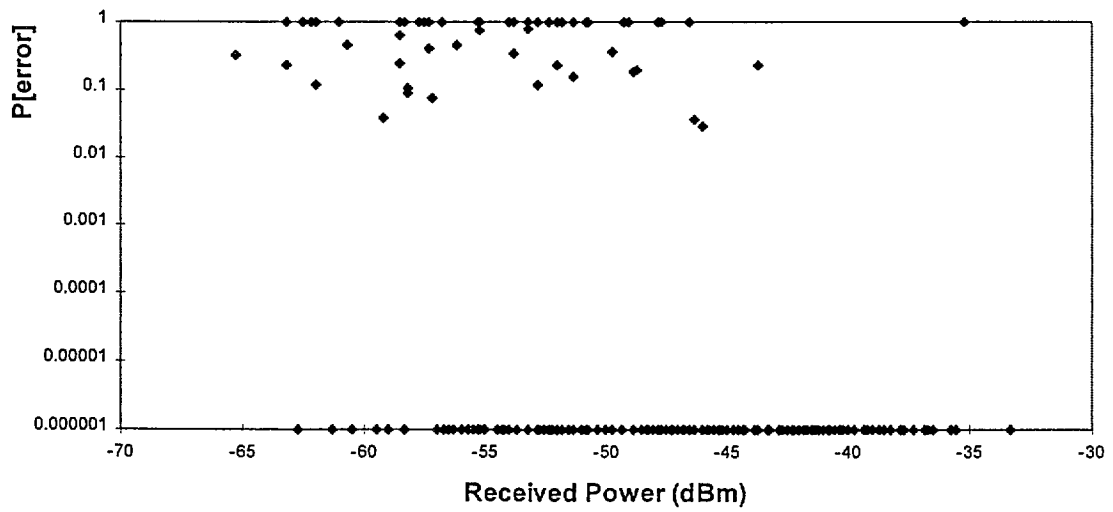

Figure 51. Packet error rates vs. received signal power for urban high-rise environment.

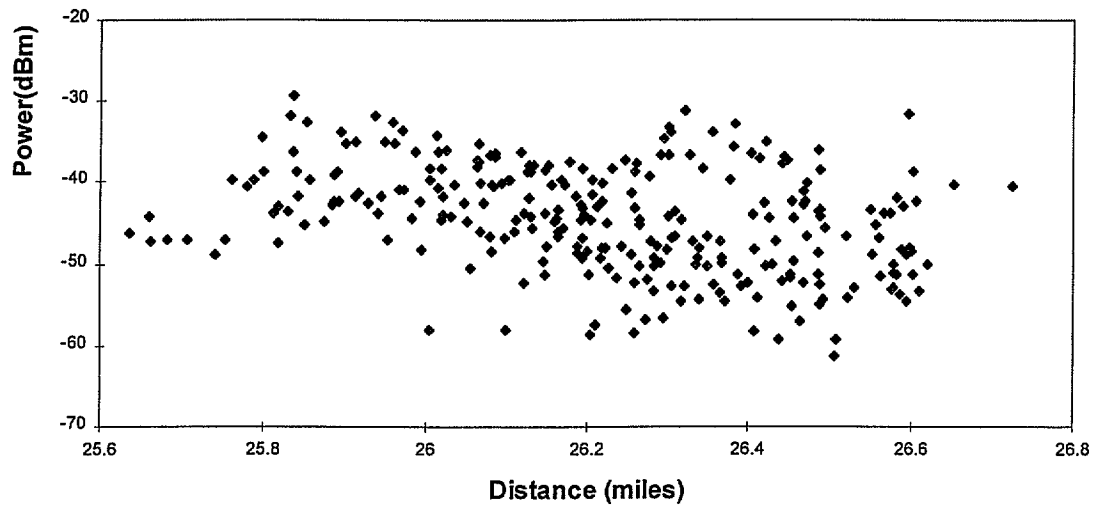

Figure 52. Received signal power vs. distance from transmitter for urban high-rise environment.

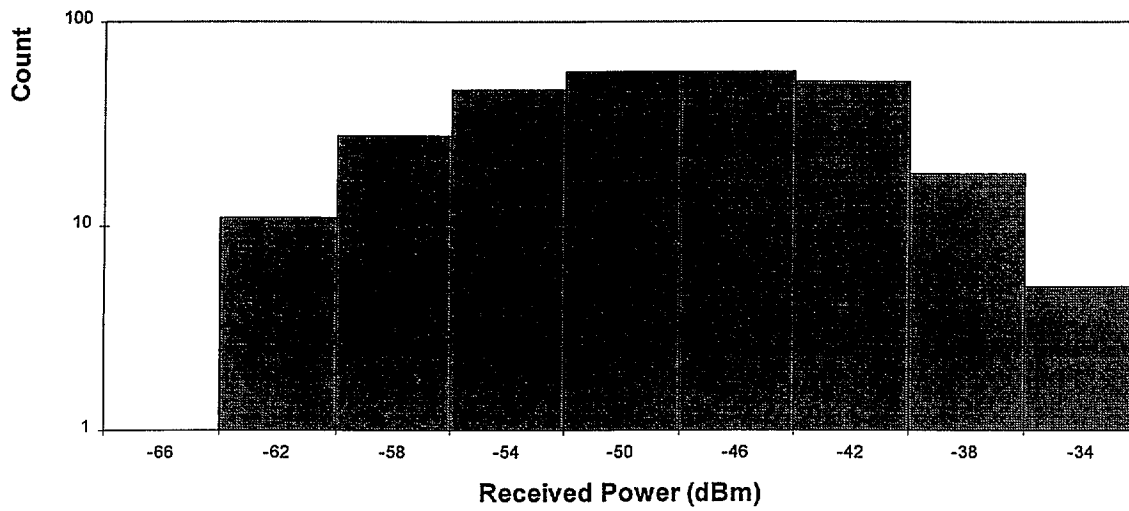

Figure 53. Measurement count vs. received signal power for urban high-rise environment.



## 5. CONCLUSIONS

Figures 54 through 57 compare mean and 95th percentile channel, bit, and packet error rates for the four environments including and excluding out-of-sync data. The STIC system performed most reliably in the rural plains environment and similarly in the urban low-rise environment. These two environments were relatively clear of significant natural or man-made obstacles. In these environments, STIC performance degradation was due to occasional severe signal shadowing by local geographic obstacles, such as hills or locally dense clusters of buildings. These encounters with severe signal shadowing often resulted in the STIC system losing synchronization.

STIC performance was degraded by 15 to 20 dB when operated in the urban high-rise environment; performance degraded by 27 to 42 dB in the rural mountain environment. This performance degradation was with respect to the rural plains environment. In the rural mountain environment, the proximity of the receiver to the transmitter was not an issue, ranging from 2-48 miles, but the signal power vs. distance scatter plot (Figure 29) shows that the effect of local terrain shadowing was significant. Proximity of receiver to transmitter may have been an issue in the analysis of the urban high-rise data. Figures 44 through 51 show a significant increase in STIC performance vs. received signal power when operated in the urban high-rise environment. As mentioned in Section 4.3.4, the Denver urban high-rise environment may not be typical of the reception environment of most high-rise areas. A typical FM transmitter, located atop a tall building in a high-rise sector, may present a greater signal level than a transmitter located 26 miles away and produce significantly improved system performance.

The primary culprit in the degradation of STIC system performance in all environments was loss of synchronization. While it can be argued that the system was initializing during this period, it was also true that the system had to first lose synchronization before this resynchronization was necessary. During the resynchronization period (approximately 15 seconds), the STIC CER, BER, and PER were at a maximum and a significant performance reduction was inflicted. Discussions with MITRE personnel suggested that the STIC synchronization performance would have improved if the x2 interleaver was used instead of the x1 interleaver.

Comparisons of measurements with predictions of received signal power were made using data from two paths for the STIC field test measurements. The results are shown in Figures D-1 and D-2 of Appendix D show that for these environments where the STIC system will be used, the NTIA/ITS Communication System Performance Model (CSPM) can be used for reliable coverage predictions.

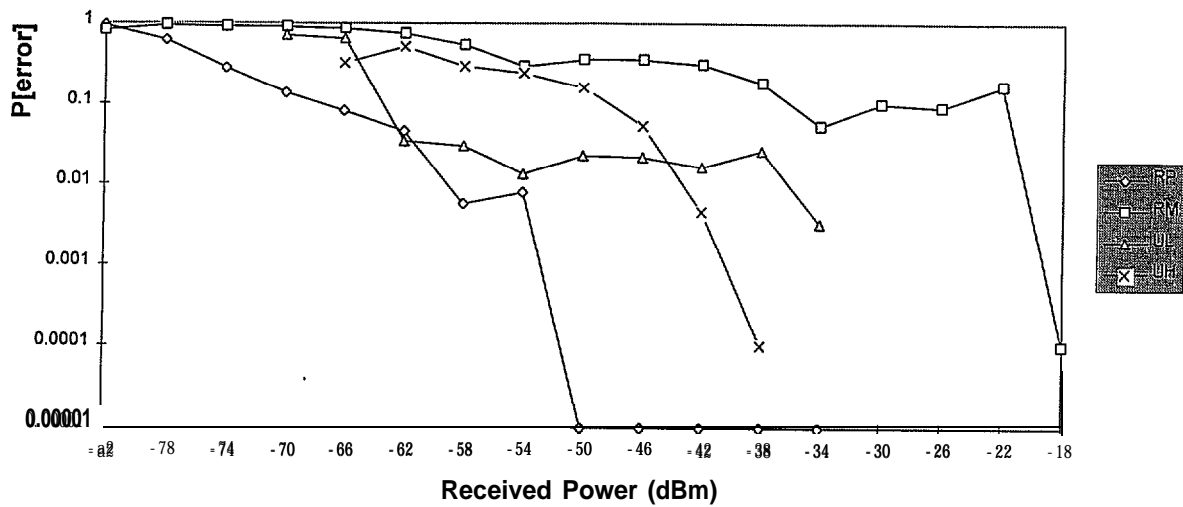

Figure 54. Mean packet error rates vs. received signal power for four environments.

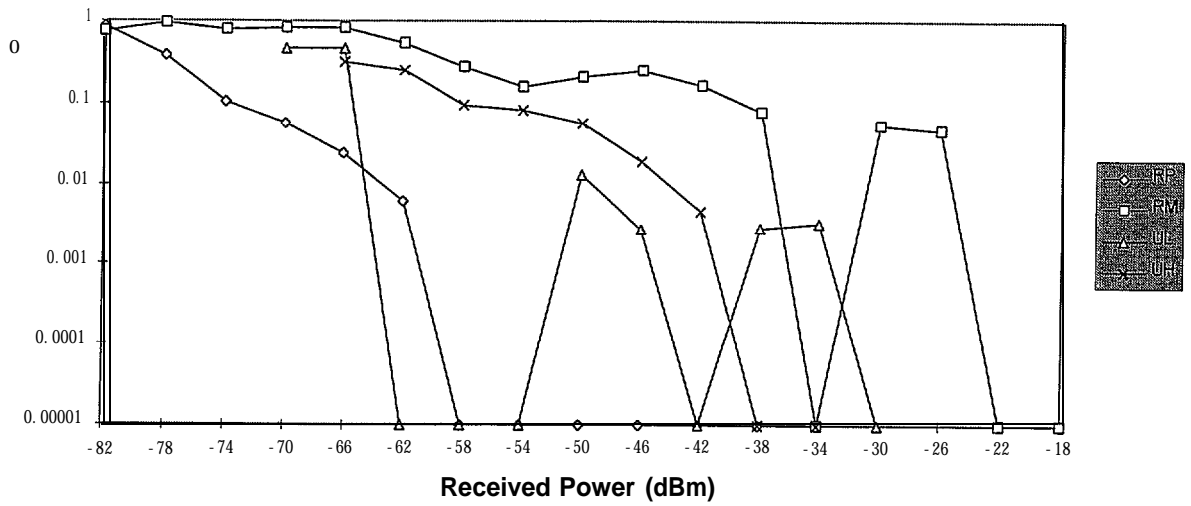

Figure 55. Mean packet error rates vs. received signal power for four environments (SYNC data).

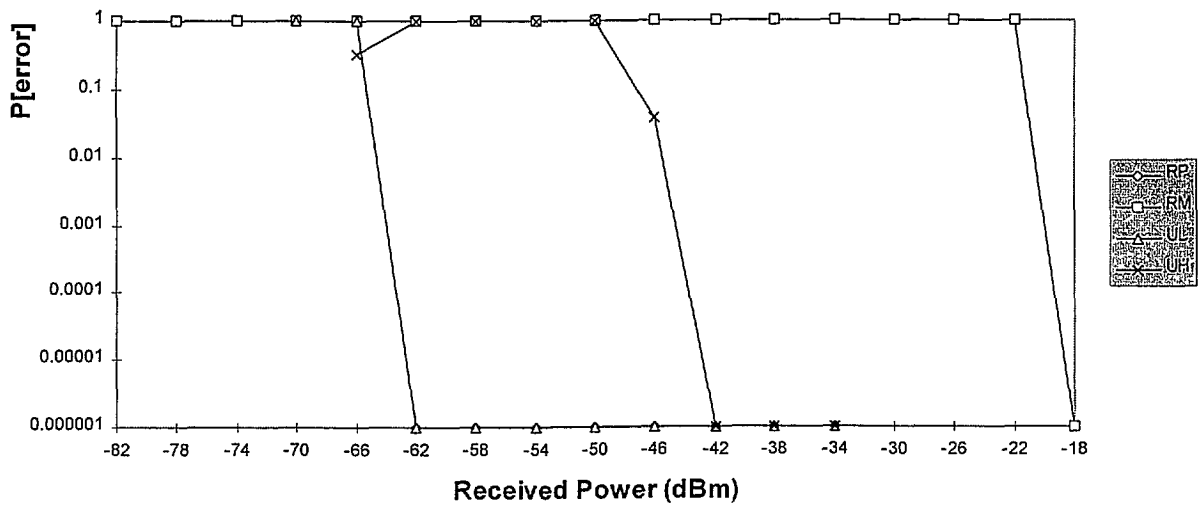

Figure 56. 95<sup>th</sup> percentile packet error rates vs. received signal power for four environments.

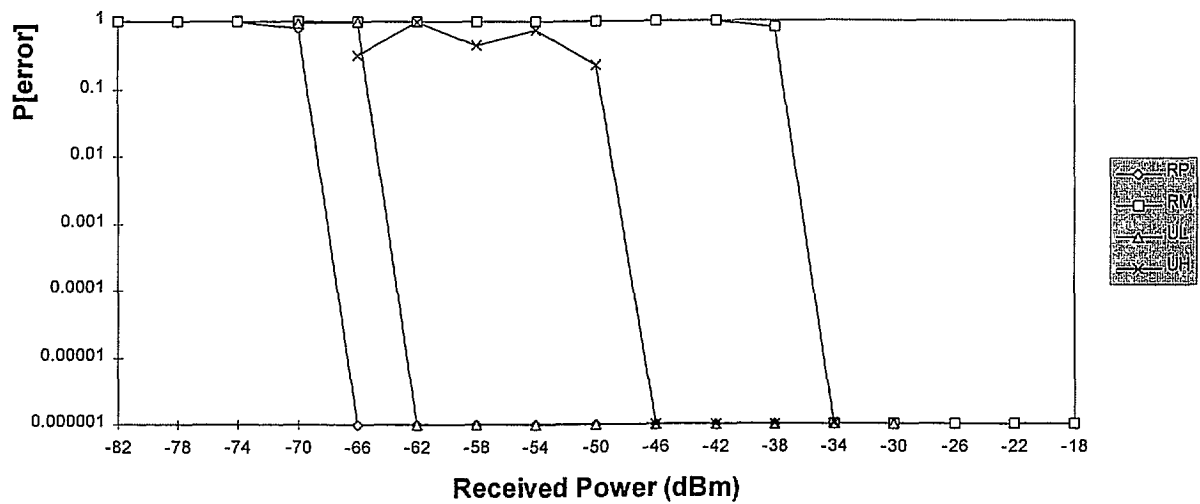

Figure 57. 95<sup>th</sup> percentile PERs vs. received signal power for four environments (SYNC data).

## APPENDIX A: DATA COLLECTION SYSTEM

In order to efficiently measure STIC performance and received signal power over a wide geographical area, a mobile data collection system was employed. The data collection system consisted of a van with both the STIC receiver and FM signal power measurement. GPS receivers were employed by both systems allowing the simultaneous collection of signal power, STIC performance, time, and location.

The STIC receiver and power measurement systems were installed in a van. The single FM antenna, shared between the STIC and FM power measurement systems, was a quarter wavelength monopole mounted on a 132-cm diameter circular ground plane. The antenna was set at a nominal height of 79 cm and adjusted for a minimum voltage standing wave ratio (VSWR) at 98.5 MHz. The VSWR was reduced to 1.5:1 by impedance matching the antenna. The antenna and ground plane were mounted on a roof rack about 13 cm above the roof of the van. The gain of the antenna was 1.5 dBi. The feed from the antenna was connected to an RF power splitter where it was routed to the FM stereo receiver (STIC system) antenna terminal and to the spectrum analyzer (FM signal power measurement system). Also mounted on the roof of the van were two GPS receiver antennas, one for each system. The STIC system has provisions for receiving and recording GPS data along with the error data. An additional GPS antenna and receiver were used with the signal power measurement system in order to continue the reception of GPS data while the STIC system was out of synchronization. They also were used to record an independent estimate of position. Each system employed a PC dedicated to system control, configuration, and data collection. The entire system was powered by a portable generator that was towed behind the van.

### A.1 Data Collection - STIC

When operating in BER mode, the STIC transmitter continuously sends a pseudorandom noise (PN) data sequence. The receiver compares the incoming sequence to the transmitted sequence (stored internally at the receiver) and computes and stores system performance data. A system data record was stored every  $T_i/72$  seconds where  $T_i$  was the interleaver time (5.76 seconds for the x1 interleaver). A data record consists of the following fields:

- time,
- speed,
- frame identification number,
- channel error count,
- packet count,
- latitude,
- heading,
- synchronization value,
- bit error count,
- packet errors,
- longitude,
- synchronization flag,
- byte count,
- Viterbi errors, and
- system parameter mask.

For the purposes of the NTIA/ITS test program, not all of the fields are relevant. All were collected, however, in order to maintain compatibility with software routines that MITRE provided. The processing of this data is explained in Appendix B.

## A.2 Data Collection Signal Power

The signal power data collection system consisted of an HP 8562A Spectrum Analyzer, Trimble PAC II GPS receiver, and a laptop PC. The spectrum analyzer was configured to operate in the detector sample mode, at a center frequency of 98.5 MHz, span of 0 Hz, resolution and video bandwidths of 300 kHz and a sweep time of 30 seconds. In this configuration, the spectrum analyzer displays and stores received power as a function of time in a 300-kHz bandwidth centered at 98.5 MHz. The sweep data were sampled and stored as a series of 601 data points. The 30-second sweep time yields a 20-Hz sampling rate. The PC alternately collects time and location data from the GPS receiver and power measurements from the spectrum analyzer. The data collection PC first queries the spectrum analyzer for the current set of received power data. At the end of each 30-second sweep, the data collection PC then queries the GPS receiver for the current time and location. These values are stored to the data collection hard disk. This cycle repeats continuously until a command was given to cease. At that time, the system continued to operate until the current sweep was finished and saved and a final GPS time and location estimate were received and stored. The received signal power data file format was as follows:

```
data header,  
time, latitude, longitude, power[0], power[1],.....power[600],  
time, latitude, longitude, power[0], power[1],.....power[600],  
.....  
.....  
.....  
.....  
time, latitude, longitude, power[0], power[1],.....power[600],  
time, latitude, longitude.
```

## APPENDIX B: DATA-PROCESSING METHODOLOGY

Data collection was performed by two independent systems. However, the data files from each system ultimately needed to be combined in order to correlate received signal power to STIC performance. The STIC system collected GPS location, GPS time, and STIC performance data. The FM power measurement system collected GPS location, GPS time, and signal power as a function of time (and therefore location). The time resolution of each GPS system was 1 second.

### B.1 Signal Power Data Analysis

The signal power measurement system consisted of an FM band antenna, GPS antenna and receiver, spectrum analyzer, and data collection PC. The spectrum analyzer was used to measure available signal power, the GPS receiver to determine position and time, and the PC to collect and store spectrum analyzer and GPS data. Data from the spectrum analyzer and GPS receiver were collected periodically and stored serially in a file.

Each file entry consisted of a time, latitude and longitude reading from the GPS receiver followed by 601 power measurements from the spectrum analyzer. The 601 points corresponded to one full sweep from the analyzer, therefore a sweep time of 30 seconds yielded a power measurement every 0.05 seconds. Following guidelines recommended by Lee [1], the recommended procedure for measuring the local received power for a mobile radio system was to obtain a series of measurements over a path, from 20 to 40 wavelengths in length, sampling at least 36 times during this interval and finding the arithmetic mean of the 36-sample set. A 40-wavelength sampling interval was preferable.

A spectrum analyzer sweep time of 30 seconds was chosen such that a single sweep would be appropriate over the expected range of receiver velocities of 5 to 60 mph. Averages were computed over intervals approaching 40 wavelengths whenever possible. Only when the average speed decreased to under 5 mph did the effective sampling interval begin to approach 20 wavelengths. Given the wavelength of the broadcast signal:

$$\lambda = \frac{3 \times 10^8}{98.5 \times 10^6} = 3.05 \text{ meters}$$

and

$$20 \times \lambda = 61 \text{ meters}, \quad 40 \times \lambda = 122 \text{ meters}$$

then the lowest vehicle speed at which the measurement system would traverse 20 wavelengths in a 30-second interval was:

$$V_{\min} = \frac{61 \text{ meters}}{30 \text{ seconds}} = 2.03 \text{ meters / second} = 4.54 \text{ miles / hour} .$$

Lee also stated that at least 36 samples should be taken over the 20- to 40-wavelength interval. At a sampling rate of 20 samples/second, 36 samples were recorded in 1.8 seconds. The receiver velocity at which 40 wavelengths were traversed in 1.8 seconds is:

$$V_{\max} = \frac{122 \text{ meters}}{1.8 \text{ seconds}} = 67.8 \text{ meters / second} = 151.5 \text{ miles / hour} .$$

This implied that our sampling rate and block length were sufficient for all vehicle speeds greater than 4.5 mph and less than 150 mph.

As mentioned previously, data were recorded in 30-second blocks of data containing power levels in dBm with time, latitude, and longitude values at the beginning of each block. The time, latitude, and longitude values at the beginning of the next block were used as the end values for the previous block. When processing the data, the first value computed was the distance traversed during the 30-second scan in order to verify that the minimum 20-wavelength distance was traversed for the block. This was computed by determining the distance between the beginning and ending (latitude, longitude) pairs for the block and then converting that value to the number of wavelengths traversed. If the distance traveled for a block was less than 20 wavelengths, the data block was discarded. If the distance traveled for a block was more than 20 wavelengths, then the data block was divided into an integral number of sub-blocks using the following equation:

$$N_{\text{sub-blocks}} = \left\lceil \frac{\text{distance}}{40 \times \text{wavelength}} \right\rceil + 1$$

Each of these sub-blocks represented the spatial sampling of the local signal power taken over an interval of 20 to 40 wavelengths and have at least 36 samples per sub-block. The mean power value was then computed on each of the sub-blocks by computing the arithmetic mean on the logarithmic power levels (dBm) in the data [1]. Since time, latitude, and longitude information was only stored in blocks every 30 seconds and a typical sub-block was approximately 5 seconds in length, estimates of time, latitude, and longitude had to be made for each of the N sub-blocks to provide position information. This was performed by linearly interpolating between the time, latitude, and longitude measurements at the beginning and end of each measurement block and evaluating these functions at the center of each sub-block. The values of center time, center latitude, center longitude, and mean signal power in dBm were stored in a file to process either separately or in conjunction with the STIC error data.

## B.2 STIC Data

The STIC data collection system consisted of a specially modified FM stereo receiver, STIC receiver and laptop PC. As described in Appendix A, the STIC system recorded a data record every 80 milliseconds.

The data in this file needed to be associated with the signal power data file in order to correlate error rates with signal power. Each signal power measurement was computed over a time interval between 4.5 and 30 seconds in length, depending on the velocity of the vehicle. Each entry in the signal power file consisted of start time, center time, stop time, center latitude, center longitude, and signal power. The start and stop times were used to select STIC data file entries that occurred during a particular signal power measurement interval.

For each signal power measurement there was an associated start and stop time. The start and stop times were used to select entries from the STIC data file. These data were then used to compute CER, BER, and PER for the current signal power measurement. The error ratios were computed as follows:

$$CER = \frac{\sum_{t = start\ time}^{stop\ time} channel\ errors}{2 \times 8 \times 243 / 228 \times \sum_{t = start\ time}^{stop\ time} byte\ count}$$

$$BER = \frac{\sum_{t = start\ time}^{stop\ time} bit\ errors}{8 \times \sum_{t = start\ time}^{stop\ time} byte\ count}$$

$$PER = \frac{\sum_{t = start\ time}^{stop\ time} packet\ errors}{\sum_{t = start\ time}^{stop\ time} packet\ count}$$

Depending on the environment, the STIC system occasionally lost synchronization; i.e., became inoperable while the STIC system attempted to regain sync with the transmitter. During these times, no data were written to the data collection PC as there were no BER data being received by the STIC. During the time that the STIC system was out of sync, there were no data entries in the STIC data file. Therefore, during these times, the sums were not formed and the error rates were assigned default values of CER = BER = 0.5 and PER = 1.



These three error ratios were computed for each signal power measurement and stored to a new file now consisting of the following fields:

- center time,
- center latitude,
- center longitude,
- signal power,
- CER,
- BER, and
- PER.

This data file was used to develop a number of graphs. The type of plots generated for each environment (rural plains, rural mountain, urban low-rise, and urban high-rise) were:

- mean error rates (CER, BER, PER) vs. signal power,
- mean error rates (sync data only) vs. signal power,
- median error rates vs. signal power,
- percentile PER vs. signal power,
- percentile PER (sync data only) vs. signal power,
- mean error rates vs. distance from transmitter,
- cumulative error rates vs. error rate,
- scatter plot of CER vs. signal power,
- scatter plot of PER vs. signal power,
- received power vs. distance from transmitter,
- measurement count vs. signal power, and
- measurement count vs. distance from transmitter.

Additional plots comparing the four environments were:

- mean PER vs. signal power for four environments,
- mean PER vs. signal power for four environments (sync data),
- percentile PER vs. signal power for four environments, and
- percentile PER vs. signal power for four environments (sync data).

## REFERENCES

- [1] W.C.Y. Lee, "Estimate of local average power of a mobile radio signal," *IEEE Trans. Veh. Technol.*, VT-34, No. 1, pp. 22-27, Feb. 1985.

## APPENDIX C: CONVERSION OF RECEIVED SIGNAL POWER TO ELECTRIC FIELD STRENGTH

Throughout this report, STIC performance has been reported as a function of received signal power. In some cases, electric field strength is a more useful parameter with which to correlate system performance. Fortunately, received signal power can easily be converted to electric field strength. The pertinent components of the signal power measurement system are shown in the Figure C- 1.

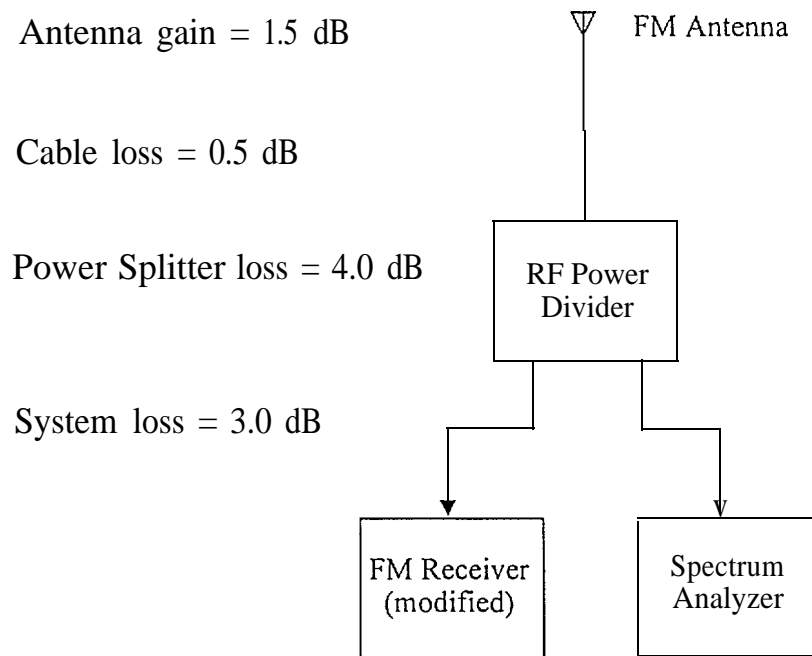

Figure C-1. FM antenna system loss.

The equation for converting received signal power to electric field strength is as follows:

$$E(\text{dBuV} / m) = \text{received signal power (dBm)} + 77.21 + 20 \times \log(f / 10^6) - \text{antenna gain(dBi)} + \text{cable loss(dB)} + \text{divider loss(dB)}.$$

Substituting the appropriate values yields:

$$\begin{aligned} E(\text{dBuV} / m) &= \text{received signal power (dBm)} + 77.21 + 39.87 - 1.5 + 0.5 + 4.0 \\ &= \text{received signal power(dBm)} + 120.1 \end{aligned}$$

## APPENDIX D: COMPARISON OF PREDICTED AND RECEIVED SIGNAL POWER LEVELS

System performance predictions were made to compare with measured data of several paths collected for this report. The received signal power level versus distance data were collected and processed using the methods described in the previous appendices to determine the mean received signal power versus distance from the transmitter. The distance from the transmitter to the test vehicle was used (not the distance along the path), since none of the paths was actually a radial path from the transmitter. The measured data were available at increasing distances -from the transmitter at approximately every 0.06 miles. The predictions were made to occur at these same points to compare directly with the measured data. The predictions were performed using the NTIA/ITS Communication System Performance Model (CSPM), a widely used and accepted model for performance of communication systems in the frequency range of 20 MHz to 20 GHz. Path locations at one-mile intervals of distance from the transmitter were selected for plotting. The final calculations for the predictions take into account the gain as a function of elevation angle of the receiver antenna on the test vehicle and the gain of the transmitter antenna at the radio station. The resulting data were plotted in Figures D-1 and D-2 for the paths along Interstate 25 and Interstate 76, respectively. Considering that the CSPM prediction model does not openly account for losses due to vegetation or man-made structures, these figures show good agreement between actual measurements and predictions. Performance predictions can be made with confidence for other areas of the country where the coverage for the STIC system needs to be determined.

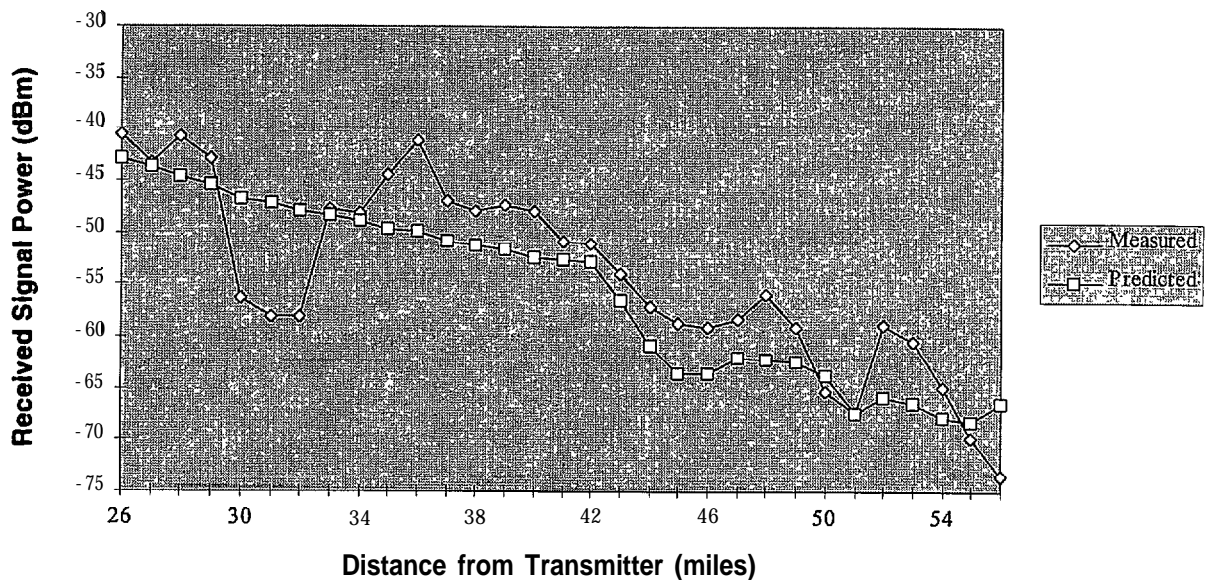

Figure D- 1. Measured and predicted mean received signal power for north-bound path (along Interstate 25).

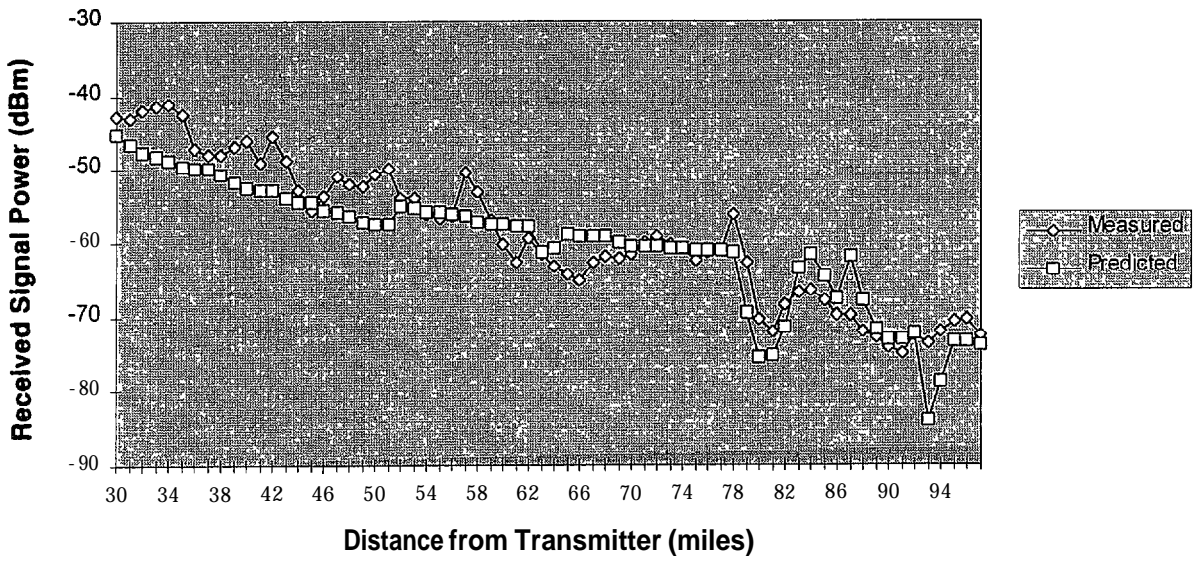

Figure D-2. Measured and predicted mean received signal power for north-east bound path (along Interstate 76).

**BIBLIOGRAPHIC DATA SHEET**

1. PUBLICATION NO. NTIA Report 96-333		2 Gov't Accession No	3 Recipient's Accession No
4 TITLE AND SUBTITLE Testing and Evaluation of the Subcarrier Traffic Information Channel		5 Publication Date September 1966	
		6 Performing Organization Code NTIA/ITS	
7 AUTHOR(S) John F. Mastrangelo and Wavne R. Rust		9 Project/Task/Work Unit No	
8 PERFORMING ORGANIZATION NAME AND ADDRESS National Telecommunications and Information Admin. Institute for Telecommunication Sciences 325 Broadway Boulder, CO 80303		10 Contract/Grant No	
11 Sponsoring Organization Name and Address Federal Highway Administration Turner Fairbank Highway Research Center 6300 Georgetown Pike McLean, VA 22101-2296		12 Type of Report and Period Covered NTIA	
14 SUPPLEMENTARY NOTES		13	
15 ABSTRACT (A 200-word or less (actual summary of most significant information if document includes a significant bibliography or literature survey. mention it here.)  In support of the Federal Highway Administration of the United States Department of Transportation, the Institute for Telecommunication Sciences has completed a laboratory and field test program designed to independently evaluate the performance of an FM subcarrier-based traveler information broadcast system. This system was developed by the MITRE Corporation to investigate the use of FM subcarriers for the broadcast of traffic data to vehicles on highways. The testing and evaluation program measured the Subcarrier Traffic Information Channel (STIC) system performance both in the laboratory and when installed in the subcarrier channel of a commercial FM broadcast station. STIC performance was measured and evaluated in a variety of reception environments in order to assist in the future prediction of STIC coverage in areas of the United States that differ dramatically in terrain and population density.			
16 Key Words (Alphabetical order, separated by semicolons) Advanced Traffic Information Systems (ATIS), FM Broadcast subcarrier, Intelligent Transportation Systems (ITS), propagation measurements, propagation predictions			
17 AVAILABILITY STATEMENT  <input type="checkbox"/> UNLIMITED  <input type="checkbox"/> FOR OFFICIAL DISTRIBUTION		16. Security Class (This report)	20 Number of pages 60
		19 Security Class (This page)	

# **NTIA FORMAL PUBLICATION SERIES**

## **NTIA CONTRACTOR REPORT**

Information generated under an NTIA contract or grant and considered an important contribution to existing knowledge.

## **NTIA HANDBOOK**

Information pertaining to technical procedures, reference and data guides, and formal user's manuals that are expected to be pertinent for a long time.

## **NTIA MONOGRAPH**

A scholarly, professionally oriented publication dealing with state-of-the-art research or an authoritative treatment of a broad area. A monograph is expected to have a long lifespan.

## **NTIA REPORT**

Important contributions to existing knowledge but of less breadth than a monograph, such as results of completed projects and major activities, specific major accomplishments, or NTIA-coordinated activities.

## **NTIA RESTRICTED REPORT**

Contributions that fit the NTIA Report classification but that are limited in distribution because of national security classification or Departmental constraints. This material receives full review and quality control equivalent to the open-literature report series.

## **NTIA SPECIAL PUBLICATION**

Information derived from or of value to NTIA activities such as conference proceedings, bibliographies, selected speeches, course and instructional materials, and directories.

## **SPONSOR-ISSUED REPORTS**

NTIA authors occasionally produce reports issued under an other-agency sponsor's cover. These reports generally embody the criteria of the NTIA Report series.

For information about NTIA publications, contact the ITS Technical Publications Office at 325 Broadway, Boulder, CO, 80303 Tel. (303) 497-3572 or e-mail

---

*This report is for sale by the National Technical Information Service, 5285 Port Royal Road, Springfield, VA 22161, Tel. (703) 487-4650.*