

LRIT RECEIVER SPECIFICATIONS

This document describes the H/W components and S/W processing for a user terminal receiving digital transmissions from the GOES-E or GOES-W satellites. This paper is intended to become a design specification for developers of USA LRIT receive stations.

LRIT RECEIVER SPECIFICATIONS

1.0 Introduction

This document describes the technical specifications for building an LRIT receiver station to capture the GOES digital broadcast. The USA LRIT receive station is designed to be interoperable with the JMA and EUMETSAT systems.

1.1 LRIT Service

The mission shall be named Low-Rate Information Transmission (LRIT) because the communications link provides a data rate below 256 kbps.

1.2 Design Application

The design of the LRIT user station will be consistent with the design of the receivers for the **CCSDS Recommendation for Space Data System Standards** for Packet Telemetry. It will be limited to reception of LRIT transmissions.

1.3 System Overview

The user station will consist of four main components as illustrated in Figure 1.

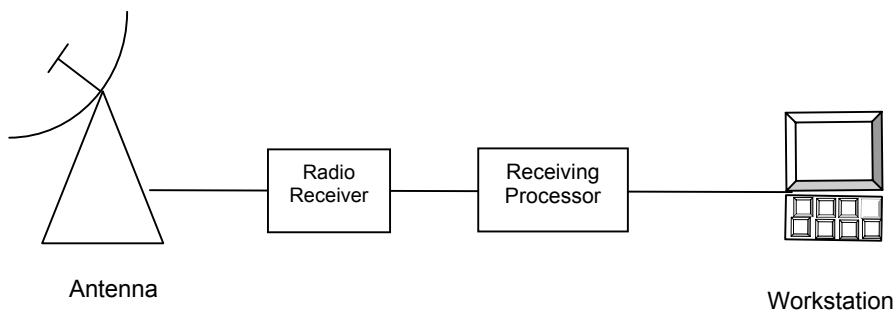

Figure 1. LRIT User Station System Components

The antenna is a parabolic dish antenna with no auto tracking. The downlink signal is received at 1691 megahertz (MHz). The signal may be filtered to reduce adjacent channel interference and/or amplified by a low-noise amplifier. Then it is down-converted to the receiver IF frequency. The IF amplifiers have a bandwidth capable of receiving a 293-kbps symbol stream. The IF signal is then demodulated in a BPSK demodulator and the baseband output to the receiving processor is a serial bit stream. Table 1 shows significant parameters of the RF system.

Table 1. LRIT Downlink Characteristics

Parameter	Value
Satellite EIRP	48.2 dBm
Center Frequency	1691.0 MHz
Useful bandwidth (@ -1 dB)	Sufficient for 293,000 symbols/sec BPSK
Packetized data rate	128 kbps
Total transmitted symbol rate	293 ksymbols/s
Modulation	PCM/NRZ-L/BPSK
Receiver Gain/Temperature (G/T)	-0.3 dB for 1-meter antenna +3.2 dB for 1.8-meter antenna
Ber	1×10^{-8}

The receiving processor decodes the bitstream, disassembles the LRIT packets, removes filler packets, removes the header information, reassembles and decompresses the original files, and sends the files to the workstation. The workstation contains the software to produce the images, lists, and text messages.

2.0 Introduction to the GOES-Specific OSI Reference Model

Table 2, given below, presents the OSI layers from top to bottom and the equivalent functionality included in the LRIT communication model from the view of the transmission service.

Table 2. LRIT OSI Layer Functionality

OSI Layer	Layer Functionality
Physical Layer	- Convolutional coding - Demodulation
Data Link Layer	- Disassembly of source packets - Demultiplexing - Acquisition of VCDUs - Reed-Solomon decoding - Derandomizing
Network Layer	- (none)
Transport Layer	- Final assembly
Session Layer	- Decryption (not used in USA implementation) - Decompression
Presentation Layer	- Retrieval of User Data from Files
Application Layer	- Processing of application data

3.0 Physical Layer

The physical layer on the LRIT service performs demodulation of the incoming signal into a serialized data stream. The serialized data stream is decoded with a Viterbi soft-decision (a.k.a. maximum likelihood) decoding algorithm.

The convolutional coding has the following characteristics:

- Nomenclature: Convolutional code with maximum-likelihood (Viterbi) decoding
- Code rate: 1/2 bit per symbol
- Constraint length: 7 bits
- Connection vectors: $G1 = 1111001$; $G2 = 1011011$
- Phase relationship: $G1$ is associated with the first symbol
- Symbol inversion: None

4.0 Data Link Layer

This section gives a general overview and discusses input to data link layer, VCA sublayer processing, as well as VCLC sublayer processing.

4.1 Input to Data Link Layer

The Physical Layer provides a decoded serial data stream to the Data Link, which contains LRIT packets.

4.2 General

This layer consists of two sublayers for VCLC processing and VCA processing. This layer receives a bit stream from the physical layer that must be decomposed into the individual packets. Fill packets are identified and discarded. Data packets are further processed and sent to the session layer.

4.3 VCA Sublayer Processing

The VCDU structure is shown in Figure 2.

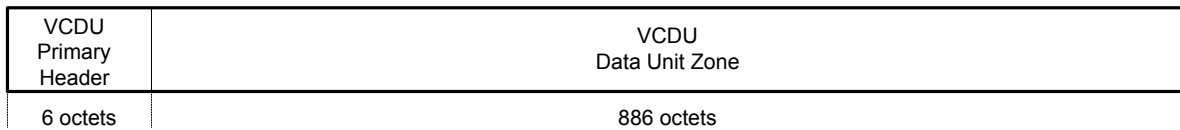

Figure 2. VCDU Structure

The decomposition of the VCDU header is given in Figure 3.

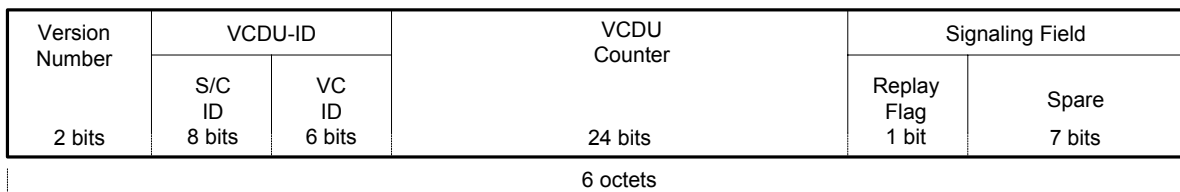

Figure 3. VCDU Primary Header

Mission-specific use:

Version Number '01'b
VCDU-ID Spacecraft (S/C) ID representing on the disseminating spacecraft
 VC ID '63'd ('all ones')
VCDU Counter Sequential count (modulo 16777216) of VCDUs on each virtual
 channel.
Signaling Field 'all zeros'

The VCA sublayer receives a data stream from the physical layer in a sequence of coded VCDU packets (C_VCDU) (Figure 2). The incoming serial datastream is synchronized into discrete CADUs. After this frame synchronization process, one randomized coded virtual channel unit CVCU is extracted from each CADU by means of stripping the synchronization markets off. Multiplying all 8160 bits of the randomized C_VCDU with a statically defined psuedonoise pattern performs derandomization. The packet structure now looks like Figure 4. After derandomization, each clear C_VCDU undergoes a forward error correction (FEC) based on the Reed-Solomon check symbols included in the packet.

After FEC, full VCDUs, with a VC = 63 are discarded. The VCA-SDU is extracted from the data unit zone of the VCDU; the VCU_ID is defined in the primary header (Figure 4).

VCDU Primary Header	VCDU Data Unit Zone	Reed-Solomon Check Symbols
6 octets	886 octets	128 octets

Figure 4. C_VCDU Structure

4.3.1 Reed-Solomon Coding

The LRIT dissemination service is a Grade-2 service; therefore, the transmission of user data will be error controlled using Reed-Solomon coding as an outer code.

The used Reed-Solomon code is (255,223) with an interleaving of $I = 4$.

The Reed-Solomon check symbols are extracted from the last 128 octets of the C_VCDU packets forming VCDU packets.

4.3.2 Derandomization

Randomization was applied to all LRIT CVCDUs. It is a process in which a pseudo-random sequence is bit wise exclusive-ORed to all 8160 bits of the CVCDU to ensure sufficient data transitions.

The de-randomization process will generate the same pseudo-random sequence, synchronize with the incoming bit stream, and exclusive-OR it to extract the original data stream.

The pseudo-random sequence will be generated using the following polynomial:

$$h(x) = x^8 + x^7 + x^3 + 1$$

This randomizing sequence will begin at the first bit of the CVCDU and be repeated after 255 bits, continuing repeatedly until the end of the CVCDU. The sequence generator will then re-initialized to all-ones for the processing of the next CVCDU.

4.4 VCLC Sublayer Processing

Upon acquisition of an M_PDU, the layer demultiplexes zero or more source packets from the acquired M_PDU and eventually the available data belonging to the same virtual channel. Whenever a source packet is complete, it is checked for being a fill packet: if the APID equals 2047, the packet is assumed to be a fill packet. Fill packets are discarded, whereas other source packets are forwarded to the network layer.

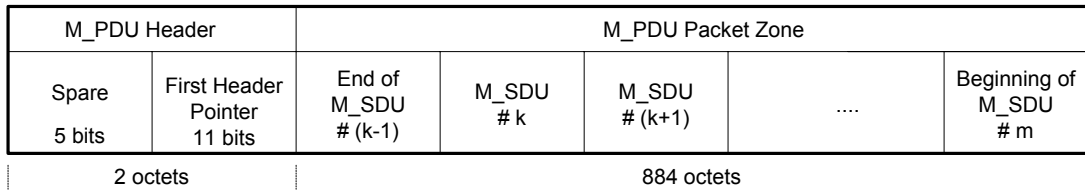

Figure 5. M_PDU Structure

5.0 Network Layer

Upon acquisition of a source packet, the network layer forwards the source packet to the transport layer. There is no other processing in this layer.

6.0 Transport Layer

This layer reassembles the LRIT files that were subdivided before transmission into transmission packets.

Upon acquisition of source packets, the packets are sorted by their APIDs. The contents of the data fields, except the last two octets are concatenated under control of the sequence flags in the packet headers, resulting in a transport file. As soon as a transport file is complete, the TP_SDU is extracted and routed to the session layer.

The CRC field included in each segment is checked to verify the integrity of the received data. Failures of this test are reported to the user application processor with a warning statement. Errors in the packet headers, which are recognized by the presence of unexpected information, may be corrected by means of redundancy (e.g., implied by sequence) and semantics.

6.1 Source Transport Service Data Unit

The TP_SDU packet structure is defined in detail in Section 6.2.1 (Source Packet Structure) of the transmit specification.

Source Packet Header (48 bits)							Packet Data Field (variable)	
Packet Identification				Packet Sequence Control		Packet Length	User Data Field	
Version No.	Type	Secondary Header Flag	APID	Sequence Flags	Packet Sequence Count		Application Data Field	Packet Error Control (CRC)
3 bits	1 bit	1 bit	11 bits	2 bits	14 bits	16 bits	Variable	16 bits
2 octets				2 octets		2 octets	Max. 8190 octets	2 octets

Figure 6. Source Packet Structure (TP_PDU)

6.2 Data Field Integrity Check

The CRC was computed over the entire application data field, using the following generator polynomial:

$$g(x) = x^{16} + x^{12} + x^5 + 1$$

7.0 Session Layer

The protocol data unit (S_PDU) may be compressed.

If the file is an image file, it is scanned for an image structure record. If the compression flag is non-zero, then the data field is decompressed and the primary header corrected accordingly (data field length).

The resulting file is the service data unit (S_SDU) forwarded to the presentation layer.

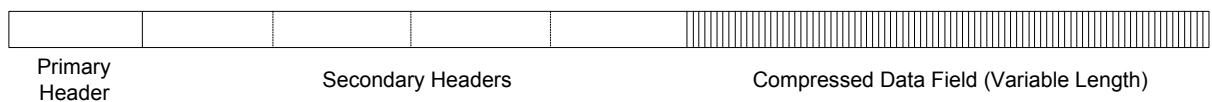

Figure 7. LRIT File Structure with Compressed Data Field

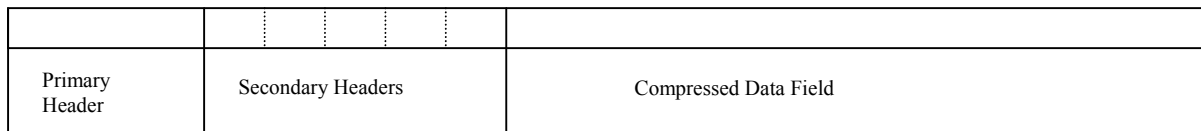

Figure 8. LRIT Session Protocol Data Unit (S_PDU)

7.1 Decompression

For NOAA LRIT, the compression flag from the Image Structure Header and the NOAA LRIT Header will be required to determine the compression. If Rice compression is to be used, the lossless compression flag will be set in the Image Structure Header and the NOAA LRIT Header will be set to 1.

In the case of alphanumeric data (text), the Image Structure Header will not exist. To determine if the text was compressed (Zipped), the NOAA-Specific Compression field will be set to 10.

7.2 Decryption

The GOES LRIT service will not use encryption.

8.0 Presentation Layer

The presentation layer converts the decompressed LRIT files (packets) into user data files. Several LRIT packets may contain the data for a single application file. Packets and their sequence will be determined from the header file and the files reassembled in the correct order.

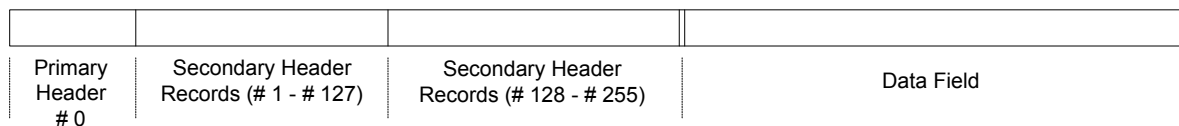

Figure 9. LRIT File Structure

The application files will be saved on a mass storage medium available to the LRIT processor and the application processor. The file name will be extracted from the secondary header record Type 4, the annotation record.

Image files that have been partitioned in the transmit application layer will have the partition number and number of partitions recorded in header type #128. The partitions are based upon a number of scan lines of the image. The partition files should be kept separate and identified as being part of an image.

Table 3. Header Types in the LRIT Files

Code	Header Record Type	Structure
Headers as Defined in LRIT Global Specification		
0	Primary header	
1	Image structure	
2	Image navigation	
3	Image data function	
4	Annotation	
5	Time stamp	
6	Ancillary text	
7	Key header	Optional
8...127	Reserved	
Mission-Specific Headers		
128	Segment identification	
129	NOAA specific	
130	Header Structure Record	
131...255	Reserved	

The headers present in the LRIT file will depend upon the file type. Table 4 below shows the headers that could come with each file type.

Table 4. Use of Header Records versus File Type

File Types	Header Record Types										
	0	1	2	3	4	5	6	7	128	129	130
Image Data	•	•	◆	◆	•	◆	◆	◆	◆	•	◆
Service Messages	•						◆			•	◆
Alphanumeric Text	•				•	◆	◆	◆		•	◆
Meteorological Data	•				•	◆	◆	◆		•	◆
GTS Messages	•				•	•		◆		•	◆

- = Mandatory
- ◆ = Optional

Mission-Specific Headers are not presented in the CGMS Global specification. They are presented below.

Table 5. Image Segment Identification Header

Size (octets)	Type	Contents	Value
1	Uint	Header type	128
2	Uint	Header record length	17
2	Uint	Image identifier	0..65535
2	Uint	Segment sequence number	0...Max segment-1
2	Uint	Start column of segment	0...Max column-1
2	Uint	Start line of segment	0...Max row - 1
2	Uint	Max segment	Number of segments
2	Uint	Max column	Width of final image
2	Uint	Max row	Height of final image

Table 6. NOAA LRIT Header

Size (octets)	Type	Contents	Value
1	Uint	Header type	129
2	Uint	Header record length	14
4	Char	Agency Signature	“NOAA”
2	Uint	Product ID	Table 8
2	Uint	Product SubID	Table 8
2	Uint	Parameter	Table 8
1	Uint	NOAA-Specific Compression	Table 7

Table 7. Compression Type

Global Image Compression Flag	NOAA Compression Flag	Compression
0 – None	0 – None	None
1 – Lossless	1 – Rice 3 – JPEG 2000 4 – PNG 5 – GIF 6 – TIFF . . Only lossless compression schemes can be referenced	Rice compression JPEG2000 compression Portable Network Graphics Graphics Interchange Format Tagged Image File Format . .
2 – Lossy	2 – JPEG 3 – JPEG 2000	Global-compatible JPEG lossy image compression JPEG2000 compression
None	10 – Zip	Zip compression (For Text)

The LRIT file structure will make the identification of the headers and their presence easily identifiable. Header 5 contains a time stamp indicating the time that the file was transmitted, and is not specifically needed to interpret the data. Header 4 will contain the file name used by the GOES LRIT transmitting domain. It can be extracted and used as the name of the file. Header type 0, which is present on all LRIT files will contain the length of the header and data fields for parsing of the LRIT files into application files and metadata files.

Service messages should be used as they arrive. The service message should be displayed for the attention of the operator.

Table 8. NOAA Product Identifiers

Product ID*	Product SubID*	Parameter	Description

CGMS-XXX USA-WP-14

Product ID*	Product SubID*	Parameter	Description
0	N/A	N/A	All
1	0	N/A	All Admin Messages
2	0	N/A	All Bulletins
3	0	N/A	All GMS Products
3	1	0	GMS IR Full Disk
3	2	Sector number	GMS IR Sector
3	3	0	GMS VIS Full Disk
3	4	Sector number	GMS VIS Sector
4	0	N/A	All METEOSAT Products
4	1	0	METEOSAT IR Full Disk
4	2	Sector number	METEOSAT IR Sector
4	3	0	METEOSAT VIS Full Disk
4	4	Sector number	METEOSAT VIS Sector
4	5	0	METEOSAT WV Full Disk
4	6	Sector number	METEOSAT WV Sector
5	0	N/A	All NOAA-16 Products
5	1	0=North, 1=South	NOAA-16 IR Polar
5	2	Enumerate Projections	NOAA-16 IR Mercator
6	0	N/A	All NWS Products
7	0	N/A	All GOES Products
7	1	0	GOES IR Full Disk
7	2	0	GOES IR northern hemisphere
7	3	0	GOES IR southern hemisphere
7	4	0	GOES IR U.S.
7	5-10	0	GOES IR special interest
7	11	0	GOES VIS Full Disk
7	12	0	GOES VIS northern hemisphere
7	13	0	GOES VIS southern hemisphere
7	14	0	GOES VIS U.S.
7	15-20	0	GOES VIS special interest
7	21	0	GOES WV Full Disk
7	22	0	GOES WV northern hemisphere
7	23	0	GOES WV southern hemisphere
7	24	0	GOES WV U.S.
7	25-30	0	GOES WV special interest
8	0	N/A	All DCS Products

*0 is reserved to represent all Ids

9.0 Application Layer

The application layer receives the LRIT files from the session layer. The files are transmitted from the receiving processor to the workstation.

In the workstation, the files are stored and identified for their applicability to the specific requirements of the user facility.

LRIT files that are administrative messages should be either printed or displayed to the user automatically. Images are sent to the application program for interpretation and display. List files are printed or displayed under autonomous control based upon a preselected setup option of the workstation operator.

9.1 File Handling

The applications processor must contain an autonomous file handling system because:

- Data in the files requires immediate attention of the user,
- Mass storage is limited,
- The image files are large,
- The data is time sensitive and becomes obsolete after a short period of time, and
- Data files will be received as a continuous input.

Each file will be identified to determine what further processing is necessary. The file handling processor will keep a record of the activity of each file. The file transmission time will be extracted from header 5 and the reception time from the system clock. The file handler will pass the file to the appropriate applications processor and know when the processing is complete. The file will be purged from the mass storage according to a user-defined storage time or passed to another processor if required by the user's specific installation. The timing of the process should be fast enough so that a new image with the same file name will not coexist in the applications processor with the older image. The files should be processed fast enough so that a file is not overwritten by the new image before it has completed processing.

9.2 Data Processing

The types of files that will be received are:

- Image data files
- Service messages
- Alphanumeric files
- Global Transmission System (GTS) messages

9.2.1 Processing Image Files

Image files will contain images in a series of 4-bit or 8-bit pixels. Each pixel represents a 128-level or 256-level gray scale (no color in the WEFAX images). GOES and POES images will have 1395 pixels per line and a number of lines that varies with the image. Images from other sources may have different dimensions and gray scale. Header type 1 will identify the dimensions of the image and the number of bits per pixel. The applications processor should have the capability to produce the image on the display screen and to print it. The information from header type 1 will be in the metadata file.

Large images such as the full disk file will be stored in smaller files containing segments with only a certain number of lines of an image. In order to decrease the latency of the data image, the processor should start producing the image without waiting for reception of all the files. The data from each file should be used to build the image as soon as it is received.

If an image file is an overlay for another image, the processor should be able to overlay the image on the original figure. Overlays can be grids, isobars, or text.

9.2.2 Processing Alphanumeric Files

The files should contain data in American Standard Code for Information Interchange (ASCII) alphanumeric format. Often these files are tables or lists. The application processor should display or print these files in their original format.

9.2.3 Processing Service Messages

It will be assumed that these messages have high priority and the user terminal operator should be alerted to them as soon as possible. When these messages are received, some method of alerting the operator should be used such as an audible alarm or flashing screen. The message should be displayed on the monitor after the image processing is complete. As a user option the message can be printed.

9.2.4 GTS Message

The meteorological data and products acquired from the Global Transmission Service (GTS) will contain GTS Data and Products.