

Technology Assessment



**Technology
Assessment Program**

**Agency for Healthcare
Research and Quality
540 Gaither Road
Rockville, Maryland 20850**

**Obstructive Sleep Apnea-
Hypopnea Syndrome:
modeling different diagnostic
strategies**

December 4, 2007

Obstructive Sleep Apnea-Hypopnea Syndrome: modeling different diagnostic strategies

Thomas A. Trikalinos, MD, PhD
Joseph Lau, MD

December 4, 2007

Tufts-New England Medical Center EPC

Relationship with previous technology assessment and author disclosures

The current follow-on project to the Tufts-NEMC technology assessment “Home diagnosis of obstructive sleep apnea-hypopnea syndrome” is a mathematical modeling of different strategies for the diagnosis of OSAHS and the subsequent titration of CPAP (for those who need the intervention). The current work is therefore based on the previous technology assessment (listed authors: TA Trikalinos, S Ip, G Raman, MS Cepeda, EM Balk, C D’Ambrosio, J Lau). Dr D’Ambrosio is chair of the membership section on sleep related breathing disorders for the American Academy of Sleep Medicine. Dr D’Ambrosio, a sleep physician, was the technical expert who clarified clinical issues. However, the methodologists developed the models, run the baseline analyses, conducted the sensitivity analyses and drafted the technology assessment documents (both the previous and the current, follow-on project). None of the other investigators has any affiliations or financial involvement related to the material presented in this report.

This report is based on research conducted by the Tufts-New England Medical Center Evidence-based Practice Center (EPC) under contract to the Agency for Healthcare Research and Quality (AHRQ), Rockville, MD (Contract No. 290-02-0022). The findings and conclusions in this document are those of the author(s) who are responsible for its contents; the findings and conclusions do not necessarily represent the views of AHRQ. Therefore, no statement in this article should be construed as an official position of the Agency for Healthcare Research and Quality or of the U.S. Department of Health and Human Services.

The information in this report is intended to help health care decision-makers; patients and clinicians, health system leaders, and policymakers, make well-informed decisions and thereby improve the quality of health care services. This report is not intended to be a substitute for the application of clinical judgment. Decisions concerning the provision of clinical care should consider this report in the same way as any medical reference and in conjunction with all other pertinent information, i.e., in the context of available resources and circumstances presented by individual patients.

Table of Contents

Table of Contents.....	5
Table of Contents for Tables.....	6
Table of Contents for Figures.....	7
Summary.....	9
Introduction.....	15
Statement of Work.....	17
Outline of the technology assessment.....	17
Methods.....	19
Definitions and terminology.....	19
Search Strategy.....	22
Markov processes.....	23
Simulated populations.....	24
Data abstraction.....	24
Description of the modeled strategies.....	24
Brief descriptions and global assumptions.....	24
Detailed descriptions and strategy-specific assumptions.....	26
Probabilities used in the simulations.....	31
Prevalence of OSAHS among people with suggestive symptoms (prev).....	35
Sensitivity and specificity of facility-based PSG (S_PSG and C_PSG).....	40
Sensitivity and specificity of split-night studies (S_SpNPSG and C_SpNPSG).....	41
Sensitivity and specificity of home monitoring (S_HomeDx and C_HomeDx).....	43
Proportion of technically inadequate tests for facility-based PSG (pFail_PSG1 and pFail_PSG2).....	48
Proportion of technically inadequate split-night studies (pFail_SpNPSG1 and pFail_SpNPSG2).....	49
Proportion of technically inadequate tests for portable monitors in the home setting (pFail_HomeDx1 and pFail_HomeDx2).....	49
Probability of technically adequate CPAP titration study in facility-based PSG (pTitr_manCPAP1 and pTitr_manCPAP2).....	50
Probability of technically adequate CPAP titration study in the home setting (pTitr_autoCPAP1 and pTitr_autoCPAP2).....	50
Average waiting time for a sleep study in the lab setting.....	51
Average waiting time for a sleep study in the home setting.....	52
Proportion of people who do not show up for the first scheduled full night or split-night PSG session.....	53
Outcomes.....	53
Sensitivity analyses.....	55
Simulation results.....	57
Proportion of people who are offered CPAP.....	57
Time to diagnosis with a sleep study.....	68
Time to CPAP level titration among people with a diagnosis of OSAHS.....	73
Discussion.....	81
Interpretation of outcomes.....	81
Proportion of people who are offered CPAP.....	81

Time to final diagnosis.....	84
Time to CPAP among people with a positive diagnosis for OSAHS who are offered CPAP.....	84
Additional caveats.....	85
Limitations	87
References.....	89

Table of Contents for Tables

Table 1. Delineation of operational rules used to classify monitors in sleep studies.	22
Table 2. Outline of the seven modeled strategies.	25
Table 3. Probabilities used in the Markov processes for a cohort of middle-aged people (50 years old).	33
Table 4. Prevalence of OSAHS (i.e., $AHI \geq 15$ events/hour of sleep with facility-based PSG) among people who were referred for sleep apnea evaluation.	36
Table 5. Sensitivity and specificity of split-night studies to predict OSAHS (i.e., $AHI \geq 15$ events/hour of sleep with full night facility-based PSG).	42
Table 6. Sensitivity and specificity of type III monitors (automated scoring) to predict OSAHS (i.e., $AHI \geq 15$ events/hour of sleep in facility-based PSG).	44
Table 7. Meta-analysis of the ability of type III monitors (home setting or automated scoring) to predict OSAHS (i.e., $AHI \geq 15$ events/hour in facility-based PSG)	47
Table 8. Baseline analyses: Proportion offered CPAP in a hypothetical cohort of 100,000 middle-aged people suspected of OSAHS.....	57
Table 9. Baseline analyses: Proportion offered CPAP in a hypothetical cohort of 100,000 older adults suspected of OSAHS.....	58
Table 10. Baseline analyses: time to (final) diagnosis of OSAHS with a sleep study in a hypothetical cohort of 100,000 middle-aged people suspected of OSAHS.....	68
Table 11. Baseline analyses: time to (final) diagnosis of OSAHS with a sleep study in a hypothetical cohort of 100,000 older adults suspected of OSAHS	69
Table 12. Baseline analyses: time to CPAP in a hypothetical cohort of 100,000 middle-aged people suspected of OSAHS	74
Table 13. Baseline analyses: time to CPAP in a hypothetical cohort of 100,000 older adults suspected of OSAHS.....	75
Table 14. Sensitivity analysis in average waiting time for a sleep study in strategy 2 (DxPSG, TxPSG): Average time to CPAP in a hypothetical cohort of 100,000 middle-aged people suspected of OSAHS.....	76

Table of Contents for Figures

Figure 1. Layout of the distinct health states assumed by strategy 2 (facility-based PSG)	27
Figure 2. Layout of the distinct health states assumed by strategy 3 (Split-Night PSG)..	28
Figure 3. Layout of the distinct health states assumed by strategy 4 (screening at home with portable monitors, and Split-Night PSG for positive cases)	29
Figure 4. Layout of the distinct health states assumed by strategy 5 (screening at home with portable monitors; auto-titration of CPAP at home for positive cases and re-evaluation of negative cases with Split-Night PSG)	30
Figure 5. Layout of the distinct health states assumed by strategy 5 (home diagnosis with portable monitors and automatic titration of CPAP level at home)	31
Figure 6. Sensitivity analysis on prevalence: proportion of people who are offered CPAP in a hypothetical cohort of 100,000 participants	59
Figure 7. Sensitivity analysis on the probability of no showing up for a study in the lab: proportion of people who are offered CPAP in a hypothetical cohort of 100,000 participants	60
Figure 8. Sensitivity analysis on the sensitivity of facility-based PSG to detect OSAHS: proportion of people offered CPAP in a hypothetical cohort of 100,000 participants	61
Figure 9. Sensitivity analysis on the specificity of facility-based PSG to detect OSAHS: proportion of people offered CPAP in a hypothetical cohort of 100,000 participants	62
Figure 10. Sensitivity analysis on the sensitivity of split-night studies to detect OSAHS: proportion of people offered CPAP in a hypothetical cohort of 100,000 participants	63
Figure 11. Sensitivity analysis on the specificity of split-night studies to detect OSAHS: proportion of people offered CPAP in a hypothetical cohort of 100,000 participants	64
Figure 12. Sensitivity analysis on the sensitivity of portable monitors to detect OSAHS: proportion of people offered CPAP in a hypothetical cohort of 100,000 participants	65
Figure 13. Sensitivity analysis on the specificity of portable monitors to detect OSAHS: proportion of people offered CPAP in a hypothetical cohort of 100,000 participants	66
Figure 14. Summary (“tornado” graph) of the variables with the greatest impact on the proportion of people offered CPAP per strategy in the univariate sensitivity analyses.	67
Figure 15. Sensitivity analysis on the average waiting time per sleep study in sleep laboratories: time to final diagnosis in a hypothetical cohort of 100,000 participants	70
Figure 16. Sensitivity analysis on the average waiting time per sleep study in the home setting: time to final diagnosis in a hypothetical cohort of 100,000 participants	70
Figure 17. Sensitivity analysis on prevalence: time to final diagnosis in a hypothetical cohort of 100,000 participants	71

Figure 18. Sensitivity analysis on the probability of not showing up for the first study if it is in the sleep lab: time to final diagnosis in a hypothetical cohort of 100,000 participants..... 72

Figure 19. Summary (“tornado” graph) of the variables with the greatest impact on the average time to final diagnosis in the univariate sensitivity analyses. 73

Figure 20. Sensitivity analysis on the average waiting time per sleep study in the lab setting: Average time to CPAP level titration among those who are offered CPAP. 76

Figure 21. Sensitivity analysis on average waiting time for a sleep study at home: time until successful CPAP titration. 77

Figure 22. Sensitivity analysis on prevalence: Average time to successful CPAP level titration among those who are offered CPAP. 78

Figure 23. Sensitivity analysis on the probability of not showing up for the first study if it is in the sleep lab: Average time to successful CPAP level titration among those who are offered CPAP. 79

Figure 24. Summary (“tornado” graph) of the variables with the greatest impact on the average to CPAP in the univariate sensitivity analyses (among people offered CPAP). 80

Summary

Obstructive Sleep Apnea-Hypopnea Syndrome (OSAHS) is characterized by sleep disturbances secondary to upper airway obstruction. OSAHS is prevalent in two to four percent of middle-aged adults, and has been associated with daytime somnolence, cardiovascular morbidity, diabetes and other metabolic abnormalities, and increased likelihood of accidents and other adverse outcomes. The prevalence of OSAHS in older adults (65 years or older) in *the general population* is believed to be higher than the aforementioned estimates, but it is not as well studied.

Typically, the diagnosis is set in the presence of suggestive symptoms and signs (e.g., day somnolence, fatigability) in association with sleep disturbances. We emphasize that there is no error-free “gold standard” for the diagnosis of OSAHS. However, many clinicians (and most studies) consider facility-based polysomnography (PSG) as a reference standard for quantifying sleep-related parameters that are useful in the diagnosis of OSAHS. PSG is a comprehensive sleep study that records and evaluates a variety of cardiorespiratory and neurophysiologic signals during sleep time, and takes place in a specialized clinic or laboratory. Portable monitors have also been developed for the diagnosis of OSAHS. They generally record and evaluate fewer signals compared to facility-based PSG, but they may be used in the home setting. They may constitute an alternative for the more costly facility-based PSG.

For people with positive diagnosis after a sleep study, the mainstay of treatment is considered to be continuous positive airway pressure (CPAP). CPAP has been shown to improve quality of life and symptoms of OSAHS (e.g., day-time somnolence, and fatigue). In addition, CPAP use might decrease the OSAHS-associated risk for cardiovascular outcomes (e.g., cardiac disease, stroke) or the risk for motor vehicle accidents among people with OSAHS.

No studies in the literature compared directly *several different strategies* to diagnose OSAHS and perform CPAP level titration in people with positive diagnoses. To compare multiple different strategies simultaneously, it is necessary to use Markov models. This is an established decision analytic approach to simulate head to head comparison of multiple strategies under various assumptions. We performed a mathematical simulation of seven different strategies that may be considered for the diagnosis of OSAHS (and the subsequent initiation of CPAP) for people who are suspected of OSAHS on the basis of suggestive symptoms and signs.

As stated above, the simulations are based on Markov processes. They assess different strategies with respect to the proportion of people who will be offered CPAP; time to final diagnosis; and time to successful titration of CPAP level among people with OSAHS who are offered CPAP.

In the simulations we defined OSAHS as presence of suggestive symptoms and signs along with an apnea-hypopnea index of at least 15 events/hour of sleep in facility-based PSG. The probabilities used in the Markov processes are derived from the literature, using meta-analysis when needed. For all transition probabilities in the mathematical models, available data from the literature pertained to middle aged people without significant comorbidities.

Because data on older people were not available, we made several assumptions on the corresponding probabilities among older people. Different analyses were performed for

hypothetical cohorts of middle-aged 50-year old people and for older adults (70 years of age).

We also performed sensitivity analyses to evaluate the impact of the various probabilities on the examined outcomes. In sensitivity analyses, the value of each probability is ranged over a pre-specified range. More uncertain estimates (i.e., those based on few literature data, poor quality data or are assumptions in the absence of data) are varied over a wider range in the sensitivity analyses.

The current model is not a full decision analysis that incorporates utilities associated with different health states, but a calculation of the expected likelihood for the aforementioned outcomes. Because no costs or utilities were assigned, it is difficult to specify which is the single preferred or the most cost-effective strategy.

The following is a brief description of the modeled strategies:

- **Strategy 1** (“None on CPAP”). None in the hypothetical cohort will ever be tested for OSAHS or offered CPAP treatment. This is one extreme scenario that has been included for comparison.
- **Strategy 2** (“DxPSG, TxPSG”). All people in the hypothetical cohort will receive a diagnostic session (DxPSG) in the sleep laboratory. If the exam is positive, a second session for CPAP level titration will be scheduled.
- **Strategy 3** (“Split-Night PSG”). All people in the hypothetical cohort will be assessed with split-night studies in the sleep lab. If the first half of the exam is positive, the second half is used to titrate the CPAP level. If the first half of the exam is negative no CPAP titration is attempted.
- **Strategy 4** (“HomeDx, SpNPSG(+)"). All people in the hypothetical cohort will be assessed in the home setting with portable sleep monitors (HomeDx). Those with *positive diagnoses* (indexed by the “+” sign in the name of the strategy) will be subjected to split-night studies in the sleep laboratory, to verify the diagnosis and to titrate CPAP level (if applicable). This is a combination of strategies 3 and 6 (see below).
- **Strategy 5** (“HomeDx, SpNPSG(-)"). This is similar to Strategy 4 in structure, but here people with *positive diagnoses* in the home setting are offered CPAP level titration, and people with *negative diagnoses* in the home setting will be re-evaluated with split-night studies in the lab (to minimize the number of people with OSAHS who have been missed as false negatives).
- **Strategy 6** (“HomeDx, autoCPAP”). The whole hypothetical cohort is managed entirely outside the sleep laboratory. Portable monitoring in the home setting (“HomeDx”) is used for the diagnosis, and auto-titration of CPAP is attempted again in the home setting on a different night.
- **Strategy 7** (“All on CPAP”). The whole cohort will be offered CPAP treatment (with auto-titration or empirical titration of the pressure level). In this scenario none is tested for OSAHS. This is the other extreme scenario that has been included for comparison.

As stated, different simulations were run for middle-aged people and for older adults.

In the following paragraphs we summarize the results of the modeled strategies. We emphasize once more that these are the results of the baseline analyses; the corresponding sensitivity analyses are reported in the text.

Table A shows the proportion of people who are offered CPAP (who had “positive diagnoses”) in the hypothetical cohorts, in the baseline analyses. One could argue that we are mostly interested in maximizing the proportion of people who have OSAHS and are correctly offered CPAP as treatment (“true positives”). Letting aside strategy 7 that offers CPAP to all patients, irrespective of diagnosis, strategy 2 and strategy 5 maximize “true positives”.

As shown in **Table A**, strategy 5 is expected to yield a lot of “false positives” in both cohorts. Although there are no data supporting immediate and detrimental health events among people without OSAHS who are (erroneously) offered CPAP, “false positives” might be associated with psychological stress secondary to labeling or other non-desirable outcomes.

Table A. Proportion of people who are offered CPAP (i.e., proportion with a positive diagnosis) in the hypothetical cohorts

Strategy (for diagnosis and CPAP titration)	Proportion offered CPAP (%)					
	Middle-aged people (~50 years old)			Older adults (~70 years old)		
	All	With OSAHS*	Without OSAHS*	All	With OSAHS*	Without OSAHS*
1. None started on CPAP	0	0	0	0	0	0
2. Full night PSG, treatment PSG	54	100	0	27	100	0
3. Split-night PSG	51	89	6	28	89	6
4. Home diagnosis, split-night PSG to verify positive cases	44	81	1	23	81	2
5. Home diagnosis, split-night PSG in all negative cases	62	99	20	52	99	34
6. Home diagnosis, home CPAP titration	56	91	15	46	91	30
7. All started on CPAP	100	100	100	100	100	100

CPAP: continuous positive airway pressure; OSAHS: Obstructive sleep apnea-hypopnea syndrome (see methods for definition)

* OSAHS was operationally defined as the presence of symptoms and signs along with an apnea-hypopnea index more than 15 events/hour in facility-based PSG.

Table B summarizes the baseline analyses for the mean time to final diagnosis in the 2 cohorts. There was little good quality evidence in the published literature that informed on the *average waiting time for a sleep study in the lab setting*. This is a key quantity in the modeling, central to the numerical estimates for time to final diagnosis for strategies 2 to 5. Based on the best available evidence, we set the mean waiting time for a sleep study in the lab would be 13 weeks for strategy 2 (and the corresponding quantities for strategies 3, 4 and 5 were calculated to be 68, 36 and 27 percent of that value). The results section provides sensitivity analyses a range of assumed average waiting times in strategy 2.

The estimates among older adults are roughly similar to the estimates among younger people. The results sections’ sensitivity analyses help explain the small differences.

Conceptually, one would favor strategies that result in shorter time to diagnosis. Shorter time to diagnosis reflects more “efficient” strategies. Furthermore, one can hypothesize that shorter time to diagnosis may reduce patient anxiety, or encourage a modification of health habits and lifestyle. Generally, shorter time to diagnosis also implies shorter time to CPAP treatment initiation (see below).

Table B. Mean time to (final) diagnosis of OSAHS with a sleep study in the hypothetical cohorts – baseline analyses

Strategy (for diagnosis and CPAP titration)	Mean time to diagnosis (Weeks)	
	Middle-aged people (~50 years)	Older adults (~70 years)
1. None started on CPAP	NA ^a	NA ^a
2. Full night PSG, treatment PSG	13.6	11.2
3. Split-night PSG	9.8	9.8
4. Home diagnosis, split-night PSG to verify positive cases	4.8	4.0
5. Home diagnosis, split-night PSG in all negative cases	3.8	4.5
6. Home diagnosis, home CPAP titration	2.1	2.1
7. All started on CPAP	NA ^a	NA ^a

CPAP: continuous positive airway pressure; NA: not applicable; OSAHS: Obstructive sleep apnea-hypopnea syndrome (see methods for definition).

^a No diagnostic assessment is performed in these strategies

The numbers for strategies 2 to 5 are very much dependent on the assumed average waiting time for a sleep study in the lab setting.

Table C summarizes the baseline analyses for the mean time to CPAP among people offered CPAP in the 2 cohorts. Again, the key quantity in the modeling is the *average waiting time for a sleep study in the lab setting*. The calculated times change proportionally, when different average waiting times are assumed, as shown in the results section, where detailed estimates for a range of assumed average waiting times are provided.

The calculated mean times among older adults are roughly similar to the estimates among younger people. The results sections' sensitivity analyses help explain the small differences.

Table C. Mean time to CPAP in the hypothetical cohorts

Strategy (for diagnosis and CPAP titration)	Mean time to CPAP* (among those offered CPAP) [weeks]	
	Middle-aged people (~50 years)	Older adults (~70 years)
1. None started on CPAP	NA ^a	NA ^a
2. Full night PSG, treatment PSG	27.3	22.4
3. Split-night PSG	9.8	9.8
4. Home diagnosis, split-night PSG to verify positive cases	5.0	5.8
5. Home diagnosis, split-night PSG in all negative cases	6.2	7.2
6. Home diagnosis, home CPAP titration	4.8	4.5
7. All started on CPAP	NA ^a	NA ^a

CPAP: continuous positive airway pressure; OSAHS: Obstructive sleep apnea-hypopnea syndrome (see methods for definition).

* "Time to CPAP" means time to a technically adequate CPAP titration study.

^a Not meaningful to assess – none (strategy 1) or all (strategy 7) patients offered CPAP in these strategies

Shorter time to CPAP initiation for people who have the disease means that any benefits from CPAP therapy will not be unnecessarily delayed. However, there are no randomized data on the *exact clinical importance* of e.g. a 6-month delay in CPAP treatment with respect to clinical outcomes such as deaths, cardiovascular disease, stroke etc. One may postulate expected beneficial health outcomes: There is randomized

evidence that CPAP versus no treatment or sham CPAP treatment of OSAHS is associated with improvements in quality of life outcomes or intermediate clinical outcomes (e.g., hypertension). Observational evidence from prospective comparative studies associates CPAP treatment of OSAHS with fewer cardiovascular events. Furthermore, patients with OSAHS have an increased risk for car accidents. CPAP has also been associated with a reduction in the risk for motor vehicle accidents among people with OSAHS.

The current modeling illustrates the tradeoff in the number of people with OSAHS who are offered CPAP and time to diagnosis or technically adequate CPAP level titration across seven different simulated strategies. Strategies that use portable monitors as a first (or only) test generally result in shorter average time to diagnosis and technically adequate CPAP level titration, but also in increased numbers of “false positives” or “false negatives” (depending on the strategy) compared to facility-based PSG. Diagnosis and CPAP level titration entirely in the sleep labs or related facilities may result in better diagnostic accuracy, but is likely to result in longer time to diagnosis and CPAP level titration. As discussed in the previous technology assessment (“Home diagnosis of Obstructive Sleep Apnea-Hypopnea Syndrome” by the Tufts-New England Medical Center Evidence-based Practice Center), more evidence is needed on both PSG and portable monitors to predict response to CPAP and changes in clinical outcomes after CPAP treatment.

Introduction

Obstructive Sleep Apneas-Hypopnea Syndrome (OSAHS)

Sleep Apnea is a relatively common disorder that can affect all ages. The condition is characterized by periods of disturbed airflow patterns during sleep time, namely reduced airflow (hypopnea) or airflow cessation (apnea). It is postulated that both types of airflow disturbance have similar pathophysiology and bear the same clinical significance.¹ Obstructive sleep apnea-hypopnea syndrome (OSAHS) is the most common type of the condition (apneas and hypopneas of central and mixed central and obstructive etiology comprise the other forms).¹ OSAHS has been associated with a variety of adverse clinical outcomes such as mortality secondary to stroke and cardiovascular events,²⁻⁴ decreased quality of life,⁵ cardiovascular disease and stroke,^{2,6} hypertension,⁷⁻⁹ diabetes and other metabolic abnormalities,^{10,11} as well as increased likelihood for driving^{12,13} and other types of accidents.

Assessing the presence and quantifying the severity of OSAHS

The severity of OSAHS is typically quantified by the number of apneas and hypopneas per hour of sleep, a quantity that has been termed Apnea-Hypopnea Index (AHI). Specific cutoffs are typically used to establish the diagnosis of OSAHS.^{1,14} For example, as of this writing, the Medicare criteria for reimbursement of continuous positive airway pressure (CPAP) therapy are AHI ≥ 15 events/hour, or AHI ≥ 5 events/hour associated with symptoms (e.g., daytime somnolence and fatigue). However, a variety of AHI thresholds ranging between 5 and 40 have been used as suggestive of OSAHS in different studies.

We emphasize that AHI alone is not sufficient to classify people into those with and without OSAHS. This is because AHI does not correlate well with the intensity of symptoms and signs (e.g., day somnolence, fatigability),¹⁴ or with daytime measures of quality of life, well-being, and cognitive performance.¹⁵ There are probably no clinical or statistical differences between patients who differ only by a few points in the AHI.

Approximately two to four percent of middle-aged women and men, respectively, have been estimated to have an AHI ≥ 5 events/hour and excessive daytime somnolence in the population-based Wisconsin Sleep Cohort Study.⁵ Using an AHI cutoff of ≥ 5 events/hour without the symptoms of excessive daytime sleepiness puts the prevalence at 9% for women and 24% for men. The symptom of excessive daytime sleepiness is quite variable and not always present in patients with OSAHS. Most people suffering from OSAHS remain undiagnosed and untreated.⁵ More recent studies also suggest a high prevalence (i.e., prevalence of AHI ≥ 5 in adults age 30-69 of 17%), perhaps due to increasing obesity rates in later years.¹⁶

The prevalence of the condition among Medicare beneficiaries (people aged 65 years or older) is believed to be higher than the aforementioned estimates among middle-aged people. In the population-based Sleep Heart Health Study the prevalence of AHI ≥ 15 events/hour was 1.7-fold higher in people older than 60 years compared to people between 40 and 60 years of age.¹⁷ Similar observations were made in cohort studies that used population-based samples and a wide range of ages.¹⁸⁻²¹ However, scant data suggest that the prevalence of OSAHS does not continue to rise with age in older adults, but reaches a plateau after the age of 60-65 years.^{17,22} This implies either a relative

increase in mortality from OSAHS, or a remission of OSAHS with advancing age (the Methods section provides a discussion on the prevalence of OSAHS in the modeled populations).

Apart from the use of AHI, other methods to quantify severity have also been used in various studies. These mainly pertain to the evaluation of O₂ desaturations during sleep, the evaluation of other respiratory events such as the Respiratory Effort Related Arousals, or the degree of daytime fatigue and somnolence.

The standard measurement of AHI (and the diagnosis of OSAHS by extension) requires a comprehensive, technologist-attended sleep study with multichannel polysomnography (PSG), which is performed in specialized sleep laboratories.^{1,14} Laboratory-based PSG records a variety of neurophysiologic and cardiorespiratory signals and is interpreted by trained technologists and sleep physicians after the sleep study has been completed. Because of the high demand, the associated costs and the need for timely diagnosis, portable devices have been developed to substitute for laboratory-based PSG.¹⁴ There are different types (classes) of portable monitors.²³ Each gathers different neurophysiologic and respiratory information and may synthesize the accumulated data differently.²³

Depending on the data they record, portable monitors are classified in different categories (which are briefly discussed in the Definitions and Terminology section).²³ Portable monitors can be used not only in the home setting, but also in the hospital and in clinics that are not specialized sleep units.

Management of OSAHS

The mainstay of treatment is considered to be continuous positive airway pressure (CPAP).²⁴ Other treatments for the condition exist and are reserved for specific cases (e.g., surgical interventions and oral-dental appliances to improve the stereometry of the upper airway).

CPAP treatment of OSAHS has been associated with beneficial health outcomes. Observational evidence from prospective comparative studies associates CPAP treatment of OSAHS with fewer cardiovascular events.^{2,4} Furthermore, patients with OSAHS have an increased risk for car accidents.^{12,13} CPAP has been associated with a reduction in the risk for motor vehicle accidents among people with OSAHS.²⁵⁻²⁷

However, apart from the aforementioned considerations there is no extensive randomized evidence on outcomes such as deaths, strokes and cardiovascular events.²⁸ There is randomized evidence that CPAP versus no treatment or sham CPAP treatment of OSAHS is associated with improvements in the Epworth Sleepiness Scale²⁸ (a subjective symptom score), objective wakefulness tests²⁸ and selected components of the SF-36 questionnaire²⁸ (e.g., the vitality component, which is more relevant to OSAHS patients compared to other SF-36 components²⁹). Randomized studies suggest that CPAP may also be inversely associated with intermediate clinical outcomes (e.g., hypertension).²⁸

Typically, the diagnosis of OSAHS is made after a positive comprehensive sleep study with multichannel polysomnography (PSG) in specialized sleep laboratories.^{1,14} For patients who meet the diagnostic criteria, a second session is needed for the titration of the CPAP device to a tolerable and effective pressure. Because of the large demand, variants of this strategy may be used. For example, in *split-night* studies, both the diagnostic workup and the titration of the CPAP device (when needed) may be performed at the same night: The diagnosis may be established during the first hours of the sleep

study and the effect of the CPAP device is assessed by the attending technician during the last hours of the sleep study. Sleep studies may also be conducted at daytime to reduce cost. Different strategies may entail prioritizing referral cases based on clinical considerations or on the results of portable, home-based sleep monitoring. In addition, several devices can function as portable unattended sleep monitors (diagnostic mode) and auto-titrate the CPAP threshold, again in an unattended fashion.

Statement of Work

The Center for Medicare and Medicaid Services (CMS) has requested a technology assessment through the Agency for Healthcare Research and Quality (AHRQ) on the role of home monitoring for the diagnosis of OSAHS. On September 28, 2004, the evidence on home monitoring devices in the diagnosis of sleep apnea was discussed at a Medicare Coverage Advisory Committee meeting. The RTI EPC presented a technology assessment on this topic,³⁰ which was an update of a prior technology assessment done for the American Academy of Sleep Medicine, the American Thoracic Society, and the American College of Chest Physicians.¹⁴ CMS has requested an update of the evidence presented in the RTI EPC technology assessment on home sleep monitoring with an expanded scope, including the assessment of the ability of PSG indices to predict a response to CPAP treatment. The current project is a follow-on to the Technology Assessment “Home diagnosis of obstructive sleep apnea-hypopnea syndrome” that was prepared by the Tufts-NEMC EPC.

There are no direct comparison studies evaluating the plausible strategies for OSAHS diagnosis and initiation of CPAP treatment. In consultation with AHRQ and CMS staff we undertook an analysis of various strategies to manage patients with high clinical suspicion for OSAHS, using a Markov process-based decision tree. Markov modeling is an established decision analytic method. It is typically used to simulate comparisons when direct data are non-existent. Herein we focus on a description of the profile of different strategies in terms of accuracy of diagnosis, proportion of people started on CPAP, time to diagnosis, and time to successful CPAP titration among people who need it. We did not perform a full decision analysis (i.e., calculation of expected utilities over lifelong projections), because there are considerable uncertainties clinical outcomes such as deaths, cardiovascular events, strokes, etc. that pose great difficulties for a meaningful analysis.

Outline of the technology assessment

The Methods section describes:

1. The modeled strategies and their assumptions.
2. Which transition probabilities and other quantities are used in the models, the values used in the baseline analyses and where these were obtained from, the uncertainty that accompanies each value.

The Results section describes:

1. (Per outcome) the results of the baseline analyses.

2. (Per outcome) the results of the sensitivity analyses, which assess how each outcome is affected if one changes the values that were use in the baseline analyses over a prespecified range.

Methods

The analyses use Markov processes to simulate 7 different strategies. The transition probabilities used in the models are based on estimates derived from our own systematic reviews of the literature, from other systematic reviews that were updated with focused literature searches, from individual papers, or using assumptions that were considered reasonable. When applicable, meta-analysis was used to summarize estimates from a collection of relevant studies. More details are given in the following sections. As of this writing, there are ongoing randomized trials that are expected to provide useful data on the role of portable monitors compared to facility-based PSG. However, their results are not available yet and could not be used to inform the modeling.

This analysis is performed from the perspective of the institutions that conduct sleep studies and extends up to a time-horizon of 2 years or until they had a technically adequate CPAP titration study. The modeled populations, strategies and the outcomes we assessed are reported in the corresponding following sections.

Definitions and terminology

Operational definition of OSAHS

We defined OSAHS as AHI of at least 15 events/hour in facility-based PSG, among people who are referred for further study on the basis of suggestive symptoms and signs.

Most clinicians consider that the cutoff of 15 events/hour of sleep in facility-based PSG is indicative of (at least moderately severe) OSAHS.

Middle-aged and older adults

As discussed later in this section, for many transition probabilities in the mathematical models, available data pertained to middle aged people without significant comorbidities. Because data on older people were not available, we made several assumptions on the values of several probabilities in this population. Thus, different analyses were performed for hypothetical cohorts of middle-aged 50-year old people and for older adults, namely 70 years of age.

- *Middle-aged adults* are men and women who are 50 years old (on average). The vast majority of the available studies focuses on people with average age around 50 to 52 years.
- *Older adults* or *Medicare beneficiaries* are men and women who are (on average) 70 years old. Identifying *older adults* with *Medicare beneficiaries* is not accurate, because some of the latter are younger than 65 years old (e.g., those with disabilities). However, most Medicare beneficiaries are over 65 years of age, and this simplification is not misleading.

Facility-based PSG and split-night studies

- The terms *diagnostic facility-based* and *diagnostic laboratory-based* PSG are used interchangeably throughout this report. They refer to the comprehensive sleep study that is performed in specialized institutions for the *diagnosis* of OSAHS, lasts a whole night, and is based on the collection of a complete set of neurophysiologic and respiratory data.

- *Facility-based PSG for CPAP level titration* is a whole night study in a specialized sleep clinic or laboratory, to determine the optimal pressure level. This happens on a different night from the diagnostic facility-based PSG.
- *Split-night studies* are sleep studies that are performed in the specialized sleep laboratory or clinic, and combine the diagnostic part and the titration of CPAP (if CPAP is needed) during the same night. The first half of the night study is reserved for diagnosis of OSAHS; if needed, the second part of the study is reserved for titration of CPAP level.

Titration of CPAP level

- A *technically adequate* CPAP titration study is a study that was completed, irrespective of its findings. For example, depending on whether the studied person has OSAHS or not, a technically adequate titration study is assumed to:
 - Decide which CPAP (pressure) level reverses sleep disturbances, provided that a person has OSAHS
 - Was unable to provide a CPAP pressure level that reverses sleep disturbances, because a person does not have OSAHS.
- A *technically inadequate* CPAP titration study might have ended prematurely (e.g., if the person did not sleep at all during the study, secondary to equipment failure) and cannot reach any conclusion. We assume that a *technically inadequate* study will have to be repeated to allow for any meaningful conclusion.
- An *autotitration home study* is the use of an auto-titrating CPAP machine to perform pressure level titration. It is assumed that each attempt to auto-titrate is short-term triage of auto-titrating CPAP devices, just to obtain an optimal pressure level.

Apnea-Hypopnea Index (AHI) and Respiratory Disturbance Index (RDI)

The frequency of respiratory events during sleep can be used to quantify the severity of OSAHS.

$$\text{frequency of respiratory events} = \frac{N_{\text{respiratory events}}}{\text{Total sleep time}}$$

The majority of the published studies define two metrics for the frequency of the respiratory events, namely the apnea-hypopnea index and a “respiratory disturbance index”. We caution that the latter, as defined in the published studies, is not the respiratory disturbance index as used in everyday clinical practice by sleep physicians, but a proxy of the former (see below for detailed explanation). Other indices have also been used.

- *Apnea-Hypopnea Index (AHI)*. The number of apneas and hypopneas per hour of sleep. It is a fraction, where the numerator is the number of apneas and hypopneas, and the denominator is total sleep time.
- *Respiratory Disturbance Index (RDI)*. As mentioned above, studies of portable monitors do not define RDI in the same way it is defined in everyday clinical practice in the sleep laboratory (i.e., the quotient of the total number of RERAs, apneas and hypopneas divided by total sleep time). In studies of portable monitors RDI is a quantity that approximates AHI, whenever the numerator (apneas or hypopneas) or the denominator (total sleep time) or both are not measured directly. In most cases the denominator is the total recording time instead of the total sleep time. Proxies for the

numerator vary depending on the recorded signals and their assessment. Therefore exact definition of RDI may vary across different studies of portable monitors.

Types of monitors used in sleep studies

The American Sleep Disorders Association (ASDA – now named American Academy of Sleep Medicine) classified the different monitors that have been used in sleep studies into four categories, depending on which channels they record and evaluate.²³ This classification scheme is rather dated; newer monitors have been developed that evaluate signals not considered in the original ASDA classification. Such monitors would be classified as category IV in the original classification scheme. To account for newer monitors we modified the ASDA classification, by splitting category IV into two subgroups: monitors assessing three or more bioparameters (where the newer monitors would fall) and monitors assessing one or two bioparameters (original category for type IV).

More details on the classification of sleep monitors and a discussion on how newer devices may fit in this classification scheme are provided in our Technology Assessment “Home diagnosis of obstructive sleep apnea-hypopnea syndrome” Section A3.

Here, we used the operational rules described in **Table 1** to classify sleep monitors. Very similar rules have been applied in previous systematic reviews.¹⁴ Briefly:

- Type I is facility-based PSG.
- Type II monitors record the same information as type I (perhaps with fewer channels). Type II monitors record signals that allow the reliable identification of (micro)arousals from sleep (e.g. EOG, chin EMG, EEG – see **Table 1** footnote for abbreviations) *and* at least two respiratory channels (two airflow channels or one airflow and one effort channel).
- Type III monitors do not record the channels that differentiate between sleep and wake, but have at least two respiratory channels (two airflow channels or one airflow and one effort channel).
- Type IV are all other monitors that fail to fulfill criteria for type III monitors. These are split into two subgroups: those assessing three or more bioparameters (i.e., most newer monitors fall here) and those assessing one or two bioparameters (i.e, the original ASDA level IV category).

We classified each monitor according to the channels *that were actually used* in the pertinent study. For example, if not all channels of a nominally type III monitor were used or analyzed, we classified the monitor as “type IV” for the particular study. This “downlabeling” occurred rarely (see the previous Technology Assessment for more details).

Table 1. Delineation of operational rules used to classify monitors in sleep studies.

Type or Level	Portability	Indicative N _{channels}	Indicative signals	≥2 airflow /effort channels	Identifies sleep /wake	AHI
I	Facility-based	~14-16	EEG, EOG, EMG, ECG/HR, airflow, effort, SaO ₂	Yes	Yes	Yes
II	Portable	≥7	(may have EEG), HR*, EOG, chin EMG, ECG/HR, airflow, effort, SaO ₂	Yes	Yes	Yes
III	Portable	≥4	Airflow and/or effort, ECG/HR, SaO ₂	Yes	No	No
IV ₃₊	Portable	≥3**	Airflow, HR, peripheral arterial tonometry, SaO ₂	No	No***	No***
IV ₂₋	Portable	~1-2	[All monitors not qualifying for type III]	No	No	No

AHI: Apnea-Hypopnea index; ECG: electrocardiogram; EEG: Electroencephalogram; EMG: electromyography; EOG: Electro-oculogram; HR: heart rate; SaO₂: arterial O₂ saturation;

* Heart rate is allowed instead of EEG in type II monitors. Essentially, many type II monitors gather the same signals as type I monitors.

** Criteria for type III are not met

***May include monitors that measure signals that are in principle able to identify arousals from sleep (are good surrogates for arousals).

In the modeling strategies we will assume that a prototype portable monitor is being used in the home setting in the corresponding strategies, rather than a specific brand. The prototype monitor has diagnostic abilities similar to those of type III devices, or type IV devices that assess at least 3 bioparameters (see below).

Search Strategy

We conducted comprehensive searches in MEDLINE from its inception through the 28th of February 2007 to identify English language publications that described prospective studies comparing portable monitors with facility-based PSG, or describing adverse events or complications of sleep studies. Three electronic searches were performed at different time points. The three searches were incremental (i.e., the latest search included all the citations of the previous searches). Relevant systematic reviews and meta-analyses, consensus statements and recommendations were also identified. Various search terms were used, including terms that described sleep studies with different monitors, OSAHS, and continuous positive airway pressure (CPAP) treatment for OSAHS. The complete search strategy has been reported in detail in Appendix A of the Tufts-NEMC technology assessment “Home diagnosis of obstructive sleep apnea-hypopnea syndrome”. Reference lists from relevant systematic or non-systematic reviews, the reviewed studies, and publications on practice recommendations were also examined for potentially useful additional citations.

Markov processes

The current problem is especially amenable to mathematical modeling: There are no studies that *directly compared multiple strategies* for the diagnosis of OSAHS and CPAP level titration. Markov modeling is an established and widely used analytic methodology. It is used in decision analyses to try to more accurately represent complex processes that involve transitions between different “health states” (complex transitions are not handled easily with simple decision trees).^{31,32}

A simple example of a Markov model

For simplicity, assume that we want to model a hypothetical cohort of patients and that we are interested in the proportion of patients who are well, become sick or die. We can use a Markov model with three “health states”, namely being “well”, being “sick” and being “dead”. We assume that as time passes:

1. people who are “well”
 - a. may become “sick”
 - b. may die before becoming “sick”
2. people who are “sick”
 - a. may become “well” (i.e., the disease is curable)
 - b. may die
3. people who are “dead” always remain dead.

Each of the aforementioned transitions happens with a predefined probability (transition probability).

Time in Markov processes is modeled in discrete intervals, i.e., it progresses in steps, or time cycles (e.g., one month long time-cycles). In the beginning of the simulation, all people are assumed to be “well”. At the end of each time-cycle we calculate the proportion of people who find themselves in each of the three health states (“well”, “sick”, and “dead”) using the transition probabilities. At each time point each patient/member of the hypothetical cohort is allowed to be in a single health state.

An intuitive introduction to Markov models for the interested reader is found in several textbooks, manuscripts and on the web.³¹⁻³⁴

Implementation

The different strategies for the diagnosis of OSAHS and the initiation of CPAP treatment were simulated with mathematical models (Markov processes) using the DATA software package (DATA ver 2.6.7; TreeAge Software Inc, Boston, Massachusetts). Each process simulates a hypothetical cohort of 100,000 people who are suspected of OSAHS, presumably on the basis of suggestive symptoms and signs. The cohorts are followed prospectively for 2 years or until all people have been diagnosed and have had a technically adequate CPAP titration study (when applicable).

Time in Markov processes is measured in discrete 1 week “cycles”. As mentioned above, each strategy is modeled as a web of mutually exclusive (and exhaustive) health states with a combination of given characteristics, so that a person is allowed to be in a single health state at any given time cycle. At the end of each cycle people may remain in the same health state or transit to other prespecified health states with predefined probabilities for each transition. The whole process is repeated at the end of the next

cycle, and the software calculates the proportion of people in the cohorts who find themselves in each health state at the end of each cycle (cohort analysis method).

The modeled strategies and the values of the transition probabilities are described in the following sections.

Simulated populations

We simulated 2 different populations: People who are middle-aged (~50 years old) and people who are older adults (~70 years old). The second population is of particular interest, but the literature does not provide data on needed transition probabilities among older adults. We therefore based our analyses on extrapolations from transition probabilities among middle-aged people. More specifically:

All eligible studies enrolled people who were predominantly men, obese (average BMI above 27 kg/m² in almost all studies), and with average age approximately 50 years old. The typical enrollee did not have comorbidities that may affect sleep (these were excluded upfront in almost all studies). In most studies people were referred to sleep labs on the basis of suggestive symptoms (i.e., fatigability, day somnolence; – see also under “Prevalence” under “Probabilities used in the simulations”).

Based on the above, one analysis simulates a cohort similar to the enrollees of the diagnostic studies, that is middle-aged people (age 50 years) without significant comorbidities who have suggestive symptoms and signs.

A second analysis (essentially a sensitivity analysis scenario) simulated a cohort for older adults (i.e., age 70 years on average – to approximate the majority of the Medicare beneficiaries). An additional factor that is being considered when deriving the transition probabilities in this secondary analysis is the potential for “indication creep”. Indication creep would emerge when testing for sleep apnea becomes easy and accessible to the point that people at low (or very low) risk for OSAHS receive testing. Explicit assumptions for the cohort on 70 year old people are made in the “Probabilities used in the simulations” section.

Data abstraction

Data were abstracted by a single reviewer (TT) directly into the corresponding summary tables. When needed, specialized planimetric software (Engauge Digitizer ver. 2.14; Mark Mitchell, 2002) was used to digitize figures and extract numerical information with the best allowable accuracy. Details are given in the corresponding sections that describe each individual transition probability.

Description of the modeled strategies

Brief descriptions and global assumptions

Seven different strategies were modeled (outlined in **Table 2**). The following is a brief description. Diagrams of the strategies and more detailed descriptions are provided in the next section.

- **Strategy 1** (“None on CPAP”). None in the hypothetical cohort will ever be tested for OSAHS or offered CPAP treatment. This is one extreme scenario that has been included for comparison.
- **Strategy 2** (“DxPSG, TxPSG”). All people in the hypothetical cohort will receive a diagnostic session (DxPSG) in the sleep laboratory. If the exam is positive, a second session for CPAP level titration will be scheduled.
- **Strategy 3** (“Split-Night PSG”). All people in the hypothetical cohort will be assessed with split-night studies. If the first half of the exam is positive, the second half is used to titrate the CPAP level. If the first half of the exam is negative no CPAP titration is attempted.
- **Strategy 4** (“HomeDx, SpNPSG(+)"). All people in the hypothetical cohort will be assessed in the home setting with portable sleep monitors (HomeDx). Those with *positive diagnoses* (indexed by the “+” sign in the name of the strategy) will be subjected to split-night studies in the sleep laboratory, to verify the diagnosis and to titrate CPAP level (if applicable). This is a combination of strategies 3 and 6 (see below).
- **Strategy 5** (“HomeDx, SpNPSG(-)"). This is similar to Strategy 4 in structure, but here people with *positive diagnoses* in the home setting are offered CPAP level titration, and people with *negative diagnoses* in the home setting will be re-evaluated with split-night studies in the lab (to minimize the number of people with OSAHS who have been missed as false negatives).
- **Strategy 6** (“HomeDx, autoCPAP”). The whole hypothetical cohort is managed entirely outside the sleep laboratory. Portable monitoring in the home setting (“HomeDx”) is used for the diagnosis, and auto-titration of CPAP is attempted again in the home setting on a different night.
- **Strategy 7** (“All on CPAP”). The whole cohort will be offered CPAP treatment (with auto-titration or empirical titration of the pressure level). In this scenario none is tested for OSAHS. This is the other extreme scenario that has been included for comparison.

Table 2. Outline of the seven modeled strategies.

Strategy Number (Name)	Diagnosis	CPAP level titration	N of sleep studies
1 (None on CPAP)	[None]	[None on CPAP]	0
2 (DxPSG, TxPSG)	Lab-PSG	Lab-PSG	≥2
3 (Split-Night PSG)	Split-night PSG		≥1
4 (HomeDx, SpNPSG(+))	Home PM	<ul style="list-style-type: none"> • Split-night PSG (if <i>positive</i> Home PM) • No further action (if <i>negative</i> Home PM) 	≥2
5 (HomeDx, SpNPSG(-))	Home PM	<ul style="list-style-type: none"> • Home autoCPAP (if <i>positive</i> Home PM) • Split-night PSG (if <i>negative</i> Home PM) 	≥1
6 (HomeDx, autoCPAP)	Home PM	Home autoCPAP	≥2
7 (All on CPAP)	[None]	[All start on CPAP]	0

CPAP: Continuous Positive Airway Pressure; N: number; PM: portable monitor; PSG: polysomnography

Global assumptions

The following assumptions are used for all strategies:

1. The severity of obstructive sleep apnea would be stable for each patient over the whole time-period of the assessment.
2. The risk of death over the whole time period of the assessment is negligible. In reality, the annual mortality rate is not zero (both for middle-aged people and especially so for Medicare beneficiaries). Moreover, there is evidence suggesting an association of OSAHS with increased risk of death from motor vehicle accidents, and perhaps increased risk for heart disease and stroke. Notwithstanding these caveats, we decided not to model mortality outcomes, because we focus on the diagnosis of the condition rather than long term projections.
3. Co-morbidities and co-existing disorders, or health conditions other than OSAHS that may affect sleep are not explicitly modeled.
4. Sleep lab capacity is assumed fixed throughout the simulation, i.e., the sleep labs do not expand their capacity during the follow up. A fixed sleep lab capacity implies that a smaller volume of sleep studies would result in shorter average waiting times.

In addition, the following implicit assumptions are made:

1. Benefits of treatments will be assumed by those with true positive diagnoses
2. Avoidance of unnecessary treatments to those with true negative diagnoses
3. Potential harm and unnecessary costs to those with false positive or false negative diagnoses

Detailed descriptions and strategy-specific assumptions

It is meaningful to discuss in more detail only strategies 2 to 6; the extreme strategies 1 and 7 are included for comparison and their results are invariable in all sensitivity analyses.

Appendix A gives a full description of the modeled strategies, by providing the actual model architecture and the conditional probabilities for each transition between the various health states.

Strategy 2: Management with facility-based PSG (DxPSG, TxPSG)

Figure 1 illustrates strategy 2. People suspected of OSAHS will be subjected to facility-based PSG for diagnosis. Those with negative diagnosis are not offered a CPAP titration study. Those with positive diagnosis will be scheduled for a second session in the sleep laboratory in order to titrate CPAP level. If the diagnostic PSG study is unsuccessful it may be repeated (up to two times). People with all three PSG studies unsuccessful are considered without OSAHS and are not offered a CPAP titration study. In the simulations this is a negligible proportion.

For people with positive diagnosis, the next step is a study to titrate CPAP level. Up to 3 sessions for CPAP level titration are allowed (in case of technically inadequate titration study).

If the third session for CPAP level titration is technically inadequate, the main analyses assume that the patient (who already has a positive diagnosis) will be offered CPAP treatment (e.g., with empirical level titration). An alternative scenario assumes that these patients would not be offered CPAP, perhaps because they do not tolerate the treatment.

The sleep laboratories have a given capacity (e.g., total number of sleep beds) that allows a certain number of sleep studies to be performed each week. Therefore, there is an average delay before each sleep study.

Figure 1. Layout of the distinct health states assumed by strategy 2 (facility-based PSG)

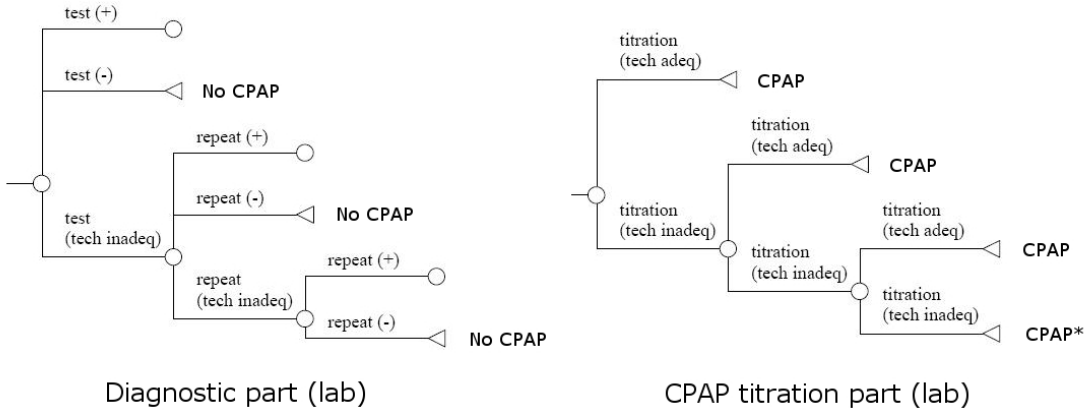

CPAP: continuous positive airway pressure; repeat; repeating of a technically inadequate diagnostic PSG or a failed CPAP level titration study; test(+/-/tech ineq): positive/negative/inconclusive test (technically inadequate) result; titration (tech adeq/tech ineq): technically adequate/inadequate CPAP level titration.

* In sensitivity analyses we assumed that this branch is not offered CPAP (see text).

We represent the model using a tree structure to enhance clarity. The actual Markov process is described in **Appendix A**.

Strategy 2 assumes management in the sleep lab in at least two different nights. The first night is to set the diagnosis of OSAHS. The second night is to titrate the level of CPAP pressure for people who have a positive diagnosis. Because of assumed finite sleep lab capacity, a time delay is assumed. People with a positive test result will proceed to CPAP level titration during the coming week. Those with a negative test will not be offered CPAP. Those with an inconclusive test will repeat the diagnostic study up to two times. Similar for people with technically inadequate CPAP level titration.

Strategy 3: Management with split-night studies (SpNPSG)

Figure 2 illustrates the different health states modeled in strategy 3. People suspected of OSAHS are evaluated in the sleep laboratory with split-night studies. Because all sleep studies are performed in the sleep lab, there is a time delay before each sleep examination. All people with negative diagnosis are not offered CPAP. People with positive diagnosis in the first part of the split-night study will be subjected to a CPAP titration study.

Technically inadequate split-night studies are repeated. Moreover, we assume that only the needed part of a split night study would be repeated (i.e., the CPAP titration part only if the diagnostic part was technically adequate).

A person may receive up to 4 split-night studies in the sleep laboratory if needed, i.e., if the previous split-night studies are technically inadequate (i.e., when either one of the their two parts is technically inadequate). In the simulations, the proportion of people who have more than one technically inadequate studies is very small. If all four split-night studies are unsuccessful, people are not started on CPAP. In the simulations this is a negligible proportion.

Figure 2. Layout of the distinct health states assumed by strategy 3 (Split-Night PSG)

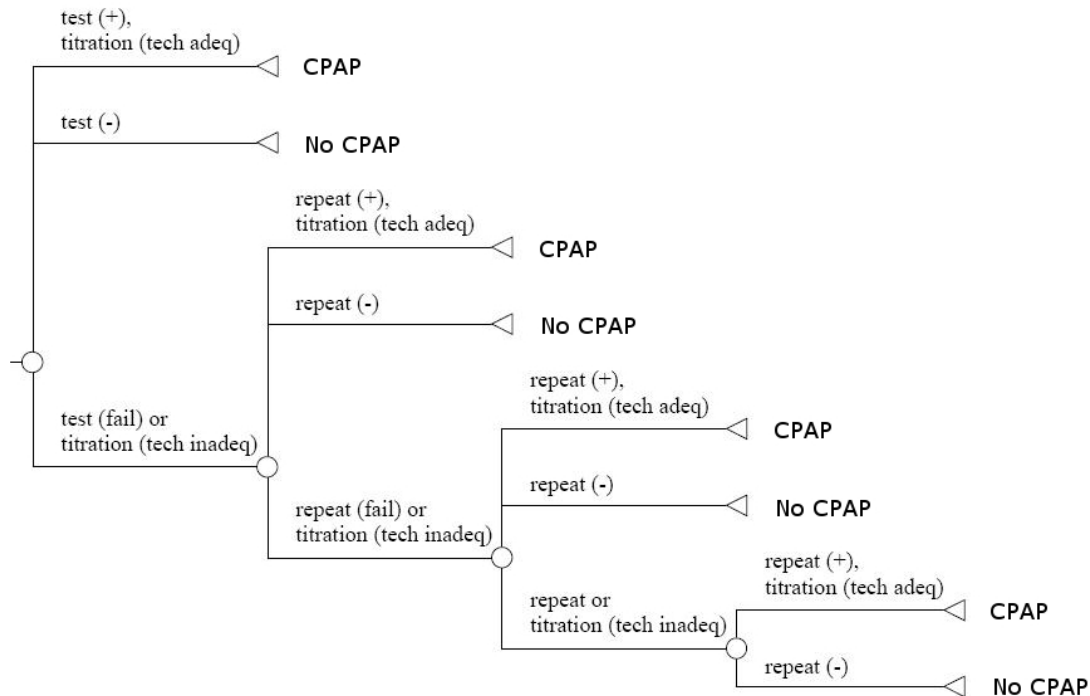

CPAP: continuous positive airway pressure; repeat; repeating of a technically inadequate split-night session; test(+/-/tech inadeq): positive/negative/technically inadequate test result; titration (tech adeq/tech inadeq): technically adequate/inadequate CPAP level titration.

We represent the model using a tree structure to enhance clarity. The actual Markov process is described in **Appendix A**.

Strategy 3 assumes management in the sleep lab in a single session using split-night studies. Because of assumed finite sleep lab capacity, not all people receive the split-night study immediately (i.e., a time delay is assumed). People with a positive test result and successful titration will be offered CPAP. Those with an technically inadequate diagnosis or titration will repeat the split night study up to three times.

Strategy 4: Diagnosis with portable monitors in the home setting, and management of positive cases with facility-based PSG (HomeDx, SpN PSG(+))

Figure 3 illustrates the different health states modeled in strategy 4. This strategy is a combination of strategy 3 and strategy 5 (see below). People suspected of OSAHS are screened in the home setting using portable sleep monitors. All positive diagnoses are then referred to the sleep laboratory for split-night studies. All negative diagnoses are not considered for CPAP.

The positive diagnoses in the home setting will be verified during the first sleep study. For some people the first split-night study will be negative (i.e., will not verify the home diagnosis); these will not be offered CPAP.

The sleep laboratories have a given capacity that allows a certain number of sleep studies to be performed each week. Therefore, time delays are assumed before each split-night PSG.

In reality, split-night studies may be technically inadequate because they have a technically inadequate diagnostic part, or a technically inadequate CPAP level titration part. In this strategy it is assumed that the *diagnostic* part of the *first* split-night study is *always technically adequate*. This is a reasonable assumption given that patients who reach the health state of the first split-night study have already been diagnosed with OSAHS using the portable monitors.

If CPAP level titration is unsuccessful in the third (and last allowed) split-night study, the main analyses assume that the patient will be offered CPAP (e.g., with empirical level titration). An alternative scenario assumes that these patients would not be offered CPAP, perhaps because they do not tolerate it.

Figure 3. Layout of the distinct health states assumed by strategy 4 (screening at home with portable monitors, and Split-Night PSG for positive cases)

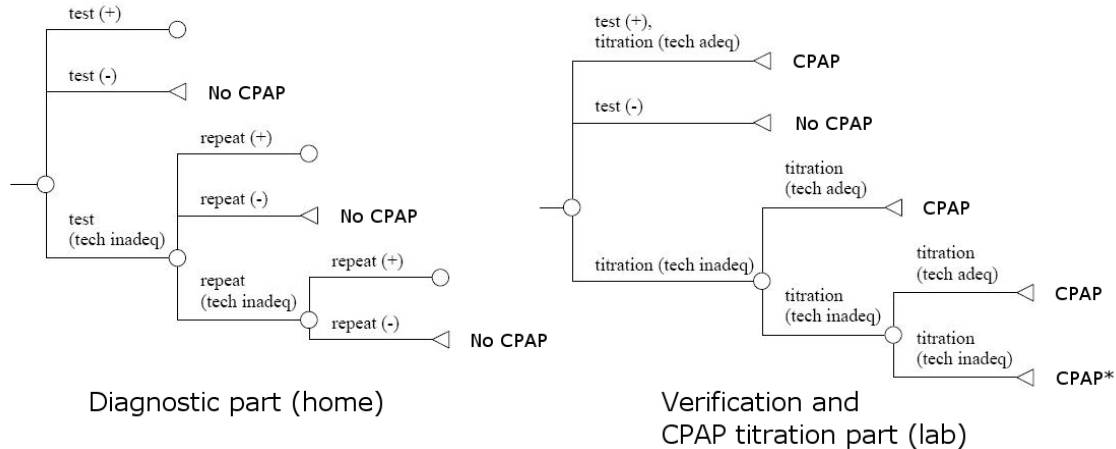

CPAP: continuous positive airway pressure; repeat; repeating of a technically inadequate diagnostic PSG or a failed CPAP level titration study; test(+/-/tech inadeq): positive/negative/technically inadequate test result; titration (tech adeq/tech inadeq): technically adequate/inadequate CPAP level titration.

* In sensitivity analyses we assumed that this branch is not offered CPAP (see text).

We represent the model using a tree structure to enhance clarity. The actual Markov process is described in **Appendix A**.

Strategy 4 assumes diagnosis at home (after a small time delay) and then, in a separate session, verification of the diagnosis and titration of the CPAP level with a split night study in the lab. Because of assumed finite sleep lab capacity, not all people will receive split-night studies immediately after a positive home test (i.e., there is a time delay).

Strategy 5: Diagnosis with portable monitors in the home setting; positive cases receive home CPAP auto-titration, while negative cases are re-evaluated with facility-based split-night studies (HomeDx, SpN PSG(-))

Figure 4 illustrates the different health states modeled in strategy 5. This strategy resembles Strategy 4 in structure, but is quite different. People suspected of OSAHS are screened in the home setting using portable sleep monitors. All positive diagnoses are offered auto-titration of CPAP levels at home (so that there is as little delay as possible in proceeding to treatment). To minimize false negatives, all negative cases are referred to the sleep laboratory for split-night studies. In more detail:

Positive diagnoses at home: All these patients will be offered auto-titration of CPAP levels at home. Up to three sessions for auto-titration of CPAP are allowed (in case of technically inadequate sessions). If CPAP level titration is technically inadequate in the third (and last allowed) session, the main analyses assume that the patient (who already has a positive diagnosis) will be offered CPAP (e.g., with empirical level titration). An alternative scenario assumes that these patients would not be offered CPAP, perhaps because they do not tolerate it.

Negative diagnoses at home: All these patients are re-evaluated with split-night studies. The sleep laboratories have a given capacity that allows a certain number of sleep studies

to be performed each week. Therefore, time delays are assumed before each split-night PSG.

In reality, split-night studies may be technically inadequate because they have a technically inadequate diagnostic part, or a technically inadequate CPAP level titration part. In this strategy it is assumed that the *diagnostic* part of the *first* split-night study is *always technically adequate*. This is a reasonable assumption given that patients who reach the health state of the first split-night study have already been diagnosed with OSAHS using the portable monitors.

If CPAP level titration is unsuccessful in the third (and last allowed) split-night study, the main analyses assume that the patient will be offered CPAP (e.g., with empirical level titration). An alternative scenario assumes that these patients would not be offered CPAP, perhaps because they do not tolerate it.

Figure 4. Layout of the distinct health states assumed by strategy 5 (screening at home with portable monitors; auto-titration of CPAP at home for positive cases and re-evaluation of negative cases with Split-Night PSG)

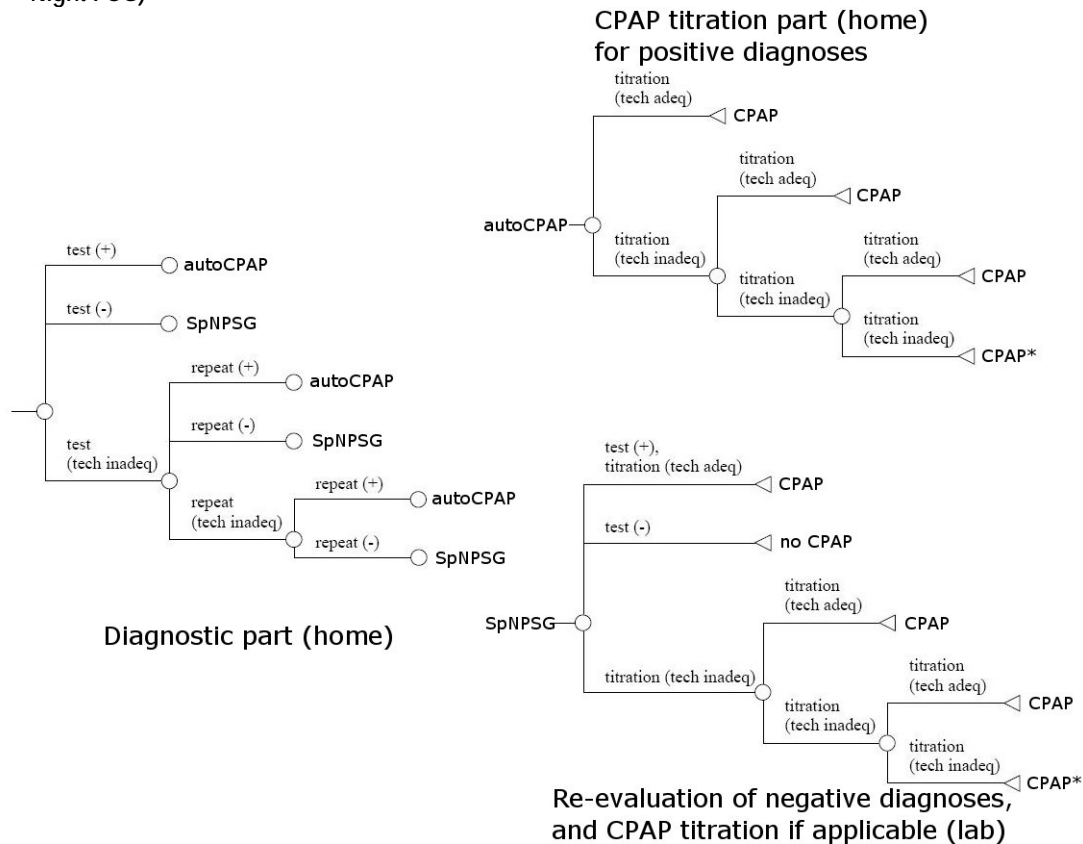

CPAP: continuous positive airway pressure; repeat; repeating of a technically inadequate diagnostic PSG or a failed CPAP level titration study; test(+/-/tech inadeq): positive/negative/technically inadequate test result; titration (tech adeq/tech inadeq): technically adequate/inadequate CPAP level titration.

* In sensitivity analyses we assumed that this branch is not offered CPAP (see text).

We represent the model using a tree structure to enhance clarity. The actual Markov process is described in **Appendix A**.

Strategy 5 assumes diagnosis at home (after a small time delay). People with positive diagnosis are offered auto-titration of CPAP at home (separate session in a different night). People with negative diagnoses are re-evaluated with split-night studies, to reduce the number of false negatives. Because of assumed finite

sleep lab capacity, not all people will receive split-night studies immediately after a positive home test (i.e., there is a time delay).

Strategy 6: Management outside the sleep laboratories (HomeDx, autoCPAP)

Figure 5 illustrates the different health states modeled in strategy 5. All people suspected of OSAHS are screened in the home setting using portable sleep monitors. All positive diagnoses are then offered auto-titration of CPAP levels at home. If a home-based study is technically inadequate, it may be repeated up to two times. People who have all three diagnostic studies technically inadequate are assumed not to start on CPAP. In the simulations this proportion is very low.

Similarly, up to three sessions for auto-titration of CPAP are allowed (in case of technically inadequate sessions). If CPAP level titration is technically inadequate in the third (and last allowed) session, the main analyses assume that the patient (who already has a positive diagnosis) will be offered CPAP (e.g., with empirical level titration). An alternative scenario assumes that these patients would not be offered CPAP, perhaps because they do not tolerate it.

Because none of the management options in this strategy involves examinations in the sleep laboratory, the corresponding time delays are assumed to be smaller (see next section on average time delays).

Figure 5. Layout of the distinct health states assumed by strategy 5 (home diagnosis with portable monitors and automatic titration of CPAP level at home)

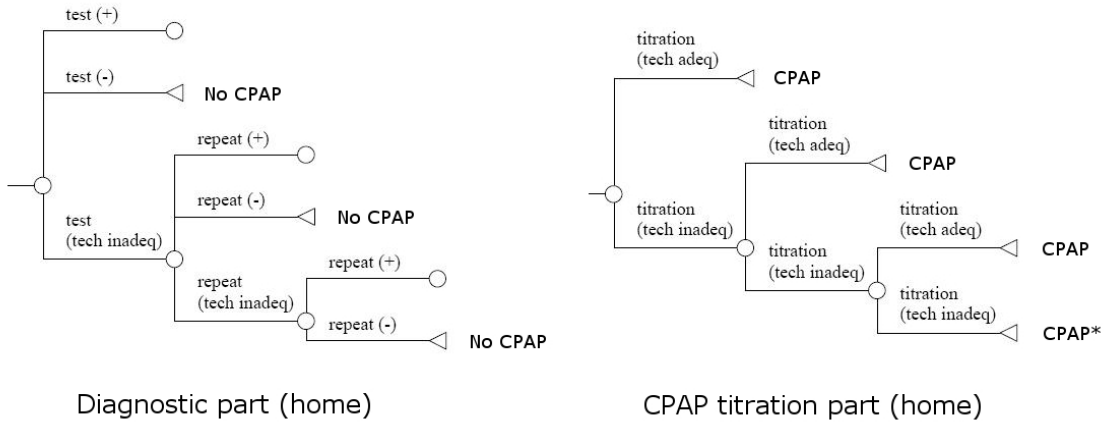

CPAP: continuous positive airway pressure; repeat; repeating of a technically inadequate diagnostic PSG; test(+/-/tech ineq): positive/negative/technically inadequate test result; titration (tech adeq/tech ineq): technically adequate/inadequate CPAP level titration.

* In sensitivity analyses we assumed that this branch is not offered CPAP (see text).

We represent the model using a tree structure to enhance clarity. The actual Markov process is described in **Appendix A**.

Strategy 6 assumes management at home in at least two different nights. The first night is to set the diagnosis of OSAHS. The second night is to titrate the level of CPAP pressure for people who have a positive diagnosis.

Probabilities used in the simulations

Table 3 summarizes the probabilities (transition probabilities and other probabilities) used in the Markov processes. The following sections discuss in detail the choice of the

probabilities, the range for the sensitivity analyses, and the rationale behind any assumptions. Explicit statements are made on the applicability of all probabilities to older adults (70 years old).

Table 3. Probabilities used in the Markov processes for a cohort of middle-aged people (50 years old).

Probability	Variable name	Baseline	Range	Rationale and comments
Prevalence of OSAHS among people with symptoms and signs (%)	prev	54*	25, 75	Summary prevalence from a synthesis of 30 prospective studies. ³⁵⁻⁶¹ The range is set to cover a wide span of plausible values (see text for details)
<i>Diagnosis with facility-based PSG</i>				
Sensitivity (%)	S_PSG	100	85, 100	Assumption, given that the operating definition of OSAHS is an AHI of at least 15 events/hour with facility-based PSG; facility-based PSG is a reference strategy.
Specificity (%)	C_PSG	100	85, 100	
Proportion of people who do not show up for the first scheduled full night PSG session	pNoShow_PSG	0	0, 25	Assumption; Range in sensitivity analyses varied to accommodate reasonably high “no show” values
Proportion of technically inadequate tests				
• among those with OSAHS (%)	pFail_PSG1	4.6	2.7, 7.0	Summary estimate and 95% CI from 19 studies reporting non-zero proportion of unsatisfactory examinations in facility-based PSG. ^{14,37,39,62-78} Assumption: probability of failure is independent of OSAHS status or AHI value
• among those without OSAHS (%)	pFail_PSG2	4.6	2.7, 7.0	
<i>Diagnosis with split-night PSG</i>				
Sensitivity (%)	S_SpNPSG	89	76, 95	Point estimate and 95% CI from a bivariate meta-analysis of 3 studies. ⁷⁹⁻⁸¹
Specificity (%)	C_SpNPSG	94	52, 100	
Proportion of people who do not show up for the first scheduled split-night PSG session	pNoShow_SpNPSG	pNoShow_PSG	0, 25	Assumption; Range in sensitivity analyses varied to accommodate reasonably high “no show” values
Proportion of technically inadequate tests				
• among those with OSAHS (%)	pFail_SpNPSG1	9.2	2.7, 14.0	Assumption, two times higher than facility-based PSG (see text); the probability of failure is independent of OSAHS status or AHI value
• among those without OSAHS (%)	pFail_SpNPSG2	9.2	2.7, 14.0	
<i>Diagnosis with “prototype” home monitor</i>				
Sensitivity (%)	S_HomeDx	90	83, 94	Point estimate and 95% CI from a bivariate meta-analysis of 14 studies. ^{39,41,50,55,58,59,63,64,82-86}
Specificity (%)	C_HomeDx	85*	67, 94	

Probability	Variable name	Baseline	Range	Rationale and comments
Proportion of technically inadequate tests				
<ul style="list-style-type: none"> among those with OSAHS (%) 	pFail_HomeDx1	8.9	6.6, 12.0	Summary estimate and 95% CI from 23 studies reporting non-zero proportion of unsatisfactory examinations in the home setting, or clearly reporting no unsatisfactory examinations. ^{37,39,47,48,50,52,55,60,62,65,66,69,73,78,87-94} <i>Assumption: probability of failure is independent of OSAHS status or AHI value</i>
<ul style="list-style-type: none"> among those without OSAHS (%) 	pFail_HomeDx2	8.9	6.6, 12.0	
<i>Technically adequate CPAP level titration study</i>				
Proportion with technically adequate <i>manual (i.e., lab-based)</i> CPAP titration study				
<ul style="list-style-type: none"> among those with OSAHS (%) 	pTitr_manCPAP1	1-pFail_PSG1	<i>[depends on pFail_PSG1]</i>	<i>Assumed to be the same for split-night studies and whole night CPAP pressure titration studies</i>
<ul style="list-style-type: none"> among those without OSAHS (%) 	pTitr_manCPAP2	1-pFail_PSG2	<i>[depends on pFail_PSG2]</i>	
Proportion with technically adequate <i>automated (i.e., home-based)</i> CPAP titration study				
<ul style="list-style-type: none"> among those with OSAHS (%) 	pTitr_autoCPAP1	78	50, 100	Based on a prospective cohort (Fletcher 2000 ⁹⁵)
<ul style="list-style-type: none"> among those without OSAHS (%) 	pTitr_autoCPAP2	78	50, 100	
Average waiting time for a single study in the sleep labs for strategy 2 (weeks)	Dt_Lab	13	4, 22	Based on Flemons 2004 ⁹⁶
Average waiting time for a single study in the sleep labs for strategies 3 and 4 (weeks)	[see text and Appendix B]	[see text and Appendix B]	[see text and Appendix B]	Based on the average waiting time in strategy 2 after accounting for the total number of studies in the sleep labs in strategies 3 and 4 [see Appendix B]
Average waiting time for a single study in the home setting (weeks)	Dt_Home	2	0, 5	<i>Assumption; also assumed independent of the demand for sleep studies in the home setting</i>

CI: confidence interval; CPAP: continuous positive airway pressure; OSAHS: Obstructive sleep apnea-hypopnea syndrome; PSG: polysomnography

* These two probabilities (prev, C_HomeDx) are assumed to be different among older adults (see text). All other probabilities were assumed to be the same among younger people (~50 year olds) and older adults.

Prevalence of OSAHS among people with suggestive symptoms (prev)

As discussed in the Terminology and Definitions section, OSAHS is operationally defined as AHI of at least 15 events/hour of sleep with a facility-based PSG study.

Estimates for middle-aged people (50 years old)

- Prev=54% in baseline analyses, ranging from 25% to 75% in sensitivity analyses (**Table 3**).

The prevalence of AHI suggestive of OSAHS among people who are referred to sleep laboratories for evaluation is higher compared to that in the general population, because referrals are based on suggestive symptoms and signs. We performed a meta-analysis to obtain the best estimate for the prevalence of OSAHS among middle-aged referrals. Eligible studies had a prospective or cross-sectional design and evaluated 11 or more adults; pertained to referrals by general practitioners, lung or other specialists for suspected OSAHS; did not screen participants with home monitoring devices or any form of sleep study to decide who will be assessed with facility-based PSG; and reported the proportion of people with AHI ≥ 15 events/hour of sleep. Only English-language studies were assessed, and no country restrictions were imposed.

Overall, 30 studies were eligible (**Table 4**).³⁵⁻⁶¹ The median number of enrolled participants in the 30 studies was 67 (interquartile range: 45, 108), and in total, 2,901 people were evaluated. The majority of the participants were males (median percentage of males was 78%, interquartile range: 71, 83). The mean age of the participants was in the early fifties (median 50 years, interquartile range: 48, 52). Most participants were overweight or obese (the average BMI was on median 30.8 kg/m², interquartile range: 29.6, 32.5).

The summary prevalence of AHI ≥ 15 events/hour of sleep was 54% (95% confidence interval: 48, 60%) in a random effects meta-analysis of the 30 studies. The summary estimate was very similar (56% [95% confidence interval: 48, 63%]) for the 27 studies that clearly described how apneas and hypopneas were defined in facility-based PSG. The boundaries of the 95% confidence interval defined the range of values in the sensitivity analyses.

Table 4. Prevalence of OSAHS (i.e., AHI \geq 15 events/hour of sleep with facility-based PSG) among people who were referred for sleep apnea evaluation.

Author, Year Country	Participants	N	Mean age (y)	Mean AHI (Range)	AHI \geq 15 events/h (%)	Male (%)	Mean BMI (kg/m ²)	Respiratory event definition for facility-based PSG
<i>Clear definition of apneas and hypopneas</i>								
Levy, 1996 France	Referrals to sleep lab	301	56	30 (ND)	64	ND	32.0	Apnea: No airflow (therm) Hypopnea: \downarrow Airflow (therm) \geq 50%
Chiner, 1999 Spain	Referrals to sleep center	275	51	42 (15-101)	79	89	30.0	Apnea: No airflow (therm) Hypopnea: \downarrow Airflow (therm) \geq 50% or \downarrow effort (Th/AB) \geq 50% or \downarrow airflow \geq 50%; both with \downarrow SaO ₂ \geq 4% or arousal
Alvarez, 2006 Spain	Referrals	187	58	40 (ND)	59	79	29.5	Apnea: No airflow (therm) Hypopnea: \downarrow Airflow (therm) discernible with \downarrow SaO ₂ \geq 4%
Issa, 1993 Canada	Referrals to sleep center	129	48	ND	36	78	30.9	Apnea: No airflow (therm) Hypopnea: \downarrow Effort (Th/AB) \geq 50% with \downarrow SaO ₂ \geq 3%
Rauscher, 1993 Austria	Referrals to sleep lab	116	ND	ND	35	82	ND	Apnea: No airflow (therm) Hypopnea: \downarrow Effort (Th/AB) \geq 50% with \downarrow SaO ₂ \geq 2% (if baseline absolute \geq 94%) or \downarrow SaO ₂ \geq 2% (if baseline absolute $<$ 94%)
Baltzan, 2000 Canada	Referrals to a sleep lab	108	52	18 (ND)	41	74	28.4	Apnea: \downarrow Airflow (therm) $>$ 90% Hypopnea: \downarrow Airflow $>$ 50% with \downarrow SaO ₂ \geq 4%
Man, 1995 Canada	Referrals to sleep clinic	104	47	17 (ND)	27	78	ND	Apnea: No airflow (therm) Hypopnea: \downarrow Airflow (therm) $>$ 50%
Portier, 2000 France	Referrals to a pneumo-logy clinic	103	52	25.7 (ND)	47	82	31.0	Apnea: \downarrow airflow \geq 75% Hypopnea: \downarrow Airflow \geq 25% (& $<$ 75%)
Ryan, 1995 UK	Referrals to sleep clinic	100	48	ND	46	83	29.6	Apnea: No airflow (therm) with \downarrow SaO ₂ \geq 4% in next 30s Hypopnea: \downarrow Airflow (therm) \geq 25% with paradoxical movement, \downarrow effort (Th) \geq 25%, and \downarrow airflow (AB) \geq 15%
Mayer, 1998	Referrals	95	53	43	75	83	30.7	Hypopnea: \downarrow Airflow

Author, Year Country	Participants	N	Mean age (y)	Mean AHI (Range)	AHI \geq 15 events/h (%)	Male (%)	Mean BMI (kg/m ²)	Respiratory event definition for facility-based PSG
France	to sleep lab			(1, 147) ^a				(therm) >50% with arousal or drop in SaO ₂ \geq 4%
Parra, 1997 Spain	Referrals to pneumology clinic	89	54	34 (ND)	71	82	29.0	Apnea: No airflow (therm) Hypopnea: \downarrow Airflow (therm) discernible with paradoxical motion (Th/AB) or cyclical dip in SaO ₂
White, 1995 USA	Referrals to sleep centers	72	48	28 (0, 133) ^a	51	74	33.0	Apnea: No airflow (therm) Hypopnea: \downarrow Airflow (therm) \geq 50% with \downarrow SaO ₂ \geq 4% or EEG arousal
Gugger, 1997 Switzerland	Referrals	67	51	26 (0, 96) ^a	58	87	31.0	Apnea: \downarrow No airflow (therm) Hypopnea: \downarrow Airflow (therm) >50%
Ayappa, 2004 USA	Referrals to sleep center & healthy people	66	ND	48 (4, 126)	84	58	38.2	Apnea: \downarrow Airflow (cannula, therm) \geq 90% Hypopnea: \downarrow Airflow (Th/AB) \geq 50% with \downarrow SaO ₂ \geq 4% or arousal
Dingli, 2003 UK	Referrals to sleep center	61	50	29 (ND)	77	77	31.0	Apnea: No airflow (cannula, therm) Hypopnea: \downarrow Effort (Th/AB) \geq 50%
Su, 2004 USA	Referrals to sleep clinic	60	45	27 (2, 122) ^a	55	42	35.6	Apnea: No airflow (therm) with \downarrow Effort (Th/AB) \geq 70% and \downarrow SaO ₂ \geq 4% Hypopnea: No airflow (therm) with \downarrow Effort (Th/AB) \geq 30% and \downarrow SaO ₂ \geq 4%
Michaelson, 2006 USA	Referrals to sleep lab	59	40	15 (1, 80) ^a	14	83	26.6	Apnea: No airflow (therm) Hypopnea: \downarrow Airflow (therm) \geq 50% or \downarrow airflow <50% with \downarrow SaO ₂ \geq 3% or arousal
Verse, 2000 Germany	Referrals to sleep clinic	53	48	18 (0, 76)	43	92	27.4	Apnea: \downarrow Airflow (therm) >80% Hypopnea: \downarrow Airflow (therm) >50%
Reichert, 2003 Netherlands	Referrals to sleep center	51	52	29 (0, 123) ^a	48	74	30.0	Apnea: No airflow (therm) Hypopnea: \downarrow Airflow (therm) \geq 50% with \downarrow SaO ₂ \geq 2%
van Surell, 1995 France	Referrals to sleep lab	50	52	22 (0, 74) ^a	52	98	27.0	Apnea: No airflow (therm) Hypopneas: \downarrow Airflow

Author, Year Country	Participants	N	Mean age (y)	Mean AHI (Range)	AHI \geq 15 events/h (%)	Male (%)	Mean BMI (kg/m ²)	Respiratory event definition for facility-based PSG
								(therm) \geq 50% with EEG arousal
Pang, 2006 USA	Referrals to a sleep lab	39	52	32 (0, 111)	69	44	35.7	Apnea: No airflow (therm). Hypopnea: \downarrow Airflow (therm) discernible, with \downarrow Effort \geq 30% and \downarrow SaO ₂ \geq 4% or arousal
Pittman, 2004a USA	Referrals to sleep lab	31	44	ND	71	70	33.7	Apnea: No airflow (therm) Hypopnea: \downarrow airflow (therm) or \downarrow effort (Th/AB) \geq 30%, with \downarrow SaO ₂ \geq 4%
Pittman, 2004b USA	Referrals to a sleep lab	30	43	32 (7, 82) ^a	76	72	33.9	Apnea: No airflow (therm). Hypopnea: \downarrow Airflow (therm, Th/AB) \geq 50% or "less reduction" with \downarrow SaO ₂ \geq 3% or arousal
Zucconi, 1996 Italy	Referrals to sleep center	30	53	32 (1, 86) ^a	65	68	30.7	Apnea: No airflow (therm) Hypopnea: \downarrow Airflow (therm) \geq 40%
Penzel, 2004 Germany	Referrals to sleep lab	21	ND	15 (0, 84) ^a	29	ND	ND	Apnea: No airflow (therm) Hypopnea: \downarrow Effort (Th/AB) \geq 50%
Mykytyn, 1999 Australia	Referrals to sleep lab	20	50	25 (1, 79) ^a	35	100	30.6	Apnea: no airflow (therm) Hypopnea: \downarrow effort (Th/AB) \geq 50%
Rees, 1998 UK	Referrals to sleep lab	20	48	39 (8-114)	95	100	31.0	Apnea: No airflow (therm) Hypopnea: \downarrow Effort (Th/AB) \geq 50%
<i>Unclear definition of apneas and hypopneas</i>								
Westbrook, 2005 USA	Referrals to sleep center	299	48	ND	55	62	ND	"Standard criteria"
Douglas, 1992 UK	Referrals to sleep lab	220	50	ND (0, 95) ^a	46	82	ND	ND
Cooper, 1991 UK ^m	Referrals to sleep center	45	ND	ND	29	63	ND	ND

Studies are ordered according to their definition of apneas and hypopneas and by decreasing total sample size. Note that the percentages are expressed with respect to the number of people that were analyzed with facility-based PSG, which may be smaller than the number of people who were enrolled in some studies. AHI: Apnea-hypopnea index; BMI: body mass index; EEG: Electroencephalogram; h: hour (of sleep); N: number enrolled; ND: not described (not extractable); PSG: polysomnography; SaO₂: Oxygen saturation (in arterial blood); Th/AB: thoracoabdominal bands; therm: thermistor; y: year(s).

^a Data from digitized graph

Estimates for older adults (70 years old)

- prev=27% i.e., half of that assumed for younger adults.

None of the identified studies reported the prevalence of OSAHS (i.e., AHI \geq 15 events/hour of sleep) among older adults who have been referred for OSAHS evaluation. Whenever individual patient data were reported in tables, the number of older adults was too small to allow for meaningful estimates: for example, two out of four people older than 60 years and one out of two people older than 70 years had AHI \geq 15 events/hour of sleep in Verse 2000.⁵⁹

Here we are interested in the prevalence of OSAHS among older adults who are referred for sleep studies, not the prevalence among older adults in the general population. We estimated this number based on several considerations. The point estimate for our calculation was assumed to be 27 percent (i.e., half of what was set for middle-aged people). Briefly, the rationale is summarized as follows:

1. The prevalence of OSAHS among typical study enrollees, referred for sleep studies on the basis of suggestive symptoms and signs is 54 percent (see above).
2. If clinical signs and symptoms are equally strong predictors of OSAHS among elderly people as among younger people, the prevalence of OSAHS among the referred elderly would be again 54 percent.

Note that the prevalence of OSAHS among elderly in the general population is a different quantity (see below, “Data on the prevalence of OSAHS among older adults in the general population”).

3. However, there are data to suggest that the association between symptoms and signs and OSAHS (AHI $>$ 15 events/hour) is *not strong* among older adults. This means that more older adults may have symptoms suggestive of OSAHS although they do not have OSAHS – equivalently, the prevalence of older adults who have OSAHS among older adults with suggestive symptoms and signs would be *lower* than that observed among typical study enrollees (~50 years old). (see below, “Data supporting that the association of symptoms and signs suggestive of OSAHS is not strong among older adults”)

4. Furthermore, among elderly people several non-OSAHS co-morbid conditions that may affect sleep indices are prevalent. This would change the prevalence values towards *lower* values.

For example Cheyne-Stokes respiration is observed among people with heart failure, and may be misdiagnosed as obstructive sleep apnea by some portable monitors that collect a minimum set of physiologic signals.

5. Finally, if one makes testing for sleep conditions easier (perhaps allowing people with lower risk or even different indications to get tested – “indication creep”), the prevalence of OSAHS among people who are candidates to receive testing will be even *lower*.

Data on the prevalence of OSAHS among older adults in the general population

The prevalence of OSAHS among older adults often cited as higher than that of middle-aged people. Ancoli-Israel 1991 used a portable monitor (Respirtrace, Medilog) to evaluate 427 people aged 65 years or older using random sampling from the general population.¹⁸ In ninety percent of the participants (385/427) RDI measurements were

available. Forty four percent (170/385) were reported to have $RDI \geq 20$ events/hour. However, as the authors comment, the RespiTrace portable monitor overestimated the number of hypopneas (data from their previous work). Moreover, the authors suggest that “most of the increase in apnea indices associated with aging occurs before age 65 is reached”.

In the population-based Sleep Heart Health Study the prevalence of $AHI \geq 15$ events/hour of sleep was 1.7-fold higher in people older than 60 years compared to people between 40 and 60 years of age.¹⁷ There was little increase in the prevalence of $AHI \geq 15$ events/hour of sleep in those older than 60 years old.¹⁷ The same leveling in the prevalence of the disease was found in population-based studies in Pennsylvania¹⁹ and Spain.^{20,21}

Data supporting that the association of symptoms and signs suggestive of OSAHS is not strong among older adults

General practitioners and specialists refer people for OSAHS testing on the basis of suggestive symptoms or signs. It has been documented that among older adults these symptoms are less strongly associated with an AHI of at least 15 events/hour of sleep. In the Sleep Heart Health Study,¹⁷ the odds ratio for an AHI of at least 15 events/hour of sleep associated with 5.3 kg/m² increase in BMI was 1.8 (95% confidence interval: 1.6, 2.0) for 50 year old people after age and race adjustments. The corresponding odds ratio for 70 year old people was 1.5 (95% confidence interval: 1.4, 1.7), yielding a relative adjusted odds ratio of 0.83 between these two age groups. Self-reported breathing pauses (sometimes and often versus never) are even less strongly associated with $AHI \geq 15$ events/hour of sleep in older adults. Among 50 year olds the age and race adjusted odds ratio was 7.6 (95% confidence interval: 4.3, 13.5), whereas it was 2.7 (95% confidence interval: 1.7, 4.3) among 70 year old people. The adjusted relative odds ratio between the two age groups is 0.35.

Sensitivity and specificity of facility-based PSG (S_PSG and C_PSG)

Estimates for middle-aged people (50 years old)

- S_PSG=100% and C_PSG=100% in baseline analyses, ranging from 85% to 100% in sensitivity analyses (**Table 3**).

The presence of OSAHS has been operationally identified with an AHI at least 15 events/hour of sleep (in the modeled population all people have suggestive symptoms and signs). Therefore, the baseline analysis assigns to facility-based PSG perfect diagnostic sensitivity and specificity for the identification of $AHI \geq 15$ events/hour (both were set to 100% for the main analyses).

We did not find values for the sensitivity and specificity of facility-based PSG in the published literature. Studies describing the night-to-night variability of facility-based PSG suggest that variability is present, but a single facility-based PSG may be sufficient.⁹⁷ A study assessing the night-to-night variability of facility-based PSG in

children suggested that 85% of children would be accurately classified by the first facility-based PSG.⁹⁸

We ranged these values in sensitivity analyses between 85% and 100%, an arbitrarily chosen wide range guided by the aforementioned caveats.

Estimates for older adults (70 years old)

We used the same probabilities as in the baseline analyses. The implicit assumption here is that the sleep physician in the sleep lab would be able to distinguish OSAHS from other conditions that may affect sleep without being OSAHS (e.g., Cheyne-Stokes respiration), as discussed previously under the “Prevalence (prev)” section.

Sensitivity and specificity of split-night studies (S_SpNPSG and C_SpNPSG)

Estimates for middle-aged people (50 years old)

- S_SpNPSG=89% in baseline analyses, ranging from 76% to 95% in sensitivity analyses (**Table 3**).
- C_SpNPSG=94% in baseline analyses, ranging from 52% to 100% in sensitivity analyses (**Table 3**).

We did not find extensive data on the sensitivity and specificity of split-night studies compared to full night PSG. We identified three English language studies that allowed us to calculate the sensitivity and specificity of split-night PSG to predict AHI \geq 15 events/hour of sleep with full night facility-based PSG.⁷⁹⁻⁸¹ In all three studies we extracted the needed information after digitizing Bland-Altman plots⁷⁹ or scatter plots^{80,81} from the original paper. **Table 5** summarizes these studies.

Sanders 1991⁸¹ assessed people who were referred only on the basis of history or symptoms. In the other two studies, patients were screened with overnight oximetry or were known to have AHI \geq 10 events/hour of sleep (**Table 5**). Overall, the three studies assessed predominantly male and obese people, with baseline AHI values that were on average as high as 40-44 events/hour of sleep with full night PSG.

We performed a bivariate meta-analysis using a generalized linear mixed model to estimate the average sensitivity and specificity of split-night studies to predict AHI \geq 15 events/hour of sleep in facility-based PSG.⁹⁹⁻¹⁰¹ The values obtained from the bivariate meta-analysis are similar to the values obtained from separate meta-analyses.

Estimates for older adults (70 years old)

We used the same probabilities as in the baseline analyses. The implicit assumption here is that the sleep physician in the sleep lab would be able to distinguish OSAHS from other conditions that may affect sleep without being OSAHS (e.g., Cheyne-Stokes respiration), as discussed previously under the “Prevalence (prev)” section.

Table 5. Sensitivity and specificity of split-night studies to predict OSAHS (i.e., AHI \geq 15 events/hour of sleep with full night facility-based PSG).

Author, Year Country	Participants	N	Mean age (y)	Mean AHI (Range)	AHI \geq 15 events/ h (%)	Male (%)	Mean BMI (kg/ m ²)	Respiratory event definition for facility-based PSG	Sensitivity (95% CI) [%]	Specificity (95% CI) [%]
Sanders, 1991 USA	Consecutive referrals for symptoms	50	50	44 (0, 114) ^a	65 ^a	ND	ND	Apnea: No airflow (therm) Hypopnea: \downarrow Airflow (therm) \geq 30% without reduction in effort	97 (83, 100) ^a	82 (57, 96) ^a
Chung, 1998 Hong Kong	Consecutive patients with AHI>10 events/h	37	42	44 (11, 113) ^a	89 ^a	95	28.8	ND	82 (65, 93) ^a	100 (40, 100) ^a
Fanfulla, 1997 Italy	Referrals on the basis of symptoms and overnight oximetry	29	54	40 (9, 95) ^a	72 ^a	93	40.0	Apnea: No airflow (therm) Hypopnea: \downarrow Airflow (therm) \geq 50%	86 (64, 97) ^a	100 (63, 100) ^a
								Bivariate meta-analysis	89 (76, 95)	94 (52, 100)
								Separate meta-analyses	86 (76, 92)	86 (66, 95)

AHI: Apnea-hypopnea index; BMI: body mass index; CI: confidence interval; h: hours of sleep; N: number enrolled; therm: thermistor; PSG: polysomnography; y: year(s).

All available English language studies that reported or allowed the calculation of sensitivities and specificities of split-night PSG were included. See text for discussion.

^a Data extracted from digitized graphs

Sensitivity and specificity of home monitoring (S_HomeDx and C_HomeDx)

Estimates for middle-aged people (50 years old)

- S_HomeDx=90% in baseline analyses, ranging from 83% to 94% in sensitivity analyses (**Table 3**).
- C_HomeDx=85% in baseline analyses, ranging from 67% to 94% in sensitivity analyses (**Table 3**).

Eligible studies assessed the ability of type III and type IV₃₊ (type IV monitors recording at least 3 bioparameters) to predict AHI \geq 15 events/hour of sleep in facility-based PSG among 11 or more adults. Studies of portable monitors in the home setting were included irrespective of whether manual or automated scoring was used. Of studies performed in the lab setting, only those that provided results with automated scoring were used.

Fourteen studies described in 13 publications^{39,41,50,55,58,59,63,64,82-86} fulfilled these criteria; six pertained to type III monitors^{39,55,59,82-84} and eight to type IV₃₊ monitors.^{41,50,58,63,64,85,86} Six studies received grade “A”³⁹ or “B”^{41,50,51,55,58,59,64,85,86} for their methodological quality, and the remaining received grade “C”. The 14 studies are described in **Table 6**. Overall, the majority of the participants were male. In all studies the average BMI was above 27 kg/m² and in 10 it was more than 30 kg/m². The mean age of the participants across the 10 studies ranged between 43 and 57 years. Nine different portable monitor types were used. We emphasize that the studies in **Table 6** are heterogeneous with respect to the type of monitor, the channels recorded by these monitors and the definition of the respiratory events in the index and reference tests.

We were able to extract the counts for the 2 by 2 tables in nine out of fourteen studies (the ones in **Table 6** for which confidence intervals for sensitivity and specificity are shown). We estimated the counts in the 2 by 2 tables in the remaining studies from the reported sensitivities and specificities, assuming that the prevalence of AHI \geq 15 events/hour was 54% (equal to the summary prevalence estimate that was calculated in a previous section).

Table 6. Sensitivity and specificity of type III monitors (automated scoring) to predict OSAHS (i.e., AHI \geq 15 events/hour of sleep in facility-based PSG).

Author, Year, Country	Participants	N	Mean age (y)	Mean AHI (Range)	Male (%)	Mean BMI (kg/m ²)	Respiratory event definition for facility-based PSG	Type III monitor (automated scoring except for Dingli 2003)				
								Name	Respiratory event definition	Att /hook-up	Sensitivity (95% CI) [%]	Specificity (95% CI) [%]
<i>Home setting - type III monitors</i>												
Dingli, 2003 UK	Referrals to sleep center	61	50	29 (ND)	77	31.0	Apnea: No airflow (cannula, therm) Hypopnea: \downarrow Effort (Th/AB) \geq 50%	Embletta	Default settings	No/Tech	95 (77, 100)	82 (57, 96)
<i>Home Setting – type IV3+ monitors</i>												
Schafer, 1997 Germany	Referrals	114	56	29 (ND)	88	30.8	Apnea: No airflow (therm). Hypopnea: \downarrow Airflow (therm) \geq 50% \downarrow SaO ₂ \geq 4% or arousal	Mesam IV	\downarrow SaO ₂ \geq 4%, or \downarrow SaO ₂ \geq 2% with visible change in HR	ND/Tech	83 (NE)	62 (NE)
Bar, 2003 Israel	Referrals to sleep center	14	ND	31 (4, 78)	ND	ND	Apnea/Hypopnea: \downarrow Airflow (therm, Th/AB) \geq 50% or “less reduction” with \downarrow SaO ₂ \geq 3% or arousal	Watch Pat 100	ND	No/P	80 (46, 95)	50 (12, 88)
Pittman, 2004 USA	Referrals to sleep lab	30	43	32 (7, 82)	72	33.9	Apnea: No airflow (therm). Hypopnea: \downarrow Airflow (therm, Th/AB) \geq 50% or “less reduction” with \downarrow SaO ₂ \geq 3% or arousal	Watch Pat 100	One of three: 1. \downarrow PAT amplitude with acceleration in pulse rate or \uparrow wrist activity 2. \downarrow PAT amplitude with \downarrow SaO ₂ \geq 3% (<4%) 3. \downarrow SaO ₂ \geq 4%	ND	95 (74, 99)	100 (59, 100)
<i>Specialized sleep unit – type III monitors</i>												
Verse, 2000 Germany	Referrals to sleep clinic	53	48	18 (0, 76)	92	27.4	Apnea: \downarrow Airflow (therm) >80% Hypopnea: \downarrow Airflow (therm) >50%	Poly-Mesam	Apnea: \downarrow Airflow (therm) >80% Hypopnea: \downarrow Airflow (therm) >50%	ND/Tech	91 (72, 99)	97 (83, 100)
Reichert 2003, Netherlands	Referrals to sleep center	51	52	29 (0, 123)	74	30.0	Apnea: No airflow (therm) Hypopnea: \downarrow Airflow (therm) \geq 50% with	Nova-Som QSG	Apnea: No airflow (therm) Hypopnea: \downarrow Airflow (therm) \geq 50% with	Yes/ND	95 (77, 100)	64 (45, 80)

Author, Year, Country	Participants	N	Mean age (y)	Mean AHI (Range)	Male (%)	Mean BMI (kg/m ²)	Respiratory event definition for facility-based PSG	Type III monitor (automated scoring except for Dingli 2003)					
								Name	Respiratory event definition	Att /hook-up	Sensitivity (95% CI) [%]	Specificity (95% CI) [%]	
							↓SaO ₂ ≥2%		drop in SaO ₂ ≥2%				
Calleja, 2002 Spain	Referrals to sleep lab	86	52	34 (ND)	89	30.1	Apnea: No airflow (therm) Hypopnea: ↓Airflow (therm) discernible with arousal or ↓SaO ₂ ≥3%	Merlin	ND	No/Tech	64 (NE)	73 (NE)	
Fietze, 2002 Germany	Referrals	66	51	24 (ND)	98	32.9	Apnea: ↓Airflow (therm) >85% Hypopnea: ↓Airflow (therm) >50% with ↓SaO ₂ ≥3%	Merlin	Apnea/Hypopnea: ↓SaO ₂ ≥3%	ND	91 (NE)	100 (NE)	
Claman, 2001 USA	Referrals to sleep center	42	54	26 (0, 90)	74	30.6	Apnea: No airflow (therm) Hypopnea: ↓Airflow (therm) ≥50% with ↓SaO ₂ ≥4%	Bedbugg	ND	ND	86 (64, 95)	95 (73, 99)	
<i>Specialized sleep unit – type IV₃₊ monitors</i>													
Ayas, 2003 US	Suspected OSAHS	30	47	23 (1-94)	63	31.0	Apnea: No airflow (therm) Hypopnea: ↓Airflow (therm) ≥50% or ↓airflow <50% with ↓SaO ₂ ≥3% or arousal	Watch Pat 100	One of three: 1. ↓PAT amplitude with acceleration in HR or ↑ wrist activity 2. ↓PAT amplitude with ↓SaO ₂ ≥3% (<4%) 3. ↓SaO ₂ ≥4%	ND	93 (NE)	73 (NE)	
Pittman, 2004 USA	Referrals to sleep lab	30	43	32 (7, 82) ^b	72	30.9	Apnea: No airflow (therm) Hypopnea: ↓Airflow (therm) ≥50% or ↓airflow <50% with ↓SaO ₂ ≥3% or arousal	Watch Pat 100	One of three: 1. ↓PAT amplitude with acceleration in HR or ↑ wrist activity 2. ↓PAT amplitude with ↓SaO ₂ ≥3% (<4%) 3. ↓SaO ₂ ≥4%	ND	91 (70, 98)	86 (42, 98)	
Esnaola, 1996 Spain	Referrals to sleep center	152 (150)	57	27 (ND)	89	29.8	Apnea: No airflow (therm) Hypopnea: ↓Airflow (therm) discernible	Mesam IV	ND	ND	97 (NE)	36 (NE)	

Author, Year, Country	Participants	N	Mean age (y)	Mean AHI (Range)	Male (%)	Mean BMI (kg/m ²)	Respiratory event definition for facility-based PSG	Type III monitor (automated scoring except for Dingli 2003)					
								Name	Respiratory event definition	Att /hook-up	Sensitivity (95% CI) [%]	Specificity (95% CI) [%]	
							with ↓SaO ₂ ≥4% or arousal						
Issa, 1993 Canada	Referrals to sleep center	129	48	ND	78	30.9	Apnea: No airflow (therm) Hypopnea: ↓Effort (Th/AB) ≥50% with ↓SaO ₂ ≥3%	SnoreSat	↓SaO ₂ >3% and amplitude of snoring	ND/Tech	87 (74, 94)	96 (89, 99)	
van Surell, 1995 France	Referrals to sleep lab	50	52	22 (0, 74)	98	27.0	Apnea: No airflow (therm) Hypopneas: ↓Airflow (therm) ≥50% with EEG arousal	CID 102	Apnea: tracheal silence Hypopneas: short tracheal silence (for ≥7s & <10s) with cyclic ↓SaO ₂ ≥4% and ↑SaO ₂ within 50s	ND/Tech	73 (53, 87)	63 (42, 79)	

Whenever NE (not estimable) is listed instead of a confidence interval for sensitivity and specificity, we could not extract the counts in the 2by2 tables, with a single exception (specificity, Rees 1998).

Att: attended; AHI: apnea-hypopnea index in events/hour of sleep; EEG: electroencephalogram; N: Number enrolled; ND: not described; NE: not estimable; PSG: polysomnography; Tech: technologist; Th/AB belts: thoracoabdominal belts; therm: Thermistors used in airflow estimation; y: year(s).

Respiratory events across all studies were of at least 10 seconds duration unless otherwise noted. Studies ordered by setting, monitor type, quality and size after grouping per monitor make.

We performed bivariate meta-analyses to estimate the summary sensitivity and specificity⁹⁹⁻¹⁰¹ of a prototype portable monitor. This hypothetical monitor is has sensitivity and specificity similar to that of type III and type IV₃₊ monitors, as discussed earlier. The results of the bivariate meta-analyses were corroborated with independent, separate meta-analyses of sensitivity and specificity across the synthesized studies.

We emphasize once more that the studies in **Table 6** are heterogeneous with respect to the type of monitor, the channels recorded by these monitors and the definition of the respiratory events in the index and reference tests. However, we preferred to use all studies in the main analyses all studies, because estimates for subgroups were generally consistent (**Table 7**). The summary sensitivity was 90% (95% confidence interval: 83, 94%), and the summary specificity was 85% (95% confidence interval: 67, 94%) in bivariate meta-analyses. As shown in **Table 7**, the estimates were similar when we excluded studies for which we imputed the 2 by 2 table counts; when we excluded studies that received grade “C” for their methodological quality; and among studies in the home and the laboratory settings. Independent, separate meta-analyses tended to underestimate the corresponding results from bivariate meta-analyses.

Table 7. Meta-analysis of the ability of type III monitors (home setting or automated scoring) to predict OSAHS (i.e., AHI≥15 events/hour in facility-based PSG)

(Subgroup) summary	N (subjects)	Sensitivity (95% CI) [%]	Specificity (95% CI) [%]
<i>Bivariate meta-analysis</i>			
All studies ^a	14 (879)	90 (83, 94)	85 (67, 94)
Studies with 2by2 table counts available	9 (440)	89 (83, 94)	89 (72, 96)
A and B quality studies ^b	10 (678)	92 (86, 96)	82 (62, 93)
Studies in the home setting	4 (207)	92 (75, 98)	58 (46, 69)
Studies in the lab setting	10 (672)	89 (81, 94)	89 (73, 96)
<i>Separate meta-analyses</i>			
All studies ^a	14 (879)	75 (70, 79)	63 (56, 68)
Studies with 2by2 table counts available	9 (440)	70 (63, 76)	75 (66, 83)
A and B quality studies ^b	10 (678)	75 (69, 80)	60 (53, 66)
Studies in the home setting	4 (207)	84 (75, 90)	56 (45, 67)
Studies in the lab setting	10 (672)	72 (66, 77)	66 (58, 72)

CI: confidence interval

^a In five studies the counts in the 2by2 table were not reported, and they were calculated from the reported sensitivities and specificities, assuming a prevalence of 54% for AHI≥15 events/hour of sleep

^b In three studies the counts in the 2by2 table were not reported, and they were calculated from the reported sensitivities and specificities, assuming a prevalence of 54% for AHI≥15 events/hour of sleep

Estimates for older adults (70 years old)

- S_HomeDx=90% same as in younger adults.
- C_HomeDx=70% (vs 85% among 50 year olds).

We did not identify data on the sensitivity and specificity of portable monitors for the diagnosis of OSAHS (as operationally defined here) among older adults. Therefore, the corresponding estimates among older adults are based on assumptions.

As mentioned in the section on prevalence, the association of symptoms and signs suggestive of OSAHS is not strong among older adults. Moreover, conditions other than obstructive that may affect sleep quality are prevalent among older adults.

It is assumed that a detailed and comprehensive sleep study that evaluates neurophysiological and respiratory signals in the sleep laboratory can correctly identify OSAHS in elderly people.

A portable monitor records respiratory information and may result in false positive diagnoses among older adults, because it does not record neurophysiologic information needed to distinguish OSAHS from other conditions that affect sleep. For this reason we reduced the specificity of portable monitors to 70 percent for older adults. This is equivalent to assuming 15 percent additional false positives for portable monitors among older adults. The assumption is reasonable especially in the presence of “indication creep”, i.e. when a wider base of patients is being referred for sleep studies, rather than the typical enrollees in the published studies. However, there is no obvious reason that justifies a similar change in the sensitivity of portable monitors.

Proportion of technically inadequate tests for facility-based PSG (pFail_PSG1 and pFail_PSG2)

Estimates for middle-aged adults (50 years old)

- pFail_PSG1 and pFail_PSG2=4.6% in baseline analyses, ranging from 2.7% to 7.0% in sensitivity analyses (**Table 3**).

Our main estimates were derived from 19 studies that reported non-zero proportion of unsatisfactory (technically inadequate) examinations in facility-based PSG^{14,37,39,62-78} (**Table 3**; 4.6% [95% confidence interval: 2.7, 7.0%]). When we included 9 studies that reported 0 unsatisfactory tests,^{46,50,51,60,77,88,102-104} the corresponding estimate became 2.7% (95% confidence interval: 1.2, 4.8%; n=28 studies). However, studies that reported zero unsatisfactory examinations may have excluded any unsatisfactory examinations or repeated them without mentioning it in the text.

We assumed that the probability of technically inadequate testing is independent of OSAHS status, and that such failures are conditionally independent (i.e., a person who had a technically inadequate test the first time has the same probability for a technically inadequate test the second time he or she is tested).

It may be argued that the corresponding probability would be different (e.g., smaller) the second time an exam is repeated (because more emphasis would be given to avoid e.g., an error). However, because only a minority of patients ever undergo repeat sleep studies, assuming a different probability for technically inadequate repeat studies does not have a major effect in the assessed outcomes.

We should emphasize that this probability implicitly models the “first night” effect. The existence of a “first night effect” has been hypothesized because of the lack of familiarity with the sleep study procedures.^{105,106} It is postulated that sleep quality will improve once people become familiar with the sleep-study procedures. However, a first night effect was not documented in repeated home-based measurements in the Sleep Heart Health Study.¹⁰⁷

Estimates for older adults (70 years old)

We used the same probability as for middle-aged people. There are no indications that the rate of technically inadequate studies or data loss would be different for older people. For home monitoring this is supported from data from the Sleep Heart Health Study.⁶⁹ We assumed that the same would be true for facility-based PSG.

Proportion of technically inadequate split-night studies (pFail_SpNPSG1 and pFail_SpNPSG2)

Estimates for middle-aged adults (50 years old)

- pFail_SpNPSG1 and pFail_SpNPSG2=9.2% in baseline analyses, ranging from 2.7% to 14.0% in sensitivity analyses (**Table 3**).

A split-night study may be technically inadequate because the first half (diagnostic part) or the second half (CPAP level titration) is technically inadequate. In the absence of relevant data we assumed that each part of the split-night study has the same probability to be technically inadequate as a diagnostic facility-based PSG study. Therefore, this probability was set to be double of the probability for technically inadequate facility-based PSG studies. The range for the sensitivity analyses was accordingly augmented (from 2.7 percent to 14 percent).

It may be argued that the corresponding probability would be different (e.g., smaller) the second time an exam is repeated (because more emphasis would be given to avoid e.g., an error). However, because only a minority of patients ever undergo repeat sleep studies, assuming a different probability for technically inadequate repeat studies does not have a major effect in the assessed outcomes.

As commented in the previous section on the corresponding probability in facility-based PSG, this probability implicitly models the “first night” effect.

We assumed that this probability is independent of OSAHS status and to remain the same for people who have already had a technically inadequate study in the past (conditional independence).

Estimates for older adults (70 years old)

We used the same probability as for middle-aged people. There are no indications that the rate of technically inadequate studies would be different for older people. For home monitoring this is supported from data from the Sleep Heart Health Study.⁶⁹ We assumed that this would be true for split-night studies as well.

Proportion of technically inadequate tests for portable monitors in the home setting (pFail_HomeDx1 and pFail_HomeDx2)

Estimates for middle-aged adults (50 years old)

- pFail_HomeDx1 and pFail_HomeDx2=8.9% in baseline analyses, ranging from 6.6% to 12.0% in sensitivity analyses (**Table 3**).

There were 23 studies that reported non-zero proportion of unsatisfactory tests or clearly stated zero unsatisfactory tests for portable monitors in the home setting.^{37,39,47,48,50,52,55,60,62,65,66,69,73,78,87-94} 8.9% (95% confidence interval: 6.6, 12.0%). The largest study is a report from the Sleep Heart Health Study. Kapur 2000⁶⁹ examined factors associated with sensor loss using unattended home sleep monitoring with a type II device (Compumedics PS-2). Approximately 9 percent of 6802 people did not have a successful first sleep examination. Of these, approximately 4 percent (279/6802) had more than one attempt until a successful sleep study, and 5 percent (362/6802) had all attempts (in the majority the single attempt) unsuccessful.

Some portable home monitors have the ability to alert the evaluated person if a probe is not correctly or does not give a valid signal (e.g., Novasom QSG, as described in Reichert 2003⁵⁵). In the Reichert 2003 study 6 percent (3/51) of home recordings were lost secondary to chip malfunction. An additional 3 people (6 percent) did not use the machine at all. Therefore, our estimate is not incompatible with the rate of inconclusive examinations in the Reichert study.

It may be argued that the corresponding probability would be different (e.g., smaller) the second time an exam is repeated (because more emphasis would be given to avoid e.g., an error). However, because only a minority of patients ever undergo repeat sleep studies, assuming a different probability for technically inadequate repeat studies does not have a major effect in the assessed outcomes.

We assumed that this probability is independent of OSAHS status and to remain the same for people who have already had a technically inadequate study in the past (conditional independence).

Estimates for older adults (70 years old)

There are no indications that the rate of inconclusive studies or data loss would be different for older people, as found in a report of the Sleep Heart Health Study.⁶⁹ Therefore, the same probability was used for older adults (Medicare beneficiaries).

Probability of technically adequate CPAP titration study in facility-based PSG (pTitr_manCPAP1 and pTitr_manCPAP2)

Estimates for middle-aged adults (50 years old)

- pTitr_manCPAP1 and pTitr_manCPAP2=95.4% in baseline analyses, ranging from 93.0% to 97.3% in sensitivity analyses (**Table 3**).

The rate of technically inadequate CPAP titration studies in facility-based PSG was assumed to be equal to the rate of technically inadequate diagnostic PSG. The probability to have a technically adequate CPAP titration study (in full night therapeutic PSG) is 100% minus the probability of failure, or 95.4%.

The corresponding number was assumed to be independent of OSAHS status and to remain the same for people who have already had a technically inadequate study in the past (conditional independence).

Estimates for older adults (70 years old)

We used the same probabilities as in the baseline analyses.

Probability of technically adequate CPAP titration study in the home setting (pTitr_autoCPAP1 and pTitr_autoCPAP2)

Estimates for middle-aged adults (50 years old)

- pTitr_autoCPAP1 and pTitr_autoCPAP2=78% in baseline analyses, ranging from 50% to 100% in sensitivity analyses (**Table 3**).

Fletcher 2000⁹⁵ describes a prospective cohort of 63 people who were managed for suspected OSAHS without facility-based polysomnography. The cohort was offered

home monitoring and auto-titration of CPAP at home. Of the 45 people who were diagnosed with OSAHS (using a cutoff of RDI=10 events/hour in bed) 35 (78%) had completed their automated CPAP titration studies. This value was selected in the baseline analyses, but was subjected to wide sensitivity analyses (from 50% to 100%).

We assumed that this probability is independent of OSAHS status and to remain the same for people who have already had a technically inadequate study in the past (conditional independence).

Estimates for older adults (70 years old)

We used the same probabilities as in the baseline analyses.

Average waiting time for a sleep study in the lab setting

This is a very central quantity, in the modeling. Unfortunately, there are no detailed data on the average waiting time per sleep study in the lab setting. Furthermore, regional differences in average waiting times within the US are may also be large. Therefore, we provide results across a range of possible values.

The architecture of the modeling is such that the relative change in the average waiting time in the sleep labs across strategies *is the constant* (see below and **Appendix B**). The average waiting time for a sleep study in the lab in each strategy depends on the total number of facility-based sleep studies that expected to be performed in the strategy: it will be longer for the strategy with the most sleep studies in the lab setting.

As discussed below, we found data on the average waiting time for strategy 2.

Appendix B shows how one can adjust the corresponding average waiting time for strategies 3, 4 and 5. Briefly, one takes into account the expected workload of the sleep labs in strategies 3, 4 and 5 relatively to strategy 2, and adjusts the corresponding average waiting times.

Estimates of average waiting time in strategy 2 for middle-aged adults (50 years old)

The time delay from referral to a diagnostic facility-based PSG may be highly variable and may depend on each country's the health system, the relative workload of the sleep laboratories, the reimbursement policies, and the exact diagnosis.⁹⁶ In 2002 the population of the US was 280 million, the total number of sleep labs was 1,292, and the estimated annual rate of sleep tests performed was 1.17 million for the whole country (or 427 per 100,000 people per year).⁹⁶

Flemons 2004 reports that, on average, the waiting time from referral to CPAP initiation ranges widely from 2 to 10 months in the USA.⁹⁶ The authors comment that there is great variability across states and across urban or rural centers, and centers affiliated with universities versus centers that are not. Similarly long delays are described in Canada (and were the impetus for a recent RCT comparing home-based management with facility-based PSG¹⁰⁸).

Shariq 2004 on the other hand reports (in a letter¹⁰⁹) that the average waiting time across approximately 350 out of 2,515 accredited and non-accredited sleep labs was "between 2 and 3" weeks.¹⁰⁹ It is unclear whether the average waiting times are similar across the more than 2,000 remaining sleep labs, or whether this estimate is robust to the many systematic errors that a survey study may have. Contrary to the Flemons 2004 paper, Shariq 2004 does not give important methodological details on sampling, survey

questions and other important aspects, and does not discuss potential systematic errors and their impact. Therefore, the main analyses used estimates from the Flemons 2004 paper.

For the main analyses we used the following rationale to obtain the average waiting time for a single sleep study:

1. The average time from referral to CPAP initiation is 26 weeks (half a year, i.e., the midpoint between 2 and 10 months).
2. In the Flemons 2004 paper, most participating US centers used facility-based PSG to diagnose OSAHS and a second session to titrate CPAP level. Assuming equally long average delay to diagnose OSAHS and to titrate CPAP level for those with positive diagnoses, the mean delay for each session in the sleep lab would be 13 weeks.
3. Because average time delay for a sleep study varies in different settings, we present estimates across a wide range, from 4 weeks to 26 weeks for a single sleep study (corresponding to the range of the average delays from referral to CPAP initiation reported in the Flemons 2004 article⁹⁶).

The corresponding estimates for strategies 3, 4 and 5 are derived based on the strategy 2 estimates as described in **Appendix B**.

Estimates for older adults (70 years old)

We used the same probabilities as in the baseline analyses, following the adjustments described in **Appendix B**.

Average waiting time for a sleep study in the home setting

Contrary to the average waiting time in the sleep lab setting, we assumed that the average waiting time for a sleep study in the home setting is independent of the total volume of sleep studies in the home setting.

Estimates for middle-aged adults (50 years old)

In the absence of relevant data, we assumed that the time delay for a home-based study (either diagnosis or CPAP titration) would be only 2 weeks. This is reasonable for a health system that has purchased enough sleep monitors to cover its needs (i.e., a health system that has reached a “steady-state” in terms of acquiring necessary equipment), and factors in the time needed to read the exams and delays secondary to bureaucratic processes.

We varied the corresponding average delay from 0 to 5 weeks (i.e., longer than the shortest mean delay for sleep studies in the lab).

Estimates for older adults (70 years old)

We used the same probabilities as in the baseline analyses.

Proportion of people who do not show up for the first scheduled full night or split-night PSG session

The main analyses assume that all people will show up for a sleep study in the lab setting (i.e., for a full night or a split-night PSG study). However, secondary to reviewer comments, we performed sensitivity analyses assuming that up to 25% of people scheduled for their first sleep lab session will not appear. We assumed that these patients will not go on to the downstream health states of the pertinent health strategy.

This applies to strategy 2 (all diagnoses are performed with facility based PSG), strategy 3 (all diagnoses are performed with split-night PSG) and strategy 5 (where people with negative home monitoring diagnoses are invited for split night PSG studies). We did not perform these sensitivity analyses for strategy 4 (people with positive home diagnoses are further verified with split-night studies). This is because people with a positive diagnosis in the home setting have an extra motive to verify their condition and start treatment if needed. Furthermore this sensitivity analysis is not applicable to strategy 1 (none is ever diagnosed or treated), strategy 6 (management outside the sleep lab) and strategy 7 (all on CPAP).

As per reviewers' suggestions we did not perform the corresponding sensitivity analyses for a "no show" for portable monitor studies.

Outcomes

The following outcomes were considered:

1. Proportion of people who are offered CPAP (i.e., essentially those with positive diagnoses)
 - a. Among all participants in the whole cohort
 - b. Among people with OSAHS (see "Terminology and Definitions" on the definition of OSAHS and related discussion)
 - c. Among people without OSAHS
2. Mean time until diagnosis.
 - a. Among all participants in the whole cohort
 - b. Among people with OSAHS
 - c. Among people without OSAHS

This outcome is meaningful only among strategies 2 to 5, where tests to diagnose OSAHS are used.

3. Mean time until successful CPAP titration among people with a *true positive* diagnosis of OSAHS (in their last sleep study)

Time to successful CPAP titration is not a meaningful outcome to evaluate in strategy 1 (none is ever tested or offered a CPAP titration study) and strategy 6 (all are offered a CPAP titration study).

Moreover, it is not meaningful to evaluate among people who received a negative diagnosis for OSAHS in their (last) diagnostic study, as they would never be offered a CPAP titration study in the modeled strategies.

Finally, people who have received a *false positive* diagnosis of OSAHS the corresponding time would be the average time to a (final) *technically adequate* CPAP titration study. This would have exactly the same length as the average time to successful CPAP titration among people with a true positive diagnosis of OSAHS.

Calculation of time to diagnosis and time to technically adequate CPAP titration study

To calculate the outcomes of time to diagnosis and time to CPAP titration we counted the total number of expected sleep studies in each strategy and multiplied with the (strategy-specific) average time-delay for a sleep study (in the lab or at home – see previous section for estimates).

Sensitivity analyses

Main analyses use the baseline values of the transition probabilities. The robustness of the baseline results was assessed with univariate sensitivity analyses. In these explorations, the value of each transition probability is changed to cover the whole range of probable values that are prespecified in **Table 3**, while keeping all other variables at baseline.

We performed one-way sensitivity analyses for the scenario that focused on middle-aged adults. The range of values used in the sensitivity analyses adequately covers plausible values for the alternative scenario that focuses on older people.

Sensitivity analyses were run for all outcomes. However, for parsimony, we present in detail only the most influential variables for outcome 1a, outcome 2a and outcome 3, which are the clinically more relevant outcomes.

During sensitivity analyses, the ranking of the different strategies with respect to the aforementioned outcomes may change. Typically, the threshold where such changes occur is described. However, in this case we are not evaluating utilities and costs, but several quite distinct outcomes. Therefore the interpretation of the thresholds at which the ranking of the various strategies changes is not straightforward. For this reason we decided not to report exact thresholds, but to describe them qualitatively.

We also performed two-way sensitivity analyses, by simultaneously varying pairs of variables over the whole range of prespecified probable values, while keeping all other probabilities at baseline. This was done for pairs of variables that had the most influence in one-way sensitivity analyses. Because their results do not add substantially to the interpretation of the simulations, they are not reported in detail.

Simulation results

We simulated hypothetical cohorts of 100,000 people suspected of OSAHS. The baseline analyses focused on middle-aged-people (i.e., people aged 50 years old) who are referred for sleep studies. As discussed in the methods, the majority of the literature pertains to middle-aged people. Because Medicare beneficiaries are of interest, we also present results for a different hypothetical cohort, composed of 70 year olds. In the sections below we discuss the simulation results and present sensitivity analyses.

The assumptions behind the modeled strategies and the probabilities that are being used, as well as details on definitions of the various health states are presented in the methods section in detail.

Proportion of people who are offered CPAP

Here we describe the proportion of people who have completed a *technically adequate* CPAP level titration study. Essentially, these are people with a positive OSAHS diagnosis.

Baseline analyses

Table 8 depicts the results of the simulations for the baseline analyses. The two reference strategies where none or all of the participants are offered CPAP treatment will not be discussed further, and they are included for comparison.

Most people (62 percent of the whole cohort) will be offered CPAP in strategy 5 (home diagnosis, and split-night PSG for negative home tests). In this strategy 99 percent of people with OSAHS and 20 percent of people without OSAHS will be offered CPAP.

The most false negatives, 19 percent, are expected with Strategy 4 (home testing, and further verification of positive cases with split-night studies in the lab). The proportion of people who will be offered CPAP without having OSAHS is low in this strategy (“false positives”, 1 percent), because two tests are applied serially.

Management completely outside of the sleep lab would result in 56 percent of the whole cohort being offered CPAP (91 percent of people with OSAHS and 15 percent of people without the disease). If split-night PSG (strategy 3) is used, it is expected that 89 percent of people with- and 6 percent of those without OSAHS will be offered CPAP.

Table 8. Baseline analyses: Proportion offered CPAP in a hypothetical cohort of 100,000 middle-aged people suspected of OSAHS

Strategy (for diagnosis and CPAP level titration)	Number (%)		
	Whole cohort	Among those with OSAHS	Among those without OSAHS
1. None started on CPAP	0 (0)	0 (0)	0 (0)
2. Full night PSG, treatment PSG	54,000 (54)	54,000 (100)	0 (0)
3. Split-night PSG	50,881 (51)	48,101 (89)	2,780 (6)
4. Home diagnosis, split-night PSG to verify positive cases	44,118 (44)	43,704 (81)	414 (1)
5. Home diagnosis, split-night PSG in all negative cases	62,703 (62)	53,462 (99)	9,241 (20)
6. Home diagnosis, home CPAP titration	56,035 (56)	49,140 (91)	6,895 (15)
7. All started on CPAP	100,000 (100)	54,000 (100)	46,000 (100)

CPAP: continuous positive airway pressure; OSAHS: Obstructive sleep apnea-hypopnea syndrome (see methods for definition).

Analyses for older adults

Table 9 shows the corresponding estimations among people who are older (70 years of age). As discussed in the Methods section, we assumed that the prevalence of OSAHS is 27 percent of older adults who are being referred for evaluation. This is because of the increased prevalence of other conditions that must be differentiated from OSAHS, and because of the relative dissociation of OSAHS with characteristic symptoms and signs among older adults (see Methods section for rationale on this assumption). Among older adults, we also expect the specificity of home diagnosis to be compromised (it can be argued that only a detailed PSG study in a specialized facility can differentiate between conditions that mimic OSAHS – see Methods section).

Table 9. Baseline analyses: Proportion offered CPAP in a hypothetical cohort of 100,000 older adults suspected of OSAHS

Strategy (for diagnosis and CPAP level titration)	Number (%)		
	Whole cohort	Among those with OSAHS	Among those without OSAHS
1. None started on CPAP	0 (0)	0 (0)	0 (0)
2. Full night PSG, treatment PSG	27,000 (27)	27,000 (100)	0 (0)
3. Split-night PSG	28,462 (28)	24,050 (89)	4,412 (6)
4. Home diagnosis, split-night PSG to verify positive cases	23,165 (23)	21,852 (81)	1,313 (2)
5. Home diagnosis, split-night PSG in all negative cases	51,682 (51)	26,731 (99)	24,951 (34)
6. Home diagnosis, home CPAP titration	46,455 (46)	24,570 (91)	21,885 (30)
7. All started on CPAP	100,000 (100)	27,000 (100)	73,000 (100)

CPAP: continuous positive airway pressure; OSAHS: Obstructive sleep apnea-hypopnea syndrome (see methods for definition). Older adults are Medicare beneficiaries aged 70 years old.

Letting strategies 1 and 7 aside, strategy 5 (home diagnosis, and split-night PSG for negative home tests) would result in most people offered CPAP (51 percent of the whole cohort; **Table 9**). Although only 1 percent of “false negatives” (people with OSAHS who are not offered CPAP) is expected in strategy 5, 34 percent of those without OSAHS would be offered CPAP (“false positives”).

Strategy 6 (management outside the sleep labs) would have 9% “false negatives” and approximately 30 percent “false positives”.

In contrast, strategies that incorporate facility-based PSG or split-night PSG have considerably lower rates of false positive diagnoses. Twenty-seven, 28 and 23 percent of people will be offered CPAP treatment when facility-based PSG, split-night PSG or a verification of positive home diagnosis with split-night PSG is used (strategies 2, 3 and 4, respectively).

Sensitivity analyses

We conducted wide range sensitivity analyses to assess the robustness of the findings. Here, we present the results of univariate analyses for those variables that had some influence on the proportion of people who will be offered CPAP, for any of the strategies.

Prevalence (prev)

Figure 6 shows the effects of varying prevalence. When people are managed with facility-based PSG the diagnosis is “optimal” (because its sensitivity and specificity are assumed to be 100% in the main analyses; strategy 2). Strategy 2 in **Figure 6** may serve as a reference for strategies which use split-night PSG only (strategy 3), a combination of portable monitoring and split-night PSG (strategies 4 and 5), and portable monitoring (strategy 6), respectively.

In the sensitivity analyses, in strategy 5 (home diagnosis, and split-night PSG for negative home tests) the proportion of people who are offered CPAP is always higher than that of strategy 2 (because of the increased number of false positives). Furthermore, as the true prevalence becomes less than approximately 60 percent, more people will be offered CPAP in strategy 5 compared to strategy 2. This is because of the increasing number of false positive diagnoses of OSAHS. In strategy 4, all positive diagnoses with portable home monitors are further verified by split-night PSG studies. The number of false positive diagnoses remains low, and the proportion of people starting on CPAP is consistently lower than that of strategies 2, 3, 5 and 6.

Figure 6. Sensitivity analysis on prevalence: proportion of people who are offered CPAP in a hypothetical cohort of 100,000 participants

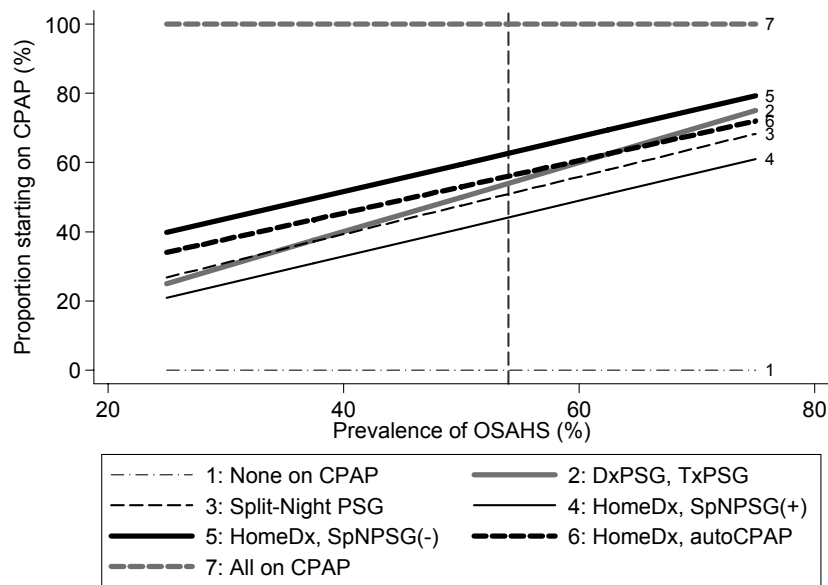

Key: (auto)CPAP: (automated) Continuous positive airway pressure titration; DxPSG: diagnostic polysomnography in the sleep laboratory; HomeDx: home diagnosis; OSAHS: obstructive sleep apnea-hypopnea syndrome; PSG: polysomnography; SpNPSG: split-night polysomnography; TxPSG: titration of CPAP levels in the sleep laboratory.

The number on the right hand side of each line in the graph corresponds to the number of the modeled strategy (see text). The vertical dashed line shows the prevalence that was used in the baseline analyses.

Probability of no showing up for the first diagnostic PSG or the first split night PSG (pNoShow_PSG and pNoShow_SpNPSG)

Figure 7 illustrates the corresponding sensitivity analyses. As the number of people who do not show up for the first lab exam increases, the proportion of people started on CPAP drops in strategies 2, 3 and 5. Strategy 5 is least affected, because only those with negative home testing are referred to the lab for further diagnostic evaluation.

Figure 7. Sensitivity analysis on the probability of no showing up for a study in the lab: proportion of people who are offered CPAP in a hypothetical cohort of 100,000 participants

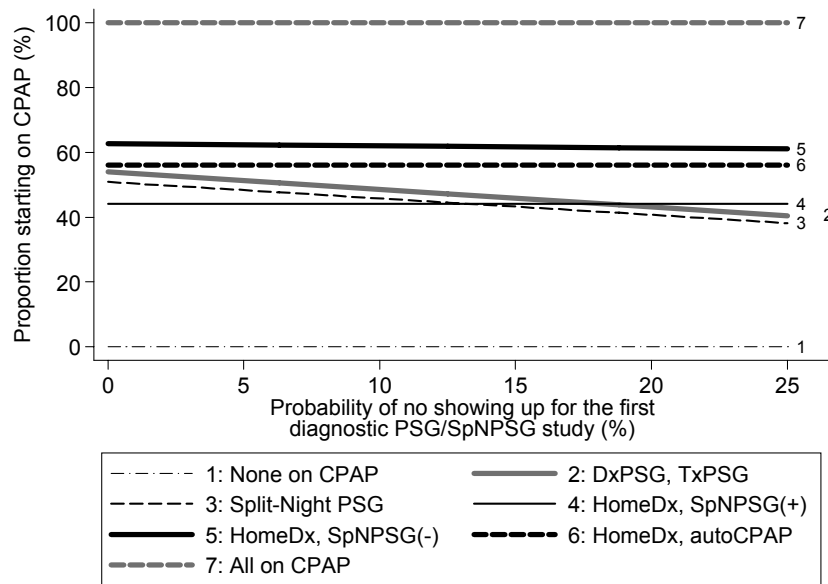

Key: (auto)CPAP: (automated) Continuous positive airway pressure titration; DxPSG: diagnostic polysomnography in the sleep laboratory; HomeDx: home diagnosis; OSAHS: obstructive sleep apnea-hypopnea syndrome; PSG: polysomnography; SpNPSG: split-night polysomnography; TxPSG: titration of CPAP levels in the sleep laboratory.

The number on the right hand side of each line in the graph corresponds to the number of the modeled strategy (see text). The vertical dashed line shows the prevalence that was used in the baseline analyses.

Sensitivity of facility-based polysomnography (S_PSG)

Figure 8 illustrates the effects of varying sensitivity of facility-based PSG. This analysis affects only strategy 2 (management with facility-based PSG and titration of CPAP levels in the sleep lab in a different night).

Figure 8. Sensitivity analysis on the sensitivity of facility-based PSG to detect OSAHS: proportion of people offered CPAP in a hypothetical cohort of 100,000 participants

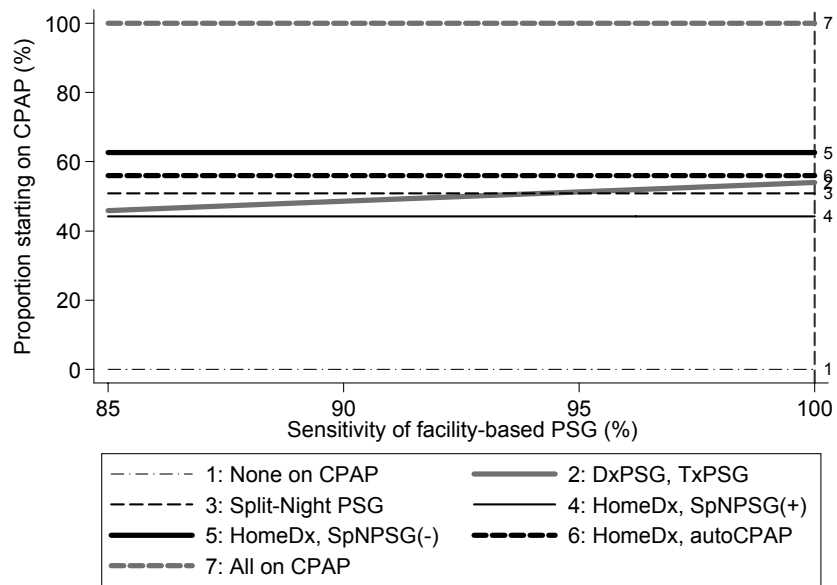

Key: (auto)CPAP: (automated) Continuous positive airway pressure titration; DxPSG: diagnostic polysomnography in the sleep laboratory; HomeDx: home diagnosis; OSAHS: obstructive sleep apnea-hypopnea syndrome; PSG: polysomnography; SpNPSG: split-night polysomnography; TxPSG: titration of CPAP levels in the sleep laboratory.

The number on the right hand side of each line in the graph corresponds to the number of the modeled strategy (see text). The vertical dashed line shows the prevalence that was used in the baseline analyses.

Specificity of facility-based polysomnography (C_PSG)

Figure 9 illustrates the effects of varying specificity of facility-based PSG. This analysis affects only strategy 2 (management with facility-based PSG and titration of CPAP levels in the sleep lab in a different night).

Figure 9. Sensitivity analysis on the specificity of facility-based PSG to detect OSAHS: proportion of people offered CPAP in a hypothetical cohort of 100,000 participants

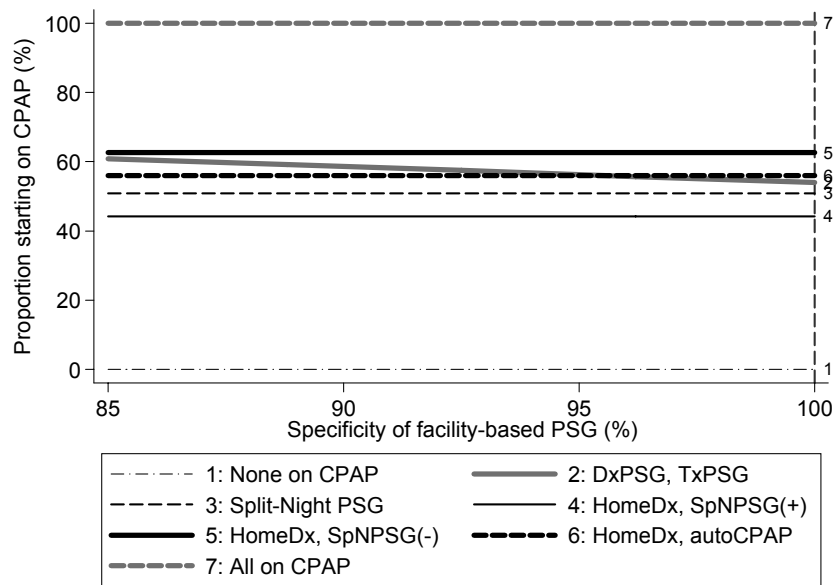

Key: (auto)CPAP: (automated) Continuous positive airway pressure titration; DxPSG: diagnostic polysomnography in the sleep laboratory; HomeDx: home diagnosis; OSAHS: obstructive sleep apnea-hypopnea syndrome; PSG: polysomnography; SpNPSG: split-night polysomnography; TxPSG: titration of CPAP levels in the sleep laboratory.

The number on the right hand side of each line in the graph corresponds to the number of the modeled strategy (see text). The vertical dashed line shows the prevalence that was used in the baseline analyses.

Sensitivity of split-night polysomnography (S_SpNPSG)

Figure 10 illustrates the effects of varying sensitivity for split-night PSG. This variable affects only strategies 3, 4 and 5, where split-night studies are used (alone or in combination with portable monitors). In these three strategies, the proportion of people who are offered CPAP changes by less than 10 percent along the range of values assumed in the sensitivity analysis (increases with increasing sensitivity values). Strategy 5 is the least affected of the three.

Figure 10. Sensitivity analysis on the sensitivity of split-night studies to detect OSAHS: proportion of people offered CPAP in a hypothetical cohort of 100,000 participants

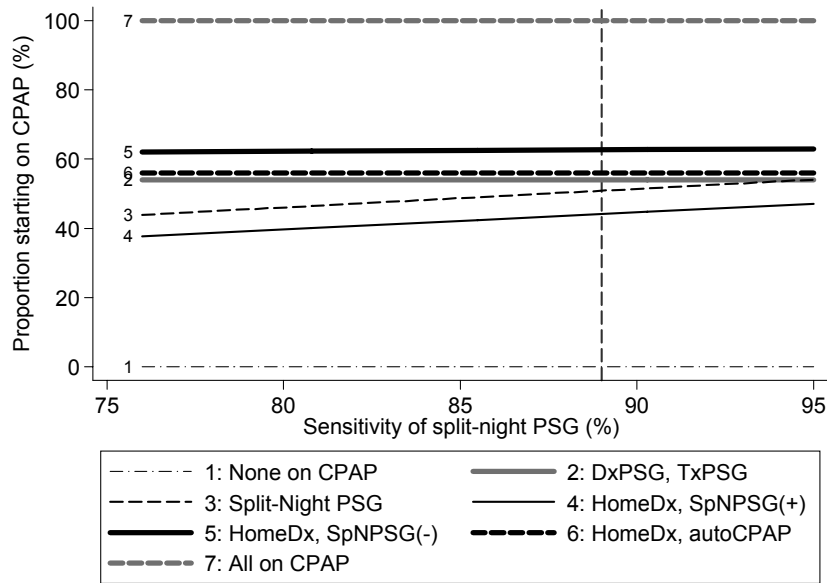

Key: (auto)CPAP: (automated) Continuous positive airway pressure titration; DxPSG: diagnostic polysomnography in the sleep laboratory; HomeDx: home diagnosis; OSAHS: obstructive sleep apnea-hypopnea syndrome; PSG: polysomnography; SpNPSG: split-night polysomnography; TxPSG: titration of CPAP levels in the sleep laboratory.

The number on the left hand side of each line in the graph corresponds to the number of the modeled strategy (see text). The vertical dashed line shows the prevalence that was used in the baseline analyses.

Specificity of split-night polysomnography (C_SpNPSG)

Figure 11 illustrates the effects of varying specificity for split-night PSG. This variable affects only strategies 3, 4 and 5 (where split-night studies are used, alone or in combination with portable monitors, respectively). When the specificity of split-night studies decreases, the proportion of false positive diagnoses increases. As a consequence, the proportion of people who are offered CPAP becomes larger.

Note that strategy 4 is least affected in this sensitivity analysis, and that strategies 3 and 5 are most affected. This is because in strategy 4 the number of “false positives” is tightly controlled (through the serial verification of a positive diagnosis with two tests).

Figure 11. Sensitivity analysis on the specificity of split-night studies to detect OSAHS: proportion of people offered CPAP in a hypothetical cohort of 100,000 participants

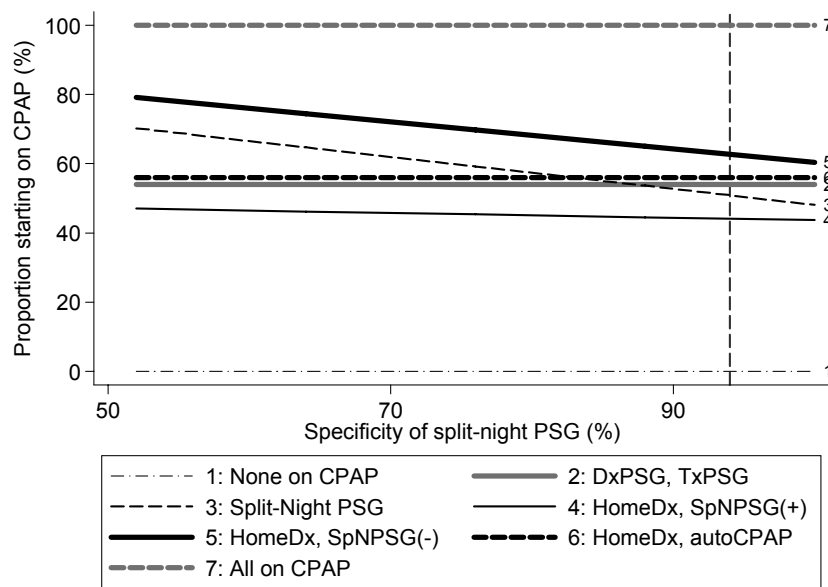

Key: (auto)CPAP: (automated) Continuous positive airway pressure titration; DxPSG: diagnostic polysomnography in the sleep laboratory; HomeDx: home diagnosis; OSAHS: obstructive sleep apnea-hypopnea syndrome; PSG: polysomnography; SpNPSG: split-night polysomnography; TxPSG: titration of CPAP levels in the sleep laboratory.

The number on the right hand side of each line in the graph corresponds to the number of the modeled strategy (see text). The vertical dashed line shows the prevalence that was used in the baseline analyses.

Sensitivity of portable home monitors (S_HomeDx)

Figure 12 illustrates the effects of varying sensitivity of portable monitors. This variable affects only strategies 4, 5, and 6 where portable home monitoring is used. Overall, the proportion of people offered CPAP changes by less than 10 percent along the range of values in the sensitivity analysis.

Figure 12. Sensitivity analysis on the sensitivity of portable monitors to detect OSAHS: proportion of people offered CPAP in a hypothetical cohort of 100,000 participants

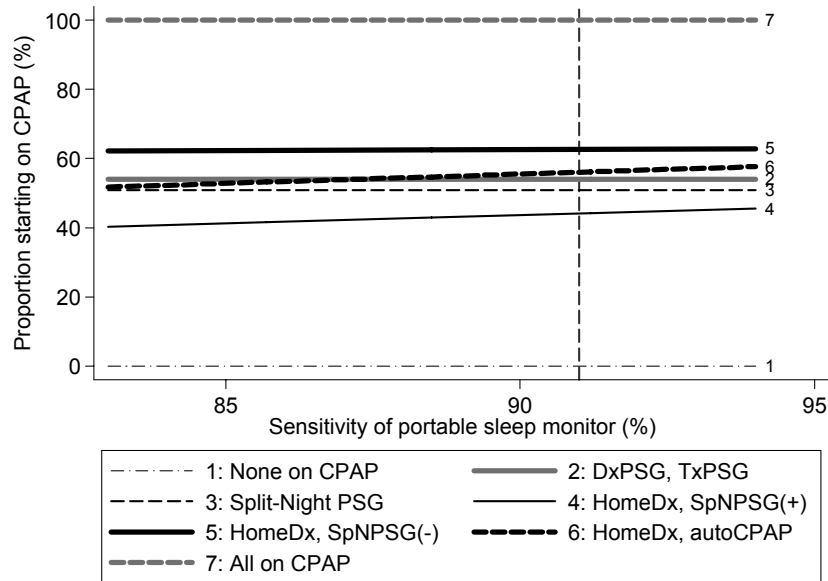

Key: (auto)CPAP: (automated) Continuous positive airway pressure titration; DxPSG: diagnostic polysomnography in the sleep laboratory; HomeDx: home diagnosis; OSAHS: obstructive sleep apnea-hypopnea syndrome; PSG: polysomnography; SpNPSG: split-night polysomnography; TxPSG: titration of CPAP levels in the sleep laboratory.

The number on the right hand side of each line in the graph corresponds to the number of the modeled strategy (see text). The vertical dashed line shows the prevalence that was used in the baseline analyses.

Specificity of portable home monitors (C_HomeDx)

Figure 13 illustrates the effects of varying specificity for the portable monitors. This variable affects only strategies 4, 5 and 6 where portable home monitoring is used. When the specificity of the portable monitors decreases, the proportion of false positive diagnoses increases. As a consequence, the proportion of people who are offered CPAP becomes larger.

Note that strategies 5 and 6 are most affected in this sensitivity analysis. Strategy 4 applies an additional test (split-night studies) to people who have positive home monitoring results, and this reduces the number of false positive diagnoses.

Figure 13. Sensitivity analysis on the specificity of portable monitors to detect OSAHS: proportion of people offered CPAP in a hypothetical cohort of 100,000 participants

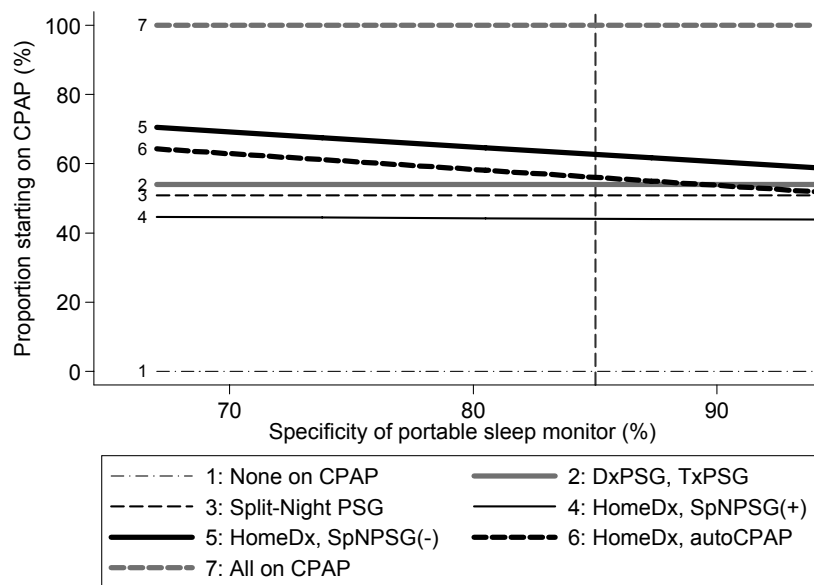

Key: (auto)CPAP: (automated) Continuous positive airway pressure titration; DxPSG: diagnostic polysomnography in the sleep laboratory; HomeDx: home diagnosis; OSAHS: obstructive sleep apnea-hypopnea syndrome; PSG: polysomnography; SpNPSG: split-night polysomnography; TxPSG: titration of CPAP levels in the sleep laboratory.

The number on the left hand side of each line in the graph corresponds to the number of the modeled strategy (see text). The vertical dashed line shows the prevalence that was used in the baseline analyses.

Other variables

Sensitivity analyses of the remaining variables had little impact on this outcome.

Overview of univariate sensitivity analyses

Figure 14 provides an overview of the univariate sensitivity analyses. The figure summarizes the four variables that have the most profound effect on the corresponding strategies in the univariate sensitivity analyses. All other variables have even smaller influence.

Figure 14. Summary (“tornado” graph) of the variables with the greatest impact on the proportion of people offered CPAP per strategy in the univariate sensitivity analyses.

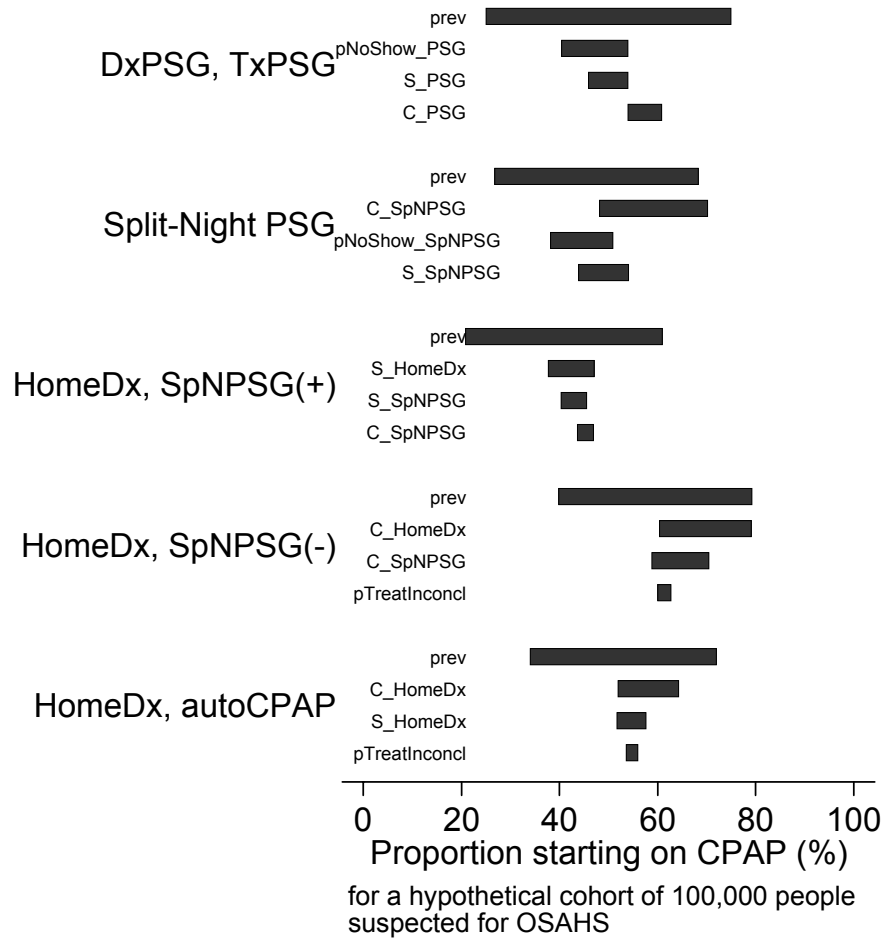

Key: (auto)CPAP: (automated) continuous positive airway pressure titration; C_[PSG|SpNPSG|HomeDx]: specificity of [PSG|SpNPSG|HomeDx]; DxPSG: diagnostic polysomnography in the sleep laboratory; HomeDx: home diagnosis; OSAHS: obstructive sleep apnea-hypopnea syndrome; pNoShow_[PSG|SpNPSG]: probability of no showing up for the first diagnostic PSG or the first split-night PSG study]; prev: prevalence; PSG: polysomnography; pTreatInconcl: probability to start on CPAP if pressure level titration is technically inadequate, but a positive diagnosis of OSAHS exists; S_[PSG|SpNPSG|HomeDx]: sensitivity of [PSG|SpNPSG|HomeDx]; SpNPSG: split-night polysomnography; TxPSG: titration of CPAP levels in the sleep laboratory. The “all on CPAP” and “none on CPAP” strategies (1 and 7, respectively) are not shown, because they are not affected by the sensitivity analyses.

The length of each bar represents the change in the outcome for each strategy, when the corresponding variable is varied throughout its whole range in the univariate sensitivity analyses. Only the four more influential variables are shown for each strategy. Because variables are ordered by diminishing influence in each strategy, the image resembles a small tornado, hence the name “tornado” graph.

Time to diagnosis with a sleep study

Baseline analyses

Table 10 shows the average time to (final) diagnosis of OSAHS with a sleep study. The average time to diagnosis is the same, irrespective of whether this is positive or negative, accurate or inaccurate. Participants in the two extreme strategies (strategy 1 – “all on CPAP” and strategy 7 – “None on CPAP”) do not receive any testing for OSAHS throughout the whole follow-up period – therefore this outcome is not meaningful to assess here.

Home diagnosis with portable monitors results in the fastest diagnosis (after approximately 2 weeks on average). The average time to diagnosis increases for strategies that rely more heavily on the sleep labs for the management of these patients, and ranges from approximately 14 weeks in strategy 2 to approximately 4 weeks in strategy 5.

Table 10. Baseline analyses: time to (final) diagnosis of OSAHS with a sleep study in a hypothetical cohort of 100,000 middle-aged people suspected of OSAHS

Strategy (for diagnosis and CPAP titration)	Time (Weeks)		
	Whole cohort	Among those with OSAHS	Among those without OSAHS
1. None started on CPAP	NA ^a	NA ^a	NA ^a
2. Full night PSG, treatment PSG	13.6	13.6	13.6
3. Split-night PSG	9.8	9.8	9.8
4. Home diagnosis, split-night PSG to verify positive cases	4.8	4.8	4.8
5. Home diagnosis, split-night PSG in all negative cases	3.8	3.8	3.8
6. Home diagnosis, home CPAP titration	2.1	2.1	2.1
7. All started on CPAP	NA ^a	NA ^a	NA ^a

CPAP: continuous positive airway pressure; NA: not applicable; OSAHS: Obstructive sleep apnea-hypopnea syndrome (see methods for definition).

^a No diagnostic assessment is performed in these strategies

Analyses for older adults

Table 11 shows the corresponding analyses among older adults (Medicare beneficiaries, aged 70 years). The results are very similar to findings among middle-aged people. The small differences with the average times shown in the previous analysis are attributable to adjustments in the average waiting time for a sleep study in the lab setting secondary to changes in the total workload of the sleep labs in each strategy.

It is interesting to note that strategy 5 (screen with portable monitors and further evaluation of all negative diagnoses in the sleep labs) is expected to result in slightly longer average time to diagnosis compared to strategy 4 (screen with portable monitors and verification of all positive diagnoses in the sleep labs), i.e., 4.4 weeks versus 4.1 weeks, respectively. The ranking of these strategies was the opposite among younger people (3.8 weeks for strategy 5 and 4.8 weeks for strategy 4; **Table 10**). This is because the prevalence of OSAHS is assumed smaller among older adults, increasing the number of negative home diagnoses and the workload of the sleep labs in strategy 5.

Table 11. Baseline analyses: time to (final) diagnosis of OSAHS with a sleep study in a hypothetical cohort of 100,000 older adults suspected of OSAHS

Strategy (for diagnosis and CPAP titration)	Time (Weeks)		
	Whole cohort	Among those with OSAHS	Among those without OSAHS
1. None started on CPAP	NA ^a	NA ^a	NA ^a
2. Full night PSG, treatment PSG	11.3	11.3	11.3
3. Split-night PSG	9.8	9.8	9.8
4. Home diagnosis, split-night PSG to verify positive cases	4.0	4.0	4.0
5. Home diagnosis, split-night PSG in all negative cases	4.5	4.5	4.5
6. Home diagnosis, home CPAP titration	2.1	2.1	2.1
7. All started on CPAP	NA ^a	NA ^a	NA ^a

CPAP: continuous positive airway pressure; NA: not applicable; OSAHS: Obstructive sleep apnea-hypopnea syndrome (see methods for definition). Older adults are Medicare beneficiaries aged 70 years old.

^a No diagnostic assessment is performed in these strategies

Sensitivity analyses

We conducted wide range sensitivity analyses to assess the robustness of the findings. Here, we present the results of univariate analyses for the variable that had some influence on the time until first diagnosis, for any of the strategies.

Average waiting time per sleep study in the sleep laboratories (Dt_Lab)

The single most influential variable for this outcome is the length of the queue in the sleep labs. **Figure 15** illustrates its effects.

Note that the mean waiting times for strategies 3 and 4 are calculated from those in strategy 2 based on the expected total number of sleep studies in the sleep labs with each strategy. See **Appendix B** for a discussion on how this calculation is performed. Strategies 1 and 7 are omitted from the figure.

Average waiting time per sleep study in the home setting (Dt_Home)

Figure 16 illustrates the effects of varying waiting times for studies in the home setting. Increasing waiting times in the home setting blunts differences across the compared strategies. When the waiting time is 5 weeks, strategies 4,5 and 6 have similar estimated time to diagnosis.

Strategies 1 and 7 are omitted from the figure because they are not meaningful. Strategies 2 and 3 are not affected by this variable with respect to this outcome.

Figure 15. Sensitivity analysis on the average waiting time per sleep study in sleep laboratories: time to final diagnosis in a hypothetical cohort of 100,000 participants

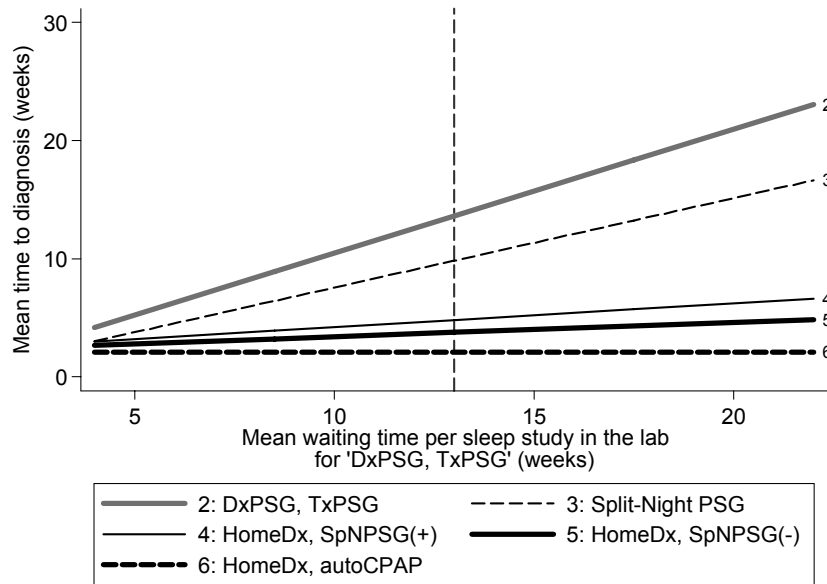

Key: (auto)CPAP: (automated) Continuous positive airway pressure titration; DxPSG: diagnostic polysomnography in the sleep laboratory; HomeDx: home diagnosis; OSAHS: obstructive sleep apnea-hypopnea syndrome; PSG: polysomnography; SpNPSG: split-night polysomnography; TxPSG: titration of CPAP levels in the sleep laboratory.

The “all on CPAP” and “none on CPAP” strategies (1 and 7, respectively) are not shown, because they are not affected by the sensitivity analyses. The number on the right hand side of each line in the graph corresponds to the number of the modeled strategy (see text). The vertical dashed line shows the prevalence that was used in the baseline analyses.

The average waiting time for a sleep study in the lab in strategies 3, 4, and 5 is expected to be 68 percent, 36 percent and 27 percent, of the waiting time in strategy 2.

Figure 16. Sensitivity analysis on the average waiting time per sleep study in the home setting: time to final diagnosis in a hypothetical cohort of 100,000 participants

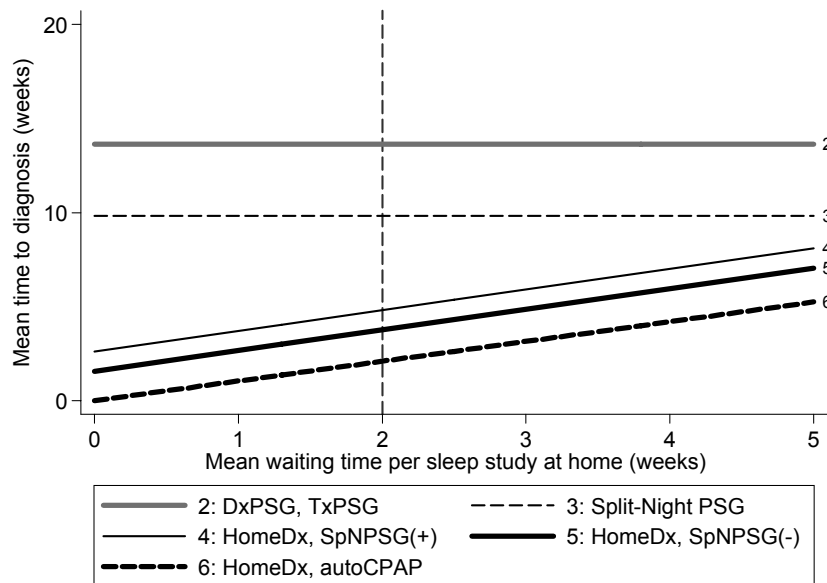

Key: (auto)CPAP: (automated) Continuous positive airway pressure titration; DxPSG: diagnostic polysomnography in the sleep laboratory; HomeDx: home diagnosis; OSAHS: obstructive sleep apnea-hypopnea syndrome; PSG: polysomnography; SpNPSG: split-night polysomnography; TxPSG: titration of CPAP levels in the sleep laboratory.

The “all on CPAP” and “none on CPAP” strategies (1 and 7, respectively) are not shown, because they are not affected by the sensitivity analyses. The number on the right hand side of each line in the graph corresponds to the number of the modeled strategy (see text). The vertical dashed line shows the prevalence that was used in the baseline analyses.

Prevalence (prev)

Figure 17 describes the sensitivity analysis on the prevalence of the condition among referrals. Notably, the mean waiting time *decreases* with decreasing prevalence in strategy 2. This is because fewer CPAP titration sessions will be performed.

Note that in strategy 4 (screening at home with a portable monitor and then verify positive diagnoses in a split-night study in the lab) the mean time to final diagnosis increases with increasing prevalence. This is because the final diagnosis is set with the split-night study, and the more test positives, the greater the burden on sleep labs and the longer the waiting time for a split-night PSG.

Note that in strategy 5 (screening at home with a portable monitor and then verify negative diagnoses in a split-night study in the lab) the impact of decreasing prevalence is in the opposite direction compared to strategies 2 and 4. In strategy 5, as the prevalence of OSAHS decreases, the number of negative diagnoses with the portable monitors increases, and so does the total number of split-night PSG studies.

Figure 17. Sensitivity analysis on prevalence: time to final diagnosis in a hypothetical cohort of 100,000 participants

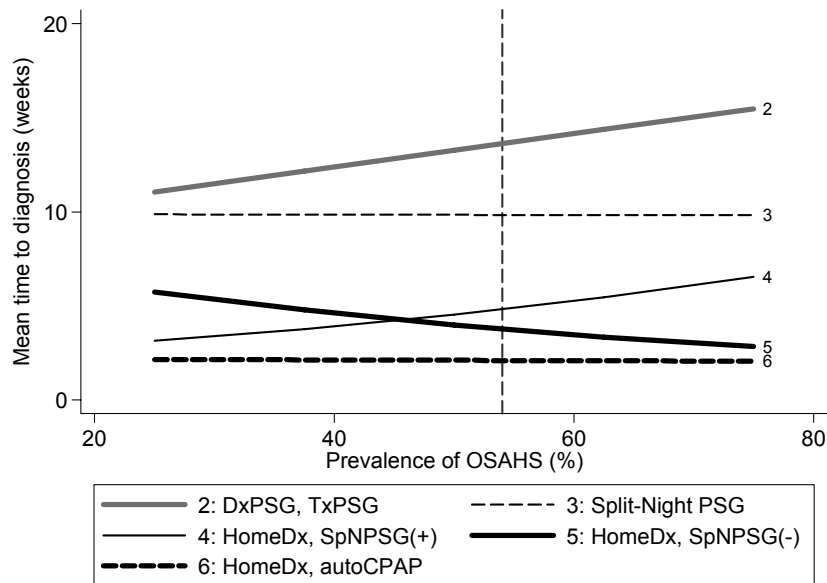

Key: (auto)CPAP: (automated) Continuous positive airway pressure titration; DxPSG: diagnostic polysomnography in the sleep laboratory; HomeDx: home diagnosis; OSAHS: obstructive sleep apnea-hypopnea syndrome; PSG: polysomnography; SpNPSG: split-night polysomnography; TxPSG: titration of CPAP levels in the sleep laboratory.

The “all on CPAP” and “none on CPAP” strategies (1 and 7, respectively) are not shown, because they are not affected by the sensitivity analyses. The number on the right hand side of each line in the graph

corresponds to the number of the modeled strategy (see text). The vertical dashed line shows the prevalence that was used in the baseline analyses.

Probability of not showing up for the first PSG or Split-night PSG study.

Figure 18 illustrates the corresponding sensitivity analyses. As the probability of no showing up increases, the time to diagnosis decreases in strategies 2 and 3 (because the workload of the sleep labs decreases).

Figure 18. Sensitivity analysis on the probability of not showing up for the first study if it is in the sleep lab: time to final diagnosis in a hypothetical cohort of 100,000 participants

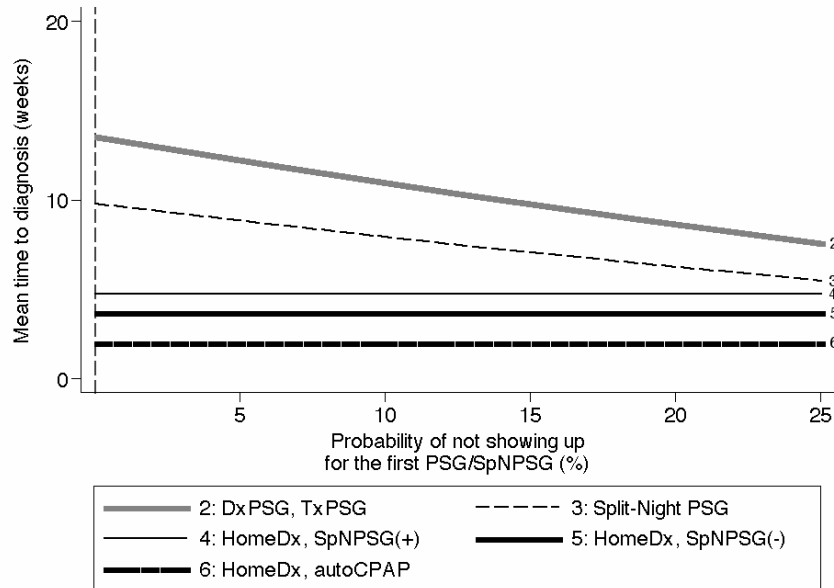

Key: (auto)CPAP: (automated) Continuous positive airway pressure titration; DxPSG: diagnostic polysomnography in the sleep laboratory; HomeDx: home diagnosis; OSAHS: obstructive sleep apnea-hypopnea syndrome; PSG: polysomnography; SpNPSG: split-night polysomnography; TxPSG: titration of CPAP levels in the sleep laboratory.

The “all on CPAP” and “none on CPAP” strategies (1 and 7, respectively) are not shown, because they are not affected by the sensitivity analyses. The number on the right hand side of each line in the graph corresponds to the number of the modeled strategy (see text). The vertical dashed line shows the prevalence that was used in the baseline analyses.

Other variables

The remaining variables had little impact on the different strategies with respect to this outcome in the prespecified sensitivity analyses. Therefore they are not discussed further. See also the next paragraph.

Overview of univariate sensitivity analyses

Figure 19 provides an overview of the univariate sensitivity analyses. The figure summarizes the two variables that have the most profound effect on time to diagnosis in the corresponding strategies in the sensitivity analyses. All other variables have even smaller influence and are not discussed further.

Figure 19. Summary (“tornado” graph) of the variables with the greatest impact on the average time to final diagnosis in the univariate sensitivity analyses.

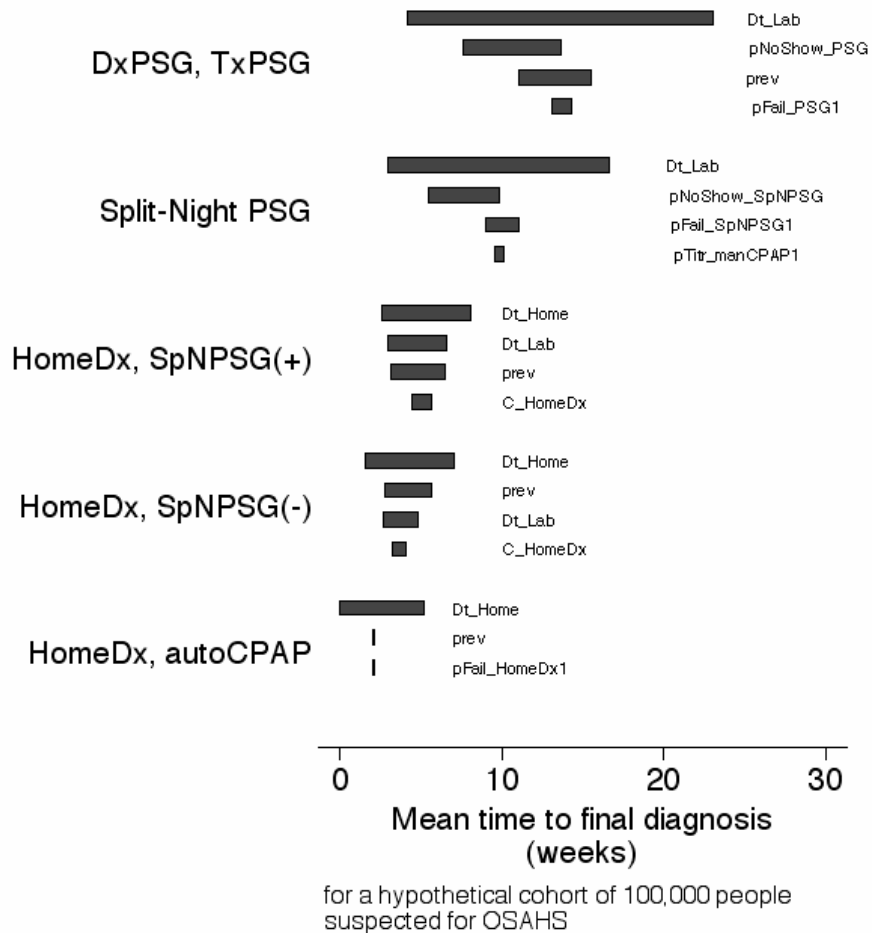

Key: (auto)CPAP: (automated) continuous positive airway pressure titration; C_HomeDx: Specificity of portable monitors; Dt_[Lab | Home]: Mean waiting time for a sleep study in the [lab | home] setting. DxPSG: diagnostic polysomnography in the sleep laboratory; HomeDx: home diagnosis; OSAHS: obstructive sleep apnea-hypopnea syndrome; pNoShow_[PSG | SpNPSG]: probability of no showing up for the first diagnostic PSG or the first SpNPSG study; pFail_PSG1: proportion of facility-based PSG that are unsuccessful; prev: prevalence; PSG: polysomnography; pTitr_manCPAP1: probability of technically adequate CPAP titration in the lab; SpNPSG: split-night polysomnography; TxPSG: titration of CPAP levels in the sleep laboratory. The “all on CPAP” and “none on CPAP” strategies (1 and 7, respectively) are not shown, because they are not affected by the sensitivity analyses.

The length of each bar represents the change in the outcome for each strategy, when the corresponding variable is varied throughout its whole range in the univariate sensitivity analyses. Only the four more influential variables are shown for each strategy (three for strategy 6, since no other variable had an effect). Because variables are ordered by diminishing influence in each strategy, the image resembles a small tornado, hence the name “tornado” graph.

Time to CPAP level titration among people with a diagnosis of OSAHS

As discussed in the methods section, this outcome is meaningful only among those who have received a diagnosis of OSAHS.

Main analyses

Table 12 shows the results of the main analyses, which pertain to a hypothetical cohort of 100,000 middle-aged people. In the two extreme strategies (strategy 1 – “all on CPAP” and strategy 7 – “None on CPAP”) the decision to proceed to CPAP treatment is completely determined; these are not meaningful to analyze further.

Among patients with a positive OSAHS diagnosis, the average time to CPAP titration is approximately 27 weeks when people are managed in the sleep lab at 2 different nights (strategy 2; **Table 12**). When people are managed with split-night studies the time to a technically adequate CPAP titration study is approximately 10 weeks (strategy 3). In strategies 4,5 and 6 the corresponding time interval is approximately 5 weeks.

Positive OSAHS diagnoses may be either false positive (i.e., person does not have OSAHS) or true positive (i.e., person truly has OSAHS). The time to a technically adequate CPAP titration study is the same for true and false positives. False positive diagnoses would probably not exhibit improvement in their AHI with CPAP treatment or would probably not tolerate the treatment as well; however, these subsequent events are not part of our analysis.

Table 12. Baseline analyses: time to CPAP in a hypothetical cohort of 100,000 middle-aged people suspected of OSAHS

Strategy (for diagnosis and CPAP titration)	Proportion offered CPAP (%)	Mean time to CPAP* (among those offered CPAP) [weeks]
1. None started on CPAP	0	NA ^a
2. Full night PSG, treatment PSG	54	27.3
3. Split-night PSG	51	9.8
4. Home diagnosis, split-night PSG to verify positive cases	44	5.0
5. Home diagnosis, split-night PSG in all negative cases	62	6.2
6. Home diagnosis, home CPAP titration	56	4.8
7. All started on CPAP	100	NA ^a

CPAP: continuous positive airway pressure; OSAHS: Obstructive sleep apnea-hypopnea syndrome (see methods for definition).

* “Time to CPAP” means time to a technically adequate CPAP titration study. The mean time is the same for people who have OSAHS and people who do not have OSAHS.

^a Not meaningful to assess

Analyses among older adults

Table 13 shows results for a hypothetical cohort of 100,000 70 year old people. Among people who received a positive diagnosis of OSAHS the time to a technically adequate CPAP titration study is similar to that calculated among middle-aged adults. The same caveats apply here as well.

Table 13. Baseline analyses: time to CPAP in a hypothetical cohort of 100,000 older adults suspected of OSAHS

Strategy (for diagnosis and CPAP titration)	Proportion offered CPAP (%)	Mean time to CPAP* (among those offered CPAP) [weeks]
1. None started on CPAP	0	NA ^a
2. Full night PSG, treatment PSG	27	22.5
3. Split-night PSG	28	9.9
4. Home diagnosis, split-night PSG to verify positive cases	23	3.9
5. Home diagnosis, split-night PSG in all negative cases	52	7.2
6. Home diagnosis, home CPAP titration	46	4.8
7. All started on CPAP	100	NA ^a

CPAP: continuous positive airway pressure; NA: Not applicable; OSAHS: Obstructive sleep apnea-hypopnea syndrome (see methods for definition). Older adults are Medicare beneficiaries aged 70 years old.

* "Time to CPAP" means time to a technically adequate CPAP titration study. The mean time is the same or people who have OSAHS and people who do not have OSAHS.

^a Not meaningful to assess

Sensitivity analyses

We conducted wide range sensitivity analyses to assess the robustness of the findings. Here, we present the results of univariate analyses for the variable that had some influence on the average time to technically adequate CPAP initiation study among people who were offered CPAP (i.e., those with either true positive or false positive diagnoses). The corresponding analyses with respect to the whole cohort are not readily interpretable.

Average waiting time per sleep study in the lab setting (Dt_Lab)

Figure 20 and **Table 14** show the pertinent analyses. On interpreting this figure one must bear in mind that the corresponding average waiting times depend on the total workload of the sleep labs. In these univariate analyses the corresponding waiting times in strategies 3, 4 and 5 are 68 percent, 36 percent and 27 percent of those in strategy 2. Please, refer to **Appendix B** for a discussion of how the mean waiting times in strategies 3, 4 and 5 are calculated based on the mean waiting time set for strategy 2.

In strategy 2 at least two sessions in the lab will be needed for people who have positive diagnoses and will be offered CPAP. In strategy 3 (management in the lab with split night studies) the dependency is relatively smaller because of the smaller burden that is placed on sleep labs, and because in the majority of people diagnosis and CPAP level titration is performed in a single session.

Figure 20. Sensitivity analysis on the average waiting time per sleep study in the lab setting: Average time to CPAP level titration among those who are offered CPAP.

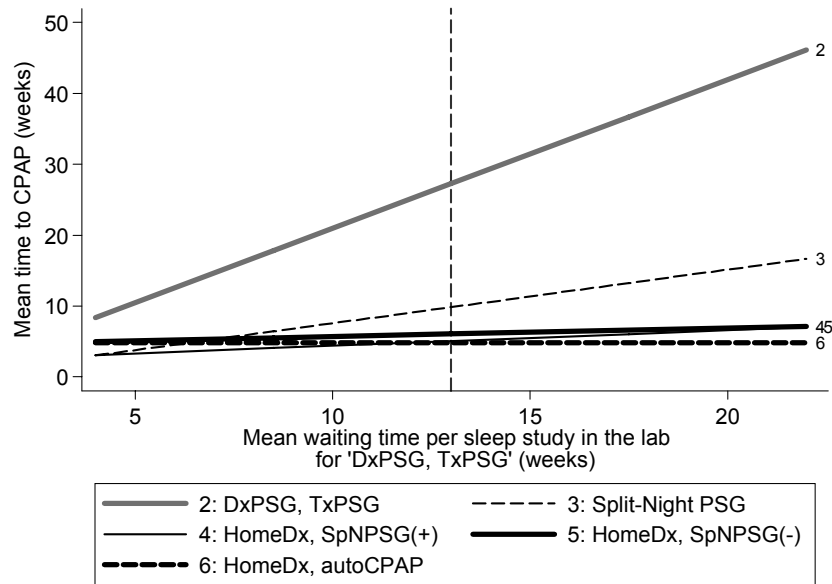

Key: (auto)CPAP: (automated) Continuous positive airway pressure titration; DxPSG: diagnostic polysomnography in the sleep laboratory; HomeDx: home diagnosis; OSAHS: obstructive sleep apnea-hypopnea syndrome; PSG: polysomnography; SpNPSG: split-night polysomnography; TxPSG: titration of CPAP levels in the sleep laboratory.

The “all on CPAP” and “none on CPAP” strategies (1 and 7, respectively) are not shown, because they are not affected by the sensitivity analyses. The number on the right hand side of each line in the graph corresponds to the number of the modeled strategy (see text). The vertical dashed line shows the prevalence that was used in the baseline analyses.

The average waiting time for a sleep study in the lab in strategies 3, 4, and 5 is expected to be 68 percent, 36 percent and 27 percent, respectively, of the waiting time in strategy 2.

Table 14. Sensitivity analysis in average waiting time for a sleep study in strategy 2 (DxPSG, TxPSG): Average time to CPAP in a hypothetical cohort of 100,000 middle-aged people suspected of OSAHS

Strategy (for diagnosis and CPAP titration)	Proportion offered CPAP (%)	Mean time to CPAP assuming different average waiting times for a sleep study* (among those offered CPAP) [weeks]				
		4.0 ^a	8.5 ^a	13.0 ^{a,b}	17.5 ^a	22.0 ^a
1. None started on CPAP	0	NA ^c	NA ^c	NA ^c	NA ^c	NA ^c
2. Full night PSG, treatment PSG	54	8.4	17.8	27.3	36.7	46.1
3. Split-night PSG	51	3.0	6.4	9.8	13.2	16.2
4. Home diagnosis, split-night PSG to verify positive cases	44	3.1	4.1	5.0	6.0	7.0
5. Home diagnosis, split-night PSG in all negative cases	62	4.9	5.5	6.2	6.6	7.2
6. Home diagnosis, home CPAP titration	56	4.8	4.8	4.8	4.8	4.8
7. All started on CPAP	100	NA ^c	NA ^c	NA ^c	NA ^c	NA ^c

CPAP: continuous positive airway pressure; NA: Not applicable; OSAHS: Obstructive sleep apnea-hypopnea syndrome (see methods for definition). Older adults are Medicare beneficiaries aged 70 years old.

* “Time to CPAP” means time to a technically adequate CPAP titration study. The mean time is the same or people who have OSAHS and people who do not have OSAHS.

^a Average waiting time for a sleep study in the lab in strategy 2; the waiting times for lab studies in the other strategies are adjusted accordingly, as shown in **Appendix B**.

^b Value in baseline analysis

^c Not meaningful to assess

Average waiting time for a sleep study in the home setting (Dt_Home)

Figure 21 shows the corresponding sensitivity analysis. Strategies that incorporate studies in the home setting (strategies 4, 5 and 6) are affected by this quantity. Note that if the mean delay is more than three weeks, management at home (strategy 6) yields similar time delays with management in the labs with split-night studies.

Figure 21. Sensitivity analysis on average waiting time for a sleep study at home: time until successful CPAP titration.

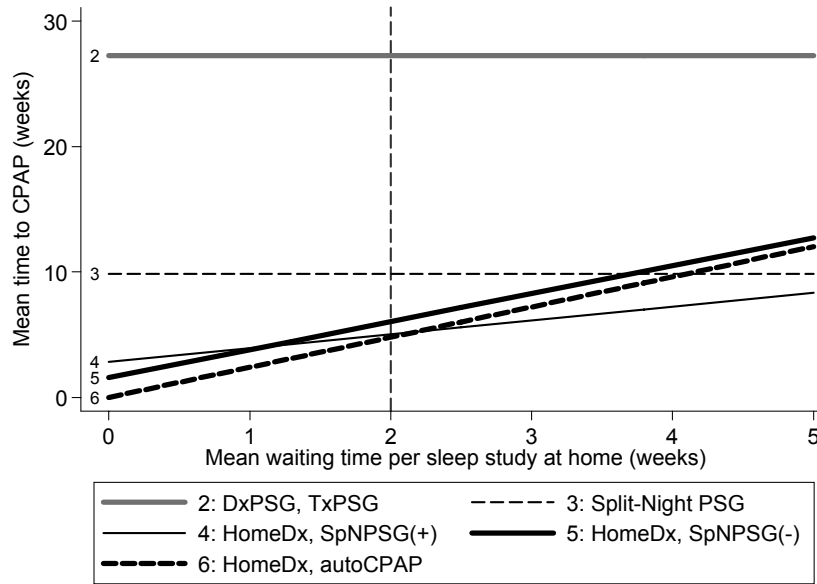

Key: (auto)CPAP: (automated) Continuous positive airway pressure titration; DxPSG: diagnostic polysomnography in the sleep laboratory; HomeDx: home diagnosis; OSAHS: obstructive sleep apnea-hypopnea syndrome; PSG: polysomnography; SpNPSG: split-night polysomnography; TxPSG: titration of CPAP levels in the sleep laboratory.

The “all on CPAP” and “none on CPAP” strategies (1 and 7, respectively) are not shown, because they are not affected by the sensitivity analyses. The number on the left hand side of each line in the graph corresponds to the number of the modeled strategy (see text). The vertical dashed line shows the prevalence that was used in the baseline analyses.

Prevalence (prev)

Figure 22 illustrates the impact of prevalence. As noted above, in these analyses we focus only on patients who were offered CPAP, and not to the whole cohort. However, the prevalence of OSAHS affects the number of positive diagnoses, and therefore the number of people who will undertake CPAP titration studies. This in turn impacts on the workload of the sleep labs and the average waiting time per sleep study in the lab setting.

Strategy 3 (management with split-night studies) is unaffected by this sensitivity analysis, because diagnosis and CPAP titration (if needed) take place in a single night. Strategy 6 (management outside the sleep lab) is also unaffected, because the average waiting time for a sleep study in the home setting is assumed to be independent of the total number of sleep studies performed.

Note that in strategy 5 (screening at home with a portable monitor and then verify negative diagnoses in a split-night study in the lab) the impact of decreasing prevalence is in the opposite direction compared to strategy 4. In strategy 5, as the prevalence of

OSAHS decreases, the number of negative diagnoses with the portable monitors increases, and so does the total number of split-night PSG studies.

Figure 22. Sensitivity analysis on prevalence: Average time to successful CPAP level titration among those who are offered CPAP.

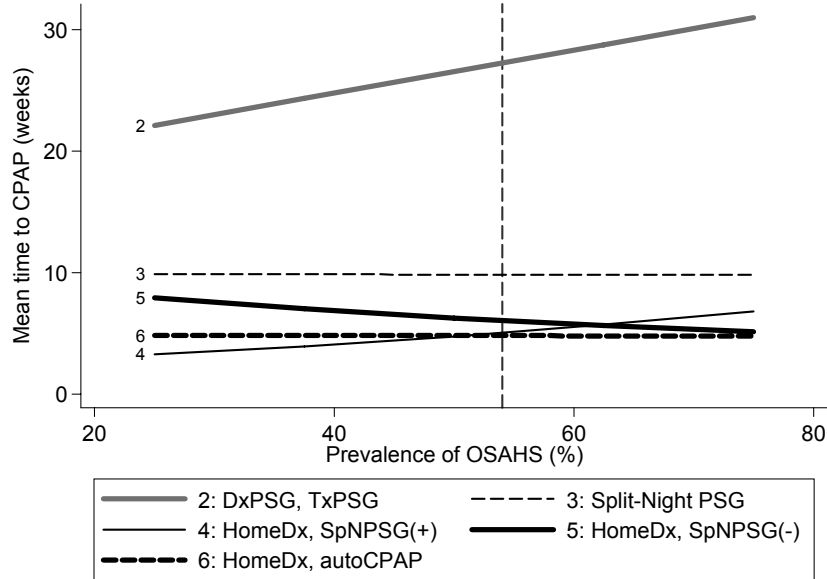

Key: (auto)CPAP: (automated) Continuous positive airway pressure titration; DxPSG: diagnostic polysomnography in the sleep laboratory; HomeDx: home diagnosis; OSAHS: obstructive sleep apnea-hypopnea syndrome; PSG: polysomnography; SpNPSG: split-night polysomnography; TxPSG: titration of CPAP levels in the sleep laboratory.

The “all on CPAP” and “none on CPAP” strategies (1 and 7, respectively) are not shown, because they are not affected by the sensitivity analyses. The number on the left hand side of each line in the graph corresponds to the number of the modeled strategy (see text). The vertical dashed line shows the prevalence that was used in the baseline analyses.

Probability of not showing up for the first PSG or Split-night PSG study

Figure 23 illustrates the corresponding sensitivity analyses. As the probability of not showing up increases, the time to a technically adequate CPAP study in strategies 2 and 3 decreases (because the workload of the sleep labs decreases).

Figure 23. Sensitivity analysis on the probability of not showing up for the first study if it is in the sleep lab: Average time to successful CPAP level titration among those who are offered CPAP.

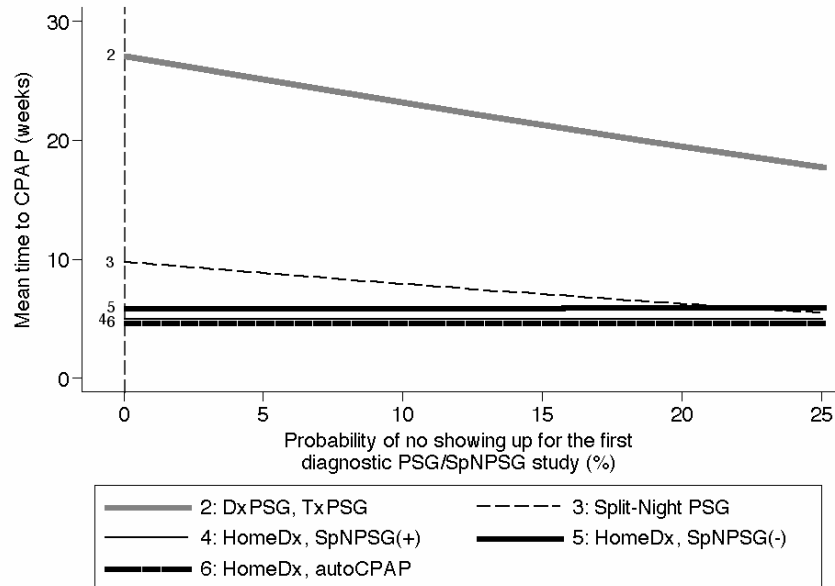

Key: (auto)CPAP: (automated) Continuous positive airway pressure titration; DxPSG: diagnostic polysomnography in the sleep laboratory; HomeDx: home diagnosis; OSAHS: obstructive sleep apnea-hypopnea syndrome; PSG: polysomnography; SpNPSG: split-night polysomnography; TxPSG: titration of CPAP levels in the sleep laboratory.

The “all on CPAP” and “none on CPAP” strategies (1 and 7, respectively) are not shown, because they are not affected by the sensitivity analyses. The number on the left hand side of each line in the graph corresponds to the number of the modeled strategy (see text). The vertical dashed line shows the prevalence that was used in the baseline analyses.

Other variables

The remaining variables had little impact on the different strategies with respect to this outcome in the prespecified sensitivity analyses. Therefore they are not discussed further. See also the next paragraph.

Overview of univariate sensitivity analyses

Figure 24 provides an overview of the univariate sensitivity analyses. The figure summarizes the four variables that have the most profound effect on time spent in “high-risk” health states in the corresponding strategies in the sensitivity analyses. All other variables have even smaller influence and are not discussed further.

Figure 24. Summary (“tornado” graph) of the variables with the greatest impact on the average to CPAP in the univariate sensitivity analyses (among people offered CPAP).

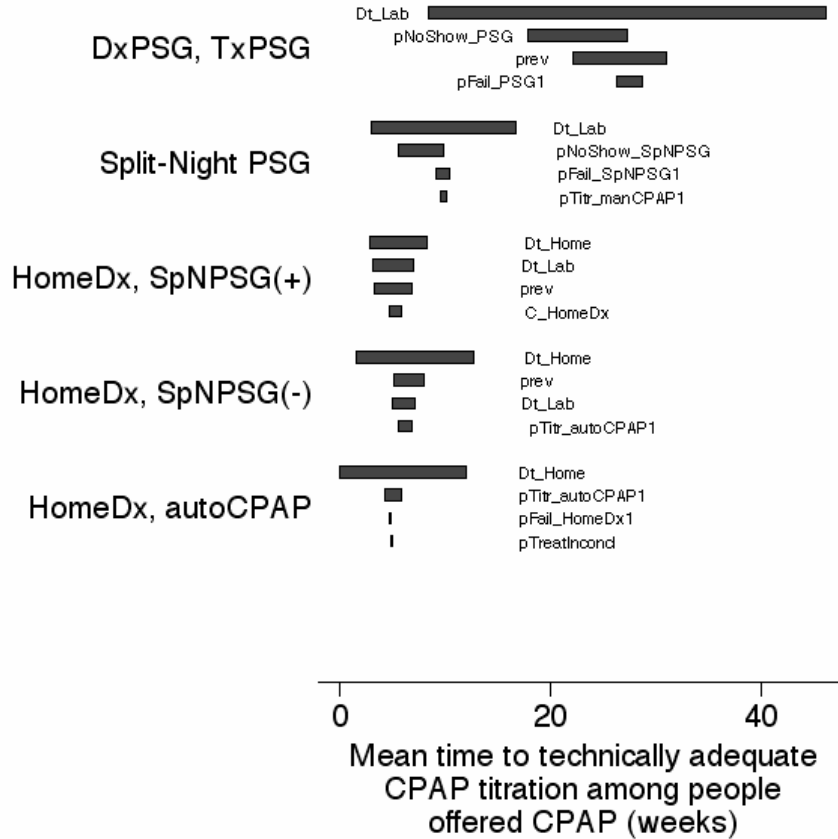

Key: (auto)CPAP: (automated) continuous positive airway pressure titration; C_HomeDx: specificity of home diagnosis with portable monitors; DxPSG: diagnostic polysomnography in the sleep laboratory; HomeDx: home diagnosis; Dt_Lab: average waiting time for a sleep study in the lab setting; OSAHS: obstructive sleep apnea-hypopnea syndrome; pFail_[PSG1 | SpNPSG1 | HomeDx1]: proportion of [facility-based PSG | split-night PSG | home] studies that are technically inadequate; pNoShow_[PSG | SpNPSG]: probability of not showing up for the first study when it is in the sleep lab. prev: prevalence; PSG: polysomnography; pTreatInconcl: probability to start on CPAP if pressure level titration is technically inadequate, but a positive diagnosis of OSAHS exists; SpNPSG: split-night polysomnography; TxPSG: titration of CPAP level in the sleep laboratory.

The “all on CPAP” and “none on CPAP” strategies (1 and 7, respectively) are not shown, because they are not affected by the sensitivity analyses.

The length of each bar represents the change in the outcome for each strategy, when the corresponding variable is varied throughout its whole range in the univariate sensitivity analyses. Only the four more influential variables are shown for each strategy. Because variables are ordered by diminishing influence in each strategy, the image resembles a small tornado, hence the name “tornado” graph.

Discussion

We used established and well-suited methods to perform mathematical modeling of the direct comparison of seven different strategies for the diagnosis of OSAHS and titration of CPAP level, which has not been done in an actual study. Our modeling approaches are based on estimates obtained from focused systematic reviews and meta-analyses of the literature. We simulated cohorts of patients suspected for OSAHS and followed them up for a time horizon of 2 years or until they had a technically adequate CPAP titration study.

The modeled populations are people with symptoms and signs suggestive of OSAHS, who are referred for further diagnostic workup. This is a subgroup of the *general population* of middle-aged people or older adults. Therefore, the models do not describe screening for OSAHS in the *general population*. The Methods section has a more detailed description of the simulated populations.

Our simulations stop at the point where people with positive diagnoses are offered CPAP treatment. Because of the uncertainty in available data, we did not model subsequent events, such as how many people actually accept the CPAP treatment, CPAP compliance and response to the intervention. Instead, we calculated the occurrence of surrogate outcomes, which have to be interpreted accordingly.

As mentioned above, the results of the modeling are based on data from the literature, and assumptions that were made for some probabilities where few or no data existed (again, see Methods section for a discussion of the evidence supporting the probabilities in the baseline analyses, and the accompanying uncertainties). In addition, we did not cover any conceivable complication that arises in everyday clinical practice. There is a tradeoff between the detail with which a strategy is simulated and the parsimony of the mathematical models.

Interpretation of outcomes

The modeling *illustrates the tradeoff* in the number of people with OSAHS (as defined in the Methods section) who are offered CPAP and time to diagnosis or technically adequate CPAP level titration across seven different simulated strategies. Strategies that use portable monitors as a first (or only) test generally result in shorter average time to diagnosis and technically adequate CPAP level titration, but also in increased numbers of “false positives” or “false negatives” compared to PSG (depending on the strategy). Diagnosis and CPAP level titration entirely in the sleep labs or related facilities is expected to result in better diagnostic accuracy, but may result in longer time to diagnosis and CPAP level titration.

Proportion of people who are offered CPAP

Interpretation of this outcome

One may argue that it is more important to maximize the number of true positive diagnoses (i.e., maximize the *sensitivity* of a strategy), rather than minimize the number of false positive diagnoses (i.e., maximize the *specificity* of a strategy).

As mentioned in the Results (and letting aside strategies 1 and 7), in the baseline analyses strategy 2 (facility-based PSG and CPAP titration in the lab) and Strategy 5 (screening at home and further evaluation of negative cases with split-night studies) are expected to offer CPAP to almost all people with OSAHS (as defined in the current project). Management in the sleep lab with split-night studies (strategy 3) and home diagnosis of OSAHS and home CPAP titration (strategy 6) would offer CPAP to approximately 90 percent of people with OSAHS (as defined in the current project), while screening at home with portable monitors and then verification of positive cases with split-night studies would result in approximately 80 percent of people with OSAHS (as defined in the current project) being offered CPAP. These proportions were the same among older adults.

Maximizing true positive diagnoses

Indeed, identifying people with OSAHS and starting them on CPAP treatment is associated with positive health outcomes. Observational evidence from prospective comparative studies associates CPAP treatment of OSAHS with fewer cardiovascular events.^{2,4} After adjustments for potential confounders, men with untreated severe OSAHS have 2.9 higher odds (95% confidence interval: 1.2, 7.5) for fatal events and 3.2 (95% confidence interval: 1.1, 7.5) higher odds for non-fatal cardiovascular events.²

Furthermore, patients with OSAHS have an increased risk for car accidents.^{12,13} Assuming that CPAP treatment is effective in reducing this risk, and that patient adherence to the treatment would not diminish drastically over a short period of time, we could project that maximizing the number of true positives may have an impact in reducing accident related morbidity and mortality.

However, apart from the aforementioned considerations there is no extensive randomized evidence on outcomes such as deaths, strokes and cardiovascular events (see below a description of the relevant findings of a Cochrane Systematic Review²⁸). There is randomized evidence that CPAP versus no treatment or sham CPAP treatment of OSAHS is associated with improvements in the Epworth Sleepiness Scale²⁸ (a subjective symptom score), objective wakefulness tests²⁸ and selected components of the SF-36 questionnaire²⁸ (e.g., the vitality component, which is more relevant to OSAHS patients compared to other SF-36 components²⁹).

Randomized evidence on whether CPAP use improves outcomes among patients

with OSAHS: As mentioned above, there is evidence from randomized trials that CPAP use is associated with improvements in quality of life scores;²⁸ however, there are no data from randomized trials on how much CPAP affects hard clinical outcomes (i.e., mortality or cardiac disease):

1. A Cochrane systematic review of randomized trials comparing CPAP with control found that CPAP use improved the Epworth Sleepiness Score (ESS) by 3.8 units on average (95% CI: 3.1, 4.6) in parallel arm trials, and approximately half of that in crossover trials.

ESS ranges from 0 to 24, and otherwise healthy people without sleep disturbances have an average score of approximately 5.¹¹⁰ However, the minimal clinically significant difference in the ESS is not reported; therefore the clinical significance of this finding is unclear.

2. Overall, no statistically significant improvement was found for the vitality component of the Short Form 36 Questionnaire (SF36) in three small parallel arm trials with random effects analyses (but a 15 unit improvement was found with fixed effects analyses). In crossover trials, the corresponding change was 8 units (95% CI: 2, 14).²⁸
The vitality component of SF36 has been shown to correlate with quality of life instruments specifically developed for OSAHS.²⁹ The lowest boundary of the 95% confidence intervals for the vitality score are lower than the minimum clinically significant difference in SF36 components, which ranges from 5 to 10 units in various diseases.^{111,112} Therefore, the clinical significance of this improvement is not very clear.
3. There were no data on how much CPAP affects hard clinical outcomes such as mortality, cardiovascular events, strokes, etc. The review's conclusion was that CPAP treatment is effective in improving quality of life measures in people with moderate and severe OSAHS (similar to the ones modeled here).

Minimizing false positive diagnoses

Receiving a false positive diagnosis of OSAHS (and undergoing a CPAP titration study) does not result in *immediate and detrimental* adverse health events.

- We did not identify any adverse health events associated with a CPAP titration study in people without OSAHS. The rate and severity of adverse events in sleep studies are low. In a large prospective study of more than 16,000 lab-based PSG sessions, complications (ventricular arrhythmias) were identified in less than 0.5% of the recordings.¹¹³ (See also Section B5 in our recent Technology Assessment “Home diagnosis of obstructive sleep apnea-hypopnea syndrome”).
- We did not identify studies associating CPAP use in people without OSAHS with adverse health events.

Considerations on “false positives”: In our models, a person without OSAHS who receives a false positive diagnosis will be subjected to a CPAP titration study. We do not model the outcomes of the titration study, or decisions contingent on its results.

In people without OSAHS, it is likely that a (technically adequate) CPAP titration study will not result in a non-negligible pressure level that improves the participant's sleep. A sleep physician may decide not to prescribe CPAP treatment in this case, despite the previous positive diagnosis. Even if CPAP treatment is prescribed, it is likely that the machine will not be used in the long term. Therefore, in “false positively” diagnosed patients CPAP may not be used at all or may be used for a relatively short period and “abandoned” thereafter. Thus, false positive diagnoses may (needlessly) increase costs. However, it is important to note that as we discussed in the previous technology assessment, there is a lack of evidence on the ability of PSG or portable monitors to predict response to CPAP and changes in clinical outcomes after CPAP treatment.

We should note that apart from inflating costs, a false positive result might also affect health adversely. Any labeling of disease that is inaccurate can have psychological implications,¹¹⁴ such as increased anxiety. False positive diagnoses might lead to inappropriate and ineffective treatment and/or lack of further diagnostic evaluation to find the true cause of the patient's symptoms. This is especially true if as a result of lack of improvement to the inappropriate treatment, the patient mistrusts the medical system.

The patient may also opt out of seeking further evaluation because of having spent considerable time and money on the evaluation and treatment for the inaccurate diagnosis. Finally, the treating physician may also not pursue other diagnoses feeling the patient is non-adherent to CPAP treatment or is just a “non-responder”.

Time to final diagnosis

Time to final diagnosis is a surrogate outcome that reflects how tiring the whole diagnostic process may be for a patient, and how “efficiently” a specific strategy classifies people. During this interval certain events (e.g., having a driving accident) might occur to a patient with OSAHS; however, whether knowledge of a diagnosis would alter the likelihood of such events happening (e.g., through modification of lifestyle and habits) is unknown.

Interpretation of this outcome

There are no data on whether a delay in the diagnosis is associated with increased anxiety or any other similar outcome from a patient perspective. One may postulate that informing a patient on whether he has OSAHS or not might affect his or her driving behavior or lifestyle; however, this is hypothetical.

Generally, it is conceivable that strategies with shorter time-to-diagnosis have a quicker turnaround; this indicates better “efficiency” (although the accuracy of the diagnoses should also be considered). Shorter mean time to final diagnosis is generally associated with shorter mean time to CPAP treatment (see below on the interpretation of shorter time to CPAP).

Time to diagnosis is shorter in strategy 6 (~2 weeks), then strategies 4 and 5 (~5 weeks), strategy 3 (~10 weeks) and strategy 2 (~14 weeks).

Time to CPAP among people with a positive diagnosis for OSAHS who are offered CPAP

Interpretation of the findings

CPAP treatment of OSAHS has been associated with beneficial health outcomes. Observational evidence from prospective comparative studies associates CPAP treatment of OSAHS with fewer cardiovascular events.^{2,4} Furthermore, patients with OSAHS have an increased risk for car accidents.^{12,13} CPAP has been associated with a reduction in the risk for motor vehicle accidents among people with OSAHS.²⁵⁻²⁷

However, apart from the aforementioned considerations there is no extensive randomized evidence on outcomes such as deaths, strokes and cardiovascular events.²⁸ There is randomized evidence that CPAP versus no treatment or sham CPAP treatment of OSAHS is associated with improvements in the Epworth Sleepiness Scale²⁸ (a subjective symptom score), objective wakefulness tests²⁸ and selected components of the SF-36 questionnaire²⁸ (e.g., the vitality component, which is more relevant to OSAHS patients compared to other SF-36 components²⁹). Randomized studies suggest that CPAP may also be inversely associated with intermediate clinical outcomes (e.g., hypertension).²⁸

This outcome is very sensitive to the actual value of the average waiting time for a sleep study in the sleep labs, a quantity for which we do not have extensive data. Moreover, there is evidence that there are many differences in the average waiting times

across various regions in the US, or even among hospitals.⁹⁶ In the results section (sensitivity analyses) we provide results for a range of average waiting times.

For the baseline analyses, a patient in strategy 6 and strategy 4 would be offered CPAP after a period of approximately 5 weeks, and in strategy 5 after approximately 6 weeks. For strategy 3 (split-night studies in the lab) the corresponding mean delay is approximately 10 weeks and for strategy 2 (facility-based PSG and CPAP titration in different nights) it would be 27 weeks, i.e. there is on average a 22-week gap between these strategies. However, in sensitivity analyses this gap may become as low as 3 weeks. As the average waiting time for a study in the sleep lab decreases, the absolute differences across strategies 2 to 6 dissipate.

RCTs on delayed CPAP initiation among people with OSAHS

A randomized trial compared immediate initiation of treatment with CPAP versus a 6 month delay in treatment.¹¹⁵ However, the trial does not directly answer how bad a 6-month delay is: The trial did not report differences in deaths or hard clinical outcomes (e.g., cardiovascular events, mortality) during the 6-month delay (and is underpowered to make any such comparison in the first place). It concludes that the delay deprives people with severe OSAHS (AHI>30 events/hour) from a 5-point improvement in the Epworth Sleepiness Scale and a 12-point improvement in the Nottingham Health Profile quality of life instrument. Delayed treatment did not impact on cognitive function measures or in healthcare expenditure.¹¹⁵ It is therefore questionable whether a 6-month delay in the diagnosis or treatment affects patient well-being appreciably.

Additional caveats

Indication creep

As discussed in the Methods section, widespread use of screening strategies for OSAHS may result in “indication creep” a phenomenon where the test is applied to a wider base of people, including also people with lower likelihood for OSAHS than the typical enrollee in clinical studies.

Indication creep would result in more people being evaluated. It would also result to lower OSAHS prevalence (compared to the value used in the modeling). A directly relevant consideration is that the diagnostic ability of the different monitors may vary in different patient populations (spectrum effects¹¹⁶). This is part of the rationale that penalized the specificity of portable monitors in the sensitivity analysis among older adults.

Indication creep might not be necessarily a bad thing – it is unknown how many patients with OSAHS are simply not recognized because they have not been referred for a diagnostic study.

Is AHI (or RDI) sufficient to diagnose OSAHS?

Polysomnographic indices alone (such as AHI, RDI, oxygen saturation levels, etc.) are not sufficient to classify people into those with and without OSAHS. This is because facility-based PSG and portable monitoring do not inform on aspects of OSAHS other than the measured sleep parameters. It is acknowledged that the AHI does not correlate well with the intensity of the symptoms in patients with OSAHS.¹⁴ The correlations

between AHI (and other PSG indices such as arousals or desaturation variables) and daytime measures of quality of life, well-being, subjective sleepiness, symptoms and cognitive performance are weak.¹⁵ There are probably no clinical or statistical differences between patients who differ only by a few points in the AHI. Moreover, AHI is not well correlated with response to CPAP therapy, or compliance to the therapy itself, among people selected for CPAP treatment.¹¹⁷⁻¹²⁴

Here we defined OSAHS as the presence of suggestive symptoms and signs (considered a given in the modeled populations) along with an AHI of more than 15 events/hour of sleep. Of course people who have AHI values less than 15 events/hour of sleep may still benefit from CPAP (or other) treatment. For example, there is no clinical reason why a patient who has an AHI of 14 events/hour in facility-based PSG would benefit less than a patient with 16 events/hour in facility-based PSG. These considerations pertain to any cutoff, and are not specific to the one used here.

Is AHI necessary for the management of people suspected of OSAHS?

As of this writing, no RCT were identified that compared hard clinical outcomes between people managed with facility-based PSG and with portable monitors only. However, as of this writing, there are ongoing trials that are evaluating the role of portable monitors in managing people suspected for OSAHS, compared to facility-based PSG.

We identified a recent RCT by Mulgrew 2007¹⁰⁸ evaluating the utility of a diagnostic algorithm that did not involve facility-based PSG in the initial management of people suspected of OSAHS. In brief, 68 patients with high probability for AHI >15 events/hour (i.e., moderate to severe OSAHS) were selected on the basis of Epworth Sleepiness Scale score, Sleep Apnea Clinical Score and overnight oximetry that were suggestive of OSAHS. They were randomly assigned to CPAP titration guided by facility-based PSG or ambulatory CPAP auto-titration (without facility-based PSG). The latter arm used a combination of auto-CPAP and overnight oximetry.

After 3 months there were no differences between arms in the AHI on CPAP (the primary endpoint). Both arms achieved low median AHI on CPAP at three months (median 3.2 versus 2.5 events/hour in the arms that used and did not use facility-based PSG, respectively). Furthermore, no differences beyond chance were found for the secondary outcomes of the RCT. The difference in the change from baseline in the Epworth Sleepiness Scale score was 1 (p=0.26 for the between-arm comparison). The corresponding difference for the Sleep Apnea Quality of Life Index was 0.17 (p=0.69 for the between-arm comparison) (the minimum clinically significant difference is 1 unit in this score^{29,125}). Scores for both aforementioned secondary outcomes improved in almost all patients compared to baseline. Finally, adherence to CPAP was higher (p=0.021) in the arm that did not receive facility-based PSG (median CPAP use, 6.0 hours/night [interquartile range: 5.1, 7.1]) compared to the arm that received facility-based PSG (median use, 5.4 hours/night [interquartile range: 3.7, 6.4]).

The RCT concluded that in the initial management of patients with *high probability of OSAHS*, PSG testing confers no advantage over an ambulatory approach in terms of diagnosis and CPAP titration. There was also evidence that adherence might be better with the ambulatory approach.

Limitations

There are several limitations in the approach we used here.

First, the scenarios that have been modeled are only a simplified version of the actual strategies. There are many additional possibilities that have not been modeled; for example no deaths or crossover between different strategies are allowed, and comorbidities have not been taken into account. There is a tradeoff between model parsimony and fidelity in the simulation of the real world. The analyst has to keep a balance between a model that is simple enough to implement, but comprehensive enough to capture all interesting phenomena that are expected to occur. We believe that the structure of the simulated strategies achieves the desirable balance.

Furthermore, some transition probability estimates are based on relatively sparse data. We refer the reader to the corresponding paragraphs in the Methods section for a detailed discussion of the sources of the transition probabilities we used, as well as the accompanying uncertainty. For example, the average waiting time for a sleep study in the lab is a key quantity that influences greatly the results for the time to diagnosis and time to CPAP. As described in the Methods, we have addressed the uncertainty that accompanies each estimate with sensitivity analyses.

Similarly, the estimates for the older adults are based on extrapolations of data that pertain to middle-aged people and on calculations that we considered plausible. There are simply no data specific to the age group that corresponds to Medicare beneficiaries for the transition probabilities used in our model. This is an obvious gap in the existing published literature. Apart from conducting new studies among older adults, analyzing the subgroup of older patients in existing datasets may provide useful information. We conducted wide-ranged sensitivity analyses in the models to help address uncertainty in some probabilities among older adults.

References

1. Practice parameters for the indications for polysomnography and related procedures. Polysomnography Task Force, American Sleep Disorders Association Standards of Practice Committee. *Sleep* 1997; 20(6):406-422.
2. Marin JM, Carrizo SJ, Vicente E, Agusti AG. Long-term cardiovascular outcomes in men with obstructive sleep apnoea-hypopnoea with or without treatment with continuous positive airway pressure: an observational study. *Lancet* 2005; 365(9464):1046-1053.
3. Yaggi HK, Concato J, Kernan WN, et al. Obstructive sleep apnea as a risk factor for stroke and death. *N Engl J Med* 2005; 353(19):2034-2041.
4. Buchner NJ, Sanner BM, Borgel J, Rump LC. CPAP Treatment of Mild to Moderate Obstructive Sleep Apnea Reduces Cardiovascular Risk. *Am J Respir Crit Care Med* 2007.
5. Young T, Palta M, Dempsey J, et al. The occurrence of sleep-disordered breathing among middle-aged adults. *N Engl J Med* 1993; 328(17):1230-1235.
6. Shahar E, Whitney CW, Redline S, et al. Sleep-disordered breathing and cardiovascular disease: cross-sectional results of the Sleep Heart Health Study. *Am J Respir Crit Care Med* 2001; 163(1):19-25.
7. Nieto FJ, Young TB, Lind BK, et al. Association of sleep-disordered breathing, sleep apnea, and hypertension in a large community-based study. Sleep Heart Health Study. *JAMA* 2000; 283(14):1829-1836.
8. Peppard PE, Young T, Palta M, Skatrud J. Prospective study of the association between sleep-disordered breathing and hypertension. *N Engl J Med* 2000; 342(19):1378-1384.
9. Young T, Peppard P, Palta M, et al. Population-based study of sleep-disordered breathing as a risk factor for hypertension. *Arch Intern Med* 1997; 157(15):1746-1752.
10. Babu AR, Herdegen J, Fogelfeld L, Shott S, Mazzone T. Type 2 diabetes, glycemic control, and continuous positive airway pressure in obstructive sleep apnea. *Arch Intern Med* 2005; 165(4):447-452.
11. Gruber A, Horwood F, Sithole J, Ali NJ, Idris I. Obstructive sleep apnoea is independently associated with the metabolic syndrome but not insulin resistance state. *Cardiovasc Diabetol* 2006; 5:22.
12. Howard ME, Desai AV, Grunstein RR, et al. Sleepiness, sleep-disordered breathing, and accident risk factors in commercial vehicle drivers. *Am J Respir Crit Care Med* 2004; 170(9):1014-1021.
13. Teran-Santos J, Jimenez-Gomez A, Cordero-Guevara J. The association between sleep apnea and the risk of traffic accidents. Cooperative Group Burgos-Santander. *N Engl J Med* 1999; 340(11):847-851.
14. Flemons WW, Littner MR, Rowley JA, et al. Home diagnosis of sleep apnea: a systematic review of the literature. An evidence review cosponsored by the American Academy of Sleep Medicine, the American College of Chest Physicians, and the American Thoracic Society. *Chest* 2003; 124(4):1543-1579.
15. Kingshott RN, Engleman HM, Deary IJ, Douglas NJ. Does arousal frequency predict daytime function? *Eur Respir J* 1998; 12(6):1264-1270.
16. Young T, Peppard PE, Taheri S. Excess weight and sleep-disordered breathing. *J Appl Physiol* 2005; 99(4):1592-1599.
17. Young T, Shahar E, Nieto FJ, et al. Predictors of sleep-disordered breathing in community-dwelling adults: the

- Sleep Heart Health Study. *Arch Intern Med* 2002; 162(8):893-900.
18. Ancoli-Israel S, Kripke DF, Klauber MR, et al. Sleep-disordered breathing in community-dwelling elderly. *Sleep* 1991; 14(6):486-495.
 19. Bixler EO, Vgontzas AN, Ten HT, Tyson K, Kales A. Effects of age on sleep apnea in men: I. Prevalence and severity. *Am J Respir Crit Care Med* 1998; 157(1):144-148.
 20. Bixler EO, Vgontzas AN, Lin HM, et al. Prevalence of sleep-disordered breathing in women: effects of gender. *Am J Respir Crit Care Med* 2001; 163(3 Pt 1):608-613.
 21. Duran J, Esnaola S, Rubio R, Iztueta A. Obstructive sleep apnea-hypopnea and related clinical features in a population-based sample of subjects aged 30 to 70 yr. *Am J Respir Crit Care Med* 2001; 163(3 Pt 1):685-689.
 22. Young T, Peppard PE, Gottlieb DJ. Epidemiology of obstructive sleep apnea: a population health perspective. *Am J Respir Crit Care Med* 2002; 165(9):1217-1239.
 23. Ferber R, Millman R, Coppola M, et al. Portable recording in the assessment of obstructive sleep apnea. *ASDA standards of practice. Sleep* 1994; 17(4):378-392.
 24. Patel SR, White DP, Malhotra A, Stanchina ML, Ayas NT. Continuous positive airway pressure therapy for treating sleepiness in a diverse population with obstructive sleep apnea: results of a meta-analysis. *Arch Intern Med* 2003; 163(5):565-571.
 25. Engleman HM, sgari-Jirhandeh N, McLeod AL, et al. Self-reported use of CPAP and benefits of CPAP therapy: a patient survey. *Chest* 1996; 109(6):1470-1476.
 26. George CF. Reduction in motor vehicle collisions following treatment of sleep apnoea with nasal CPAP. *Thorax* 2001; 56(7):508-512.
 27. Krieger J, Meslier N, Lebrun T, et al. Accidents in obstructive sleep apnea patients treated with nasal continuous positive airway pressure: a prospective study. The Working Group ANTADIR, Paris and CRESGE, Lille, France. *Association Nationale de Traitement a Domicile des Insuffisants Respiratoires. Chest* 1997; 112(6):1561-1566.
 28. Giles TL, Lasserson TJ, Smith BJ, et al. Continuous positive airways pressure for obstructive sleep apnoea in adults. *Cochrane Database Syst Rev* 2006;(1):CD001106.
 29. Flemons WW, Reimer MA. Development of a disease-specific health-related quality of life questionnaire for sleep apnea. *Am J Respir Crit Care Med* 1998; 158(2):494-503.
 30. Lux L, Boehlecke B, Lohr KN. Effects of portable monitoring devices for diagnosing obstructive sleep apnea: Update of a systematic review. 290-20-0016. 2006. Agency for Healthcare Research and Quality.
 31. Beck JR, Pauker SG. The Markov process in medical prognosis. *Med Decis Making* 1983; 3(4):419-458.
 32. Chapman GB, Sonnenberg FA. *Decision making in health care. Theory, psychology and applications.* New York: Cambridge University Press, 2003.
 33. Pettiti DB. *Meta-analysis, decision analysis and cost-effectiveness analysis.* New York: Oxford University Press, 1994.
 34. Sokol J. An intuitive Markov chain lesson from baseball. <http://ite.pubs.informs.org/Vol5No1/Sokol> . 2007.
 35. Alvarez D, Hornero R, Abasolo D, del CF, Zamarron C. Nonlinear

- characteristics of blood oxygen saturation from nocturnal oximetry for obstructive sleep apnoea detection. *Physiological Measurement* 2006; 27(4):399-412.
36. Ayappa I, Norman RG, Suryadevara M, Rapoport DM. Comparison of limited monitoring using a nasal-cannula flow signal to full polysomnography in sleep-disordered breathing. *Sleep* 2004; 27(6):1171-1179.
 37. Baltzan MA, Verschelden P, Al-Jahdali H, Olha AE, Kimoff RJ. Accuracy of oximetry with thermistor (OxiFlow) for diagnosis of obstructive sleep apnea and hypopnea. *Sleep* 2000; 23(1):61-69.
 38. Chiner E, Signes-Costa J, Arriero JM, et al. Nocturnal oximetry for the diagnosis of the sleep apnoea hypopnoea syndrome: a method to reduce the number of polysomnographies?[see comment]. *Thorax* 1999; 54(11):968-971.
 39. Dingli K, Coleman EL, Vennelle M, et al. Evaluation of a portable device for diagnosing the sleep apnoea/hypopnoea syndrome. *European Respiratory Journal* 2003; 21(2):253-259.
 40. Gugger M. Comparison of ResMed AutoSet (version 3.03) with polysomnography in the diagnosis of the sleep apnoea/hypopnoea syndrome. *European Respiratory Journal* 1997; 10(3):587-591.
 41. Issa FG, Morrison D, Hadjuk E, et al. Digital monitoring of sleep-disordered breathing using snoring sound and arterial oxygen saturation. *American Review of Respiratory Disease* 1993; 148(4:Pt 1):t-9.
 42. Levy P, Pepin JL, schaux-Blanc C, Paramelle B, Brambilla C. Accuracy of oximetry for detection of respiratory disturbances in sleep apnea syndrome. *Chest* 1996; 109(2):395-399.
 43. Man GC, Kang BV. Validation of a portable sleep apnea monitoring device. *Chest* 1995; 108(2):388-393.
 44. Mayer P, Meurice JC, Philip-Joet F, et al. Simultaneous laboratory-based comparison of ResMed Autoset with polysomnography in the diagnosis of sleep apnoea/hypopnoea syndrome. *European Respiratory Journal* 1998; 12(4):770-775.
 45. Michaelson PG, Allan P, Chaney J, Mair EA. Validations of a portable home sleep study with twelve-lead polysomnography: comparisons and insights into a variable gold standard. *Annals of Otology, Rhinology & Laryngology* 2006; 115(11):802-809.
 46. Mykityn IJ, Sajkov D, Neill AM, McEvoy RD. Portable computerized polysomnography in attended and unattended settings. *Chest* 1999; 115(1):114-122.
 47. Pang KP, Dillard TA, Blanchard AR, et al. A comparison of polysomnography and the SleepStrip in the diagnosis of OSA. *Otolaryngology - Head & Neck Surgery* 2006; 135(2):265-268.
 48. Parra O, Garcia-Escclasans N, Montserrat JM, et al. Should patients with sleep apnoea/hypopnoea syndrome be diagnosed and managed on the basis of home sleep studies?[see comment]. *European Respiratory Journal* 1997; 10(8):1720-1724.
 49. Penzel T, Kesper K, Pinnow I, Becker HF, Vogelmeier C. Peripheral arterial tonometry, oximetry and actigraphy for ambulatory recording of sleep apnea. *Physiological Measurement* 2004; 25(4):1025-1036.
 50. Pittman SD, Ayas NT, MacDonald MM, et al. Using a wrist-worn device based on peripheral arterial tonometry to diagnose obstructive sleep apnea: in-laboratory and ambulatory validation. *Sleep* 2004; 27(5):923-933.
 51. Pittman SD, MacDonald MM, Fogel RB, et al. Assessment of automated scoring of polysomnographic recordings in a population with suspected sleep-disordered breathing. *Sleep* 2004; 27(7):1394-1403.

52. Portier F, Portmann A, Czernichow P, et al. Evaluation of home versus laboratory polysomnography in the diagnosis of sleep apnea syndrome. *American Journal of Respiratory & Critical Care Medicine* 2000; 162(3:Pt 1):t-8.
53. Rauscher H, Popp W, Zwick H. Model for investigating snorers with suspected sleep apnoea. *Thorax* 1993; 48(3):275-279.
54. Rees K, Wraith PK, Berthon-Jones M, Douglas NJ. Detection of apnoeas, hypopnoeas and arousals by the AutoSet in the sleep apnoea/hypopnoea syndrome. *European Respiratory Journal* 1998; 12(4):764-769.
55. Reichert JA, Bloch DA, Cundiff E, Votteri BA. Comparison of the NovaSom QSG, a new sleep apnea home-diagnostic system, and polysomnography. *Sleep Medicine* 2003; 4(3):213-218.
56. Ryan PJ, Hilton MF, Boldy DA, et al. Validation of British Thoracic Society guidelines for the diagnosis of the sleep apnoea/hypopnoea syndrome: can polysomnography be avoided? *Thorax* 1995; 50(9):972-975.
57. Su S, Baroody FM, Kohrman M, Suskind D. A comparison of polysomnography and a portable home sleep study in the diagnosis of obstructive sleep apnea syndrome. *Otolaryngology - Head & Neck Surgery* 2004; 131(6):844-850.
58. Van Surell C., Lemaigre D, Leroy M, et al. Evaluation of an ambulatory device, CID 102, in the diagnosis of obstructive sleep apnoea syndrome. *European Respiratory Journal* 1995; 8(5):795-800.
59. Verse T, Pirsig W, Junge-Hulsing B, Kroker B. Validation of the POLY-MESAM seven-channel ambulatory recording unit. *Chest* 2000; 117(6):1613-1618.
60. White DP, Gibb TJ, Wall JM, Westbrook PR. Assessment of accuracy and analysis time of a novel device to monitor sleep and breathing in the home.[see comment]. *Sleep* 1995; 18(2):115-126.
61. Zucconi M, Ferini-Strambi L, Castronovo V, Oldani A, Smirne S. An unattended device for sleep-related breathing disorders: validation study in suspected obstructive sleep apnoea syndrome. *European Respiratory Journal* 1996; 9(6):1251-1256.
62. Ancoli-Israel S, Mason W, Coy TV, et al. Evaluation of sleep disordered breathing with unattended recording: the Nightwatch System. *Journal of Medical Engineering & Technology* 1997; 21(1):10-14.
63. Bar A, Pillar G, Dvir I, et al. Evaluation of a portable device based on peripheral arterial tone for unattended home sleep studies.[see comment]. *Chest* 2003; 123(3):695-703.
64. Esnaola S, Duran J, Infante-Rivard C, Rubio R, Fernandez A. Diagnostic accuracy of a portable recording device (MESAM IV) in suspected obstructive sleep apnoea. *European Respiratory Journal* 1996; 9(12):2597-2605.
65. Fry JM, DiPhillipo MA, Curran K, Goldberg R, Baran AS. Full polysomnography in the home. *Sleep* 1998; 21(6):635-642.
66. Gagnadoux F, Pelletier-Fleury N, Philippe C, Rakotonanahary D, Fleury B. Home unattended vs hospital telemonitored polysomnography in suspected obstructive sleep apnea syndrome: a randomized crossover trial. *Chest* 2002; 121(3):753-758.
67. Hedner J, Pillar G, Pittman SD, et al. A novel adaptive wrist actigraphy algorithm for sleep-wake assessment in sleep apnea patients. *Sleep* 2004; 27(8):1560-1566.
68. Ip MS, Lam B, Tang LC, et al. A community study of sleep-disordered breathing in middle-aged Chinese women in Hong Kong: prevalence and

- gender differences. *Chest* 2004; 125(1):127-134.
69. Kapur VK, Rapoport DM, Sanders MH, et al. Rates of sensor loss in unattended home polysomnography: the influence of age, gender, obesity, and sleep-disordered breathing. *Sleep* 2000; 23(5):682-688.
 70. Margel D, Cohen M, Livne PM, Pillar G. Severe, but not mild, obstructive sleep apnea syndrome is associated with erectile dysfunction. *Urology* 2004; 63(3):545-549.
 71. Masa JF, Corral J, Martin MJ, et al. Assessment of thoracoabdominal bands to detect respiratory effort-related arousal. *European Respiratory Journal* 2003; 22(4):661-667.
 72. Neven AK, Middelkoop HA, Kemp B, Kamphuisen HA, Springer MP. The prevalence of clinically significant sleep apnoea syndrome in The Netherlands. *Thorax* 1998; 53(8):638-642.
 73. Series F, Marc I, Cormier Y, La FJ. Utility of nocturnal home oximetry for case finding in patients with suspected sleep apnea hypopnea syndrome.[see comment]. *Annals of Internal Medicine* 1993; 119(6):449-453.
 74. Series F, Marc I. Nasal pressure recording in the diagnosis of sleep apnoea hypopnoea syndrome.[see comment]. *Thorax* 1999; 54(6):506-510.
 75. Vazquez JC, Tsai WH, Flemons WW, et al. Automated analysis of digital oximetry in the diagnosis of obstructive sleep apnoea. *Thorax* 2000; 55(4):302-307.
 76. Zamarron C, Romero PV, Rodriguez JR, Gude F. Oximetry spectral analysis in the diagnosis of obstructive sleep apnoea. *Clinical Science* 1999; 97(4):467-473.
 77. Zamarron C, Gude F, Barcala J, Rodriguez JR, Romero PV. Utility of oxygen saturation and heart rate spectral analysis obtained from pulse oximetric recordings in the diagnosis of sleep apnea syndrome. *Chest* 2003; 123(5):1567-1576.
 78. Zou D, Grote L, Peker Y, Lindblad U, Hedner J. Validation a portable monitoring device for sleep apnea diagnosis in a population based cohort using synchronized home polysomnography. *Sleep* 2006; 29(3):367-374.
 79. Chung KF. Half-night polysomnography: how is it compared to full-night polysomnography? *Eur Respir J* 1998; 12(3):748-749.
 80. Fanfulla F, Patruno V, Bruschi C, Rampulla C. Obstructive sleep apnoea syndrome: is the "half-night polysomnography" an adequate method for evaluating sleep profile and respiratory events? *Eur Respir J* 1997; 10(8):1725-1729.
 81. Sanders MH, Black J, Costantino JP, et al. Diagnosis of sleep-disordered breathing by half-night polysomnography. *Am Rev Respir Dis* 1991; 144(6):1256-1261.
 82. Calleja JM, Esnaola S, Rubio R, Duran J. Comparison of a cardiorespiratory device versus polysomnography for diagnosis of sleep apnoea. *European Respiratory Journal* 2002; 20(6):1505-1510.
 83. Claman D, Murr A, Trotter K. Clinical validation of the Bedbug in detection of obstructive sleep apnea. *Otolaryngol Head Neck Surg* 2001; 125(3):227-230.
 84. Fietze I, Glos M, Rottig J, Witt C. Automated analysis of data is inferior to visual analysis of ambulatory sleep apnea monitoring. *Respiration* 2002; 69(3):235-241.
 85. Ayas NT, Pittman S, MacDonald M, White DP. Assessment of a wrist-worn device in the detection of obstructive sleep apnea. *Sleep Medicine* 2003; 4(5):435-442.

86. Schafer H, Ewig S, Hasper E, Luderitz B. Predictive diagnostic value of clinical assessment and nonlaboratory monitoring system recordings in patients with symptoms suggestive of obstructive sleep apnea syndrome. *Respiration* 1997; 64(3):194-199.
87. Bearpark H, Elliott L, Grunstein R, et al. Snoring and sleep apnea. A population study in Australian men. *American Journal of Respiratory & Critical Care Medicine* 1995; 151(5):1459-1465.
88. Bednarek M, Plywaczewski R, Jonczak L, Zielinski J. There is no relationship between chronic obstructive pulmonary disease and obstructive sleep apnea syndrome: a population study. *Respiration* 2005; 72(2):142-149.
89. Golpe R, Jimenez A, Carpizo R. Home sleep studies in the assessment of sleep apnea/hypopnea syndrome. *Chest* 2002; 122(4):1156-1161.
90. Middelkoop HA, Knuistingh NA, van Hilten JJ, Ruwhof CW, Kamphuisen HA. Wrist actigraphic assessment of sleep in 116 community based subjects suspected of obstructive sleep apnoea syndrome. *Thorax* 1995; 50(3):284-289.
91. Quintana-Gallego E, Villa-Gil M, Carmona-Bernal C, et al. Home respiratory polygraphy for diagnosis of sleep-disordered breathing in heart failure. *European Respiratory Journal* 2004; 24(3):443-448.
92. Westbrook PR, Levendowski DJ, Cvetinovic M, et al. Description and validation of the apnea risk evaluation system: a novel method to diagnose sleep apnea-hypopnea in the home. *Chest* 2005; 128(4):2166-2175.
93. Whittle AT, Finch SP, Mortimore IL, Mackay TW, Douglas NJ. Use of home sleep studies for diagnosis of the sleep apnoea/hypopnoea syndrome. *Thorax* 1997; 52(12):1068-1073.
94. Williams AJ, Yu G, Santiago S, Stein M. Screening for sleep apnea using pulse oximetry and a clinical score. *Chest* 1991; 100(3):631-635.
95. Fletcher EC, Stich J, Yang KL. Unattended home diagnosis and treatment of obstructive sleep apnea without polysomnography. *Arch Fam Med* 2000; 9(2):168-174.
96. Flemons WW, Douglas NJ, Kuna ST, Rodenstein DO, Wheatley J. Access to diagnosis and treatment of patients with suspected sleep apnea. *Am J Respir Crit Care Med* 2004; 169(6):668-672.
97. Pittsley M, Gehrman P, Cohen-Zion M, et al. Comparing night-to-night variability of sleep measures in elderly African Americans and Whites. *Behav Sleep Med* 2005; 3(2):63-72.
98. Li AM, Wing YK, Cheung A, et al. Is a 2-night polysomnographic study necessary in childhood sleep-related disordered breathing? *Chest* 2004; 126(5):1467-1472.
99. Chu H, Cole SR. Bivariate meta-analysis of sensitivity and specificity with sparse data: a generalized linear mixed model approach. *J Clin Epidemiol* 2006; 59(12):1331-1332.
100. Harbord RM, Deeks JJ, Egger M, Whiting P, Sterne JA. A unification of models for meta-analysis of diagnostic accuracy studies. *Biostatistics* 2007; 8(2):239-251.
101. Rutter CM, Gatsonis CA. A hierarchical regression approach to meta-analysis of diagnostic test accuracy evaluations. *Stat Med* 2001; 20(19):2865-2884.
102. Lloberes P, Montserrat JM, Ascaso A, et al. Comparison of partially attended night time respiratory recordings and full polysomnography in patients with suspected sleep apnoea/hypopnoea syndrome. *Thorax* 1996; 51(10):1043-1047.
103. Orr WC, Eiken T, Pegram V, Jones R, Rundell OH. A laboratory validation

- study of a portable system for remote recording of sleep-related respiratory disorders. *Chest* 1994; 105(1):160-162.
104. Stoohs R, Guilleminault C. MESAM 4: an ambulatory device for the detection of patients at risk for obstructive sleep apnea syndrome (OSAS). *Chest* 1992; 101(5):1221-1227.
 105. Hutter DA, Holland BK, Ashtyani H. Occult sleep apnea: the dilemma of negative polysomnography in symptomatic patients. *Sleep Med* 2004; 5(5):501-506.
 106. Le Bon O., Hoffmann G, Tecco J, et al. Mild to moderate sleep respiratory events: one negative night may not be enough. *Chest* 2000; 118(2):353-359.
 107. Quan SF, Griswold ME, Iber C, et al. Short-term variability of respiration and sleep during unattended nonlaboratory polysomnography--the Sleep Heart Health Study. *Sleep* 2002; 25(8):843-849.
 108. Mulgrew AT, Fox N, Ayas NT, Ryan CF. Diagnosis and initial management of obstructive sleep apnea without polysomnography: a randomized validation study. *Annals of Internal Medicine* 2007; 146(3):157-166.
 109. Shariq K. Sleep centers in the U.S. reach 2515 in 2004. *Sleep* 2005; 28(1):145-146.
 110. Johns MW. A new method for measuring daytime sleepiness: the Epworth sleepiness scale. *Sleep* 1991; 14(6):540-545.
 111. Wells GA, Tugwell P, Kraag GR, et al. Minimum important difference between patients with rheumatoid arthritis: the patient's perspective. *J Rheumatol* 1993; 20(3):557-560.
 112. Kosinski M, Zhao SZ, Dedhiya S, Osterhaus JT, Ware JE, Jr. Determining minimally important changes in generic and disease-specific health-related quality of life questionnaires in clinical trials of rheumatoid arthritis. *Arthritis Rheum* 2000; 43(7):1478-1487.
 113. Mehra R, Strohl KP. Incidence of serious adverse events during nocturnal polysomnography.[see comment]. *Sleep* 2004; 27(7):1379-1383.
 114. Bonis PA, Trikalinos TA, Chung M, et al. Hereditary nonpolyposis colorectal cancer: diagnostic strategies and their implications. *Evid Rep Technol Assess (Full Rep)* 2007;(150):1-180.
 115. Pelletier-Fleury N, Meslier N, Gagnadoux F, et al. Economic arguments for the immediate management of moderate-to-severe obstructive sleep apnoea syndrome. *Eur Respir J* 2004; 23(1):53-60.
 116. Mulherin SA, Miller WC. Spectrum bias or spectrum effect? Subgroup variation in diagnostic test evaluation. *Ann Intern Med* 2002; 137(7):598-602.
 117. Bennett LS, Langford BA, Stradling JR, Davies RJ. Sleep fragmentation indices as predictors of daytime sleepiness and nCPAP response in obstructive sleep apnea. *Am J Respir Crit Care Med* 1998; 158(3):778-786.
 118. d'Ortho MP, Grillier-Lanoir V, Levy P, et al. Constant vs. automatic continuous positive airway pressure therapy: home evaluation. *Chest* 2000; 118(4):1010-1017.
 119. Hermida RC, Zamarron C, Ayala DE, Calvo C. Effect of continuous positive airway pressure on ambulatory blood pressure in patients with obstructive sleep apnoea. *Blood Pressure Monitoring* 2004; 9(4):193-202.
 120. Lloberes P, Marti S, Sampol G, et al. Predictive factors of quality-of-life improvement and continuous positive airway pressure use in patients with sleep apnea-hypopnea syndrome: study at 1 year. *Chest* 2004; 126(4):1241-1247.

121. Marrone O, Salvaggio A, Bonsignore MR, Insalaco G, Bonsignore G. Blood pressure responsiveness to obstructive events during sleep after chronic CPAP. *European Respiratory Journal* 2003; 21(3):509-514.
122. Nosedá A, Kempenaers C, Kerkhofs M, Houben JJ, Linkowski P. Sleep apnea after 1 year domiciliary nasal-continuous positive airway pressure and attempted weight reduction. Potential for weaning from continuous positive airway pressure. *Chest* 1996; 109(1):138-143.
123. Nosedá A, Jann E, Hoffmann G, Linkowski P, Kerkhofs M. Compliance with nasal continuous positive airway pressure assessed with a pressure monitor: pattern of use and influence of sleep habits. *Respiratory Medicine* 2000; 94(1):76-81.
124. Whitelaw WA, Brant RF, Flemons WW. Clinical usefulness of home oximetry compared with polysomnography for assessment of sleep apnea.[see comment]. *American Journal of Respiratory & Critical Care Medicine* 2005; 171(2):188-193.
125. Flemons WW, Reimer MA. Measurement properties of the calgary sleep apnea quality of life index. *Am J Respir Crit Care Med* 2002; 165(2):159-164.

Appendix A – Modeling details for the different strategies

This Appendix provides the actual architecture of the modeled strategies, using a “decision tree” layout. It consists of a series of figures that show the possible health states and the corresponding transition probabilities. The values of the transition probabilities, the range of the corresponding sensitivity analyses, and a discussion of the different assumptions are provided in the main text of this technology assessment.

Table of contents for figures in Appendix A

Figure A1: Overview of the 7 strategies	3
Figure A2: Strategy 2 (DxPSG, TxPSG), people with OSAHS	4
Figure A3: Strategy 2 (DxPSG, TxPSG), people without OSAHS	5
Figure A4: Strategy 3 (Split-Night PSG), people with OSAHS	6
Figure A5: Strategy 3 (Split-Night PSG), people without OSAHS	7
Figure A6: Strategy 4 (HomeDx, SpNPSG(+)), people with OSAHS	8
Figure A7: Strategy 4 (HomeDx, SpNPSG(+)), people without OSAHS	9
Figure A8: Strategy 5 (HomeDx, SpNPSG(-)), people with OSAHS	10
Figure A9: Strategy 5 (HomeDx, SpNPSG(-)), people without OSAHS	11
Figure A10: Strategy 6 (HomeDx, autoCPAP), people with OSAHS	12
Figure A11: Strategy 6 (HomeDx, autoCPAP), people without OSAHS	13

A brief description of the strategies is the following:

- **Strategy 1** (“None on CPAP). None in the hypothetical cohort will ever be tested for OSAHS or offered CPAP treatment. This is one extreme scenario that has been included for comparison.
- **Strategy 2** (“DxPSG, TxPSG”). All people in the hypothetical cohort will receive a diagnostic session (DxPSG) in the sleep laboratory. If the exam is positive, a second session for CPAP level titration will be scheduled.
- **Strategy 3** (“Split-Night PSG”). All people in the hypothetical cohort will be assessed with split-night studies in the sleep lab. If the first half of the exam is positive, the second half is used to titrate the CPAP level. If the first half of the exam is negative no CPAP titration is attempted.
- **Strategy 4** (“HomeDx, SpNPSG(+)"). All people in the hypothetical cohort will be assessed in the home setting with portable sleep monitors (HomeDx). Those with *positive diagnoses* (indexed by the “+” sign in the name of the strategy) will be subjected to split-night studies in the sleep laboratory, to verify the diagnosis and to titrate CPAP level (if applicable). This is a combination of strategies 3 and 6 (see below).
- **Strategy 5** (“HomeDx, SpNPSG(-)"). This is similar to Strategy 4 in structure, but here people with *positive diagnoses* in the home setting are offered CPAP level titration, and people with *negative diagnoses* in the home setting will be re-evaluated with split-night studies in the lab (to minimize the number of people with OSAHS who have been missed as false negatives).

- **Strategy 6** (“HomeDx, autoCPAP”). The whole hypothetical cohort is managed entirely outside the sleep laboratory. Portable monitoring in the home setting (“HomeDx”) is used for the diagnosis, and auto-titration of CPAP is attempted again in the home setting on a different night.
- **Strategy 7** (“All on CPAP”). The whole cohort will be offered CPAP treatment (with auto-titration or empirical titration of the pressure level). In this scenario none is tested for OSAHS. This is the other extreme scenario that has been included for comparison.

Figure A1: Overview of the 7 strategies

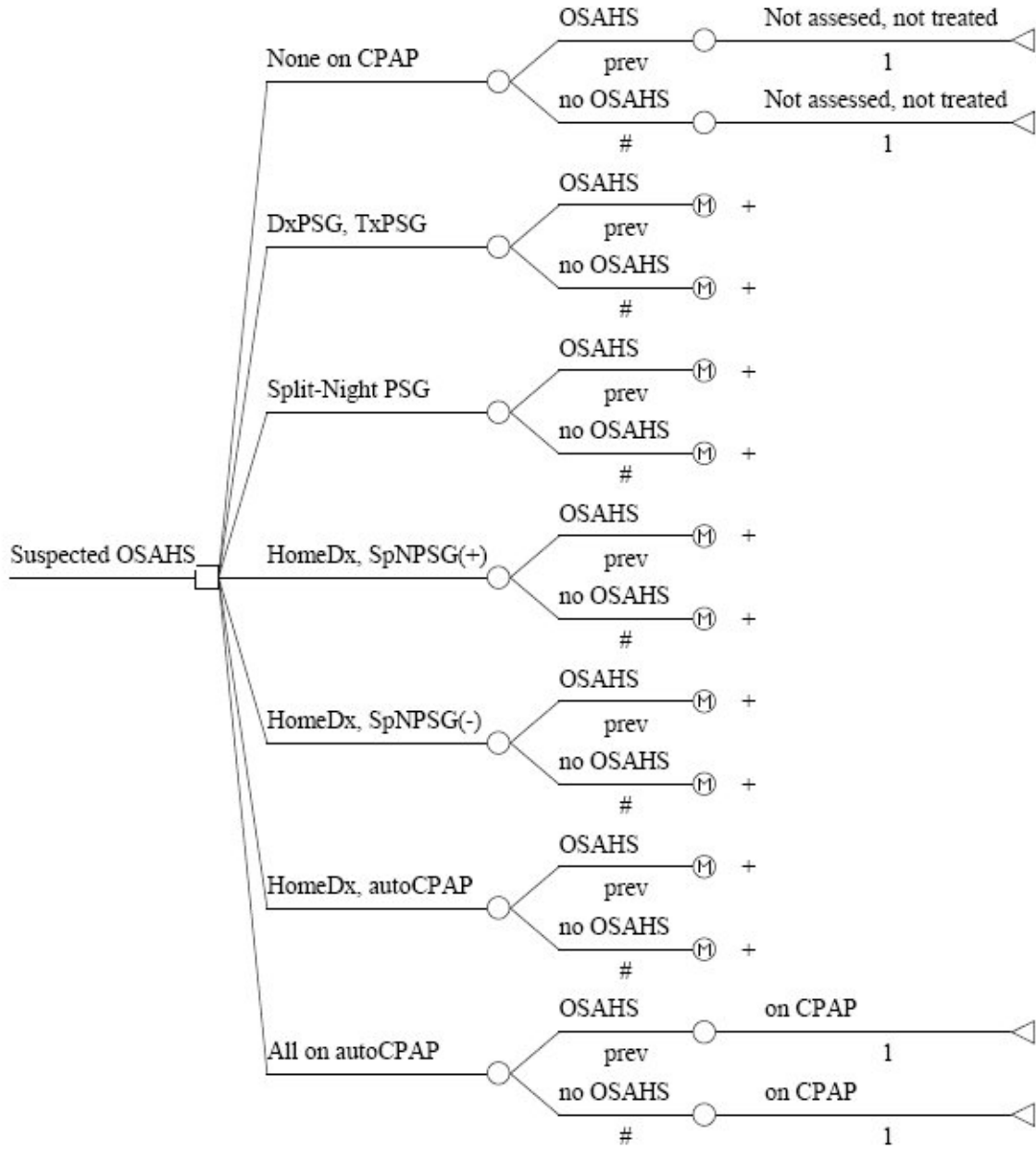

Figure A2: Strategy 2 (DxPSG, TxPSG), people with OSAHS

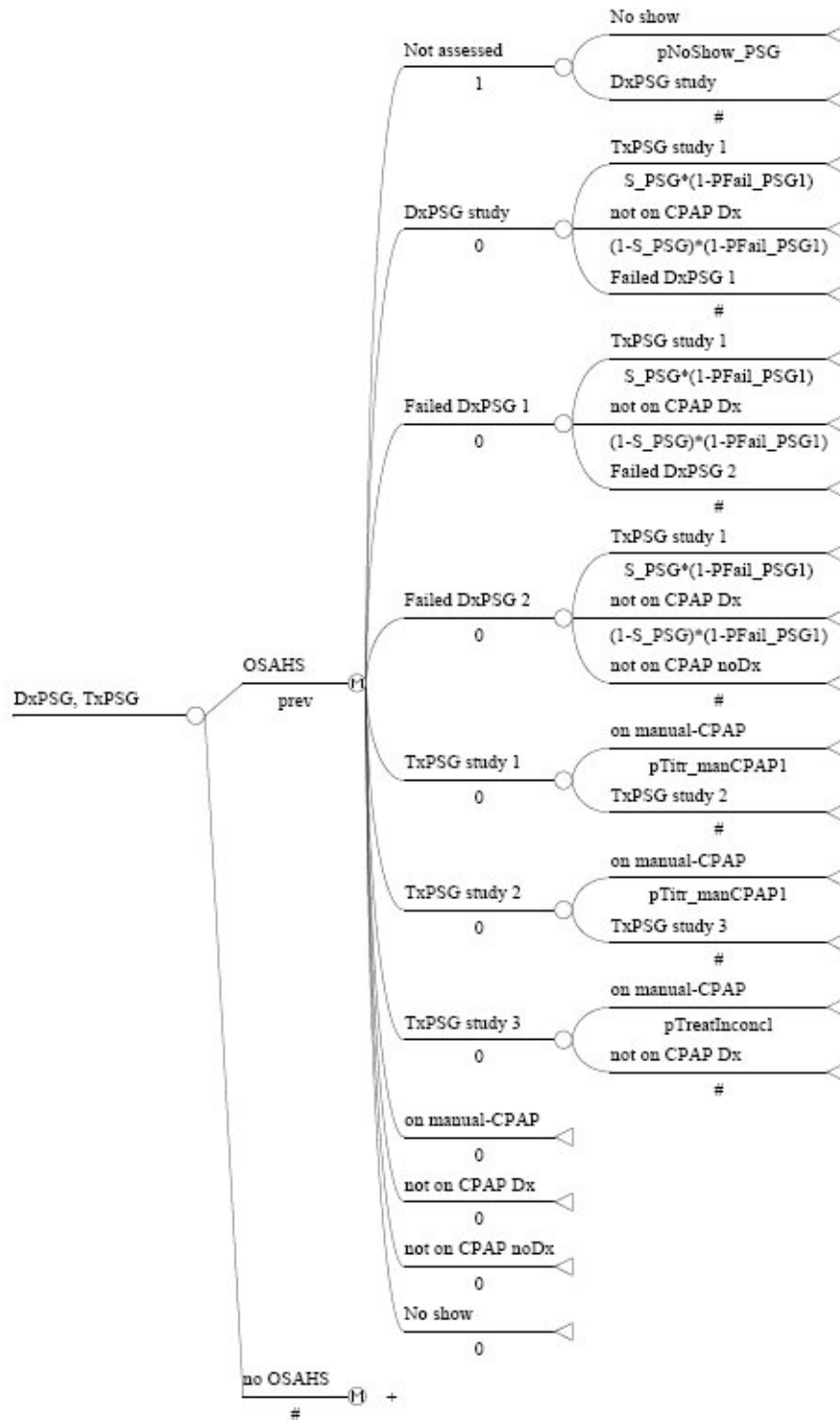

Figure A3: Strategy 2 (DxPSG, TxPSG), people without OSAHS

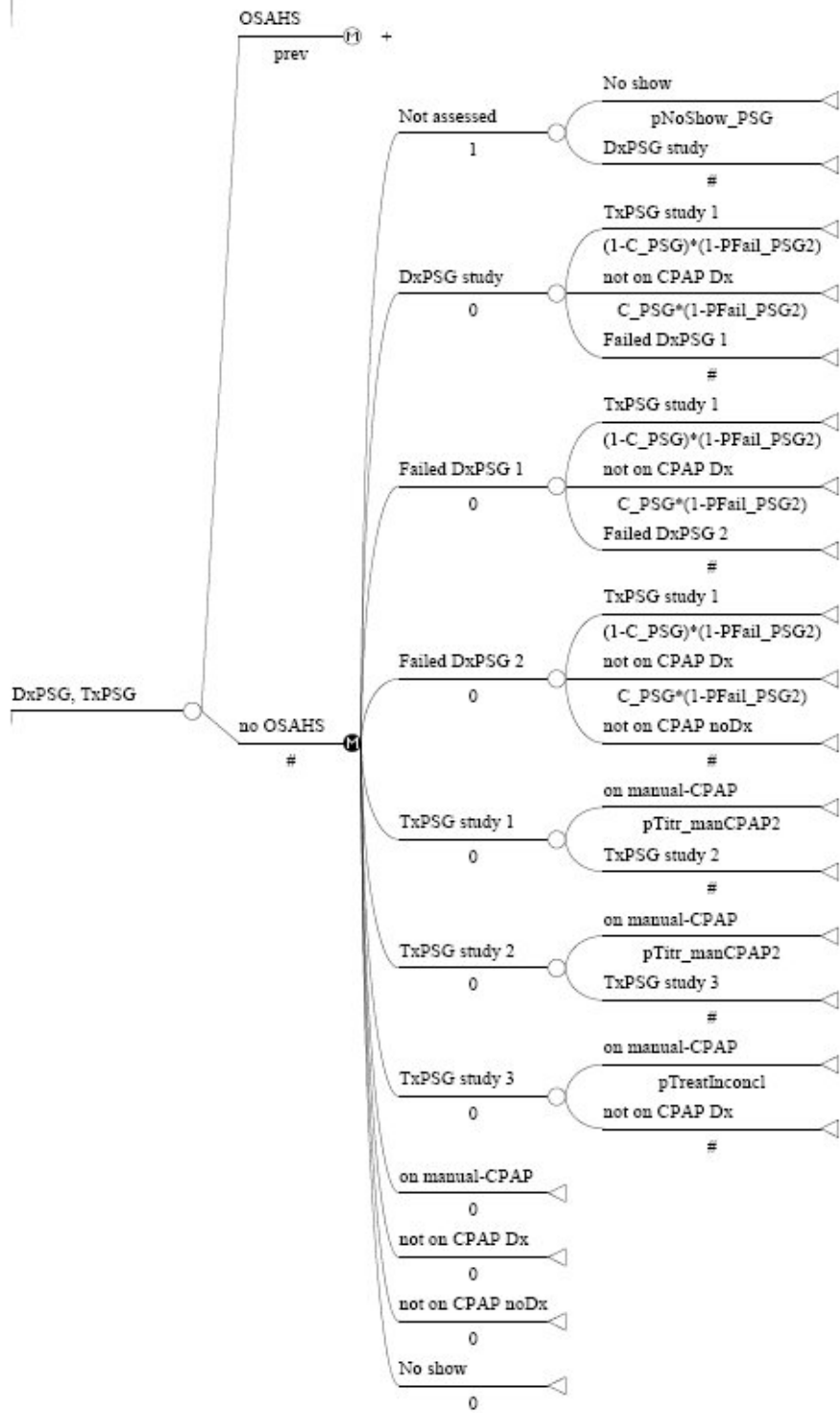

Figure A4: Strategy 3 (Split-Night PSG), people with OSAHS

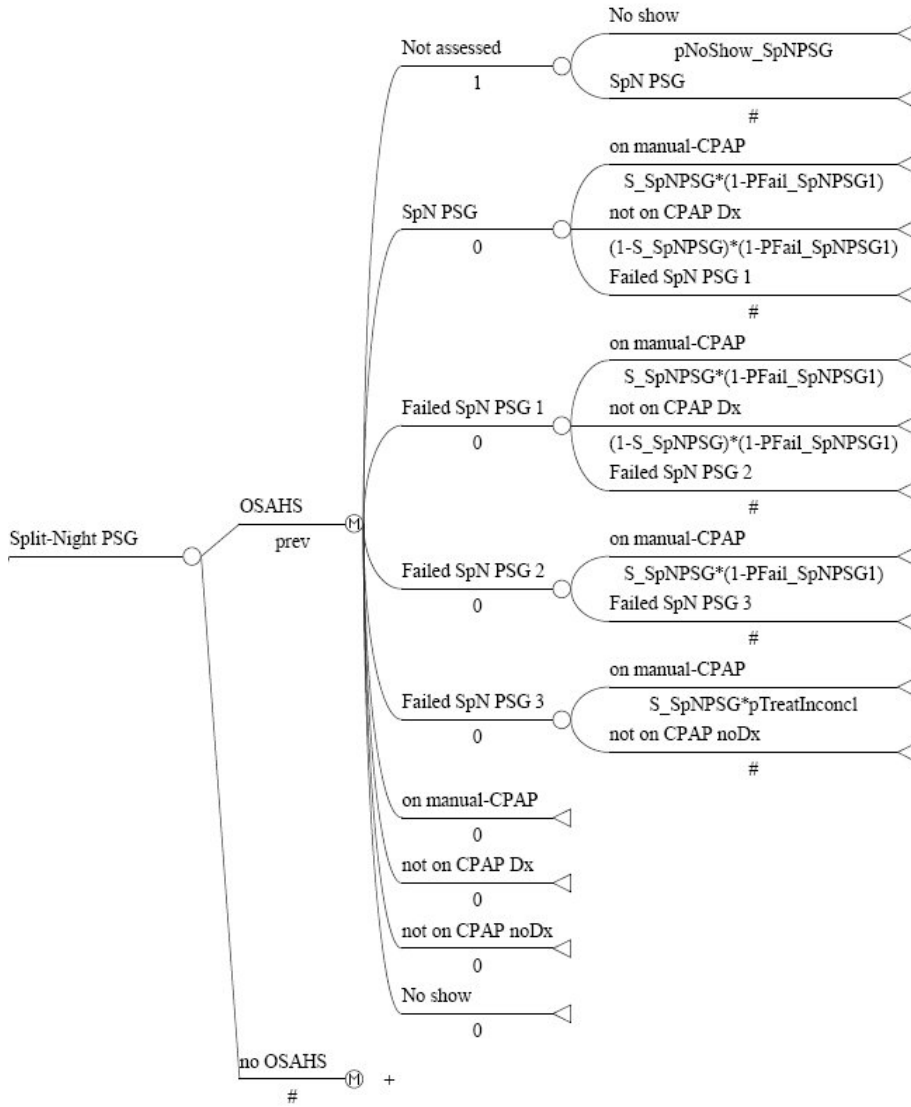

Figure A5: Strategy 3 (Split-Night PSG), people without OSAHS

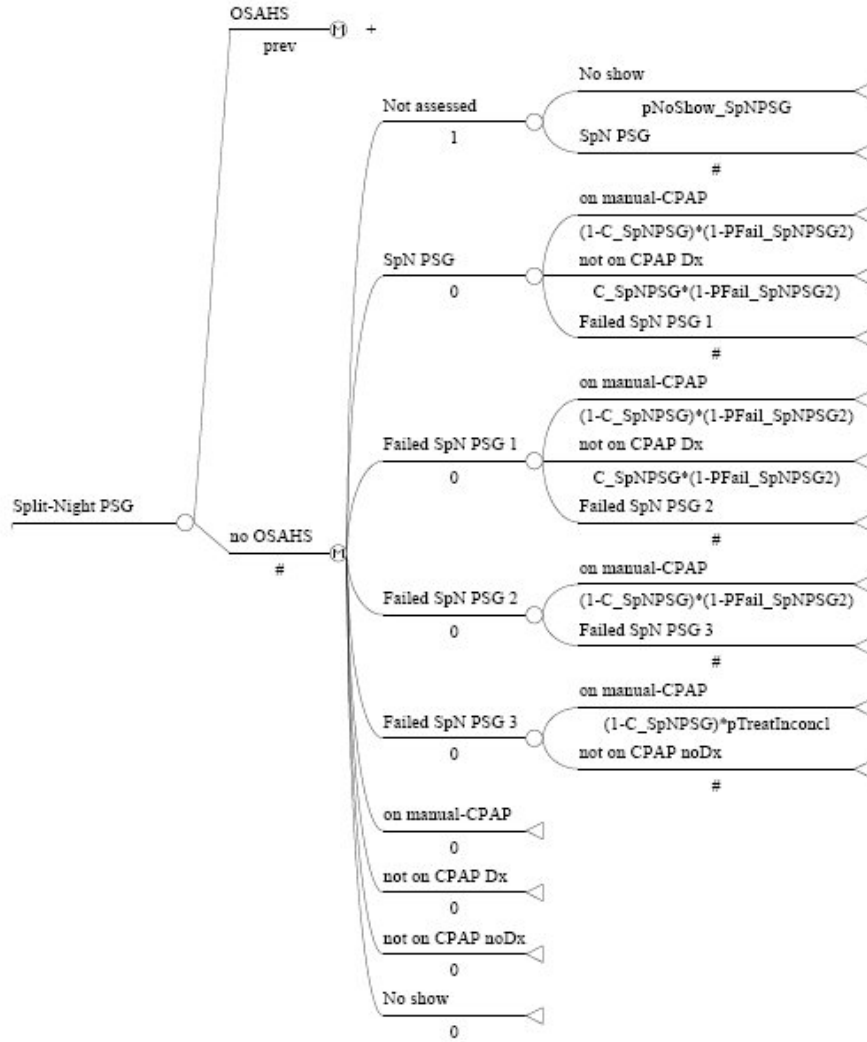

Figure A6: Strategy 4 (HomeDx, SpNPSG(+)), people with OSAHS

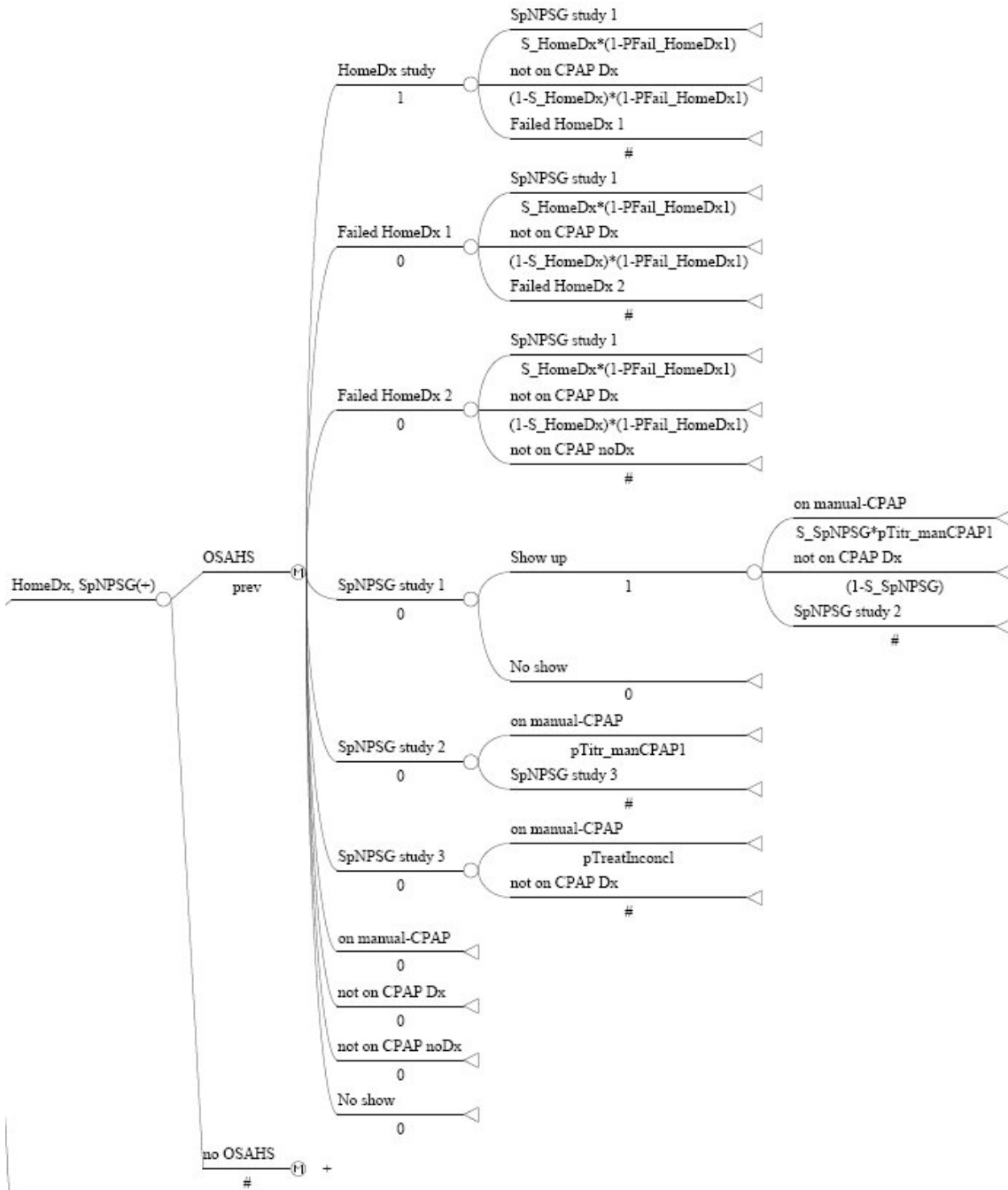

Figure A7: Strategy 4 (HomeDx, SpNPSG(+)), people without OSAHS

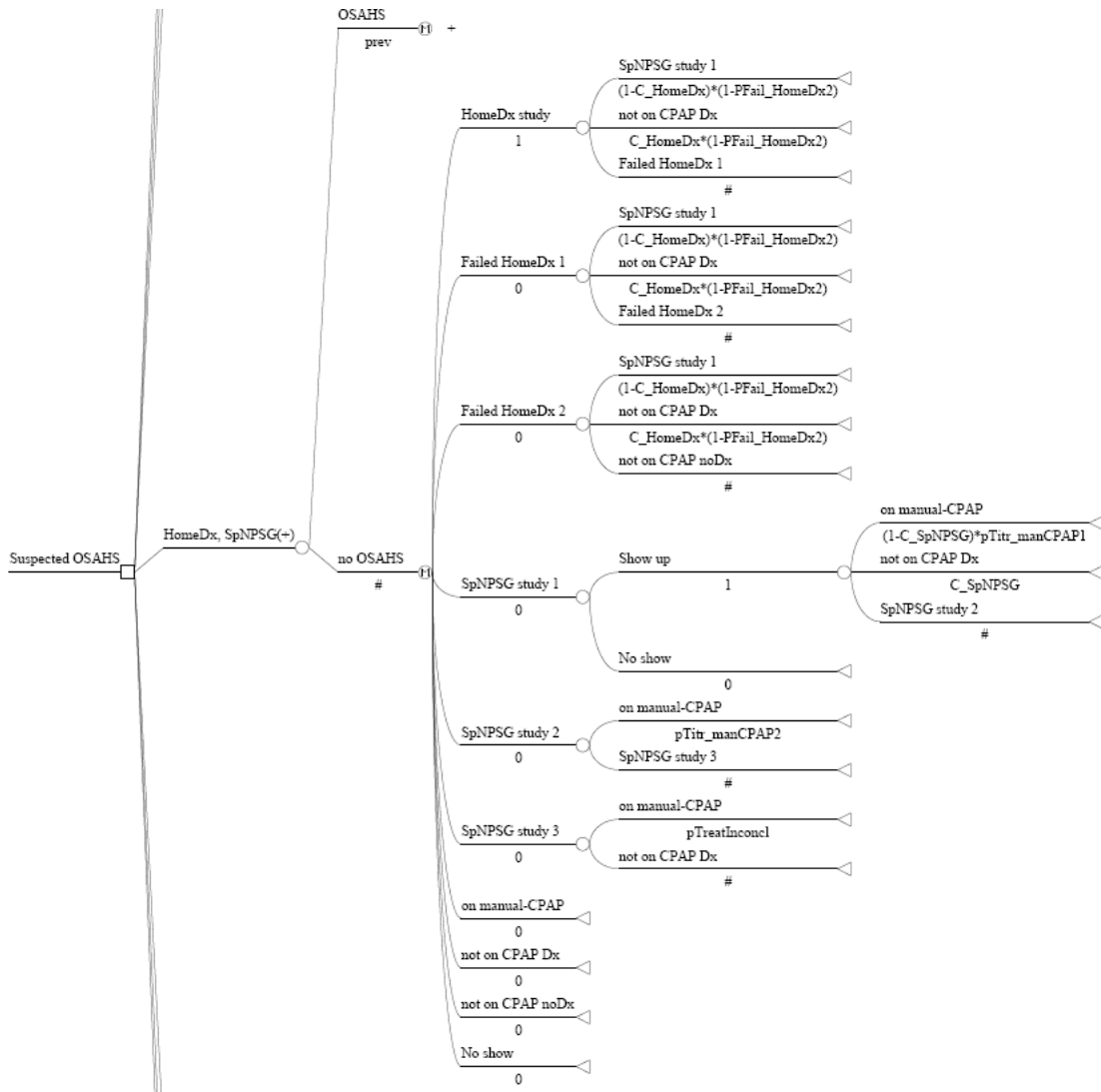

Figure A8: Strategy 5 (HomeDx, SpNPSG(-)), people with OSAHS

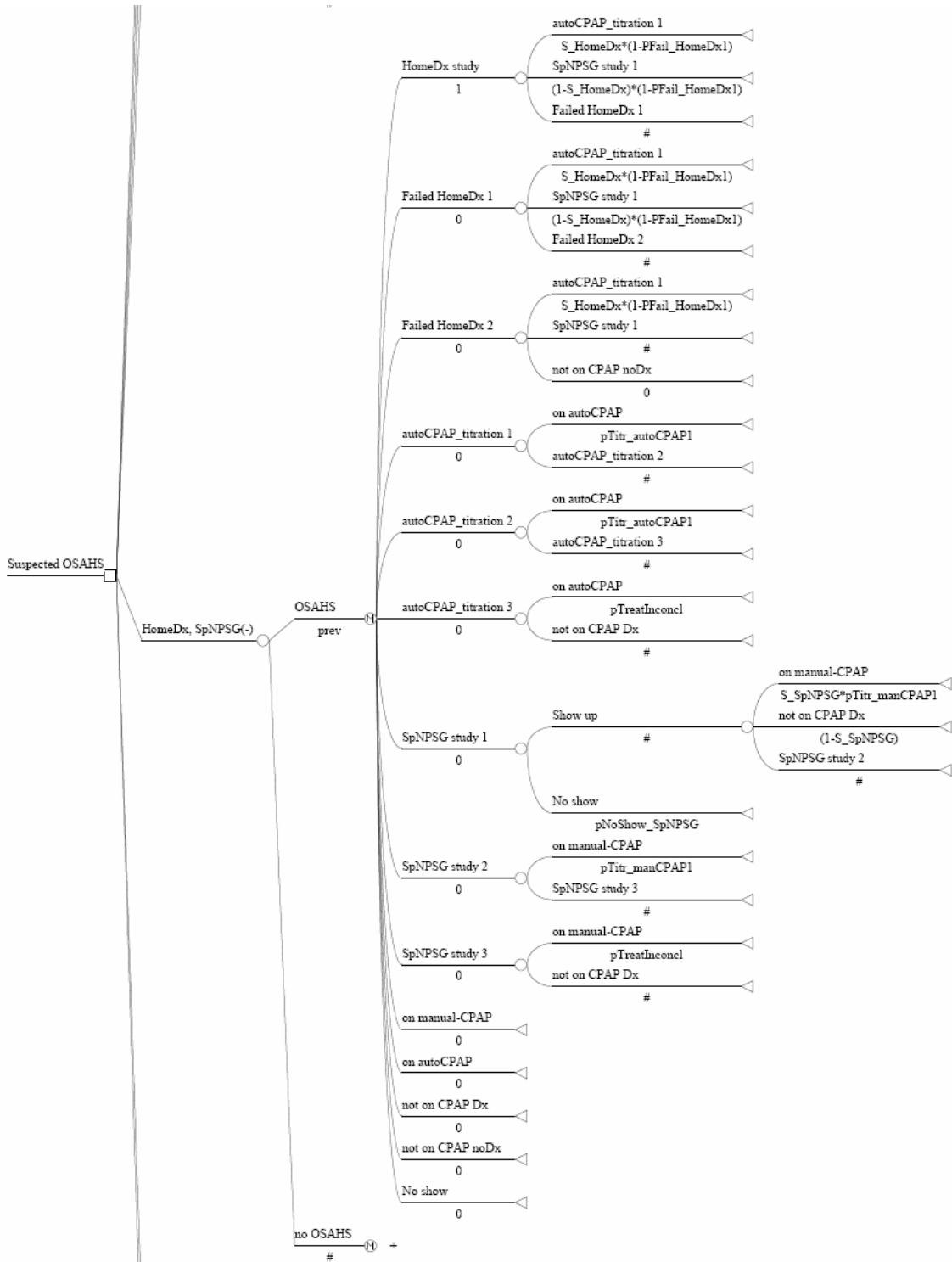

Figure A9: Strategy 5 (HomeDx, SpNPSG(-)), people without OSAHS

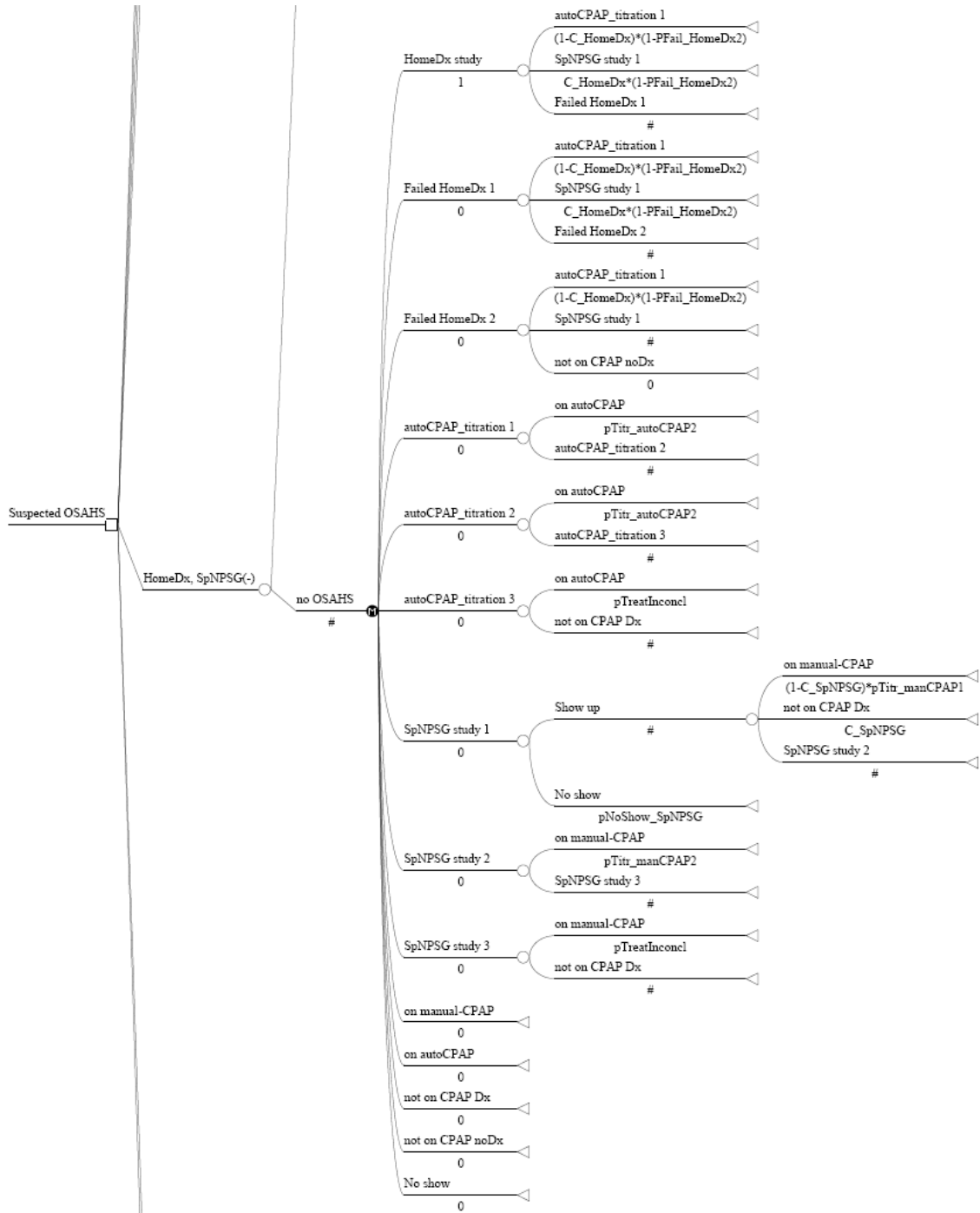

Figure A10: Strategy 6 (HomeDx, autoCPAP), people with OSAHS

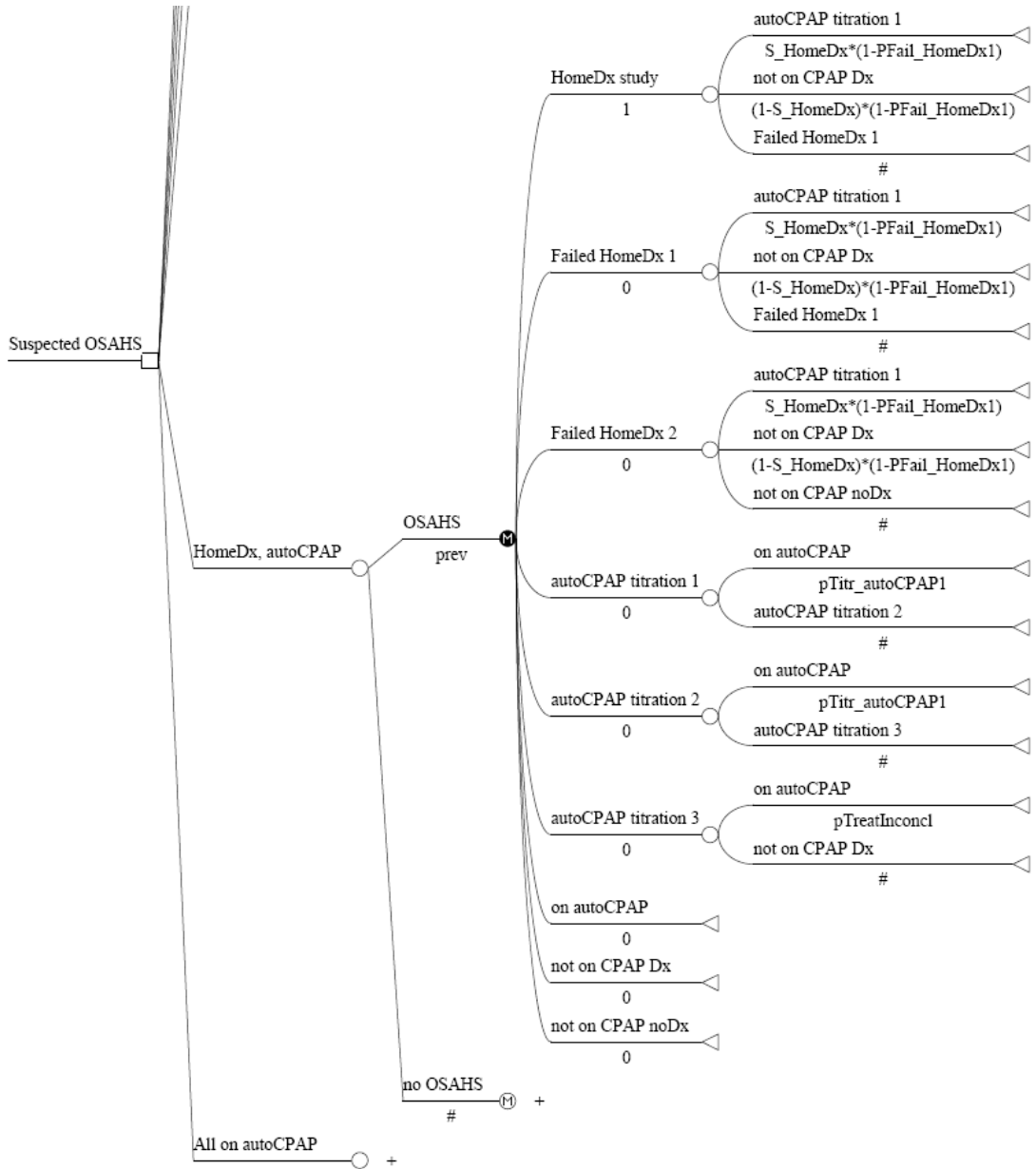
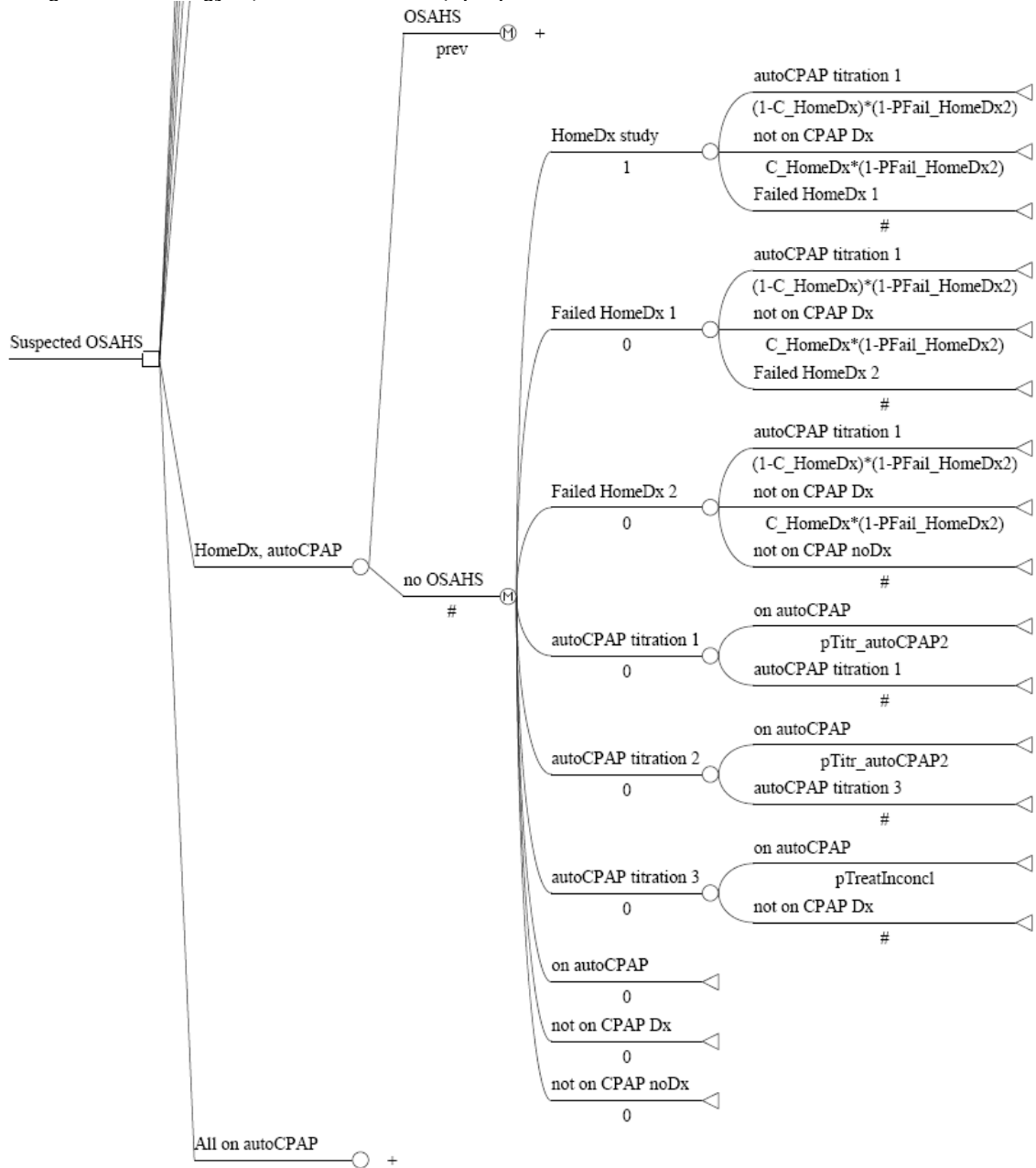

Figure A11: Strategy 6 (HomeDx, autoCPAP), people without OSAHS



Appendix B. Calculating the average waiting time for a sleep study

This appendix shows how one calculate the mean waiting time for a sleep study the lab in strategies 3, 4 and 5 (see text for a description of the various strategies) if one knows the corresponding mean waiting time in strategy 2.

More specifically:

The mean waiting time for a sleep study with different strategies will vary. The capacity of the sleep labs (i.e., the number of sleep studies they can perform in a certain time period) is fixed. However, in different strategies the total number of sleep studies differs, and this results in different workload for the sleep labs.

Sleep lab kinetics

Assuming a fixed capacity for sleep labs means that every week a given number of sleep studies can be performed. We call C the number of sleep studies that can be performed in a time cycle (a week).

Let N_0^{Str2} be the total number of sleep studies (either diagnostic or for CPAP level titration) that will be performed for the hypothetical cohort of 100,000 people in strategy 2. A single person may receive more than one sleep study in strategy 2 (i.e., after a positive diagnostic study one would receive at least one CPAP level titration study).

At each time point t (weeks) the number of remaining sleep studies is

$$N_t^{Str2} = \begin{cases} N_0^{Str2} - C \cdot t, & 0 < t \leq \frac{N_0^{Str2}}{C} \\ 0, & t > \frac{N_0^{Str2}}{C} \end{cases} \quad (1)$$

In Equation (1) the rate at which the (unperformed) sleep studies decrease is:

$$\frac{dN_t^{Str2}}{dt} = -C \quad (2)$$

for appropriate values of t .

Equations (1) and (2) describe the kinetics of the sleep labs. Namely, the kinetics of the sleep labs follows a “zero-order” law (i.e., a linear decrease). Because the capacity of the sleep labs is fixed, the rate will always be $-C$ in all strategies that utilize sleep labs.

Average waiting time for a sleep study in the lab setting

From Equation (1) it follows that all sleep studies will have been performed within time T_{\max}^{Str2} :

$$T_{\max}^{Str2} = \frac{N_0^{Str2}}{C} \quad (3)$$

For “zero-order” kinetics, the distribution of waiting times for a sleep study is uniform between 0 and T_{\max}^{Str2} . Therefore, the mean waiting time per sleep study in strategy 2 is:

$$\bar{T}^{Str2} = \frac{T_{\max}^{Str2}}{2} = \frac{N_0^{Str2}}{2C} \quad (4)$$

This quantity is known from the literature search. As mentioned in the text of the technology assessment the mean waiting time was set to 13 weeks for a sleep study in the lab setting.

Following similar rationale, the mean waiting time per sleep study in the lab in strategy 3 or 4 (the other strategies that use sleep labs in the management of people suspected for OSAHS) would be (e.g., for strategy 3):

$$\bar{T}^{Str3} = \frac{N_0^{Str3}}{2C} \quad (5)$$

From equations (4) and (5) we can estimate the mean waiting time in strategy 3

$$\bar{T}^{Str3} = \frac{N_0^{Str3}}{N_0^{Str2}} \cdot \bar{T}^{Str2} \quad (6)$$

and similarly for strategies 4 and 5:

$$\bar{T}^{Str4} = \frac{N_0^{Str4}}{N_0^{Str2}} \cdot \bar{T}^{Str2} \quad (7)$$

$$\bar{T}^{Str5} = \frac{N_0^{Str5}}{N_0^{Str2}} \cdot \bar{T}^{Str2} \quad (8)$$

Therefore, as long as we count how many sleep lab studies are expected in strategies 2, 3, 4 and 5 for 100,000 people, we can estimate the mean waiting time in strategies 3, 4 and 5 based on the mean waiting time in strategy 2.

Appendix C. Table of eligible studies

The following citations have been deemed eligible after full text review. They are listed in alphabetical order (by first author's surname).

Appendix Table. Citations of included publications

Citation	PMID
Adachi, H., Mikami, A., Kumano-go, T., Suganuma, N., Matsumoto, H., Shigedo, Y., Sugita, Y., and Takeda, M. Clinical significance of pulse rate rise during sleep as a screening marker for the assessment of sleep fragmentation in sleep-disordered breathing.[see comment]. <i>Sleep Medicine</i> 2003. 4 (6):537-542.	14607348
Alvarez, D., Hornero, R., Abasolo, D., del Campo F., and Zamarron, C. Nonlinear characteristics of blood oxygen saturation from nocturnal oximetry for obstructive sleep apnoea detection. <i>Physiological Measurement</i> 2006. 27 (4):399-412.	16537981
Ancoli-Israel, S., Mason, W., Coy, T. V., Stepnowsky, C., Clausen, J. L., and Dimsdale, J. Evaluation of sleep disordered breathing with unattended recording: the Nightwatch System. <i>Journal of Medical Engineering & Technology</i> 1997. 21 (1):10-14.	9080356
Ayappa, I., Norman, R. G., Suryadevara, M., and Rapoport, D. M. Comparison of limited monitoring using a nasal-cannula flow signal to full polysomnography in sleep-disordered breathing. <i>Sleep</i> 2004. 27 (6):1171-1179.	15532212
Ayas, N. T., Pittman, S., MacDonald, M., and White, D. P. Assessment of a wrist-worn device in the detection of obstructive sleep apnea. <i>Sleep Medicine</i> 2003. 4 (5):435-442.	14592285
Bagnato, M. C., Nery, L. E., Moura, S. M., Bittencourt, L. R., and Tufik, S. Comparison of AutoSet and polysomnography for the detection of apnea-hypopnea events. <i>Brazilian Journal of Medical & Biological Research</i> 2000. 33 (5):515-519.	10775882
Ballester, E., Solans, M., Vila, X., Hernandez, L., Quinto, L., Bolivar, I., Bardagi, S., and Montserrat, J. M. Evaluation of a portable respiratory recording device for detecting apnoeas and hypopnoeas in subjects from a general population. <i>European Respiratory Journal</i> 2000. 16 (1):123-127.	10933097
Baltzan, M. A., Verschelden, P., Al-Jahdali, H., Olha, A. E., and Kimoff, R. J. Accuracy of oximetry with thermistor (OxiFlow) for diagnosis of obstructive sleep apnea and hypopnea. <i>Sleep</i> 2000. 23 (1):61-69.	10678466
Bar, A., Pillar, G., Dvir, I., Sheffy, J., Schnall, R. P., and Lavie, P. Evaluation of a portable device based on peripheral arterial tone for unattended home sleep studies.[see comment]. <i>Chest</i> 2003. 123 (3):695-703.	12628865
Bearpark, H., Elliott, L., Grunstein, R., Cullen, S., Schneider, H., Althaus, W., and Sullivan, C. Snoring and sleep apnea. A population study in Australian men. <i>American Journal of Respiratory & Critical Care Medicine</i> 1995. 151 (5):1459-1465.	7735600
Bednarek, M., Plywaczewski, R., Jonczak, L., and Zielinski, J. There is no relationship between chronic obstructive pulmonary disease and obstructive sleep apnea syndrome: a population study. <i>Respiration</i> 2005. 72(2):142-149.	15824523
Bonsignore, G., Marrone, O., Macaluso, C., Salvaggio, A., Stallone, A., and Bellia, V. Validation of oximetry as a screening test for obstructive sleep apnoea syndrome. <i>European Respiratory Journal - Supplement</i> 1990. 11:542s-544s.	2278624
Bradley, P. A., Mortimore, I. L., and Douglas, N. J. Comparison of polysomnography with ResCare Autoset in the diagnosis of the sleep apnoea/hypopnoea syndrome. <i>Thorax</i> 1995. 50 (11):1201-1203.	8553279
Calleja, J. M., Esnaola, S., Rubio, R., and Duran, J. Comparison of a cardiorespiratory device versus polysomnography for diagnosis of sleep apnoea. <i>European Respiratory Journal</i> 2002. 20 (6):1505-1510.	12503711
Carrasco, O., Montserrat, J. M., Lloberes, P., Ascasco, C., Ballester, E., Fornas, C., and Rodriguez-Roisin, R. Visual and different automatic scoring profiles of respiratory variables in the diagnosis of sleep apnoea-hypopnoea syndrome. <i>European Respiratory Journal</i> 1996. 9 (1):125-130.	8834345
Chiner, E., Signes-Costa, J., Arriero, J. M., Marco, J., Fuentes, I., and Sergado, A. Nocturnal oximetry for the diagnosis of the sleep apnoea hypopnoea syndrome: a method to reduce the number of polysomnographies?[see comment]. <i>Thorax</i> 1999. 54 (11):968-971.	10525553
Chung, K. F. Half-night polysomnography: how is it compared to full-night polysomnography?	9762809

Citation	PMID
Eur Respir J 1998. 12 (3):749-749.	
Claman D, Murr A, Trotter K. Clinical validation of the Bedbug in detection of obstructive sleep apnea. <i>Otolaryngol Head Neck Surg</i> 2001; 125(3):227-230.	11555758
Cooper, B. G., Veale, D., Griffiths, C. J., and Gibson, G. J. Value of nocturnal oxygen saturation as a screening test for sleep apnoea. <i>Thorax</i> 1991. 46 (8):586-588.	1926029
Dingli, K., Coleman, E. L., Vennelle, M., Finch, S. P., Wraith, P. K., Mackay, T. W., and Douglas, N. J. Evaluation of a portable device for diagnosing the sleep apnoea/hypopnoea syndrome. <i>European Respiratory Journal</i> 2003. 21 (2):253-259.	12608438
Douglas, N. J., Thomas, S., and Jan, M. A. Clinical value of polysomnography.[see comment]. <i>Lancet</i> 1992. 339 (8789):347-350.	1346422
Emsellem, H. A., Corson, W. A., Rappaport, B. A., Hackett, S., Smith, L. G., and Hausfeld, J. N. Verification of sleep apnea using a portable sleep apnea screening device. <i>Southern Medical Journal</i> 1990. 83 (7):748-752.	2371595
Esnaola, S., Duran, J., Infante-Rivard, C., Rubio, R., and Fernandez, A. Diagnostic accuracy of a portable recording device (MESAM IV) in suspected obstructive sleep apnoea. <i>European Respiratory Journal</i> 1996. 9 (12):2597-2605.	8980975
Fanfulla, F., Patruno, V., Bruschi, C., and Rampulla, C. Obstructive sleep apnoea syndrome: is the "half-night polysomnography" an adequate method for evaluating sleep profile and respiratory events? <i>Eur Respir J</i> 1997. 10 (8):1725-1729.	9272910
Ficker JH, Wiest GH, Wilpert J, Fuchs FS, Hahn EG. Evaluation of a portable recording device (Somnocheck) for use in patients with suspected obstructive sleep apnoea. <i>Respiration</i> 2001; 68(3):307-312.	11416253
Fietze, I., Glos, M., Rottig, J., and Witt, C. Automated analysis of data is inferior to visual analysis of ambulatory sleep apnea monitoring. <i>Respiration</i> 2002. 69 (3):235-241.	12097767
Flemons, W. W., Whitelaw, W. A., Brant, R., and Remmers, J. E. Likelihood ratios for a sleep apnea clinical prediction rule. <i>American Journal of Respiratory & Critical Care Medicine</i> 1994. 150 (5:Pt 1):t-85.	7952553
Flemons, W.W., Douglas, N.J., Kuna, S.T., Rodenstein, D.O., and Wheatley, J. Access to diagnosis and treatment of patients with suspected sleep apnea. <i>Am J Respir Crit Care Med</i> 2004. 169 (6):668-672.	15003950
Fletcher, E. C., Stich, J., and Yang, K. L. Unattended home diagnosis and treatment of obstructive sleep apnea without polysomnography. <i>Archives Fam Med</i> 2000. 9 (2):168-174.	10693735
Fleury, B., Rakotonanahary, D., Hausser-Hauw, C., Lebeau, B., and Guilleminault, C. A laboratory validation study of the diagnostic mode of the Autoset system for sleep-related respiratory disorders. <i>Sleep</i> 1996. 19 (6):502-505.	8865509
Fry, J. M., DiPhillipo, M. A., Curran, K., Goldberg, R., and Baran, A. S. Full polysomnography in the home. <i>Sleep</i> 1998. 21 (6):635-642.	9779523
Gagnadoux, F., Pelletier-Fleury, N., Philippe, C., Rakotonanahary, D., and Fleury, B. Home unattended vs hospital telemonitored polysomnography in suspected obstructive sleep apnea syndrome: a randomized crossover trial. <i>Chest</i> 2002. 121 (3):753-758.	11888956
Golpe, R., Jimenez, A., and Carpizo, R. Home sleep studies in the assessment of sleep apnea/hypopnea syndrome. <i>Chest</i> 2002. 122 (4):1156-1161.	12377836
Gugger, M. Comparison of ResMed AutoSet (version 3.03) with polysomnography in the diagnosis of the sleep apnoea/hypopnoea syndrome. <i>European Respiratory Journal</i> 1997. 10 (3):587-591.	9072989
Gugger, M., Mathis, J., and Bassetti, C. Accuracy of an intelligent CPAP machine with in-built diagnostic abilities in detecting apnoeas: a comparison with polysomnography. <i>Thorax</i> 1995. 50 (11):1199-1201.	8553278
Gurubhagavatula, I., Maislin, G., Nkwuo, J. E., and Pack, A. I. Occupational screening for obstructive sleep apnea in commercial drivers. <i>American Journal of Respiratory & Critical Care Medicine</i> 2004. 170 (4):371-376.	15142866
Gyulay, S., Gould, D., Sawyer, B., Pond, D., Mant, A., and Saunders, N. Evaluation of a microprocessor-based portable home monitoring system to measure breathing during sleep. <i>Sleep</i> 1987. 10 (2):130-142.	3589326
Hedner, J., Pillar, G., Pittman, S. D., Zou, D., Grote, L., and White, D. P. A novel adaptive wrist actigraphy algorithm for sleep-wake assessment in sleep apnea patients. <i>Sleep</i> 2004. 27 (8):1560-1566.	15683148
Ip, M. S., Lam, B., Tang, L. C., Lauder, I. J., Ip, T. Y., and Lam, W. K. A community study of sleep-disordered breathing in middle-aged Chinese women in Hong Kong: prevalence and gender differences. <i>Chest</i> 2004. 125 (1):127-134.	14718431

Citation	PMID
Issa, F. G., Morrison, D., Hadjuk, E., Iyer, A., Feroah, T., and Remmers, J. E. Digital monitoring of sleep-disordered breathing using snoring sound and arterial oxygen saturation. <i>American Review of Respiratory Disease</i> 1993. 148 (4:Pt 1):t-9.	8214920
Kapur, V. K., Rapoport, D. M., Sanders, M. H., Enright, P., Hill, J., Iber, C., and Romaniuk, J. Rates of sensor loss in unattended home polysomnography: the influence of age, gender, obesity, and sleep-disordered breathing. <i>Sleep</i> 2000. 23 (5):682-688.	10947036
Kiely, J. L., Delahunty, C., Matthews, S., and McNicholas, W. T. Comparison of a limited computerized diagnostic system (ResCare Autoset) with polysomnography in the diagnosis of obstructive sleep apnoea syndrome. <i>European Respiratory Journal</i> 1996. 9 (11):2360-2364.	8947086
Koziej, M., Cieslicki, J. K., Gorzelak, K., Sliwinski, P., and Zielinski, J. Hand-scoring of MESAM 4 recordings is more accurate than automatic analysis in screening for obstructive sleep apnoea. <i>European Respiratory Journal</i> 1994. 7 (10):1771-1775.	7828683
Levy, P., Pepin, J. L., schaux-Blanc, C., Paramelle, B., and Brambilla, C. Accuracy of oximetry for detection of respiratory disturbances in sleep apnea syndrome. <i>Chest</i> 1996. 109 (2):395-399.	8620711
Lloberes, P., Montserrat, J. M., Ascaso, A., Parra, O., Granados, A., Alonso, P., Vilaseca, I., and Rodriguez-Roisin, R. Comparison of partially attended night time respiratory recordings and full polysomnography in patients with suspected sleep apnoea/hypopnoea syndrome. <i>Thorax</i> 1996. 51 (10):1043-1047.	8977607
Man, G. C. and Kang, B. V. Validation of a portable sleep apnea monitoring device. <i>Chest</i> 1995. 108 (2):388-393.	7634872
Margel, D., Cohen, M., Livne, P. M., and Pillar, G. Severe, but not mild, obstructive sleep apnea syndrome is associated with erectile dysfunction. <i>Urology</i> 2004. 63 (3):545-549.	15028455
Marrone, O., Salvaggio, A., Insalaco, G., Bonsignore, M. R., and Bonsignore, G. Evaluation of the POLYMESAM system in the diagnosis of obstructive sleep apnea syndrome. <i>Monaldi Archives for Chest Disease</i> 2001. 56 (6):486-490.	11980277
Masa, J. F., Rubio, M., and Findley, L. J. Habitually sleepy drivers have a high frequency of automobile crashes associated with respiratory disorders during sleep. <i>American Journal of Respiratory & Critical Care Medicine</i> 2000. 162 (4:Pt 1):t-12.	11029353
Mayer, P., Meurice, J. C., Philip-Joet, F., Cornette, A., Rakotonanahary, D., Meslier, N., Pepin, J. L., Levy, P., and Veale, D. Simultaneous laboratory-based comparison of ResMed Autoset with polysomnography in the diagnosis of sleep apnoea/hypopnoea syndrome. <i>European Respiratory Journal</i> 1998. 12 (4):770-775.	9817143
Michaelson, P. G., Allan, P., Chaney, J., Mair, E. A. Validations of a portable home sleep study with twelve-lead polysomnography: comparisons and insights into a variable gold standard. <i>Annals of Otolaryngology, Rhinology & Laryngology</i> 2006; 115 (11):802-809.	17165661
Middelkoop, H. A., Knuistingh, Neven A., van Hilten, J. J., Ruwhof, C. W., and Kamphuisen, H. A. Wrist actigraphic assessment of sleep in 116 community based subjects suspected of obstructive sleep apnoea syndrome. <i>Thorax</i> 1995. 50 (3):284-289.	7660344
Mykityn, I. J., Sajkov, D., Neill, A. M., and McEvoy, R. D. Portable computerized polysomnography in attended and unattended settings. <i>Chest</i> 1999. 115 (1):114-122.	9925071
Neven, A. K., Middelkoop, H. A., Kemp, B., Kamphuisen, H. A., and Springer, M. P. The prevalence of clinically significant sleep apnoea syndrome in The Netherlands. <i>Thorax</i> 1998. 53 (8):638-642.	9828848
Overland, B., Bruskeland, G., Akre, H., and Skatvedt, O. Evaluation of a portable recording device (Reggie) with actimeter and nasopharyngeal/esophagus catheter incorporated. <i>Respiration</i> 2005. 72 (6):600-605.	15988172
Pang, K. P., Dillard, T. A., Blanchard, A. R., Gourin, C. G., Podolsky, R., and Terris, D. J. A comparison of polysomnography and the SleepStrip in the diagnosis of OSA. <i>Otolaryngology - Head & Neck Surgery</i> 2006; 135 (2):265-268.	16890080
Parra, O., Garcia-Escasans, N., Montserrat, J. M., Garcia, Eroles L., Ruiz, J., Lopez, J. A., Guerra, J. M., and Sopena, J. J. Should patients with sleep apnoea/hypopnoea syndrome be diagnosed and managed on the basis of home sleep studies?[see comment]. <i>European Respiratory Journal</i> 1997. 10 (8):1720-1724.	9272909
Penzel, T., Kesper, K., Pinnow, I., Becker, H. F., and Vogelmeier, C. Peripheral arterial tonometry, oximetry and actigraphy for ambulatory recording of sleep apnea. <i>Physiological Measurement</i> 2004. 25 (4):1025-1036.	15382839
Pepin, J. L., Levy, P., Lepaulle, B., Brambilla, C., and Guilleminault, C. Does oximetry contribute to the detection of apneic events? Mathematical processing of the SaO2 signal. <i>Chest</i> 1991. 99 (5):1151-1157.	2019170

Citation	PMID
Pillar, G., Bar, A., Betito, M., Schnall, R. P., Dvir, I., Sheffy, J., and Lavie, P. An automatic ambulatory device for detection of AASM defined arousals from sleep: the WP100. <i>Sleep Medicine</i> 2003. 4 (3):207-212.	14592323
Pittman, S. D., Ayas, N. T., MacDonald, M. M., Malhotra, A., Fogel, R. B., and White, D. P. Using a wrist-worn device based on peripheral arterial tonometry to diagnose obstructive sleep apnea: in-laboratory and ambulatory validation. <i>Sleep</i> 2004. 27 (5):923-933.	15453551
Pittman, S. D., MacDonald, M. M., Fogel, R. B., Malhotra, A., Todros, K., Levy, B., Geva, A. B., and White, D. P. Assessment of automated scoring of polysomnographic recordings in a population with suspected sleep-disordered breathing. <i>Sleep</i> 2004. 27 (7):1394-1403.	15586793
Portier, F., Portmann, A., Czernichow, P., Vascaut, L., Devin, E., Benhamou, D., Cuvelier, A., and Muir, J. F. Evaluation of home versus laboratory polysomnography in the diagnosis of sleep apnea syndrome. <i>American Journal of Respiratory & Critical Care Medicine</i> 2000. 162 (3:Pt 1):t-8.	10988088
Quintana-Gallego, E., Villa-Gil, M., Carmona-Bernal, C., Botebol-Benhamou, G., Martinez-Martinez, A., Sanchez-Armengol, A., Polo-Padillo, J., and Capote, F. Home respiratory polygraphy for diagnosis of sleep-disordered breathing in heart failure. <i>European Respiratory Journal</i> 2004. 24 (3):443-448.	15358704
Rauscher, H., Popp, W., and Zwick, H. Quantification of sleep disordered breathing by computerized analysis of oximetry, heart rate and snoring. <i>European Respiratory Journal</i> 1991. 4 (6):655-659.	1889491
Rauscher, H., Popp, W., and Zwick, H. Model for investigating snorers with suspected sleep apnoea. <i>Thorax</i> 1993. 48 (3):275-279.	8497828
Redline, S., Tosteson, T., Boucher, M. A., and Millman, R. P. Measurement of sleep-related breathing disturbances in epidemiologic studies. Assessment of the validity and reproducibility of a portable monitoring device. <i>Chest</i> 1991. 100 (5):1281-1286.	1935282
Rees, K., Wraith, P. K., Berthon-Jones, M., and Douglas, N. J. Detection of apnoeas, hypopnoeas and arousals by the AutoSet in the sleep apnoea/hypopnoea syndrome. <i>European Respiratory Journal</i> 1998. 12 (4):764-769.	9817142
Reichert, J. A., Bloch, D. A., Cundiff, E., and Votteri, B. A. Comparison of the NovaSom QSG, a new sleep apnea home-diagnostic system, and polysomnography. <i>Sleep Medicine</i> 2003. 4 (3):213-218.	14592324
Ryan, P. J., Hilton, M. F., Boldy, D. A., Evans, A., Bradbury, S., Sapiano, S., Prowse, K., and Cayton, R. M. Validation of British Thoracic Society guidelines for the diagnosis of the sleep apnoea/hypopnoea syndrome: can polysomnography be avoided? <i>Thorax</i> 1995. 50 (9):972-975.	8539678
Sanders, M. H., Black, J., Costantino, J. P., Kern, N., Studnicki, K., and Coates, J. Diagnosis of sleep-disordered breathing by half-night polysomnography. <i>Am Rev Respir Dis</i> 1991. 144 (6): 1256-1261.	1741536
Schafer, H., Ewig, S., Hasper, E., and Luderitz, B. Predictive diagnostic value of clinical assessment and nonlaboratory monitoring system recordings in patients with symptoms suggestive of obstructive sleep apnea syndrome. <i>Respiration</i> 1997. 64 (3):194-199.	9154670
Series, F. and Marc, I. Nasal pressure recording in the diagnosis of sleep apnoea hypopnoea syndrome.[see comment]. <i>Thorax</i> 1999. 54 (6):506-510.	10335004
Series, F., Marc, I., Cormier, Y., and La, Forge J. Utility of nocturnal home oximetry for case finding in patients with suspected sleep apnea hypopnea syndrome.[see comment]. <i>Annals of Internal Medicine</i> 1993. 119 (6):449-453.	8357109
Shochat, T., Hadas, N., Kerkhofs, M., Herchuelz, A., Penzel, T., Peter, J. H., and Lavie, P. The SleepStrip: an apnoea screener for the early detection of sleep apnoea syndrome. <i>European Respiratory Journal</i> 2002. 19 (1):121-126.	11843310
Stoohs, R. and Guilleminault, C. MESAM 4: an ambulatory device for the detection of patients at risk for obstructive sleep apnea syndrome (OSAS). <i>Chest</i> 1992. 101 (5):1221-1227.	1582275
Su, S., Baroody, F. M., Kohrman, M., and Suskind, D. A comparison of polysomnography and a portable home sleep study in the diagnosis of obstructive sleep apnea syndrome. <i>Otolaryngology - Head & Neck Surgery</i> 2004. 131 (6):844-850.	15577778
Van Surell C., Lemaigre, D., Leroy, M., Foucher, A., Hagenmuller, M. P., and Raffestin, B. Evaluation of an ambulatory device, CID 102, in the diagnosis of obstructive sleep apnoea syndrome. <i>European Respiratory Journal</i> 1995. 8 (5):795-800.	7656952
Vazquez, J. C., Tsai, W. H., Flemons, W. W., Masuda, A., Brant, R., Hajduk, E., Whitelaw, W. A., and Remmers, J. E. Automated analysis of digital oximetry in the diagnosis of obstructive sleep apnoea. <i>Thorax</i> 2000. 55 (4):302-307.	10722770
Verse, T., Pirsig, W., Junge-Hulsing, B., and Kroker, B. Validation of the POLY-MESAM	10858392

Citation	PMID
seven-channel ambulatory recording unit. <i>Chest</i> 2000. 117 (6):1613-1618.	
Westbrook, P. R., Levendowski, D. J., Cvetinovic, M., Zavora, T., Velimirovic, V., Henninger, D., and Nicholson, D. Description and validation of the apnea risk evaluation system: a novel method to diagnose sleep apnea-hypopnea in the home. <i>Chest</i> 2005. 128 (4):2166-2175.	16236870
White, D. P., Gibb, T. J., Wall, J. M., and Westbrook, P. R. Assessment of accuracy and analysis time of a novel device to monitor sleep and breathing in the home.[see comment]. <i>Sleep</i> 1995. 18 (2):115-126.	7792491
Whittle, A. T., Finch, S. P., Mortimore, I. L., Mackay, T. W., and Douglas, N. J. Use of home sleep studies for diagnosis of the sleep apnoea/hypopnoea syndrome. <i>Thorax</i> 1997. 52 (12):1068-1073.	9516901
Williams, A. J., Yu, G., Santiago, S., and Stein, M. Screening for sleep apnea using pulse oximetry and a clinical score. <i>Chest</i> 1991. 100 (3):631-635.	1889245
Wiltshire, N., Kendrick, A. H., and Catterall, J. R. Home oximetry studies for diagnosis of sleep apnea/hypopnea syndrome: limitation of memory storage capabilities. <i>Chest</i> 2001. 120 (2):384-389.	11502633
Yin, M., Miyazaki, S., and Ishikawa, K. Evaluation of type 3 portable monitoring in unattended home setting for suspected sleep apnea: factors that may affect its accuracy. <i>Otolaryngology - Head & Neck Surgery</i> 2006. 134 (2):204-209.	16455365
Zamarron, C., Gude, F., Barcala, J., Rodriguez, J. R., and Romero, P. V. Utility of oxygen saturation and heart rate spectral analysis obtained from pulse oximetric recordings in the diagnosis of sleep apnea syndrome. <i>Chest</i> 2003. 123 (5):1567-1576.	12740275
Zamarron, C., Romero, P. V., Rodriguez, J. R., and Gude, F. Oximetry spectral analysis in the diagnosis of obstructive sleep apnoea. <i>Clinical Science</i> 1999. 97 (4):467-473.	10491347
Zucconi, M., Ferini-Strambi, L., Castronovo, V., Oldani, A., and Smirne, S. An unattended device for sleep-related breathing disorders: validation study in suspected obstructive sleep apnoea syndrome. <i>European Respiratory Journal</i> 1996. 9 (6):1251-1256.	8804946