

Dosimetric Significance of the ICRP's Updated Guidance and Models, 1989-2003, and Implications for U.S. Federal Guidance

August 2003

**Prepared by
R. W. Leggett and K. F. Eckerman
Oak Ridge National Laboratory
Oak Ridge, Tennessee 37831**

DOCUMENT AVAILABILITY

Reports produced after January 1, 1996, are generally available free via the U.S. Department of Energy (DOE) Information Bridge:

Web site: <http://www.osti.gov/bridge>

Reports produced before January 1, 1996, may be purchased by members of the public from the following source:

National Technical Information Service
5285 Port Royal Road
Springfield, VA 22161
Telephone: 703-605-6000 (1-800-553-6847)
TDD: 703-487-4639
Fax: 703-605-6900
E-mail: info@ntis.fedworld.gov
Web site: <http://www.ntis.gov/support/ordernowabout.htm>

Reports are available to DOE employees, DOE contractors, Energy Technology Data Exchange (ETDE) representatives, and International Nuclear Information System (INIS) representatives from the following source:

Office of Scientific and Technical Information
P.O. Box 62
Oak Ridge, TN 37831
Telephone: 865-576-8401
Fax: 865-576-5728
E-mail: reports@adonis.osti.gov
Web site: <http://www.osti.gov/contact.html>

This report was prepared as an account of work sponsored by an agency of the United States Government. Neither the United States government nor any agency thereof, nor any of their employees, makes any warranty, express or implied, or assumes any legal liability or responsibility for the accuracy, completeness, or usefulness of any information, apparatus, product, or process disclosed, or represents that its use would not infringe privately owned rights. Reference herein to any specific commercial product, process, or service by trade name, trademark, manufacturer, or otherwise, does not necessarily constitute or imply its endorsement, recommendation, or favoring by the United States Government or any agency thereof. The views and opinions of authors expressed herein do not necessarily state or reflect those of the United States Government or any agency thereof.

This work was sponsored by the Office of Radiation and Indoor Air, U. S. Environmental Protection Agency, under Interagency Agreement DOE No. 1824-C148-A1, under contract DE-AC05-84OR21400 with UT-Battelle.

**Dosimetric Significance of the ICRP's
Updated Guidance and Models, 1989-2003,
and Implications for U.S. Federal Guidance**

Authors
R. W. Leggett
K. F. Eckerman

Date Published: August 2003

Prepared by
OAK RIDGE NATIONAL LABORATORY
P.O. Box 2008
Oak Ridge, Tennessee 37831-6285
managed by
UT-Battelle, LLC
for the
U.S. DEPARTMENT OF ENERGY
under contract DE-AC05-00OR227

CONTENTS

	Page
LIST OF FIGURES	vii
LIST OF TABLES	ix
ABSTRACT	xv
1. INTRODUCTION	1
2. REVISION OF TISSUE WEIGHTING FACTORS	3
2.1. Comparison of previous and updated tissue weighting factors	3
2.2. Sensitivity of effective dose coefficients for workers to updated weighting factors.	5
2.2.1. Sensitivity analysis based on models of ICRP Publication 30	5
2.2.2. Sensitivity analysis based on updated biokinetic models for adults	8
2.3. Sensitivity of effective dose coefficients for children to changes in tissue weighting factors.....	11
3. REVISION OF THE RESPIRATORY TRACT MODEL	13
3.1. Background	13
3.2. Description of the TGLM	13
3.3. Description of the updated respiratory model.....	15
3.4. Differences in predictions of the two respiratory models for workers.....	18
3.4.1. Total and regional deposition of inhaled particles.....	18
3.4.2. Rate of clearance of deposited activity from the respiratory tract.....	19
3.4.3. Rate of absorption from the respiratory tract to blood.....	21
3.4.4. Implications of updated respiratory model for lung dose.....	23
3.4.5. Changes in the treatment of gases and vapors.....	23
3.5. Comparison of the updated respiratory model and TGLM with regard to evaluation of environmental exposures	26
4. CHANGES IN f_I VALUES.	31
4.1. Description of the ICRP's gastrointestinal tract model	31
4.2. Revisions of f_I values for workers	32

CONTENTS (continued)

4.3. Effects of the modifications of f_I values on dose coefficients for workers	32
4.4. ICRP's f_I values for members of the public.....	35
4.5. Sensitivity of dose coefficients for members of the public to f_I values.....	38
5. CHANGES IN SYSTEMIC BIOKINETIC MODELS FOR RADIONUCLIDES	41
5.1. Background.....	41
5.2. Comparison of previous and updated models for bone-volume seekers	43
5.2.1. ICRP Publication 30 model for alkaline earth elements.....	43
5.2.2. ICRP Publication 30 model for lead.....	45
5.2.3. ICRP Publication 30 model for uranium	45
5.2.4. Updated models for the alkaline earths, lead, and uranium.....	46
5.2.5. Comparison of predictions of updated and previous models.....	47
5.3. Comparison of previous and updated models for bone-surface seekers.....	50
5.3.1. ICRP Publication 30 models for plutonium and related elements.....	50
5.3.2. ICRP Publication 30 model for thorium.....	51
5.3.3. Updated models for thorium, plutonium, and related elements.....	51
5.3.4. Comparison of predictions of updated and previous models.....	53
5.4. Comparison of previous and updated models for iron.....	54
5.4.1. ICRP Publication 30 model for iron	54
5.4.2. Updated model for iron.....	56
5.4.3. Comparison of predictions of updated and previous models.....	56
5.5. Examples of other model updates for workers	57
5.5.1. Hydrogen.....	57
5.5.2. Sulfur.....	57
5.5.3. Selenium	58
5.5.4. Zirconium.....	58
5.5.5. Molybdenum.....	59
5.5.6. Silver.....	59
5.5.7. Antimony	60
5.5.8. Tellurium.....	61
5.5.9. Polonium.....	61

CONTENTS (continued)

5.6. Changes in treatment of systemic kinetics of decay chain members formed <i>in vivo</i>	62
5.6.1. Different approaches used by the ICRP	62
5.6.2. Detailed example: Treatment of ²³² Th chain members produced in systemic tissues	64
5.7. Implications of biokinetic model updates for interpretation of bioassay data	66
5.8. The ICRP's age-specific systemic biokinetic models	70
5.8.1. Elements for which age-specific models have been developed	70
5.8.2. Physiologically based models for bone-seeking radionuclides	70
5.8.3. Age-specific models for frequently studied elements other than bone seekers	73
5.8.4. Age-specific models for remaining elements	74
5.9. Differences in predictions of systemic biokinetic models for workers and the public	74
6. CONCLUSIONS: NET EFFECTS OF UPDATED ICRP MODELS AND RECOMMENDATIONS ON DOSE ESTIMATES	77
6.1. Summary of main changes in the ICRP's dosimetric scheme	77
6.1.1. Tissue weighting factors	77
6.1.2. Respiratory tract model	77
6.1.3. Gastrointestinal absorption fractions	78
6.1.4. Systemic biokinetic models	79
6.2. Extent of changes in ICRP's dose coefficients for workers	79
6.3. Comparison of effective dose coefficients of ICRP Publication 30 with currently recommended values for members of the public	84
REFERENCES	87

LIST OF FIGURES

Figure

2.1	Ratio of effective dose coefficients for ingestion based on the tissue weighting factors of ICRP Publication 60, <i>e(60)</i> , and ICRP Publication 26, <i>e(26)</i>	9
2.2	Ratio of effective dose coefficients for inhalation (Type F) based on the tissue weighting factors of ICRP Publication 60, <i>e(60)</i> , and ICRP Publication 26, <i>e(26)</i> ...	9
2.3	Ratio of effective dose coefficients for inhalation (Type M) based on the tissue weighting factors of ICRP Publication 60, <i>e(60)</i> , and ICRP Publication 26, <i>e(26)</i> ...	10
2.4	Ratio of effective dose coefficients for inhalation (Type S) based on the tissue weighting factors of ICRP Publication 60, <i>e(60)</i> , and ICRP Publication 26, <i>e(26)</i> ...	10
3.1	Structure of the Task Group Lung Model (TGLM) formerly used by the International Commission on Radiological Protection (ICRP, 1966, 1979)	14
3.2	Structure of the ICRP's current respiratory model (ICRP, 1994b).....	16
3.3	For three different particle sizes, deposition fractions for deep lungs and total respiratory tract predicted by the TGLM (ICRP, 1966) and the ICRP's updated respiratory model (ICRP, 1994b). Predictions of the updated model are based on reference breathing rates for occupational exposure	18
3.4	Retention curves for compartments of the TGLM (ICRP, 1966) and updated ICRP respiratory model (ICRP, 1994b).....	20
3.5	Reference age- and gender-specific inhalation rates used with the updated respiratory model (ICRP, 1994b).....	28
3.6	Deposition in deep lungs and total respiratory tract as a function of age, as predicted by the ICRP's updated respiratory model (ICRP, 1994b)	28
4.1	Structure of the ICRP's model of the gastrointestinal tract (ICRP, 1979)	31

LIST OF FIGURES (continued)

Figure

5.1	Structure of the model for iodine used in ICRP Publication 30 (1979) and current ICRP documents	42
5.2	Generic structure of most of the non-recycling biokinetic models currently used by the ICRP	43
5.3	ICRP's generic model structure for calcium-like elements, introduced in ICRP Publication 67 (1993) and applied in that document or subsequent ICRP documents to calcium, strontium, barium, radium, lead, and uranium.....	46
5.4	Time-dependent inventories of radium in tissues as predicted by the previous and updated ICRP models, for the case of injection of radium into blood at time zero.....	49
5.5	Model for plutonium and related elements used in Parts 1-3 of ICRP Publication 30 (1979, 1980, 1981).....	50
5.6	Generic model structure currently applied by the ICRP to plutonium and related elements (ICRP 1993, 1994a, 1995a, 1995b)	52
5.7	Time-dependent inventories of thorium in tissues as predicted by the previous and updated ICRP models, for the case of injection of thorium into blood at time zero ...	55
5.8	Urinary excretion rates for inhaled thorium predicted by the previous respiratory tract model and systemic model for thorium (ICRP 1979, 1988b) and the current models (ICRP 1995a, 1997). Thorium is assumed to be inhaled in insoluble form (Type S or Class Y). The assumed particle size is 1- μ m (AMAD)	69
6.1	Overall effect of the ICRP's updated models and recommendations on tissue dose coefficients. The histogram for a given mode of intake shows the percentages of ratios of dose coefficients (ICRP 68 : ICRP 30) that fall above or below specified values	80

LIST OF TABLES

Table

2.1	Tissue weighting factors given in ICRP Publication 26 (1977) and ICRP Publication 60 (1991).....	4
2.2	Inhalation cases most affected by revision of tissue weighting factors (ICRP, 1991), based on biokinetic and dosimetric models of ICRP Publication 30. The cases listed are those for which the effective dose coefficients are changed by more than 40% when weighting factors of ICRP Publication 26 are replaced by those of ICRP Publication 60	6
2.3	Ingestion cases most affected by revision of tissue weighting factors (ICRP, 1991), based on biokinetic and dosimetric models of ICRP Publication 30. The cases listed are those for which the effective dose coefficients are changed by more than 40% when weighting factors of ICRP Publication 26 are replaced by those of ICRP Publication 60	7
3.1	Parameters of the TGLM for 1- μ m particles (AMAD). The biological half-times, $T_{1/2}$, are assumed to be independent of particle size	15
3.2	Reference masses of target regions in the respiratory tract of the adult male	17
3.3	Regional deposition fractions predicted by the TGLM and updated respiratory models for 1- μ m and 5- μ m particles (AMAD), the default particle sizes for occupational intake used in ICRP Publication 30 and Publication 68, respectively ...	19
3.4	Comparison of predictions of the TGLM and updated respiratory tract models: cumulative absorption to blood as a function of time following inhalation of 1- μ m particles (AMAD). Predictions are for occupational exposure	21
3.5	Comparison of two sets of predictions of the updated respiratory model: cumulative absorption from respiratory tract to blood as a function of time following inhalation of 1- μ m and 5- μ m particles (AMAD). Predictions are for occupational exposure.....	22

LIST OF TABLES (continued)

Table

3.6	For selected radionuclides, comparison of lung doses predicted by the models of ICRP Publication 30 and Publication 68 for acute inhalation of particulates	24
3.7	Comparison of dose coefficients for inhalation of radioactive mercury vapor by a worker, based on models of ICRP Publication 30 and Publication 68. The systemic biokinetic model for mercury is essentially the same in the two documents	25
3.8	Comparison of dose coefficients for inhaled mercury vapor given in ICRP Publication 68 with values derived from a revised model (Leggett et al., 2001)	27
3.9	Total and regional deposition fractions as a function of age, as predicted by the updated respiratory model for inhalation of 1- μ m particles (AMAD)	27
3.10	Reference masses of target tissues in the updated respiratory tract model for ages 1 y and 10 y, relative to values for the adult male	29
3.11	Examples of differences with age in estimates of lung dose, based on the updated respiratory model. Two comparisons are made for each radionuclide: dose per unit intake, and dose per unit exposure, where the latter refers to dose per unit intake normalized to the age-specific ventilation rate	29
4.1	Comparison of f_I values applied in ICRP Publication 30 and ICRP Publication 68 ...	33
4.2	Significance of changes in f_I values as judged by effect on dose estimates for workers. Calculations are based on biokinetic models of ICRP Publication 68. Only the f_I value is varied	34
4.3	Comparison of f_I values applied in ICRP Publication 30 and Publication 68 to inhaled material	36

LIST OF TABLES (continued)

Table

4.4	Sensitivity of ingestion dose coefficients for members of the public to the f_I value. Dose coefficients for a given radionuclide and age at intake are calculated using alternate f_I values: (1) the value assigned to the worker in ICRP Publication 30 and (2) the value applied by the ICRP to members of the public. In both calculations, the biokinetic model applied is that for members of the public	39
5.1	Sources of biokinetic models (original ICRP publication) and urinary to fecal ratios U:F used in ICRP Publication 68.....	44
5.2	For selected bone-volume-seeking radionuclides, comparison of 50-y integrated activities in tissues of the adult as predicted by the models of ICRP Publication 30 and Publication 68. It is assumed that 1 Bq is injected into blood at ime zero	48
5.3	For selected bone-surface-seeking radionuclides, comparison of 50-y integrated activities in tissues of the adult as predicted by the models of ICRP Publication 30 and Publication 68. It is assumed that 1 Bq is injected into blood at time zero	54
5.4	For radioisotopes of iron, comparison of 50-y integrated activities in tissues of the adult as predicted by the models of ICRP Publication 30 and Publication 68. It is assumed that 1 Bq is injected into blood at time zero	57
5.5	For radioisotopes of molybdenum, comparison of 50-y integrated activities in tissues of the adult as predicted by the models of ICRP Publication 30 and ICRP Publication 68. It is assumed that 1 Bq is injected into blood at time zero	59
5.6	For radioisotopes of silver, comparison of 50-y integrated activities in tissues of the adult as predicted by the models of ICRP Publication 30 and ICRP Publication 68. It is assumed that 1 Bq is injected into blood at time zero	60
5.7	For radioisotopes of antimony, comparison of 50-y integrated activities in tissues of the adult as predicted by the models of ICRP Publication 30 and ICRP Publication 68. It is assumed that 1 Bq is injected into blood at time zero	61

LIST OF TABLES (continued)

Table

5.8	Comparison of 50-y integrated doses following injection of 1 Bq of the parent into blood, based on alternate assumptions concerning biokinetics of decay chain members produced <i>in vivo</i> . The ICRP's updated biokinetic models were used in both cases.....	64
5.9	Comparison of estimated 50-y integrated activities of ²³² Th and its decay chain members, assuming (A) independent or (B) shared kinetics of decay chain members, for the case of injection of ²³² Th into blood of an adult.....	67
5.10	Comparison of ICRP's updated (ICRP, 1995a) and previous (ICRP, 1979) models as predictors of 50-y integrated activity after acute intake of ²³² Th by an adult	67
5.11	Comparison of dose estimates based on updated and previous ICRP models and recommendations for the case of acutely inhaled ²³⁸ U (insoluble, 5 µm AMAD), back-calculating from urinary excretion measured 24-48 h after intake	68
5.12	Age-specific transfer coefficients (d ⁻¹) in the systemic biokinetic model for thorium (ICRP, 1995a).....	72
5.13	For selected radionuclides and tissues, cumulative activity for different ages at injection, relative to the adult	76
6.1	Examples of substantial differences in corresponding tissue dose coefficients from ICRP Publication 68 and ICRP Publication 30	81
6.2	For occupational intake of radionuclides by inhalation, examples of effective dose coefficients <i>E</i> from ICRP Publication 68 that differ substantially from the corresponding coefficients <i>H_E</i> of ICRP Publication 30	82
6.3	For occupational intake of radionuclides by ingestion, examples of effective dose coefficients <i>E</i> from ICRP Publication 68 that differ substantially from the corresponding coefficients <i>H_E</i> of ICRP Publication 30	83

LIST OF TABLES (continued)

Table

6.4	For inhalation, examples of usage-adjusted effective dose coefficients E for members of the public that differ substantially from the value H_E of ICRP Publication 30	85
6.5	For ingestion, examples of usage-adjusted effective dose coefficients E for members of the public that differ substantially from the value H_E of ICRP Publication 30	86

ABSTRACT

Over the past two decades the U.S. Environmental Protection Agency (EPA) has issued a series of Federal guidance documents for the purpose of providing the Federal and State agencies with technical information to assist their implementation of radiation protection programs. Currently recommended dose conversion factors, annual limits on intake, and derived air concentrations for intake of radionuclides are tabulated in Federal Guidance Report No. 11 (FGR 11), published in 1988. The tabulations in FGR 11 were based on dosimetric quantities and biokinetic and dosimetric models of the International Commission on Radiological Protection (ICRP) developed for application to occupational exposures. Since the publication of FGR 11 the ICRP has revised some of its dosimetric quantities and its models for workers and has also developed age-specific models and dose conversion factors for intake of radionuclides by members of the public. This report examines the extent of the changes in the inhalation and ingestion dose coefficients of FGR 11 implied by the updated recommendations of the ICRP, both for workers and members of the public.

1. INTRODUCTION

Over the past two decades the U.S. Environmental Protection Agency (EPA) has issued a series of Federal guidance documents for the purpose of providing the Federal and State agencies with technical information to assist their implementation of radiation protection programs. Currently recommended dose conversion factors and corresponding annual limits on intake (ALIs) and derived air concentrations (DACs) for intake of radionuclides are tabulated in Federal Guidance Report No. 11 (EPA, 1988). The tabulations were based on the radiation protection guidance given in two reports by the International Commission on Radiological Protection (ICRP) that have since been superseded: ICRP Publication 26 (1977), which defined the dosimetric quantities and dose limitation system and provided primary guidance for assessing radiation dose to workers; and ICRP Publication 30 (1979, 1980, 1981, 1988a), which recommended biokinetic and dosimetric models and provided secondary guidance in the form of limits on intake for workers. The guidance and models underlying Federal Guidance Report No. 11 were designed for application to occupational exposures to radionuclides but have been applied to environmental exposures as well.

The dosimetric quantities and primary guidance of ICRP Publication 26 (1977) were superseded by ICRP Publication 60 (1991). The concept of effective dose as defined in Publication 60 differs little from that originally formulated in Publication 26, but Publication 60 revised and extended the list of tissue weighting factors used to calculate effective dose coefficients.

The guidance on occupational exposure to radionuclides given in ICRP Publication 30 was superseded by ICRP Publication 68 (1994a). The dosimetric models and methods used in ICRP Publication 68 do not differ greatly from those used in ICRP Publication 30, but many of the systemic biokinetic models and reference gastrointestinal absorption fractions (f_i values) were changed substantially. Systemic biokinetic models carried over from ICRP Publication 30 generally had to be modified for use in Publication 68 because they did not explicitly address some tissues that were given weighting factors in ICRP Publication 60 (1991) but not in Publication 26 (1977). In particular, loss of activity from the body in excretion was depicted explicitly in the biokinetic models of Publication 68 in order to address the doses to the colon and urinary bladder.

A particularly important difference between ICRP Publication 30 and Publication 68 is the application of substantially different models of the respiratory tract. The updated respiratory model used in Publication 68 was introduced in ICRP Publication 66 (1994b). That model involves greater detail and physiological realism than the respiratory model used in Publication 30 and produces considerably different predictions for some situations.

Several of the biokinetic models and f_i values used in ICRP Publication 68 were taken from a series of ICRP documents, initiated in the late 1980s, on doses to members of the public from intake of radionuclides (ICRP 1989, 1993, 1995a, 1995b, 1996). Those documents provide age-specific dosimetric and biokinetic models, including gastrointestinal uptake fractions, for 31 environmentally important elements. With the exception of gastrointestinal uptake fractions for a few elements, the models for the adult given in those documents were considered appropriate for application to workers and were used in Publication 68.

The purpose of this report is to examine the extent of the changes in the inhalation and ingestion dose coefficients of Federal Guidance Report No. 11 implied by the updated recommendations of the ICRP, both for workers and members of the public. Specifically, the dose coefficients given in Federal Guidance Report No. 11 are compared with: (1) values for the worker produced by the models and assumptions of ICRP Publication 68 (1994a), and (2) values for members of the public generated by the models and assumptions used in the ICRP's series of documents on environmental intakes.

The report is divided into five parts. Section 2 describes the changes that have been made since the appearance of ICRP Publication 30 in the effective dose concept and tissue weighting factors and examines the sensitivity of effective dose coefficients to these changes. In Section 3 the ICRP's updated respiratory model is described, and its structure and predictions are compared with the respiratory model used in ICRP Publication 30. Sections 4 and 5 discuss changes in the ICRP's gastrointestinal absorption fractions and systemic biokinetic models, respectively, and examine implications of those changes. Section 6 examines the net effects, with regard to derived dose coefficients, of the updated models discussed in Sections 2-5.

2. REVISION OF TISSUE WEIGHTING FACTORS

2.1. Comparison of previous and updated tissue weighting factors

The effective dose equivalent, H_E , defined in ICRP Publication 26 (1977) is a weighted sum of doses to selected tissues. It is defined as

$$H_E = \sum_T w_T H_T$$

where w_T is a weighting factor for tissue T and H_T is the mean dose equivalent to that tissue. Because the weighting factors are normalized to sum to 1.0, a weighting factor for tissue T corresponds to the fractional contribution of that tissue to the total risk of stochastic health effects when the body is uniformly irradiated. The weighting factors given in ICRP Publication 26 and used in ICRP Publication 30 (1979, 1980, 1981, 1988a) and Federal Guidance Report No. 11 are shown in Table 2.1.

ICRP Publication 26 (1977) was superseded by Publication 60 (1991), which introduced a new dosimetric quantity called the effective dose, E . The effective dose is also a weighted sum of doses to radiosensitive tissues:

$$E = \sum_T w_T H_T$$

In contrast to the definition of the effective dose equivalent H_E , the weighting factors w_T in the equation for the effective dose E are not specified as part of the definition of E but can take any assigned values. Thus, the effective dose equivalent, H_E , may be interpreted as a special case of the effective dose, E . In the following, lower case e will be used to denote an effective dose *coefficient* for intake of a radionuclide through inhalation or ingestion.

Values recommended in ICRP Publication 60 for the tissue weighting factors w_T are also shown in Table 2.1. This list of tissue weighting factors reflects updated information on tissues at risk as well as risk per unit dose and includes values for the following tissues not addressed explicitly in ICRP Publication 26: colon, stomach, urinary bladder wall, liver, esophagus, and skin. The largest changes to existing tissue weighting factors were a threefold reduction for bone surface, a 67% increase for the thyroid, and a sixfold reduction of the weight to remaining tissues in conjunction with a reduction in the number of radiosensitive tissues that were not assigned a specific factor.

Table 2.1. Tissue weighting factors given in ICRP Publication 26 (1977) and ICRP Publication 60 (1991)^a.

Organ or tissue	Tissue weighting factor (w_T)	
	ICRP Pub. 26	ICRP Pub. 60
Gonads	0.25	0.20
Bone marrow (red)	0.12	0.12
Colon	--	0.12
Lung	0.12	0.12
Stomach	--	0.12
Bladder	--	0.05
Breast	0.15	0.05
Liver	--	0.05
Esophagus	--	0.05
Thyroid	0.03	0.05
Skin	--	0.01
Bone surface	0.03	0.01
Remainder	0.30 ^a	0.05 ^{b,c}

^aThe value 0.30 is applied to the average dose to the five remaining tissues receiving the highest dose, excluding the skin, lens of the eye, and the extremities.

^bRemainder is composed of the following tissues: adrenals, brain, extrathoracic airways, small intestine, kidneys, muscle, pancreas, spleen, thymus, and uterus.

^cThe value 0.05 is applied to the mass-weighted average dose to the Remainder tissue group, except when the following “splitting rule” applies: If a tissue of Remainder receives a dose in excess of that received by any of the 12 tissues for which weighting factors are specified, a weighting factor of 0.025 (half of Remainder) is applied to that tissue and 0.025 to the mass-averaged committed equivalent dose in the rest of the Remainder tissues.

2.2. Sensitivity of effective dose coefficients for workers to updated weighting factors

For a given radionuclide and intake mode, the sensitivity of dose coefficients to changes in tissue weighting factors depends on the biokinetic models applied. Two separate sensitivity analyses were performed, one based on the biokinetic models of ICRP Publication 30 and the other based on the ICRP's updated models. In the following, an effective dose coefficient based on tissue weighting factors of ICRP Publication 26 (1977) is denoted $e(26)$ and a coefficient based on weighting factors of ICRP Publication 60 (1991) is denoted $e(60)$.

2.2. 1. Sensitivity analysis based on models of ICRP Publication 30

The analysis based on the biokinetic models of ICRP Publication 30 indicates that effective dose coefficients for most radionuclides are relatively insensitive to the changes in the tissue weighting factors. The values $e(60)$ and $e(26)$ are virtually identical for cases in which the integrated dose is nearly uniformly distributed among tissues. This is because the weighting factors sum to 1.0 in each case, and the expression for the effective dose is almost numerically equivalent to the average of the integrated doses to the various tissues.

Cases for which changes in tissue weighting factors led to a change of 40% or more in the effective dose coefficient are listed in Table 2.2 (inhalation) and Table 2.3 (ingestion). As indicated in the last column of each of these tables, differences of this magnitude are usually associated with one or more of the following factors:

1. A threefold reduction of the weighting factor for bone surface, which results in a two- to threefold decrease in effective dose coefficients for some bone-seeking radionuclides.
2. A 67% increase in the weighting factor for thyroid. For example, this leads to noticeable increases (up to 67%) in the effective dose coefficients for inhalation of some isotopes of tellurium and iodine in soluble or moderately soluble form (Class D or W).
3. Introduction of explicit weighting factors for colon and stomach. This is particularly important for consideration of some short-lived radionuclides but affects effective dose estimates for some important long-lived radionuclides as well.
4. A decrease in the weight of Remainder, which affects the contribution of tissues such as the kidneys that are not named explicitly in either set of weighting factors.

For inhalation, the largest changes in the effective dose coefficients generally are for soluble or moderately soluble forms of radionuclides. For inhalation of a radionuclide in relatively insoluble form, there is usually little difference between E and H_E derived from the same biokinetic models because both values typically are dominated by the dose to the lung, whose weighting factor (0.12) was not changed in ICRP Publication 60.

Table 2.2. Inhalation cases most affected by revision of tissue weighting factors (ICRP, 1991), based on biokinetic and dosimetric models of ICRP Publication 30. The cases listed are those for which the effective dose coefficients are changed by more than 40% when weighting factors of ICRP Publication 26 are replaced by those of ICRP Publication 60.

Radionuclides	Class	e(60):e(26)	Modification(s) of weighting factors having greatest influence on effective dose coefficient
Zr-93, Te-123m, Te-123, Gd-148, Gd-152, Hf-182, Pb-210	D	~0.5-0.6	Threefold reduction of factor for bone surface. The number of radionuclides in this set is limited by the fact that Class D was not considered in ICRP Pub. 30 for many bone-seeking radionuclides such as the actinides and lanthanides.
Zr-93, Te-123, Gd-148, Gd-152, Lu-176, Hf-182, Th-228, Th-229, Th-230, Th-232, Pa-231, Pa-232, Np-232, Np-236a, Np-236b, Np-237, Np-238, Pu-238, Pu-239, Pu-240, Pu-241, Pu-242, Pu-244, Am-241, Am-242m, Am-243, Cm-245, Cm-246, Cm-247, Cm-248, Cm-250, Bk-247, Bk-249, Bk-250, Cf-249, Cf-250, Cf-251, Es-250	W	~0.5-0.6	Threefold reduction of factor for bone surface. For many of these bone-seeking radionuclides, the decrease due to the reduced weighting factor for bone was partially offset by other changes, such as introduction of a weighting factor for liver.
U-230, U-232, U-233, U-234, U-235, U-236, U-238	D	~0.3-0.4	Threefold reduction of factor for bone surface and reduction of contribution of kidney dose to Remainder. The latter arises due to reduction of weighting factor for Remainder and introduction of mass weighting for doses.
Tc-97m, Tc-97, Tc-99, Re-184m, Re-186m, Re-186, Re-187, Re-188m, Re-188, Re-189	D	~1.4-1.7	Introduction of a weighting factor for stomach wall (source organ in biokinetic models for Tc and Re. The portion of total-body decays occurring in the stomach is relatively high for some inhaled short-lived radionuclides.
Te-131m, Te-132, Te-133m, Te-133, I-121, I-123, I-124, I-125, I-126, I-129, I-130, I-131, I-132m, I-133, I-135	D	~1.4-1.7	Increase in weighting factor for thyroid, which dominates effective dose for these cases.
Te-131m, Te-131, Te-132, Te-133m, Te-133	W	~1.4-1.5	Increase in weighting factor for thyroid, which dominates effective dose for these cases.
Cd-109, Cd-133m, Cd-113, Cd-115, Bi-210m, Bi-210, Po-210	D	~0.4-0.5	H_E is dominated by tissues in Remainder (kidney for Bi and Cd and spleen plus kidney for Po) that contribute little to E because of their small masses.
Cd-113m, Cd-113	W	~0.5	H_E is dominated by a tissue in Remainder (kidney) that contributes little to E because of its small mass.

Table 2.3. Ingestion cases most affected by revision of tissue weighting factors (ICRP, 1991), based on biokinetic and dosimetric models of ICRP Publication 30. The cases listed are those for which the effective dose coefficients are changed by more than 40% when weighting factors of ICRP Publication 26 are replaced by those of ICRP Publication 60.

Radionuclides	$e(60):e(26)$	Modification(s) of weighting factors having greatest influence on effective dose coefficient
Be-10, Si-32, S-35, Sc-47, V-49, Ni-66, Sr-82, Sr-89, Y-90, Y-91, Nb-93m, Nb-95m, Mo-99, Ru-106, Pd-103, Pd-107, Ag-111, Sn-117m, Sn-119m, Sn-121m, Sn-123, Sn-125, Sb-127, Ba-140, Ce-141, Cd-144, Pr-143, Nd-147, Pm-147, Pm-148, Pm-149, Tb-161, Tb-166, Er-169, Er-172, Tm-167, Tm-170, Tm-171, Tm-172, Yb-175, Lu-174m, Lu-177, Ta-183, W-185, W-188, Os-191, Os-194, Pt-193m, Pt-193, Pt-195m, Au-199, Th-234, Pa-233, U-237, Pu-246	~1.4-1.6	Introduction of weighting factor for colon (0.12). A substantial portion of total-body decays of these radionuclides occurs in the contents of the intestines.
Cl-38, Cl-39, K-44, K-45, Mn-52m, Co-60m, Co-62m, Ga-65, Ga-70, Ge-67, Ge-75, As-69, Se-81, Br-74m, Br-74, Br-75, Br-80m, Br-80, Br-83, Br-84, Rb-79, Rb-81m, Rb-88, Rb-89, Y-94, Y-95, Mo-101, Tc-101, Tc-104, Rh-107, Ag-102, Ag-106, Ag-115, In-112, In-119m, Sb-120a, Sb-126m, Sb-128a, I-120m, I-120, I-128, I-134, Cs-125, Cs-130, Cs-134m, Cs-138, Ba-131m, La-143, Pr-136, Pr-144, Pr-147, Nd-151, Pm-141, Sm-141, Sm-155, Ho-162, Ho-164, Tm-175, Lu-178, Ta-182m, Ta-186, Re-177, Re-178, Re-188m, Ir-182, Au-201, Hg-199m, Tl-194m, Bi-214, Th-226, U-239, Am-244m	~1.4-1.9	Introduction of a weighting factor for stomach (0.12). For the case of ingestion, a substantial portion of the total-body decays of these short-lived radionuclides occurs in the stomach contents.
Tc-97m, Tc-97, Tc-98, Tc-99, Re-184m, Re-186m, Re-186, Re-187, Re-188, Re-189	~1.4-1.7	Introduction of weighting factor for stomach wall, a source organ in biokinetic models for Tc and Re.
Cd-113m, Cd-113	~0.5	H_E is dominated by a Remainder tissue (kidney) that contributes little to E due to its small mass.
Te-131m, Te-132, Te-133, I-121, I-123, I-124, I-125, I-126, I-129, I-130, I-131, I-132m, I-132, I-133, I-135	~1.4-1.7	Increase in weighting factor for thyroid, which dominates effective dose for these cases.
Te-123, Pb-210, Ac-227, Th-229, Th-230, Th-232, Pa-231, Np-236a, Np-237, Pu-238, Pu-239, Pu-240, Pu-241, Pu-242, Pu-244, Am-241, Am-242m, Am-243, Cm-243m, Cm-245, Cm-246, Cm-247, Cm-248, Cm-250, Bk-247, Bk-249, Cf-249, Cf-250, Cf-251, Cf-252	~0.4-0.6	Threefold reduction of weighting factor for bone surface. For many bone seekers, decrease in effective dose due to reduced weighting factor for bone is partially offset by other changes, e.g., introduction of weighting factors for liver and colon.
U-230, U-232, U-233, U-234, U-235, U-236, U-238	~0.4-0.5	Threefold reduction of factor for bone surface and reduction of contribution of kidney dose to Remainder (introduction of lower weighting factor for Remainder and mass weighting for doses).

2.2.2. Sensitivity analysis based on updated biokinetic models for adults

A second analysis of the sensitivity of effective dose coefficients to the change in tissue weighting factors was based on the updated models of the ICRP as applied to adults in Federal Guidance Report No. 13 (EPA, 1999). The effective dose coefficient was again found to be only moderately sensitive to the change in weighting factors in most cases. For ingestion, the ratios $e(60):e(26)$ are in the range 0.44-1.9 for all radionuclides. For inhalation of radionuclides as Type F, Type M, or Type S material, the ratio $e(60):e(26)$ is in the range 0.45-3.3, 0.46-2.7, or 0.65-2.6, respectively, and $e(60)$ is within a factor of 2 of $e(26)$ for approximately 78%, 94%, and 96%, respectively, of the radionuclides addressed in Federal Guidance Report No. 13.

Results of the second analysis are summarized graphically in Figure 2.1 (ingestion) and Figures 2.2-2.4 (inhalation of Type F, M, and S material, respectively) to point out a trend in the ratio $e(60):e(26)$. That is, the ratio tends to decrease as $e(60)$ increases. This is because lower values of $e(60)$ generally arise from short-lived radionuclides that decay largely along the route of intake, in or near tissues that were given explicit weighting factors in ICRP Publication 60 but not in ICRP Publication 26. For the case of ingestion, an increase in the effective dose coefficient for short-lived radionuclides often arises from the dose to the stomach wall, which has a weight of 0.12 in ICRP Publication 60 but a maximum implicit weight of 0.06 as part of Remainder in ICRP Publication 26. For the case of inhalation, an increase in the effective dose estimate for many short-lived radionuclides results from the relatively detailed representation of the extrathoracic (ET) airways in the updated respiratory model (ICRP, 1994b).

According to the updated model, the ET airways often are the most highly irradiated tissues of the body following inhalation of relatively short-lived radionuclides (Nelson et al., 1997). In the formulation of the effective dose, the ET airways are assigned to Remainder. Due to a multiplicative effect in the definition of Remainder in the updated tissue weighting factors and the predicted doses to the ET airways, particularly the anterior nasal (ET₁) region, the dose to the ET airways sometimes represents >50% of the calculated effective dose for inhaled radionuclides. For example, this occurs for ²¹²Pb ($T_{1/2} = 10.6$ h) and ²¹¹At ($T_{1/2} = 7.2$ h).

The cluster of points above the horizontal equality line and the region of $e(60)$ greater than 10^{-8} Sv Bq⁻¹ in Fig. 2.2, 2.3, or 2.4 represents the short-lived radionuclides ²¹⁴Pb, ²¹³Bi, ²¹⁴Bi, ²²²Fr, ²²⁶Th, ²²⁷Pa, and ²⁴⁴Cf. These radionuclides or their short-lived progeny emit alpha particles, with the result that the anterior nasal region of the respiratory tract is the most highly irradiated tissue of the body. The “splitting” of the weighting factor for the remainder tissue group in the computation of $e(60)$ results in the anterior nasal region being a major contributor to $e(60)$.

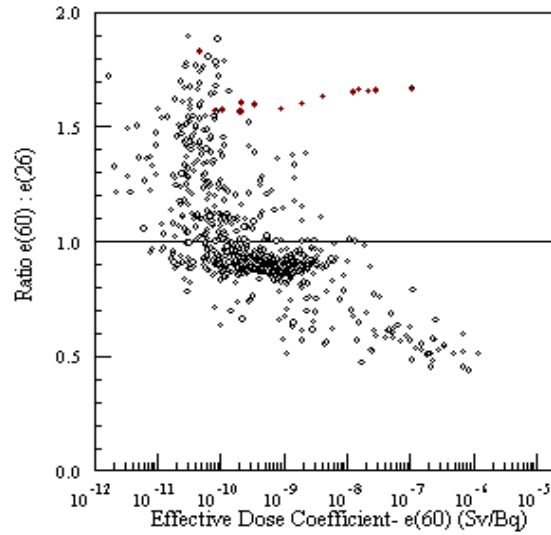

Figure 2.1. Ratio of effective dose coefficients for ingestion based on the tissue weighting factors of ICRP Publication 60, $e(60)$, and ICRP Publication 26, $e(26)$.

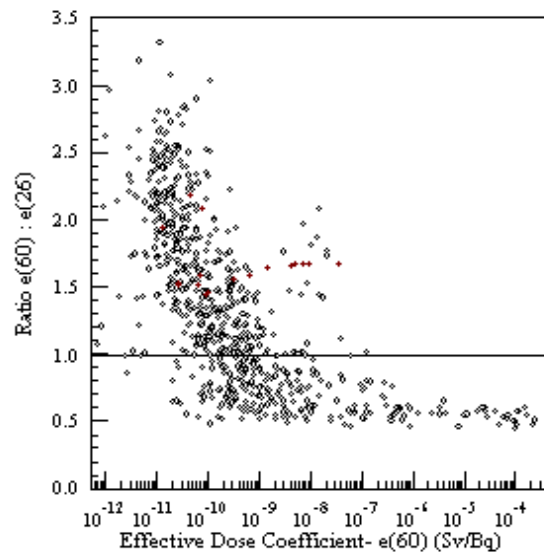

Figure 2.2. Ratio of effective dose coefficients for inhalation (Type F) based on the tissue weighting factors of ICRP Publication 60, $e(60)$, and ICRP Publication 26, $e(26)$.

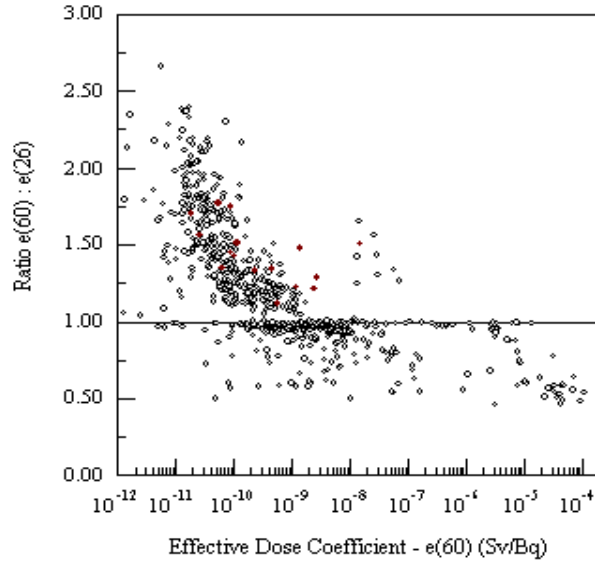

Figure 2.3. Ratio of effective dose coefficients for inhalation (Type M) based on the tissue weighting factors of ICRP Publication 60, $e(60)$, and ICRP Publication 26, $e(26)$.

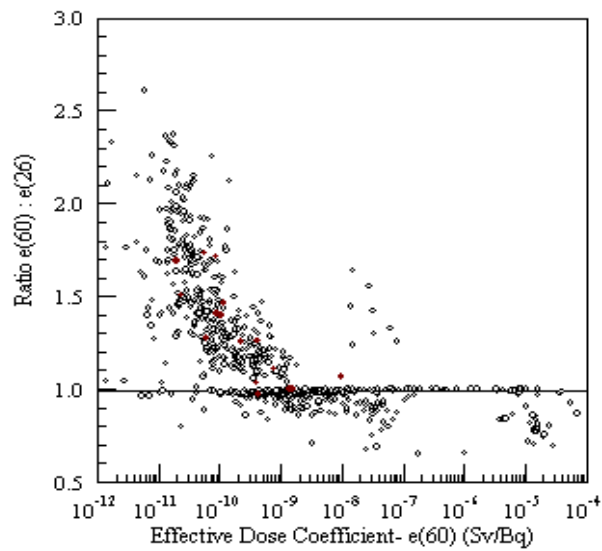

Figure 2.4. Ratio of effective dose coefficients for inhalation (Type S) based on the tissue weighting factors of ICRP Publication 60, $e(60)$, and ICRP Publication 26, $e(26)$.

Another group of radionuclides that does not follow the general trend of declining ratios $e(60):e(26)$ with decreasing values of $e(60)$ are isotopes of iodine. The coefficients for radioiodine depend largely on the estimated dose to the thyroid gland and the tissue-weighting factor for this tissue, which was increased from 0.03 in ICRP Publication 26 to 0.05 in ICRP Publication 60. Thus, the ratio $e(60):e(26)$ could approach 0.05:0.03, or about 1.7. This ratio is approximated for ingestion of most isotopes of iodine; the isolated string of points in the upper right portion of Figure 2.1 represents these radionuclides. For inhalation intakes, the contribution of the segments of the respiratory tract to the effective dose reduces the sensitivity of the effective dose coefficient to the weighting factor for the thyroid gland.

2.3. Sensitivity of effective dose coefficients for children to changes in tissue weighting factors

In a series of reports published between 1989 and 1996 (ICRP, 1989, 1993, 1995a, 1995b, 1996), the ICRP provided its first recommendations of biokinetic and dosimetric models and dose coefficients for intake of radionuclides by members of the public. These documents give dose coefficients for acute inhalation or ingestion of radionuclides for each of the following ages at intake: 3 mo, 1 y, 5 y, 10 y, 15 y, and adult. The integration period is 50 y for the adult and to age 70 y for intake by children. The radionuclides addressed are selected isotopes of hydrogen, carbon, sulfur, calcium, iron, cobalt, nickel, zinc, selenium, strontium, zirconium, niobium, molybdenum, technetium, ruthenium, silver, antimony, tellurium, iodine, cesium, barium, cerium, lead, polonium, radium, thorium, uranium, neptunium, plutonium, americium, and curium.

The tissue weighting factors given in ICRP Publication 26 (1977) and Publication 60 (1991) are independent of age. Effective dose coefficients given in Part 1 of the series on intake of radionuclides by members of the public (ICRP, 1989) are based on tissue weighting factors given in ICRP Publication 26. Coefficients given in later parts of the series are based on weighting factors recommended in ICRP Publication 60, which appeared shortly after publication of Part 1 of the series. The dose coefficients tabulated in Part 1 were updated in Part 2 (ICRP, 1993) for ingestion and Part 4 (ICRP, 1995a) for inhalation, to reflect the updated recommendations of ICRP Publication 60 as well as updates of some models used in Part 1.

For children, conclusions regarding the sensitivity of effective dose coefficients to changes in the tissue weighting factors are not much different than indicated earlier for adults. Effective dose coefficients for children usually are changed by less than a factor of 2, and in many cases are virtually unchanged, by switching between the tissue weighting factors of ICRP Publication 26 and Publication 60. This is indicated, for example, by comparing age-specific

effective dose coefficients given in Part 1 of the series on occupational intakes (ICRP Publication 56, 1989, which applied the weighting factors of ICRP Publication 26) and the modifications of those coefficients in later documents (ICRP, 1993; ICRP, 1995a) to reflect the recommendations of ICRP Publication 60. As is the case for the adult, the largest effects of the updated tissue weighting factors on dose coefficients for children are seen in cases where the effective dose is dominated by the dose to bone surface, thyroid, colon, or stomach. Recall that substantial modifications were made in weighting factors for bone surface and thyroid, and that colon and stomach are addressed explicitly in the updated tissue weighting factors but not in those given in ICRP Publication 26. Occasionally, the decrease in the weighting factor for Remainder leads to a substantial change in the effective dose coefficient, and the peculiarities associated with the ET region of the updated lung model also come into play in the same cases as for adults. In general, the numerical effects of the changes in tissue weighting factors indicated in Tables 2.2 and 2.3 apply with only minor changes for children.

3. REVISION OF THE RESPIRATORY TRACT MODEL

3.1. Background

An important change in the ICRP's methodology since the appearance of ICRP Publication 30 is the introduction of a relatively detailed, physiologically realistic model of the respiratory tract (ICRP, 1994b). In contrast to the ICRP's previous respiratory model, the updated model addresses differences with age, gender, breathing rate, and other factors affecting deposition of inhaled material in the respiratory tract. For example, age-specific deposition fractions for different regions of the tract are provided for consideration of environmental intakes, and different patterns of deposition within the lung are also provided for occupational and environmental intakes by the adult to account for differences in breathing rates and mouth versus nose breathing. Also, in contrast to the earlier model, the dosimetric features of the updated model represent an attempt to address the heterogeneous distribution of radiosensitive cells within the respiratory tract.

Along with the introduction of a new respiratory model, the ICRP changed its recommendation for a default particle size for assessment of occupational intake, from 1 μm to 5 μm (activity median aerodynamic diameter, or AMAD). Depending to some extent on the half-life of the radionuclide and the types and energies of emitted radiations, the change in the default particle size sometimes leads to noticeable changes in dose estimates for occupational intakes due to differences in total or regional deposition of 1- and 5- μm particles in the respiratory tract.

The ICRP's previous and updated respiratory tract models are compared in the following sections. For brevity, the respiratory model used in ICRP Publication 30 is referred to as the TGLM (Task Group Lung Model), and the model used in ICRP Publication 68 is referred to as the updated model. The TGLM was introduced in a publication by the ICRP Task Group on Lung Dynamics (1966) and was later summarized and applied in ICRP Publication 19 (1972) and ICRP Publication 30 (1979, 1980, 1981, 1988a). The updated model, also known as the Human Respiratory Tract Model or HRTM, was introduced in ICRP Publication 66 (1994b), where its basis and features are described.

3.2. Description of the TGLM

The structure of the TGLM is shown in Figure 3.1. The model includes four main regions: *nasal-pharynx (NP)*, *tracheobronchial (TB)*, *pulmonary (P)*, and *lymphatic (L)*. Inhaled material is deposited in regions *NP*, *TB*, and *P*, with regional deposition depending on the size (AMAD) of the inspired particles. A given chemical or physical form of a radionuclide is

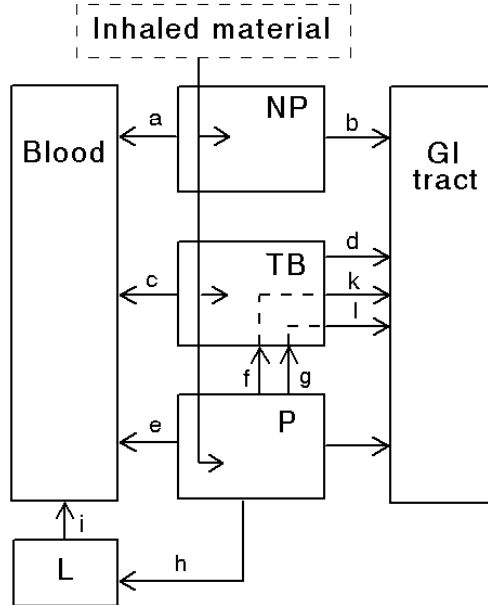

Figure 3.1. Structure of the Task Group Lung Model (TGLM) formerly used by the International Commission on Radiological Protection (ICRP, 1966, 1979).

assigned to one of three clearance classes, D (days), W (weeks), or Y (years), corresponding, respectively, to rapid, intermediate, or slow clearance of material deposited in the respiratory passages. Removal half-times are assumed to be independent of particle size.

Parameter values for the TGLM are given in Table 3.1 for a particle size of $1 \mu\text{m}$ (AMAD). For this particle size, fractional deposition of inhaled material in the total respiratory tract is assumed to be 0.63, of which 0.25 is assigned to NP, 0.08 to TB, and 0.25 to P. For a long-lived radionuclide, fractional transfer of inhaled activity to blood is estimated as $0.48 + 0.15 \cdot f_l$ for Class D, $0.12 + 0.51 \cdot f_l$ for Class W, and $0.05 + 0.58 \cdot f_l$ for Class Y material, where f_l represents fractional absorption of swallowed activity (paths *b*, *d*, *k*, and *l*).

The dose to the lungs is based on the assumption that the total activity in the TB, P, and LN regions is uniformly distributed in the total blood-filled lungs.

Table 3.1. Parameters of the TGLM for 1- μ m particles (AMAD). The biological half-times, $T_{1/2}$, are assumed to be independent of particle size.

Region and fractional deposition	Path	Class					
		D		W		Y	
		$T_{1/2}$ (d)	Fraction	$T_{1/2}$ (d)	Fraction	$T_{1/2}$ (d)	Fraction
NP (0.3)	a	0.01	0.5	0.01	0.1	0.01	0.01
	b	0.01	0.5	0.4	0.9	0.4	0.99
TB (0.08)	c	0.01	0.95	0.01	0.5	0.01	0.01
	d	0.2	0.05	0.2	0.5	0.2	0.99
P (0.25)	e	0.5	0.8	50	0.15	500	0.05
	f	NA	NA	1.0	0.4	1.0	0.4
	g	NA	NA	50	0.4	500	0.4
	h	0.5	0.2	50	0.05	500	0.15
L	i	0.5	1.0	50	1.0	1000	0.9

3.3. Description of the updated respiratory model

The structure of the updated respiratory tract model is shown in Figure 3.2. The model divides the respiratory system into extrathoracic (*ET*) and thoracic regions. The airways of the *ET* region are further divided into two categories: the anterior nasal passages, in which deposits are removed by extrinsic means such as nose blowing, and the posterior nasal passages including the nasopharynx, oropharynx, and the larynx, from which deposits are swallowed. The airways of the thorax include the bronchi (compartments labeled *BB_i*), bronchioles (compartments labeled *bb_i*), and alveolar region (compartments labeled *AI_i*). Material deposited in the thoracic airways may be cleared into blood by absorption, to the GI tract by mechanical processes (that is, transported upward and swallowed), and to the regional lymph nodes via lymphatic channels.

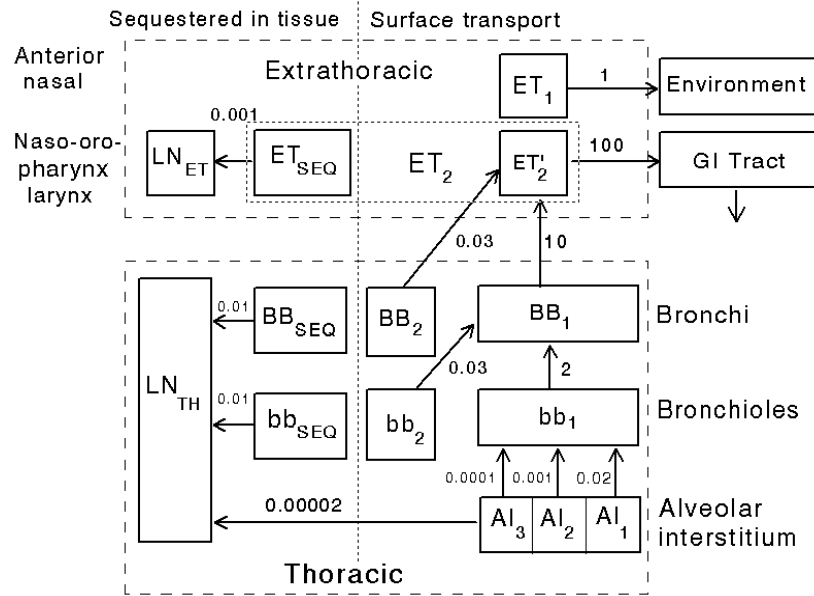

Figure 3.2. Structure of the ICRP's current respiratory model (ICRP, 1994b).

The number of compartments in each region was chosen to allow duplication of the different kinetic phases observed in humans or laboratory animals. Particle transport rates shown beside the arrows in Figure 3.2 are reference values in units of d^{-1} . For example, particle transport from bb_1 to BB_1 is assumed to occur at a fractional rate of $2\ d^{-1}$, and particle transport from ET_2 to the gastrointestinal tract is assumed to occur at a fractional rate of $100\ d^{-1}$.

For an inhaled compound, the mechanical clearances of particles indicated in Figure 3.2 are in addition to dissolution rates and absorption to blood, which depend on the element and the chemical and physical form in which it is inhaled. Although the model permits consideration of compound-specific dissolution rates, a particulate is generally assigned to one of three default absorption types: Type F, representing fast dissolution and a high level of absorption to blood; Type M, representing an intermediate rate of dissolution and an intermediate level of absorption to blood; and Type S, representing slow dissolution and a low level of absorption to blood. Ideally, the user has information on the physical and chemical properties of the material of interest. In practice, properties of inhaled material often are not known.

The fractional rates of absorption (d^1) assigned to the default types are

$$\text{Type F: } 100,$$

$$\text{Type M: } 10 e^{-100t} + 0.005 e^{-0.005t},$$

$$\text{Type S: } 0.1 e^{-100t} + 0.0001 e^{-0.0001t},$$

where t is time (days) since deposition.

In contrast to the TGLM, dosimetry for the updated model addresses the heterogeneous distribution of radiosensitive cells in the respiratory tract. Six target tissues are considered: keratinized epithelium of the skin in the anterior part of the nose (ET_1); stratified squamous epithelium of the main extrathoracic airways (ET_2); ciliated epithelium of the bronchi (BB); ciliated epithelium of the bronchioles (bb); alveolar-interstitium (AI); and thoracic and extrathoracic lymph nodes (LN_{TH} and LN_{ET} , respectively). Reference masses of the target regions of the respiratory tract of the adult male are given in Table 3.2.

The lung dose is defined as a weighted average of the doses to different regions of the lungs. The following weights are assigned: bronchial region, 0.333, divided evenly between the basal and secretory cells; secretory cells of the bronchiolar region, 0.333; the alveolar-interstitial region, 0.333; and the thoracic lymph nodes, 0.001. The dose to the extrathoracic regions, including its lymph nodes, is considered as part of Remainder tissue. Although equal weights are given to the bronchial, bronchiolar, and alveolar-interstitial regions, the ICRP (1994b) points out the possibility, in view of the regional distribution of spontaneous lung cancers in the general non-smoking population, that uniform irradiation of the lungs could result in a greater risk to the bronchial region than to the other regions of the lung.

Table 3.2. Reference masses of target regions in the respiratory tract of the adult male.

Tissue	Reference mass for the adult male (g)
Extrathoracic 1 - Basal Cells	0.0200
Extrathoracic 2 - Basal Cells	0.450
Bronchial - Basal Cells	0.432
Bronchial - Secretory Cells	0.864
Bronchiolar - Secretory Cells	1.94
Alveolar-Interstitial	1100
Lymph Nodes - Extrathoracic	15.0
Lymph Nodes - Thoracic	15.0

3.4. Differences in predictions of the two respiratory models for workers

3.4.1. Total and regional deposition of inhaled particles

There is not an exact correspondence between the different regions of the updated respiratory model and the TGLM, but the *ET* region of the updated model is broadly comparable to the *NP* region of the TGLM; the *bronchi (BB)* and *bronchioles (bb)* combined are comparable to the *TB* region; and the *AI* region is comparable to the *P* region. The baseline Types F, M, and S associated with the updated model are broadly similar to the clearance Classes D, W, and Y, respectively, associated with the TGLM. In ICRP Publication 68 (1994a), compounds of an element for which clearance was given as Classes D, W, and Y in ICRP Publication 30 were assigned to absorption types F, M, and S, respectively.

Compared with the TGLM, the updated model generally predicts lower total deposition in both the total respiratory tract and lower lungs (pulmonary or alveolar-interstitial regions). This is illustrated in Figure 3.3 for particle sizes 0.2, 1.0, and 5.0 μm (AMAD). Predictions of the updated model are based on reference breathing rates for occupational exposure.

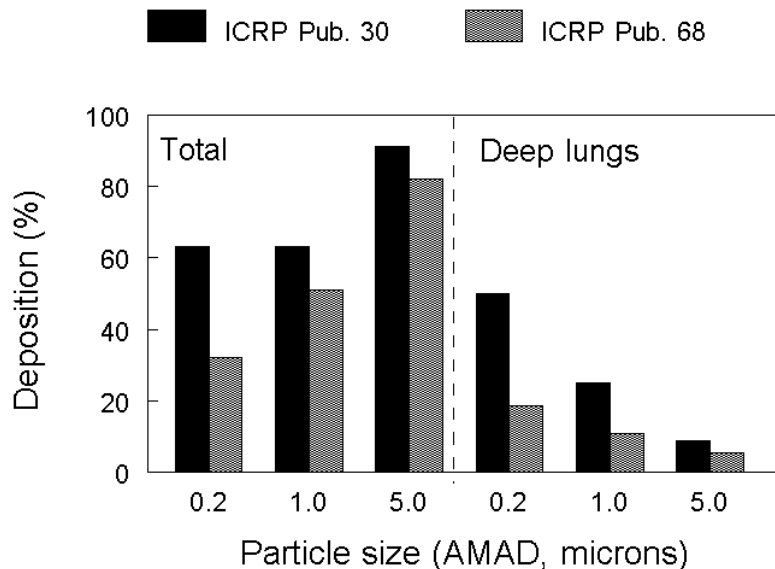

Figure 3.3. For three different particle sizes, deposition fractions for deep lungs and total respiratory tract predicted by the TGLM (ICRP, 1966) and the ICRP's updated respiratory model (ICRP, 1994b). Predictions of the updated model are based on reference breathing rates for occupational exposure.

Regional deposition fractions predicted by the two models are compared in Table 3.3 for particle sizes 1.0 and 5.0 μm , the default sizes used in ICRP Publication 30 and Publication 68, respectively. The dose coefficients for workers given in Publication 30 and Publication 68 are based on somewhat different regional distributions. For example, Publication 30 assigns 30% of deposited material to nose and pharynx and 25% to deep lung (pulmonary). Publication 68 assigns 74% to the extrathoracic region and ~5% to the deep lung (alveolar-interstitial region).

3.4.2. Rate of clearance of deposited activity from the respiratory tract

Predicted retention times for long-lived radionuclides within the main divisions of the updated model are compared in Figure 3.4 with predictions of the TGLM. In this figure, “B” represents the combined activity in the bronchi and bronchioles, as predicted by the updated model. Comparisons are made for acute inhalation of 1- μm particles by a worker. Predictions of the updated model for Types F, M, and S are compared with predictions of the TGLM for Classes D, W, and Y, respectively.

For highly soluble material (Class D or Type F), the updated model predicts much faster removal from the thoracic region ($B + AI$ or $TB + P$) than does the TGLM. However, the updated model predicts slower removal from the extrathoracic region (ET or NP), due to relatively slow removal from the anterior part of the nose (compartment ET_1 in the updated model).

Table 3.3. Regional deposition fractions predicted by the TGLM and updated respiratory models for 1- μm and 5- μm particles (AMAD), the default particle sizes for occupational intake used in ICRP Publication 30 and Publication 68, respectively.

Respiratory tract model and ICRP publication	Region	Deposition fraction		
		1 μm	5 μm	Default particle size (1 μm in Pub. 30; 5 μm in Pub. 68)
Updated (Pub. 68) TGLM (Pub. 30)	ET	0.38	0.74	0.74
	NP	0.30	0.74	0.30
Updated (Pub. 68) TGLM (Pub. 30)	BB+bb	0.029	0.029	0.029
	TB	0.08	0.08	0.08
Updated (Pub. 68) TGLM (Pub. 30)	AI	0.11	0.053	0.053
	P	0.25	0.088	0.25

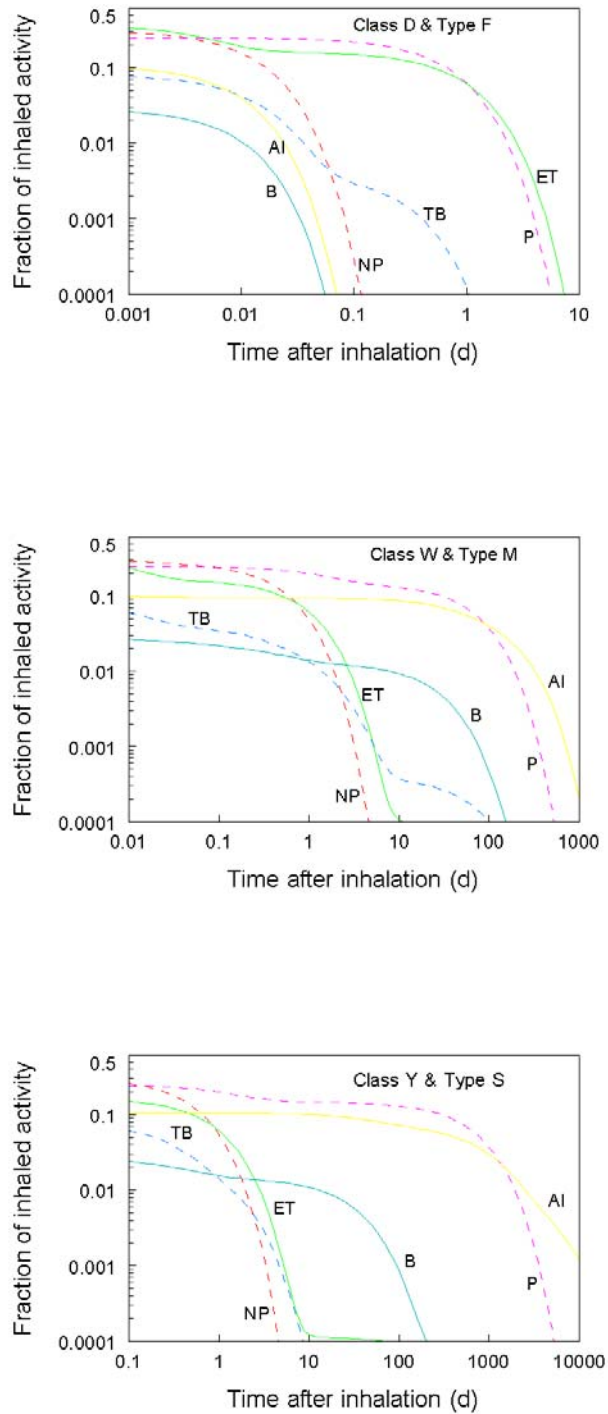

Figure 3.4. Retention curves for compartments of the TGLM (ICRP, 1966) and updated ICRP respiratory model (ICRP, 1994b).

For moderately soluble (Class W or Type M) or relatively insoluble (Class Y or Type S) material, the updated model depicts more tenacious retention in the thoracic region than does the TGLM. For times remote from inhalation, the content of the lungs as predicted by the updated model is several times greater than that predicted by the TGLM. This difference between the two models can have important implications with regard to interpretation of bioassay data. As illustrated later, backward calculation of an inhalation intake based on a low level of activity in the lungs or urine at times remote from exposure can yield much greater estimates of intake if based on the TGLM than if based on the updated model.

3.4.3. Rate of absorption from the respiratory tract to blood

Compared with the TGLM, the updated model generally predicts lower absorption from the respiratory tract to blood for a given particle size, at least for particle sizes commonly encountered in the work place or environment. This is illustrated in Table 3.4 for 1- μm particles, for which predicted total absorption is about two times greater for Class D than Type F, about one-third greater for Class W than Type M, and about four times greater for Class Y than Type S. The values given in Table 3.4 are in addition to gastrointestinal absorption of activity that is swallowed after removal from the respiratory tract by mucociliary transport.

Table 3.4. Comparison of predictions of the TGLM and updated respiratory tract models: cumulative absorption to blood as a function of time following inhalation of 1- μm particles (AMAD). Predictions are for occupational exposure.

Time (d)	Cumulative absorption (fraction of inhaled amount)					
	Class D	Type F	Class W	Type M	Class Y	Type S
0.01	0.12	0.18	0.036	0.018	0.0000	0.00018
0.1	0.26	0.24	0.071	0.024	0.0039	0.00024
1	0.40	0.24	0.072	0.025	0.0039	0.00025
10	0.48	0.24	0.076	0.029	0.0041	0.00036
100	0.48	0.24	0.10	0.057	0.0057	0.0011
1,000	0.48	0.24	0.12	0.089	0.022	0.0074
10,000	0.48	0.24	0.12	0.089	0.05	0.011
20,000	0.48	0.24	0.12	0.089	0.05	0.012

The above comparisons are based on a particle size of 1 μm (AMAD), the default value applied in ICRP Publication 30. Current ICRP documents (ICRP, 1994a, 1994b) recommend a default particle size of 5 μm for occupational intakes. As indicated in Table 3.5, the predicted pattern of absorption to blood differs for 1- μm and 5- μm particles. According to the updated model, the rate of absorption to blood initially is higher for 5- μm particles than for 1- μm particles because the larger particles deposit mainly in the upper portions of the tract, where the rate of absorption to blood is relatively high. After material has largely cleared from the upper respiratory tract, predicted absorption is lower for 5- μm particles than for 1- μm particles because of the relatively low deposition of the larger particles in the lower regions of the tract.

For highly soluble particles (Type F), total absorption to blood is predicted by the updated model to be greater for 5- μm particles than for 1- μm due to elevated deposition of the larger particles in the upper respiratory tract and the subsequently rapid absorption of activity from that region to blood (Table 3.5). For particles that dissolve more slowly (Type M and Type S), the updated model predicts that a substantial portion of the deposited particles is cleared to the gastrointestinal tract by mechanical transport before there is sufficient dissolution to allow absorption of the radionuclide into blood. The net effect for Type M or S is that predicted absorption from the respiratory tract is lower for 5- μm than for 1- μm particles (Table 3.5).

Table 3.5. Comparison of two sets of predictions of the updated respiratory model: cumulative absorption from respiratory tract to blood as a function of time following inhalation of 1- μm and 5- μm particles (AMAD). Predictions are for occupational exposure.

Time (d)	Cumulative absorption (fraction of inhaled amount)					
	Type F		Type M		Type S	
	1 μm	5 μm	1 μm	5 μm	1 μm	5 μm
0.01	0.18	0.22	0.018	0.022	0.00018	0.00022
0.1	0.24	0.28	0.024	0.028	0.00024	0.00028
1	0.24	0.28	0.025	0.028	0.00025	0.00029
10	0.24	0.28	0.029	0.031	0.00036	0.00034
100	0.24	0.28	0.057	0.045	0.0011	0.00074
1,000	0.24	0.28	0.089	0.061	0.0074	0.0029
10,000	0.24	0.28	0.089	0.061	0.011	0.0059
20,000	0.24	0.28	0.089	0.061	0.012	0.0064

3.4.4. Implications of updated respiratory model for lung dose

The predictive differences between the TGLM and updated respiratory models and the different dosimetric assumptions used with the two models often result in substantially different estimates of lung dose from inhaled radionuclides. The magnitude and direction of the differences vary with the solubility of the inhaled material, the half-time of the radionuclide and its radio active progeny, and the types and energies of emitted radiations.

For selected radionuclides, comparisons were made of the 50-y equivalent dose to the lungs as predicted by the models of ICRP Publication 30 (that is, the TGLM together with the systemic models and f_l values used in ICRP Publication 30) and the models of ICRP Publication 68 (that is, the updated respiratory model together with the systemic biokinetic models and f_l values used in ICRP Publication 68). Two sets of comparisons were made, one assuming inhalation of 1- μm particles, and the other assuming inhalation of the default particles sizes, that is, 1 μm in the calculations based on models of ICRP Publication 30 and 5 μm in the calculations based on models of Publication 68. Predictions of the updated models for Type F, M, or S were compared with predictions of the previous models for Class D, W, or Y, respectively.

Results are shown in Table 3.6. The updated model generally gives much smaller estimates of lung dose for relatively long-lived radionuclides inhaled in insoluble form because it predicts relatively low deposition of material in the deep lungs compared with the TGLM, and it is activity in the deep lungs that generally accounts for much of the lung dose after inhalation of long-lived radionuclides in insoluble form. For short-lived radionuclides in moderately soluble or insoluble form, the updated model often yields higher doses than the TGLM because of the relatively high dose estimates for a small mass of sensitive tissue in the bronchi and bronchioles.

3.4.5. Changes in the treatment of gases and vapors

In contrast to inhaled particulates, the deposition and retention of gases and vapors in the respiratory tract is material specific, depending on the chemistry of the compound. The TGLM does not address gases and vapors, and no attempt was made in ICRP Publication 30 to provide a uniform treatment of gases or vapors.

The updated respiratory model divides gases and vapors into three general classes, identified as SR-1, SR-2, and SR-0. Class SR-1 represents moderately soluble or reactive gases, for which consideration is given to retention in respiratory tract tissues and to uptake to the systemic circulation. Class SR-2 represents highly soluble or reactive gases or vapors, for which complete and instantaneous systemic uptake of the inhaled activity is assumed. Class SR-0

Table 3.6. For selected radionuclides, comparison of lung doses predicted by the models of ICRP Publication 30 and Publication 68 for acute inhalation of particulates.

Radio-nuclide	Half-life	Class/Type	Ratio of lung doses (50-y) ICRP Pub. 68 : ICRP Pub. 30	
			Based on 1 μm (AMAD)	Based on default particle sizes (1 μm for Pub. 30 and 5 μm for Pub. 68)
Co-60	5.271 y	M/W	1.4	0.9
		S/Y	0.49	0.28
Sr-90	29.12 y	F/D	0.17	0.21
		S/Y	0.42	0.22
Y-90	64.0 h	M/W	0.73	0.51
		S/Y	0.79	0.55
Ru-106	368.2 d	M/W	0.89	0.49
		S/Y	0.48	0.25
Pb-212	10.64 h	F/D	0.04	0.05
		M/W	3.9	3.5
Th-232	1.4E10 y	M/W	1.7	1.1
		S/Y	0.16	0.08
U-234	2.45E5 y	F/D	1.1	1.3
		M/W	1.5	1.0
Pu-239	2.41E4 y	M/W	1.7	1.2
		S/Y	0.25	0.15

represents relatively insoluble or non-reactive gases or vapors, for which consideration is given to internal irradiation from gas within the respiratory tract. Within this general framework, gases and vapors are assigned material-specific parameter values when information is available or default values when such information is lacking.

With regard to treatment of gases and vapors, an important feature of the updated respiratory model is the postulation of “bound” compartments within the BB, bb, and AI regions. According to the model, material reaching these compartments is not cleared by particle transport processes but is available for gradual absorption to blood. For some gases or vapors in Class SR-1, assignment of a portion of the inhaled activity to the bound compartments leads to

dose estimates that differ noticeably from those given in ICRP Publication 30. Especially large differences in the updated and previous dose coefficients are seen for mercury vapor (Table 3.7). For all major mercury isotopes except ^{194}Hg ($T_{1/2} = 260$ y), effective doses given in ICRP Publication 68 are substantially greater than values given in ICRP Publication 30. The reasons for such large differences in effective dose coefficients for mercury vapor were investigated.

According to the model for mercury vapor given in ICRP Publication 30, 70% of inhaled mercury vapor is deposited in the lungs, and all of the deposited mercury is absorbed to blood with a half-time of 1.7 d. In effect, mercury vapor is assumed to be distributed uniformly in the lungs. The model of ICRP Publication 68 assumes the same kinetics for mercury vapor, but assigns a different distribution: 10% is assigned to the bound compartment of the large bronchi (BB), 20% to the bound compartment of the small bronchi (bb), and 40% to the bound compartment of the bound compartment of the alveolar interstitial (AI) region.

The ICRP's assumptions are not consistent with current information on the gross distribution or residence time of mercury vapor in the respiratory tract (Leggett et al., 2001). It appears that inhaled mercury vapor deposits largely in the AI region, that most of the deposited mercury is nearly instantaneously absorbed to blood, and that the remainder may have multiple components of retention in the lungs.

Table 3.7. Comparison of dose coefficients for inhalation of radioactive mercury vapor by a worker, based on models of ICRP Publication 30 and Publication 68. The systemic biokinetic model for mercury is essentially the same in the two documents.

Radionuclide	Half-life	Ratio of dose coefficients, ICRP 68 : ICRP 30
		Effective
Hg-193	3.5 h	23
Hg-193m	11.1 h	15
Hg-194	260 y	0.85
Hg-195	9.9 h	25
Hg-195m	41.6 h	20
Hg-197	64.1 h	23
Hg-197m	23.8 h	18
Hg-199m	42.6 h	9.7
Hg-203	46.6 d	4.0

An alternate model of the distribution and retention of inhaled mercury vapor in the respiratory tract has been proposed (Leggett et al., 2001). The proposed model differs from that of ICRP Publication 68 in several ways. As a minor change, total deposition in the respiratory tract is increased from 70% to 80%. More importantly, a different regional distribution in the respiratory tract is assumed: 2% in the extrathoracic region (sub-region ET2 in the updated model), 1% in the large bronchi (BB), 2% in the small bronchi (bb); and 75% in the alveolar-interstitial region (AI). In addition, multiple retention components are assumed. A portion of the mercury deposited in AI equivalent to 70% of the deposition in the respiratory tract (i.e., 56% of inhaled mercury) is assumed to be absorbed to blood at a rate of 1000 d^{-1} . Of the remaining activity in all regions of the respiratory tract, 80% is assumed to be absorbed to blood with a half-time of 8 h and 20% is assumed to be absorbed with a half-time of 5 d.

The effect of the proposed model revisions on estimates of effective dose and integrated dose to lungs and kidneys due to inhalation of isotopes of mercury as vapor are summarized in Table 3.8. In this comparison, both the ICRP's respiratory model and the proposed revision of the model were coupled with the ICRP's current systemic biokinetic model for mercury. The revisions generally lead to a substantial decrease in the estimated lung dose due to a much smaller integrated activity in the lungs and an increase in the dose to kidneys and other systemic tissues due to the higher assumed deposition and more rapid movement of activity to the systemic circulation. The extent of changes in estimated doses depends on the radiological half-life of the radioisotope and the types and energies of its emitted radiations.

3.5. Comparison of the updated respiratory model and TGLM with regard to evaluation of environmental exposures

Although the TGLM was designed and intended for application to occupational intakes, it has also been applied to environmental exposures. In contrast to the TGLM, the updated respiratory model was designed to address environmental as well as occupational intakes. For example, the updated model includes ventilation rates and deposition fractions that depend on age, gender, and level of physical activity (Figures 3.5 and 3.6, Table 3.9).

On the other hand, parameters of the updated model describing mechanical clearance of material from the lungs or absorption of activity to blood are assumed to be independent of age and gender. Because of the smaller mass of the lung tissue in infants and children (Table 3.10) and the fact that deposition per unit activity inhaled does not differ markedly with age (Figure 3.6, Table 3.9), the estimated lung dose per unit inhaled is often much greater in children than in adults. When adjusted to account for the smaller quantities of air inhaled at younger ages, however, the lung doses do not vary substantially with age (Table 3.11).

Table 3.8. Comparison of dose coefficients for inhaled mercury vapor given in ICRP Publication 68 with values derived from a revised model (Leggett et al., 2001).

Radionuclide	Half-life	Ratio of dose coefficients, proposed model: ICRP 68		
		Lung	Kidneys	Effective
Hg-193	3.5 h	0.08	4.1	0.12
Hg-193m	11.1 h	0.07	3.1	0.12
Hg-194	260 y	0.74	1.1	1.1
Hg-195	9.9 h	0.07	2.6	0.11
Hg-195m	41.6 h	0.06	1.9	0.10
Hg-197	64.1 h	0.06	1.7	0.10
Hg-197m	23.8 h	0.06	2.2	0.10
Hg-199m	42.6 h	0.11	15	0.18
Hg-203	46.6 d	0.09	1.2	0.26

Table 3.9. Total and regional deposition fractions as a function of age, as predicted by the updated respiratory model for inhalation of 1- μ m particles (AMAD).

Region	Age						Worker
	100 d	1 y	5 y	10 y	15 y	Adult member of public	
Al	0.0856	0.0964	0.0985	0.0951	0.107	0.115	0.107
bbe	0.0204	0.0171	0.0185	0.017	0.020	0.0195	0.0165
Bbi	0.0104	0.0104	0.0104	0.0117	0.0169	0.0129	0.0124
ET	0.482	0.484	0.397	0.406	0.320	0.339	0.376
Total	0.598	0.608	0.524	0.530	0.464	0.486	0.512

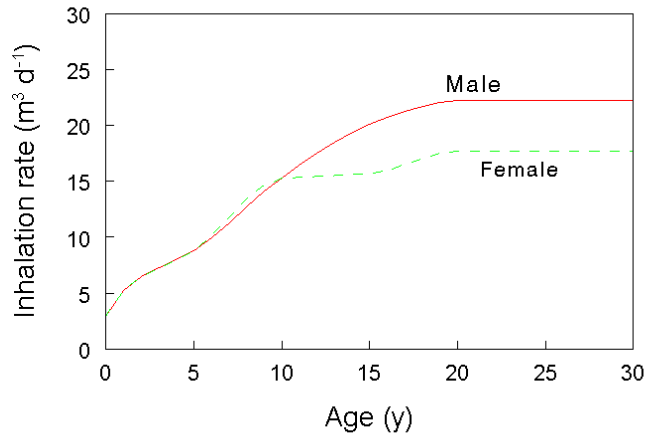

Figure 3.5. Reference age- and gender-specific inhalation rates used with the updated respiratory model (ICRP, 1994b).

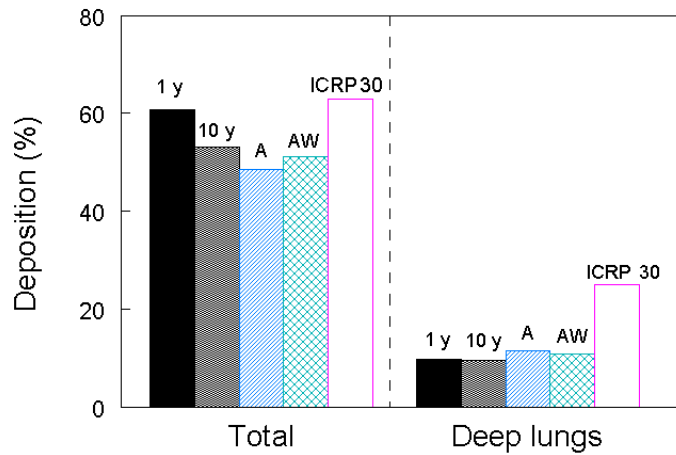

Figure 3.6. Deposition in deep lungs and total respiratory tract as a function of age, as predicted by the ICRP's updated respiratory model (ICRP, 1994b).

Table 3.10. Reference masses of target tissues in the updated respiratory tract model for ages 1 y and 10 y, relative to values for the adult male.

Region	Ratio, mass at given age : mass in adult	
	1 y	10 y
Subregions of ET	0.207	0.632
Subregions of BB	0.359	0.719
bb	0.306	0.670
Al	0.137	0.452
LN	0.137	0.452

Table 3.11. Examples of differences with age in estimates of lung dose, based on the updated respiratory model. Two comparisons are made for each radionuclide: dose per unit intake, and dose per unit exposure, where the latter refers to dose per unit intake normalized to the age-specific ventilation rate.

Radio-nuclide	Half-life	Type	Referent (per unit intake or unit exposure)	Ratio of estimated lung dose, Updated model (age-specific): TGLM (adult)		
				1 y	10 y	Adult
Co-60	5.271 y	M	Intake	4.5	2.0	1.5
			Exposure	1.1	1.4	1.5
Sr-90	29.12 y	F	Intake	1.2	0.34	0.17
			Exposure	0.28	0.23	0.17
Pb-212	10.64 h	F	Intake	0.20	0.07	0.04
			Exposure	0.05	0.05	0.04
Th-232	1.4E10 y	M	Intake	5.9	2.6	1.9
			Exposure	1.4	1.8	1.9
Th-232	1.4E10 y	S	Intake	0.38	0.18	0.17
			Exposure	0.09	0.12	0.17
U-234	2.45E5 y	F	Intake	2.6	1.4	1.1
			Exposure	0.61	1.0	1.1
U-234	2.45E5 y	M	Intake	5.6	2.4	1.7
			Exposure	1.3	1.7	1.7
Pu-239	2.41E4 y	M	Intake	6.2	2.7	1.9
			Exposure	1.5	1.9	1.9
Pu-239	2.41E4 y	S	Intake	0.82	0.35	0.27
			Exposure	0.19	0.24	0.27

4. CHANGES IN f_I VALUES

4.1. Description of the ICRP's gastrointestinal tract model

The ICRP's model for transit of material through the gastrointestinal tract has not been changed since its appearance in ICRP Publication 30 (1979), but the ICRP has since updated several of its reference values for gastrointestinal uptake of elements (f_I values). The updated f_I values are used in ICRP Publication 68 (1994a). In contrast to ICRP Publication 30, some of the systemic biokinetic models used in ICRP Publication 68 depict feedback of activity from the systemic tissues and fluids into the contents of the tract.

The gastrointestinal transit model, shown in Figure 4.1, divides the tract into four segments or compartments: *stomach (St)*, *small intestine (SI)*, *upper large intestine (ULI)*, and *lower large intestine (LLI)*, and depicts first-order transfer of material from one segment to the next. Material is assumed to transfer from *St* to *SI* at the fractional rate of 24 d^{-1} , from *SI* to *ULI* at 6 d^{-1} , from *ULI* to *LLI* at 1.8 d^{-1} , and from *LLI* to *Feces* at 1 d^{-1} .

Absorption of ingested material to blood generally is assumed to occur only in *SI* and is described in terms of an element-specific f_I value. In the absence of radioactive decay, the fraction f_I of ingested material moves from *SI* to *BLOOD* and the fraction $1-f_I$ moves from *SI* to *ULI* and is excreted in feces. The transfer coefficient from *SI* to *BLOOD* is $6f_I / (1-f_I) \text{ d}^{-1}$.

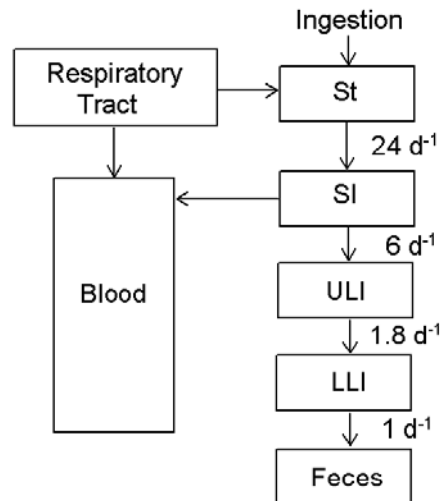

Figure 4.1. Structure of the ICRP's model of the gastrointestinal tract (ICRP, 1979).

4.2. Revisions of f_I values for workers

The ICRP's series of documents on doses to members of the public (ICRP, 1989, 1993, 1995a, 1995b, 1996) provides updated information on gastrointestinal uptake of 31 elements: hydrogen, carbon, sulfur, calcium, iron, cobalt, nickel, zinc, selenium, strontium, zirconium, niobium, molybdenum, technetium, ruthenium, silver, antimony, tellurium, iodine, cesium, barium, cerium, lead, polonium, radium, thorium, uranium, neptunium, plutonium, americium, and curium. In some cases, the updated information is relevant to occupational as well as environmental intakes. For example, in ICRP Publication 69 (1995a), the f_I value for uranium in the adult was reduced from 0.05 (ICRP Publication 30, 1979) to 0.02 on the basis of generally consistent results from environmental studies and controlled experimental studies on human subjects, and several of the studies appear to be applicable both to occupational and environmental intakes. In such cases, the f_I values adopted by the ICRP for adult members of the public were also applied to workers in ICRP Publication 68. In other cases, values selected for adult members of the public were not applied in Publication 68 because they were based primarily on forms of radionuclides that were unlikely to be encountered in occupational intakes. For example, an f_I value for polonium of 0.5 was selected for adult members of the public on the basis of data for organically bound polonium. Because occupational intakes are more likely to involve inorganic than organic forms of polonium, the f_I value of 0.1 applied to polonium in ICRP Publication 30 was also used in Publication 68.

The f_I values applied in ICRP Publication 68 are compared in Table 4.1 with values applied in Publication 30. The largest absolute change from f_I values given in ICRP Publication 30 was a decrease from 0.3 to 0.1 for some forms of cobalt. Fairly large relative changes (say, by 50% or more) were made for several elements with low absorption such as actinide and lanthanide elements.

4.3. Effects of the modifications of f_I values on dose coefficients for workers

The effect of the modifications of f_I values on dose coefficients for workers is examined in Table 4.2. For selected radionuclides, comparisons were made of the effective dose as well as dose coefficients for colon and red marrow, based on the previous and updated f_I values but leaving all other models and assumptions unchanged. The systemic biokinetic models of ICRP Publication 68 were used in this analysis.

Table 4.1. Comparison of f_1 values applied in ICRP Publication 30 and Publication 68.

Element	ICRP Pub. 30	ICRP Pub. 68	Basis for revised f_1
Cobalt			
Other compounds	0.3	0.1	ICRP Pub. 67 (1993)
Oxides, hydroxides	0.05	0.05	
Tellurium	0.2	0.3	ICRP Pub. 67 (1993)
Cerium	0.0003	0.0005	ICRP Pub. 67 (1993)
Lanthanum, europium	0.001	0.0005	Analogy with cerium; ICRP Pub. 67, 1993
Other lanthanides	0.0003	0.0005	Analogy with cerium; ICRP Pub. 67, 1993
Thorium			
Oxides, hydroxides	0.0002	0.0002	ICRP Pub. 69 (1995a)
Other compounds	0.0002	0.0005	
Uranium	0.05 (soluble) 0.002 (insoluble)	0.02 (soluble) 0.002 (insoluble)	ICRP Pub. 69 (1995a)
Plutonium			
Oxides	0.00001	0.00001	ICRP Pub. 67 (1993)
Nitrate	0.0001	0.0001	
Other compounds	0.0001 (Part 1) 0.001 (Part 4)	0.0005	
Neptunium	0.01 (Part 2) 0.001 (Part 4)	0.0005	ICRP Pub. 67 (1993)
Americium	0.0005 (Part 1) 0.001 (Part 4)	0.0005	ICRP Pub. 67 (1993)
Curium	0.0005 (Part 1) 0.001 (Part 4)	0.0005	ICRP Pub. 71 (1995b)
Actinium, protactinium	0.001	0.0005	Analogy with americium, and neptunium; ICRP Pub. 67 (1993)
Other actinides	0.0005 (Parts 1,3) 0.001 (Part 4)	0.0005	Analogy with americium and curium; ICRP Pub. 67 (1993) and 71 (1995b).
All other elements	--	As in ICRP Pub. 30	--

Table 4.2. Significance of changes in f_I values as judged by effect on dose estimates for workers. Calculations are based on biokinetic models of ICRP Publication 68. Only the f_I value is varied.

Radionuclide	f_I value		Ratio of integrated doses A:B, where A is based on f_I from Pub 68 and B is based on f_I from Pub. 30		
	ICRP Pub. 30	ICRP Pub. 68	Colon	Red marrow	Effective dose
Co-60 (some compounds)	0.3	0.1	0.77	0.39	0.49
Ce-144	0.0003	0.0005	1.0	1.6	1.0
La-140	0.001	0.0005	1.0	1.0	1.0
Eu-152	0.001	0.0005	1.0	2.0	1.1
Th-232 (some compounds)	0.0002	0.0005	1.5	2.5	2.5
U-234	0.05	0.02	0.59	0.40	0.42
Pu-239 (some compounds)	0.001 (Part 4)	0.0005	0.77	0.50	0.51
Np-239	0.001 (Part 4)	0.0005	1.0	0.98	1.0

As indicated in Table 4.2, the effect of f_I on dose coefficients depends strongly on the radionuclide and tissue, varying from virtually no effect to changes proportional to the changes in f_I values. The effect on a dose coefficient depends on some combination of the following factors: the half-life of the radionuclide, the types and energies of the emitted radiations, the magnitude of the f_I value, and the systemic biokinetic model for the element. When the f_I value is changed from one relatively small number to another (e.g., from 0.0003 to 0.0005 for ^{144}Ce , 0.001 to 0.0005 for ^{152}Eu , or 0.001 to 0.0005 for ^{239}Np), the estimated dose to the colon shows little change in many cases because the cumulative activity in the colon is nearly unchanged. The derived effective dose will show little change in such cases if it is dominated by the dose to the colon. Doses to systemic tissues (e.g., red marrow) often change nearly in proportion to f_I , but this is not always the case. In cases where the effective dose is determined largely by the dose to systemic tissues (e.g., ^{232}Th , ^{234}U , ^{239}Pu), variation of f_I may result in a proportional change in the effective dose coefficient. Depending on the residence time in systemic tissues, the effect on the

dose to systemic tissues may be diminished to some extent for radionuclides with highly penetrating radiations (e.g., ^{60}Co) due to the contribution to dose from emissions from the intestinal contents. For short-lived radionuclides such as ^{140}La that are poorly absorbed and emit highly penetrating radiations, the dose to systemic tissues may be affected little by a variation in f_I because the dose may arise mainly from emissions from the contents of the gastrointestinal tract.

Dose estimates for inhaled radionuclides address the gastrointestinal absorption of activity swallowed after removal from the respiratory tract by mucociliary transport. For selected radionuclides, it is considered in both ICRP Publication 30 and Publication 68 that radionuclides cleared from the respiratory tract may be minor constituents of the inhaled particles and that absorption from the gastrointestinal tract may depend on dissolution of the particle matrix as well as the elemental form of the radionuclide. The special f_I values for inhaled material used in ICRP Publication 68 are compared in Table 4.3 with values used in ICRP Publication 30. Changes in f_I for inhaled material were made for only three elements: cobalt (from 0.05 for Class W to 0.1 for Type M), uranium (from 0.05 for Class D or W to 0.02 for Type F or M), and plutonium (from 0.001 for Class W to 0.0005 for Type M). These modifications have only modest effects on dose estimates because they do not result in large changes in the total absorption of activity to blood from the respiratory and gastrointestinal tracts, and they have little effect on the estimate of cumulative activity in the contents of the gastrointestinal tract.

4.4. ICRP's f_I values for members of the public

In its series of documents on doses to the public from environmental intakes of radionuclides (ICRP, 1989, 1993, 1995a, 1995b, 1996), the ICRP summarized information on age-specific gastrointestinal uptake of 31 elements (listed earlier). On the basis of these reviews, the following generic rules were applied in the assignment of age-specific f_I values to most of these elements, for the case of ingestion:

1. The f_I value for adults is assigned to ages ≥ 1 y.
2. If f_I for adults is ≤ 0.001 , then f_I for infants is 10 times the value for adults.
3. If f_I for adults is 0.01-0.5, then f_I for infants is 2 times the value for adults.
4. If f_I for adults is greater than 0.5, then complete absorption is assumed for the infant.

Table 4.3. Comparison of f_I values applied in ICRP Publication 30 and Publication 68 to inhaled material.

Element	ICRP Pub. 30	ICRP Pub. 68
Cobalt	W: 0.05 Y: 0.05	M: 0.1 S: 0.05
Strontium	D: 0.3 Y: 0.01	F: 0.3 S: 0.01
Molybdenum	D: 0.8 Y: 0.05	F: 0.8 S: 0.05
Antimony	D: 0.1 W: 0.01	F: 0.1 M: 0.01
Uranium	D: 0.05 W: 0.05 Y: 0.002	F: 0.02 M: 0.02 S: 0.002
Plutonium	W: 0.0001 (Part 1) W: 0.001 (Part 4) Y: 0.00001	M: 0.0005 S: 0.00001
All other elements	Same as for ingestion	Same as for ingestion

Rules 1-4 given above were not applied to ingested calcium, iron, cobalt, strontium, barium, lead, or radium (ICRP 1993, 1995a, 1995b). For these elements, separate f_I values were assigned to infants, children of ages 1-15 y, and adults, respectively, based on indications that gastrointestinal absorption of these elements is elevated in young children and adolescents as well as infants. For calcium and strontium, the f_I values applied to these three age groups are 0.6, 0.4, and 0.3, respectively; for barium and radium, the values are 0.6, 0.3, and 0.2, respectively; for iron, the values are 0.6, 0.2, and 0.1, respectively; for cobalt, the values are 0.6, 0.3, and 0.1, respectively; and for lead, the values are 0.6, 0.4, and 0.2, respectively.

For elements not reviewed in the ICRP's series on environmental intakes, f_I values for the adult are extended in ICRP Publication 72 (1996) to other age groups using Rules 1-4, with three exceptions: for palladium, values 0.005 and 0.05 are applied to the adult and infant,

respectively; for beryllium, values 0.005 and 0.02 are applied; and for hafnium, values 0.002 and 0.02 are applied.

In ICRP Publication 72 (1996), two different sets of age-dependent f_I values are considered for radioisotopes of chromium. Because chromium is not addressed in the ICRP documents on intake of radionuclides by members of the public, f_I values for ingestion of chromium by the adult were carried over from ICRP documents on occupational intakes and extended to younger age groups using the rules listed above. The different f_I values for the adult, 0.1 and 0.01, reflect expected differences in absorption of hexavalent and trivalent compounds, respectively, of chromium encountered in the work place.

Age-specific f_I values for polonium used in ICRP Publication 72 are taken from ICRP Publication 67 (1993) on environmental intake of radionuclides by members of the public and are based on data for ingestion of organically bound polonium. The authors of ICRP Publication 67 point out that gastrointestinal absorption of inorganic forms of polonium appears to be much lower than that of polonium that is biologically incorporated into food. Because there are situations in which environmental polonium seems more likely to be in inorganic than organic form (for example, in tap water), separate sets of age-specific f_I values for inorganic and organic polonium were considered in Federal Guidance Report No. 13 (EPA, 1999). For polonium ingested in inorganic form, the f_I value for the adult was taken as 0.1, the value applied by the ICRP to ingestion of polonium in the work place (ICRP 1979, 1994a). Based on Rules 1-4 listed above, this value was applied to ages ≥ 1 y in Federal Guidance Report No. 13, and the value 0.2 was applied to infants.

As described above for occupational intakes, the dosimetric scheme for members of the public includes the consideration that activity cleared from the respiratory tract may be present as minor constituents of the inhaled particles and that subsequent gastrointestinal absorption may depend on dissolution of the particle matrix (ICRP, 1996). In ICRP Publication 72, the element-specific f_I values applied to ingestion generally are applied to inhalation of Type F compounds. The most important exception is polonium, for which an f_I value of 0.5 is applied to ingestion in food and a value of 0.1 is applied to polonium inhaled as a Type F compound. For inhaled material of Type M or Type S, a default f_I value of 0.1 or 0.01, respectively, is applied unless a lower f_I value for that absorption type, or a more soluble type, was used in the ICRP's most recent document on occupational exposures (ICRP Publication 68, 1994a). In the latter case, the lower f_I value is applied.

The f_I values for "infant" apply to ages 0-100 days. Biokinetic parameter values are assumed to vary with age up to age 20 y for most elements (e.g., iron, cesium, and iodine) but up

to age 25 y for some elements that deposit largely in the skeleton (e.g., calcium, radium, and plutonium). Linear interpolation with age is used to vary parameter values between ages 100 d and 1 y, 1 y and 5 y, 5 y and 10 y, 10 y and 15 y, and 15 y and adult (defined either as 20 y or 25 y, depending on the element). For example, parameter values for age 3 y would fall midway between values for ages 1 y and 5 y.

4.5. Sensitivity of dose coefficients for members of the public to f_I values

The importance of assigning elevated f_I values to certain age groups and/or to environmental forms of radionuclides is illustrated in Table 4.4. This table shows the extent to which ingestion dose coefficients for selected radionuclides and age groups are changed by changing f_I from the value assigned to the worker in ICRP Publication 30 to the value applied to members of the public. For purposes of this sensitivity analysis, the biokinetic models applied in both cases are those for members of the public; only the f_I values are changed.

As indicated earlier for workers, the effect of f_I on dose coefficients for members of the public depends strongly on the radionuclide and tissue, varying from virtually no effect to a change in proportion to the modification of f_I . When the f_I value is changed from one relatively small number to another (e.g., from 0.0003 to 0.0005 for ^{144}Ce), the dose to the colon is not affected much because the cumulative activity in the colon is not changed much and is the main determinant of the dose to the colon. If the effective dose is determined largely by the dose to the colon, then the effective dose may be changed little by a substantial change in f_I due to the small change in the colon dose. Doses to systemic tissues (e.g., red marrow) change nearly in proportion to f_I in most cases. Exceptions occur in cases where the dose to systemic tissues comes mainly from emissions from the gastrointestinal contents rather than absorbed activity.

Table 4.4. Sensitivity of ingestion dose coefficients for members of the public to the f_1 value. Dose coefficients for a given radionuclide and age at intake are calculated using alternate f_1 values: (1) the value assigned to the worker in ICRP Publication 30, and (2) the value applied by the ICRP to members of the public. In both calculations, the biokinetic model applied is that for members of the public.

Radio-nuclide	Age at intake	f_1 value		Ratio of dose coefficient based on A to coefficient based on B		
		A: from ICRP series on intakes by public	B: from ICRP Pub. 30 (worker)	Colon	Red marrow	Effective dose
Fe-59	100 d	0.6	0.1	0.9	5.8	2.9
Fe-59	15 y	0.2	0.1	1.0	1.9	1.4
Sr-90	100 d	0.6	0.3	0.8	2.0	1.9
Sr-90	15 y	0.4	0.3	0.9	1.3	1.3
Ce-144	Adult	0.0005	0.0003	1.0	1.6	1.0
La-140	Adult	0.0005	0.001	1.0	1.0	1.0
Po-210	100 d	1.0	0.1	5.1	8.0	7.9
Po-210	5 y	0.5	0.1	3.3	4.9	4.9
Po-210	Adult	0.5	0.1	3.4	4.9	4.9
Pu-239	100 d	0.005	0.001	1.9	5.0	4.8
Pu-239	Adult	0.0005	0.001	0.8	0.5	0.5

5. CHANGES IN SYSTEMIC BIOKINETIC MODELS FOR RADIONUCLIDES

5.1. Background

The biokinetic models of ICRP Publication 30 (1979, 1980, 1981, 1988a) generally are formulated as simple mathematical expressions and address only the initial distribution and net rate of decline of radionuclides in a few major organs. Retention of a radionuclide in the whole body or specific organ typically is described in terms of 1-3 removal half-times, with multiple half-times representing retention in multiple hypothetical compartments. With the exception of the biokinetic model for iodine, feedback of material from tissues to blood is not treated explicitly in Publication 30. Rather, it is assumed that material leaving an organ moves directly to excreta.

The ICRP's series of documents on doses to members of the public (ICRP 1989, 1993, 1995a, 1995b, 1996) include physiologically based, age-specific models for several elements, including calcium, strontium, barium, radium, iron, lead, thorium, uranium, neptunium, plutonium, americium, and curium. These models depict feedback of material from organs to blood plasma, loss of material by specific excretion pathways, and certain physiological processes such as bone remodeling that are known to influence the biokinetics of radionuclides.

Despite this trend toward physiological realism, most of the biokinetic models adopted by the ICRP for application to members of the public are similar in format to the models of ICRP Publication 30. In particular, retention functions were applied to hydrogen (tritium), carbon, sulfur, cobalt, nickel, zinc, selenium, zirconium, niobium, molybdenum, technetium, ruthenium, silver, antimony, tellurium, cesium, cerium, and polonium. For some but not all elements, age-specific parameter values (coefficients or half-times in the retention functions) were assigned to represent expected changes in distribution or retention of radionuclides during growth. The models were modified to depict transfer of systemic activity to the urinary bladder or large intestine prior to excretion, which became a typical feature of ICRP biokinetic models after the introduction of explicit tissue weighting factors for the urinary bladder wall and colon in ICRP Publication 60 (1991).

The model for iodine applied in the ICRP's series on doses from environmental exposures (ICRP, 1989, 1993) is an age-specific version of the model for the adult originally applied in ICRP Publication 30 (Figure 5.1). That is the only systemic biokinetic in Publication 30 in which recycling of material is depicted explicitly.

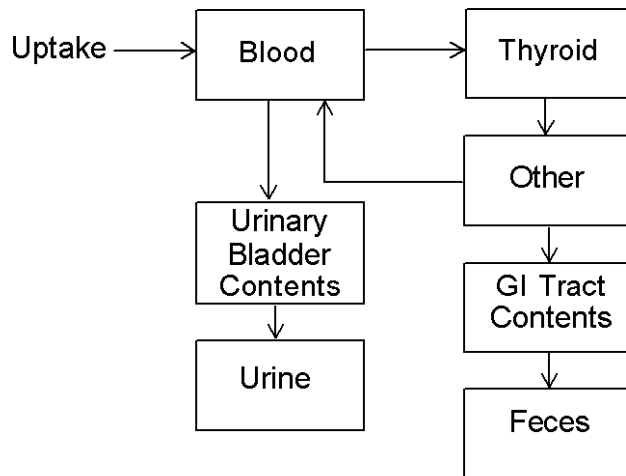

Figure 5.1. Structure of the model for iodine used in ICRP Publication 30 (1979) and current ICRP documents.

The physiologically based models applied by the ICRP to adult members of the public generally were carried over to ICRP Publication 68 (1994a), which updates effective dose coefficients for workers. Exceptions are the models for curium and calcium, which appeared in ICRP Publication 71 (1995b), after Publication 68 had been completed. Several non-physiological models applied by the ICRP to adult members of the public were also carried over to ICRP Publication 68, including models for hydrogen (as tritiated water or organically bound tritium), zinc, selenium, niobium, zirconium, molybdenum, silver, antimony, tellurium, cerium, and polonium. For the remaining elements, the models of ICRP Publication 30 were applied in ICRP Publication 68 but were modified to depict passage of excreted activity through the urinary bladder contents and the large intestine. The generic form of these models (i.e., the implicit compartments and directions of flow of activity) is shown in Figure 5.2.

Because most of the models of ICRP Publication 30 do not specify a division of excreted activity between urine and feces, element-specific ratios of urinary to fecal excretion were assigned in ICRP Publication 68 to elements other than hydrogen and carbon. For tritium and radioisotopes of carbon, the dose is assumed to be uniform throughout the body, including the urinary bladder wall and upper and lower large intestines. Table 5.1 lists the ICRP publications that introduced the biokinetic models applied in ICRP Publication 68 and the ratio of urinary to fecal excretion applied in Publication 68 to each element.

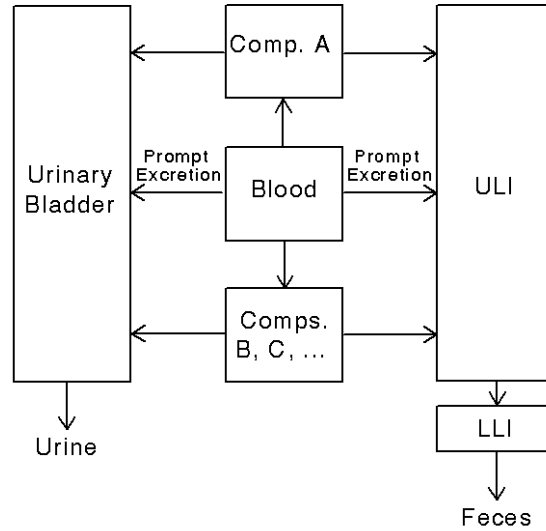

Figure 5.2. Generic structure of most of the non-recycling biokinetic models currently used by the ICRP.

The following sections discuss the primary changes in systemic biokinetic models between ICRP Publication 30 and ICRP Publication 68 and the significance of those changes with regard to estimates of cumulative activity in radiosensitive tissues.

5.2. Comparison of previous and updated models for bone-volume seekers

5.2.1. ICRP Publication 30 model for alkaline earth elements

The alkaline earth model introduced in ICRP Publication 20 (1973) is applied in ICRP Publication 30 (in modified form) to calcium and its physiological analogues, strontium, barium, and radium. Compared with most of the biokinetic models traditionally used in radiation protection, the alkaline earth model of ICRP Publication 20 is unusual in its detail and in the association of some model parameters with physiological processes. The formulation of the model is also unusual in that retention is expressed as a combination of power functions and exponential functions. Whole-body retention $R(t)$ at time t days after injection is described by the equation:

$$R(t) = (1 - p)\exp(-mt) + pE^b(t + E)^{-b}[B\exp(-rLt) + (1-B)\exp(-srLt)].$$

Table 5.1. Sources of biokinetic models (original ICRP publication) and urinary to fecal ratios U:F used in ICRP Publication 68.

Element	ICRP Pub. / U:F	Element	ICRP Pub. / U:F	Element	ICRP Pub. / U:F
Hydrogen	56/a	Zirconium	67/5.0	Lutetium	30/1.0
Beryllium	30/1.0	Niobium	56/5.0	Hafnium	30/1.0
Carbon	30/a	Molybdenum	67/8.0	Tantalum	30/1.0
Fluorine	30/1.0	Technetium	30/1.0	Tungsten	30/1.0
Sodium	30/100	Ruthenium	30/4.0	Rhenium	30/1.0
Magnesium	30/1.0	Rhodium	30/1.0	Osmium	30/1.0
Aluminum	30/1.0	Palladium	30/1.0	Iridium	30/1.0
Silicon	30/1.0	Silver	67/0.05	Platinum	30/1.0
Phosphorous	30/9.0	Cadmium	30/1.0	Gold	30/b
Sulfur	30/9.0	Indium	30/1.0	Mercury	30/1.0
Chlorine	30/100	Tin	30/1.0	Thallium	30/1.0
Potassium	30/1.0	Antimony	69/4.0	Lead	67/b
Calcium	30/1.0	Tellurium	67/4.0	Bismuth	30/1.0
Scandium	30/1.0	Iodine	56/b	Polonium	67/0.5
Titanium	30/1.0	Cesium	30/4.0	Astatine	30/1.0
Vanadium	30/1.0	Barium	67/b	Francium	30/1.0
Chromium	30/1.0	Lanthanum	30/1.0	Radium	67/b
Manganese	30/1.0	Cerium	67/0.11	Actinium	30/1.0
Iron	69/b	Praseodymium	30/1.0	Thorium	69/b
Cobalt	30/6.0	Neodymium	30/1.0	Protactinium	30/1.0
Nickel	30/20	Promethium	30/1.0	Uranium	69/b
Copper	30/1.0	Samarium	30/1.0	Neptunium	67/b
Zinc	67/0.25	Europium	30/1.0	Plutonium	67/b
Gallium	30/1.0	Gadolinium	30/1.0	Americium	67/b
Germanium	30/c	Terbium	30/1.0	Curium	30/1.0
Arsenic	30/1.0	Dysprosium	30/1.0	Berkelium	30/1.0
Selenium	69/2.0	Holmium	30/1.0	Californium	30/1.0
Bromine	30/1.0	Erbium	30/1.0	Einsteinium	30/1.0
Rubidium	30/3.0	Thulium	30/1.0	Fermium	30/1.0
Strontium	67/b	Ytterbium	30/1.0	Mendelevium	30/1.0
Yttrium	30/1.0				

^aExcretion pathways are not considered.

^bExcretion pathways included explicitly in the recommended biokinetic model.

^cExcretion only in urine for activity deposited in kidney. Ratio of 1.0 used for activity in other tissues.

^dExcretion only in urine.

Some of the parameters are element dependent, and some are related to processes rather than specific elements. The parameter L is the rate of apposition and resorption in compact bone, s is the ratio of turnover rates of trabecular and compact bone, B is the fraction of bone volume activity deposited in compact bone, and r is an element-specific factor that corrects for redeposition of activity in new bone at sites of resorption long after injection. The power function slope, b , is related to diffusion of activity from bone but is element specific. The element-specific parameter values E (a small time related to the turnover of an initial pool), m (the rate constant of a small early exponential in R), and p (the fraction of R not in the early exponential) are not clearly related to processes.

5.2.2. ICRP Publication 30 model for lead

The biokinetic model for lead recommended in ICRP Publication 30 is typical of the models used in that document. Based on experimental data on dogs, it is assumed that 55% of lead leaving the transfer compartment (blood) deposits in the skeleton, 25% in the liver, and 2% in the kidneys. The remaining 18% is uniformly distributed throughout the rest of the body. The residence time of lead in blood is based on the generic half-time of 0.25 d used for most elements in ICRP Publication 30. Each of the source organs (skeleton, liver, kidneys, other) consists of three hypothetical compartments corresponding to biological half-times of 12, 180, and 10,000 d. The first two half-times are derived from data for dogs, and the third (10,000 d) is based on indications of a long-term retention component for lead in humans. The relative fractions assigned to short-, intermediate-, and long-term retention in the skeleton are 0.6, 0.2, and 0.2, respectively, and those for other organs are 0.8, 0.18, and 0.02, respectively. On the basis of findings that lead can substitute for calcium in bone mineral, the assumption is made that relatively long-lived isotopes of lead such as ^{210}Pb are uniformly distributed throughout the volume of mineral bone at all times after deposition in the skeleton. Isotopes of lead with half-lives less than 15 d are assigned to bone surfaces.

5.2.3. ICRP Publication 30 model for uranium

The biokinetic model for uranium introduced in ICRP Publication 30 was based on limited data on human subjects (including environmental data that now appear to be in error), occupational data on one subject, and experimental data involving terminally ill subjects. The body is divided into a transfer compartment (blood) and three repositories: mineral bone, kidneys, and all other tissue. Of uranium entering the transfer compartment, fractions 0.2 and 0.023 are assigned to mineral bone and removed with half-times of 20 and 5,000 d, respectively; fractions 0.12 and 0.00052 are assigned to the kidneys and removed with half-times of 6 and 1500 d, respectively; and fractions 0.12 and 0.00052 are assumed to be uniformly distributed

among all other tissues of the body and removed with half-lives of 6 and 1500 d, respectively. The remainder is assigned to excretion. Long-lived uranium isotopes such as ^{234}U , ^{235}U , and ^{238}U are assumed to be distributed uniformly throughout mineral bone at all times following deposition in the skeleton, but short-lived isotopes are assigned to bone surfaces.

5.2.4. Updated models for the alkaline earths, lead, and uranium

The ICRP's alkaline earth model was updated in the ICRP series on doses to members of the public. The structure of the updated model (Figure 5.3) was also applied in that series to lead and uranium, two elements whose skeletal behavior is broadly similar to that of calcium (ICRP, 1993, 1995a, 1995b).

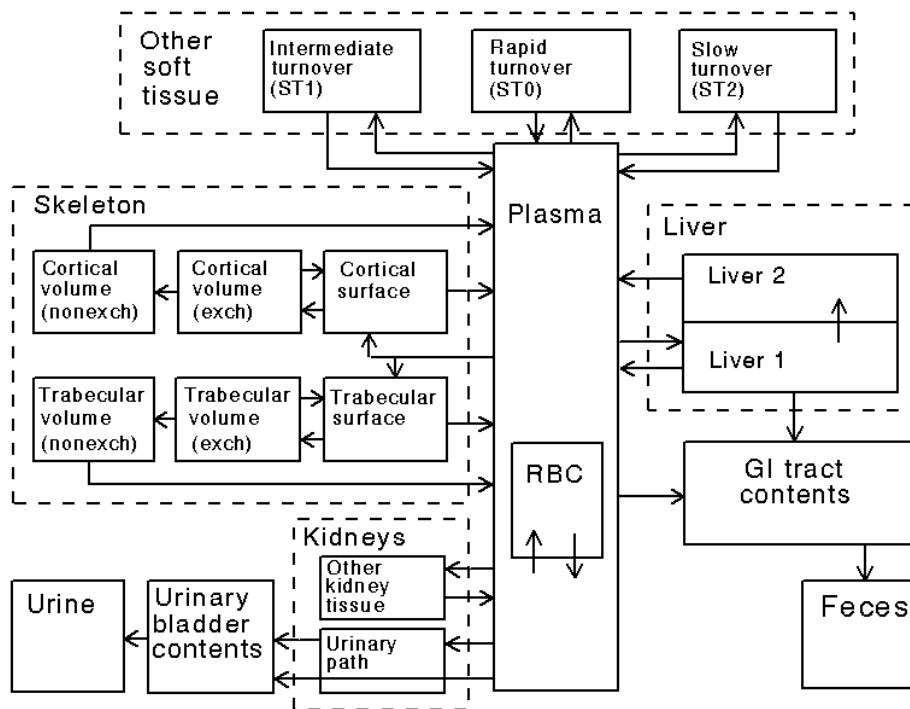

Figure 5.3. ICRP's generic model structure for calcium-like elements, introduced in ICRP Publication 67 (1993) and applied in that document or subsequent ICRP documents to calcium, strontium, barium, radium, lead, and uranium.

In the updated model for the alkaline earth elements and related elements, plasma is treated as a uniformly mixed pool. A compartment representing red blood cells is included for application to lead and uranium but is not used in the models for the alkaline earth elements. Soft tissues (excluding liver and kidneys, when these organs are treated explicitly) are divided into compartments corresponding to fast, intermediate, and slow return of activity to plasma (compartments ST0, ST1, and ST2, respectively). The liver and kidneys are not assigned separate parameter values for calcium, strontium, and barium, but liver is assumed to have elevated uptake and retention of radium, and liver and kidneys are both important components of the biokinetic models for lead and uranium. As in the alkaline earth model described in ICRP Publication 20 (ICRP 1973), bone is divided into cortical surface, cortical volume, trabecular surface, and trabecular volume, and rapidly exchangeable activity in bone is assumed to reside on bone surfaces. The model of ICRP Publication 20 has a power-function component accounting for most of the biological removal from bone during the first few months after injection (ICRP, 1973). In the updated alkaline earth model, this intermediate-term removal from bone is treated as first-order removal from “exchangeable” bone volume pools. That is, cortical and trabecular bone volume are each divided into “exchangeable” and “non-exchangeable pools”. Activity moving from bone surfaces to bone volume enters the exchangeable pool and leaves this pool with an element-specific half-time, on the order of a few weeks or months. Part of the activity leaving exchangeable bone volume returns to rapidly exchanging bone surfaces and part goes to non-exchangeable bone volume, from which it is removed to plasma at the rate of bone turnover. Excretion of the alkaline earth elements and uranium is assumed to occur only in urine and feces, but excretion via sweat and hair is also considered in the model for lead.

As a rule, the updated models for bone-volume seekers were based on a larger set of information than was used in the construction of the models of ICRP Publication 30. For example, parameter values for lead were derived from information from lead tracer studies on healthy adult human volunteers; autopsy data for environmentally exposed subjects; lead balance studies on adult human subjects; bioassay and autopsy data on lead workers; studies of radilead in baboons, monkeys, beagles, and other laboratory animals; and comparisons of lead and alkaline earths in bone.

5.2.5. Comparison of predictions of updated and previous models

Cumulative activities in tissues as predicted by the previous and updated models are compared in Table 5.2 for selected bone-volume-seeking radionuclides. These comparisons address only the parent radionuclides. Updated models of chain members produced in the body are addressed later.

Table 5.2. For selected bone-volume-seeking radionuclides, comparison of 50-y integrated activities in tissues of the adult as predicted by the models of ICRP Publication 30 and Publication 68. It is assumed that 1 Bq is injected into blood at time zero.

Radio-nuclide	Half-life	Ratio of predicted integrated activity following injection into blood ICRP 68 : ICRP 30				
		Blood	Soft tissue	Compact bone	Trabecular bone	Whole body
Sr-89	52 d	1.5	0.8	0.9	1.4	1.0
Sr-90	28.1 y	3.6	0.5	1.1	1.0	1.0
Ba-133	10.7 y	1.5	1.2	1.3	1.7	1.4
Ba-140	12.8 d	1.4	0.4	2.0	2.9	1.6
Ra-223	11.4 d	1.5	0.4	1.7	2.3	1.4
Ra-224	3.64 d	1.5	0.4	1.5	1.9	1.5
Ra-226	1602 y	1.5	0.5	1.8	1.5	1.5
Pb-210	22.3 y	71	1.1	1.2	1.4	1.0
Pb-212	10.64 h	1.5	0.8	0.8	0.5	1.0
U-234	2.445E5 y	0.3	17	1.3	1.5	1.8
U-237	6.75 d	0.2	1.3	0.6	0.8	0.8

Inventories of radium in skeleton and soft tissues as a function of time after intravenous injection as predicted by the previous and current models are compared in Figure 5.4. The updated model predicts a higher skeletal content at all times after injection and a lower content in soft tissues for the first few years after injection. For times beyond five years after injection, the two models yield similar predictions of the radium content in soft tissues.

Differences in model predictions of the cumulative activity of lead in the skeleton generally are greater for short-lived isotopes such as ^{212}Pb than relatively long-lived isotopes such as ^{210}Pb (Table 5.2). This is because the previous and updated models for lead predict much different patterns of early uptake and retention of lead but reasonably similar patterns of long-term skeletal retention. The “one-directional”, exponential models used in ICRP Publication 30 often were calibrated to yield a reasonable long-term distribution of an element.

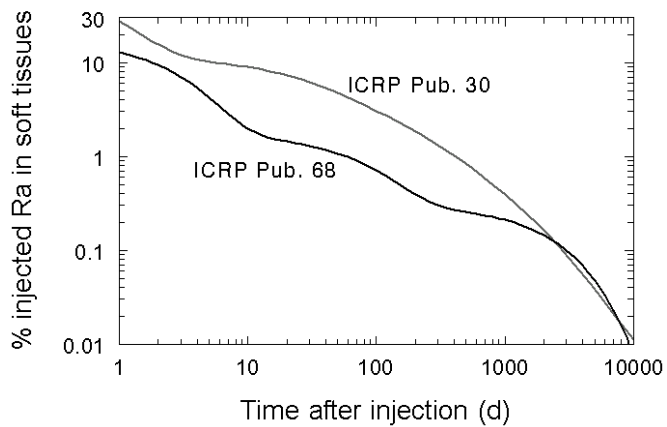
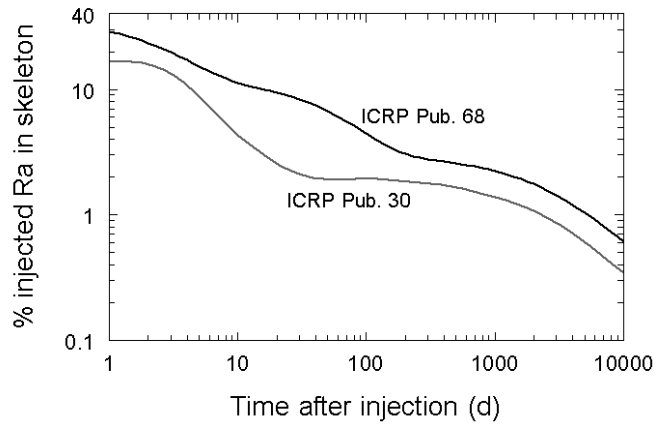

Figure 5.4. Time-dependent inventories of radium in tissues as predicted by the previous and updated ICRP models, for the case of injection of radium into blood at time zero.

Because the models of ICRP Publication 30 generally did not address recycling of activity, the maximal contents of organs were depicted as occurring soon after introduction of activity to blood, which is often not the case. In the apparently more realistic representation of lead kinetics in the updated model, much of the lead reaching blood is taken up by red blood cells and transferred over a period of weeks to longer-term storage in the skeleton.

An important feature of the physiologically based models used in recent ICRP documents is that the models link excretion with interchange of activity among body tissues. Thus, the same model can be used both for interpretation of bioassay and for radiation dosimetry.

5.3. Comparison of previous and updated models for bone-surface seekers

5.3.1. ICRP Publication 30 models for plutonium and related elements

The model initially applied in ICRP Publication 30 (Part 1, 1979; Part 2, 1980; Part 3, 1981) to plutonium as well as to actinium, neptunium, and transplutonium elements was introduced in ICRP Publication 19 (1972). In the implementation of that model in ICRP Publication 30, it is assumed that 45% of activity leaving the transfer compartment deposits on bone surfaces, from which it is removed directly to excretion with half-time of 100 y; 45% deposits in liver and is removed directly to excretion with half-time of 40 y; almost 10% goes directly to excretion, and 0.035% deposits in the testes and 0.011% in the ovaries, where it is permanently retained. Parameter values were based on consideration of data for humans as well as for a variety of animal species. The biological half-time in liver was based mainly on an assumed relationship between body weight and hepatic retention. The half-time in the skeleton was based mainly on an assumed relationship between life span and skeletal retention.

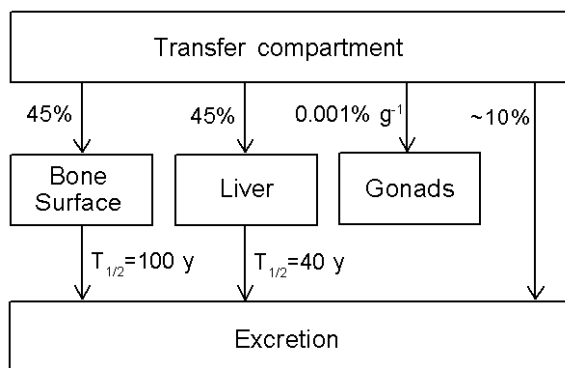

Figure 5.5. Model for plutonium and related elements used in Parts 1-3 of ICRP Publication 30 (1979, 1980, 1981).

The model for plutonium and related elements was modified in ICRP Publication 48 (1986), where some element-specific parameter values were introduced. The modified models were used in Part 4 of ICRP Publication 30, which superseded portions of Parts 1-3. For plutonium, americium, and curium, the assigned removal half-time from skeleton was reduced to 50 y and that from liver was reduced to 20 y. These same removal half-times are assigned to other elements addressed in ICRP Publication 48, but the initial division of activity between bone surfaces and liver is assumed to be 75% / 15% for neptunium and 65% / 25% for berkelium, californium, einsteinium, fermium, and mendelevium. The remaining actinide elements were not addressed in ICRP Publication 48.

5.3.2. ICRP Publication 30 model for thorium

The biokinetic model for thorium used in ICRP Publication 30 was developed separately from the model for plutonium and related elements. On the basis of observations of the fate of ²²⁸Th in beagles, it is assumed that thorium leaves the transfer compartment with a half-time of 0.5 d, with 70% depositing on bone surfaces, 4% depositing in the liver, 16% depositing in other soft tissues, and 10% lost in excreta. Thorium is removed from bone surfaces to excretion with a biological half-time of 8000 d and from liver and other soft tissues to excretion with a biological half-time of 700 d. The assumption that skeletal deposits remain on bone surfaces until removed to excretion is generally applied in ICRP Publication 30 to actinide elements, with the exception of long-lived isotopes of uranium.

5.3.3. Updated models for thorium, plutonium, and related elements

In the ICRP documents addressing environmental exposures to members of the public, a generic model structure was applied to the “bone-surface-seeking” actinide elements thorium, neptunium, plutonium, americium, and curium (Figure 5.6). The updated models for these elements, excluding curium, were applied to the worker in ICRP Publication 68. The updated model for curium was adopted after the completion of ICRP Publication 68.

While the model structure for these five elements is generic, many of the transfer coefficients are not. Some transfer coefficients associated with compartments within the skeleton are expressed in terms of bone remodeling rates and thus are independent of the bone-surface seeker. Nevertheless, element-specific transfer coefficients are required for most of the paths shown in Figure 5.6. For the most part, the element-specific parameter values were chosen to reproduce data on human subjects, but it was often necessary to supplement data on man with information derived from studies of laboratory animals.

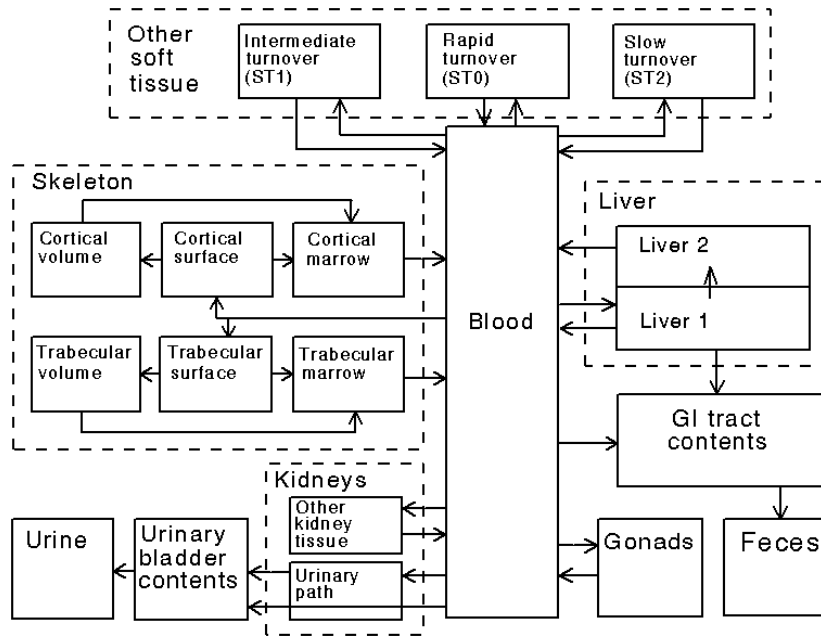

Figure 5.6. Generic model structure currently applied by the ICRP to plutonium and related elements (ICRP 1993, 1994a, 1995a, 1995b).

The generic model structure divides systemic tissues and fluids into six main parts, corresponding to blood, skeleton, liver, kidneys, gonad, and other soft tissues. Blood and gonads are each treated as uniformly mixed pools, but each of the other major divisions of the model is further divided into a minimal number of compartments needed to explain available biokinetic data on thorium and chemically similar elements. The skeleton is divided into cortical and trabecular fractions, and each of these is subdivided into fractions associated with bone surface, bone volume, and bone marrow. Activity entering the skeleton is assigned to compartments of bone surface but is assumed to transfer gradually to bone marrow by bone resorption or to compartments of bone volume by bone formation. Activity in bone volume compartments transfers gradually to bone marrow compartments by resorption. Activity moves from bone marrow compartments to blood over a few months and is redistributed in the same pattern as the original input to blood. Liver is divided into two compartments representing short-term and relatively long-term retention. Activity enters the short-term liver compartment and subsequently is divided among blood, the long-term liver compartment, and the contents of the gastrointestinal tract. Activity leaving the long-term liver compartment is assigned to blood. The kidneys are divided into two compartments, one that loses activity to urine and another that returns activity to blood. The urinary bladder content is considered as a separate pool that

receives all material destined for urinary excretion. Other soft tissues are divided into three pools corresponding to rapid (hours or days), intermediate (weeks or months), and slow (years) turnover. The rapid-turnover pool, which includes extracellular fluids, exchanges activity with blood.

5.3.4. Comparison of predictions of updated and previous models

Cumulative activities in tissues as predicted by the previous and updated models are compared in Table 5.3 for selected bone-surface-seeking radionuclides. These comparisons address only the parent radionuclides. The extent of differences in predictions of the old and new models varies with the element and tissue as well as the half-life of the isotope. For example, the old and new models for thorium predict similar initial uptake by the liver, but the new model depicts recycling from bone and other tissues to liver, with the result that differences in predictions of cumulative activity in the liver are large for the long-lived thorium isotope ^{232}Th and small for the short-lived isotope ^{234}Th . In most cases, the new models for bone-surface seekers do not predict appreciably lower activity on bone surfaces than the older models despite consideration of gradual burial of activity in bone surface in the new models, because the new models also depict gradual movement of activity from liver to bone surfaces, which offsets some of the effects of burial in bone. For isotopes of neptunium, however, predicted activity on bone surface is decreased substantially because there is little initial activity in the liver to replenish the bone-surface activity buried in bone volume.

Time-dependent inventories of thorium in different tissues, as predicted by the old and new models for the case of injection into blood at time zero, are compared in Figure 5.7. The updated model predicts longer retention in the skeleton, liver, and other soft tissues, and consequently longer retention in the total body of the adult. For example, the model of Publication 30 predicts that ~75% of long-lived thorium injected into blood at time zero will be excreted in 10,000 days, compared with a prediction of ~30% based on the updated model.

In Table 5.4, comparisons are made of the updated and previous models as predictors of the 50-y cumulative activity of ^{232}Th and ^{228}Ra in selected organs of an acutely exposed adult. Three types of acute intake are considered: injection of ^{232}Th into blood, ingestion of ^{232}Th , and inhalation of a moderately soluble form of ^{232}Th (Type M or class W, respectively, in the updated and previous respiratory tract models). The assumption of independent kinetics of decay chain members is used in conjunction with the updated systemic model (as in ICRP Publication 68), and the assumption of shared kinetics is used with the model of ICRP Publication 30.

Table 5.3. For selected bone-surface-seeking radionuclides, comparison of 50-y integrated activities in tissues of the adult as predicted by the models of ICRP Publication 30 and Publication 68. It is assumed that 1 Bq is injected into blood at time zero.

Radio-nuclide	Half-life	Ratio of predicted integrated activity for injection of 1 Bq into blood ICRP 68 : ICRP 30				
		Blood	Liver	Other	Bone surface	Whole body
Th-232	1.4E10 y	2.5	11	7.7	1.4	2.0
Th-234	24.1 d	0.7	1.2	1.1	1.0	1.0
Np-237	2.1E6 y	3.2	0.18	a	0.4	0.5
Np-239	2.355 d	1.2	0.6	a	0.5	0.8
Pu-237	45.3 d	4.2	0.7	a	1.1	1.1
Pu-239	24065 y	14	1.1	a	0.9	1.3
Am-240	50.8 h	0.1	1.1	a	0.7	1.0
Am-241	432.2 y	0.6	0.3	a	1.0	1.0

^aOther soft tissue not included in the model of ICRP Publication 30.

Differences between the old and new models for bone-surface-seeking radionuclides generally are more important for applications involving interpretation of bioassay data than for derivation of dose coefficients. For example, the rate of urinary excretion of plutonium at times remote from injection as predicted by the updated model for plutonium is an order-of-magnitude higher than predicted by the bioassay model for plutonium given in ICRP Publication 54 (1988b). This will result in large differences in dose estimates based on urinary plutonium measured long after exposure.

5.4. Comparison of previous and updated models for iron

5.4.1. ICRP Publication 30 model for iron

The biokinetic model for iron recommended in ICRP Publication 30 was based on the equilibrium distribution of iron in the human body as indicated by Reference Man data (ICRP, 1975). It is assumed that 8% of iron leaving the transfer compartment is deposited in the liver

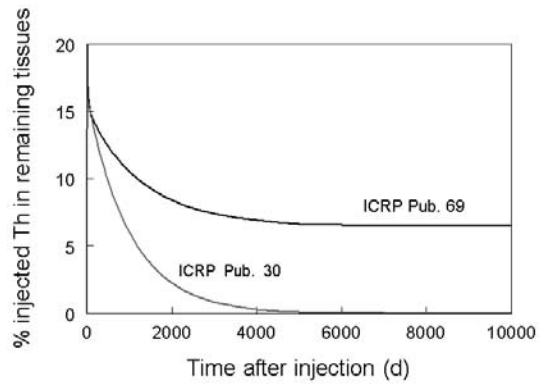
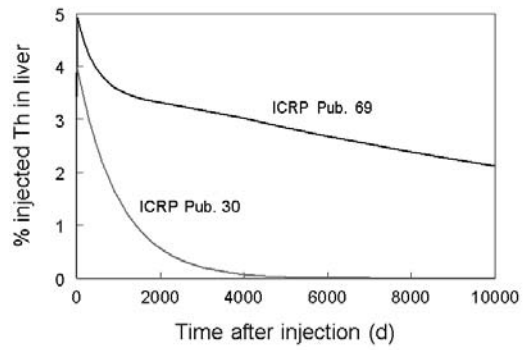
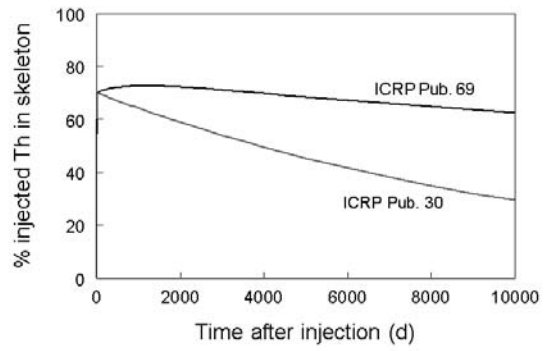

Figure 5.7. Time-dependent inventories of thorium in tissues as predicted by the previous and updated ICRP models, for the case of injection of thorium into blood at time zero.

and 1.3% is deposited in the spleen, and the remainder is uniformly distributed throughout all other tissues of the body. The removal half-time from all tissues is assumed to be 2000 d.

5.4.2. Updated model for iron

A physiologically based model for iron was introduced in ICRP Publication 69 (1995a). This updated model was applied to the worker in ICRP Publication 68. This recycling model describes three main aspects of iron metabolism: (1) the hemoglobin cycle, including uptake of transferrin-bound iron by the erythroid marrow for incorporation into hemoglobin, subsequent appearance of iron in red blood cells, uptake of old and damaged red blood cells by the reticuloendothelial system, and eventual return of iron to plasma; (2) removal of transferrin-bound iron from plasma to the extravascular spaces and return to plasma via the lymphatic system; and (3) uptake and retention of iron by the parenchymal tissues. The soft tissues include a pool of extravascular iron that exchanges rapidly with plasma iron. Storage iron is divided among liver, spleen, red marrow, and other soft tissues. Destruction of red blood cells is viewed as occurring in the red marrow. The liver is viewed as consisting of two pools: a transit pool representing parenchymal tissues that exchange iron with plasma, and a storage pool associated with the reticuloendothelial system. Excretion of iron is depicted as occurring through exfoliation of skin, losses of plasma iron in urine, and leakage of red blood cells into the intestines and subsequent removal in feces.

5.4.3. Comparison of predictions of updated and previous models

Cumulative activities in tissues as predicted by the previous and updated models for iron are compared in Table 5.4 for ^{52}Fe , ^{55}Fe , ^{59}Fe , and ^{60}Fe . These comparisons address only the parent radionuclide.

Parameter values for the iron model in ICRP Publication 30 were designed to reproduce the equilibrium distribution of iron in selected tissues. The updated model was designed to approximate the iron inventories of blood and tissues as a function of time after injection of iron into blood. It is not surprising, therefore, that the extent of differences in model predictions for a given tissue depend on the half-life of the iron isotope. For all isotopes, reasonable agreement between the two models is obtained for cumulative activity in the total body. Because the previous model does not depict recycling of iron to blood, it underestimates the blood content at times remote from injection. For the spleen, the previous model predicts a much higher cumulative activity than does the updated model for short-lived isotopes but a much lower cumulative activity for long-lived isotopes. For the liver, the updated model predicts cumulative activities that are 40-60% lower than those predicted by the previous model.

Table 5.4. For radioisotopes of iron, comparison of 50-y integrated activities in tissues of the adult as predicted by the models of ICRP Publication 30 and Publication 68. It is assumed that 1 Bq is injected into blood at time zero.

Radio-nuclide	Half-life	Ratio of predicted integrated activity for injection of 1 Bq into blood ICRP 68 : ICRP 30				
		Blood	Liver	Spleen	Remaining tissues ^a	Whole body
Fe-52	8.275 h	0.7	2.6	0.07	1.1	1.0
Fe-55	2.7 y	1500	1.9	4.4	0.4	1.2
Fe-59	44.53 y	120	2.1	1.0	0.2	1.0
Fe-60	1E5 y	5500	2.5	7.7	0.7	1.6

^aRed marrow is considered as a separate source organ in the updated model but not the previous model. For the present comparison, red marrow is considered part of remaining tissues.

5.5. Examples of other model updates for workers

5.5.1. Hydrogen

ICRP Publication 68 provides biokinetic models for both tritiated water and organically bound tritium, while Publication 30 provides a model only for tritiated water. According to the model of Publication 30, tritiated water is uniformly distributed in the body and removed with a half-life of 10 d. In Publication 68, half-times of 10 d (97%) and 40 d (3%) are assumed for tritiated water. The same half-times are used in Publication 68 for organically bound tritium, but each half-time is assumed to be associated with 50% of the absorbed amount.

Little difference in predictions of the cumulative activity in the body arises from the two slightly different models for tritiated water. The model of Publication 68 for organically bound tritium yields an estimated cumulative activity in the total body roughly 2.5 times greater than that produced by the model for tritiated water.

5.5.2. Sulfur

The systemic model for sulfur in ICRP Publication 30 addresses only inorganic sulfur. According to the model, fractions 0.15 and 0.05 of sulfur leaving the transfer compartment are distributed uniformly throughout the body and retained with half-times of 20 and 2000 d,

respectively. The remaining fraction, 0.8, goes directly to excreta. A similar model, with added excretion pathways, was applied in ICRP Publication 68 to inorganic sulfur.

An alternate model was applied in ICRP Publication 68 to organic sulfur. According to that model, all of the organically bound sulfur leaving blood is uniformly distributed in the body and removed with a half-time of 140 d. Compared with the model for inorganic sulfur, this model gives an eightfold higher cumulative total-body activity for ^{35}S .

5.5.3. Selenium

In the model for selenium in ICRP Publication 30, liver, kidneys, spleen, pancreas, and all other tissues receive 15%, 5%, 1%, 0.5%, and 78.5%, respectively, of activity leaving the transfer compartment. For any tissue, fractions 0.1, 0.4, and 0.5 are assumed to be retained with biological half-times of 3, 30, and 150 d, respectively.

The model for selenium used in ICRP Publication 68 (1994a) was developed for application to adult members of the public (ICRP, 1995a). According to that model, the liver, kidneys, spleen, pancreas, testes, ovaries, and remaining tissues receive 25%, 10%, 1%, 0.5%, 0.1%, 0.02%, and 63.4%, respectively, of selenium leaving blood. For any tissue, fractions 0.1, 0.4, and 0.5 are retained with biological half-times of 3, 30, and 200 d, respectively.

The modifications of the selenium model make little difference in predictions of cumulative activity for relatively short-lived isotopes. For long-lived isotopes, the model increases the predicted cumulative activity in the liver and kidneys by more than a factor of 2 and in the total body by about a factor of 1.3.

5.5.4. Zirconium

The retention model for zirconium given in ICRP Publication 30 includes two removal half-times: 7 d (50%) and 8000 d (50%). The long-term component is associated with bone and the short-term component with all other tissues. Skeletal zirconium is assigned to bone surfaces. The model of Publication 68 is similar, but the removal half-time from bone is assumed to be 10,000 d rather than 8,000 d. This minor change stems from a generic assumption first applied in ICRP Publication 67 (1993) to bone-seeking radionuclides whose biokinetic models are the traditional “one-directional” retention functions. As with most elements addressed in ICRP Publication 68, the model of Publication 30 was also modified to include specific urinary and fecal excretion fractions and passage of excreted activity through the urinary bladder and large intestine. The modifications yield only trivial changes in predicted cumulative activities and tissue doses from important isotopes of zirconium.

5.5.5. Molybdenum

The systemic model for molybdenum adopted in ICRP Publication 30 is a two-component retention function with half-times of 1 d (10%) and 50 d (10%). The model of Publication 68, introduced in ICRP Publication 67 (1993), assumes that 10% of activity leaving blood is deposited in the skeleton, from which is removed with a half-time of 10,000 d. The remaining activity is distributed to liver (25%), kidneys (5%), and all other tissues (60%). For tissues other than skeleton, fractions 0.1 and 0.9 are assumed to be removed with half-times of 1 and 50 d, respectively. Differences in predictions of the two models are modest for short-lived isotopes of molybdenum but make a substantial difference in the predicted cumulative activity in bone and total-body for the long-lived isotope ⁹³M (Table 5.5).

5.5.6. Silver

In the model for silver given in ICRP Publication 30, 80% of activity leaving the transfer compartment is assigned to liver and 20% is assigned to other tissues. For each pool, fractions 0.1 and 0.9 are assigned biological half-times of 3.5 d and 50 d, respectively. The model was modified in ICRP Publication 67 (1993) to depict greater deposition in tissues other than liver and a small retention component with a long half-time. In the updated model, 50% of activity leaving blood is assigned to liver and 50% to other tissues. For each pool, fractions 0.1, 0.8, and 0.1 of deposited activity are assigned biological half-times of 3.5 d, 50 d, and 500 d, respectively. The effects of the updated model on predictions of cumulative activity in liver, other tissues, and total body are indicated in Table 5.6 for three isotopes of silver with much different half-lives.

Table 5.5. For radioisotopes of molybdenum, comparison of 50-y integrated activities in tissues of the adult as predicted by the models of ICRP Publication 30 and Publication 68. It is assumed that 1 Bq is injected into blood at time zero.

Radio-nuclide	Half-life	Ratio of predicted integrated activity for injection of 1 Bq into blood ICRP 68 : ICRP 30					
		Cortical bone	Trabecular bone	Liver	Kidney	Other tissue	Total body
Mo-93	3500 y	170	42	0.8	1.0	1.2	17
Mo-99	66.0 h	0.8	0.8	0.8	1.0	1.2	1.0

Table 5.6. For radioisotopes of silver, comparison of 50-y integrated activities in tissues of the adult as predicted by the models of ICRP Publication 30 and Publication 68. It is assumed that 1 Bq is injected into blood at time zero.

Radio-nuclide	Half-life	Ratio of predicted integrated activity for injection of 1 Bq into blood ICRP 68 : ICRP 30		
		Liver	Other tissue	Total body
Ag-108m	127 y	0.8	0.2	0.5
Ag-110m	249.9 d	0.8	33	1.3
Ag-111	7.45 d	0.6	2.5	1.0

5.5.7. Antimony

In the model for antimony given in ICRP Publication 30, 20% of activity leaving the transfer compartment is assigned to excreta, 20% to bone surface, 10% to liver, and 50% to all other tissues. For any tissue, fractions 0.95 and 0.05 are assigned biological half-times of 5 and 100 d, respectively.

The model for antimony was updated in ICRP Publication 69 (1995a), and the updated model was applied in ICRP Publication 68. In the revised model, 20% of antimony leaving blood is assigned to excreta, 40% to bone surface, 5% to liver, and 35% to all other tissues. For any tissue, fractions 0.85, 0.1, and 0.05 are assigned biological half-times of 5, 100, and 5000 d, respectively.

The effects of the updated model on predictions of cumulative activity in various tissues are indicated in Table 5.7 for three isotopes of antimony with much different half-lives. Compared with the previous model, the updated model predicts substantially higher cumulative activity in most tissues, particularly bone, for relatively long-lived isotopes.

Table 5.7. For radioisotopes of antimony, comparison of 50-y integrated activities in tissues of the adult as predicted by the models of ICRP Publication 30 and Publication 68. It is assumed that 1 Bq is injected into blood at time zero.

Radio-nuclide	Half-life	Ratio of predicted integrated activity for injection of 1 Bq into blood ICRP 68 : ICRP 30				
		Cortical bone	Trabecular bone	Liver	Other tissue	Total body
Sb-124	60.2 d	3.4	3.4	0.9	1.2	1.7
Sb-125	2.77 y	12	12	3.0	4.2	5.8
Sb-126	12.4 d	2.4	2.4	0.6	0.8	1.2

5.5.8. Tellurium

In the model for tellurium given in ICRP Publication 30, 50% of tellurium entering the transfer compartment is assigned to excreta, 25% to mineral bone, and 25% to remaining tissues. Retention half-times assigned to bone and other tissues are 5000 d and 20 d, respectively. The clearance half-time from the transfer compartment is assumed to be 0.8 d, rather than the default half-time of 0.25 d generally used in ICRP Publication 30.

The model for tellurium was updated in ICRP Publication 67 (1993), and the updated model was applied in ICRP Publication 68. In the revised version of the model, 50% of tellurium entering the blood is assigned to excreta, 25% to mineral bone, 0.2% to the thyroid, 2.3% to the kidneys, and 22.5% to remaining tissues. Retention half-times assigned to bone and other tissues are 10,000 d and 20 d, respectively. The clearance half-time from blood is assumed to be 0.8 d. For important isotopes of tellurium, the updated model yields relatively modest changes in estimates of cumulative activity in tissues.

5.5.9. Polonium

In ICRP Publication 30, percentages 10%, 10%, 10%, and 70% of polonium leaving the transfer compartment are assigned to liver, kidney, spleen, and other tissues, respectively. In Publication 68, 30%, 10%, 5%, 10%, and 45% are assigned to liver, kidneys, spleen, red bone marrow, and all other tissues, respectively. In both models, a retention half-time of 50 d is assigned to all tissues. For ^{210}Po , these changes result in a threefold reduction in the estimated cumulative activity in liver and a twofold increase in the estimate for spleen. Because the red

marrow is an explicitly identified source organ in the updated model and is assigned a deposition fraction much greater than its mass fraction, the updated model yields a sixfold higher estimate of integrated dose to red marrow than the previous model.

5.6. Changes in treatment of systemic kinetics of decay chain members formed *in vivo*

5.6.1. Different approaches used by the ICRP

In ICRP Publication 30, decay chain members produced in the body generally are assigned the biokinetic model of the parent radionuclide, which is referred to as the assumption of “shared kinetics”. Exceptions are made for radioiodine produced by decay of radiotellurium and for noble gases appearing in certain decay chains. Iodine as a daughter of tellurium is assumed to be translocated instantaneously to the transfer compartment in inorganic form and then to follow the same kinetics as iodine introduced into blood as a parent radionuclide. The assumption for noble gases varies with the radiological half-time and the site of production in the body. For example, it is assumed that: ^{222}Rn ($T_{1/2} = 3.8$ d) produced from ^{226}Ra in soft tissues escapes from the body before decay; 70% of ^{222}Rn produced in bone escapes from the body and the remaining 30% decays at the site of production; ^{220}Rn ($T_{1/2} = 56$ s) produced from ^{224}Ra decays at the site of production, either in soft tissues or bone; 20% of $^{83\text{m}}\text{Kr}$ ($T_{1/2} = 1.83$ h) produced from ^{83}Rb decays at the site of production and the remaining 80% escapes from the body; and ^{79}Kr ($T_{1/2} = 35$ h) produced from ^{79}Rb escapes from the body.

Experimental data on laboratory animals and postmortem data on human subjects indicate that many decay chain members produced *in vivo* behave much differently from the parent radionuclide (ICRP, 1993; ICRP, 1995a). It appears that radionuclides born in soft tissues and, to some extent, on bone surfaces may relocate as if injected directly into blood, while radionuclides born in bone volume are more limited in their ability to migrate from the parent radionuclide. With regard to inhaled material deposited in the lung, a reasonable default assumption may be that a radionuclide born in the respiratory tract remains with the parent if originating in an undissolved particle but otherwise translocates according to its own characteristic parameter values (i.e., values derived for that element assuming its direct deposition into the respiratory tract). There is little information on the behavior of decay chain members produced in the gastrointestinal tract, but the rate of translocation through different segments of the tract should be relatively independent of the radionuclide. In view of the tightly controlled and highly selective nature of absorption of material through the gastrointestinal tract wall, it seems reasonable to assume that the absorption fraction for decay chain members produced in the gastrointestinal tract contents is independent of absorption properties of the parent radionuclide.

For most decay chains, the assumption of shared kinetics was carried over to ICRP Publication 68 and to the ICRP's series on intakes of radionuclides by members of the public. The assumption of independent kinetics of radioactive progeny is applied in those document in selected situations, as summarized in the following:

1. Iodine produced from decay of tellurium is assumed to be translocated at a fractional rate of 1000 d^{-1} to the transfer compartment in inorganic form and then to follow the same kinetics as iodine introduced into the transfer compartment as a parent radionuclide.
2. If the parent is an isotope of lead, radium, thorium, or uranium, then a radionuclide other than a noble gas formed in soft tissues or on bone surfaces is assigned the characteristic biokinetics of that radionuclide. That is, it is assumed to have the same biokinetics as if the radionuclide had been taken in as a parent radionuclide. A radionuclide other than a noble gas formed in bone volume is assigned the biokinetics of the parent. Noble gases produced in soft tissues and bone surfaces are assumed to migrate from the body with a transfer coefficient of 100 d^{-1} . Noble gases produced in exchangeable and non-exchangeable bone volume are assumed to migrate from the body at rates of 1.5 d^{-1} and 0.36 d^{-1} , respectively.

The effects of these assumptions on dose coefficients are illustrated in Table 5.8 for selected radionuclides.

In ICRP Publication 68 and ICRP documents on intakes of radionuclides by members of the public, radionuclides produced in the respiratory tract are assumed to have the same kinetics as the parent radionuclide while in the respiratory tract. The rate of dissolution of the carrier of the radionuclide is assumed to control the rate of migration of inhaled radionuclides and their radioactive progeny. An exception is made for ^{222}Rn , which is assumed to escape from the body at a fractional rate of 100 d^{-1} after its production in any segment of the respiratory tract.

Chain members produced in, or migrating to, the gastrointestinal tract after intake of the parent radionuclide are assigned the gastrointestinal absorption fraction (f_i) of the parent in most cases. For consistency with the treatment of the systemic biokinetics of radionuclides formed *in vivo*, exceptions are made if the parent is lead, radium, actinium, thorium, protactinium, or uranium. In these cases, absorption of a chain member produced *in vivo* is assumed to be the same as if that chain member had been taken in as a parent radionuclide.

Table 5.8. Comparison of 50-y integrated doses following injection of 1 Bq of the parent into blood, based on alternate assumptions concerning biokinetics of decay chain members produced *in vivo*. The ICRP's updated biokinetic models were used in both cases.

Parent	Ratio of dose coefficients A:B, where A is based on independent kinetics and B on shared kinetics	
	Effective dose	Tissue most affected
²¹⁰ Pb	0.8	11 (spleen)
²²⁵ Ra	2.8	9.7 (kidneys)
²²⁶ Ra	1.0	1.5 (kidneys)
²²⁸ Ra	2.4	12 (liver)
²²⁷ Th	0.3	0.3 (several organs)
²²⁸ Th	0.5	0.4 (several organs)
²³² Th	0.2	0.2 (several organs)
²³² U	1.3	1.8 (bone surface, red marrow)

5.6.2. Detailed example: Treatment of ²³²Th chain members produced in systemic tissues

There is experimental evidence to support the assumption of independent kinetics for some chains of radionuclides, including some thorium chains (Leggett et al., 1984). For example, activity ratios ²²⁴Ra:²²⁸Th in tissues and excreta of beagles injected with ²²⁸Th are consistent with the assumption that ²²⁴Ra born on bone surfaces migrates from ²²⁸Th over a period of days and then behaves as if injected directly into blood. Time-dependent activity ratios of subsequent members of the ²²⁸Th chain also suggest redistribution consistent with the characteristic biokinetic models of individual members, although the extent of migration of these chain members and hence the interpretation of the data are limited by the short half-lives of the chain members.

The assumption of independent kinetics was applied in ICRP Publication 69 (1995a) to chain members produced *in vivo* after absorption of thorium isotopes to blood, except that some simplifying assumptions were made in cases where there was little difference, in effect, between

the assumptions of shared and independent kinetics. Parameter values for individual chain members can be found in Appendix C of ICRP Publication 71 (ICRP, 1995b). The following general assumptions are made for members of thorium chains:

1. Radium isotopes formed *in vivo* are assumed to follow the model for radium as a parent (ICRP, 1993). This requires that the model structure for thorium be expanded to include compartments that are in the radium model but not in the thorium model. For example, each bone volume compartment in the thorium model must be divided into exchangeable and nonexchangeable bone volume compartments to describe the behavior of radium after its movement from plasma to bone surfaces to bone volume. According to the radium model, bone contains about 30%, soft tissues about 15%, and excreta plus excretion pathways (mainly intestinal contents) about 55% of the injected amount at 1 d after injection of long-lived radium into blood of an adult. Most radium atoms entering bone or soft tissues return to plasma within a few days. By 100 d after injection, bone retains less than 5% and soft tissues less than 1% of the injected amount, the rest having been lost in excreta.
2. Radon produced in soft tissues or bone surfaces is assumed to move to plasma at a rate of 100 d^{-1} . Radon produced in the exchangeable and nonexchangeable bone volume compartments is assumed to migrate to plasma at rates of 1.5 and 0.36 d^{-1} , respectively. Radon entering plasma is assumed to leave the body by exhalation at a rate of 1 min^{-1} .
3. Lead isotopes formed *in vivo* are assumed to follow the model for lead as a parent (ICRP, 1993). Therefore, the model structure used to address a thorium chain that includes lead as a daughter must include compartments such as red blood cells and exchangeable and nonexchangeable bone volume that are in the lead model but are not identified separately in the thorium model. According to the lead model, the approximate contents of various regions at 1 d after injection of long-lived lead into blood of an adult are as follows: red blood cells, 59% (of the injected amount); bone, 15%; liver, 11%; kidneys, 5%; other soft tissues, 3%; and excreta plus excretion pathways, 7%. Over the next few weeks there is a gradual shift of lead from red blood cells to bone, soft tissues, and excreta. After 100 d, the predicted contents of the regions are as follows: red blood cells, 4% (of the injected amount); bone, 22%; liver, 5%; kidneys, 2%; other soft tissues, 5%; and excreta, 62%.
4. The model for polonium as a decay chain member is based on the non-recycling model for polonium as a parent given in ICRP Publication 67 (1993), but the latter model

is converted into a recycling model to fit into the framework used for thorium, radium, and lead. Removal of polonium from all tissues except bone volume is assumed to occur at a rate of 0.1 d^{-1} , with activity going to plasma. Removal from bone volume to plasma is assumed to occur at the rate of bone turnover. Of polonium reaching plasma, 10% goes to the upper large intestine, 5% to the urinary bladder contents, 30% to liver, 10% to kidneys, 5% to spleen, 10% to red marrow, and 45% to other tissues.

5. Bismuth is assumed to leave all tissues except bone volume at a rate of 0.035 d^{-1} , with activity going to plasma. From plasma, 35% goes to urine, 7% to feces via the intestines, 35% to the kidneys, 5% to the liver, and 18% to other tissues.

6. Isotopes of thallium appearing in important thorium chains are short-lived and are assumed to decay at their point of origin. Isotopes of actinium, protactinium, and thorium produced *in vivo* are assigned the model for thorium.

The treatment of decay chain members is a particularly important consideration in the internal dosimetry of ^{232}Th because the radioactive progeny of ^{232}Th yield substantially more alpha energy than the parent over a period of years. The estimated alpha activity of the total chain is reduced substantially if it is assumed, as indicated by available experimental data, that ^{228}Ra and subsequent chain members migrate over a period of hours or days from sites of production on bone surfaces and in soft tissues and then behave as if injected directly into blood (Tables 5.9 and 5.10).

5.7. Implications of biokinetic model updates for interpretation of bioassay data

The ICRP's updated models often lead to considerably different interpretation of bioassay data than would be made from the biokinetic models of ICRP Publication 30 or the related bioassay models of ICRP Publication 54 (1988b). Potential differences are illustrated in Table 5.11, which gives estimated 50-year integrated absorbed doses for acutely inhaled ^{238}U derived from measurements of urinary ^{238}U made 24-48 h after intake. It is assumed that ^{238}U is inhaled in relatively insoluble form and the particle size is $5 \mu\text{m}$ (AMAD). The large differences in dose estimates result from a combination of differences in predictions of the updated and previous respiratory models, systemic models, and f_I values.

Table 5.9. Comparison of estimated 50-y integrated activities of ^{232}Th and its decay chain members, assuming (A) independent or (B) shared kinetics of decay chain members, for the case of injection of ^{232}Th into blood of an adult.^a

Radionuclide	Ratio of integrated activities, A:B						
	Cortical bone surface	Trabecular bone surface	Cortical bone volume	Trabecular bone volume	Red bone marrow	Liver	Testes, ovaries
^{232}Th	1.0	1.0	1.0	1.0	1.0	1.0	1.0
^{228}Ra , ^{228}Ac	0.001	0.003	0.9	0.7	0.08	0.04	0.05
^{228}Th	0.02	0.06	0.8	0.5	0.2	0.06	0.05
^{224}Ra through ^{208}Tl	~0.005	~0.02	~0.8	~0.5	~0.1	~0.05	~0.05

^aThe biokinetic model for thorium given in ICRP Publication 69 (ICRP, 1995a) is applied to ^{232}Th . For the case of independent kinetics, the models and assumptions of Publication 69 are applied to the radioactive progeny of ^{232}Th .

Table 5.10. Comparison of ICRP's updated (ICRP, 1995a) and previous (ICRP, 1979) models as predictors of 50-y integrated activity after acute intake of ^{232}Th by an adult.

Compartment	Ratio of integrated activities (updated models : previous models)					
	Injection		Ingestion		Inhalation	
	^{232}Th	$^{228}\text{Ra}^a$	^{232}Th	$^{228}\text{Ra}^a$	^{232}Th	$^{228}\text{Ra}^a$
Trabecular surfaces	0.49	0.0014	1.2	0.0036	0.39	0.0011
Cortical surfaces	2.3	0.0026	5.7	0.0064	1.8	0.0020
Liver	11	1.4	27	3.5	8.4	1.0
Kidneys	110	9.0	280	23	86	7.0
Gonads	60	8.9	150	22	47	7.0
Other	25	56	62	140	19	42

^aRefers to ^{228}Ra produced in the body after intake of ^{232}Th .

The implications of the revised models with regard to interpretation of bioassay data are more difficult to generalize or summarize than those for dose coefficients, because differences in back calculations from bioassay data depend not only on the radionuclide and exposure mode but also on the time after intake. Consider, for example, the case of inhalation of a relatively insoluble form of thorium (Type S or Class Y) in 1- μm (AMAD) particles. Urinary excretion rates predicted by the previous respiratory tract model and systemic model for thorium (ICRP 1979, 1988b) and the current models (ICRP 1995a, 1997) are shown in Figure 5.8. The ratio of predicted excretion rates (updated models : previous models) ranges from about 2 to about 20, depending on the observation time. Large differences in predictions of intake based on previous and updated methods may not lead to large differences in dose estimates, provided the dose coefficients are based on the same models as the backward calculations of intake. This is because the same models that yield relatively high estimates of intake from bioassay data often

Table 5.11. Comparison of dose estimates based on updated and previous ICRP models and recommendations for the case of acutely inhaled ^{238}U (insoluble, 5 μm AMAD), back-calculating from urinary excretion measured 24-48 h after intake.

Tissue	Ratio of absorbed dose estimates ICRP Pub. 68 : ICRP Pub. 30
Bone surface	9.7
Breast	110
Colon	17
Kidneys	8.6
Lung	7.5
Red marrow	15
Testes	130
Effective ($E:H_E$)	11

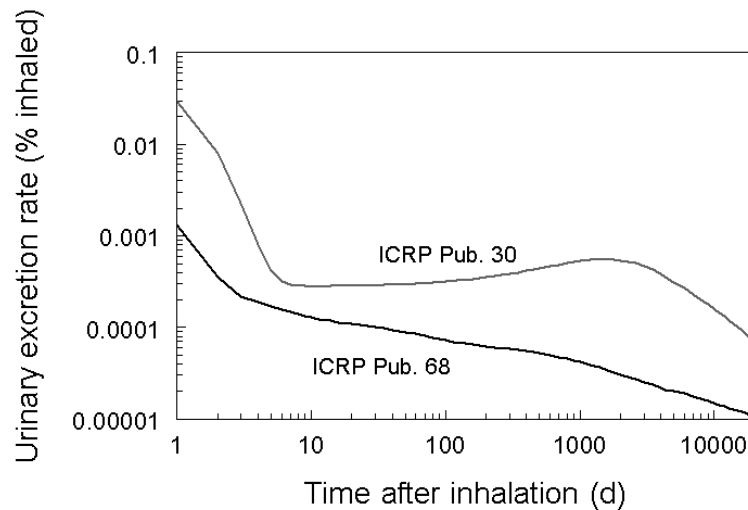

Figure 5.8. Urinary excretion rates for inhaled thorium predicted by the previous respiratory tract model and systemic model for thorium (ICRP 1979, 1988b) and the current models (ICRP 1995a, 1997). Thorium is assumed to be inhaled in insoluble form (Type S or Class Y). The assumed particle size is 1- μm (AMAD).

yield relatively low estimates of dose per unit intake. For example, the updated models yield a 2- to 20-fold higher estimate of inhalation intake of insoluble ^{232}Th based on one or more measurements of urinary ^{232}Th (Figure 5.8). In an estimate of the resulting effective dose, however, the higher estimate of intake may be largely offset by the fact that the updated effective dose coefficient for inhaled ^{232}Th in insoluble form is about 14-fold lower than the effective dose coefficient from ICRP Publication 30. If intake of ^{232}Th is estimated from a urinary measurement made at a time when the curves in Figure 5.8 differ by a factor of 20, then there is only a modest difference in the alternate estimates of effective dose. If the measurement of urinary ^{232}Th is made at a time when the two curves differ by a factor of 2, then the two estimates differ considerably.

In practice, calculations of intake of a radionuclide often are based on measurements of decay chain members rather than the parent radionuclide. For example, intake of ^{232}Th may be estimated from external measurement of total-body ^{212}Pb or ^{208}Tl . Due to the considerable changes in recent years in the ICRP's assumptions concerning the fate of some decay chain

members produced in the body, the previous and updated models can yield considerably different estimates of intake based on measurement of decay chain members.

5.8. The ICRP's age-specific systemic biokinetic models

5.8.1. Elements for which age-specific models have been developed

The ICRP's series of documents on intakes of radionuclides by members of the public (ICRP, 1989, 1993, 1995a, 1995b, 1996) provides age-specific biokinetic models for 31 elements: hydrogen, carbon, sulfur, calcium, iron, cobalt, nickel, zinc, selenium, strontium, zirconium, niobium, molybdenum, technetium, ruthenium, silver, antimony, tellurium, iodine, cesium, barium, cerium, lead, polonium, radium, thorium, uranium, neptunium, plutonium, americium, and curium. The 31 models represent a variety of modeling approaches.

5.8.2. Physiologically based models for bone-seeking radionuclides

As described earlier, the ICRP has adopted a generic, physiologically based model structure for bone-volume-seeking radionuclides and a similar but separate generic structure for bone-surface-seeking radionuclides. These models have been applied to workers but were developed for consideration of environmental intakes of radionuclides by adults or children and have age-specific parameter values. Some of the parameter values describing translocation of skeletal activity are generic and are based on basic physiological information on bone restructuring. Other parameter values are element-specific and are selected from available data on the element of interest and its physiological analogues in human subjects and laboratory animals. The quantity and quality of available age-specific information varies considerably from one bone-seeking element to another. For example, there is a sizable database on the age-specific biokinetics of calcium or strontium, smaller but useful databases for radium or lead, and relatively little direct information on the age-specific biokinetics of barium or uranium. The age-specific biokinetics of plutonium has been studied frequently in laboratory animals, but there is not much age-specific information on most other bone-surface-seeking radionuclides.

Consider, for example, the age-specific biokinetic database on strontium. A large data base related to the transfer of ^{90}Sr from food and milk to the human skeleton was developed in the 1950s and 1960s, although interpretation of this information is complicated by the fact that measured skeletal burdens were accumulated over an extended period. More easily interpreted but more limited age-specific data on the systemic biokinetics of strontium in human subjects are available from controlled studies. Because strontium is a close physiological analogue of calcium, data from controlled studies of calcium in humans provide supporting information for selection of age-specific parameter values for strontium. The use of a physiologically

descriptive model framework allows age-specific data on human subjects and laboratory animals to be superimposed on information concerning addition and turnover of skeletal calcium and restructuring of bone. Experimental and environmental data on strontium in humans subjects were used as primary sources of information but were supplemented with data on the behavior of strontium and its physiological analogues in laboratory animals, and data on the behavior of physiological analogues of strontium in humans. For example, data on laboratory animals provide evidence that the initial uptake by bone is similar for all alkaline earth elements. This strengthens confidence in estimates of the biokinetics of strontium at early times after intake, for which there are reasonably good data on human subjects but little information regarding the division between bone and soft tissues in those subjects. Age-specific data on strontium in dogs help strengthen confidence in judgments, based mainly on fallout data, concerning relative patterns of buildup and decline of strontium in bone at different stages of bone development.

Thorium provides an example of a bone-seeking radionuclide for which there is relatively little direct information on age-specific biokinetics. The model was developed within the generic structure for bone-surface-seeking radionuclides (Figure 5.6). Default assumptions concerning the relative kinetics of bone seekers in children and adults were used in ICRP Publication 69 (1995a) to extend parameter values from adults to children. These assumptions are based on numerous observations of the age-specific biokinetics of various bone seekers in laboratory animals and, to a lesser extent, human subjects. It is postulated that differences with age in the biokinetics of a bone-seeking radionuclide is determined largely by three factors: increased fractional transfer from plasma to bone in children in association with elevated bone formation rates in the maturing skeleton; decreased fractional transfer from plasma to soft tissues and excreta in children due to relatively greater competition from immature bone; and an elevated rate of transfer from bone to plasma in children due to an elevated rate of bone turnover. For actinide elements, the additional assumption is made that fractional deposition in the gonads at a given age depends on the mass of the gonads at that age. Except where there is evidence to the contrary, removal half-times from soft tissues, bone surfaces, and exchangeable bone volume are assumed to be independent of age. Age-specific parameter values of the ICRP's systemic biokinetic model for thorium are given in Table 5.12.

Table 5.12. Age-specific transfer coefficients (d^{-1}) in the systemic biokinetic model for thorium (ICRP, 1995a).

Pathway ^a	Age (y)					
	Infant (100 d)	1 y	5 y	10 y	15 y	Adult
Blood to Liver 1	0.0647	0.0647	0.0647	0.0647	0.0647	0.0970
Blood to Cort Surf	0.7763	0.7763	0.7763	0.7763	0.7763	0.6793
Blood to Trab Surf	0.7763	0.7763	0.7763	0.7763	0.7763	0.6793
Blood to UBC	0.0711	0.0711	0.0711	0.0711	0.0711	0.1067
Blood to Urinary Path	0.0453	0.0453	0.0453	0.0453	0.0453	0.0679
Blood to OKT	0.0129	0.0129	0.0129	0.0129	0.0129	0.0194
Blood to LI Contents	0.00647	0.00647	0.00647	0.00647	0.00647	0.00970
Blood to Testes	0.000039	0.000058	0.000066	0.000077	0.00062	0.00068
Blood to Ovaries	0.000023	0.000030	0.000076	0.00013	0.00023	0.00021
Blood to ST0	0.832	0.832	0.832	0.832	0.832	0.832
Blood to ST1	0.162	0.162	0.162	0.162	0.162	0.243
Blood to ST2	0.0259	0.0259	0.0259	0.0259	0.0259	0.0388
ST0 to Blood	0.462	0.462	0.462	0.462	0.462	0.462
Urinary Path to UBC	0.0462	0.0462	0.0462	0.0462	0.0462	0.0462
OKT to Blood	0.00038	0.00038	0.00038	0.00038	0.00038	0.00038
ST1 to Blood	0.00095	0.00095	0.00095	0.00095	0.00095	0.00095
ST2 to Blood	0.000019	0.000019	0.000019	0.000019	0.000019	0.000019
Trab Surf to Trab Vol	0.00822	0.00288	0.00181	0.00132	0.000959	0.000247
Trab Surf to Bone Marrow	0.00822	0.00288	0.00181	0.00132	0.000959	0.000493
Cort Surf to Cort Vol	0.00822	0.00288	0.00153	0.000904	0.000521	0.0000411
Cort Surf to Bone Marrow	0.00822	0.00288	0.00153	0.000904	0.000521	0.0000821
Trab Vol to Bone Marrow	0.00822	0.00288	0.00181	0.00132	0.000959	0.000493
Cort Vol to Bone Marrow	0.00822	0.00288	0.00153	0.000904	0.000521	0.0000821
Bone Marrow to Blood	0.0076	0.0076	0.0076	0.0076	0.0076	0.0076
Liver 1 to Liver 2	0.00095	0.00095	0.00095	0.00095	0.00095	0.00095
Liver 1 to SI Contents	0.000475	0.000475	0.000475	0.000475	0.000475	0.000475
Liver 1 to Blood	0.000475	0.000475	0.000475	0.000475	0.000475	0.000475
Liver 2 to Blood	0.000211	0.000211	0.000211	0.000211	0.000211	0.000211
Testes/Ovaries to Blood	0.00019	0.00019	0.00019	0.00019	0.00019	0.00019

^aCort = Cortical, Trab = Trabecular, Surf = Surface, Vol = Volume, UBC = Urinary Bladder Contents, OKT = Other Kidney Tissue, LI = Large Intestine, SI = Small Intestine.

5.8.3. Age-specific models for frequently studied elements other than bone seekers

The age-specific biokinetics of a few other elements (i.e., other than bone seekers) can be characterized on the basis of experimental or environmental data and/or information on the processes controlling their behavior in the human body. The best understood elements in this regard are hydrogen (tritium, as tritiated water or HTO), cesium, iodine, carbon, and iron.

In the ICRP's biokinetic model for ^3H as HTO, activity is assumed to be uniformly distributed in the body. Whole-body retention at t days after injection is described by a sum of two exponential terms:

$$R(t) = 0.97\exp(-0.693t/T_1) + 0.03\exp(-0.693t/T_2).$$

The coefficients are assumed to be independent of age, but the half-times T_1 and T_2 are assumed to decrease with decreasing age, based on an assumed equivalence of tritium turnover and body water turnover. For the adult, $T_1 = 10$ d, and $T_2 = 40$ d. The theoretical model predicts that the short-term half-time of tritium, representing 97% of the amount of tritiated water consumed, is 3.0, 3.5, 4.6, 5.7, 7.9, and 10 d at ages 3 mo, 1 y, 5 y, 10 y, 15 y, and adulthood, respectively. The long-term half-times at these ages are assumed to be 8, 15, 19, 26, 32, and 40 d, respectively. Data for workers exposed to tritiated water are consistent with the theoretical model.

The age-specific model for cesium is similar in form to the tritium model. Cesium is assumed to be uniformly distributed in the body. Whole-body retention t days after injection is described by a sum of two exponential terms:

$$R(t) = a \exp(-0.693t/T_1) + (1 - a) \exp(-0.693t/T_2).$$

The values a , T_1 , and T_2 vary with age, based on observations of more rapid turnover of cesium in children than in adults and established relations between the parameter values and total-body potassium. For the adult, $a = 0.1$, $T_1 = 2$ d, and $T_2 = 110$ d. For ages 100 d and 1 y, the model has only one term, with half-times of 16 d and 13 d, respectively. For ages 5, 10, and 15 y, the coefficient a is 0.45, 0.30, and 0.13, respectively; the short-term half-time T_1 is 9.1, 5.8, and 2.2 d, respectively; and the long-term half-time T_2 is 30, 50, and 93 d, respectively.

The structure of the ICRP's recycling model for iodine is shown in Figure 5.1. Age-specific parameter values were based largely on observed differences with age in the behavior of iodine in human subjects, but selection of central values for a given age was complicated by considerable variability in the biokinetics of iodine. According to the model for the adult, 30% of iodine entering blood is taken up by the thyroid gland and the remainder is excreted in urine.

Iodine leaves the thyroid in organic form with a biological half-time of 80 d and is metabolized by the tissues in the rest of the body. Iodine is removed from tissues other than the thyroid with a biological half-time of 12 d. It is assumed that 20% of iodine leaving these other tissues is excreted in feces. The remainder is assumed to return to blood in inorganic form and to behave the same as the original input to blood. Turnover of iodine in the thyroid and other tissues is assumed to be faster in children than in adults. Specifically, biological half-times in the thyroid at ages 3 mo and 1, 5, 10, and 15 y are assumed to be about 11, 15, 23, 58, and 67 d, respectively. For each age, the biological half-time in other tissues is assumed to be 10% of that in thyroid.

A model of the age-specific biokinetics of carbon was built from observations on laboratory animals together with balance considerations for carbon. Carbon is assumed to be uniformly distributed in the body, and removal is assumed to be described by a single half-time. The assigned half-time at ages 100 d, 1 y, 5 y, 10 y, 15 y, and adult is 8, 15, 19, 26, 32, and 40 d.

A detailed, physiologically realistic model structure was developed for iron. Age-specific parameter values, which will not be given here, are based on estimates of the sizes of the body's main iron pools (hemoglobin, myoglobin, liver, and red marrow) as a function of age, together with methods proposed in the literature for scaling iron kinetics.

5.8.4. Age-specific models for remaining elements

Age-specific models for the remaining elements were developed on the basis of best available, but generally weak, evidence for each element. The biokinetics of polonium is assumed to be invariant with age on the basis of limited data for children suggesting whole-body retention times not greatly different from those determined in adults. For zirconium and zinc, parameter values for the adult are assigned to infants and children, except that activity is assumed to be removed from bone at the rate of bone turnover. For niobium and cerium, it is assumed that fractional uptake by the skeleton is elevated and uptake by soft tissues is decreased at younger ages but that removal half-times are invariant with age. For sulfur, cobalt, nickel, selenium, molybdenum, technetium, ruthenium, silver, antimony, and tellurium, the model for the adult is assigned to all age groups in the absence of pertinent age-specific data.

5.9. Differences in predictions of systemic biokinetic models for workers and the public

For some radionuclides, dose coefficients given in the ICRP's series on environmental exposures vary substantially with age as a net result of the application of age-specific tissue masses and biokinetic parameter values. For selected radionuclides, an analysis was performed

to determine whether the age-specific parameter values alone are of much consequence with regard to dose estimates, i.e., whether they yield substantially different estimates of cumulative activity in tissues for different ages at intake. To avoid the complications of differences with age in fractional absorption of inhaled or ingested radionuclides, intake was assumed to be by intravenous injection. Results of the analysis are summarized in Table 5.13. Evidently, the cumulative activity is invariant with injection age for isotopes of elements for which the ICRP applied parameter values for the adult to all age groups (e.g., cobalt, ruthenium, antimony, and polonium). In such cases, dose coefficients may vary substantially with age due solely to differences in tissue masses. For uniformly distributed radionuclides whose total-body retention time is assumed to decrease with age (e.g., ^3H , ^{14}C , and ^{137}Cs), cumulative activity in the total body increases substantially between infancy and adulthood and tends to offset the increase in body mass in the derivation of dose coefficients. For the relatively short-lived radionuclide ^{131}I , the substantial increase with age in the assumed half-time in the thyroid does not result in a corresponding difference with age in predicted cumulative activity in the thyroid because the model predicts that most of the atoms deposited in the thyroid will decay there before they can be removed by biological removal. This results in considerable difference with age in the estimated dose to thyroid and the effective dose from ingested ^{131}I , for example, due to the considerable changes with age in the mass of the thyroid

Table 5.13. For selected radionuclides and tissues, cumulative activity for different ages at injection, relative to the adult.

Radionuclide	Tissue	Cumulative activity in tissue divided by corresponding value for the adult	
		Injection age 100 d	Injection age 10 y
H-3	Total body	0.3	0.6
C-14	Total body	0.2	0.7
Fe-55	Red marrow	0.5	1.1
	Liver	0.7	0.8
Co-60	All tissues	1.0	1.0
Sr-90	Trabecular bone volume	0.4	0.9
	Cortical bone volume	0.7	2.0
Ru-106	All tissues	1.0	1.0
Sb-126	All tissues	1.0	1.0
I-131	Thyroid	0.7	1.0
Cs-137	Total body	0.2	0.4
Pb-210	Trabecular bone volume	0.2	0.5
	Cortical bone volume	0.4	1.1
Po-210	All tissues	1.0	1.0
Ra-226	Trabecular bone volume	0.2	0.9
	Cortical bone volume	0.7	1.9
Th-232	Trabecular bone surface	0.7	0.9
	Cortical bone surface	0.4	0.7
	Liver	1.5	1.1
U-238	Trabecular bone volume	0.3	0.7
	Cortical bone volume	0.4	1.4
	Kidney	1.0	1.0
Pu-239	Trabecular bone surface	0.5	0.7
	Cortical bone surface	0.4	0.6
	Liver	0.9	0.9
Cm-240	Trabecular bone surface	1.5	1.5
	Cortical bone surface	1.9	1.6
	Liver	0.2	0.6

6. CONCLUSIONS: NET EFFECTS OF UPDATED ICRP MODELS AND RECOMMENDATIONS ON DOSE ESTIMATES

This section summarizes major changes in the ICRP's dosimetric scheme since the appearance of ICRP Publication 30 and describes the net effects of those changes on dose coefficients for inhalation or ingestion of radionuclides.

6.1. Summary of main changes in the ICRP's dosimetric scheme

6.1.1. Tissue weighting factors

The tissue weighting factors used in ICRP Publication 30 are those recommended in ICRP Publication 26 (1977). The latter publication was superseded by Publication 60 (1991), which provides a modified and expanded set of tissue weighting factors. In the majority of cases, effective dose coefficients for inhalation and ingestion are relatively insensitive to the changes in the tissue weighting factors. In some cases, however, effective dose coefficients are noticeably affected by some combination of the following modifications of the tissue weighting factors: a threefold reduction of the weighting factor for bone surface; a 67% increase in the weighting factor for thyroid; introduction of explicit weighting factors for colon and stomach; a sixfold decrease in the weight of Remainder, which affects the contribution of tissues such as the kidneys that are not named explicitly in either set of weighting factors; and introduction of the splitting rule. The splitting rule states that a tissue in Remainder is given half the weight of Remainder if it receives a dose in excess of that received by any of the 12 tissues for which weighting factors are specified. The splitting rule has a particularly large influence on the effective dose for inhalation of many short-lived radionuclides due to the high dose to the extrathoracic region of the respiratory tract, which has no explicit weighting factor.

6.1.2. Respiratory tract model

The ICRP's updated respiratory tract model, introduced in ICRP Publication 66 (1994b), differs considerably from the Task Group Lung Model (TGLM) used in ICRP Publication 30 with regard both to structure and predictions. In contrast to the TGLM, the updated model addresses differences with age, gender, breathing rate and other factors in total and regional deposition of inhaled material in the respiratory tract. For the reference adult male, the updated model predicts lower total deposition in the respiratory tract and lower deposition in the lower lungs than does the TGLM for most particle sizes. Compared with the TGLM, the updated model predicts much different rates of absorption from the respiratory tract to blood. Estimates of

lung dose derived with the TGLM are based on the assumption, in effect, that the total activity in the lungs is uniformly distributed in the total blood-filled lungs weighing 1000 g. Estimates based on the updated respiratory model address the heterogeneous distribution of radiosensitive cells within the respiratory tract. Differences in the biokinetic and dosimetric properties of the two respiratory models lead to substantially different estimates of lung dose in many cases.

6.1.3. Gastrointestinal absorption fractions

Since the appearance of ICRP Publication 30 the ICRP has updated its gastrointestinal absorption fractions (f_I values) for a number of elements. Revisions were largely in connection with the development of age-specific values for application to members of the public, but some of the updated values assigned to adult members of the public have also been applied to workers. For the worker, substantial changes have been made in f_I values for at least some forms of cobalt, tellurium, lanthanide elements, and actinide elements including uranium. The largest absolute changes are a decrease from 0.3 to 0.1 for forms of cobalt other than oxides and hydroxides and a decrease from 0.05 to 0.02 for soluble forms of uranium.

For some elements, the f_I values recommended for evaluation of environmental intakes differ considerably from the values recommended in ICRP Publication 30. For example, a value of 0.5 is recommended for environmental intake of polonium by an adult, compared with the value of 0.1 used in ICRP Publication 30 for occupational intake of polonium. The ICRP's f_I values for infants are up to an order of magnitude greater than those for adult members of the public for some poorly absorbed elements such as plutonium and thorium.

The effect of the changes in the f_I values on dose coefficients depends strongly on the radionuclide and tissue, varying from virtually no effect to a change in proportion to the modification of f_I . When the f_I value is changed from one relatively small number to another, the dose to the colon may be affected very little because the nearly unchanged cumulative activity may be the main determinant of the dose to the colon. If the effective dose is determined largely by the dose to the colon, then the effective dose may be changed little by a substantial change in f_I due to the small change in the colon dose. Doses to systemic tissues change nearly in proportion to f_I in most cases, but this is not the case when doses to systemic tissues arise mainly from penetrating radiations originating in the intestinal contents.

6.1.4. Systemic biokinetic models

The ICRP's documents on environmental intakes of radionuclides provide age-specific systemic biokinetic models for 31 elements. The models for some elements are more detailed and physiologically realistic than the corresponding models in ICRP Publication 30. For other elements, the age-specific models are similar in format to the simplistic retention functions used in ICRP Publication 30. The systemic models developed for adult members of the public were generally applied to workers in ICRP Publication 68 (1994a).

In ICRP Publication 30, decay chain members produced in the body generally were assigned the biokinetic model of the parent radionuclide; this is referred to as "shared kinetics" of decay chains. The assumption of shared kinetics is still used by the ICRP for many decay chains, but an apparently more realistic assumption of "independent kinetics" is now applied to some chains. If the parent is an isotope of lead, radium, thorium, or uranium, then a radionuclide (other than a noble gas) formed either in soft tissues or on bone surfaces is assumed to have the same biokinetics as if the radionuclide had been taken in as a parent radionuclide, and a radionuclide formed in bone volume is assigned the biokinetics of the parent. Dose coefficients for some but not all parent radionuclides are relatively insensitive to assumptions concerning the fate of decay chain members.

6.2. Extent of changes in ICRP's dose coefficients for workers

A comparison was made of dose coefficients for workers based on models of ICRP Publication 68 and Publication 30. The analysis addressed both inhalation and ingestion of radionuclides in the work place and included all (~800) radionuclides addressed in ICRP Publication 30. The tissues considered were the lungs, stomach wall, colon wall, bone surface, red marrow, liver, thyroid, breast, testes, and muscle. The solubility classes considered for a given radionuclide were those considered in ICRP Publication 30. Dose coefficients for the absorption types, Type F, Type M, and Type S, currently used by the ICRP were compared with coefficients for Class D, W, and Y compounds, respectively, as defined in ICRP Publication 30. Inhalation dose coefficients generated by models of ICRP Publication 30 were based on the default particle size of 1 μm (AMAD) recommended in that document, and coefficients generated by models of ICRP Publication 68 were based on the default particle size of 5 μm recommended in that document. Comparisons were made in terms of the ratio of the dose coefficient from ICRP Publication 68 to that from ICRP Publication 30.

Results are summarized in Figure 6.1 in the form of separate histograms for inhalation and ingestion of radionuclides. The histogram for a given mode of intake shows the percentages of ratios of dose coefficients (ICRP 68 : ICRP 30) that fall above or below specified values. Overall, differences in the two sets of dose coefficients are greater for inhalation than for

ingestion. For inhalation, ~40% of the ratios fall in the range 0.7-1.5; ~4% of the ratios are greater than 10; and ~1.4% are less 0.1. For ingestion, ~73% of the ratios fall in the range 0.7-1.5; ~3.4% are greater than 10, and ~1.3% are less than 0.1. Examples of cases in which the models of Publication 68 and Publication 30 yield substantially different dose coefficients for specific tissues are given in Table 6.1.

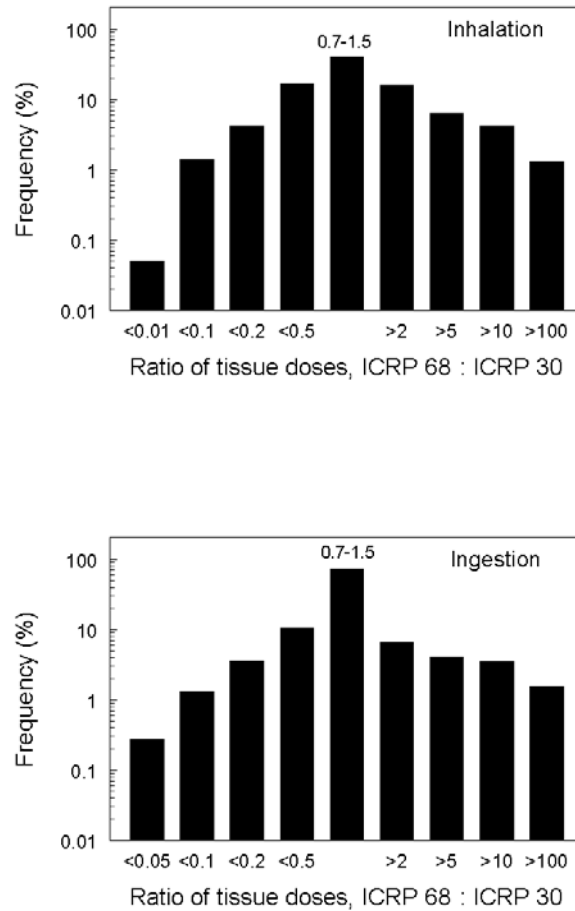

Figure 6.1. Overall effect of the ICRP’s updated models and recommendations on tissue dose coefficients. The histogram for a given mode of intake shows the percentages of ratios of dose coefficients (ICRP 68 : ICRP 30) that fall above or below specified values.

Table 6.1. Examples of substantial differences in corresponding tissue dose coefficients from ICRP Publication 68 and ICRP Publication 30.

Radionuclide	Type of exposure	Tissue	Ratio	Tissue	Ratio
			(ICRP 68 : ICRP 30)		(ICRP 68 : ICRP 30)
Be-10	Inhalation (S or Y)	Bone surface	0.16	Lung	0.19
Zr-93	Inhalation (S or Y)	Breast	0.07	Lung	0.09
Ba-131m	Inhalation (F or D)	Colon	4.3	Bone surface	3.0
Tc-101	Inhalation (M or W)	Stomach wall	16	Colon	7.2
Bi-214	Inhalation (M or W)	Stomach wall	8.9	Lung	6.0
Th-232	Inhalation (S or Y)	Bone surface	0.03	Red marrow	0.02
U-238	Inhalation (S or Y)	Lung	0.13	Liver	11
Np-237	Inhalation (M or W)	Breast	52	Thyroid	0.09
Pu-239	Inhalation (S or Y)	Red marrow	0.07	Breast	390
C-11	Ingestion	Stomach wall	55	Thyroid	0.34
Mo-93	Ingestion	Bone surface	45	Red marrow	53
Te-123	Ingestion	Breast	150	Liver	170
Th-232	Ingestion	Breast	28	Liver	18
Am-241	Ingestion	Thyroid	1200	Lung	460

As a weighted sum of tissue doses, the effective dose generally is less sensitive than individual tissues to changes in biokinetic and dosimetric models. Nevertheless, cases arise in which the ICRP's current effective dose coefficient E for occupational intake of a radionuclide is substantially different from the coefficient H_E given in ICRP Publication 30. Several such cases are listed in Table 6.2, which addresses inhalation, and Table 6.3, which addresses ingestion. In each table, the radionuclides are grouped into cases in which the effective dose coefficients have been changed to roughly the same extent for generally the same reasons. For each group, the last column of the table indicates the main reasons for the change in the effective dose coefficients.

Table 6.2. For occupational intake of radionuclides by inhalation, examples of effective dose coefficients E from ICRP Publication 68 that differ substantially from the corresponding coefficients H_E of ICRP Publication 30.

Radionuclides	Type	E: H_E	Changes in ICRP models contributing most heavily to change in effective dose coefficient
Mo-93	F	~5	Addition of long-term retention component for bone to systemic biokinetic model.
Ba-131m	F	5	Updated systemic biokinetic model with high secretion into colon; introduction of explicit weighting factor for colon; high dose to ET region of lungs; introduction of splitting rule for Remainder.
Tc-101, Re-177, Re-178, Hg-199m	M	~5	Explicit weighting factor for stomach; stomach tissue is a source organ for Tc and Re.
Ag-104, In-112, In-116m, In-117, Sb-116m, Sb-128a, Ho-157, Ho-159, Ho-162, Ho-164, Tm-175, Lu-178m, Hf-177m, Hf-182m, Os-180, Np-233	M	5-7	Explicit weighting factors for stomach and/or colon.
Bi-212, Bi-213, Bi-214, Th-226, Am-237, Am-246	M	8-13	High dose to ET region of lungs; introduction of splitting rule for Remainder; high weight given to dose to bronchial tissues.
Ac-227, Th-229, Np-232, Np-236a, Np-236b, Np-237, Np-238	M	0.10-0.12	Reduced absorption to blood; reduced dose estimates for bone surface due to updated systemic biokinetic model, including treatment of decay chain members in some cases; reduced weighting factor for bone surface.
Be-10, Mo-93, Pd-107, Pm-145, Lu-176, Ir-192m,	S	0.08-0.2	Lower deposition in deep lung due to changes in deposition model and default particle size. Dose to deep lung main contributor to effective dose.
Zr-93; Ac-227, Th-229, Th-230, Th-232, U-233, U-234, U-235, U-236, U-238, Pu-238, Pu-239, Pu-240, Pu-241, Pu-242, Pu-244	S	0.06-0.2	Reduced deposition in deep lungs; reduced absorption to blood; lower dose estimates for bone surface often given by updated systemic models and/or treatment of decay chain members; reduced weighting factor for bone surface.
Hg-193, Hg-193m, Hg-195, Hg-195m, Hg-197, Hg-197m, Hg-199m	V	15-25	Assignment of mercury vapor to bound compartments of respiratory tract, which are close to sensitive cells.

Table 6.3. For occupational intake of radionuclides by ingestion, examples of effective dose coefficients E from ICRP Publication 68 that differ substantially from the corresponding coefficients H_E of ICRP Publication 30.

Radionuclides	$E:H_E$	Changes in ICRP models contributing most heavily to change in effective dose coefficient
C-11	7	Change from assumption of instantaneous distribution of ingested (or inhaled) C-11 among tissues to residence in stomach, together with introduction of explicit tissue weighting factor for stomach.
Mo-93	7	Addition of long-term retention component for bone to systemic biokinetic model.
Ge-68, Ge-71	4-5	Introduction of explicit weighting factor for colon, together with explicit transfer of excreted Ge through intestines (and urinary bladder) rather than directly to excreta as in ICRP Publication 30.
Several actinides, including Np-236a, Np-237, Pu-236, Pu-238, Pu-239, Pu-240, Pu-241, Pu-242, Pu-244, Am-241, Am-242m, Am-243, Cm-243, Cm-244, Cm-245, Cm-246, Cm-247	0.08-0.33	Decrease in f_1 values. Substantially different systemic biokinetic models for bone surface seekers, depicting burial in bone volume and resulting in lower dose estimates for bone surface and red marrow. Reduction of tissue weighting factor for bone surface.

As is the case for the dose coefficients for individual tissues, substantial changes in effective dose coefficients are seen more frequently for inhalation than for ingestion. This is due primarily to the substantial differences in the previous and updated respiratory tract models.

Some of the largest differences in the effective dose coefficients of ICRP Publication 68 and those of ICRP Publication 30 are seen for inhaled mercury vapor. For inhalation of ^{193}Hg , $^{193\text{m}}\text{Hg}$, ^{195}Hg , $^{195\text{m}}\text{Hg}$, ^{197}Hg , $^{197\text{m}}\text{Hg}$, and $^{199\text{m}}\text{Hg}$, the value E given in Publication 68 is 15-25 times greater than the value H_E from Publication 30 (Table 6.2). As discussed in Section 3, there is evidence that the models of both ICRP Publication 30 and Publication 68 substantially overestimate retention of mercury vapor in the lungs. Modeling of the behavior of mercury vapor within the structure of the updated respiratory model but with improved parameter values that are more consistent with the experimental data would yield substantially lower effective dose coefficients than those given in ICRP Publication 68 for most isotopes of mercury.

6.3. Comparison of effective dose coefficients of ICRP Publication 30 with currently recommended values for members of the public

The dose coefficients of ICRP Publication 30 and Federal Guidance Report No. 11, particularly the effective dose coefficient, have been applied to members of the public as well as to workers. While it is recognized by most investigators that dose per unit intake may often be greater for infants and children than for adults, it is considered that such difference with age may often be offset by lower usage (intake) of environmental media at younger ages.

To compare effective dose coefficients for members of the public with coefficients given in ICRP Publication 30, the coefficients for members of the public were normalized to the expected usage of environmental media, as given in Federal Guidance Report No. 13 (EPA, 1999). That is, inhalation dose coefficients were adjusted to consider differences with age in air intake, and the ingestion dose coefficients were adjusted to consider differences with age in intake of food energy and water. It is recognized that these adjustments may not be appropriate for consideration of specific cases. For example, ingestion of radioiodine is often determined largely by intake of milk, which may not be closely related to intake of food energy or water for a given individual or group. Similarly, intake of radiostrontium appears to be closely related to intake of calcium, whose age-specific pattern of intake may not be closely related to intake of food energy or water for a given individual or group.

Adjustment factors used to account for differences with age in air “usage” were 0.15, 0.23, 0.40, 0.69, and 0.90 for ages 100 d, 1 y, 5 y, 10 y, and 15 y, respectively, based on average ventilation rates given in Federal Guidance Report No. 13 (EPA, 1999). For ingestion, adjustment factors were based on consideration of differences with age in intake of both food energy and water. Water intake was normalized to a value of 1.0 for the adult, whose intake was based on the average of values given in Federal Guidance Report No. 13 for ages 20-50 y. A similar normalization was done for food intake, and the value for each age was taken as the average of the normalized values for food and water. For ingestion ages 100 d, 1 y, 5 y, 10 y, 15 y, and adulthood, this yielded normalized values of 0.17, 0.22, 0.48, 0.61, 0.78, and 1.0.

Results are summarized in Table 6.4 for inhalation and Table 6.5 for ingestion. In these tables, the radionuclides are divided into cases in which the effective dose coefficients have been changed to roughly the same extent for generally the same reasons. For each such grouping, the last column of the table indicates the main reasons for changes in the effective dose coefficients.

Table 6.4. For inhalation, examples of usage-adjusted effective dose coefficients E for members of the public that differ substantially from the value H_E of ICRP Publication 30.

Radionuclides	Type	$E(\text{adjusted}):H_E$	Changes in ICRP models contributing most heavily to change in effective dose coefficient
Sr-90, Cs-137, Pb-202, Pb-205, Pb-210	F	~0.1-0.2 infants, young children	New biokinetic and dosimetric models depicting faster turnover but lower tissue masses for children yield only moderate differences with age in inhalation doses. Lower intakes by infants, young children give lower adjusted values.
Several short-lived radionuclides, such as Sb-128a, Ho-162, Hf-177m, Hf-182m, Ta-182m, Os-180	M	5-8 Infants, young children	Introduction of explicit weighting factors for stomach and/or colon.
Bi-212, Bi-213, Bi-214, Th-226	M	5-10 various ages	High dose to ET region of lungs; introduction of splitting rule for Remainder; high weight given to dose to bronchial tissues.
Ac-227, Th-229, Np-232, Np-236a, Np-237	M	0.02-0.2 all ages	Reduced absorption to blood; reduced dose estimates for bone surface due to updated systemic biokinetic model, including treatment of decay chain members in some cases; reduced weighting factor for bone surface.
Be-10, Mo-93, Pd-107, Pm-145, Lu-176, Ir-192m	S	0.1-0.2 mainly infants and young children	Lower deposition in deep lung due to changes in deposition model, default particle size. Dose to deep lung main contributor to effective dose.
Zr-93; Ac-227, Th-229, Th-230, Th-232, Pu-239, Pu-240, Pu-241, Pu-242, Pu-244, Cf-249, Cf-251	S	0.03-0.2 all ages	Reduced deposition in deep lungs; reduced absorption to blood; lower dose estimates for bone surface often given by updated systemic biokinetic models including new treatment of decay chain members in some cases; reduced weighting factor for bone surface.
Hg-193, Hg-193m, Hg-195, Hg-195m, Hg-197, Hg-197m, Hg-199m	V	5-25 all ages	Assignment of mercury vapor to bound compartments of respiratory tract, which are close to sensitive cells.

For ingestion as well as inhalation, numerous cases arise in which the usage-adjusted effective dose coefficient for members of the public differs substantially from the corresponding effective dose coefficient of ICRP Publication 30. This is in contrast to the conclusions for occupational exposure, where the changes in ingestion dose coefficients are less extensive than those for inhalation dose coefficients. The greater differences for environmental intakes are associated mainly with changes in f_i values, particularly the use of relatively high f_i values for infants and children.

Table 6.5. For ingestion, examples of usage-adjusted effective dose coefficients E for members of the public that differ substantially from the value H_E of ICRP Publication 30.

Radionuclides	E(adjusted): H_E	Changes in ICRP models contributing most heavily to change in effective dose coefficient
C-11	7-14 (all ages)	Change from instantaneous distribution of C to allow residence in stomach; introduction of tissue weighting factor for stomach.
Short-lived nuclides such as Cl-39, K-45, Co-60m, Ga-67, As-69, Se-81, Br-80, Rb-89, Y-95, Nb-88, Rh-107, In-112, Sb-120a, Cs-130, Te-133, Ba-131m, La-143, Pr-147, Sm-155, Lu-178, Ta-186, Pb-211, Bi-214, Am-244m, Cf-244	3-4 (infants)	Introduction of explicit weighting factors for stomach, colon; application of adult transit times to children in conjunction with smaller organ masses for children.
Ge-67, Ge-68, Ge-69, Ge-71, Ge-75, Ge-77	3-8 (various ages)	Introduction of explicit weighting factor for colon; explicit transfer of excreted Ge through intestines.
Several isotopes of Tc and Re, including Tc-99 and Re-187	3-5 (infants, young children)	Introduction of explicit weighting factor for stomach (source organ for Tc and Re); age-invariant biokinetics in conjunction with age-specific organ masses.
Fe-55, Fe-59, Fe-60	3-8 (various pre-adult ages)	Higher f_1 values for Fe in infants and children; changes in systemic biokinetic model for Fe giving higher estimates of activity in red marrow and liver.
Mo-93	3-9 (all ages)	Updated model for Mo has long-term retention in bone.
I-120, I-123, I-124, I-126, I-128, I-130, I-131, I-132m, I-133, I-135	3-4 (infants, young children)	Smaller thyroid mass at young ages, with similar effective half-times at different ages for short-lived isotopes of iodine. Increased tissue weighting factor for thyroid.
Cs-134, Cs-137	0.2-0.3 (infants)	Difference with age in usage of food and water.
Sm-146, Sm-147, Gd-148, Gd-152	~5 (infant)	Substantially higher f_1 value assigned to infant.
Po-210	3-9 (various ages)	Substantially higher f_1 values for all ages. Much different biokinetic model depicts high accumulation in some tissues with high weighting factors (e.g., red marrow). Highest ratios for young children stem from age-independent biokinetics and smaller tissue masses.
Ba-133, Ra-224, Ra-225, Ra-226, Ra-227, Ra-228	3-13 (various ages)	Higher f_1 values assigned to children. Substantially different biokinetic models. High skeletal retention at some ages. Independent kinetics of Ra chain members.
Several actinides, including Ac-227, Th-232, Pa-231, Np-236a, Np-237, Pu-236, Pu-238, Pu-239, Pu-240, Pu-241, Pu-242, Pu-244, Am-241, Am-242m, Am-243, Cm-243, Cm-244, Cm-245, Cm-246, Cm-247	0.04-0.3 (ages 1 y through adult)	Decrease in f_1 values. Substantially different systemic biokinetic models for bone surface seekers depicting burial in bone volume, resulting in lower dose estimates for bone surface and red marrow. Reduction of tissue weighting factor for bone surface.

REFERENCES

EPA (1988). Limiting Values of Radionuclide Intake and Air Concentration and Dose Conversion Factors for Inhalation, Submersion, and Ingestion, Federal Guidance Report No. 11, EPA-520/1-88-020 (Oak Ridge National Laboratory, Oak Ridge, TN; U. S. Environmental Protection Agency, Washington, DC).

EPA (1999). Cancer Risk Coefficients for Environmental Exposure to Radionuclides. Federal Guidance Report No. 13, EPA 402-R-99-001 (U. S. Environmental Protection Agency, Washington, DC).

ICRP Task Group on Lung Dynamics (1966). Deposition and Retention Models for Internal Dosimetry of the Human Respiratory Tract. *Health Phys.* 12:173-207.

ICRP (1972). International Commission on Radiological Protection, The Metabolism of Compounds of Plutonium and Other Actinides, ICRP Publication 19 (Pergamon Press, Oxford).

ICRP (1973). International Commission on Radiological Protection, Alkaline Earth Metabolism in Adult Man, ICRP Publication 20 (Pergamon Press, Oxford).

ICRP (1975). International Commission on Radiological Protection, Report of the Task Group on Reference Man. ICRP Publication 23 (Pergamon Press, Oxford).

ICRP (1977). International Commission on Radiological Protection, Annals of the ICRP. ICRP Publication 26 (Pergamon Press, Oxford).

ICRP (1979). International Commission on Radiological Protection, Limits for Intakes by Workers, ICRP Publication 30, Part 1 (Pergamon Press, Oxford).

ICRP (1980). International Commission on Radiological Protection, Limits for Intakes by Workers, ICRP Publication 30, Part 2 (Pergamon Press, Oxford).

ICRP (1981). International Commission on Radiological Protection, Limits for Intakes by Workers, ICRP Publication 30, Part 3 (Pergamon Press, Oxford).

ICRP (1986). International Commission on Radiological Protection, The Metabolism of Plutonium and Related Elements, ICRP Publication 48 (Pergamon Press, Oxford).

ICRP (1988a). International Commission on Radiological Protection, Limits for Intakes by Workers: An Addendum, ICRP Publication 30, Part 4 (Pergamon Press, Oxford).

ICRP (1988b). International Commission on Radiological Protection. Individual Monitoring for Intakes of Radionuclides by Workers: Design and Interpretation. ICRP Publication 54 (Pergamon Press, Oxford).

ICRP (1989). International Commission on Radiological Protection, Age-Dependent Doses to Members of the Public from Intake of Radionuclides, Part 1, ICRP Publication 56 (Pergamon Press, Oxford).

ICRP (1991). International Commission on Radiological Protection, 1990 Recommendations of the International Commission on Radiological Protection, ICRP Publication 60 (Pergamon Press, Oxford).

ICRP (1993). International Commission on Radiological Protection, Age-Dependent Doses to Members of the Public from Intake of Radionuclides, Part 2, ICRP Publication 67 (Pergamon Press, Oxford).

ICRP (1994a). International Commission on Radiological Protection, Dose Coefficients for Intakes of Radionuclides by Workers, ICRP Publication 68 (Pergamon Press, Oxford).

ICRP (1994b). International Commission on Radiological Protection, Human Respiratory Tract Model for Radiological Protection, ICRP Publication 66 (Pergamon Press, Oxford).

ICRP (1995a). International Commission on Radiological Protection, Age-Dependent Doses to Members of the Public from Intake of Radionuclides, Part 3, ICRP Publication 69 (Pergamon Press, Oxford).

ICRP (1995b). International Commission on Radiological Protection, Age-Dependent Doses to Members of the Public from Intake of Radionuclides, Part 4, ICRP Publication 71 (Pergamon Press, Oxford).

ICRP (1996). International Commission on Radiological Protection, Age-Dependent Doses to Members of the Public from Intake of Radionuclides, Part 5. Compilation of Ingestion and Inhalation Dose Coefficients, ICRP Publication 72 (Pergamon Press, Oxford).

ICRP (1997). International Commission on Radiological Protection. Individual Monitoring for Internal Exposure of Workers. Replacement of ICRP Publication 54. ICRP Publication 78 (Pergamon Press, Oxford).

R. W. Leggett, D. E. Dunning, Jr., and K. F. Eckerman (1984). Modelling the Behaviour of Chains of Radionuclides Inside the Body, *Radiat. Prot. Dosim.* 9:77-91.

R. W. Leggett, N. B. Munro, K. F. Eckerman (2001). A Proposed Revision of the ICRP's Model for Inhaled Mercury Vapor. *Health Phys.* 81:450-455.

C. B. Nelson, A. Phipps, T. Silk, G. M. Kendall (1997). The ICRP Publication 60 Formulation of Effective Dose and its Contribution to Effective Dose in Internal Dosimetry. *Radiat. Prot. Dosim.* 71:33-40.