

The New ICRP Respiratory Tract And Systemic Models

Thomas R. La Bone

Westinghouse Savannah River Company
Savannah River Site
Aiken, SC 29808

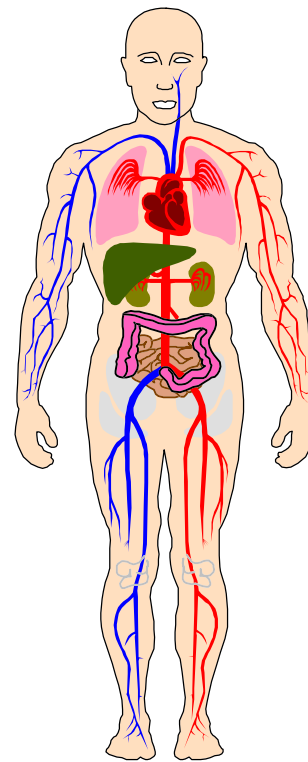

The New ICRP Respiratory Tract and Systemic Models

Thomas R. La Bone

**Westinghouse Savannah River Company
Savannah River Site
Aiken, SC 29808**

**WSRC-MM-2000-00097
August 8, 2000**

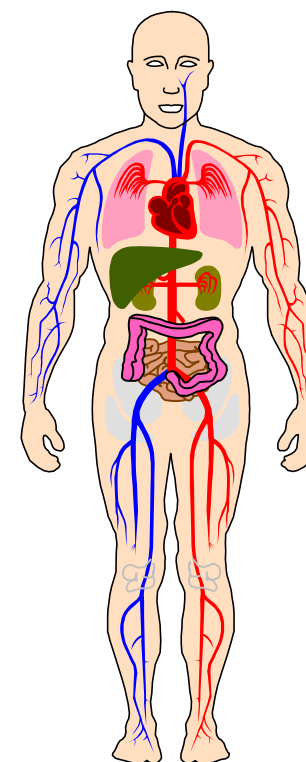

Overview

- **Review respiratory tract models**
 - ICRP 66
 - ICRP 30
 - ICRP 2
 - NCRP 125
- **Benchmark ICRP 66 respiratory tract model**
- **Review systemic models**
 - ICRP 2
 - ICRP 30
 - ICRP 56 series
- **Benchmark ICRP 66/67 Pu-239 model**
- **Discuss practical applications of the new ICRP models**

Characteristics of All Four Lung Models

- **Anatomy and Physiology**
- **Deposition**
- **Clearance**
- **Dosimetry**

To some extent, all models are wrong

ICRP 2

- **Issued in 1959 in ICRP 2, “Permissible Dose for Internal Dosimetry”**
- **Designed for deriving secondary limits for adult radiation workers**

Deposition and Clearance

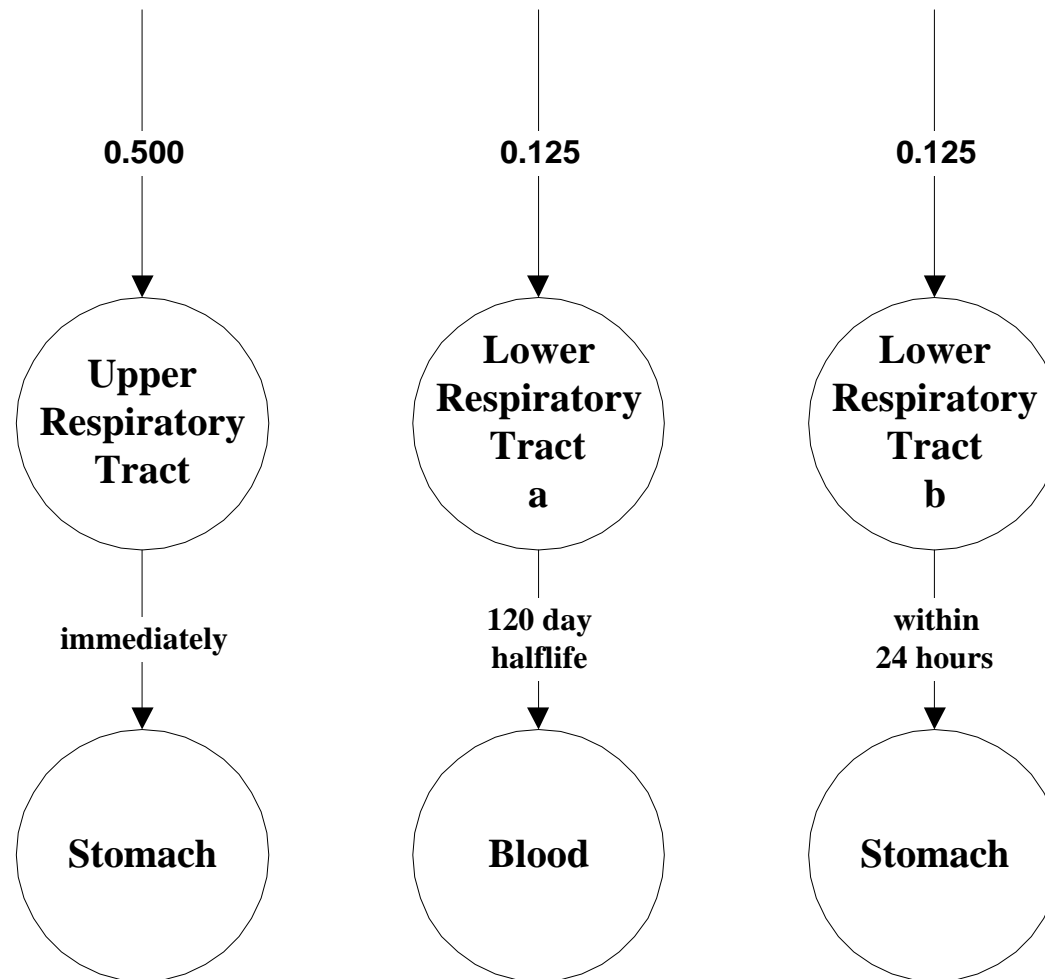

Lung Dosimetry

Lung

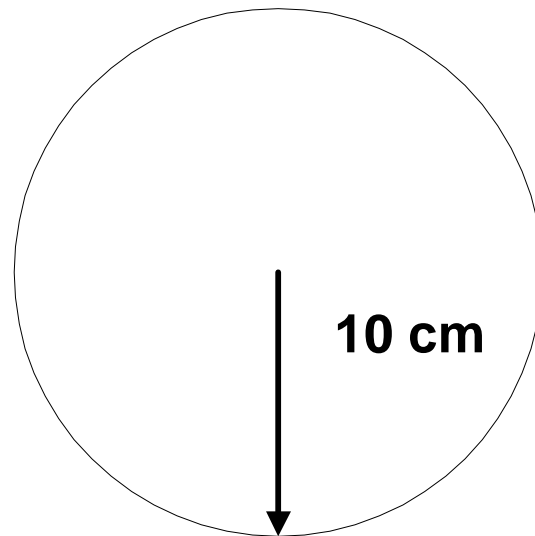

$$E = E_g f (1 - e^{-s x})$$

Limitations of Model

- **Does not define the anatomy of the respiratory tract**
- **Does not fully define the kinetics of lung clearance**
- **Does not address the dependence of clearance on the solubility of the material**
- **Does not address the dependence of deposition on particle size**
- **Does not address cross fire from other source organs**
- **Treats the lung as a single 1000-gram organ**

However

The ICRP 2 lung model was used to derive Maximum Permissible Concentrations (MPCs) for air that were used with great success to protect radiation workers for over 30 years.

ICRP 30

- **Issued in 1978 in ICRP 30, “Limits for Intakes of Radionuclides by Workers”**
- **Designed for deriving secondary limits for adult radiation workers**
- **Based on the 1966 report of the Task Group on Lung Dynamics**
- **Designed to improve on ICRP 2 model while retaining its simplicity**
 - **Deposition model accounts for aerosol size**
 - **Clearance model addresses solubility**
 - **Completely defined kinetics**

Anatomy and Physiology

- **nasal passage (NP region)**
- **trachea and bronchial tree (TB region)**
- **pulmonary parenchyma (P region)**

Lung Deposition

- Deposition in each of the regions depends on the activity median aerodynamic diameter (AMAD) of the aerosol

1 μm
sphere



1 μm aerodynamic
diameter particle

Deposition Model

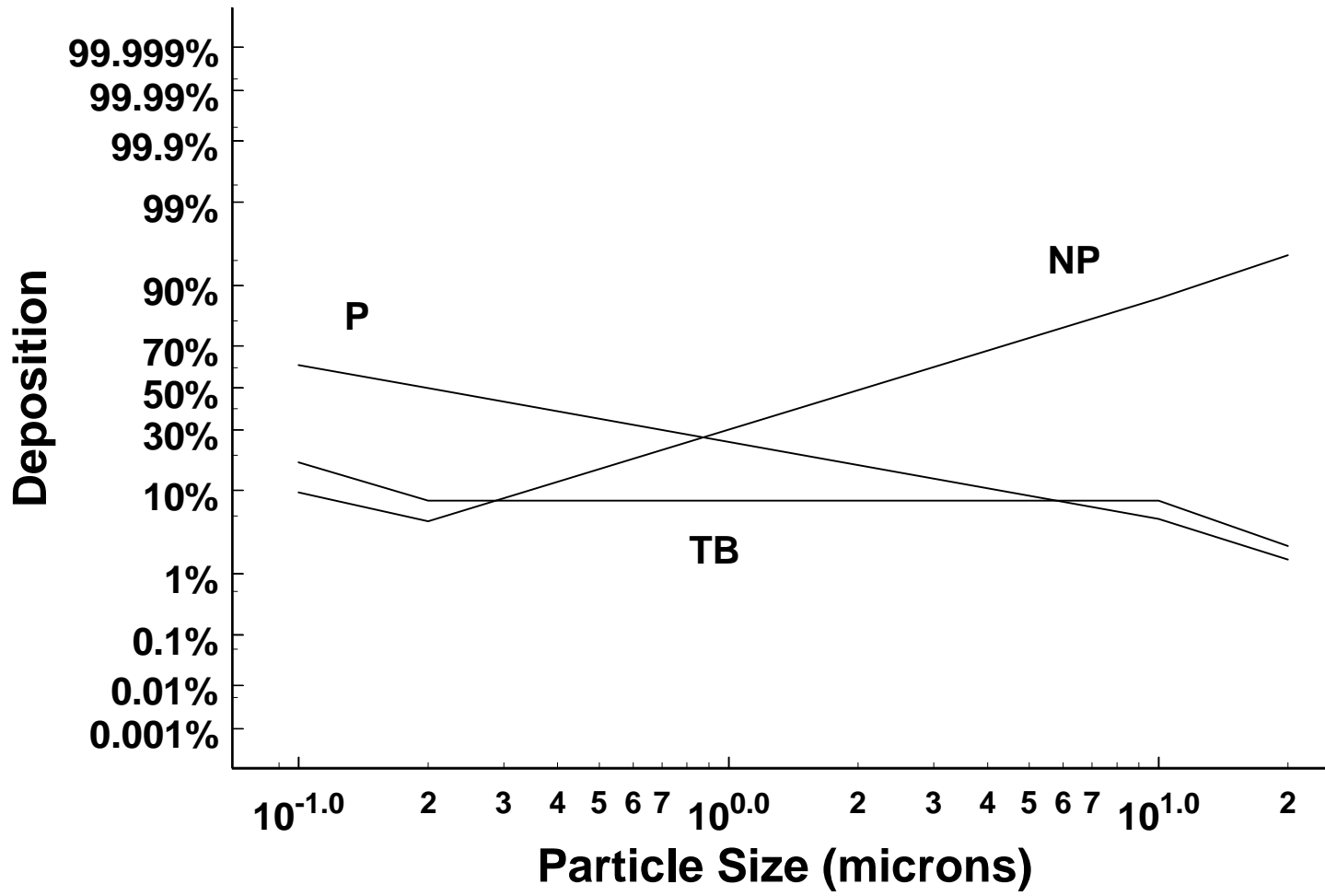

Default Deposition

- **Aerosol AMAD of 1 μm is assumed for occupational exposures**
 - Deposition in the NP region D_{NP} is 0.30 of the inhaled aerosol
 - Deposition in the TB region D_{TB} is 0.08 of the inhaled aerosol
 - Deposition in the P region D_{P} is 0.25 of the inhaled aerosol
 - Total deposition is 0.63 of the inhaled aerosol

Clearance Model

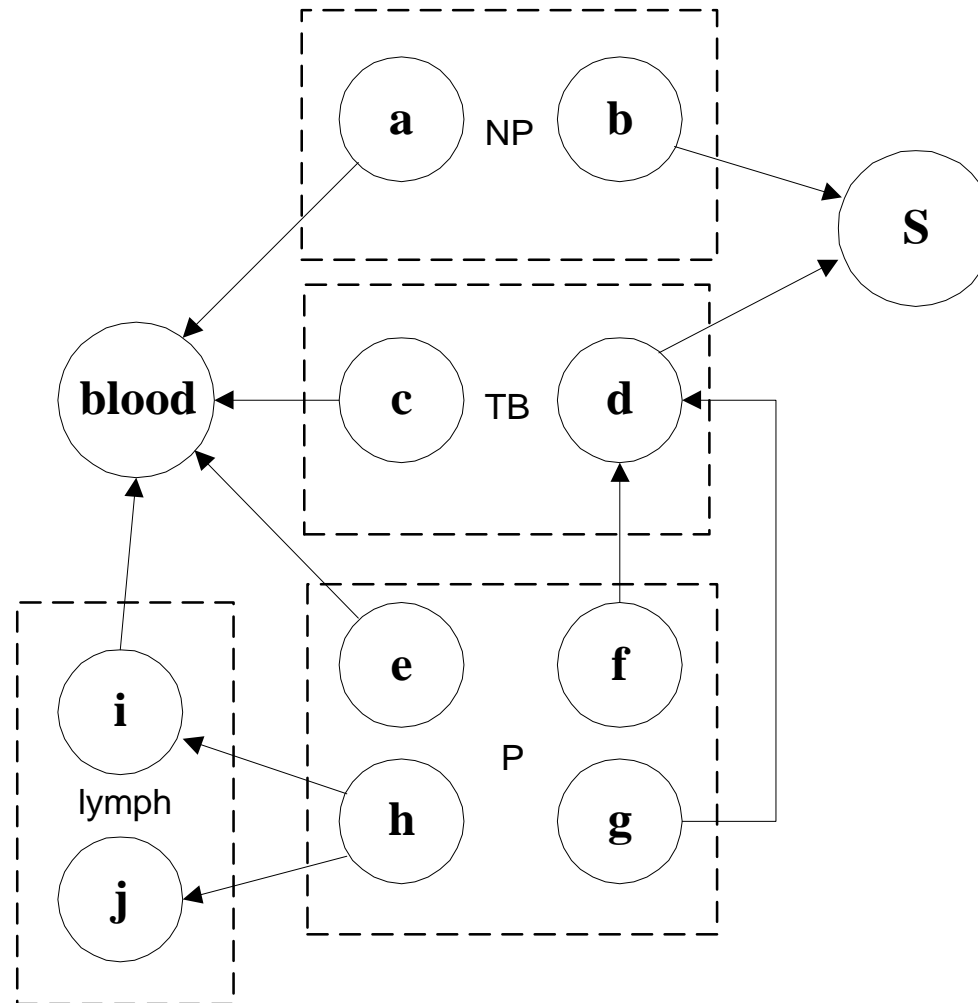

Lung Clearance Classes

- **Class D - cleared from P region in less than 10 days (0.5 day default)**
- **Class W - cleared from the P region in less than 100 days but more than 10 days (50 day default)**
- **Class Y - cleared from the P region in more than 100 days (500 day default)**

Model Parameters for Class Y Material

Compartment	Halflife (days)	Fraction
a	0.01	0.01
b	0.4	0.99
c	0.01	0.01
d	0.2	0.99
e	500	0.05
f	1	0.4
g	500	0.4
h	500	0.15
l	1000	0.9
j	1.00E+10	0.1

System of ODEs

$$\frac{dN_a}{dt} = ID_{NP} f_a - k_a N_a$$

$$\frac{dN_b}{dt} = ID_{NP} f_b - k_b N_b$$

$$\frac{dN_c}{dt} = ID_{NP} f_c - k_c N_c$$

Solving ODEs

- Laplace transforms
- Recursive algebraic solutions (Skrable's Dragon)
- Numerical ODE solvers
 - MathCad
 - Mathematica
 - Maple
- MathCad example for Pu-239

Dose Equivalent

$$H_T = c \sum_s \sum_j U_{s,j} SEE(T \leftarrow S)_j$$

Specific Effective Energy

$$SEE(T \leftarrow S) = \sum_R \frac{Q_R E_R Y_R AF(T \leftarrow S)_R}{M_T}$$

$$SEE(lung \leftarrow lung) = (1.6 \times 10^{-10}) \frac{(20)(5.15 \text{ MeV})}{1000 \text{ g}}$$

$$SEE(lung \leftarrow lung) = 1.648 \times 10^{-11} \text{ Sv/decay}$$

SEE, Decays, and Dose

	LaBone	ICRP 30
SEE (Sv/decay)	1.648E-11	1.6E-11
Decays	1.925E+07	1.9E+07
Lung DE (Sv)	3.172E-04	3.0E-04

Lung DE is listed in ICRP 30 as 3.2E-4 Sv/Bq

Effective Dose Equivalent

$$H_e = \sum_i w_i H_i$$

Weighting factor for the lung is 0.12

Limitations of Model

- **Lung is a single 1000-gram organ**
- **Ignores dose to NP region**
- **Conservative model designed for adult radiation workers**
- **Not designed for evaluating bioassay data**

NCRP 125

- **Issued in 1997 in NCRP 125, “Deposition, Retention and Dosimetry of Inhaled Radioactive Substances”**
- **Different than the ICRP 66 model**
- **Recommends the use of ICRP 66 model for radiation protection**
- **Uses non-linear kinetics**
- **Not intended for interpretation of bioassay data**

ICRP 66

- **Issued in 1994 in ICRP 66, “Human Respiratory Tract Model for Radiological Protection”**

Goals of ICRP 66

- **“provide a realistic framework for modeling lung retention and excretion characteristics in an individual case, and the resulting lung and systemic organ doses, based on bioassay data;**
- **take account of factors such as cigarette smoking and lung disease which influence lung retention;**
- **enable knowledge of the dissolution and absorption behavior of specific materials to be used in the calculation of lung dose, systemic absorption and excretion;**

- **apply explicitly to all members of the population, giving reference values for children aged 3 months, 1, 5, 10, and 15 years, and for adults;**
- **apply to gases and vapors as well as particulates, and in all cases;**
- **calculate biologically meaningful doses in a manner that is consistent with the morphological, physiological, and radiobiological characteristics of the various tissues of the respiratory tract.”**

**A. C. James
ICRP Task Group on Lung Model**

ICRP 66 Lung Model

- ① *Anatomy and physiology*
- ② *Deposition*
- ③ *Clearance*
- ④ *Dosimetry*

① *Anatomy and Physiology* Extrathoracic Region

- ET₁ - anterior nose
- ET₂ - posterior nose, mouth, pharynx, larynx
- NP region in ICRP 30 Model

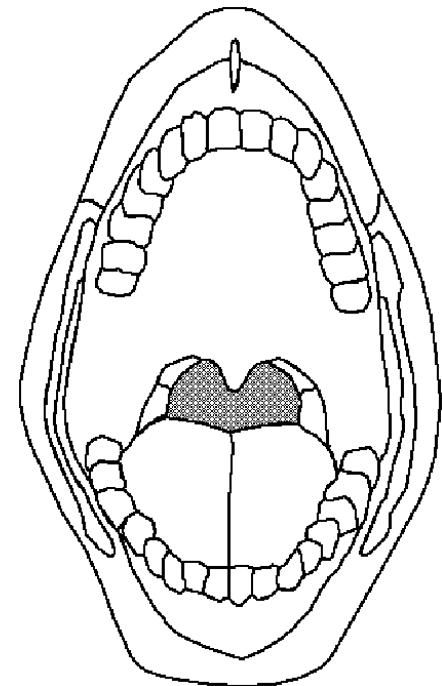
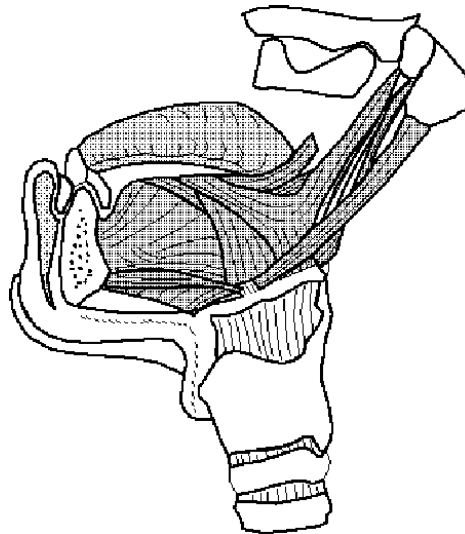
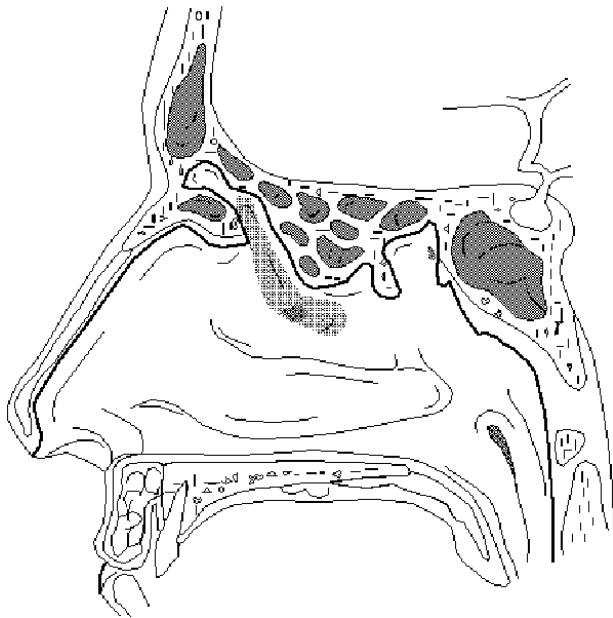

Thoracic Region

- **Bronchial region (0-8)**
 - BB or BBi
- **Bronchiolar region (9-15)**
 - bb or bbe
 - TB region (with BB) in ICRP 30 model
- **Alveolar-interstitial region (16-26)**
 - AI
 - P region in ICRP 30 model

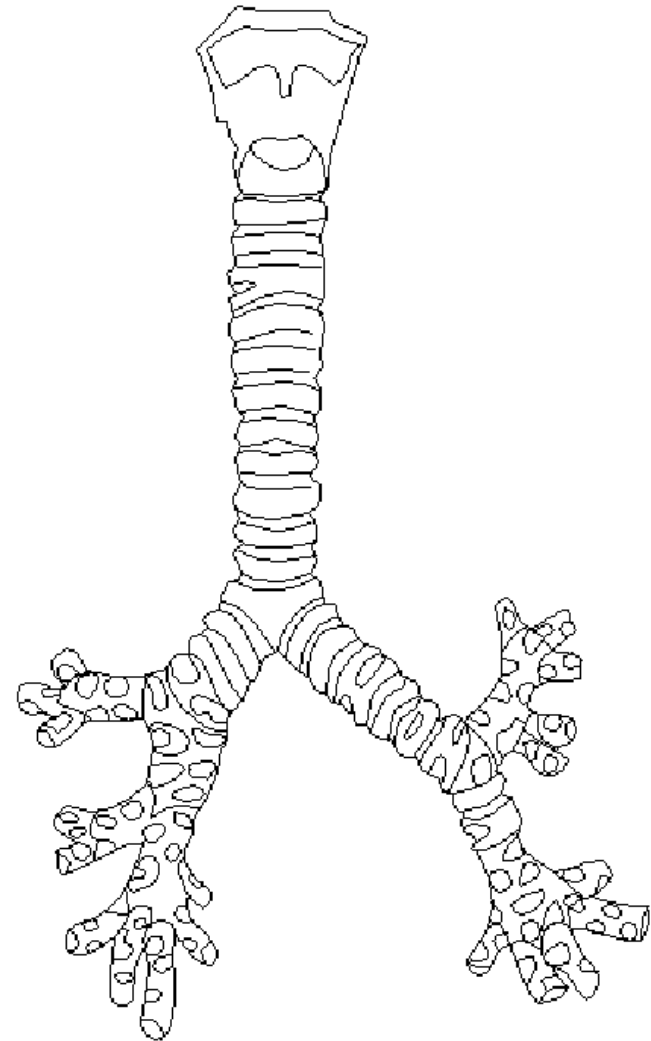
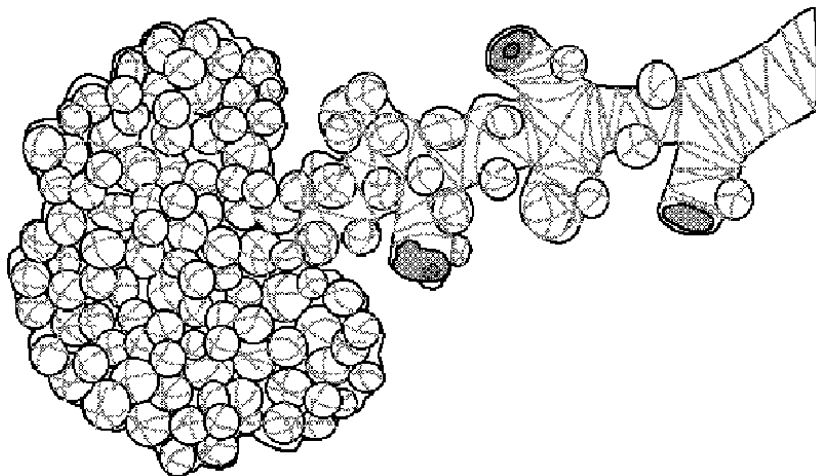

Anatomical Regions of the Respiratory Tract

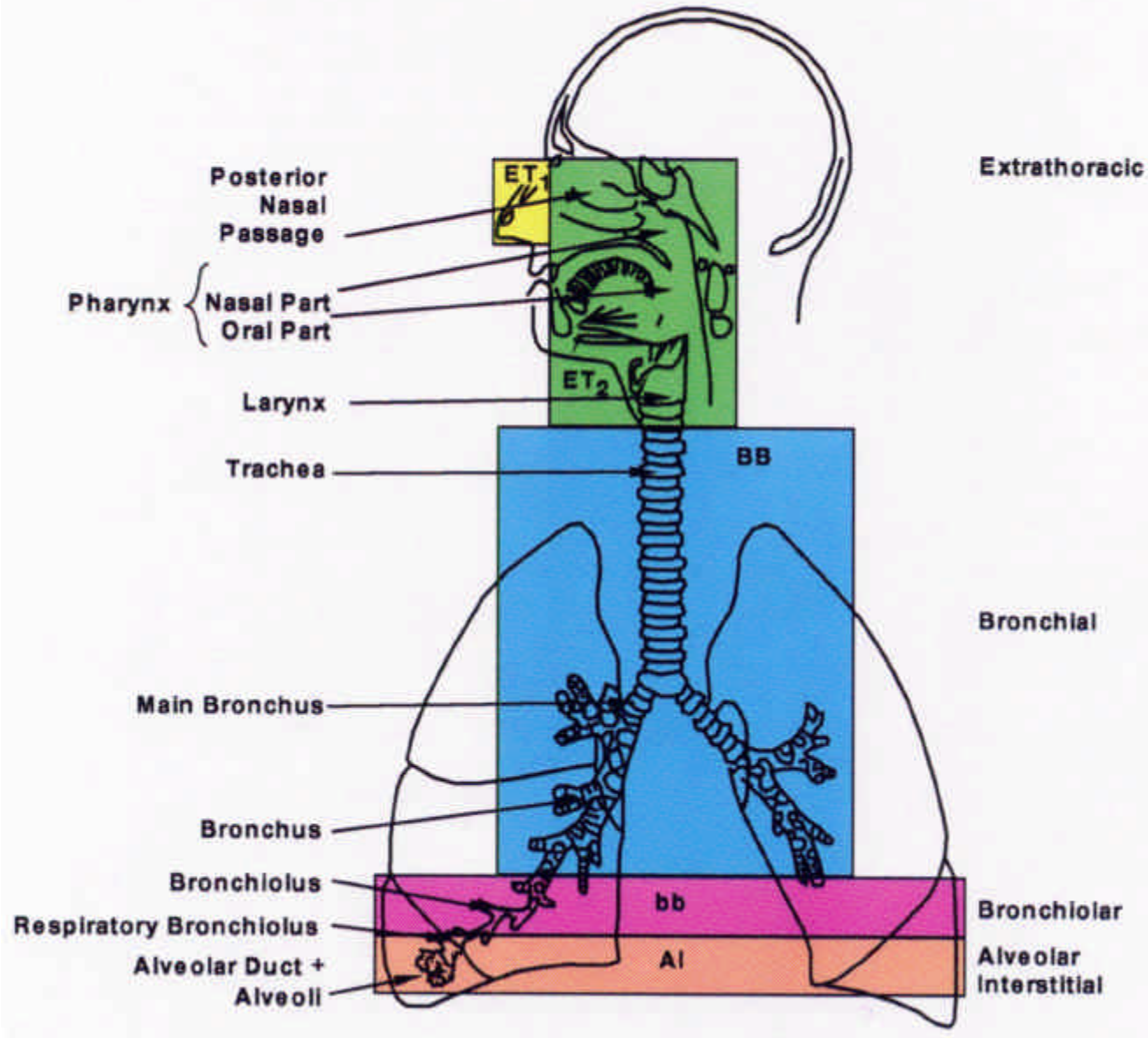

Physiology

- **Tidal volume V_T**
 - inhale-exhale volume
 - 1250 mL for light exercise
 - 750 mL for sitting
- **Functional residual capacity FRC**
 - volume left on exhale
 - 3301 mL
- **Anatomical dead space**
 - volume of airways that do not exchange gases
 - 146 mL
- **volumetric flow rate**
 - twice breathing rate
 - 833 mL/second for light exercise
 - 300 mL/second for sitting

② *Deposition*

- **Deposition model is empirical**
- **Applicable to 0.0005 μm to 100 μm AMAD aerosols**
- **Takes into account**
 - physical exertion
 - gender
 - age
 - ethnic origin
 - body size
- **Can give ranges for regional deposition**
- **Quite complex**

Series of Filters

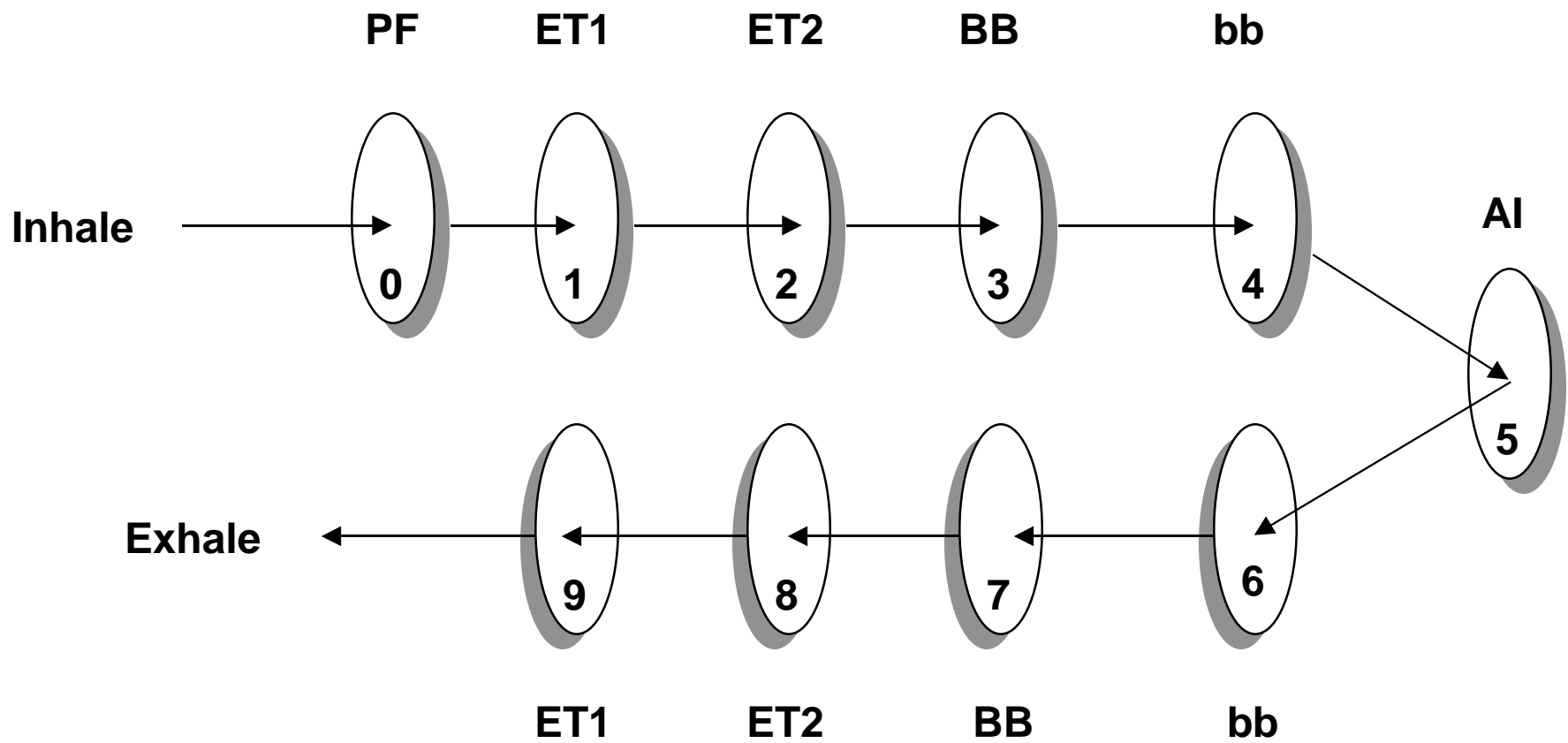

Characteristics of Filters

Each filter has

- a filtration efficiency, η (eta)
- a volume, v
 - function of physiological parameters

Deposition Processes

Particles are caused to impinge on the surfaces of the respiratory tract by two different processes:

- **aerodynamic**
 - particles carried by airflow
 - dominate with larger particles ($>1 \mu\text{m}$)
 - characterized by aerodynamic equivalent diameter, d_{ae}
- **thermodynamic**
 - particles moved by Brownian motion
 - dominate with smaller particles ($<0.1 \mu\text{m}$)
 - characterized by thermodynamic diameter, d_{th}

Dual Properties

All particles have both aerodynamic and thermodynamic properties. For example, for a 5 μm d_{ae} aerosol

$$5 \text{ mm} d_{ae} = 3.5 \text{ mm} d_{th}$$

Filtration Efficiency

$$h = \frac{\textit{input} - \textit{output}}{\textit{input}}$$

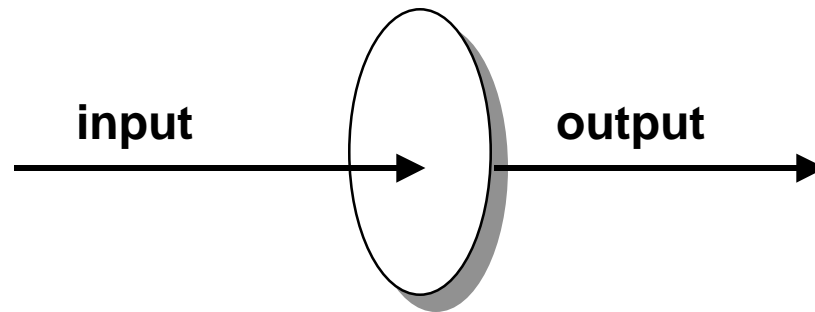

Calculating η

The filtration efficiency is calculated using empirical equations like the one shown below:

$$h = 1 - e^{-aR^p}$$

where a , R , and p are parameters supplied in ICRP 66.

η_{th} for 5 μm d_{ae} aerosol

Filter	Region	a	R	p	η
1	ET1	18.0000	1.343E-08	0.5000	0.0010
2	ET2	15.1000	1.343E-08	0.5380	0.0009
3	BB	60.1773	5.049E-09	0.6391	0.0003
4	bb	90.2000	4.833E-09	0.5676	0.0017
5	AI	273.0000	9.247E-08	0.6101	0.0139
6	bb	90.2000	4.833E-09	0.5676	0.0017
7	BB	60.1773	5.049E-09	0.6391	0.0003
8	ET2	15.1000	1.343E-08	0.5380	0.0009
9	ET1	18.0000	1.343E-08	0.5000	0.0010

η_{ae} for 5 μm d_{ae} aerosol

Filter	Region	a	R	p	η
1	ET1	3.000E-04	2.083E+04	1.0000	0.4310
2	ET2	5.500E-05	2.083E+04	1.1700	0.8613
3	BB	4.080E-06	2.083E+04	1.1520	0.3197
4	bb	1.147E-01	1.735E+00	1.1730	0.1966
5	AI	1.460E-01	3.205E+01	0.6495	0.7504
6	bb	1.147E-01	1.735E+00	1.1730	0.1966
7	BB	2.040E-06	2.083E+04	1.1520	0.1752
8	ET2	5.500E-05	2.083E+04	1.1700	0.8613
9	ET1	3.000E-04	2.083E+04	1.0000	0.4310

Total Filtration Efficiency η_1

$$h_1 = \left(h_{ae}^2 + h_{th}^2 \right)^{1/2}$$

$$h_1 = \left(0.4310^2 + 0.0010^2 \right)^{1/2}$$

$$h_1 = 0.4310$$

Prefilter

- The nasal opening is a prefilter having no volume and a filtration efficiency of η_0
- The prefilter filtration efficiency is the complement of the inhalability η_I
- Inhalability is the ratio of the concentration C_I of particles in inspired air to the concentration C_A of particles in ambient air

$$h_I = \frac{C_I}{C_A}$$

$$h_0 = 1 - h_I$$

Total Filtration Efficiency η

For a monodisperse aerosol with an aerodynamic equivalent diameter (d_{ae}) of 5 μm , the filtration efficiencies are:

$$\eta_0 := 3.221 \cdot 10^{-2} \quad \eta_5 := 0.7506$$

$$\eta_1 := 0.4310 \quad \eta_6 := 0.1966$$

$$\eta_2 := 0.8613 \quad \eta_7 := 0.1752$$

$$\eta_3 := 0.3197 \quad \eta_8 := 0.8613$$

$$\eta_4 := 0.1966 \quad \eta_9 := 0.4310$$

Filter Volume for Light Exercise

$$v_0 := 0$$

$$v_1 := 0$$

$$v_2 := 50$$

$$v_3 := 49 \cdot \left(1 + \frac{1250}{3301} \right)$$

$$v_3 = 67.555$$

$$v_4 := 47 \cdot \left(1 + \frac{1250}{3301} \right)$$

$$v_4 = 64.798$$

$$v_5 := 1250$$

$$v_6 := v_4$$

$$v_7 := v_3$$

$$v_8 := v_2$$

$$v_9 := v_1$$

Volumetric fraction

$$f_0 = 1$$

$$f_k = 1 - \left(\frac{\sum_{i=0}^{k-1} v_i}{V_T} \right), k = 1 \text{ to } 5$$

$$f_k = f_{10-k}, k = 6 \text{ to } 9$$

$$\phi_1 := 1$$

$$\phi_9 := \phi_1$$

$$\phi_2 := 1$$

$$\phi_8 := \phi_2$$

$$\phi_3 := 1 - \frac{v_2}{V_T}$$

$$\phi_3 = 0.96$$

$$\phi_7 := \phi_3$$

$$\phi_4 := 1 - \frac{v_2 + v_3}{V_T}$$

$$\phi_4 = 0.906$$

$$\phi_6 := \phi_4$$

$$\phi_5 := 1 - \frac{v_2 + v_3 + v_4}{V_T}$$

$$\phi_5 = 0.854$$

Deposition Fraction

$$DE_i = h_i \cdot f_i \cdot \prod_{k=0}^{i-1} (1 - h_k)$$

$$DE_1 := \eta_1 \cdot (1 - \eta_0) \quad DE_1 = 4.171 \cdot 10^{-1}$$

$$DE_2 := \eta_2 \cdot (1 - \eta_0) \cdot (1 - \eta_1) \quad DE_2 = 4.743 \cdot 10^{-1}$$

$$DE_3 := \left(1 - \frac{v_2}{V_T}\right) \cdot \eta_3 \cdot (1 - \eta_0) \cdot (1 - \eta_1) \cdot (1 - \eta_2) \quad DE_3 = 2.344 \cdot 10^{-2}$$

$$DE_4 := \eta_4 \cdot \left(1 - \frac{v_2 + v_3}{V_T}\right) \cdot [(1 - \eta_0) \cdot (1 - \eta_1) \cdot (1 - \eta_2) \cdot (1 - \eta_3)] \quad DE_4 = 9.255 \cdot 10^{-3}$$

$$DE_5 := \eta_5 \cdot \left(1 - \frac{v_2 + v_3 + v_4}{V_T}\right) \cdot [(1 - \eta_0) \cdot (1 - \eta_1) \cdot (1 - \eta_2) \cdot (1 - \eta_3) \cdot (1 - \eta_4)] \quad DE_5 = 2.676 \cdot 10^{-2}$$

$$DE_5 := \eta_5 \cdot \left(1 - \frac{v_2 + v_3 + v_4}{V_T}\right) \cdot \left[(1 - \eta_0) \cdot (1 - \eta_1) \cdot (1 - \eta_2) \cdot (1 - \eta_3) \cdot (1 - \eta_4)\right] \quad DE_5 = 2.676 \cdot 10^{-2}$$

$$DE_6 := \eta_6 \cdot \left(1 - \frac{v_2 + v_3}{V_T}\right) \cdot \left[(1 - \eta_0) \cdot (1 - \eta_1) \cdot (1 - \eta_2) \cdot (1 - \eta_3) \cdot (1 - \eta_4) \cdot (1 - \eta_5)\right] \quad DE_6 = 1.854 \cdot 10^{-3}$$

$$DE_7 := \eta_7 \cdot \left(1 - \frac{v_2}{V_T}\right) \cdot \left[(1 - \eta_0) \cdot (1 - \eta_1) \cdot (1 - \eta_2) \cdot (1 - \eta_3) \cdot (1 - \eta_4) \cdot (1 - \eta_5) \cdot (1 - \eta_6)\right] \quad DE_7 = 1.407 \cdot 10^{-3}$$

$$DE_8 := \eta_8 \cdot \left[(1 - \eta_0) \cdot (1 - \eta_1) \cdot (1 - \eta_2) \cdot (1 - \eta_3) \cdot (1 - \eta_4) \cdot (1 - \eta_5) \cdot (1 - \eta_6) \cdot (1 - \eta_7)\right] \quad DE_8 = 5.942 \cdot 10^{-3}$$

$$DE_9 := \eta_9 \cdot \left[(1 - \eta_0) \cdot (1 - \eta_1) \cdot (1 - \eta_2) \cdot (1 - \eta_3) \cdot (1 - \eta_4) \cdot (1 - \eta_5) \cdot (1 - \eta_6) \cdot (1 - \eta_7) \cdot (1 - \eta_8)\right] \quad DE_9 = 4.124 \cdot 10^{-4}$$

Recursive Form

Given $\mathbf{x}_i = \frac{\mathbf{f}_i}{\mathbf{f}_{i-1}}$, then

$$\text{DE}_1 := \eta_1 \cdot (1 - \eta_0) \quad \text{DE}_1 = 4.171 \cdot 10^{-1}$$

$$\text{DE}_2 := \text{DE}_1 \cdot \eta_2 \cdot \xi_2 \cdot \left(\frac{1}{\eta_1} - 1 \right) \quad \text{DE}_2 = 4.743 \cdot 10^{-1}$$

$$\text{DE}_3 := \text{DE}_2 \cdot \eta_3 \cdot \xi_3 \cdot \left(\frac{1}{\eta_2} - 1 \right) \quad \text{DE}_3 = 2.344 \cdot 10^{-2}$$

$$\text{DE}_4 := \text{DE}_3 \cdot \eta_4 \cdot \xi_4 \cdot \left(\frac{1}{\eta_3} - 1 \right) \quad \text{DE}_4 = 9.255 \cdot 10^{-3}$$

$$\text{DE}_5 := \text{DE}_4 \cdot \eta_5 \cdot \xi_5 \cdot \left(\frac{1}{\eta_4} - 1 \right) \quad \text{DE}_5 = 2.676 \cdot 10^{-2}$$

$$\text{DE}_6 := \text{DE}_5 \cdot \eta_6 \cdot \xi_6 \cdot \left(\frac{1}{\eta_5} - 1 \right) \quad \text{DE}_6 = 1.854 \cdot 10^{-3}$$

$$\text{DE}_7 := \text{DE}_6 \cdot \eta_7 \cdot \xi_7 \cdot \left(\frac{1}{\eta_6} - 1 \right) \quad \text{DE}_7 = 1.407 \cdot 10^{-3}$$

$$\text{DE}_8 := \text{DE}_7 \cdot \eta_8 \cdot \xi_8 \cdot \left(\frac{1}{\eta_7} - 1 \right) \quad \text{DE}_8 = 5.942 \cdot 10^{-3}$$

$$\text{DE}_9 := \text{DE}_8 \cdot \eta_9 \cdot \xi_9 \cdot \left(\frac{1}{\eta_8} - 1 \right) \quad \text{DE}_9 = 4.124 \cdot 10^{-4}$$

Total Deposition for Light Exercise

$$D_{\text{et1}} := DE_1 + DE_9 \quad D_{\text{et1}} = 4.175 \cdot 10^{-1}$$

$$D_{\text{et2}} := DE_2 + DE_8 \quad D_{\text{et2}} = 4.802 \cdot 10^{-1}$$

$$D_{\text{BB}} := DE_3 + DE_7 \quad D_{\text{BB}} = 2.485 \cdot 10^{-2}$$

$$D_{\text{bb}} := DE_4 + DE_6 \quad D_{\text{bb}} = 1.111 \cdot 10^{-2}$$

$$D_{\text{ai}} := DE_5 \quad D_{\text{ai}} = 2.676 \cdot 10^{-2}$$

$$D := D_{\text{et1}} + D_{\text{et2}} + D_{\text{BB}} + D_{\text{bb}} + D_{\text{ai}}$$

$$D = 9.605 \cdot 10^{-1}$$

Slow Clearing Fraction for BB and bb

$$f_s = 0.5, \quad d_{ae} \leq 2.5 \sqrt{\frac{\mathbf{r}}{\mathbf{c}}}$$

$$f_s = 0.5 e^{-\frac{0.693}{1.1}(d_t - 2.5)}, \quad d_{ae} > 2.5 \sqrt{\frac{\mathbf{r}}{\mathbf{c}}}$$

ρ is the density of the particle and χ is the shape factor

Slow Clearing Fraction for 5 μm d_{ae} particle

$$f_s = 0.5 \cdot e^{\frac{-\ln(2)}{1.1} \cdot (3.5-2.5)}$$

$$f_s = 0.266$$

Lognormal Probability Density Function

$f(x)$ gives the differential fraction of particles
between $d_{ae} x$ and $x + dx$

$$f(x) = \frac{e^{-[\ln(x) - \ln(m_g)]^2 / [2 \ln(s_g)]^2}}{x \ln(s_g) \sqrt{2p}}$$

Lognormal PDF

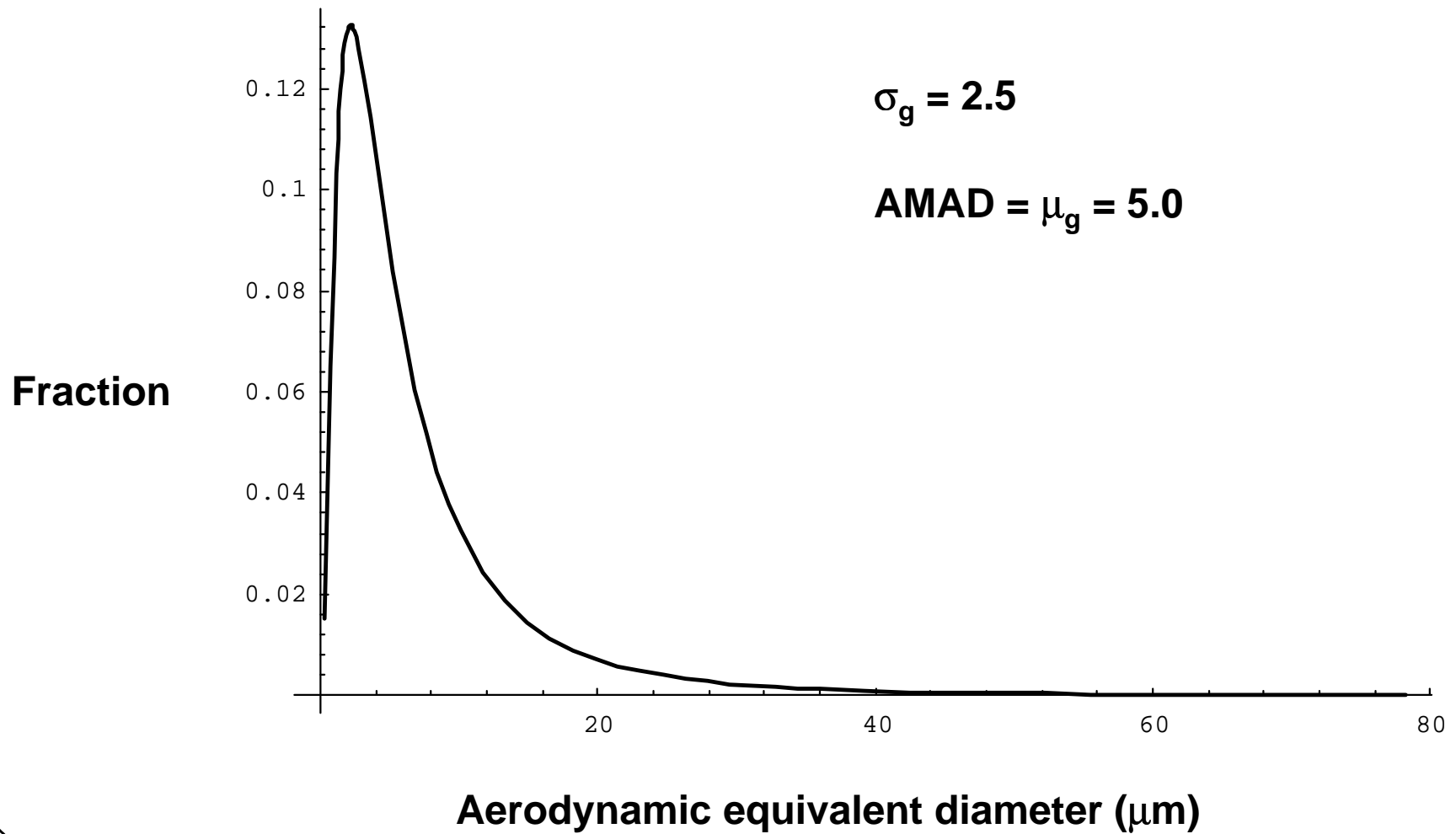

Lognormal Cumulative Probability Function

F(X) gives the probability of observing a particle the same size or smaller than X:

$$F(X) = \int_0^X f(x) dx$$

Deposition for Polydisperse Aerosol

$$DE(AMAD, \mathbf{s}_g) = \sum_{\min}^{\max} DE(d_{ae}) \left[F\left(d_{ae} + \frac{\Delta d_{ae}}{2}\right) - F\left(d_{ae} - \frac{\Delta d_{ae}}{2}\right) \right]$$

Range and Increments of Summation

- Summation runs from min of $-4 \sigma_g$ to max of $+4 \sigma_g$
- Δd_{ae} is given by $(\text{max} - \text{min}) / 500$

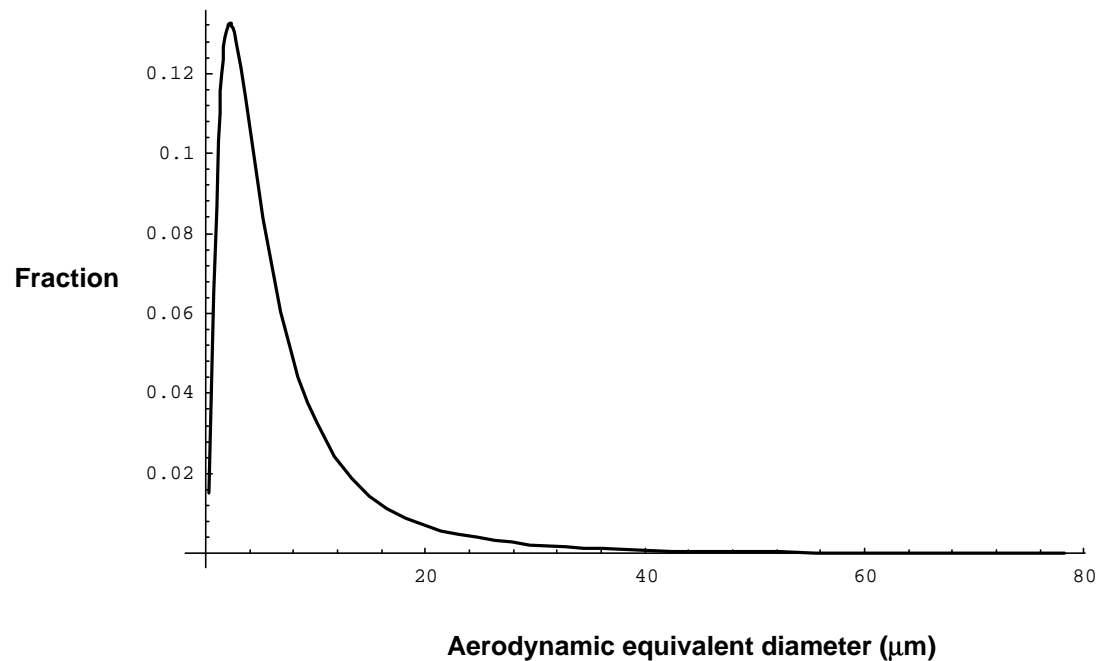

Total Percent Deposition for 5 μm AMAD Aerosol during Light Exercise

	Percent			
	La Bone	Ludep	Error	ICRP 66
ET1	34.77	34.80	-0.09	35.00
ET2	40.91	40.94	-0.07	41.00
BB	1.80	1.80	0.00	1.82
bb	0.89	0.89	0.00	0.90
AI	4.49	4.49	0.00	4.50
TOTAL	82.86	82.92	-0.07	83.00
FsBB	34.33	34.32	0.03	34.07
Fsbb	41.09	41.07	0.05	41.11

Total Percent Deposition for 5 μm AMAD Aerosol during Sitting

	Percent			ICRP 66
	La Bone	Ludep	Error	
ET1	28.08	28.10	-0.07	28.00
ET2	33.58	33.61	-0.09	34.00
BB	1.62	1.63	-0.61	1.63
bb	2.37	2.37	0.00	2.37
AI	10.38	10.40	-0.19	10.00
TOTAL	76.04	76.10	-0.08	76.00
FsBB	26.75	26.73	0.07	26.38

Deposition Fractions for Light Work

- **Light Work consists of**
 - 5.5 hours of light exercise breathing at 1.5 m³ per hour
 - 2.5 hours of sitting, breathing at 0.54 m³ per hour
- **The deposition fractions for light work are the volume-weighted deposition fractions for the two activity levels**

$$f_{sitting} = \frac{0.54 \times 2.5}{0.54 \times 2.5 + 1.5 \times 5.5} = 0.14$$

$$f_{le} = \frac{1.5 \times 5.5}{0.54 \times 2.5 + 1.5 \times 5.5} = 0.86$$

Total Percent Deposition for 5 μm AMAD Aerosol during Light Work

	Percent			ICRP CD
	La Bone	Ludep	Error	
ET1	33.83	33.85	-0.06	33.85
ET2	39.88	39.91	-0.08	39.91
BB	1.77	1.77	0.00	1.78
bb	1.10	1.10	0.00	1.10
AI	5.32	5.32	0.00	5.32
TOTAL	81.90	81.96	-0.07	81.96
FsBB	33.26	33.34	-0.24	33.35
Fsbb	40.47	39.75	1.81	39.75

Additional Calculations

- **Other mixtures of breathing rates**
- **breathing habits**
 - **mouth breather during light exercise**
 - » **40% of air through nose**
 - » **60% of air through mouth**
- **adjustments for age and sex**
- **smokers and respiratory ailments**

③ Clearance

- **mechanical clearance of particles**
 - to lymph nodes and GI tract
 - dependent on region of lung
 - independent of material
- **absorption to blood**
 - dependent on solubility of particles
 - F/M/S classification
 - same for all regions of lung (except ET1)
- **competitive processes**
- **linear first order kinetics**

Mechanical Clearance

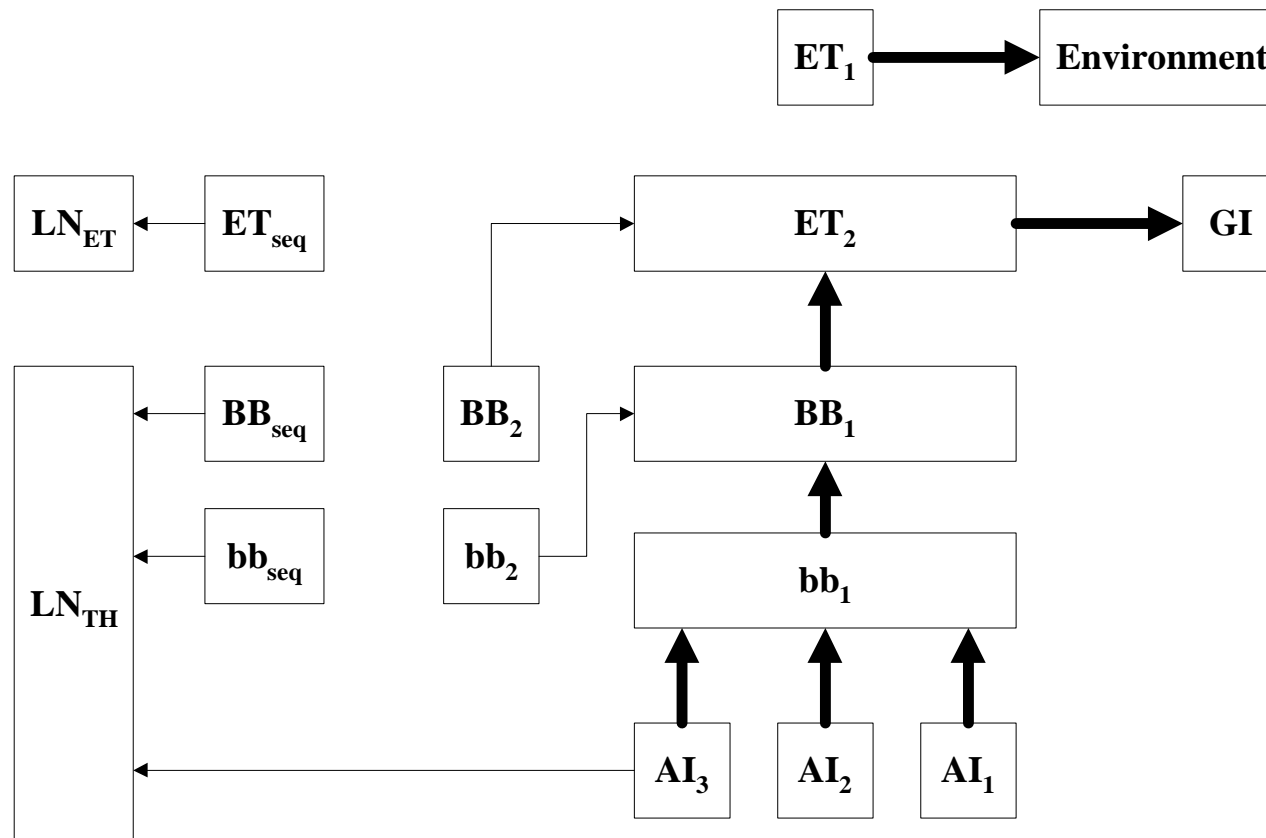

Partition of Deposition

Compartment	Partition Fraction
ET2	0.9995
ETseq	0.0005
BB1	$0.993 - F_s BB$
BB2	$F_s BB$
BBseq	0.007
bb1	$0.993 - F_s bb$
bb2	$F_s bb$
bbseq	0.007
AI1	0.3
AI2	0.6
AI3	0.1

Mechanical Clearance Parameters

	Rate	half-time
Pathway	(1/d)	(d)
AI1-bb1	0.02	3.47E+01
AI2-bb1	0.001	6.93E+02
AI3-bb1	0.0001	6.93E+03
AI3-LNTH	0.00002	3.47E+04
bb1-BB1	2	3.47E-01
bb2-BB1	0.03	2.31E+01
bbseq-LNTH	0.01	6.93E+01
BB1-ET2	10	6.93E-02
BB2-ET2	0.03	2.31E+01
BBseq-LNTH	0.01	6.93E+01
ET2-GI	100	6.93E-03
ETseq-LNTH	0.001	6.93E+02
ET1-Env	1	6.93E-01

Absorption into Blood

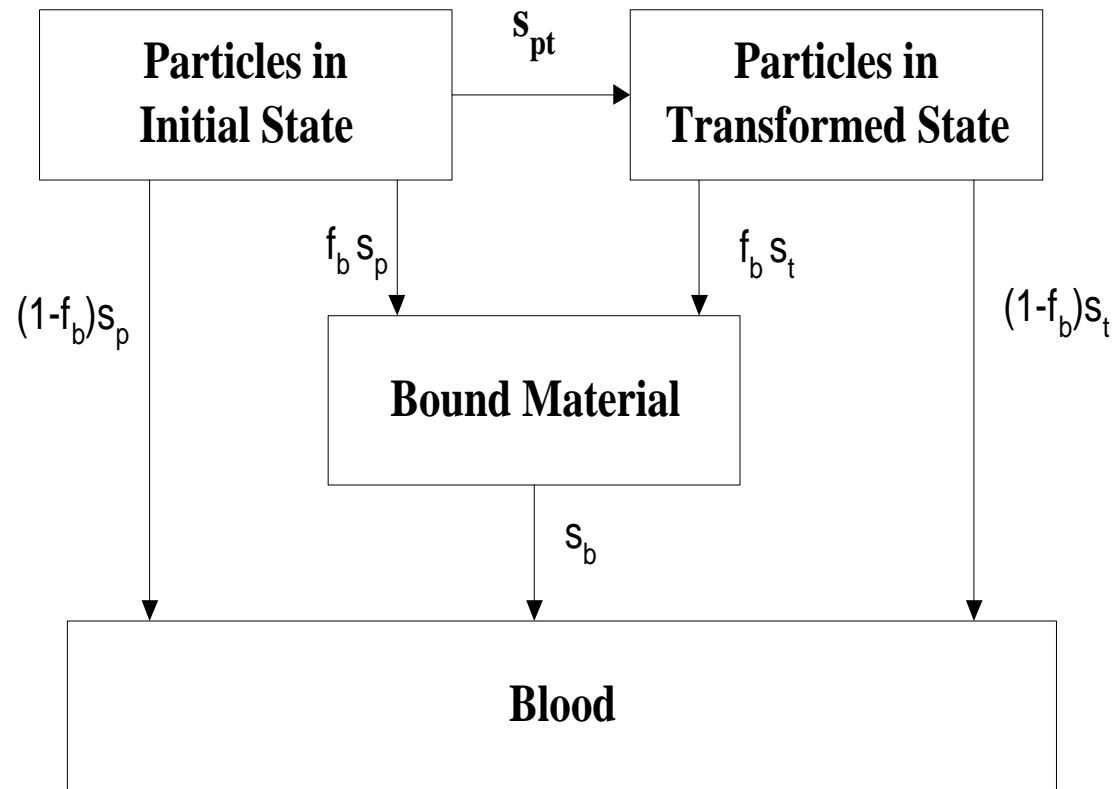

Time Dependant Dissolution Function

$$r(t) = f_r \cdot e^{-s_r t} + (1 - f_r) \cdot e^{-s_s t}$$

$$s_p = s_s + (s_r - s_s) \cdot f_r$$

$$s_{pt} = (s_r - s_s) \cdot (1 - f_r)$$

$$s_t = s_s$$

Total Clearance

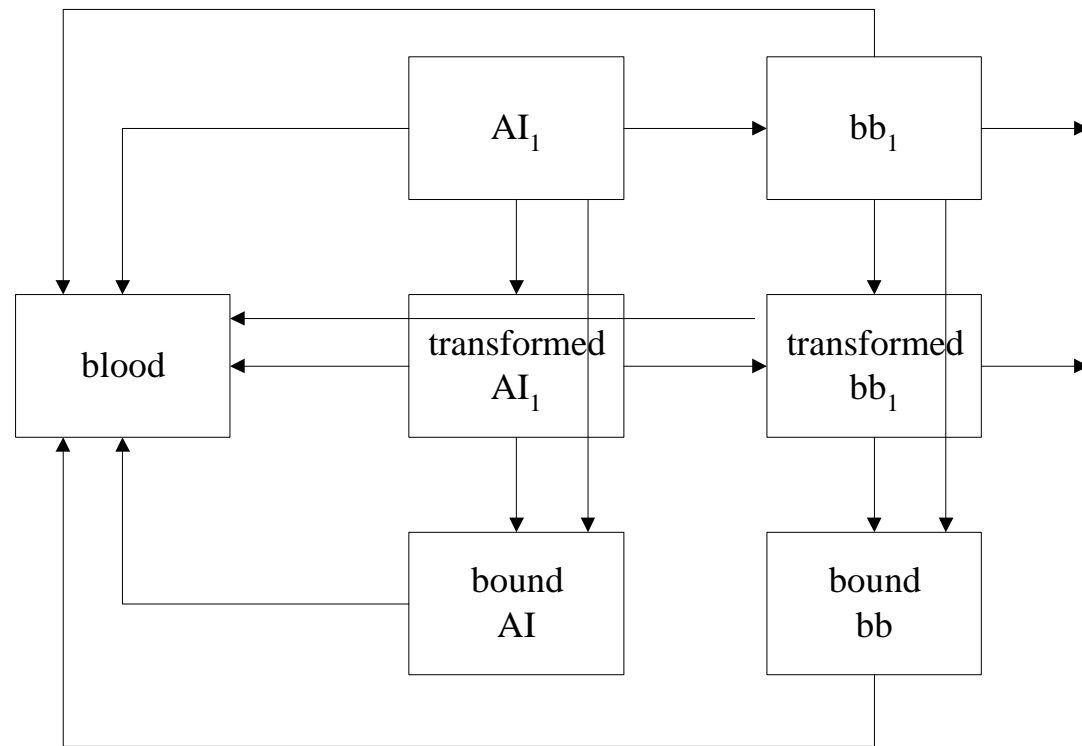

Solubility Classifications

- **ICRP 66**
 - F, fast dissolution
 - M, moderate dissolution
 - S, slow dissolution
 - refers to absorption to blood only
- **ICRP 30**
 - D, cleared in days
 - W, cleared in weeks
 - Y, cleared in years
 - refers to total clearance (absorption and mechanical)

Absorption Parameters

	D/F	W/M	Y/S
s_p	100	10	0.1
s_{pt}	0	90	100
s_t	na	0.005	0.0001
f_b	0	0	0

Gases and Vapors

- **No general deposition and clearance models as for aerosols**
- **General classifications**
 - Insoluble and non-reactive: SR-0
 - » H₂, He, N₂
 - soluble or reactive: SR-1
 - » O₃, NO₂, H₂O
 - soluble and reactive: SR-2
 - » SO₂, HF

④ Dosimetry

- **ICRP 60 quantities**
 - equivalent dose (dose equivalent)
 - effective dose (effective dose equivalent)
- **Equivalent dose to target tissues**
 - Nuclear transformations (decays) in source tissues
 - Specific effective energy (SEE) for all source-target tissue combinations
 - Cellular targets
- **Detriment weighted equivalent dose**
 - radiation detriment apportionment factors
- **Effective dose**
 - ICRP 60 weighting factors

Decays

The number of decays of radionuclide j in source organ S over 50 years is given by

$$U_{s,j} = \int_0^{50} q_{s,j}(t) dt$$

Decay Benchmark for 5 μm AMAD Class S Pu-239 (light work)

Compartment	La Bone	Ludep	Percent Error
AI	4621000	4600000	0.46
bb1	2323	2300	1.00
bb2	12570	13000	-3.31
bbseq	660	660	0.00
BB1	603	600	0.50
BB2	16980	17000	-0.12
BBseq	1062	1100	-3.45
ET1	29250	29000	0.86
ET2	410	410	0.00
ETseq	15660	16000	-2.13
LNET	128800	130000	-0.92
LNTH	444200	440000	0.95

Sources

- ET1-sur (ET_1)
- ET2-sur $(ET_2 + TET_2)$
- ET2-seq $(ET_{seq} + TET_{seq})$
- LN-ET $(LN_{ET} + TLN_{ET})$
- BB-gel $(BB_1 + TBB_1)$
- BB-sol $(BB_2 + TBB_2)$
- BB-seq $(BB_{seq} + TBB_{seq})$
- bb-gel $(bb_1 + Tbb_1)$
- bb-sol $(bb_2 + Tbb_2)$
- bb-seq $(bb_{seq} + Tbb_{seq})$
- AI $(AI_1 + AI_2 + AI_3 + TAI_1 + TAI_2 + TAI_3)$
- LN-TH $(LN_{TH} + TLN_{TH})$

Specific Effective Energy

$$SEE(T \leftarrow S; t) = \sum_R \frac{w_R E_R Y_R AF(T \leftarrow S; t)_R}{M_T(t)}$$

Targets

- **ET1-bas**
- **ET2-bas**
- **LN-ET**
- **BBi-bas**
- **BBi-sec**
- **bbe-sec**
- **AI**
- **LN-TH**

Model of Source and Target Geometry for Bronchial Dosimetry

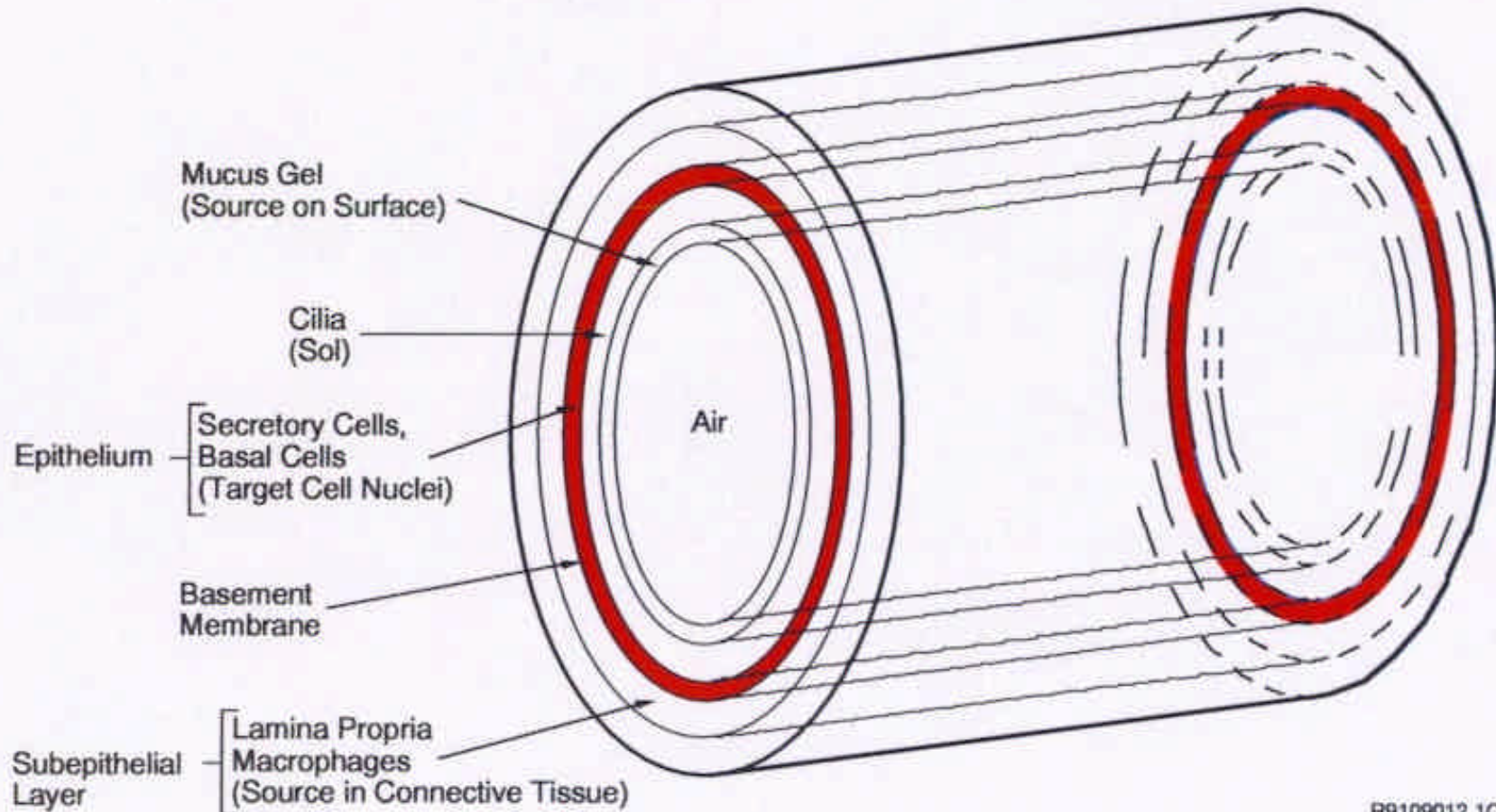

R9109012.1C

Model of Target Cell Nuclei (Basal Cells) in Stratified Squamous Epithelia of Oropharynx and Larynx (Most Sensitive Parts of ET₂ Region)

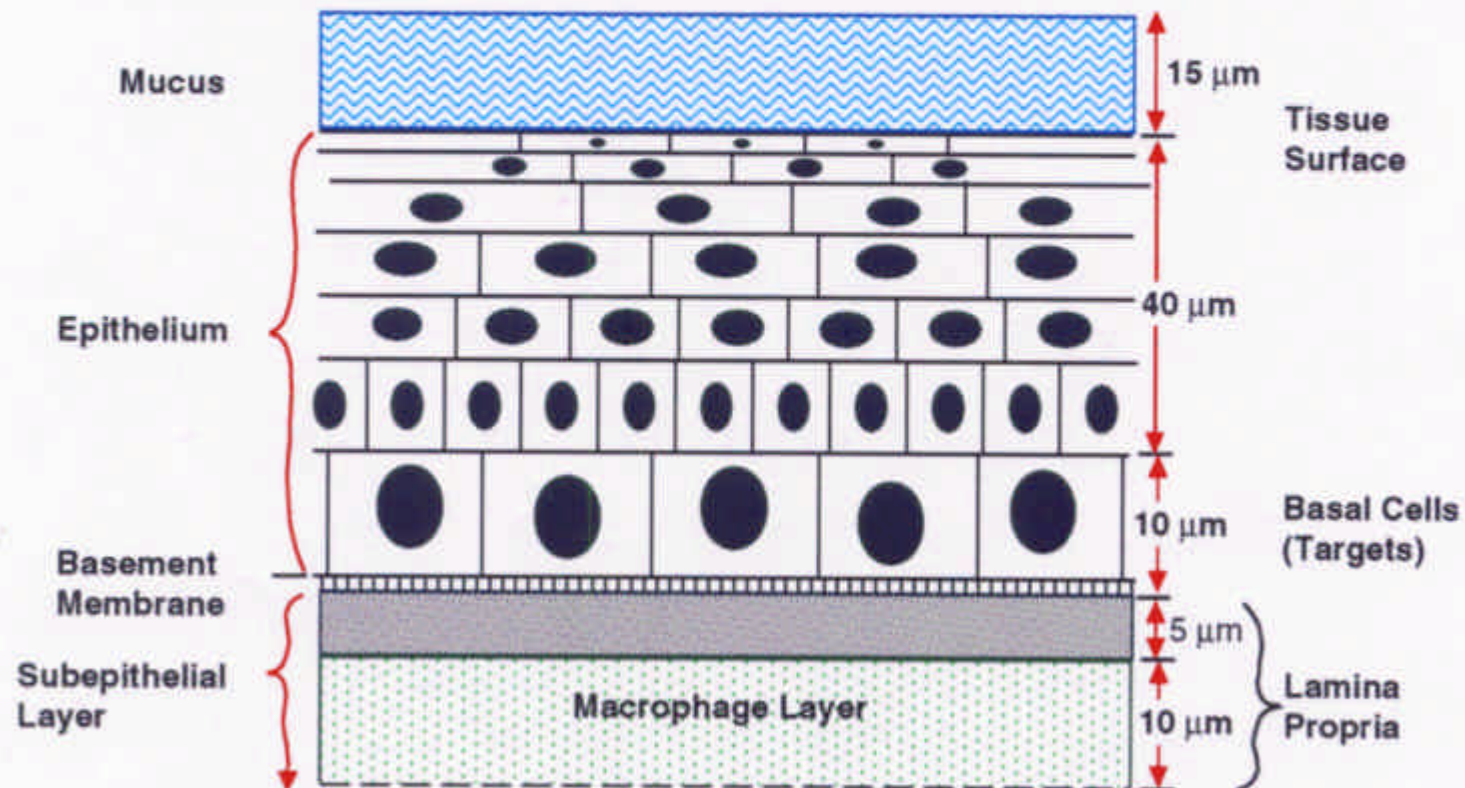

SEE, decays, and H_T for Pu-239

SEE

Targets	Sources											
	ET1-sur	ET2-sur	ET2-seq	LN-ET	BBi-gel	BBi-sol	BBi-seq	bbe-gel	bbe-sol	bbe-seq	AI	LN-Th
ET1-bas	2.85E-14	2.84E-15	2.84E-15	2.84E-15	4.49E-20	4.49E-20	4.49E-20	4.49E-20	4.49E-20	4.49E-20	4.49E-20	4.49E-20
ET2-bas	2.84E-15	3.38E-15	5.06E-09	2.84E-15	4.49E-20	4.49E-20	4.49E-20	4.49E-20	4.49E-20	4.49E-20	4.49E-20	4.49E-20
LN-ET	2.84E-15	2.84E-15	2.84E-15	1.12E-09	4.49E-20	4.49E-20	4.49E-20	4.49E-20	4.49E-20	4.49E-20	4.49E-20	4.49E-20
BBi-bas	4.60E-20	4.60E-20	4.60E-20	4.60E-20	1.35E-15	2.04E-11	5.15E-09	7.13E-17	7.13E-17	7.13E-17	7.13E-17	7.13E-17
BBi-sec	4.60E-20	4.60E-20	4.60E-20	4.60E-20	2.74E-09	3.66E-09	9.80E-10	7.13E-17	7.13E-17	7.13E-17	7.13E-17	7.13E-17
bbe-sec	4.60E-20	4.60E-20	4.60E-20	4.60E-20	7.13E-17	7.13E-17	7.13E-17	1.97E-09	2.01E-09	9.40E-10	5.96E-13	7.13E-17
AI	4.60E-20	4.60E-20	4.60E-20	4.60E-20	7.13E-17	7.13E-17	7.13E-17	7.13E-17	7.13E-17	7.13E-17	1.53E-11	5.67E-16
LN-Th	4.60E-20	4.60E-20	4.60E-20	4.60E-20	7.13E-17	7.13E-17	7.13E-17	7.13E-17	7.13E-17	7.13E-17	7.13E-17	1.12E-09

decays	29250	410	15660	128800	603	16980	1062	2323	12570	660	4621000	444200
---------------	-------	-----	-------	--------	-----	-------	------	------	-------	-----	---------	--------

S ν

Targets	Sources											
	ET1-sur	ET2-sur	ET2-seq	LN-ET	BBi-gel	BBi-sol	BBi-seq	bbe-gel	bbe-sol	bbe-seq	AI	LN-Th
ET1-bas	8.34E-10	1.16E-12	4.44E-11	3.66E-10	2.71E-17	7.62E-16	4.77E-17	1.04E-16	5.64E-16	2.96E-17	2.07E-13	1.99E-14
ET2-bas	8.30E-11	1.39E-12	7.92E-05	3.66E-10	2.71E-17	7.62E-16	4.77E-17	1.04E-16	5.64E-16	2.96E-17	2.07E-13	1.99E-14
LN-ET	8.30E-11	1.16E-12	4.44E-11	1.44E-04	2.71E-17	7.62E-16	4.77E-17	1.04E-16	5.64E-16	2.96E-17	2.07E-13	1.99E-14
BBi-bas	1.35E-15	1.89E-17	7.21E-16	5.93E-15	8.16E-13	3.46E-07	5.47E-06	1.66E-13	8.96E-13	4.70E-14	3.30E-10	3.17E-11
BBi-sec	1.35E-15	1.89E-17	7.21E-16	5.93E-15	1.65E-06	6.21E-05	1.04E-06	1.66E-13	8.96E-13	4.70E-14	3.30E-10	3.17E-11
bbe-sec	1.35E-15	1.89E-17	7.21E-16	5.93E-15	4.30E-14	1.21E-12	7.57E-14	4.58E-06	2.52E-05	6.20E-07	2.75E-06	3.17E-11
AI	1.35E-15	1.89E-17	7.21E-16	5.93E-15	4.30E-14	1.21E-12	7.57E-14	1.66E-13	8.96E-13	4.70E-14	7.05E-05	2.52E-10
LN-Th	1.35E-15	1.89E-17	7.21E-16	5.93E-15	4.30E-14	1.21E-12	7.57E-14	1.66E-13	8.96E-13	4.70E-14	3.29E-10	4.97E-04

SEECAL gives SEE in units of Sv.

Equivalent Dose Benchmark

Target	La Bone (Sv)	Ludep (Sv)	Percent Error
ET1-bas	1.25E-09	3.44E-06	-99.96
ET2-bas	7.92E-05	8.16E-05	-2.89
LN-ET	1.44E-04	1.43E-04	0.70
BBi-bas	5.81E-06	7.79E-06	-25.37
BBi-sec	6.48E-05	6.70E-05	-3.25
bbe-sec	3.32E-05	3.51E-05	-5.50
AI	7.05E-05	7.12E-05	-1.02
LN-Th	4.97E-04	4.90E-04	1.35

Detriment Weighted Equivalent Doses

$$H_{ET} = H_{ET_1} A_{ET_1} + H_{ET_2} A_{ET_2} + H_{LN_{ET}} A_{LN_{ET}}$$

$$H_{TH} = H_{BB_{sec}} A_{BB_{sec}} + H_{BB_{bas}} A_{BB_{bas}} + H_{bb} A_{bb} + H_{AI} A_{AI} + H_{LN_{TH}} A_{LN_{TH}}$$

Detriment Weighted Equivalent Dose Benchmark

Target	ED	RAF	DWED	Ludep	Genmod	ICRP CD
	(Sv)		(Sv)			
ET1-bas	1.25E-09	0.0010	1.25E-12			
ET2-bas	7.92E-05	0.9980	7.91E-05			
LN-ET	1.44E-04	0.0010	1.44E-07			
ET			7.92E-05	8.16E-05	7.93E-05	8.0E-05
BBi-bas	5.81E-06	0.1665	9.68E-07			
BBi-sec	6.48E-05	0.1665	1.08E-05			
bbe-sec	3.32E-05	0.3330	1.10E-05			
AI	7.05E-05	0.3330	2.35E-05			
LN-TH	4.97E-04	0.0010	4.97E-07			
TH			4.68E-05	4.83E-05	4.68E-05	4.7E-05

Effective Dose

- H_{TH} (lung dose) is weighted by 0.12 and added to the effective dose sum
- H_{ET} is treated as a remainder organ

Systemic Biokinetic Models

- **ICRP 2 (1959)**
- **ICRP 30 series (1979-1988)**
 - Parts 1, 2, 3, 4, and ICRP 48
- **ICRP 56 series (1990-1996)**
 - ICRP 56, 67, 69, 71, 72

ICRP 2

- **Based on**
 - stable element distribution in humans
 - rat experimental data
 - limited human occupational and experimental data
- **Single exponential retention functions for organs**
- **Designed for calculating MPCs**
 - concerned with long-term retention
 - MPC based on critical organ
 - does not address systemic excretion
- **Mid 1950's technology**

ICRP 2 Plutonium Bone Model

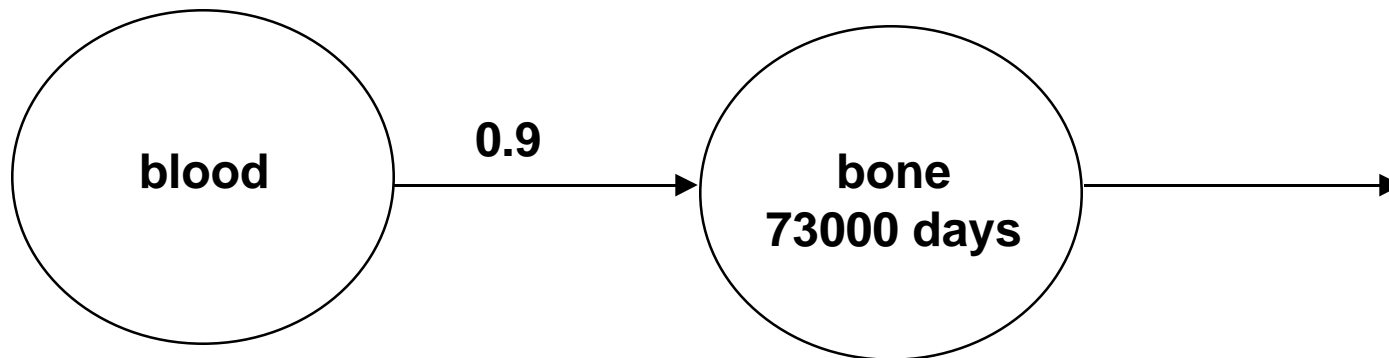

$$q_{bone}(t) = 0.9e^{\frac{-\ln(2)t}{73000}}$$

ICRP 30

- **Based on**
 - ICRP 2 database
 - large mammal/primate experimental data
 - additional human data
- **Multiple exponential retention functions possible for organs**
- **Designed for calculating worker ALIs and DACs**
 - does not address systemic excretion
 - ALI based on dose to all specified organs, not just the critical organ
- **Some physiologically based models (iodine)**
- **Mid 1970's technology**

ICRP 30 Plutonium Bone Model

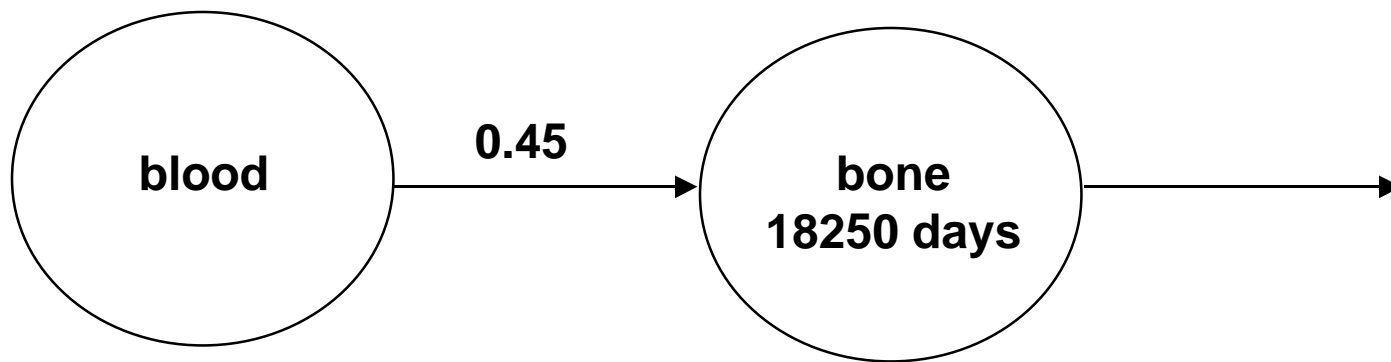

$$q_{bone}(t) = 0.45 e^{\frac{-\ln(2)t}{18250}}$$

ICRP 30 Uranium Bone Model

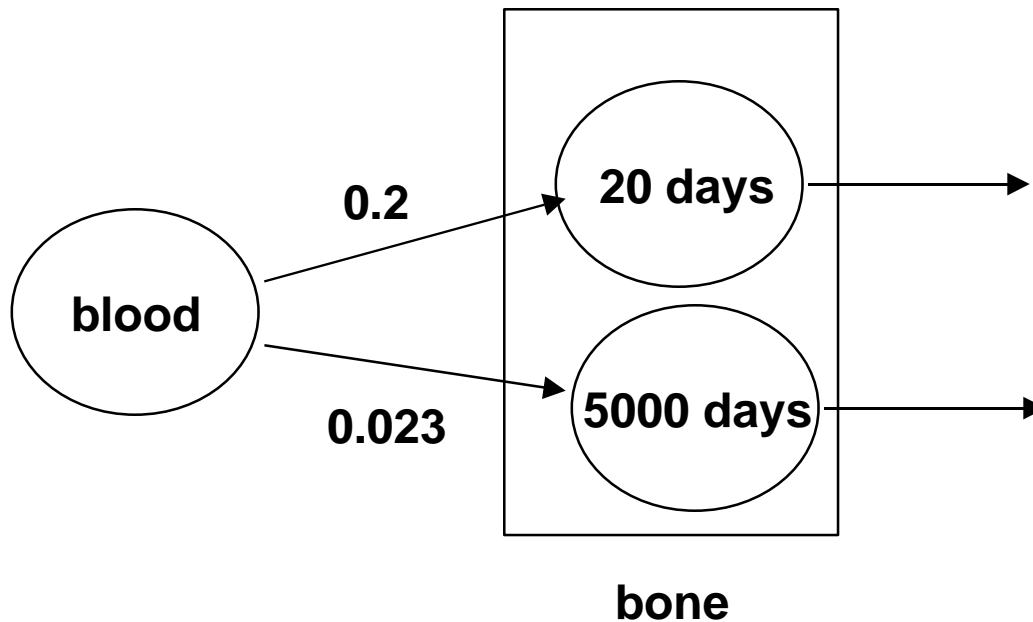

$$q_{bone}(t) = 0.2e^{\frac{-\ln(2)t}{20}} + 0.023e^{\frac{-\ln(2)t}{5000}}$$

ICRP 67

- **Multiple exponential retention functions for organs**
- **Physiologically based biokinetic models for bone seekers**
- **Designed for calculating dose to public and radiation workers**
- **Systemic excretion addressed**
 - either explicitly in model or with f_r/f_u
 - ICRP 60 w_t for bladder
 - bioassay
- **Mid 1980's technology**

New Physiological Models

- **Bone Surface Seeker**
 - plutonium (ICRP 67)
 - neptunium (ICRP 67)
 - thorium (ICRP 69)
 - americium (ICRP 67)
- **Bone Volume Seeker**
 - uranium (ICRP 69)
 - strontium and alkaline earths (ICRP 67)

General Bone Volume Seeker Model

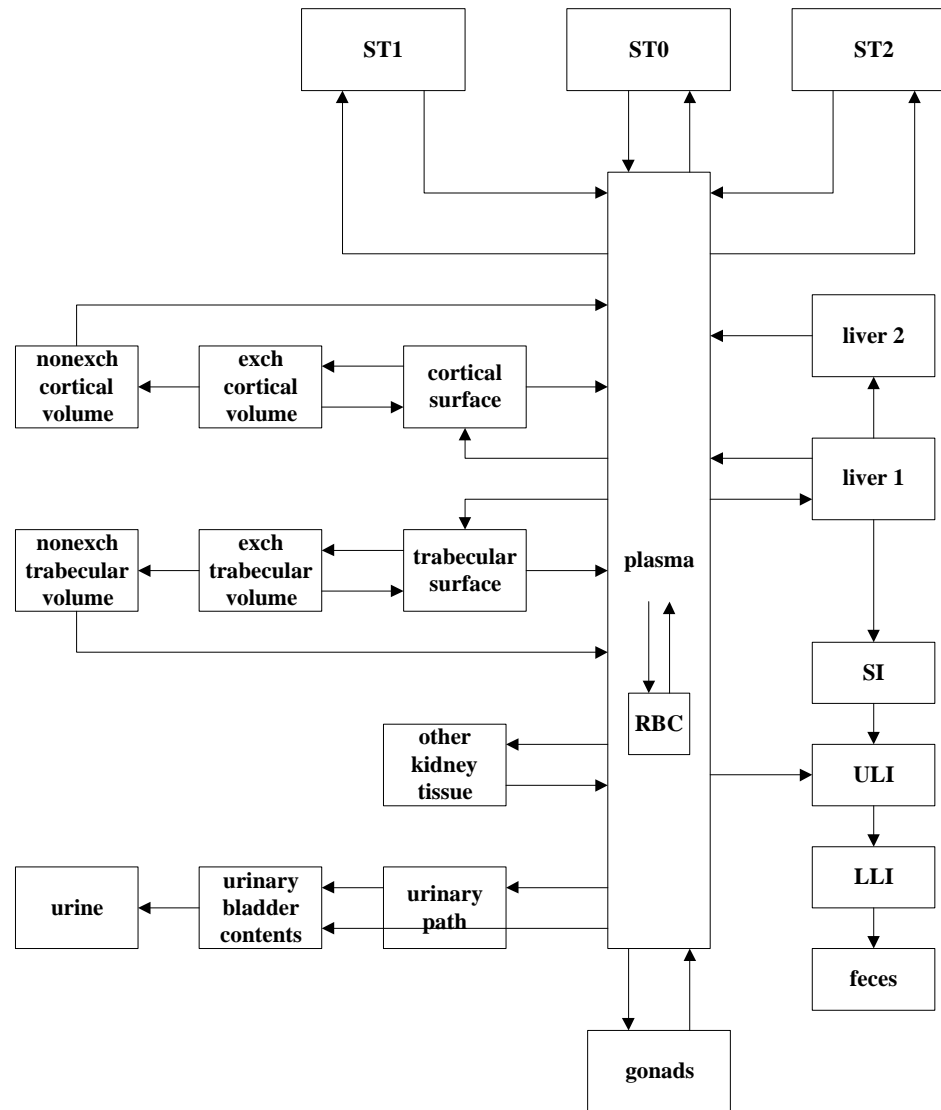

General Bone Surface Seeker Model

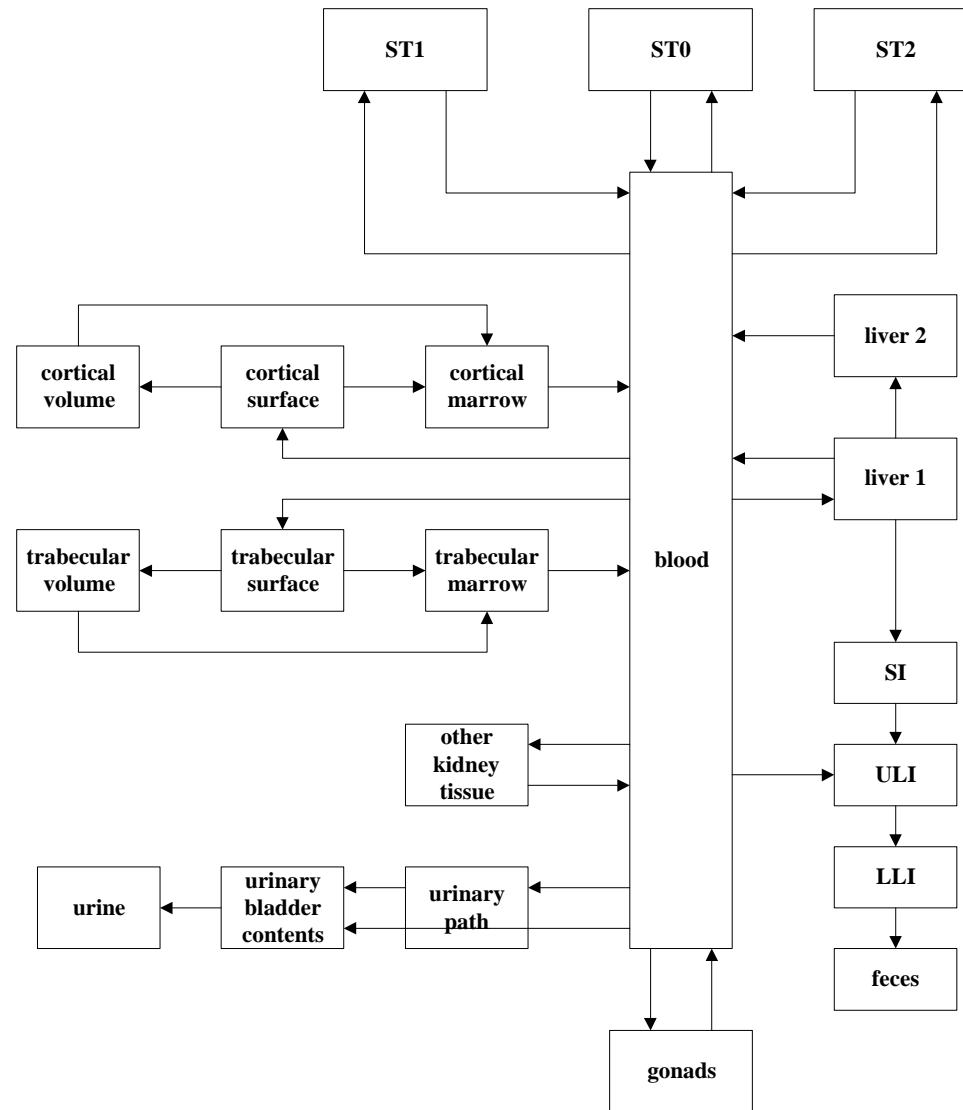

Advantages of Physiological Biokinetic Models

- **Realistic models**
- **Aid in development of realistic models**
 - extrapolating to human subgroups
 - extrapolating from animals to humans
 - extrapolating from chemical analogs
 - extrapolating model in time
- **Realistic treatment of daughters**
 - shared kinetics
 - independent kinetics
- **Explicit treatment of systemic excretion**
- **Evaluate intakes following chelation therapy**

Disadvantages of Physiological Biokinetic Models

- **Complexity**
- **Absence of commercially available software**
 - LuDep does not use new systemic models
 - Genmod is in beta test
- **Acceptance of of new models by regulators**
- **Internal dosimetrists' general lack of familiarity with the new models**

Pu-239 Type S Benchmark

- **Acute inhalation of type S 5.0 μm AMAD plutonium-239 under light-work conditions**
- **Comparison of results from three sources**
 - **MathCad and Excel worksheets with SEECAL SEEs**
 - **ICRP Database of Dose Coefficients Workers and Members of the Public (V1.0 CD)**
 - **Genmod-PC V4.13 beta test**

Mathcad Method

- **Calculate decays**
 - Mathcad worksheet using eigensystem or matrix exponential method of solving systems of ODEs.
- **Create SEE matrix**
 - SEECAL SEEs in Excel spreadsheet
- **Multiply decays by SEE matrix**
- **Sum doses from all source organ over each target organ.**
- **Sum target doses and apply weights to obtain effective dose.**

SEE Matrix with Decays - Left Side

SEE	UB_Cont	C_Bone-S	C_Bone-V	T_Bone-S	T_Bone-V.	St_Cont	SI_Cont	ULI_Cont.	LLI_Cont	Kidneys	Liver	ET1-sur	ET2-sur
Adrenals	4.404E-21	1.550E-19	1.550E-19	3.491E-19	3.491E-19	1.544E-19	3.382E-20	4.217E-20	1.064E-20	2.562E-18	9.717E-19	3.759E-21	3.759E-21
UB_Wall	6.920E-13	1.875E-20	1.875E-20	4.357E-20	4.357E-20	9.001E-21	1.197E-19	8.364E-20	5.207E-19	9.614E-21	5.917E-21	9.305E-23	9.305E-23
Bone_Sur	4.894E-20	3.437E-11	1.375E-12	3.437E-11	3.437E-12	8.520E-20	2.611E-19	1.620E-19	4.918E-19	2.315E-19	2.214E-19	2.445E-19	2.445E-19
Brain	9.104E-24	3.830E-19	3.830E-19	2.493E-19	2.493E-19	2.954E-22	3.952E-23	4.637E-23	1.895E-23	1.222E-22	4.993E-22	6.661E-20	6.661E-20
Breasts	7.300E-22	6.208E-20	6.208E-20	1.184E-19	1.184E-19	2.839E-20	3.799E-21	4.342E-21	1.387E-21	9.684E-21	3.638E-20	1.391E-20	1.391E-20
St_Wall	9.600E-21	3.192E-20	3.192E-20	6.435E-20	6.435E-20	3.321E-13	3.063E-19	6.765E-19	9.693E-20	1.479E-19	9.988E-20	2.123E-21	2.123E-21
SI_Wall	1.132E-19	6.162E-20	6.162E-20	2.238E-19	2.238E-19	1.587E-19	2.076E-13	7.684E-18	3.890E-18	1.384E-19	1.024E-19	2.907E-22	2.907E-22
ULI_Wall	8.250E-20	6.235E-20	6.235E-20	2.266E-19	2.266E-19	4.134E-19	1.710E-17	3.774E-13	2.449E-18	1.224E-19	1.921E-19	5.261E-22	5.261E-22
LLI_Wall	5.773E-19	1.426E-19	1.426E-19	5.134E-19	5.134E-19	5.607E-20	6.671E-18	7.861E-19	6.151E-13	2.589E-20	6.684E-21	1.627E-22	1.627E-22
Kidneys	9.904E-21	5.699E-20	5.699E-20	1.564E-19	1.564E-19	1.500E-19	1.384E-19	1.136E-19	3.365E-20	5.412E-11	3.515E-19	1.810E-21	1.810E-21
Liver	5.781E-21	5.007E-20	5.007E-20	9.035E-20	9.035E-20	9.068E-20	1.024E-19	1.725E-19	8.251E-21	3.515E-19	9.320E-12	4.291E-21	4.291E-21
ET1-bas	9.259E-23	6.197E-20	6.197E-20	5.315E-20	5.315E-20	1.576E-21	2.907E-22	5.152E-22	1.972E-22	1.810E-21	4.291E-21	2.851E-14	2.838E-15
ET2-bas	9.259E-23	6.197E-20	6.197E-20	5.315E-20	5.315E-20	1.576E-21	2.907E-22	5.152E-22	1.972E-22	1.810E-21	4.291E-21	2.838E-15	3.384E-15
LN-ET	9.259E-23	6.197E-20	6.197E-20	5.315E-20	5.315E-20	1.576E-21	2.907E-22	5.152E-22	1.972E-22	1.810E-21	4.291E-21	2.838E-15	2.838E-15
BBi-bas	6.091E-22	8.574E-20	8.574E-20	1.540E-19	1.540E-19	1.045E-19	6.519E-21	8.394E-21	2.399E-21	3.524E-20	7.294E-19	4.603E-20	4.603E-20
BBi-sec	6.091E-22	8.574E-20	8.574E-20	1.540E-19	1.540E-19	1.045E-19	6.519E-21	8.394E-21	2.399E-21	3.524E-20	7.294E-19	4.603E-20	4.603E-20
bbe-sec	6.091E-22	8.574E-20	8.574E-20	1.540E-19	1.540E-19	1.045E-19	6.519E-21	8.394E-21	2.399E-21	3.524E-20	7.294E-19	4.603E-20	4.603E-20
AI	6.091E-22	8.574E-20	8.574E-20	1.540E-19	1.540E-19	1.045E-19	6.519E-21	8.394E-21	2.399E-21	3.524E-20	7.294E-19	4.603E-20	4.603E-20
LN-Th	6.091E-22	8.574E-20	8.574E-20	1.540E-19	1.540E-19	1.045E-19	6.519E-21	8.394E-21	2.399E-21	3.524E-20	7.294E-19	4.603E-20	4.603E-20
Muscle	3.680E-19	1.638E-19	1.638E-19	2.229E-19	2.229E-19	2.496E-19	3.395E-19	2.092E-19	2.862E-19	5.576E-19	2.668E-19	1.009E-18	1.009E-18
Ovaries	3.645E-19	4.498E-20	4.498E-20	1.576E-19	1.576E-19	2.688E-20	3.779E-18	3.485E-18	8.600E-18	3.245E-20	1.744E-20	1.914E-22	1.914E-22
Pancreas	6.790E-21	4.081E-20	4.081E-20	9.323E-20	9.323E-20	3.119E-18	7.026E-20	8.295E-20	2.330E-20	3.738E-19	4.228E-19	3.534E-21	3.534E-21
R_Marrow	3.856E-20	2.429E-18	2.429E-18	5.498E-12	5.501E-13	4.748E-20	2.087E-19	1.343E-19	3.598E-19	1.524E-19	8.720E-20	5.519E-20	5.519E-20
Skin	3.729E-20	1.425E-19	1.425E-19	1.367E-19	1.367E-19	3.404E-20	1.882E-20	2.006E-20	4.962E-20	7.483E-20	4.070E-20	4.551E-20	4.551E-20
Spleen	4.682E-21	4.408E-20	4.408E-20	8.227E-20	8.227E-20	7.368E-19	5.089E-20	5.138E-20	3.017E-20	2.122E-18	3.413E-20	4.032E-21	4.032E-21
Testes	2.357E-19	1.930E-20	1.930E-20	1.466E-20	1.466E-20	1.807E-21	1.252E-20	9.661E-21	8.379E-20	1.862E-21	9.978E-22	2.975E-23	2.975E-23
Thymus	5.395E-22	6.272E-20	6.272E-20	1.185E-19	1.185E-19	1.737E-20	2.371E-21	2.943E-21	1.173E-21	8.506E-21	2.878E-20	7.815E-20	7.815E-20
Thyroid	9.259E-23	6.197E-20	6.197E-20	5.315E-20	5.315E-20	1.576E-21	2.907E-22	5.152E-22	1.972E-22	1.810E-21	4.291E-21	6.661E-20	6.661E-20
Uterus	2.309E-18	2.392E-20	2.392E-20	7.576E-20	7.576E-20	2.250E-20	1.374E-18	2.496E-19	3.486E-19	2.877E-20	1.487E-20	1.777E-22	1.777E-22
Decays	1.284E+01	1.900E+06	4.332E+05	6.623E+05	3.058E+05	1.708E+03	6.838E+03	2.224E+04	4.106E+04	7.237E+03	2.070E+06	2.925E+04	4.099E+02

SEE Matrix with Decays - Right Side

ET2-seq	LN-ET	BBI-gel	BBI-sol	BBI-seq	bbe-gel	bbe-sol	bbe-seq	AI	LN-Th	R_Marrow	Testes	Blood	BT-Soft
3.759E-21	3.759E-21	3.207E-19	3.207E-19	3.207E-19	3.207E-19	3.207E-19	3.207E-19	3.207E-19	3.207E-19	3.491E-19	9.583E-22	2.437E-13	2.63E-13
9.305E-23	9.305E-23	8.325E-22	8.325E-22	8.325E-22	8.325E-22	8.325E-22	8.325E-22	8.325E-22	8.325E-22	4.357E-20	2.459E-19	2.437E-13	2.63E-13
2.445E-19	2.445E-19	3.428E-19	3.428E-19	3.428E-19	3.428E-19	3.428E-19	3.428E-19	3.428E-19	3.428E-19	5.592E-12	4.952E-20	2.437E-13	1.31E-13
6.661E-20	6.661E-20	3.952E-21	3.952E-21	3.952E-21	3.952E-21	3.952E-21	3.952E-21	3.952E-21	3.952E-21	2.493E-19	3.035E-24	2.437E-13	2.63E-13
1.391E-20	1.391E-20	3.317E-19	3.317E-19	3.317E-19	3.317E-19	3.317E-19	3.317E-19	3.317E-19	3.317E-19	1.184E-19	0.000E+00	2.437E-13	2.63E-13
2.123E-21	2.123E-21	1.800E-19	1.800E-19	1.800E-19	1.800E-19	1.800E-19	1.800E-19	1.800E-19	1.800E-19	6.435E-20	2.338E-21	2.437E-13	2.63E-13
2.907E-22	2.907E-22	6.450E-21	6.450E-21	6.450E-21	6.450E-21	6.450E-21	6.450E-21	6.450E-21	6.450E-21	2.238E-19	1.252E-20	2.437E-13	2.63E-13
5.261E-22	5.261E-22	8.396E-21	8.396E-21	8.396E-21	8.396E-21	8.396E-21	8.396E-21	8.396E-21	8.396E-21	2.266E-19	9.196E-21	2.437E-13	2.63E-13
1.627E-22	1.627E-22	1.821E-21	1.821E-21	1.821E-21	1.821E-21	1.821E-21	1.821E-21	1.821E-21	1.821E-21	5.134E-19	1.285E-19	2.437E-13	2.63E-13
1.810E-21	1.810E-21	3.433E-20	3.433E-20	3.433E-20	3.433E-20	3.433E-20	3.433E-20	3.433E-20	3.433E-20	1.564E-19	1.862E-21	2.437E-13	2.63E-13
4.291E-21	4.291E-21	6.592E-19	6.592E-19	6.592E-19	6.592E-19	6.592E-19	6.592E-19	6.592E-19	6.592E-19	9.035E-20	9.978E-22	2.437E-13	2.63E-13
2.838E-15	2.838E-15	4.490E-20	4.490E-20	4.490E-20	4.490E-20	4.490E-20	4.490E-20	4.490E-20	4.490E-20	5.315E-20	2.975E-23	2.437E-13	2.63E-13
5.060E-09	2.838E-15	4.490E-20	4.490E-20	4.490E-20	4.490E-20	4.490E-20	4.490E-20	4.490E-20	4.490E-20	5.315E-20	2.975E-23	2.437E-13	2.63E-13
2.838E-15	1.118E-09	4.490E-20	4.490E-20	4.490E-20	4.490E-20	4.490E-20	4.490E-20	4.490E-20	4.490E-20	5.315E-20	2.975E-23	2.437E-13	2.63E-13
4.603E-20	4.603E-20	1.354E-15	2.037E-11	5.148E-09	7.126E-17	7.126E-17	7.126E-17	7.132E-17	7.126E-17	1.540E-19	2.664E-22	2.437E-13	2.63E-13
4.603E-20	4.603E-20	2.742E-09	3.659E-09	9.803E-10	7.126E-17	7.126E-17	7.126E-17	7.131E-17	7.126E-17	1.540E-19	2.664E-22	2.437E-13	2.63E-13
4.603E-20	4.603E-20	7.126E-17	7.126E-17	7.126E-17	1.972E-09	2.006E-09	9.398E-10	5.959E-13	7.126E-17	1.540E-19	2.664E-22	2.437E-13	2.63E-13
4.603E-20	4.603E-20	7.126E-17	7.126E-17	7.126E-17	7.126E-17	7.126E-17	7.126E-17	1.525E-11	5.674E-16	1.540E-19	2.664E-22	2.437E-13	2.63E-13
4.603E-20	4.603E-20	7.126E-17	7.126E-17	7.126E-17	7.126E-17	7.126E-17	7.126E-17	7.126E-17	1.118E-09	1.540E-19	2.664E-22	2.437E-13	2.63E-13
1.009E-18	1.009E-18	6.737E-19	6.737E-19	6.737E-19	6.737E-19	6.737E-19	6.737E-19	6.737E-19	6.737E-19	2.229E-19	6.340E-19	2.437E-13	2.63E-13
1.914E-22	1.914E-22	2.787E-21	2.787E-21	2.787E-21	2.787E-21	2.787E-21	2.787E-21	2.787E-21	2.787E-21	1.576E-19	0.000E+00	2.437E-13	2.63E-13
3.534E-21	3.534E-21	1.252E-19	1.252E-19	1.252E-19	1.252E-19	1.252E-19	1.252E-19	1.252E-19	1.252E-19	9.323E-20	1.465E-21	2.437E-13	2.63E-13
5.519E-20	5.519E-20	1.339E-19	1.339E-19	1.339E-19	1.339E-19	1.339E-19	1.339E-19	1.339E-19	1.339E-19	1.118E-11	1.346E-20	2.437E-13	2.63E-13
4.551E-20	4.551E-20	4.312E-20	4.312E-20	4.312E-20	4.312E-20	4.312E-20	4.312E-20	4.312E-20	4.312E-20	1.367E-19	1.105E-18	2.437E-13	2.63E-13
4.032E-21	4.032E-21	3.127E-19	3.127E-19	3.127E-19	3.127E-19	3.127E-19	3.127E-19	3.127E-19	3.127E-19	8.227E-20	1.279E-21	2.437E-13	2.63E-13
2.975E-23	2.975E-23	2.662E-22	2.662E-22	2.662E-22	2.662E-22	2.662E-22	2.662E-22	2.662E-22	2.662E-22	1.466E-20	4.793E-10	2.437E-13	2.63E-13
7.815E-20	7.815E-20	2.085E-19	2.085E-19	2.085E-19	2.085E-19	2.085E-19	2.085E-19	2.085E-19	2.085E-19	1.185E-19	1.630E-22	2.437E-13	2.63E-13
6.661E-20	6.661E-20	4.490E-20	4.490E-20	4.490E-20	4.490E-20	4.490E-20	4.490E-20	4.490E-20	4.490E-20	5.315E-20	2.975E-23	2.437E-13	2.63E-13
1.777E-22	1.777E-22	2.158E-21	2.158E-21	2.158E-21	2.158E-21	2.158E-21	2.158E-21	2.158E-21	2.158E-21	7.576E-20	0.000E+00	2.437E-13	2.63E-13
1.566E+04	1.288E+05	6.034E+02	1.698E+04	1.062E+03	2.323E+03	1.257E+04	6.598E+02	4.621E+06	4.442E+05	6.248E+04	2.548E+03	2.648E+03	5.556E+05

Dose Matrix - Left Side

Dose	UB_Cont	C_Bone-S	C_Bone-V	T_Bone-S	T_Bone-V.	St_Cont	SI_Cont	ULI_Cont.	LLI_Cont	Kidneys	Liver	ET1-sur	ET2-sur .
Adrenals	5.657E-20	2.945E-13	6.714E-14	2.312E-13	1.067E-13	2.637E-16	2.312E-16	9.379E-16	4.369E-16	1.854E-14	2.011E-12	1.099E-16	1.541E-18
UB_Wall	8.888E-12	3.563E-14	8.122E-15	2.886E-14	1.332E-14	1.537E-17	8.185E-16	1.860E-15	2.138E-14	6.958E-17	1.225E-14	2.721E-18	3.814E-20
Bone_Sur	6.286E-19	6.531E-05	5.956E-07	2.276E-05	1.051E-06	1.455E-16	1.785E-15	3.603E-15	2.019E-14	1.675E-15	4.583E-13	7.151E-15	1.002E-16
Brain	1.169E-22	7.278E-13	1.659E-13	1.651E-13	7.623E-14	5.045E-19	2.702E-19	1.031E-18	7.781E-19	8.844E-19	1.034E-15	1.948E-15	2.730E-17
Breasts	9.376E-21	1.180E-13	2.689E-14	7.841E-14	3.620E-14	4.849E-17	2.598E-17	9.657E-17	5.695E-17	7.008E-17	7.531E-14	4.068E-16	5.702E-18
St_Wall	1.233E-19	6.065E-14	1.383E-14	4.262E-14	1.968E-14	5.672E-10	2.094E-15	1.505E-14	3.980E-15	1.070E-15	2.067E-13	6.209E-17	8.702E-19
SI_Wall	1.454E-18	1.171E-13	2.669E-14	1.482E-13	6.843E-14	2.711E-16	1.419E-09	1.709E-13	1.597E-13	1.002E-15	2.120E-13	8.502E-18	1.192E-19
ULI_Wall	1.060E-18	1.185E-13	2.701E-14	1.501E-13	6.929E-14	7.061E-16	1.169E-13	8.394E-09	1.006E-13	8.858E-16	3.976E-13	1.539E-17	2.157E-19
LLI_Wall	7.415E-18	2.710E-13	6.177E-14	3.400E-13	1.570E-13	9.577E-17	4.561E-14	1.748E-14	2.526E-08	1.874E-16	1.384E-14	4.758E-18	6.669E-20
Kidneys	1.272E-19	1.083E-13	2.469E-14	1.036E-13	4.782E-14	2.562E-16	9.463E-16	2.527E-15	1.382E-15	3.917E-07	7.276E-13	5.294E-17	7.419E-19
Liver	7.425E-20	9.514E-14	2.169E-14	5.984E-14	2.763E-14	1.549E-16	7.002E-16	3.837E-15	3.388E-16	2.544E-15	1.929E-05	1.255E-16	1.759E-18
ET1-bas	1.189E-21	1.178E-13	2.684E-14	3.520E-14	1.625E-14	2.692E-18	1.988E-18	1.146E-17	8.097E-18	1.310E-17	8.882E-15	8.338E-10	1.163E-12
ET2-bas	1.189E-21	1.178E-13	2.684E-14	3.520E-14	1.625E-14	2.692E-18	1.988E-18	1.146E-17	8.097E-18	1.310E-17	8.882E-15	8.300E-11	1.387E-12
LN-ET	1.189E-21	1.178E-13	2.684E-14	3.520E-14	1.625E-14	2.692E-18	1.988E-18	1.146E-17	8.097E-18	1.310E-17	8.882E-15	8.300E-11	1.163E-12
BBi-bas	7.824E-21	1.629E-13	3.714E-14	1.020E-13	4.709E-14	1.785E-16	4.457E-17	1.867E-16	9.850E-17	2.550E-16	1.510E-12	1.346E-15	1.887E-17
BBi-sec	7.824E-21	1.629E-13	3.714E-14	1.020E-13	4.709E-14	1.785E-16	4.457E-17	1.867E-16	9.850E-17	2.550E-16	1.510E-12	1.346E-15	1.887E-17
bbe-sec	7.824E-21	1.629E-13	3.714E-14	1.020E-13	4.709E-14	1.785E-16	4.457E-17	1.867E-16	9.850E-17	2.550E-16	1.510E-12	1.346E-15	1.887E-17
AI	7.824E-21	1.629E-13	3.714E-14	1.020E-13	4.709E-14	1.785E-16	4.457E-17	1.867E-16	9.850E-17	2.550E-16	1.510E-12	1.346E-15	1.887E-17
LN-Th	7.824E-21	1.629E-13	3.714E-14	1.020E-13	4.709E-14	1.785E-16	4.457E-17	1.867E-16	9.850E-17	2.550E-16	1.510E-12	1.346E-15	1.887E-17
Muscle	4.727E-18	3.112E-13	7.095E-14	1.476E-13	6.816E-14	4.263E-16	2.321E-15	4.653E-15	1.175E-14	4.035E-15	5.523E-13	2.951E-14	4.136E-16
Ovaries	4.682E-18	8.547E-14	1.948E-14	1.044E-13	4.819E-14	4.591E-17	2.584E-14	7.751E-14	3.531E-13	2.348E-16	3.610E-14	5.598E-18	7.846E-20
Pancreas	8.721E-20	7.754E-14	1.768E-14	6.174E-14	2.851E-14	5.327E-15	4.804E-16	1.845E-15	9.567E-16	2.705E-15	8.752E-13	1.034E-16	1.449E-18
R_Marrow	4.953E-19	4.615E-12	1.052E-12	3.641E-06	1.682E-07	8.109E-17	1.427E-15	2.987E-15	1.477E-14	1.103E-15	1.805E-13	1.614E-15	2.262E-17
Skin	4.790E-19	2.708E-13	6.172E-14	9.053E-14	4.180E-14	5.814E-17	1.287E-16	4.462E-16	2.037E-15	5.415E-16	8.425E-14	1.331E-15	1.865E-17
Spleen	6.014E-20	8.376E-14	1.909E-14	5.448E-14	2.516E-14	1.258E-15	3.480E-16	1.143E-15	1.239E-15	1.536E-14	7.065E-14	1.179E-16	1.653E-18
Testes	3.027E-18	3.667E-14	8.360E-15	9.709E-15	4.483E-15	3.086E-18	8.561E-17	2.149E-16	3.440E-15	1.348E-17	2.065E-15	8.701E-19	1.219E-20
Thymus	6.930E-21	1.192E-13	2.717E-14	7.848E-14	3.623E-14	2.967E-17	1.621E-17	6.545E-17	4.816E-17	6.156E-17	5.957E-14	2.286E-15	3.203E-17
Thyroid	1.189E-21	1.178E-13	2.684E-14	3.520E-14	1.625E-14	2.692E-18	1.988E-18	1.146E-17	8.097E-18	1.310E-17	8.882E-15	1.948E-15	2.730E-17
Uterus	2.966E-17	4.545E-14	1.036E-14	5.017E-14	2.316E-14	3.843E-17	9.395E-15	5.551E-15	1.431E-14	2.082E-16	3.078E-14	5.197E-18	7.284E-20

Dose Matrix - Right Side

ET2-seq	LN-ET	BBI-gel	BBI-sol	BBI-seq .	bbe-gel	bbe-sol	bbe-seq	AI	LN-Th	R_Marrow	Testes	Blood	BT-Soft
5.887E-17	4.841E-16	1.935E-16	5.445E-15	3.407E-16	7.450E-16	4.032E-15	2.116E-16	1.482E-12	1.424E-13	2.181E-14	2.442E-18	6.453E-10	1.460E-07
1.457E-18	1.198E-17	5.023E-19	1.413E-17	8.843E-19	1.934E-18	1.047E-17	5.493E-19	3.847E-15	3.698E-16	2.722E-15	6.266E-16	6.453E-10	1.460E-07
3.829E-15	3.148E-14	2.068E-16	5.820E-15	3.641E-16	7.963E-16	4.309E-15	2.262E-16	1.584E-12	1.523E-13	3.494E-07	1.262E-16	6.453E-10	7.301E-08
1.043E-15	8.578E-15	2.385E-18	6.710E-17	4.198E-18	9.181E-18	4.968E-17	2.608E-18	1.826E-14	1.755E-15	1.558E-14	7.734E-21	6.453E-10	1.460E-07
2.178E-16	1.791E-15	2.001E-16	5.632E-15	3.523E-16	7.705E-16	4.170E-15	2.189E-16	1.533E-12	1.473E-13	7.398E-15	0.000E+00	6.453E-10	1.460E-07
3.325E-17	2.734E-16	1.086E-16	3.056E-15	1.912E-16	4.181E-16	2.263E-15	1.188E-16	8.317E-13	7.995E-14	4.021E-15	5.958E-18	6.453E-10	1.460E-07
4.553E-18	3.743E-17	3.892E-18	1.095E-16	6.851E-18	1.498E-17	8.109E-17	4.256E-18	2.980E-14	2.865E-15	1.398E-14	3.190E-17	6.453E-10	1.460E-07
8.239E-18	6.775E-17	5.066E-18	1.426E-16	8.919E-18	1.950E-17	1.055E-16	5.540E-18	3.880E-14	3.729E-15	1.416E-14	2.343E-17	6.453E-10	1.460E-07
2.548E-18	2.095E-17	1.099E-18	3.092E-17	1.934E-18	4.230E-18	2.289E-17	1.202E-18	8.414E-15	8.088E-16	3.208E-14	3.275E-16	6.453E-10	1.460E-07
2.835E-17	2.331E-16	2.071E-17	5.829E-16	3.647E-17	7.975E-17	4.316E-16	2.265E-17	1.586E-13	1.525E-14	9.772E-15	4.745E-18	6.453E-10	1.460E-07
6.720E-17	5.526E-16	3.978E-16	1.119E-14	7.002E-16	1.531E-15	8.287E-15	4.350E-16	3.046E-12	2.928E-13	5.645E-15	2.543E-18	6.453E-10	1.460E-07
4.445E-11	3.655E-10	2.709E-17	7.623E-16	4.769E-17	1.043E-16	5.645E-16	2.963E-17	2.075E-13	1.994E-14	3.321E-15	7.581E-20	6.453E-10	1.460E-07
7.924E-05	3.655E-10	2.709E-17	7.623E-16	4.769E-17	1.043E-16	5.645E-16	2.963E-17	2.075E-13	1.994E-14	3.321E-15	7.581E-20	6.453E-10	1.460E-07
4.445E-11	1.440E-04	2.709E-17	7.623E-16	4.769E-17	1.043E-16	5.645E-16	2.963E-17	2.075E-13	1.994E-14	3.321E-15	7.581E-20	6.453E-10	1.460E-07
7.209E-16	5.927E-15	8.170E-13	3.459E-07	5.468E-06	1.655E-13	8.958E-13	4.702E-14	3.296E-10	3.165E-11	9.622E-15	6.789E-19	6.453E-10	1.460E-07
7.209E-16	5.927E-15	1.655E-06	6.213E-05	1.041E-06	1.655E-13	8.958E-13	4.702E-14	3.295E-10	3.165E-11	9.622E-15	6.789E-19	6.453E-10	1.460E-07
7.209E-16	5.927E-15	4.300E-14	1.210E-12	7.570E-14	4.581E-06	2.522E-05	6.201E-07	2.753E-06	3.165E-11	9.622E-15	6.789E-19	6.453E-10	1.460E-07
7.209E-16	5.927E-15	4.300E-14	1.210E-12	7.570E-14	1.655E-13	8.958E-13	4.702E-14	7.047E-05	2.520E-10	9.622E-15	6.789E-19	6.453E-10	1.460E-07
7.209E-16	5.927E-15	4.300E-14	1.210E-12	7.570E-14	1.655E-13	8.958E-13	4.702E-14	3.293E-10	4.966E-04	9.622E-15	6.789E-19	6.453E-10	1.460E-07
1.580E-14	1.299E-13	4.065E-16	1.144E-14	7.156E-16	1.565E-15	8.469E-15	4.445E-16	3.113E-12	2.992E-13	1.393E-14	1.616E-15	6.453E-10	1.460E-07
2.997E-18	2.465E-17	1.682E-18	4.732E-17	2.960E-18	6.474E-18	3.504E-17	1.839E-18	1.288E-14	1.238E-15	9.847E-15	0.000E+00	6.453E-10	1.460E-07
5.535E-17	4.551E-16	7.554E-17	2.126E-15	1.330E-16	2.908E-16	1.574E-15	8.261E-17	5.785E-13	5.561E-14	5.825E-15	3.733E-18	6.453E-10	1.460E-07
8.643E-16	7.107E-15	8.079E-17	2.273E-15	1.422E-16	3.111E-16	1.683E-15	8.835E-17	6.187E-13	5.947E-14	6.985E-07	3.430E-17	6.453E-10	1.460E-07
7.127E-16	5.860E-15	2.602E-17	7.321E-16	4.580E-17	1.002E-16	5.421E-16	2.845E-17	1.992E-13	1.915E-14	8.541E-15	2.816E-15	6.453E-10	1.460E-07
6.314E-17	5.192E-16	1.887E-16	5.309E-15	3.322E-16	7.264E-16	3.931E-15	2.063E-16	1.445E-12	1.389E-13	5.140E-15	3.259E-18	6.453E-10	1.460E-07
4.659E-19	3.831E-18	1.606E-19	4.520E-18	2.828E-19	6.184E-19	3.346E-18	1.756E-19	1.230E-15	1.182E-16	9.160E-16	1.221E-06	6.453E-10	1.460E-07
1.224E-15	1.006E-14	1.258E-16	3.540E-15	2.215E-16	4.843E-16	2.621E-15	1.376E-16	9.634E-13	9.261E-14	7.404E-15	4.154E-19	6.453E-10	1.460E-07
1.043E-15	8.578E-15	2.709E-17	7.623E-16	4.769E-17	1.043E-16	5.645E-16	2.963E-17	2.075E-13	1.994E-14	3.321E-15	7.581E-20	6.453E-10	1.460E-07
2.783E-18	2.288E-17	1.302E-18	3.664E-17	2.292E-18	5.013E-18	2.713E-17	1.424E-18	9.972E-15	9.585E-16	4.734E-15	0.000E+00	6.453E-10	1.460E-07

Remainder Organs

- If the maximum dose to any remainder organ is less than the maximum dose to any risk organ, then

$$H_{\text{remainder}} = \frac{\sum_{T=1}^{10} m_T \cdot H_T}{\sum_{T=1}^{10} m_T}$$

Remainder Organs

- If the maximum dose to a remainder organ T' is greater than the maximum dose to the any risk organ, then

$$H_{\text{remainder}} = 0.5 \frac{\sum_{T=1, T \neq T'}^{10} m_T \cdot H_T}{\sum_{T=1, T \neq T'}^{10} m_T} + 0.5 H_{T'}$$

ICRP 60

	Ht	A	A x Ht	Wt	Mass (g)	Ht x Mass	Ht x Wt
<i>Adrenals</i>	1.467E-07				14	2.053E-06	
UB_Wall	1.467E-07			0.050			7.333E-09
Bone_Sur	9.014E-05			0.010			9.014E-07
<i>Brain</i>	1.467E-07				1400	2.053E-04	
Breasts	1.467E-07			0.050			7.333E-09
St_Wall	1.472E-07			0.120			1.767E-08
<i>SI_Wall</i>	1.481E-07				640	9.477E-05	
ULI_Wall	1.551E-07	0.570	8.838E-08				
LLI_Wall	1.719E-07	0.430	7.392E-08				
<i>Kidneys</i>	5.383E-07				310	1.669E-04	
Liver	1.944E-05			0.050			9.720E-07
ET1-bas	1.479E-07	0.001	1.479E-10				
ET2-bas	7.939E-05	0.998	7.923E-05				
LN-ET	1.441E-04	0.001	1.441E-07				
BBi-bas	5.960E-06	0.167	9.924E-07				
BBi-sec	6.497E-05	0.167	1.082E-05				
bbe-sec	3.332E-05	0.333	1.109E-05				
AI	7.062E-05	0.333	2.352E-05				
LN-Th	4.968E-04	0.001	4.968E-07				
<i>Muscle</i>	1.467E-07				28000	4.107E-03	
Ovaries	1.467E-07						
<i>Pancreas</i>	1.467E-07				100	1.467E-05	
R_Marrow	4.655E-06			0.120			5.586E-07
Skin	1.467E-07			0.010			1.467E-09
<i>Spleen</i>	1.467E-07				180	2.640E-05	
Testes	1.368E-06			0.200			2.736E-07
<i>Thymus</i>	1.467E-07				20	2.933E-06	
Thyroid	1.467E-07			0.050			7.333E-09
<i>Uterus</i>	1.467E-07				80	1.173E-05	
Composite Organs							
lungs	4.692E-05			0.120			5.630E-06
<i>ET</i>	7.937E-05				15		
colon	1.623E-07			0.120			1.948E-08
oesophagus	1.467E-07			0.050			7.333E-09
remainder	1.506E-07			0.050			7.528E-09
				1.000	30759	4.631E-03	
effective							8.411E-06

Dose Benchmark

	DCF (Sv/Bq)
LaBone	8.41E-06
Genmod	8.41E-06
ICRP	8.30E-06

Genmod uses SEEs from SEECAL

ICRP 30 vs ICRP 66/67: Which is Better?

- **Neither model gives “right” answer for a particular person, but on the average the new models are more “right.”**
 - ICRP 66/67 designed for evaluating bioassay data.
 - ICRP 66/67 designed to be “accurate” instead of “conservative.”
- **ICRP 66/67 is as complex as it has to be.**

Using New Models with Current Regulations

- **No regulations prohibit the use of the new respiratory tract and systemic models.**
 - 10CFR835 requires the use of ICRP 26 weighting factors.
 - DACs and ALIs are based on ICRP 30.
- **How to mix new with old**
 - ICRP 2 versus ICRP 30 mentality - been there, done that.
 - No guidance on mixing models.
 - Should I recalculate my historic doses?

ICRP 30

	Ht	A	A x Ht	Wt	Ht x Wt
Adrenals	1.467E-07				
UB_Wall	1.467E-07				
Bone_Sur	9.014E-05			0.03	2.704E-06
Brain	1.467E-07				
Breasts	1.467E-07			0.15	2.200E-08
St_Wall	1.472E-07				
SI_Wall	1.481E-07			0.06	8.885E-09
ULI_Wall	1.551E-07			0.06	9.303E-09
LLI_Wall	1.719E-07			0.06	1.031E-08
Kidneys	5.383E-07			0.06	3.230E-08
Liver	1.944E-05			0.06	1.166E-06
<i>ET1-bas</i>	1.479E-07	0.001	1.479E-10		
<i>ET2-bas</i>	7.939E-05	0.998	7.923E-05		
<i>LN-ET</i>	1.441E-04	0.001	1.441E-07		
<i>BBI-bas</i>	5.960E-06	0.167	9.924E-07		
<i>BBI-sec</i>	6.497E-05	0.167	1.082E-05		
<i>bbe-sec</i>	3.332E-05	0.333	1.109E-05		
<i>AI</i>	7.062E-05	0.333	2.352E-05		
<i>LN-Th</i>	4.968E-04	0.001	4.968E-07		
Muscle	1.467E-07				
Ovaries	1.467E-07				
Pancreas	1.467E-07				
R_Marrow	4.655E-06			0.12	5.586E-07
Skin	1.467E-07				
Spleen	1.467E-07				
Testes	1.368E-06			0.25	3.420E-07
Thymus	1.467E-07				
Thyroid	1.467E-07			0.03	4.400E-09
Uterus	1.467E-07				
Composite Organs					
lungs	4.692E-05			0.12	5.630E-06
effective				1.00	1.049E-05

Mixing Models for Plutonium

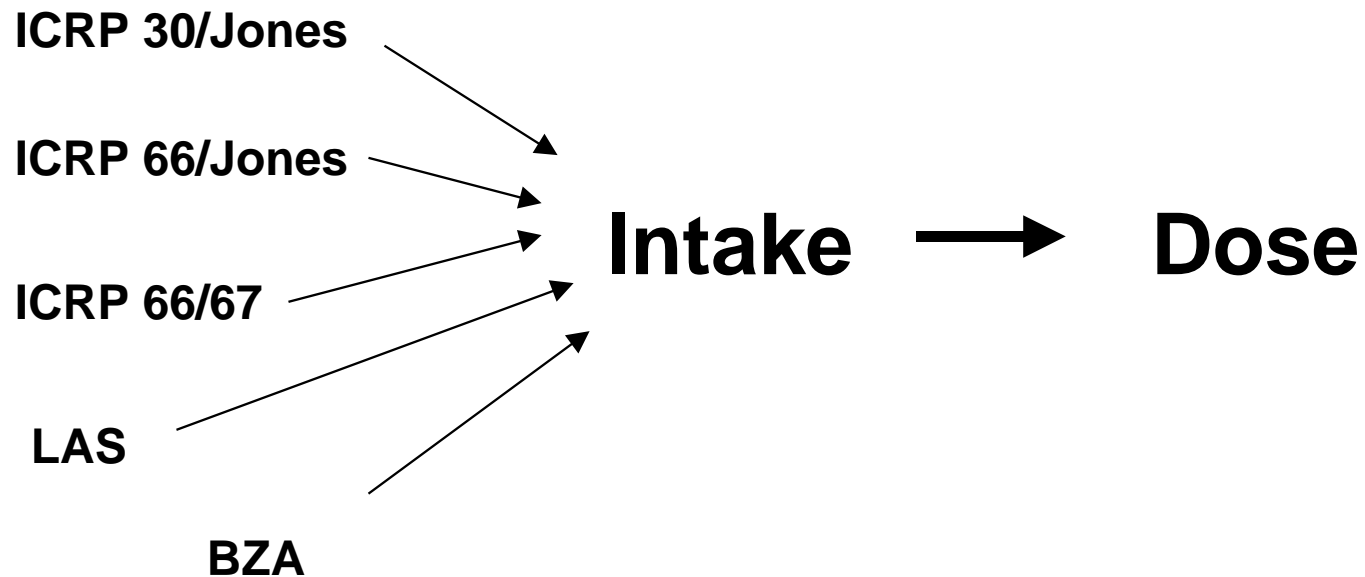

In-vitro Lung Solubility

- **Difficult to use with ICRP 30 lung model**
- **Readily adapted to F/M/S classifications of ICRP 66 lung model**
- **Practical application of in-vitro solubility data to ICRP 66 lung model discussed in ICRP 71**

Chelation Therapy

- **The ICRP 67 systemic model explicitly considers the plutonium content of the bloodstream, including recycling from systemic organs.**
- **This suggests a direct and rather simple method for modeling the urinary excretion of plutonium following chelation therapy.**
 - **Stop biokinetic model at time of chelation**
 - **Remove plutonium (chelate) that is in the blood compartment**
 - **Restart biokinetic model with new initial compartment contents**
 - **Add chelate excretion to normal plutonium excretion**

Simplified Model

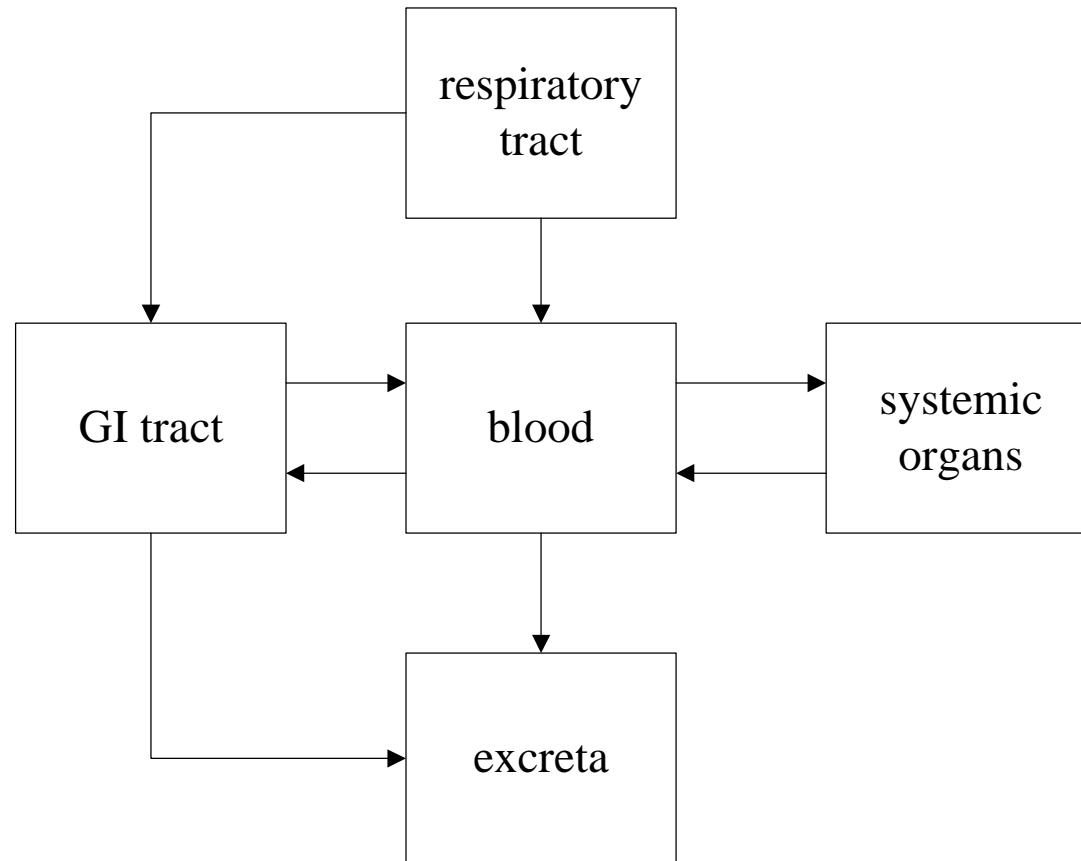

Initial Contents

	fraction		fraction
Compartment	0 days	Compartment	10 days
ET2	3.989E-01	feces	4.000E-01
ET1	3.385E-01	ENV	3.380E-01
AI2	3.191E-02	TAI2	2.700E-02
AI1	1.596E-02	TAI1	1.100E-02
BB1	1.171E-02	LIV1	9.000E-03
bb1	6.570E-03	TS	9.000E-03
BB2	5.920E-03	CS	6.000E-03
AI3	5.320E-03	TAI3	5.000E-03
bb2	4.380E-03	TBB2	4.000E-03
ETseq	2.000E-04	ST1	4.000E-03
BBseq	1.200E-04	Tbb2	3.000E-03
bbseq	7.721E-05	LLI	1.000E-03
feces	0.000E+00	blood	1.000E-03

Excretion Curve

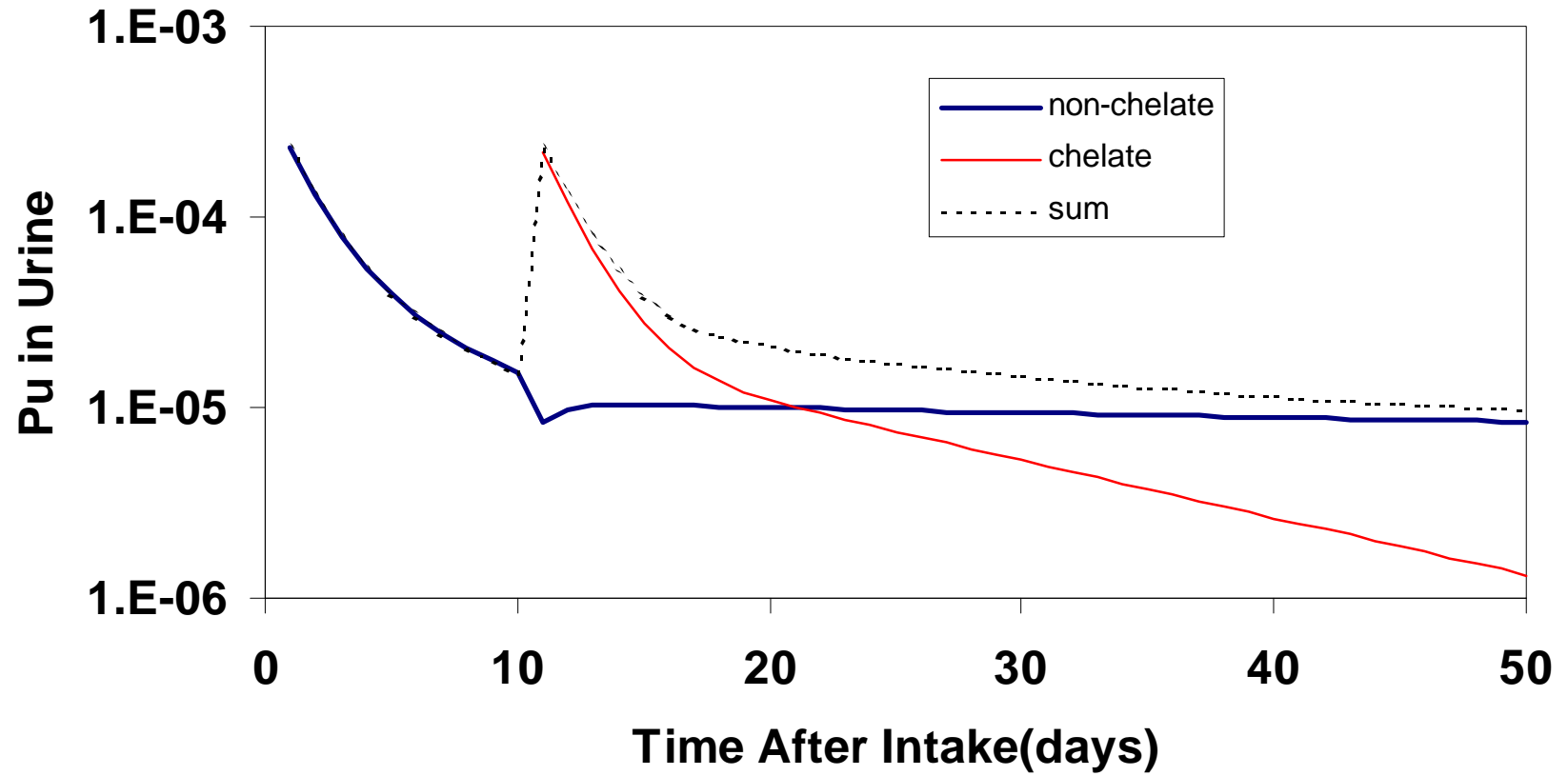

Acknowledgments

- **Keith Eckerman, ORNL**
- **Alan Birchall, NRPB**
- **Tony James, ACJ and Associates**
- **Ken Skrable, Retired**
- **Clay French, UML**
- **Gary Mansfield, LLNL**
- **Guthrie Miller, LANL**

Appendicies

1. Listing of Pascal code *LUNGDEP66* that calculates the deposition fractions for the ICRP 66 respiratory tract model.
2. Listing of the Mathcad worksheet *pu239sDecays* that calculates the decays that occur following an inhalation intake of 5.0 μm AMAD type S Pu-239.
3. Listing of the Mathcad worksheet *Functions* that is called by *pu239sDecays*.
4. Output of Genmod for inhalation intake of 5.0 μm AMAD type S Pu-239.
5. Output of ICRP CD for inhalation intake of 5.0 μm AMAD type S Pu-239.
6. Listing of the Mathcad worksheet *iodine* that illustrates the eigensystem and matrix exponential methods of solving systems of ordinary differential equations.

```

{SN+}
{SR+}
program lungdp66;
{
  Calculates the deposition in the five regions of the respiratory
  tract using the ICRP 66 respiratory tract model.  Written in
  Turbo Pascal V6.0.

  T. R. La Bone
  22 January 1998
}
uses wincrt;

const
  chi = 1.5; {particle shape factor}
  rho = 3.0; {density of particle}

type
  depo_record = record
    eta : double; {filtration efficiency for a region}
    phi : double; {fraction of air reaching a region}
    xi : double; {ratio of phi for two filters}
  DE : double; {deposition in a region}
  end;
  depo_type = (ae,th);
  depo_array = array[1..5] of double;

var
  ouf : text;
  dep : depo_array;
  sum : double;
  i,j : integer;
  BB1s,
  bb2s,
  amad,
  s,
  amtd,
  U,
  V,
  Vn,
  FRC,
  FRCL,
  VT,
  VDet,
  VDbb2,
  VDBB1,
  SFA,
  SFT,
  SFB : double;
  poly_deposition : depo_array; {deposition in five regions of RT}

  (*****)
function sexp( x:double ) : double;
{ Prevents runtime errors caused by exp underflowing. }
begin
  if x < -2000 then
    sexp := 0.0
  else
    sexp := exp(x);
end;

function rse( a,b:double ) : double;
{ Raises a to the b power. }
var
  sign : integer;
  c : double;
begin
  if (a > 0.0) then
    rse := sexp(b*ln(a))
  else if a = 0.0 then
    rse := 0
  else
    begin
      c := trunc(b);
      if b <> c then begin
        write('error in function rse');
        halt;
      end;
      if odd(trunc(b)) then sign := -1 else sign := 1;
      rse := sign*sexp(b*ln(abs(a)));
    end;
  end; {rse}

function log( x:double ) : double;
{ Calculates the common (base 10) logarithm of x. }
begin
  log := ln(x) / ln(10.0);
end; {log}

function alog( x:double ) : double;
{ Calculates 10 raised to the power of x. }
begin
  alog := sexp(x*ln(10));
end; {alog}

function c( d:double ) : double;
{ Slip correction factor, Equation D.6 in ICRP 66. }
begin
  c := 1.0 + 0.0683/d*(2.514+0.8*sexp(-0.55*d/0.0683));
end; {c}

procedure calc_diameter( var dt:double; da:double );
{ Calculates the thermodynamic diameter from the aerodynamic diameter,
  see Equation D.13 in ICRP 66. Uses Newton's method to find root. }
var
  new_dt,diff : double;
  function k_0( da,dt:double ) : double;
  begin
    k_0 := sqr(dt)*c(dt) - sqr(da)*c(da)*chi/rho;
  end;
  function k_1( dt:double ) : double;
  begin
    k_1 := 0.8*0.0683*sexp(-0.55*dt/0.0683) + 2.0*dt + 2.514*0.0683
      - 0.55*0.8*dt*sexp(-0.55*dt/0.0683);
  end;
begin
  dt := da;
  repeat
    new_dt := dt - k_0(da,dt) / k_1(dt);
    diff := abs(new_dt - dt)/new_dt;
    dt := new_dt;
  until diff < 1.0e-15;
end; {calc_diameter}

procedure nose_deposition(

```

```

var deposition : depo_array;
da,
dt,
U,
V,
Vn,
FRc,
VT,
Vdet,
Vdbb2,
VDBB1,
SFA,
SFT,
Sfb : double );
{
  The procedure nose_deposition calculates the deposition in the five
  regions of the respiratory track following an inhalation of a
  monodisperse particulate material through the nose.
}
var
depo : array[1..9] of depo_record;
eta,a,R,P : array[depo_type,1..9] of double;
i : integer;
V_Dbb2,
V_DBB1,
D,
P_sith,
tb1,
tb2,
ta : double;
begin
  for i := 1 to 5 do deposition[i] := 0.0;
  V_Dbb2 := Vdbb2 * (1 + VT/FRc);
  V_DBB1 := VDBB1 * (1 + VT/FRc);
  D := 1.38e-16*310*c(dt) / (3*Pi*1.88e-8*dt);
  P_sith := 1 + 100*sexp(-Sqr(log(100+10/rse(dt,0.9)))));
  tb1 := VDBB1/V * (1 + 0.5*VT/FRc);
  ta := (VT - Vdet - (VDBB1+V_Dbb2) * (1 + VT/FRc)) / V;
  tb2 := Vdbb2/V * (1 + 0.5*VT/FRc);
{ assign parameters from Table 1.2 of ICRP 66 }
  a[ae,1] := 3.0e-4;
  a[ae,2] := 5.5e-5;
  a[ae,3] := 4.08e-6;
  a[ae,4] := 0.1147;
  a[ae,5] := 0.146*rse(SFA,0.98);
  a[ae,6] := 0.1147;
  a[ae,7] := 2.04e-6;
  a[ae,8] := 5.5e-5;
  a[ae,9] := 3.0e-4;
  a[th,1] := 18.0;
  a[th,2] := 15.1;
  a[th,3] := 22.02*rse(SFT,1.24)*P_sith;
  a[th,4] := -76.8 + 167.0*rse(Sfb,0.65);
  a[th,5] := 170 + 103*rse(SFA,2.13);
  a[th,6] := -76.8 + 167.0*rse(Sfb,0.65);
  a[th,7] := 22.02*rse(SFT,1.24)*P_sith;
  a[th,8] := 15.1;
  a[th,9] := 18.0;
  R[ae,1] := Sqr(da)*Vn*rse(SFT,3);
  R[ae,2] := Sqr(da)*Vn*rse(SFT,3);
  R[ae,3] := Sqr(da)*V*rse(SFT,3);
  R[ae,4] := Sqr(da)*Vn*rse(SFT,3);
  R[ae,5] := Sqr(da)*Vn*rse(SFT,3);
  R[ae,6] := Sqr(da)*Vn*rse(SFT,3);
  R[ae,7] := Sqr(da)*Vn*rse(SFT,3);
  R[ae,8] := Sqr(da)*Vn*rse(SFT,3);
  R[ae,9] := Sqr(da)*Vn*rse(SFT,3);
  R[th,1] := D*rse(Vn*SFT,-0.25);
  R[th,2] := D*rse(Vn*SFT,-0.25);
  R[th,3] := D*tb1;
  R[th,4] := D*tb2;
  R[th,5] := D*ta;
  R[th,6] := D*tb2;
  R[th,7] := D*tb1;
  R[th,8] := D*rse(Vn*SFT,-0.25);
  R[th,9] := D*rse(Vn*SFT,-0.25);
  p[ae,1] := 1.0;
  p[ae,2] := 1.17;
  p[ae,3] := 1.152;
  p[ae,4] := 1.173;
  p[ae,5] := 0.6495;
  p[ae,6] := 1.173;
  p[ae,7] := 1.152;
  p[ae,8] := 1.17;
  p[ae,9] := 1.0;
  p[th,1] := 0.5;
  p[th,2] := 0.538;
  p[th,3] := 0.6391;
  p[th,4] := 0.5676;
  p[th,5] := 0.6101;
  p[th,6] := 0.5676;
  p[th,7] := 0.6391;
  p[th,8] := 0.538;
  p[th,9] := 0.5;
{ calculate phi, xi, and DE }
  depo[1].phi := 1.0;
  depo[2].phi := 1.0;
  depo[3].phi := 1 - Vdet/VT;
  depo[4].phi := 1 - (Vdet+V_DBB1)/VT;
  depo[5].phi := 1 - (Vdet+V_DBB1+V_Dbb2)/VT;
  depo[6].phi := depo[4].phi;
  depo[7].phi := depo[3].phi;
  depo[8].phi := depo[2].phi;
  depo[9].phi := depo[1].phi;
  eta[ae,1] := 0.5*(1-1/(a[ae,1]*rse(R[ae,1],p[ae,1])+1));
  eta[ae,2] := 1-1/(a[ae,2]*rse(R[ae,2],p[ae,2])+1);
  eta[ae,3] := 1 - sexp(-a[ae,3]*rse(R[ae,3],p[ae,3]));
  eta[ae,4] := 1 - sexp(-a[ae,4]*rse(R[ae,4],p[ae,4]));
  eta[ae,5] := 1 - sexp(-a[ae,5]*rse(R[ae,5],p[ae,5]));
  eta[ae,6] := eta[ae,4];
  eta[ae,7] := 1 - sexp(-a[ae,7]*rse(R[ae,7],p[ae,7]));
  eta[ae,8] := eta[ae,2];
  eta[ae,9] := eta[ae,1];
  eta[th,1] := 0.5*(1-sexp(-a[th,1]*rse(R[th,1],p[th,1])));
  eta[th,2] := 1 - sexp(-a[th,2]*rse(R[th,2],p[th,2]));
  eta[th,3] := 1 - sexp(-a[th,3]*rse(R[th,3],p[th,3]));
  eta[th,4] := 1 - sexp(-a[th,4]*rse(R[th,4],p[th,4]));
  eta[th,5] := 1 - sexp(-a[th,5]*rse(R[th,5],p[th,5]));
  eta[th,6] := eta[th,4];
  eta[th,7] := eta[th,3];
  eta[th,8] := eta[th,2];
}

```

```

eta[th,9] := eta[th,1];
depo[1].xi := 1.0;
for i := 2 to 9 do
  depo[i].xi := depo[i].phi / depo[i-1].phi;
for i := 1 to 9 do { Equation 10 }
  depo[i].eta := Sqrt( Sqr(eta[ae,i]) + Sqr(eta[th,i]));
depo[1].DE := depo[1].eta { Equation 8 }
  * ( 1 - 0.5*(1-1/(7.6e-4*rse(da,2.8)+1)) + 1e-5*rse(U,2.75)*sexp(0.055*da));
for i := 2 to 9 do
  depo[i].DE := depo[i-1].DE * depo[i].eta * depo[i].xi * (1/depo[i-1].eta - 1);
depo[1].DE := depo[1].DE + depo[9].DE;
depo[2].DE := depo[2].DE + depo[8].DE;
depo[3].DE := depo[3].DE + depo[7].DE;
depo[4].DE := depo[4].DE + depo[6].DE;
for i := 1 to 5 do
  depo[deposition[i]] := depo[i].DE;
end; {nose_deposition}

function integral( x,m,s:double ) : double;
{ Calculates integral of the normal PDF between -infinity and x,
  given x, the mean m, and the standard deviation s. }
var
  p,z,r : double;
begin
  z := (x-m)/s;
  r := 1/(1+0.2316419*abs(z));
  p := sexp(-z*z/2) * r*(0.319381530 + r*(-0.356563782 + r*(1.781477937
    + r*(-1.821255978 + r*1.330274429))) / sqrt(2*pi));
  if z > 0.0 then p := 1 - p;
  integral := p;
end; {integral}

procedure nose_polydeposition(
  var poly_deposition : depo_array;
  var BB1s : double;
  var bb2s : double;
  amad,
  amtd,
  s,
  U,
  V,
  Vh,
  FRC,
  VT,
  VDet,
  VDdb2,
  VDDB1,
  SFA,
  SFT,
  SFB : double );
{
  The procedure nose_polydeposition calculates the deposition in
  the five regions of the respiratory track following an inhalation
  of a polydisperse particulate material through the nose.
}
const
  number_increments = 500;
  z = 4.0;

```

```

var
  lower_limit,upper_limit,increment : double;
  da,dt,fs : double;
  prob : double;
  i,j : integer;
  deposition : depo_array;
begin
  BB1s := 0.0;
  bb2s := 0.0;
  lower_limit := ln(amad) - z*ln(s);
  upper_limit := ln(amad) + z*ln(s);
  increment := (upper_limit - lower_limit) / number_increments;
  for i := 1 to 5 do poly_deposition[i] := 0.0;
  for j := 1 to number_increments do begin
    prob := integral(lower_limit+increment,ln(amad),ln(s))
      - integral(lower_limit,ln(amad),ln(s));
    da := exp(lower_limit + increment/2);
    calc_diameter(dt,da);
    nose_deposition(deposition,da,dt,U,V,Vh,FRC,VT,VDdet,VDdb2,VDDB1,SFA,SFT,SFB);
    for j := 1 to 5 do
      poly_deposition[j] := poly_deposition[j] + prob*deposition[j];
    if da <= 2.5*sqrt(rho/chi) then
      fs := 0.5
    else
      fs := 0.5*sexp( -ln(2)/1.1*(dt-2.5));
    BB1s := BB1s + fs*prob*deposition[3];
    bb2s := bb2s + fs*prob*deposition[4];
    lower_limit := lower_limit + increment;
  end;
end; {nose_polydeposition }

procedure sigma_g( var s:double; amad,amtd:double );
{ Calculates the geometric standard deviation of a polydisperse aerosol,
  see Equation 16 of ICRP 66. }
begin
  if amad > 1.0 then
    s := 2.5
  else if amad < 0.0005 then
    s := 1.0
  else
    s := 1 + 1.5*(1- 1/(100*rse(amtd,1.5)+1));
end; {sigma_g}

(*****)

begin
  clrscr;
  {for light exercise}
  V := 833.0;
  Vh := V;
  VT := 1250.0;

  amad := 5.0;
  U := 0.0;
  FRC := 3301.0;
  VDet := 50.0;
  VDdb2 := 47.0;
  VDDB1 := 49.0;
  SFA := 1.0;
  SFT := 1.0;
  SFB := 1.0;

```

```

calc_diameter(amt_d,amad);
sigma_g(s,amad,amt_d);

for i := 1 to 5 do poly_deposition[i] := 0.0;
nose_polydeposition(dep,BE1s,bb2s,amad,amt_d,s,U,V,Vn,FRC,VT,VDet,VDbb2
,VDBB1,SFA,SFT,SFB);
for i := 1 to 5 do poly_deposition[i] := dep[i];

writeln('ET1 : ',(100*poly_deposition[1]):12:2);
writeln('ET2 : ',(100*poly_deposition[2]):12:2);
writeln('BB : ',(100*poly_deposition[3]):12:2);
writeln('bb : ',(100*poly_deposition[4]):12:2);
writeln('AI : ',(100*poly_deposition[5]):12:2);

sum := 0.0;
for i := 1 to 5 do
  sum := sum + poly_deposition[i];
writeln('Sum : ',100*sum:12:2);
writeln;
writeln('Fs BB : ',(BE1s/poly_deposition[3]):12:5);
writeln('Fs bb : ',(bb2s/poly_deposition[4]):12:5);

assign(ouf,'lungdp66.out');
rewrite(ouf);
writeln(ouf,'ET1 : ',(100*poly_deposition[1]):12:2);
writeln(ouf,'ET2 : ',(100*poly_deposition[2]):12:2);
writeln(ouf,'BB : ',(100*poly_deposition[3]):12:2);
writeln(ouf,'bb : ',(100*poly_deposition[4]):12:2);
writeln(ouf,'AI : ',(100*poly_deposition[5]):12:2);
writeln(ouf,'Sum : ',100*sum:12:2);
writeln(ouf);
writeln(ouf,'Fs BB : ',(BE1s/poly_deposition[3]):12:5);
writeln(ouf,'Fs bb : ',(bb2s/poly_deposition[4]):12:5);
close(ouf);

end.

```

Dose from an inhalation intake of 5 μm Type S plutonium-239 using the ICRP 66 lung model and ICRP 67 systemic model. Written in Mathcad 2000 and Excel 97.

T. R. La Bone

1.0 Define global variables.

$$\lambda \equiv \frac{\ln(2)}{(8.7837 \cdot 10^6)} \text{Radioactive decay constant for Pu-239.}$$

ORIGIN \equiv 1 Defines arrays to begin with the 1,1 element.

T₁ \equiv 0 T₂ \equiv 50.365 Times in days for calculating decays.

 Reference:D:\PROJECTS\ABHP Course\functions.mcd(R)

2.0 The compartments in the model are assigned numbers to clarify their use in the arrays to be defined.

Respiratory tract compartments.

AI1 := 1 bb1 := 4 BB1 := 7 ET2 := 10 LNet := 13
AI2 := 2 bb2 := 5 BB2 := 8 ETseq := 11 LNth := 14
AI3 := 3 bbseq := 6 BBseq := 9 ET1 := 12

Transformed respiratory tract compartments.

TAI1 := 15 Tbb1 := 18 TBB1 := 21 TET2 := 24 TLNth := 27
TAI2 := 16 Tbb2 := 19 TBB2 := 22 TETseq := 25
TAI3 := 17 Tbbseq := 20 TBBseq := 23 TLNet := 26

GI tract compartments and feces.

S := 28 SI := 29 ULI := 30 LLI := 31

Systemic compartments of the ICRP 67 plutonium model.

blood := 32 ST0 := 35 CV := 38 TV := 41 OKT := 44 nads := 47 feces := 49
LIV1 := 33 ST1 := 36 CS := 39 TS := 42 UP := 45 ENV := 48 urine := 50
LIV2 := 34 ST2 := 37 CM := 40 TM := 43 UBC := 46

4.0 Initial content of the compartments for an aerosol whose AMAD is defined later in the spreadsheet . Any content not explicitly given has a value of zero.

$$AMAD \equiv 5$$

$$D := \text{Depo}(AMAD)$$

$$i := AI1..ET1$$

$$q0_i := D_i$$

$$q0_{\text{urine}} := 0$$

5.0 Define rate constants. All rate constants are in units of 1/days.

Absorption rate constants Type S material in units of 1/days. Defaults are $f_r=0.001$, $s_r=100$, $s_s=0.0001$.

$$f_r \equiv 0.001$$

$$s_r \equiv 100$$

$$s_s \equiv 0.0001$$

$$s_p := s_s + f_r \cdot (s_r - s_s)$$

$$s_{pt} := (1 - f_r) \cdot (s_r - s_s)$$

$$s_t := s_s$$

$$s_p = 0.10010$$

$$s_{pt} = 99.89990$$

$$s_t = 0.00010$$

Define transfer rate constants for the respiratory tract compartments.

$$k_{\text{urine, urine}} := 0$$

$$k_{AI1, bb1} := 0.02$$

$$k_{bb2, BB1} := 0.03$$

$$k_{ETseq, LNet} := 0.001$$

$$k_{AI1, blood} := s_p$$

$$k_{bb2, blood} := s_p$$

$$k_{ETseq, blood} := s_p$$

$$k_{AI1, TAI1} := s_{pt}$$

$$k_{bb2, Tbb2} := s_{pt}$$

$$k_{ETseq, TETseq} := s_{pt}$$

$$k_{AI2, bb1} := 0.001$$

$$k_{BB1, ET2} := 10$$

$$k_{BBseq, LNth} := 0.01$$

$$k_{AI2, blood} := s_p$$

$$k_{BB1, blood} := s_p$$

$$k_{BBseq, blood} := s_p$$

$$k_{AI2, TAI2} := s_{pt}$$

$$k_{BB1, TBB1} := s_{pt}$$

$$k_{BBseq, TBBseq} := s_{pt}$$

$$k_{AI3, bb1} := 0.0001$$

$$k_{BB2, ET2} := 0.03$$

$$k_{bbseq, LNth} := 0.01$$

$$k_{AI3, LNth} := 0.00002$$

$$k_{BB2, blood} := s_p$$

$$k_{bbseq, blood} := s_p$$

$$\begin{array}{lll}
 k_{AI3, \text{blood}} := s_p & k_{BB2, TBB2} := s_{pt} & k_{bbseq, Tbbseq} := s_{pt} \\
 k_{AI3, TAI3} := s_{pt} & k_{ET2, S} := 100 & k_{LNth, TLNth} := s_{pt} \\
 k_{bb1, BB1} := 2 & k_{ET2, \text{blood}} := s_p & k_{LNet, \text{blood}} := s_p \\
 k_{bb1, \text{blood}} := s_p & k_{ET2, TET2} := s_{pt} & k_{LNet, TLNet} := s_{pt} \\
 k_{bb1, Tbb1} := s_{pt} & k_{ET1, ENV} := 1 & k_{LNth, \text{blood}} := s_p
 \end{array}$$

Define transfer rate constants for the transformed respiratory tract compartments.

$$\begin{array}{ll}
 k_{TAI1, Tbb1} := k_{AI1, bb1} & k_{TBB2, TET2} := k_{BB2, ET2} \\
 k_{TAI1, \text{blood}} := s_t & k_{TBB2, \text{blood}} := s_t \\
 k_{TAI2, Tbb1} := k_{AI2, bb1} & k_{TET2, S} := k_{ET2, S} \\
 k_{TAI2, \text{blood}} := s_t & k_{TET2, \text{blood}} := s_t \\
 k_{TAI3, Tbb1} := k_{AI3, bb1} & k_{TETseq, TLNet} := k_{ETseq, LNet} \\
 k_{TAI3, TLNth} := k_{AI3, LNth} & k_{TETseq, \text{blood}} := s_t \\
 k_{TAI3, \text{blood}} := s_t & k_{TBBseq, TLNth} := k_{BBseq, LNth} \\
 k_{Tbb1, TBB1} := k_{bb1, BB1} & k_{TBBseq, \text{blood}} := s_t \\
 k_{Tbb1, \text{blood}} := s_t & k_{Tbbseq, TLNth} := k_{bbseq, LNth} \\
 k_{Tbb2, TBB1} := k_{bb2, BB1} & k_{Tbbseq, \text{blood}} := s_t \\
 k_{Tbb2, \text{blood}} := s_t & k_{TLNet, \text{blood}} := s_t \\
 k_{TBB1, TET2} := k_{BB1, ET2} & k_{TLNth, \text{blood}} := s_t \\
 k_{TBB1, \text{blood}} := s_t &
 \end{array}$$

Define transfer rate constants for the systemic compartments.

$$\begin{array}{lll}
 k_{\text{blood}, LIV1} := 0.1941 & k_{\text{blood}, ST2} := 0.0129 & k_{CS, CM} := 0.0000821 \\
 k_{\text{blood}, CS} := 0.1294 & k_{ST0, \text{blood}} := 0.693 & k_{TV, TM} := 0.000493 \\
 k_{\text{blood}, TS} := 0.1941 & k_{UP, UBC} := 0.01386 & k_{CV, CM} := 0.0000821
 \end{array}$$

$$\begin{array}{lll}
 k_{\text{blood, UBC}} := 0.0129 & k_{\text{OKT, blood}} := 0.00139 & k_{\text{CM, blood}} := 0.0076 \\
 k_{\text{blood, UP}} := 0.00647 & k_{\text{ST1, blood}} := 0.000475 & k_{\text{TM, blood}} := 0.0076 \\
 k_{\text{blood, OKT}} := 0.00323 & k_{\text{ST1, UBC}} := 0.000475 & k_{\text{LIV1, LIV2}} := 0.00177 \\
 k_{\text{blood, ULI}} := 0.0129 & k_{\text{ST2, blood}} := 0.000019 & k_{\text{LIV1, SI}} := 0.000133 \\
 k_{\text{blood, nads}} := 0.00023 & k_{\text{TS, TV}} := 0.000247 & k_{\text{LIV2, blood}} := 0.000211 \\
 k_{\text{blood, ST0}} := 0.2773 & k_{\text{TS, TM}} := 0.000493 & k_{\text{nads, blood}} := 0.00019 \\
 k_{\text{blood, ST1}} := 0.0806 & k_{\text{CS, CV}} := 0.0000411 & k_{\text{UBC, urine}} := 12
 \end{array}$$

Define transfer rate constants for the GI tract.

$$\begin{array}{lll}
 f_1 := 1 \cdot 10^{-5} & k_{\text{S, SI}} := 24 & k_{\text{SI, ULI}} := 6 \\
 k_{\text{SI, blood}} := \frac{k_{\text{SI, ULI}} \cdot f_1}{1 - f_1} & k_{\text{ULI, LLI}} := \frac{24}{13} & k_{\text{LLI, feces}} := 1
 \end{array}$$

Define total removal rate constants.

$$k := \text{total}(k, \lambda)$$

6.0 Calculate eigenvalues, eigenvectors, and coefficients.

$$e := \text{eigenvals}(k^T)$$

$$C := \text{coeff}(k, q_0)$$

7.0 Calculate retention functions.

$$q_{\text{all}}(t) := \sum_{j = \text{All}}^{\text{urine}} \sum_{i = \text{All}}^{\text{urine}} C_{j,i} \cdot \exp(e_i \cdot t)$$

This function defines the content of the entire biokinetic system.

If everything goes OK, what goes into the system $\sum_{i=AI1}^{urine} q0_i = 0.8195741$

should equal the material that is in the system $q_{all}(0) = 0.8195741$

8.0 Calculate decays in each source organ for 50 years after the intake.

sET1sur := 12 sBBgel := 16 sbbgel := 19 sAI := 22 sRM := 24 sOther := 27
sET2sur := 13 sBBsol := 17 sbsol := 20 sLNth := 23 sNads := 25 sUBcont := 1
sET2seq := 14 sBBseq := 18 sbbseq := 21 sBlood := 26
sLNet := 15

sCS := 2 sS := 6 sKidney := 10
sCV := 3 sSI := 7 sLiver := 11
sTS := 4 sULI := 8
sTV := 5 sLLI := 9

Decays(x) := $\left\{ \begin{array}{l} s \leftarrow 0 \\ \text{for } j \in AI1..urine \\ s \leftarrow s - \frac{C_{x,j}}{e_j} \cdot (\exp(e_j \cdot T_1) - \exp(e_j \cdot T_2)) \text{ if } |C_{x,j}| > 0 \\ \text{Decays} \leftarrow s \cdot 24 \cdot 3600 \end{array} \right.$

$U_{sET1sur} := \text{Decays}(ET1)$

$U_{sET2sur} := \text{Decays}(ET2) + \text{Decays}(TET2)$

$U_{sET2seq} := \text{Decays}(ETseq) + \text{Decays}(TETseq)$

$U_{sBBsol} := \text{Decays}(BB2) + \text{Decays}(TBB2)$

$U_{sBBgel} := \text{Decays}(BB1) + \text{Decays}(TBB1)$

$U_{sBBseq} := \text{Decays}(BBseq) + \text{Decays}(TBBseq)$

$$U_{\text{sbbSol}} := \text{Decays}(\text{bb2}) + \text{Decays}(\text{Tbb2})$$

$$U_{\text{sbbGel}} := \text{Decays}(\text{bb1}) + \text{Decays}(\text{Tbb1})$$

$$U_{\text{sbbSeq}} := \text{Decays}(\text{bbseq}) + \text{Decays}(\text{Tbbseq})$$

$$U_{\text{sAI}} := \text{Decays}(\text{AI1}) + \text{Decays}(\text{TAI1}) + \text{Decays}(\text{AI2}) + \text{Decays}(\text{TAI2}) + \text{Decays}(\text{AI3}) + \text{Decays}(\text{TAI3})$$

$$U_{\text{sLNet}} := \text{Decays}(\text{LNet}) + \text{Decays}(\text{TLNet})$$

$$U_{\text{sLNth}} := \text{Decays}(\text{LNth}) + \text{Decays}(\text{TLNth})$$

$$U_{\text{sS}} := \text{Decays}(\text{S})$$

$$U_{\text{sSI}} := \text{Decays}(\text{SI})$$

$$U_{\text{sULI}} := \text{Decays}(\text{ULI})$$

$$U_{\text{sLLI}} := \text{Decays}(\text{LLI})$$

$$U_{\text{sBlood}} := \text{Decays}(\text{blood})$$

$$U_{\text{sOther}} := \text{Decays}(\text{ST0}) + \text{Decays}(\text{ST1}) + \text{Decays}(\text{ST2})$$

$$U_{\text{sLiver}} := \text{Decays}(\text{LIV1}) + \text{Decays}(\text{LIV2})$$

$$U_{\text{sCV}} := \text{Decays}(\text{CV})$$

$$U_{\text{sCS}} := \text{Decays}(\text{CS})$$

$$U_{\text{sRM}} := \text{Decays}(\text{TM})$$

$$U_{\text{sTV}} := \text{Decays}(\text{TV})$$

$$U_{\text{sTS}} := \text{Decays}(\text{TS})$$

$$U_{\text{sKidney}} := \text{Decays}(\text{OKT}) + \text{Decays}(\text{UP})$$

$$U_{\text{sUBcont}} := \text{Decays}(\text{UBC})$$

$$U_{\text{sNads}} := \text{Decays}(\text{nads})$$

Breakdown of decays in organs and tissues

$U_{sET1sur} = 29246.398$	$U_{sLLI} = 41059.948$
$U_{sET2sur} = 409.909$	$U_{sBlood} = 2647.784$
$U_{sET2seq} = 15660.872$	$U_{sOther} = 555637.581$
$U_{sBBsol} = 16978.792$	$U_{sLiver} = 2069967.044$
$U_{sBBgel} = 603.392$	$U_{sCV} = 433156.513$
$U_{sBBseq} = 1062.247$	$U_{sCS} = 1900138.691$
$U_{sbbsol} = 12571.360$	$U_{sRM} = 62480.379$
$U_{sbbgel} = 2323.014$	$U_{sTV} = 305764.877$
$U_{sbbseq} = 659.824$	$U_{sTS} = 662270.350$
$U_{sAI} = 4620729.120$	$U_{sKidney} = 7236.970$
$U_{sLNet} = 128772.180$	$U_{sUBcont} = 12.844$
$U_{sLNth} = 444159.826$	$U_{sNads} = 2548.309$
$U_{sS} = 1707.955$	
$U_{sSI} = 6837.634$	
$U_{sULI} = 22240.809$	

The following table is an embedded MS Excel 97 spreadsheet. The decays in organs and tissues are in array U. This array is passed to the spreadsheet where it is used with the appropriate SEEs to calculate dose to each organ and tissue. The SEEs were calculated with the ORNL code SEECAL. You can open the spreadsheet and scroll to view the SEE tables. Finally, the organ and tissue doses are weighted and summed to give the committed effective dose.

	Ht	A	A x Ht	Wt	Mass (g)	Ht x Mass	Ht x Wt
<i>Adrenals</i>	1.47E-07				14	2.05E-06	
UB_Wall	1.47E-07			0.050			7.33E-09
Bone_Sur	9.01E-05			0.010			9.01E-07
<i>Brain</i>	1.47E-07				1400	2.05E-04	
Breasts	1.47E-07			0.050			7.33E-09
St_Wall	1.47E-07			0.120			1.77E-08
<i>SI_Wall</i>	1.48E-07				640	9.48E-05	
ULI_Wall	1.55E-07	0.570	8.84E-08				
LLI_Wall	1.72E-07	0.430	7.39E-08				
<i>Kidneys</i>	5.38E-07				310	1.67E-04	
Liver	1.94E-05			0.050			9.72E-07
ET1-bas	1.48E-07	0.001	1.48E-10				
ET2-bas	7.94E-05	0.998	7.92E-05				
LN-ET	1.44E-04	0.001	1.44E-07				
BBI-bas	5.96E-06	0.167	9.93E-07				
BBI-sec	6.50E-05	0.167	1.08E-05				
bbe-sec	3.33E-05	0.333	1.11E-05				
Al	7.06E-05	0.333	2.35E-05				
LN-Th	4.97E-04	0.001	4.97E-07				
<i>Muscle</i>	1.47E-07				28000	4.11E-03	
Ovaries	1.47E-07						
<i>Pancreas</i>	1.47E-07				100	1.47E-05	
R_Marrow	4.65E-06			0.120			5.59E-07
Skin	1.47E-07			0.010			1.47E-09
<i>Spleen</i>	1.47E-07				180	2.64E-05	
Testes	1.37E-06			0.200			2.74E-07
<i>Thymus</i>	1.47E-07				20	2.93E-06	
Thyroid	1.47E-07			0.050			7.33E-09
<i>Uterus</i>	1.47E-07				80	1.17E-05	
Composite Organs							
lungs	4.69E-05			0.120			5.63E-06
<i>ET</i>	7.94E-05				15	1.19E-03	
colon	1.62E-07			0.120			1.95E-08
esophagus	1.47E-07			0.050			7.33E-09
remainder	1.89E-07			0.050			9.46E-09
				1.000	30759	5.82E-03	
effective							8.41E-06

U^T

ORIGIN=1 Defines arrays to begin with the 1,1 element.

Calculate the coefficients and rate constants for the retention functions.

coeff(k, q0) :=
$$\left. \begin{array}{l} V \leftarrow \text{eigenvecs}(k^T) \\ M \leftarrow \text{lsolve}(V, q0) \\ \text{for } j \in 1.. \text{cols}(k) \\ \quad \text{for } i \in 1.. \text{cols}(k) \\ \quad \quad C_{i,j} \leftarrow V_{i,j} \cdot M_j \\ C \end{array} \right|$$
 This approach to solving systems of ODEs is discussed in many textbooks. 'The Linear Algebra Problem Solver' by the Research and Education Association, 1980, gives excellent examples and discussion of the method (see problems 18-6 through 18-11).

Calculate the total removal rate constants

total(k, λ) :=
$$\left. \begin{array}{l} K \leftarrow k \\ \text{for } \text{comp} \in 1.. \text{cols}(k) \\ \quad \left. \begin{array}{l} K_{\text{comp}, \text{comp}} \leftarrow 0 \\ \text{for } j \in 1.. \text{cols}(k) \\ \quad K_{\text{comp}, \text{comp}} \leftarrow K_{\text{comp}, \text{comp}} + k_{\text{comp}, j} \quad \text{if } \text{comp} \neq j \\ K_{\text{comp}, \text{comp}} \leftarrow - (K_{\text{comp}, \text{comp}} + \lambda) \end{array} \right| \\ K \end{array} \right|$$

Deposition fractions from the ICRP CD-Rom for AMADs in the range of 0.001 to 10 microns. Uses the ICRP 66 respiratory tract model.

D :=

	0.001	0.003	0.01	0.03	0.1	0.3
AI1	1.359E-04	6.714E-03	8.229E-02	1.525E-01	8.688E-02	4.458E-02
AI2	2.718E-04	1.343E-02	1.646E-01	3.051E-01	1.738E-01	8.916E-02
AI3	4.530E-05	2.238E-03	2.743E-02	5.085E-02	2.896E-02	1.486E-02
bbf	2.262E-02	8.770E-02	1.291E-01	7.188E-02	3.328E-02	1.523E-02
bbs	2.294E-02	8.895E-02	1.309E-01	7.290E-02	3.376E-02	1.544E-02
bbseq	3.212E-04	1.245E-03	1.833E-03	1.021E-03	4.726E-04	2.162E-04
BBf	3.117E-02	4.420E-02	2.685E-02	1.035E-02	4.746E-03	3.260E-03
BBs	3.161E-02	4.483E-02	2.723E-02	1.049E-02	4.813E-03	3.293E-03
BBseq	4.425E-04	6.276E-04	3.812E-04	1.469E-04	6.738E-05	4.619E-05
ET2	4.390E-01	3.494E-01	1.735E-01	6.994E-02	3.218E-02	5.820E-02
ETseq	2.196E-04	1.748E-04	8.680E-05	3.499E-05	1.610E-05	2.912E-05
ET1	4.433E-01	3.327E-01	1.539E-01	6.248E-02	3.071E-02	5.217E-02

Interpolate deposition fractions in the range of 0.001 to 10 microns.

$$\text{Depo}(\text{AMAD}) := \left\{ \begin{array}{l} \text{for } i \in 2..13 \\ \text{Depo}_i \leftarrow \text{interp}\left[\left(D^T\right)^{\langle 1 \rangle}, \left(D^T\right)^{\langle i \rangle}, \text{AMAD}\right] \\ \text{Depo} \end{array} \right.$$

Appendix 4

Committed Dose.

```

<none>
Pu239 (T½=8.7837e+06 d)
Adult Male
Acute Inhalation of 1 Bq of type Slow material.
ICRP 66 Lung Model
  Occupational, Standard Worker
  Breathing: Nasal augmenter
  ParticleSize: 5µm AMAD
  sigmaG: 2.5, Density: 3, ShapeFactor=1.5
Eves' Gut Model
  f1: 1e-05
ICRP 67 Plutonium Model
  
```

Specified Targets	w(t)	Equivalent Dose (Sv)
Gonads	0.20	1.37e-06
Colon	0.12	1.62e-07
Lung	0.12	4.68e-05
Oesophag	0.05	1.47e-07
St_Wall	0.12	1.47e-07
R_Marrow	0.12	4.65e-06
UB_Wall	0.05	1.47e-07
Breasts	0.05	1.47e-07
Liver	0.05	1.94e-05
Thyroid	0.05	1.47e-07
Skin	0.01	1.47e-07
Bone_Sur	0.01	9.10e-05

Remainder Target	w(t)	Equivalent Dose (Sv)
ExtraTH		7.93e-05
Remainder	0.050	9.52e-09

Effective Dose (Sv)

8.41e-06

Appendix 5

Pu-239, adult worker
 Inhalation of particulate aerosol: AMAD = 5.000 micron, absorption Type S, f1 = 0.00001
 Highest committed equivalent dose coefficient: Bone Surface, 9.1E-05 Sv/Bq
 Remainder formulation: default

	1 day	7 days	30 days	1 year	5 years	10 years	20 years	30 years	45 years	50 years
Time after intake										
Adrenals	4.8E-12	1.9E-11	5.6E-11	1.2E-09	1.2E-08	2.6E-08	5.5E-08	8.6E-08	1.4E-07	1.5E-07
Bladder Wall	4.8E-12	1.9E-11	5.6E-11	1.2E-09	1.2E-08	2.6E-08	5.5E-08	8.6E-08	1.4E-07	1.5E-07
Bone Surface	1.1E-10	2.3E-09	1.5E-08	5.2E-07	5.9E-06	1.5E-05	3.4E-05	8.2E-05	9.1E-05	9.1E-05
Brain	4.8E-12	1.9E-11	5.6E-11	1.2E-09	1.2E-08	2.6E-08	5.5E-08	8.6E-08	1.4E-07	1.5E-07
Breast	4.8E-12	1.9E-11	5.6E-11	1.2E-09	1.2E-08	2.6E-08	5.5E-08	8.6E-08	1.4E-07	1.5E-07
GI-Tract										
Oesophagus	4.8E-12	1.9E-11	5.6E-11	1.2E-09	1.2E-08	2.6E-08	5.5E-08	8.6E-08	1.4E-07	1.5E-07
St Wall	5.0E-10	5.2E-10	5.7E-10	1.8E-09	1.2E-08	2.6E-08	5.5E-08	8.6E-08	1.4E-07	1.5E-07
SI Wall	1.2E-09	1.3E-09	1.3E-09	2.6E-09	1.3E-08	2.7E-08	5.6E-08	8.7E-08	1.4E-07	1.6E-07
ULI Wall	5.5E-09	7.6E-09	7.8E-09	9.4E-09	2.0E-08	3.4E-08	6.3E-08	9.4E-08	1.4E-07	1.6E-07
LLI Wall	6.1E-09	2.2E-08	2.3E-08	2.5E-08	3.6E-08	5.1E-08	8.0E-08	1.1E-07	1.6E-07	1.8E-07
Colon	5.8E-09	1.4E-08	1.4E-08	1.6E-08	2.7E-08	4.2E-08	7.0E-08	1.0E-07	1.5E-07	1.7E-07
Kidneys	8.8E-12	1.1E-10	6.4E-10	1.2E-08	7.1E-08	1.3E-07	2.1E-07	2.8E-07	3.6E-07	3.9E-07
Liver	2.1E-11	3.7E-10	2.4E-09	8.6E-08	1.1E-06	3.0E-06	7.4E-06	1.2E-05	1.7E-05	1.9E-05
Muscle	4.8E-12	1.9E-11	5.6E-11	1.2E-09	1.2E-08	2.6E-08	5.5E-08	8.6E-08	1.4E-07	1.5E-07
Ovaries	5.1E-12	3.2E-11	1.6E-10	5.2E-09	6.6E-08	1.8E-07	4.5E-07	7.1E-07	1.1E-06	1.2E-06
Pancreas	4.8E-12	1.9E-11	5.6E-11	1.2E-09	1.2E-08	2.6E-08	5.5E-08	8.6E-08	1.4E-07	1.5E-07
Red Marrow	1.4E-11	2.3E-10	1.5E-09	5.1E-08	5.4E-07	1.2E-06	2.3E-06	3.1E-06	4.2E-06	4.5E-06
Respiratory Tract										
ET Airways	8.8E-08	6.1E-07	2.6E-06	2.6E-05	6.9E-05	7.8E-05	8.0E-05	8.0E-05	8.0E-05	8.0E-05
Lungs	8.3E-07	4.2E-06	1.3E-05	2.7E-05	3.7E-05	4.1E-05	4.4E-05	4.6E-05	4.7E-05	4.7E-05
Skin	4.8E-12	1.9E-11	5.6E-11	1.2E-09	1.2E-08	2.6E-08	5.5E-08	8.6E-08	1.4E-07	1.5E-07
Spleen	4.8E-12	1.9E-11	5.6E-11	1.2E-09	1.2E-08	2.6E-08	5.5E-08	8.6E-08	1.4E-07	1.5E-07
Testes	5.0E-12	3.2E-11	1.6E-10	5.3E-09	6.7E-08	1.8E-07	4.5E-07	7.2E-07	1.1E-06	1.2E-06
Thymus	4.8E-12	1.9E-11	5.6E-11	1.2E-09	1.2E-08	2.6E-08	5.5E-08	8.6E-08	1.4E-07	1.5E-07
Thyroid	4.8E-12	1.9E-11	5.6E-11	1.2E-09	1.2E-08	2.6E-08	5.5E-08	8.6E-08	1.4E-07	1.5E-07
Uterus	4.8E-12	1.9E-11	5.6E-11	1.2E-09	1.2E-08	2.6E-08	5.5E-08	8.6E-08	1.4E-07	1.5E-07
Remainder	7.4E-11	3.4E-10	1.3E-09	1.4E-08	4.6E-08	6.5E-08	9.5E-08	1.3E-07	1.8E-07	2.0E-07
Effective dose	1.0E-07	5.0E-07	1.5E-06	3.2E-06	4.6E-06	5.4E-06	6.4E-06	7.2E-06	8.0E-06	8.3E-06

ICRP 30 Biokinetic Model for Iodine-125 solved by eigensystem (es) and matrix exponential (me) methods.

T. R. La Bone

Define biokinetic model for iodine-125.

ORIGIN \equiv 1

blood := 1

thyroid := 2

other := 3

feces := 4

urine := 5

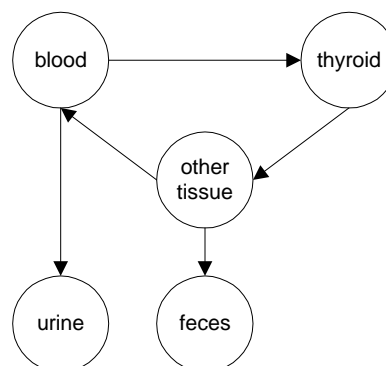

$$\lambda := \frac{\ln(2)}{60}$$

$$k_{\text{blood, thyroid}} := 0.33 \cdot \frac{\ln(2)}{0.25}$$

$$k_{\text{other, feces}} := 0.1 \cdot \frac{\ln(2)}{12}$$

$$k_{\text{blood, urine}} := 0.67 \cdot \frac{\ln(2)}{0.25}$$

$$k_{\text{other, blood}} := 0.9 \cdot \frac{\ln(2)}{12}$$

$$k_{\text{blood, blood}} := -(k_{\text{blood, thyroid}} + k_{\text{blood, urine}} + \lambda)$$

$$k_{\text{thyroid, other}} := \frac{\ln(2)}{80}$$

$$k_{\text{other, other}} := -(k_{\text{other, blood}} + k_{\text{other, feces}} + \lambda)$$

$$k_{\text{thyroid, thyroid}} := -(\lambda + k_{\text{thyroid, other}})$$

$$q0_{\text{urine}} := 0$$

$$k_{\text{urine, urine}} := -\lambda$$

$$q0_{\text{blood}} := 1.0$$

$$k_{\text{feces, feces}} := -\lambda$$

Calculate eigensystem (es) and define retention functions as described by G. G. Killough and K. F. Eckerman in "A Conversational Eigenanalysis Program for Solving Differential Equations," in Computer Applications in Health Physics, Proceedings of the Seventeenth Midyear Topical Symposium of the Health Physics Society, 1984.

```
e := eigenvals(kT)
V := eigenvecs(kT)
M := lsolve(V, q0)

c := | for j ∈ blood.. urine
      |   for i ∈ blood.. urine
      |     ci,j ← Vi,j·Mj
      | c

qes(t, comp) := ∑i = bloodurine ccomp,i·exp(ei·t)
```

Define functions for matrix exponential (me) as described by A. Birchall and A. C. James "A Microcomputer Algorithm for Solving First-Order Compartmental Models Involving Recycling," Health Physics (56), pp 857-868, 1989.

```
taylor(A) := | sum ← identity(rows(A))
              | term ← identity(rows(A))
              | i ← 1
              | while  $\frac{\max(\text{term})}{\max(\text{sum})} > 10^{-9}$ 
              |   | term ← term· $\frac{A}{i}$ 
              |   | sum ← sum + term
              |   | i ← i + 1
              | sum
```

calculate Taylor series expansion of the matrix exponential

$\text{MatrixExp}(k) := \left\{ \begin{array}{l} \text{MaxNum} \leftarrow |\min(k)| \\ \text{MaxNum} \leftarrow \max(k) \text{ if } \max(k) > \text{MaxNum} \\ P \leftarrow \text{trunc} \left(\frac{\log\left(\frac{\text{MaxNum}}{0.2}\right)}{\log(2)} + 1 \right) \\ P \leftarrow 0 \text{ if } P < 0 \\ B \leftarrow \text{taylor}(k \cdot 2^{-P}) \\ \text{for } i \in 1..P \text{ if } P \neq 0 \\ \quad B \leftarrow B \cdot B \\ B \end{array} \right.$

Scale matrix to prepare it for expansion and then multiply it by itself P times

$q_{me}(t, \text{comp}) := \left\{ \begin{array}{l} r \leftarrow \text{MatrixExp}(k \cdot t) \\ \text{sum} \leftarrow \sum_{i=1}^{\text{rows}(r)} r_{i, \text{comp}} \cdot q_0^i \end{array} \right.$

Compare thyroid retention calculated by the two methods:

$$q_{me}(100, \text{thyroid}) = 5.524 \times 10^{-2}$$

$$q_{es}(100, \text{thyroid}) = 5.524 \times 10^{-2}$$

$i := 1..1000$

$$\text{error}_i := \frac{(q_{es}(i, \text{thyroid}) - q_{me}(i, \text{thyroid}))}{q_{es}(i, \text{thyroid})}$$

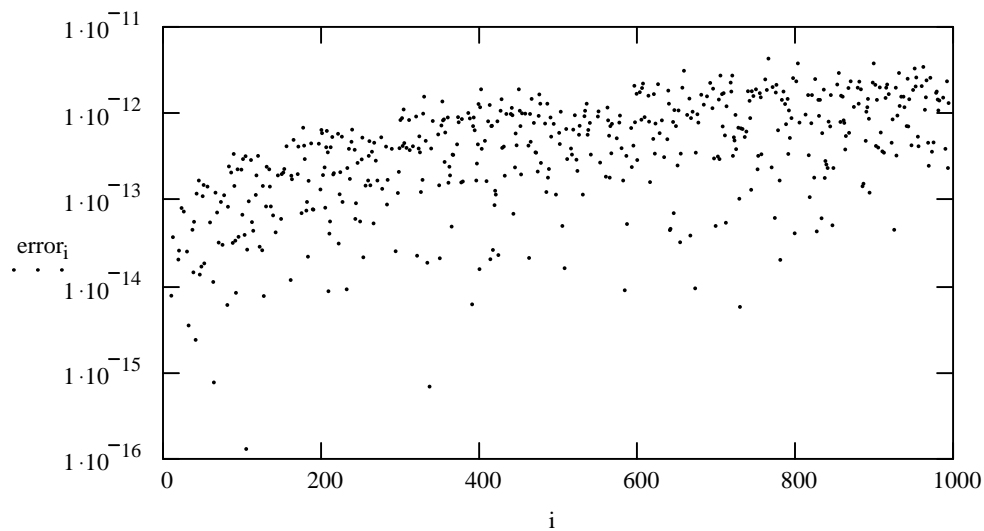

Compare decays calculated by the two methods:

$$T_1 := 0$$

$$T_2 := 50.365$$

$$\text{Decays}_{\text{me}}(\text{comp}) := \left| \begin{array}{l} I \leftarrow \text{identity}(\text{rows}(k)) \\ U \leftarrow k^{-1} \cdot (\text{MatrixExp}(k \cdot T_2) - I) \\ 24 \cdot 3600 \cdot \sum_{i=1}^{\text{rows}(k)} U_{i, \text{comp}} \cdot q_i \end{array} \right.$$

$$\text{Decays}_{\text{es}}(\text{comp}) := \left| \begin{array}{l} s \leftarrow 0 \\ \text{for } j \in 1.. \text{urine} \\ s \leftarrow s - \frac{c_{\text{comp}, j}}{e_j} \cdot (\exp(e_j \cdot T_1) - \exp(e_j \cdot T_2)) \text{ if } |c_{\text{comp}, j}| > 0 \\ s \cdot 24 \cdot 3600 \end{array} \right.$$

$$\text{Decays}_{\text{me}}(\text{thyroid}) = 1.57 \times 10^6$$

$$\text{Decays}_{\text{es}}(\text{thyroid}) = 1.57 \times 10^6$$