

# 2005 DOE Hydrogen Program Review

## Development of a Thermal and Water Management (TWM) System for PEM Fuel Cells

**Guillermo Pont**  
**Honeywell**

**May 25, 2005**

**Project ID # FC 29**

**Honeywell**

This presentation does not contain any proprietary or confidential information

## Timeline

- **Project start date:** 10/03
- **Project end date:** 4/07
- **Percent complete:** 35%

## Budget

FY	Total	DOE Share	Honeywell Share
Total	\$4.1M	\$3.25M	\$812K
% cost share		80%	20%
2004	\$694k	\$555k	\$139k
2005	\$1,318k	\$1,054k	\$264k

## Partners

- **U.S. Dept. of Energy** - V. Lightner, D. L. Ho
- **ANL** - Dr. R. Ahluwalia, Dr. B. Concannon, Dr. R. Sutton
- **Emprise** - Adsorbent (Enthalpy) Wheel
- **Perma Pure** - Vapor-Vapor Membrane
- **University of Cincinnati** - Dr. R. Manglik
- **Honeywell**
  - Engines Systems & Services - Turbocompressor project
  - Transportation Systems - Automotive

## Barriers \*

- **D: Thermal, Air and Water Management**
  - More efficient heat recovery systems, improved system designs, advanced heat exchangers... are needed
  - Water management techniques to address humidification requirements and maintain water balance are required.
- **B: Cost**

## Tasks\*

- **Task 4: Investigate and develop advanced heat rejection technologies and materials (compact humidifiers, heat exchangers, and radiators)**

## Technical targets\*

- Cathode inlet Humidity
- TWM system power consumption
- TWM system volume
- TWM system durability
- TWM system cost
- TWM system weight

\* H2 MYPP

# Project Goal and Objectives

## Project Goal

- **To assist DOE in developing a humidification and cooling system for PEM Fuel Cells in transportation applications**
  - Focus on cathode humidification, and heat rejection for an 80 kW PEM FC power system
    - ◆ Steady state loads
    - ◆ Ambient temperature 20°C and 40°C

## Project Objectives

Project Objectives		Tasks	Time
1	Analyze and select the most efficient TWM system for further development and testing	<ul style="list-style-type: none"><li>• Evaluate cathode humidification options</li><li>• Evaluate thermal management options</li></ul>	FY 2004-2005
2	Design and develop the optimal TWM components and system	<ul style="list-style-type: none"><li>• Generate component and system specifications</li><li>• Design &amp; develop WM components</li><li>• Validate advanced TM performance</li><li>• Evaluate TM low cost manufacturing feasibility</li><li>• Design &amp; develop TM components</li></ul>	FY 2005-2006
3	Develop and test integrated TWM system	<ul style="list-style-type: none"><li>• Demonstrate integrated TWM system</li></ul>	FY 2006-2007

- **Analyze & select the most efficient TWM system**
  - **Evaluate cathode humidification options**
    - ◆ Humidify cathode inlet with cathode exhaust moisture - no make-up water
    - ◆ Avoid bulk condensation – vapor-vapor exchange
  - **Evaluate thermal management options**
    - ◆ Evaluate aerospace/advanced heat exchanger technologies
    - ◆ Incorporate low cost/high volume automotive manufacturing processes
- **Design & develop optimal TWM components and system**
  - **Generate system and component specifications**
  - **Water management development**
    - ◆ Combine testing with predictive modeling
    - ◆ Avoid bulk condensation
  - **Thermal management development**
    - ◆ Combine aerospace designs & development tools with automotive manufacturing processes
- **System integration and demonstration**
  - **Utilize fuel cell simulator**
  - **Utilize Honeywell Turbocompressor**

## Next 14 slides

- **Evaluation of cathode humidification options**
  - Cathode recycle/water injection
  - Porous plate
  - Vapor-vapor membrane
  - Adsorbent (enthalpy) wheel
- **System & component design & development**
  - Vapor-vapor membrane/system
  - Adsorbent (enthalpy) wheel/system
- **Evaluation of thermal management options**
  - Radiator thermal performance trade study

# Evaluate Cathode Humidification Options

- **Goal: Humidify cathode inlet with cathode exhaust moisture**
  - No make-up water
  - Avoid bulk condensation – vapor-vapor exchange
- **Four concepts of cathode humidification compared for sizing and performance evaluation**
  - **A) Cathode recycle**
  - **B) Porous plate**
  - **C) Vapor-vapor membrane**
  - **D) Adsorbent wheel**
    - ◆ 50kW\* steady state, sea level, 40°C ambient
- **Current system evaluation priority (critical to quality)**
  - ◆ Size: 5 (most critical)
  - ◆ Reliability: 4
  - ◆ Cost: 3
  - ◆ Power consumption: 2
  - ◆ Weight : 1 (least critical)
  - **Prioritization developed in conjunction with DOE and FreedomCar Tech Team**
  - **System/component targets & status to be established FY '05**

\* 50kW was original DOE problem statement power level

# A) Cathode Recycle System Analysis

- **How:** mix cathode exhaust gases with compressed air prior to cathode inlet
- **Analysis**
  - Utilizes cathode recycle compressor
  - Needs pre-cooler
  - Needs water injection to achieve required humidification at cathode inlet (60% RH @ 80°C)
  - Cathode recycle compressor becomes redundant

... therefore system becomes a water injection system

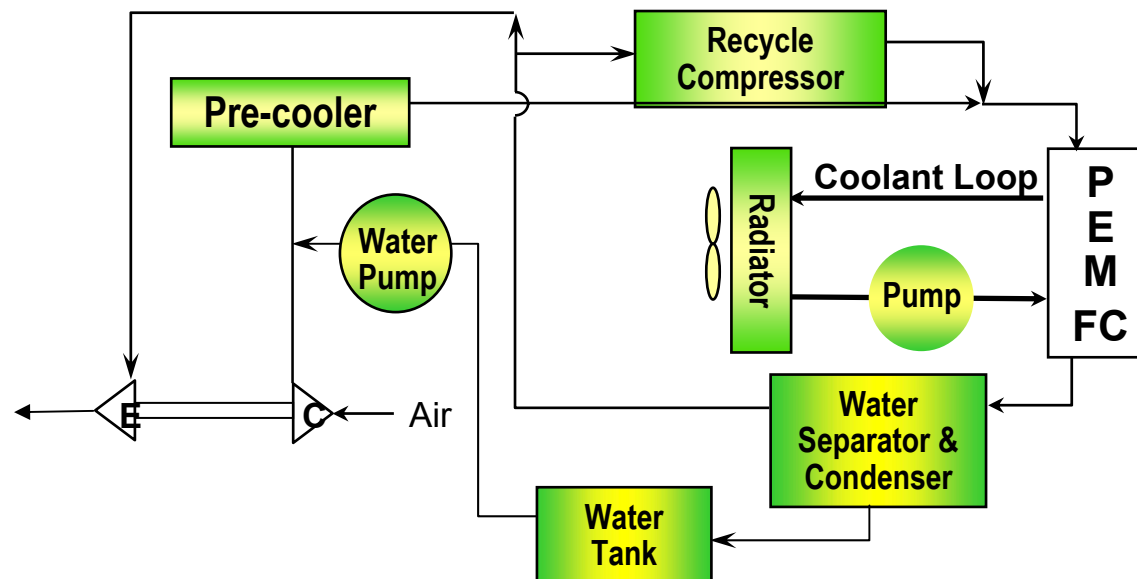

# A) Cathode Recycle System Analysis (cont.)

- **How: inject condensed cathode exhaust water into cathode inlet**
- **Analysis**
  - Achieves humidification requirement (60% RH @ 80°C) with low cathode inlet temperatures
  - Condensation & evaporation occur
  - No need for pre-cooler due to water evaporation latent heat

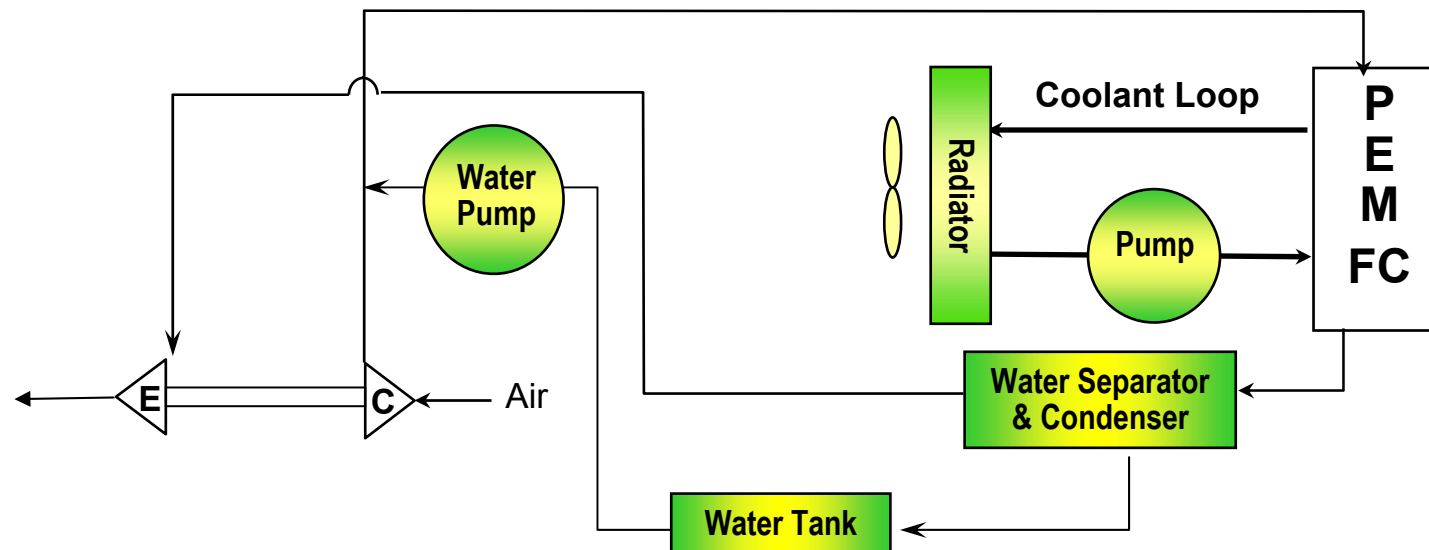



# B) Porous Plate System Analysis

- **How: Transfer water across porous metal plate through capillary action**
- **Analysis**
  - Needs sub-ambient pre-cooling to meet requirements during hot day/high power operation
  - Narrow operating window - needs control hardware
  - Large size
  - Condensation & evaporation occur
  - Material properties tested – permeability & capillary pressure

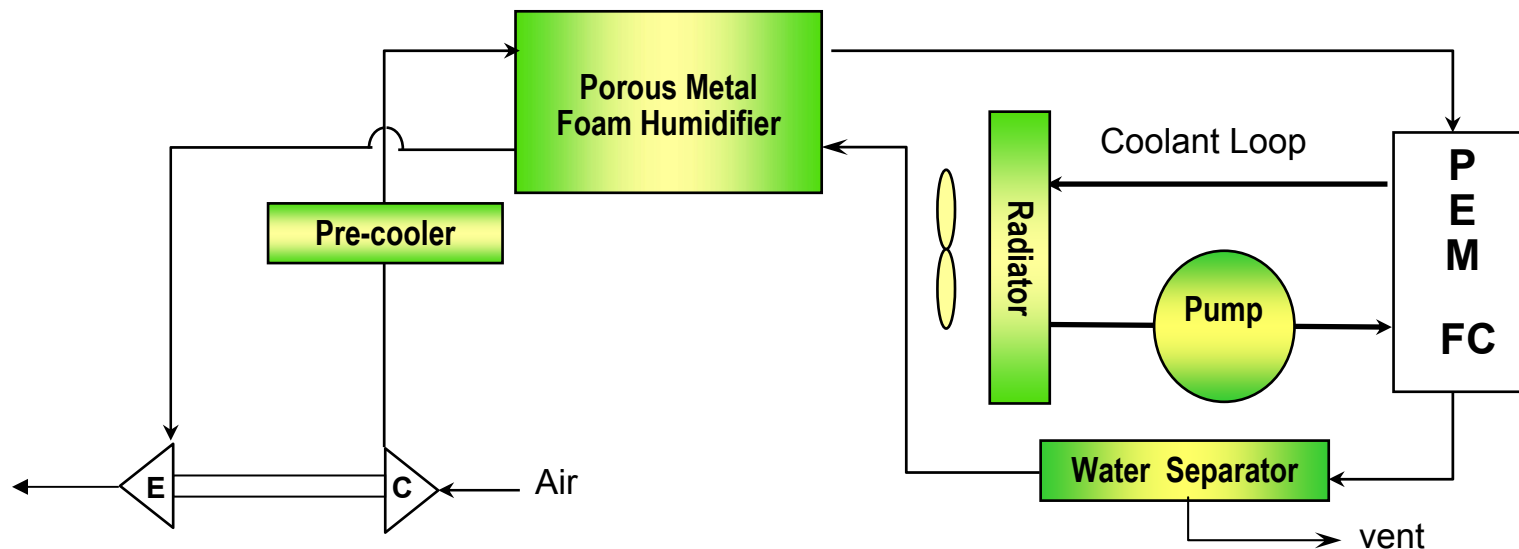

# C) Vapor-Vapor Membrane System Analysis

- **How: Transfer water vapor from cathode exhaust across a barrier to the cathode inlet**
- **Analysis**
  - **Able to achieve required humidification (60% RH @ 80°C) with a reasonably size**
    - ◆ Nafion based membrane used in analysis
  - **Need pre-cooler**
  - **May need to remove liquid water from cathode exhaust before entering membrane humidifier**
    - ◆ Resolve during testing

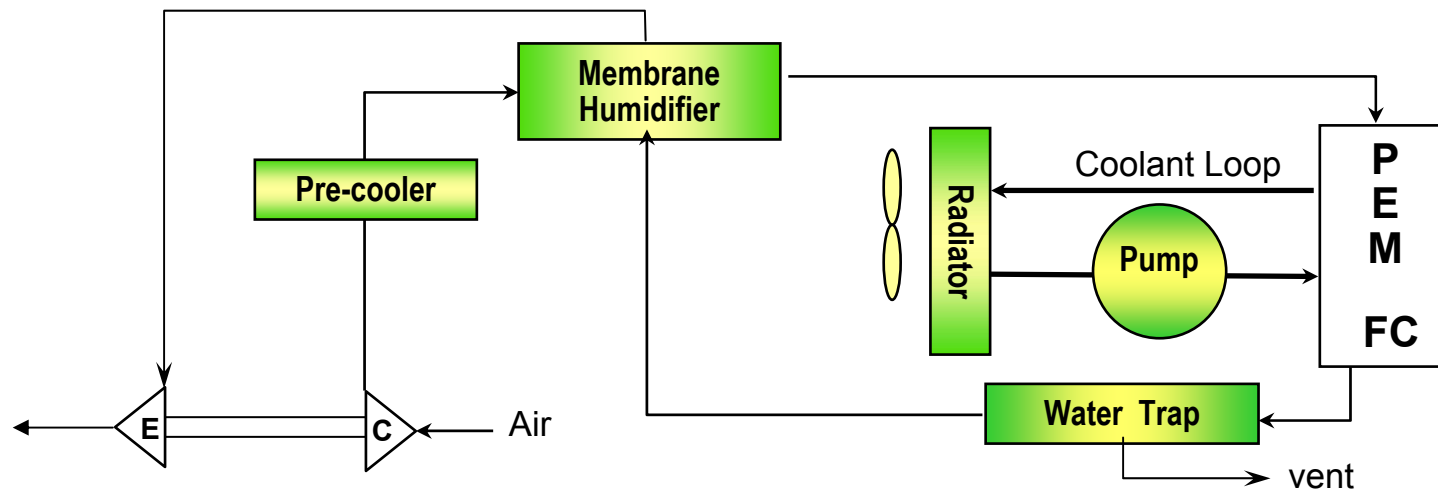

# D) Adsorbent (Enthalpy) Wheel System Analysis

- **How: concentrates water vapor from cathode exhaust and transfers it to the cathode inlet**
- **Analysis**
  - **Able to achieve required humidification with a reasonable size**
    - ◆ Scaled prototype tested
  - **No need for pre-cooler**
  - **Reliability of seals, moving parts, and motor need development**

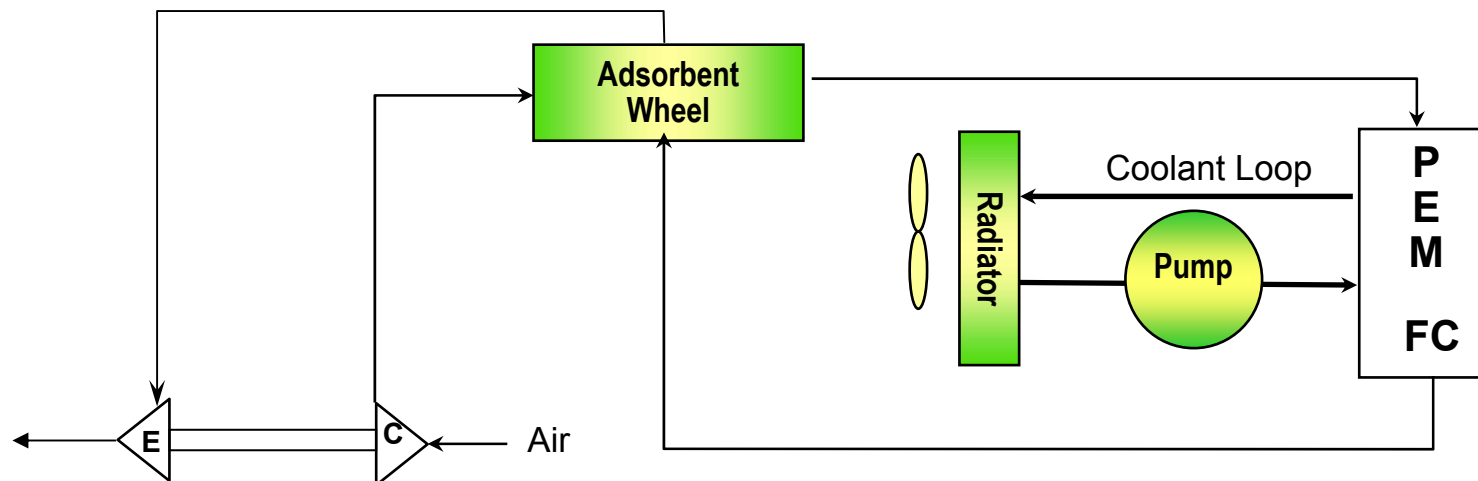

# Evaluate Cathode Humidification Options

- **Quality Function Deployment (QFD) analysis**
  - **Using developed evaluation priority (critical to quality)**
    - ◆ Size: 5 (most critical)
    - ◆ Reliability: 4
    - ◆ Cost: 3
    - ◆ Power consumption: 2
    - ◆ Weight : 1

## QFD Analysis Results

Metric: Priority/weight factor:	Weighted Sum
Cathode Recycle/Water Injection	11.4
Porous Plate	8.7
<b>Vapor-Vapor Membrane</b>	<b>12.4</b>
<b>Adsorbent Wheel</b>	<b>12.5</b>

- **Membrane and adsorbent wheel show best characteristics**
- **Continue development with two systems**
  - **Adsorbent (enthalpy) wheel**
  - **Vapor-vapor membrane**

# Adsorbent Wheel System Design & Development

## • Technical targets established

- 80kW FC Stack
- 60% RH (80°C) @ cathode inlet
- No supplemental water injection
- TWM max power : 3% system power
  - ◆ Includes radiator fan power

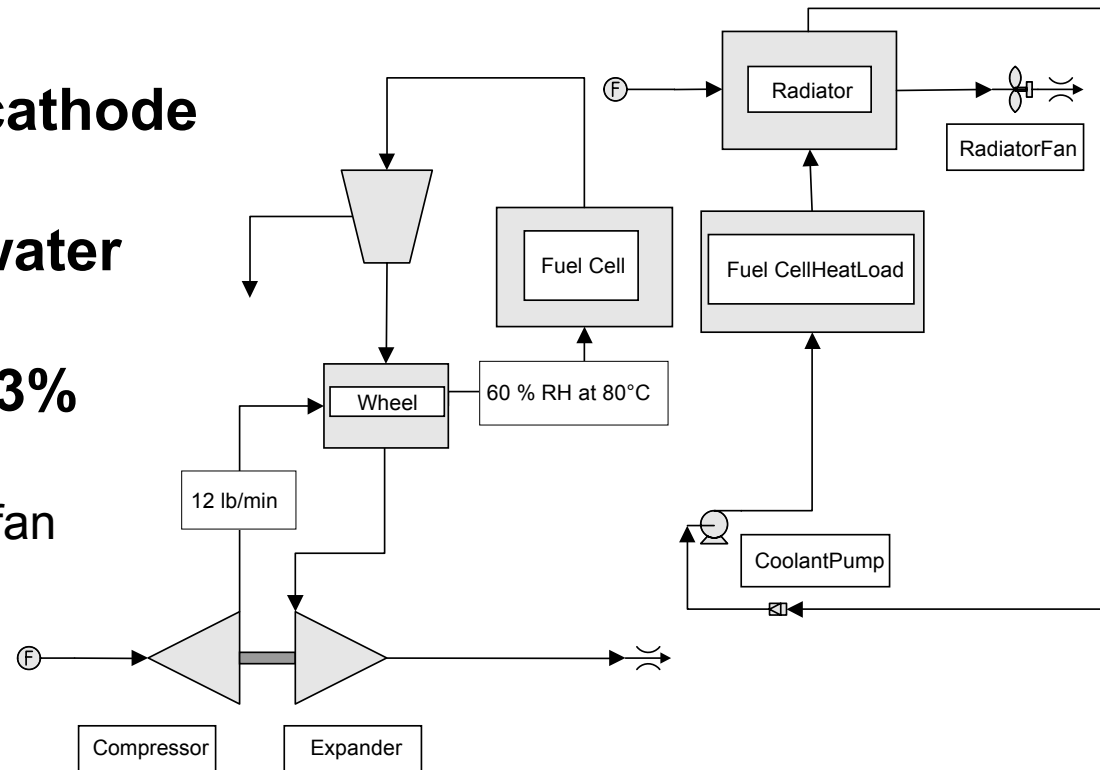

- Adsorbent wheel system design completed
  - Emprise Adsorbent wheel used in design
- Component specifications generated

# Adsorbent Wheel Component Development

- Adsorbent wheel sub-scale testing results

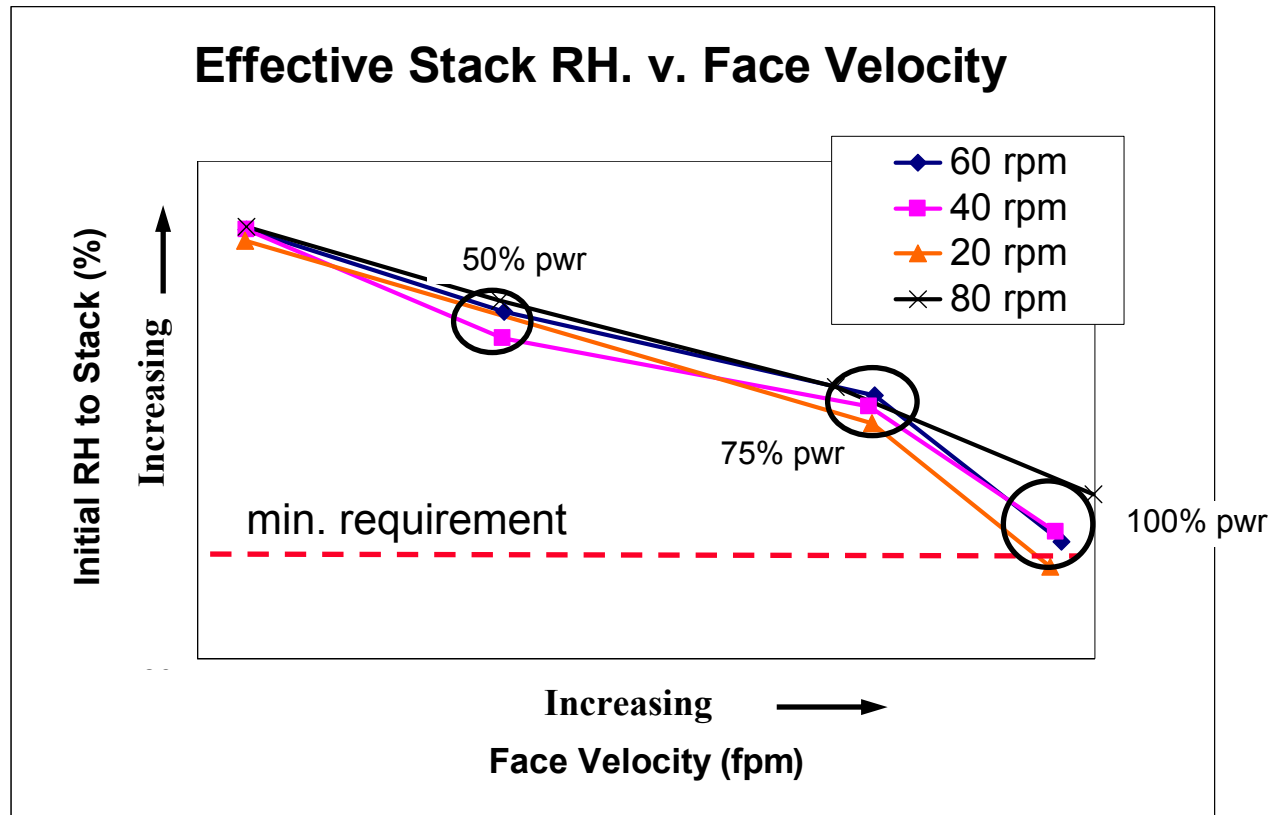

- Emprise Adsorbent wheel used
- Should be able to meet humidification requirements
- Performance is weak function of wheel speed
- Characterized leakage and power consumption
- Full scale adsorbent wheel design in progress

# Vapor-Vapor Membrane System Development

- **Technical targets established**
  - 80kW FC Stack
  - 60% RH (80°C) @ cathode inlet
  - No supplemental water injection
  - **TWM max power : 3% system power**
    - ◆ Includes radiator fan power

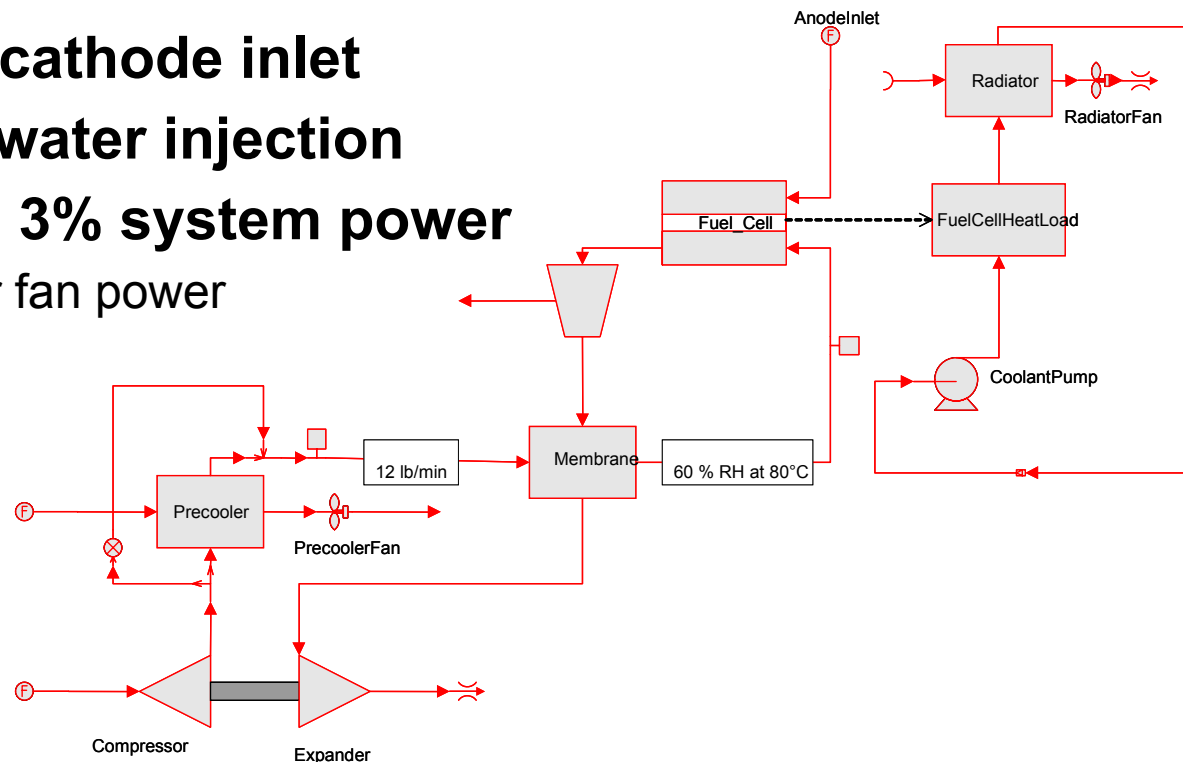

- **Vapor-vapor membrane system design completed**
  - Nafion membrane used in design (Perma Pure)
  - Evaluating pre-cooler system options
- **Component specifications generated**

# Vapor-Vapor Membrane Component Development

- Vapor-vapor membrane sub-scale testing results

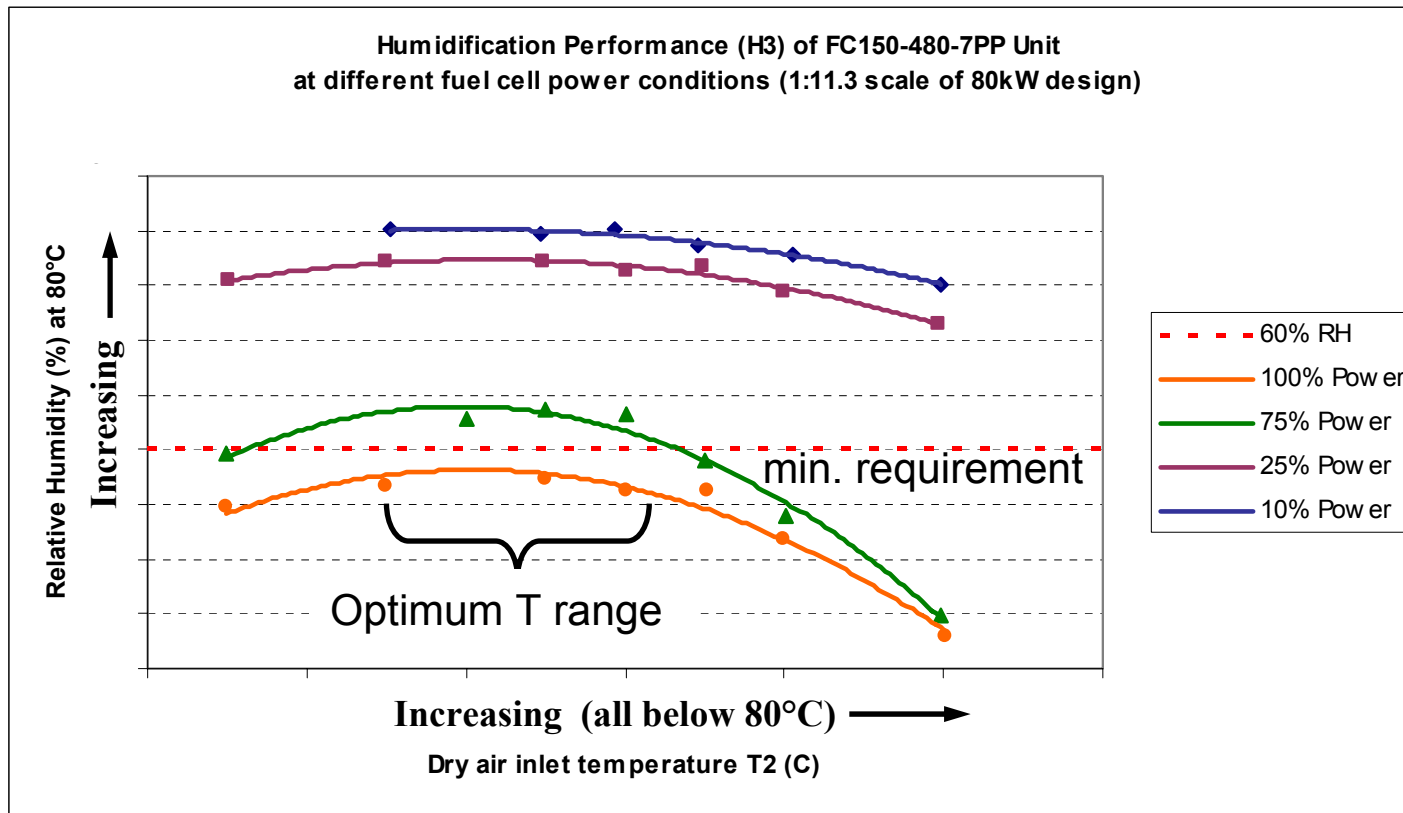

- Nafion membrane used (Perma Pure)
- Should be able to meet humidification requirements
- Performance highly sensitive to power level and temperature
- Full scale membrane design in progress



# Evaluate Thermal Management Options

**Goal: evaluate performance of advanced heat exchanger technologies**

**Technologies evaluated**

- **Automotive tubefin – standard and advanced**
- **Aerospace platefin – standard, microchannel, and Al foam**

**Evaluate radiator system performance**

- **Radiator size & weight, and parasitic power consumption**
- **Utilize Value function (VF) analysis**
  - Includes fan & pump weight
  - Combines power and weight into single variable using stack specific power (lb/kW)

**Radiator thermal performance trade study problem statement**

- **Technical target**
  - **60 kW heat rejection**
  - **TWM max power : 3% system power (2.4 kW)**
    - ◆ Includes radiator fan power
  - **558 in<sup>2</sup> (3,600 cm<sup>2</sup>) max face area**

**Heat rejection rate = 60 kW**

<b>Hot flow:</b>	Glycol/water (50/50)		
Flow Rate:	370	lb/min	(2.8 kg/sec)
T <sub>in</sub> :	167	°F	(75 °C)
P <sub>in</sub> :	50.3	psia	
<b>Cold flow:</b>	Air		
T <sub>in</sub> air:	104	°F	(40 °C)
P <sub>in</sub> air:	14.7	psia	

$\Delta T: 35\text{ }^{\circ}\text{C}$

- **Standard automotive designs cannot meet technical targets**
- **AI foam and microchannel designs show best performance**
  - Foam and microchannel performance based on theoretical / limited information
  - Predictions need validation
- **AI foam, microchannel, and aerospace designs**
  - Offer an advantage over standard automotive designs
  - Need suitable air side contamination control
  - Need development for low cost and mass production
- **Focus on validating foam and microchannel performance to achieve targets**

# Radiator Thermal Performance Trade Study

## Standard automotive designs cannot meet technical targets

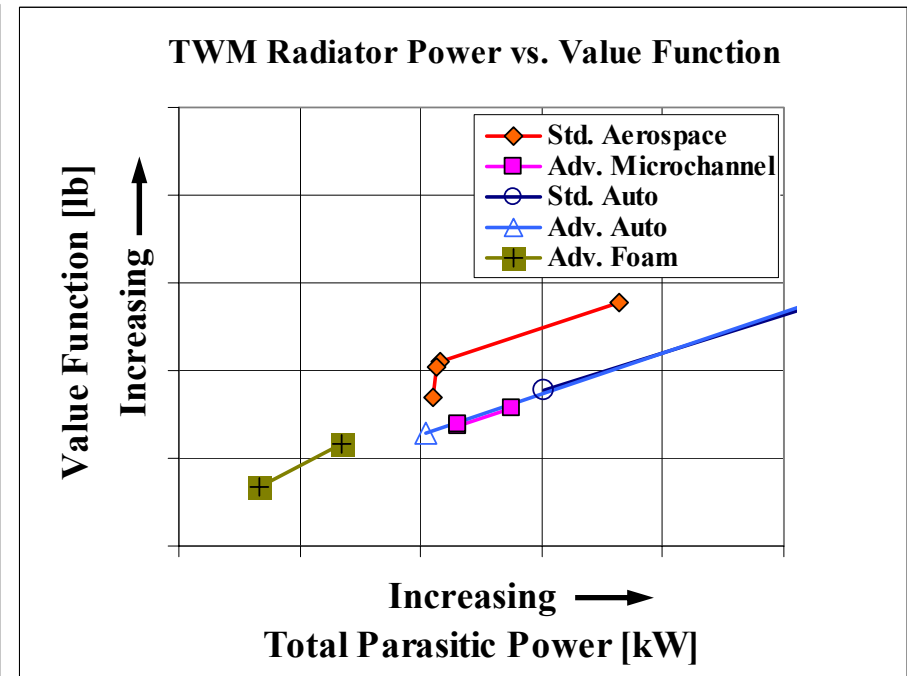
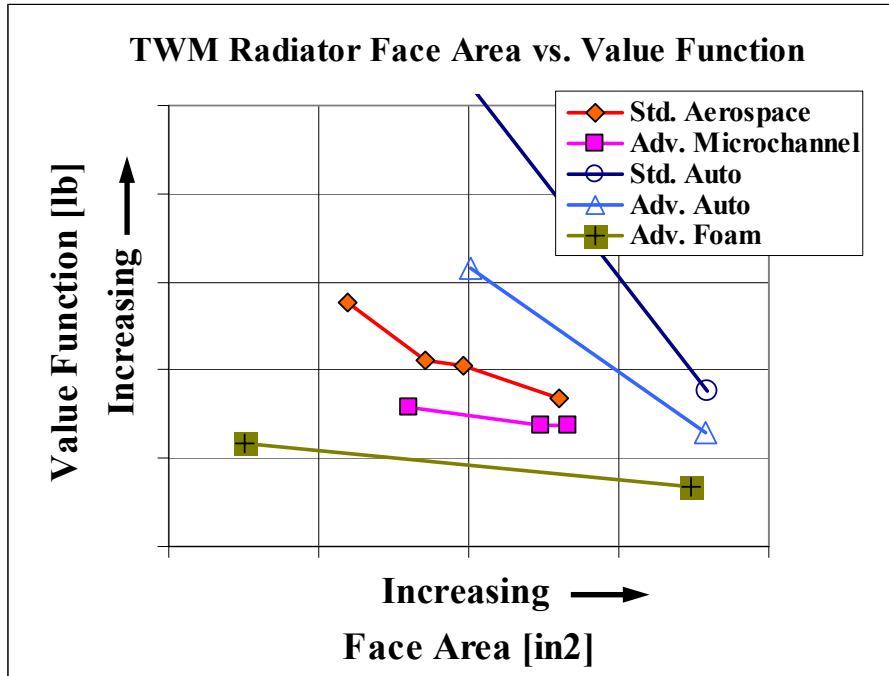

All foam and microchannel have lowest equivalent weight as face area is reduced

All foam has smallest power requirements  
Able to meet power targets

- Foam and microchannel predictions need validation
- Focus on validating foam and microchannel performance to achieve targets

# Responses to Previous Year Reviewers' Comments

- **Collaboration with OEMs, system integrators, and developers should be stronger**
  - Have conducted discussions of Honeywell TWM development with various fuel cell system developers
- **No critique as to why different WM systems being considered; some may not be mechanically suitable. Why consider them?**
  - Initial survey of vapor-vapor water transfer devices resulted in the aforementioned options. The five evaluation priorities attempt to capture suitability
- **Show alignment of project performance to DOE targets and goals**
  - Targets limited due to system nature
  - Current/future efforts focused on defining technical targets
- **Work w/ANL to establish PEM stack interface with TWM system**
  - ANL stack data used as basis for Honeywell TWM system development
    - ◆ Cathode inlet humidity requirement
    - ◆ Radiator specification

- **Remainder of FY 2005**
  - Quantify system size, reliability, cost, & weight
  - Test preparation for WM components
  - Design WM components
  - Validate advanced radiator performance
  - Evaluate advanced radiator cost and manufacturing feasibility
    - ◆ Foam
    - ◆ Microchannel
    - ◆ Aerospace/advanced automotive
- **FY 2006**
  - Develop and test WM components
  - Design & develop advanced radiator

# **Questions/Comments?**

**Guillermo Pont**  
**Fuel Cell Thermal & Water Management**  
**Honeywell Engines Systems & Services**  
**Torrance, CA**  
**Phone: (310) 512-2483**  
**E-mail: [guillermo.pont@honeywell.com](mailto:guillermo.pont@honeywell.com)**

- **Presentations**

- **“Air, Water and Thermal Management for PEM Fuel Cell Systems”, 2004 Fuel Cell Seminar, November 2004. San Antonio, TX**
- **“Advanced Thermal Management Solutions for Aerospace Applications”, Sixth Biennial SAE Power System Conference, November 2004, Reno, NV**

**The most significant hydrogen hazard associated with this project is:**

- **It is not believed that there is a significant hydrogen hazard associated with this project**
  - **This project deals with radiators and water management devices, which do not normally come into contact with hydrogen**
  - **The development and testing during this project does not use any form of hydrogen**



**Our approach to deal with this hydrogen hazard is**

- **No special approach taken to deal with hydrogen hazards**