

**PERMIT APPLICATION FOR CLASS I NON-HAZARDOUS  
INJECTION WELL**

California Specialty Cheese  
Section 24-T1S-R6E, SE/4  
San Joaquin County, California

October 2005

***Prepared for:***

California Specialty Cheese  
14253 South Airport Way  
Manteca, CA 95336  
209-858-9696

***Prepared by:***

Todd Engineers  
2200 Powell Street, Suite 225  
Emeryville, CA 94608  
510-595-2120

***With assistance from:***

Dennis Stone, P.E.  
10110 Bell Creek Drive  
Riverview, FL 33569  
813-677-4421

Irani Engineering  
2625 Fair Oaks Blvd., Suite 10  
Sacramento, CA 95864  
916-482-2847

California Specialty Cheese  
14253 South Airport Way  
Manteca, CA 95336  
209-858-9696



United States Environmental Protection Agency  
**Underground Injection Control  
 Permit Application**  
 (Collected under the authority of the Safe Drinking  
 Water Act, Section: 1421, 1422, 40 CFR 144)

I. EPA ID Number		T/A	C
U			

Read Attached Instructions Before Starting  
 For Official Use Only

Application approved mo day year	Date received mo day year	Permit Number	Well ID	FINDS Number

II. Owner Name and Address			III. Operator Name and Address		
Owner Name California Specialty Cheese			Owner Name California Specialty Cheese		
Street Address 14253 South Airport Way		Phone Number (209) 858-9696	Street Address 14253 South Airport Way		Phone Number (209) 858-9696
City Manteca	State CA	ZIP CODE 95336	City Manteca	State CA	ZIP CODE 95336

IV. Commercial Facility <input checked="" type="checkbox"/> Yes <input type="checkbox"/> No	V. Ownership <input checked="" type="checkbox"/> Private <input type="checkbox"/> Federal <input type="checkbox"/> Other	VI. Legal Contact <input checked="" type="checkbox"/> Owner <input type="checkbox"/> Operator	VII. SIC Codes 2022
---	---	---	------------------------

VIII. Well Status (Mark "x")			
<input type="checkbox"/> A. Operating	Date Started mo day year	<input type="checkbox"/> B. Modification/Conversion	<input checked="" type="checkbox"/> C. Proposed

IX. Type of Permit Requested (Mark "x" and specify if required)			
<input checked="" type="checkbox"/> A. Individual	<input type="checkbox"/> B. Area	Number of Existing Wells 0	Number of Proposed Wells 2 (1 operating; 1 optional back-up)
Name(s) of field(s) or project(s) California Specialty Cheese			

X. Class and Type of Well (see reverse)			
A. Class(es) (enter code(s)) Class 1	B. Type(s) (enter code(s)) Type I	C. If class is "other" or type is code 'x,' explain	D. Number of wells per type (if area permit) 1

XI. Location of Well(s) or Approximate Center of Field or Project												XII. Indian Lands (Mark 'x')			
Latitude			Longitude			Township and Range								<input type="checkbox"/> Yes <input checked="" type="checkbox"/> No	
Deg	Min	Sec	Deg	Min	Sec	Sec	Twp	Range	1/4 Sec	Feet From	Line	Feet From	Line		
121	15	22.7	37	50	0.91	24	1S	6E	SE	882	E	2,565	S		

XIII. Attachments  
 (Complete the following questions on a separate sheet(s) and number accordingly; see instructions)  
 For Classes I, II, III, (and other classes) complete and submit on a separate sheet(s) Attachments A--U (pp 2-6) as appropriate. Attach maps where required. List attachments by letter which are applicable and are included with your application.

XIV. Certification  
 I certify under the penalty of law that I have personally examined and am familiar with the information submitted in this document and all attachments and that, based on my inquiry of those individuals immediately responsible for obtaining the information, I believe that the information is true, accurate, and complete. I am aware that there are significant penalties for submitting false information, including the possibility of fine and imprisonment. (Ref. 40 CFR 144.32)

A. Name and Title (Type or Print) Ming Shin Kou, Vice President	B. Phone No. (Area Code and No.) (323) 234-9000
C. Signature 	D. Date Signed 10/13/2005

ORIGINAL

## Permit Application Attachments Table of Contents

Executive Summary .....	E-1
Introduction.....	E-1
Selection of Target Injection Zones.....	E-2
Area of Review .....	E-3
Underground Source of Drinking Water (USDW).....	E-3
Target Injection Zones .....	E-5
Drilling and Testing Program .....	E-6
Monitoring Program.....	E-6
Plugging and Abandonment Program.....	E-7
ATTACHMENT A – Area of Review (AOR).....	1
Requirements .....	1
Approach.....	1
Estimated Area of Review - Volumetric Assessment.....	2
Estimated Area of Review (AOR) – Theis Equation Method .....	3
Estimated Area of Review – Pressure Wave Calculation Method .....	6
Area of Review Selection .....	8
ATTACHMENT B - Maps Of Well/Area and Area Of Review .....	10
Requirements .....	10
Physical Setting and Surface Water Features .....	10
Wells Within Area of Review.....	11
Water Supply Wells .....	11
City of Stockton .....	12
City of Lathrop.....	12
City of Manteca.....	13
Monitoring Wells .....	13
CSC Site.....	13
DDJC Sharpe .....	13
Former Occidental Chemicals.....	14
Injection Wells .....	14
DDJC - Sharpe .....	14
Former Occidental Chemicals.....	14
San Joaquin CoGen (abandoned).....	14
Oil and Gas Wells .....	14
ATTACHMENT C – Corrective Action Plan and Well Data .....	16
Requirements .....	16
Closest Wells Penetrating the Target Injection Zones.....	16
Corrective Action Plan.....	17
ATTACHMENT D – Maps and Cross Sections of USDW.....	18
Requirements .....	18
Estimation of the Base of USDW .....	18
Geologic and Hydrogeologic Setting.....	18

Aquifers and Hydrostratigraphy .....	19
Water Levels .....	20
Groundwater Flow Directions.....	21
Base of Fresh Water.....	22
Base of USDW.....	23
Salinity Estimates from Quintana SP No. 1 Well.....	24
ATTACHMENT F - Maps and Cross Sections of Geologic Structure of Area .....	26
Requirements .....	26
Regional Geological Setting .....	26
Faults.....	27
Stratigraphy.....	27
Miocene Target Injection Zone.....	28
Cretaceous Target Injection Zone.....	29
ATTACHMENT H – Operating Data.....	32
Requirements .....	32
Wastewater Generation and Treatment.....	32
Injection Well Operation.....	34
ATTACHMENT I – Formation Testing Program .....	35
Requirements .....	35
Fracture Pressure Determination.....	35
Mechanical Integrity Test .....	35
Formation Water Sampling.....	36
Injection Fluid Sampling.....	36
ATTACHMENT J – Stimulation Program.....	37
ATTACHMENT K – Injection Procedures .....	38
Requirements .....	38
Proposed Injection Procedures.....	38
ATTACHMENT L – Construction Procedures .....	39
Requirements .....	39
Permits .....	39
Proposed CSC Injection Well Drilling and Logging .....	39
Drilling and Completion Program – Miocene Sand Completion.....	40
Drilling & Completion Program – Miocene Sand .....	40
Casing Program – Miocene Sand.....	42
Liner Program .....	42
Drilling and Completion Program – Cretaceous 2 <sup>nd</sup> Tracy Sand Completion.....	44
Drilling & Completion Program – Cretaceous Sand .....	44
Casing Program – Cretaceous Sand.....	46
Liner Program – Cretaceous Sand .....	46
Standing Orders, Drilling & Remedial Operations.....	48
Logging Program Summary.....	50
ATTACHMENT M – Construction Details .....	52
Requirements .....	52
Construction Diagram.....	52
ATTACHMENT O – Plans for Well Failures .....	53
Requirements .....	53

Contingency Options ..... 53  
ATTACHMENT P – Monitoring Program..... 54  
    Requirements ..... 54  
    Quarterly Reporting of Continuous Pressure and Flow Monitoring..... 54  
    Quarterly Sampling of Injection Fluids ..... 55  
    Annual Well Logging ..... 55  
    Mechanical Integrity Testing ..... 55  
    Recordkeeping ..... 56  
ATTACHMENT Q – Plugging and Abandonment Program ..... 57  
    Requirements ..... 57  
    Plugging and Abandonment Program..... 57  
ATTACHMENT R – Necessary Resources ..... 58  
ATTACHMENT T – Existing USEPA Permits ..... 59  
ATTACHMENT U – Description of Business..... 60  
References..... 61

## List of Tables

1. Wells Within Area of Review
2. Deep Wells Within 2 Miles of Proposed Injection Well
3. Industrial Process Water Treatment, Material Balance and Conceptual Design
4. Wastewater Characterization

## List of Figures

1. Project Location Map
2. Air Photo, California Specialty Cheese Site
3. Wells in Area of Review
4. Abandoned Deep Wells
5. Geologic Map, California Specialty Cheese
6. Hydrostratigraphic Units, San Joaquin County
7. USDW Cross Section
8. Groundwater Elevations near California Specialty Cheese Site
9. Groundwater Flow, Eastern San Joaquin Subbasin
10. Base of Fresh Water near CA Specialty Cheese
11. Salinity Profile, TDS with Depth
12. Stratigraphic Units of Northern San Joaquin Valley
13. Type Log, Miocene Sand Target Injection Zone
14. Structural Contour Map, Top of Target Miocene Sand
15. Isopach Map, Miocene Confining Layer
16. Structural Cross Section A-A'
17. Structural Cross Section B-B'
18. Type Log, Cretaceous Sand Target Injection Zone
19. Structural Contour Map, Top of Target Cretaceous Sand (2<sup>nd</sup> Tracy Sand)
20. Isopach Map, Cretaceous Confining Layer
21. Proposed Miocene Injection Well Design
22. Proposed Cretaceous Injection Well Design

## List of Supporting Documentation (on Compact Disc)

Electric logs for: Quintana Petroleum, S.P. No. 1, 25-1S-6E  
Pan Petroleum, Hayre Egg Farms No. 1, 18-1S-7E  
Christiana Oil, Schleiss No. 1, 30-1S-7E (Induction and Sonic Logs)  
U.S. Natural Resources, Towne-S.P. Unit Two No. 1, 14-1S-6E  
California Division of Oil and Gas, Well Abandonment Records for:  
Quintana Petroleum, S.P. No. 1, 25-1S-6E  
Pan Petroleum, Hayre Egg Farms No. 1, 18-1S-7E  
Well Record – 1888 abandoned gas exploration well, 24-1S-6E  
Class II Injection Well records – Laymac Reynolds & Carver-Long  
McMullin Ranch Gas Field documenting permeability of Tracy Sand  
Plugging and Abandonment Cost Estimates for UIC Injection Well  
Certificate of Recognition to Fisherman's Pride Processing, 2004

# Executive Summary

## *Introduction*

The California Specialty Cheese (CSC) facility is located at 14253 South Airport Way in Manteca, California, approximately nine miles south of Stockton and 75 miles east of San Francisco (Figure 1). The site is located on approximately 60 acres with the southern 18 acres containing the main plant site and the northern 42 acres containing former wastewater ponds constructed by the site's previous owner (Figure 2).

Cheese processing operations have been halted at the site since 2003 when the current owners (CSC) purchased the site. The previous owner had processed cheese at the facility until wastewater and other issues contributed to plant closure. Wastewater that had been discharged to onsite ponds was discovered to have impacted local groundwater quality. The current owner plans to return the site to cheese processing after conducting significant plant upgrades and incorporating a newly-designed wastewater improvement process. More details on the processing operation are included in Attachment U.

CSC has examined various methods of wastewater disposal and has determined that a deep injection well that fully protects drinking water aquifers is the most environmentally viable option. Details on wastewater generation and treatment prior to injection at the site are provided in Attachment H. The wastewater flow process is shown conceptually on Table 3. Anticipated wastewater quality prior to treatment is summarized from site historical data on Table 4.

The proposed injection well requires a permit through the U.S. Environmental Protection Agency's (USEPA) Underground Injection Control (UIC) program. This application is being submitted to USEPA to obtain a permit to drill, construct, test, and operate a Class 1 Non-Hazardous injection well at depths below 2,000 feet. Depending on the subsurface conditions, up to 300,000 gallons per day of non-hazardous wastewater from cheese manufacturing will be treated and injected into the Class 1 well. Operating data and injection procedures are described in Attachments H and K. This application submittal follows the regulations of 40 CFR Parts 144-146 and various guidance documents prepared by or for the USEPA as listed in the references section of this application.

This permit application assumes that only one well will be necessary for injection operations. However, the applicant requests the option of installing a back-up well in the future as part of a contingency plan in the event of well failure (Attachment O). The installation of a back-up well would not increase total injection volumes contained in this application. In addition, the back-up well would be located close to the initial injection well such that the distances and analysis for the Area of Review and the geological evaluation would remain applicable for the additional well.

## ***Selection of Target Injection Zones***

Based on an evaluation of the subsurface geology of the area, two zones have been selected as possible injection targets. The main target for injection is a Miocene Sand, likely equivalent to the Valley Springs formation and expected to occur at a depth of 2,010 feet in the proposed well. An alternative target injection zone has also been identified in the event that the Miocene Sand does not meet stated requirements. This alternative target is a Cretaceous Sand, referred to locally as the 2<sup>nd</sup> Tracy Sand, and is expected to occur at a depth of 5,235 feet in the proposed well. Both of the targets appear to meet regulatory requirements for total dissolved solids (TDS) exceeding 10,000 milligrams per liter (mg/L). In addition, both targets are protective of underground sources of drinking water (USDWs) as documented in the Attachments to this summary.

Data collected during the drilling and testing process will be evaluated to select one of the targets for well completion. The shallower Miocene Sand will be tested first, and if the zone meets regulatory and operational requirements, the well will be completed there and will not be drilled deeper. However, if it appears that TDS regulatory requirements cannot be met in the Miocene Sand, the well will be drilled deeper to the alternative injection target.

This application describes the geological evaluation that identified the target injection zones and demonstrates that injection into these zones would not impact USDWs. The selection of target injection zones considered geology, hydrogeology, groundwater quality, and operational and regulatory requirements. Potential target injection zones interpreted to occur beneath the CSC site were assessed using the following criteria:

- Protects USDWs
- TDS exceeds 10,000 mg/L
- Meets other UIC regulatory requirements
- Thickness and permeability sufficient for injection capacity
- Shallow depth to minimize drilling, installation, and rehabilitation costs.

Because permeability generally decreases with depth, shallow targets were considered to be preferable and were investigated first. While deep Cretaceous sands (>6,000 feet), such as the Lathrop Sand, have been targets for gas exploration in this area, these deeper targets do not contain sufficient permeability to sustain injection rates required for most industrial operations (as indicated by permeability data from nearby gas fields, CDOG, 1982). A nearby UIC injection well at the San Joaquin CoGen facility attempted to inject into the Lathrop Sand, but could not sustain a rate of more than 100 gallons per minute (gpm). A rate of 100 to 200 gpm is required for CSC's wastewater program. For this reason, the Lathrop Sand is not a target and the Cretaceous 2<sup>nd</sup> Tracy Sand is considered the deepest potential target for injection in this area.

In order to select the most feasible target based on site-specific data collected during drilling and testing, this application requests a permit allowing for either the



Miocene Sand or the Cretaceous 2<sup>nd</sup> Tracy Sand to be the target injection zone without preparing an additional application.

## ***Area of Review***

The Area of Review (AOR) is the radius around the injection well in which impacts from injection could potentially occur. It is based on parameters of the target injection zones and the location of USDWs. Three methods were used to calculate and compare potential AORs including the USEPA method for calculating the Zone of Endangering Influence (Attachment A). These calculations indicate that an AOR of 0.5 miles is reasonable. In addition, the calculations consider locations of the nearest wells outside of the AOR that have penetrated either of the two target injection zones. Using reasonable site-specific data and assumptions, calculations indicate that these wells will not provide a conduit and will not result in impacts to USDWs. As such, a corrective action program to locate and seal wells is not proposed (Attachment C).

## ***Underground Source of Drinking Water (USDW)***

Data from more than 600 water supply wells, more than 300 monitoring wells, about 10 injection wells, and 20 abandoned gas exploration wells were used to evaluate groundwater occurrence and use in the area (Attachment B). Most of the water supply wells were extracting water from depths of 50 feet to 300 feet. None of the wells pump water below 400 feet and only two wells were drilled below 500 feet. Those two wells, located at the former Occidental Chemicals site, are used for injection only. Other wells in the area include monitoring wells installed by various facilities, including DDJC-Sharpe and CSC, to monitor shallow groundwater quality and abandoned gas exploration wells (Attachment B).

Of the more than 900 well records reviewed in the area, only 27 wells appear to have been drilled in the AOR. None of these wells penetrate either of the two target injection zones. According to public records compiled from eight separate sources, wells within the 0.5-mile AOR include the following:

- 12 water supply wells
- 1 abandoned gas exploration well
- 14 monitoring wells.

These wells in the AOR are shown on Figure 3, summarized in Table 1, and described in more detail in Attachment B. Well data compiled both inside and in the vicinity of the AOR are described in the attachment.

Only two wells within about 1.5 miles of the proposed CSC injection site have penetrated the target injection zone (Attachment B). These two abandoned gas exploration wells, Quintana S.P. No. 1 well and the Pan Petroleum Hayre Egg Farms No.

1 well, are located approximately 4,385 feet and 4,520 feet, respectively from the CSC site. Analyses presented in Attachments A, B, and C indicate that USDWs will not be impacted through these abandoned wells due to the distance away from the proposed injection well, plug depths, and mud weight of the fluid remaining in the wells (Figure 4). There are seven deep wells within 2 miles of the CSC injection site (Table 2). Data from these wells and 13 additional deep wells were used to correlate and map the regional geology.

Attachment D provides geologic and hydrogeologic analyses of the USDW. The geologic map on Figure 5 shows the site's location in the Central Valley of California between the Sierra Nevada to the east and the Coast Ranges to the west. Quaternary deposits transition to Tertiary and Cretaceous sediments at depth. These sediments overlie the Jurassic bedrock complex at an estimated depth of about 12,000 feet in this area (Bartow, 1983). Local hydrostratigraphic units with the corresponding ages and characteristics are summarized on Figure 6. A regional cross section of these units across the valley with the CSC site projected onto the section is shown on Figure 7.

The CSC site is located in the Eastern San Joaquin subbasin of the larger San Joaquin Valley groundwater basin (DWR, March 5, 2003). The subbasin covers more than 1,000 square miles and is bounded by the San Joaquin River on the west, the Stanislaus River on the south, and the Mokelumne River on the north. The eastern subbasin boundary is the surface intersection of the alluvium and the outcropping consolidated rocks of the Sierra Nevada foothills. Groundwater occurs in the unconsolidated alluvial deposits beneath this basin under unconfined conditions and becomes more confined with depth.

The water table beneath the CSC site is unconfined and occurs at an approximate depth of 10 feet. Water levels in the drinking water aquifers (with approximate depths ranging from 50 feet to 300 feet) have declined over the last 30 years as indicated by a water level hydrograph from a nearby DWR monitoring well (Figure 8). However, water levels appear to have stabilized at about 7 feet above msl.

Historically, groundwater within this basin flowed toward the major drainages, including the San Joaquin River, and then north and west toward the Sacramento-San Joaquin delta. Groundwater extraction over time has lowered water levels near pumping centers and has altered regional flow patterns. Groundwater in the aquifers down to about 400 feet in the vicinity of the CSC site is in the transition zone between the natural northwesterly flow and the pumping-influenced northeasterly groundwater flow. Groundwater beneath the site generally flows northeast toward the central pumping depression while groundwater just west of the site flows westward toward the river (Figure 9).

According to maps produced by DWR and USGS, the base of fresh water (generally defined as TDS of less than about 2,000 mg/L) occurs beneath the CSC site at an approximate elevation of -550 feet below msl (Figure 10). The base of the USDW, defined by a TDS of less than 10,000 mg/L, is not known. By using water quality data

from nearby wells at depths of 500 feet and electric log analyses of salinity from regional gas exploration wells to depths below 2,500 feet (Figure 11), the base of the USDW may be as shallow as 900 to 1,300 feet. Given the variability in regional log response and focusing on the closest wells, the base of the USDW is conservatively estimated at 1,789 feet beneath the CSC site. This depth is the bottom of the sand immediately above the confining layer of the target Miocene Sand, a depth that represents the most conservative and worst-case scenario for purposes of this analysis. Attachment D provides more detail on this analysis.

## ***Target Injection Zones***

Attachment F provides the geological evaluation of the subsurface stratigraphy in the area and the selection of target injection zones. The geological evaluation indicates that both target injection zones can be correlated and mapped within an approximate 50-square mile study area (Figure 1). The geological relationships between the target zones and the other geologic units of the area can be seen on Figure 12. Due to their thickness and permeability, the Miocene Valley Springs Sand and the Cretaceous 2<sup>nd</sup> Tracy Sand were identified as the most promising injection targets. The Miocene target contains approximately 372 feet of permeable sand as indicated by electric log responses in wells near the CSC site (Figure 13). A structural contour map on top of the sand indicates that it slopes to the southwest at approximately one degree (Figure 14). The sand is separated from USDWs by a confining layer of thick low permeability clay and silt that is approximately 250 feet thick beneath the CSC site (Figure 15). Two geologic cross sections (Figures 16 and 17) show details of the local structure and stratigraphy within one mile of the proposed well.

Cross sections also show the stratigraphy and structure of the Upper Cretaceous section, including the alternative injection target, the Cretaceous 2<sup>nd</sup> Tracy Sand (Figures 16 and 17). The alternative target contains approximately 267 feet of sand, as correlated between existing electric logs. The zone is illustrated on the closest electric log, Quintana S.P. No. 1, shown on Figure 18. Electric log response, as well as permeability estimates from nearby gas fields, indicates that the sand is sufficiently permeable for injection. The top of the zone is predicted to occur at an elevation of 5,200 feet below msl as shown on the structural contour map on Figure 19. As shown on the map, the sand dips to the southwest an average of 3 degrees across the site with dips steepening to the southwest. The sand is confined by a shale unit that extends for several miles around the CSC site and is estimated to be approximately 135 feet thick (Figure 20). An even thicker confining layer, the Ragged Valley Shale, occurs uphole of the mapped confining layer. This thick and regionally-extensive shale can be seen on the cross sections on Figures 16 and 17 and is easily correlated throughout the study area. This layer provides further protection between the Cretaceous 2<sup>nd</sup> Tracy Sand and the base of the USDW.

Although faults have been interpreted by the California Division of Oil and Gas (CDOG) to intersect the 2<sup>nd</sup> Tracy Sand interval (Figure 19), these faults are not anticipated to be a conduit of fluid into shallower sediments. The faulting provides a seal

for natural gas at the Lathrop Sand level, demonstrating its lack of conductive properties. In addition, the faulting is associated with pre-Miocene deposition and does not extend up into the USDW.

## ***Drilling and Testing Program***

Attachments L, M, and I provide details on the proposed drilling and testing of the injection zone and well at the CSC site. A flexible well design will allow for drilling to 5,550 feet, if necessary, but will test the shallower Miocene Sand (top of zone at an approximate depth of 2,010 feet) before drilling deeper (Figure 21). If the Miocene Sand can be demonstrated to meet regulatory requirements through an open-hole test sample or other testing method, the well will be completed in the Miocene Sand and will not be drilled deeper. If the Miocene Sand does not meet regulatory requirements, the well will be deepened to the alternative target zone, the Cretaceous 2<sup>nd</sup> Tracy Sand. The well will be permitted as an exploration well under CDOG guidelines to ensure adequate safety measures are followed in this area of gas production.

For either completion, 13-3/8 inch diameter, 48#, H-40 surface casing will be run below the base of fresh water to approximately 650 feet and cemented to the surface. Production casing will consist of 8-5/8 inch diameter, 32#, J-55 ST&S casing and will extend approximately 10 feet below the top of the target injection zone (2,020 feet for a Miocene Sand completion or 5,245 feet for a Cretaceous 2<sup>nd</sup> Tracy Sand completion) (Figures 21 and 22). In order to maximize the injection area at depth, the target injection zone will be under-reamed to a diameter of 15 inches. A 5-1/2 inch diameter Bakerweld gravel pack screen will be placed across the zone and the hole filled with gravel pack material. Blank 5 1/2 inch, 15.5#, J-55 LT&C liner will extend from the screen up into the 8-5/8 inch casing and secured with a liner packer. Injection will occur through 4-1/2 inch, 12.75#, EUE, J-55 tubing, held in place with an 8-5/8 inch Baker Model D packer (set at approximately 1,900 feet for the Miocene Sand completion or 5,100 feet for the Cretaceous 2<sup>nd</sup> Tracy Sand completion) (Figures 21 and 22).

## ***Monitoring Program***

Attachment P outlines a proposed monitoring program for injection operations at the CSC site. The monitoring program will consist of continuous readings of injection pressure, annular pressure, flow rate, and volume, as well as quarterly sampling and analysis of wastewater to be injected. Pressure readings in the annulus of the 8-5/8 inch diameter casing and the 4-1/2 inch diameter tubing will be capable of detecting any leaks within the tubing or at the packer. Annual logging will include temperature, spinner, and radioactive logs to ensure no fluid migration above the shoe of the 8-5/8 inch diameter casing or around the lower packer. Measurements and data will be submitted to USEPA on a quarterly basis and maintained at the site for inspection. Injection fluid will be monitored for a suite of organic and inorganic constituents as well as physical parameters (Attachment P). A hazardous waste determination will be made on the injection fluid

prior to injection and at any change in the waste stream or treatment process that could impact water quality.

### ***Plugging and Abandonment Program***

Once the injection well is no longer necessary or not performing as required, the well will be abandoned in accordance with CDOG and USEPA abandonment procedures. Attachment Q provides a general plugging and abandonment program for the injection well. The exact depths of the plugs and abandonment procedures will be determined after the well has been installed. At a minimum, the following plugs and plate are anticipated:

- Plug across the injection zone, bringing cement 100 feet into the 8-5/8 inch casing (>300 foot plug)
- Plug at the base of the USDW, estimated at 1,789 feet (200-foot plug)
- Plug at the surface of the well (100-foot plug)
- Cut casing 5 feet below ground and weld steel plate on top of the casing stub.

of impression and the radius away from the wellbore where the cone would potentially rise above the USDW hydrostatic head. The third method, and perhaps the most relevant to potential injection impacts from this project, estimates the horizontal movement of the pressure wave in the target injection zone. This calculation is used to predict pressure increases at the closest wells that penetrate the injection zones. Since the injection target zone could be either the Miocene Sand or the Cretaceous Tracy Sand, depending on drilling and testing results, all calculations are performed for both target zones.

### ***Estimated Area of Review - Volumetric Assessment***

A volumetric assessment has been provided by some UIC permit applicants as one methodology for estimating the AOR (NCPA, October 1993; Hilmar Cheese, September 17, 2004). This method compares the injection amounts with the porosity and storage volume in the injection zone. Inherent in the methodology is the assumption that the injection fluid will fill an expanding cylinder away from the injection well, assuming horizontal flow and reasonable estimates of dispersion (Engineering Enterprises, May 1985). This method estimates the fluid front radius only and does not consider the pressure buildup that defines the ZEI. As such, it has been suggested that the method should not be used for AOR delineation (Engineering Enterprises, May 1985). However, it is provided here as an additional check for estimating minimum requirements for storage volume in the injection zone and the possible movement of the injected fluid.

$$R = (V / (23.4 \times H \times P))^{1/2}$$

where:            R = radius of invaded zone from the well, in feet  
                       V = volume injected, in gallons  
                       H = height (thickness) of the injection zone, in feet  
                       P = percent porosity of the aquifer

using:            V = 2,186,496,000 gallons (208 gpm for 20 years)  
                       H = 372 feet (Miocene target zone - mapping and nearby logs)  
                               267 feet (Cretaceous target zone - mapping and nearby logs)  
                       P = 0.30 (Miocene target zone – Sonic log 1.75 miles SE)  
                               0.17 (Cretaceous target zone – Sonic log 1.75 miles SE)

Miocene Target Zone, R = 916 feet  
 Cretaceous Target Zone, R = 1,437 feet

Correcting for dispersion with a dispersion coefficient for sandstone, the following equation is used:

$$r' = r + (2.3 \times (D \times r)^{1/2})$$

where:  
                       r' = radius of invaded zone with dispersion, in feet

r = 100 percent invaded zone – from calculation above  
D = dispersion coefficient – 3 feet (Warner and Lehr, 1981)

Miocene Target Zone, R = 1,001 feet  
Cretaceous Target Zone, R = 1,543 feet

These calculations indicate that if the total volume of injected fluid moves uniformly and radially away from the well, the injectate front is predicted to be approximately 1,001 feet away from the well in the Miocene target zone after 20 years of injection. If the Cretaceous target zone is selected, the front is predicted to migrate approximately 1,543 feet away from the well after 20 years. Migration is further in the Cretaceous due to the lower porosity and thinner sand interval, resulting in less storage space.

### ***Estimated Area of Review (AOR) – Theis Equation Method***

A modified version of the Theis well pumping equation is offered in the UIC regulations for a conservative calculation of the ZEI and AOR (40 CFR Part 146, Subpart A, Section 146.6). The methodology relies on reasonable estimates for injection zone parameters such as hydraulic conductivity, thickness, storativity, and hydrostatic heads, as well as injection rates and duration (Engineering Enterprises, May 1985). The equation is applied with the assumption that when the potentiometric surface of the injection cone is higher than the hydrostatic head of the USDW, there is a higher potential for possible impacts, *assuming a vertical pathway for injectate to reach USDW*.

The modified Theis equation is as follows:

$$r = (2.25KHt / S10^x)^{1/2}$$

where:

r = radius of endangering influence from injection well (ZEI) (length)

K = hydraulic conductivity of the injection zone (length/time)

H = thickness of the injection zone (length)

t = duration of injection, project life (time)

S = storage coefficient (dimensionless)

x =  $(4 \pi KH) (h_w - h_{bo} * S_p G_b) / 2.3Q$

Q = injection rate (volume/time)

$h_w$  = hydrostatic head of USDW (length) measured from the base of the USDW

$h_{bo}$  = observed original hydrostatic head of injection zone (length) measured from the base of the USDW

$S_p G_b$  = specific gravity of fluid in the injection zone (dimensionless)

A major assumption in this calculation is that there is a vertical pathway for USDWs to be impacted. For consistent units, input parameters in length, volume, and time are expressed as feet, cubic feet, and days.

The injection rate (Q) is calculated from the maximum amount of wastewater that will require disposal, currently estimated at 300,000 gallons per day (gpd) or 40,107 cubic feet per day (ft<sup>3</sup>/day). Additional treatment may lower this amount by about one-half. In addition, this injection rate will not be reached until several years after resuming operation. Nonetheless, the maximum capacity over a 20-year project life (t=7,300 days) is conservatively assumed in the calculations. These two parameters, Q and t, are held constant for the separate calculations for the two potential target injection zones. A specific gravity of one is assumed for the injection fluid.

Input parameters that are specific to the hydrogeologic conditions are developed for each target zone using site-specific data where available or reasonable estimates. Storativity is estimated using an empirical relationship based on the target injection zone thicknesses and confined aquifers where zone thickness is multiplied by 10<sup>-6</sup> (Engineering Enterprises, May 1985; Warner and Lehr, 1981). The Miocene zone is 372 feet thick and the Cretaceous zone is 267 feet thick (documentation provided in Attachment F). Based on these values, storativity (S) values are calculated at 3.7 x 10<sup>-4</sup> and 2.7 x 10<sup>-4</sup> for the Miocene and Cretaceous zones, respectively.

A value for hydraulic conductivity (K) for the Cretaceous Tracy Sand is converted from permeability data of 117 millidarcies (md) for this sand in the McMullin Gas field, located approximately five miles south of the CSC site (CDOG, 1982; included in Supporting Documentation attached to this application). This published permeability of 117 md (0.117 darcy) is converted to a hydraulic conductivity of 0.32 feet/day using the conversion factor of 1 darcy = 2.725 feet/day (Warner and Lehr, 1981). This permeability is consistent with the 100 md value used by SMS Briners for the equivalent Starkey Sand in their Class I UIC permit application (SMS Briners, September 1991). The SMS Briners' permeability estimate was based on core data in the injection zone.

Permeability values are unavailable for the target Miocene Sand. DWR (1967) reports a regional transmissivity value of 68,000 gallons per day per foot (gpd/ft) for the Miocene Mehrten, which converts to a K value of about 24 feet/day (based on a thickness of 372 feet). The K value for the Mehrten formation is considered to be a good surrogate for the target sand, given that the sands are the same age and were sourced from the same parent rock. However, the DWR regional K value is based on wells producing from the Mehrten outside of the study area and the permeability in this area would be expected to be lower, given its deeper depth. DWR (1967) reports Mehrten permeability values about 20 miles northeast of the CSC site, near the Farmington Control Dam. These values range from 0.01 feet/day to 50 feet/day. The electric log response of the target Miocene Sand indicates a permeable sand package as shown, in part, by the relatively large negative deflection of the SP curve (up to -40 millivolts from an average shale baseline, see type log in Supporting Documentation). Additional information relating to the Miocene permeability is the measured value in the much deeper Tracy Sand of 117 md (0.32 feet/day). The Miocene would be expected to have a much higher permeability, given the younger age, shallower depth of about 2,000 feet (compared to the Cretaceous Tracy Sand depth of 5,235 feet), and thick sand development as indicated by the electric logs in



the area. Considering all of the information discussed, it seems reasonable to assume that the Miocene permeability is at least one order of magnitude lower than the highest reported Miocene permeability (50 feet/day or 20,000 md) and one order of magnitude higher than the Cretaceous Tracy Sand of 117 md. As such, a permeability of 1 darcy (1,000 md) or a K of 2.7 ft/day is used for the Miocene target injection zone in the AOR calculation.

Hydrostatic head data for the USDW ( $h_w$ ) or the injection zone ( $h_{bo}$ ) are not available and are difficult to estimate. The hydrostatic head, (i.e. the height to which groundwater rises in a well completed in a confined aquifer) is the sum of the pressure head and elevation head (Todd, 2004; Fetter, 1988). Some of the factors considered in the head estimation are outlined below.

From a regional perspective, the geologic formations of the USDWs and the Miocene target injection zone both outcrop in the foothills of the Sierra Nevada to the east, controlling the elevation head. As water pressure increases toward the center portion of the basin, hydrostatic heads may increase with depth. This regional condition may be altered somewhat due to the outlets of the USDW and the target zones as water moves out of the basin. Groundwater production is not occurring from either target zone so the hydrostatic head is likely unimpacted from pumping. Although the shallow USDWs are pumped in the area, the deeper USDWs are confined and the impact from pumping is assumed to be less with depth.

Given this uncertainty, various trial inputs of hydrostatic head were used in the equation to determine the sensitivity of the AOR calculation to head. Since the equation only applies the difference in the hydrostatic heads, actual head estimates are not required. Using the estimated input parameters summarized in the following table, the ZEI (and AOR) can be estimated for each of the two target zones for several estimates of  $h_w - h_{bo}$ .

Parameter	Miocene Target Zone	Cretaceous Target Zone
K, feet/day	2.7	0.3
H, feet	372	267
t, days	7,300	7,300
S, dimensionless	$3.7 \times 10^{-4}$	$2.7 \times 10^{-4}$
Q, cubic feet/day	40,106.95	40,106.95
$S_p G_b$ , dimensionless	1	1
$h_w - h_{bo}$ , feet	32	335
Solve for r:	1,310	1,266
$h_w - h_{bo}$ , feet	28	274
Solve for r:	2,474	2,617
$h_w - h_{bo}$ , feet	25	233
Solve for r:	3,985	4,264

As shown in the three calculations for r above, results are sensitive to estimates of  $h_w - h_{bo}$ . Much larger differences in head are required in the Cretaceous zone to produce

the same r, but larger differences are more likely due the larger vertical distance between the Cretaceous and the USDW base (3,462 feet) compared to the Miocene target (372 feet). As shown from the calculations, an AOR of less than 0.25 mile (1,310 feet) is supported by a difference in heads of only 32 feet in the Miocene and 335 feet in the Cretaceous. For an AOR of about 0.5 miles, a head difference of about 28 feet should exist between the Miocene and the USDW and a head difference of 274 feet between the Cretaceous and the USDW. The required head differences drop further when evaluating an AOR that extends to the closest deep well (about 4,385 feet), which has been abandoned. To support an AOR less than that distance, head differences of only 25 feet and 233 feet are required for the Miocene and Cretaceous sands, respectively.

Again, this calculation assumes that there is a possible vertical pathway to the USDW, a condition that does not exist at this site at a distance less than 4,385 feet. As explained in Attachment F, there is a 250 foot thick confining layer above the Miocene target that is laterally continuous for at least several miles around the site. There are no faults or other natural conduits within 0.5 miles that have been identified that could transport injectate into USDWs. The only identified pathway within at least one mile of the site is the presence of two abandoned gas exploration wells that penetrate the target zones and are located about 4,400 feet from the CSC proposed injection well. To further analyze potential impacts at these wells, additional calculations to estimate pressure changes at the abandoned well locations are presented in the following section.

### ***Estimated Area of Review – Pressure Wave Calculation Method***

In order to estimate the increase in formation pressure resulting from the injection project at specific times and distances from the injection well, an equation provided by Warner and Lehr (1981) was used. This equation assumes that the system has reached steady state from injection, an assumption applicable to this project because impacts are analyzed for a long time (20 years) after injection is initiated. The equation used in this calculation, along with inputs for both Miocene and Cretaceous injection targets, is provided below.

$$P(r,t) = (P_i + (162.6Qu)/(kh)) (\log t + \log(k/(pu\alpha r^2))) - 3.23 + 0.87s$$

where:

P(r,t) = pressure as function of distance from the injection well and time since injection began, psi

P<sub>i</sub> = initial reservoir pressure, psi

Q = flow rate, bbls/day

u = viscosity of injectate, cp

k = permeability, md

h = reservoir thickness, feet

t = time, hours

p = porosity, fraction

c = compressibility, v/v/psi  
 r = radial distance, feet  
 s = well efficiency, considered negligible for this example

using:

Pi = 870.3 psi (Miocene target 2,010 feet x 0.433 psi/ft)  
 2,266.7 psi (Cretaceous target 5,235 feet x 0.433 psi/ft)  
 Q = 7,131.4 bbls/day (both injection targets)  
 u = 1 cp (both injection targets)  
 k = 1,000 md (Miocene target)  
 117 md (Cretaceous target)  
 h = 372 feet (Miocene target)  
 267 feet (Cretaceous target)  
 t = 175,200 hours (hours in 20 years for both injection targets)  
 p = 0.30 (Miocene target)  
 0.17 (Cretaceous target)  
 c = 0.000003, dimensionless (Warner and Lehr, 1981 for both targets)  
 r = up to 5,000 feet including a calculation at 4,400 feet (distance to closest deep well)

Solving the above equation for various distances (r) from the injection well and subtracting the initial pressure from the total pressure, the increase in pressure due to 20 years of injection at 208 gpm is predicted as follows:

Distance from injection well, r	Increase in pressure in Miocene Sand	Increase in pressure in Cretaceous Sand
1,000 feet	16 psi	163 psi
2,000 feet	14 psi	140 psi
3,000 feet	13 psi	127 psi
4,000 feet	12 psi	118 psi
4,400 feet	12 psi	115 psi
5,000 feet	11 psi	111 psi

As shown above, the increase in pressure 5,000 feet from the injection well after 20 years of injection is either approximately 11 psi in the Miocene Sand or 111 psi in the Cretaceous Sand, depending on the completion zone. Assuming an AOR of 0.5 mile (2,640 feet), predicted pressure increases are about 13 psi and 131 psi for the Miocene target and the Cretaceous target, respectively.

The order of magnitude increase in the Cretaceous Sand pressure is primarily controlled by the order of magnitude decrease in permeability. Again, the permeability of the Cretaceous Sand has been measured in nearby gas fields (Supporting Documentation). The permeability of the Miocene Sand is less certain, however, it is reasonable to assume a much higher permeability given the much shallower depth, younger age, and permeable character on electric logs. Even if the Miocene Sand permeability was reduced by one half from the current estimate (1,000 md to 500 md),

the pressure increase at 4,400 feet from the injection well (distance to the closest well) would only be 22 psi, still a relatively small increase.

As previously mentioned, the only two wells within about 1.5 miles of the proposed CSC injection site are the Quintana S.P. No. 1 well, which is about 4,385 feet southwest, and the Pan Petroleum Hayre Egg Farms No. 1 well, which is about 4,520 feet northeast. Using the equation and values discussed above, the predicted pressure increases at the abandoned wells are only about 12 psi from injection into the Miocene Sand and about 115 psi from injection into the Cretaceous Sand using a distance of 4,400 feet from the injection well (see table above).

As shown in more detail in Attachment C, the weight of the fluid in the abandoned wells would prevent fluid migration, given these ranges of pressures. Borehole fluids (mud) in the Quintana and Pan Petroleum wells have pressures of 87 pounds per cubic foot (ppcf) and 78 ppcf, respectively. These provide pressures of 1,078 psi and 1,050 psi for the two wells at the Miocene level, and 3,166 psi and 2,745 psi for the two wells at the Cretaceous level. Subtracting formation pressures from the mud pressures results in 303 psi and 288 psi at the Miocene level and 840 psi and 545 psi at the Cretaceous level for the Quintana and Pan Petroleum wells, respectively. Injection pressures are anticipated to be much lower than these calculated pressures in the abandoned wells. Abandonment procedures for the two wells are provided in Attachment C and in the Supporting Documentation included with this application. Given the abandonment procedures and mud weights in the two abandoned wells, these pressures are not expected to impact USDWs.

### **Area of Review Selection**

Until the injection well is drilled and tested, there are unknowns associated with all of the methods used to determine a reasonable AOR. However, using reasonable input estimates, all of the calculations support an AOR of less than 0.5 mile. Permit applications at three UIC well sites in San Joaquin County were reviewed to determine the respective AORs chosen at these facilities after the injection wells were drilled and site-specific conditions were better known. The AORs are summarized below:

<b>UIC Class I Permit Applicant</b>	<b>Distance from CSC Site</b>	<b>Target Injection Zone</b>	<b>Area of Review (AOR)</b>
San Joaquin CoGen	2.5 miles southwest	Cretaceous sand	0.25 mile
SMS Briners	11 miles northeast	Cretaceous sand	0.25 mile
NCPA	19 miles northwest	Eocene sand	1 mile*

\*AOR for NCPA was arbitrarily expanded to the closest well. All calculations supported <0.25 mile.

Because of the many uncertainties that cannot be presently addressed, a conservative (relatively large) AOR of 0.5 mile is selected with respect to providing detailed information on wells and other possible pathways for injection fluids. This will ensure a conservative AOR, even in the unlikely event that site-specific data from injection well testing supports enlarging the AOR from previous calculations. As such, an

AOR of 0.5 mile from the location of the proposed injection well is used in the remainder of this permit application.

## **ATTACHMENT B - Maps Of Well/Area and Area Of Review**

### ***Requirements***

This attachment provides information on the physical setting in the vicinity of the proposed injection well and information on wells and water features to ensure that the project poses no risk to drinking water supplies. At a minimum, a topographic map that extends one mile beyond the property boundaries must be included. Maps must include the intake and discharge structures and all hazardous waste treatment, storage, or disposal facilities. Within the AOR, wells, surface water bodies, and other pertinent features must be shown on a map. The map must also identify drinking water wells within one quarter mile of the facility or in the AOR. However, only public information is required to be placed on the map.

### ***Physical Setting and Surface Water Features***

The CSC site is located approximately three miles northwest of the City of Manteca and one mile northeast of the City of Lathrop in south-central San Joaquin County (Figure 1). The topography is generally flat to gently sloping to the west toward the San Joaquin River, located about 3.5 miles west of the site. Natural ground surface elevations are approximately 20 to 23 feet above mean sea level (msl) at the site. Several shallow basins have been excavated on the western and northern portions of the site associated with former wastewater treatment and disposal (Figure 2).

The only natural surface water feature in the area is the San Joaquin River (Figure 1). The river drains the southern San Joaquin Valley and flows northward toward the Sacramento-San Joaquin Delta and ultimately into San Francisco Bay. The site is bounded on the west and south by irrigation drainage canals operated by the South San Joaquin Irrigation District (SSJID) (Figure 2). Additional canals associated with the SSJID canal distribution system cross the general area (Figures 1 and 2). Onsite stormwater currently drains westward to a series of onsite ponds associated with the former wastewater treatment system.

The San Joaquin Valley has a semi-arid climate and the site receives about 14 inches of precipitation each year (URS, May 2005). More than 80 percent of the precipitation falls from November to April.

Land use around the CSC site is predominantly agricultural with industrial facilities to the west and south. Adjacent to the site on the west is the Defense Distribution Depot San Joaquin, California Sharpe military facility (a.k.a. Sharpe Army Depot or DDJC-Sharpe) (Figure 1). Some of the surrounding land is being converted

from agricultural to residential as the nearby cities of Manteca and Lathrop continue to grow (Figure 1).

Two water supply wells exist on the CSC site (Figure 2). One well, on the southeastern portion of the site, was drilled in 1972 to a depth of 160 feet. Records are unavailable for the second well, which is located on the south-central portion of the site and used only for backup and fire protection. Three shallow monitoring wells have been installed on the northern parcel of the property to monitor impacts to groundwater from former land application of wastewater (Figure 2).

## ***Wells Within Area of Review***

Because groundwater serves as a source of municipal, domestic, and irrigation water supply, there are more than 600 water supply wells that have been drilled within 2.5 miles of the project. In addition, nearby industrial facilities, including the former owner of the CSC site, have installed a total of more than 400 wells to monitor and/or extract shallow contaminated groundwater. The occurrence of hydrocarbons in nearby gas fields have resulted in eight gas exploratory wells drilled within about two miles of the site. None of these wells are currently producing gas. With the exception of seven of the exploratory gas wells (all abandoned), none of the wells have penetrated the target injection zones.

According to the public records compiled from eight separate sources, wells within the 0.5-mile AOR include following:

- 12 water supply wells
- 1 abandoned gas exploration well
- 14 monitoring wells.

These wells in the AOR are shown on Figure 3 and are summarized in Table 1. Well data compiled both inside and in the vicinity of the AOR are described in more detail below.

## ***Water Supply Wells***

Local permitting agencies for water supply wells in California require that drillers submit a Water Well Drillers report to the Department of Water Resources (DWR) for all water supply wells drilled in the state, including domestic, municipal, industrial, and irrigation wells (Water Code Section 13752). Although these records are not available to private parties due to confidentiality requirements, public agencies can allow access to the records for specific uses. In support of this project, the Central Valley Regional Water Quality Control Board (CVRWQCB) allowed access to well records within an approximate 2.5 mile radius around the site. According to the DWR records, more than 600 water wells have been drilled within this area, although well depths are significantly shallower than the target injection zones. None of the wells produce drinking water below

400 feet. Only six wells out of the 600 wells in the DWR records were drilled below 400 feet (several of these were abandoned test holes) and only two of the six were drilled below 500 feet. The two wells below 500 feet were drilled on the former Occidental Chemicals facility for wastewater injection to total depths of 504 feet and 510 feet. Wells from the DWR records were plotted on the map both inside the 0.5-mile AOR and an additional mile outside the AOR (Figure 3). Well locations were not field checked and are approximate since most of the DWR well records do not contain detailed location data. However, by plotting wells in a much larger area than the AOR, it is reasonable to assume that all wells on file with DWR in the AOR have been reasonably identified. Since none of the wells within an approximate 2.5 mile radius penetrate either of the injection zones, approximate locations were determined to be sufficient for the purposes of this evaluation.

Although the DWR records contained information for hundreds of wells in the site vicinity, records from CVRWQCB documents indicated that several known wells appeared to be missing in the DWR files. In order to ensure a more accurate accounting of wells in the area, additional documents and data were compiled from the following sources to supplement the DWR data.

- City of Stockton
- City of Lathrop
- City of Manteca
- San Joaquin County
- Former Occidental Chemicals (documents accessed through the CVRWQCB)
- Defense Distribution Depot San Joaquin Sharpe site (DDJC-Sharpe)

Although many of these wells were outside of the AOR, they were considered in this evaluation for completeness. A summary of the well data is provided below.

**City of Stockton** – The City of Stockton is located approximately six miles north of the project site and provides municipal water supply to residents through a combination of groundwater wells and surface water deliveries that are organized into three service areas. The South Stockton service area is the closest to the proposed injection well with the southern boundary located along Roth Road, approximately 1.5 miles north of the site. Well depths within the service area range from 172 feet to 625 feet (West Yost, 2004). The closest well to the project site is located approximately 3.75 miles to the northeast and is 429 feet deep (West Yost, 2004), outside of the AOR.

**City of Lathrop** – The CSC property is located east and north of the City of Lathrop's water service area. The City has historically relied on groundwater for its municipal water supply and currently pumps from four active wells (Nolte, 2001; City of Lathrop, personal communication, July 26, 2005). None of these wells are in the AOR. Wells are completed in the Victor and Laguna formations with casing depths from 270 feet to 282 feet. The closest well to the CSC site is approximately 6,000 feet to the southwest and is completed to a depth of 270 feet (Nolte, 2001). Three additional wells are planned, but



they will be more than a mile away from the site and will not be drilled below about 300 feet (City of Lathrop, personal communication, July 26, 2005).

**City of Manteca** – The City of Manteca water system consists of 16 active groundwater wells completed to depths ranging from 100 feet to 400 feet (City of Manteca, personal communication, July 22, 2005 and July 25, 2005). The City wells closest to the site are Well No. 23 and Well No. 12, approximately 4,900 feet and 9,800 feet to the southwest, respectively (Kennedy/Jenks, December 30, 2002). An additional unnamed test well has been drilled approximately 6,700 feet east (near the intersection of Lathrop and Union roads) for the new Union Ranch development. A new City well may be drilled at that location in the near future (City of Manteca, personal communication, July 22, 2005). No City wells have been drilled deeper than 425 feet due to increasing salinity below that depth (City of Manteca, July 25, 2005, and personal communication, July 22, 2005).

### ***Monitoring Wells***

**CSC Site** – There have been five shallow groundwater monitoring wells installed to depths of 30 feet on and off of the site. Four of the five wells are within the AOR. These wells were installed in 2000 in response to regulatory requirements for monitoring percolation of treated wastewater at the site. Two of the wells were drilled on agricultural parcels east of the facility owned by the previous site operator. This parcel does not belong to the current CSC owners. Three additional wells were drilled on the northern parcel of the current site to monitor onsite percolation ponds. Water levels from these wells were used to assess local groundwater flow in the drinking water aquifers.

**DDJC Sharpe** – The Defense Distribution Depot San Joaquin Sharpe Site (Sharpe) is an active storage and distribution facility serving the U.S. military in the western U.S. and throughout the Pacific Region (CVRWQCB, June 9, 2004). The facility was first established in 1940 and covers 720 acres west of the project site. The Sharpe site is adjacent to the western parcel boundary of the CSC site, separated by an agricultural distribution canal. More than 300 wells have been drilled on the facility to investigate and remediate groundwater contamination. These wells consist of 212 monitoring wells, 45 extraction wells, 10 injection wells, 6 observation wells for injection, and 40 piezometers (URS, May 2005). Ten monitoring wells and piezometers are within the AOR.

Most of the monitoring, extraction, and injection wells target aquifers from the water table down to about 200 feet. Only 11 monitoring wells have been drilled to depths greater than 200 feet and none were drilled deeper than 300 feet (URS, May 2005). Piezometers are completed at the water table and are generally shallower than 30 feet. The deepest wells in the Sharpe monitoring program are offsite production wells that have total depths ranging from 100 feet to 375 feet deep (URS, May 2005). The deepest well within the AOR is 113 feet.

**Former Occidental Chemicals** – The former Occidental Chemical Corporation facility, located on 341 acres approximately 1.7 miles southwest of the project site, has manufactured fertilizers and pesticides since 1952 (CVRWQCB, no date 2004). Soil and groundwater has been impacted with various chemicals including 1,2-dibromo-3-chloropropane (DBCP), ethylene dibromide (EDB), solfolane, and several inorganic constituents. As a result of documented groundwater contamination, more than 60 monitoring wells, 8 extraction wells, and 2 injection wells have been installed at this facility (CVRWQCB, no date 2004). None of these wells are within the AOR and none have been drilled deeper than 510 feet.

## ***Injection Wells***

**DDJC - Sharpe** - As a result of groundwater contamination at the site, groundwater is being extracted, treated and re-injected back into the groundwater system. Ten injection wells have been installed in the central portion of the site. Wells are screened over various shallow aquifers from depths of 22 feet to 152 feet (URS, July 29, 2005).

**Former Occidental Chemicals** – At the former Occidental Chemicals facility, two injection wells receive treated effluent from the facility’s groundwater extraction and treatment program for the remediation of groundwater contamination. The two injection wells, IW-1 and IW-2, are located on the western and southwestern portions of the property and are drilled to depths of 504 feet and 510 feet, respectively. Injection zones are screened in various sand intervals from depths of 300 feet to 496 feet. Neither well is in the AOR.

**San Joaquin CoGen (abandoned)** – This facility, located 2.5 miles southwest of the project site, installed a deep UIC injection well in January 1990 to dispose of wastewater associated with electricity generation (San Joaquin CoGen, November 1988). The well was drilled to a depth of 9,646 feet and completed as a Class I non-hazardous UIC injection well in the Lathrop sands from 9,585 feet to 8,574 feet. The injection well could not take sufficient quantities of wastewater and was essentially idle until 1993 when the well was plugged back and re-completed in shallower Cretaceous sands at approximately 4,600 feet. Due in part to the low permeability of the sands, sufficient injection capacity was never established and the well was properly abandoned in 2003 (CDOG May 19, 2005).

## ***Oil and Gas Wells***

Information on gas exploration and production wells in and surrounding the local gas fields was obtained from the California Division of Oil and Gas (CDOG) and supplemented with DWR well files. One well in the DWR files may have been drilled within the AOR although the exact location is not documented. This well was drilled by an unknown party for the exploration of gas in 1888. The section-township-range location indicates that the well was drilled within a mile of the CSC site. The well was

apparently drilled to a total depth of 1,042 feet and recovered small amounts of gas and salt water before being abandoned. Although abandonment procedures of the well are unknown given its early date, the well depth is not sufficient to have penetrated the target injection zones or the upper confining layers, and as such, the abandoned well is not considered a risk for vertical migration. The well record is included in the Supporting Documentation attached to this application.

The two closest wells to penetrate the target injection zones, Quintana S.P. No. 1 and Pan Petroleum Hayre Egg Farms No. 1, are located approximately 4,385 feet southwest and 4,520 feet northeast of the proposed CSC injection well, respectively (Figure 3). Both of these wells were abandoned when petroleum reserves were not found in commercial quantities. Wells were properly plugged according to the CDOG requirements. Additional well data and plugging information are provided in Attachment C.

Additional gas exploration wells have been drilled outside the AOR and were used to interpret the regional geology and prepare the target injection zone maps. Data from 20 wells within about 4 miles of the site were used in the interpretations in Attachment F. These wells are labeled on Figure 1.

# **ATTACHMENT C – Corrective Action Plan and Well Data**

## ***Requirements***

This attachment requires a tabulation of well data for all wells within the AOR that penetrate the target injection zones. The table must include the well type, construction data, location, depth, date drilled, and records of plugging and/or completion. A corrective action plan must be proposed under 40 CFR 144.55 if any of these wells have not been properly plugged to prevent the migration of injectate through improperly sealed wellbores into the overlying USDW. As provided in 40 CFR 146.7, the following criteria shall be considered in determining the adequacy of any corrective action plan:

- Nature and volume of injected fluid
- Nature of native fluids or by-products of injection
- Potentially affected population
- Geology
- Hydrology
- History of the injection operation
- Completion and plugging records
- Abandonment procedures in effect at the time the well was abandoned
- Hydraulic connections with USDW.

## ***Closest Wells Penetrating the Target Injection Zones***

As discussed in Attachment B, no wells have been identified within the 0.5 mile AOR that have penetrated the target injection zones. Only seven wells within a two-mile radius have penetrated the target injection zones. Information and plugging data for those wells are summarized on Table 2.

As shown on Table 2, the closest deep wells are located approximately 4,385 feet southwest (Quintana SP No. 1 well) and 4,520 feet to the north (Pan Petroleum Hayre Egg Farms No. 1 well) (Figures 1 and 3). The analysis in Attachment A indicated that no impacts to USDWs would result from these wells. To further illustrate the details of the plugged wells, a schematic cross section is shown on Figure 4. Abandonment records obtained from the CDOG are provided in the supporting documentation attached to this submittal.

Figure 4 illustrates the depth relationships between the target injection zones in the proposed injection well and the plugs located in the two closest deep wells. As shown the S.P. No. 1 well lowermost plug separates the alternative target injection zone in the Cretaceous from USDWs. The upper plugs in both wells at approximately 1,000 feet

separate the base of the fresh water aquifers (TDS <2,000 mg/L) at approximately 570 feet (elevation -550 below msl) from both target injection zones (more information on the base of fresh water provided in Attachment D). Although the plugs do not separate the Miocene target from the estimated base of the USDW, the mud weight, confining layer, and distance from the injection well assure no impacts to USDWs from injection, given the anticipated pressures increases from injection as calculated in Attachment B.

### ***Corrective Action Plan***

Since no known wells within the AOR have penetrated the zones of injection, no corrective action plan is required under 40 CFR 144.55. Data collected during the drilling and testing process will be used to confirm the current assumptions.

## **ATTACHMENT D – Maps and Cross Sections of USDW**

### ***Requirements***

All Underground Sources of Drinking Water (USDWs) are to be defined using geologic maps and cross sections that delineate the vertical and horizontal limits of USDW in the AOR. The occurrence of groundwater and the direction of flow in the USDW, where known, shall be described. Cross sections shall also depict the vertical location of USDW relative to the injection formation.

### ***Estimation of the Base of USDW***

USDWs are defined by the UIC regulations as aquifers containing groundwater with a TDS value below 10,000 mg/L. In this area, the base of the USDW has not been defined. Shallow drinking water aquifers above about 300 feet produce fresh water to wells with TDS values below 500 mg/L. Some TDS data are available in the area down to about 500 feet. Data are also available from the deeper Cretaceous-age marine sands, indicating TDS concentrations greater than 10,000 mg/L below 3,500 feet in this area. However, water quality data are unavailable between about 500 feet and 3,500 feet. To determine the base of the USDW, regional geologic and hydrogeologic information was used. An approximate depth of 1,800 feet for the base of the USDW beneath the CSC site was selected as explained in more detail in the following sections.

### ***Geologic and Hydrogeologic Setting***

The CSC site is located in south-central San Joaquin County in the northern portion of the San Joaquin Valley of California. This valley has been filled with thousands of feet of Tertiary and Quaternary sediments sourced from the consolidated rocks of the Sierra Nevada to the east and the Coast Range rocks to the west. The geologic map on Figure 5 identifies the geologic formation names of these sediments and shows the extent of the valley around the CSC site, marked predominantly by the Quaternary aged deposits (“Q” abbreviations on Figure 5). The Jurassic rocks of the Sierra Nevada on the northeast (Jgo and Jch) and the Jurassic and Cretaceous rocks of the Coast Range on the southwest (Kjf) extend beneath the valley and form the basement complex of the sedimentary basin.

Because the Sierra Nevada mountain-building processes pre-dated the rising of the Coast Ranges, deposition through at least Cretaceous time was predominantly marine (Norris and Webb, 1990). The rising of the Coast Ranges ultimately cut off the valley’s outlet to the ocean and resulted in increasing non-marine deposition throughout most of the Tertiary and Quaternary. Shallow brackish and freshwater lakes resulted in deposition

of widespread clays throughout the valley during the Tertiary, including the Corcoran Clay, which appears to extend into the study area south of the CSC site. Shallow sediments down to these lacustrine clays at about 500 feet are used in the area for water supply.

The CSC site is located in the Eastern San Joaquin subbasin of the larger San Joaquin Valley groundwater basin (DWR, March 5, 2003). The subbasin covers more than 1,000 square miles and is bounded by the San Joaquin River on the west, the Stanislaus River on the south, and the Mokelumne River on the north. The eastern subbasin boundary is the intersection of the alluvium with the consolidated rocks of the Sierra Nevada foothills. Groundwater occurs in the unconsolidated alluvial deposits beneath this basin under unconfined conditions and becomes more confined with depth.

### ***Aquifers and Hydrostratigraphy***

Local nomenclature of the geologic units and hydrostratigraphy beneath the CSC site are summarized on Figure 6. The stratigraphic column presented on Figure 6 was slightly modified from DWR (1955) to better reflect project-specific conditions. The main aquifers that provide water supply in the subbasin are comprised of the Quaternary and Upper Tertiary (Pliocene) sediments that extend below the site at an approximate depth of 1,000 feet. These sediments include various recent alluvial deposits as well as the Modesto, Riverbank, and Victor formations of Quaternary age and the Laguna formation of Tertiary age. Salinity increases with depth and limits water use at about 500 feet. The underlying Mehrten formation of Miocene age is considered to provide suitable water supply in some portions of the groundwater basin, but is limited by water quality problems in the study area (Figure 6) (DWR, 1955, 1967).

The Modesto and Riverbank formations and other Quaternary alluvial deposits are exposed on the surface at the CSC site and east of the site (Qm, Qr, and Qs on Figure 5) (Wagner, et. al., 1991). These sediments are Recent to Late Pleistocene in age and consist of dune sands, alluvial fans and inter-fan deposits sourced from the east. Maximum thicknesses of about 150 feet are recorded near the central portion of the basin near the CSC site (DWR, March 5, 2003). Geologic investigations at the Occidental Chemical facility show interbeds of sand and silty clay (assumed to be mostly the Modesto formation) down to about 200 feet, where a 10- to 50-foot clay layer has been mapped. The clay is interpreted to be the northern extension of the Pleistocene Corcoran Clay or the equivalent (Figure 6) (Franks, 1981; The Source Group, July 18, 2002).

The Laguna formation is Plio-Pleistocene in age and provides water for most of the supply wells in the area. Sands and gravels from stream deposition result in high permeability and productive wells. However, the heterogeneous nature of the deposits results in local confining units. DWR mapping indicates that the Laguna extends to a depth of around 1,000 feet beneath the CSC site and is the lowermost aquifer containing fresh water. TDS concentrations are <2,000 mg/L in the upper portions of this formation.

The Miocene-age Mehrten formation lies below the fresh water aquifers. The Mehrten is typically a well-indurated andesitic sandstone, but varies in lithology. Interbeds of conglomerate, tuffaceous siltstone, and claystone have been mapped in the formation (DWR, March 5, 2003). Groundwater in the Mehrten is assumed to be confined in this area of the basin. The Mehrten formation is reported to be approximately 600 to 800 feet thick in the vicinity of the CSC site (DWR, 1967). Using nearby electric logs and other data, the Mehrten is interpreted to occur at about 1,000 feet beneath the CSC site and extends to an approximate depth of 1,800 feet (CDOG, May 19, 2005; DWR, 1967). Although the Mehrten contains fresh water north of the Stockton Arch, it is considered “saline” for drinking water purposes in this area (DWR, 1967). This observation and other data (discussed in subsequent sections) indicate that the Mehrten is likely the lowermost USDW in the area.

Below the Mehrten formation is the Valley Springs formation, also Miocene in age (Figure 6). The Valley Springs is considered to contain saline water and has not been developed for water supply in the area (DWR, 1967; DWR, March 5, 2003). Available data indicate that the Valley Springs formation has TDS above 10,000 mg/L (discussed in more detail in following sections) and, therefore, is below USDWs.

The exact thickness of the Valley Springs or the age of the sediments underlying this formation is not known. Thicker sections of Eocene and Paleocene sediments exist north of the Stockton Arch and south of the study area in the central San Joaquin Valley, but these sediments have been interpreted to be either thin or missing in this area. (Figure 6; additional information provided in Attachment F). Most investigations south of the site do not differentiate between Paleocene and upper Cretaceous ages for the sediments between about 2,300 feet and 3,500 feet. The main Cretaceous unconformity is mapped at a depth of about 3,500 feet in this area with marine-deposited sediments extending below the unconformity to thicknesses in excess of 8,500 feet (CDOG, May 19, 2005, Figure 6). Data from nearby gas fields indicate that the Cretaceous age sediments have TDS concentrations above 10,000 mg/L (CDOG, 1982).

A cross section of USDWs discussed above is included on Figure 7. The section was prepared by DWR (1967) and has been modified below -800 feet to show the Mehrten formation top below the projected location of the CSC injection well. The base of the Mehrten is assumed to be the base of the USDW in this area as discussed in the following sections.

## **Water Levels**

Groundwater occurs at a relatively shallow depth of approximately 20 feet in the study area. Water level data have been monitored by DWR at a well within about two miles of the site since the 1970s (DWR, July 31, 2005). Data are plotted over time to illustrate the trends and fluctuations of water levels in the area (Figure 8). As shown on the hydrograph, water levels illustrate an overall decline in the last 30 years from an elevation of 22 feet above msl in 1973 to about 9 feet above msl in 2005, although levels



have stabilized to some degree over the last 10 years. This overall trend in water levels has been registered throughout the County and results from over-pumping of the groundwater basin (San Joaquin County, September 2004). Water levels have declined significantly during drought cycles (e.g., 1987 to 1992) and recovered during times of increased precipitation (e.g., 1978 to 1986). In 2004, water levels beneath the adjacent Sharpe facility ranged from about 12 feet above msl in the water table aquifer to about -8 feet below msl in deeper aquifers (URS, May 2005).

## ***Groundwater Flow Directions***

Prior to groundwater development for agriculture, regional groundwater flow in the area was westerly toward the San Joaquin River and then northward toward the Sacramento-San Joaquin delta. However, pumping has occurred in the groundwater basin dating back to the mid-1800s and groundwater flow patterns have been altered significantly since that time (San Joaquin County, September 2004). Due to over-pumping in the central portion of the County, especially east of Stockton, large water level declines have changed groundwater flow directions toward the central County.

This pattern is illustrated on County-wide water level contour maps prepared through a cooperative monitoring program by the U.S. Geological Survey (USGS), DWR, and San Joaquin County. One of these maps showing water levels in the fall of 1998 is provided on Figure 9. The map indicates that the lowest water levels are recorded in the central portion of the basin east of Stockton. This persistent pumping depression causes regional flow directions to shift to the northeast near the CSC site as shown by the arrows depicting groundwater flow. While water levels below the CSC site are about five feet above msl, the water levels in the pumping depression about ten miles to the northeast are below -50 feet msl, a water level drop of 55 feet (Figure 9). However, the CSC site is located near the transition zone where the influences of regional gradients west and southwest toward the river are less affected by the regional pumping depression. As such, groundwater flow directions west of the CSC site are westerly to northwesterly. Temporal and spatial fluctuations in water levels alter groundwater flow directions from westerly to northeasterly in the vicinity of the site with local flow directions possibly influenced by nearby pumping wells.

According to groundwater investigations beneath the nearby Sharpe facility, flow directions appear to be influenced by both natural westerly flow and the regional pumping depression, resulting in a northwesterly groundwater flow direction (URS, May 2005). The northwesterly flow is evident in all of the shallow unconfined to semi-confined aquifers beneath the Sharpe facility to approximate depths of 300 feet. However, the operation of extraction wells, injection wells, disposal ponds, and, perhaps, local irrigation canals appear to impact local flow directions across the site as indicated by water level contour maps and well locations (URS, May 2005). Easterly to northeasterly flow on the east side of the facility, closest to the CSC site, occurs during some time periods (URS, May 2005).

Water level data in the five CSC monitoring wells are available for 2000 and 2001 (Nolte, February 2002). Water level contour maps presented in the former site owner's annual monitoring reports indicate a variety of groundwater flow directions beneath the site ranging from southwest to northeast. These maps may not reflect regional water table conditions due to the localized influences from the onsite percolation ponds.

Groundwater elevation data from the former Occidental Chemicals facility to the southwest of the CSC site also indicates variable directions of groundwater flow. Shallow groundwater flows mainly to the west and southwest as indicated by contaminant plume mapping (The Source Group, July 18, 2002). However, the deeper aquifer (150 to 200 feet deep), which is apparently influenced more by regional pumping, has a more northeasterly flow direction, especially on the eastern portion of the site, closest to the CSC site.

Groundwater flow in the sedimentary units below about 500 feet cannot be mapped in the area due to a lack of data. However, flow in the deeper section of the USDW, including the Mehrten formation, is expected to be unimpacted by local pumping and is likely controlled mainly by the outcrop elevations in the Sierra Nevada foothills to the east and the regional groundwater discharge area in the Sacramento-San Joaquin delta to the northwest.

### ***Base of Fresh Water***

In 1955, DWR published a map on the base of fresh water, placing it at a subsea elevation of approximately -550 feet msl beneath the CSC site (Plate 5, DWR, 1955). A portion of this map is presented unmodified on the right side of Figure 10. This elevation was further corroborated by DWR during a multi-year study about ten years later (DWR, 1967). The DWR definition of fresh water was based on chloride concentrations below about 300 mg/L (DWR, 1967).

An additional map of the base of fresh water was constructed by USGS in 1973 (Berkstresser, 1973). The USGS map was based on more than 900 electric logs and 4,000 chemical analyses in the Sacramento Valley and northern San Joaquin Valley. For the purposes of mapping, USGS defined "fresh water" as groundwater with a specific conductance less than 3,000 umhos/cm (an equivalent TDS concentration of about 2,000 mg/L). These conductance and TDS values are consistent with a chloride concentration in excess of 200 to 300 mg/L, allowing the USGS map to be compared directly to the DWR map. The portion of the USGS map covering the CSC site is shown with the DWR map on the left side of Figure 10. Both maps indicate that the base of fresh water as defined by a TDS concentration of about 2,000 mg/L occurs at an elevation of -550 feet below msl at the CSC site, a depth of about 572 feet at the location of the proposed injection well.

This depth is also consistent with water quality data generated at the former Occidental Chemicals facility, located two miles southwest of the CSC site (Figure 1). At this facility, treated effluent associated with groundwater remediation is being injected

back into the lower portion of the main drinking water aquifers at depths of 300 to 500 feet. Formation water from a test hole in this interval contained TDS concentrations from 1,930 mg/L to 2,580 mg/L (Luhdorff & Scalmanini, December 1981).

TDS data were also provided by the DDJC-Sharpe facility in support of this project (URS, July 29, 2005). Although they are not required to monitor groundwater for TDS, 47 measurements in 25 monitoring and production wells were available. A few TDS values exceeded 1,000 mg/L, but well construction data were unavailable for these wells and a relationship between TDS and depth could not be established. Since the deepest well recorded in the DDJC-Sharpe well construction database was only 375 feet deep (URS, May 2005), it was assumed that wells were not sufficiently deep to provide additional information on the base of the USDW.

### ***Base of USDW***

Although the base of the fresh water appears to have been adequately defined in this area, the exact base of the USDW (defined by TDS concentrations greater than 10,000 mg/L) is unknown. Upper Cretaceous sands, occurring below about 3,400 feet, appear to have TDS concentrations in excess of 10,000 mg/L as indicated by data from nearby gas fields and a UIC Class I well drilled about 2.5 miles southwest (CDOG, 1982; San Joaquin CoGen, 1988). Although these upper sands are not expected to be well developed beneath the CSC site, the entire Cretaceous interval is likely below the base of the USDW. This places the base of the USDW below 500 feet and above about 3,400 feet, a zone with very limited data.

As previously discussed, the Miocene Mehrten formation is interpreted to occur at an elevation of about -1,000 feet below msl at the CSC site and is reported to contain “saline water” in this area (DWR, 1967; Franks, 1981; CDOG, May 19, 2005; DWR, 1955; Brown and Caldwell, 1985). Salinities of the Mehrten and underlying formations in the vicinity of the Occidental Chemical facility were estimated by Dr. Alvin Franks of the USGS using electric log data (Franks, 1981). His investigation considered data in 20-square mile study area, which included the CSC site. Franks interprets TDS concentrations from about 2,000 mg/L to above 10,000 mg/L in the upper section of the Mehrten at depths from about 800 feet to 1,000 feet, indicating that the base of the USDW may occur within this section. However, data were not consistent with depth.

To further examine these data, the TDS laboratory measurements from the wells at Occidental Chemicals and estimates from log values discussed above were plotted with depth (Figure 11). Data included 27 laboratory measurements of TDS in monitoring well samples from depths of 300 to 500 feet (Luhdorff & Scalmanini, 1981) and 8 depth-specific TDS interpretations from electric logs (Franks, 1981). Data from wells more than four miles away from the site are not included on the plot.

These TDS data are shown on Figure 11 with laboratory data represented by circles or squares, and log estimates represented by the triangles. A linear trend line

through all of the data delineates a preliminary salinity profile at the site. As seen on the graph, laboratory analyses follow a better defined salinity trend with depth than do estimates from electric logs, which show significant scatter. Electric log TDS estimates range from 2,210 mg/L to more than 10,000 mg/L in the depth range between about 800 and 1,000 feet. A trend line using only laboratory data would predict TDS values of 10,000 mg/L close to a depth of 1,000 feet.

Although information is incomplete, data from a late 1800s exploratory well provides some additional information on the base of the USDW. Historical well records from DWR files indicate that this well was drilled within one mile of the CSC site (indicated by State well number) and recovered gas and water at a depth of 1,042 feet. The well was apparently drilled in 1888 by an unknown operator and was included in the DWR well files. The well was included in the AOR, even though the exact location is unknown (Table 1). Since the well apparently recovered hydrocarbons at 1,042 feet, it is unlikely that USDW extend significantly deeper than this unit. A reproduction of the well record is provided in the supporting documentation.

Additional TDS data at depths from 2,000 feet to 2,500 feet are available several miles to the north. TDS value of 7,150 mg/L at a depth of 2,000 feet was reported in one well about 6.5 miles north of the site (23B-1N-6E), presumably resulting from a laboratory measurement (DWR, 1955). About 2.5 miles south of this well (about 4.25 miles northwest of the CSC site), TDS values of more than 10,000 mg/L were estimated in a Miocene sand at a depth of 2,500 feet. This well, the Laymac Corporation No. 1 Reynolds & Carver-Long (34-1N-6E, Figure 1), was permitted and operated as a Class II water injection well for the French Camp gas field. Although TDS laboratory analyses were unavailable, a geological and engineering study documented TDS estimates from electric logs from 13,600 mg/L to 18,000 mg/L, meeting the 10,000 mg/L permit requirement for a Class II well (Laymac, 1985; CDOG, July 12, 2005). Geologic correlations to this log indicate that the CSC Miocene target injection zone is equivalent to the interval just above the injection zone of the Laymac well. Class II injection records from the CDOG files are included in the supporting documentation attached to this application.

Collectively all of these data support a USDW base between about 1,000 feet and about 2,000 feet. Salinity estimates from the closest abandoned exploratory well were used to further refine the exact depth of the base of the USDW and to document the likelihood of the target Miocene Sand meeting TDS regulatory requirements. These estimates are presented in the following section.

### ***Salinity Estimates from Quintana SP No. 1 Well***

The Quintana S.P. No. 1 well is the well closest to the CSC site that has penetrated the Miocene target injection zone (Figures 1 and 3). The well was drilled by Quintana Petroleum Corporation in 1970 and contains an induction-electrical log over the Miocene section. This log, included in the supporting documentation, was used to

estimate formation water salinity, applying a water resistivity method as outlined by Schlumberger (1984). The method calculates water resistivity at formation temperature using an equation relating apparent resistivity of the formation water (Rwa) to the resistivity measurement on the electric log and properties of the formation. A Schlumberger crossplot is then used to graphically determine the salinity of the water (as NaCl) in mg/L. The equation is shown below.

$$Rwa = (Sw)^2 (Rt) / F$$

and:

F = formation factor defined by

$$F = 0.62/P^{2.15}$$

where:

Rwa = actual resistivity of the formation water

Rt = true resistivity read from the Quintana electric log = 2.5 ohm meters

Sw = water saturation of the sand – assumed to be 100% (1.0)

P = porosity = 0.3 estimated from nearby Sonic log (30-1S-7E)

Formation Temperature = corrected to 90 °F from measurement of 156°F at 7,933 ft

solving:

$$F = 8.25$$

$$Rwa = 0.3$$

Using crossplot with Rwa and formation temperature (Schlumberger Gen-7):

$$\text{Salinity} = 15,000 \text{ mg/L}$$

Although some uncertainties are inherent in this calculation such as the percentage of fine-grain material in the sand, porosity, and water saturation, this estimate of NaCl salinity appears sufficiently high to conclude that TDS would exceed 10,000 mg/L and, therefore, the Miocene target injection zone would be below USDWs. Using this same methodology to estimate salinity values for shallower sands in the Quintana well, electric log data indicate that the sands at a depth of 1,700 feet may contain TDS values between 9,000 and 10,000 mg/L, although the calculation is less certain because of the thinner and finer-grained sand. For a conservative estimate of the USDW base, the bottom of the 1,700-foot sand package (1,789 feet on the Quintana log) is assumed to be the base in this area. Regional correlations indicate that this base will be encountered a depth of 1,773 feet in the CSC injection well.

# **ATTACHMENT F - Maps and Cross Sections of Geologic Structure of Area**

## ***Requirements***

Information in this attachment provides the regional geologic setting as well as the local geologic conditions to illustrate the structure, stratigraphy, and lithology of the target injection zones and adjacent confining intervals. Results of the geological evaluation are to be presented on appropriate maps and cross sections.

## ***Regional Geological Setting***

The CSC site lies in the central portion of the Great Valley, a large structural basin with a surface elevation near sea level and surrounded by mountains (Norris and Webb, 1990). Also referred to as the Central Valley, the basin represents a relatively undeformed syncline filled with sediments eroded from the Sierra Nevada to the east and the Coast Ranges to the west. Beneath the CSC site, a thickness of more than 12,000 feet of sedimentary units has been deposited on the basement complex of the Sierra Nevada (Bartow, 1983).

The tectonic history dates to the Late Jurassic with the inception of a subduction zone and trench west of the valley, allowing for the deposition of large thicknesses of sediment from the continental margin (Cherven, May 1983). The subduction likely reactivated volcanic activity, resulting in the plutons and volcano remnants that make up the Sierra Nevada. Sediments eroded from the rising Sierra Nevada were deposited in marine depositional environments in the Central Valley area throughout the Cretaceous.

By the end of the Cretaceous, the subduction complex had been sufficiently uplifted to form a ridge at or above sea level (Cherven, May 1983). This cut off the basin from the sea and created a western source area for sedimentation. Subsidence and regression caused a large thickness of fluvial sediments to be deposited in the basin during the Paleocene, but most of this section appears to have been eroded in the project area, likely due to the uplift of the Stockton Arch (Cherven, May 1983). The Stockton Arch is a regional cross-basin fault with about 3,000 feet of displacement (Teitworth, 1964). This structural high resulted in the erosion or non-deposition of a significant thickness of Early Tertiary (Paleocene and Eocene) sediments in the vicinity of the site. This erosional surface, called the Cretaceous unconformity, separates Miocene sediments of continental origin from Cretaceous sediments of marine origin in the CSC study area.

## **Faults**

Regional faulting near the CSC site vicinity includes the cross-cutting Stockton Arch described above and a basin-bounding fault, the Vernalis fault, located on the western side of the valley (Figure 5). Both of these faults are regionally extensive. The Vernalis fault is a large reverse fault that parallels regional strike and has a maximum vertical displacement of 1,500 feet (Hoffman, 1963). The bounding fault of the Stockton Arch is thought to exhibit about 3,000 feet of vertical displacement (Teitsworth, 1964). However, both of these faults are located more than five miles from the CSC site and well outside of the 0.5 mile AOR.

In addition to these regional faults, local deformation occurred during the Cretaceous that formed structural and stratigraphic traps of hydrocarbons in the area. Although these faults have not been regionally mapped, they all appear to reflect reverse dip slip with displacement of about 100 feet (CDOG, 1981). These faults were formed in a compressional regime and are not likely conduits for transmitting fluids. Additional evidence for their lack of transmissivity is the fact that faulting has served to trap gas in the productive fields. In addition, these Cretaceous faults do not extend above the Cretaceous unconformity according to regional mapping (CDOG, 1981). As such, they are not considered to be conduits for injectate into USDWs.

Extensive faulting is not anticipated in the post-Cretaceous sediments in this area. Bartow (1991) characterizes the eastern limb of the valley syncline between the Stockton Arch and the San Joaquin River (CSC study area) as the least deformed region of the San Joaquin Valley. No known faults have been mapped in the Miocene section in this area.

## **Stratigraphy**

A stratigraphic section provided by Edmondson et. al. (1964) has been slightly modified to reflect site-specific conditions and is included on Figure 12. This stratigraphic column focuses on nomenclature for a portion of the Upper Cretaceous section (Edmondson, et. al., 1964). Stratigraphic names are assigned to the east side or west side of the valley based on usage. In most cases, the divisions correspond to the source direction of the sand deposition (i.e., west side sands were sourced from the Coast Range on the west and east side sands were sourced from the Sierra Nevada on the east). Although the CSC site is just on the east side of the valley, many of the west-side units extend into the study area since the site is close to the valley center.

Below the USDW discussed in the previous attachment (base of the Mehrten formation) lies a 1,600-foot section of Miocene and Lower Tertiary sediments underlain by a thick sedimentary sequence of Upper Cretaceous age. The lower Miocene section, beginning at about 1,700 feet at the CSC site, is thought to be the Valley Springs formation. The base is less certain since the exact thickness of the unit beneath the site is unknown and older Tertiary sediments may underlie the Valley Springs. These sediments are separated from the main Cretaceous units with an erosional unconformity.

Due to its central location in the valley, the study area is sufficiently far from both eastern and western source areas, and, as a result, has fewer well-developed sands. Many of the thick and coarse-grain sand packages of the Upper Cretaceous are either not present at the site or poorly developed. For example, the Azevedo and Blewett sands are eroded or very thin beneath the CSC site even though they are more than 500 feet thick just a few miles to the southwest (San Joaquin CoGen, 1988; CDOG, May 19, 2005). Western-sourced Tracy sands also pinch out in this area. The Starkey sands, while present, thin dramatically to the west near the CSC site. The lack of sand and lower permeability makes the upper Cretaceous sands a difficult target for injection in this area.

Callaway (1964) indicated that the sands in the Tracy interval (nomenclature used in nearby Lathrop, S.E. gas field) near the CSC site were actually more correctly referred to as the Starkey sands, sourced from the east. The regressive sand pattern of the Starkey as seen on electric logs can be correlated across the area and appears to thin to the west, consistent with an eastern source. Callaway mapped the Tracy sands as deltaic sands extending from western sources and thinning to the east. Both sections appear to thin within the study area, although one thick regressive sand package appears to persist beneath the CSC site, as evidenced by electric log data. However, because the nearby gas fields of Lathrop, Lathrop S.E, and French Camp all keep the nomenclature of Tracy Sand as applied to the Starkey section, the name “Tracy Sand” is used in this document as a synonym for the Cretaceous target injection zone.

Although deeper Cretaceous sands exist beneath the Tracy Sand, they are much less permeable (CDOG, 1982). Further, the deeper sands were tested in a nearby UIC Class I injection well and could not sustain reasonable injection rates (San Joaquin CoGen, 1988). This abandoned UIC well, located 2.5 miles southwest at the San Joaquin CoGen facility, failed to function as an adequate injection well in the Lathrop Sand at a depth of about 8,575 feet. A comparison of electric logs does not indicate that the Lathrop sands are significantly thicker or more permeable beneath the CSC site. As such, they are not considered a target for injection.

### ***Miocene Target Injection Zone***

The character and thickness of the Miocene target injection zone is illustrated on the electrical log of the nearby S.P. No. 1 well, located 4,385 feet southwest of the CSC proposed well (Figure 13). The sand interval is approximately 389 feet thick. The target sand is estimated to be approximately 372 feet thick in the proposed CSC injection well based on an average thickness of the zone in nearby logs. As indicated by the significant negative deflection of the SP curve (up to -40 mv from an average shale baseline, Figure 13), the sands appear coarse-grained with only minor amounts of silt and clay. The separation of the deep induction curve and the short normal curve indicates the more permeable zones.



Low permeability layers exist both above and below the target sand. The upper confining layer is almost 300 feet thick. Mapping indicates that the zone extends for miles around the site and maintains a thickness of at least 180 feet where mapped. On a mudlog from a well 1.8 miles southeast, the Miocene confining layer is described as a blue-gray clay to dark gray shale (Schleiss No. 1, location shown on Figure 1 and electric and sonic logs in Supporting Documentation). This thick, persistent, and low permeability unit provides significant protection for the USDWs in the area.

Structural contours on the top of the Miocene Sand target injection zone are shown on Figure 14. As shown by the contours, the sand occurs at subsea elevations from about -1,800 feet below msl to -2,250 feet below msl, indicating a southwestern structural dip of about one degree. As shown on the map, the top of the target zone is expected to exist at an elevation of -1,975 feet below msl at the proposed CSC injection well (Figure 14). Assuming a ground surface elevation of 23 feet and a rig floor height of approximately 12 feet, the depth of the Miocene is anticipated at 2,010 feet in the CSC injection well.

An isopach map of the upper confining layer for the Miocene Sand target is shown on Figure 15. The confining layer persists across the study area and ranges from about 125 feet to 375 feet thick as indicated by electric logs. The thickness of the unit is expected to be approximately 250 feet thick in the CSC injection well (Figure 15).

Cross sections illustrating the structural and stratigraphic relationships of the target injection zones across the site are shown on Figures 16 and 17. Cross section locations are included on Figure 15. Figure 16 shows a cross section oriented southwest-northeast, approximately along the structural dip of the area. The cross section on Figure 17 is oriented northwest-southeast, approximately along the structural strike. As shown on the sections, a deep abandoned exploration well is correlated on either side of the CSC site, approximately equidistant from the proposed well. Both sections have the same vertical scale, but the section on Figure 17 has a horizontal scale of almost twice that on Figure 16, increasing the vertical exaggeration on the strike-oriented section.

Both sections show the persistence of the target Miocene sand package and the upper confining layer across the study area. Both the confining layer and the sand thicken to the southwest (Figure 16), consistent with the maps previously discussed (Figures 14 and 15).

## ***Cretaceous Target Injection Zone***

The injection target in the Cretaceous section is the equivalent of the 2<sup>nd</sup> Tracy Sand, using nomenclature from the Lathrop S.E. gas field (CDOG, 1982). This sand is generally equivalent to the Starkey Sands, consistent with nomenclature used east of the site (Figure 12). In general, the Starkey Sands are thought to be sourced from the east and the Tracy Sands sourced from the west. Log character has been used in the past to differentiate the units and based on these descriptions, the target injection sand may be

more correctly called the Starkey Sands. However, to avoid confusion with previously-established nomenclature in the local area, the target sand is referred to as the 2<sup>nd</sup> Tracy Sand. The more general term, Cretaceous Sand target, also refers to this sand.

The electric log response of the Cretaceous target injection zone is shown on the type log on Figure 18. Again the log from the nearby Quintana S.P. No. 1 well is used to illustrate the sand. The thick sand interval is approximately 350 feet thick on the log. The interval thins to the northeast and is expected to be approximately 267 feet thick in the CSC injection well. As indicated by the SP curve, the sand package demonstrates a coarsening-upward sequence, whereby the fine-grained sands in the lower portion of the zone grade upward into more coarse-grained sands (Figure 18). This pattern produces a characteristic “carrot” shape on the electric log, assisting log correlation. The permeability of the sand is demonstrated by the large negative SP deflection and the separation of the short normal and deep induction curves. The separation indicates that the zone is sufficiently permeable to have been invaded by drilling fluids, a typical indication of permeability (Schlumberger, 1984). A sidewall core sample from the 2<sup>nd</sup> Tracy Sand in the Christiana Schleiss well (30-1S-7E, Figure 1) is described as gray fine to medium-grained sand that is well sorted, kaolinitic, friable, and permeable.

A structural contour map on the top of the Cretaceous target injection zone is shown on Figure 19. As shown by the contours, the zone dips to the southwest at an average dip of approximately 3.5 degrees. The top of the sand is flatter in the immediate vicinity of the CSC site and steepens to the southwest. A fault on the updip (northeast) side of the nearby abandoned Southeast Lathrop Gas Field has been projected onto this map using the fault location mapped by CDOG (1982) in their geologic summary of the gas field. The displacement across the fault appears to be decreasing up-section and is interpreted to be between 100 and 200 feet at this level. However, the lack of gas in the Tracy Sand may indicate that the fault did not provide closure to the structure. The fault is not expected to be a conduit to USDWs, given the nature and age of the fault. CDOG interprets the fault to be truncated along the Cretaceous unconformity, an interpretation consistent with other geologic interpretations in the area, and does not extend the fault into younger sediments. In addition, the nature of the field-bounding faults is to provide closure to a gas reservoir and therefore, is not a conduit to flow.

Numerous confining units separate the target Cretaceous Sand from USDWs over the 3,500-foot interval between the two zones. As shown on Figures 16, 17, and 18, a continuous local confining layer exists immediately above the sand package. The thickness of this local confining layer is contoured on Figure 20. As shown on the map, the unit thins to the west, but is persistent within a few miles of the site. The zone apparently does not separate the 2<sup>nd</sup> Tracy Sand from upper Tracy sands in the Lathrop Gas Field located four miles northwest (CDOG, 1982). However, an additional confining unit exists above the Tracy Sand interval (sands above the 2<sup>nd</sup> Tracy Sand). This unit, called the Ragged Valley Shale, is a very thick and regionally-extensive confining layer that adds additional separation from the target injection zone and the base of the USDW. This unit is correlated across the site on the cross sections on Figures 16 and 17. As shown by the electric logs on the sections, the Ragged Valley Shale confining layer

# ATTACHMENT A – Area of Review (AOR)

## **Requirements**

UIC regulations require that an *Area of Review (AOR)* be established around a new injection well for the investigation of possible pathways for vertical migration of injected fluids, including improperly abandoned wells or conductive geologic faults. Within that area, data that are *reasonably available from public records* are reviewed to identify existing, improperly completed, and abandoned wells, and faults and fractures. In order to conduct this investigation, the AOR must first be determined using site-specific conditions. Regulations require that the minimum AOR for a Class I Non-Hazardous UIC is a *fixed radius* of 0.25 mile (1,320 feet) around the injection well, but may be larger as defined by site-specific conditions.

The determination of the AOR also involves a consideration of the *radius of endangering influence also called the zone of endangering influence (ZEI)*. As defined in the regulations, the ZEI is the radial zone around the well that extends to the point where the projected injection cone of impression, or pressure curve, intersects the potentiometric surface of the lowermost USDW. If the radius of endangering influence is calculated to be larger than the fixed radius of 0.25 mile, then the ZEI becomes the AOR.

## **Approach**

Many of the parameters needed in the calculation of the ZEI are unknown prior to injection well drilling. USEPA guidance states that since the potentiometric surface of the lowermost USDW is only rarely known, the elevation of the base of the USDW is commonly used (Engineering Enterprises, May 1985). It is acknowledged that this assumption is used as a conservative approach, but seems unrealistic given the regional groundwater flow systems commonly associated with synclinal basins. Other parameters are also difficult to estimate such as the initial undisturbed potentiometric surface in the target zone prior to injection. The calculations are subject to large errors when this surface is unknown (McLin, 1986).

Although reasonable and conservative estimates are used in the following calculations, results contain many assumptions and uncertainties that may need refinement after the drilling and testing phases of this project. The selected AOR considers several different methods of evaluating potential impacts, both vertically and horizontally away from the injection well.

The first method presents a volumetric calculation to assess the physical storage space needed for the volumes of injectate associated with this project. The calculation also considers dispersion of the injected fluid in the reservoir. The second method uses a modified version of the Theis equation (provided in the regulations) to estimate the cone

consists of more than 500 feet of low permeability units. This interpretation is consistent with sample descriptions of the zone in the area.

# ATTACHMENT H – Operating Data

## ***Requirements***

As provided by 40 CFR 146.13, the operating requirements shall at a minimum specify that:

- Except during stimulation, injection pressure at the wellhead shall not exceed the calculated pressure that would allow the injection zone pressure to initiate new fractures or propagate existing fractures in the injection zone. In no case shall injection pressure initiate fractures in the confining zone or cause the movement of injection or formation fluids into a USDW.
- Injection between the outermost casing protecting USDWs and the well bore is prohibited.
- Unless an alternative to a packer has been approved under Part 146.12(c), the annulus between the tubing and the long string of casings shall be filled with a fluid approved by the Director. A certain pressure, also approved by the Director, shall also be maintained on the annulus.

## ***Wastewater Generation and Treatment***

As previously discussed, the CSC site is not currently generating wastewater and will not be in full operations until manufacturing and wastewater treatment equipment, including the proposed injection well, have been designed and installed. Therefore, the information in this section describes the treatment process as currently envisioned, but minor modifications may be necessary to the proposed system as the design and installation process proceeds.

Wastewater from the CSC plant will be generated during cheese-manufacturing activities. The process waste streams resulting from plant operations is summarized on Table 3 and described below. The quality of wastewater from the facility is related to cheese and whey production and cleaning operations. Before final discharge to the UIC well for disposal, the wastewater passes through a wastewater treatment system.

**Cheese and Whey Production:** The CSC facility will produce mozzarella, provolone, and ricotta cheese. When operating at capacity, approximately 210,000 gpd of raw milk will be delivered to the facility. Milk deliveries are likely to occur seven days a week throughout the year, with little seasonal variation. The facility is expected to operate twenty-four hours per day.

In the production of mozzarella and provolone, pasteurized milk and starter media are added to fermentation vats. After fermentation, the curdled solids and whey are pumped to long tables where the whey drains through screens. The curds are rinsed and salt is added. The whey is transferred to further processing. The rinse water is discharged

to the wastewater system. The separated curds are then cooked, molded, chilled, conveyed through brine flumes, wrapped, and stored in a cooler until shipped. Ricotta cheese is curdled with acetic acid, blended to the desired consistency, and placed in tubs and stored in a cooler until shipped.

Screened whey passes through specialized equipment for removal of solids and whey cream, respectively, which are sold. The remaining whey is processed through ultrafiltration (UF) for protein removal, and reverse osmosis (RO) for lactose removal. The whey protein concentrate and lactose are also sold. The RO permeate is discharged to the wastewater treatment system.

**Cleaning Operations:** In addition to processed whey (RO permeate) and cheese table rinse water, CSC wastewater will include wash water from cleaning operations. CSC will use Clean-In-Place (CIP) processes for most equipment (milk storage silos, fermentation vats, whey-processing equipment, and interior of milk tanker trucks). In the CIP process, the units are rinsed, followed by an application of heated caustic, an acid wash, and a final rinse. CIP clean-up will be performed once every 24 hours and will require about four hours. Nearly all of the equipment (except the cheese washing tables and floors, which are washed by hoses) are suitable for the CIP process. CIP solutions will be pumped from the CIP solution tanks through the process equipment and discharged to the wastewater collection sump.

The silo room floor will be washed daily using pressurized hoses, and portions of the floor area are washed as needed throughout the day. Floors in the cheese production rooms will be washed down using spray hoses at the end of each shift. The insides of the milk tanker trucks will be washed at the CSC facility, but the outsides will not be washed at the facility.

**Sanitary Wastewater:** Sanitary wastewater from employee restrooms is treated separately and not combined with food-processing wastewater.

**Wastewater Treatment:** The wastewater treatment plant and disposal system is expected to operate seven days per week. Table 4 shows the process flow and mass balance of the proposed wastewater treatment system. The influent wastewater will flow into a main collection sump. Oily water waste will be removed from the sump, collected in an above ground tank, and disposed offsite at a permitted facility. The main collection sump pumps will lift the wastewater through a fixed (coarse) and rotary (fine) screen process and into the first stage equalization. The first stage equalization will provide surge control for the pretreatment lift pumps. The water will then be filtered and recovered settled solids will be disposed offsite at a permitted facility. The filtrate will then discharge into the UIC equalization. This basin provides surge capacity and collection and feed for the UIC injection pumps.

The wastewater quality and quantity is estimated based on historical information and sound engineering assumptions. Information from past site operations during years 2000 and 2002 provided the basis of the quantity and quality estimations. This information is summarized in the attached Wastewater Characterization on Table 4.

As discussed above, the CSC waste stream consists of processed whey (RO permeate) and rinse water generated from washing equipment. Dairy wastewater tends to be acidic due to the conversion of lactose to lactic acid and other organic acids. In addition, a relatively small amount of CIP cleaning solutions (caustic and acids, such as nitric and phosphoric acid) will be discharged to the wastewater treatment system. An appropriate base such as caustic will be dosed to neutralize the pH.

Other added chemicals include salt (used to control cheese moisture content), acetic acid (used to make ricotta cheese), starter media (fermentation culture bacteria), and a small amount of cleaning chemicals, such as bleaches and detergents. Polymer and coagulant may be added to facilitate removal of suspended material. Wastewater treatment and site operations will ensure that the injected liquid is non-hazardous.

## ***Injection Well Operation***

It is anticipated that approximately 300,000 gpd (208 gpm) of wastewater may be generated at the site for injection. Although initial production will be significantly less, the details of this permit are based on this anticipated maximum rate. Depending on the properties of the formation and the injection capacity of the well, additional treatment processes could be incorporated to concentrate the wastewater, resulting in lower volumes.

The injection well will be operated so as not to initiate or propagate fractures in the formation. Injection will occur through tubing as further described in Attachment L and shown on Figures 21 and 22. The maximum surface injection pressure will be determined based on data collected during formation testing on the new well. A fracture gradient limit of 0.8 psi/ft has been used by CDOG for a 2,500-foot sand in a Class II injection well located 4.25 miles northwest (Laymac Corporation, September 30, 1985). This information is documented in the well's Class II Injection Well records at CDOG and provided in the supporting documentation attached to this application. Based on reasonable assumptions compiled to date, and a formation fracture gradient of 0.8 psi/ft, the following maximum pumping pressure can be estimated.

### Miocene Sand Completion (top of sand at 2,010 feet):

$2,010' \times (0.8-0.433) = 738 \text{ psig} + \text{friction pressure between the } 4 \frac{1}{2} \text{ inch tubing and injected fluid}$

(The friction pressure is a function of the injection rate and can be calculated more accurately after construction of the well).

### Cretaceous 2<sup>nd</sup> Tracy Sand Completion (top of sand at 5,235 feet):

$5,235' \times (0.8-0.433) = 1,921 \text{ psig} + \text{friction pressure between the } 4 \frac{1}{2} \text{ inch tubing and injected fluid}$

(The friction pressure is a function of the injection rate and can be calculated more accurately after construction of the well).

# ATTACHMENT I – Formation Testing Program

## ***Requirements***

The formation testing program for Class I wells must be designed to obtain data on fluid pressure, temperature, and fracture pressure of the injection zone. The program must also collect data to characterize the physical, chemical, and radiological characteristics of both the formation water as well as the injection fluids.

## ***Fracture Pressure Determination***

The open-hole testing planned for the Miocene Sand will determine the formation pressure and reconfirm the salinity of the formation water. The formation fracture gradient as provided by CDOG ranges from 0.8 to 1 psi/ft. CDOG used a fracture gradient of 0.8 for a Class II injection well injecting into a similar depth as the Miocene Sand (2,500 feet) (Laymac well files included in supporting documentation attached to this application). As shown previously in Attachment H, the fracture pressure can be estimated as follows (using the more conservative gradient of 0.8 psi/ft) and determined more accurately after the well is installed:

### Miocene Sand Completion (top of sand at 2,010 feet):

$2,010' \times (0.8-0.433) = 738 \text{ psig} + \text{friction pressure between the } 4 \frac{1}{2} \text{ inch tubing and injected fluid}$

(the friction pressure is a function of the injection rate and can be calculated more accurately after the construction of the well).

### Cretaceous 2<sup>nd</sup> Tracy Sand Completion (top of sand at 5,235 feet):

$5,235' \times (0.8-0.433) = 1,921 \text{ psig} + \text{friction pressure between the } 4 \frac{1}{2} \text{ inch tubing and injected fluid}$

(the friction pressure is a function of the injection rate and can be calculated more accurately after the construction of the well).

## ***Mechanical Integrity Test***

The absence of significant leaks in the casing, tubing, and/or liner hanger will be demonstrated by a pressure test on the annular space between the tubing and production casing. The test shall be conducted for a minimum of 30 minutes at a pressure equal to the maximum allowable injection pressure determined from the fracture pressure testing summarized above. Temperature, spinner, and natural radioactive logs will be run to ensure that fluid is entering the injection zone only and that no fluid migration is



indicated above the top of the 8-5/8 inch casing or around the packer. A cement bond log will demonstrate the inability for fluid migration within the cemented annulus.

### ***Formation Water Sampling***

Samples of the formation water in the selected injection zone will be taken and analyzed to determine the physical, chemical, and radiological characteristics of the water. Samples from open-hole testing, if successful, will be analyzed before well completion. If testing fails to produce a credible sample in the target injection zone, the well will be completed and formation water produced for sampling.

### ***Injection Fluid Sampling***

Since the plant is not currently in operation, no injection fluid is available for sampling. Wastewater data from past operations at the site (expected to be similar to future wastewater generated) are provided in Attachment H and Table 4. Once plant facilities are in place to develop wastewater, samples will be collected and analyzed for physical, chemical, and radiological characteristics. The conveyance system will allow for sampling of the injectate just before entering the wellhead. Data will be generated for a waste determination to ensure that injection fluid is not hazardous as defined in 40 CFR Part 261. As shown on Table 3, wastewater will be pre-treated prior to injection to ensure that hazardous liquids are not injected and that solids and other constituents are reduced to levels suitable for injection.

## **ATTACHMENT J – Stimulation Program**

No stimulation is expected to be necessary for the target injection zone.

# **ATTACHMENT K – Injection Procedures**

## ***Requirements***

Equipment and procedures are to be documented including details on the pump, surge, tank, etc.

## ***Proposed Injection Procedures***

The conceptual design of the wastewater treatment system prior to injection is described in Attachment H and summarized on Table 3. Filtered and treated wastewater will be discharged into the UIC equalization basin with surge capacity and collection and feed for the UIC injection pumps. The wellhead will be designed with a tap allowing for the sampling of injection fluid prior to conveyance down the tubing string. As detailed in the monitoring program, devices will be installed to continuously measure and record injection pressure, annulus pressure, flow rate, and injection volumes. The maximum allowable surface pressure for injection will be determined after the well has been completed, and the well will be operated so as not to exceed the established pressure.

# ATTACHMENT L – Construction Procedures

## ***Requirements***

This section describes the procedures for the construction of the injection well and includes details on the casing and cementing program, logging procedures, deviation checks, the drilling and testing program, and proposed annulus fluid. Construction procedures follow the requirements listed in 40 CFR Part 146.12 for Class I Non-hazardous wells.

## ***Permits***

The injection well will require a draft permit for a UIC Class I injection well from USEPA under the UIC program, a drilling permit from San Joaquin County, and a well permit from CDOG. Because of the depth of the target injection zones and the local occurrence of gas-bearing formations, the well will be drilled as an exploratory gas well under the requirements of a CDOG permit.

## ***Proposed CSC Injection Well Drilling and Logging***

In order to provide USEPA with the proper documentation and planning data required for both target injection zones, two drilling programs are provided below. The first program includes drilling to the Miocene Sand, testing the formation water and permeability, documenting that the zone meets regulatory and technical requirements, and completing the well in that zone. The second program involves drilling to the Miocene Sand, finding that it doesn't meet either regulatory or technical requirements, drilling to the alternative injection target of the Cretaceous 2<sup>nd</sup> Tracy Sand, and completing the well in the deeper zone.

Each program contains specifications and information on the drilling procedures, casing lengths and materials, and liner installation (including gravel packing). General procedures to be required of the drilling contractor and site personnel are also included throughout the procedures and in the requirements provided in the ***Standing Orders*** section following the two drilling programs. For completeness, significantly more detail is provided in the text than required. The additional text is included to provide USEPA with a full vision of the drilling and completion program that we are proposing. Some of the drilling and completion details that are not relevant to the overall permit requirements may be modified in the field as necessary.

The logging program is summarized after the two drilling programs. The logging program includes both open-hole and cased-hole logs envisioned to evaluate the USDW, target injection zones, and the mechanical integrity of the well.

Target depths and elevations for both of the programs are summarized in the following table:

**General Information: CSC Proposed Injection Well**

<b>Well Location</b>	24-1S-6E MD	2143847.09N; 13742028.22 E*
<b>Surface Elevation</b>	22 feet, msl	USGS, Lathrop, CA 1996
<b>Estimated KB</b>	35 feet, msl	
<b>Top of Miocene Injection Target</b>	2,010 feet, MD	-1,975 feet below msl
<b>Base of Miocene Injection Target</b>	2,382 feet, MD	-2,347 feet below msl
<b>Top of Cretaceous Injection Target</b>	5,235 feet, MD	-5,200 feet below msl
<b>Base of Cretaceous Injection Target</b>	5,502 feet, MD	-5,467 feet below msl

\*NAD\_1927\_UTM\_Zone\_10N  
 MD = measured depth  
 msl = mean sea level

All depths in the drilling and completion program are approximations and will be modified in the field based on site-specific data.

***Drilling and Completion Program – Miocene Sand Completion***

**Drilling & Completion Program – Miocene Sand**

1. Install 24-inch diameter conductor casing cemented at 40 feet. Drill 17.5 inch hole to approximately 650 feet. Run open-hole logs over freshwater zone from total depth (TD) to 40 feet. Cement 13-3/8 inch 48# H-40 ST&C casing at about 650 feet with 250 sacks Class G premixed 3% CaCl<sub>2</sub> and 6% gel, followed with 100 sacks Class G cement premixed 3% CaCl<sub>2</sub> (50% excess). Tack weld and Bakerlok bottom 4 collars and weld shoe solid. Run float shoe. Run centralizer 15 feet above shoe. Use top rubber plug only and plug holding head. Bump plug on shoe.
2. After 2 hours waiting on cement, land casing. Test weld 500 psig. Install Series 900 Shaffer dual hydraulic control gate and Hydril GK. Test according to Standing Orders. Notify CDOG & UEPA to witness.
3. Drill 12-1/4 inch hole to 1900'. Install mud loggers at 1700 feet. Circulate as necessary for evaluation. Take one set of wet and dry samples every 30 feet. Monitor pit level closely at all times.
4. At 1900 feet, reduce the size of the hole to 7-7/8 inch diameter and drill 35 feet into the Miocene Sand (the top of the Miocene sand expected at 2010 feet). Run

Baker open-hole tester with 500 feet of 8000 mg/L TDS saltwater in tools and 25 feet of perforated tail with two pressure bombs. Set bottom packer 10 feet into sand. Open test tools. Keep tools open until sufficient entry has been observed. Close tools for one hour and obtain bottom hole shut-in pressure. Unset packers and pull out of hole. Obtain several samples of the formation fluid and determine the TDS. Notify USEPA to witness open-hole test.

If the TDS for the samples are higher than 10,000 mg/L or if the test fails, go to Step No. 5. If the TDS is below 10,000 mg/L, the well will be drilled to the 2<sup>nd</sup> Tracy Sand as described in the next section, ***Drilling and Completion program – Cretaceous 2<sup>nd</sup> Tracy Sand.***

5. Run in hole with 12-1/4 inch diameter bit and drill from 1900 feet to 2020 feet (10 feet into Miocene Sand). Run open-hole logs from total depth (TD) to 650 feet.
6. Run 8-5/8 inch, 32#, J-55, LT&C, new casing, equipped with float shoe and float collar on top of shoe joint on bottom. Cement casing with to surface. Perform a top job with PVC pipe and 60 sacks of G cement premixed 3% CaCl<sub>2</sub>. The cement program will be prepared after logging.
7. Wait on cement. Remove blow-out prevention equipment (BOE). Install tubinghead. Install adapter. Install and test BOE. Notify CDOG to witness. Run 7-7/8 inch diameter bit and drill out float collar and shoe. Drill as directed to expose 300 feet or more of the Miocene Sand. Run open-hole logs. Run 8-5/8-inch scraper to bottom of 8-5/8 inch casing. Run 7-7/8 inch bit and check for fill. Clean mud pits. Change hole to 9.0 pounds per gallon (ppg) HEC polymer saltwater. Run a 15 inch under-reamer and open 7-7/8 inch hole to 15 inches. Circulate clean. Check for fill. Clean mud pits. Equalize clean 9.0 ppg HEC polymer saltwater pill from bottom to 200 feet above shoe. Pull up to 100' above shoe and change hole to clean saltwater.
8. Run 5-1/2 inch Baker liner and gravel pack as described in the Liner Program for the Miocene Sand completion on the following pages.
9. Mud Program. Geo-Western. Cypan Mud System.
 

Depth	Weight	Viscosity	Water Loss
0'- 560'	To protect fresh water		
560'-1900'	9.0-9.3 ppg	35-45 sec	6cc/30 min
1900'- TD	9.3 ppg	35-45 sec	6cc/30 min
10. Have sufficient mud material on location to raise mud weight 0.4 pounds per cubic foot (pcf). Adjust mud weight to maintain mud log baseline below 30 units and to stabilize shale.
11. Set Baker Model D packer with a flapper valve at 1900'. Pick up seal assembly on bottom of 4-1/2 inch, 12.75#, EUE, J-55 tubing. Run in hole to top of packer. Change annulus to freshwater treated with corrosion inhibition chemical. Have

filtered saltwater in tubing. Stab into packer. Test annulus to 2,000 psig. Install single master X-mas tree.

12. Perform a 2-hour injection test with Baker pump truck using 240 bbls of filtered saltwater. Monitor annulus for any leaks. Notify USEPA to witness. Start the construction of the surface facilities.

### **Casing Program – Miocene Sand**

Hole conditions: 13-3/8 inch 48# surface casing at 650 feet, 12 ¼ inch diameter hole, mud weight of 9.3 ppg.

1. Run 8-5/8 inch 32# J-55 LT&C 8RD, R3, new casing to 2020'. Sand blast bottom 6 joints.
2. Run float shoe. Run float collar on top of shoe joint. Weld shoe solid.
3. No X-over joints should be required.
4. Prepare tally sheets for the casing using dark ink. Last joint in the hole should be on the first sheet.
5. Use B&L casing tongs to run casing. Run fill-up and circulating tool. Clean threads. Visually inspect casing. Have welder on location while running casing. Have extra LT&C collar on location to weld on top joint if pipe stops off bottom.
6. X-mas tree should be 3000 psi.
7. Run two centralizers per joint from TD of casing to 1900', then one centralizer per joint into surface casing. Run casing to desired depth. Rig up cementing head. Have two lines to cementing head and two pump trucks on location. Circulate casing clean. Do not work pipe.
8. Cement Mix: Pump 35 bbls of mud flush ahead and cement casing shoe at 2020' measured depth (MD) per Halliburton cementing program. Bump top plug on float collar. Use two vacuum trucks full of mud for displacement. Perform 60 sacks top job with PVC pipe.

### **Liner Program**

Hole conditions: TD 2382 feet, 8-5/8 inch 32# production casing set at 2020', 15 inch diameter hole with MW of 9.0 pcf.

1. Open hole with polymer mud. Circulate clean. Pull to shoe. Wait one hour. Run in hole and check for fill. Spot a clean viscous pill across the open hole interval and 200 feet into the 8-5/8 inch casing.

2. Pull up to 100 feet above the shoe of the 8-5/8 inch casing. Rig up Baker Defiltering Unit. Change hole over to clean filtered 9.0 ppg saltwater.
3. Pull out of hole.
4. Run cement bond log and gamma ray log (CBL/GR) from bottom of hole to surface.
5. Pick up liner assembly consisting of:
  - 4 feet 5-1/2" Circulating Shoe with open hole centralizer
  - ? feet 5-1/2" (6" OD) Excluder Screen.
  - ? feet 5-1/2" Blank Pipe (1 joint is 38 feet)
  - 35 feet 8-5/8 inch Baker SC-1 Gravel Pack Tool with Sliding Sleeve, extensions setting and crossover tool
  - 130 feet tail pipe and polished stinger for circulating shoe (to be run inside WWS)

Note: Centralize both circulating shoe and blank pipe. Minimize the use of pipe dope. Apply to pin end only.
6. Run in with liner assembly on 4 inch diameter drill pipe to desired depth.
7. Rig up pumping equipment and lines.
8. Conduct safety meeting.
9. Test lines to about 4,000 psi. Drop ball.
10. Set and test gravel pack tools. Blow ball seat.
11. Using clean filtered brine from rig pits, establish and record pump rate and pressure in reverse position.
12. Clean drill pipe by performing a sand scour. With the crossover tool in the reverse position, pump a 5-bbl slurry of about 2 ppg sand down the work string to the reverse port in the crossover tool. Immediately reverse the slurry out of the work string. Keep pump rate as high as conditions allow. Inspect returns to see what material the scour may have removed from the work string.
13. Establish and record pump rate and pressure in circulating position and circulate viscous pill from 15 inch open hole annulus and into the annulus of the drill pipe and the 8-5/8 inch casing. Un-sting from circulating shoe. Using Baker Gravel Infuser System, install gravel pack. Begin infusing Baker Low Fine Ottawa Gravel into clean brine at 0.5 lb/gal. Typical pump rates are 4 to 6 barrels per minute (bpm). Once sand clears crossover tool then increase sand loading to maximum of 2 ppg as conditions allow. Continue pumping at this rate and



concentration until wellhead pressure begins increasing. Pump rate should be reduced accordingly as well head pressure increases. Once pressure reaches 500 psi over initial circulating pressure is achieved stop pumps. Do not restress pack at this time.

14. Close annular blow-out preventer (BOP) and apply 500 psi to the annulus. Place the crossover tool in the reverse position. Reverse out excess gravel until returns are clean. Monitor and determine the volume of gravel reversed out. To test the gravel pack, lower crossover tool into the circulating position. Circulate at sand out rate and attempt to achieve sand out pressure established earlier. If same sand out pressure cannot be achieved, mix and pump another amount of gravel recommended by pump specialist. Repeat this step until final sand out occurs. Pull out of hole with service tools.

Recommend a minimum of 200 bbl of brine available at surface for gravel pack operations.

Volume Estimates

300 feet of 15 inch open hole	66 bbls	300 ft x .22 bbl/ft
2020 feet of 8-5/8 inch 32# casing	123 bbls	2020 ft x .0609 bbl/ft
Gravel for 300 feet of 6 inch OD Liner in 15 inch open hole plus 40%	310 cf (62,000 lbs)	300 ft x 1.03 cf/ft
Brine for GP Slurry at 1 lb/gal	62,000 gal (1,400 bbls)	62000 lb x 1 lb/gal
Brine for misc. GP steps (Set packer, establish rates, reversing, etc.)	300 bbls	
Subtotal brine needs	1,889 bbls	

***Drilling and Completion Program – Cretaceous 2<sup>nd</sup> Tracy Sand Completion***

**Drilling & Completion Program – Cretaceous Sand**

1. If a decision is made to complete the well in the Cretaceous 2<sup>nd</sup> Tracy Sand per Step 4 of the original Miocene Sand program, the following steps will be taken.
2. Run in hole with 12-1/4 inch bit and drill to 5100 feet. Reduce the size of the hole to 7-7/8 inch and drill 35 feet into the 2<sup>nd</sup> Tracy Sand (the top of the 2<sup>nd</sup> Tracy

Sand is expected at 5235 feet). Run Baker open-hole tester with 500 feet of 8000 mg/L TDS saltwater in tools and 25 feet of perforated tail with two pressure bombs. Set bottom packer 10 feet into sand. Open test tools. Keep tools open until sufficient entry has been observed. Close tools for 1 hour and obtain bottom hole shut in pressure. Unset packers and pull out of hole. Obtain several samples of the formation fluid and determine the TDS for the samples.

3. Run in hole with 12-1/4 inch bit and open hole to 12-1/4 inch from 5100 feet to 5245 feet (10 feet into the target Tracy Sand). Run open-hole logs per logging program from 650 feet to TD.
4. Run 8-5/8 inch, 32#, J-55, LT&C new casing equipped with float shoe and float collar on top of shoe joint on bottom. Cement the shoe with enough cement to have returns at surface. Perform a top job with PVC pipe and 60 sacks of G cement premixed 3% CaCl<sub>2</sub>. The cement program will be prepared after the logging.
5. Wait on cement. Remove BOE. Install tubinghead. Install adapter. Install BOE. Test BOE. Notify CDOG to witness. Run 7-7/8 inch bit and drill out float collar and shoe. Drill as directed to expose 250 feet or more of the target Tracy Sand. Run open-hole logs over the target interval per logging program. Run 8-5/8 inch scraper to bottom of 8-5/8 inch casing. Run 7-7/8 inch bit and check for fill. Clean mud pits. Change hole to 9.0 ppg HEC polymer saltwater. Run a 15 inch under-reamer and open 7-7/8 inch hole to 15 inches. Circulate clean. Check for fill. Clean mud pits. Equalize clean 9.0 ppg HEC polymer saltwater pill from bottom to 200 feet above shoe. Pull up to 100 feet above shoe and change hole to clean saltwater.
6. Run 5-1/2 inch Baker liner and gravel pack per the attached program.
7. Mud Program: Geo-Western. Cypan Mud System.

<u>Depth</u>	<u>Weight</u>	<u>Viscosity</u>	<u>Water Loss</u>
0- 650 ft	To protect drinking water		
650-1,900 ft	9.0-9.3 ppg	35-45 sec.	6cc/30 min
1,900 ft - TD	9.3-9.9 ppg	35-45 sec.	6cc/30 min

Have sufficient mud material on location to raise mud weight 0.4 pcf. Adjust mud weight to maintain mud log base line below 30 units and to stabilize shale.

8. After the liner is gravel packed, perform an injection test with Baker pump truck using 200 bbls of filtered saltwater.
9. Set Baker Model D packer with a flapper valve at 5100 feet. Pick up seal assembly on bottom of 4-1/2 inch, 12.75#, EUE, J-55 tubing. Run in hole to top of packer. Change annulus to freshwater treated with corrosion inhibition

chemical. Have filtered saltwater in tubing. Stab into packer. Test annulus to 2000 psig. Install single master X-mas tree.

11. Perform an injection test with Baker pump truck using 200 bbls of filtered saltwater. Monitor annulus for any leaks. Notify USEPA to witness. Start the construction of the surface facilities.

### **Casing Program – Cretaceous Sand**

Hole Conditions: TD 5,500 feet, 13-3/8 inch 48# surface casing at 650 feet, 12-1/4 inch hole, MW 9.8 ppg.

1. Run 8-5/8 inch 32# J-55 LT&C 8RD, R3, new casing to 5245 feet. Sand blast bottom 6 joints.
2. Run float shoe. Run float collar on top of shoe joint. Weld shoe solid.
3. No X-over joints should be required.
4. Tally sheets for the casing will be prepared.
5. Use B&L casing tongs to run casing. Run fill-up and circulating tool. Clean threads. Visually inspect casing. Have welder on location while running casing. Have extra LT&C collar on location to weld on top joint if pipe stops off bottom.
6. X-mas tree should be 3000#.
7. Run two centralizers per joint from TD of casing to 5100 feet, then one centralizer per joint into surface casing (625 feet). Run casing to desired depth. Rig up cementing head. Have two lines to cementing head. Have two pump trucks on location. Circulate casing clean. Do not work pipe.
8. Cement Mix: Pump 35 bbls of mud flush ahead and cement casing shoe at 5245 feet per Halliburton cementing program. Bump top plug on float collar. Use three vacuum trucks full of mud for displacement. Perform 60 sacks top job with PVC pipe.

### **Liner Program – Cretaceous Sand**

1. Open hole with polymer mud. Circulate clean. Pull to shoe. Wait one hour. Run in hole and check for fill. Spot a clean viscous pill across the open hole interval and 200 feet into the 8-5/8 inch casing.
2. Pull up to 100 feet above the shoe of the 8-5/8 inch casing. Rig up Baker Defiltering Unit. Change hole over to clean filtered 9.0 ppg saltwater.

3. Pull out of hole.
4. Run CBL/GR from bottom of hole to surface.
5. Pick up liner assembly consisting of:
  - 4' 5-½ inch Circulating Shoe with open hole centralizer
  - ? 5-½ inch (6" OD) Excluder Screen.
  - ? 5-½ inch Blank Pipe (1 joint is 38 feet)
  - 35' 8-5/8 inch Baker SC-1 Gravel Pack Tool with Sliding Sleeve, extensions setting and crossover tool
  - 130' Tail Pipe and polished stinger for circulating shoe (to be run inside WWS)

Note: Centralize both circulating shoe and blank pipe. Minimize the use of pipe dope. Apply to pin end only.
6. Run in with liner assembly on 4 inch drill pipe to desired depth.
7. Rig up pumping equipment and lines.
8. Conduct safety meeting.
9. Test lines to about 4,000 psi. Drop ball.
10. Set and test gravel pack tools. Blow ball seat.
11. Using clean filtered brine from rig pits, establish and record pump rate and pressure in reverse position.
12. Clean drill pipe by performing a sand scour. With the crossover tool in the reverse position, pump a 5-bbl slurry of about 2 ppg sand down the work string to the reverse port in the crossover tool. Immediately reverse the slurry out of the work string. Keep pump rate as high as conditions allow. Inspect returns to see what material the scour may have removed from the work string.
13. Establish and record pump rate and pressure in circulating position and circulate viscous pill from 15 inch open hole annulus into the annulus between the drill pipe and the 8-5/8 inch casing. Un-sting from circulating shoe. Using Baker Gravel Infuser System, install gravel pack. Begin infusing Baker Low Fine Ottawa Gravel into clean brine at ½ lb/gal. Typical pump rates are 4-6 bpm. Once sand clears crossover tool then increase sand loading to maximum of 2 ppg as conditions allow. Continue pumping at this rate and concentration until wellhead pressure begins increasing. Pump rate should be reduced accordingly as well head pressure increases. Once pressure reaches 500 psi over initial circulating pressure is achieved stop pumps. Do not restress pack at this time.

14. Close annular BOP and apply 500 psi to the annulus. Place the crossover tool in the reverse position. Reverse out excess gravel until returns are clean. Monitor and determine the volume of gravel reversed out. To test the gravel pack, lower crossover tool into the circulating position. Circulate at sand out rate and attempt to achieve sand out pressure established earlier. If same sand out pressure cannot be achieved, mix and pump another amount of gravel recommended by pump specialist. Repeat this step until final sand out occurs. Pull out of hole with service tools.

Recommend that driller has a minimum of 200 bbl of brine at surface available for gravel pack operations.

Volumes Estimate

300 feet of 15 inch open hole	66 bbls	300' x .22 bbl/ft
5235 feet of 8-5/8 inch 32# Casing	320 bbls	5235' x .0609 bbl/ft
Gravel for 300 feet of 6 inch OD Liner in 15 inch open hole plus 40 %	310 cf (62000 lbs)	300' x 1.03 cf/ft
Brine for GP Slurry @ 1 lb/gal	62000 gal (1400 bbls)	62000 lb x 1 lb/gal
Brine for misc. GP steps Set packer, establish rates, reversing.	300 bbls	
Subtotal brine needs:	2,090 bbls	

***Standing Orders, Drilling & Remedial Operations***

The following general guidelines have been prepared as part of the well planning process. They will be carried out by the onsite drilling contractors and are provided here for general information.

- \*1. Prior to drilling out the surface casing, the blowout prevention and all associated equipment shall be pressure tested to 50% of the rated working pressure (Bag preventer to 40%). Equipment to be tested separately are: pipe rams, blind rams, bag preventer, kelly cock, standpipe valve, kill line (stop valve, check valve) and blow down line (each valve, choke and bean). Blow down manifold shall have at least one operating pressure gage of a range at least 1000 psig higher than blowout preventer rated working pressure. CDOG to witness.
- \*2. Blowout preventers on protection and production casing shall be tested as above to 70% of rated pressure (Bag to 50%).

- \*3. Each drilling crew is to have at least one blowout drill weekly.
- \*4. Before tripping, check the ditch for flow with pumps off.
- \*5. Daily record the one-half pump stroke standpipe pressure.
- 6. Measure drill pipe on first trip after installing mud loggers.
- 7. All casing run shall be carefully visually inspected for pipe body and thread defects as it is unloaded. Casing shall not be permitted to drop from trucks, roll it off on ramps.
- 8. Protection and production casing shall be run with hydraulic tongs set to the proper torque for the casing being run. Pick up thread protectors shall be used.
- 9. All casing shall have threads "bright" cleaned and a teflon pipe dope (Bakerseal, TF-17) liberally applied.
- 10. Keep hole full at all times.
- \*11. Check operation of BOE each round trip.
- 12. Take all measurements from Kelly bushing (KB).
- 13. Drilling rig mud pits shall have a calibrated tank to gage mud used to fill the hole on trips.

Each 60 feet stand of 4 inch drill pipe takes 0.29 barrels.

\*Shall be entered on tour sheet and signed by person in responsible charge.

### **Additional Orders**

- 1. Run a stabilizer to drill the surface hole.
- 2. Use the following bottom hole assembly for drilling out shoe: 12-1/4 inch bit, stab, 8 inch drill collars, stab, 8 inch drill collars, BS, 10 Hw's. Use straight edged stabilizers and bumper sub from Brewster.
- 3. Drill out shoe with a new bit with 16/16/16 jets.
- 4. Mud weight must be 9.3 ppg by 1,900'. The first two wiper runs should be to the shoe, after that 10 stands would do. Wipe hole every 4 to 6 hours. Wipe to shoe every 50 to 60 hours.
- 5. Survey as directed.

6. Install a mud cleaner.
7. Keep pipe moving at all times.

### ***Logging Program Summary***

The logging program will consist of at least three open-hole logging runs in the well. The first logging run will be conducted after the drilling of the upper 650 feet of the hole and prior to setting the 13-3/8 inch surface casing. Logging will assist in the determination of fresh water and the further evaluation of USDWs. Logs will include Spontaneous Potential (SP), Induction Resistivity, and Sonic.

The second open-hole logging run will be conducted after the well has just penetrated the top 10 feet of the Miocene Sand target injection zone at an approximate depth of 2,020 feet. This logging run will allow for delineation of the base of the USDW as well as providing lithologic information on the confining zone above the Miocene Sand target. The logging suite will include an Array Induction Electrical Resistivity and SP log that will provide formation resistivity at five radial depths of investigation to determine formation water salinity (in combination with formation porosity). Porosity tools will consist of a compensated neutron porosity, a triple detector litho-density and a gross gamma ray. These logs will provide the lithology and porosity of the lower USDW and the confining zone to allow for salinity calculations to be made. They will also provide porosity and relative permeability information for the top of the target Miocene Sand.

Following the open-hole test, a decision whether to complete the well in the Miocene Sand or drill deeper will be made. If the well is completed in the Miocene Sand, the entire target injection zone will be drilled and open-hole logs will be run to cover the injection interval. This third open-hole logging run will include, at a minimum, the same tools run in the second open-hole run. Depending on data obtained in the second logging run, the third logging run may include a Combinable Magnetic Resonance logging run to more accurately define effective porosity and permeability of the target zone.

If the well is to be drilled deeper, the third open-hole logging run will be deferred until the upper 10 feet of the Cretaceous 2<sup>nd</sup> Tracy Sand is penetrated. After the 8-5/8 inch production casing has been set and the full target injection sand has been drilled, a final open-hole logging run will be conducted to evaluate the target zone. Proposed logging tools for the Cretaceous 2<sup>nd</sup> Tracy Sand will be the same as those proposed for the logging runs in the Miocene Sand. USEPA will be given 24 hour advance notice of all tests and logging to be conducted.

The cased hole logging program will consist of cement bond logs run to ensure no fluid migration in the annulus of the casing strings. After well completion, temperature,

spinner, and/or natural radioactive logs will be run to ensure that injection fluid is contained within the tubing, liner, and injection zone.



## **ATTACHMENT M – Construction Details**

### ***Requirements***

The injection well must demonstrate mechanical integrity to comply with a UIC permit. The two main tests for mechanical integrity include a demonstration that the casing does not contain leaks and that there is no significant fluid movement into a USDW adjacent to the well casing. The well must be constructed in a way to comply with these two requirements. A well construction diagram is required to be submitted with this attachment.

### ***Construction Diagram***

The well construction diagram for a well completed in the Miocene Sand target injection zone is provided on Figure 21. The well construction diagram for a completion in the alternative injection zone, the Cretaceous 2<sup>nd</sup> Tracy Sand, is provided on Figure 22. The two diagrams conform to USEPA guidance and are consistent with the procedures described in Attachment L.

## **ATTACHMENT O – Plans for Well Failures**

### ***Requirements***

Contingency plans should be developed for failure of the injection well to perform as permitted. These plans will outline steps to ensure that injection fluids will not migrate into USDWs.

### ***Contingency Options***

Numerous options for handling liquids during a possible future well failure are being investigated. After the well is drilled and the capacity is known, the operator will have a better understanding of the amount and quality of fluid requiring management. Onsite storage facilities will be able to store 50,000 gallons of wastewater as needed. Production can then be curtailed until the well can be brought back on line.

Some flexibility exists with respect to anticipated operations at the site. Early operations will be conducted at a much lower capacity than allowed in this permit (start-up capacity expected to be around 50,000 gallons). Production will increase over time, allowing for modifications and optimizations in the wastewater treatment system. The gradual increase in needed injection capacity will allow for a more methodical approach to providing temporary alternatives to injection, should the well fail. If the injection well goes down, production would be curtailed.

The applicant also requests the option to install a back-up injection well to be used in the event of a well failure. This would also provide flexibility with respect to ongoing well maintenance. However, until the first well is installed, the cost and expected performance are unknowns. To avoid future permit modification, CSC requests permission in this permit to install a back-up well in the future, if desired, provided that the additional well will not increase the total amount of injection volume associated with the project. The backup well would be drilled close to the original well such that all distances and details within the area of review and the geological evaluation would also apply to the back-up well.

# ATTACHMENT P – Monitoring Program

## ***Requirements***

As provided by 40 CFR 146.13, monitoring requirements shall, at a minimum, include:

- The analysis of the injected fluids with sufficient frequency to yield representative data of their characteristics
- Installation and use of continuous recording devices to monitor injection pressure, flow rate and volume, and the pressure on the annulus between the tubing and the long string of casing
- A demonstration of mechanical integrity pursuant to Part 146.8 at least once every five years during the life of the well
- The type, number, and location of wells within the AOR to be used to monitor any migration of fluids into and pressure in USDWs, the parameters to be measured and the frequency of monitoring.

Quarterly reporting requirements include:

- The physical, chemical and other relevant characteristics of injection fluids
- Monthly average, maximum and minimum values for injection pressure, flow rate and volume, and annular pressure
- The results of other monitoring prescribed as above
- Results of periodic tests of mechanical integrity
- Any other test of the injection well conducted by the permittee if required by the Director
- Any well rehabilitation or work-over activities.

## ***Quarterly Reporting of Continuous Pressure and Flow Monitoring***

The wellhead will be equipped with a pressure monitoring device to allow for continuous recording of the injection pressure at the wellhead. The monitoring will be conducted with a digital recorder to an accuracy of one psi. The minimum, maximum, and monthly averages of injection pressure and annular pressure will be submitted in quarterly reports. In addition, the flow rate and volume of injectate will be monitored and reported to USEPA as required. The flow rate will be measured in the supply line immediately before the wellhead. Continuous readings will be recorded with a digital totalizer.

All monitoring equipment shall be calibrated and maintained on a regular basis to ensure proper working order of all equipment.

## ***Quarterly Sampling of Injection Fluids***

Samples of injection fluid will be taken at or before the wellhead and analyzed for a full suite of chemicals to characterize the fluid and ensure that no hazardous substances are injected into the well. A hazardous waste determination will be performed prior to injection and at any time that wastewater procedures are changed. In addition, injection fluids will be sampled and analyzed on a quarterly basis while the well is in operation. Samples will be taken under appropriate quality assurance/quality control (QA/QC) procedures, following a sampling and analysis plan to be implemented at the site. Samples will be transported to and analyzed by a commercial laboratory certified by the State of California. The following constituents and methods are to be included in the program:

Inorganic Constituents – appropriate USEPA methods for major anions and cations (including an anion/cation balance), TDS, and Total Suspended Solids (TSS).

General and Physical Parameters – appropriate USEPA or certified laboratory methods for turbidity, pH, conductivity, hardness, specific gravity, alkalinity, and biological oxygen demand (BOD)

Trace Metals – USEPA Method 200.8 for trace metals analysis

Volatile Organic Compounds (VOCs) – USEPA Methods 8010/8020 or 8240

Semi-Volatile Organic Compounds – USEPA Method 8270

## ***Annual Well Logging***

To ensure that injected fluid is moving into the injection zone only, an annual logging program will be conducted. Temperature, spinner, and natural radioactive logs will be run to evaluate possible fluid migration above the shoe of the 8-5/8 inch diameter casing or around the packer. In addition, as previously described, the annulus of the 8-5/8 inch diameter casing and 4-1/2 inch diameter tubing will be monitored with a continuous pressure recorder at the surface to detect any leaks in the tubing or packer.

## ***Mechanical Integrity Testing***

Mechanical integrity tests will be conducted on the injection well every five years or at any time that a work-over is conducted on the well. Test results will be included in the next quarterly monitoring report.

## ***Recordkeeping***

Laboratory analyses and flow volume records for all injected fluids will be maintained for three years after all injection wells have been plugged and abandoned. Copies of monitoring reports, calibration and maintenance records, and continuous monitoring readings shall be kept for five years after all injection wells have been plugged and abandoned. Records may be discarded after this retention time only with written approval from USEPA.

# **ATTACHMENT Q – Plugging and Abandonment Program**

## ***Requirements***

The plugging and abandonment program must contain details on the following:

1. Type, number, and placement (including elevation of the top and bottom) of plugs to be used.
2. Type, grade, and quantity of cement to be used.
3. Method used to place plugs including the method used to place the well in a state of static equilibrium prior to placement of the plugs.

## ***Plugging and Abandonment Program***

An exact plugging and abandonment program cannot be developed for the well until drilling and construction are complete. Plug depths and remaining fluids in the borehole will vary depending on the depth of the injection zone. However, the well will be plugged and abandoned following procedures required by the CDOG including requirements for fluid weight and viscosity. The tubing will be removed from the hole. In general, the following plugs and plate will be used in the abandonment process:

- Plug across injection zone, bringing cement 100 feet into the 8-5/8 inch casing (>300-foot plug)
- Plug at base of the USDW, estimated at 1,789 feet (200-foot plug)
- Plug at surface of the well (100-foot plug)
- Cut casing 5 feet below ground and weld steel plate on top of the casing stub.

USEPA may approve modifications to this program based on information developed during the drilling, construction, and operation of the well. In addition, USEPA may modify the program in the future based on approved work-overs or well modifications. CSC will notify EPA no less than 60 days before conversion, work-over, or abandonment. Within 60 days of abandonment, CSC will provide details of the plugging plan on Form 750-14 to USEPA. Wells will be properly plugged in accordance with the plugging and abandonment program after injection operations have ceased for two years unless the permittee demonstrates that the wells will be used in the future or that the well will not endanger USDWs while temporarily abandoned.

Costs for plugging and abandoning the injection well have been estimated by Irani Engineering at \$45,000 for a Miocene injection well and \$60,000 for a Cretaceous injection well. Preliminary cost estimates are included in the Supporting Documentation attached to this application.

## **ATTACHMENT R – Necessary Resources**

A surety bond or other financial assurance will be provided to USEPA by CSC prior to operation of the injection well. The amount of the bond will be determined by USEPA and will consider the estimated costs for the proposed plugging and abandonment program. Irani Engineering estimates \$45,000 for plugging and abandoning a Miocene injection well and \$60,000 for plugging and abandoning a Cretaceous injection well. The preliminary cost estimates are included in the Supporting Documentation attached to this application.

## **ATTACHMENT T – Existing USEPA Permits**

CSC has no existing USEPA permits for this site.



## ATTACHMENT U – Description of Business

The CSC facility will produce mozzarella, provolone, and ricotta cheese. The site was purchased from the former owner who conducted similar cheese manufacturing operations. Currently, cheese production is not occurring at the site. When operating at capacity, approximately 210,000 gallons per day (GPD) of raw milk will be delivered to the facility. Milk deliveries are likely to occur seven days a week throughout the year, with little seasonal variation. The facility is expected to operate twenty-four hours per day.

In the production of mozzarella and provolone, pasteurized milk and starter media are added to fermentation vats. After fermentation, the curdled solids and whey are pumped to long tables where the whey drains through screens. The curds are rinsed and salt is added. The whey is transferred to further processing. The rinse water is discharged to the wastewater system. The separated curds are then cooked, molded, chilled, conveyed through brine flumes, wrapped, and stored in a cooler until shipped. Ricotta cheese is curdled with acetic acid, blended to the desired consistency, and placed in tubs and stored in a cooler until shipped.

Screened whey passes through specialized equipment for removal of solids and whey cream, respectively, which are sold. The remaining whey is processed through ultrafiltration (UF) for protein removal, and reverse osmosis (RO) for lactose removal. The whey protein concentrate and lactose are also sold. The RO permeate will be discharged to the wastewater treatment system. Equipment cleaning operations will also add to the wastewater stream. Sanitary wastewater from employee restrooms will be treated separately and not combined with the food-processing wastes. Wastewater will be treated prior to injection as described in Attachment H and shown on Table 4.

The CSC management team and the parent corporation have a demonstrated commitment to responsible operation of facilities and compliance with environmental requirements. Two facilities that are a part of the parent corporation recently received recognition for excellence.

**Tampa Bay Fisheries, Inc.** received the **WATEREUSE ASSOCIATION 2005 Small Project of the Year Award** for a wastewater reuse project at their Florida facility. This award was presented at the Twentieth Annual WateReuse Symposium in Denver, Colorado in September of this year.

**Fisherman's Pride Processing, Inc.** received a **Certificate of Recognition** in June 2005 from the Sanitation Districts of Los Angeles County. The Certificate was presented to Fisherman's Pride Processing, Inc. for consistently complying with USEPA and County Sanitation Districts' industrial wastewater discharge limits and permit requirements. This certificate is provided in the Supporting Documentation included with this application.

## References

- Agency for Substances and Disease Registry (ATSDR), excerpts, tables, and figures only, Prepared by ATSDR, U.S. Federal Facilities Assessment Branch, Division of Health Assessment and Consultation, Public Health Assessment, Sharpe Army Depot, Lathrop, San Joaquin County, California, CERCLIS NO. CA8210020832, March 31, 1998.
- Bartow, Alan J., The Cenozoic Evolution of the San Joaquin Valley, California, USGS Professional Paper 1501, 1991.
- Bartow, Alan J., Map Showing Tertiary Stratigraphy and Structure of the Northern San Joaquin Valley, California, Miscellaneous Field Studies, map MF-1761, 1985.
- Bartow, Alan J., Map Showing Configuration of the Basement Surface, Northern San Joaquin Valley, California, Miscellaneous Field Studies, Map MF-1430, 1983.
- Berkstresser, C. F., Jr., Base of Fresh Ground Water – Approximately 3,000 Micromhos – in the Sacramento Valley and Sacramento–San Joaquin Delta, California, WRI 40-73, 6217-05, December 1973.
- Brown and Caldwell Consulting Engineers, Eastern San Joaquin County Groundwater Study, Final Report, Prepared for San Joaquin County Flood Control and Water Conservation District, October 1985.
- California Department of Conservation, Division of Oil, Gas, and Geothermal Resources, (CDOG), unpublished miscellaneous well files, reviewed May 19 and July 12, 2005.
- California Department of Conservation, Division of Oil, Gas, and Geothermal Resources, (CDOG) History, PR11, <http://www.consrv.ca.gov/dog>, accessed May 5, 2005.
- California Department of Conservation, Division of Oil, Gas, and Geothermal Resources (CDOG), 2003 Production & Reserves, <http://www.consrv.ca.gov/dog>, downloaded May 5, 2005.
- California Department of Conservation, Division of Oil, Gas, and Geothermal Resources (CDOG), Access Database of District 6 Wells, downloaded May 16, 2005, <http://www.consrv.ca.gov/dog>, .dbf file date December 17, 2004.
- California Department of Conservation, Division of Oil, Gas, and Geothermal Resources (CDOG), Publications & Forms, Publication No. PR2S, March 2003.
- California Department of Conservation, Division of Oil, Gas, and Geothermal Resources (CDOG), Map 606, District 6 well and field location map, 1:36,000, downloaded May 16, 2005, <http://www.consrv.ca.gov/dog>, October 31, 2002.

California Department of Conservation, Division of Oil, Gas, and Geothermal Resources (CDOG), Drilling and Operating Oil and Gas Wells in California, Publication No. PR6S, 2002.

California Department of Conservation, Division of Oil, Gas, and Geothermal Resources (CDOG), California Oil & Gas Fields, Contour Maps, Cross Sections, and Data Sheets, Publications TR10, TR11, and TR12 in .pdf format, Volume III, Northern California, 1982.

California Department of Conservation, Division of Oil, Gas, and Geothermal Resources (CDOG), Index to Articles Published by the California Division of Oil & Gas, Publication No. PR3S, 1975.

California Department of Water Resources (DWR), Unpublished water level data, downloaded from website, <http://well.water.ca.gov> , July 31, 2005.

California Department of Water Resources (DWR), San Joaquin Valley Groundwater Basin, Eastern San Joaquin Subbasin, Draft, California's Groundwater Bulletin 118, March 5, 2003.

California Department of Water Resources (DWR), Central District, Historical Ground Water Levels in San Joaquin County, April 1990.

California Department of Water Resources (DWR), San Joaquin County Ground Water Investigation, Bulletin 146, July 1967.

California Department of Water Resources, Quality of Ground Water in the Stockton Area, San Joaquin County, Water Quality Investigations, Report No. 7, March 1955.

California Regional Water Quality Control Board, Central Valley Region (CVRWQCB), Waste Discharge Requirements For Degroot And Sons, A&J Foods, INC., And Chiron Corporation, Wastewater Disposal To Land, San Joaquin County, Order No. 91-161, July 26, 1991.

California Regional Water Quality Control Board Central Valley Region (CVRWQCB), Waste Discharge Requirements For Degroot And Sons Suprema Specialties West. Inc., Cheese Manufacturing And Wastewater Disposal Facility, San Joaquin County, Order No. 5-00-057, March 17, 2000.

California Regional Water Quality Control Board, Central Valley Region (CVRWQCB), Waste Discharge Requirements for Closure, Post Closure and Corrective Action of Surface Impoundments at Kruger Foods, Inc – SMS Briners Vegetable Brining Facility, San Joaquin County, Order No. R5-2004-0157, October 15, 2004.

California Regional Water Quality Control Board (CVRWQCB), Order Rescinding Various Waste Discharge Requirements, Order No. R5-2004-0033, CAL Suprema Cheese, and others, March 19, 2004.

California Regional Water Quality Control Board, Central Valley Region (CVRWQCB), Waste Discharge Requirements for Defense Distribution Depot San Joaquin Sharpe Wastewater Treatment Facility, San Joaquin County, Order No. R5-2004-0083. June 9, 2004.

California Regional Water Quality Control Board, Central Valley Region (CVRWQCB), Monitoring and Reporting Program No. R5-2004-0800 California Water Code Section 13267, former Occidental Chemical Corporation Facility, Lathrop, San Joaquin County, no date, 2004.

California Regional Water Quality Control Board, Central Valley Region (CVRWQCB), Notice of Regional Board Information Item Concerning Regulation of Food Processing Waste Discharges to Land in the Central Valley Region, Staff Report, Regulation of Food Processing Waste Discharge to Land, January 13, 2005.

California Regional Water Quality Control Board, Central Valley Region (CVRWQCB), Site Cleanup List, <http://www.waterboards.ca.gov/centralvalley>, downloaded May 4, 2005.

California Regional Water Quality Control Board, Central Valley Region (CVRWQCB), Unpublished Correspondence Files, CAL Suprema Cheese, Degroot and Sons, Manteca, CA, Copied excerpts May 23, 2005.

California Water Project Authority (CWPA), Investigation of the Sacramento-San Joaquin Delta, Report No. 1, Ground Water Geology, May 1956.

Callaway, David C., Distribution of Uppermost Cretaceous Sands in the Sacramento-Northern San Joaquin Basin of California, in Edmondson, W.F., ed., Selected Papers Presented to San Joaquin Geological Society, v. 2, pp. 5-18, April 1964.

Cherven, V.B., and Graham, S.A., editors, Geology and Sedimentology of the Southwestern Sacramento Basin and East Bay Hills, Annual Meeting Pacific Section, Society of Economic Paleontologists and Mineralogists, Los Angeles, CA Field Trip Guidebook, May 20-22, 1983.

City of Lathrop, Unpublished information on City website, public works, water systems page, [www.lathropgov.org/pwd/utilities/water.asp](http://www.lathropgov.org/pwd/utilities/water.asp), accessed May 12, 2005.

City of Lathrop, personal communication, July 26, 2005.

City of Lathrop, Annual Water Quality Report, Water testing performed in 2003, City website, <http://www.lathropgov.org/pwd/utilities/water.asp>, downloaded July 26, 2005.

City of Manteca, Unpublished well information table, transmitted by Keith Conarroe to Todd Engineers, July 25, 2005.

City of Manteca, personal communication, July 22, 2005.

City of Manteca, 2003 Report to consumers on Water Quality, City website, <http://www.ci.manteca.ca.us/eng/>, downloaded July 22, 2005.

City of Manteca, Urban Water Management Plan, 2002 Update, Adopted January 6, 2003.

City of Stockton Municipal Utilities Department and Camp, Dresser, and McKee (CDM), Delta Water Supply Project, Groundwater Analysis, March 17, 2005.

City of Stockton and Kennedy Jenks Consultants, Urban Water Management Plan 2000 Update, City of Stockton Department of Municipal Utilities, December 2000.

Ken E. Davis and Associates (Davis), Survey of Methods to Determine Total Dissolved Solids Concentrations, Prepared for U.S. Environmental Protection Agency, Underground Injection Control Program, September 1988.

Edmondson, W. F., Callaway, D. C., Hoffman, R. D., and Teitsworth, R. A., Stratigraphic Units of Northern San Joaquin Valley and Southern Sacramento Valley, Selected Papers Presented to San Joaquin Geological Society, Volume 2, April 1964.

Edmondson, W., F., Stratigraphy of the Late Upper Cretaceous in the Sacramento Valley, in Karp, Stanley E., ed., Selected Papers to San Joaquin Geological Society, v. 1, October 1962.

Engineering Enterprises, Guidance Document for the Area of Review Requirement, Prepared for USEPA, May 1985.

Fetter, C. W., Applied Hydrogeology, second edition, Macmillan Publishing Company, 1988.

Franks, Alvin L., Base of Fresh Ground Water and Groundwater Quality Beneath the Injection Interval, unpublished study in the vicinity of the Occidental Chemical facility, Luhdorff & Scalmanini, December 1981.

Goudkoff, P. P., Stratigraphic Relations of Upper Cretaceous in Great Valley, California, Bulletin American Association of Petroleum Geologists, v. 29, n. 7, p. 956-1007, July 1945.

Hilmar Cheese Company, Underground Injection Control Permit Application, Portion of Section 10, T6S/R10E, MDB&M, Merced County, California, Prepared by San Joaquin Energy Consultants, Inc., September 17, 2004.

Hoffman, R.D., Geology of the Northern San Joaquin Valley in Edmondson, W.F., ed., Selected Papers Presented to San Joaquin Geological Society, San Joaquin Geological Society, Bakersfield, California, v. 2, pp. 30-45, April 1964.

Hotchkiss, William R., Generalized Subsurface Geology of the Water-Bearing Deposits, Northern San Joaquin Valley, California, Prepared in cooperation with the California Department of Water Resources, USGS Open-File Report 73-119, May 12, 1972.

Kennedy/Jenks Consultants, 2002 Water Master Plan, City of Manteca, prepared for City of Manteca, December 30, 2002.

Laymac Corporation, Engineering and Geological Study Proposed Waste Water Disposal, Laymac Co. Reynolds & Carver-Long No. 1, Sec. 24, T1N, R6E, MDB&M, French Camp Field, San Joaquin County, California, September 30, 1985.

Luhdorff & Scalmanini, Feasibility of Groundwater Injection for Disposal of Treated Effluent, Prepared for Occidental Chemical Company, December 19, 1981.

McLin, Stephen G., Evaluation of Aquifer Contamination from Salt Water Disposal Wells, Proceedings Oklahoma Academy of Science, v. 66, pp 53-61, 1986.

Modesto Bee, New Water Supply for Central Valley, by Melanie Turner, staff writer, July 6, 2005.

Nolte, City of Lathrop, Master Plan Documents, Hydrology/Water Quality Report for Environmental Impact Report, March 2001.

Nolte Associates, Inc., Evaluation of Treatment Effectiveness Report, Prepared for Suprema Specialties West, Inc., September 29, 2000.

Nolte Associates, Inc., Salt Reduction and Water Recycling Investigation Report, Prepared for Suprema Specialties West, Inc., September 29, 2000.

Nolte Associates, Inc., Wastewater Facility Pond Storage Report, Prepared for Suprema Specialties West, Inc., November 2000.

Nolte Associates, Inc., Notice of Violation Response Report, Prepared for Suprema Specialties West, Inc., December 2000.

Nolte Associates, Inc., Report of Waste Discharge, Prepared for Suprema Specialties West, Inc., January 2000.

Nolte Associates, Inc., Notice of Violation Response Report, Prepared for Suprema Specialties West, Inc., April 2001.

Nolte, 2001 Annual Monitoring Report, Suprema Specialties West, Inc., Manteca, California, February 2002.

Nolte Associates, Inc., Report of Waste Discharge For Small Food-Processor WDR Waiver Program, Prepared For, CAL Suprema Cheese, Inc., October 2003.

Norris, Robert M. and Webb, Robert W., Geology of California, Second Edition, John Wiley & Sons, 1990.

Northern California Power Agency (NCPA), Mechanical Integrity Test of Northern California Power Agency, Lodi Facility Injection Well STIG #1, Prepared by Fairchild and Wells, Inc., Performed on November 25 and December 3, 2003.

Northern California Power Agency (NCPA), Permit Application, Class 1 Underground Injection Well, Northern California Power Agency CT-2 Facility, Lodi, California, October 22, 1993.

Occidental Chemical Company, 1982 Annual Report, Unbound Data Compilation, no date, submitted to CVRWQCB May 31, 1983.

Occidental Chemical Corporation, Injection Zone Aquifer Investigation Report Groundwater Remedial Program, Occidental Chemical Corporation, Lathrop, California, revised September 17, 1992.

Occidental Chemical Corporation, Lathrop Remedial Project, Well Field Master Listing, unbound data compilation, no date, Copied May 23, 2005.

San Joaquin CoGen LTD, Permit Application for Class I Waste Water Disposal Well, facility files accessed at USEPA, November, 1988.

San Joaquin County, Eastern San Joaquin Groundwater Basin, Groundwater Management Plan, Northeastern San Joaquin County Groundwater Banking Authority, September 2004.

Schlumberger Well Services (Schlumberger), Unpublished Reference Manual, 1984.

SMS Briners, Permit Application, Class I Non-hazardous UIC Injection Well, San Joaquin County, September 1991.

Sorenson, S.K., Chemical Quality of Ground Water in San Joaquin and Part of Contra Costa Counties, California, USGS Water-Resources Investigation 81-26, 1981.

Teitsworth, Robert A., Geology and Development of the Lathrop Gas Field San Joaquin County, California, Edmondson, W.F., ed., Selected Papers Presented to San Joaquin Geological Society, v. 2, pp. 19-29, April 1964.

The Source Group, Inc., Transmittal to Sudhakar Talanki, Regional Water Quality Control Board, Central Valley Region, Subject: Well Data Logs Former OCC Facility Remedial Program, Lathrop, California, Unpublished well construction information from four water supply wells operated by City of Lathrop, February 19, 2003.

The Source Group, Inc., Final Application for Designation of a Groundwater Containment Zone, Former Occidental Chemical Corporation Facility, Prepared for Glenn Springs Holdings, Inc., July 18, 2002.

Todd, D.K., Groundwater Hydrology, Wiley & Sons, 3<sup>rd</sup> Edition, 2004.

David Keith Todd Consulting Engineers, Inc. (Todd Engineers), Groundwater Quality in the Vicinity of Occidental Chemical Company, Lathrop, California, September 1979

David Keith Todd Consulting Engineers, Inc. (Todd Engineers), Groundwater Quality in the Vicinity of Occidental Chemical Company, Lathrop, California, Supplemental Report on Organic Compounds, October 1979.

URS Group, Inc., Unpublished well construction table with location information, TDS table (query from water quality database), provided by DDJC-Sharpe, July 29, 2005.

URS Group, Inc., DDJC-Sharpe FFA Annual Progress Report October 2003 – September 2004, Final, Prepared for U.S. Army Corps of Engineers, May 2005.

U.S. Code of Federal Regulations (CFR), Title 40 – Protection of Environment, Chapter 1 – Environmental Protection Agency, Part 144 – Underground Injection Control Program, Part 145 – State UIC Program Requirements, Part 146 – Underground Injection Control Program: Criteria and Standards, Part 147 – State Underground Injection Control Programs, <http://www.washingtonwatchdog.org/documents/cfr/title40/>, accessed May 11, 2005.

U.S. Environmental Protection Agency (USEPA), UIC Reporting Forms (7520s), Underground Injection Control Program, <http://www.epa.gov/ogwdw/uic/7520s.html>, accessed May 11, 2005.

U.S. Environmental Protection Agency (USEPA), Drinking Water Academy, Introduction to the Underground Injection Control Program, PowerPoint format Presentation, <http://www.epa.gov/safewater/dwa/electronic/presentations/uic/...>, downloaded April 7, 2005.

U.S. Environmental Protection Agency (USEPA), Introduction to UIC Permitting, PowerPoint format Presentation,



<http://www.epa.gov/safewater/dwa/electronic/presentation/uic...>, accessed website April 2005.

U.S. Environmental Protection Agency (USEPA), Instructions for Underground Injection Control Permit Application, EPA Form 7520-6 Well Class and Type Codes, <http://www.epa.gov/r5water/uic/forms>, downloaded April 2005.

U.S. Environmental Protection Agency (USEPA), General information on the Underground Injection Control Program, <http://www.epa.gov/safewater/uic>, accessed February 21, 2005.

U.S. Environmental Protection Agency (USEPA), Underground Injection Control Permit Application, EPA Form 7520-6 (Rev. 8-01), OMB No. 2040-0042, Approval Expires January 31, 2005.

U.S. Environmental Protection Agency (USEPA), Region 6, UIC Pressure Falloff Testing Guideline, Third Revision, August 8, 2002.

U.S. Environmental Protection Agency (USEPA), Class I Underground Injection Control Program: Study of the Risks Associated with Class I Underground Injection Wells, Office of Water (4601), EPA 816-R-01-007, [www.epa.gov/safewater](http://www.epa.gov/safewater), March 2001

U.S. Environmental Protection Agency (USEPA), Memorandum, Subject: Underground Injection Control (UIC) Class I SNC Redefinition – UICP Guidance No. 81, To: Water Management Division Directors Regions I – X, From: Robert I. Van Heuvelen, Director, Office of Regulatory Enforcement (2241A) and Cynthia C. Dougherty, Director, Office of Ground Water and Drinking Water (4601), March 3 1995.

U.S. Environmental Protection Agency (USEPA), Technical Program Overview: Underground Injection Control Regulations, Office of Water 4606, EPA 816-R-02-025, <http://www.epa.gov>, Revised July 2001, December 2002.

U.S. Environmental Protection Agency (USEPA), EDPA Superfund Record of Decision: Sharpe Army Depot, EPA ID: CA8210020832, OU 1, EPA/ROD/R09-93/089, downloaded from website, figures unavailable, Lathrop, CA, January 25, 1993.

U.S. Federal Register, Part IV, Environmental Protection Agency, 40 CFR Parts 9, 144, 145, 146, Underground Injection Control, Regulations for Class V Injection Wells, Revision; Final Rule, December 7, 1999.

U.S. Geological Survey (USGS), Topographic map, Stockton West, CA, 7.5 Minute Series, 1:24,000, DMA 1759 IV NE-Series, V895, 1968, Photo revised 1987.

U.S. Geological Survey (USGS), Topographic map, Stockton East, CA, 7.5 Minute Series, 1:24,000, DMA 1759 I NW-Series, V895, 1968, Photo revised 1987.

U.S. Geological Survey (USGS), Topographic map, Peters, CA, 7.5 Minute Series, 1:24,000, DMA 1759 1 NE-Series, V895, 1952, Photo revised 1968, Minor Revision 1994.

U.S. Geological Survey (USGS), Topographic map, Avena, CA, 7.5 Minute Series, 1:24,000, DMA 1759 1 SE-Series, V895, 1952, Photo revised 1968, Minor Revision 1994.

U.S. Geological Survey (USGS), Topographic map, Manteca, CA, 7.5 Minute Series, 1:24,000, DMA 1759 1 SW-Series, V895, 1952, Photo revised 1987, Minor Revision 1994.

U.S. Geological Survey (USGS), Topographic map, Lathrop, CA, 7.5 Minute Series, 1:24,000, NIMA 1759 IV SE-Series, V895, 1996.

Van Voorhees, Robert F., Removed from the Environment, The Environmental Law Institute, Copyright © 2001.

Wagner, D.L., Bortugno, E.J., and McJunkin, R.D., Geologic Map of the San Francisco-San Jose Quadrangle, California Department of Conservation, Division of Mines and Geology, Scale 1:250,000, 1991.

Warner, D.L., and Lehr, J. H., Subsurface Wastewater Injection, The Technology of Injecting Wastewater into Deep Wells for Disposal, Premier Press, Berkeley, California, 1981.

West Yost, City of Stockton, South Stockton Master Plan Update, November 2004.

**Table 1**  
**Wells Within Area of Review**  
**California Specialty Cheese UIC Permit Application**

Owner and Well No.	Date Drilled	Total Depth (ft, bgs)	Perforations	Well Use	Status
<b>Water Supply Wells</b>					
DeGroot - Jersey Crown Dairy #1	1972	160	142 - 157	Industrial	Active
DeGroot No. 2 #2				Industrial	Inactive - backup
DeGroot	1977	320	110 - 320	Irrigation	Unknown
Jersey Crown Dairy	1977	160	145 - 160	Irrigation	Unknown
DeGroot	1992	295	180 - 270	Irrigation	Unknown
DeGroot	1973	141	124 - 131	Domestic	Unknown
Aufdermaur	1977	172	116 - 126	Domestic	Unknown
Western Stone Products	1994	250	200 - 240	Domestic	Unknown
Manteca Unified School District		170	119 - 159	Municipal	Unknown
Crabtree	1959	100		Domestic	Unknown
Cardoza	1975	110	105 - 110	Domestic	Unknown
Vanetti	1966	130	100 - 130	Domestic	Unknown
<b>Oil and Gas Wells</b>					
Owner unknown - Record from a State Mineralogist Report	1888	1,042	None	Exploration	Abandoned
<b>Monitoring Wells</b>					
Suprema Specialties West MW2	2000	25	15 - 25	Monitoring	Active
Suprema Specialties West MW3	2000	25	15 - 25	Monitoring	Active
Suprema Specialties West MW4	2000	24	11 - 23	Monitoring	Active
Suprema Specialties West MW5	2000	25	15 - 25	Monitoring	Active
DDJC - Sharpe MW428A	1984	32	22 - 32	Monitoring	Active
DDJC - Sharpe MW429A	1984	30	20 - 30	Monitoring	Active
DDJC - Sharpe MW441A	1987	25	15 - 25	Monitoring	Active
DDJC - Sharpe MW441B	1987	75	65 - 75	Monitoring	Active
DDJC - Sharpe MW441C	1987	113	103 - 113	Monitoring	Active
DDJC - Sharpe MW478A	1994	22	11 - 21	Monitoring	Active
DDJC - Sharpe MW489A	1997	28	13 - 28	Monitoring	Active
DDJC - Sharpe MW502A	1984	35	25 - 34	Monitoring	Active
DDJC - Sharpe PZ018	2002	23	13 - 23	Monitoring	Active
DDJC - Sharpe PZ019	2002	25	15 - 25	Monitoring	Active

bgs - below ground surface  
see text for sources of well information

**Table 2**  
**Deep Wells Within 2 Miles of Proposed Injection Well**  
**California Specialty Cheese UIC Permit Application**

Operator	Well Name	Location	Distance from CSC Site (ft)	Date Drilled	Total Depth (ft)	Date Abandoned	Abandonment Plug Depths (ft)
Quintana Petroleum	S.P. No. 1	25-1S-6E	4,385	Apr-1970	9,471	Apr-1970	4,216'-3,936'; 1,045'-847'; 25'-sfc
Pan Petroleum Company	Hayre Egg Farms No. 1	18-1S-7E	4,520	Dec-1969	8,455	Dec-1969	7,716'-7,416'; 1,311'-900'; 15'-sfc
Christiana Oil Corp.	Schleiss No. 1	30-1S-7E	9,826	Dec-1959	5,756	Dec-1959	956'-593'; 10'-sfc
S.I. Corporation	Great Basins Unit No. 22	22-1S-6E	10,236	Jul-1962	8,993	Jul-1962	795'-sfc
E.B. Towne	Southeast Lathrop Unit A1	14-1S-6E	9,456	Oct-1967	8,493	Dec-1971	7,391'; 3,150'-2,887'; 25'-sfc
U.S. Natural Resources	Towne S.P. Unit Two No. 1	14-1S-6E	8,040	Nov-1968	8,147	Nov-1968	7,300'-7,008'; 952'-780'; 25'-15'
E.B. Towne	S.P. Unit One No. 1	14-1S-6E	8,208	Feb-1968	8,479	Mar-1968	950'-720'; 10'-sfc

See Figure 1 for well locations.

Table includes all wells within a 2-mile radius of the proposed CSC site that have penetrated the target injection zones.

**Table 3**  
**Industrial Process Water Treatment**  
**Material Balance and Conceptual Design**  
**California Specialty Cheese UIC Permit Application**

BASIS: 24 HOUR BASIS AND YEAR 2000 WATER USE

CONVERSION DATA			GALLONS/DAY						
GRAM =	1000	MILLIGRAMS	WATER SUPPLY WELL	310,460	CALCULATED FROM DATA BELOW				
GALLON =	3.785	LITERS	PRODUCT/PROCESS LOSS	24,960	ASSUMED AVERAGE GALLONS DAILY FLOW				
DENSITY WATER =	8.33	LB/GALLON	DOMESTIC SEWAGE	5,000	ASSUMED AVERAGE GALLONS DAILY FLOW				
POUND =	454	GRAMS	MAIN SUMP	249,600	AVERAGE GALLONS DAILY FLOW				
			RINSE WATER	30,900					
STREAM NUMBER			1	2	3	4	5	6	MAIN EQUALIZATION
STREAM DESCRIPTION			RAW FEED MAIN SUMP	ROTARY SCREEN SCREENINGS	ROTARY SCREEN EFFLUENT	INDUSTRIAL WASTEWATER PRETREATMENT		UIC WELL INJECTION	VOLUME GALLONS 50,000
COMPONENT									
FLOW, GALLONS			249,600	500	249,100		280,000	280,000	UIC EQUALIZATION
SUSPENDED SOLIDS, MG/L			1,300	1,300	1,300		1,300	19.91	VOLUME GALLONS
SUSPENDED SOLIDS, LBS.			2,705	5	2,700		2,700	41.00	GALLONS
DISSOLVED SOLIDS, MG/L			3,300	3,300	3,300		3,300	3,300	50,000
DISSOLVED SOLIDS, LBS.			6,867	14	6,853		6,853	6,795	
DEBRIS, POUNDS			300	300	-		-	-	

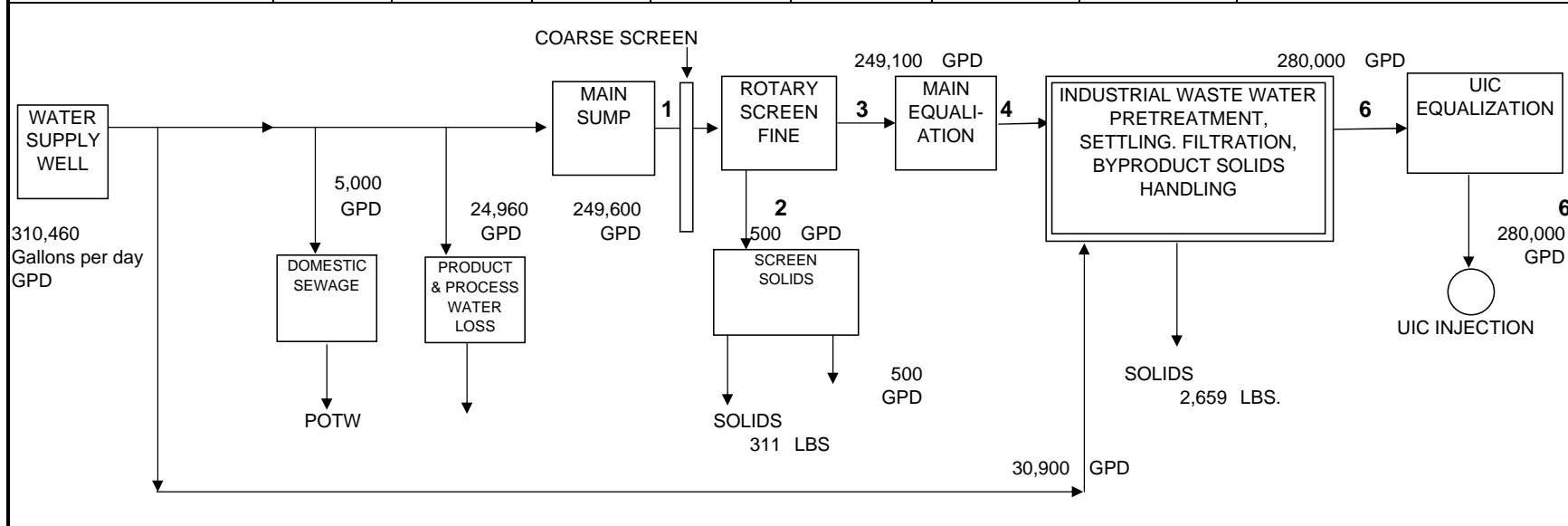

**Table 4**  
**Wastewater Characterization**  
**California Specialty Cheese UIC Permit Application**

Compiled data are on a 24-hour basis.

Anticipated wastewater volume of 300,000 gallons per day.

WASTEWATER CONSTITUENT/PARAMETER	SUMP MG/L 8/9/2002	SUMP LB/DAY 8/9/2002	SUMP MG/L 9/11/2000	DAF FEED MG/L 9/11/2000	DAF EFFLUENT MG/L 9/11/2000	DAF EFFECIENCY PERCENT	EQUALIZATION MG/L 8/9/2000	DAF EFFLUENT MG/L 8/9/2000	DAF EFFECIENCY PERCENT	SUMP MG/L 8/1/2000	EQUALIZATION MG/L 8/1/2000
TOTAL SUSPENDED SOLIDS	1300	3251		633	273	56.9	4900	610	87.6		
TOTAL DISSOLVED SOLIDS	3300	8254					2400	2400			
FIXED DISSOLVED SOLIDS	1300	3251									
VOLATILE DISSOLVED SOLIDS	2000	5002									
ELECTRICAL CONDUCTIVITY	2800	7003					3300	3400			
BOD	3900	9754		5265	2185		8400	2500		3026	2797
BOD5							1900				
SOLUBLE BOD				1586	1405			2000			
COD										8056	6928
pH	9.8						6	6			
TKN	940	2351					260	150			
AMMONIA NITROGEN			33.8	320.9	263.5		68				
ORGANIC NITROGEN			99.6	57.4	50.7		190				
NITRATE			227								
CHLORIDE	1110	2776		1110	1110		1110	1110			1110

**NOTES:**

DAF = Dissolved air flotation

DAF efficiency based on equalization/feed and effluent information.

All data from previous operations on CSC site by former operator.

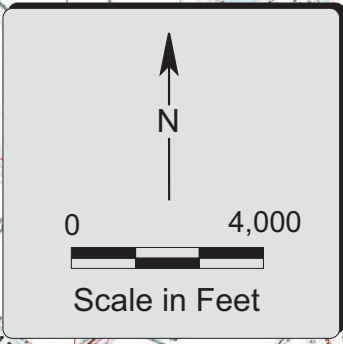
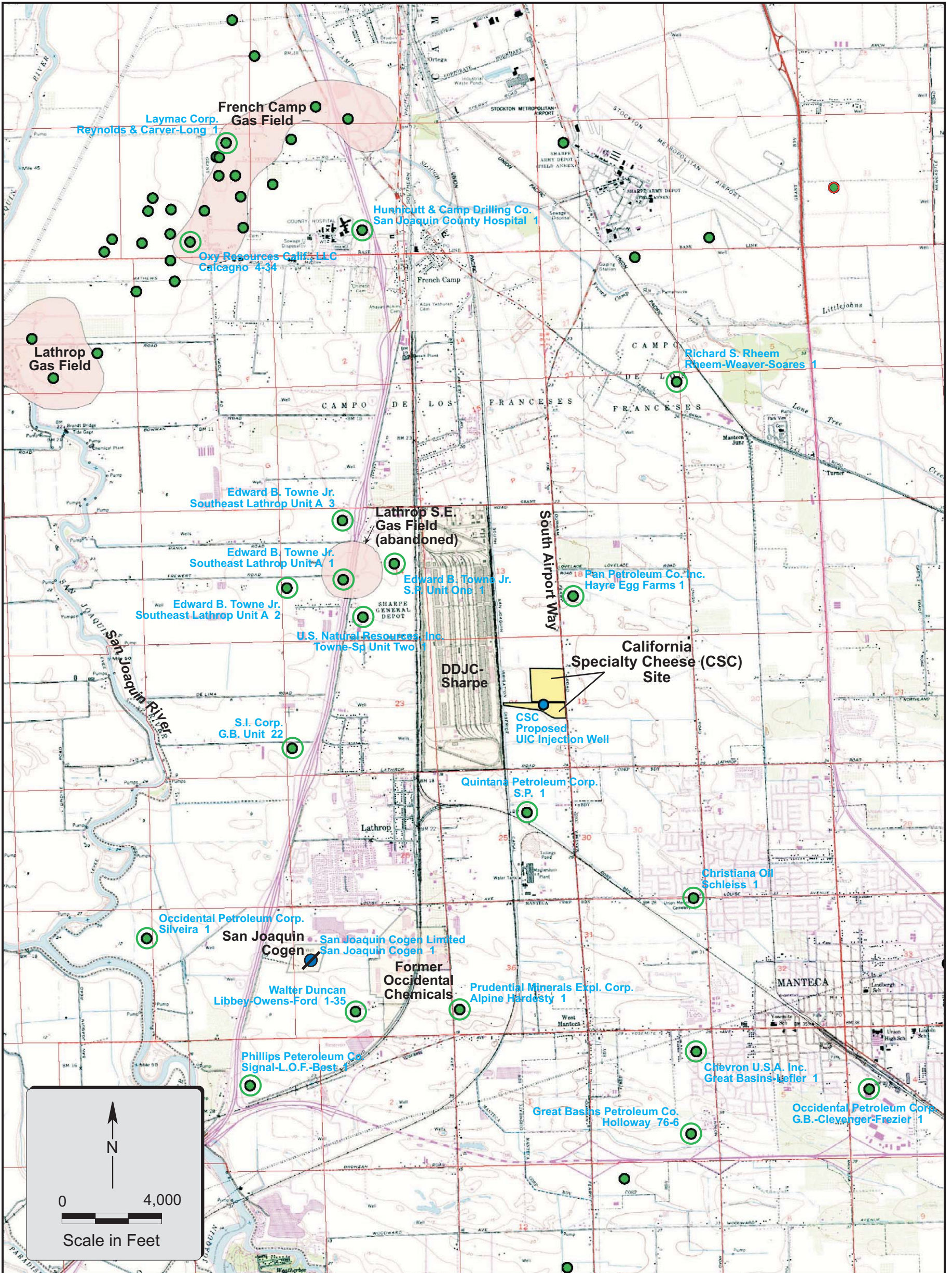

**LEGEND**

- Deep Gas Exploratory Well
- Well used in regional mapping
- Proposed UIC Injection Well
- Abandoned UIC Injection Well
- Gas Field

October 2005  
 TODD ENGINEERS  
 Emeryville, California

**Figure 1**  
**Project Location**  
**Map**



Photo shown for information and planning only. Not for commercial use.

October 2005

TODD ENGINEERS  
Emeryville, California

**Figure 2**  
**Air Photo**  
**California Specialty**  
**Cheese Site**



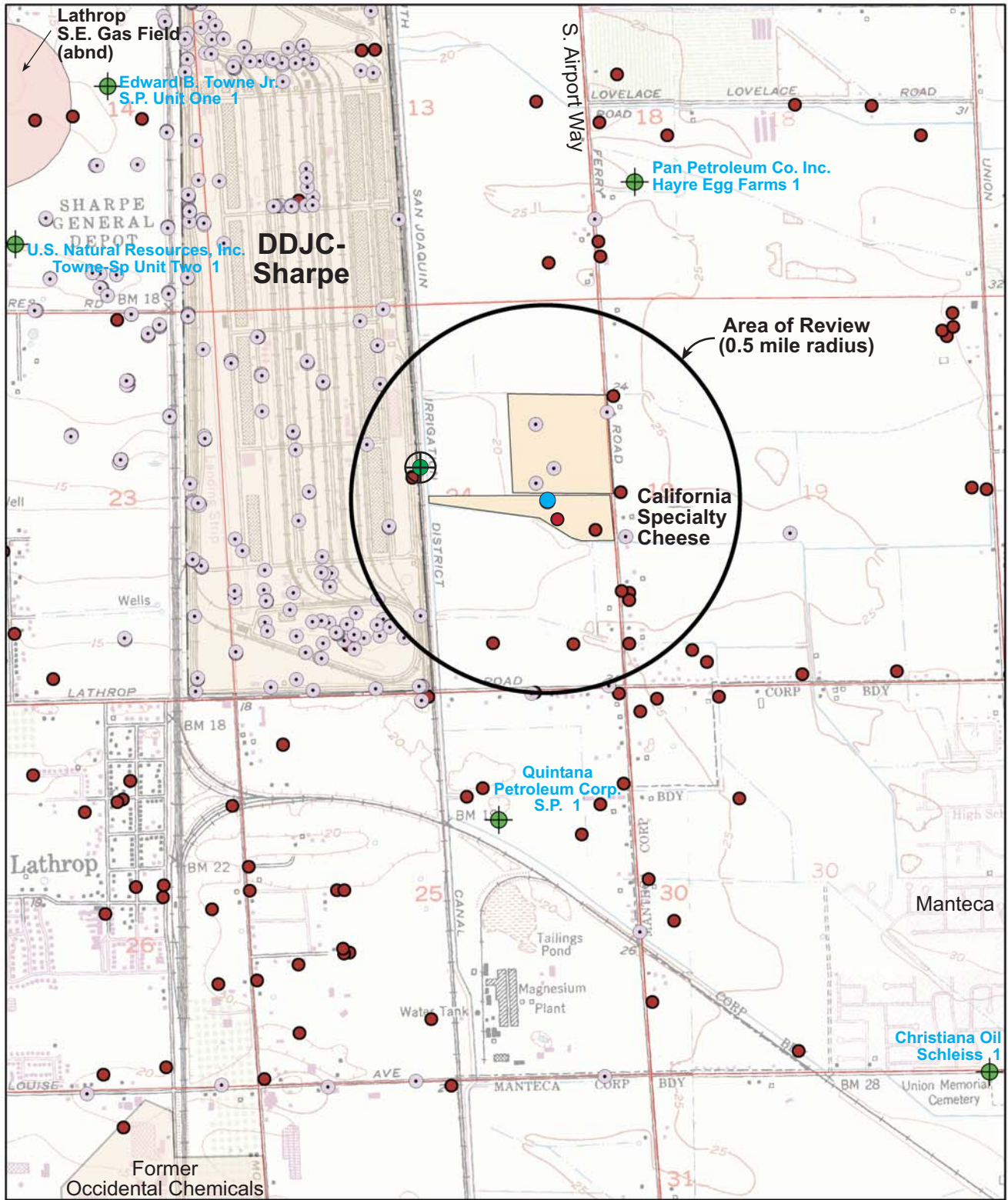

**Legend**

- Proposed Injection Well
- ⊙ Facility Monitoring or Extraction Well (CSC or DDJC-Sharpe)
- Water Supply Well
- ⊕ Abandoned Gas Exploration Well
- ⊕ Abandoned Gas Well not drilled to injection zones. Operator and location unknown. Drilled in 1888 to 1,042 feet.

Note: All well locations are approximate.

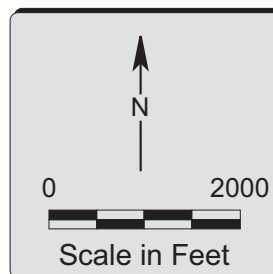

**Figure 3**  
**Wells in Area of Review**  
 October 2005  
 TODD ENGINEERS  
 Emeryville, California

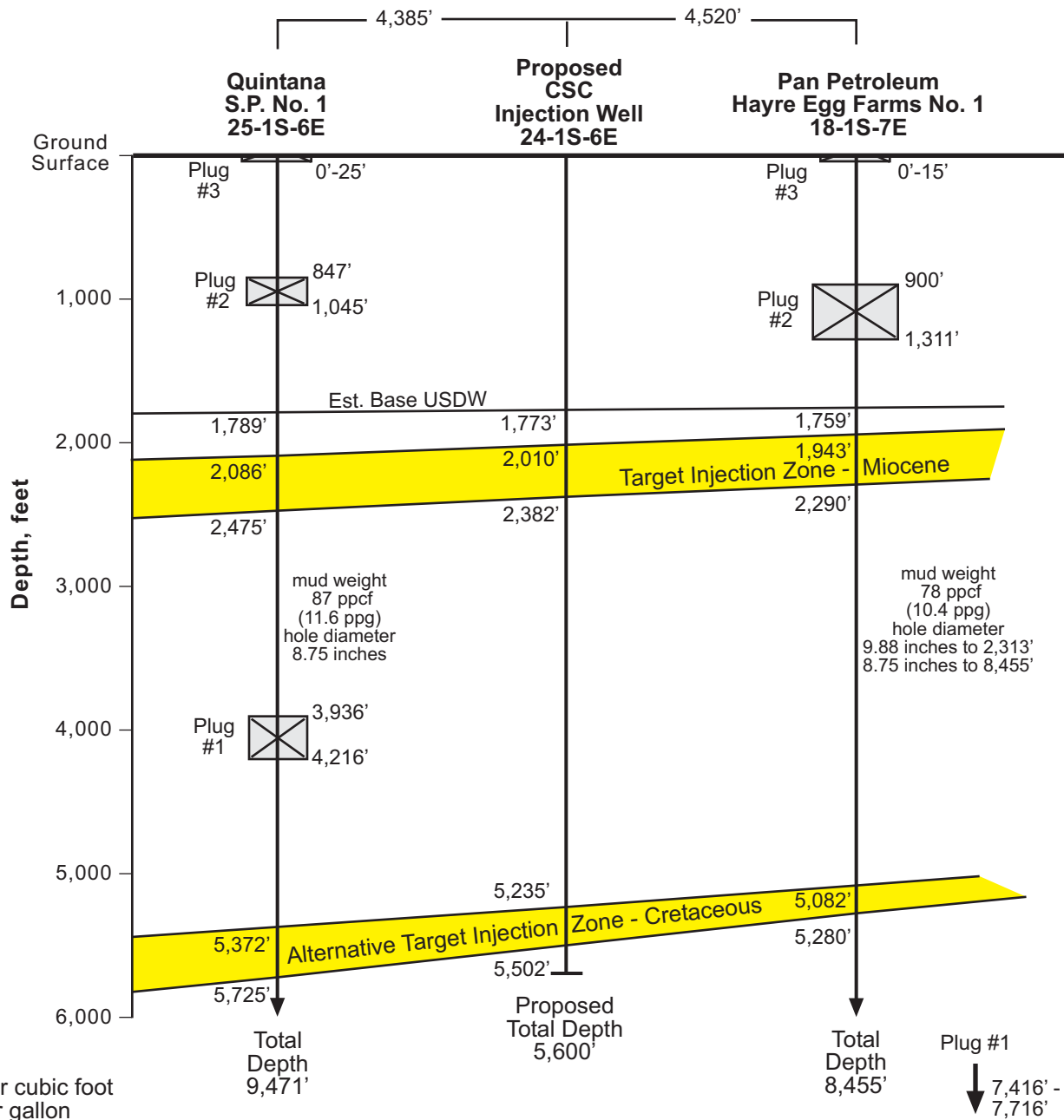

Note: These are the only 2 wells that penetrate either of the 2 target injection zones within 1.5 miles of CSC site.

ppcf = pounds per cubic foot  
 ppg = pounds per gallon  
 No horizontal scale

**Figure 4**  
**Abandoned Deep Wells**  
 October 2005  
 TODD ENGINEERS  
 Emeryville, California

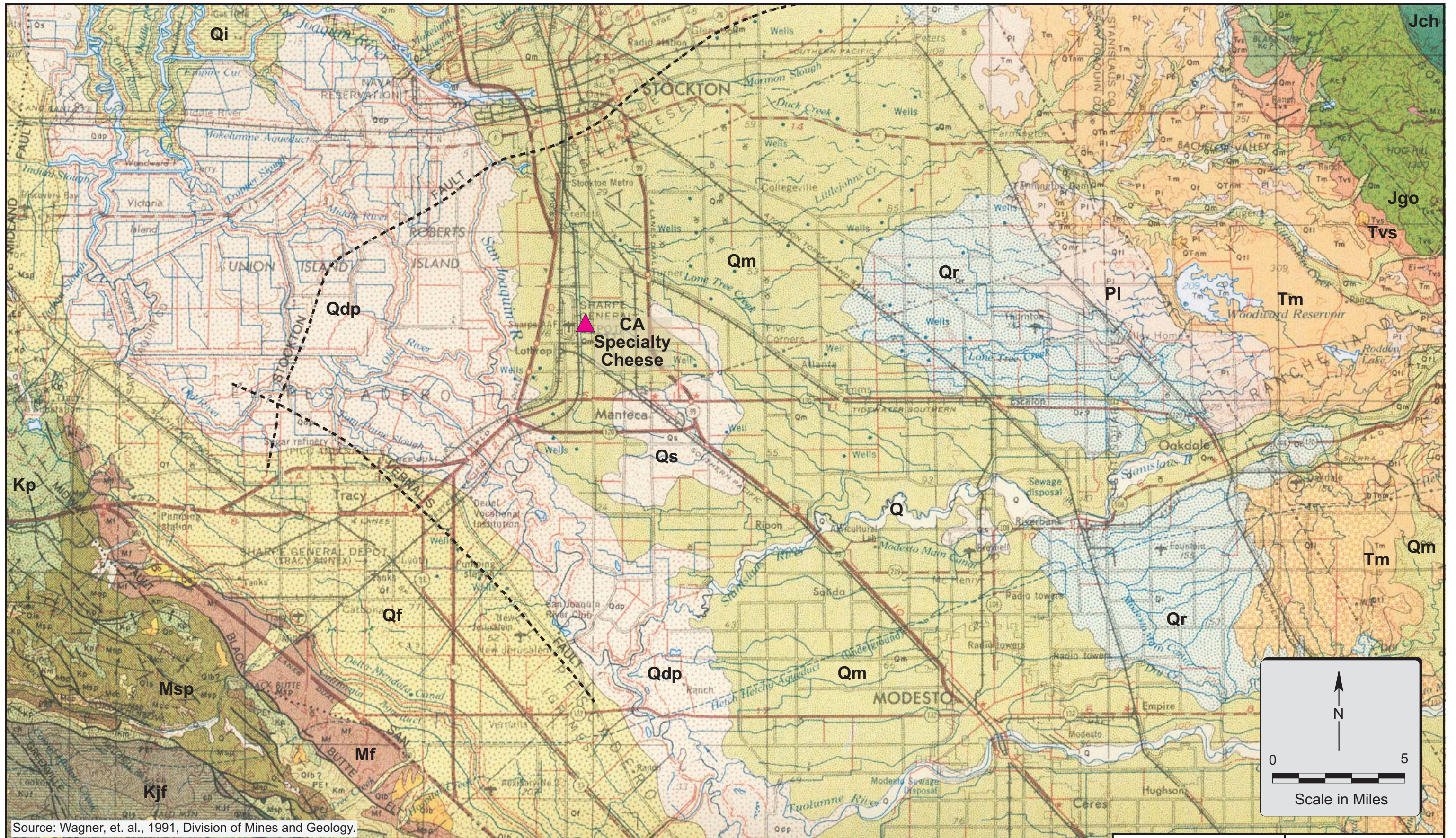

Source: Wagner, et. al., 1991, Division of Mines and Geology.

LEGEND			
Q	Alluvium	Qr	Riverbank Formation
Q1s	Landslide deposits	Qs	Dune Sand
Q1	Intertidal deposits	Qdp	Dos Palos Alluvium
Qf	Alluvial Fan deposits	Qm	Modesto Formation
Q11	Turlock Lake Formation	Qib	Los Banos Alluvium
PI	Laguna Formation	Msp	San Pablo Group
Msp	Santa Cruz Mudstone	Mf	Fanglomerate
Tvs	Valley Springs Formation	Tm	Mehrten Formation
Kp	Panoche Formation	Kjf	Franciscan Complex
Jch	Copper Hill Volcanics		
Jgo	Gopher Hill Volcanics		

October 2005  
 TODD ENGINEERS  
 Emeryville, California

**Figure 5**  
**Geologic Map**  
**California**  
**Specialty Cheese**

### Hydrostratigraphy in Vicinity of CSC Site

AGE		Geologic Units	Approximate Thickness (feet)	Physical Character	Water-bearing Properties
<b>Quaternary</b>	<b>Recent</b>	Modesto Formation, Riverbank Formation, Victor Formation, Misc. Alluvial Deposits	150	Unconsolidated gravel, sand, silt and clay deposits with extensive sand and gravel stringers.	This material is moderately permeable and yields fresh water.
	<b>Pleistocene</b>	Corcoran  or equivalent	50	Lacustrine Clay.	Confining layer.
		Laguna Formation	800	Semiconsolidated, poorly sorted silt, sand and clay with some gravel.	Permeability varies. Generally permeable and yields fresh water.
<b>Tertiary</b>	<b>Pliocene</b>				
	<b>Miocene</b>	Mehrten Formation	800	Conglomerate, silt and clay with interbedded lenses of black sands and agglomeratic material derived from andesitic mudflows.	The conglomerate, silt and agglomeratic material are relatively impermeable. Black sands are highly permeable and yield saline water in the Stockton area.
		Valley Springs Formation	500?	Consolidated rhyolitic tuffs, conglomerates, clay-shales, and sandstones.	This material is only slightly permeable and contains saline water in the Stockton area.
	<b>Eocene-Paleocene</b>	Undifferentiated Lower Tertiary/Upper Cretaceous	1,200	Consolidated marine sediments.	These deposits are only slightly permeable and contain saline water in the Stockton area.
<b>Pre-Cretaceous</b>		Undifferentiated Cretaceous Sediments	>8,500	Consolidated marine sandstones, shales, and conglomerates.	Saline water.
		Pre-Cretaceous Basement Complex	Unknown	Igneous and/or metamorphic rocks.	Fracture permeability only. No water quality data.

Modified from DWR, 1955.

October 2005

TODD ENGINEERS  
Emeryville, California

**Figure 6**  
**Hydrostratigraphic**  
**Units**  
**San Joaquin County**

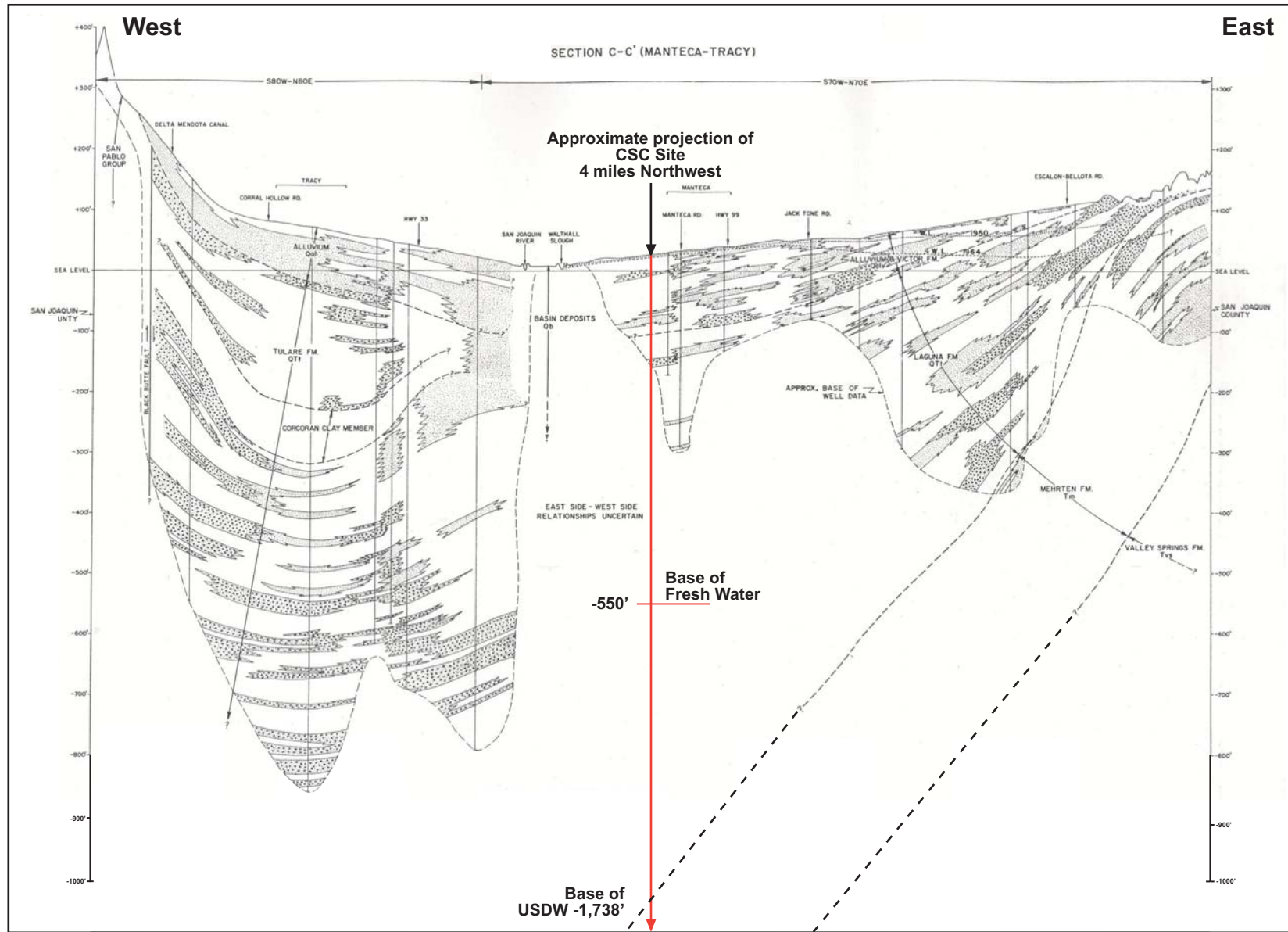

Source: From DWR, 1967, modified below -800 feet.

October 2005
TODD ENGINEERS Emeryville, California

<b>Figure 7</b> <b>USDW</b> <b>Cross Section</b>
--

**Water levels  
1972 - 2005  
Well 1S-7E-30R1**

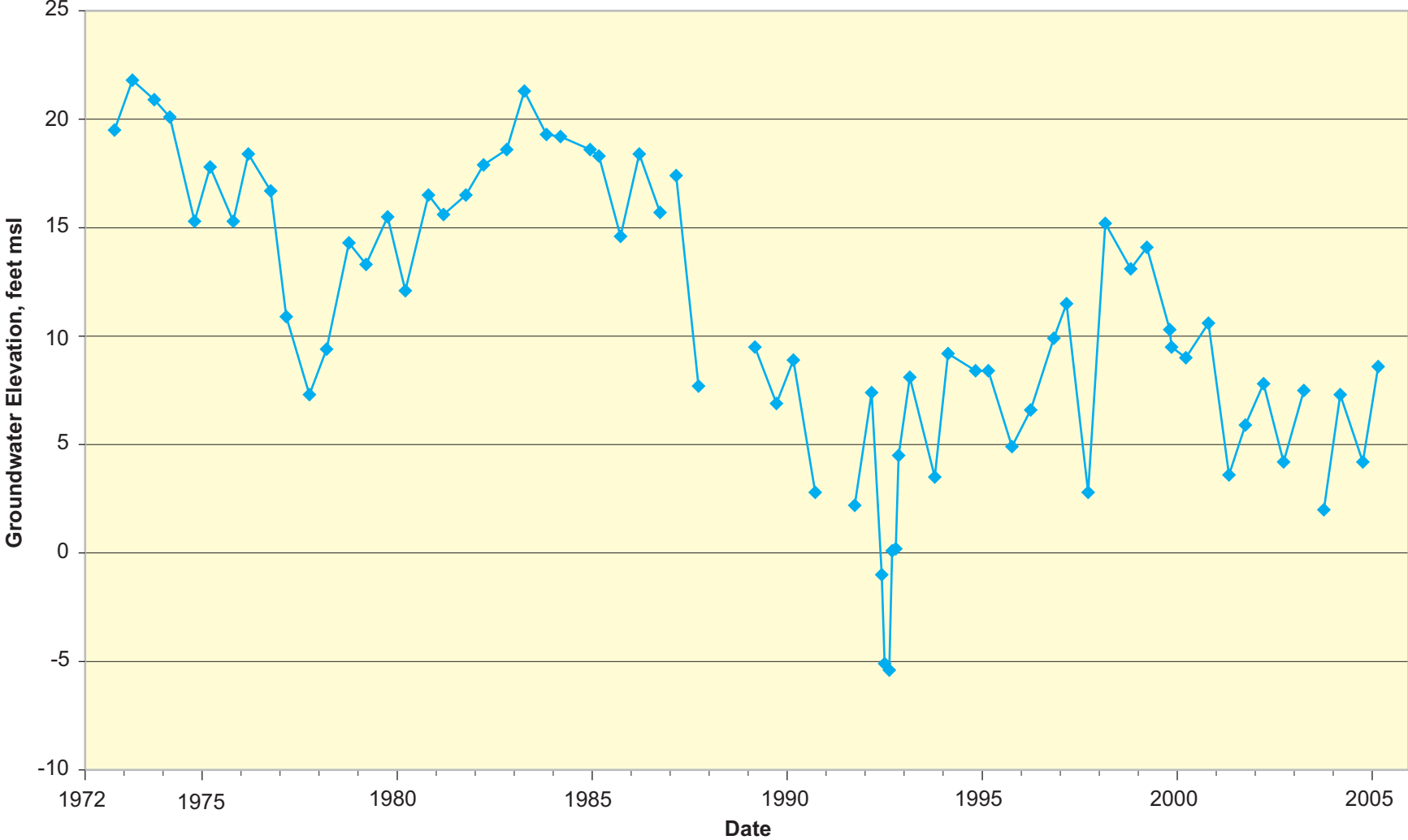

Note: Well is approximately 1.5 miles southeast of California Specialty Cheese site.

Source: Department of Water Resources, July 31, 2005.

October 2005	<b>Figure 8 Groundwater Elevations near California Specialty Cheese Site</b>
TODD ENGINEERS Emeryville, California	

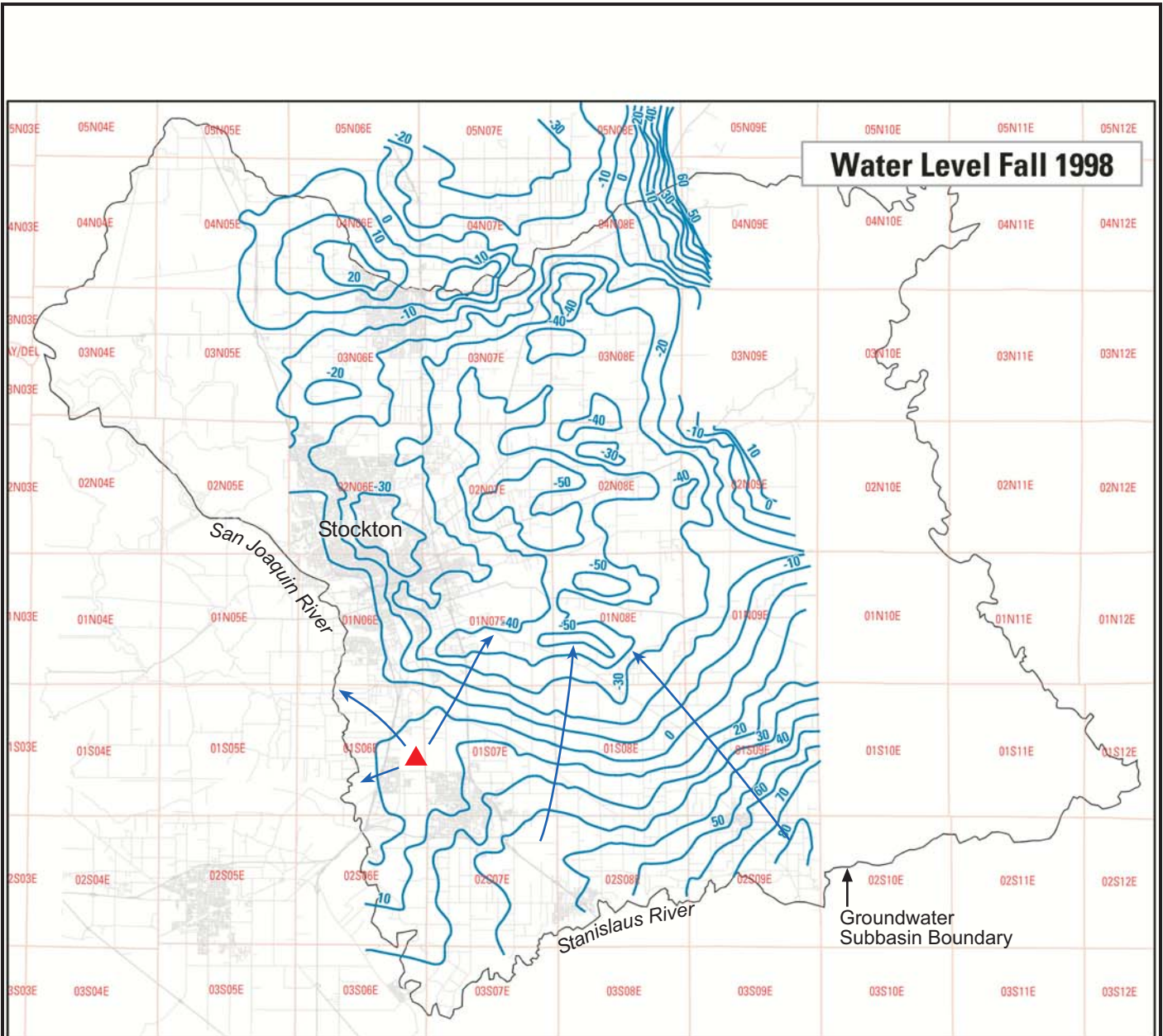

Source: USGS, DWR, and San Joaquin County, 1998.



- Groundwater elevation contour, feet above mean sea level
- ← Groundwater flow direction (not on original map)
- ▲ California Specialty Cheese Site

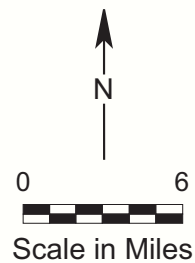

October 2005  
 TODD ENGINEERS  
 Emeryville, California

**Figure 9**  
**Groundwater Flow**  
**Eastern San Joaquin**  
**Subbasin**

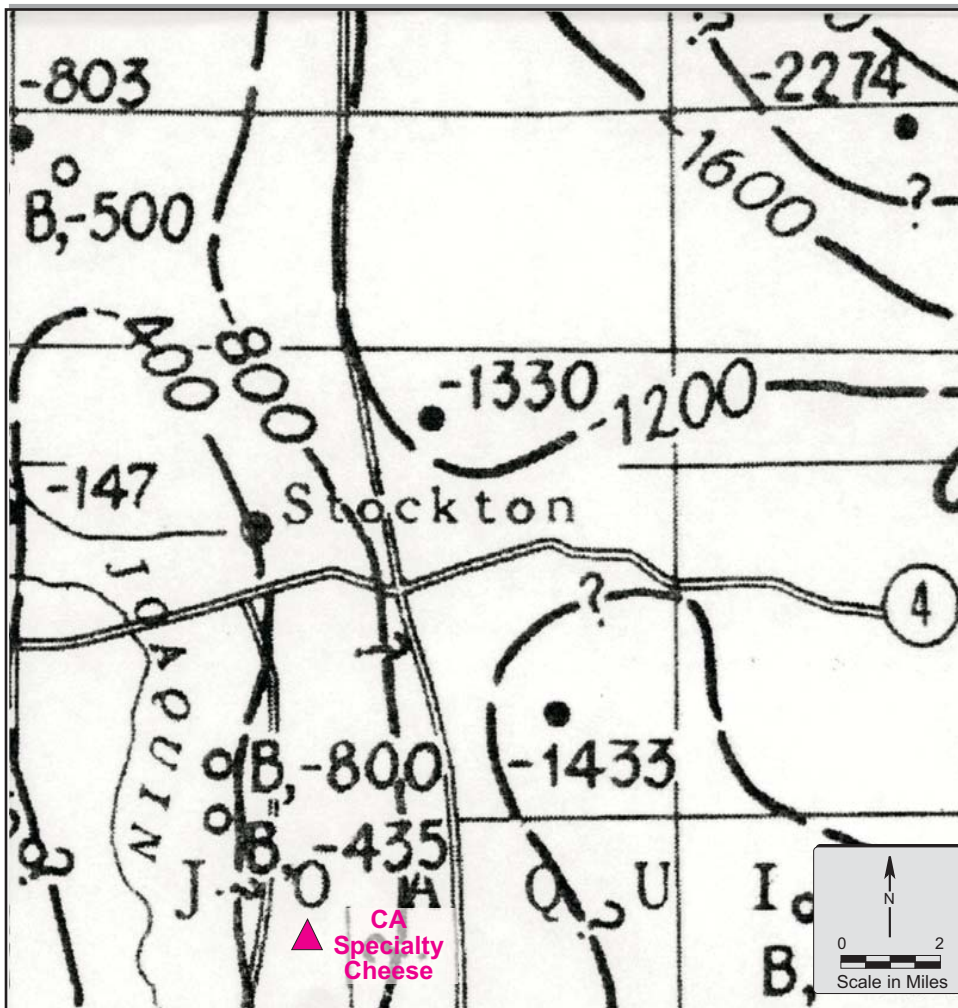

Base of Fresh Groundwater - C.F. Berkstresser, Jr., December 1973.

Defined as <2,000 mg/L TDS.

Estimated -550 feet below MSL at CA Specialty Cheese site.

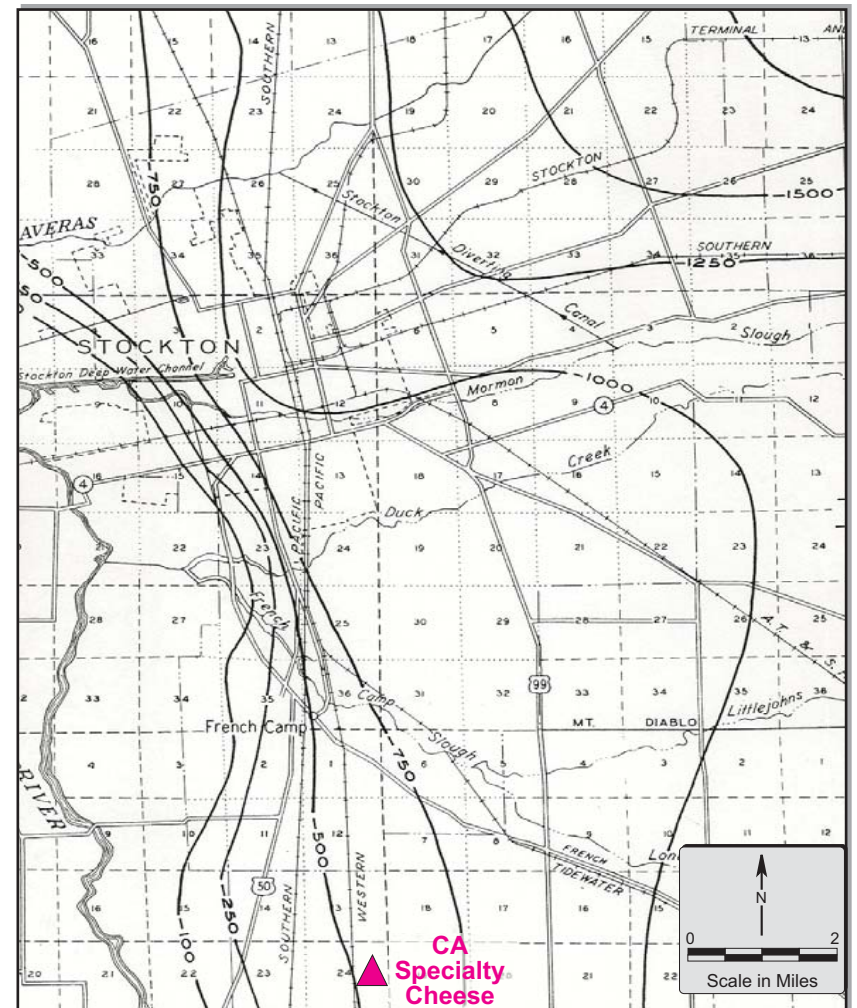

Subsurface Contours of the Base of Fresh Water, DWR, March 1955.

Defined as <300 mg/L chloride; equivalent to 2,000 mg/L TDS.

Estimated -550 feet below MSL at CA Specialty Cheese site.

October 2005	<b>Figure 10</b> <b>Base of Fresh Water</b> <b>near</b> <b>CA Specialty Cheese</b>
TODD ENGINEERS Emeryville, California	



### Preliminary Salinity Profile

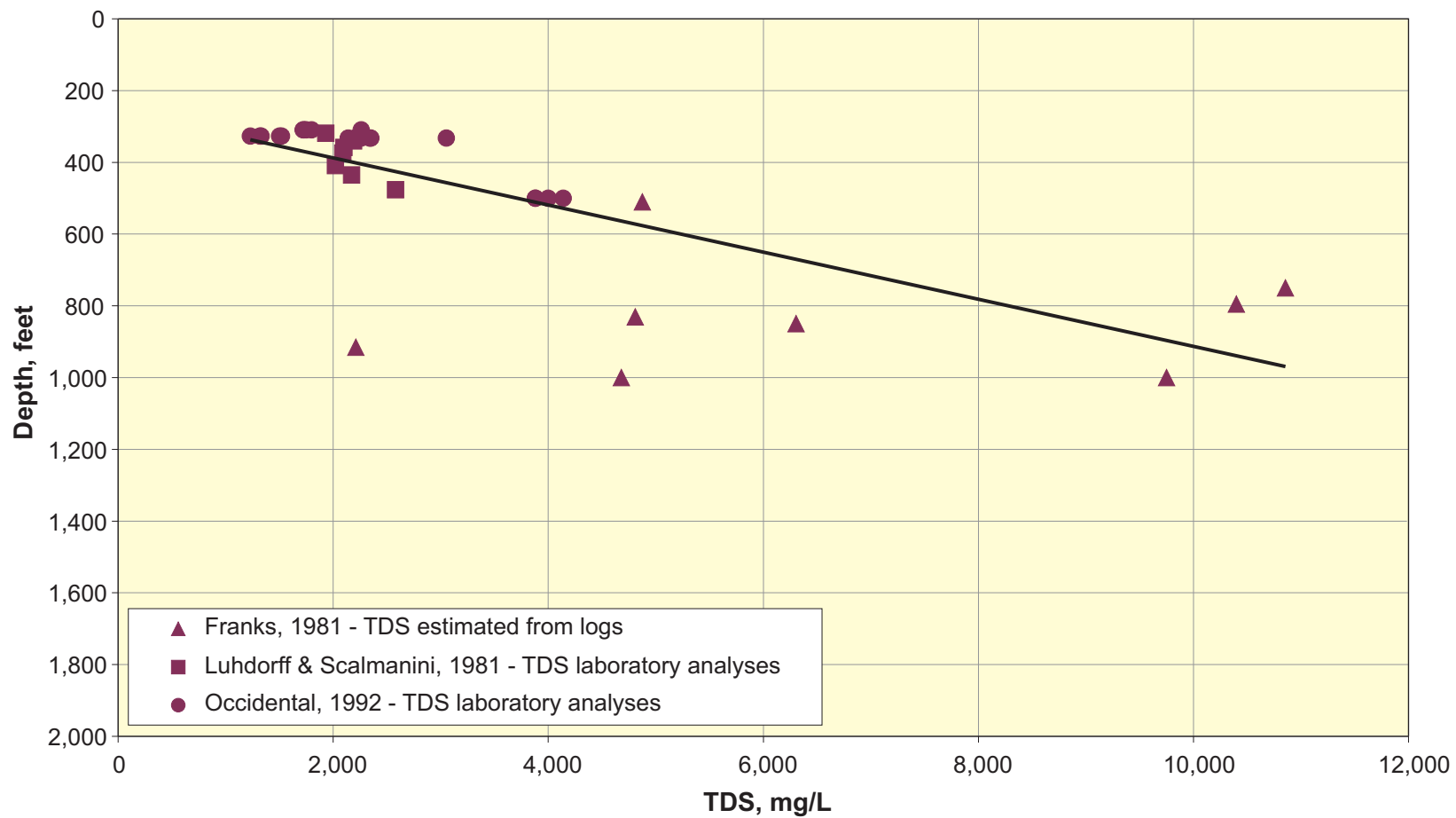

October 2005

TODD ENGINEERS  
Emeryville, California

**Figure 11**  
**Salinity Profile**  
**TDS with Depth**

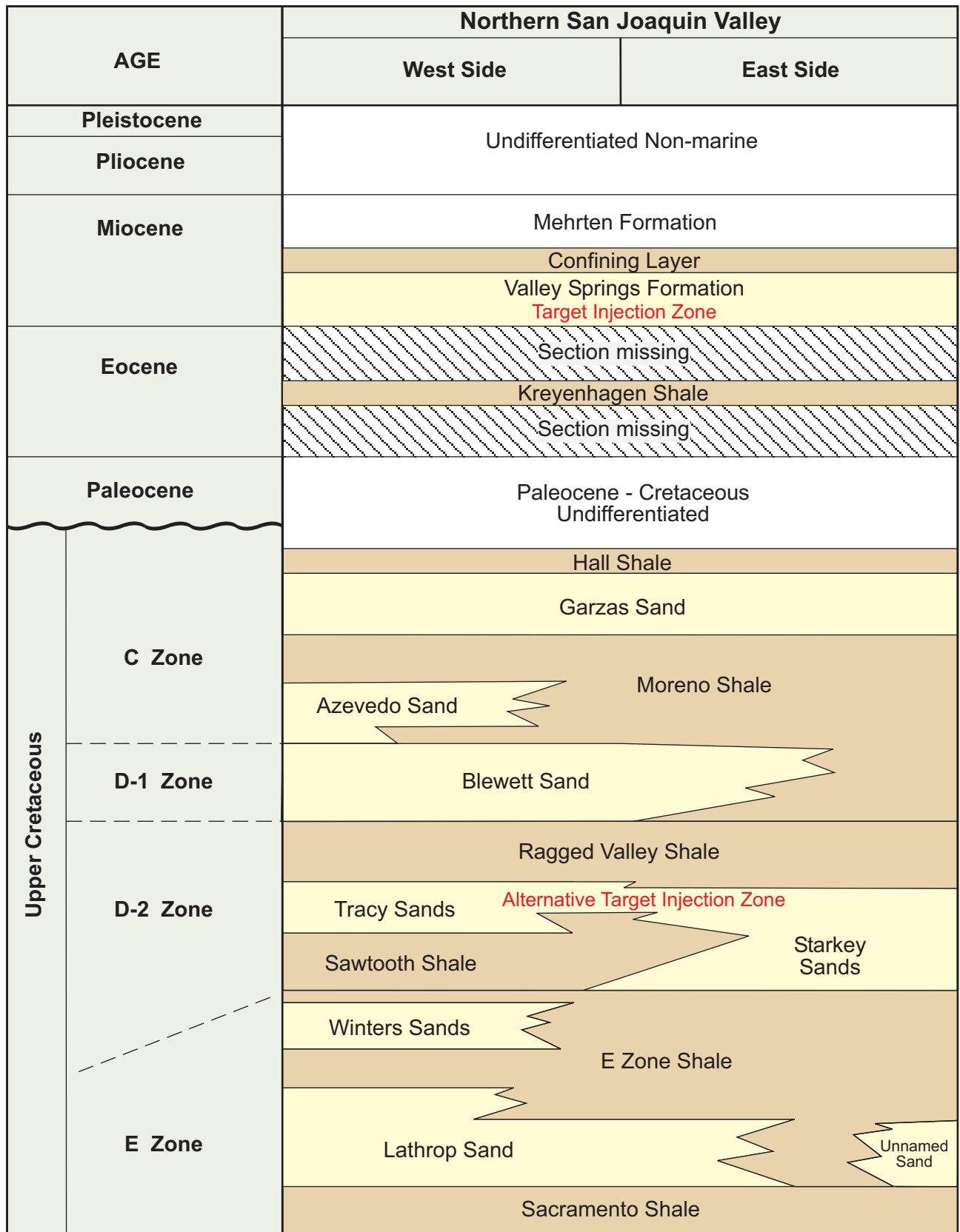

Source: Modified from W.F. Edmondson, et. al., 1964.

October 2005  
**TODD ENGINEERS**  
 Emeryville, California

**Figure 12**  
**Stratigraphic Units**  
**of Northern**  
**San Joaquin Valley**

Quintana Petroleum  
S.P. No 1  
25-1S-6E

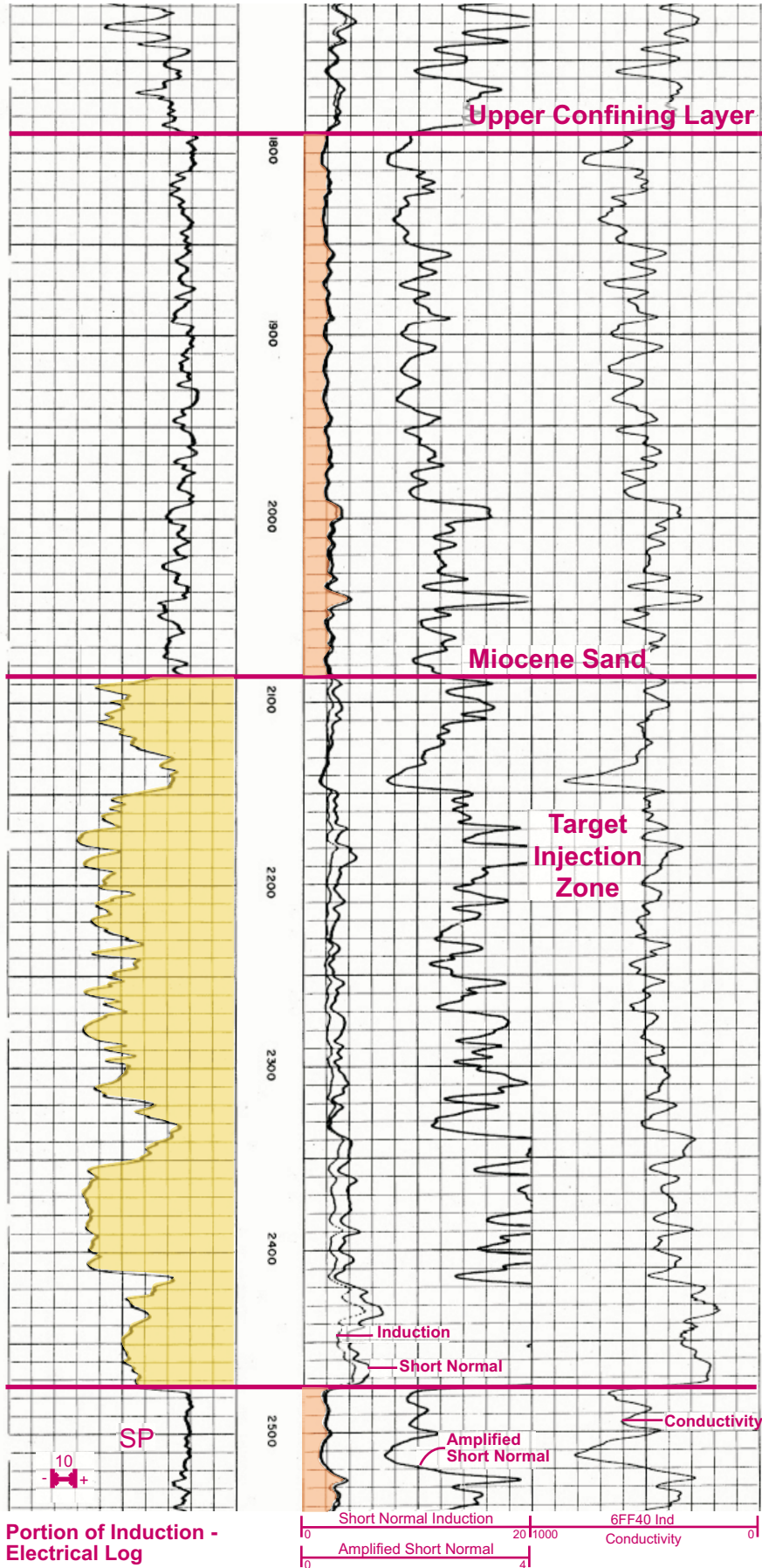

Assumed  
Base of USDW

Portion of Induction -  
Electrical Log

Figure 13  
Type Log  
Miocene Sand  
Target Injection Zone

October 2005

TODD ENGINEERS  
Emeryville, California

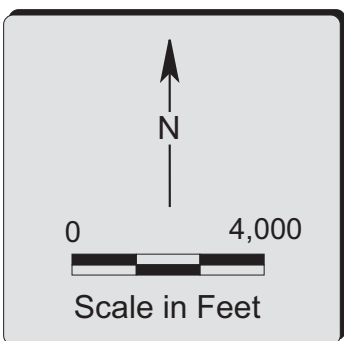
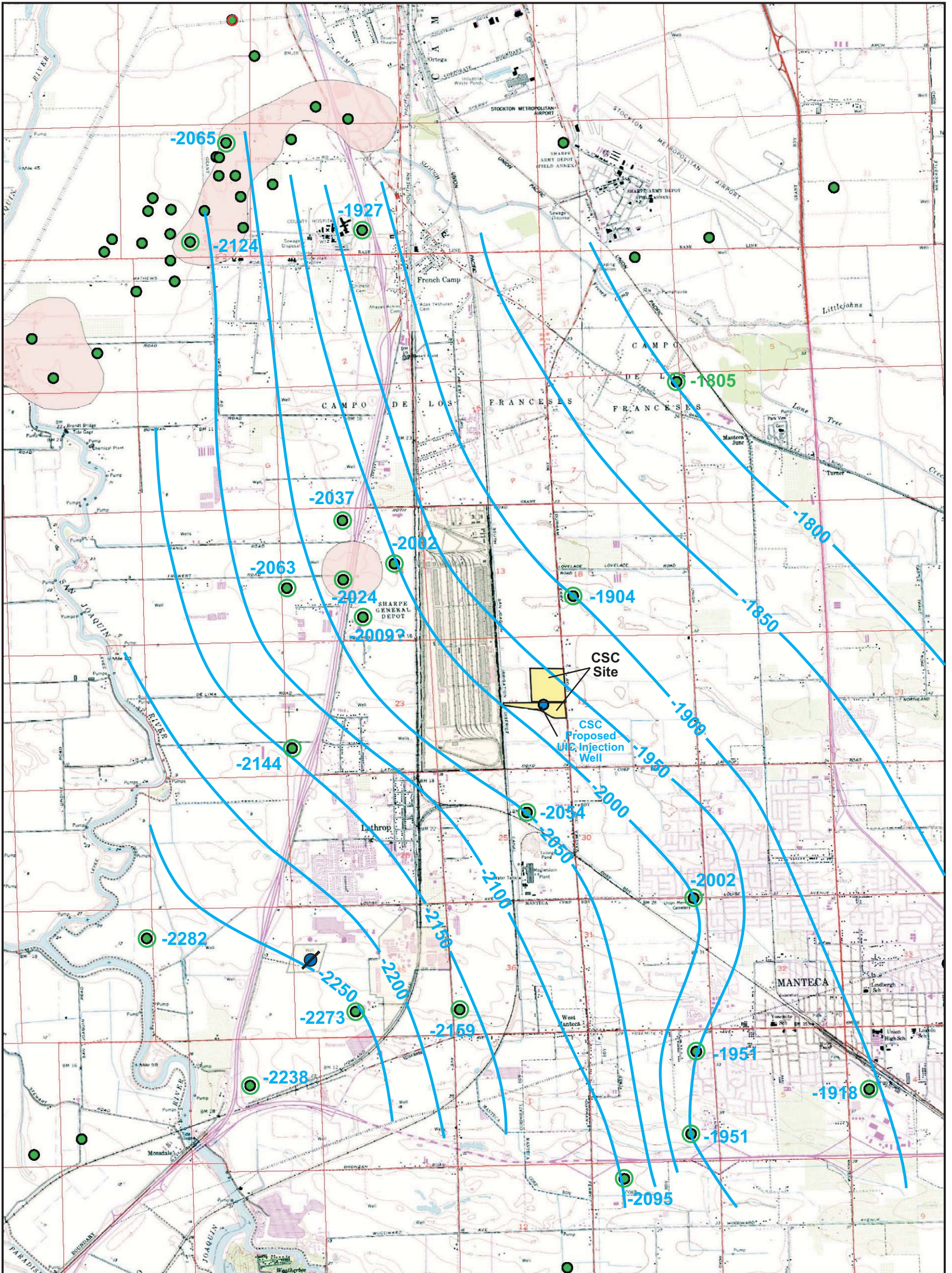

**LEGEND**

- Deep Gas Exploratory Well
- Well used in regional mapping
- Proposed UIC Injection Well at CSC site
- Abandoned UIC Injection Well
- 2282 Top of the Target Miocene Sand in exploratory gas well, feet below msl
- -2000 - - Structural contour, equal elevation, feet below msl

**Figure 14**  
**Structural Contour Map**  
**Top of the Target**  
**Miocene Sand**

October 2005

TODD ENGINEERS  
 Emeryville, California

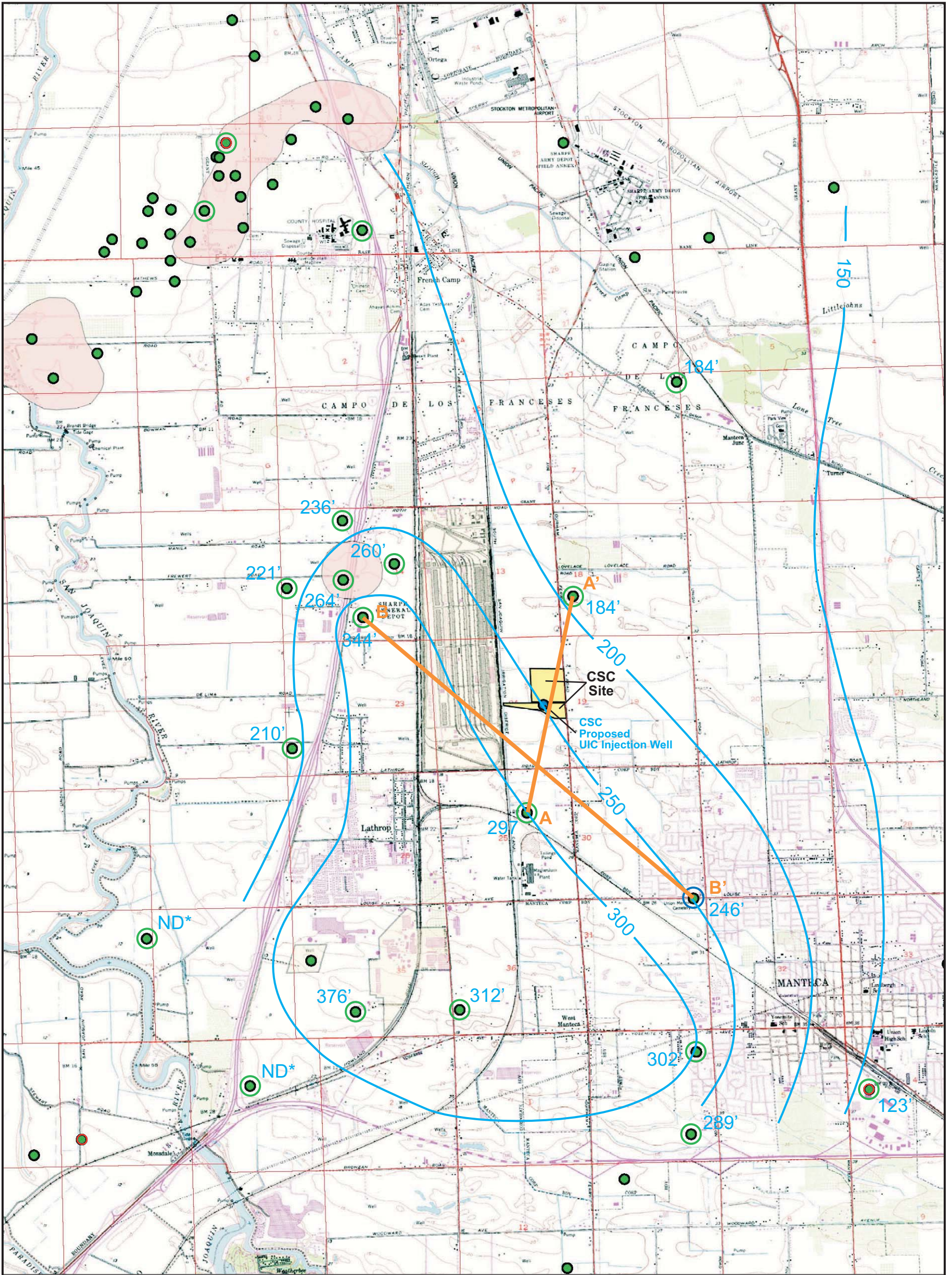

**LEGEND**

- Deep Gas Exploratory Well
- Well used in regional mapping
- Proposed UIC Injection Well at CSC site
- Abandoned UIC Injection Well
- 376' Thickness of confining layer in exploratory gas well, feet
- 250 — Equal thickness of confining layer, feet
- ND\* Target sand package not developed  
Correlations are suspect

— A — A' — Cross Section

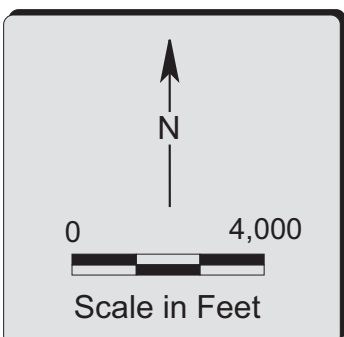

**Figure 15**  
**Isopach Map**  
**Miocene Confining Layer**

October 2005

TODD ENGINEERS  
Emeryville, California

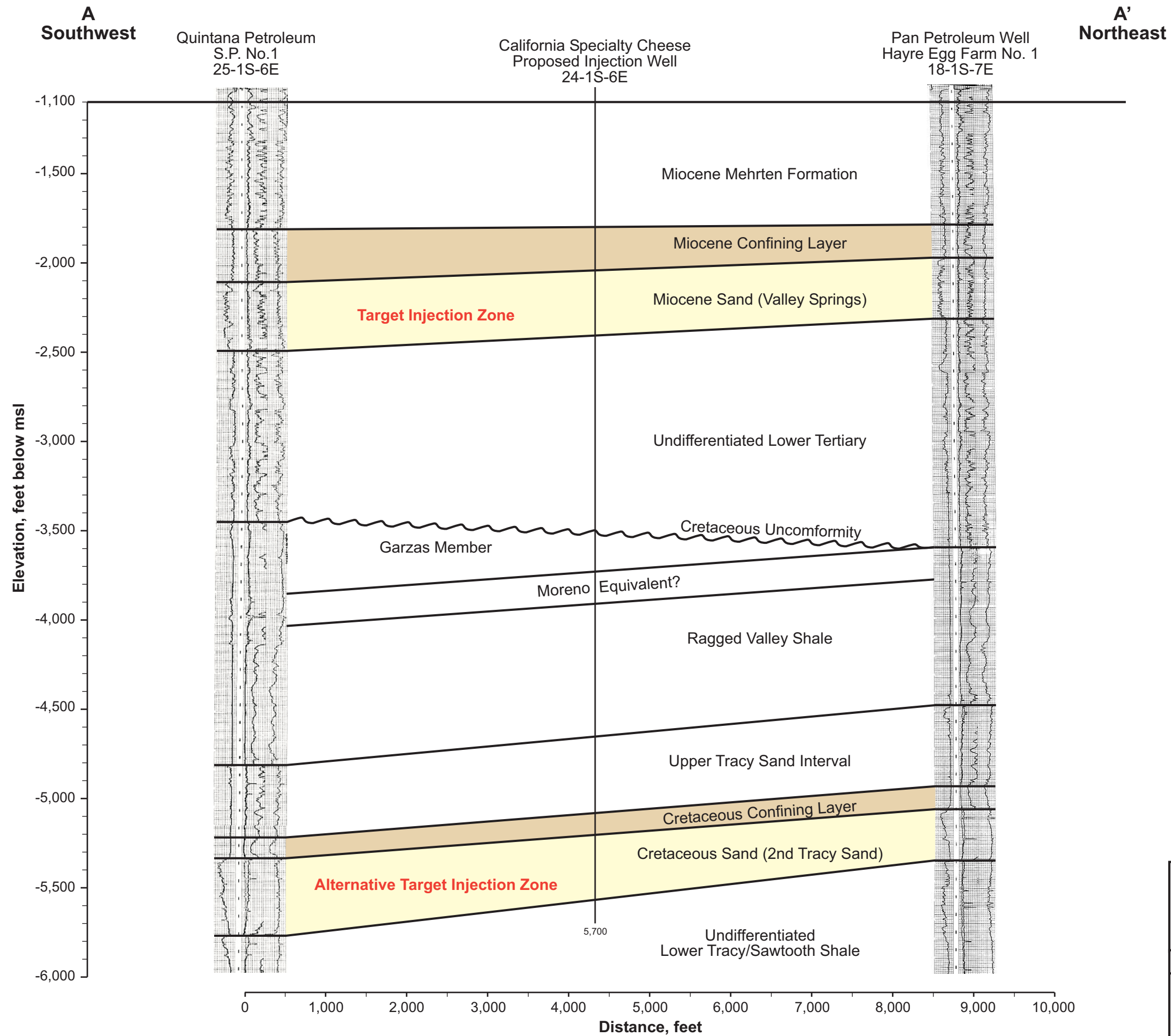

**Figure 16**  
**Structural**  
**Cross Section**  
**A - A'**

October 2005

TODD ENGINEERS  
 Emeryville, California

**B**  
**Northwest**

U.S. Natural Resources  
Towne - S.P. Unit Two No. 1  
14-1S-6E

California Specialty Cheese  
Proposed Injection Well  
24-1S-6E  
(projected 2,000' Southwest)

Christiana Oil  
Schleiss No. 1  
30-1S-7E

**B'**  
**Southeast**

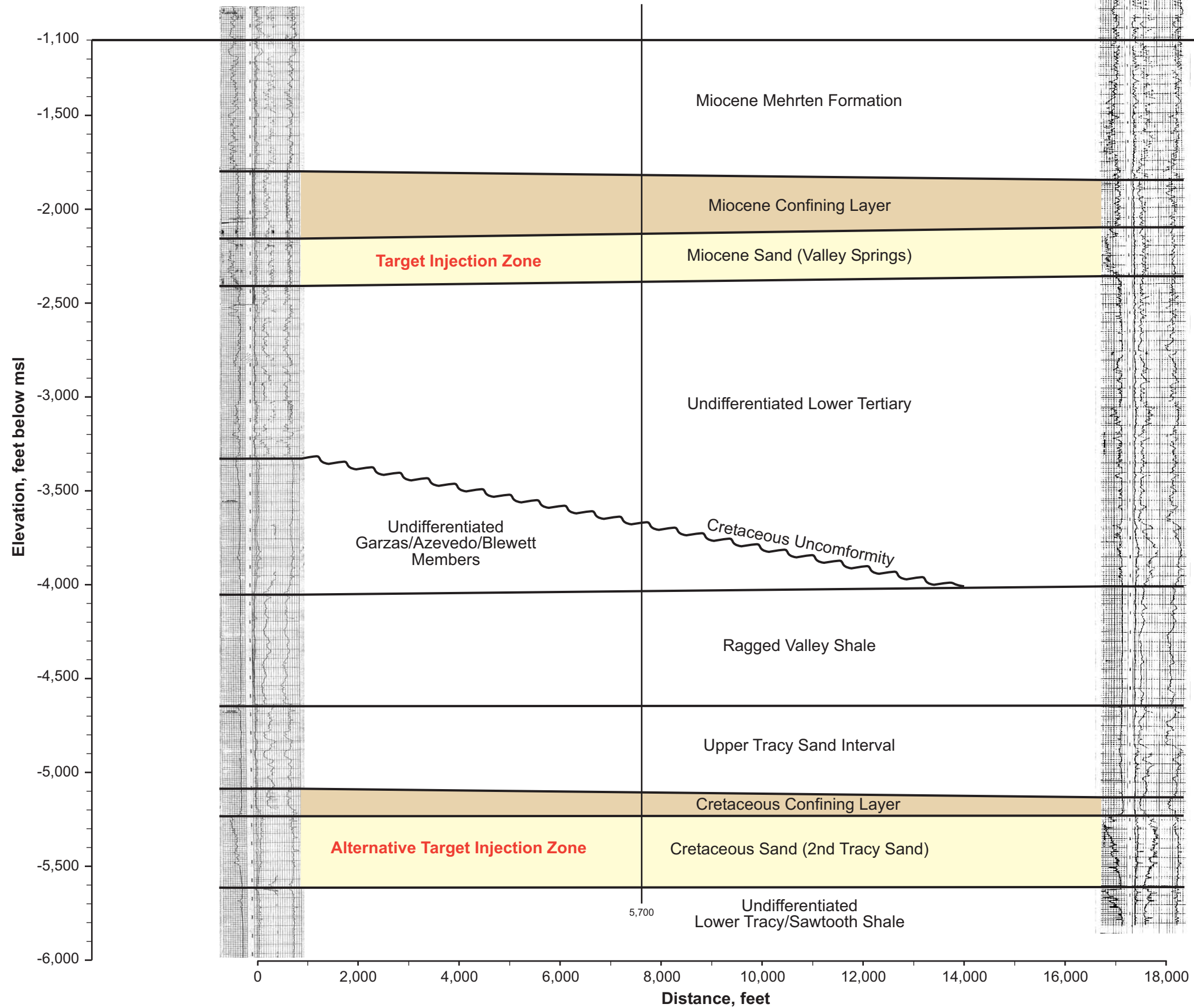
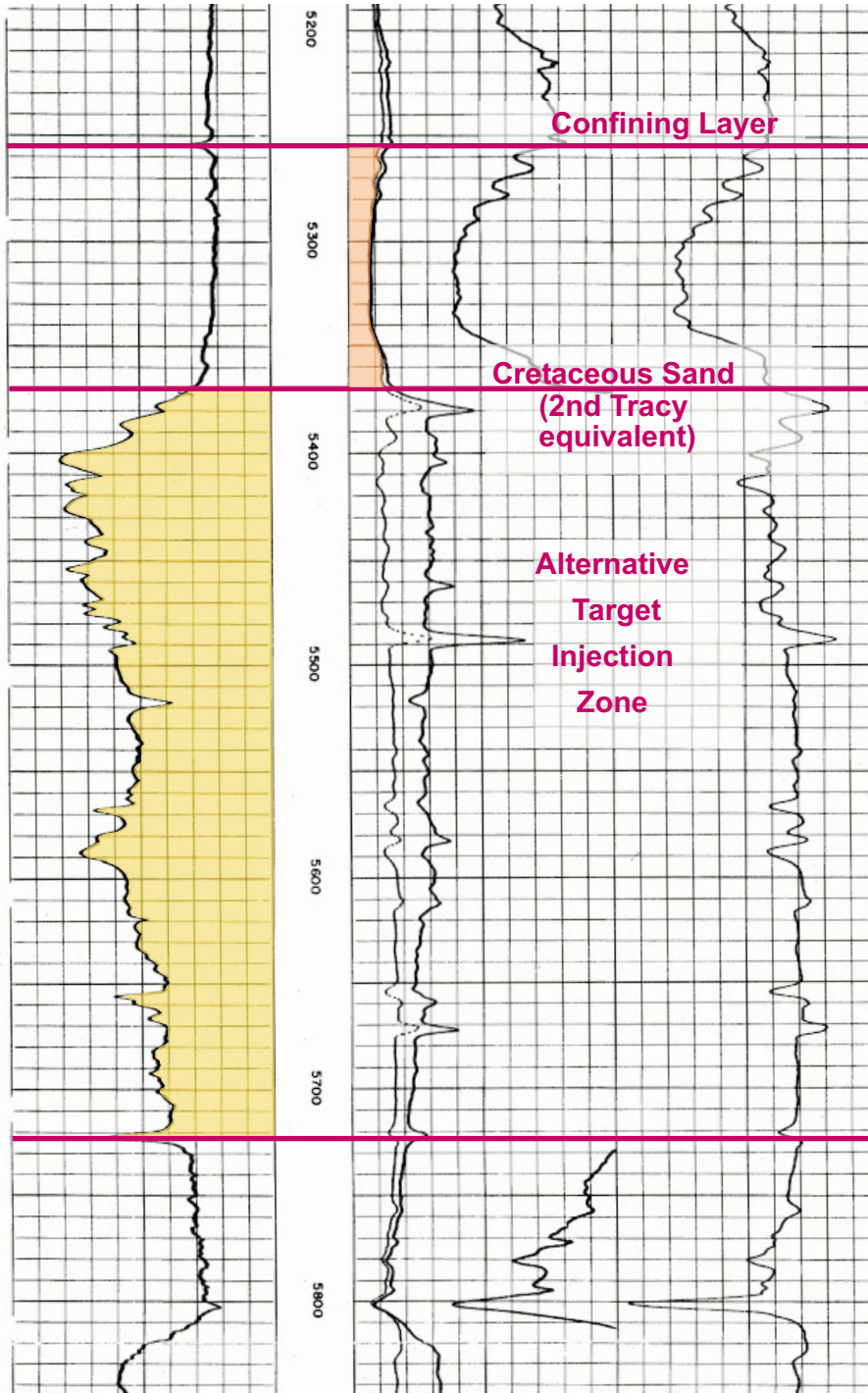

**Figure 17**  
**Structural**  
**Cross Section**  
**B - B'**

October 2005

TODD ENGINEERS  
Emeryville, California

Quintana Petroleum  
S.P. No 1  
25-1S-6E



SPONTANEOUS POTENTIAL millivolts	DEPTH	RESISTIVITY ohms - m <sup>2</sup> /m	CONDUCTIVITY millimhos/m = $\frac{1000}{\text{ohms} \cdot \text{m}^2/\text{m}}$
<p>10</p> <p>- ← → +</p>		A - 16" - M SHORT NORMAL	6FF40 INDUCTION
		0	1000
		20	0
		0	200
		200	1000
		0	2000
		INDUCTION	
	0	20	
	0	200	
		AMP. SHORT NORMAL	
	0	20	

Portion of Induction Electrical Log

Figure 18  
Type Log  
Cretaceous Sand  
Target Injection Zone

October 2005

TODD ENGINEERS  
Emeryville, California



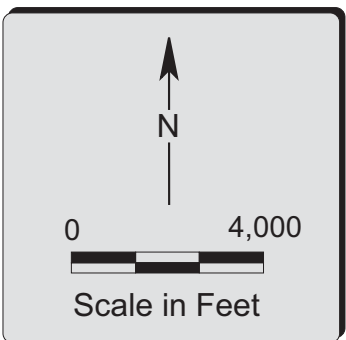
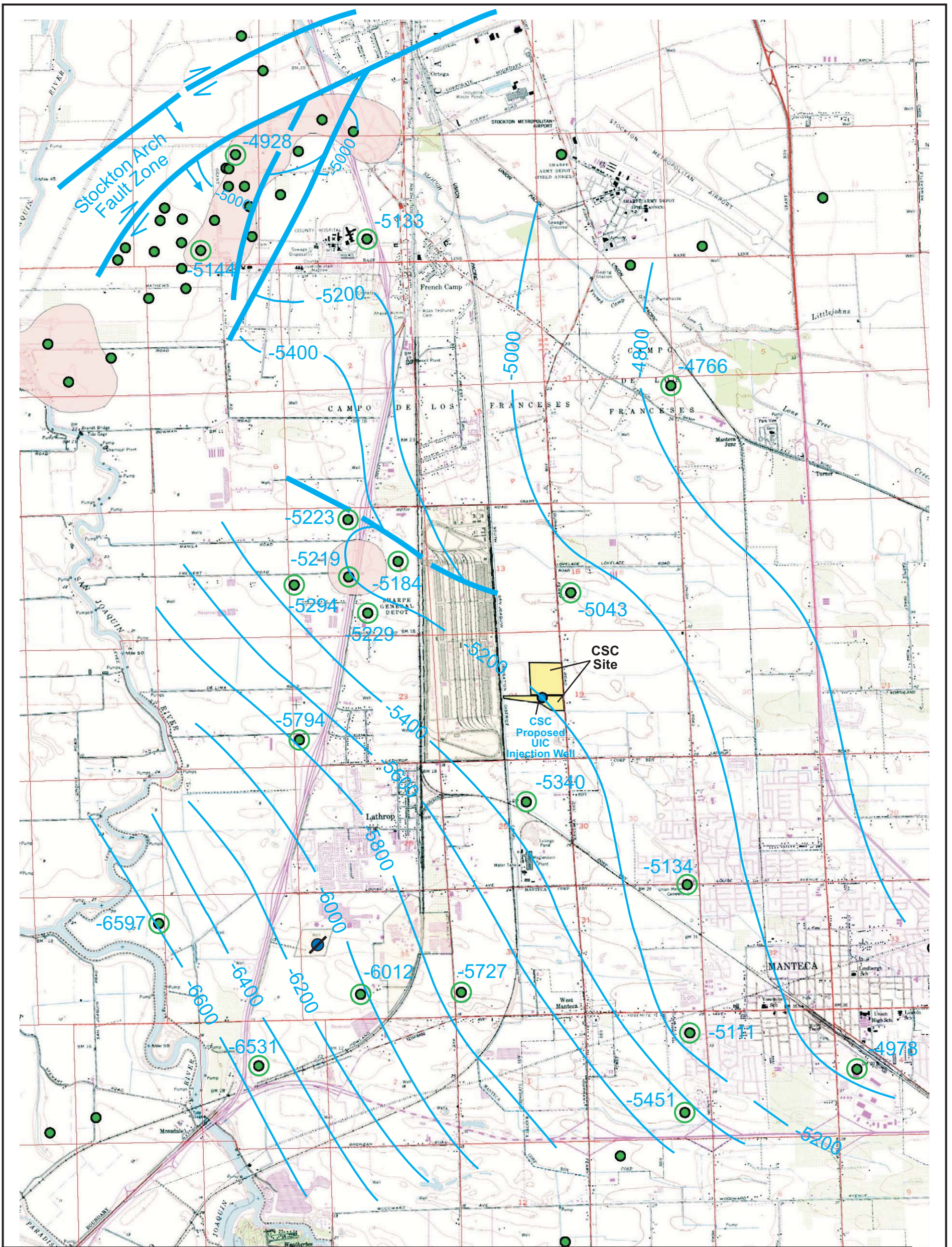

**LEGEND**

- Deep Gas Exploratory Well
- Well used in regional mapping
- Proposed UIC Injection Well at CSC site
- Abandoned UIC Injection Well
- 5219 Top of 2nd Tracy Sand in gas exploratory well, feet below msl
- 5200 Structural contour, top of 2nd Tracy Sand, feet below msl
- Fault (fault locations taken from CDOG, 1982)

**Figure 19**  
**Structural Contour Map**  
**Top of Target**  
**Cretaceous Sand**  
**(2nd Tracy Sand)**

October 2005

TODD ENGINEERS  
 Emeryville, California

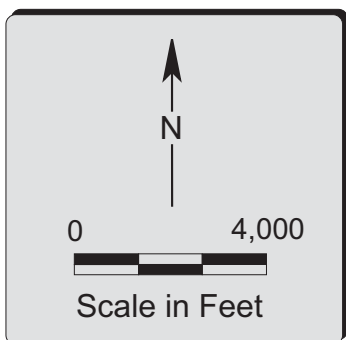
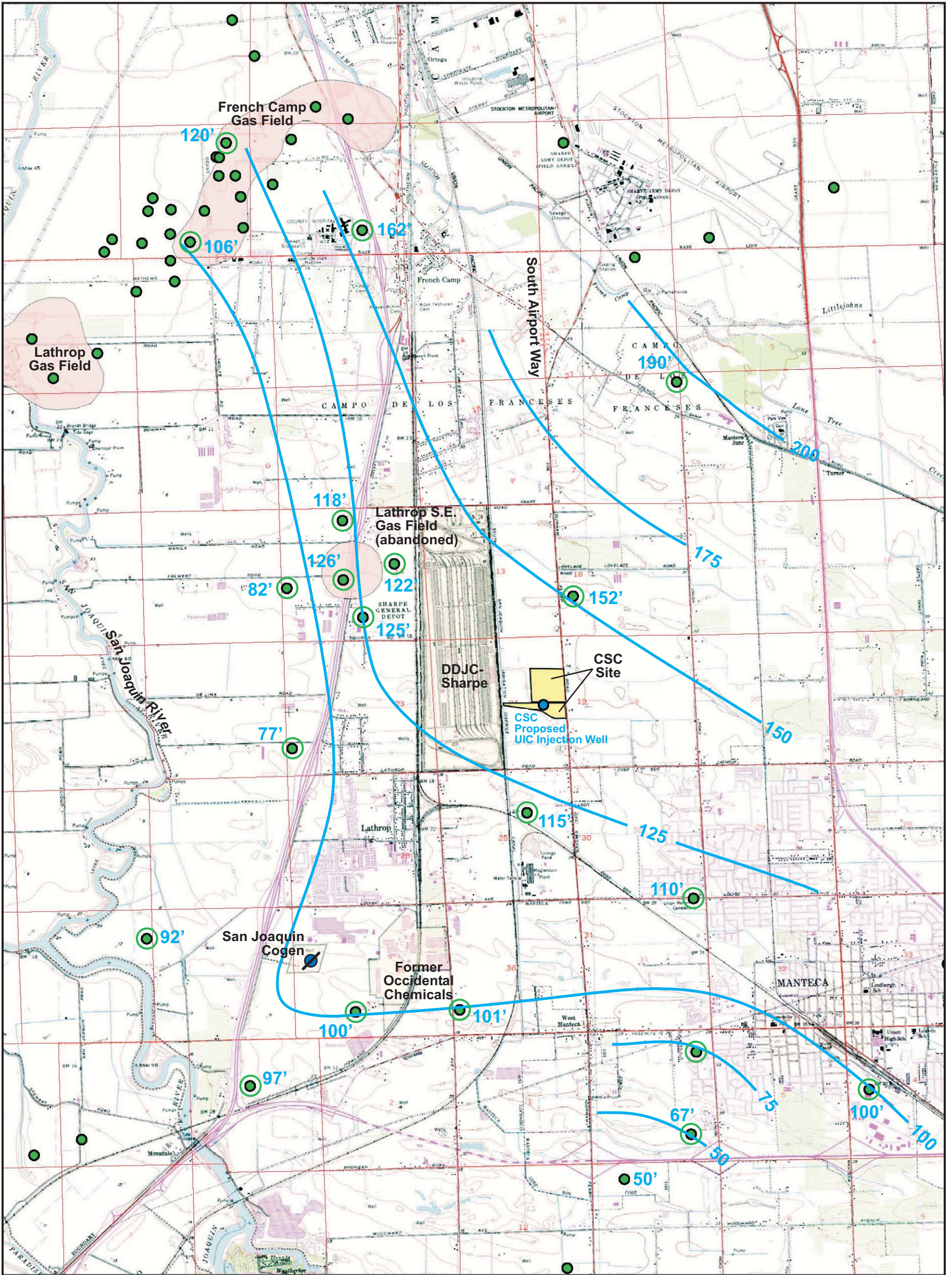

**LEGEND**

- Deep Gas Exploratory Well
- Well used in regional mapping
- Proposed UIC Injection Well at CSC site
- Abandoned UIC Injection Well
- 200 — Equal thickness of low permeability confining layer above injection target zone (2nd Tracy Sand), feet

**Figure 20  
Isopach Map  
Cretaceous  
Confining Layer**

October 2005

TODD ENGINEERS  
Emeryville, California

### Proposed Miocene Injection Well

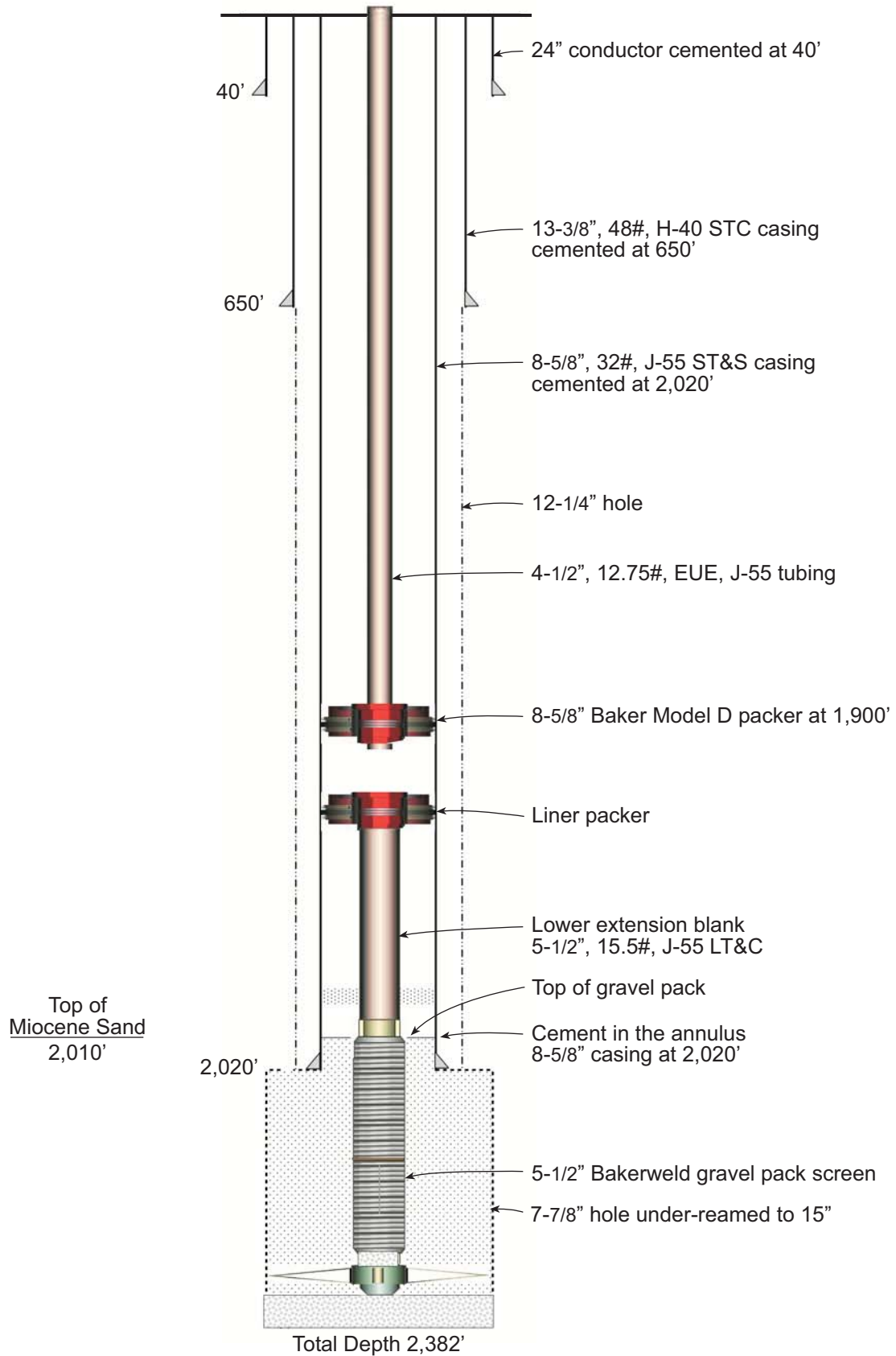

Note: All depths and equipment descriptions are approximate.

October 2005

TODD ENGINEERS  
Emeryville, California

**Figure 21**  
**Proposed**  
**Miocene Injection Well**  
**Design**

## Proposed Cretaceous 2nd Tracv Iniection Well

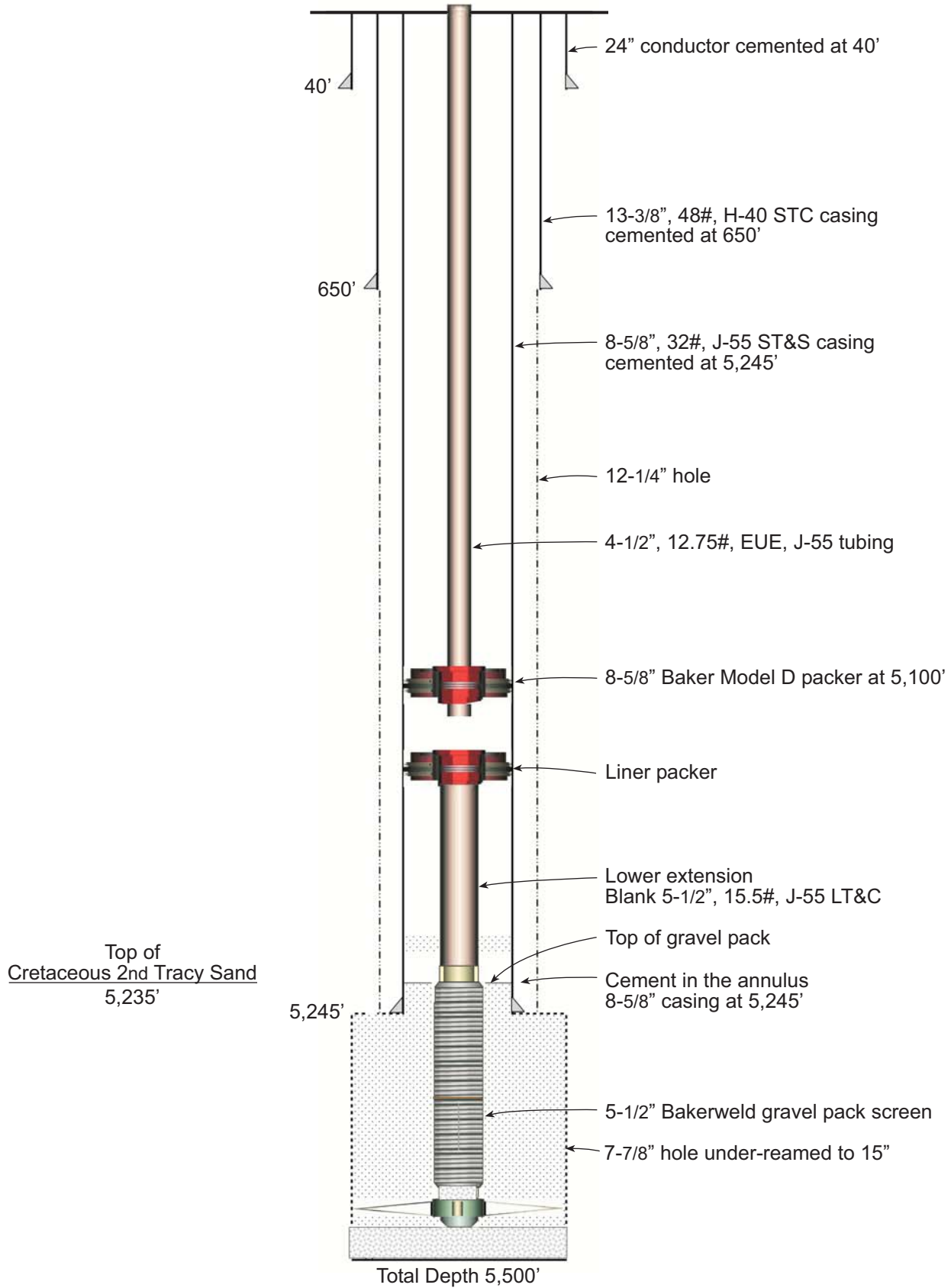

Top of  
Cretaceous 2nd Tracv Sand  
5,235'

Note: All depths and equipment descriptions are approximate.

October 2005

TODD ENGINEERS  
Emeryville, California

**Figure 22**  
**Proposed**  
**Cretaceous Injection**  
**Well Design**