



Best Practices in Underground Coal Gasification

Elizabeth Burton
Julio Friedmann
Ravi Upadhye



Lawrence Livermore National Laboratory

This work was performed under the auspices of the U.S. Department of Energy by the University of California, Lawrence Livermore National Laboratory under contract No. W-7405-Eng-48.

Table of Contents

1	Executive Summary	11
2	Introduction	13
2.1	Underground Coal Gasification Process Description	13
2.2	Why Consider Underground Coal Gasification?	14
2.3	Timeliness of Underground Coal Gasification R&D Investment	15
2.4	Potential Limitations and Concerns for UCG	16
2.5	Potential Use in Developing Countries	17
2.5.1	India	17
2.5.2	China	18
3	Historical Overview	20
3.1	Experience from 1960 through 1999	21
3.1.1	U.S. Trials	31
3.1.2	European UCG Trials (1982-1999)	37
3.1.3	People's Republic of China (1980s to present)	38
3.1.4	Australia (1990s to present)	39
3.1.5	Japan	41
3.1.6	Former Soviet Union (FSU)	42
3.1.7	Other Countries	47
4	Ignition and Gasification	49
4.1.1	Well Characteristics and Flow Path Enhancement	49
4.1.2	Injection Process (CRIP, ϵ UCG)	50
4.1.3	Other Processing Considerations	52
4.1.4	Surface Facilities	54
4.2	UCG Economics	55
5	Environmental Management	57
5.1	U.S. Regulatory Framework	57
5.2	The Risk-Based Decision-Making (RBDM) Process	59
5.3	Geologic Assessment of UCG Sites	60
5.3.1	Stratigraphic Framework	61
5.3.2	Structural Framework	65
5.3.3	Hydrological and Geomechanical Framework	66
5.3.4	Geochemical Framework	66

5.4	Induced Subsidence	72
5.4.1	Simulation and Prediction.....	72
5.5	Integrating Factors to Assess Risk.....	74
5.5.1	Rock Springs Uplift	76
5.5.2	The Ferron Sandstone Coal Succession.....	76
5.5.3	The Blackhawk Formation Coal Succession	77
5.6	Experience from UCG pilots	78
5.6.1	Hoe Creek, WY.....	78
5.6.2	Carbon County, WY	80
5.6.3	Chinchilla Project, Australia.....	80
6	Carbon Management.....	82
6.1	Carbon Capture	82
6.2	UCG and Conventional Carbon Storage.....	85
6.3	UCG and Carbon Storage in the Reactor Zone.....	85
6.3.1	Potential Advantages and Disadvantages to RZCS	86
6.3.2	Description of Key Scientific Concerns	87
6.3.3	Outline of Scientific Program to Address RZCS Hazards and Risks	88
7	Best Practices and Lessons Learned	90
7.1	Siting and Operation	90
7.2	Initiation of UCG Burns.....	91
7.3	Surface Facility Planning and Operation	91
7.4	Extended Operation	91
7.5	Environmental Management.....	92
7.5.1	Well Design and Construction	92
7.5.2	Well Operation.....	92
7.5.3	Burn Front Monitoring and Control.....	92
7.5.4	Closure and Abandonment.....	92
7.5.5	Groundwater Protection.....	93
7.5.6	Subsidence Management	93
7.5.7	Monitoring	94
7.6	Carbon Management.....	95
7.6.1	Site Selection	95
7.6.2	CO ₂ Capture and Separation.....	95

7.6.3 CO₂ Storage 95

8 Technology Gaps and Recommendations..... 97

8.1 R&D Gaps..... 97

8.2 Technology Gaps 98

8.2.1 Improved Combustion/Gasification Models..... 98

8.2.2 Improved Monitoring..... 99

8.2.3 Improved Environmental Simulation..... 102

8.2.4 UCG + CCS (Carbon Capture and Sequestration)..... 104

8.2.5 Laboratory Experiments..... 106

8.2.6 Integrated Process and Subsurface Modeling..... 106

9 References..... 107

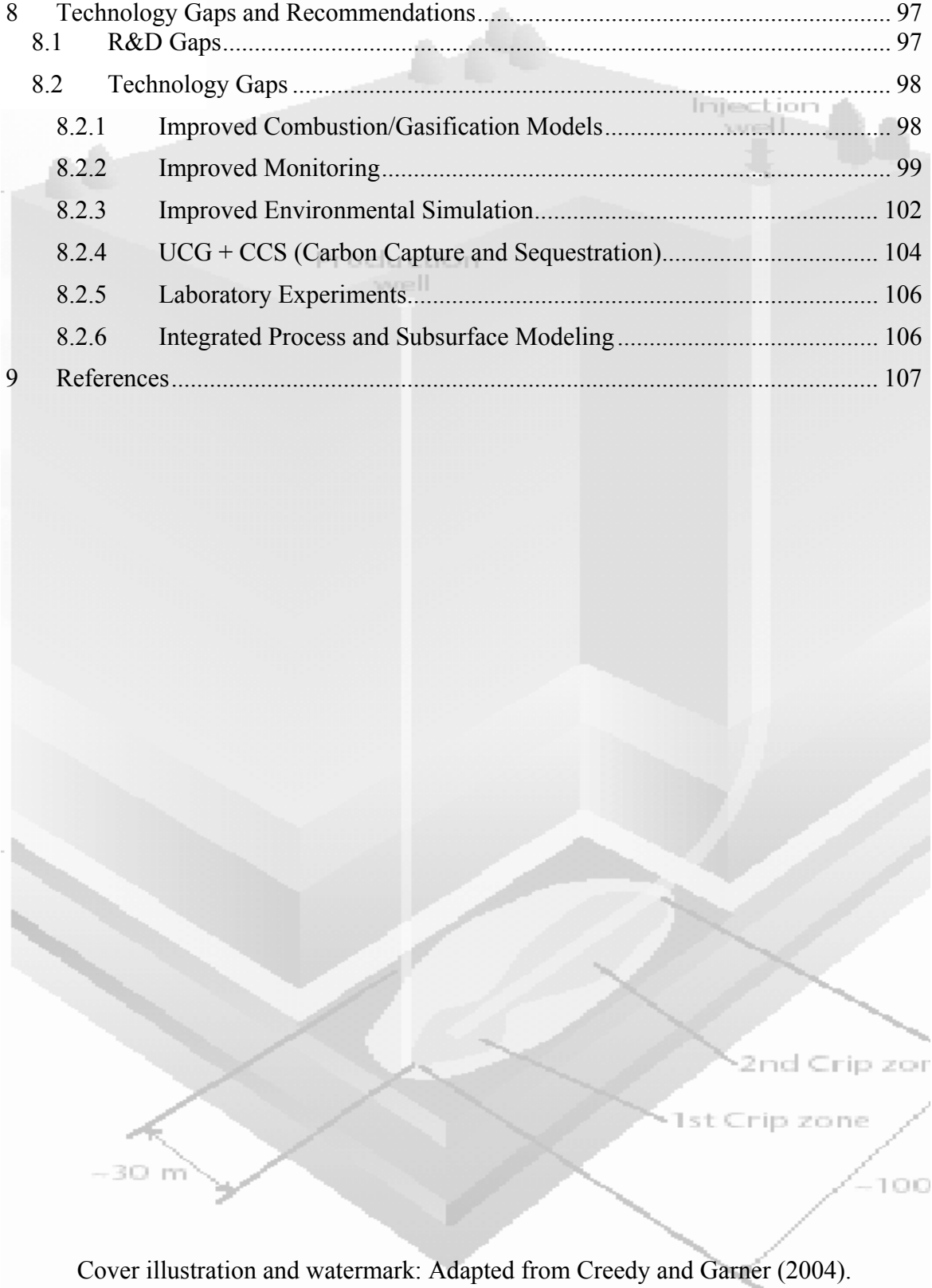

Cover illustration and watermark: Adapted from Creedy and Garner (2004).

List of Tables

Table 3-1: International UCG pilots, excluding U.S. and FSU 23

Table 3-2: Recent UCG Operations in the Former Soviet Union (FSU)..... 24

Table 3-3: UCG pilots in the United States. 26

Table 3-4: Production data for Angren station 1962-1976 (Olness, 1982)..... 42

Table 3-5: Characteristics of Soviet UCG projects 1933-1965 (Gregg, et al., 1976; Olness and Gregg, 1977) 44

Table 4-1: Fundamental reactions for coal gasification (adapted from Ruprecht, et al., 1988) 49

Table 5-1: Groundwater pollutants found in Texas UCG pilot sites (From Humenick and Mattox, 1978)..... 68

Table 5-2: Physical properties of water as a function of temperature. 69

Table 5-3: Risk Matrix Considering Stratigraphic Control 74

Table 7-1: Minimal requirements for UCG siting and operation 90

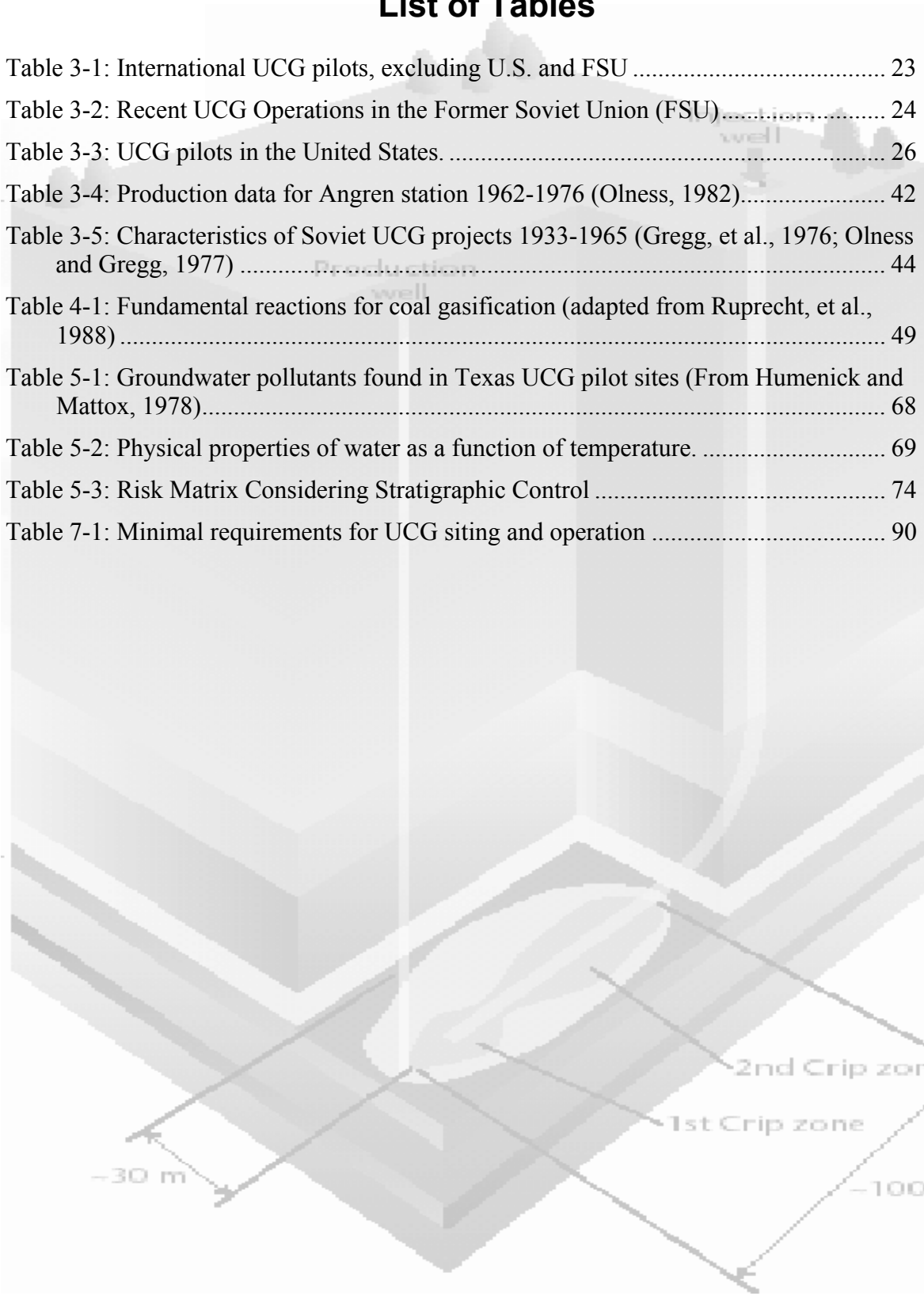

List of Figures

Figure 2-1: Schematic of the components of the UCG process collocated with electricity generation (UCG Engineering, Ltd., 2006)	13
Figure 3-1: World-wide distribution of UCG tests, including sites of note and some announced or planned projects. Underlying prospect map describes potential for geological carbon storage (Adapted from Bradshaw & Dance, 2005)	20
Figure 3-2: Reproduction of Betts's patent specifications, including an air, and ,if required, steam injection pipe from the pumping plant, in-situ gasification of the coal seam, and a collection pipe that feeds produced gas directly to an electric power plant (Olness and Gregg, 1977)	21
Figure 3-3: Worldwide UCG operations experience with respect to coal seam depth and thickness (modified from Perkins, unpublished).	22
Figure 3-4: UCG Trials as function of coal seam depth (Burton, et al., 2004).....	22
Figure 3-5: UCG projects in the United States. In many cases, individual dots represent multiple tests. Also shown are coal-fired plant locations (black dots) and sites with potential for geological carbon storage (color-shaded regions). (Adapted from Bradshaw and Dance, 2005)	31
Figure 3-6: Hoe Creek stratigraphic sequence (Covell and Thomas, 1996).....	32
Figure 3-7: Underground coal gasification process showing the transverse cross-section of the reactor zone (Stephens, 1981) and a longitudinal section showing the transportation and condensation of liquefied coal pyrolysates (Covell and Thomas, 1996).	34
Figure 3-8: Schematic view of the large block experimental configuration.....	35
Figure 3-9: Comparison of actual and calculated cavity shapes in the plane perpendicular to the injection borehole at the injection point of the PSC CRIP cavity (Britten, 1986, 1987; Britten and Thorsness, 1988).	36
Figure 3-10: Conceptual Design of the Chinchilla Project (Blinderman, 2003b).	40
Figure 3-11: Gas production history at Chinchilla (Blinderman, 2003).	41
Figure 3-12: The Stream Method for gasifying coal in steeply dipping coal beds. This was the first design that the Soviets felt had promise. They tried many schemes in the first few years of their effort. The Stream Method was first tested in Lischansk in 1935. The injection and exhaust holes were drilled along the coal seam and were connected at the bottom by a mined shaft. The flame was initiated in the connecting channel and gradually spread over the entire length. The flow had to be reversed periodically to approximate a horizontal burn front that moved up the seam. The key feature of this system is that as coal was consumed, more coal would fall into the void that was created, automatically creating rubbleized coal in the combustion zone (Gregg et al., 1976).....	46

Figure 3-13: This figure shows a typical plan view of the Soviet process for horizontal seams. The dotted lines are meant to show the location of the underground linkage channels formed in the coal by a countercurrent combustion step in preparation for gasification. The production phase of gasification is carried out by concurrent combustion in the channels. Concurrent and countercurrent refer to the flame front propagating in the same or opposite direction as the gas flow, respectively (Gregg et al., 1976).	48
Figure 4-1: Schematic of the CRIP Process.....	51
Figure 5-1: RBDM flow diagram for UCG operations.....	60
Figure 5-2: Schematic block diagrams showing the general habitat of coal occurrence (A) basinal, (B) sub-regional, and (C) local. (From Hamilton and Tadros, 1994).....	62
Figure 5-3: Stratigraphic successions associated with one sea-level cycle. (From Bohacs and Suter, 1997).	63
Figure 5-4: Schematic representation of accommodation cycles and distribution and character of associated coal deposits. (Top) Schematic drawing of one depositional sequence through an accommodation cycle, showing the general distribution of coaly units (black) and their associated facies. (Bottom) Associated cycle of base-level change. The six category numbers underlie the risk matrix below. (From Bohacs and Suter, 1997).	64
Figure 5-5: Example of an equilibrium calculation for coal gasification (From Stephens, 1980).	67
Figure 5-6: Aqueous solubility of selected organic compounds as a function of temperature. (Modified from Wauchope and Getzen, 1972, including Leif and Knauss, unpubl. data).....	70
Figure 5-7: Surface deformation produced by evacuation of a coal seam of fixed width and thickness according to the geometry of a bending subsidence model with very little strength. H equals depth to top of seam, H_s corresponds to a subjacent unit depth, and $s_o(x_o)$ is the subsidence profile. (After Shu and Battacharyya, 1993).	73
Figure 5-8: Cross-section of the Brooks-McCourt Sequences within the Rock Springs uplift, S. Wyoming. Note abundant coals (black) within the succession. The isolated coals beneath the #1 seam and its correlative flooding surface present the lowest risk for leakage into neighboring porous, permeable units. (From Bohacs and Suter, 1997).	75
Figure 5-9: Thickness, vertical, and lateral distribution of the five main coal seams within the Ferron Sandstone member, Mancos Shale Fm., Emery coalfield. From Bohacs & Suter (1997).	76
Figure 5-10: The Blackhawk Fm, eastern Utah, showing overall progradation and multiple coal bodies. (After Young, 1955).	77
Figure 5-11: Illustration of UCG process operating at negative pressure. (From Blinderman and Jones, 2002.).....	81

Figure 5-12: Measured concentrations of organic contaminants, benzene, total phenols, and total PAH, at Chinchilla (first three sets of bars) compared to Hoe Creek and Carbon County. Condensate water and oil, second and third sets, show high levels of these compounds are being produced, but groundwater first set, shows levels remain below background (red dashed line). (Blinderman and Jones, 2002)..... 81

Figure 6-1: Thermal efficiencies of power plants with and without CO₂ capture, % LHV-basis (From Thambimuthu, et al., 2005, and references therein: Davison 2005, IEA GHG 2004, IEA GHG 2003; 5 IEA GHG, 2000b; Dillon *et al.*, 2005). 84

Figure 6-2: Percentage increase in fuel use per kWh of electricity due to CO₂ capture, compared to the same plant without capture (From Thambimuthu, et al., 2005, and references therein: Davison, 2005; IEA GHG, 2004; IEA GHG, 2003; IEA GHG, 2000b; Dillon *et al.*, 2005). 84

Figure 6-3: A schematic diagram of the physical and chemical transients that affect reactor zone characteristics 87

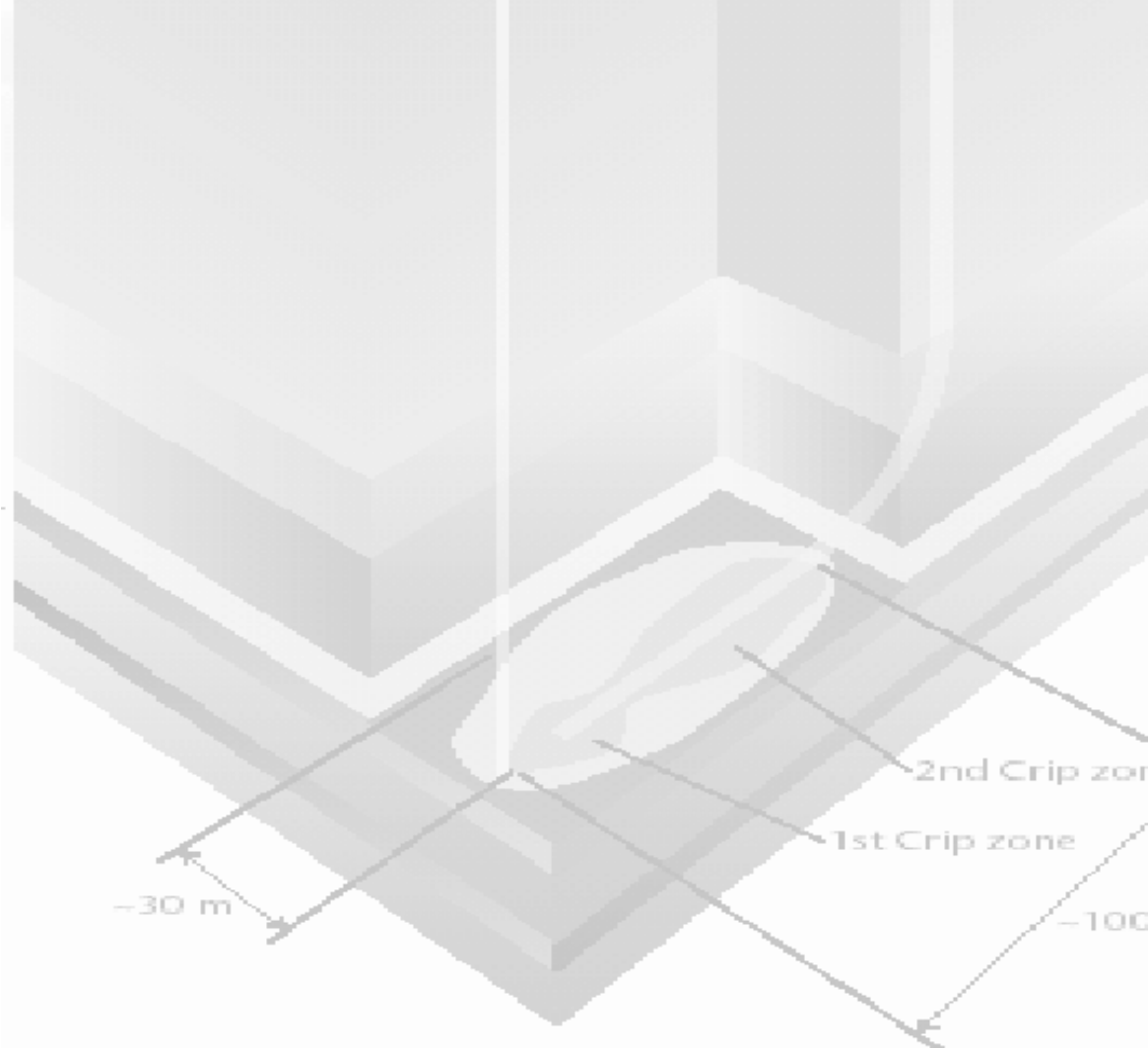

List of Acronyms

AGR	Acid Gas Removal
BHEL	Bharat Heavy Electricals, Limited
BLM	Bureau of Land Management (U.S.)
BTEX	Benzene, toluene, ethylbenzene, xylenes
CBM	Coal Bed Methane
CCS	Carbon Capture and Sequestration
CFD	Computational Fluid Dynamics
CIL	Coal India, Limited
CMPDIL	Central Mine Planning and Design Institute, Limited
COE	Cost of Electricity
CRIP	Controlled Retraction Injection Point
CSIRO	Commonwealth Scientific and Industrial Research Organisation (Australia)
DOE	US Department of Energy
DTI	UK Department of Trade and Industry Technology
EGR	Enhanced Gas Recovery
EMIT	Electro-Magnetic Induction Tomography
EOR	Enhanced Oil Recovery
EPA	Environmental Protection Agency (United States)
ERT	Electrical Resistance Tomography
εUCG	Ergo-Exergy UCG
FSU	Former Soviet Union
GAIL	Gas Authority India Limited
GCS	Geologic Carbon Storage
GPS	Global Positioning System
GSI	Geological Survey of India
IGCC	Integrated Gasification combined Cycle
InSAR	Interferometric Synthetic Aperture Radar
LLNL	Lawrence Livermore National Laboratory
MDEA	Methyldiethanolamine process
MOC	Ministry of Coal
MOM	Ministry of Mining
NAPL	Non-Aqueous-Phase Liquids
NASA	National Aeronautics and Space Administration (USA)
NETL	National Energy Technology Laboratory
NGCC	Natural Gas Combined Cycle
NLCL	Neyveli Lignite Corporation, Limited
PAHs	Polycyclic Aromatic Hydrocarbons
PC	Pulverized Coal
PCR	Polymerase Chain Reaction
RBDM	Risk-Based Decision-Making
RZCS	Reactor Zone Carbon Storage
SACS	Saline Aquifer CO ₂ Storage Project at Sleipner
SDWA	Safe Drinking Water Act
TDS	Total Dissolved Solids

UCG	Underground Coal Gasification
UK	United Kingdom
USDW(S)	Underground source(s) of drinking water
VOCs	Volatile Organic Compounds
WA	State of Washington, USA
WIDCO	Washington Irrigation and Development Company
WY	State of Wyoming, USA

1 Executive Summary

Underground coal gasification (UCG) converts coal in-situ into a gaseous product, commonly known as synthesis gas or syngas through the same chemical reactions that occur in surface gasifiers. Gasification converts hydrocarbons into a synthesis gas (syngas) at elevated pressures and temperatures and can be used to create many products (electric power, chemical feedstock, liquid fuels, hydrogen, synthetic gas). Gasification provides numerous opportunities for pollution control, especially with respect to emissions of sulfur, nitrous oxides, and mercury. UCG could increase the coal resource available for utilization enormously by gasifying otherwise unmineable deep or thin coals under many different geological settings. A 300-400% increase in recoverable coal reserves in the U.S. is possible. For developing countries undergoing rapid economic expansion, including India and China, UCG also may be a particularly compelling technology.

UCG has been tested in many different experimental tests in many countries. The U.S. carried out over 30 pilots between 1975 and 1996, testing bituminous, sub-bituminous, and lignite coals. Before that, the Former Soviet Union executed over 50 years of research on UCG, field tests and several commercial projects, including an electric power plant in Angren, Uzbekistan that is still in operation today after 47 years. Since 1991, China has executed at least 16 tests, and has several commercial UCG projects for chemical and fertilizer feedstocks. In 2000, Australia began a large pilot (Chinchilla) which produced syngas for 3 years before a controlled shut-down and controlled restart. As present, multiple commercial projects are in various stages of development in the U.S., Canada, South Africa, India, Australia, New Zealand, and China to produce power, liquid fuels, and synthetic natural gas.

Several processes exist to initiate and control UCG reactions, including the Controlled Retraction Injection Point (CRIP) process and Ergo Exergy's proprietary ϵ UCG process. These ignition processes create a syngas stream which is compositionally similar to surface-produced syngas. It can have higher CO₂ and hydrogen products due to a number of factors, including a higher than optimal rate of water flux into the UCG reactor and ash catalysis of water-gas shift. Because of the nature of in-situ conversion, UCG syngas is lower in sulfur, tar, particulates and mercury than conventional syngas and has very low ash content. Other components are similar and can be managed through conventional gas processing and clean up.

The economics of UCG appear extremely promising. The capital expenses of UCG plants appear to be substantially less than the equivalent plant fed by surface gasifiers because purchase of a gasifier is not required. Similarly, operating expenses are likely to be much lower because of the lack of coal mining, coal transportation, and significantly reduced ash management facilities. Even for configurations requiring a substantial environmental monitoring program and additional swing facilities, UCG plants retain many economic advantages.

UCG has the potential to create two environmental hazards if operations are not optimally managed: ground-water contamination and surface subsidence. Both of these hazards appear avoidable through careful site selection and adoption of best management practices for operations. At Hoe Creek, WY, U.S., the site of several UCG pilot tests, improper site selection and over-pressurization of the reactor drove a plume containing benzene, volatile organic carbons, and other contaminants into local fresh-water aquifers. In contrast, the recent pilot at Chinchilla, Australia, demonstrates that it is possible to operate UCG without creating either hazard. An explicit risk management framework (e.g., risk-based decision making) can be used to identify and proactively address the component risks involved in UCG siting and operations. Environmental risk assessment for UCG has unique aspects, requiring consideration of a complex array of changing conditions, including high cavity temperatures, steep thermal gradients, and stress fields obtained during and after the burn process. In the context of the site stratigraphy, structure and hydrogeology, risk models must evaluate the permeability changes from cavity development and collapse as well as the effects of changes in buoyancy, thermal and mechanical forces on the transport of organic and inorganic contaminants. Operational variables (e.g., temperature, feed gas composition) also impact the amount and nature of contaminants produced and groundwater flow directions. Furthermore, subsequent use of the cavity for CO₂ sequestration will impact the mobility of byproducts and will alter risk.

The challenge of managing CO₂ emissions creates a strong drive towards pairing UCG with carbon capture and sequestration (CCS). The composition and outlet pressures of UCG streams at the surface are comparable to those from surface gasifiers; as such, the costs and methodologies for pre-combustion separation are directly comparable (e.g., Selexol at \$25/ton CO₂). Conventional post-combustion and oxy-firing options may also be applied to UCG-driven surface applications. In addition, the close spatial coincidence of conventional geological carbon storage (GCS) options with UCG opportunities suggests that operators could co-locate UCG and GCS projects with a high likelihood of effective CO₂ storage. There is also the possibility of storing some fraction of concentrated CO₂ streams in the subsurface reactor. While this appears to have many attractive features, there remains substantial scientific uncertainty in the environmental risks and fate of CO₂ stored this way.

While UCG appears to be commercially ready in many contexts, there remain several key scientific and technical gaps. These gaps could be addressed in a short period of time with an accelerated research program. This program could lever substantially off of existing knowledge, planned commercial tests, and advances in engineering and earth-science simulations. The US should undertake a plan to evaluate advanced simulation opportunities, critical laboratory components, and current and potential sites for field work, especially in monitoring and process control. This research would help to support a framework proposed herein for best practices, and validate aspects of the current understanding that have not been thoroughly studied and rendered.

2 Introduction

The energy, economic and environmental demands of the 21st century appear to support a renewed and expanded role for commercial UCG development. Definition of the future U.S. role in R&D for UCG must be based on an integration of the worldwide knowledge base and the international collective experience in UCG. The goals of this paper are to create a foundation for that role by summarizing current knowledge of UCG, identifying where the current knowledge base is sufficient to formulate best practices and where additional R&D efforts are needed to make UCG a successful commercial technology.

2.1 Underground Coal Gasification Process Description

Gasification is a chemical process for converting a solid or liquid fuel into a combustible gas that subsequently can be used to produce heat, generate power or as a feedstock for chemical products such as hydrogen, methanol or synthetic natural gas. Hundreds of surface gasification plants have been constructed. More than 160 coal gasification plants worldwide are in operation, producing the equivalent of 50,000 MW (thermal) of syngas (Simbeck, 2002).

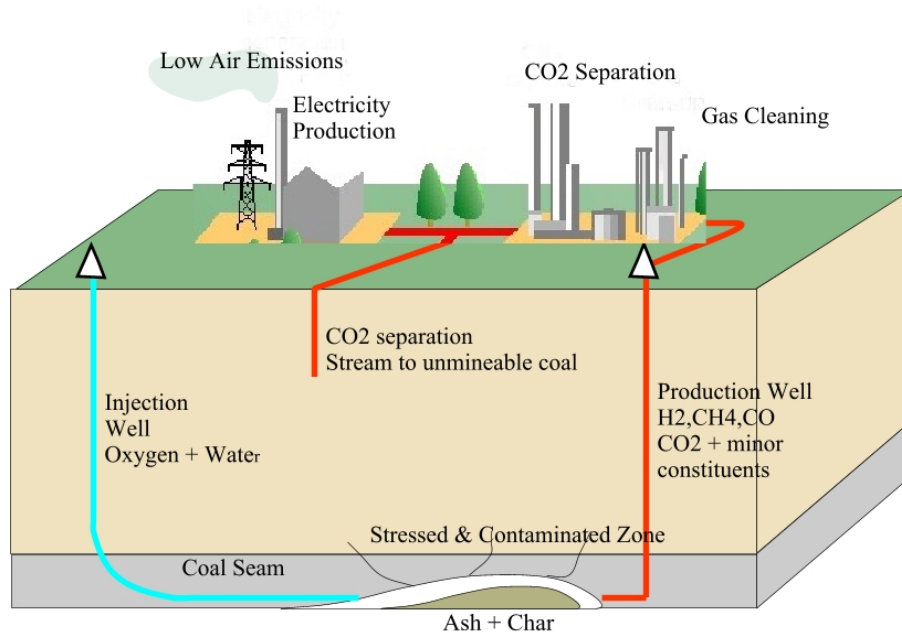

Figure 2-1: Schematic of the components of the UCG process collocated with electricity generation (UCG Engineering, Ltd., 2006)

Underground coal gasification (UCG), wherein coal is converted to gas in-situ, moves the process of coal gasification underground. Gas is produced and extracted through wells drilled down into the coal seam, to inject air or oxygen to combust the coal in-situ, and to produce the coal gas to the surface for further processing, transport, or utilization (e.g.,

Figure 2-1). The process relies on the natural permeability of the coal seam to transmit gases to and from the combustion zone, or on enhanced permeability created through reversed combustion, an in-seam channel, or hydro-fracturing (Gregg, and Edgard, 1978; Stephens et al., 1985a; Walker et al., 2001; Creedy & Garner, 2004).

2.2 Why Consider Underground Coal Gasification?

The United States is increasingly looking to its coal reserves as a solution to its dependence on imports to fuel its economy. The U.S. is estimated to have about 27% of the world's supply of about 1000 billion tons of recoverable coal resources (U.S. Energy Information Administration, 2006). At present rates of consumption of about 1.1 billion tons annually, coal reserves can provide a secure domestic energy supply for nearly the next 300 years. Most coal in the U.S. is consumed for electricity production. While petroleum imports may be vulnerable to geopolitical uncertainties, domestic coal extraction and usage are limited primarily by environmental concerns. Utilizing coal in place of oil, therefore, poses numerous challenges, including reducing the impact of coal mining and combustion on the environment and human health, and the need to improve technologies to cleanly convert coal to liquid fuels or gas.

UCG has numerous advantages over conventional underground or strip mining and surface gasification, including:

- Conventional coal mining is eliminated with UCG, reducing operating costs, surface damage and eliminating mine safety issues such as mine collapse and asphyxiation;
- Coals that are unmineable (too deep, low grade, thin seams) are exploitable by UCG, thereby greatly increasing domestic resource availability;
- No surface gasification systems are needed, hence, capital costs are substantially reduced;
- No coal is transported at the surface, reducing cost, emissions, and local footprint associated with coal shipping and stockpiling
- Most of the ash in the coal stays underground, thereby avoiding the need for excessive gas clean-up, and the environmental issues associated with fly ash waste stored at the surface;
- There is no production of some criteria pollutants (e.g., SO_x, NO_x) and many other pollutants (mercury, particulates, sulfur species) are greatly reduced in volume and easier to handle.
- UCG eliminates much of the energy waste associated with moving waste as well as usable product from the ground to the surface;
- UCG, compared to conventional mining combined with surface combustion, produces less greenhouse gas and has advantages for geologic carbon storage. The well infrastructure for UCG can be used subsequently for geologic CO₂ sequestration operations. It may be possible to store CO₂ in the reactor zone underground as well in adjacent strata.

With respect to this last bullet, petroleum and coal combustion contribute two-thirds of US-produced carbon dioxide. Coal mining by traditional methods also contributes another greenhouse gas, methane, to the atmosphere. The added potential of economically sequestering greenhouse gas emissions in the combustion cavity or adjacent strata gives UCG an especially important added advantage over other clean coal technologies.

Domestic coal also is the obvious source for hydrogen production, especially in light of escalating natural gas prices. The proposition of a hydrogen economy relies on affordable hydrogen with significantly reduced or near-zero emissions. Although nuclear or renewable energy sources have been proposed to supply the required hydrogen, renewables are still too intermittent and costly and nuclear has yet to satisfactorily solve its waste disposal and proliferation issues. Until these issues are solved, the near to mid-term source for hydrogen is likely to be fossil fuels (U.S. Department of Energy, 2005). Coal gasification, in particular UCG, provides an attractive pathway to low-cost hydrogen production from coal.

While UCG is a proven technology, albeit only in the initial stages of commercialization, the technologies needed for the analogous concept of “down-hole refining” in the oil industry have not yet been developed. Down-hole refining, like UCG, has great potential to improve the environmental and economic picture for fossil fuel extraction and is a strategic long-term goal of many major oil companies. Approaches developed and lessons learned from UCG may help to shorten the timeline for down-hole processing of liquid fuels.

2.3 Timeliness of Underground Coal Gasification R&D Investment

A recent resurgence of interest in UCG has been driven in large part by the economic pressures of fuel prices. In 2006, the price of light sweet crude oil commodities exceeded \$70/bbl, with a mean price above \$60/bbl. In early 2006, natural gas price rose above \$15/million BTU and have averaged above \$8. In this market, many alternative fuels (including biofuels or synthetic liquid fuels) look attractive. As such, the possibility that UCG can deliver syngas at competitive costs has increased interest.

Concerns over the security of fuel supplies also have increased in recent years. The growing instability of the international energy situation is driving stakeholders in countries with major coal deposits and current or future energy deficits, to renew focus on all technologies with potential to increase use of domestic coal resources. These countries include the U.S., some countries of the former Soviet Union, China and India. For example, utilizing UCG to access deep unmineable coal increases estimates of exploitable U.S. coal resources by three or more times their current levels (Stephens, et al., 1984).

Gasification technologies for coal resources are receiving great attention because of growing concerns over the global impact of ballooning emissions of greenhouse gases and environmental contamination in rapidly growing economies such as those of China and India. Given that UCG offers the potential to gasify coal economically and to produce raw materials for economic expansion, government agencies in these and other developing countries with coal deposits, the coal-mining and power industries, as well as integrated energy companies, are increasingly demonstrating interest in UCG.

The growing level of industry interest in UCG is evidenced by the increasing number of workshops and consortia in recent years. In 2006, there were two workshops (Houston and Kolkata); two new consortia, one commercial project set to deliver gas, and a resurgence in published documents. Already, for 2007, there are two workshops planned (London and Canberra) and several commercial projects that appear ready to deliver gas. Companies in the US (GasTech), India (GAIL), South Africa (Eskom), China (XinAo), Canada (Laurus), and Australia (Linc Energy, Ltd.) have announced projects that include both electric generation and coal-to-liquids. Renewed interest also has been driven by recent successful UCG pilots overseas, such as the Chinchilla operation in Australia, and more widespread knowledge of the 40+ year Uzbekistan UCG commercial operation, although published information about this operation is still limited.

While the advantages of UCG are readily recognized for deep or thin coal seams that would be unmineable by conventional methods, companies worldwide are also beginning to explore the broader potential of the technology. For example, Eskom converged rapidly on UCG when it was discovered that the coal for a new plant could not be mined. Dioritic dikes segmented the main deposit into small sections, and mining attempts damaged major capital machines irretrievably. However, this kind of coal seam segmentation is advantageous to UCG, and Eskom is investigating constructing a series of UCG-fired power plants within this trend.

2.4 Potential Limitations and Concerns for UCG

The road to widespread commercialization still holds a number of challenges that will require research and development investment to overcome. Even though UCG has a number of advantages, the technology is not perfect, and has several limitations:

- UCG can have significant environmental consequences: aquifer contamination, and ground subsidence. While a framework can be constructed from current knowledge that can eliminate or reduce these environmental risks, as is discussed at length later in this report, it is important to proactively address this constraint on siting and operation of any future UCG projects;
- While UCG may be technically feasible for many coal resources, the number of deposits that are suitable may be much more limited because some may have geologic and hydrologic features that increase environmental risks to unacceptable levels;

- UCG operations cannot be controlled to the same extent as surface gasifiers. Many important process variables, such as the rate of water influx, the distribution of reactants in the gasification zone, and the growth rate of the cavity, can only be estimated from measurements of temperatures and product gas quality and quantity;
- The economics of UCG has major uncertainties, discussed later in this report, that are likely to persist until such times as a reasonable number of UCG-based power plants are built and operated;
- UCG is inherently an unsteady-state process, and both the flow rate and the heating value of the product gas will vary over time. Any operating plant must take this factor into consideration.

While the U.S. DOE was an early pioneer of UCG, interest in further pursuing the technology was curtailed by environmental problems and poor process control of some early U.S. UCG pilot studies. In addition, the perceived need at that time was for pipeline-quality gas (>1000 BTU/cft), whereas the syngas from UCG yielded only 150 BTU/cft. These issues, taken together, were deemed significant enough at the time to discontinue U.S. efforts in UCG research and development. However, overseas, the development of UCG continued during the U.S. hiatus. The fact that numerous past UCG projects, and the recent Australian pilot, operated without resulting in environmental problems also is receiving renewed recognition.

2.5 Potential Use in Developing Countries

As noted above, some developing nations have enormous coal resources that could potentially benefit from UCG commercialization. In particular, India and China have large reserves paired with rapid economic growth that has created unparalleled demands for energy including electricity, liquid fuels, and chemical feedstocks. Simultaneously, these countries are coming to terms with rapid growth in pollution and global concerns with their CO₂ emissions. UCG provides unique opportunities to serve these rapidly evolving needs for both countries.

2.5.1 India

The Indian economy is growing steadily, limited only by the availability of energy and current infrastructure. More than half of the power consumed in India is from coal. India has huge reserves of coal (bituminous and sub-bituminous). However, most of this coal is low grade, with as much as 35-50% ash content. The high ash content of the Indian coals places a limit on the economic transportation distance for these coals. If coal cleaning technologies are made available to India, the efficiency of their coal utilization will improve significantly.

Most of the coal in India is mined by strip mining (open cast mining). Very few coal mines in India are underground. This places a restriction of the de facto availability of the

coal, despite the large coal reserves on paper. In addition, India has large deposits of lignite, which is difficult to mine economically, because of its low energy content. In both these cases, underground coal gasification (UCG) presents an attractive alternative:

Underground coal gasification (UCG) is an appropriate technology to economically access the energy resources in deep and/or unmineable coal seams and potentially to extract these reserves through production of synthetic gas (syngas) for power generation, production of synthetic liquid fuels, natural gas, or chemicals. India is a potentially good area for underground coal gasification. India has an estimated amount of about 467 billion tonnes (bt) of possible reserves, nearly 66% of which is potential candidate for UCG, located at deep to intermediate depths and are low grade. As noted earlier, the coal available in India is of poor quality, with very high ash content and low calorific value. Use of coal gasification has the potential to eliminate the environmental hazards associated with ash, with open pit mining and with greenhouse gas emissions if UCG is combined with re-injection of the CO₂ fraction of the produced gas. With respect to carbon emissions, India's dependence on coal and its projected rapid rise in electricity demand will make it one of the world's largest CO₂ producers in the near future. Underground coal gasification, with separation and reinjection of the CO₂ produced by the process, is one strategy that can decouple rising electricity demand from rising greenhouse gas contributions.

UCG is well suited to India's current and emerging energy demands. The syngas produced by UCG can be used to generate electricity through combined cycle. It can also be shifted chemically to produce synthetic natural gas (e.g., Great Plains Gasification Plant in North Dakota). It may also serve as a feedstock for methanol, gasoline, or diesel fuel production and even as a hydrogen supply. Currently, this technology could be deployed in both eastern and western India in highly populated areas, thus reducing overall energy demand. Most importantly, the reduced capital cost and lack of facilities provide a platform for rapid acceleration of coal-fired electric power and other high-value products.

Under the auspices of the Asian Pacific Partnership, a workshop on UCG is being organized in Kolkata, India, in November 2006. The main objective of the workshop is to accelerate the implementation of UCG in India.

2.5.2 China

The Chinese economy supports the most rapid growth rates of any large country, with average growth rates greater than 8% for each year since 1978. They too are limited only by the availability of energy and current infrastructure. More than 65% of the power consumed in China is from coal and 70% of their electric power. Coal is used as a feedstock for chemical, fuel, and fertilizer plants, and China has over 50 large coal gasification facilities nationwide. It uses over 1.9 billion tons of coal each year, and emits over 3.5 billion tons of CO₂, 75% from stationary point sources, mostly coal (World Energy Council, 2004).

China has huge reserves of coal of every rank, estimated at 114 trillion tons (World Energy Council, 2004). This coal varies in grade, including high-low sulfur and high-low ash coal. Coal basins are spread over all of China, but are mostly mined from basins in the east close to population centers. Demands for energy and electricity have greatly increased mining operations. China has the highest incidence of mining accidents, with many thousands of deaths each year, with some years in excess of 5000 deaths. China reports 80% of the world's coal mining fatalities associated with only 35% of coal utilization. There are many reasons for this, including the large number of small mining operations active throughout the country. In a recent attempt to improve mine safety, many of these mines have been officially closed, leaving thousands of abandoned small underground mines throughout China.

A number of environmental problems stem from China's coal use. The high sulfur content of many coals has resulted in substantial emissions of sulfur aerosols leading to acid rain and other environmental problems. Similarly, particulate and ozone levels have climbed steeply, as has asthma incidence; China's average child asthma incidence of 2% and some cities as high as 4.3%. Mercury emissions have substantially increased. Although the government has announced clear policies to reduce pollution in China, it is not clear if these policies will be enacted effectively.

Against this backdrop, it is perhaps not surprising that China has emerged as a UCG technology development leader. As is discussed in Section 3.1.3 below, China has executed at least 16 pilots since 1991, and has invested in extensive research programs at China University of Mining Technology in Beijing. Currently, UCG provides syngas as feedstock to commercial fertilizer and chemical plants. Interestingly, China has explored a technology where abandoned mines are used as gasifiers, utilizing the small closed mines throughout the country. It appears that Chinese companies and government entities are accelerating the deployment of commercial UCG. This supports the notion that UCG economics are favorable.

3 Historical Overview

There have been over 50 UCG tests or pilot operations worldwide and over 30 in the U.S. (Table 3-1, 3-2, 3-3; Figure 3-1, 3-5). Some of the most well-documented UCG operations are those at Centralia, Washington, and Hanna, Wyoming (Stephens, et al., 1985a), Hoe Creek, Wyoming (Stephens, et al., 1981) and Chinchilla, Australia (Blinderman and Jones, 2002; Walker, et al., 2001).

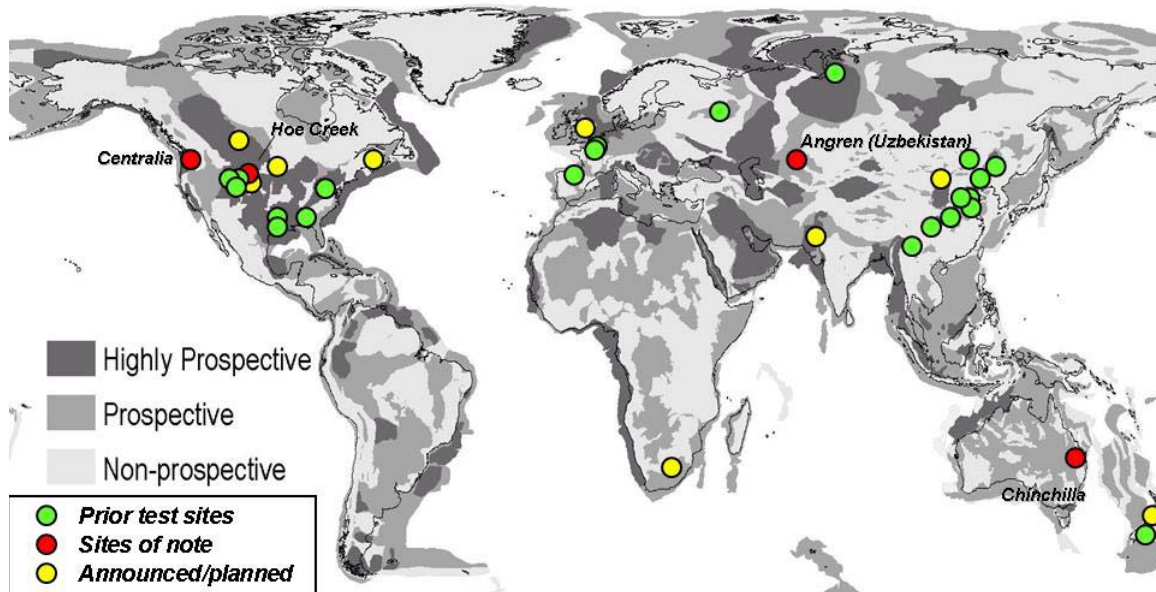

Figure 3-1: World-wide distribution of UCG tests, including sites of note and some announced or planned projects. Underlying prospect map describes potential for geological carbon storage (Adapted from Bradshaw & Dance, 2005)

Sir William Siemens, a German scientist, is credited with the first suggestion to gasify coal underground in 1868. At about the same time, in Russia, Dmitriy Mendeleev, suggested the idea of controlling and directing spontaneous underground coal fires, including the idea of drilling injection and production wells (Olness and Gregg, 1977). The first patent recorded for underground coal gasification was issued in 1909 in Great Britain to an American, A.G. Betts (Figure 3-2). Over the next several years, Sir William Ramsey promoted and expanded upon Betts's idea, culminating in plans for a first trial experiment underground. The experiment obtained financing but never occurred, however, because of Ramsey's death and the outbreak of World War I.

Ramsey's speeches on underground coal gasification did attract the interest of Lenin, in exile in Zurich at the time. In May 1913, he published an article in Pravda, citing the huge potential benefits of the technology for socialist society because it eliminated hard mining labor. Joseph Stalin was a champion of the early Soviet program. The national program began in 1928, continued at a high level for nearly the next 50 years, and

included successful commercial production at numerous sites. The total Soviet effort far exceeded the combined efforts of other nations.

UCG efforts in the U.S. began in the early 1960s and were terminated by the mid-1980s. In China, efforts began in the 1980s and continue to the present. In Australia, New Zealand and Europe, efforts started in the 1990s.

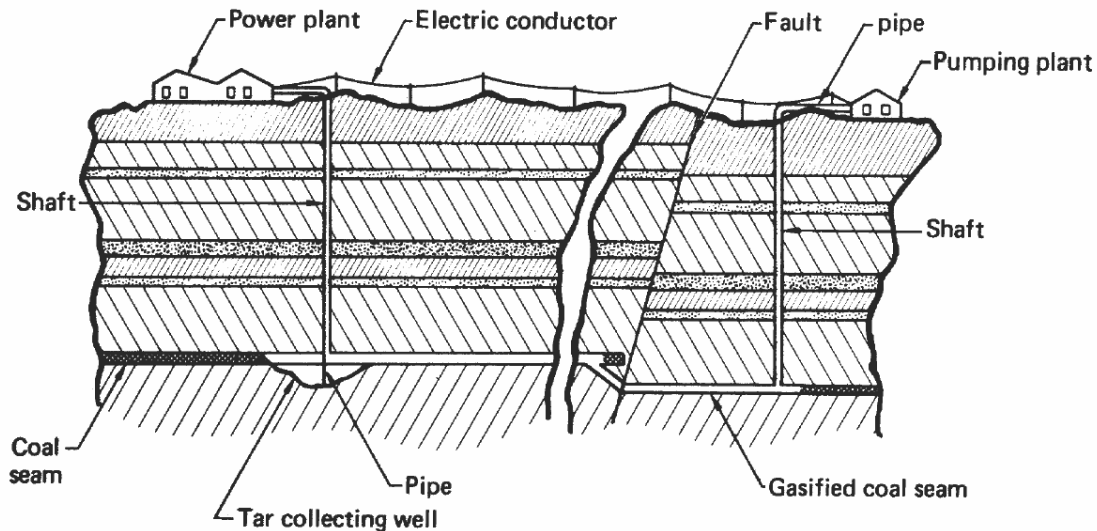

Figure 3-2: Reproduction of Betts's patent specifications, including an air, and ,if required, steam injection pipe from the pumping plant, in-situ gasification of the coal seam, and a collection pipe that feeds produced gas directly to an electric power plant (Olness and Gregg, 1977)

3.1 Experience from 1960 through 1999

During this period, pioneering research in the U.S. and abroad brought the promise of UCG considerably closer to broad commercialization. Worldwide, there is UCG operating experience over a range of coal seam depths and thicknesses (Figure 3-3). In the U.S., the basic feasibility of UCG was proven in both extensive trials and by long-term, large-scale UCG pilots (Thorsness and Britten, 1989). From these operations, we have data available as to how differences in stratigraphy, structure and hydrogeology, coal, rock and groundwater compositions, and engineering design of burn operations can influence process control, contaminant transport away from the burn site, and the consequent impacts on economics, the environment and human health.

Over time, with improvements in drilling technology, the depth of UCG operations has increased markedly (Figure 3-4). As shown in Figures 3-3 and 3-4, Europe in particular has emphasized developing UCG for deep seams.

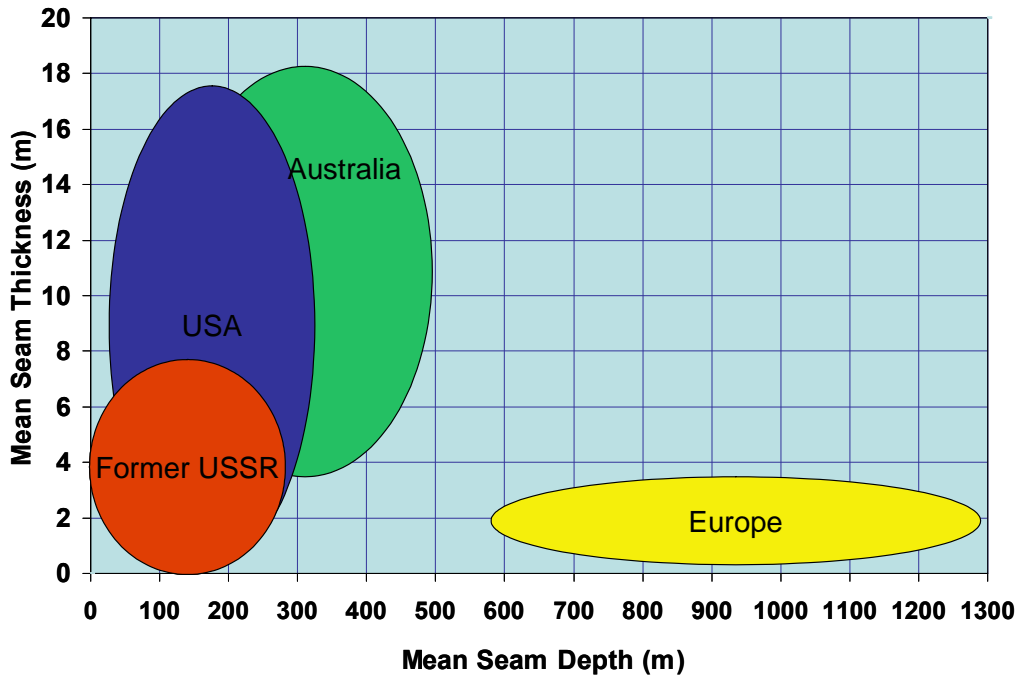

Figure 3-3: Worldwide UCG operations experience with respect to coal seam depth and thickness (modified from Perkins, unpublished).

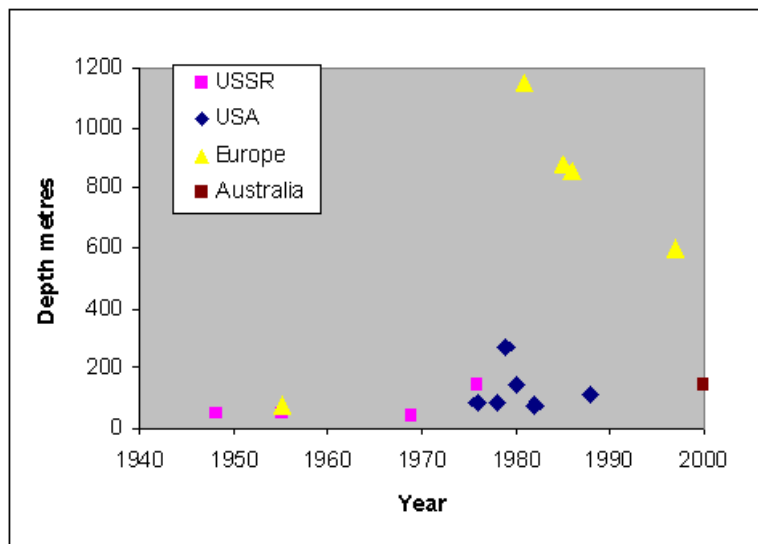

Figure 3-4: UCG Trials as function of coal seam depth (Burton, et al., 2004).

Table 3-1: International UCG pilots, excluding U.S. and FSU

Dates	Place (Test Name)	Duration (days)	Well Separation (m)	Coal Gasified (tons)	System Pressure (kPa)	Feed gas	Coal Seam Depth (m)	Auspices/ Comments	Reference
1982-1985	Thulin, Belgium	12	35	4	30,000 to 80,000	air; mix of N ₂ , O ₂ , CO ₂	860	Institut pour le Development de la Gazeification Souterraine, Belgium	Chandelle, V. 1986, Overview About Thulin Field Test, Proceedings of the Twelfth Annual Underground Coal Gasification Symposium, DOE/FE/60922-H1.
1983-1984	Initially at Bruay en Artois, and later at La Haute Deule, France	75	60	0.3 1 st phase 1.5 next phase	45,000	N ₂ , O ₂ , CO ₂	880	Groupe d'Etude de la Gazeification Souterraine, France (Production well plugged by particulates and tar, terminating the tests)	Gadelle, C., et al., 1985, Status of French UCG Field Test at La Haute Deule, Proceedings of the Eleventh Annual Underground Coal Gasification Symposium, DOE/METC-85/6028 (DE85013720).
1992-1999	Province of Teruel, NE Spain (El Tremedal)						550	Spain, UK, Belgium, Supported by the European Commission, used CRIP	www.coal-ucg.com/currentdevelopments2.html
1980-present	China, 16 separate trails *							UCG centre at China Univ. of Mining and Technology, Beijing.	www.coal-ucg.com/currentdevelopments2.html
1990 - present	Chinchilla, Queensland, Australia								www.coal-ucg.com/currentdevelopments2.html
1994	Huntley, New Zealand							with US technical assistance	www.coal-ucg.com/currentdevelopments2.html

* The work uses abandoned galleries of disused coal mines for the gasification. Vertical boreholes are drilled into the gallery to act as the injection and production wells. A system of alternating air and steam injection is used to improve the production of hydrogen.

Table 3-2: Recent UCG Operations in the Former Soviet Union (FSU)

Dates	Place (Test/Project Name)	Duration (yr)	Well Separation (m)	Coal Gasified (tons)	Gas Production (m ³ /yr)	System Pressure (kPa)	Coal Seam Thickness (m)	Coal Seam Depth (m)	Comments	Reference
1959-1976	Shatsk, Moscow Basin (Shatskaya UCG 1)	17	25 to 30	262030		150	2 to 4, average 1.9	30 to 60, avg 40	Flat bed	1
1941-1946	Tula, Moscow Basin (Podmoskovnaya UCG 1)	5			30				Phase 2 was small-scale commercial operation; flat bed	2
1946-1963	Tula, Moscow Basin (Podmoskovnaya UCG 2)	17		1647800 (from 1950 to 1960)	460		1 to 5	50	Phase 1 R&D; 110 boreholes drilled, 61 links (1588 m) using counter-current combustion; flat bed; shut down 1963, partly due to coal exhaustion; production peaked at 2 billion m ³ /yr (0.85 million tons)	2
production stopped in 1977	Donets coal basin (Lisichansk)			831604 (from 1950 to 1960)					Steeply dipping beds; shut down in 1964, partially due to coal source exhaustion	3
	Siberia (Yuzhno-Abinsk)		17 to 40	1735112 (sporadic data or operation, from 1955 to 1977)					Steeply dipping beds	3

Dates	Place (Test/Project Name)	Duration (yr)	Well Separation (m)	Coal Gasified (tons)	Gas Production (m ³ /yr)	System Pressure (kPa)	Coal Seam Thickness (m)	Coal Seam Depth (m)	Comments	Reference
1955 to present	Tashkent, Uzbekistan (Angren)	50	25	1040060		156 (average)	24	250	Flat bed; still operating	

- 1) Olness, Dolores, "The Shatskaya UCG Station", UCRL-53229, 1981
- 2) Olness, Dolores, "The Podmoskovnaya UCG Station", UCRL-53144, 1981
- 3) Stephens, D.R., et al., "Underground Coal Gasification: Status and Proposed Program", UCRL-53572, 1984; Olness, D.U., UCRL-50026-80-1

Table 3-3: UCG pilots in the United States.

Dates	Place (Test Name)	Duration (days)	Well Separation (m)	Coal Gasified (tons)	System Pressure (kPa)	Feed Gas	Coal Seam Depth (m)	Auspices	Reference
1947 - 1960	Gorgas, Alabama, US							US Bureau of Mines	Stephens, et al. 1985a
1976	Hoe Creek, Wyoming, USA (Hoe Creek I)	11	10	123	207	air		LLNL/USDOE	Wang, F.T, et al., 1982c Stephens, et al. 1985a
1977	Hoe Creek, Wyoming, USA (Hoe Creek II—air-1)	13	18	286	324	air		LLNL/USDOE	Wang, F.T, et al., 1982c Stephens, et al. 1985a
1977	Hoe Creek, Wyoming, USA (Hoe Creek II-O2)	2	18	47	324	Oxygen		LLNL/USDOE	Wang, F.T, et al., 1982c Stephens, et al. 1985a
1977	Hoe Creek, Wyoming, USA (Hoe Creek II-air -2)	43	18	1155	324	air		LLNL/USDOE	Wang, F.T, et al., 1982c Stephens, et al. 1985a
1979	Hoe Creek, Wyoming, USA (Hoe Creek III-air)	7	40	256	297	air		LLNL/USDOE	Wang, F.T, et al., 1982c Stephens, et al. 1985a
1979	Hoe Creek, Wyoming, USA (Hoe Creek III-O2)	47	40	3251	297	Oxygen/ steam		LLNL/USDOE	Wang, F.T, et al., 1982c Stephens, et al. 1985a
1981-1982	Centralia, Washington (Centralia-LBK-O2)	20		140		Oxygen/ steam		LLNL/Gas Research Institute/USDOE	Stephens, et al., 1985a
1981-1982	Centralia, Washington (Centralia LBK-air)	Unknown		Unknown		air		LLNL/Gas Research Institute/USDOE	Stephens, et al., 1985a
1983	Centralia, Washington (Centralia CRIP-O2)	28		2000		Oxygen/ steam		LLNL/Gas Research Institute/USDOE	Stephens, et al., 1985a

Dates	Place (Test Name)	Duration (days)	Well Separation (m)	Coal Gasified (tons)	System Pressure (kPa)	Feed Gas	Coal Seam Depth (m)	Auspices	Reference
1973-1974	Hanna, Wyoming (LETC-1)	168		2720		air		Laramie Energy Technology Center/USDOE	Stephens, et al., 1985a
1975	Hanna, Wyoming (LETC-II-1A)	37		962				Laramie Energy Technology Center/USDOE	Stephens, et al., 1985a
1975	Hanna, Wyoming (LETC-II-1B)	38		780				Laramie Energy Technology Center/USDOE	Stephens, et al., 1985a
1976	Hanna, Wyoming (LETC-II-II)	26		2201				Laramie Energy Technology Center/USDOE	Stephens, et al., 1985a
1976	Hanna, Wyoming (LETC-II-III)	39		3414				Laramie Energy Technology Center/USDOE	Stephens et al., 1985a
1977	Hanna, Wyoming (LETC-III)	38		2663				Laramie Energy Technology Center/USDOE	Stephens et al., 1985a
1978	Hanna, Wyoming (LETC-IV-A(a))	7		294				Laramie Energy Technology Center/USDOE	Stephens et al., 1985a
1978	Hanna, Wyoming LETC-IV-A(b)	48		3184				Laramie Energy Technology Center/USDOE	Stephens et al., 1985a
1977	Hanna, Wyoming (LETC-III)	38		2663				Laramie Energy Technology Center/USDOE	Stephens et al., 1985a
1978	Hanna, Wyoming (LETC-IV-A(a))	7		294				Laramie Energy Technology Center/USDOE	Stephens et al., 1985a

Dates	Place (Test Name)	Duration (days)	Well Separation (m)	Coal Gasified (tons)	System Pressure (kPa)	Feed Gas	Coal Seam Depth (m)	Auspices	Reference
1977	Hanna, Wyoming (LETC-III)	38		2663				Laramie Energy Technology Center/USDOE	Stephens et al., 1985a
1978	Hanna, Wyoming (LETC-IV-A(a))	7		294				Laramie Energy Technology Center/USDOE	Stephens et al., 1985a
1978	Hanna, Wyoming LETC-IV-A(b)	48		3184				Laramie Energy Technology Center/USDOE	Stephens et al., 1985a
1979	Hanna, Wyoming LETC-IV-B(a)	7		468				Laramie Energy Technology Center/USDOE	Stephens et al., 1985a
1979	Hanna, Wyoming (LTC-IV-B(b))	16		663				Laramie Energy Technology Center/USDOE	Stephens et al., 1985a
1979	Princeton, W. Virginia (METC-1)	17		234				Morgantown Energy Technology Center/USDOE	Stephens et al., 1985a
1979	Rawlins, Carbon County, Wyoming (GRD-I-air)	30		1207		air		Gulf Research and Development Company/USDOE	Stephens et al., 1985a
1979	Rawlins, Carbon County, Wyoming (GRD-I-O2)	5		125		Oxy- gen		Gulf Research and Development Company/USDOE	Stephens et al., 1985a
1979	Rawlins, Carbon County, Wyoming (GRD-I-O2)	5		125		Oxy- gen		Gulf Research and Development Company/USDOE	Stephens et al., 1985a
1981	Rawlins, Carbon County, Wyoming (GRD-II-O2)	66		8550		Oxy- gen		Gulf Research and Development Company/USDOE	Stephens et al., 1985a

Dates	Place (Test Name)	Duration (days)	Well Separation (m)	Coal Gasified (tons)	System Pressure (kPa)	Feed Gas	Coal Seam Depth (m)	Auspices	Reference
1976	Fairfield, Texas (BRI-I)	26						Basic Resources, Inc. (privately funded)	Stephens et al., 1985a
1978-1979	Tennessee Colony, Texas (BRI-IIa)	197		4500		air		Basic Resources, Inc. (privately funded)	Stephens et al., 1985a
1978-1979	Tennessee Colony, Texas (BRI-IIb)	10		212		Oxygen		Basic Resources, Inc. (privately funded)	Stephens et al., 1985a
1978	Reno Junction, Wyoming (ARCO-I)	60		3600				Atlantic Richfield Company (privately funded)	Stephens et al., 1985a
1977	College Station, Texas (TAM-I)	1		2				Texas A&M University Industrial Consortium (privately funded)	Stephens et al., 1985a
1979	Bastrop County, Texas (TAM-II)	2		Un-known				Texas A&M University Industrial Consortium (privately funded)	Stephens et al., 1985a
1980	Bastrop County, Texas (TAM-III)	Un-known		Un-known				Texas A&M University Industrial Consortium (privately funded)	Stephens et al., 1985a

Dates	Place (Test Name)	Duration (days)	Well Separation (m)	Coal Gasi-fied (tons)	System Pressure (kPa)	Feed Gas	Coal Seam Depth (m)	Auspices	Reference
1987-1988	Hanna, Wyoming (Rocky Mt.) (RM1-ELW) (extended linked well)	40		4100		Oxy- gen/ Steam	10	Gas Research Institute and METC (USDOE)	GRI Report GRI-90/008; Thorsness and Britten, 1989
1987-1988	Hanna, Wyoming (Rocky Mt.) (CRIP-ELW)	93		11400		Oxy- gen/ Steam	10	Gas Research Institute and METC (USDOE)	GRI Report GRI-90/008; Thorsness and Britten, 1989

3.1.1 U.S. Trials

As shown in Table 3-3 and Figure 3-5, 31 tests were conducted within the U.S. between 1973 and 1989. Most of these were part of the DOE's coal gasification program, although some were commercially funded (e.g., ARCO-I). In each case, ignition was achieved, monitored, and managed. While the goals of each test were different, it is fair to say that they were conceived and executed to address specific sets of engineering concerns (e.g., improved permeability of the coals; testing completion methods; improving syngas energy yield). A number of these tests are notable for what they achieved and the data available from them. Specifically, Hoe Creek (WY) and Centralia (WA) will be discussed in depth.

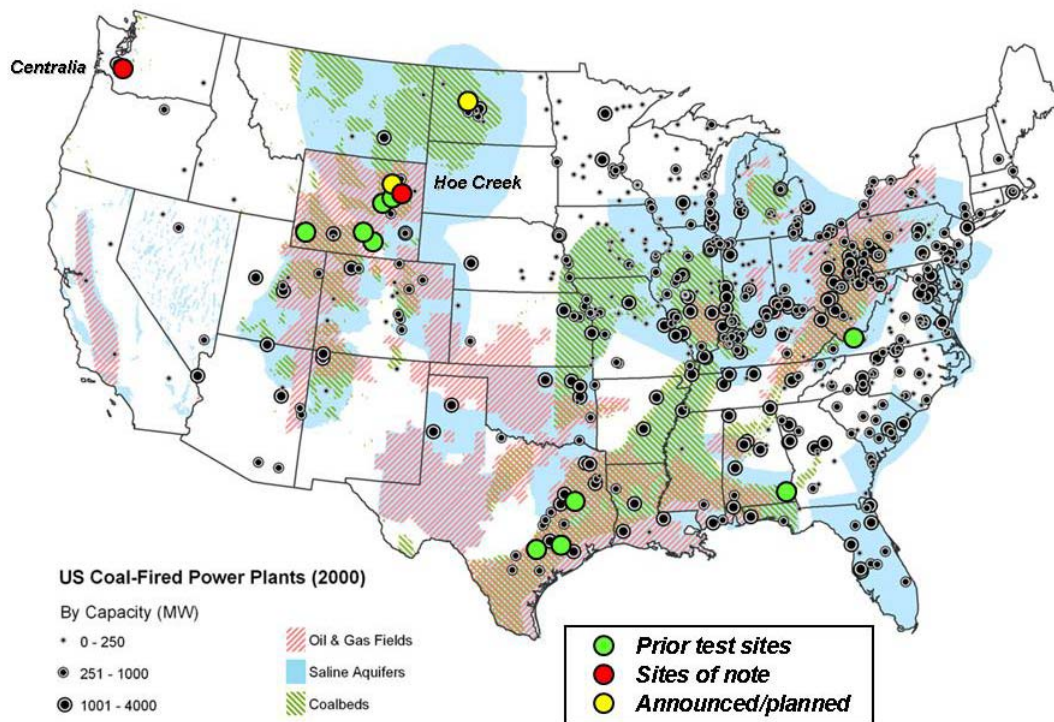

Figure 3-5: UCG projects in the United States. In many cases, individual dots represent multiple tests. Also shown are coal-fired plant locations (black dots) and sites with potential for geological carbon storage (color-shaded regions). (Adapted from Bradshaw & Dance, 2005)

3.1.1.1 Hoe Creek, WY

From 1976 to 1979, Lawrence Livermore National Laboratory (LLNL) conducted three UCG tests at the Hoe Creek UCG Site in Campbell County, Wyoming, approximately 20 miles southwest of Gillette (Stephens, 1981). Figure 3-6 shows the stratigraphic sequences at this site. The Channel Sand unit and the two coal seams, Felix No. 1 and Felix No. 2, are the three aquifers in this area, and the Felix No. 2 coal seam was the target for the gasification study.

LLNL conducted three UCG experiments at the Hoe Creek site, located about 25 miles south of Gillette, Wyoming during 1976-1979 (Thorsness, 1982). The stratigraphy of the site was derived from cores, drill-cutting samples, and downhole geophysical logs. These are unique among U.S. experiments because three different linking methods were used: explosive fracture, reverse combustion, and directional drilling. Air was injected in all three experiments, and a steam/oxygen mixture during 2 days of the second and most of the third experiment. Subsequent analysis showed that the linking method did not influence gas quality, which was dependent on whether air or oxygen was used, but independent of other operating parameters.

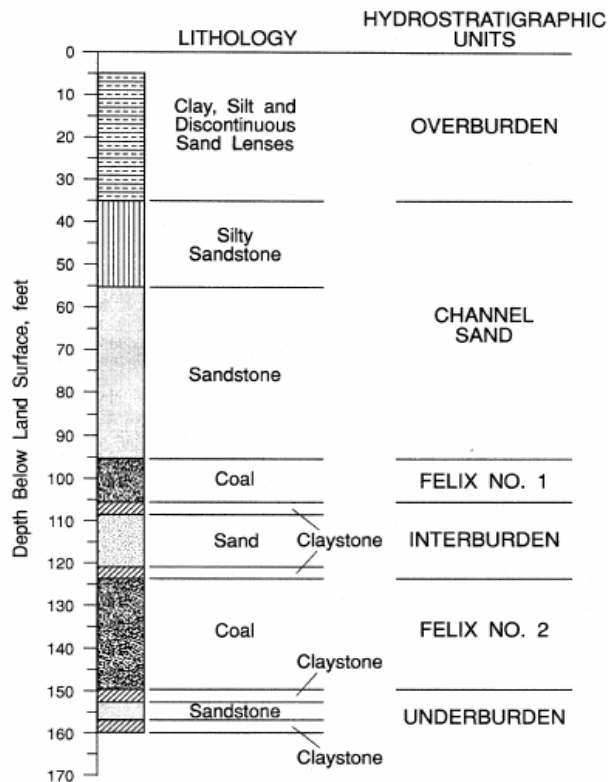

Figure 3-6: Hoe Creek stratigraphic sequence (Covell and Thomas, 1996).

The tests took place in the Felix No. 1 seam near Gillette, an Eocene coal of the Wasatch Formation (Figure 3-6). The seam is the thickest and most continuous of the Wasatch Fm. coals and is a classic Powder River basin sub-bituminous coal (Qualheim, 1977). The coal is interbedded with lenses of course- and fine-grained sandstones deposited in a fluvial environment. Rapid thickness changes of units directly above the Hoe Creek were recognized by assessments prior to testing, especially at site No. 2. The choice of the Hoe Creek site was dictated by a combination of practical (the site was on federal land under the control of the Bureau of Land Management) and technical (the site was typical of the entire Powder River Basin, with 30 m coal seam at a depth of about 300 m) considerations.

All three Hoe Creek experiments were extensively instrumented. The instrumentation used at Hoe Creek can be divided into three categories: process, cavity and geotechnical. All the significant variables were monitored. The injection and production flows were monitored using orifice plates and pressure transducers, and pressures at the injection and production wells were measured. The individual components of the injection flow, air, steam and oxygen also were measured separately. A small fraction of the product gas was cleaned and cooled, with tar and water retained in traps. Periodic weighings of the traps gave average tar and water content of the product gas. In all experiments, the concentrations of CO₂, CO, H₂, CH₄ and other hydrocarbons were determined from chromatography, mass spectrometry and by infra-red absorption meters.

A variety of instruments were used to measure the growth of the gasification cavity. Thermocouples indicated the arrival of the burn front at various locations in instrumentation wells. A high frequency electro-magnetic (HFEM) absorption technique was used to measure the growth of the cavity in the two latter experiments. Post-burn coring showed the extent of voids and allowed understanding of the way underground materials were altered. Tracers were injected to measure void volumes, residence times and dispersivity in the underground system.

A number of geo-technical instruments were used to monitor earth motion, both on the surface and underground. Tiltmeters and surveyors monuments were deemed adequate to measure surface subsidence. To measure underground motion of the overburden material, selected wells were fitted with extensometers. In contrast, results from downhole piezometers, shear strips and borehole deflectometers were found to be of limited utility.

One reason why this field demonstration of UCG was situated below the water table was that uncontrolled burns could be prevented by simply stopping the injection. Unfortunately, significant amounts of organic contaminants were generated and introduced into the groundwater during these tests and the clean-up has taken many years (See Section 5 for more detail).

The three tests were named Hoe Creek I, II and III. One of the main objectives for these tests was to evaluate three different permeability enhancement techniques that could be used to link the injection wells and the production wells. Explosive fracturing was used for Hoe Creek I and the test continued for 11 days with air injection (Stephens, 1981). During this test, approximately 7% of the gas was lost to the formation. Reverse combustion was used for Hoe Creek II (Stephens, 1981). Gasification at this site lasted for 43 days. Water influx significantly lowered the gas quality. Increased operating pressure in the burn zone was used in an effort to decrease water influx, but this approach resulted in a significant amount of gas lost to the formation (approx. 20%). Much of this loss is thought to have occurred when the burn zone collapsed, exposing the upper Felix No. 1 seam, which was at a lower hydrostatic pressure. Hoe Creek III combined a horizontally drilled link with reverse combustion. (Aiman, et al., 1980) The burn zone moved into the upper coal seam, and also resulted in significant gas loss during the test (approx. 17%). Subsidence eventually propagated to the surface at the Hoe Creek II and III Sites.

Active gasification processes introduced toxic volatile and semi-volatile organic compounds into the aquifers at the Hoe Creek site, especially when the burn zone was over-pressurized to help mitigate water influx. But the persistent groundwater quality problems are the result of migration of contaminants derived from the nonaqueous phase liquids (NAPLs) that are gasification byproduct residues formed by the pyrolytic breakdown of the coal (e.g. viscous tars, semi-volatile and volatile organic compounds) (Figure 3-7; Wang et al., 1982b; Covell and Thomas, 1996). The problems were exacerbated by subsidence and collapse of the cavity roof, which resulted in the interconnection of the hydrostratigraphic zones and contamination of all three local aquifers. A more detailed discussion of the groundwater contamination issues around UCG and the Hoe Creek site are found in Section 5, below.

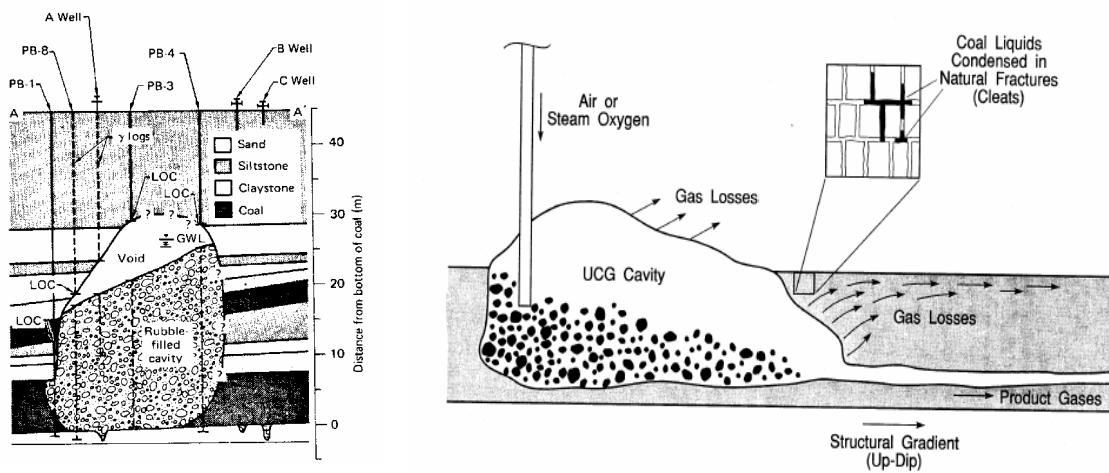

Figure 3-7: Underground coal gasification process showing the transverse cross-section of the reactor zone (Stephens, 1981) and a longitudinal section showing the transportation and condensation of liquefied coal pyrolysates (Covell and Thomas, 1996).

Hoe Creek provided a basis for a number of important technology tests and developments (Stephens, 1981). These included the proof-of-concept validation for the CRIP ignition scheme (detailed in Section 4), validation of subsidence models (Trent and Langland 1981), the first oxygen/steam injection gasification experiments (Stephens, et al., 1985a), and validation of some early simulators (Thorsness and Creighton, 1982; Thorsness, 1985; 1986a; 1986b; 1987). The instrumentation of the site was notable for its density, multiplicity, range of tools and use of tracers (Thorsness and Creighton, 1982). Perhaps, ironically, the first recognition in the U.S. of possible groundwater hazards was made at the Hoe Creek site (Raber and Stone, 1980) before the site contamination later became recognized. It is perhaps noteworthy that the recent protocols developed for site evaluation (See Section 5.) would have classed this site as having high environmental risk.

3.1.1.2 WIDCO Mine (Tono Basin) experiments, Centralia, WA

From 1981 to 1982, a series of experiments known as the large block experiments were carried out near Centralia, Washington at the Washington Irrigation and Development Company (WIDCO) coal mine (Hill and Thorsness, 1983; Hill, et al., 1983). These were followed by two more tests, a partial seam CRIP (Cena, et al., 1984) and full seam CRIP burn. (Hill, et al., 1984). Experiments were jointly funded by the DOE, the Gas Research Institute (now the Gas Technology Institute), the Washington Power Company, and Pacific Power & Light; the experiments were run by Lawrence Livermore National Laboratory, Sandia National Laboratory and Radian Corporation.

The experiments took place in adjacent section on a single exposed coal face (Figure 3-8). The coal was Eocene Skookumchuck Formation coal, a sub-bituminous coal with substantial ash component (14%). The vertical relief of the test site allowed for both ease of access and extensive monitoring, mostly in the form of thermocouples in well pits. In addition, the UCG reactor zones were quarried shortly after the tests, providing a means of directly validating aspects of the simulators. This allowed the investigators to improve their understanding of how the burn cavity grows and is influenced by site geology and to test the CRIP technology (Controlled Reacting Ignition Point; see Section 4 for details).

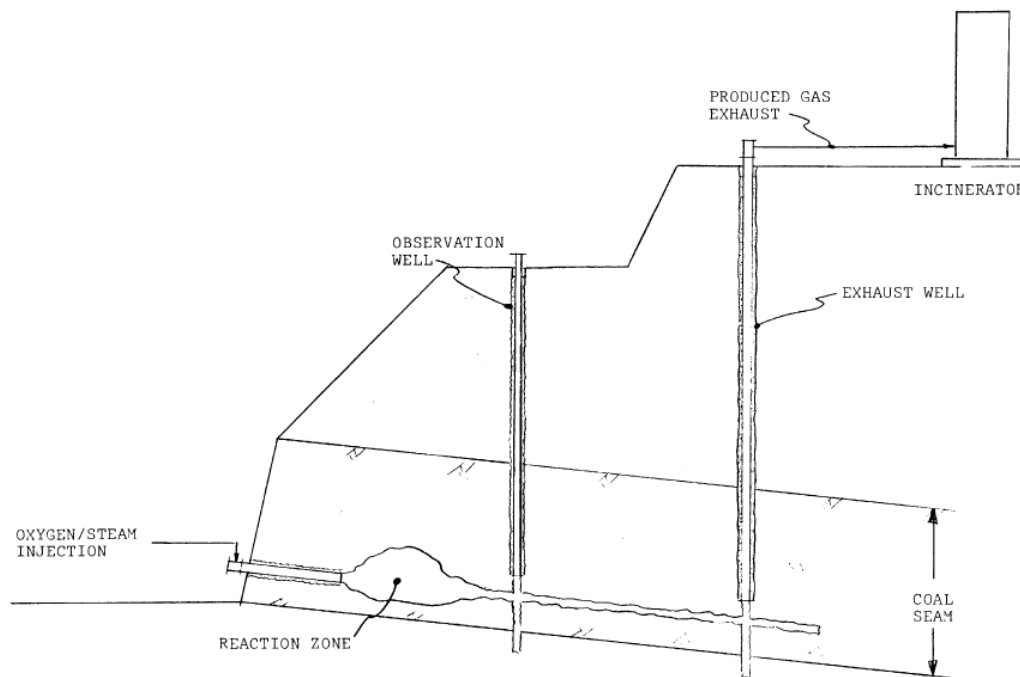

Figure 3-8: Schematic view of the large block experimental configuration.

The large block tests experiments were short (~4 days). Unlike at Hoe Creek, silane gas (SiO_4) was used with propane to ignite the burns and to melt through the horizontal casing to control burn cavity retreat. The partial seam CRIP test was ~30 days duration

with a factor of 20-30 more coal utilized; the full seam test consumed still five times more.

Experiments were run with differences in steam:oxygen injection ratio as well as total flow rate changes. Perhaps surprisingly, it did not appear that varying these parameters greatly changed the quality or constancy of the syngas (Hill et al., 1984). The conclusion reached from these experiments is that the reactor zone is self-stabilizing, and that the flow rate and oxygen/steam ratios did not affect gas quality.

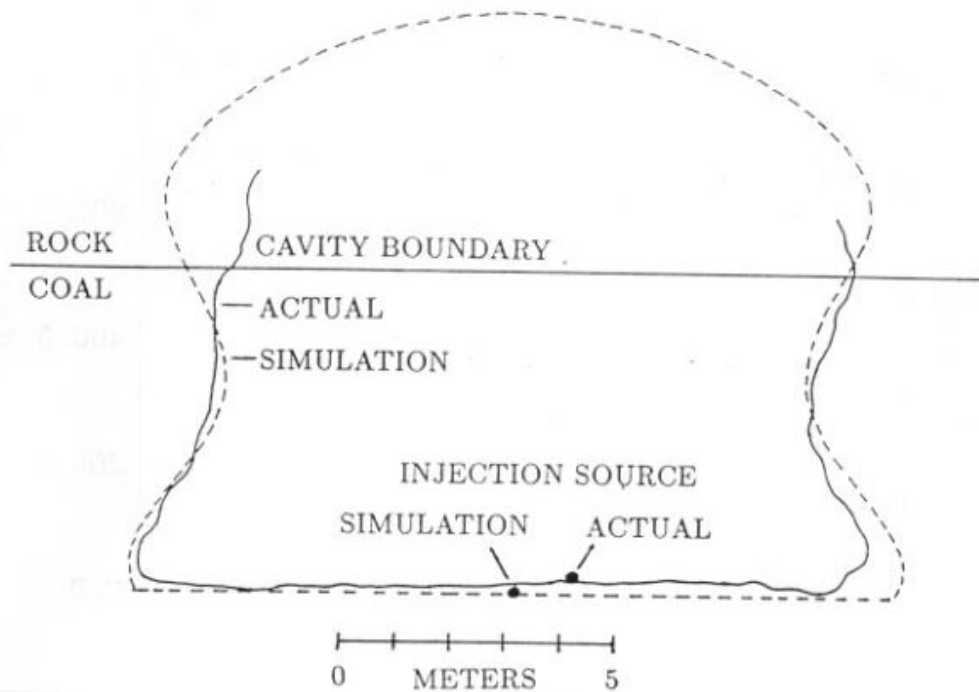

Figure 3-9: Comparison of actual and calculated cavity shapes in the plane perpendicular to the injection borehole at the injection point of the PSC CRIP cavity (Britten, 1986, 1987; Britten and Thorsness, 1988).

Trenching through the reactor zone allowed for both model validation and direct examination of the burn zone and products. The UCG cavity was filled mostly with rubble consisting of dried coal, char, and ash, as well as thermally altered coal. In some cases, the casing of the horizontal wells was found, again providing model constraint and grounds for validation.

The WIDCO mine site provided a basis for a number of important technology tests and developments. These included the first test of the fully-developed CRIP technology (Hill and Thorsness 1983), a high-density thermocouple and early resistivity and magneto-

telluric monitoring program (Hill, et al., 1984), and validation of codes predicting cavity shape and evolution (Figure 3-9; Cena, et al., 1987; Britten and Thorsness, 1988). In addition, attempts were made to improve gas quality and constancy by changing drilling configuration, including slanted long-reach wells.

3.1.2 European UCG Trials (1982-1999)

A number of UCG tests have been carried out in Western Europe. One of the earlier tests was in Thulin, Belgium (Chandelle, 1986; Kurth, et al., 1986). The objective of these tests was to develop the method of linking the wells by reverse combustion for deep seams. The experiments were carried out between 1982 and 1984. The Thulin program was characterized by the utilization of special drilling techniques to achieve the links, which was successful. The CRIP method was used in one of the tests, and retraction of the injection point was demonstrated. Special corrosion resistant alloys were used in the well completion equipment.

UCG experiments were carried out in France during 1983-1984, initially at Bruay en Artois, and later on at La Haute Deule (Gadelle, et al., 1985). The objectives of these tests were to develop a better understanding of the coal reactivity and of the hydraulic properties of the linking between the wells. During these tests, operating conditions were determined for reverse combustion with limited risks of self ignition. The experiments were stopped because of plugging of the production well by particles and tars.

The European Working Group on UCG recommended in 1989 that a series of trials should be undertaken to evaluate the commercial feasibility of UCG in the thinner and deeper coal seams typical of Europe. The first would be at an intermediate depth of around 500m to test the feasibility of the previously developed technology at this greater depth. If successful, later trials would follow to test UCG operations at ~1000m depth, and evaluate power generation from the resultant production gas.

The first of these proposed trials became the Spanish trial of 1992-1999. The trial was undertaken by Spain, the UK and Belgium, and was supported by the European Commission. A suitable site at "El Tremedal" in the Province of Teruel, NE Spain was chosen based on its geological suitability, coal seam depth (550m) and the availability of extensive borehole data (Pirard, 2000, Creedy, 2001). The objectives were to test the use of directional in-seam drilling to construct the well configuration and to evaluate the feasibility of gasification at depths greater than 500m. The CRIP process was used for the trial.

The Spanish trial was completed successfully (although it only operated for a short period). It demonstrated the feasibility of gasification at depth, the viability of directional drilling for well construction and intersection, and the benefits of a controllable injection and ignition point.

The operating and drilling experience provided a number of useful lessons for future

trials in terms of the detailed engineering design of the underground components, the control of the in-seam drilling process and the geological selection of trial sites. The problems identified during the Spanish trial are relatively easy to solve. For example, the maximum in-seam length that could be achieved at the time was about 50m. Controlling the drill bit in the seam proved difficult with the equipment then available, and was attributed to unsuitable downhole assemblies and a lack of coal experience by the drilling operatives (U.K. Department of Trade and Industry, 2004). Given the current technology and the accumulated experience worldwide, a further trial of sustained channel gasification would lay the technical foundations for commercial operations, and provide a basis for a detailed economic assessment of the process of UCG.

Largely as a result of the Spanish trial results, The Department of Trade & Industry Technology (DTI) in the United Kingdom identified UCG as one of the potential future technologies for the development of the UK's large coal reserves. Technology targets for UCG development were set as follows (U.K. Department of Trade and Industry, 1999):

- Improved accuracy of in-seam drilling;
- Assessment of the implications of burning UCG gas in a gas turbine;
- Estimates of the landward reserves of coal that could be technically suited to UCG;
- Identification of a site for a semi-commercial trial of UCG;
- Identification of the parameters that UCG would have to meet to compete with current North Sea gas production costs;
- A pre-feasibility study for the exploitation of UCG offshore in the southern North Sea.

An initial pre-feasibility study was completed in January 2000 by the DTI in conjunction with The Coal Authority, and work then began on the selection of a U.K. site for a drilling and in-seam gasification trial. Detailed work was done on the geological and hydrogeological criteria for UCG, the evaluation of suitable sites, and the legislative policies that would apply to an onshore UCG scheme.

This work emphasized the growing importance of environmental issues and a thorough investigation of these issues will likely be undertaken before legislative approval of a test site. In addition to the work on a trial site, paper feasibility studies have been initiated into the technology of UCG, and the potential of the U.K. coal resources.

3.1.3 People's Republic of China (1980s to present)

China has the largest UCG program currently underway, including 16 trials carried out or currently operating since the late 1980's. These include the Xinhe #2 mine test, the industrial trial at Liuzhuang mine in Tangshan, XinWen's tests at Suncun in Shangdong, and the Caozhuang mine in Feicheng. The work uses abandoned galleries of coal mines for the gasification. Vertical boreholes are drilled into the gallery to act as the injection

and production wells. A system of alternating air and steam injection is used to improve the production of hydrogen.

Due to government encouragement to diversify coal utilization and approach, several companies are pursuing or utilizing UCG syngas. The XinWen coal mining group in Shangdong province has six reactors with syngas used for cooking and heating. (Creedy and Garner, 2004). A project in Shanxi Province uses UCG gas for the production of ammonia and hydrogen. Small-scale power production schemes using converted coal boilers or gas turbines are also under consideration, as is a 350 MW electric generating plant. Finally, the XinAo corporation has announced plans for a liquid fuel production facility fed by UCG, with methanol and DME as the likeliest products.

The UCG center at the China University of Mining and Technology, Beijing, also is testing UCG in abandoned coal mines. A technical centre for UCG has been set up in the University of Beijing, and a technical exchange of information on UCG is taking place with the UK. Work there includes both laboratory and numerical work, including a large autoclave to conduct experiments on large packed beds at elevated pressures and temperatures.

3.1.4 Australia (1990s to present)

CSIRO is undertaking feasibility studies of UCG, and is currently evaluating cavity models in association with the University of Sydney. CSIRO have also been examining the process and power implications of UCG.

3.1.4.1 The Chinchilla Project

The Chinchilla project (Blinderman and Jones, 2002), in Chinchilla (350 km west of Brisbane), Queensland, Australia, was run from 1997 through 2003, and is the largest UCG project to date in the West. Ergo Exergy Technologies Inc, Canada (Ergo Exergy) provided UCG technology for the project under an agreement with the developing company Linc Energy, Ltd, Australia. Ergo Exergy also designed and operated the UCG plant at Chinchilla.

The long-term goals of the Chinchilla project were power production and liquid fuels production using gas-to-liquid technology, such as Fischer-Tropsch synthesis. Figure 3-10 shows a conceptual schematic of the system.

The process plant is used to condition the gas to satisfy strict requirements of the gas turbine. Raw gas produced at the wellhead is cooled down to separate the liquids that are further processed and prepared either for sale or disposal. The gas then is cleaned up in sintered metal candle filters. Since candle filters require dry gas for normal functioning, the gas is reheated to the temperatures above dew point before entering the filters. A pilot cleanup plant simulating conditions of the full-scale process was tested on site.

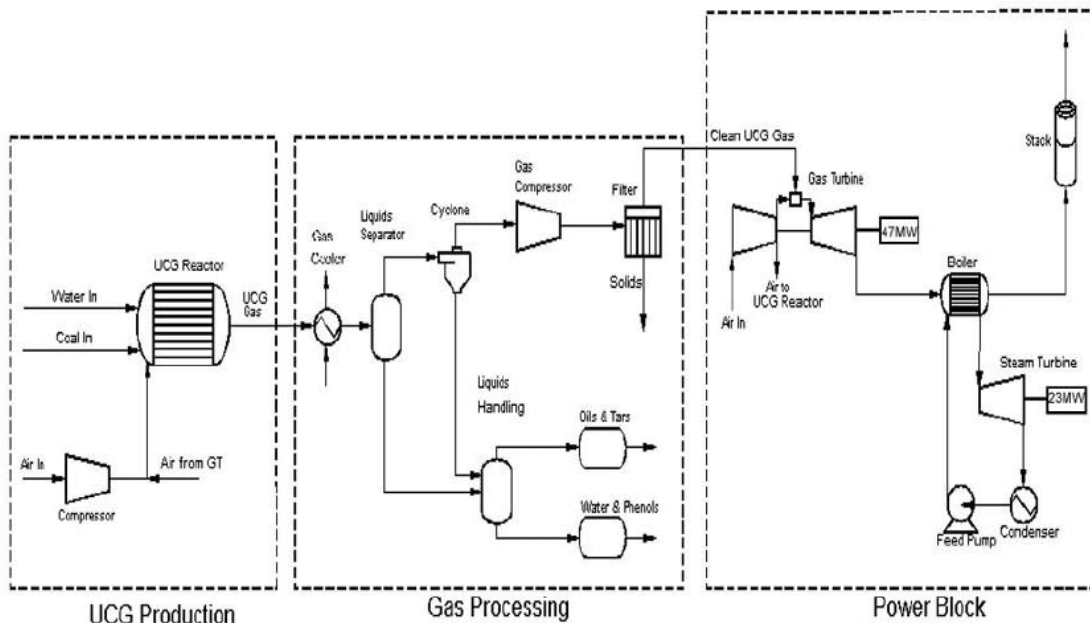

Figure 3-10: Conceptual Design of the Chinchilla Project (Blinderman, 2003b).

A gas compressor is required to bring the pressure of the gas to the level acceptable for the gas turbine. Water separated from the gas flow is used for cooling the raw gas in a heat exchanger and air in the air compressor intercoolers. It will also comprise a part of makeup water needed to operate the steam cycle once a steam turbine is installed.

As pointed out by Blinderman (2003b), the need for the gas compressor is dictated only by the specific conditions of Chinchilla site, namely the thickness and permeability of the overburden. A deeper coal seam or less permeable rock in the overburden may allow gasification under much higher pressure, so that the gas can be supplied directly into the gas turbine avoiding the need in additional compression. Figure 3-6 depicts an example of a 70 MW IGCC plant. The Chinchilla project targeted this size of plant in an attempt to minimize the capital investment required and to provide sufficient output to produce attractive commercial returns. The ultimate goal of IGCC development at Chinchilla is the scaling up of the initial plant to the size optimal for commercial performance, possibly 400 MW.

The site selection for the project began in November 1997. By December 1999, the construction was completed, and gas production began on December 26, 1999. The tests and controlled shutdown were completed in April 2003.

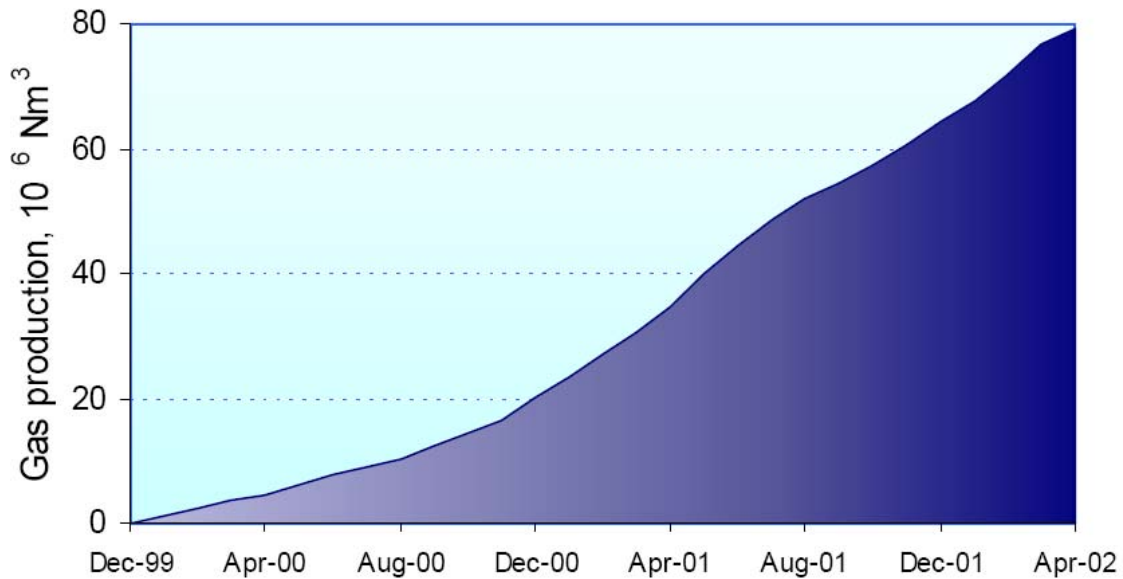

Figure 3-11: Gas production history at Chinchilla (Blinderman, 2003).

During the course of the tests, 9 process wells were drilled, producing syngas from a 10 m thick coal seam at the depth of about 140 m at the rate of 80,000Nm³/h, equivalent to 70MWe. About 35,000 tons of coal was extracted, and over 80,000,000 Nm³ of gas, at LHV of 5.0 MJ/Nm³ at the pressure of 10 barg (145 psig) and temperature of 300°C was produced. Figure 3-11 gives a history of the gas production at Chinchilla.

The current status of the project is that it is being maintained in preparation for a gas-turbine and gas-cleanup plant, but Linc Energy, Ltd. recently announced plans for a large coal-to-liquids plant at the site in collaboration with Syntroleum Corporation.

3.1.5 Japan

Japan, which has substantial coal interests outside its borders, as well as continental shelf resources, has included UCG in its future research plans for coal exploitation, and has been maintaining a low level program- for many years. Economic and technical studies have been produced, and there are reports that a Japanese-sponsored trial, possibly overseas, will be undertaken in the near term.

The University of Tokyo has undertaken technical and economic studies of UCG, and maintains a watching brief on behalf of NEDO. Japanese coal companies are interested in the technology as a possible export opportunity.

3.1.6 Former Soviet Union (FSU)

The Former Soviet Union (FSU) was the first nation to initiate a national program of UCG research and development. By 1928, a national research program had been organized, and underground experiments had begun by 1933 at Krutova, Tula, Shakhty, Lenisk-Kuznets, Gorlovka and Lisichansk. In parallel with the experimental program, a theoretical program and laboratory studies were undertaken.

Table 3-4: Production data for Angren station 1962-1976 (Olness, 1982).

Indicator	Year of operation							
	1962	1963	1964	1965	1966	1967	1968	1969
Gas production (10^6 m ³)	489	893 ^b	1063	1410 ^c	1252	1020	1005.6	1000
Reference fuel (10^6 tonnes)	55.5	101 ^d	121	160 ^e	142	115	110	
Lower heating value of gas (kcal/m ³)	792	840	790	794 ^{c,d}	794	785	766	750 ^d
Coal gasified (10^6 tonnes)	182	320	482		484	375	369	
Product gas/kg coal (m ³)	2.6	2.8	2.46	2.65 ^d	2.59	2.75	2.73	2.67
Product gas/m ³ blast injected (m ³) ^d	1.05 ^e	1.25 ^e	1.00	1.15	1.00	1.15	1.05	1.00
Gas losses (% from theor.) ^f	15.1	10.3	23		20	14.6	16.5	
Chemical efficiency – LCV gas/LCV coal gasified (%) ^g	59.2	62.3	53.6	59.2 ^d	57.3	59.6	57.8	
Specific electricity consumption (kWh/1000 m ³) ^h	115	91	102		90	85.0	94.5	
Linking/year (1000 m ³) ^d	1.8	2.1	3.4	4.6	4.1	3.3	1.8	2.0
Cost (rubles/1000 m ³) ^d	3.7	2.2	2.0	1.8	2.0	2.0	2.0	2.0
	1970	1971	1972	1973	1974	1975	1976	1977
Gas production (10^6 m ³)	996.4	750 ^d	700 ^d	667	546.8	514.3	482.6	395.3
Reference fuel (10^6 tonnes)	115			74.1	57.6	57.6	53.6	41.0
Lower heating value of gas (kcal/m ³)	783	750 ^d	767 ^d	785	737	780	778	726
Coal gasified (10^6 tonnes)	356			238	183	180	183	140
Product gas/kg coal (m ³)	2.8	2.80 ^d	2.50 ^d	2.80	2.98	2.86	2.64	2.83
Product gas/m ³ blast injected (m ³) ^d	1.20	1.05	1.15	1.20				
Gas losses (% from theor.) ^f	14			16.7	13.1	13.0	18.6	14.5
Chemical efficiency – LCV gas/LCV coal gasified (%) ^g	61	58.5 ^d	55.5 ^d	60.5	61.0	61.9	58.9	58.5
Specific electricity consumption (kWh/1000 m ³) ^h	86.2			109.8	102.5	96.3	112.0	122.7
Linking/year (1000 m ³) ^d	1.7	1.3	0.9	1.5				
Cost (rubles/1000 m ³) ^d	2.0	2.2	2.4	2.7				

Commercial-scale production of gas was achieved at numerous locations and for long periods of time, most notably at Angren, Shatskaya, Kamen, Yuzhno-Abinsk, and Podmoskovia. UCG activity peaked in the 1960s. The Angren mine still has UCG technology in place to produce 18 billion cubic feet of gas for the Angren power station

(U.S. Energy Information Administration, 1997). Some of the production data for Angren are shown in Table 3-4. By 1996, UCG plants in the Soviet Union had extracted over 17 million metric tonnes of coal (Blindermann, 2005).

The Soviets experimented with a number of different designs. The first design was literally an underground gasification chamber built into the coal and required workers underground. Later they moved toward using boreholes and designs wherein the boreholes were linked by directional drilling underground. By the early 1950's, the FSU had evolved a successful UCG system, which was applied in the flat-lying beds in coal fields near Moscow and steeply-dipping beds in Siberia and the Donets coal basin (de Crombrughe, 1959; Svjagincev, 1979; Stephens, 1980). Table 3-5 summarizes the early UCG projects. The same basic design at different angles to the surface was used in all places. The Soviets demonstrated repeatedly that UCG could be made to operate successfully in coals in a wide variety of geologic settings and in the complex and changing conditions created by a burning coal seam and collapsing cavity (Gregg, et al., 1976). The Soviet UCG design incorporated features that enabled achieving a number of conditions, including:

- Minimizing gas leakage: in UCG the loss of injected and product gas through cracks to the surface and surrounding strata must be minimized. The Soviets operated at the lowest possible pressure and ensured that the permeability in the coal was higher than any permeability created by subsidence by “linking” the injection and production wells prior to gasification (Figure 3-12);
- High gas flow rates at low pressure: The Soviets generally used gas flow rates of 3000-10000 m³/hr with driving pressures of no more than 2.5 atm. Maintaining high gas flow rates and minimum leakage again requires that permeability between injector and producer wells be high;
- Directional control of gas flow: Directional control ensures gas flow to the production well, operational reproducibility and optimization. The Soviets achieved directional control using highly permeable linkage paths at the bottom of the coal seam. These paths make the UCG process insensitive to variations in the natural coal permeability.
- High surface area reactor with high permeability: High surface area infers a zone of rubble without bypass channels to ensure efficient gas-solid reaction. In the Soviet design, the flame front undercuts the coal which then falls into the void as rubble. In steeply dipping seams, combustion is initiated at the bottom and moves up the seam, causing coal to fall into the void below (Figure 3-13) ;
- Liquid control: Liquids can accumulate at the bottom of the seam, causing gas flow and the flame front to be limited to the top of the seam. By creating the linkage path at the bottom of the seam prior to the burn, the Soviet methods minimize this problem. Also, by keeping the channels hot throughout the process, water and many of the pyrolysis products are kept in the vapor phase;

Table 3-5: Characteristics of Soviet UCG projects 1933-1965 (Gregg, et al., 1976; Olness and Gregg, 1977)

Basin	Site	Development Date	Coal Type	Depth	Seam Thickness (m)	Energy Content (kcal/kg)	Gasification Characteristics
Donets	Shakhta	1933	Anthracite	Depth unknown, dipping 19-22°	0.38		600-1250 kcal/m ³
	Lisichansk	1933	bituminous	24-138 m, steeply dipping (20-60°)	0.4 – 2.7	4500-5000	300-2200 kcal/m ³ alt. air and steam 1.5 x 10 ⁸ m ³ /yr (1959)
	Gorlovka	1935	bituminous	40-110 m steeply dipping (70°)	1.9		900-1000 kcal/m ³ (air) 1400-2400 kcal/m ³ (steam and O ₂)
	Kamensk	1960					
Kuznets	Leninskt	1933	bituminous	28-30 m, dipping 20°	4.85		900-2400 kcal/m ³
	Yuzhno-Abinsk	Podzemgaz station 1955	bituminous	Steeply dipping (55-70°)	2-9	5000-6000	1000 kcal/m ³ 3.9 x 10 ⁸ m ³ /yr (1965)
	Stalinsk	1960					

Basin	Site	Development Date	Coal Type	Depth	Seam Thickness (m)	Energy Content (kcal/kg)	Gasification Characteristics
Moscow	Krutova mine	1932	Lignite	16-20 m., horizontal	2		989 kcal/m ³
	Podmoskovia station (Tula)	1940	Lignite	40-60 m horizontal	2-4	2000-5000	700-900 kcal/m ³ 4.6 x 10 ⁸ m ³ /yr
	Shatskaya	1960					
Near Tashkent	Angren	1962	Lignite	110-250 m, horizontal (5-15°)	4-24	3650	800-850 kcal/m ³ 1.4 x 10 ⁹ m ³ /yr (1965)

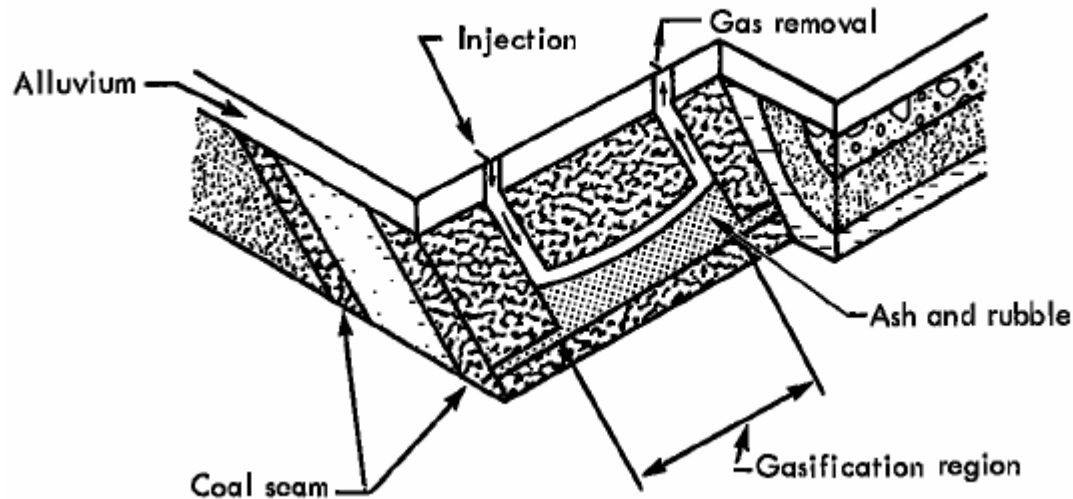

Figure 3-12: The Stream Method for gasifying coal in steeply dipping coal beds. This was the first design that the Soviets felt had promise. They tried many schemes in the first few years of their effort. The Stream Method was first tested in Lischansk in 1935. The injection and exhaust holes were drilled along the coal seam and were connected at the bottom by a mined shaft. The flame was initiated in the connecting channel and gradually spread over the entire length. The flow had to be reversed periodically to approximate a horizontal burn front that moved up the seam. The key feature of this system is that as coal was consumed, more coal would fall into the void that was created, automatically creating rubbleized coal in the combustion zone (Gregg et al., 1976).

- Minimize aquifer contamination: The mechanism for liquid control also ensures the removal of phenols so that they are not allowed to condense and contaminate groundwater;
- Maximized survival and spacing of access pipes: A large fraction of the cost of UCG is associated with access pipes. Ideally, well casing should be removable for reuse, and the spacing should be optimized to maximize coal volume gasified per hole. The Soviet design removed access holes from the zone of subsidence, minimizing potential for damage to casing and need for heavier casings that could withstand earth motion. The Soviets also used water spray to cool produced gases to reduce heat stress and corrosion. The linkage system was important to maintaining large spacings between holes;
- System adapts to thick or thin seams: the Soviets found no maximum limit to coal thickness. They did find that when the seams were less than 3-4 ft. thick that the heating value of the gas became too low. With thinner seams, too much heat was conveyed into the surrounding rock.

- No men underground: In early Soviet designs and in the British design, men were required to work underground. There is always the possibility of the toxic gasification products leaking into worker areas, and so this is a key design consideration.
- A system that is applicable to multiple layered seams: The Soviets demonstrated sequential gasification of multiple coal seams, beginning with the topmost seam and working downward.
- A continuous system as well as intermittent load system: The Soviet system sweeps continuously across the coal seam and therefore can produce product to create a predictable continuous base load for electric power generation. It was also shown that the UCG burn could be turned on and off, making it possible to power intermittent load;
- Constant gas composition vs. time: The Soviet system makes it possible to maintain a constant product gas composition with constant heating value by controlling flow rate to “fine tune” heating value;
- Minimum sensitivity to coal swelling: the large-dimension channels formed in the linkage process are not likely to be plugged by coal swelling;
- Minimum sensitivity to flame front channeling: The Soviet method encourages flame front channeling, but avoids changes in gas quality by making channels very long.
- Simplicity of design and operation: the Soviet design is simple involving only the technology of drilling a pattern of holes and use of compressed air.

UCG production appears to have peaked in the FSU in the mid 1960's. This includes the site in Angren (outside of Tashkent, Uzbekistan). UCG at Angren began in 1959, and has continued more or less without interruption since. Despite the ambitious early plans for development in Angren, it appears that disappointing early results and lower than expected volumes and flows limited deployment there and elsewhere in the FSU (Stephens, 1980).

It is not clear why UCG declined after the 1970s. It has been suggested that the discovery of extensive natural gas deposits in the country siphoned off support for the UCG effort to build gas pipelines and other infrastructure. It is also possible that UCG ceased to be economically competitive with this new gas resource. It also may be that something did not work sufficiently well in Soviet UCG technology, and there is some evidence that the Soviets ignored recommendations of their own technical experts and made minimal use of diagnostics and modeling. Russia maintains technical expertise in UCG at the Russian Academy of Sciences in Moscow, and it is understood that one of the original schemes, developed in the Soviet era, is still in production.

3.1.7 Other Countries

Feasibility studies have been undertaken recently by New Zealand, and a small trial burn was initiated at Huntley in 1994 with US technical advice.

Pakistan and some Eastern European countries, like Ukraine and Romania maintain an interest in UCG, and developments may already be underway.

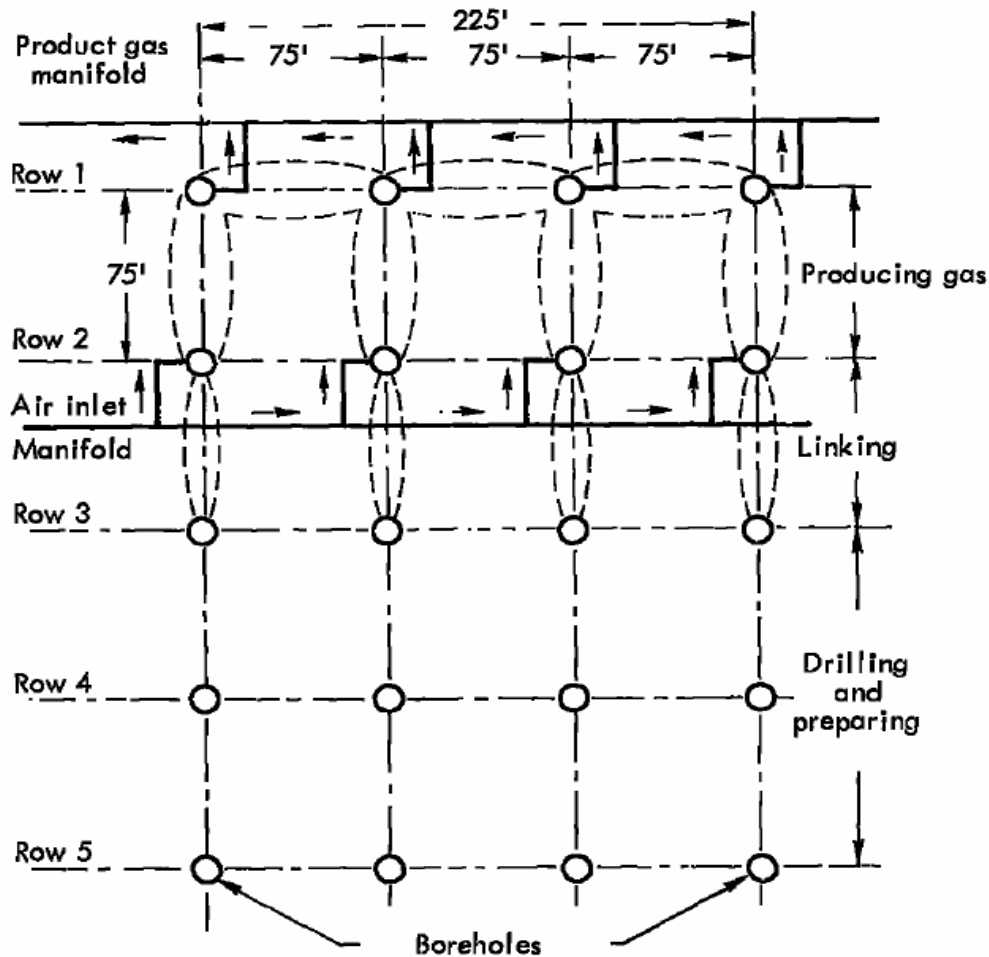

Figure 3-13: This figure shows a typical plan view of the Soviet process for horizontal seams. The dotted lines are meant to show the location of the underground linkage channels formed in the coal by a countercurrent combustion step in preparation for gasification. The production phase of gasification is carried out by concurrent combustion in the channels. Concurrent and countercurrent refer to the flame front propagating in the same or opposite direction as the gas flow, respectively (Gregg et al., 1976).

4 Ignition and Gasification

The overall chemistry underlying coal gasification processes is well understood. Table 4-1 summarizes the important overall reactions participating in the coal gasification process. The most important reaction is the gasification reaction (Reaction 1). This is the reaction that produces the syngas comprising H₂ and CO. However, as shown in the Table, this reaction is endothermic, and needs external heat input to proceed to any significant extent. This heat is provided by the two oxidation reaction, (Reactions 5 and 6). A part of the coal is combusted by these two reactions to sustain Reaction 1.

In addition, a number of side reactions also take place, such as methane formation (Reactions 3 and 4) and the Boudouard reaction (Reaction 7). Additional hydrogen can be made from the syngas by Reaction 2, wherein the available steam reacts with the CO in the syngas to generate more H₂ and CO₂.

Table 4-1: Fundamental reactions for coal gasification (adapted from Ruprecht, et al., 1988)

Reaction	Enthalpy
(1) Heterogeneous water-gas shift reaction $C + H_2O = H_2 + CO$	$\Delta H = +118.5 \text{ kJ mol}^{-1}$
(2) Shift conversion $CO + H_2O = H_2 + CO_2$	$\Delta H = -42.3 \text{ kJ mol}^{-1}$
(3) Methanation $CO + 3H_2 = CH_4 + H_2O$	$\Delta H = -206.0 \text{ kJ mol}^{-1}$
(4) Hydrogenating gasification $C + 2H_2 = CH_4$	$\Delta H = -87.5 \text{ kJ mol}^{-1}$
(5) Partial oxidation $C + 1/2O_2 = CO$	$\Delta H = -123.1 \text{ kJ mol}^{-1}$
(6) Oxidation $C + O_2 = CO_2$	$\Delta H = -406.0 \text{ kJ mol}^{-1}$
(7) Boudouard reaction $C + CO_2 = 2CO$	$\Delta H = +159.9 \text{ kJ mol}^{-1}$

4.1.1 Well Characteristics and Flow Path Enhancement

To facilitate flow through the injection well, combustion zone and production wells, a “link” must be created to enhance in-situ permeability of the coal seam. This is done by methods such as reversed combustion, hydro-fracturing, directional drilling, electrical linking, or explosive fracturing. For gasification over long distances in the coal seam, the process can be improved by an in-seam channel, constructed prior to coal seam ignition and development of the gasification cavity. Various methods can be used to construct the in-seam channel including:

- Drilling from an outcrop;
- Slant drilling from the surface;
- Constructing man-made in-seam galleries;
- Directional drilling.

These methods have all been used in the various trials and commercial projects that have taken place, but until recently no consensus had emerged as to which approach was most reliable or cost-effective. Two processes, wherein the injection process is coupled to channel formation, are described in more detail in Section 4.1.2 below.

The technology of directional underground drilling advanced considerably in the 1990's as a result of developments in the oil and gas industries. The same technology is being used regularly for the de-gassing of coal seams in Australia, South Africa and the United States. For the first time, in-seam coal wells can be constructed reliably and accurately, with much less risk of failure. Furthermore, the option of constructing gasification wells in much deeper coal seams, over 1000 m, has become possible. Access to deeper coal brings advantages in terms of cavity growth, power output and environmental benefits, and the possibility of maintaining supercritical conditions for CO₂ sequestration.

UCG operating conditions require injection well construction and materials to withstand the extreme thermal and mechanical stresses associated with UCG: high pressures and temperatures (up to 1500°C), sulfidation and oxidation reactions, and subsidence of the cavity roof. Wells are usually cased with carbon or high-strength stainless steel. Cementing of wells is done above the reaction zone to facilitate the controlled introduction of air and to prevent loss through the wellbore of gases to the surface or into overlying strata. If UCG infrastructure is subsequently used for CCS operations, well materials must also withstand the corrosion associated with carbon dioxide.

The pilot-scale operations in the U.S. and other parts of the world have not lasted long enough to require mechanical integrity testing (MIT) of wells. However, the Soviet experience at the commercial scale indicates that injection well life is about two to four years. MIT was required before injection and when material balance calculations indicated injectate losses through well casing (U.S. Environmental Protection Agency, 1999).

4.1.2 Injection Process (CRIP, ϵ UCG)

4.1.2.1 CRIP

One of the most important considerations in UCG is the method used to establish a channel between the injection well and the production well. If the coal has high permeability, such a channel might exist naturally. Sometimes the coal seam may have a number of fractures and fissures, which also leads to a natural channel. However, in many cases, the coal seam has low permeability, and other means of establishing the connection between the wells is necessary.

The two alternatives available today are the CRIP (Continuous Retraction Injection Point) process, and ϵ UCG, practiced by Ergo Exergy. Over twenty years ago, LLNL developed the CRIP method for efficient production of synthetic gas from underground coal seams (Hill et al., 1983; Hill, 1986). In the CRIP process, the production well is drilled vertically, and the injection well is drilled using directional drilling techniques so as to connect to the production well, as shown in Figure 4.1. Once the channel is established, a gasification cavity is initiated at the end of the injection well in the horizontal section of the coal seam. Once the coal near the cavity is used up, the injection point is retracted (preferably by burning a section of the liner) and a new gasification cavity is initiated. In this manner, a precise control over the progress of gasification is obtained.

The CRIP process retracts the combined steam and oxygen injection point to control the location of the combustion front. The syngas, which was more than a third hydrogen in many of the early UCG pilots, (remainder is CO_2 , CO , CH_4 and higher hydrocarbons) is brought to the surface and processed to remove particulates, CO_2 , and H_2S and to convert the CO , CH_4 and higher hydrocarbons to more hydrogen.

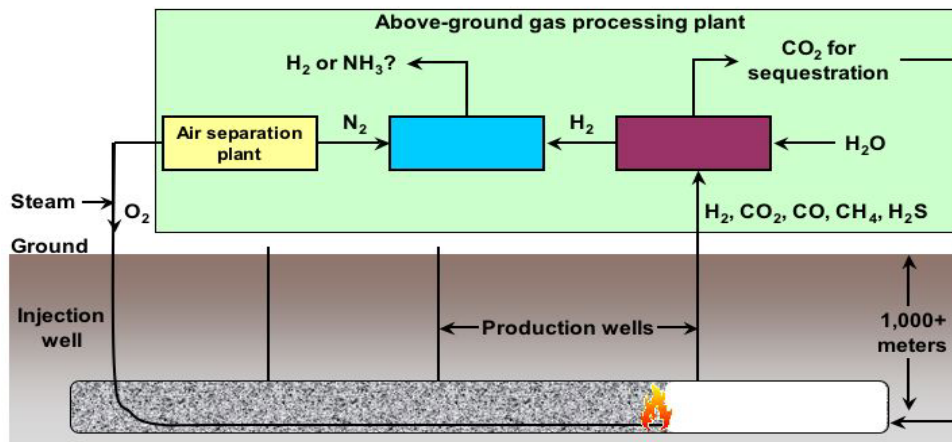

Figure 4-1: Schematic of the CRIP Process.

4.1.2.2 ϵ UCG

ϵ UCG, a proprietary process employed the Ergo Exergy, may be based on the old Soviet UCG technology. It relies on making use of the natural pathways that already exist in the coal seam and enhancing them further, if necessary, to create a link between the injection and production wells (Blinderman, 2005).

The ϵ UCG technology was successfully demonstrated for the Chinchilla Project in Australia (see Section 3.1.4.1 above), wherein an estimated 35,000 tons of coal were used up to produce 80,000,000 Nm^3 of syngas at $5\text{MJ}/\text{Nm}^3$. The ϵ UCG technology is also

under consideration for the proposed Powder River Basin UCG project, and for a joint venture between Gas Authority India, Ltd. (GAIL) and Ergo Exergy.

Unfortunately, because ϵ UCG is a proprietary process, not much has been published on it. Some key questions remain that will need to be answered to establish best practices for ignition and injection and whether practices should vary with UCG conditions. These questions include:

- What are the key differences among the old soviet UCG, ϵ UCG and CRIP?
- What methods are used in ϵ UCG to establish reliable connections between the injection and the production wells?
- How does it compare with CRIP in terms of reproducibility, reliability and cost?

4.1.3 Other Processing Considerations

Ideally, the coal seam will be located in a region where the products of UCG can be used. A remote location may make it necessary to convert the product gas into a transportable product (such as methanol) or use it to make electricity that can be transported over the power grid.

Process parameters such as operating pressure, outlet temperature and flow are governed by coal and rock properties that vary with time and location (Blinderman and Jones, 2002; Walker, et al., 2001). Information on the process conditions must be constantly monitored and updated as the gasification process moves forward.

Pressure balance considerations indicate that deeper coal seams would require higher pressures to control the influx of water from the surroundings into the gasification zone, however, the use of pressure as a practical tool to control water influx has been questioned (Stephens, et al., 1985b; 1985c). Optimal pressure in UCG promotes groundwater flow into the cavity, thus confining the chemical process to the limits of the gasification zone and preventing contamination in the area (Blinderman and Jones, 2002). However, as the pressure increases, so do the losses of the product gas. If the coal in deep seams is surrounded by impermeable overburden, a reasonable balance between pressure and gas losses can be accomplished. However, deep seams with high coal and overburden permeability pose a problem in that the required pressure may make gas losses unacceptable. Pressure also affects the chemistry of gasification. The relationship between methane production and pressure seems to be weak, at best (Stephens, et al., 1985b; 1985c).

The ideal temperatures of above ground coal gasification are about 1000°C, however, it may or may not be possible to achieve these temperatures in UCG, primarily because of the lack of control on water influx and reactant gas flow patterns.

The depth of the coal seam to be gasified is an important selection factor. Deeper seams require guided drilling technology to initiate a well at the surface that is deviated to

intercept and follow a coal seam for many hundreds of meters, and establish a link between injection and production wells. This results in higher drilling costs. Deep seams require higher injection and operating pressure, and increase the cost of any subsequent pump-and-treat option. On the other hand, deeper seams are less likely to be linked with potable aquifers, thus avoiding drinkable water contamination problems. Also, if the product gas is to be used in gas turbines, additional compression may not be necessary. Shallower seams are more likely to produce surface subsidence. In general, as extraction depth increases, surface subsidence decreases.

Porosity and permeability of the coal seam is also an important factor. More permeable seams make it easier to link the injection and production wells, and increase the rate of gasification by making reactant transport easier. For example, lignite is easily gasified due to its high porosity (Grens, 1985; Creedy and Garner, 2004). On the other hand, higher porosity and permeability increase the influx of water, and increase product gas losses. As noted above, seam permeability can also be artificially enhanced through various methods.

The coal seam should not be a major aquifer, nor should major aquifers be found above the coal for at least twice the stable cavity height (Stephens, et al., 1985a). In selecting the right seam, we need to look at not only current connections, but also potential connections. For example, a thin layer of overburden may collapse upon the gasification of the underlying coal, and thereby may create a connection with an aquifer that was not initially present.

All ranks from lignite to anthracite can be gasified by surface plants and all have been tested in UCG operations. Low rank coals, such as lignite and sub-bituminous-rank coals, appear to be easier to gasify in-situ. However, UCG also seems to work for some bituminous coals. In the FSU, there was at least one test of UCG in anthracite, and that test was not a success. It may be that UCG works better on lower rank coals because they tend to shrink upon heating, enhancing permeability and connectivity between injection and production wells. Bituminous coals, on the other hand, tend to swell (Stephens, et al., 1985a) and occur in thinner seams that results in some operational constraints. It has also been suggested that the impurities in lower rank coals improve the kinetics of gasification by acting as catalysts for the burn process.

The thickness of coal seams is an important factor. Thicker seams require fewer wells, thus reducing drilling costs. The Soviet, British and early US experiments in UCG encountered severe problems while attempting to gasify coal seams 2 m thick or less (Stephens, et al., 1985a). Heat losses are considerable with such seams, leading to low thermal efficiency and lower product gas quality. UCG is generally easier to sustain in dipping seams as tars and fluids flow away from the gasification zone (Creedy and Garner, 2004).

A coal seam overlain by a strong, dry roof rock seems desirable to minimize heat losses and escape of gas to the overburden (Stephens, et al., 1985a). Roof lithology is important

in that low permeability of the overburden reduces both gas loss from and water influx in to the gasification zone (Creedy and Garner, 2004).

Field experiments have been performed to investigate if the method of linking the injection and the production wells has an effect on the gas quality. The study conducted at Hoe Creek (Thorsness and Creighton, 1982) suggests that linking methods did not influence gas quality.

4.1.4 Surface Facilities

The product gas from UCG can be used in a variety of ways, including:

- Combustion in a gas turbine connected to an electric generator. The hot gas from the turbine can be used to make steam, which in turn can be used to drive a steam turbine or steam engine, connected to an electric generator;
- Combustion in a boiler to make steam which can drive a steam turbine or a steam engine connected to an electric generator;
- Direct feed to a fuel cell that can tolerate carbon monoxide to generate low voltage electrical current, which can be stepped up and fed to a power grid;
- The gas can be “shifted” to make a mixture of hydrogen and carbon dioxide, with very low levels of carbon monoxide, and then fed to a low-temperature fuel cell to generate low voltage current;
- Used as a chemical feedstock to produce methanol, or a variety of other chemicals via Fischer-Tropsch processes.

Regardless of what the end use is, the gas needs to be cleaned up to make it usable. The main impurities commonly encountered in the product gas are particulates and tars, and sulfur compounds, such as H₂S/COS.

4.1.4.1 Removal of particulates and tars

UCG tends to produce fewer particulates in the production gas (Blinderman, 2002). For the particulates that do exit the production well at the surface, technologies for the removal of particulates and tars are well-established. They include cyclones, bag-house filters, and electrostatic precipitators.

4.1.4.2 Removal of sulfur compounds, such as H₂S and COS

Technologies for the removal of sulfur compounds from syngas (or producer gas) are well-established. Collectively known as AGR (acid gas removal) technologies, they include absorption of the sulfur-containing compounds (mainly H₂S and COS) by solvents such as methyldiethanolamine (MDEA process), dimethylethers of polyethylene glycol (Selexol process) and methanol (Rectisol process) (Kohl and Riesenfeld, 1979). In addition, catalyst-based technologies are available for the removal of sulfur compounds using zinc oxide catalysts (Kohl and Riesenfeld, 1979).

4.1.4.3 Removal of mercury and other volatile metals

There is a possibility of volatile electronegative metals, such as arsenic, mercury, and lead, present essentially in the ash, being reduced and entrained in the product gas in vapor form or as finely divided liquid droplets. If present the concentrations are likely to be extremely small (Sury, 2004).

However, in the unlikely event that unacceptable concentrations of mercury and other volatile metals are encountered in the syngas exiting the production well, well-established techniques for their removal are available (Western Research Institute, 2006). It was found that activated carbon (activated charcoal) was the best medium for adsorbing mercury from the syngas. Since the scope of the investigation cited here was to remove mercury from a fluidized bed gasifier, the method used in the study was the injection of carbon particles into a stream of syngas. However, for other gasifiers, including UCG, well-established technology of fixed bed adsorption is readily available (Lund, 1971).

4.1.4.4 Auxiliary surface facilities

A number of auxiliary surface facilities may be needed in order to make the syngas suitable for introduction into gas turbines. Among them are:

- gas coolers to cool the syngas down to the temperatures suitable for filters;
- filters to remove ash and tar particles. As mentioned earlier, the amount of ash and tar particulates out of a UCG-production well is significantly smaller than that for a surface gasifier, however, it is unlikely to be zero, hence the need for filters. A number of standard filter technologies may be used, including baghouse filters and electrostatic precipitators;
- CO₂ removal: If the CO₂ is to be captured and sequestered, it may be advantageous to remove it from the syngas, rather than the flue gas. In this case, a number of technologies to remove the CO₂ from the syngas are available (Halmann and Steinberg, 1999);
- If the syngas is to be used for making methanol (or other liquid fuels), it may be desirable to balance its composition (H₂ to CO ratio) to make it suitable for the downstream process. In such cases, a water-gas shift reactor may be needed. (See Reaction 2, Table 4.1, above.)

4.2 UCG Economics

Even though the syngas obtained from a UCG operation can be used in many applications, such as the production of chemicals (e.g., hydrogen, ammonia, or methanol), or liquid fuels, the primary use is for electricity generation. This section will deal with just power generation.

A UCG-based power plant will be very similar to an IGCC (integrated gasification combined cycle) power plant, minus the surface gasifier. Thus, they need the same process equipment: gas cleanup and cool-down, gas turbines, heat exchangers to produce

steam, steam turbine, and electrical generators. It can be readily seen the a UCG-based system will be inherently advantageous because it does not need surface gasifiers, and it needs much smaller gas cleanup equipment, because both the tar and ash content of UCG-based syngas is substantially lower than that obtained from a surface gasifier.

A number of studies have been published on the economics of IGCC power plants, and pulverized coal power plants, the current standard. According to the information developed by GE and Bechtel (Bechtel and General Electric, 2005), the cost of a super-critical pulverized coal (SCPC) power plant ranges from 1200 to 1460 \$/kW. The same study estimates that the next generation of IGCC power plants will be about 10% more expensive than the SCPC plants (vs. the current 20 to 25 % premium). This places the cost of IGCC plants at 1440 to 1750 \$/kW current technology, and 1320 to 1600 \$/kW (advanced technology). Dalton has estimated the cost of an IGCC plant at 1350 \$/kW (Dalton, 2004), which is in the same range as that estimated by Bechtel for the advanced technology IGCC plants.

Another measure of cost competitiveness is the cost of electricity (COE). Dalton has estimated the COE for SCPC and IGCC plants at \$46.6/MWh and \$49.9/MWh, respectively (Dalton, 2004).

Based on the numbers published by Ergo Exergy (Blinderman, 2002), UCG-based IGCC plants are significantly cheaper to build, and they have a lower COE. The costs presented by Blinderman show that the capital cost of a 177 MW plant is about \$600/KW, and that of a 280 MW plant is about \$450/KW. The COE is estimated at about \$12/MWh.

Even though a qualitative analysis, presented earlier in this section, suggests that UCG-based power plants and COE would be lower than those based on IGCC, an exact comparison between these two sets of numbers is difficult. There exist at least four operating IGCC power plants in the world, in addition to numerous pilot plants. A large number of SCPC plants also exist. This provides a solid basis for the capital costs and COE for these plants. On the other hand, there are no UCG-based power plants in the Western World. Consequently, there is no external validation of the numbers published by Ergo Exergy. Until a reasonable number of UCG-based power plants are built, this uncertainty in economic projections will continue.

5 Environmental Management

To remove the stigma that UCG has had, particularly in the U.S., as an environmentally damaging technology, any future demonstrations will need to operate without creating any significant environmental impacts. Since previous UCG projects in the U.S. in the 1970s and 1980s, we have learned a great deal more about the behavior and types of contaminant compounds produced by UCG and have improved modeling capabilities to predict the complex geochemical-geomechanical-geohydrological framework within which UCG operates. The worldwide UCG experience demonstrates that avoidance of environmental contamination in future operations can be achieved but should involve integration of criteria for site selection with choices of operating parameters.

Some of the steps that can be taken to avoid the situations that caused past groundwater pollution problems include:

- balancing operating conditions to minimize outward transport of contamination from greatly over-pressurized burn zones;
- ensuring UCG sites are situated where geologic seals sufficiently isolate the burn zone from surrounding strata;
- selecting sites with favorable hydrogeology to minimize widespread movement of the contaminated groundwater plume;
- isolating UCG locations from current or future groundwater resources;
- if possible, removing liquid accumulations of undissolved pyrolysis products.

5.1 U.S. Regulatory Framework

In the U.S., in-situ fossil fuel recovery wells are categorized and regulated by the Environmental Protection Agency (EPA) as Class V underground injection wells. In-situ fossil fuel recovery wells are defined in the existing underground injection control (UIC) regulations (40CFR 146.5), authorized by the Safe Drinking Water Act (SDWA), as “injection wells used for the in-situ recovery of lignite, coal, tar sands, and oil shale.” In 1999, the EPA conducted a study to evaluate the risk posed by all Class V underground injection wells to underground sources of drinking water (USDW) (U.S. Environmental Protection Agency, 1999).

Several federal, state and local programs in the U.S. either directly manage or regulate Class V in-situ fossil fuel recovery wells. In 19 states or territories (Alaska, American Samoa, Arizona, California, Colorado, Hawaii, Indiana, Iowa, Kentucky, Michigan, Minnesota, Montana, New York, Pennsylvania, South Dakota, Tennessee, Virginia, Virgin Islands, and Washington, D.C.) and on Tribal lands, the USEPA directly implements all Class V UIC programs. In all other states, called Primacy states, implementation of Class V UIC programs falls to state agencies.

Under 40CFR 144.12 (a), owners or operators of Class V wells are prohibited from engaging in any injection activity that allows the movement of fluids containing any contaminant into USDWS, “if the presence of that contaminant may cause a violation of any primary drinking water regulation...or may otherwise adversely affect the health of persons.” Under CFR 144.26, owners or operators of Class V wells are required to submit basic inventory information. Under CFR 144.27, they may also be required to submit any additional information deemed necessary by the USEPA to protect USDWS. Sections 144.12 (c) and (d) describe the mandatory and discretionary actions that the UIC Program Director takes if a well is not in compliance with 144.12(a). Possible actions include requiring that the well be permitted individually, ordering well closure, or taking enforcement actions.

The SDWA amendments of 1996, which established a requirement for source water assessments by the states, requires inclusion of Class V wells in the inventory of potential sources of contamination in delineated source water protection areas.

When assessing Class V wells, the primary constituent properties of concern for contaminants are toxicity, persistence, and mobility. In the EPA’s view (U.S. Environmental Protection Agency, 1999), most injected materials, usually air or oxygen, are not likely to create contaminants at levels exceeding maximum contaminant levels (MCL) or health advisory levels (HAL), but, if they enter a USDW, may unfavorably alter its characteristics, including temperature and gas saturation. The use of ignition or explosive agents, such as propane or ammonium nitrate, to initiate combustion or rubbleize the coal seam may directly create contamination of USDW. USDW contamination also can result from combustion byproducts, residuals such as ash and hydrocarbons, or from mineral-water-gas reactions induced by operations. Ash typically contains many toxic metals such as arsenic, lead, mercury, selenium and chromium. Residual hydrocarbons include tars, polynuclear aromatic and heterocyclic compounds. It is also important to note that use of the UCG site for CCS may increase the mobility of many of these contaminants in that organics typically have high solubilities in CO₂, and metals are mobilized under acidic aqueous conditions.

The EPA notes that differences in operation scale may have significant effects on contamination. In the U.S., in-situ fossil fuel recovery operations have all been at the pilot scale, a scale at which reaction zone temperatures are not able to reach those expected for full-scale operations. At lower temperatures, pyrolysis can result in generation of greater amounts of products of incomplete combustion than would be anticipated for full-scale operations. The larger reaction zone of full-scale operations also is more likely to create an extensive groundwater depression zone, creating flow into rather than away from the combustion site (U.S. Environmental Protection Agency, 1999).

Additional advantages of in-situ operations include the avoidance of many risks associated with conventional coal mining and surface gasification. With UCG, ash and organic residues remain underground and leachate from surface accumulations of these materials will not contaminate surface or ground waters. The elimination of people from

underground mining also avoids many safety and health risks. In sum, with optimization of UCG operations and careful site selection, it is likely that UCG can meet an acceptable level of environmental risk, equivalent to or less than the risks posed by conventional mining and surface gasification.

Based on the operational experience in the FSU and Australia, additional points can be made. The higher temperatures associated with full-scale operations will keep many volatile contaminants in the vapor phase such that they are produced along with the gas rather than left underground. Minimizing operating pressures also promotes flow into rather than away from the cavity. For example, the Australian Chinchilla UCG project keeps the gasification pressure slightly below the local hydrostatic pressure such that groundwater flows into the cavity, creating a “steam jacket” to minimize heat loss and prevent contaminant migration out of the cavity (Blinderman and Jones, 2002).

Persistence and mobility characteristics of a contaminant depend both on its chemical properties and on the environment. Benzene, nitrate and ammonia are common contaminants found in USDW associated with in-situ fossil fuel recovery operations, but their persistence may vary greatly depending on the levels of dissolved oxygen in the aquifer. In aerobic groundwaters, ammonia would tend to not be persistent because it would convert to nitrate; in contrast, under anaerobic conditions, nitrate converts rapidly to nitrogen gas.

Mobility is typically high at UCG sites because there are natural and artificial permeability conduits. Coal seams typically contain many natural fractures, cleats and joints. The rubbleizing and fracturing of the coal enhances these conduits. However, by maintaining the direction of groundwater flow into rather than away from the cavity, the mobility of soluble contaminants can be greatly reduced.

5.2 The Risk-Based Decision-Making (RBDM) Process

Since the 1970s, approaches to environmental protection have changed dramatically; they are now routinely based on risk assessment and the focus of risk management is on areas of greatest potential for risk reduction. Environmental risk-based decision-making (RBDM) is now used during the design stages of new oil and gas production and exploration developments to optimize environmental and human health protection proactively (e.g., McMillen, et al., 2001). Using an RBDM approach also makes sense for siting and design of UCG operations by quantifying risk for various potential scenarios and identifying the conditions necessary to meet an acceptable level of risk.

An RBDM approach requires a sufficiently robust technical framework that can reliably predict contaminant generation, behavior, and human/environmental exposure pathways. Figure 5-1 is an example of part of a typical RBDM flow diagram showing potential paths by which UCG may contribute contaminant compounds to various exposure media (e.g., air, groundwater, surface water, soil). With addition of other parameters, such as

land and water use or climatic factors, such diagrams form the basis for creating risk-based screening levels for human or environmental receptors.

However, the technical framework presently has not been built to predict the behavior of contaminants of concern along the pathways of Figure 5-1 under conditions applicable to UCG scenarios, including the high cavity temperatures, steep thermal gradients, and stress fields obtained during and after the burn process. This will require pre-assessment of site stratigraphy, structure and hydrogeology, characterization of the nature and mobility of byproducts of coal burning, including organic and inorganic species, process variable (e.g., temperature, O₂) impacts on product/byproduct yield, permeability changes from cavity development and collapse, effects of buoyancy, thermal and mechanical force changes on contaminant transport and the potential for natural bioattenuation. It is important to note that using the cavity for CO₂ sequestration will impact mobility of byproducts and will alter risk.

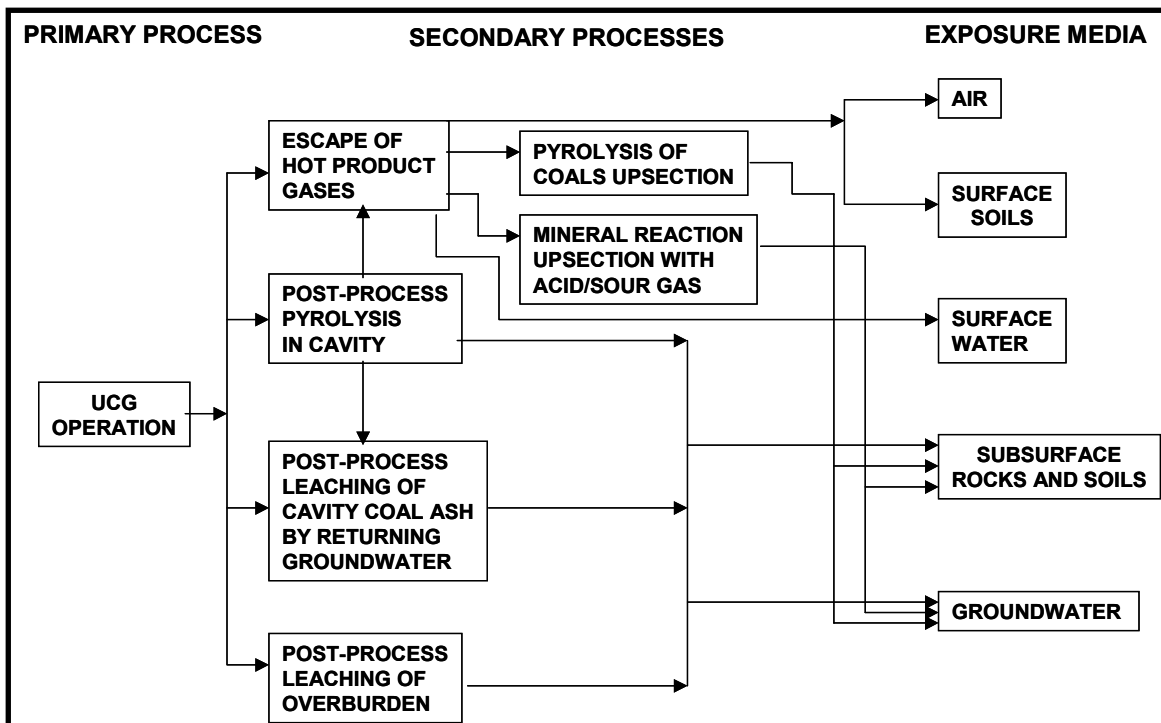

Figure 5-1: RBDM flow diagram for UCG operations.

5.3 Geologic Assessment of UCG Sites

Correct assessment of site geology is key to assuring that future UCG operations are sited to create minimal environmental risk. While there are numerous locations where coal resources are appropriate for UCG, particularly where modern mining methods either are not practical or are uneconomical, deep coal beds which are geologically isolated are especially attractive sites for future UCG operations. Suitable future UCG locations should be located at depths where local aquifers consist of saline, nonpotable water, with

stratigraphic seals, with structural integrity, including no possibility of cavity roof caving that would create connectivity with other adjacent potable aquifers.

5.3.1 Stratigraphic Framework

The initial local permeability fields around potential UCG sites depend on the geological history of stratigraphic deposition, the specifics of stratigraphic succession, and the geological structure of the region. UCG operations will alter these initial fields through imposition of new thermal and geomechanical stress fields and its impact will depend on their relative relationship to the natural stress fields, and the intrinsic geomechanical properties of the rock types and rock sequences.

Rapid stratigraphic characterization of the succession provides first-order information as to the general potential for contaminant escape, which provides one ranking criterion for coal contaminant risks according to their depositional context. Some coals are thick and isolated, whereas others are thinner and more regionally expressed. Some coals are overlain by impermeable units, such as marine or lacustrine shales, whereas others are overlain by permeable zones associated with deltaic or fluvial successions.

5.3.1.1 Stratigraphic successions and relative base level changes

As basins accumulate sediment, changes in tectonics, climate, eustatic sea level, and sediment supply force changes depositional environments (e.g. Mitchum, et al. 1977; Jervey, 1988). These stratigraphic-forcing functions, first and foremost, alter base level, defined as the level below which erosion cannot take place (Davis, 1902; Twenhofel, 1939; Schumm, 1993). Base level determines the location and style of sedimentary deposition and, in most sedimentary systems, is equivalent to sea level.

Base-level changes through geologic time, driven by any stratigraphic forcing, strongly affect the style and distribution of sedimentary types. Stratigraphic forcing also affects accommodation space, defined as the space available to deposit sediments (e.g. Jervey 1988; Van Wagoner, et al 1990). For example, as subsidence increases or absolute sea level rises, there is an increase in accommodation space.

A useful predictive, description conceptual framework for base level and accommodation changes is *sequence stratigraphy* (e.g. Mitchum, et al 1977; Van Wagoner, et al., 1990). Increases or decreases in accommodation or base level cause a predictable migration of depositional systems that are bounded by temporally defined surfaces, including flooding surfaces or unconformities. Such surfaces can be used to define positions in the context of relative base level changes, and are often grouped into *lowstand*, *transgressive*, and *highstand systems tracts* based on internal characteristics and overall stacking patterns. By examining the stacking patterns of these stratal packages bounded by key surfaces, one can predict the lateral and vertical character of sedimentary units away from data points such as wells, seismic lines, or outcrops (Van Wagoner, et al., 1990).

Coals generally accumulate in mires, initially as accumulations of peat (e.g., Moore, 1989). This requires a high water table and low rate of clastic influx (McCabe 1984,

Courel 1989; Allen 1990; McCabe 1991). The location, volume, quality, and extent of coal seams reflect changes in accommodation and peat accumulation rates (e.g., Hamilton and Tadros, 1994; Bohacs and Suter, 1997). Other linked depositional systems, such as deltas, shorefaces, tidal systems, rivers, and coastal plains, also respond to this stratigraphic forcing (Jervey, 1988, Van Wagoner, et al., 1990). Coals can be deposited in three major environmental contexts: regional (e.g., during a basin-wide disruption of siliciclastic influx), during nodal avulsion of channels, and local (within abandoned or between active channels). Figure 5-2 illustrates these different settings. It is apparent that some of these coals have a higher likelihood of connection to permeable and porous units depending on their depositional context.

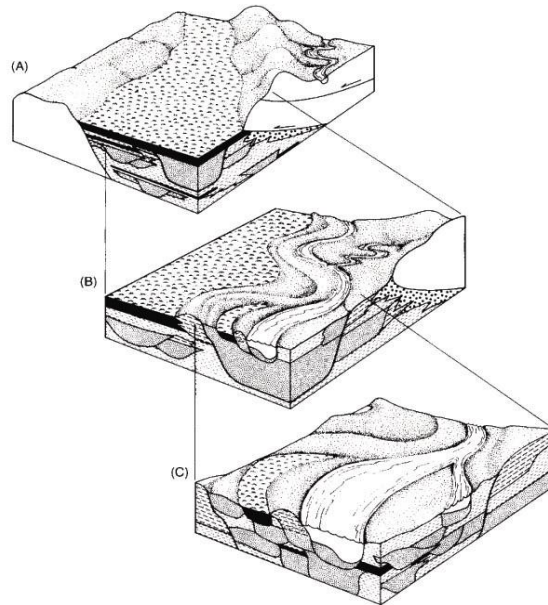

Figure 5-2: Schematic block diagrams showing the general habitat of coal occurrence (A) basinal, (B) sub-regional, and (C) local. (From Hamilton and Tadros, 1994).

Figure 5-3 shows how these different coal-related environments move through space over geological time during one cycle of base-level fluctuations. Although these are marine systems, the same methodology applies to base-level changes in lacustrine coal systems as well (e.g., Hamilton and Tadros, 1994). Increases in relative base-level produce transgressions (e.g., transgressive systems tract) and a backstepping of the depositional systems. In some circumstances, this results in coals being buried in marine or lacustrine shales, which have a low permeability. Relative base-level falls cause progradation of sedimentary systems and regression, wherein coals may be succeeded by river systems, erosion, and exposure (e.g., Dalrymple, et al., 1992). These changes also affect the thickness and lateral extent of coals (Bohacs and Suter, 1997).

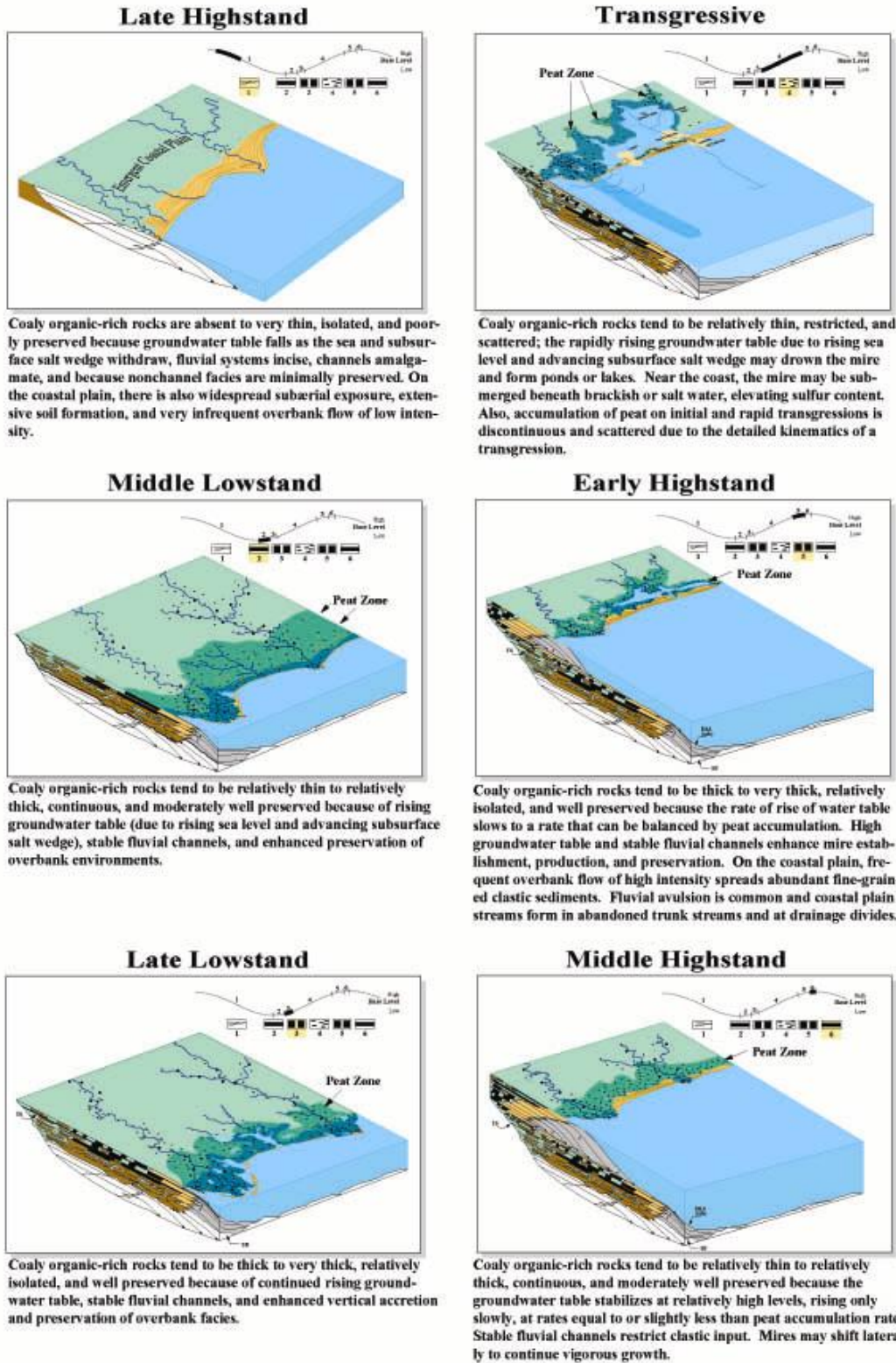

Figure 5-3: Stratigraphic successions associated with one sea-level cycle. (From Bohacs and Suter, 1997).

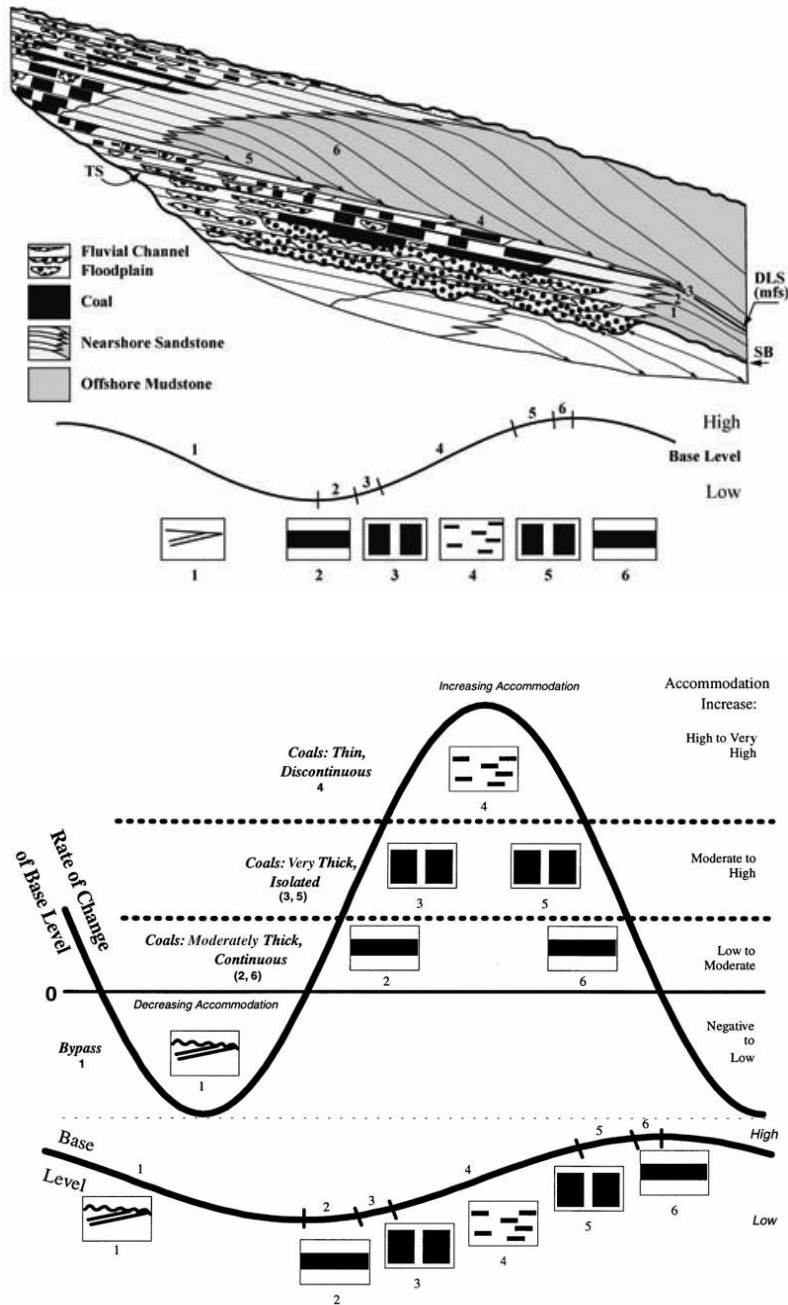

Figure 5-4: Schematic representation of accommodation cycles and distribution and character of associated coal deposits. (Top) Schematic drawing of one depositional sequence through an accommodation cycle, showing the general distribution of coaly units (black) and their associated facies. (Bottom) Associated cycle of base-level change. The six category numbers underlie the risk matrix below. (From Bohacs and Suter, 1997).

5.3.1.2 Coal containment and stratigraphic successions

As stratigraphic forces alter the lateral and vertical distribution of strata, they directly affect the permeability field surrounding coals. They will affect the lithology immediately surrounding the coals, e.g., whether a coal is surrounded by low-permeability coastal-plain mudstone or by fluvial channels filled with permeable sandstone. Stratigraphic forcing also affects the vertical evolution of coaly units (see above), which impacts the likelihood of high permeability zones overlying target coals. Such zones may be aquifers that serve or may serve as groundwater sources for various applications (e.g., agriculture).

The predictive framework supplied by sequence stratigraphy provides a context for observations of coal targets. Bohacs and Suter (1997) provide one model of this approach, presenting a six-tiered categorization of coal body continuity and thickness as a function of stratigraphic position (Figure 5-4). In the parlance of non-linear dynamics, these changes from one category to the next occur as sedimentary systems move through a multi-dimensional phase space bounded by accommodation space, base-level position, and peat accumulation rate. Importantly, these predictions can be made based on sparse or irregularly spaced data sets, including neighboring outcrops, individual well-logs, or limited cores from neighboring wells. This allows the trained geologist to determine whether the target coal is Category 3 or 5, despite similar composition and thickness.

5.3.2 Structural Framework

Post-depositional tilting and faulting may alter the integrity of seals in stratigraphic sequences. Tectonic deformation may result in tilted sequences wherein coal seams on one side of a basin are isolated, but those seams may rise to shallow depths or even outcrop at the surface in other parts of the basin. The Ferron coals (described below), for example, range from 1700 ft (520 m) to 4100 ft (1250 m) (Lamarre, 2002, 2003). Uplift and erosion exposed the southern part of the trend to the atmosphere, and there, the coals are “leaky”, no longer able to trap the coal bed methane that is abundant in the northern part of the basin. Major faulting or small fracture sets can create conduits from the gasification zone to other strata or to the surface. The risk to UCG includes gas loss, contaminant transport and water inflow (Creedy and Garner, 2004). UCG site assessments should include enough geophysical and logging information to constrain the pattern of structural overprints that may influence coal seam integrity.

In addition, it is important to consider how the stress fields induced by the burn and cavity collapse will interact with the ambient stresses. The process of cavity collapse depends on the mechanical properties of the overburden rock, and on geological and thermal stresses. Any associated subsidence, and its impact on the overlying aquifers, depends on the cavity geometry and the depth (Creedy and Garner, 2004).

5.3.3 Hydrological and Geomechanical Framework

The UCG process has the potential to cause significant hydrologic and geomechanical changes in the area surrounding the coal seam. Estimation of the environmental threat posed to groundwater resources as a result of UCG involves consideration of several elements, including:

- Generation of the contaminants within the burn chamber;
- Enhanced vertical hydraulic conductivity of the rock matrix above the burn chamber as a result of collapse and fracturing;
- Buoyancy-driven upward flow imparted by differences in fluid density reflecting different dissolved salt content distributions of groundwater in the vicinity of the burn chamber;
- Thermally-driven upward flow of groundwater resulting from *in situ* burning of coal;
- Whether speciation and partitioning of organic compounds, and possibly dissolved metals, will favor transport or sorption to mineral surfaces;
- Potential for bioattenuation of contaminant compounds that migrate into potable water aquifers.

To directly address the issue of environmental risk posed to groundwater, the parameter spaces associated with these relevant processes need to be explored to identify, in a quantitative context, those scenarios are most favorable for UCG and which are least favorable. Output from such an effort will facilitate comparison of risk scenarios.

5.3.4 Geochemical Framework

From a chemical standpoint, UCG is the partial in-situ combustion of a coal seam to produce a useable gas. It is achieved by injecting steam and air or oxygen into coal seams, which is then ignited to initiate the gasification reactions. High temperatures are required for the gasification reactions to proceed. In Section 4 above, Table 4-1 lists the basic reactions.

The distribution of produced gases and contaminant byproducts varies as a function of the amount of steam, whether air or oxygen is used, the temperature, and pressure (Stephens, 1980). The product gases consist primarily of carbon monoxide, carbon dioxide, hydrogen and methane, and to a lesser extent hydrogen sulfide, and some higher molecular weight pyrolysis products (e.g. phenols, PAHs). Typical gasification processes should operate at temperatures in excess of 1000°C to achieve the desired product mix (Figure 5-5), and higher pressures favoring the formation of methane. Lower temperatures result in production of more contaminant byproducts.

It is important to note that even though thermodynamic considerations, such as the ones presented in Figure 5-5, play significant roles in determining the course of gasification, they are by no means the only determinants of the final product distribution. The kinetics of a number of reactions and mass transfer to the reacting zones also play an important, and sometimes limiting, role. For example, even though the methanation reaction (see Reaction 3 of Table 4-1) is expected to give a higher yield of methane at higher pressures, the observed data from the field does not always support this conclusion (e.g., Stephens, et al., 1985a, 1985b).

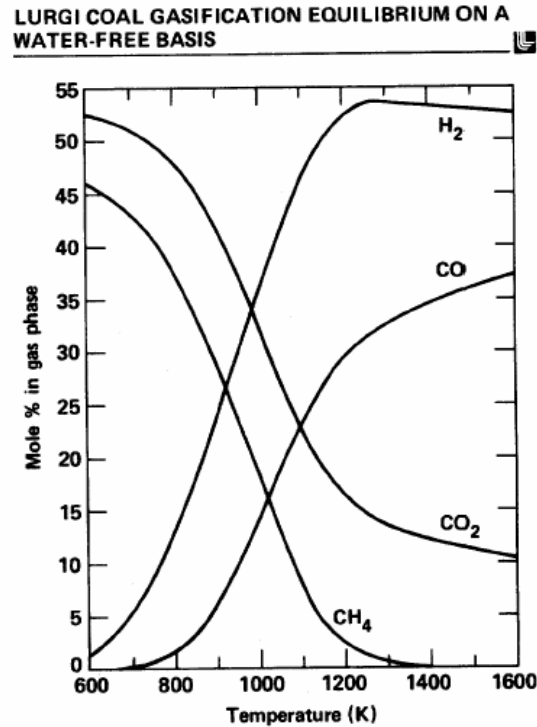

Figure 5-5: Example of an equilibrium calculation for coal gasification (From Stephens, 1980).

A variety of harmful compounds are by-products of UCG. These are comprised largely of the BTEX compounds (benzene, toluene, ethylbenzene, and xylenes), phenols, and aromatics (e.g., naphthalene), as well as gases (e.g., CO, H₂S, etc.). There is also the potential for release of heavy metals from residual coal ash left underground.

The solubility of organic compounds is enhanced by the elevated temperatures associated with UCG. If the cavity and nearby strata are considered as potential sequestration sites for CO₂, the high solubility of these organics in supercritical CO₂ is also an issue. Metals also become more soluble under the acidic conditions that would be created by introduction of CO₂ into a UCG site.

To minimize or eliminate the environmental impact of UCG and of any subsequent carbon sequestration on local ground water, we need to predict and avoid the conditions

by which UCG-associated contaminants may become soluble and migrate into groundwater during and after a UCG operation. In past underground coal gasification (UCG) operations that resulted in contaminated aquifers, the contaminants were primarily low molecular weight organic compounds. The compounds of greatest concern were phenols and low molecular weight polycyclic aromatic hydrocarbons (PAHs), primarily the carcinogen benzene, formed by the thermal breakdown of coal in the high-temperature gasification chamber.

Table 5-1: Groundwater pollutants found in Texas UCG pilot sites (From Humenick and Mattox, 1978)

Chemical constituent	Before burn (mg/l)	After burn (mg/l)
Ca	20	200
Mg	5	15
Na	100	300
HCO ₃ ⁻	300	500
CO ₃ ²⁻	2	0
SO ₄ ²⁻	4	1150
H ₂ S	0.02	0.4
Cl ⁻	30	40
F ⁻	0.1	0.7
NO ₃ ⁻	--	2.0
NH ₃	1	100
TDS	350	2300
Phenols	0.1	20
TOC	20	200
Volatile dissolved solids	--	300
CN ⁻	--	<0.01
CNS ⁻	--	<0.5
CH ₄	0.42	0.16
pH	--	7.6
As	--	<0.01
Ba	--	<1
Cd	--	<0.01
Cu	--	<0.1
Cr (total)	--	<0.05
Mn	--	0.07
Hg	--	0.002
Se	--	<0.01
Ag	--	<0.05
Zn	--	<0.1
B	--	0.3

When groundwater is in contact with UCG operations, a suite of organic and inorganic contaminants has been found. A small field study of Texas sites is illustrative, where the groundwater showed increases in organics, ammonia, sulfate and total dissolved solids (TDS) after the burn (Table 5-1). The environmental contamination at Hoe Creek and Carbon County, WY, also is illustrative.

5.3.4.1 Properties of water

The ability of water to interact with sedimentary organic matter under hydrothermal conditions is derived from the physical properties of liquid water at elevated temperatures, and how these properties influence the mechanisms by which water can react with organic matter. At ambient conditions, water is a highly polar liquid, exhibiting a high capacity for dissolving polar and ionic substances but having a small capacity for solvating nonpolar compounds. However, the physical and chemical properties of liquid water change dramatically at elevated temperatures (e.g. 250-350°C).

Table 5-2: Physical properties of water as a function of temperature.

Temperature (°C)	Density (g/cm ³)	Viscosity (cp)	Dielectric Constant	Dissociation Constant
25	0.997	0.960	78.4	10 ⁻¹⁴
250	0.799	0.110	26.8	10 ^{-11.2}
300	0.712	0.096	20.1	10 ^{-11.3}
350	0.575	0.079	13.1	10 ^{-12.3}

The properties of liquid water that change as a function of temperature include density, viscosity, dielectric constant and dissociation constant. At temperatures above 200°C, the dielectric constant of water is comparable to the room temperature dielectric constants of methanol and acetone. At elevated temperatures, liquid water becomes a highly diffusive medium with good solubility for both polar and nonpolar organic solutes. Table 5-2 is a compilation of properties for water at selected temperatures (Todheide, 1982; Cobble and Lin, 1989; Siskin and Katritzky, 1991).

The solubility behavior of compounds in water changes significantly at elevated temperatures and how this affects contaminant dispersion needs to be fully integrated into contaminant transport modeling for UCG sites. For example, the solubility of organic compounds in hot, hydrothermal fluids is greatly increased and can result in a fully homogeneous solution capable of dissolving both ionic species and neutral, nonpolar organic compounds.

A dramatic increase in aqueous solubilities of higher molecular weight PAHs is shown in Figure 5-6, where the aqueous solubility measurements of fluorene, a 3-ring PAH, have been extended up to 150°C (Leif and Knauss, unpublished data). Other 3- to 5-ring PAH compounds, many of these being carcinogenic, are expected to behave in a similar fashion.

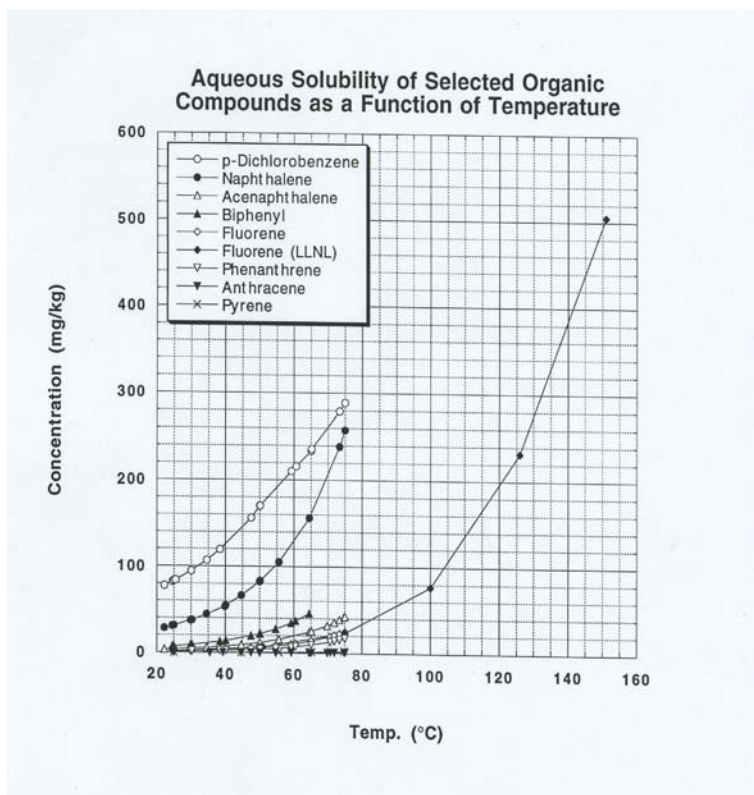

Figure 5-6: Aqueous solubility of selected organic compounds as a function of temperature. (Modified from Wauchope and Getzen, 1972, including Leif and Knauss, unpubl. data).

So, in addition to UCG process controls and geological isolation and containment, high temperature aqueous solubilities of coal pyrolysates need to be addressed, along with a better understanding of the potential of continued hydrolytic breakdown of the coal in the formation after the completion of UCG operations.

Water-hydrocarbon phase behavior is of interest in the environmental sciences and in the chemical and petroleum industries. This is an active area of research (e.g. Knauss and Copenhaver, 1995; Jou and Mather, 2003; Marche, et al., 2003), driven both by the demand for the data and by the fact that there is poor agreement among the published literature, or in many instances, the data do not exist. The large increase in K_w with temperature translates to “neutral” water at 300°C having a pH of 5.7, capable of facilitating acid-catalyzed reactions (e.g. Leif and Simoneit, 1995, 2000; Siskin and Katritzky, 1991). In addition to enhanced solubility of coal pyrolysates, coal in contact with hot water will likely undergo hydrolytic breakdown of the coal structure, releasing more water-soluble compounds.

5.3.4.2 Organic contaminant characteristics

Because UCG is a high-temperature, high-pressure process, the production and transport of toxic organic compounds from the burn cavity will be a consequence no matter what coal type is gasified. The key to lowering environmental risk lies in limiting their mobility.

Mobility, in turn, is dependent on the solubility of the contaminants. There are limited data available to address this issue. There are compilations of the solubilities of some compounds of interest in both water (Yaws, 1999) and supercritical CO₂ (Bartle, 1991). However, the temperature range is very small (typically, below 37°C and almost always below 100°C) and the compilations are uncritical. In particular, as noted by Bartle (1991), the low values in a data set should be treated with more caution (Knauss, et al., 1999).

Deeper UCG locations will have to be run at higher pressures to maintain the burn zone. One advantage of higher pressures, according to many, is a product distribution with a higher percentage of methane, however there is no universal agreement on this point. The combination of high operating temperatures of UCG and higher hydrostatic pressures with increasing depth increase the risk of outward flow to regional groundwater; however, this is offset by the greater distances between deep UCG operations and USDW that typically occur at shallow depths. Deep UCG sites with higher residual groundwater temperatures also will likely mobilize and transport higher molecular weight PAHs in addition to the usual lower molecular weight pollutants.

To minimize post-operation contamination, future UCG operations will need to both minimize the formation of residual NAPL accumulations and/or perform effective approaches to post-burn NAPL removal, preferably while the formation contains substantial residual heat from the UCG process, facilitating removal of free products.

5.3.4.3 Inorganic contaminants

Most of the inorganic contaminants are extracted from the coal ash when the groundwater intrudes into the cavity after the burn, and the suite of constituents, is in fact, quite similar to those found in groundwaters and surface waters contaminated by leaching of ash residuals from conventional coal operations at the surface. The organics and ammonia are deposited via condensation from cooling gases migrating out from the burn cavity during the gasification process (e.g., Humenick and Mattox, 1978; Wang, et al., 1982; Campbell et al., 1978, 1979).

Subsequently, as the contaminated groundwater migrates from the burn cavity, it reacts with the surrounding rocks through adsorption-desorption, precipitation-dissolution, and ion-exchange reactions (e.g., Chaback, et al., 1996). In addition, biological activity can break down contaminant ions and contribute new products compounds. The collective effects of these processes result in retardation of certain, less mobile contaminants, and changes in the chemistry of the plume as it migrates.

In some cases, the presence of certain types of minerals in the groundwater flow path has been shown to effectively remove contaminants of concern from the groundwater. At the Fairchild, TX site, lignite and clay strata above and below the burn cavity were demonstrated to sorb organics and ammonia effectively (Humenick and Mattox, 1978). Bounding clay layers also are important in limiting connectivity of the coal to groundwater, as was discussed above.

5.4 Induced Subsidence

Conversion of coal to syngas in-situ and extraction results in inevitable mass transfer to the surface and evacuation of the volume utilized, forming a cavity in the underground reactor. This volume removal leads to stoping of the coal, sidewall collapse and spallation, limited to substantial roof collapse of the cavity, and potentially subsidence above the reactor zone (Gregg, 1977). The magnitude and form of the subsidence is a function of many factors, including the seam depth (thickness of the overburden), effective rock stiffness and yield strength, fracture density and orientation, structural disposition of the seam, and in-situ stress tensor (Britten, 1985, 1986, 1987).

In most cases, even in shallow cases, the potential magnitude of subsidence is likely to be quite small. In most of the field tests, including Centralia and Chinchilla, negligible subsidence was predicted and observed). However, most tests, including those in the U.S., do not accurately represent commercial deployment and large-scale evacuation of coal by UCG. In contrast, subsidence was noted in several former Soviet projects, including subsidence greater than 1 m and local crater formation. In addition, failure that does not lead to substantial subsidence might lead to escape of product gas or aqueous contaminants (Gregg, 1977). As such, the potential for subsidence hazards and attendant risks may affect both public acceptance and facility design and operation, requiring further discussion and study.

5.4.1 Simulation and Prediction

There are four primary failure modes leading to different styles of subsidence: stoping, chimney formation, bending subsidence, and plug failure (Gregg, 1977).

- **Stoping** is the progressive collapse of roof material into a cavity through spallation (e.g. Hartman, 1992). This generally leads to formation of an arch or elliptical shape for the roof. Stopping increases rock volume, and will stop when the failed rock mass fills the cavity.
- **Chimney formation** or “chimneying” (Obert and Duvall, 1967) occurs when a fairly small area fails, forming a self-reinforcing, spatially limited failure that can penetrate a distance into the overlying rock. Usually, chimneys form in highly incompetent, penetratively fractured rock, and are more common in steeply dipping units.

- **Bending subsidence** produces a trough above the evacuated zone in accordance with mechanical bending equations where the crust has substantial strength (e.g., Krastch, 1983). Bending subsidence results in both vertical and horizontal displacements (Figure 5-7). It is observed in many long-wall mining operations and can thus be expected in some large-scale commercial UCG deployments. This mechanism is generally well understood and readily quantified.
- **Plug failure** (Obert and Duvall, 1967) is akin to the mechanical failure modes of landsliding in which a discrete block of material slides into the cavity suddenly *en masse*. Vertical shear is a dominant failure mechanism. This mode is most common in weakly consolidated sediments or closely jointed but weakly bonded rock. Plug failure is most likely to occur in areas where evidence of surface failure already exists.

Currently, a great deal is known about these failure modes in association with shallow underground mining, and there are both substantial literatures and many tools to characterize and quantify potential failure extent (e.g., National Coal Board, 1975; Karmis, et al., 1992; Shu and Battacharyya, 1993; Ambrozic and Turk, 2003). In the case of shallow UCG operations, the tools and characterizations from shallow mining are strictly analogous.

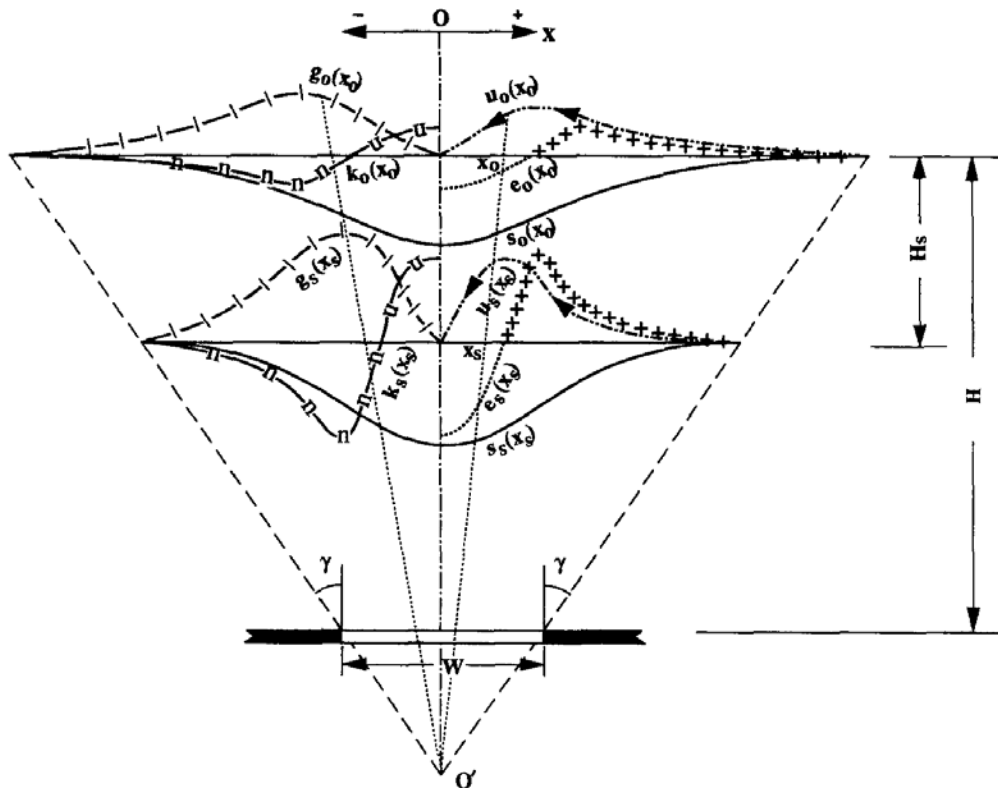

Figure 5-7: Surface deformation produced by evacuation of a coal seam of fixed width and thickness according to the geometry of a bending subsidence model with very little strength. H equals depth to top of seam, H_s corresponds to a subjacent unit depth, and $s_0(x_0)$ is the subsidence profile. (After Shu and Battacharyya, 1993).

In the case of deeper operations, the magnitude of the surface deformation will generally be smaller and the distribution of deformation wider (See Figure 5-7). However, predictions may be inaccurate if failure is highly localized (e.g., chimneying). This is because many rocks exhibit non-linear stress-strain behavior, complicating prediction. In addition, it is often difficult to get reliable site data given uncertainties in the fracture field and the non-linear response to stress. Nonetheless, several institutions have working models for prediction that have been tested in the field (e.g., Trent and Langland, 1981; Blinderman & Jones, 2002; Morris, et al., 2002), including both finite element and explicit finite difference approaches.

To constrain the potential risk from subsidence hazards, bounding analyses are helpful. For example, Langland & Fletcher (1976) looked at two scenarios, “stiff” and “soft”, and bounded the deformation between 0.06–3.5 inches (0.15–8.75 cm). The actual maximum subsidence along the centerline was less than 4.5 cm, including all thermal effects (Trent and Langland, 1981), consistent with these predictions. However, to obtain better fits for large-scale evacuations, a combination of empirical and numerical approaches appear to provide the best predictive capabilities.

5.5 Integrating Factors to Assess Risk

Using these basic concepts, it is possible to derive a crude matrix for assessing the overall risk associated with the characteristics of a given site, including stratigraphic and structural factors, the types of contaminants that would result from combustion of coals of different grades and compositions, the process parameters (e.g., temperature, pressure) chosen, the geometry of the cavity, the hydrogeology of the site, the mobility of the contaminants, and the ability of the adjacent strata and microbial communities to retard or breakdown contaminants during transport.

Table 5-3: Risk Matrix Considering Stratigraphic Control

Stratigraphic category	Lateral Isolation	Overlying Unit Character	Relative Risk of Leakage
1	Low	Sand-prone	High
2	Low	Shale-prone	Moderate
3	High	Shale-prone	Low
4	Moderate	Shale-prone	Moderate
5	Moderate	Sand-prone	High
6	Low	Sand-prone	High

The stratigraphically and structurally controlled permeability field surrounding a target coal can be used as a first cut to select potential sites. This flows from two assessments: the degree of lateral and vertical connection of the coal seam, and the character of units overlying the coals. High isolation is preferable, as this reduces the risk of later contaminant flow into adjacent aquifers. Shale-prone intervals overlying coal seams are

similarly preferable. Convolving these two aspects produces a relative ranking. This ranking can be used as a crude screening tool to high-grade potential project sites, followed by consideration of the risk impacts of the other factors discussed above.

It is important to note that the burn process and cavity development act to alter the permeability field of the site from its natural stratigraphic and structurally controlled state. The post-burn permeability field depends on the geomechanical properties of the strata, the impact of the induced stresses added to the natural ambient stress field, and to understand how these factors govern the response of the surrounding rock to the thermal and mechanical stresses created by the burn. For example, while shale layers overlying coal seams appear to be preferable from the standpoint of their ability to act as aquitards or aquicludes, they may not have the required mechanical properties to maintain their integrity after the burn. Additionally, some shale contains minerals that will actively sorb organic contaminants, whereas other shales may be less effective.

Three examples of the use of stratigraphic criteria are provided below, all from the Cretaceous of the western Great Basin. By using lateral isolation and overlying unit character, six categories were created (Table 5-3). These examples are meant to illustrate a relative stratigraphic-ranking methodology, and should be able to be applied in the overwhelming majority of potential cases. Hoe Creek is used as a fourth example, considering stratigraphic and other factors that influenced the outcome at that site.

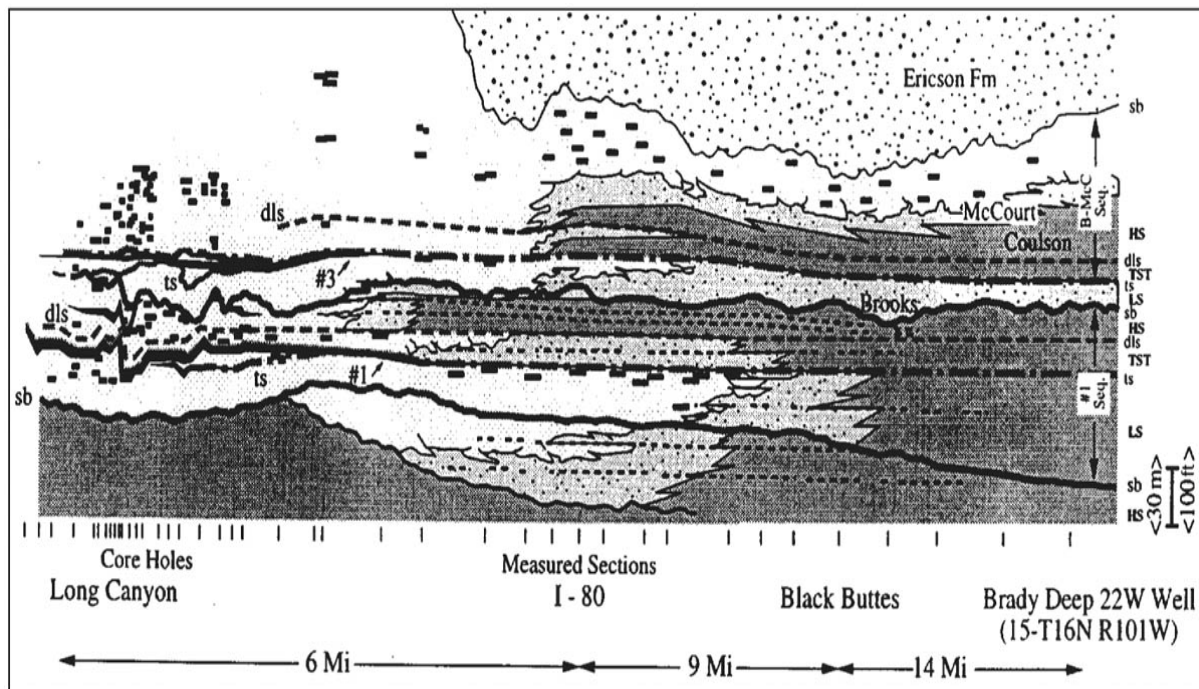

Figure 5-8: Cross-section of the Brooks-McCourt Sequences within the Rock Springs uplift, S. Wyoming. Note abundant coals (black) within the succession. The isolated coals beneath the #1 seam and its correlative flooding surface present the lowest risk for leakage into neighboring porous, permeable units. (From Bohacs and Suter, 1997).

5.5.1 Rock Springs Uplift

The first example from south central Wyoming involved Campanian (late Cretaceous) units of the Brooks/McCourt interval (Hendricks, 1981; Beauboeuf, et al., 1995). Major coal seams include the #1 and #3 coals, although there are many coal units of varying thickness and quality distributed through the section (Figure 5-8). Some of these coals are deposited within fluvial channels, whereas others represent widespread mires in a coastal plain environment. The coals below the #1 seam would fall into Category 3 (low risk) and are capped by a thick package of marine shales. In contrast, the coals above the #3 seam would fall into Category 5, and are capped by thick fluvial sandstones. A simple examination of the physical rock properties does not reveal this fact – only the recognition of the stratigraphic architecture of the whole succession provides this insight. Roughly 400 m up-section, the coals within the Almond Fm. are also Category 3 coals, but they are even better expressed, thicker, more isolated, and capped by the thick Lewis Shale (Van Wagoner, et al., 1990). Thus, within the Rock Springs uplift there are two regionally disposed high-quality, low-risk intervals to prospect for UCG. While there are a great many more coals available, they would all generally be more risky due to their proximity to other porous and permeable units (e.g., the Erickson Fm.).

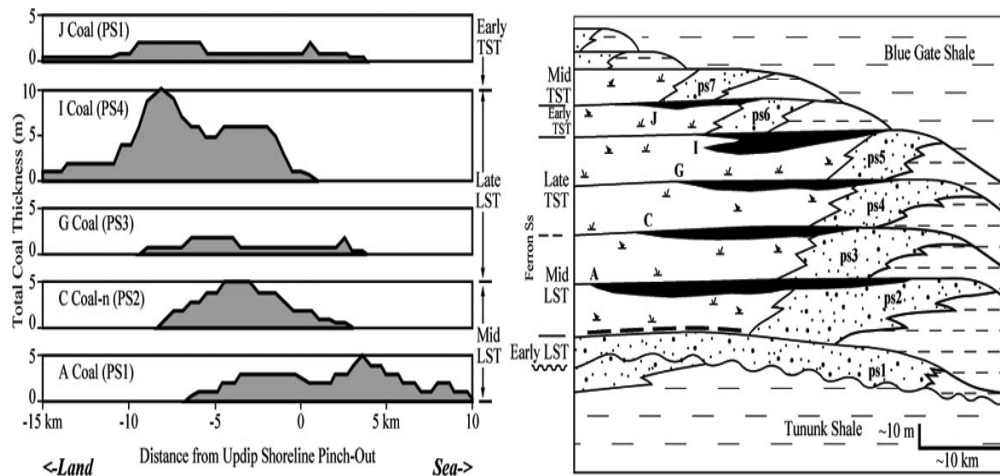

Figure 5-9: Thickness, vertical, and lateral distribution of the five main coal seams within the Ferron Sandstone member, Mancos Shale Fm., Emery coalfield. From Bohacs & Suter (1997).

5.5.2 The Ferron Sandstone Coal Succession

The Ferron sandstone member of the Mancos Shale accumulated during the Turonian (early Cretaceous) in eastern Utah (e.g., Cotter, 1976). The Ferron is a sandstone wedge protruding far into the Mancos Shale, and as such most of the coals probably represent a

low to moderate risk (Ryer, 1981, 1984). In the Emery coalfield, five major coal seams stack within an aggradational to retro-gradational set. Of these, the I and J coals would be the lowest risk, with the I coal providing both low risk and high thickness (Figure 5-9).

5.5.3 The Blackhawk Formation Coal Succession

The Campanian (upper Cretaceous) Blackhawk formation comprises multiple cycles of transgression and regression within an overall progradational package (Figure 5-10; Young 1955, Taylor & Lovell, 1991). The succession bears at least a dozen major coal seams, which are mined for electric power generation. Despite the great thickness, continuity, and economic utility of these coals, they all are elevated in risk. The progradational nature of the succession places many fluvial and deltaic sandstones above the coals across short distances laterally and vertically. These would be Category 5 or 6 coals, again as seen from the context of the sedimentary succession where the coals occur.

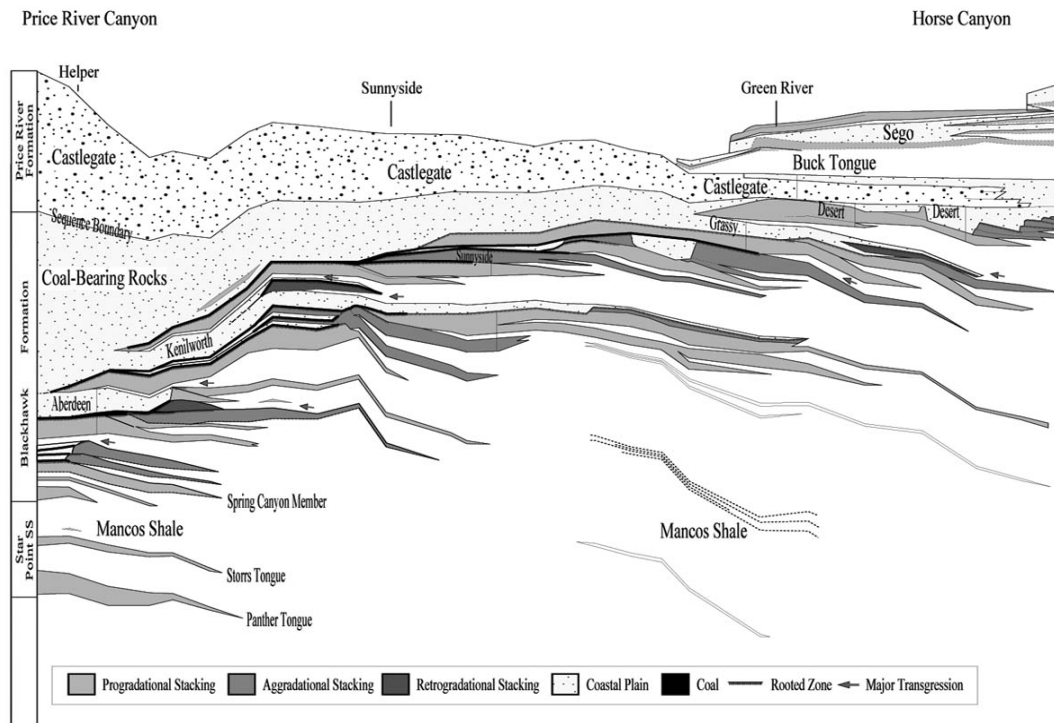

Figure 5-10: The Blackhawk Fm, eastern Utah, showing overall progradation and multiple coal bodies. (After Young, 1955).

There are examples where it looks like Category 3 coals hold significant gas accumulations in part due to lateral and vertical stratigraphic seals (Lamarre, 2002). These coals would probably be less likely to leak injected CO₂ or contaminated water associated with injection, and would be less likely to be affected by potential stratigraphic or structural leakage paths (e.g., Friedmann & Nummedal, 2003). If true, this

methodology would provide a quick screen for assessing the stratigraphic control on leakage associated with injection into unmineable coals seams.

Detailed groundwater analyses of previous UCG operations identified a large number of coal pyrolysis products contaminating regional groundwaters (Campbell, et al., 1978; 1979; Humenick and Mattox, 1978; 1982; Humenick et al., 1987; King, et al., 1978; Mattox and Humenick, 1980; Mead, et al., 1982; Stuermer, et al., 1982; Wang, et al., 1981; 1982a). The organic groundwater contaminants at the Hoe Creek site were generated by the high temperature pyrolytic breakdown of coal during the UCG process. During active gasification, temperatures within the burn zone can exceed 1000°C. The heat both dries and pyrolyzes the coal, forming hundreds of organic compounds, ranging from volatiles to high molecular weight tars.

The higher pressures in the UCG cavity and buoyant gas forces can exceed the confining hydrostatic pressure. This results in contaminants being transport into the unheated formation, where the vaporized contaminants with boiling points above the ambient temperatures condense and accumulate. Due to their low thermal conductivities, coals can have temperature gradients greater than 3000°F/ft; therefore, a majority of the condensed pyrolysates will accumulate in the walls of the burn cavity relatively close to the high-temperature burn chamber. The condensed pyrolysates will either be consumed during growth of the burn chamber or remobilized to migrate in front of the advancing burn chamber. Under sustained gas flow through cracks or other transport channels, hot escaping gases will heat these conduits, allowing the normally condensable pyrolysates to be transported farther away from the burn zone (Wang et al., 1982b; Covell and Thomas, 1996).

5.6 Experience from UCG pilots

5.6.1 Hoe Creek, WY

The Hoe Creek Underground Gasification Site occupies 32.4 hectares (80 acres) of private land located in Campbell County, Wyoming, near the town of Gillette. Three pilot-scale UCG tests were conducted between 1976 and 1979 at Hoe Creek. Aquifers are present in the two gasified coal seams, Felix I and II, and in an overlying channel sand. Sampling of these aquifers indicated that the collapse of the cavity had interconnected the three aquifers, groundwater was recharging the reaction zone, and a broad range of organic combustion products had been introduced into the groundwater system. A variety of inorganic compounds also were released from the residual ash bed.

The U.S. Department of Energy's (DOE) current mission is limited to completing environmental remediation activities at the site. This property is owned by the Bureau of Land Management (BLM), which granted a right-of-way to DOE for conducting underground coal gasification experiments and subsequent groundwater clean-up activities. In 1993, the U.S. Dept of Energy had a preliminary assessment prepared for the site which concluded that the groundwater contamination posed a significant potential

risk to humans and livestock that obtained drinking water from nearby wells, and to the wetlands located downgradient from the test site (Dames and Moore, 1996).

Elevated levels of petroleum hydrocarbons, including coal tars, residual organic carbon, and organic compounds (e.g., benzene, toluene, ethyl benzene, and xylene) have contaminated an onsite coal seam aquifer situated about 55 meters (180 feet) beneath the surface. The contaminated groundwater has migrated onto private property adjacent to the site. DOE's Office of Fossil Energy is conducting remediation activities at the site in cooperation with the State of Wyoming. An air sparge/bioremediation system for clean-up of the contaminated groundwater was approved by the Wyoming Department of Environmental Quality in July 1997, and construction of the system was completed in January 1998. In 1998, DOE installed 64 air sparge wells in the Hoe Creek 2 well field, with 45 wells in the Felix 1 coal seam and 19 wells in the Felix 2 coal seam. In 1999, an additional 50 wells were installed in the Hoe Creek 3 well field, with 42 wells in the Felix 1 coal seam and 8 wells in the Felix 2 coal seam.

A coring study identified two different types of coal pyrolysate accumulations, a light liquid phase and a viscous coal tar (Dames and Moore, 1995; Covell and Thomas, 1996). These NAPL deposits have been the primary source of the ongoing groundwater problems at the Hoe Creek site. The most important site specific parameter causing migration was the normal groundwater velocity, and the contaminants causing the greatest problem due to migration were low molecular weight compounds with high aqueous solubilities and which did not exhibit appreciable sorptive properties. These include phenols and benzene, a carcinogenic compound, present at concentrations above the action limit (Humenick and Novak, 1978).

At the Hoe Creek site, the organic compound of greatest concern is benzene. Under near-surface ambient conditions, benzene has an aqueous solubility high enough to be a problem. The process of pyrolysis, vaporization and condensation is essentially a retort/distillation process that results in accumulations of organic compounds based on boiling points. This is what appears to have occurred at the Hoe Creek site.

Remediation includes a "pump-and-treat" system with activated carbon for removal of organic compounds. Natural attenuation also has reduced levels of some compounds, but the benzene and phenol levels remain high. The failure of these processes to remove benzene led to a combined approach of source removal by air sparging and plume treatment by bioremediation (Covell and Thomas, 1996). The air sparge/bioremediation system is designed to operate for about five years followed by shutdown for one year to determine if the contaminants in the groundwater have been removed. If the contamination is still present, the system will resume operations for another year or until levels of contamination are acceptable to the Wyoming Department of Environmental Quality.

In order for the gasification experiments to be conducted, DOE acquired a research and development mining license (permit) from the Wyoming Department of Environmental Quality, Land Quality Division. The primary laws governing activities at the field site

were the *Wyoming Environmental Quality Act of 1973* and the *Surface Mine Control Reclamation Act of 1977*. As a result, these laws must be satisfied prior to release from the property. Groundwater must be returned to background conditions or maintain a certain class restriction through the use of a Best Practicable Technology (BPT). The remediation systems in place at the property are considered to be BPT. DOE is responsible for surveillance and maintenance activities at the Hoe Creek Underground Gasification Site. After remediation, due to be complete in 2006, DOE will monitor the groundwater and surface vegetation through 2014 in accordance with the State of Wyoming and the Department of the Interior's Office of Surface Mining long-term monitoring requirements. Anticipated site-wide long-term stewardship activities include groundwater and surface vegetation monitoring, record-keeping, and institutional controls. If necessary, drilling restrictions will be implemented through the Wyoming State Engineer's Office (U.S. Environmental Protection Agency, 1999).

The costs for long-term stewardship activities, including groundwater monitoring, record-keeping, and institutional controls enforcement were estimated at about \$3 million dollars between 2004 and 2014. After long-term stewardship activities are complete in 2014, BLM may sell the property following groundwater cleanup in order to divest itself of small in-holdings surrounded by private land. Following groundwater remediation, DOE will be released from liability by the Wyoming Department of Environmental Quality, and the research and development mining permit will be terminated. The land is expected to be sold by the BLM and used for livestock grazing (U.S. Environmental Protection Agency, 1999).

5.6.2 Carbon County, WY

Field tests of UCG in steeply dipping coal seams in the Indian Springs Coal Resource area near Rawlins, WY were conducted in April and August of 1995. Monitoring before and after operations indicated that some organic compounds increased in concentration in groundwater after the burn. Again, as at Hoe Creek, high benzene levels were measured in groundwater aquifers within the target coal and in overlying and underlying sandstone units.

5.6.3 Chinchilla Project, Australia

According to Linc Energy, Ltd. and Ergo-Exergy, there has been no groundwater contamination from the Chinchilla UCG pilot operation. This was accomplished by optimizing operating conditions such that the pressure in the gasifier was kept lower than pressure in the coal seam and in the surrounding strata (Figure 5-11). As a result, there is no drive for groundwater flow from the gasifier chamber or loss of product or contaminants into the surroundings (Figure 5-12).

The site, subject to annual audit, has been in full compliance with the environmental management plan and applicable environmental agency regulations. One key feature of

the Chinchilla Project was the continuous groundwater monitoring (by 19 monitoring wells) in the vicinity of the project. According to Blinderman (2003a, 2003b), the data showed no groundwater contamination, surface contamination, or subsidence.

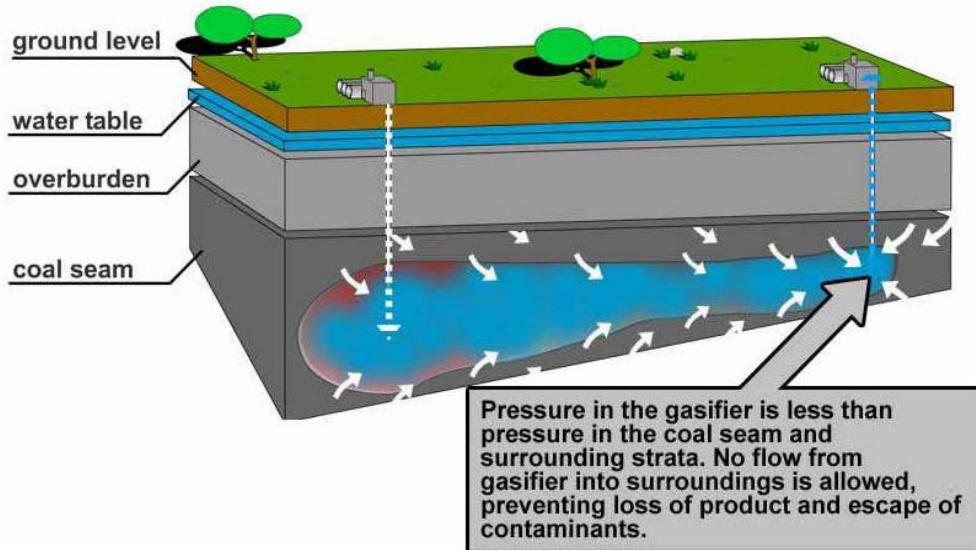

Figure 5-11: Illustration of UCG process operating at negative pressure. (From Blinderman and Jones, 2002.)

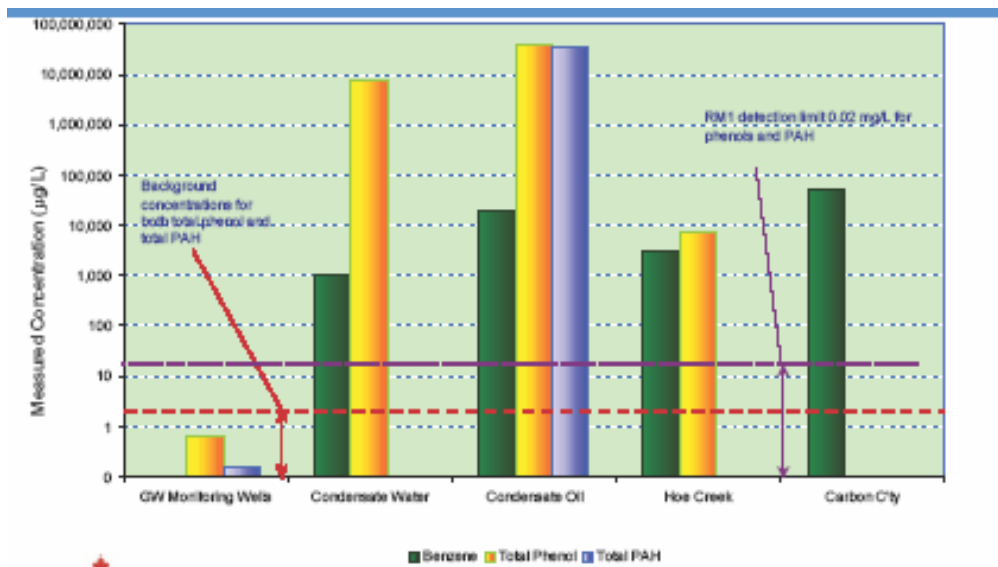

Figure 5-12: Measured concentrations of organic contaminants, benzene, total phenols, and total PAH, at Chinchilla (first three sets of bars) compared to Hoe Creek and Carbon County. Condensate water and oil, second and third sets, show high levels of these compounds are being produced, but groundwater first set, shows levels remain below background (red dashed line). (Blinderman and Jones, 2002).

6 Carbon Management

Carbon capture and storage (CCS) has emerged as a key technology component to reduce greenhouse gas emissions, chiefly CO₂, through geological sequestration. Carbon dioxide can be stored in geological targets, usually as a supercritical phase. The chief geological targets for carbon storage include deep saline aquifers, depleted gas fields, active oil fields (EOR), depleted oil or gas fields, and unmineable coal seams. All of these targets are frequently found near coal seams chosen for UCG. It has been noted repeatedly that opportunities for storage are often plentiful in coal basins (e.g., Schroeder, et al., 2001; Stevens, et al., 1998), therefore, it seems likely that storage options will co-exist with most, if not all, future UCG sites. Carbon capture economics and coincidence of storage targets make UCG-CCS an attractive carbon management package.

6.1 Carbon Capture

There are three main approaches to CO₂ capture for industrial and power plant applications (Thambimuthu, et al. 2005):

- post combustion systems separate CO₂ from the flue gases produced by combustion of the primary fuel, such as coal or natural gas;
- oxy-fuel combustion uses oxygen instead of air, producing flue gas comprising mainly CO₂ and steam. In this case, the CO₂ is readily recovered in pure form by condensing the steam;
- pre-combustion systems process the primary fuel to produce separate streams of hydrogen and CO₂.

Any one of the three approaches can be combined with UCG for carbon capture and sequestration. The post-combustion approach is straightforward. The oxyfuels approach can be used if both the gasification and the combustion are carried out using oxygen rather than air. The precombustion approach can be implemented using oxygen for gasification, followed by water-gas shift reactors to convert almost all the CO to CO₂, thereby producing a stream of hydrogen and carbon dioxide, from which the CO₂ can be readily removed by a number of available technologies.

Thambimuthu, et al. (2005) have reviewed recent studies of the performance and cost of commercial or near-commercial technologies, as well as that of newer CO₂ capture concepts. The following summary is excerpted from this reference:

“For power plants, current commercial CO₂ capture systems can reduce CO₂ emissions by 80–90% kWh⁻¹ (85–95% capture efficiency). Across all plant types the cost of electricity production (COE) increases by 12–36 US\$ MWh⁻¹ (US\$ 0.012–0.036 kWh⁻¹) over a similar type of plant without capture, corresponding to a 40–85% increase for a supercritical pulverized coal (PC) plant, 35–70% for a natural gas combined cycle (NGCC) plant and 20–55% for an integrated

gasification combined cycle (IGCC) plant using bituminous coal. Overall the COE for fossil fuel plants with capture, ranges from 43–86 US\$ MWh⁻¹, with the cost per tonne of CO₂ ranging from 11–57 US\$/tCO₂ captured or 13–74 US\$/tCO₂ avoided (depending on plant type, size, fuel type and a host of other factors). These costs include CO₂ compression but not additional transport and storage costs. NGCC systems typically have a lower COE than new PC (pulverized coal) and IGCC plants (with or without capture) for gas prices below about 4 US\$ GJ⁻¹. Most studies indicate that IGCC plants are slightly more costly without capture and slightly less costly with capture than similarly sized PC plants, but the differences in cost for plants with CO₂ capture can vary with coal type and other local factors. The lowest CO₂ capture costs (averaging about 12 US\$/t CO₂ captured or 15 US\$/tCO₂ avoided) were found for industrial processes such as hydrogen production plants that produce concentrated CO₂ streams as part of the current production process; such industrial processes may represent some of the earliest opportunities for CO₂ Capture and Storage (CCS). In all cases, CO₂ capture costs are highly dependent upon technical, economic and financial factors related to the design and operation of the production process or power system of interest, as well as the design and operation of the CO₂ capture technology employed. Thus, comparisons of alternative technologies, or the use of CCS cost estimates, require a specific context to be meaningful.”

It is important to realize, however, that new or improved methods of CO₂ capture, combined with advanced power systems and improved process designs offer the potential of significantly reducing CO₂ capture costs and associated energy requirements. Improvements in commercial technologies can reduce CO₂ capture costs by 20-30% over the next decade (Thambimuthu, et al., 2005). New technologies under development promise even better cost reductions, depending on the extent of the R&D sustained.

A number of technologies exist for separating CO₂ from other gases. They can be conveniently classified as:

- sorbent systems, wherein a liquid sorbent is used to preferentially adsorb/absorb CO₂ in the first stage. The sorbent loaded with CO₂ is then sent to the next stage where the sorbent is regenerated and recycled back. The stripped CO₂ is processed further to make it ready for sequestration; Examples of such systems are amines-based CO₂ absorption systems. At least three commercial processes using liquid sorbents are available;
- membrane separation, wherein a selective membrane is used to preferentially allow either CO₂ or the non-CO₂ gases to pass through the membrane;
- cryogenic separation, wherein the entire gas mixture is liquefied, and the gaseous components are separated by distillation.

It is clear that not all these technologies will be suitable for any given case, and specific analyses may be required to select the best one among them. Detailed descriptions for all three types of technologies can be found in the monograph by Halmann and Steinberg (1999).

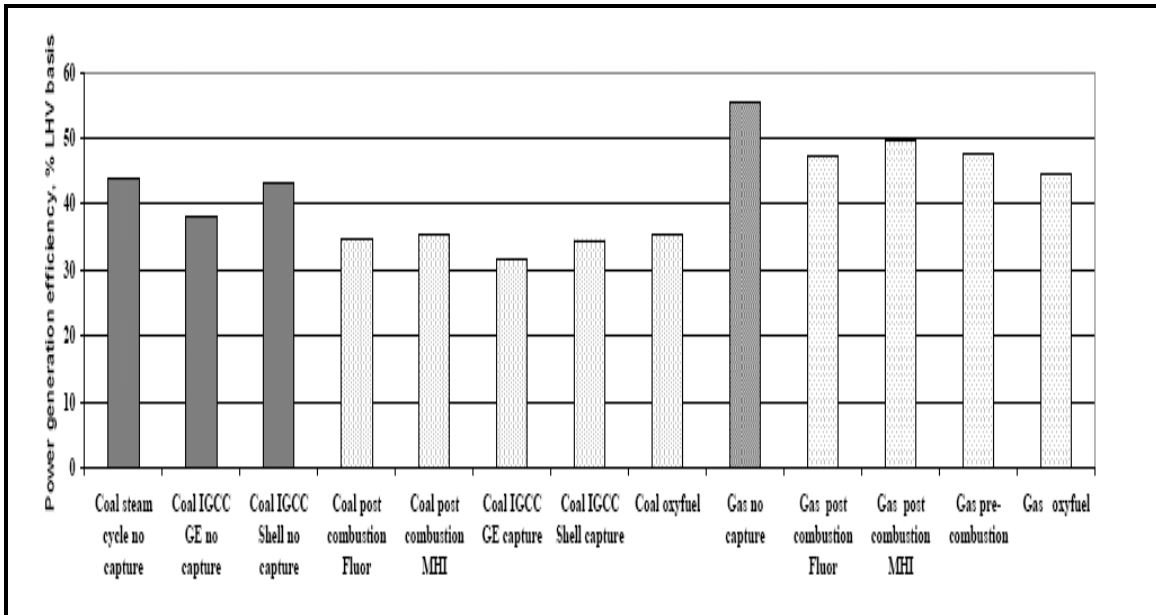

Figure 6-1: Thermal efficiencies of power plants with and without CO₂ capture, % LHV-basis (From Thambimithu, et al., 2005, and references therein: Davison 2005, IEA GHG 2004, IEA GHG 2003; 5 IEA GHG, 2000b; Dillon *et al.*, 2005).

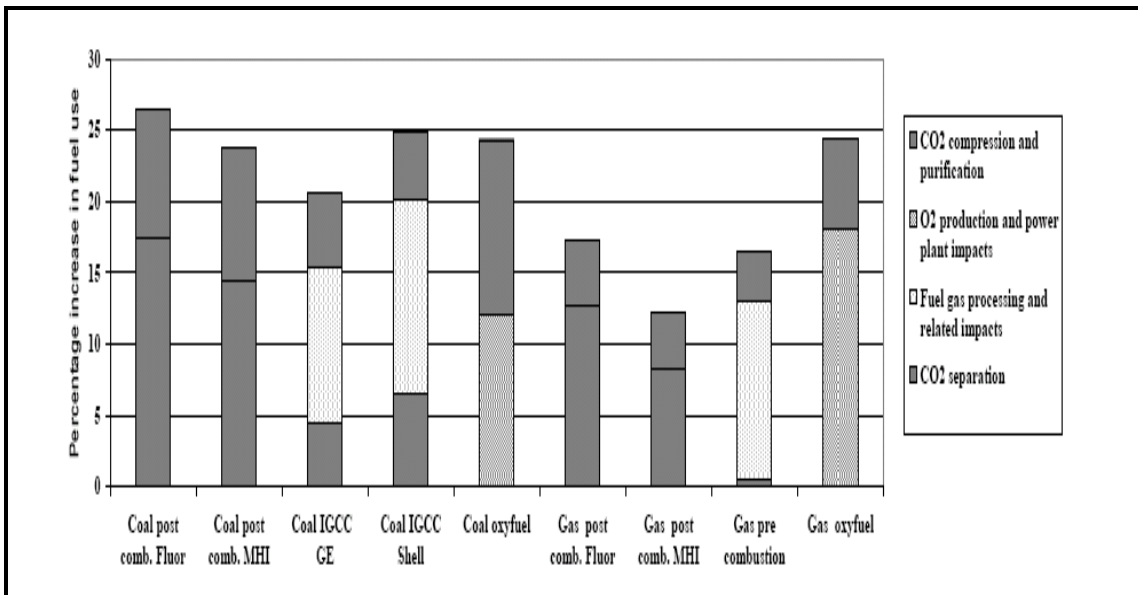

Figure 6-2: Percentage increase in fuel use per kWh of electricity due to CO₂ capture, compared to the same plant without capture (From Thambimithu, et al., 2005, and references therein: Davison, 2005; IEA GHG, 2004; IEA GHG, 2003; IEA GHG, 2000b; Dillon *et al.*, 2005).

In addition to conventional technologies cited above, newer technologies are being developed. Among them are:

- newer solvents;
- adsorption on molecular sieves or activated carbon, using PSA (pressure swing adsorption) or TSA (temperature swing adsorption);
- solid sorbents, such as sodium and potassium oxides and carbonates;
- newer membranes;
- hybrid membrane-solvent processes.

The specific energy penalties for a UCG-based power plant have not been analyzed, however, they have been estimated and reported for a number of power generation schemes (Thambimuthu, et al., 2005). Figures 6-1 and 6-2 show the energy penalties for different power generation scenarios.

6.2 UCG and Conventional Carbon Storage

Quite a lot has been written about geological storage of carbon dioxide (GCS) in geological formations. Most notably, the Intergovernmental Panel on Climate Change published a special report on carbon capture and storage (Thambimuthu, et al., 2005), with chapter five dedicated to geological storage. In terms of concept, physical and chemical processes, likely targets, and costs, storage in conventional GCS targets with UCG gas would be very similar to any other CCS stream. Secondary issues, such as co-storage of contaminant gases (e.g., H₂S), would also be similar.

It is unlikely that the operations of UCG and GCS would interfere geologically. In conventional storage, CO₂ would be injected as a supercritical phase, requiring injection into formations at a depth typically greater than 800 m. For shallow UCG projects (<500m), substantial rock volumes would separate the CCS and UCG efforts, and it is unlikely that there would be any substantial mass transfer between them. Although there may be some pressure transfer from the storage reservoir at depth into the UCG strata, these pressure changes should be small relative to the pressure changes associated with gasification, and as long as cavity pressure remained at or slightly below hydrostatic, transport should not be affected. It is thus unlikely that there would be any substantial interference between UCG and CCS components which could be treated independently.

6.3 UCG and Carbon Storage in the Reactor Zone

In the prior analysis, conventional CO₂ repositories appear sufficient to decarbonize UCG syngas streams. However, there is value to considering storage in the void space made by the UCG process in the reactor zone. While it appears there may be substantial advantages to reactor zone carbon storage (RZCS), these are reasonably matched with potential concerns. We explore these below, with the goal of circumscribing the key risk elements and outlining a potential research agenda to reduce and redress them.

6.3.1 Potential Advantages and Disadvantages to RZCS

Three substantial advantages attend CO₂ storage in UCG cavities. The first is that there is substantial capacity. The UCG process creates a fairly large cavity (order of 5-8 m diameter) between the wells. A single burn with 300m spaced vertical wells would create a void of ~6000-15000 m³. If just 50% of that cavity were available (due to roof or wall collapse), at 1000 m depth and using a conventional geotherm (30°C/km), close to 1700-4500 tons CO₂ could be stored in the cavity.

Another advantage is that wells already penetrate into the void. Proper management of the burn would leave both production and injection wells available for CO₂ delivery to the sub surface and appropriate plugging and abandonment. Since well drilling represent a substantial portion of the projected storage cost (40-60%), this could significantly reduce storage costs.

Finally, the physical response of the coal is likely to enhance sequestration. First, coals swell and plasticize in the presence of CO₂, which could close fractures and porosity relatively quickly. Second, adsorption of CO₂ onto organic mineral surfaces will immobilize and attenuating potential CO₂ leakage, since any CO₂ migrating from the cavity could adsorb into the coal matrix. Finally, if the coal lay beneath a regional sealing formation, the CO₂ would be immobilized by the cavity walls, first, the coal matrix, second, and a caprock, third. This kind of storage reinforcement could lower storage risk and increase confidence in storage.

It may be that the potential problems with cavity storage outweigh potential benefits. The first is that the cavity itself is quite disturbed. Heating, quenching, water flux, and potential roof and wall collapse may seriously compromise the integrity of the cavity. It is known that such processes operate in UCG sites, and it may be difficult to predict or measure their extent before CO₂ storage. Although thoughtful site selection could mitigate some of these concerns, it is not likely that they will entirely be redressed.

Secondly, CO₂ will interact with water to form carbonic acid. It may interact with the coal, char, and ash to form sulfuric acid. These acids could migrate out of the cavity with CO₂ and react with the rock and fluid crustal mass. In these cases, the risk for leaching metals and other harmful chemicals into water may be substantial. In addition, volatile organic compounds (VOCs) like benzene may dissolve into the CO₂ and be transported out of the reservoir and travel upwards through the crust with CO₂. Such processes could conceivably increase the risk of groundwater contamination even for deep UCG projects.

Finally, the crust is a complex heterogeneous medium. There is always some uncertainty in subsurface operations. While that uncertainty may affect neither the UCG effort nor a separate CCS effort, the uncertainties in initial fracture distribution, bulk crustal response, fracture development due to subsidence, and the composition of cavity brines and chars could substantially complicate storage efforts. Given that CO₂ injection will create changes in temperature, pressure, stress, pH, chemical concentrations, coal permeability,

porosity, and reaction kinetics (Figure 6-3), a scientific program to better understand the responses to these transients would be well advised.

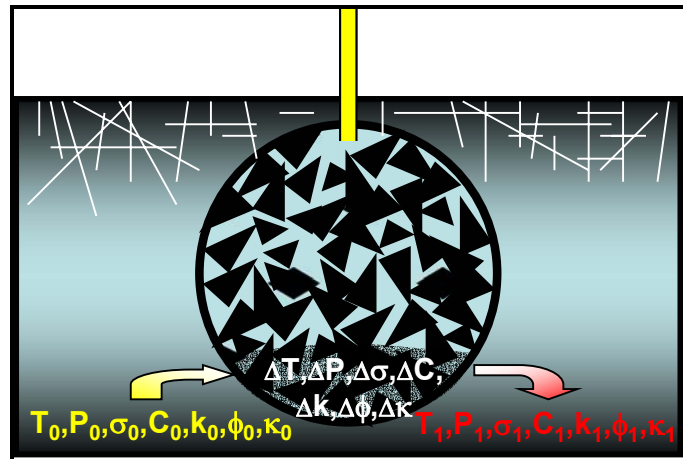

Figure 6-3: A schematic diagram of the physical and chemical transients that affect reactor zone characteristics

6.3.2 Description of Key Scientific Concerns

At the least, storage in evacuated cavities must occur with supercritical CO₂ in order to store substantial volumes of CO₂. This will limit coupled storage to UCG projects below 800m of hydrologic head, and in some cases deeper. This will also limit the timing of injection to sometime after quenching of the cavity. If not, the active or residual thermal anomalies could cause the CO₂ to expand to gaseous state or at the least increase cavity pressure and attendant risk.

Unfortunately, if injection occurs after the cavity is filled with brine, any VOCs in the cavity may be forced out with the expelled water. This suggests that at a minimum hydrologic flow be confined to saline formations with good top-seals. Fortunately, the expelled water should not be buoyant and is likely to remain near the target.

Before a substantial program of intra-cavity CO₂ injection begins, a number of key scientific concerns should be addressed. This initial list delineates some of the larger concerns and attempts to bound the necessary science to address them:

- **T-P constraints:** The cavity temperature at a given pressure must be sufficiently low to avoid flashing or boiling of CO₂ at injection pressures. Similarly, the injection pressure must be sufficient to remain supercritical and ideally to prevent flashing. *The risk of sudden phase change must be well understood as an initial condition for cavity injection, and will require both experiments and simulation;*
- **Geomechanical response:** The injection pressure must exceed hydrostatic pressures in order to displace cavity water. This will prompt a number of

geomechanical responses, such as fracture dilation, crustal uplift, and potentially inducing fracture. These will vary as a function of stress tensor and fracture geometry, which may be difficult to characterize in this setting. This risk may be accentuated by the collapse of the cavity roof or walls. In contrast, coal swelling will cause fracture closure. *Valid geomechanical models for stress and rock deformation are required, as are coupled geomechanical/fluid-flow simulators;*

- **Ground-water displacement risk:** Cavity injection above hydrostatic pressures will displace cavity brines into the coal seam and adjoining formation. This may flush VOCs or high metal concentrations from the cavity into saline aquifers or coals. *The nature of these materials should be circumscribed, and the concentrations and fate of these materials reasonably well characterized through experiments and simulations;*
- **Geochemical response:** CO₂ injection will form carbonic acid in the cavity, which may react quickly with the coal, rock, ash, or slag in the cavity. This could leach metals into the cavity water elevating risk of groundwater contamination. Similarly, injection could mobilize sulfur from these materials to form sulfuric acid, further altering the local chemistry and increasing risk. VOCs could dissolve into the CO₂ and move with mobile phases. *The key suite of reactive species for typical coals should be studied experimentally as a basis for reactive transport simulation;*
- **CO₂ fate:** Free-phase CO₂ would remain supercritical and buoyant. This would create its own upward pressure on the cavity, and lead to the same set of risks commonly considered for conventional CO₂ storage. In this environment, the geomechanical, fault migration, and well-leakage risks may be greater due to the thermal stresses and shocks of heating and quenching. The specific leakage risks for cavity storage should be further delineated and considered in concert with conventional processes (e.g., coal-gas adsorption).

The magnitude of these scientific tasks is great, and the system both non-linear and poorly constrained. As such, a substantial research effort would be required to being addressing chief concerns.

6.3.3 Outline of Scientific Program to Address RZCS Hazards and Risks

This preliminary analysis reveals a set of potential concerns that might arise from CO₂ injection into UCG cavities. However, the advantages could still be substantial, and if sites are chosen properly to reduce stratigraphic and structural risks, the concerns may be reasonably managed.

A thoughtful, targeted research program could serve to better delineate the key aspects of geologic CO₂ storage risk. Such a program would necessarily have a large component of

simulation and laboratory work, given the lack of storage efforts at any current UCG field sites (many of which are too shallow for CO₂ injection). Improved geomechanical models would be central to this effort, and should be able to simulate both discrete fracture networks and tunnel collapse due to stress changes. Good simulations would also have some stratigraphic richness regarding the hosting and adjacent strata and should be supported by focused CO₂ laboratory experiments conducted on materials of chief concern (e.g., tars, chars, and slagged ash). Each of the topical areas would require some focus, and a substantial risk assessment should be undertaken before a field site is selected for CO₂ cavity injection.

7 Best Practices and Lessons Learned

The extensive experience, lengthy literature, and current commercial experiments with UCG provide enough information to begin to distill a few key learnings. These are meant to advise potential investors, operators, regulators, and decision makers in planning, approving, and ultimately operating UCG sites. These learnings are spelled out in some depth below, but can be reduced to a few quick discussion points:

- Geological characterization of a site is central to technical success and environmental risk management;
- Advanced simulation can help provide insight into planning surface facilities, operational programs, and environmental due diligence;
- UCG projects should be operated at negative reactor pressure so as to draw water into the reactor zone.

7.1 Siting and Operation

Table 7-1: Minimal requirements for UCG siting and operation

	Minimal requirements	Additional notes
Coal Rank	Must be bituminous or lower rank	May have difficulties with high ranked bituminous coals
Coal seam thickness	> 0.5 m thick	Best performance above 1.5 m thickness
Seam depth	12 m	Preferred deeper than 150 m
Site access	Must have broad drilling and monitoring access	
Water table	Must be below water table	
Water composition	Should not be source of local drinking water	Best if not potable water i.e. TDS >1,000 ppm

UCG may safely operate under many different conditions and ranks of coal. However, in the near term, environmental concerns prompt consideration of site characteristics well before burn initiation:

- Potential sites must meet minimal requirements (Table 7-1);
- Stratigraphic and structural characterization is needed to satisfy information requirements for rapid qualitative risk protocols (See Section 5 above);
- Preferred consideration should be given for sites deeper than 200 m;
- Preferred consideration should be given for sites with strong or rigid overlying strata;
- Downgraded consideration should be given to sites where the coal seams or surrounding strata act as aquifers that may be USDWS;

- Downgraded consideration should be given to heavily deformed structures or steeply dipping seams.

In particular, the first two points are most critical to determining the likely commercial, technical, and operational success of operations. Several of the other concerns could be rapidly tested and altered in characterization (e.g., steeply dipping seams). However, these sites would also be sites of higher initial risk, and some mitigating factor should be investigated to offset that initial increase in risk.

7.2 Initiation of UCG Burns

As of today, there are several different approaches to initiating UCG (e.g., ϵ UCG, CRIP, open mine initiation). Given the literature as it stands, it is not clear which technologies are best suited to initiation of burns or UCG management. Because burn initiation is critically dependent on establishing atmospheric connection between injection and production wells, choice of technology will depend greatly on the permeability and transmissivity of the coals themselves. Again, this places a premium on site characterization before project testing begins.

7.3 Surface Facility Planning and Operation

The Chinchilla project demonstrated that UCG syngas could be delivered at a fairly constant rate and composition. However, given current technical knowledge and experience, it is clear that variance in gas content, quality, composition, and flux is non-negligible. In addition, some fraction of tar, VOC, mercury, and sulfur will be produced, although these will be in smaller concentrations and volumes than conventional surface gasification.

In this context, surface facilities must be engineered to handle the swings in production characteristics. While there are many possible solutions, such provision must be considered early on given the composition and depth of the seam in question. Advanced simulation can provide insight into the likely variance of systems in question.

7.4 Extended Operation

The likely uses for UCG syngas (e.g., liquid fuels, electric power generation) require substantial capital investments in fixed facilities. Initially, the UCG reactors can be quite close to these facilities. However, through time UCG wells will naturally step further and further away from the surface plants to access new coal supplies. While the total footprint may remain quite small, it is likely that pipelines will be needed to bring the syngas to the plants at some early date. This presents a minor challenge to operators, but one that must be planned during the initial development phases of the project.

7.5 Environmental Management

7.5.1 Well Design and Construction

Well integrity is important to protect groundwater and to control the combustion process. Well siting should avoid locations showing rock deformation and subsidence that could affect casing integrity. Directional drilling can potentially be used to avoid siting a well in a geologically unstable area. Well construction materials need to withstand elevated temperatures and corrosion caused by injection and produced fluids. Mechanical integrity testing is recommended initially and at regular intervals during the UCG project.

7.5.2 Well Operation

The pressure at which air, steam or other fluids are injected into the seam is key to controlling the combustion process and to prevent loss of produced gases and migration of contaminants away from the reaction zone. Too high an injection pressure, as at Hoe Creek, significantly increases the risk of spreading contamination to groundwater. Limits on injection pressure need to be established in advance and monitored carefully throughout the operation. The Soviet method of enhancing permeability between injector and producer wells also ensures that product gases and volatile contaminants will travel in the high permeability conduit preferentially over secondary migration paths.

Maintaining an appropriate injection flow rate also is important. High flow rates can serve to gas-lift groundwater and contaminants from the reaction zone to the surface. Optimized flow rates also maintain the desired combustion temperatures which ensure combustion of many contaminants.

7.5.3 Burn Front Monitoring and Control

Cavities created by in-situ combustion may result in formation collapse that may compromise the integrity of the injection and production wells as well as any stratigraphic seals above the coal seam. Monitoring and controlling the burn front can prevent unintended paths and excessive cavity growth too closely around wells (See section 7.5.7).

7.5.4 Closure and Abandonment

When coals are used for in-situ recovery have hydraulic communication with a USDW, any contaminants that remain in the reaction zone must be removed to avoid subsequent groundwater contamination. At test sites in the U.S., removal has been achieved by controlled flooding and pumping of the reaction zone. In addition, plugging the entire length of the well and following proper procedures for well abandonment for the injection, production and monitoring wells is important. Plugging with cement, bentonite

or drilling mud may prevent contaminant migration. Depending on the type of bottomhole completion and the well position relative to the reaction zone, plugging may require setting a packer at the bottom of the casing and then filling the well.

7.5.5 Groundwater Protection

The events at Hoe Creek and the Williams site have raised reasonable concerns about the hazards UCG might present to groundwater quality. The Chinchilla project demonstrated that these hazards could be managed by maintaining reactor pressure below the ambient pressure field ("*negative pressure*", usually near lithostatic). In such cases, water flow from the host rock into the UCG cavity, thereby preventing transport of contaminants into adjacent aquifers. Operating at negative pressure can dramatically reduce risks posed by UCG groundwater hazards.

In addition to poor siting, both the Hoe Creek and Williams cases became problems because they took place within potable aquifers. Another method to avoid freshwater contamination is to operate at depths well below fresh water systems. In many basins, formation water below 150-200m depth is too saline for conventional uses; as such, operation at or below these depths is generally advised. However, it should be noted that in some locations the vadose zone is very deep (>300m) and fresh water may occur in units much deeper than 500 m. In general, these zones are recognized, and it is relatively simple to avoid operation within them.

7.5.6 Subsidence Management

Because UCG transforms coal to gas and evacuates that gas to the surface, the rock volume is necessarily reduced. The resulting subsidence is comparable to that accompanied with long-wall mining techniques when UCG operates at similar depths. Where coal overburden is weak, subsidence effects are likely to be more discrete and potentially disruptive.

Management and mitigation of that subsidence can be accomplished in several ways. First, selecting a seam at great depth will reduce the likely effects of subsidence. In general, evacuation of seams greater than 200m in depth will have minimal surface expression, in part because the mechanical strength of many lithologies increases with depth within the UCG window. Alternatively, it may be possible to reduce subsidence effects if overburden rocks have high yield strength.

Second, proper structural and geomechanical characterization of overlying units is central to management of subsidence. Simple geological mapping and limited geophysical surveys can greatly reduce uncertainty in likely subsidence by identifying potential hazards (e.g., large faults). Similarly, laboratory tests on representative overburden lithologies can provide some estimates for crustal strength above UCG targets. Finally, there are many commercial codes for structural analysis (e.g., TrapTester, Rockware,

Petrel, GeoSec) that could be used or modified to provide insight into potential risks. Of course, advanced simulations may provide results that are substantially better and lower in uncertainty, and may be warranted given the goals and characteristics of a given project.

Finally, monitoring of subsidence in real time can both track changes at the surface and anticipate potential problems. See Section 7.5.7 below.

7.5.7 Monitoring

Both groundwater and subsidence concerns can be managed through monitoring of field operations. At Chinchilla, 19 wells monitored pressure and water chemistry to provide data relevant to groundwater contamination. This effort was central to the validation of UCG not producing groundwater degradation. Similarly, subsidence could be monitored with arrays of conventional passive geophysical tools, including GPS stations, InSAR, and tilt-meter arrays. Microseismic arrays could detect mechanical failure in anticipation of plug flow, chimneying or shallow venting of product gas. Shallow electrical arrays such as electrical resistance tomography or electromagnetic induction tomography could provide insight to cavity evolution, groundwater transport, and potential loss of product gas. Such monitoring could alert operators to early unexpected complications in crustal response to UCG operations.

It should be mentioned that early commercial pilots of UCG might consider parallel science programs that feature multiple monitoring approaches. Such approaches provide insight into crustal processes and features as well as build data sets that help allay concerns of public stakeholders and potential investors. This case was made strongly in CO₂ storage operations. The Sleipner and Weyburn projects, both commercially driven, had sustained and substantial scientific and technical programs, SACS and the Weyburn storage project (Torp and Gale, 2002; Wilson and Monea, 2004). These research programs provided tremendous technical insight as well as a basis for future regulatory consideration and public outreach programs. Validation of safe operation could greatly increase the commercial prospects of UCG as an energy technology.

Moreover, there remains substantial potential to monitor and possibly control reactor processes. Monitoring of UCG is currently in its infancy. Pending commercial or demonstration projects could benefit substantially from a comprehensive monitoring program aimed at improving understanding of in-situ gas conversion and aqueous transport near the reactor zone. See Section 8.2.2 for more discussion of R&D gaps in UCG monitoring.

7.6 Carbon Management

7.6.1 Site Selection

In addition to considerations for UCG siting, concerns about the potential siting of large GCS operations requires additional focus and due diligence. A substantial literature exists on the potential siting needs of GCS sites, and while a set of protocols has not yet developed or received widespread acceptance, a number of consensus positions have emerged (e.g., Friedmann 2005). These include a need for understanding the injectivity of target formations, their long term capacity for storage, and their overall effectiveness. Such characterization is inexpensive but crucial to technical success.

In general, it is possible to collect data for GCS when collecting data for UCG site characterization. The same sets of data (e.g., well logs, geophysical surveys, core analyses) are relevant to both problems. Data availability will affect ease of site characterization, and in some cases new data may need to be collected to properly understand the potential risks of project siting and operation (e.g., MIT report; IEA/CSLF report).

7.6.2 CO₂ Capture and Separation

As mentioned in Section 7.1, CO₂ must be separated and concentrated (>95% purity) for injection. Many UCG applications (e.g., synthetic natural gas, liquid fuels, hydrogen production) create by-product streams of CO₂ at this level of purity suitable for GCS. In the case of power generation, CO₂ may be separated from the syngas pre-combustion using the Selexol or Rectisol processes at relatively low costs (~\$0.01/kW-h; \$24/t). This would allow power generation from UCG syngas with the carbon footprint of a conventional NGCC facility.

In the cases of deep UCG operations (>600 m depth), the syngas stream will reach the surface at high pressure. In some commercial applications (e.g., methanol or DME formulation) that pressure may be used reduce operational costs and “energy penalty”. Similarly, some CO₂ capture technologies perform better at high pressure (e.g., fluorinated solvents, Nexant’s CO₂ hydrate process). It may be possible to reduce capture and separation costs further using these approaches. However, some of these approaches have not been tested at large commercial scale and would require further analysis before deployment.

7.6.3 CO₂ Storage

As discussed above and in Section 5, proper site characterization and selection will be critical to project success. In general, conventional storage operations (in saline formations and hydrocarbon fields) are reasonably well understood. GCS in these units is not likely to present any additional risk to UCG operations and should be considered

targets in the initial project formulation. In contrast, storage in unconventional units (e.g., oil shales, basalts) would require more advanced scientific knowledge than currently available to obtain their benefits.

Similarly, GCS in the reactor zone (RZCS) presents both substantial opportunity but also substantial risk (Blinderman and Friedmann 2006). While it may prove possible to store substantial volumes of carbon dioxide within reactor zone structures, more technical knowledge is needed to understand and constrain the likely operational concerns. If this option is of substantial interest to operators, an accelerated research program could provide constraints on likely operating conditions, potential storage volumes, and risk characterization, management and mitigation.

8 Technology Gaps and Recommendations

A number of scientific and technical knowledge gaps need to be bridged before UCG can be applied routinely. Here we summarize our understanding of what we need to know in order to bridge this gap between our present knowledge and the knowledge necessary for an improved technical understanding of UCG.

The knowledge gaps can be put into two major categories:

- Needed improvements to the CFD gasification model:
 - Steady-state → Dynamic
 - 2-D → 3-D model; no axial symmetry
 - Increase the length of the channel
 - Include radiation
 - Include coal → methane kinetics
 - Treat some reactions as surface reactions
 - Include separate kinetics for combustion and reforming
 - Improvements in the treatment of/coupling to the porous zone
 - Calculate local recession rate for coal
 - Integration of Aspen with the CFD model;
- Improvements to the environmental assessment and monitoring tools
 - Electrical resistance tomography (ERT) and EM induction tomography (EMIT)
 - Passive seismic monitoring (e.g., microseismic)
 - Crust deformation tools, such as tilt-meter, InSAR and GPS
 - Understand and predict acoustic, thermal, electrical, deformational and gravitational transients
 - Integration and inversion techniques, including stochastic inversion using Monte-Carlo Markov-chain approaches
 - Measuring and predicting the effects of UCG burn-induced changes in stress fields on rock properties
 - Experimental simulations of UCG-effects on rock-fluid systems.

8.1 R&D Gaps

Despite the availability of the tools listed above, research is still needed to ensure that the models can be readily applied to the proper site selection to provide both the desired conditions for suitable UCG processes and the confidence that the usable groundwater resources are not adversely impacted. Even though most UCG operations have not produced any significant environmental consequences, some UCG demonstrations (including two in the U.S.) resulted in contamination of groundwater resource. A

combination of site-selection, operational and monitoring criteria need to be developed to directly address the issue of environmental risk posed to groundwater.

Site and process considerations are inter-dependent, one will affect the other. The parameters associated with the relevant process need to be explored to identify, in a quantitative context, which scenarios are most favorable and which are least, for UCG at a particular site. Also, the coal seam should be located in a region where the products of UCG can be used; otherwise an expensive transportation or conversion scenario would develop. Once the models are unified, such considerations will be an integral part of the model, rather than *ad hoc*, stand-alone factors to be considered in series.

8.2 Technology Gaps

8.2.1 Improved Combustion/Gasification Models

In general, the basics of combustion processes are well understood. A number of national laboratories and universities have the general capability to address issues of ignition, flame extinction, emissions, performance modification both for enhancement and for inhibition of combustion, and overall performance for a wide range of practical fuels, and have the capability to develop comparable models for fuels not previously studied.

Extensive modeling of UCG processes was done at the Lawrence Livermore National Laboratory during the late 1970s and mid 1980s, using the best tools available at that time (e.g., Kang, 1986) . However, major changes have taken place in computers, software and the methodology of modeling in the last twenty years. In addition, more has been learned on the mechanism of how pollutants leave the gasification zone and move to the surroundings. For these reasons, the currently available models are insufficient to address the current problems encountered in UCG. In addition, a number of environmental fate and transport models have been developed, which are disjoint with the existing process models.

LLNL and others have already started develop improved UCG models using computational fluid dynamics (CFD) (Wallman, 2005; Perkins, 2005). While these models constitute a step in the right direction, a number of improvements are needed before these models can be used for design, operation and control of UCG processes:

- **Steady-state-Dynamic:** The current CFD models are steady state, whereas in actuality, UCG processes are transient;
- **2-D→3-D model; no axial symmetry:** The current models are 2-D axisymmetric, whereas in reality, a UCG process geometry is 3-dimensional and asymmetric
Increase the length of the channel: Due to memory limitations, the LLNL model is limited to short lengths compared to actual UCG in the field;
- **Include radiation:** The LLNL model ignores radiative heat transfer, which, as high flame and wall temperatures can be significant;

- Calculate local recession rate for coal: both models ignore local recession rates of coal, whereas the coal recession rate is the main determinant of the cavity growth rate;
- Incorporate full product prediction: Combustion simulations should predict the formation, disposition, and production of complex gasification and partial combustion species. This includes produced tars, the down-hole char, and the fate of sulfur, mercury, and particulates.

The CFD models of UCG, mentioned above, are stand-alone models, and are not coupled with above-ground facilities. It would be very useful to couple the UCG process models with above-ground facilities models developed using a process simulator, such as AspenPlus, so that the entire process can be modeled at once rather than sequentially.

8.2.2 Improved Monitoring

To date, monitoring of UCG experiments and commercial operations has been quite limited. Usually, it involved placement of thermocouples in monitoring wells above shallow burns (Metzger, 1984; Beyer, 1986). Limited attempts have been made to test EM induction tools. In the Chinchilla experiment, groundwater pressure and composition was monitored in 19 wells surrounding the burn (Blinderman and Jones, 2002). As such, no UCG project has been monitored in such a fashion as to give detailed process control information or to show the evolution of the in-situ reactor.

Both geophysical and geochemical technologies can be used to assess the hydrology of a coal seam and its connectivity with nearby aquifers. However, standard approaches often are inadequate for application to UCG settings. For example, the extreme structural heterogeneity of coal-gas systems often precludes using seismic methods or formation evaluation to detect permeability conduits between coal seams and aquifers.

A small set of geophysical tools show particular promise in resolving process information and providing real-time information to operators. These are all essentially off-the-shelf technologies that could be immediately deployed in UCG monitoring, although they could be tailored to the task:

- Electrical resistance tomography (ERT) and EM induction tomography (EMIT);
- Passive seismic monitoring (e.g., microseismic);
- Crust deformation tools, such as tilt-meter, InSAR and GPS;
- Down-hole temperature, pressure, and chemical monitoring.

Although 3-D and 4-D reflection seismic monitoring could also provide key information, the high cost and long processing times limit its potential utility.

LLNL was a pioneer in the development of geophysical electrical resistance tomography (ERT) methods and has continued researching the technique. ERT images subsurface structure and processes using an array of in-ground or surface, electrodes to measure

voltages resulting from application of electrical currents to the subsurface. From these data, the distribution of electrical resistivity is calculated by minimizing the misfit between the data and voltages calculated from a numerical model. Depending on the completeness of the sampling, either a two- or three-dimensional reconstruction is possible.

ERT can be deployed using existing metal well casings as part of the monitoring equipment. This makes the technique particularly well suited to monitoring of oil and gas fields. The wellbore metal casings are used as long electrodes, along with specialized hardware that can produce, measure and switch currents of 10 amperes or higher (at about 100V). Vertical wells provide information regarding the lateral changes in a field; whereas horizontal wells yield information on changes with depth. In recent field tests using abandoned steel casings in an oil field undergoing a CO₂ flood, ERT-detected changes in the electrical properties were found to be consistent with production events (Newmark et al., 1999, 2000).

If imaging can be performed using well casings as electrodes, this provides a nearly noninvasive method and relatively low-cost method for monitoring. Using existing subsurface infrastructure requires no additional drilling. ERT surveys can be made in an automated, remote fashion. The ability to conduct surveys at any time, without disrupting operations, has distinct advantages over conventional cross-well and logging surveys that often require the removal of pumps and tubing from wells, thereby disrupting operations.

The ERT method has been used to image both static features and time-dependent processes in the subsurface, and is particularly well-suited for monitoring processes involving fluids. The electrical resistivity and impedance of rocks and soils depend on: water saturation, the amount and type of ions in the water, pH, cation exchange capacity of the minerals, and on temperature. As a result of these dependencies, high resolution tomography of electrical properties has been used with success for site characterization, imaging underground structures such as barriers designed to confine the spread of contaminated ground water, and to follow the subsurface movement of fluid plumes (e.g., Binley et al., 1996; Daily et al., 1992; Daily and Ramirez, 2000; Kemna, et al. 2000, Lundegard and LaBrecque., 1995, Newmark et al., 1998, Ramirez et al., 1993; Ramirez et al., 1996). It has been demonstrated to work to image fluid movement at shallow depths and in oil reservoirs over 5000 feet deep. While electrical resistivity studies of coal have been done (e.g., Singh, et al., 2004), there appear to be no published examples to date of using ERT to track coal seam waters in the subsurface. Because the progress of the UCG burn will cause large resistivity contrasts, ERT should be an optimal method to track the UCG process. The technique may also prove useful as an environmental monitoring tool to track any gas or water migration into overlying strata or aquifers.

Geochemical fingerprinting of waters in UCG sites can provide information on coal hydrology that would prevent subsequent aquifer contamination. In general, geochemical fingerprinting involves identification of trace constituents or isotopic ratios that change significantly through a water's compositional history. For example, radiogenic isotopes from cosmogenic sources with different half-lives can be used to bracket the ages of

waters. Iodine-129, with a half-life on the order of 16 million years, would occur in actively recharging groundwater, but be found only at low levels in connate waters coeval with a Cretaceous coal. Chlorine-36, with a half-life of 0.3 million years, would be completely decayed away in Cretaceous-aged water. In some cases, differences in major ion water chemistry may be diagnostic of a water's history, but it may be difficult to interpret these data because drilling, completion or workover fluids can contaminate major ion chemistry in wells for 6 months or more. Fingerprinting also can provide environmental forensic information in cases where UCG is implicated in environmental contamination, and can aid in characterizing the suitability of post-burn coal cavities for CO₂ sequestration or EGR. LLNL researchers have applied geochemical tracer techniques to tracking and fingerprinting groundwater in a variety of settings, including the Fruitland Formation in the San Juan Basin of the U.S, which is being exploited for coalbed methane (e.g., Snyder, et al., 2002, 2003).

A number of key learnings would come from direct subsurface monitoring during UCG. The first of these would be to provide real-time insight into potential hazards from UCG (e.g., subsidence, contaminant transport). The second would be to validate and improve simulations of UCG processes. The third is to improve understanding of key processes in the subsurface (e.g., geomechanical response to heating and evacuation of coal). Finally, monitoring holds out the possibility of real-time process control through rapid integration of monitoring data.

“Smart borehole casings” use a densely spaced network of sensors, emplaced along and outside oil well casings, to monitor critical parameters in subsurface reservoirs. Data from multiple sensor types are combined with modern data fusion technology to yield unprecedented, real-time knowledge of processes within the reservoir. The technology enables continuous, real-time mapping and monitoring of subsurface fluid composition and distribution in reservoirs. There are three aspects of this technology:

- Installing sensors on the outside of borehole casings before they are grouted in place;
- Installing multiple types of sensors that will produce complementary data;
- Processing these data sets using the stochastic engine, a Monte Carlo Markov Chain approach for statistically optimizing models based on integrated datasets (Ramirez et al., 2004).

This approach has several advantages over traditional approaches to obtain reservoir information by well-logging or other methods once well operations have commenced. Sensors located deep within the reservoir are much more sensitive than sensors located on the surface. They obtain data in real-time and continuously. The sensor hardware and data acquisition process do not interfere with normal well operations. The approach has a relatively low net operations and capital cost relative to existing methods for obtaining the same types of data sets. Data acquisition can be remote. Examples of sensors that can be installed include seismic sensors, electrical resistance tomography (ERT) electrodes, tiltmeters, electromagnetic (EM) induction tomography coils and thermocouples.

In addition to these scientific and technical values, there would be tremendous value for the commercial sector and key stakeholders (e.g., regulators, insurers, public agents) in the demonstration of knowledge, control, and predictability of in-situ coal conversion.

Remote sensing offers a rapid technique to monitor large areas for adverse environmental effects. If remote sensing surveys can be done prior to the initiation of operations, they also can provide evidence of baseline conditions against which future claims of environmental damage can be compared. Hyperspectral imaging, for example, can detect plant stress associated with gas leakage. LLNL also has begun investigating the applicability of NASA's new satellite instrumentation to directly measure gas compositions from space. While remote sensing techniques have been criticized in the past because they lacked the necessary resolution to address some environmental problems, new instruments and data processing techniques can achieve the necessary resolution to measure the environmental changes associated with gas leakage scenarios.

The risks associated with gas leakage to the near surface or surface, whether that gas is from the UCG operation or CO₂ sequestered after operations are abandoned, can be captured by coupling subsurface, vadose zone and atmospheric dispersion models to risk-indexing tools. For example, heavy gases like CO₂, if they reach unvented basements or the atmosphere through leakage up faults, leaky well seals or caprock seals, may accumulate to lethal levels. Outdoors, topographic lows and low-wind conditions are factors that increase the risk of local build-up to lethal levels. Such conditions can result in human and livestock fatalities. Methane is a light gas that is unlikely to accumulate outdoors, but it can accumulate in indoor areas and has the potential to ignite, causing explosions and/or fire. There are tools to assess these types of risks.

This approach has the potential to be used throughout the life of UCG-CCS projects. During site selection processes, it has application as a rapid screening tool to identify areas of high potential risk. Later, it can greatly enhance the effectiveness of risk mitigation efforts, for example, by targeting specific areas for detailed surveys for abandoned wells. Finally, it can be used as a "triage" tool, to identify areas for response efforts, should a catastrophic release occur.

8.2.3 Improved Environmental Simulation

Even though most UCG operations have not produced any significant environmental consequences, some UCG demonstrations (including two in the U.S.) resulted in contamination of groundwater resource. Integrated site-selection, operational and monitoring guidelines need to be developed to assure that all future UCG operations pose minimal risk to the environment. The standard types of hydrologic models used for environmental assessments are not appropriate for UCG and if used, may give spurious results.

These models do not include consideration of the full suite of effects of UCG operations, all of which can greatly influence flow fields and the consequent fate and transport of

contaminants during or after the burn. Specifically, models must include thermo-hydro-geochemical-geomechanical coupled processes to fully understand the risk to the subsurface environment of UCG, and how to reduce the risk of contamination from CO₂ leakage and/or seam collapse in the case of coupled UCG-CSS.

It is well known that there are interdependencies among hydrologic, geochemical and geomechanical changes in the subsurface. When the UCG process moves through the coal seam, there will be concurrent changes in rock stress fields, creating changes in fracture apertures, pore pressures, temperature and buoyancy gradients. In turn, these changes alter the hydrologic flow paths. Old minerals may dissolve or new minerals may form in newly open fractures and pore spaces, creating further changes in permeability. If subsequent EGR or CO₂ sequestration is part of the development plan, it is also important to ensure that modeling includes consideration of the effects of burn and CO₂ injection on hydrology, geochemistry and geomechanics, such as the creation of acidic aqueous conditions in aquifers that have the potential to enhance contaminant migration by creating permeability conduits through rock dissolution or solubilizing metals.

Bacteria in the subsurface (e.g., Amy and Haldeman, 1997), through natural aerobic biologic reactions, often provide one of the most effective ways to remediate organic compound contamination and some metals contamination, but it is difficult to obtain regulatory acceptance because it is difficult to assess rates of clean-up. LLNL has pioneered use of PCR (polymerase chain reaction) detection to quantify rates of natural bioremediation in the subsurface.

There are existing simulation tools available that can be linked and adapted to environmental risk assessment for UCG. Some of these were developed to provide environmental assessments for underground nuclear tests or to model nuclear storage scenarios that require consideration of the impact of thermal and geomechanical changes to flow fields. Examples include FEFLOW (a commercially available finite element simulator for modeling of flow and transport processes in porous media under saturated and unsaturated conditions that includes provision for density driven flow from thermal effects) and NUFT (a finite-difference based reactive transport model developed at LLNL). With respect to capturing geomechanical aspects, LLNL has a toolbox of forward and inverse geophysical solvers to model acoustic, thermal, electrical, deformational and gravitational transients, and integration and inversion techniques, including stochastic inversion using Monte-Carlo Markov-chain approaches. These tools are appropriate both for environmental risk assessment modeling and for interpretation of geophysical monitoring data.

While there is much work still to be done to create and integrated simulation model for UCG environmental risk assessment from existing component models, there is a larger gap to be filled with regard to the data needed to populate and test the model. These data gaps include:

- Identification of parameters controlling fate and transport (e.g., water solubility, organic carbon partitioning coefficient) for the potential contaminant compounds that may be generated by *in situ* burning of coal;
- Quantification of changes in the hydraulic conductivity tensor and porosity reflecting rock crushing and possible of fracture/fissure propagation in the vicinity of the collapsed zone;
- Model calibration to post-seam collapse hydraulic head and concentration measurements for pilot sites where historical data are available;
- Assembly of the thermo-hydrological model and calibration to existing thermohydrological data such as temperature profiles;
- Coupling the thermal effects on the density and viscosity to better mimic the pertinent physical processes and quantitative assessment of the effects of the thermally- and density-driven forces on the risk of contaminant migration;
- Quantification of bioattenuation effects (with bioattenuation rates derived from a literature review) and comparison to existing data, including the abundant literature describing hydrocarbon contamination migration in shallow groundwater systems.

Also, research is needed to ensure that the models can be used to screen candidate sites to provide criteria for proper site selection, addressing both the desired conditions for suitable UCG processes and conditions that minimize risk of contaminating groundwater resources. What is needed is a unified and integrated model that incorporates all the component models mentioned here: CFD process model for UCG; above-ground facilities model in Aspen; and the pollutants generation, fate and transport model.

8.2.4 UCG + CCS (Carbon Capture and Sequestration)

There exists a strong synergy between UCG and carbon sequestration. In some cases, there may be substantial cost reductions in carbon capture and separation due to the high temperatures and pressures available from UCG syngas streams. As mentioned earlier, the cavity developed during the course of UCG might be used for storing supercritical carbon dioxide. In all cases, it is highly likely that the neighboring rocks will contain saline formations (non-potable aquifers) or depleted oil and gas fields suitable for storing CO₂.

In the most likely case wherein neighboring formations are used for storage, the site characterization and storage risks are likely to be similar to conventional CCS sites (Blinderman and Friedmann, 2006). However, important gaps remain regarding how UCG operations might be reasonably integrated into commercial operations. Engineering considerations, potential systems feedbacks, and likely costs need to be considered as part of a system characterization. While it is not expected that this step is likely to be difficult technically, the gap remains today and requires some focus and study.

Should one try to store CO₂ in the evacuated reactor zone, much less is known about the likely risks of storage. This initial list delineates some of the larger concerns and attempts to bound the necessary science to address them:

- **T-P constraints:** The cavity temperature at a given pressure must be sufficiently low to avoid flashing or boiling of CO₂ at injection pressures. Similarly, the injection pressure must be sufficient to remain supercritical and ideally to prevent flashing. *The risk of sudden phase change must be well understood as an initial condition for cavity injection, and will require both experiments and simulation;*
- **Geomechanical response:** The injection pressure must exceed hydrostatic pressures in order to displace cavity water. This will prompt a number of geomechanical responses, such as fracture dilation, crustal uplift, and potentially inducing fracture. These will vary as a function of stress tensor and fracture geometry, which may be difficult to characterize in this setting. This risk may be accentuated by the collapse of the cavity roof or walls. In contrast, coal swelling will cause fracture closure. *Valid geomechanical models for stress and rock deformation are required, as are coupled geomechanical/ fluid-flow simulators;*
- **Ground-water displacement risk:** Cavity injection above hydrostatic pressures will displace cavity brines into the coal seam and adjoining formation. This may flush VOCs or high metal concentrations from the cavity into saline aquifers or coals. *The nature of these materials should be circumscribed, and the concentrations and fate of these materials reasonably well characterized through experiments and simulations;*
- **Geochemical response:** CO₂ injection will form carbonic acid in the cavity, which may react quickly with the coal, rock, ash, or slag in the cavity. This could leach metals into the cavity water elevating risk of groundwater contamination. Similarly, injection could mobilize sulfur from these materials to form sulfuric acid, further altering the local chemistry and increasing risk. VOCs could dissolve into the CO₂ and move with mobile phases. *The key suite of reactive species for typical coals should be studied experimentally as a basis for reactive transport simulation;*
- **CO₂ fate:** Free-phase CO₂ would remain supercritical and buoyant. This would create its own upward pressure on the cavity, and lead to the same set of risks commonly considered for conventional CO₂ storage. In this environment, the geomechanical, fault migration, and well-leakage risks may be greater due to the thermal stresses and shocks of heating and quenching. The specific leakage risks for cavity storage should be further delineated and considered in concert with conventional processes (e.g., coal-gas adsorption).

The magnitude of these scientific tasks is great, and the system both non-linear and poorly constrained. As such, a substantial research effort would be required to being addressing chief concerns. However, the advantages could still be substantial, and if sites are chosen properly to reduce stratigraphic and structural risks, the concerns may be reasonably managed.

8.2.5 Laboratory Experiments

To optimize UCG process design and to assess the fate and transport behavior of contaminant byproducts will require a number of laboratory experiments. Among the data needed are the solubilities of coal-derived chemical contaminants in water at high temperatures and pressures and in supercritical CO₂, the types of contaminants leached from various types of coals under various conditions, and the potential for and kinetics of biodegradation and other types of reactions that could destroy or alter these contaminants in situ.

8.2.6 Integrated Process and Subsurface Modeling

Site and process considerations are interdependent, one will affect the other. The parameters associated with the relevant process need to be explored to identify, in a quantitative context, which scenarios are most favorable and which are least, for UCG at a particular site. Once the models are unified, such considerations will be an integral part of the model, rather than *ad hoc*, stand-alone factors to be considered in series. Advanced simulation tools that integrate a host of surface and subsurface processes would serve a number of useful ends:

- To vet possible operational scenarios, including drilling configuration, injection rates, injectate compositions, and surface plant design.
- To constrain operational parameters, including end-member scenarios, reactor pressure and subsidence tolerances, and well density.
- To understand engineering systems response, including incorporation of CCS into UCG operations.
- To plan and execute monitoring programs, including array design and interpretation of monitoring signals.
- To improve environmental management, including coupled subsidence/groundwater effects, fate and transport of contaminants, reactor zone carbon storage, and potential mitigation strategies.

Much prior work was done with highly simplified, linear models. Many modern approaches provide information of greater accuracy and precision that lead to better insight. For example, modern computational fluid dynamics (CFD) codes improves accuracy of many syngas parameter, including analysis of gas composition production of contaminants of concern. The preceding sections discuss many of the needs for individual components (e.g., CFD, environmental modeling), but the non-linear nature of the crustal response to perturbations and the complexity of the integrated system present a need for an integrated capability. A research program aimed at providing integrated simulations and characterizations could help decision makers, regulators, and operators in their tasks.

9 References

- Aiman, W.R., R. J. Cena, R.W. Hill, C. B. Thorsness, and R. R. Stephens, 1980, Highlights of the LLL Hoe Creek No. 3 Underground Coal Gasification Experiment., Lawrence Livermore National Laboratory, Livermore, CA. UCRL-83768.
- Allen, J.R.L., 1990, The formation of coastal peat marshes under an upward tendency or relative sea level, *J. of the Geol. Soc. London*, 147, 743-745.
- Ambrozic, T, and Turk G., 2003, Prediction of subsidence due to underground mining by artificial neural networks *Computers & Geosciences* 29, 627–637
- Amy P. and Haldeman D.L., 1997, *The Microbiology of the Terrestrial Deep Subsurface*. CRC Press, New York.
- Bartle, K., 1991, Solubilities of solids and liquids of low volatility in supercritical carbon-dioxide. *Journal Of Physical And Chemical Reference Data*, 20(4): 713-756.
- Beauboeuf, R.T, McLaughlin, P.P., Bohacs, K.M., Suter, J.R., and Devlin, W.J., 1995, Sequence stratigraphy of coal-bearing strata, Upper Cretaceous, Washakie basin, southwest Wyoming (abs.): AAPG Annual Meeting Abstracts, p. 7-8.
- Bechtel and General Electric, 2005, About IGCC Power. <http://www.clean-energy.us/facts/igcc.htm>
- Beyer, L., et al., 1986, Large Scale Apparatus for Simulating UCG, Proceedings of the Twelfth Annual Underground Coal Gasification Symposium, DOE/FE/60922-H1.
- Binley, A., S. Henry-Poulter and B. Shaw, 1996, Examination of solute transport in an undisturbed soil column using electrical resistance tomography, *Water Resources. Res.*, 32(4), 763-769.
- Blinderman, M.S., and Jones, R.M., 2002, The Chinchilla IGCC Project to Date: UCG and Environment, 2002 Gasification Technologies Conference, San Francisco, USA, October 27-30, 2002.
- Blinderman, M.S., 2003a,
- Blinderman, M.S., 2003b,
- Blinderman, M.S., 2005a, UCG History. http://www.ergoexergy.com/eUCG_his.htm
- Blinderman, M.S., 2005b, eUCG. <http://www.ergoexergy.com/eucg.htm>

Blinderman, M.S. and Friedmann, S.J., 2006, Underground coal gasification and carbon capture and storage: Technologies and synergies for low-cost, low-carbon syngas and secure storage. Lawrence Livermore National Laboratory, Livermore, CA. UCRL-ABS-218560.

Bohacs, K.M, and Sutter, J., 1997, Sequence Stratigraphic Distribution of Coaly Rocks: Fundamental Controls and Paralic Examples, AAPG Bulletin, 81, 1612- 1639.

Bradshaw, J.B. and Dance, T., 2005, Mapping geological storage prospectivity of CO₂ for the world sedimentary basins and regional source to sink matching. Proceedings of the 7th International Conference on Greenhouse Gas Technologies (GHGT-7), September 5-9, 2004, Vancouver, Canada, V. I, 583-592.

Britten, J. A., 1985, Modeling Thermal and Material Interactions Between A Reacting Char Bed and A Gasifying/Spalling Coal Roof., Lawrence Livermore National Laboratory, Livermore, CA. UCRL-92488-abstract.

Britten, J. A., 1986, Mechanistic Model For Axisymmetric UCG Cavity Growth. Part 2, Parameter Study And Comparison With Field Data, Lawrence Livermore National Laboratory, Livermore, CA. UCRL-94420-abstract.

Britten, J.A., 1987, Further Development Of An Axisymmetric Global UCG Cavity Growth Simulator, Lawrence Livermore National Laboratory, Livermore, CA. UCRL-96461-abstract.

Britten, J. A., and C. B. Thorsness, 1988, A Mechanistic Model for Axisymmetric Cavity Growth during Underground Coal Gasification., Lawrence Livermore National Laboratory, Livermore, CA. UCRL-97604.

Burton, E.A., Upadhye, R., Friedmann, S.J., Leif, R., McNab, W., Knauss, K., Ezzedine, S., Smith, J.R., 2004, Assessment of UCG site locations. Lawrence Livermore National Laboratory, Livermore, CA. Internal report.

Campbell, J. H., Pellizzari, E. and Santor, S., 1978, Results of a Groundwater Quality Study Near an Underground Coal Gasification Experiment (Hoe Creek I). Lawrence Livermore National Laboratory, Livermore, CA. UCRL-52405.

Campbell, J. H., Wang, F. T., Mead, S. W. and Busby, J. F., 1979, Groundwater quality near an underground coal gasification experiment. J. Hydrology 44, 241-266.

Cena, R.J., Hill R.W., Stephens, D.R., Thorsness, C.B., 1984, The Centralia Partial Seam CRIP underground coal gasification experiment, Lawrence Livermore National Laboratory, Livermore, CA UCRL-91252.

Cena, R. J., et al., 1987, Excavation of the Partial Seam Crip Underground Coal Gasification Test Site. Lawrence Livermore National Laboratory, Livermore, CA UCRL-97245.

Chaback, J.J., Morgan, W.D., and Yee, D., 1996, Sorption of nitrogen, methane, carbon dioxide and their mixtures on bituminous coals at in-situ conditions. *Fluid Phase Equilibria* 117 , 289-296.

Chandelle, V, 1986, Overview About Thulin Field Test, Proceedings of the Twelfth Annual Underground Coal Gasification Symposium, DOE/FE/60922-H1.

Cobble, J. W. and Lin, S. W., 1989, *The ASME Handbook on Water Technology for Thermal Power Systems* (Ed. P. Cohen), American Society of Mechanical Engineers, New York.

Cotter, E., 1976, The role of deltas in the evolution of Ferron Sandstone and its coals, Castle Valley, Utah. *Brigham Young University Studies* 22, part 3, p. 15-41.

Courel, L, 1989, Organics versus clastics: conditions necessary for peat (coal) development. *Int. J of Coal Geology*, 12, 193-207.

Covell, J. R. and Thomas, M. H., 1996, Combined Air Sparging and Bioremediation of an Underground Coal Gasification Site. EG&G Report DE-AC21-95MC31346.

Creedy, D. P., and K. Garner, 2004, Clean Energy from Underground Coal Gasification in China, DTI Cleaner Coal Technology Transfer Programme, Report No. COAL R250 DTI/Pub URN 03/1611, February 2004.

Creedy, D. P., et al., 2001, Review of Underground Coal Gasification Technological Advancements, DTI Report No. COAL R211, DTI/Pub URN 01/1041, August 2001.

Daily, W., A. Ramirez, D. LaBrecque and J. Nitao, 1992. Electrical Resistivity Tomography of Vadose Water Movement, *Water Resources Research*, v. 28, no. 5, 1429-1442.

Daily, W. and A. Ramirez, 2000, Electrical imaging of engineered hydraulic barriers, *Geophysics*, vol. 65, no. 1, pp. 83-94.

Dalrymple, R. W., Zaitlin, B.A. and Boyd, R., 1992, Estuarine facies models: conceptual basis and stratigraphic implications. *J. Sedimentary Petr.*, 62, 1130-1146.

Dalton, S., 2004, Cost Comparison IGCC and Advanced Coal, July 2004.
http://www.climatevision.gov/pdfs/coal_roundtable/dalton.pdf#search=%22Stu%20Dalton%20IGCC%22

Dames & Moore, 1995, Draft Coring Report, Hoe Creek UCG Site, Campbell County, WY. Report prepared for U.S. Army Corps of Engineers under Contract #DACW45-93-D0021.

Dames & Moore, 1996, Final Project Summary Report Drill and Sample Monitoring Wells for Remediation at Hoe Creek UCG Site, Campbell County, Wyoming. Job # 13474-021-030. March 27, 1996.

Davis, W.M., 1902, Base-level, grade, and peneplain: *J of Geology*, 10, 77-111.

deCrombrughe, O., 1959, Underground gasification (of coal) in the USSR, US Dept. of Interior Translation TN7, E59 394, from *Annales des Mines de Belgique* 5, 478-534

Energy Blog, 2005,
http://thefraserdomain.typepad.com/energy/2005/09/about_igcc_powe.html

Friedmann, S.J. and Nummedal, D., 2003, Reassessing the geological risks of seals failure for saline aquifers and EOR projects. Second Annual Carbon Sequestration Conference, DOE/NETL, Alexandria, VA.

Friedmann, S.J., 2005, Underground Coal Gasification in the USA and Abroad, Congressional hearing on climate change, November 14 in the Senate Foreign Relations Committee.

Gadelle, C., et al., 1985, Status of French UCG Field Test at La Haute Deule, Proceedings of the Eleventh Annual Underground Coal Gasification Symposium, DOE/METC-85/6028 (DE85013720).

Gregg, D.W., 1977, Ground subsidence resulting from underground coal gasification, Lawrence Livermore National Laboratory, Livermore, CA, UCRL-52255.

Gregg, D. W. and Edgard, T. F., 1978, Underground Coal Gasification. *AIChE J.* 24, 753-781.

Gregg, D. W., Hill, R. W., and Olness, D.U., 1976, An Overview of the Soviet effort in underground coal gasification. Lawrence Livermore National Laboratory, Livermore, CA UCRL-52004.

Grens, E.A., 1985, Effect Of Non-uniform Bed Properties On Cavity Wall Recession. Lawrence Livermore National Laboratory, Livermore, CA. UCRL-92487.

Halmann, M.M. and Steinberg, M., 1999, Greenhouse Gas Carbon Dioxide Mitigation. Lewis Publishers.

- Hamilton, D.S, and Tadros, N.Z, 1994, Utility of coal seams as genetic stratigraphic sequence boundaries in non-marine basins: an example from the Gunnedah basin, Australia. AAPG Bulletin, 78, 267-286.
- Hartman, H.L. (ed.) 1992, SME Mining Engineering Handbook, Society of Mining and Metallurgy, and Exploration, Littleton, CO, 2394p.
- Hendricks, M. L., 1981, Stratigraphy and tectonic history of the Mesaverde Group (Upper Cretaceous), east flank of the Rock Springs uplift, Sweetwater County, Wyoming: Ph.D. thesis, Colorado School of Mines, 179 p.
- Hill, R. W., 1986, Review of the CRIP Process, Proceedings of the Twelfth Annual Underground Coal Gasification Symposium, DOE/FE/60922-H1.
- Hill, R.W. and Thorsness C.B., 1983, Large-block experiments in underground coal gasification, Lawrence Livermore National Laboratory, Livermore, CA UCRL-87611-R2
- Hill, R.W., et al., 1983, The Centralia Partial-Seam CRIP Test. Lawrence Livermore National Laboratory, Livermore, CA UCRL-89010.
- Hill, R.W., Thorsness, C.B., Cena R.J., and Stephens, D.R., 1984, Results from the Centralia Underground Coal Gasification, Field Test, Lawrence Livermore National Laboratory, Livermore, CA UCRL-90680.
- Humenick, M. J. and Mattox, C. F., 1978, Groundwater pollutants from underground coal gasification. Water Res. 12, 463-469.
- Humenick, M. J. and Mattox, C. F., 1982, Characterization of condensates produced during underground coal gasification. In Situ 6, 1-27.
- Humenick, M. J., Morgan, J. R. and Nolan, B. T., 1987, Adsorption of UCG organics by coal, char, activated char and ash. In Situ 11, 329-347.
- Humenick, M. J. and Novak, A. E., 1978, Parametric analysis of pollutant migration following in situ gasification of lignite. In Situ 2, 329-352.
- Jervey, M.T., 1988, Quantitative geological modeling of clastic depositional systems and their seismic expression. In CK Wilgus et al. (eds), Sea-level changes: an integrated approach. SEPM Spec. Publ. 42, 183-213.
- Jou, F.-Y. and Mather, A.E., 2003, Liquid-liquid equilibria for binary mixtures of water + benzene, water + toluene, and water + p-xylene from 273K to 458K. J. Chem. Eng. Data 48, 750-752.
- Kang, S-W., 1986, Computational Packed-bed Analysis Related To Coal Gasification

Processes. Lawrence Livermore National Laboratory, Livermore, CA. UCRL-94421-abstract.

Karmis, M., C. Haycocks, and Z. Agioutantis. 1992. *The prediction of ground movements caused by mining*. p. 1-9, In: Proceedings, Third Workshop on Subsidence Due to Underground Mining. Dept of Mining Engineering, West Virginia U., Morgantown.

Kemna, A, A. Binley, A. Ramirez, and W. Daily, 2000, Complex resistivity tomography for environmental applications, *Chemical Engineering Journal*, vol. 77, p. 11-18.

King, S. B., Brandenburg, C. F. and Lanum, W. J., 1978, Characterization of nitrogen compounds in tar produced from underground coal gasification. *Energy Sources* 3, 263-275.

Knauss, K.G. and Copenhaver, S.A., 1995, The solubility of p-xylene in water as a function of temperature and pressure and calculated thermodynamic quantities. *Geochim. Cosmochim. Acta* 59, 2443-2448.

Knauss, K.G., Dibley, M.J., Leif, R.N., Mew, D.A. and Aines, R.D., 1999, The aqueous solubility of trichloroethene (TCE) and tetrachloroethene (PCE) as a function of temperature. *Appl. Geochem.*, 15(4): 501-512.

Kohl, A. and F. Riesenfeld, 1979, *Gas Purification*, Third Edition, Gulf Publishing Company.

Kratsch, H., 1983, *Mining Subsidence Engineering*. Springer, Berlin, 543pp

Kurth, M., et al., 1986, Linking and Gasification in Thulin, A New Endeavor, Proceedings of the Twelfth Annual Underground Coal Gasification Symposium, DOE/FE/60922-H1.

Lamarre, R.A., 2002, Hydrodynamic and stratigraphic controls for a large coalbed methane accumulation in Ferron coals of east-central Utah. In S.D. Schwochow and V. Nuccio (eds.), *Coalbed methane of North America, II: Rocky Mountain Association of Geologists*, p. 71-82.

Lamarre, R.A., 2003, Hydrodynamic and stratigraphic controls for a large coalbed methane accumulation in Ferron coals of east-central Utah. *International Journal of Coal Geology* 56: 97-110.

Langland, R. and Fletcher, D., 1976, Predictiong subsidence over coal-gasification sites, Lawrence Livermore National Laboratory, Livermore, CA, UCID-17326.

Leif, R.N. and Simoneit, B.R.T., 1995, Ketones in hydrothermal petroleum and sediment extracts from Guaymas Basin, Gulf of California. *Org. Geochem.* 23, 889-904.

- Leif, R.N. and Simoneit, B.R.T., 2000, The role of alkenes produced during the pyrolysis of a shale. *Org. Geochem.* 31, 1189-1208.
- Levey, R.A., 1981, A depositional model for major coal seams in the Rock Springs Formation, Upper Cretaceous, southwest Wyoming: Ph.D. dissertation, Univ. South Carolina, Columbia, 227 p.
- Lund, H. F., 1971, *Industrial Pollution Control Handbook*, McGraw-Hill.
- Lundegard, P. D. and LaBrecque, D. J., 1995, Air sparging in a sandy aquifer (Florence Oregon): actual and apparent radius of influence, *Journal of Contaminant Hydrology*, 19, 1-27.
- Marche, C., Delepine, H., Ferronato, C., and Jose, J., 2003, Apparatus for the on-line GC determination of hydrocarbon solubility in water: Benzene and cyclohexane from 70°C to 150°C. *J. Chem. Eng. Data* 48, 498-401.
- Mattox, C.F. and Humenick, M.J., 1980, Organic groundwater contaminants from UCG. *In Situ*, 4, 129-151.
- McCabe, P.J., 1984, Depositional environments of coal and coal-bearing strata. In R.A. Rahmani & R.M. Flores (eds), *Sedimentology of coal and coal-bearing sequences*, Spec. Publ. of the Int. Assoc. of Sedimentologists, 7, 13-42.
- McCabe, P.J., 1991 Tectonic controls on coal accumulation, *Bulletin de Societé Géologique de France*, 162, 277-282.
- McMillen, S., Magaw, R.L., and Carovillano, R.L., 2001, Risk-based Decision-Making for Assessing Petroleum Impacts at Exploration and Production Sites., U.S. Dept. of Energy and Petroleum Environmental Research Forum, Government Printing Office, p. 239.
- Mead S.W., Wang F.T. and Stuermer D.H., 1982, UCG Environmental Research – Summary and Suggested Projections. Lawrence Livermore National Laboratory, Livermore, CA. UCRL-88015.
- Metzger, G., 1984, Instrumentation and Data System for the 1983 Partial-Seam CRIP Experiment, *Proceedings of the Tenth Annual Underground Coal Gasification Symposium*, DOE/METC-85/5 (DE85001956).
- Mitchum, R.M., Vail, P.R., and Thompson III, S., 1977, Seismic stratigraphy and global changes of sea-level, part 2: the depositional sequence as a basic unit for stratigraphic analysis. In C.E Payton, et al. (eds.), *Seismic stratigraphy – applications to hydrocarbon exploration*, AAPG Memoir 26, 53-62.

- Moore, P.D., 1989, The ecology of peat-forming processes: a review, *Int. J of Coal Sciences*, 12, 89-103.
- Morris, J.P., Rubin, M.B., Glenn, L.A., Heuze, F.E., Blair, S.C., 2002; Simulations of Underground Structures Subjected to Dynamic Loading using the Distinct Element Method submitted to *Engineering Computations*; UCRL-JC-146927-REV-1
- National Coal Board, 1975, *Subsidence Engineers' Handbook*, London.
- Newmark, R.L., W.D. Daily, K.R. Kyle and A. L. Ramirez, 1998. Monitoring DNAPL pumping using integrated geophysical techniques, *Journal of Environmental and Engineering Geophysics*, v. 3, no.1, 7-14.
- Newmark, R.L., Daily, W., and Ramirez, A., 1999, Electrical resistance tomography using steel cased boreholes as long electrodes. 1999 Oil and Gas Conference Technology Options for Producer Survival. Dallas, TX, June 28-30, 1999.
- Newmark, R.L., Ramirez, A., and Daily, W., 2000, Geophysical monitoring of carbon dioxide injection and sequestration using electrical resistance tomography (ERT): Sensitivity studies. Lawrence Livermore National Laboratory, Livermore, CA. UCRL-JC-140217-ABS-REV-1.
- Obert, L., and Duvall, W.I., 1967, *Rock Mechanics and the Design of Structures in Rock*, John Wiley and Sons, Inc.
- Olness, D., 1982, Angrenskaya underground coal gasification station. Lawrence Livermore National Laboratory, Livermore, CA. UCRL-53300.
- Olness D. and Gregg, D.W., 1977, The historical development of underground coal gasification. Lawrence Livermore National Laboratory, Livermore, CA. UCRL-52283.
- Pirard, J. P., et al., 2000, Results of the tracer tests during the El Tremedal underground coal gasification at great depth, *Fuel*, 79, 4710478, 2000
- Perkins, G., 2005, Numerical modelling of underground coal gasification and its application to Australian coal seam conditions.
<http://www.ac3.edu.au/edu/papers/perkinsg01.pdf>
- Qualheim, B.J., 1977, Geological exploration of potential underground coal gasification sites in the Powder River Basin of Wyoming and Montana, Lawrence Livermore National Laboratory, Livermore, CA, UCRL-52237
- Raber, E., and R. Stone, 1980, Ground-Water Hydrologic Effects Resulting from Underground Coal Gasification Experiments at the Hoe Creek Site near Gillette, Wyoming. Lawrence Livermore National Laboratory, Livermore, CA UCID-18627.

- Ramirez, A., W. Daily, D. LaBrecque, E. Owen and D. Chesnut, 1993, Monitoring an underground steam injection process using electrical resistance tomography. *Water Resources Research*, vol. 29, no. 1, pp 73-87.
- Ramirez, A., W. Daily, A. Binley, D. LaBrecque, and D. Roelant, 1996, Detection of leaks in underground storage tanks using electrical resistance methods, *Journal of Environmental and Engineering Geophysics*, Vol. 1, no. 3, 189-203.
- Ramirez, A., Pasyanos, M. and Al Franz, G., 2004, Development of generalized mapping tools to improve implementation of data driven computer simulations. LLNL Report UCRL-TR-206664.
- Reichle, D. Houghton, J., Kane, B., Ekmann, J., Benson, S., Clarke, J., Dahlman, R., Hendry, G., Herzog, H., Hunter-Cevera, J., Jacobs, G., Judkins, R., Ogden, J., Palmisano, A., Socolow, R., Stringer, J., Surlis, T., Wolsky, A., Woodward, N., York, M., 1999, Carbon Sequestration Research and Development. U.S. Department of Energy Report DOE/SC/FE-1. http://www.ornl.gov/carbon_sequestration/
- Ruprecht, P., Schafer, W. and Wallace, P., 1988, A computer model of entrained coal gasification. *Fuel* 67, 739-742.
- Ryer, T.A., 1981, Deltaic coals of Ferron Sandstone member of Mancos Shale: predictive model for Cretaceous coal-bearing strata of western interior: *AAPG Bulletin*, 65, 2323-2340.
- Ryer, T.A., 1984, Transgressive-regressive cycles and the occurrence of coal in some Upper Cretaceous strata of Utah, U.S.A. In R.A. Rahmani, (ed.), *Sedimentology of coal and coal-bearing sequences*. Int. Assoc. of Sedimentologists Spec. Publ. 7, 217-227.
- Schumm, S.A., 1993, River response to baselevel changes: implications for sequence stratigraphy. *J. of Geology*, 101, 279-294.
- Schroeder, K., Ozdemir, E. and Morsi, B.I., 2001, Sequestration of carbon dioxide in coal seams. National Energy Technology Laboratory, First National Conference on Carbon Sequestration, 10p.
- Shu, D.M. and Battacharya, A.K., 1993, Prediction of sub-surface subsidence movements due to underground coal mining, *Geotechnical and Geological Engineering*, v.11, pp. 221-234
- Simbeck, D. 2002. Carbon Separation and Capture from Energy Systems: The Forms and Costs of Separation and Capture. Presentation at the workshop Complements to Kyoto: Technologies for Controlling CO₂ Emissions, April 23, National Academy of Engineering, Washington, D.C.

Singh, K.K.K., Singh, K.B., Lokhande, R.D., and Prakash, A., 2004, Multielectrode resistivity imaging technique for the study of coal seam. *Journal Of Scientific & Industrial Research* 63 (11): 927-930.

Siskin, M. and Katritzky, A.R., 1991, Reactivity of organic compounds in hot water: Geochemical and technological implications. *Science* 254, 231-237.

Snyder, G.T., Fehn, U., Riese, W.C., Moran, J.E., Pelzmann, W.L. Franks, S and Gorody, A. , 2002, Iodine-129 as a tracer of fluids associated with hydrocarbon systems: Results from the Fruitland Fm., San Juan Basin, CO and from other depositional settings. 2002 AAPG Rocky Mt. Section Meeting Technical Program.

Snyder, G.T., Riese, W.C. , Franks, S., Fehn, U., Pelzmann, W. L., Gorody, A.W. and Moran, J. E., 2003, Origin and history of waters associated with coalbed methane: ^{129}I , ^{36}Cl , and stable isotope results from the Fruitland Formation, CO and NM. *Geochimica et Cosmochimica Acta* Volume 67, Issue 23, 4529-4544.

Stephens, D.R., 1980, *An Introduction to Underground Coal Gasification*. Lawrence Livermore National Laboratory, Livermore, CA. UCRL-18801.

Stephens, D.R., 1981, *The Hoe Creek Experiments: LLNL's underground coal gasification project in Wyoming*, Lawrence Livermore National Laboratory, Livermore, CA. UCRL-53211

Stephens, D.R., Thorsness, C.B., Hill R.W., and Thompson, D.S., 1984, UCG is technically feasible, *Chemical Engineering Progress*, February, pp. 39- 45

Stephens, D.R., R. W. Hill, and I. Y. Borg, 1985a, *Underground Coal Gasification Review*. Lawrence Livermore National Laboratory, Livermore, CA UCRL-92068.

Stephens, D. R., et al. 1985b, *LLNL Underground Coal Gasification Project Annual Report - Fiscal Year 1984*, Lawrence Livermore National Laboratory, Livermore, CA. UCRL-50032-84.

Stephens, D. R., Hill, R. W., and Borg, I. Y., 1985c, Status of Underground Coal Gasification. *American Association of Petroleum Geologists Bulletin*, v. 69, no. 2, p. 309-309.

Stevens, S.H., Kuuskraa, V.A., Spector, D., and Riemer, P., 1998, *CO₂ Sequestration in Deep Coal Seams: Pilot Results and Worldwide Potential*. Paper presented at GHGT-4 in Interlaken, Switzerland, 30 Aug. - 2 Sep. 1998.
<http://www.ieagreen.org.uk/pwrghgt4.htm>

Stuermer, D.H., Ng, D.J. and Morris, C.J., 1982, Organic contaminants in groundwater near an underground coal gasification site in northeastern Wyoming. *Environ. Sci. Tech.* 16, 582-587.

Sury, M., 2004, Review of Environmental Issues of Underground Coal Gasification, Report No. COAL R272 DTI/Pub URN 04/1880, November 2004

Svjagincev, K.H., 1979, Underground coal gasification in the Soviet Union, *Gluckauf* 115 (No. 11), 540-546; Engl. Translation Lawrence Livermore National Laboratory, Livermore, CA UCRL-11556

Taylor, D.R., and Lovell, R.W.W., 1991, Recognition of high-frequency sequences in the Kenilworth Member of the Blackhawk Formation, Book Cliffs, Utah. In J.C VanWagoner, et al. (eds), *Sequence stratigraphy applications to shelf sandstone reservoirs; outcrop to subsurface examples*. Field Guide for AAPG Field Conference, Sept. 21-28, 1-9.

Thambimuthu, Kailai, et al., 2005, IPCC Special Report on Carbon Dioxide Capture and Storage, Chapter 3, 10 October 2005.

Thorsness, C.B. 1985, Further Development Of A General-purpose, Packed-bed Model For Analysis Of Underground Coal Gasification Processes. Lawrence Livermore National Laboratory, Livermore, CA. UCRL-92489-abstract.

Thorsness, C.B., 1986a, Mechanistic Model For Axisymmetric UCG Cavity Growth. Part 1: An Overview. Lawrence Livermore National Laboratory, Livermore, CA. UCRL-94419.

Thorsness, C.B., 1986b, General-purpose, Packed-bed Model For Analysis Of Underground Coal Gasification Processes. Lawrence Livermore National Laboratory, Livermore, CA. UCID-20731.

Thorsness, C.B., 1987, Unconfined Flow As A Mechanism Of Water Influx To A UCG System. Lawrence Livermore National Laboratory, Livermore, CA. UCRL-97203.

Thorsness, C.B., and Britten, J.A., 1989, Lawrence Livermore National Laboratory Underground Coal Gasification Project: Final Report. Lawrence Livermore National Laboratory, Livermore, CA. UCRL-21853.

Thorsness, C.B., and Creighton, J.R., 1982, Review of Underground Coal Gasification Experiments at Hoe Creek, Lawrence Livermore National Laboratory, Livermore, CA. UCRL-87662

Todheide, K., 1982, Hydrothermal solutions. *Ber. Bunsenges. Phys. Chem.* 86, 1005-1016.

Torp, T.A. and Gale, J., 2002, Demonstrating Storage of CO₂ in Geological Reservoirs: The Sleipner and Sacs Projects. Abstracts of the 6th International conference on Greenhouse Gas Control Technology (GHGT-6), Kyoto, Japan, 1-4 October 2002

Trent, B.C., and Langland, R.T., 1981, Computer models to support investigations of surfacae subsidence and associated ground motion induced by underground coal gasification, Lawrence Livermore National Laboratory, Livermore, CA. UCRL-53029

Twenhofel, W.H., 1939, Principles of sedimentation, McGraw-Hill, New York, 610 p.

UCG Engineering, Ltd., 2006, Underground Coal Gasification: Basic Concepts.
<http://www.coal-ucg.com/concept2.html>

U.K. Department of Trade and Industry (DTI), 1999, Publication # DTI/Pub URN 04/1643, Appendix 1
<http://www.dti.gov.uk/files/file19146.pdf#search=%22Spanish%20UCG%20trials%22>

U.K. Department of Trade and Industry, 2004, Cleaner Coal Technologies. Energy Paper 67. London, Stationary Office. <http://www.dti.gov.uk/files/file22078.pdf>

U.S. Department of Energy (DOE), 2005, Hydrogen and Clean Fuels Research.
<http://www.fe.doe.gov/programs/fuels/index.html>

U.S. Department of Energy Office of Legacy Management, National Defense Authorization Act (NDAA) Long-Term Stewardship Report: Wyoming.
http://www.lm.doe.gov/documents/3_pro_doc/lts_study/pdf/wyoming.pdf

U.S. Energy Information Administration (EIA), 1997, Country Analysis Brief: Uzbekistan. <http://www.converger.com/eiacab/uzbek.htm>

U.S. Energy Information Administration (EIA), 2006, International Energy Outlook 2006. Report #: DOE/EIA-0484(2006). <http://www.eia.doe.gov/oiaf/ieo/coal.html>

U.S. Environmental Protection Agency (USEPA), 1999, The Class V Underground Injection Control Study: Volume 13, In-situ fossil fuel recovery wells. EPA/816-R-99-014m.

Van Wagoner, J.C., Mitchum, R.M., Campion, K.M., and Rahmanian, V.D., 1990, Siliciclastic sequence stratigraphy in well-logs, cores, and outcrops: concepts for high-resolution correlation of time and facies.

Walker, L.K., et al., 2001, An IGCC Project at Chinchilla, Australia, based on UCG, in Gasification Technologies Conference, San Francisco, USA.

Wallman, H., 2005, Model for Underground Production of H₂ from Coal. Lawrence Livermore National Laboratory, Livermore, CA. Internal Report.

Wang, F.T., Mead, S.W. and Stuermer, D.H., 1981, Groundwater contamination near the Hoe Creek UCG experiments. Lawrence Livermore National Laboratory, Livermore, CA. UCRL-85880.

Wang, F.T., Mead, S.W. and Stuermer, D.H., 1982a, Water quality monitoring at the Hoe Creek test site: review and preliminary conclusions. Lawrence Livermore National Laboratory, Livermore, CA. UCRL-87650.

Wang, F. T., Mead, S. W. and Stuermer, D. H., 1982b, Mechanisms for Groundwater Contamination by UCG – Preliminary Conclusions from the Hoe Creek Site. Lawrence Livermore National Laboratory, Livermore, CA. UCRL-88012.

Wang, F.T., Mead, S.W. and Stuermer, D.H., 1982c, Mechanisms for groundwater contamination by UCG – preliminary conclusions from the Hoe Creek study, Proceedings of the Eighth Underground Coal Conversion Symposium.

Wauchope, R.D. and Getzen, F.W., 1972, Temperature dependence of solubilities in water and heats of fusion of solid aromatic hydrocarbons. J. Chem. Eng. Data 17, 38-41.

Western Research Institute (WRI), 2006, Removal of Mercury from Coal-derived Synthesis Gas, Final Report for Base Task 1.i, WRI-06-R013, March 2006.

Wilson M, and Monea, M. (Eds.), 2004, IEA GHG Weyburn CO₂ Monitoring & Storage Project Summary Report 2000-2004, 273 p.

World Energy Council (WEC), 2004, Survey of Energy Resources, Elsevier, London

Yaws, C., 1999, Chemical Properties Handbook: physical, thermodynamic, environmental, transport, safety, and health related properties for organic and inorganic chemicals. McGraw-Hill, New York, 779 pp.

Young, R.G., 1955, Sedimentary facies and intertonguing in the Upper Cretaceous of the Book Cliffs, Utah-Colorado: Geological Society of America Bulletin, v. 66, p. 177-201.