

National Aeronautics and  
Space Administration

Langley Research Center  
Hampton, VA 23681-2199

Educational Product

Educators

Grades 6-8

EG-2002-07-11-LARC

NASA CONNECT™

# *The Centennial of Flight Special Edition: Problem Solving: The “Wright” Math*

An Educator Guide with Activities in Mathematics, Science, and Technology

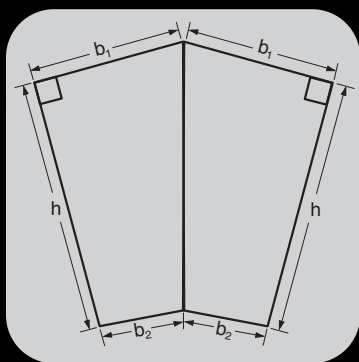



*The Centennial of Flight Special Edition: Problem Solving: The "Wright" Math* is available in electronic format through NASA Spacelink - one of NASA's electronic resources specifically developed for the educational community. This publication and other educational products may be accessed at the following address:

**<http://spacelink.nasa.gov/products>**

A PDF version of the educator guide for NASA CONNECT™ can be found at the NASA CONNECT™ web site: **<http://connect.larc.nasa.gov>**

NASA CONNECT™ is produced by the NASA Center for Distance Learning, a component of the Office of Education at NASA's Langley Research Center, Hampton, VA, and is a collaborative endeavor of NASA with the following organization. The NASA Center for Distance Learning is operated under cooperative agreement NCC-1-02039 with Christopher Newport University, Newport News, VA. Use of trade names does not imply endorsement by NASA.



# ***The Centennial of Flight Special Edition: Problem Solving: The “Wright” Math***

**An Educator Guide with Activities in Mathematics, Science, and Technology**

## **Program Overview**

Summary and Objectives .....	5
Student Involvement .....	5
Cue Card Questions.....	5
Hands-On Activity .....	5
Interactive Kite Modeler.....	5
Resources.....	5

## **Hands-On Activity**

Background.....	6
National Standards .....	7
Instructional Objectives .....	8
Vocabulary .....	8
Preparing for the Activity.....	8
Student Materials .....	8
Teacher Materials .....	8
Time .....	8
Focus Questions .....	9
Advance Preparation.....	9
The Activity .....	9
Extensions.....	11

## **Student Worksheets**

Kite Measurement Chart .....	12
Flight Rating Chart.....	13
Cue Cards .....	14

## **Teacher Materials**

Cue Card Answers .....	15
------------------------	----

## **Interactive Kite Modeler**

National Standards.....	16
Instructional Objectives .....	17

## **Resources**

Books, Pamphlets, and Periodicals .....	18
Web Sites.....	18

 Registered users of the NASA CONNECT™ may request a The American Institute of Aeronautics and Astronautics (AIAA) classroom mentor. For more information or to request a mentor, e-mail [nasaconnect@aiaa.org](mailto:nasaconnect@aiaa.org).

 Captioning provided by NEC Foundation of America

**Acknowledgments:** Special thanks to Summer 2002 Educators in Residence, Chris Giersch, Bill Williams, and The National Council of Teachers of Mathematics (NCTM).



# Program Overview

## SUMMARY AND OBJECTIVES

In *Problem Solving: The "Wright" Math*, students will learn about the evolution of flight. They will learn how the Wright Brothers became the first human beings to successfully design, construct, and fly an airplane. Students will learn the method the Wright Brothers used in designing their airplane. They will also be introduced to NASA's Morphing Project, a radically new approach to designing aircraft of the

future. They will observe NASA researchers using problem-solving techniques to design wings that will change their shape during flight. By conducting hands-on and web activities, students will make connections between NASA research and the mathematics, science, and technology they learn in their classrooms.

## STUDENT INVOLVEMENT

### Cue Card Questions



Norbert, NASA CONNECT's™ animated co-host, poses questions throughout the broadcast. These questions direct the instruction and encourage students to think about the concepts being presented. When viewing a videotaped version of NASA CONNECT™, educators have the option to use the Cue Card Review, which gives students an opportunity to reflect and record their answers on the Cue Cards (p. 14). NASA CONNECT's™ co-host, Jennifer Pulley, will indicate an appropriate time to pause the videotape and discuss the answers to the questions.

### Hands-On Activity

The hands-on activity is teacher created and is aligned with the National Council of Teachers of Mathematics (NCTM) standards, the National Science Education (NSE) standards, and the International Technology Education Association

(ITEA) standards. Students will investigate the basic principles of kite flight and gain an understanding of stability and control. They will construct and test three kites based on kite sail area and aspect ratio.

### Interactive Kite Modeler

The Interactive Kite Modeler is aligned with the National Council of Teachers of Mathematics (NCTM) standards, the National Science Education (NSE) standards, and the International Technology Education Association (ITEA) standards. This kite simulation, developed by Tom Bensen at NASA's Glenn Research Center, provides middle and high school students an opportunity to study the physics and mathematics which describe the flight of a kite. You can choose from several types of kites and change the shape, size, and materials to produce your own design. To access the Interactive Kite Modeler, go to Dan's Domain on NASA CONNECT's™ web site at <http://connect.larc.nasa.gov/dansdomain.html>.

## RESOURCES

Teacher and student resources (p. 18) support, enhance, and extend the NASA CONNECT™ program. Books, periodicals, pamphlets, and web sites provide teachers and students with background information and extensions. In addition to the resources listed in this educator guide, the

NASA CONNECT™ web site, <http://connect.larc.nasa.gov> offers online resources for teachers, students, and parents.

# Hands-On Activity

## BACKGROUND

As the Wright Brothers initially began their work to develop a flying machine, they studied the efforts of earlier experimenters and observed flight in nature. Bird flight was the obvious example of flight to evaluate and copy. However, the most striking feature of bird flight (flapping of wings) was the most misleading. Many experimenters were led down this blind alley. The flapping motion of bird wings disguises two separate problems at once—those of lift and thrust. Even today, the two most basic challenges of human flight are those of lift against gravity and thrust against drag.

In the summer of 1889, as Wilbur Wright stood contemplating a small cardboard box, he noticed that if he squeezed two diagonal corners on one end of the box and the two opposite corners on the other end of the box, the box twisted. In his mind's eye, he saw the top and bottom of the box as wings on a biplane and thought this sequence of events could be used to "fly." Wilbur designed an experiment to test whether his new warping technique could be used to balance and control an airplane, allowing it to roll right or left.

To test his new wing-warping technique, he built a biplane box kite with a small tail attached to the back. The Wrights controlled the kite from the ground with four strings. By angling the sticks in opposite directions while the kite was flying, they could bank the kite right or left. By angling the sticks in the same direction, they could raise or lower the tail, making the kite climb or dive. They could maneuver the kite! Thus, kites began to play an important role in designing the first plane.

The 1899 kite test afforded a comparatively simple and inexpensive means of developing and testing their wing-warping control system, one of the most fundamental aspects of the Wright invention. They continually returned to kiting their man-carrying gliders to test new designs and to analyze puzzling results from free glides. This experimentation allowed them to evaluate their theories and experimental data under actual flight conditions for extended periods of time.

Historically, kites have been used for a variety of purposes. Scientists have used kites for experimentation and testing. Benjamin Franklin may have performed the most famous kite experiments by proving electricity is one of the routine operations of nature. Guglielmo Marconi used a kite in the first transatlantic transmission of wireless telegraphy. Alexander Graham Bell used kites to solve the problem of stability in aircraft, thus making them easier to fly. Kites were used by the Chinese military during battles to scare the enemy. Those kites were made of bamboo and had a tendency to shriek and hum.

Kites are used today for many scientific purposes including weather and aerodynamic testing, and as an aid to fishing in the Solomon Islands. Kites were often used to announce the birth of a child in Korea as well as recreationally at kite festivals and competitions, and sometimes just for fun.

Kites are aerodynes. They overcome the force of gravity and are kept in the air by the force of the wind or the forces of wind pressure on the kite. The aerodynamic force involved is called lift. Lift on a kite is perpendicular to the relative wind direction. Relative wind is actual wind - [in terms of direction and speed]. For a kite to fly, the lift potential must be greater than the weight of the kite. The aspect ratio parameter is very important in determining the lift and drag of a kite. Airplane wings typically have a very long span and a high aspect ratio. Kites, on the other hand, usually have a small span and are a low aspect ratio.

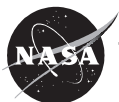

## NATIONAL STANDARDS

### Mathematics (NCTM) Standards

- Develop meaning for integers and represent and compare quantities with them.
- Model and solve contextualized problems using various representations such as graphs, tables, and equations.
- Understand, select, and use units of appropriate size and type to measure angles, perimeter, area, surface area and volume.
- Select and apply techniques and tools to accurately find length, area, volume, and angle measures to appropriate levels of precision.
- Build new mathematical knowledge through problem solving.
- Solve problems that arise in mathematics and other contexts.
- Apply and adapt a variety of appropriate strategies to solve problems.
- Monitor and reflect on the process of mathematical problem solving.
- Communicate mathematical thinking coherently and clearly to peers, teachers, and others.
- Use the language of mathematics to express mathematical ideas precisely.
- Select, apply, and translate among mathematical representations to solve problems.
- Describe sizes, positions, and orientations of shapes under informal transformations such as flips, turns, slides, and scaling.
- Draw geometric objects with specified properties such as side lengths or angle measures.

### Science (NSE) Standards

- Motions and forces
- Transfer of energy
- Abilities of technological design
- Science and technology in society
- History of science

### Technology (ITEA) Standards

#### Technology and Society

- The use of technology affects people in various ways, including their safety, comfort, choices, and attitudes about technology's development and use.
- Economic, political, and cultural issues are influenced by the development and use of technology.

#### Design

- Invention is a process of turning ideas and imagination into devices and systems. Innovation is the process of modifying an existing product or system to improve it.
- Troubleshooting is a problem-solving method used to identify the cause of a malfunction in a technological system
- Some technological problems are best solved through experimentation.
- Assess the value of products and systems
- Interpret and evaluate the accuracy of the information obtained and determine if it is useful.

## INSTRUCTIONAL OBJECTIVES

The student will

- use prior knowledge to predict the effect of kite sail area on kite flight.
- use a ruler to measure the base and height of a trapezoidal kite.
- use a reflection in creating kites.
- calculate the area of a trapezoid.
- calculate the aspect ratio.
- gain an understanding of how early flight was influenced by kites.
- incorporate collaborative problem-solving strategies in a real-life application.

## VOCABULARY

**aerodynamic** – having a shape that allows for smooth air flow and lift

**air flow** – the motion of air molecules as they flow around an object

**airfoil** – an object with a special shape that is designed to produce lift efficiently when it is moved through the air

**aspect ratio** – the ratio of the square of the span (the widest distance from side to side) to the area of the kite

**Bernoulli's principle** – fast flow of air over the long upper surface of an airfoil results in reduction of pressure creating lift

**drag** – a force that pushes against an object and slows it down

**kite** – a tethered object that relies on wind for lift

**lift** – the aerodynamic force that holds an airplane in the air

**reflection** – a one-to-one mapping over a line of symmetry; a mirror image; when a point A is reflected over a line of symmetry, the corresponding point is labeled A' (A prime)

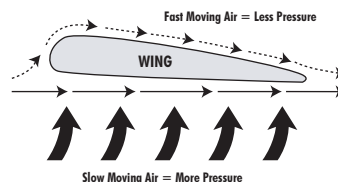

## PREPARING FOR THE ACTIVITY

### Student Materials (per 3-student group)

- 3 sheets of 8 1/2" x 11" multipurpose paper
- masking tape
- 3 metric rulers
- 3 wooden skewer sticks
- 3 8-m lengths of kite string
- 3 string holders (empty toilet tissue rolls work well)
- data charts
- timer–stopwatch or second hand
- hole puncher
- 3 2-cm x 200-cm kite tails

### Teacher Materials

- 1 large garbage bag
- kite template – for demonstration, identification and, clarification of kite directions

### Time

- |                            |            |
|----------------------------|------------|
| Discussion of the activity | 10 minutes |
| Preparing kites            | 15 minutes |
| Conducting the activity    | 30 minutes |

**Focus Questions**

1. What makes flight possible?
2. What keeps a kite flying?
3. What are lift and drag? How do lift and drag relate to kite flight?
4. How do you think the area of the kite sail will affect its flight?

**Advance Preparation**

1. To construct the kite tails, cut the garbage bag into 2-cm x 200-cm strips. Each group will receive 3 kite tails.

**To calculate the area of the kite sail:**

Area of trapezoid  $A = \frac{1}{2} h (b_1 + b_2)$   
 $h$  = height  
 $b_1$  = base  
 $b_2$  = base

Find the area of one trapezoid and multiply by two.

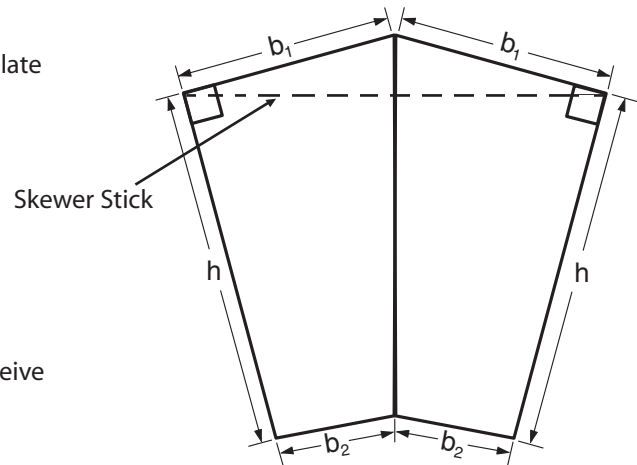

To calculate the aspect ratio (AR):

$$AR = \frac{s^2}{A}$$

$s$  = kite span (length of skewer stick)  
 $A$  = kite sail area

**THE ACTIVITY**

**Step 1: Introducing the Activity**

- A. Announce, "Today, NASA has asked us to investigate the size of kite sails to determine how area and aspect ratio influence flight efficiency."
- B. Organize students into groups of three. Explain that each student will assume one of three roles on a rotating basis (change after two trials) as follows:
  1. Kite flyer – Launch and control kite flight.
  2. Timer – Time the flight.
  3. Recorder – Record the time and flight rating on the data chart.
- C. Distribute student materials.
- D. Have each student group construct three kites according to the following directions:

For the first kite,

1. Fold a sheet of 8 1/2 in. X 11 in. paper in half (fold side to side) to 8 1/2 in. X 5 1/2 in.

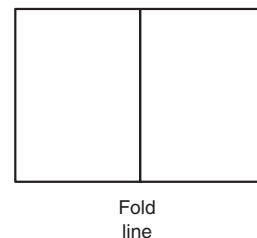

**Figure 1**

2. Open the sheet. Starting at the fold, measure 3.5 cm along the top on one side and mark point A. At the bottom, starting from the fold line, measure 9 cm and mark point B. Draw line segment AB.



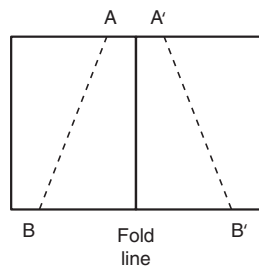
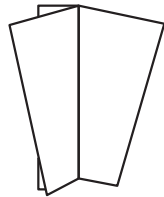

Figure 2

3. Reflect segment AB over the fold line. Mark the reflection of A as A' and the reflection of B as B'. Draw line segment A'B'. (figure 2).

*Note: A reflection is a one-to-one mapping over a line of symmetry; a mirror image; when a point A is reflected over a line of symmetry, the corresponding point is labeled A' (A prime).*

4. Fold in along the centerfold; then fold back along line segments AB and A'B', forming kite shape in (figure 3).



5. Flip kite over to the back and fold the flap back and forth until it stands perpendicular to the kite sails; otherwise, it acts like a rudder, and the kite spins around in circles. **Figure 3**
6. Flip kite over to the front and place a piece of tape firmly along fold line where AB meets A'B'. (No skewer stick is needed here because the fold stiffens the paper and acts like a spine.)

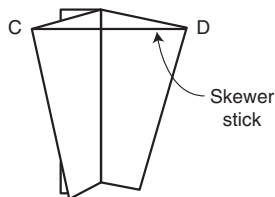

Figure 4

7. Place a skewer stick from point C to point D and tape down firmly along the entire length of the stick (figure 4).  
Cut off any excess stick from the pointed end.
8. Tape a kite tail to the bottom of the kite sail where point B meets point B'.

9. Flip the kite over to the back and punch a hole in the flap at point E about 7 cm down from the top point F and 1 cm from the fold (see figure 5).

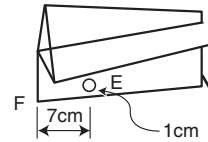

Figure 5

10. Tie one end of the string to the hole and wind the other end onto the cardboard string winder.

For the second kite,

- Repeat all the steps, adjusting step 2 as follows:  
Measure 1.75 cm along the top and mark point A. At the bottom, measure 4.5 cm and mark point B. (Remember, the next step is the reflection.)

For the third kite,

- Repeat all the steps, adjusting step 2 as follows:  
Measure 5.25 cm along the top and mark point A. At the bottom, measure 13.5 cm and mark point B. (Remember, the next step is the reflection.)

### Step 2: Conducting the Activity

- A. Have students complete the kite measurement chart for all the kites. (See diagram for kite identification on p. 9.)
1. Measure and record the length of the bases.
  2. Measure and record the height.
  3. Calculate and record the sail area using the given formula.
  4. Measure and record the span.
  5. Calculate and record the aspect ratio using the given formula.

**Note:** Before proceeding to the test flight area, have students loosely wrap the tail around the kite and place the string winder next to the keel to protect the kite from damage.

- B. Proceed to the flying space.

 *Note: Make sure the chosen area is open and free from trees, electrical and telephone lines, buildings, and automobile traffic. Wind that is too strong or too light is difficult to fly in. About 5 – 25 mph is best for kite flying, when leaves and bushes start to move, but before it really starts to blow. Never fly kites in rain or lightning.*

- C. Stand with your back to the wind. If there is sufficient wind, the kite will go right up. Let the kite fly away from you a little and pull in on the line as the kite points up, so it will climb. Repeat this process until your kite gains the altitude necessary to find a good, steady wind. (If the kite sinks tail first, there might not be enough wind. If it comes down head first or spins, there might be too much wind.)
- D. Allow a few minutes for trial flights.
- E. Announce, "Students, ready your kites!"
- F. Perform two trials for each kite, rotating the roles until all three kites have completed two trial flights.

### Step 3: Discussion

- A. How did the surface area of the kite affect its flight? Was the effect significant?
- B. Compare the aspect ratios of the three kites. Is the difference significant enough to draw a conclusion about the effect of aspect ratio on the flight of the kite?
- C. What other factors could be changed to investigate the effect on the kite flight?
- D. What other method could be used to calculate the area of the kite sail?
- E. Based on the kite sail area, aspect ratio, and stability and control observations, determine which kite the Wright brothers would choose?



### Extensions

- 1. Modify the kite by changing a variable other than area, such as materials, position of the string attachment, addition of a bridle, or using a second string control.  
<<http://www.grc.nasa.gov/WWW/K12/airplane/ki-teprog.html>> – This site allows a simulation of changing the variable and testing the results.
- 2. Have students design, build and test kites of their own design.  
<<http://www.grc.nasa.gov/WWW/K-12/airplane/kiteprog.html>> This site allows a simulation of changing the variable and testing the results.
- 3. Have students design, build and test kites of their own design. <[12/airplane/kitehighg.html](http://www.grc.nasa.gov/WWW/K-12/airplane/kitehighg.html)> or <<http://www.grc.nasa.gov/WWW/K-12/airplane/kitehigh.html>> Both of these sites offer solutions to height estimation.
- 4. Use AutoCad, Geometer's Sketchpad, or Microsoft Word to create a kite design.

# Student Worksheets

Name: \_\_\_\_\_ Date: \_\_\_\_\_

## Kite Measurement Chart

	$AR = \frac{s^2}{A}$								
									Aspect Ratio
									Span
									Kite Sail Area
									Height
									Base 2
									Base 1
 Kite 1									
 Kite 2									
 Kite 3									

$$A = 2 \left[ \frac{1}{2} h ( b_1 + b_2 ) \right]$$

### Notes

---

---

---

---

---

---

---

---

---

---

---

---

---

---

---

---

---

---

---

---

---

---

---







Name : \_\_\_\_\_ Date: \_\_\_\_\_

# ***Flight Rating Chart***

	Kite 1	Time Aloft	Stability (1-5)	Control (1-5)	Observations
	Flight 1				
	Flight 2				
	Average	Average			

	Kite 2	Time Aloft	Stability (1-5)	Control (1-5)	Observations
	Flight 1				
	Flight 2				
	Average	Average			

	Kite 3	Time Aloft	Stability (1-5)	Control (1-5)	Observations
	Flight 1				
	Flight 2				
	Average	Average			

***Scale***

5- Excellent  
3- Good  
1- Fair



Name: \_\_\_\_\_

Date: \_\_\_\_\_

# Cue Cards

## Anna-Maria McGowan, Program Manager, NASA's Morphing Project

1

How can biology be helpful in designing aircraft?

---

---

---

---

---

2

What is the relationship between pressure and force?

---

---

---

---

---

3

Why are computer simulations important in the aircraft design process?

---

---

---

---

---



# Teacher Materials

## Cue Cards

Anna-Maria McGowan, Program Manager, NASA's Morphing Project

1

How can biology be helpful in designing aircraft?

**Possible Answer:** NASA's Researchers and engineers are studying bird wings and fish fins to help them discover new approaches to wing design. In the future, NASA hopes to enable wings to gently change the shape in many different ways, similar to birds wings.

2

What is the relationship between pressure and force?

**Possible Answer:** There is a direct relationship between pressure and force. If the force increases, the pressure increases for a given area.

3

Why are computer simulations important in the aircraft design process?

**Possible Answer:** Computer simulations help NASA researchers and engineers understand the mechanics of flight and tell them how a component, like a wing, will perform in real life.



# Interactive Kite Modeler

## NATIONAL STANDARDS

### Mathematics (NCTM) Standards

- Use two-dimensional representations of three-dimensional objects to visualize and solve problems such as those involving surface area and volume.
- Use visual tools such as networks to represent and solve problems.
- Recognize and apply geometric ideas and relationships in areas outside the mathematics classroom such as art, science and everyday life.
- Understand both metric and customary units of measure.
- Monitor and reflect on the process of mathematical problem solving.
- Use the language of mathematics to express mathematical ideas precisely.
- Analyze and evaluate the mathematical thinking and strategies of others.
- Use representations to model and interpret physical, social, and mathematical phenomena.

### Science (NSE) Standards

- Understandings about Scientific inquiry
- Understandings about science and technology
- Abilities of technological design
- Change, constancy, and measurement
- Evidence, models, and explanation

### Technology (ITEA) Standards

#### Scope of Technology

- Corporations can often create demand for a product by bringing it into the market and advertising.
- New products and systems can be developed to solve problems or to help do things that could not be done without the help of technology.

### Nature of Technology

- Systems thinking involves considering how every part relates to others.
- A product, system, or environment developed for one setting may be applied to another setting.

### Technology and Society

- The use of inventions and innovations has led to changes in society in the creation of new wants and needs.

### Design

- Models are used to communicate and test design ideas and processes.
- Modeling, testing, evaluating, and modifying are used to transform ideas into practical solutions.
- Invention is a process to turn ideas and imagination into devices and systems. Innovation is the process of modifying an existing product or system to improve it.

### Abilities for a Technical World

- Apply a design process to solve problems in and beyond the laboratory-classroom.
- Make two-dimensional and three-dimensional representations of the design solution.
- Test and evaluate the design in relation to pre-established requirements, such as criteria and constraints, and refine as needed.
- Use computers and calculators in various applications.
- Interpret and evaluate the accuracy of the information obtained and determine if it is useful.



### The Design World

- Information and communication systems allow information to be transferred from human being to human being, human being to machine, and machine to human being.
- The design of a message is influenced by such factors as the intended audience, medium, purpose, and nature of the message.
- The use of symbols, measurements, and drawings promotes clear communication by providing a common language to express ideas.
- Transportation vehicles are made up of subsystems - structural, propulsion, suspension, guidance, control and support - that must function together for a system to work effectively.

## INSTRUCTIONAL OBJECTIVES

Students will

- To use the simulator to match and check student calculated surface area and aspect ratio of hands-on activity for the Twin-Trap kite
- Modify the kite to change other variables other than surface area and compare results
- To explore other kite shapes through the interactive kite modeler
- To draw conclusions concerning the optimum kite design

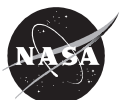



## Resources

### BOOKS, PAMPHLETS, AND PERIODICALS

Adair, Stan. *The Sky's the Limit with Math and Science: Aerodynamics*. AIMS, 1994.

Dolan, Edward. *The Complete Beginner's Guide to Making and Flying Kites*. Doubleday and Co., 1977.

Freedman, Russell; Wright, Orville; Wright, Wilbur. *The Wright Brothers: How They Invented the Airplane*; Holiday House, 1994.

Hunt, Leslie. *Twenty-five Kites That Fly*. Dover, 1971.

Kirk, Stephen. *First in Flight: The Wright Brothers in North Carolina*, John Blair, 1995.

Krinsky, Steven, Day, Larry (illustrator), *Taking Flight: Story of the Wright Brothers*, Aladdin, 2001.

Reynolds, Quentin, *Wright Brothers: Pioneers of American Aviation*, Landmark Books, 1981.

Thiebeault, Andre. *Kites and Other Wind Machines*. Sterling Publishing Co. 1982.

Wright, Orville, *How We Invented the Airplane*, CD-ROM The Way Things Work – Dorling Kindersley MultiMedia Wright Stuff – Wright Brothers, 1996.

### WEB SITES

#### Kite Information

[http://members.aol.com/GEngvall/kite\\_bks.htm](http://members.aol.com/GEngvall/kite_bks.htm)

<http://members.aol.com/Gengvall/events.html>

<http://www.GombergKites.com/nkm/index.html>

<http://enterprise.act.gu.edu.au/~anthony/kites/cartoons/>

<http://kckiteclub.org/DaveEllis/TOC.htm>

<http://www.planemath.com/activities/flykite/kitecareer.html>

[http://www.education-world.com/a\\_lesson/lesson056.shtml.html](http://www.education-world.com/a_lesson/lesson056.shtml.html)

#### Wright Brothers – First Flight

<http://www.nps.gov.wrbr/>

<http://www.hfmgv.org/exhibits/wright/default.asp>

<http://www.wright-brothers.org/>

<http://first-to-fly.com/>

<http://www.wrightflyer.org/>

<http://www.centennialofflight.gov/1903/htm>

<http://www.aviation-worlds-fair.com/>

#### Trivia Quizzes

<http://www.firstflightcentennial.org/quizzes/>

#### Forces of Flight

<http://www.grc.nasa.gov/WWW/K-12/airplane/short.html>

#### Figure This

Offers Mathematics Challenges that middle school students can do at home with their families to emphasize the importance of a high-quality mathematics education for all.

<http://www.figurethis.org>

#### Engineer Girl

Part of the National Academy of Engineering's Celebration of Women in the Engineering project. The project brings national attention to the opportunity that engineering represents to people of all ages, but particularly to women and girls.

<http://www.engineergirl.org>

#### National Council Teachers of Mathematics

<http://www.nctm.org>

