

DOE-WD-2005-001  
January 2006

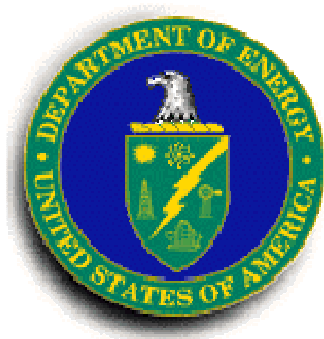

**Basis for  
Section 3116 Determination  
for  
Salt Waste Disposal  
at the  
Savannah River Site**

**TABLE OF CONTENTS**

**1.0 INTRODUCTION AND PURPOSE ..... 6**

**2.0 BACKGROUND..... 10**

    2.1 SALT PROCESSING STRATEGY ..... 12

**3.0 SECTION 3116 (A) OF THE RONALD W. REAGAN NATIONAL DEFENSE AUTHORIZATION  
ACT FOR FISCAL YEAR 2005 (NDAA) ..... 28**

**4.0 THE WASTE DOES NOT REQUIRE PERMANENT ISOLATION IN A DEEP GEOLOGIC  
REPOSITORY FOR SPENT FUEL OR HIGH-LEVEL RADIOACTIVE WASTE ..... 30**

**5.0 THE WASTE HAS HAD HIGHLY RADIOACTIVE RADIONUCLIDES REMOVED TO THE  
MAXIMUM EXTENT PRACTICAL..... 32**

    5.1 HIGHLY RADIOACTIVE RADIONUCLIDES ..... 32

    5.2 REMOVAL TO THE MAXIMUM EXTENT PRACTICAL ..... 34

**6.0 THE WASTE DOES NOT EXCEED CONCENTRATION LIMITS IN 10 CFR 61.55..... 49**

**7.0 THE WASTE WILL BE DISPOSED OF IN ACCORDANCE WITH THE PERFORMANCE  
OBJECTIVES SET OUT IN 10 CFR PART 61, SUBPART C ..... 57**

    7.1 10 CFR PART 61 PERFORMANCE OBJECTIVES..... 57

    7.2 GENERAL REQUIREMENT (10 CFR 61.40)..... 58

**8.0 STATE-ISSUED PERMIT..... 83**

**9.0 CONCLUSION ..... 84**

**10.0 REFERENCES..... 85**

**APPENDIX 1: SYSTEM DESCRIPTION ..... 91**

**APPENDIX 2: WASTE CHARACTERIZATION SYSTEM ..... 101**

**ATTACHMENT 1: *RESPONSE TO REQUEST FOR ADDITIONAL INFORMATION ON THE DRAFT  
SECTION 3116 DETERMINATION FOR SALT WASTE DISPOSAL AT THE SAVANNAH  
RIVER SITE***

**ATTACHMENT 2: *RESPONSE TO ACTION ITEMS FROM PUBLIC MEETINGS BETWEEN NRC AND  
DOE TO DISCUSS RAI FOR THE SAVANNAH RIVER SITE***

**ATTACHMENT 3: *U. S. NUCLEAR REGULATORY COMMISSION TECHNICAL EVALUATION REPORT  
FOR THE U.S. DEPARTMENT OF ENERGY SAVANNAH RIVER SITE DRAFT SECTION  
3116 WASTE DETERMINATION FOR SALT WASTE DISPOSAL***

**ATTACHMENT 4: SALTSTONE PERFORMANCE OBJECTIVES DEMONSTRATION DOCUMENT  
(AVAILABLE AT [HTTP://APPS.EM.DOE.GOV/SWD](http://apps.em.doe.gov/swd))**

## LIST OF TABLES

TABLE 6.1: 10 CFR 61.55 .....	49
TABLE 6.2: 10 CFR 61.55 .....	50
TABLE 6.3: DDA WASTE STREAM COMPARISON TO 10 CFR 61.55 .....	50
TABLE 6.4: DDA WASTE STREAM COMPARISON TO 10 CFR 61.55 .....	51
TABLE 6.5: ARP/MCU WASTE STREAM COMPARISON TO 10 CFR 61.55 .....	51
TABLE 6.6: ARP/MCU WASTE STREAM COMPARISON TO 10 CFR 61.55 .....	52
TABLE 6.7: SWPF WASTE STREAM COMPARISON TO 10 CFR 61.55 .....	52
TABLE 6.8: SWPF WASTE STREAM COMPARISON TO 10 CFR 61.55 .....	53

## LIST OF FIGURES

FIGURE 2.1: SALT PROCESSING PATHWAYS [2,4] .....	13
FIGURE 2.2: SALT PROCESSING VOLUMES [3] .....	14
FIGURE 2.3: DDA PROCESS (INITIAL CONDITIONS, STEPS 1 AND 2) .....	15
FIGURE 2.4: DDA PROCESS (STEPS 3 THROUGH 5) .....	16
FIGURE 2.5: DDA PROCESS (STEPS 6 THROUGH 8) .....	17
FIGURE 2.6: ACTINIDE REMOVAL PROCESS .....	20
FIGURE 2.7: MODULAR CSSX UNIT PROCESS .....	21
FIGURE 2.8: SWPF ALPHA STRIKE PROCESS .....	23
FIGURE 2.9: SWPF CSSX PROCESS .....	24
FIGURE 5.1: WASTE TANK COMPOSITE INVENTORY (AS OF 12/01/04) [2] .....	39
FIGURE 7.1: MODELED 10 CFR 61.41 PATHWAYS [38] .....	61
FIGURE 7.2: RESIDENT INTRUDER PATHWAYS [38] .....	65

## LIST OF ACRONYMS

AEA	Atomic Energy Act
AFP	Alpha Finishing Process
ALARA	As Low As Reasonably Achievable
ARP	Actinide Removal Process
ASP	Alpha Strike Process
CEDE	Committed Effective Dose Equivalent
CFR	Code of Federal Regulations
CHA	Consolidated Hazards Analysis
CSS	Clarified Salt Solution
CSSX	Caustic Side Solvent Extraction
DDA	Deliquification, Dissolution, and Adjustment
DF	Decontamination Factor
DNFSB	Defense Nuclear Facilities Safety Board
DOA	Department of Energy Organization Act
DOE	Department of Energy
DSA	Documented Safety Analysis
DSS	Decontaminated Salt Solution
DWPF	Defense Waste Processing Facility
EIS	Environmental Impact Statement
EPA	Environmental Protection Agency
FFT	Filter Feed Tank
FHT	Filtrate Hold Tank
gpm	Gallons per Minute
GWSB	Glass Waste Storage Building
HAW	High Activity Waste
HLW	High Level Waste
HM	H Modified
ICRP	International Commission on Radiological Protection
ISWLF	Industrial Solid Waste Landfill
ITP	In-Tank Precipitation
IW	Inhibited Water
Kg	Kilograms
kgal	Thousand Gallons
LAW	Low Activity Waste
LLW	Low Level Waste
MCi	Million Curies
MCL	Maximum Contaminant Level
MCU	Modular CSSX Unit
Mgal	Million Gallons
MST	Monosodium Titanate
NASA	National Aeronautics and Space Administration
NCRP	National Council on Radiation Protection and Measurements
NDAA	National Defense Authorization Act

NRC	Nuclear Regulatory Commission
OSHA	Occupational Safety and Health Administration
PA	Performance Assessment
PEL	Permissible Exposure Limit
PODD	Performance Objectives Demonstration Document
PUREX	Plutonium Recovery and Extraction
RAI	Request for Additional Information
ROD	Record of Decision
RPP	Radiation Protection Program
SA	Special Analysis
SCDHEC	South Carolina Department of Health and Environmental Control
SDF	Saltstone Disposal Facility
SEIS	Supplemental Environmental Impact Statement
SNF	Spent Nuclear Fuel
SPF	Saltstone Production Facility
SRS	Savannah River Site
SWPF	Salt Waste Processing Facility
TEDE	Total Effective Dose Equivalent
TER	Technical Evaluation Report
TPB	Tetraphenylborate
TRU	Transuranic
TSR	Technical Safety Requirements
USC	United States Code
WAC	Waste Acceptance Criteria
WCS	Waste Characterization System
WCP	Waste Compliance Plan
WSRC	Westinghouse Savannah River Company

## 1.0 INTRODUCTION AND PURPOSE

The Secretary of Energy is making this 3116 Determination pursuant to Section 3116 of the Ronald W. Reagan National Defense Authorization Act for Fiscal Year 2005 (NDAA) [1]. This 3116 Determination concerns the disposal of separated, solidified low-activity radioactive salt waste at the Savannah River Site (SRS) near Aiken, South Carolina.

As a matter of background, there are presently 36.4 million gallons<sup>1</sup> [2] (Mgal) of liquid radioactive waste stored in underground waste storage tanks at SRS. Much of this waste resulted from the reprocessing of spent nuclear fuel for defense purposes by the Department of Energy (DOE) and its predecessor agencies, which has been commingled with non-reprocessing waste that resulted from the production of targets for nuclear weapons and the production of material for the National Aeronautics and Space Administration (NASA) space missions. Over the next 14 years, DOE anticipates that the tanks will receive an additional 41.3 Mgal [3] of waste<sup>2</sup>. The Department of Energy's top cleanup priority at SRS is to remove, stabilize, and dispose of the waste in these tanks and close the tanks.

The tank waste consists of two distinct kinds of material: 2.6 Mgal [2] of sludge consisting primarily of metals that settled at the bottom of the tanks; and 33.8 Mgal [2] of salt waste which is comprised of concentrated salt solution (supernate) and crystallized saltcake.

DOE's plans call for stabilizing and disposing of the sludge in a deep geologic repository for spent nuclear fuel (SNF) and high-level radioactive waste. This will be done by stabilizing the high-level waste (HLW) in a borosilicate glass matrix through vitrification in a facility known as the Defense Waste Processing Facility (DWPF). This process has been on-going since 1996.

As for the salt waste: DOE contemplates removing fission products and actinides from these materials using a variety of technologies, combining the removed fission products and actinides with the metals being vitrified in DWPF, and solidifying the remaining low-activity salt stream into a grout matrix known as saltstone grout suitable for disposal in vaults at the Saltstone Disposal Facility (SDF) at SRS.

---

<sup>1</sup> The numbers and percentages in this 3116 Determination are either rounded numbers and percentages or are DOE's best estimates at this time. The numbers, percentages, and dates in this 3116 Determination should be viewed as approximate numbers, percentages, and dates.

<sup>2</sup> The majority of this future waste is comprised of unconcentrated liquid waste resulting from the operation of the Defense Waste Processing Facility (DWPF). The DWPF recycle waste stream is a generally very low-activity waste stream that consists of condensate from chemical processing and melter operation, waste from decontamination activities, and waste from miscellaneous drains and sumps in DWPF. Before the recycle stream is transferred to the Tank Farm, it is chemically adjusted with sodium nitrite and sodium hydroxide to ensure that Tank Farm Waste Acceptance Criteria (WAC) is met. The remainder of the future waste results from the stabilization of legacy nuclear materials in the H-Canyon Facility. The volumes discussed above assume that H-Canyon will cease operations in 2010.

It is the disposal of this latter solidified low-activity salt stream that is the subject of the Determination set forth in this document. Section 3116 of the NDAA authorizes the Secretary of Energy, in consultation with the Nuclear Regulatory Commission (NRC), to determine that certain waste from reprocessing is not HLW if it meets the criteria set forth in that Section: that it does not require disposal in a deep geologic repository, that it has had highly radioactive radionuclides removed to the maximum extent practical, that it meets concentration limits and/or dose-based performance objectives for near-surface disposal of radioactive waste, and that it will be disposed of pursuant to a State-issued permit or State-approved closure plan. In this document, the Secretary is determining that the treated, solidified low-activity salt waste from the tanks meets all of these criteria. Accordingly, the Secretary is determining that this material is not HLW and will be disposed in SDF.

Although this 3116 Determination addresses only the disposal of solidified low-activity salt waste streams, it is important to understand that successful and timely salt waste removal and disposal is integral to DOE's efforts to proceed with all aspects of tank cleanup and closure, extending well beyond disposal of the solidified low-activity salt waste streams themselves. This is not only for the obvious reason that the salt waste must be removed and treated before the tanks may be closed. Less obviously, but more importantly, the disposal pursuant to this 3116 Determination will enable DOE to continue without interruption to remove and stabilize the high-activity fraction of the waste. This is because DOE uses the tanks to prepare the high-activity waste so that it may be fed into DWPF. The issue is that the salt waste is filling up tank space needed to allow this preparation activity to continue. Thus, removal and disposal of low-activity salt waste is critical in order to relieve this tank space shortage and assure that vitrification of the high-activity fraction will be able to continue uninterrupted.

The Department of Energy is tailoring the waste treatment for the salt waste based on the radiological properties of those wastes as shown by tank waste characterization data. DOE is separating the salt waste to segregate the low-activity fraction at SRS using a two-phase, three-part process. The first phase will involve two parts to treat the lower activity salt waste: a) beginning in 2006, processing of a minimal amount of the lowest activity salt waste through a process involving deliquification, dissolution, and adjustment (DDA) of the waste; and b) beginning in 2007, processing of a minimal amount of additional salt waste with slightly higher activity levels using an Actinide Removal Process (ARP) and a Modular Caustic Side Solvent Extraction (CSSX) Unit (MCU), along with deliquification and dissolution of saltcake. The second, and longer term phase, beginning in 2011<sup>3</sup>, involves the separation and processing of the

---

<sup>3</sup> The start date for Salt Waste Processing Facility (SWPF) operations has been delayed slightly (from 2009 to 2011) to allow for modification of the SWPF preliminary design to incorporate a higher degree of performance category (PC) in the confinement barriers necessary for worker protection during natural phenomena hazard events. The Defense Nuclear Facilities Safety Board (DNFSB) initially identified concerns related to the PC designation of the SWPF in August, 2004. DOE agreed in November, 2005 to modify the SWPF design after extensive analysis and review, resulting in an approximate two year delay in the planned startup of the SWPF. DOE anticipates that it will continue to explore possible ways to improve the schedule for design and construction of the SWPF. It remains DOE's goal to complete processing of salt waste through the SWPF by 2019 although this date may need to be modified in the future. Despite this projected delay, DOE will not increase the quantity of waste (total curies) to be disposed of in the SDF nor increase the quantities (curies) processed with interim processes or SWPF. While the modified schedule is reflected in this 3116 Determination, the revised dates are not reflected in the reference

remaining (and by far the majority) of the salt waste using a Salt Waste Processing Facility (SWPF) (augmented as necessary by ARP). This second phase will begin as soon as SWPF is constructed, permitted by the State of South Carolina, and operational [4].

This Determination refers to the first phase as Interim Salt Processing because it will be used to initiate treatment and disposal of solidified low-activity salt waste streams using the technologies available during the interim period between 2006 and 2011 when DOE anticipates that SWPF will become operational. As explained in more detail later in this 3116 Determination, DOE believes it should proceed with this interim approach because doing so will enable DOE to continue uninterrupted use of DWPF as well as to use SWPF at higher capacity as soon as it comes on line. This will allow DOE to complete cleanup and closure of the tanks years earlier than would otherwise be the case. That, in turn, will reduce the time during which the tanks – including some that do not have full secondary containment and have a known history of leak sites – continue to store liquid radioactive waste. Finally, Interim Salt Processing will make more tank space available for routine operations, thereby reducing the number of transfers among tanks and increasing the safety of operations. Therefore, Interim Salt Processing will accelerate the reduction of potential risk to the environment, the public, and SRS workers.

SWPF will be a high-capacity salt processing facility that will process the remaining salt waste retrieved from aging tanks that do not have full secondary containment, as well as tanks with full secondary containment. Thus, SWPF will also support associated reduction of potential risk to the environment, the public, and SRS workers.

After undergoing removal of radionuclides through DDA, ARP/MCU, and SWPF, as the case may be, the low-activity salt solution will be solidified into a grout matrix and disposed in the SDF vaults at SRS. The low-activity salt solution will be mixed with dry chemicals (cement, slag, and fly ash) to form a homogeneous grout mixture in the Saltstone Production Facility (SPF) and the slurry transferred to SDF where it solidifies. SDF and SPF are commonly collectively referred to as the Saltstone Facility.

All told, these various technologies are expected to result in removal and vitrification through DWPF of 97.8 to 98.7% (218 to 220 million curies (MCi)) of the 223 MCi total curies originally contained in the salt waste. The total curies being disposed of in SDF will be 1.3 to 2.2% (3 to 5 MCi) of the 223 MCi. DOE's current best estimate is that 3 MCi will be disposed of in SDF.

The purpose of this 3116 Determination is to demonstrate and document that the resulting solidified low-activity salt streams meet the 3116 criteria, and therefore are not HLW and will be disposed at SRS in accordance with Section 3116 of the NDAA. This 3116 Determination addresses disposal of the solidified low-activity salt streams from both Interim Salt Processing and SWPF through the end of salt processing at SRS.

---

documents because the schedule change did not occur until after those documents were completed. The date changes do not affect the analysis in those documents and this 3116 Determination or the consultation with the NRC.

---



As required by Section 3116 of the NDAA, DOE has developed this 3116 Determination in consultation with the NRC. To facilitate the consultative process, DOE provided the NRC with a non-publicly available draft 3116 Determination on February 28, 2005. Following final security reviews for release to the public, DOE made available to the NRC and the public the draft Section 3116 Determination on March 31, 2005. During its review of the draft 3116 Determination, the NRC requested additional information from DOE. [5] NRC and DOE also sponsored a series of public discussions between the NRC and DOE. The DOE responses to the NRC Request for Additional Information (RAI) [6] and the DOE responses to Action Items resulting from the public meetings [7] are Attachments 1 and 2, respectively, to this Final 3116 Determination. The NRC concluded its review with issuance of its Technical Evaluation Report (TER) [8], which is included as Attachment 3 to this Determination. Although not required by Section 3116, DOE also made the draft 3116 Determination available for public review and has considered these public comments in making this determination [9].

## 2.0 BACKGROUND

Since it became operational in 1951, SRS has produced nuclear material for national defense, research, medical, and space programs resulting in the generation of large quantities of radioactive waste which are currently stored onsite in 49<sup>4</sup> underground carbon steel waste storage tanks.

Since initiation of operations at SRS, the Tank Farms have received over 140 Mgal [10] of liquid waste from the chemical separation processes in F- and H-Canyons associated with the reprocessing of spent nuclear fuel, the production of nuclear materials for weapons, and the production of material for NASA space missions. Prior to transfer of the waste material from the F- and H-Canyons, chemicals (sodium hydroxide) are added to adjust the waste to an alkaline state to prevent corrosion of the carbon steel waste tanks. This chemical adjustment results in the precipitation of metals including strontium (Sr) and actinides (e.g., plutonium (Pu)). These solids settle to the bottom of the waste tanks forming a layer that is commonly referred to as sludge. After settling of the solids has occurred, the salt solution (supernate) above this sludge layer is decanted off. In order to maximize the space available in the tanks for storing additional waste, DOE's practice at SRS has been to use the Tank Farm evaporator systems to reduce the volume of the decanted supernate and concentrate the waste.

During the evaporation process, the salt waste is concentrated and forms two distinct phases – concentrated supernate solution and solid saltcake (collectively called salt waste). The solid saltcake is composed predominantly of nitrate, carbonate, aluminate, and sulfate salts and contains relatively small quantities of radioactive material. Because of the relative high solubility of cesium (Cs), the predominant radionuclide present in salt waste, 95% [2] of the Cs-137 in the salt waste is found in the concentrated supernate solution. As the result of the evaporation process, over 140 Mgal of liquid waste originally received have been reduced to the present volume of 36 Mgal [2]. Evaporator operations have been extremely effective in minimizing waste volume stored in SRS waste tanks, but because the majority of the waste has been fully concentrated using the available SRS equipment, significant further reductions via evaporation of the total waste volume stored are not possible.

SRS no longer conducts the weapons or NASA-related materials production activities or the weapons-related spent nuclear fuel reprocessing that generated the original waste, and DOE is now in the process of deactivating and decommissioning F-Canyon and cleaning out and closing the Tank Farms. Nevertheless, DOE continues to have a need for tank space for a number of purposes. Perhaps most significantly, substantial amounts of tank space are required in order to safely and effectively remove and prepare the tank waste for disposal. Tank space is also needed for the waste generated by other on-going cleanup activities as well as stabilization of legacy nuclear materials in the DOE Complex.

---

<sup>4</sup> SRS has a total of 51 underground waste storage tanks. In 1997, following approval of closure modules by the State of South Carolina, DOE operationally closed Tanks 17 and 20. On June 30, 2000, the NRC issued to DOE its final Technical Evaluation Report concerning those tanks.

Accordingly, an integral element of DOE's on-going efforts to clean up and close the tanks without significant inefficiency and delay is prompt initiation of salt retrieval and processing so as to create sufficient tank space to allow DOE to maintain sustained risk-reduction activities, including the vitrification of high-activity sludge waste through DWPF and subsequent disposal in a federal repository for HLW and spent nuclear fuel.

In March 2001, DOE issued a draft environmental impact statement on salt waste processing alternatives. The SRS Salt Processing Alternatives Final Supplemental Environmental Impact Statement (SEIS) [11] was published in June 2001, and in October 2001, DOE issued a Record of Decision (ROD)<sup>5</sup> [12] identifying CSSX and monosodium titanate (MST) as the preferred treatment technologies for salt waste. The ROD also stated that:

“... DOE will evaluate implementation of any of the other salt processing alternatives for specific waste portions for which processing could be accelerated or that could not be processed in the Caustic Side Solvent Extraction facility. These evaluations and potential operations would be undertaken to maintain operational capacity and flexibility in the HLW system, and to meet commitments for closure of high-level waste tanks.”

Since issuing the SEIS and the ROD, DOE has evaluated alternative technologies for the purposes contemplated in the ROD. In particular, to separate, treat, and dispose of the salt waste, DOE has now developed a strategy using a two-phase, three-part approach: (a) “Interim Salt Processing” [10], which will rely on one of the alternative technologies, DDA along with small-scale implementation of the technologies originally selected for SWPF (ARP and CSSX), beginning in 2006 and (b) “High Capacity Salt Processing” using SWPF from 2011 through 2019<sup>6</sup>. The quantities and percentages shown in Figure 2.1 reflect the radioactivity (i.e., curies) in the 33.8 Mgal of salt waste currently stored in underground storage tanks at SRS [2,4]. Although as explained above, DOE also anticipates processing an additional 41.3 Mgal of future waste which are not included in these estimates. DOE believes the inclusion of this waste will not appreciably affect the total curies to be disposed of in SDF. This is because the majority of this future waste is composed of the low-activity DWPF Recycle waste stream and because future H-Canyon receipts will be processed through SWPF, so that the final curies disposed of in SDF should be as shown in this figure. DOE has prepared a Supplement Analysis and updated ROD to reflect specific use of DDA and ARP/MCU.

### **NRC CONSULTATION**

On December 28, 2005, the NRC issued its “Technical Evaluation Report for the U.S. Department of Energy Savannah River Site Draft Section 3116 Waste Determination for Salt Waste Disposal” (TER) [8]. The TER presents information on DOE's salt waste processing strategy, the applicable review criteria, and the NRC's review approach, as well as the NRC's

---

<sup>5</sup> Additional discussion of the alternatives evaluated, their environmental impacts, and DOE's decision to implement the CSSX and MST technologies to treat salt waste can be found in the SEIS and the ROD.

<sup>6</sup> It remains DOE's goal to complete processing of the salt waste with the SWPF by 2019 although this end date may need to be modified slightly in the future.

analysis and conclusions with respect to whether there is reasonable assurance that DOE's proposed approach can meet the applicable requirements of the NDAA for determining that waste is not HLW. As noted in their executive summary, "Based on the information provided by DOE to the NRC ..., the NRC staff has concluded that there is reasonable assurance that the applicable criteria of the NDAA can be met provided certain assumptions made in DOE's analyses are verified via monitoring." [8, page v]

NRC made a number of observations regarding DOE's analyses in the draft Section 3116 Determination and its supporting documents. Key elements of these observations are addressed throughout this Final Section 3116 Determination as appropriate. DOE considered all of these observations in making this 3116 Determination.

Section 4.3.1 of the NRC's TER lists eight factors that the NRC identified as being important to assessing compliance with 10 CFR 61, Subpart C<sup>7</sup>. DOE will consider these and other appropriate factors in undertaking monitoring and other confirmatory actions to verify the ongoing validity of the assumptions that underlie this 3116 Determination.

Section 3116 requires the NRC, in coordination with the State of South Carolina, to monitor disposal actions taken by DOE for the purpose of assessing compliance with the performance objectives of 10 CFR 61, Subpart C. DOE will work with the NRC and the State of South Carolina to facilitate their efforts to fulfill their independent responsibilities.

## **2.1 SALT PROCESSING STRATEGY**

As described above, DOE has developed a two-phase, three-part approach for salt processing. The salt processing pathways and associated curie distribution are shown below in Figure 2.1.

---

<sup>7</sup> DOE also notes that Appendix A of the NRC's TER contained fifteen recommendations for DOE's consideration. "The purpose of the recommendations is to communicate actions that DOE might consider to further enhance its approach for management of the salt waste at SRS, as well as the approach for future waste determinations. As stated in this TER, the NRC staff has concluded that there is reasonable assurance that DOE will meet the applicable criteria of the NDAA if certain assumptions made in DOE's analyses are verified. Thus, it is the NRC staff's view that implementation of these recommendations is not necessary to meet the criteria in the NDAA." [8, page 93] DOE will factor these recommendations into its management of salt waste and development of future Section 3116 Determinations.

**Figure 2.1: Salt Processing Pathways [2,4]**

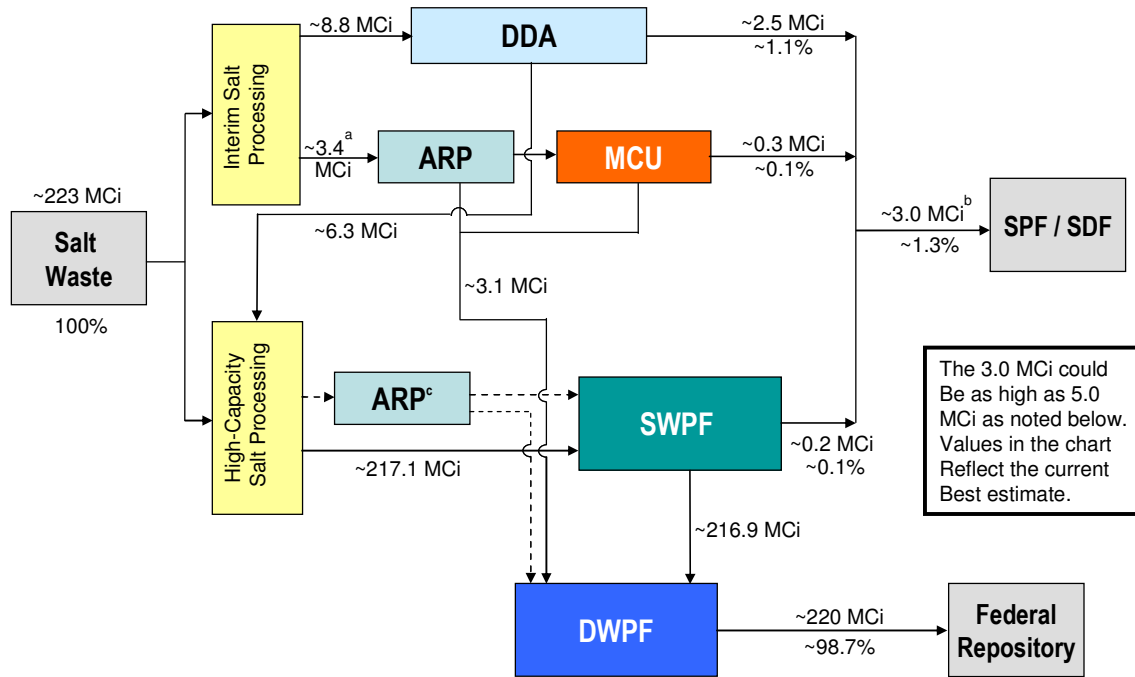

<sup>a</sup> Prior to treatment in ARP/MCU all saltcake waste will have undergone DDA.

<sup>b</sup> Due to the uncertainty associated with the current characterization of the saltcake waste, the actual curie content of this material may be as high as 5 MCi and the percentages would change accordingly. Curie numbers include daughter products of Cs-137 and Sr-90.

<sup>c</sup> ARP Facilities will have the capability to supplement the actinide removal capacity of SWPF if needed.

As stated earlier, 33.8 Mgal of salt waste are currently stored in underground waste storage tanks at SRS. This waste, along with future salt waste receipts forecasted to be sent to the Tank Farms, will be processed through DDA, ARP/MCU, and SWPF. It is estimated that an additional 41.3 Mgal [3] of unconcentrated salt waste will be received by the Tank Farms between December 1, 2004 and the completion of salt waste processing. After both liquid removal by processing through the Tank Farm evaporator systems and later additions of liquids for saltcake dissolution and chemistry adjustments required for processing, 84 Mgal (5.9 Mgal existing salt waste through the DDA process, 1.0 Mgal future salt waste through the DDA process, 2.1 Mgal through ARP/MCU, 69.1 Mgal existing salt waste through SWPF, and 5.9 Mgal future salt waste through SWPF) of salt solution will be processed by Interim Salt Processing and SWPF resulting in 168 Mgal of grout output from SPF to be disposed of in SDF [3] (see Figure 2.2 below).

Figure 2.2: Salt Processing Volumes<sup>8</sup> [3]

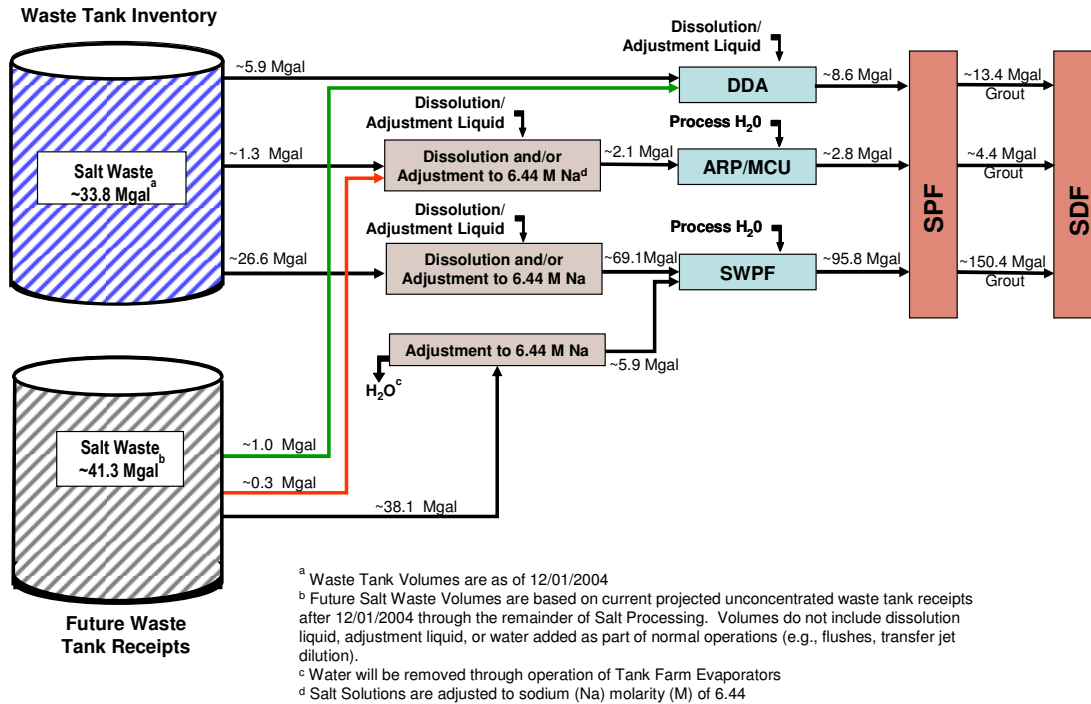

Each salt waste treatment process is described below.

### DDA PROCESS

The DDA process will be the first interim process used. It will be used to process some of the lowest activity salt waste from 2006 until no later than 2011. When SWPF begins operation, the DDA process will cease after processing 5.9 Mgal of existing salt waste and 1.0 Mgal of future salt waste as shown above. In 2007, ARP and MCU operations will be initiated to further process slightly higher activity salt waste. The DDA process will continue in parallel with the ARP and MCU facilities, handling the lowest activity salt waste.

The DDA process involves the following: 1) removing the supernate from above the saltcake; 2) extracting interstitial liquid within the saltcake matrix; 3) dissolving the saltcake and transferring the resulting salt solution to a settling tank; and 4) transferring the salt solution to the Saltstone Facility feed tank where, if required, the salt solution is aggregated with other Tank Farm waste to adjust batch chemistry. Chemistry adjustment may be required to ensure the salt solution feed stream meets processing parameters (e.g., sodium concentration, organic content, facility shielding limitations) for processing at SPF.

<sup>8</sup> Volumes shown are based on current knowledge of waste tank characterization data and process parameters. As processing continues and additional knowledge is gained, these volumes may be adjusted.

As shown in Figure 2.3, each waste tank undergoing the DDA process will initially contain salt waste consisting of both saltcake and supernate. Based on process knowledge to date, it is estimated that 30 percent of the saltcake volume is interstitial liquid [13].

Because of the relatively high solubility of Cs, 95% [2] of the Cs-137 in the salt waste is found in the concentrated supernate solution and interstitial liquid. Cs-137 is the predominant radionuclide found in salt waste. Therefore, removal of supernate and interstitial liquid from the waste tank prior to dissolution of the saltcake will significantly reduce the total Cs inventory sent to SDF. The supernate and interstitial liquid removed during the DDA process will be transferred to another waste tank and stored for future processing through SWPF. The removal of the supernate and interstitial liquid is the “deliquification” phase of the DDA process.

**Figure 2.3: DDA Process (Initial Conditions, Steps 1 and 2)**

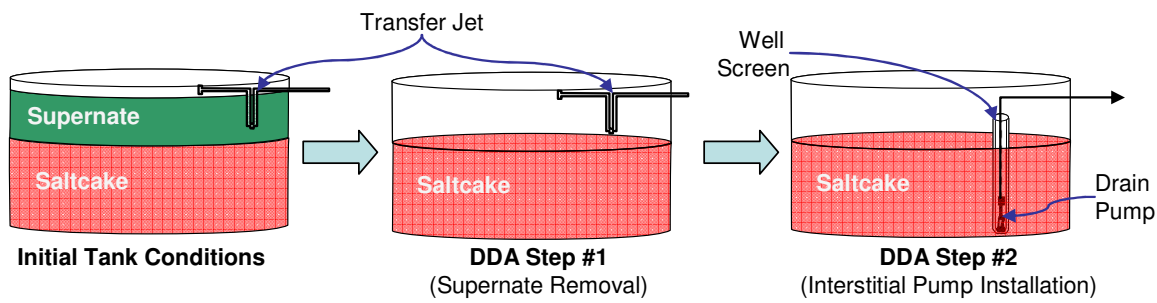

The first step in the deliquification phase (Figure 2.3, Step 1) is to remove the free supernate stored above the saltcake surface. Removal of the free supernate will generally be done using the existing tank transfer jet in each tank undergoing the DDA process. The free supernate will be transferred to another Tank Farm waste tank where it will be held for future treatment at SWPF.

After completion of the free supernate removal, the transfer jet will be removed from the waste tank to allow equipment to be installed for deliquification of the tank interstitial liquid. The transfer jets typically installed in waste tanks operate at flow rates that are too high for interstitial liquid removal. To remove interstitial liquid, a pumping system must be installed as close to the tank bottom as possible and must operate at very low flow rates (less than one gallon per minute). In order to place a pump near the bottom of the tank, a well will be formed in the saltcake from the top of the saltcake surface to the bottom of the tank. The well is formed by dissolving a column of the solid saltcake, typically by using a high pressure water spray nozzle. As the well is formed, a stainless steel well screen, 14 inches in diameter, will be lowered into the well. The well screen is the full height of the saltcake, which may be as high as 30 feet. The well screen protects the pump from collapse of the saltcake into the well. Once the well screen has been installed, a new transfer pump will be lowered to the bottom of the well screen (Figure 2.3, Step 2).

Removal of the interstitial liquid will be performed by operating the pump until the liquid level in the well is pulled down to pump suction level and flow can no longer be maintained. Then, as interstitial liquid is removed from the saltcake, the well will refill with liquid and the pump will be turned back on to draw down the liquid level. This process will be repeated until there is no longer appreciable flow into the well (Figure 2.4, Step 3). The interstitial liquid that is removed from the tank will be sent to another Tank Farm waste tank and stored for future processing at SWPF.

**Figure 2.4: DDA Process (Steps 3 through 5)**

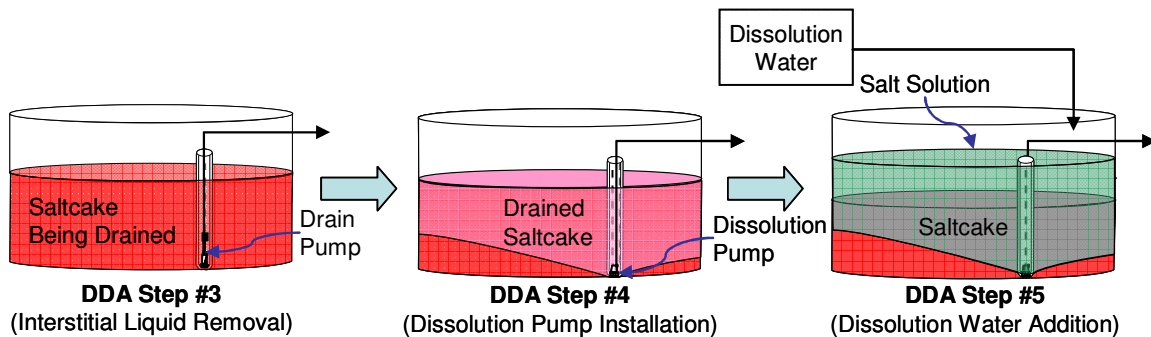

After interstitial liquid has been extracted to the point that the well recharge rate has become too slow to support the efficient removal of interstitial liquid, it is expected that the bottom five feet of saltcake will remain fully saturated and 50% of the interstitial liquid will have been extracted from the remainder of the saltcake, based on Tank 41 operational experience [13].

The next step in the DDA process is to dissolve the saltcake. This dissolution makes the saltcake into a mobile solution for processing, and allows the entrained solids to settle before the salt solution, minus the entrained solids that have settled, is transferred to SDF. Since the interstitial liquid removal pump is designed to operate at only low flow rates, the pump must be replaced with a separate dissolution pump (Figure 2.4, Step 4).

In order to dissolve the saltcake and create the salt solution batches, the tank will be filled with dissolution water, that is water chemically treated to prevent corrosion of the carbon steel waste tanks, (Figure 2.4, Step 5) until the saltcake surface has been flooded. This water dissolves a portion of the saltcake and a salt solution is formed.

The next step in the process is transfer of the salt solution from the tank where it was dissolved to a second waste tank that acts as a settling tank (Figure 2.5, Step 6).



**Figure 2.5: DDA Process (Steps 6 through 8)**

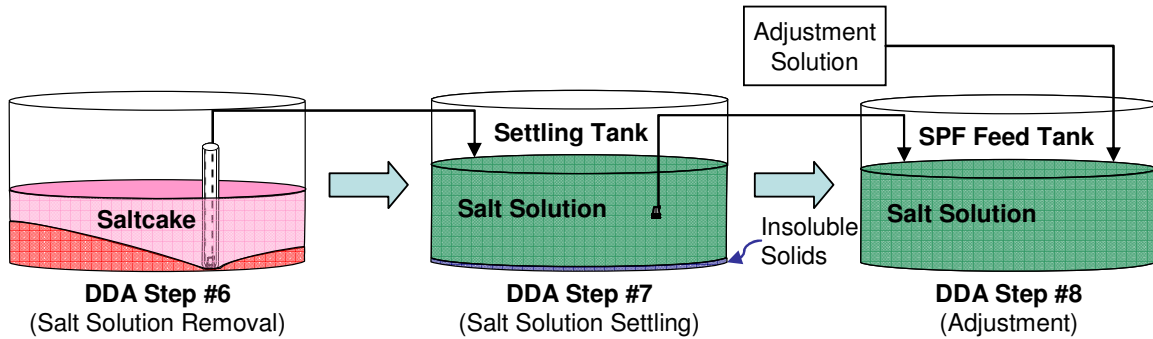

After the salt solution has been transferred, the dissolution process will be repeated to continue to dissolve the remaining saltcake (Steps 5 and 6) until the desired batch volume has accumulated in the settling tank (typically one million gallons). At that point, the insoluble solids that were transported with the salt solution will be allowed to settle in the tank (Figure 2.5, Step 7). The solids include insoluble Sr and actinides so the effect of allowing them to settle is to remove some of these radionuclides from the salt solution before it is treated and stabilized for disposal. In the chemistry of the salt waste, actinides and Sr are predominately insoluble so removal of insoluble actinides and Sr through settling is expected to remove a significant portion of these radionuclides.

After the salt solution has been held in the settling tank, the salt solution will then be decanted and transferred from the settling tank to Tank 50, the Saltstone Facility feed tank (Figure 2.5, Step 8). The settled solids will ultimately be transferred to DWPF for vitrification and disposal in the geologic repository. Once the salt solution is in Tank 50, the salt solution may be aggregated with other Tank Farm waste to adjust batch chemistry. Chemistry adjustment may be required to ensure the salt solution feed stream meets SPF processing parameters (e.g., sodium concentration, organic content, facility shielding limitations) for processing at SPF. After confirmation through sample analysis, processing of the material through SPF is initiated.

The DDA process, as described above, has been implemented up to the addition of the first batch of dissolution water (Figure 2.4, Step 5) on Tank 41 at SRS [13]. Removal of supernate from Tank 41 was undertaken in early 2002. Deliquification of Tank 41 occurred over a nine-month period beginning in September 2002. A total of 150 thousand gallons (kgal) of interstitial liquid and 25 kgal of supernate were transferred to other SRS waste tanks for future processing at SWPF. Flow rates during the deliquification process ranged from an initial rate of 10 gpm to a final rate of less than 0.5 gpm. At the completion of interstitial liquid removal, 240 kgal of dissolution water were added to the tank, and an estimated 350 kgal of new salt solution was formed. Dissolution water was added to Tank 41 in early July 2003, and the tank has since been sitting idle pending resumption of salt disposition activities<sup>9</sup>.

<sup>9</sup> Salt waste disposition activities were suspended in 2003 after a federal District Court in Idaho issued a decision striking down certain portions of DOE's Order 435.1 and accompanying Manual. [Natural Resources Defense](#)

In addition to the DDA activities already completed on Tank 41, two additional tanks will undergo deliquification and dissolution in support of the Interim Salt Processing Strategy. The tanks currently contemplated for deliquification and dissolution, in addition to Tank 41, are Tanks 25 and 28. Based on characterization information available today, those tanks are believed to contain some of the lowest activity material in all of the waste tanks at SRS [10]. Activities to characterize tank waste continue, and as additional knowledge of the dissolution process is gained, other tanks may be substituted for Tanks 25 and 28 if tanks better suited for DDA are identified.

In addition, during the DDA part of Interim Salt Processing, DOE also plans to process a unique salt waste stream currently stored in Tank 48. This waste consists of 0.24 Mgal [2] of relatively low-activity salt solution<sup>10</sup> containing 19,000 Kg [14] of potassium and cesium tetraphenylborate (TPB) salts generated during an earlier unsuccessful effort to prepare salt waste for disposal, known as the In-Tank Precipitation (ITP) process. This process was briefly operated from 1995 through 1996 and was subsequently abandoned because DOE determined that the ITP process could not be safely operated at the necessary production rates. The ITP process resulted in generation of the TPB salts described above. The organic nature of TPB salts requires them to be stored separately from other tank waste. This is because as TPB breaks down into benzene and other organic compounds, it can form a potentially explosive mixture in the vapor space of a waste tank if not carefully managed. Other tanks are not equipped with safety systems required to manage this flammable mixture. Accordingly, all of the space in the 1.3 Mgal Tank 48 is being entirely used to store the 0.24 Mgal of TPB salts. In addition, this waste cannot be processed through DWPF because the breakdown of TPB in sufficient quantities in the DWPF melter could pose safety concerns. Currently, there is no practically available or contemplated technology that could be used to remove additional radioactivity and dispose of that radioactivity using DWPF. Accordingly, the waste in Tank 48 will be processed without further removal of radionuclides by combining the Tank 48 stream with another salt waste stream, currently planned to be the low-activity liquid recycle waste stream from DWPF<sup>11</sup>. The two waste streams will be aggregated to ensure the processing limits for allowable organic content at SPF are not exceeded. The aggregated low-activity waste stream will then be transferred to the Saltstone Facility feed tank.

---

Council v. Abraham, 271 F. Supp. 2d 1260 (D. Idaho. 2003). The provisions of the Order the court invalidated were those that set out criteria for determining that certain waste from reprocessing is “waste incidental to reprocessing” rather than “high-level radioactive waste.” DOE resumed salt waste disposition planning after Congress enacted Section 3116 of the NDAA on October 28, 2004. That section clarified the Secretary’s authority with respect to certain waste from reprocessing, including the salt waste at issue here, and spelled out the criteria for making these determinations. Shortly thereafter, on November 5, 2004, the U.S. Court of Appeals for the Ninth Circuit reversed the District Court’s decision and remanded it with instructions to dismiss the case as unripe. Natural Resources Defense Council v. Abraham, 388 F.3d 701 (9<sup>th</sup> Cir. 2004), rehearing and rehearing en banc denied (9<sup>th</sup> Cir. 1/20/2004).

<sup>10</sup> It does not contain any saltcake.

<sup>11</sup> The DWPF recycle waste stream is a generally very low-activity stream that consists of condensate from chemical processing and melter operation, waste from decontamination activities, and waste from miscellaneous drains and sumps in DWPF. Before the recycle stream is transferred to the Tank Farm, it is chemically adjusted with sodium nitrite and sodium hydroxide to ensure that Tank Farm WAC are met.

## **ARP AND MCU**

The second interim process used for slightly higher activity salt waste will entail use of interim facilities to remove additional radionuclides, as well as cesium, before the resultant low-activity salt waste stream is sent to SPF for combination with a grout matrix and transfer to SDF, where the waste-grout slurry hardens and is disposed of. The radionuclides that will be removed are primarily actinides (uranium (U), Pu, americium (Am), neptunium (Np), and curium (Cm)), strontium, and cesium. The removal of these radionuclides will be accomplished through ARP and MCU.

### **ARP**

ARP will use modified existing facilities at SRS to remove Sr and actinides from some additional saltcake waste after the waste has undergone DDA.

As shown in Figure 2.6, the ARP facilities will provide the capability to treat salt solution from the Tank Farms to remove soluble radioactive Sr and actinides by addition of MST and will remove insoluble Sr and actinides by cross-flow filtration. ARP is currently planned to be completed and ready for operations in 2007. Because this facility will be available several months earlier than MCU, DOE is considering whether to operate that facility separate from MCU for a short period of time. This would allow for the removal of additional strontium and actinides from a quantity of salt waste that would not have otherwise undergone this treatment thereby reducing the number of curies disposed in the Saltstone Facility.

ARP also has the ability to provide additional strontium and actinide removal capability to supplement the capability of the SWPF when it comes on line in 2011. DOE will evaluate the need for the additional strontium and actinide removal capability provided by ARP closer to the time of startup of the SWPF when the expected processing rates for the SWPF are better known.

Based on current process flowsheet information, MST strikes will be conducted on all salt solution processed through ARP, even if the salt solution already does not exceed Class C concentration limits in 10 CFR 61.55 in the grouted waste form, as long as throughput can be maintained, with adequate margin, to support necessary tank space needs. The waste will be received into either of two MST Strike Tanks. Waste received in MST Strike Tank #1 or #2 will be adjusted with water to 5.6 Molar sodium concentration to provide optimum conditions for sorption of Sr-90 and actinides onto MST.

Following the addition of MST to either Strike Tank, the contents will be agitated for a reaction period between 4 and 24 hours based on the curie concentration of the soluble actinides to be removed. The resulting slurry will be transferred from either of the strike tanks into the Filter Feed Tank (FFT). The ARP facilities will be used to remove soluble Sr-90 and actinides through MST strikes, as long as tank space objectives can be met with appropriate operational margin. If emergent technical or processing information becomes known that indicates that tank space objectives cannot be met AND the soluble actinides in the original salt solution are sufficiently

low (i.e., below Class C concentration limits) to achieve the necessary tank space recovery prior to SWPF start-up, the stream will only be filtered prior to being sent to MCU.

The batch received in the FFT will be circulated through a cross-flow filter to remove and concentrate the insoluble solids and the MST solids loaded with Sr and actinides, if MST treatment of the waste was performed. The cross-flow filtration process will yield a Clarified Salt Solution (CSS) which will be received in the Filtrate Hold Tank (FHT). The solids will be concentrated in the FFT over a number of batches depending on the entrained solids loading of the waste incoming to ARP. The concentrated solids heel in the FFT will then be washed and filtered to remove soluble sodium salts. The washed MST/sludge slurry will be transferred to DWPF for vitrification processing.

The CSS and spent wash water from the solids washing operation will then be transferred from the FHT to the Saltstone Facility feed tank for transfer to the Saltstone Facility, if the waste has a sufficiently low cesium concentration to meet the Saltstone Facility WAC. The Saltstone Facility WAC will always require Cs concentrations to be below Class C limits. If the waste is a higher Cs salt waste, the CSS will be sent directly to MCU during Interim Salt Processing or to SWPF once SWPF is operational.

**Figure 2.6: Actinide Removal Process**

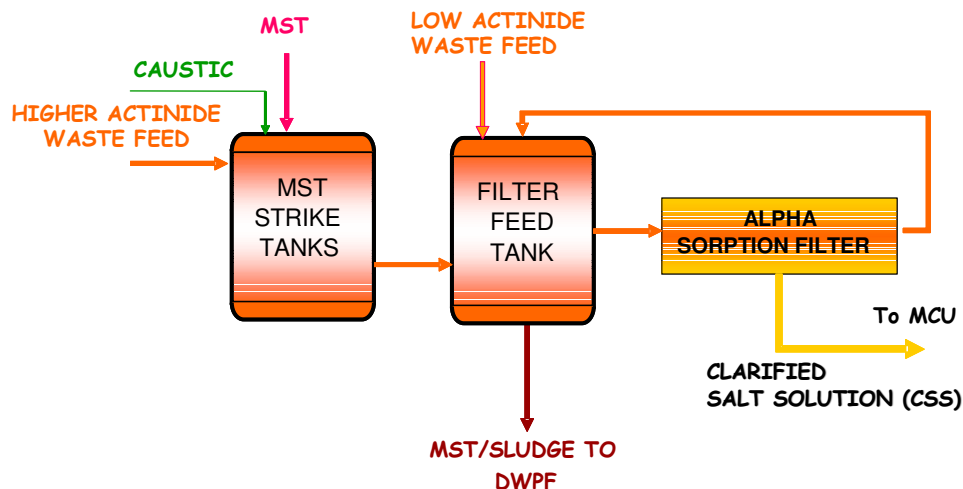

## MCU

MCU will utilize the CSSX process to remove Cs from the salt waste. The solvent extraction process will use an organic solvent to complex with (or tie up) Cs atoms in the waste stream. The solvent and salt solution will then be fed to a bank of centrifugal contactors which will ensure complete mixing of the waste and solvent and extraction of the solvent and Cs from the salt waste stream. The Cs will then be stripped from the solvent in another bank of contactors and sent to DWPF for vitrification. The solvent will then be recycled. The Decontaminated Salt Solution

(DSS) resulting from solvent extraction will be sent to the Saltstone Facility feed tank. SRS is constructing this small scale solvent extraction capability to be operational in 2007 and it will process 2.1 Mgal of salt solution [10].

MCU will be a short-term Cs removal process that will be operated downstream of ARP before SWPF becomes operational. MCU will utilize the same technology as that to be used by SWPF but its decontamination capability will be less than that of SWPF since MCU will only be used to process lower curie material.

As shown in Figure 2.7, the CSSX process will use multiple centrifugal contactors to provide the necessary contact and separation of the aqueous and organic streams. Current plans are to use seven stages for extraction, two stages for scrubbing, seven stages for stripping, and two additional stages for solvent washing.

**Figure 2.7: Modular CSSX Unit Process**

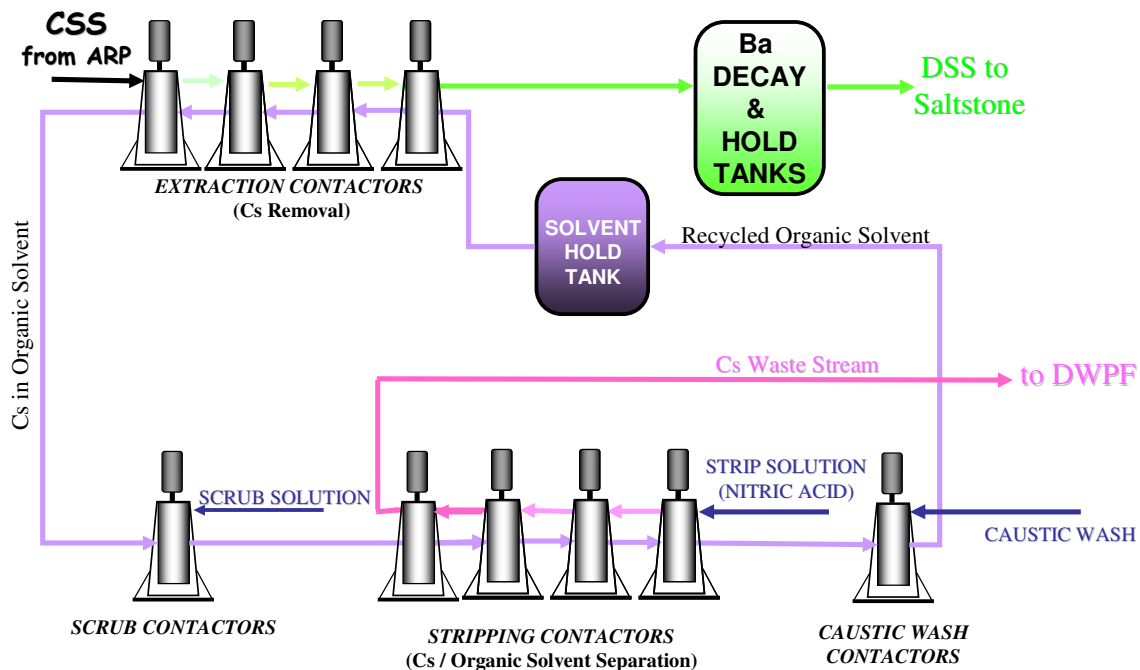

The extraction section will use the organic solvent to extract Cs (as well as some sodium and potassium) from the salt solution. The scrub section will then return the sodium and potassium to the salt solution leaving the Cs in the solvent and will neutralize any hydroxide carried over in the solvent. The strip section will return the Cs to a separate aqueous phase that will be sent to DWPF for vitrification and will allow the solvent to be reused in the process.

The solvent will be made up of four components: an extractant based on a modified calixarene molecule designed to complex with Cs, a modifier that will improve the solubility of the extractant, a suppressor that will counter the negative effects of anionic impurities in the waste,

and a diluent. The solvent will be contacted with the alkaline waste stream in a series of countercurrent centrifugal contactors (the extraction stages). The resulting DSS will be transferred to the Saltstone Facility via the Saltstone Facility feed tank for disposal. Following Cs extraction, the solvent will be scrubbed with dilute acid to remove other soluble salts from the solvent stream (the scrub stages). The scrubbed solvent will then pass into the strip stages where it will contact a very dilute acid stream to transfer the Cs to the aqueous phase. Based on volumetric flow ratios of the solvent extraction streams, the Cs concentration will increase by a factor of 12 to 15 over the salt feed solution to minimize the aqueous flow to DWPF. The aqueous strip effluent containing the Cs removed will be transferred to DWPF.

## **SWPF**

DOE is designing and will construct a large scale SWPF<sup>12</sup>. SWPF will utilize the same technologies as ARP and MCU to remove Sr, actinides, and Cs from the salt waste. However, due to its large scale, SWPF will provide a much higher decontamination factor (DF)<sup>13</sup> for Cs than the MCU, about 40,000 and 12, respectively, and DFs for Sr and actinides is similar to or higher than the interim ARP process that will be deployed earlier. SWPF also will have a much higher capacity (6 to 9 Mgal per year [4]) than ARP and MCU and will be able to treat all of the remaining salt waste including the supernate and interstitial liquid which start out with significantly higher concentrations of Cs than the small amount of low-activity salt waste that DOE will treat through the interim processes. SWPF is planned to be completed and become operational in 2011, and will consist of three basic unit operations: the Alpha Strike Process (ASP), CSSX, and the Alpha Finishing Process (AFP).

ASP will be the initial processing stage of SWPF, operating in a batch mode to remove soluble Sr and actinides from the waste feed by sorption onto MST. The resultant slurry will be filtered to concentrate the MST and insoluble solids. The resulting filtrate, or CSS, will be sent forward to CSSX and the concentrated MST/sludge will be washed and sent to DWPF as shown in Figure 2.8.

---

<sup>12</sup> The SWPF preliminary design is being modified to incorporate a higher degree of performance category (PC) in the confinement barriers necessary for worker protection during natural phenomena hazard events.

<sup>13</sup> DF is defined as the quotient of the influent concentration of a given radionuclide and the effluent concentration of that same radionuclide.

**Figure 2.8: SWPF Alpha Strike Process**

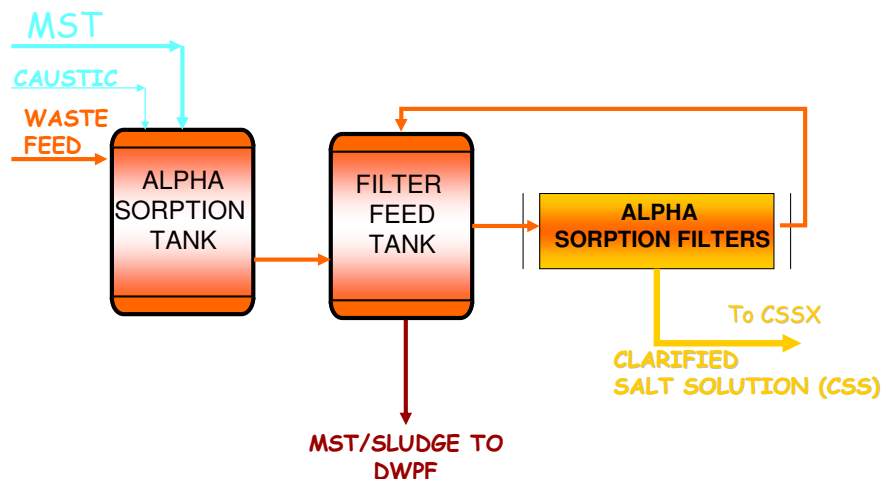

The second SWPF processing operation will use the CSSX process to remove Cs from the CSS. Based on the current design, this will be a continuous flow process, utilizing centrifugal contactor stages for extracting (16 stages), scrubbing (2 stages), stripping (16 stages), and washing (2 stages) CSS streams as shown in Figure 2.9. Cs will be captured by contacting the aqueous salt solution with a specially engineered extractant (BOBCalixC6) which will be part of a four component organic solvent that will also include a modifier that will improve the solubility of the extractant, a suppressor that will counter the negative effects of anionic impurities in the waste, and a diluent. The Cs then will be stripped from the organic solvent by contacting with a dilute nitric acid strip solution and separating the phases. The scrub and wash stages will be used to condition and purify the solvent for recycling. The strip effluent (high Cs concentration) is sent to DWPF for vitrification. After allowing for barium (Ba)-137m decay (half-life of approximately two minutes), the DSS, which will be comprised of the aqueous effluent raffinate from the extraction stages and aqueous wash effluent from the wash stages, will be sampled to confirm that process requirements have been met. The DSS then will be sent to the Saltstone Facility feed tank or to AFP if additional Sr and actinide removal is required.

Figure 2.9: SWPF CSSX Process

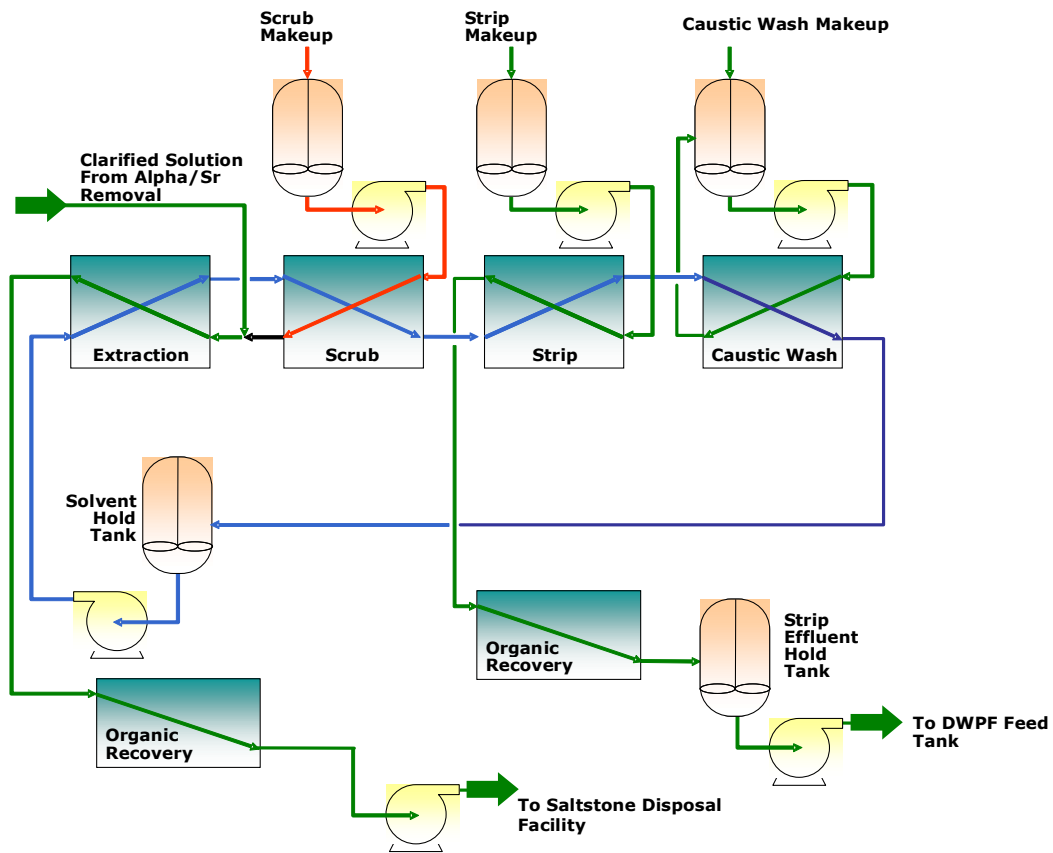

AFP will be the final SWPF unit operation in which an additional MST strike may be performed. This unit operation will be located downstream of CSSX and will remove Sr and actinides not removed in ASP. AFP will be similar to ASP in equipment/tank sizes, configuration, and operational sequence. AFP will provide the benefit of additional MST strike capability without any reduction in SWPF throughput and allows the equipment to be located in a contact-handled area of the plant. This will provide further assurance that the processed salt waste will meet the Saltstone Facility WAC limits, even if the waste feed has higher than expected concentrations of actinides or Sr than previously anticipated.

As mentioned previously, SWPF will be capable of processing 6 to 9 Mgal of salt solution per year after the first year of operation with a nominal annual processing rate of 7 Mgal. SWPF is scheduled to begin hot commissioning activities in 2011 followed by one year of hot operations with a planned processing rate of 5 Mgal [4]. SWPF is expected to continue to operate until the completion of salt processing.



## SALTSTONE FACILITY

As discussed earlier, DOE intends to use a low-level waste disposal facility known as the Saltstone Facility for final treatment, stabilization and disposal of the salt waste. This facility, located in Z-Area of SRS, consists of the SPF and SDF facilities.

Construction of SPF and the first two vaults of SDF were completed between February 1986 and July 1988. The Saltstone Facility started radioactive operations in June 1990. Since that time, it has continued to be operated on an intermittent, as-needed basis to treat and dispose of waste concentrate from the F- and H- Area Effluent Treatment Facility as well as low-level waste from the Naval Fuel Material Facility.

SPF will receive and mix the low-activity salt solution from the DDA, ARP/MCU, and SWPF processes with cement, fly ash, and slag to form a homogeneous grout mixture or slurry. The slurry will be mechanically pumped into engineered disposal vaults, located in SDF, where the grout solidifies into a monolithic, non-hazardous, solid low-level waste form called "saltstone."

The salt waste from the tanks has higher activity levels than the very low-activity waste the Saltstone Facility has been used to treat and dispose of to date. The Saltstone Facility was originally designed to dispose of very low-activity waste with concentrations less than Class A limits. Therefore, several modifications in the design and operation of the facilities have been completed to prepare them for receipt of the low-activity salt solutions produced by Interim Salt Processing. To minimize radiation exposure to SPF workers during normal operations, additional shielding will be added to the major pieces of SPF process equipment, including the salt feed line to SPF and the grout line running from the process to the SDF disposal vaults. In addition, several inches of uncontaminated grout will be poured on top of the saltstone grout in the inactive vault cells to reduce the amount of exposure to facility workers<sup>14</sup> due to sky shine (a phenomenon where gamma radiation is reflected off molecules in the air and back toward the earth). Equipment has also been redesigned and replaced to minimize the impact of an SPF grout delivery system failure. This includes redesign to facilitate removal of affected system components without significant hands-on requirements.

As presently planned, SDF will contain several large concrete vaults divided into cells. Each of the cells will be filled with solid saltstone grout. The saltstone grout itself provides primary containment of the waste, and the walls, floor, and roof of the vaults provide secondary containment. Existing vaults will be used for the low-activity salt waste resulting from Interim Salt Processing. Additional vaults will be added as needed to receive the low-activity salt waste on a just-in-time basis. A more detailed discussion of these facilities may be found in Appendix 1.

The Saltstone Facility is located one mile from the salt processing facilities and 6.2 miles from the nearest SRS site boundary. Z-Area, where the Facility is located, lies on a local topographic high at 290 feet above mean sea level [15]. This site was selected for low-level waste disposal

---

<sup>14</sup> The facility workers will be primarily in SPF rather than SDF during normal operations.

because of its location on a well-drained topographic high, as evidenced by the lack of marshes or other bodies of standing water. Z-Area is bounded by two streams: Upper Three Runs and McQueen Branch, a tributary to Upper Three Runs. McQueen Branch is located 1.0 miles to the East and 0.75 miles to the Northeast of Z-Area, and Upper Three Runs is located 1.0 miles to the Northwest [15]. Under Z-Area, the minimum depth to the water table from the ground surface in any given year is estimated to be 43 feet (i.e., at 247 feet above mean sea level) on the basis of water table fluctuations [16]. Per South Carolina Department of Health and Environmental Control (SCDHEC) Regulation R.61-107.16, the bottom of all current and future disposal vaults must be located at least two feet above this historic high water table.

There are no lakes or flow control structures on Upper Three Runs or its tributaries. The Probable Maximum Flood value for Upper Three Runs is 175 feet above mean sea level, which is substantially below the planned maximum depth of the SDF vaults [15]. The 500-year and 100-year flood plains are located at 153.1 feet and 151.7 feet above mean sea level, respectively [17].

Two major earthquakes have occurred within 100 miles of SRS. The largest known earthquake to affect SRS was the Charleston earthquake of 1886, with an epicenter approximately 90 miles from SRS and a magnitude of 6.6 on the Richter Scale. It is estimated that an earthquake of this magnitude would result in a peak ground acceleration of 0.10 g at SRS [18]. A seismic evaluation of Z-Area shows that the soils beneath Z-Area are not susceptible to significant liquefaction for earthquakes having a peak ground acceleration less than or equal to 0.17 g [19]. The second earthquake occurred 90 – 100 miles from SRS, with an estimated magnitude of 4.5.

### **RADIONUCLIDE REMOVAL TECHNOLOGIES**

The DDA process was developed to treat the lowest activity salt waste streams because it utilizes readily available technologies that could be implemented in the near term. Technologies from the chemical, mining, geology, and other industries were adapted for the DDA process to provide the capability to remove the cesium-bearing interstitial liquid from the saltcake [13]. Other options to improve deliquification effectiveness were considered. The sheer size of the waste tanks (typically 85 feet in diameter and 35 feet tall) and the process cooling coils (typically over a mile of piping within each individual tank) adds great complexity and limits the options. The structural design of SRS waste tanks precludes positively pressurizing them to force liquids from the solid saltcake. In addition, such positive pressure could result in a significant release of airborne radioactivity to the environment. Also, options to use additional fluid to improve Cs removal efficiencies were considered. Methods to displace the existing Cs-laden interstitial liquid were not viable due to tank configuration and chemistry constraints (fluids that would displace the liquid would also dissolve the saltcake). Flushing of the saltcake after initial deliquification also was not viable due to tank space limits and the same chemistry constraints.

The ARP and MCU facilities are based on the same technologies that will be implemented in SWPF. They have been scaled down to accelerate their availability and to allow the processes to fit within existing facilities at SRS. In addition, these small scale facilities offer DOE the opportunity to demonstrate the technologies that will be implemented on a large scale in SWPF. The identification, evaluation, and selection of the technologies for Sr, actinide, and Cs removal

for SWPF were the subject of numerous studies and reviews. Starting in 1998, more than 140 technologies were evaluated and considered [11]. In 2000 and 2001, the National Academy of Sciences reviewed DOE's technology evaluations and selections [20]. This review validated the DOE technology evaluation and selection process and provided input for continuing technology development. DOE continued to invest in technology development for the alternatives considered and down-selected to CSSX and MST in late 2001. The Salt Processing Alternatives SEIS [11] was the basis for DOE's selection of MST and CSSX as the technologies to be implemented in SWPF.

The solidified salt solutions arising from the salt waste treatments described above will be safely disposed of at SDF. The higher activity fractions, separated from the waste by the DDA process, ARP/MCU, and SWPF and containing nearly all radioactive inventories (close to 99%), will be immobilized at DWPF in a vitrified glass waste form for disposal at a Federal geologic repository. Appendix 1 contains a system description, which includes a brief history and background on waste generating activities and a description of facilities used at SRS for waste storage, evaporation, waste removal, treatment, vitrification, and disposal activities.

### **3.0 SECTION 3116 (A) OF THE RONALD W. REAGAN NATIONAL DEFENSE AUTHORIZATION ACT FOR FISCAL YEAR 2005 (NDAA)**

Section 3116 (a) of the NDAA provides:

In General. – Notwithstanding the provisions of the Nuclear Waste Policy Act of 1982, the requirements of section 202 of the Energy Reorganization Act of 1974, and other laws that define classes of radioactive waste, with respect to material stored at a Department of Energy site at which activities are regulated by a covered State pursuant to approved closure plans or permits issued by the State, the term “high-level radioactive waste” does not include radioactive waste resulting from the reprocessing of spent nuclear fuel that the Secretary of Energy (in this section referred to as the “Secretary”), in consultation with the Nuclear Regulatory Commission (in this section referred to as the “Commission”), determines -

- (1) does not require permanent isolation in a deep geologic repository for spent fuel or high-level radioactive waste;
- (2) has had highly radioactive radionuclides removed to the maximum extent practical; and
- (3) (A) does not exceed concentration limits for Class C low-level waste as set out in Section 61.55 of title 10, Code of Federal Regulations, and will be disposed of -
  - (i) in compliance with the performance objectives set out in subpart C of part 61 of title 10, Code of Federal Regulations; and
  - (ii) pursuant to a State-approved closure plan or State-issued permit, authority for the approval or issuance of which is conferred on the State outside of this section; or(B) exceeds concentration limits for Class C low-level waste as set out in section 61.55 of title 10, Code of Federal Regulations, but will be disposed of -
  - (i) in compliance with the performance objectives set out in subpart C of part 61 of title 10, Code of Federal Regulations, and
  - (ii) pursuant to a State-approved closure plan or State-issued permit, authority for the approval or issuance of which is conferred on the State outside of this section; and
  - (iii) pursuant to plans developed by the Secretary in consultation with the Commission.

As demonstrated in the following sections, the solidified DSS will not exceed the concentration limits for Class C waste in Code of Federal Regulations (CFR) 10 CFR 61.55 [21]. Therefore, the provisions of NDAA Section 3116 (a)(3)(B), concerning waste which exceeds Class C concentration limits, are not addressed in this 3116 Determination.

#### **4.0 THE WASTE DOES NOT REQUIRE PERMANENT ISOLATION IN A DEEP GEOLOGIC REPOSITORY FOR SPENT FUEL OR HIGH-LEVEL RADIOACTIVE WASTE**

Section 3116 (a) of the NDAA provides in pertinent part:

[T]he term “high-level radioactive waste” does not include waste from reprocessing of spent nuclear fuel that the Secretary of Energy....., in consultation with the Nuclear Regulatory Commission...determines –

- (1) does not require permanent isolation in a deep geologic repository for spent fuel or high-level radioactive waste[.]

The purpose of Section 3116 is to clarify the Secretary’s authority, in consultation with the NRC, to determine that certain waste from reprocessing that meets the criteria set out in the section should not be classified as “high-level radioactive waste.” It sets out two specific criteria for making this determination in clauses (2) and (3). Clause (2) requires DOE to remove highly radioactive radionuclides to the maximum extent practical. Clause (3) generally mirrors the criteria that the NRC has established for determining whether waste qualifies for land disposal as low level waste (LLW) (See 10 CFR. 61.55 and 61.58). This includes waste that meets the performance objectives of 10 CFR Part 61, Subpart C and which either falls within the classes set out in 10 CFR 61.55 or for which DOE has consulted with the NRC concerning DOE’s disposal plan.

Clause (1) is a broader criterion that requires the Secretary, in consultation with the NRC to consider whether, notwithstanding that waste from reprocessing meets the other two criteria, there are other considerations that, in the Secretary’s judgment, require its disposal in a deep geologic repository. Generally speaking, this would be an unusual case. This is because waste that meets the third criterion would be waste that the Secretary, in consultation with the NRC, has determined will be disposed of in a manner that meets the Part 61 Subpart C performance objectives, and which falls within one of the classes of waste that the NRC has specified are considered generally acceptable for near-surface disposal or for which the Secretary has consulted with NRC concerning DOE’s disposal plan. These performance objectives, as the NRC recently explained, “set forth the ultimate standards and radiation limits for: (1) protection of the general population from releases of radioactivity; (2) protection of individuals from inadvertent intrusion; (3) protection of individuals during operations; and (4) stability of the disposal site after closure.” In the Matter of Louisiana Energy Services (National Enrichment Services), CLI-05-05, slip op. at 11 (Jan. 18, 2005). It follows that if disposal of a waste stream in a facility that is not a deep geologic repository will meet these objectives, in the ordinary case that waste stream does not “require disposal in a deep geologic repository” because non-repository disposal will be protective of the public health and safety.

That said, it is possible that in rare circumstances, a waste stream that meets the third criterion might have some other unique radiological characteristic or may raise unique policy considerations that warrant its disposal in a deep geologic repository. Clause (1) is an acknowledgment by Congress of that possibility. For example, the waste stream could contain material that, while not presenting a health and safety danger if disposed of at near or intermediate surface, nevertheless presents non-proliferation risks that the Secretary concludes cannot be adequately guarded against absent deep geologic disposal. Clause (1) gives the Secretary, in consultation with the NRC, the authority to consider such factors in determining whether waste that meets the other two criteria nonetheless requires disposal in a deep geologic repository in light of such considerations.

That is not the case here. As is demonstrated later in this document, the solidified low-activity salt waste falls within Class C limits and hence falls within one of the categories that the NRC has concluded is generally appropriate for near-surface disposal. Moreover, as is also demonstrated later in this document, its disposal in SDF will meet the performance objectives of Part 61 Subpart C. Therefore, the disposal of this waste in SDF will provide for the protection of the public health and the environment. Accordingly, the waste does not require disposal in a deep geologic repository by reason of risk to the public health and safety. Furthermore, disposal of the solidified low-activity salt waste in SDF does not raise any unique considerations that, notwithstanding these demonstrations, nevertheless require its permanent isolation in a deep geologic repository. Accordingly, the solidified low-activity salt waste qualifies for disposal as other than high-level waste under the first clause of subsection (a).

## **5.0 THE WASTE HAS HAD HIGHLY RADIOACTIVE RADIONUCLIDES REMOVED TO THE MAXIMUM EXTENT PRACTICAL**

Section 3116 (a)(2) of the NDAA provides in pertinent part:

[T]he term “high level waste” does not include radioactive waste resulting from the reprocessing of spent nuclear fuel that the Secretary of Energy..., in consultation with the Nuclear Regulatory Commission..., determines –

\*\*\*

(2) has had highly radioactive radionuclides removed to the maximum extent practical[.]

### **5.1 HIGHLY RADIOACTIVE RADIONUCLIDES**

Based on consultation with the NRC, DOE views “highly radioactive radionuclides” to be those radionuclides that, using a risk-informed approach, contribute most significantly to radiological risk to workers, the public, and the environment. Cesium-137 (including its daughter, Ba-137m)<sup>15</sup>, Sr-90 (including its daughter Y-90), four alpha-emitting transuranic (TRU) nuclides (Pu-238, Am-241, Cm-244 and Pu-239), Se-79, Tc-99 and I-129 are the highly radioactive radionuclides in the SRS low-activity salt waste for disposal that DOE believes, on the basis of a risk-informed approach, may contribute significantly to radiological risk to workers, the public and the environment, taking into account scientific and health physics principles, knowledge and expertise<sup>16</sup>. This list of highly radioactive radionuclides was developed beginning with the inventory of over 40 radionuclides in the SRS salt waste that are tracked on a monthly basis [22]. DOE reviewed this inventory of radionuclides and identified those radionuclides in Tables 1 and

---

<sup>15</sup> Cs-137, and its daughter Ba-137m, are typically considered as a single radionuclide for human health protection purposes because the half-life of Ba-137m is so short that it only exists when Cs-137 is present. The same is true for Sr-90 and its daughter Y-90. Accordingly, the discussions that follow in this 3116 Determination focus on Cs-137 or Sr-90 since approaches that are effective in removing Cs-137 and Sr-90 also remove Ba-137m and Y-90, respectively.

<sup>16</sup> Some of the radionuclides listed as highly radioactive radionuclides for the SRS low-activity salt waste may not be listed for other 3116 Determinations if such radionuclides are not present in the waste or do not contribute to dose to the workers, the public, or the intruder.



2 of 10 CFR 61.55<sup>17</sup>, as well as any additional radionuclides that may be important to meeting the performance objectives in 10 CFR 61, Subpart C because they contribute to the dose to workers, the public, and/or the inadvertent intruder (for one or more reasonable intruder scenarios) in the expected (base) case and sensitivity scenarios. In DOE's view, this approach results in a risk-informed list of highly radioactive radionuclides that includes: those short-lived radionuclides that may present risk because they produce radiation emissions that, without shielding or controls, may harm humans simply by proximity to humans without inhalation or ingestion; and those long-lived radionuclides that persist well into the future, may be mobile in the environment, or may pose a risk to humans if inhaled or ingested. [6]

The short-lived fission products Cs-137 and Sr-90 and their equilibrium daughter products, Ba-137m and Y-90, are by far the predominant sources of radioactivity present in the SRS salt waste. Based on process and sampling knowledge as reflected in the current WCS database, more than 99% [2] of the current radioactivity in the SRS salt waste is associated with these two radionuclides and their daughters. Indeed, Cs-137 and its daughter Ba-137m alone account for over 95% of the salt waste's radioactivity [2]. Moreover, Cs-137, Sr-90, and their daughters are present in sufficient concentrations in the salt waste so that without shielding and controls they produce radiation emissions that would present risk to humans simply due to their proximity without direct inhalation or ingestion. Accordingly, they are of potential acute hazard to occupational workers, the public and the environment.

Although the alpha-emitting TRU nuclides in the concentrations present in the salt waste (i.e., Pu-238, Am-241, Cm-244, Pu-239) do not require distance and shielding to protect workers and the public, these radionuclides contain the majority of the long-lived isotopes that may pose the greatest risk in the future to human health because of their long life and because they present human health risk if directly inhaled or ingested. Other radionuclides which DOE views as highly radioactive radionuclides are those that persist in the waste form well into the future due to their long lives, are relatively mobile in the environment, and may present a health risk if ingested. These radionuclides are Se-79, Tc-99, and I-129. These two groups of radionuclides (i.e., the alpha-emitting TRU nuclides, Se-79, Tc-99, and I-129) together account for less than 1% [2] of the radionuclide inventory in the salt waste<sup>18</sup>.

---

<sup>17</sup> Although Tables 1 and 2 in 10 CFR 61.55 specify concentration limits for certain radionuclides in the form of activated metal, DOE includes such radionuclides, if present in the waste, in the list of "highly radioactive radionuclides" as it exists in the waste, without regard to whether such radionuclides are in the form of activated metal. Consistent with Table 1, DOE excludes alpha-emitting transuranic nuclides with half lives of 5 years or less from the list of highly radioactive radionuclides. All radionuclides in Tables 1 and 2 are considered with respect to section 6 of the Determination (concerning 3116(a)(3)(A) of the NDAA) and, where relevant, section 7 of the Determination (concerning 3116(a)(3)(A)(i) of the NDAA). However, radionuclides with half lives of 5 years or less, as well as H-3, C-14, Co-60 and Ni-63 (which are present in low concentrations that are well below Class A concentration limits), are not discussed in section 5 of the Determination concerning "removal to the extent practical."

<sup>18</sup> The above list of highly of highly radioactive radionuclides is the same as the list of radionuclides considered in DOE's Draft Section 3116 Determination with the exception of Sn, Np, and U isotopes. Tin, neptunium, and uranium isotopes are excluded from the list of highly radioactive radionuclides based on the results of the 2005 SA [23], which used improved analytical models and additional sensitivity analyses that more accurately depicted the potential dose impacts of salt waste disposal. Based on the results of this SA and subsequent analysis outlined in the response to NRC RAI Comment 11 [6] (see Attachment 1) and NRC Action Item 3 (7/27/05) [7] (see Attachment 2),

Based on an approach recommended by the NRC during consultation, DOE also conducted an analysis which compared the radionuclide inventory in untreated salt waste to NRC Class A concentrations limits, and, for the untreated inventory, compared the doses to the workers, the public, and the inadvertent intruder that would result from the untreated inventory to the relevant NRC limits from the performance objectives in 10 CFR 61, Subpart C<sup>19</sup>. This approach supported the inclusion of Cs-137 (and its daughter Ba-137m), Sr-90 (and its daughter, Y-90), Pu-238, Am-241, Cm-244, and Pu-239 on the list of highly radioactive radionuclides, as discussed in DOE's response to Action Item 3 (7/27/05) [7], which clarified DOE's response to NRC's RAI Comment 11 [6]. Pursuant to consultation with the NRC, DOE also conducted numerous sensitivity analyses (in addition to those already included in the updated performance assessment, the 2005 Special Analysis [23]). Those sensitivity analyses confirmed the inclusion of Se-79, Tc-99, and I-129 on the list of highly radioactive radionuclides.

## 5.2 REMOVAL TO THE MAXIMUM EXTENT PRACTICAL

Section 3116 (a) of the NDAA provides that certain waste resulting from reprocessing is not high-level waste if the Secretary, in consultation with the NRC, determines, among other things, that the waste has had highly radioactive radionuclides removed "to the maximum extent practical." This section discusses the basis on which the Secretary may conclude that DOE's two-phase, three-part strategy for removing the radionuclides considered above meets this criterion.

Removal to the extent "practical" is not removal to the extent "practicable" or theoretically "possible." Rather, a "practical" approach to removal is one that is "adapted to actual conditions<sup>20</sup>," "adapted or designed for actual use; useful<sup>21</sup>," a method that is selected "mindful

---

Sn-126, Np-237 and the uranium isotopes were found to be insignificant contributors to the future potential risk to the public, workers, or the environment in the expected case and, therefore, are no longer included in the list of highly radioactive radionuclides.

In DOE's responses to NRC RAI Comment 11 and Action Item 3 (7/27/05), DOE showed that the concentrations of Se-79, Tc-99 and I-129 in the SRS salt waste are such that they have low associated risks in the expected case based on DOE's analysis premised on the updated SA. In its TER, the NRC agreed that DOE's expected case PA results are consistent with this conclusion although NRC emphasized that realistically conservative sensitivity analyses suggest that doses from Se-79, Tc-99, and I-129 may be significantly greater, and therefore, doses from these radionuclides should not be discounted solely on the basis of expected case results. Consistent with NRC's observations and for the reasons set forth above, DOE continues to include Se-79, Tc-99 and I-129 as "highly radioactive radionuclides" as it did in DOE's Draft 3116 Determination based on further NRC consultation.

<sup>19</sup> This approach will not necessarily be used in other 3116 Determinations.

<sup>20</sup> *A Dictionary of Modern English Usage* 453, H. Fowler (1930).

<sup>21</sup> *Random House Unabridged Dictionary*, Copyright © 1997, by Random House, Inc., on Infoplease ([www.infoplease.com/ipd/A0598638.html](http://www.infoplease.com/ipd/A0598638.html)).

of the results, usefulness, advantages or disadvantages, etc., of [the] action or procedure<sup>22</sup>.” The considerations that bear on whether radionuclide removal will be accomplished to the maximum extent practical will therefore vary depending not only on the theoretically possible or available technologies that may be deployed but also the overall costs and benefits, not only economic but more broadly considered, of deploying them with respect to a particular waste stream. The “maximum extent practical” standard contemplates room for the exercise of expert judgment in weighing, for example, environmental, health, timing or other exigencies; the risks and benefits to public health, safety, and the environment arising from further radionuclide removal as compared with countervailing public health and considerations that may ensue from delay; the reasonable availability of proven technologies; the usefulness of such technologies; and the sensibleness of utilizing such technologies. What may be removal to the maximum extent practical at one point in time may not be that which, on balance, is practical, feasible, or sensible at a prior or later point in time<sup>23</sup>.

DOE’s two-phase, three-part plan for processing the salt waste will result in removal of highly radioactive radionuclides to the maximum extent practical, bearing in mind the considerations outlined above. In all, the plan will result in removal of 218 to 220 MCi of the 223 MCi [2] present in SRS salt waste. An estimated 3 to 5 MCi, mostly the short-lived radionuclide Cs-137 and its daughter Ba-137m, will be solidified and disposed of at SDF. DOE’s current best estimate is that 3 MCi will be disposed of in SDF [4]. Collectively, DDA, ARP, MCU, and SWPF will remove 98.7% of the curies from salt waste for vitrification in DWPF and ultimately permanent disposal in a deep geologic repository.

Because of the techniques used to adjust the chemistry of the tank waste to prevent corrosion, the salt waste starts out with low concentrations of most of the radionuclides from reprocessing, because 48% of the radioactivity, including by far the vast majority of the long-lived actinides and Sr-90, is in the metals that precipitated to the bottom of the tanks to form the sludge waste. To remove additional radionuclides from the salt waste, DOE will process by far the greatest volume of this waste using SWPF, which will remove over 99% of the Cs-137 and its daughter product, Ba-137m, the majority of the Sr and actinides, as well as other radionuclides. In addition, DOE will use the first-phase, interim technologies to process a limited amount of salt

---

<sup>22</sup> *Id.* definition 7. See also Cambridge Dictionary of American English, Cambridge University Press 2004 ([http://dictionary.cambridge.org/define.asp?key=practical\\*2+0&dict=A](http://dictionary.cambridge.org/define.asp?key=practical*2+0&dict=A)): “practical (EFFECTIVE): fitting the needs of a particular situation in a helpful way; helping to solve a problem or difficulty; effective or suitable”.

It is notable that while prior NRC and Department criteria for waste incidental to reprocessing called for removal “to the maximum extent technically and economically practical,” the statute omits the adverbs, thereby suggesting that a broad range of considerations, including but not limited to technical and economic practicalities, may appropriately be taken into account in determining the extent of removal that is practical.

<sup>23</sup> In this regard, DOE also notes that it may not be practical to undertake any further removal of certain radionuclides because further removal is not sensible or useful in light of the overall benefit to human health or the environment. As a general matter, such a situation may arise if certain radionuclides are present in such extremely low quantities that they make an insignificant contribution to potential dose. In its TER, NRC agreed that multiple factors can and should be considered when weighing what is the maximum extent practical for any given radionuclide. [8, page 28]

while SWPF is being designed and constructed. These interim technologies will also remove significant quantities of the radionuclides considered, although less than SWPF will remove.

Proceeding with interim processing using these technologies is necessary, however, if DOE is to be in a position to continue removal and vitrification of the high-activity sludge between now and the start-up of SWPF, including removing sludge waste from the tanks that lack full secondary containment, and to operate SWPF effectively after its construction is complete. The only practical way DOE will be able to move forward with these activities without significant interruption and delay is by using the interim technologies to remove and dispose of a limited amount of the salt waste currently in the tanks during this interim period. The alternative would be either: (1) to shut down sludge removal and vitrification activities now, or (2) to continue with those activities knowing that the effect will be to force a DWPF shutdown some time around 2008. At that time, DOE will no longer have the tank space needed to prepare the feed for DWPF and will require several years of SWPF operation (operating, at first, well below capacity, because it too requires significant tank space to run efficiently) before DOE will have enough space to be able to resume full-scale DWPF operations. Either way, a multi-year delay in removing and vitrifying the sludge and salt waste – the prerequisite to closing the tanks, including those that lack full secondary containment – will result. That is not in the interest of the public health and safety or the environment.

Given the significant disadvantages of waiting to begin processing salt waste until SWPF is available, the preferable course from the perspective of the public health, safety, and the environment is, during this interim period, to process a minimal amount of the lowest activity salt waste using technologies that are the best available now and in the near future to remove significant amounts of radionuclides from some of the lowest-activity salt waste. After removal of these radionuclides, the solidified low-activity salt waste will be below Class C concentration limits and its disposal in SDF will meet 10 CFR Part 61, Subpart C, performance objectives. In light of all these considerations, DOE's overall salt strategy, including the use of the interim technologies to process only enough salt to create enough tank space to allow uninterrupted sludge removal and treatment and efficient operation of SWPF, results in removal of highly radioactive radionuclides from the salt waste to the maximum extent practical.

### **5.2.1 Salt Waste Processing Facility**

SWPF is the cornerstone of the salt processing strategy. Of the 84 Mgal of salt solution that must be processed from the salt waste, 75 Mgal [3] will be processed through SWPF. This facility will be capable of processing 6 to 9 Mgal of salt solution per year after the first year of operation with a nominal annual processing rate of 7 Mgal. SWPF will become operational in 2011 with a planned processing rate of 5 Mgal during the first twelve months of operation.

DSS produced by SWPF is anticipated to be below Class A concentration limits for Cs-137, Sr-90, and actinides, and will add less than 0.2 MCi [4] to the SDF inventory through the projected end of salt treatment and disposal.

SWPF uses specific processes that have been developed and that will be the state-of-the-art methods to target the removal of Cs-137, Sr-90, and actinides from SRS salt wastes. SWPF will remove 99.998% [24] of the Cs-137/Ba-137m activity. In addition, SWPF is anticipated to remove 99.98% of the Sr and 96% of the alpha-emitting TRU activity [6]<sup>24</sup>.

With respect to Se-79, Tc-99 and I-129, the concentrations of these radionuclides in the salt waste are such that they do not present a significant risk to the workers, the public or the environment in the expected case as discussed in the response to NRC Action Item 3 (7/27/05) [7]. Because of the low associated risk in the expected case, these radionuclides are not targeted for removal by the processes DOE plans to deploy. In this regard, the “maximum extent practical” removal standard in Section 3116 of the NDAA contemplates, among other things, the exercise of judgment and consideration of the sensibleness, reasonableness and usefulness of further removal of radionuclides. For the SRS salt waste streams, the associated risks of Se-79, Tc-99 and I-129 are so low in the expected case that it would not be sensible or reasonable to target these radionuclides for further removal. Nevertheless, because Se-79, Tc-99, and I-129 are long-lived radionuclides that may persist in the environment and because certain DOE sensitivity studies suggest that these radionuclides may contribute to dose in these cases, DOE has considered the removal efficiencies of the SWPF for these radionuclides. Because of the processes utilized in SWPF, removal of the insoluble fraction of Se-79, Tc-99 and I-129 will be accomplished through cross-flow filtration. The insoluble fraction within the salt waste comprises 60%, 6%, and 0.05% respectively of the SRS inventory for each of these radionuclides [25]. However, removal of the soluble-phase of these radionuclides is impractical due to the low maturity of removal technologies, particularly in light of the low contribution to risk posed by these radionuclides in the expected case. A review of technology options for removal of similarly low concentrations and inventories of these isotopes was performed at the DOE Hanford Site [26]. This review did not identify any non-bench-scale, technically practical technologies to isolate and further remove these isotopes. Because of the relative low risk associated with these radionuclides in the expected case [23,36], DOE has not historically contemplated removal of these radionuclides from waste and no significant research and development activities have been conducted on removal of these radionuclides<sup>25</sup>.

---

<sup>24</sup> SWPF removal percentages shown are based on a single 12-hr MST strike. The operational goal of SWPF will be to achieve a Class A waste stream after solidification. At this time, a minimum of one strike is anticipated for all waste batches. Reduction of the soluble concentration of actinides and Sr is dependent on the concentration of the incoming waste stream, duration of the MST strike, and the number of strikes. Some waste batches will use more than one strike to achieve the goal of Class A concentrations.

<sup>25</sup> In its TER, NRC also concluded that additional removal of Se-79, Tc-99, and I-129 would not be practical, but for different reasons. In the TER, NRC explained: “Because DOE has indicated that it did not target Se-79, Tc-99, and I-129 for removal, NRC’s conclusion that additional removal would not be practical is not based on DOE’s assessment of existing technologies, but rather on consideration of the impacts of delays to the proposed schedule that would result from changes to the treatment process design to implement applicable technologies.... NRC concludes that the proposed removal of Se-79, Tc-99, and I-129 from salt waste at this point in the design of the treatment processes would cause unjustified increases in project costs and worker risks.” [8, page 27] In this regard, DOE has no indication that the expected delay in the SWPF startup is sufficient to develop, procure, and design additional – and as yet unknown – treatment technologies without increases in project costs and worker risks.

## 5.2.2 Interim Salt Processing

In addition to SWPF, as explained earlier, DOE's salt processing strategy also contemplates use of interim technologies (DDA, ARP, and MCU) to process just enough of some of the lowest activity salt waste to create enough tank space to allow DOE to continue removing and vitrifying sludge and to operate SWPF effectively immediately upon becoming operational. These interim technologies will not remove as much radioactivity from the salt waste as SWPF. However, they will remove significant amounts. Moreover, DDA is available now and ARP and MCU will be available in 2007, sooner than SWPF, which will not be available until 2011. They are the best removal technologies available to DOE during this interim period.

Rather than wait until SWPF becomes available, DOE believes the better course is for it to proceed to use these technologies to remove radionuclides from and process a minimal amount of some of the lowest activity salt waste so that it can dispose of these salt wastes at SDF. This will allow DOE to create the tank space necessary to continue cleanup of the sludge and operate SWPF effectively once that facility has been constructed. In DOE's view, use of these interim technologies is the proper course of action because the public health, safety, and environmental risks and disadvantages that would result from waiting until SWPF is available and significantly delaying further sludge removal and full-scale operation of SWPF once it has been constructed plainly outweigh the negligible public health, safety, and environmental disadvantages from proceeding with disposal of this waste after using the interim technologies to remove those radionuclides that can be removed now. Accordingly, use of these interim technologies accelerates risk reduction through processing the minimal amount of the lowest activity salt waste to create the necessary tank space for continued sludge removal and earlier full SWPF operation resulting in removal of highly radioactive radionuclides to the maximum extent practical during that timeframe.

### 5.2.2.a The Need for Interim Salt Processing

As explained briefly above, the reason DOE sought to develop an interim salt processing strategy is that if DOE were to wait to begin processing salt waste until 2011, when SWPF is expected to come online, DOE would be forced to decrease, postpone, and eventually halt the on-going activities to remove and stabilize tank waste that currently are reducing risk to the occupational workers, the public, and the environment. Chief among these risk-reduction activities is the processing of sludge waste in DWPF, including its removal from the aging waste tanks that lack full secondary containment (old-style tanks)<sup>26</sup>.

As described in Appendix 1, the underground waste storage tanks have been receiving waste since 1954. The last of the 51 waste storage tanks was placed into operation in 1986<sup>27</sup>. Since

---

<sup>26</sup> "Old-style tanks" refers to 24 Type I, Type II, and Type IV waste tanks that were constructed and placed into service between 1952 and 1964. These tanks lack full secondary containment, i.e., they are not a tank inside of a tank. The Type I and Type II tanks have a five-foot high annulus pan; the Type IV tanks have no secondary containment vessel.

<sup>27</sup> Two of the 51 waste tanks have been operationally closed; 49 waste tanks continue to be in active service.

that time, waste receipts have continued and waste processing (sludge removal, sludge processing, and immobilization of sludge in glass in DWPF) has been on-going.

As shown in Figure 5.1, while salt waste makes up 93% of the volume of waste stored at SRS, it represents 52% of the total waste radioactivity. Sludge makes up 7% of the volume but comprises 48% of the total waste radioactivity. The sludge in the waste tanks contains nearly all the long-lived actinides (e.g., U, Pu, Am, Np, and Cm) and Sr and poses the greatest risk to human health and the environment. Removal of the sludge from the waste tanks and immobilization of this waste stream in glass significantly decreases this risk. Sludge removal, processing, and vitrification in DWPF have been ongoing since 1996 and are described in Appendix 1.

**Figure 5.1: Waste Tank Composite Inventory (As of 12/01/04) [2]**

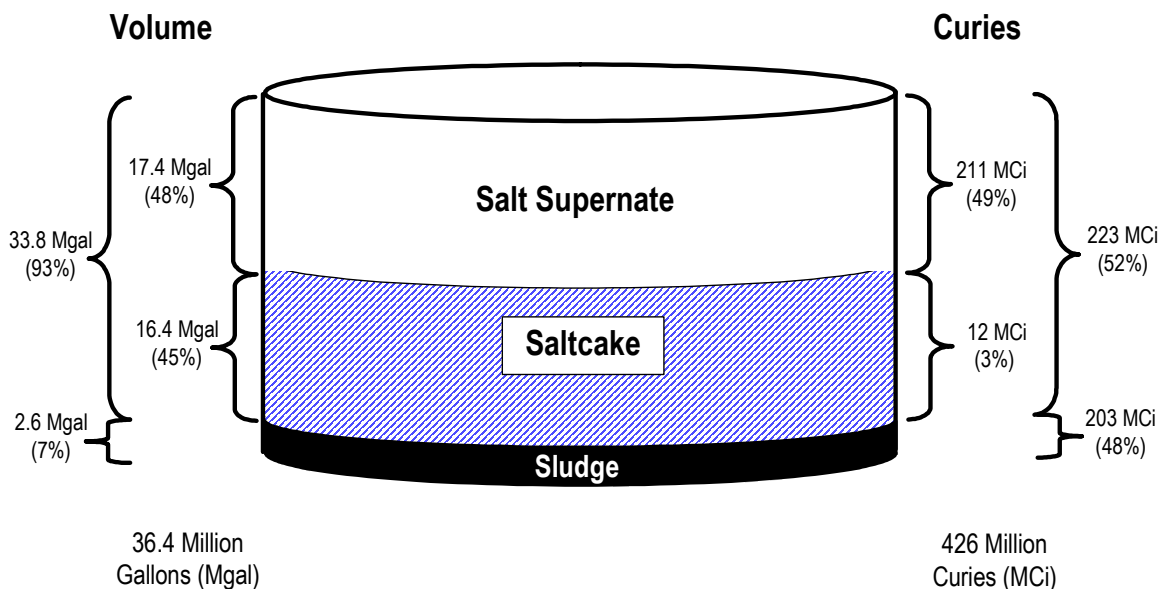

The problem is that usable space is required in the waste tanks to process the sludge waste. The only space that is usable for this purpose is in newer waste tanks (new-style tanks)<sup>28</sup> with full secondary containment that have usable space, since DOE does not want to return liquid waste to the old-style tanks that have leaked and that DOE is trying to empty. Tank space is required to wash the sludge, to process the wastes generated during the sludge washing process, and to store the concentrated wastes generated from sludge washing and from the DWPF recycle stream. If

<sup>28</sup> “New-style tanks” refers to the 27 Type III waste tanks that were constructed and placed into service between 1967 and 1986. These tanks have full secondary containment, i.e., they are a “tank within a tank.” These tanks were also stress-relieved at the time of construction to address nitrite-induced stress corrosion cracking that led to the formation of leak sites in the old-style tanks. There have been no leak sites in the new-style tanks.

there is insufficient usable tank space available, especially tank space associated with the evaporator systems<sup>29</sup>, sludge processing at DWPF will be slowed and eventually halted.

Although sludge processing results in removal of sludge from the tanks, it actually generates more waste in volume than it removes from the Tank Farms. Therefore, it is not the case that processing sludge creates tank space. To the contrary, on average, for every one gallon of settled sludge removed and processed through DWPF, 1.3 gallons [4] of salt waste is generated in one of the newer waste tanks (new-style tanks).

Further compounding this is the fact that the sludge that is currently being removed is from the old-style tanks, since these tanks, with their history of corrosion and leak sites (13 of the 24 old-style tanks have leakage history), represent the greatest risk of environmental insult. Over 1.1 Mgal of sludge waste [2] remain in these old-style tanks. Continuing sludge removal activities for these old-style tanks continues to be the highest priority at SRS but may have to stop unless salt waste processing starts in a timely manner and recovers the new-style tank space necessary for continued sludge processing.

In addition, processing the salt waste will itself require tank space. That waste has been concentrated and precipitated over the years through the use of robust evaporator systems. In order to make the salt mobile for transferring and to adjust the salt concentrations (molarity) for processing and disposal, significant quantities of chemically treated water must be added. Although 33.8 Mgal of salt waste currently resides in the Tank Farms, 84 Mgal of salt solution [3] will be processed. New-style tank space must be available for receiving and adjusting these solutions.

SWPF is scheduled to begin operation in 2011. With enough tank space available, SWPF should be able to process a minimum of 5 Mgal of salt solution during the first year of operation and 6 to 9 Mgal of salt solution per year thereafter, with a nominal annual processing rate of 7 Mgal [4]. This will allow DOE to complete waste removal from the remaining 49 active waste tanks at SRS by 2019, as contemplated by the SRS Environmental Management Program Performance Management Plan [27].

This aggressive processing rate, however, is predicated on two key assumptions: 1) that the salt waste has been staged and is ready to feed through SWPF at the time of startup; and 2) that sufficient new-style tank space will be available to continue to process and stage batches of SWPF feed. Specifically, it assumes that multiple new-style tanks are available to be used to blend salt solutions so that they meet the WAC for SWPF feed, store the blended feed while it is being characterized, and stage the waste to feed SWPF. The processing rate dictates the amount

---

<sup>29</sup> There are currently three operating waste evaporator systems in the SRS Tank Farms. The volume reduction capabilities of the evaporator systems are the key to continued processing of sludge and receipts of influents. Specifically, the evaporators must have adequate space in their associated concentrate receipt tanks to receive the concentrated waste from the evaporator. If the concentrate receipt tank for an evaporator system becomes filled with saltcake and a viable, alternative receipt tank is not available, the system cannot operate. Or, if the evaporator system concentrates that waste to the maximum extent possible and no other new-style tank space exists into which to transfer the concentrated solution, then the system must shut down.



of necessary space; larger processing rates require more dedicated processing space. This is because the time it takes to blend and characterize the unprocessed solution is relatively slow compared to the feed rate. If adequate processing space is not available to prepare salt feed solutions, SWPF production rates will be reduced. A reduction in SWPF production rates will slow the rate at which waste is removed from the old-style tanks and thus delay reducing the risk to the occupational worker, the public, and the environment.

Thus, failure to proceed expeditiously with salt processing will have many significant consequences on DOE's efforts to accelerate reduction of the risks posed by the continued long-term storage of this waste within the aging infrastructure of the Tank Farms. If DOE continues sludge removal operations without removing some salt waste, the remaining available waste tank space will decrease and the ability to efficiently treat tank waste for disposal also diminishes. Instead of being able to process large batches of material, small batches must be used. Once the available space decreases to a certain volume, significant programmatic delays will occur. For instance, it is estimated that a one-year delay in salt processing will result in a three- to four-year delay in the overall program execution with an associated significant increase in cost (estimated to be in excess of \$1 billion). Likewise, if DOE were to cease sludge removal operations now in order to preserve tank space, similar program delays and cost impacts would result due to the requirement to recover tank space for full-capacity SWPF operations and to go through a complex restart process for DWPF.

Either continuing sludge removal without initiating salt processing or halting sludge removal in order to preserve tank space and restarting these operations later also significantly increases operational risks. If sludge removal were simply continued without some removal of salt waste, as recognized by the Defense Nuclear Facilities Safety Board (DNFSB) [28], the reduction in usable storage space will require increasingly frequent and complex waste transfers and reduce the amount of contingency space reserved for emergency inter-tank transfers in the event a tank leaked. This translates to additional risk to occupational workers, the public, and the environment. If sludge removal and processing were stopped now, significant facility maintenance and modifications would be necessary in both the Tank Farms and in DWPF for resumption of operations. These maintenance and modification activities would result in significant increased worker exposure to radiation and radiological contamination hazards<sup>30</sup>.

---

<sup>30</sup> DOE would not have the current tank space problem if salt processing had been initiated as originally planned. That did not occur for two reasons. First, the initial technology DOE selected for salt processing, In-Tank Precipitation (ITP), was not successful. In January 1998, DOE determined that the ITP process could not be safely operated at the throughputs required. DOE then performed studies, including a Supplemental EIS completed in June 2001, to select viable alternative technologies for salt waste disposition activities. These activities were suspended in 2003 when the Idaho District Court issued its decision in Natural Resources Defense Council v. Abraham, 271 F. Supp. 2d 1260 (D. Idaho. 2003) invalidating the provisions in DOE's Order 435.1 that set out DOE's criteria for classifying waste from reprocessing as "waste incidental to reprocessing" rather than "high-level radioactive waste." The criteria the District Court struck down were a central underpinning of DOE's entire salt strategy. DOE has only recently been in a position to proceed with this strategy as a result of the enactment of Section 3116.

### 5.2.2.b Interim Salt Processing Strategy

Given these exigencies and recognizing that SWPF cannot be constructed, permitted, and operated until 2011, DOE developed a two-part interim processing approach that is tailored to the physical attributes of the different waste forms and the existing available technologies<sup>31</sup>. This approach will allow ongoing risk reduction activities through sludge removal to continue at its current accelerated pace until SWPF is operational without resulting in back-end delays, thereby reducing risks to public health and safety and the environment, as well as occupational risks.

The Interim Salt Processing Strategy will be implemented so as to minimize the curies in the waste that will be disposed of at SDF following treatment using the interim technologies. This is accomplished by: 1) processing only that salt waste volume necessary to provide the minimum tank space needed to support efficient DWPF and SWPF operations and 2) carefully selecting the salt waste that will be processed from the tanks containing lower activity waste (with the majority of the total curies disposed of in SDF being associated with the shorter-lived Cs-137)<sup>32</sup> [10].

The Interim Salt Processing Strategy provides for treatment of these lower activity streams to remove the Cs-137 and other actinides with a lower contribution to total activity utilizing DDA and ARP/MCU technologies. This tank selection process limits the total estimated radioactivity inventory permanently disposed of in SDF vaults to an estimated 3 MCi [4]. Due to some uncertainty associated with the characterization of the saltcake waste, the actual curie content of this volume of material may be as high as 5 MCi [4]. Nearly all of these curies are associated with Cs-137, which has a half-life of 30 years<sup>33</sup>.

### 5.2.2.c DDA, ARP, and MCU

DOE identified three technologies for removing radionuclides from the salt waste that it could deploy during the interim period between now and 2011 when SWPF is slated to come online. These are DDA, ARP, and MCU.

These processes were selected for their ability to reduce Cs-137, Sr-90, and actinide concentrations. DOE assessed projected tank space availability versus needs during the time between now and the start-up of SWPF and determined that insufficient space existed for sustained sludge disposition activities or for feed preparation for SWPF. Options for nearer term deployment of treatment technologies were evaluated and, based upon the technology selection process used for SWPF, DOE decided to pursue early small-scale implementation of similar

---

<sup>31</sup> The interim processing approach was developed after input from the South Carolina Governor's Nuclear Advisory Council and SCDHEC and is referred to as the Interim Salt Processing Strategy.

<sup>32</sup> Extensive tank space modeling projections were performed to determine optimal selection of salt waste to be processed as part of Interim Salt Processing given the goal to minimize curies disposed in SDF. Tank process histories and available sample data were analyzed to select the tanks with the lowest cesium and actinide content. New samples of salt cake and supernate are planned to further confirm selection of salt waste in specific tanks.

<sup>33</sup> DOE is exploring ways to mitigate the impacts associated with the delay in the startup of the SWPF without increasing the curies to be disposed of with interim processing (DDA, ARP, MCU). Among other things, DOE anticipates exploring possible ways to decrease the design and construction time for the SWPF. DOE will not increase the curies to be disposed of under the interim strategy.

actinide and Cs removal technologies (i.e., ARP and MCU). Capacity limitations imposed by the re-use of existing facilities necessitated initiation of salt removal prior to availability of the small-scale facilities. DDA was selected as the best alternative to augment ARP/MCU capacities until SWPF was operational.

DOE anticipates using all three technologies in combination in 2007, when ARP and MCU are expected to come online. Because ARP will be available several months earlier than MCU, DOE is considering whether to operate that facility separate from MCU for a short period of time. This would allow for the removal of additional strontium and actinides from a quantity of salt waste that would not have otherwise undergone this treatment thereby reducing the number of curies disposed in the Saltstone Facility. In the meantime, in 2006 after issuance of this final 3116 Determination, DOE anticipates using DDA alone to process some of the lowest activity salt waste.

### **DDA**

The deliquification and dissolution processes involved in DDA will remove substantial amounts of Cs-137, as well as some insoluble Sr and actinides, from this already relatively low-curie material<sup>34</sup>. Through deliquification, DDA will remove 50% [29] of the Cs-137 and its daughter product Ba-137m from the saltcake targeted for dissolution. The liquid removed from the saltcake will be transferred to other tanks for future processing by SWPF. The saltcake will then be dissolved, after which it will be managed in a manner that will facilitate the settling of the insoluble sludge solids (e.g., Sr-90 and actinides) entrained in the salt solution and minimize the transfer of these materials to SDF. This is done by transferring the dissolved salt solution to a staging tank where the solids are allowed to settle before transfer to the Saltstone Facility feed tank. The DDA process will result in the removal of 50% of the Cs-137/Ba-137m activity, 66% of the Sr activity and 63% of the alpha-emitting TRU activity [6]<sup>35</sup>. After being processed through DDA and after being solidified in a grout matrix, the solidified low-activity salt waste will have concentrations below Class C limits for all radionuclides. DOE can begin to use DDA immediately.

### **ARP and MCU**

ARP and MCU are expected to come online in 2007. ARP and MCU will remove an additional 92% [30] of the Cs-137/Ba-137m following DDA while also removing 99.997% of the Sr

---

<sup>34</sup> This process will not be used for Tank 48 waste.

<sup>35</sup> In its TER, NRC calculated removal efficiencies for DDA, ARP, MCU, and SWPF which generally confirmed the removal efficiencies calculated by DOE. NRC also calculated the removal efficiencies for various isotopes of uranium even though uranium isotopes are not “highly radioactive radionuclides”.

With respect to DDA, NRC also observed that the greatest amount of uncertainty in the composition of waste sent to SDF stems in part from uncertainties in the results of the DDA process. While DOE acknowledges the potential for higher activity salt solutions than expected, the first batch of dissolved salt waste from Tank 41 has been staged and sampled, and sample data indicates that the material meets existing plans for disposal. DOE intends to continue with its planned efforts to maximize the amount of deliquification achieved, minimize the amount of entrained sludge, and maximize the amount of settled sludge to reduce uncertainties and the radionuclides resulting from the DDA process.

activity and 98% of the alpha-emitting TRU activity [6]. The ARP facilities will be used to remove soluble Sr-90 and actinides through MST strikes<sup>36</sup> as long as tank space objectives can be met with appropriate operational margin. If emergent technical or processing information becomes known that indicates that tank space objectives cannot be met AND the soluble actinides in the original salt solution are sufficiently low (i.e., below Class C concentration limits) to achieve the necessary tank space recovery prior to SWPF start-up, the stream will only be filtered prior to being sent to MCU. With respect to Se-79, Tc-99, and I-129, the concentrations of these radionuclides in the salt waste are such that they do not present a significant risk to the workers, the public or the environment in the expected case as discussed in the response to NRC Action Item 3 (7/27/05) [7]. Based on sensitivity studies and other factors explained previously, DOE has included Se-79, Tc-99, and I-129 as “highly radioactive radionuclides” and, as explained above, has provided removal efficiencies for these radionuclides. Because of the low associated risk in the expected case, these radionuclides are not targeted for removal by the processes DOE plans to deploy. In this regard, the “maximum extent practical” removal standard in Section 3116 of the NDAA contemplates, among other things, the exercise of expert judgment and consideration of the sensibleness, reasonableness and usefulness of further removal of radionuclides. For the SRS salt waste streams, the associated risks of Se-79, Tc-99 and I-129 are so low in the expected case that it would not be sensible or reasonable to target these radionuclides for further removal. Nevertheless, because Se-79, Tc-99, and I-129 are long-lived radionuclides that may persist in the environment and because certain DOE sensitivity studies suggest that these radionuclides may contribute to dose in unexpected cases, DOE has considered the removal efficiencies of the ARP/MCU for these radionuclides. Because of the processes utilized in ARP/MCU, removal of the insoluble fraction of Se-79, Tc-99, and I-129 will be accomplished through a combination of settling and cross-flow filtration. The insoluble fraction within the salt waste comprises 60%, 6%, and 0.05% respectively of the SRS inventory for each of these radionuclides [25]. However, removal of the soluble-phase of these radionuclides is impractical due to the low maturity of removal technologies [26], particularly in light of the low contribution to risk posed by these radionuclides in the expected case. Because of the relative low risk associated with these radionuclides [23,36], DOE has not historically contemplated removal of these radionuclides from waste and no significant research and development activities have been conducted on removal of these radionuclides<sup>37</sup>.

---

<sup>36</sup> The duration of the MST strikes of the salt solutions will be dependent on the concentration of the Sr-90 and actinides present, and will range from 4 to 24 hours.

<sup>37</sup> In its TER, NRC also concluded that additional removal of Se-79, Tc-99, and I-129 would not be practical, but for different reasons. In the TER, NRC explained: “Because DOE has indicated that it did not target Se-79, Tc-99, and I-129 for removal, NRC’s conclusion that additional removal would not be practical is not based on DOE’s assessment of existing technologies, but rather on consideration of the impacts of delays to the proposed schedule that would result from changes to the treatment process design to implement applicable technologies.... NRC concludes that the proposed removal of Se-79, Tc-99, and I-129 from salt waste at this point in the design of the treatment processes would cause unjustified increases in project costs and worker risks.” [8, page 27] In this regard, DOE has no indication that the expected delay in the SWPF startup is sufficient to develop, procure, and design additional – and as yet unknown – treatment technologies without increases in project costs and worker risks.

### **Use of ARP, MCU, and DDA**

Once ARP/MCU are online, in 2007, DOE anticipates using them on waste that has already undergone DDA to process 2.1 Mgal of salt waste that are expected to result in an estimated 0.3 MCi disposed of in SDF vaults from these facilities [4]. By processing this salt solution through ARP and MCU, rather than just DDA, the total number of curies ultimately disposed of in SDF vaults will be decreased by an estimated 3.1 MCi.

DOE anticipates using DDA alone to process 6.0 Mgal of some of the lowest curie salt solution, resulting in an estimated 1.7 MCi disposed of in SDF vaults from these streams [4]<sup>38</sup>. This is because if salt processing is delayed until the ARP/MCU facilities become operational in 2007, this still will result in significant delay to DOE's sludge removal efforts. This, in turn, is because DOE has an immediate need for usable working space in specific new-style tanks within the Tank Farms to continue these activities. This particular space is needed because of the proximity of these tanks to the salt processing facilities and the existing transfer line infrastructure, as well as the need to have viable concentrate receipt tanks for the evaporator systems associated with sludge batch preparation and concentration of the recycle waste stream returning from DWPF. Without use of DDA to remove salt waste until ARP and MCU are online, there will still be insufficient space created in the new-style tanks to ensure continued risk-reduction at DWPF at its current rate of processing and sufficient feed batches cannot be prepared to ensure that SWPF can start-up operations at the rate of 5 Mgal during the first twelve months of operation. In addition, the increased waste inventory will result in increased safety risks associated with the operational activities of the Tank Farms as identified by the DNFSB [28].

After ARP/MCU are on-line, DOE will continue to use DDA alone in the interim period for some of the salt waste. This is because the capacity of the combined ARP/MCU facilities is only 1.5 Mgal salt solution per year and these facilities, therefore, cannot be used to process enough salt waste to create the tank space needed.

### **Tank 48 Waste**

In addition to the low-activity salt wastes that DOE proposes to process during the interim period using combinations of DDA, ARP, and MCU, DOE also proposes to create additional tank space during this interim period by removing a unique low-activity salt waste in Tank 48, aggregating it with DWPF recycle, and disposing of the aggregated salt waste stream in SDF as a solidified low-activity salt waste.

Tank 48, a new-style waste tank that is strategically located in close proximity to the salt processing facilities, is currently being used to store 0.24 Mgal [2] of relatively low-activity salt solution containing 19,000 Kg [14] of potassium and cesium TPB salts generated during the 1983

---

<sup>38</sup> These figures do not include the materials in Tank 48, which are unique and are discussed further later in this document.

ITP<sup>39</sup> process demonstration and subsequent operation of the ITP facility from 1995 through 1996. ITP was DOE's earlier unsuccessful salt processing technology. It produced a salt waste that contains organic compounds not found in the other tanks at SRS. These organic compounds prevent DOE from using any of the facilities discussed in prior portions of this document to remove radionuclides.

The organic nature of TPB salts makes the Tank 48 waste incompatible with the existing Tank Farm facilities or future salt waste treatment facilities. The decomposition of TPB produces flammable vapors, predominantly benzene. Flammable vapors are a concern because they could initiate a vapor deflagration. The high vapor pressure of benzene allows evaporation within the current operating temperature ranges for waste tanks. Tank 48 has unique, restrictive controls to limit the potential of TPB decomposition. These controls include low temperature and a restriction on addition of any material into the tank. The rate of evolution of benzene increases with increased temperature and in the presence of catalysts that are present in other Tank Farm waste. Therefore, the presence of catalysts precludes combining this waste with other Tank Farm wastes and the need to maintain relatively low temperatures precludes mixing with materials that may be processed through one of the three existing evaporator systems.

For the reasons noted above, this material cannot be concentrated into saltcake using existing facilities. Accordingly, DDA cannot be used to remove cesium. Likewise, the need to control temperature precludes treatment of this waste through ARP/MCU or SWPF because the effluents from these facilities receive subsequent high temperature processing through the DWPF melter. In addition, the current TPB concentration in Tank 48 is likely to adversely affect glass chemistry and impact canister throughput and waste loading in the glass.

DOE has performed extensive evaluation of alternative technologies for processing the Tank 48 salt waste. In conjunction with the Savannah River National Laboratory, treatment options within existing site facilities were evaluated and, in a parallel effort, vendor proposals for the design and installation of a separate waste treatment unit were solicited. Options were explored for organic destruction within Tank 48 (in-situ) including hydrolysis, both chemical (e.g., Fenton's Reagent) and thermal, and catalysis (e.g., palladium). All of these options require taking the waste to an acidic state which is incompatible with the carbon steel materials of construction associated with Tank 48 (as well as all other SRS waste tanks). External options were explored that utilized existing site facilities including both precipitate and acid hydrolysis at DWPF. The DWPF options were eliminated due to direct conflict with the need for these same facility spaces for receipt of the high-level waste effluents from ARP/MCU and SWPF. DOE also explored construction of a separate waste treatment unit to remove the organics and concluded it would be extremely costly, would take years to build and permit and hence for all these reasons would be impractical. Thus, there are currently no proven, practical options for removing additional radionuclides from the Tank 48 waste that would allow disposal of the

---

<sup>39</sup> The In-Tank Precipitation process was a technology that was designed to separate the high-activity and low-activity waste fractions of the salt waste by mixing sodium tetraphenylborate and monosodium titanate. The sodium tetraphenylborate targeted the separation of cesium and the monosodium titanate targeted the separation of strontium and actinides. During full scale operations, the In-Tank Precipitation process could not achieve production goals and safety requirements for processing tank waste.

removed radionuclides using DWPF, and likewise there are no practical approaches on the horizon that would allow this to be accomplished.

Tank 48 currently contains a relatively small quantity of salt waste, 0.24 Mgal, and a relatively small number of curies, 0.8 MCi, when compared to other waste tanks. By processing the 0.24 Mgal of existing Tank 48 waste, a 1.3 Mgal waste tank would be made available for salt processing activities. No other available new-style tank that could substitute in place of Tank 48 contains salt waste that can be disposed of and result in less than 0.8 MCi being sent to SDF. In addition, Tank 48 is uniquely well situated to assist in the overall salt processing strategy. It is located in close proximity to the salt processing facilities and already has dedicated transfer lines to the cells that will house the ARP reaction tanks. For this reason, Tank 48 is physically ready to serve as the ARP/MCU feed tank with only minimal modifications. Tank 48 also has an existing pump and dedicated transfer line that connects Tank 48 directly to Tank 49. Tank 49 is currently slated to be the feed tank for SWPF. Considerable infrastructure work would need to be completed to set up any other tank as the feed tank for the ARP and to provide the transfer flexibility associated with Tank 48.

Accordingly, given the unavailability of current, proven, or contemplated practical technologies to remove radionuclides from the salt waste in Tank 48, given the relatively low radioactive content of this material, given that its disposal after mixing it with other low-activity salt waste would free up considerable key tank space by adding fewer curies to SDF than other salt waste DOE has been able to identify that would free up the same amount of tank space, and given that when mixed with the low-activity waste to make adjustments for Saltstone Facility processability requirements (and stabilized at an approximate one-to-one ratio with grout), the solidified waste will be below Class C concentrations, it is appropriate, under the “maximum extent practical” consideration, to process Tank 48 waste without further removal of radionuclides as part of DOE’s overall interim salt waste strategy<sup>40</sup>.

In sum, DOE’s salt waste processing strategy will result in removal of highly radioactive radionuclides to the maximum extent practical. As explained above, in all, the plan will result in removal of 218 to 220 MCi of the 223 MCi [2] present in the SRS salt waste. DOE’s best estimate is that 3 MCi, mostly the short-lived radionuclide Cs-137 and its daughter Ba-137m, will be solidified and disposed of at SDF (although due to the uncertainty associated with the current characterization of the saltcake waste, the actual curie content of this material may be as high as 5 MCi [4]). Collectively, DDA, ARP, MCU, and SWPF will remove 98.7% of the curies from salt waste for vitrification in DWPF and ultimately permanent disposal in a deep geologic repository.

To process the vast majority and the more radioactive salt waste, DOE will use the SWPF, which will use state-of-the-art removal technologies, as soon as this facility is constructed and operational. In the meantime, DOE will use combinations of the interim technologies to process the minimal amounts of particularly low-activity salt waste that must be removed to create the tank space necessary to allow DOE to continue to vitrify sludge and to be in a position to operate

---

<sup>40</sup> With respect to Tank 48, NRC similarly concluded that there has been reasonable assurance that the Tank 48 waste has been processed to the maximum extent practical. [8, page 27]

SWPF at close to capacity as soon as it is operational. These technologies are the best available during this timeframe to remove radionuclides from enough of this waste to create the needed space, and all will remove significant amounts of radionuclides from this waste<sup>41</sup>. Accordingly, DOE's salt waste processing strategy will remove highly radioactive radionuclides to the maximum extent practical.

---

<sup>41</sup> In its TER, NRC also concluded that interim processing (DDA, ARP, MCU) would remove highly radioactive radionuclides to the maximum extent practical, although NRC emphasized slightly different considerations in reaching its conclusion. Specifically, NRC stated in relevant part on page 29 of the TER "Because the NRC staff believes there is reasonable assurance that worker and public performance objectives will be satisfied if DDA and ARP/MCU are used to process the volume of low-activity waste describes in the draft waste determination and supporting document ..., NRC staff concludes that expenditure of an additional \$1.0 billion (2004 dollars) to \$1.5 billion (2004 dollars) to decrease public exposure further below the performance objectives would not be warranted...." [Citations and references omitted.]



## 6.0 THE WASTE DOES NOT EXCEED CONCENTRATION LIMITS IN 10 CFR 61.55

Section 3116 of the NDAA provides in relevant part:

[T]he term “high-level radioactive waste” does not include waste from reprocessing of spent nuclear fuel that the Secretary of Energy...in consultation with the Nuclear Regulatory Commission...determines –

\*\*\*

(3)(A) does not exceed concentration limits for Class C low-level waste as set out in section 61.55 of title 10, Code of Federal Regulations...[.]

The NRC regulations at 10 CFR 61.55 categorize low-level radioactive waste intended for near surface disposal as Class A, Class B, or Class C. To make the waste classification determination, the waste concentrations for specified radionuclides are compared to concentration limits defined in 10 CFR 61.55. The radionuclides and their associated limits are specified in two separate tables within 10 CFR 61.55 which are reproduced below.

**Table 6.1: 10 CFR 61.55**

Radionuclides (Long-lived)	Concentration (Ci/m <sup>3</sup> )
C-14	8
C-14 in activated metal	80
Ni-59 in activated metal	220
Nb-94 in activated metal	0.2
Tc-99	3
I-129	0.08
Alpha Emitting Transuranic (TRU) nuclides with half-life greater than 5 years	100 <sup>(1)</sup>
Pu-241	3,500 <sup>(1)</sup>
Cm-242	20,000 <sup>(1)</sup>

<sup>1</sup>Units are in nanocuries per gram.

**Table 6.2: 10 CFR 61.55**

Radionuclides (Short-lived)	Concentration, curies per cubic meter		
	Column 1 [Class A]	Column 2 [Class B]	Column 3 [Class C]
Total of all nuclides with less than 5 year half-life	700	(1)	(1)
H-3	40	(1)	(1)
Co-60	700	(1)	(1)
Ni-63	3.5	70	700
Ni-63 in activated metal	35	700	7000
Sr-90	0.04	150	7000
Cs-137	1	44	4600

<sup>1</sup> There are no limits established for these radionuclides in Class B or C wastes. Practical considerations such as the effects of external radiation and internal heat generation on transportation, handling, and disposal will limit the concentrations for these wastes. These wastes shall be Class B unless the concentrations of other nuclides in the table determine the waste to be Class C independent of these nuclides.

Estimated average concentrations for the grouted salt waste associated with the DDA, ARP/MCU, and SWPF processes were calculated [31] for radionuclides identified in 10 CFR 61.55, Tables 1 and 2. These concentrations are compared to 10 CFR 61.55 Class C concentration limits in Tables 6.3 through 6.8 below. Tables 6.3 and 6.4 show the comparison done for the grouted salt waste associated with the DDA process, Tables 6.5 and 6.6 show the comparison done for the grouted salt waste associated with the ARP/MCU process, and Tables 6.7 and 6.8 show the comparison done for the grouted salt waste associated with the SWPF process. Concentrations in these tables are shown in curies per cubic meter (Ci/m<sup>3</sup>) in the grouted salt waste unless otherwise noted.

**Table 6.3: DDA Waste Stream Comparison to 10 CFR 61.55**

Radionuclides (Long-lived)	10 CFR 61.55 Class C Limit (Ci/m <sup>3</sup> )	Estimated Average Concentration (Ci/m <sup>3</sup> )	% of 10 CFR 61.55 Class C Limit
C-14	8	0.001	0.01%
C-14 in activated metal	80	(1)	(1)
Ni-59 in activated metal	220	(1)	(1)
Nb-94 in activated metal	0.2	(1)	(1)
Tc-99	3	0.006	0.2%
I-129	0.08	0.000004	0.005%
Alpha Emitting Transuranic (TRU) nuclides with half-life greater than 5 years	100 <sup>(2)</sup>	41 <sup>(2)</sup>	41%
Pu-241	3,500 <sup>(2)</sup>	2 <sup>(2)</sup>	0.07%
Cm-242	20,000 <sup>(2)</sup>	0.00005 <sup>(2)</sup>	0.000002%

<sup>1</sup> Not present in the grouted salt waste in the Saltstone Disposal Facility.

<sup>2</sup> Units are in nanocuries per gram.

**Table 6.4: DDA Waste Stream Comparison to 10 CFR 61.55**

<b>Radionuclides (Short-lived)</b>	<b>10 CFR 61.55 Class C Limit (Ci/m<sup>3</sup>)</b>	<b>Estimated Average Concentration (Ci/m<sup>3</sup>)</b>	<b>% of 10 CFR 61.55 Class C Limit</b>
Total of all nuclides with less than 5 year half-life	(1)	(1)	(1)
H-3	(1)	(1)	(1)
Co-60	(1)	(1)	(1)
Ni-63	700	0.002	0.0002%
Ni-63 in activated metal	7000	(2)	(2)
Sr-90	7000	0.1	0.001%
Cs-137	4600	22	0.5%

<sup>1</sup> There are no limits established for these radionuclides in Class B or C wastes. Practical considerations such as the effects of external radiation and internal heat generation on transportation, handling, and disposal will limit the concentrations for these wastes. These wastes shall be Class B unless the concentrations of other nuclides in the table determine the waste to be Class C independent of these nuclides. For the Saltstone Disposal Facility, a low level waste disposal facility, the grouted salt waste will meet or be lower than the concentration limits for Class C.

<sup>2</sup> Not present in the grouted salt waste in the Saltstone Disposal Facility.

**Table 6.5: ARP/MCU Waste Stream Comparison to 10 CFR 61.55**

<b>Radionuclides (Long-lived)</b>	<b>10 CFR 61.55 Class C Limit (Ci/m<sup>3</sup>)</b>	<b>Estimated Average Concentration (Ci/m<sup>3</sup>)</b>	<b>% of 10 CFR 61.55 Class C Limit</b>
C-14	8	0.001	0.01%
C-14 in activated metal	80	(1)	(1)
Ni-59 in activated metal	220	(1)	(1)
Nb-94 in activated metal	0.2	(1)	(1)
Tc-99	3	0.03	0.9%
I-129	0.08	0.00001	0.01%
Alpha Emitting Transuranic (TRU) nuclides with half-life greater than 5 years	100 <sup>(2)</sup>	2 <sup>(2)</sup>	2%
Pu-241	3,500 <sup>(2)</sup>	0.1 <sup>(2)</sup>	0.004%
Cm-242	20,000 <sup>(2)</sup>	0.00008 <sup>(2)</sup>	0.0000004%

<sup>1</sup> Not present in the grouted salt waste in the Saltstone Disposal Facility.

<sup>2</sup> Units are in nanocuries per gram.

**Table 6.6: ARP/MCU Waste Stream Comparison to 10 CFR 61.55**

<b>Radionuclides (Short-lived)</b>	<b>10 CFR 61.55 Class C Limit (Ci/m<sup>3</sup>)</b>	<b>Estimated Average Concentration (Ci/m<sup>3</sup>)</b>	<b>% of 10 CFR 61.55 Class C Limit</b>
Total of all nuclides with less than 5 year half-life	(1)	(1)	(1)
H-3	(1)	(1)	(1)
Co-60	(1)	(1)	(1)
Ni-63	700	0.0009	0.0001%
Ni-63 in activated metal	7000	(2)	(2)
Sr-90	7000	0.02	0.0003%
Cs-137	4600	8	0.2%

<sup>1</sup> There are no limits established for these radionuclides in Class B or C wastes. Practical considerations such as the effects of external radiation and internal heat generation on transportation, handling, and disposal will limit the concentrations for these wastes. These wastes shall be Class B unless the concentrations of other nuclides in the table determine the waste to be Class C independent of these nuclides. For the Saltstone Disposal Facility, a low level waste disposal facility, the grouted salt waste will meet or be lower than the concentration limits for Class C.

<sup>2</sup> Not present in the grouted salt waste in the Saltstone Disposal Facility.

**Table 6.7: SWPF Waste Stream Comparison to 10 CFR 61.55**

<b>Radionuclides (Long-lived)</b>	<b>10 CFR 61.55 Class C Limit (Ci/m<sup>3</sup>)</b>	<b>Estimated Average Concentration (Ci/m<sup>3</sup>)</b>	<b>% of 10 CFR 61.55 Class C Limit</b>
C-14	8	0.0008	0.01%
C-14 in activated metal	80	(1)	(1)
Ni-59 in activated metal	220	(1)	(1)
Nb-94 in activated metal	0.2	(1)	(1)
Tc-99	3	0.06	2%
I-129	0.08	0.00003	0.04%
Alpha Emitting Transuranic (TRU) nuclides with half-life greater than 5 years	100 <sup>(2)</sup>	< 10 <sup>(2)</sup>	< 10%
Pu-241	3,500 <sup>(2)</sup>	7 <sup>(2)</sup>	0.2%
Cm-242	20,000 <sup>(2)</sup>	0.0001 <sup>(2)</sup>	0.0000005%

<sup>1</sup> Not present in the grouted salt waste in the Saltstone Disposal Facility.

<sup>2</sup> Units are in nanocuries per gram.

**Table 6.8: SWPF Waste Stream Comparison to 10 CFR 61.55**

Radionuclides (Short-lived)	10 CFR 61.55 Class C Limit (Ci/m <sup>3</sup> )	Estimated Average Concentration (Ci/m <sup>3</sup> )	% of 10 CFR 61.55 Class C Limit
Total of all nuclides with less than 5 year half-life	(1)	(1)	(1)
H-3	(1)	(1)	(1)
Co-60	(1)	(1)	(1)
Ni-63	700	0.0002	0.00004%
Ni-63 in activated metal	7000	(2)	(2)
Sr-90	7000	0.002	0.00003%
Cs-137	4600	0.005	0.0001%

<sup>1</sup> There are no limits established for these radionuclides in Class B or C wastes. Practical considerations such as the effects of external radiation and internal heat generation on transportation, handling, and disposal will limit the concentrations for these wastes. These wastes shall be Class B unless the concentrations of other nuclides in the table determine the waste to be Class C independent of these nuclides. Because the Saltstone Disposal Facility is a low level waste disposal facility, the grouted salt waste must meet or be lower than the concentration limits for Class C.

<sup>2</sup> Not present in the grouted salt waste in the Saltstone Disposal Facility.

In accordance with 10 CFR 61.55, the determination of the class of the waste is made by one of four different methods utilizing Tables 6.1 and 6.2. The relevant NRC regulations are reproduced below:

- 1) If the waste contains only the long-lived radionuclides listed in Table 6.1 above (10 CFR 61.55 Table 1), then classification is determined by 10 CFR 61.55 (a)(3):

**10 CFR 61.55 (a)(3)** – “Classification determined by long-lived radionuclides. If radioactive waste contains only radionuclides listed in Table 1, classification shall be determined as follows: (i) If the concentration does not exceed 0.1 times the value in Table 1, the waste is Class A. (ii) If the concentration exceeds 0.1 times the value in Table 1 but does not exceed the value in Table 1, the waste is Class C. (iii) If the concentration exceeds the value in Table 1, the waste is not generally acceptable for near-surface disposal. (iv) For wastes containing mixtures of radionuclides listed in Table 1, the total concentration shall be determined by the sum of fractions rule described in paragraph (a)(7) of this section”.

- 2) If the waste contains only the short-lived radionuclides contained in Table 6.2 above (10 CFR 61.55 Table 2), then classification is determined by 10 CFR 61.55 (a)(4):

**10 CFR 61.55 (a)(4)** – “Classification determined by short-lived radionuclides. If radioactive waste does not contain any of the radionuclides listed in Table 1, classification shall be determined based on the concentrations shown in Table 2. However, as specified in paragraph (a)(6) of this section, if radioactive waste does not contain any nuclides listed in either Table 1 or 2, it is Class A. (i) If the concentration does not exceed the value in Column 1, the waste is Class A. (ii) If the concentration exceeds the value in Column 1, but does not exceed the value in Column 2, the waste is Class B. (iii) If the concentration exceeds the value in Column 2, but does not

exceed the value in Column 3, the waste is Class C. (iv) If the concentration exceeds the value in Column 3, the waste is not generally acceptable for near-surface disposal. (v) For wastes containing mixtures of the nuclides listed in Table 2, the total concentration shall be determined by the sum of fractions rule described in paragraph (a)(7) of this section”.

- 3) If the waste contains a mixture of short-lived and long-lived radionuclides, some of which are listed in Table 6.1 above (10 CFR 61.55 Table 1), and some of which are listed in Table 6.2 above (10 CFR 61.55 Table 2), classification is determined by 10 CFR 61.55 (a)(5):

**10 CFR 61.55 (a)(5)** – “Classification determined by both long- and short-lived radionuclides. If radioactive waste contains a mixture of radionuclides, some of which are listed in Table 1, and some of which are listed in Table 2, classification shall be determined as follows: (i) If the concentration of a nuclide listed in Table 1 does not exceed 0.1 times the value listed in Table 1, the class shall be that determined by the concentration of nuclides listed in Table 2. (ii) If the concentration of a nuclide listed in Table 1 exceeds 0.1 times the value listed in Table 1 but does not exceed the value in Table 1, the waste shall be Class C, provided the concentration of nuclides listed in Table 2 does not exceed the value shown in Column 3 of Table 2”.

- 4) If the waste does not contain any of the radionuclides listed in either of the tables then classification is determined by 10 CFR 61.55 (a)(6):

**10 CFR 61.55 (a)(6)** – “Classification of wastes with radionuclides other than those listed in Tables 1 and 2. If radioactive waste does not contain any nuclides listed in either Table 1 or 2, it is Class A”.

The low-activity salt waste streams to be disposed of at SDF will contain a mixture of short-lived and long-lived radionuclides from Tables 6.1 and 6.2. Therefore, the waste concentration limits will be determined in accordance with 10 CFR 61.55 (a)(5). As provided in 10 CFR 61.55 (a)(5), the radionuclide limits shown in Table 6.1 above (10 CFR 61.55 Table 1) and radionuclide limits shown in Column 3 of Table 6.2 above (10 CFR 61.55 Table 2) are applicable.

All waste treated through interim processing or SWPF and disposed of at SDF will meet the concentration limits established in 10 CFR 61.55 for Class C waste as shown in Tables 6.3 through 6.8 above. Mixing dry chemicals with the low-activity salt waste stream to form grout is designed to stabilize the waste for disposal. All waste treated through interim processing or SWPF and disposed of at SDF will be mixed with dry chemicals in the approximate ratio of 1:1 and solidified in a manner to achieve reasonable homogeneity. Thus, consistent with the guidance of the NRC’s Branch Technical Position [32], the radionuclide concentrations in the low activity salt waste stream will be reasonably homogeneous for the grouted salt waste disposed of in SDF [23,33]<sup>42</sup>.

---

<sup>42</sup> Similarly, NRC concluded on page 34 of the TER that “DOE has appropriately applied the NRC Branch Technical

The Saltstone Facility WAC will include limits established to ensure that concentration limits for Class C low-level waste in Section 10 CFR 61.55 are protected.

The Saltstone Facility WAC establishes the physical, chemical, and radionuclide limits for all waste to ensure that, at a minimum, the following are not exceeded:

- Limits established by the Performance Assessment (PA)/Special Analysis (SA)<sup>43</sup>
- SDF operating permit limits (State issued)
- Documented Safety Analysis (DSA) limits
- Processability limits<sup>44</sup>

Limits established in the WAC are set to ensure that the most restrictive limits from the criteria listed above are not exceeded. Therefore, the WAC and SRS sampling [34], analysis, and quality assurance procedures provide added assurance that the NRC Class C waste disposal limits will be met.

For example, to ensure compliance with the Saltstone Facility WAC, all generating facilities are required to develop a Waste Compliance Plan (WCP) which describes the controls or procedures imposed to meet the requirements set forth in the WAC. In addition to the generating facility requirements, the Saltstone Facility is required to provide testing and maintain records necessary to support certification of the resulting grout as suitable for disposal at SDF as defined in permits issued by the State of South Carolina and in DOE orders. The requirements and responsibilities associated with the Saltstone Facility WAC program are outlined in the Saltstone Facility Waste Acceptance Criteria Program Requirements [35]<sup>45</sup>.

---

Position on concentration averaging for the saltstone waste form....” NRC further concluded that “Although there is uncertainty in the characterization data, the NRC staff believes the waste treated through interim processing and the SWPF will likely meet the concentration limits established in 10 CFR 61.55 for Class C waste ....”

<sup>43</sup> See Section 7.2.1.

<sup>44</sup> Processability limits in this context refer to chemical, physical, and/or radiological limits placed on the incoming low-activity waste stream to ensure the ability of SPF and SDF to safely handle the waste stream and to produce an acceptable grout product at the necessary throughputs.

<sup>45</sup> With regard to the inventory of low activity salt waste, the NRC stated in its TER that “... the greatest amount of uncertainty in the radiological composition of the waste sent to the SDF results from uncertainties in the tank inventories and uncertainties in the results of the DDA process.” [8, page 13] The following briefly summarizes the various DOE measures to address uncertainties in the salt waste inventory, including recommendations in NRC’s TER. As explained in more detail in Appendix 2, DOE has developed a comprehensive Waste Characterization System (WCS) at SRS which is continually updated on a monthly basis, and is based on samples, process histories, composition studies, and theoretical relationships. Although DOE’s sampling has been somewhat limited so as to avoid the worker exposure associated with robotic-assisted sampling, DOE has engaged in enhanced campaigns, particularly since 2002, to improve the estimates of the radiological composition of the salt waste as noted by the NRC. [8, page 13] DOE has also developed a sampling plan as well as a detailed Waste Acceptance Criteria (WAC) for the Saltstone Feed Tank (Tank 50). In addition, DOE will develop a detailed Waste Compliance Plan which will include periodic samples of DDA solution, grout, and the Saltstone Feed Tank. [6, 8, page 39] Samples, along with

The salt solution arising from the treatment of salt waste per the Salt Processing Strategy must meet the Saltstone Facility WAC to be accepted for processing and disposition at the Saltstone Facility. WAC limits will be established to ensure that NRC Class C waste disposal limits set out in 10 CFR 61.55 are not exceeded. Therefore, the Saltstone Facility WAC program adds assurance that criterion (a)(3)(A) of NDAA Section 3116 is met<sup>46</sup>.

---

process knowledge, will also be used prior to transfer of material to Tank 50 to maintain the waste in Tank 50 in compliance with the WAC. DOE's sampling plan will, among other things, provide characterization of the waste streams fed into the Saltstone Feed Tank, ensure that grout composition can be modified as needed to compensate for changes in the salt, organic, or solids contained in the low activity salt waste solutions, verify that the waste is nonhazardous, and verify compliance with the WAC. [34, 8, page 39] Consistent with NRC's suggestion in its TER [8, page 39], DOE will sample representative batches of waste in the Saltstone Feed Tank prior to transfer to the SPF unless process knowledge adequately predicts the concentrations of radionuclides. Moreover, DOE has developed inventory limits, based on performance assessments, for the SDF. As noted by the NRC, Cs-137 and its daughter Ba-137m, are already relatively well-characterized, particularly when compared to other radionuclides [8, pages 13, 38] and DOE anticipates that the measures outlined above – including the measures recommended by the NRC – will further reduce uncertainties and enhance the characterization of the radioactivity in the salt waste. Moreover, as noted by the NRC, DOE has accounted for the potential uncertainty in the waste by basing this 3116 Determination on a range of curies, from 3 MCi, which is expected, to 5 MCi, as explained previously in this 3116 Determination.

<sup>46</sup> Discussion in this Final 3116 Waste Determination of the SA, WAC, sampling, quality assurance, WCP, and the like should not be construed to suggest that such activities are required by or subject to Section 3116 of the NDAA; rather, these activities are undertaken by DOE pursuant to the Atomic Energy Act of 1954, as amended, and other applicable laws.



## **7.0 THE WASTE WILL BE DISPOSED OF IN ACCORDANCE WITH THE PERFORMANCE OBJECTIVES SET OUT IN 10 CFR PART 61, SUBPART C**

Section 3116 of the NDAA provides in relevant part:

[T]he term “high-level radioactive waste” does not include waste from reprocessing of spent nuclear fuel that the Secretary of Energy...in consultation with the Nuclear Regulatory Commission...determines –

\*\*\*

(3)(A) [W]ill be disposed of –

- (i) in compliance with the performance objectives set out in subpart C of part 61 of title 10, Code of Federal Regulations[.]

### **7.1 10 CFR PART 61 PERFORMANCE OBJECTIVES**

Subpart C of 10 CFR Part 61 lists one general requirement and four performance objectives, which are reproduced below.

#### **7.1.1 Section 61.40, General Requirement**

Land disposal facilities must be sited, designed, operated, closed, and controlled after closure so that reasonable assurance exists that exposures to humans are within the limits established in the performance objectives in Sections 61.41 through 61.44.

#### **7.1.2 Section 61.41, Protection of the General Population from Releases of Radioactivity**

Concentrations of radioactive material which may be released to the general environment in ground water, surface water, air, soil, plants, or animals must not result in an annual dose exceeding an equivalent of 25 millirems to the whole body, 75 millirems to the thyroid, and 25 millirems to any other organ of any member of the public. Reasonable effort should be made to maintain releases of radioactivity in effluents to the general environment as low as is reasonably achievable.

#### **7.1.3 Section 61.42, Protection of Individuals from Inadvertent Intrusion**

Design, operation, and closure of the land disposal facility must ensure protection of any individual inadvertently intruding into the disposal site and occupying the site or contacting the waste at any time after active institutional controls over the disposal site are removed.

#### **7.1.4 Section 61.43, Protection of Individuals During Operations**

Operations at the land disposal facility must be conducted in compliance with the standards for radiation protection set out in part 20 of this chapter, except for releases of radioactivity in effluents from the land disposal facility, which shall be governed by Section 61.41 of this part. Every reasonable effort shall be made to maintain radiation exposures as low as is reasonably achievable.

#### **7.1.5 Section 61.44, Stability of the Disposal Site After Closure**

The disposal facility must be sited, designed, used, operated, and closed to achieve long-term stability of the disposal site and to eliminate to the extent practicable the need for ongoing active maintenance of the disposal site following closure so that only surveillance, monitoring, or minor custodial care are required.

### **7.2 GENERAL REQUIREMENT (10 CFR 61.40)**

The general provision at 10 CFR 61.40 calls for “reasonable assurance” that exposures are within the limits of the four subsequent performance objectives - 10 CFR 61.41, 10 CFR 61.42, 10 CFR 61.43, and 10 CFR 61.44 – as discussed below. Within each ensuing discussion of these four performance objectives, the general provision of 10 CFR 61.40 is also addressed.

#### **7.2.1 Protection Of The General Population (10 CFR 61.41)**

10 CFR 61.41 states:

Concentrations of radioactive material which may be released to the general environment in ground water, surface water, air, soil, plants, or animals must not result in an annual dose exceeding an equivalent of 25 millirems to the whole body 75 millirems to the thyroid, and 25 millirems to any other organ of any member of the public. Reasonable effort should be made to maintain releases of radioactivity in effluents to the general environment as low as is reasonably achievable<sup>47</sup>.

To determine whether the salt waste will be disposed of in conformity with the 10 CFR Part 61 Subpart C performance objective relating to protection of the general population, DOE has used

---

<sup>47</sup> The NRC has stated: “The NRC performance objective set forth in Section 61.41, is based on the [International Commission on Radiation Protection Publication 2] ICRP 2 dose methodology (ICRP, 1959), but current health physics practices follow the dose methodology used in Part 20, which is currently based on ICRP 30 methodology (ICRP, 1979)...For internal consistency...it is recommended that the performance assessment be consistent with the methodology approved by the NRC in Part 20 for comparison with the performance objective” [33]. Based on this guidance, radiological doses in this document and in applicable supporting documents are calculated in accordance with the newer methodology in 10 CFR Part 20. This newer methodology calculates dose in total effective dose equivalent (TEDE) versus the organ doses of the earlier methodology.

two performance assessment documents prepared in 1992 and 2005. These documents and the manner of their use are described further below.

In 1992, as part of the process for siting and building the Saltstone Facility, DOE conducted a Performance Assessment (Saltstone PA) [36] of that facility. The PA evaluated whether doses the general public would be likely to receive as a result of disposal of the waste anticipated to be disposed of in this facility would meet performance standards specified by DOE Order 5820.2A, the Order then governing disposal of low-level radioactive waste. To do so, the PA simulated migration of radionuclides from the disposal of the solidified waste form through the disposal vaults into the surrounding environment to a hypothetical groundwater well located 100 meters from the disposal facility.

In 1992, the waste to be disposed of in the Saltstone Facility was expected to consist of a saltstone grouted waste produced by mixing salt waste from the tanks that had been processed through a different salt processing technology, ITP, together with a small amount of salt waste from the Effluent Treatment Facility, with specially-formulated grout. This waste inventory was expected to be considerably lower for fission products and actinides than the currently-planned inventory.

DOE has compiled an extensive site-specific hydrogeological database for SRS which includes the area around the Saltstone Facility using test borings and groundwater wells to understand how water flows in the site. It also has information on the chemical and physical composition of the soils through which the groundwater and radionuclides would flow. Based on this and other materials, DOE developed groundwater flow and transport models for the unsaturated and saturated zones using site-specific adsorption and permeability information as well as information from the scientific literature. The models also incorporated laboratory and other data to model the physical and chemical properties of the grouted waste form [23].

The PA results indicated that the vast majority of the radionuclides never reach the 100 meter point of assessment because their movement is sufficiently retarded by a combination of the soils, the saltstone grout, and the waste chemistry such that they decay first. The movement of many longer-lived radionuclides, such as U, Pu, and Tc-99 is also substantially retarded because they are only slightly soluble in the waste form. The PA analyzed two cases for groundwater: the degraded case which assumed that the grout in the vaults developed cracks upon closure of SDF; and the intact case which assumed that the vault and the grout structure remained intact. Based on the results of the performance assessment, the calculated doses from estimated radionuclide concentrations in groundwater were at least two orders of magnitude below the 4 mrem per year limit used in the PA analysis for all radionuclides, even if the facility degraded. The peak dose from the intact case was 0.001 mrem per year at greater than two million years after closure. The peak dose from the degraded case was 0.03 mrem per year at 15,000 years. The PA also included qualitative rationale that showed that the air pathway would be insignificant and would not contribute to the doses to the member of the public.

In 2002, DOE updated the analysis in the PA by performing an SA [37] in response to updated facility inventory information due to suspending ITP and replacing that waste stream with

expected low curie salt solution feed. In 2005, DOE prepared an SA [23] to supplement the 1992 PA and supersede the analysis in the 2002 SA. The 2005 SA captured the latest information on the SDF feed solutions expected to be disposed of in Vault 4 [31], updated modeling methods, updated closure cap design and evaluations. The *Saltstone Performance Objective Demonstration Document* [38] was generated in order to demonstrate and document that the solidified low-activity salt streams from the SRS salt processing activities meet the performance objectives set out in Subpart C of Part 61 of Title 10, Code of Federal Regulations. The PODD describes the process, analysis methods, input/assumptions, results, and references necessary to demonstrate compliance with the performance objectives of 10 CFR 61.41, through 44. While DOE expected the updated Vault 4 salt waste inventory would meet Class C concentration limits, the feed solution concentrations were higher than those of the waste DOE had previously analyzed. The PODD also analyzed whether the disposal of solidified DDA and ARP-processed waste in the Saltstone Facility would result in doses to the general public that would still meet the performance objectives of 25 mrem per year to a member of the general public from all pathways, 10 mrem per year to a member of the general public for the air pathway alone, and the Environmental Protection Agency (EPA) Maximum Contaminant Levels (MCLs) for the groundwater pathway, consistent with the Federal Facilities Agreement for SRS.

In the 2005 SA, calculations were performed to determine disposal limits on the maximum quantity and concentration of radionuclides that could be disposed of in SDF using DOE revised salt processing plans, without exceeding the DOE performance objectives set forth above. The SA calculated disposal limits for the radionuclides that were identified by a screening process based on the National Council on Radiation Protection and Measurements (NCRP) screening methodology [39]. For the groundwater pathway, the 826 radionuclides originally considered potentially significant were reduced to 45 to be evaluated in detail. For the air pathway, the 826 radionuclides originally considered potentially significant were reduced to 9 of interest to be evaluated in more detail: H-3, C-14, Cl-36, Se-79, Sn-121m, Sb-125, Sn-126, and I-129.

For each radionuclide, the all-pathways and intruder disposal limits were determined by calculating the maximum dose that would result from disposal of one curie (i.e., mrem/year per curie). Then, the performance measure (e.g., 25 mrem/year) was divided by the dose per curie to give the disposal limit in curies. The all-pathways analysis is a combination of the doses derived from the maximum exposure via groundwater pathways and the doses from the maximum exposure via air pathways. The following figure depicts the modeled pathways:

**Figure 7.1: Modeled 10 CFR 61.41 Pathways [38]**

**MEMBER OF PUBLIC**

1. Drinking water from hypothetical well 100-meters from vault
2. Ingestion of fish from pond filled with water from 100-meter well
3. Direct irradiation resulting from recreational activities (swimming, boating, and shoreline use) in pond filled with water from 100-meter well
4. Ingestion of produce irrigated with water from 100-meter well and contaminated from the airborne plume
5. Ingestion of meat from cows fed vegetation irrigated with water from 100-meter well and contaminated from the airborne plume
6. Ingestion of milk from cows fed vegetation irrigated with water from 100-meter well and contaminated from the airborne plume
7. Direct irradiation from airborne plume
8. Air inhalation from airborne plume

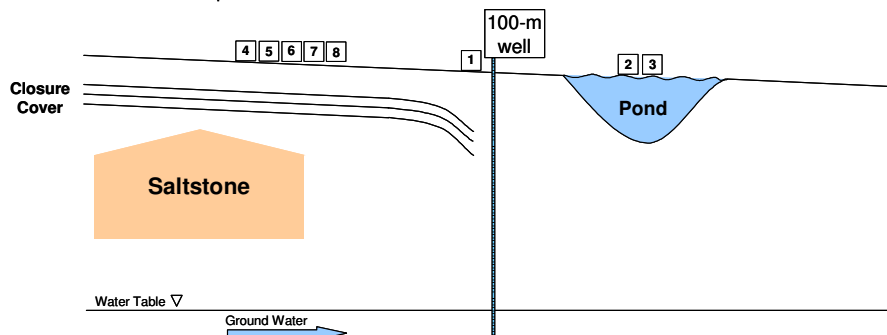

[Not to Scale]

The SA then verified that the proposed salt waste inventory contemplated in 2005 would meet the DOE disposal limit derived in the SA<sup>48</sup> and hence would be DOE's dose-based performance objective for the general public.

During consultation with the NRC, NRC performed extensive evaluations of DOE's PA and SA. NRC noted a number of concerns with the PA and SA which are reflected in the NRC's TER<sup>49</sup>. In response to NRC's concerns raised during consultation, DOE conducted numerous sensitivity analyses the results of which are reflected in DOE's Response to Action Item 10 (8/17/05) [7]<sup>50</sup>. Furthermore, in its TER, NRC concluded that "Overall, DOE's calculational methodology for performing the PA to evaluate protection of the public is generally consistent with NRC guidance", although NRC noted "[t]here are a few areas related to the approach to PA where there is some divergence between NRC and DOE..." [8, page 72] Moreover, NRC developed a different PA model applicable to the SDF, and conducted its own independent analysis which

<sup>48</sup> In addition, DOE performed a series of over 30 sensitivity cases with the model used to estimate the all-pathways public dose rates to determine how sensitive the projected doses are to the selection of key input parameters (Action Item 10 (8/17/05) [7]).

<sup>49</sup> See, for example, pages 26 and 78 of the TER.

<sup>50</sup> With respect to DOE's sensitivity studies, NRC noted a potential inconsistency in DOE's approach resulting from the use of the estimated Vault 4 inventory. NRC's analysis approach resulted in their application of a multiplier to the dose results of DOE's sensitivity analyses to account for their understanding of expected inventory for specific radionuclides in Vault 4, as well as for their projected contribution to doses resulting from potential interactions of multiple vaults. NRC also noted that the sensitivity scenarios which assumed 100% oxidation – which DOE notes are the scenarios which resulted in the highest doses – were unrealistic.

generated results that were in general agreement with DOE's performance assessment. [8, page 79] Given these facts, and noting that Section 3116 of the NDAA does not dictate specific modeling approaches, DOE believes that while it plans to enhance its performance assessment models to reflect NRC's observations, the PA and SA provide sufficient analysis in the context of Section 3116 to show that the performance objectives in 10 CFR Part 61, Subpart C can be met.

For this 3116 Determination, DOE estimated the doses to the general public by conservatively assuming that the entire inventory of salt waste radioactivity (including existing Saltstone inventory in Vaults 1 and 4 and projected inventory for all future vaults) is contained in Vault 4 and the maximum concentration of each radionuclide in the two media (groundwater and atmospheric) occurs at the same time for each radionuclide. The projected inventory was compared to the Vault 4 limits from the 2005 SA [23] and based on the all-pathways performance objective of 25 mrem/yr to the whole body and the sum-of-fractions of the inventory limits shows a peak whole body dose of 2.3 mrem/yr over the 10,000-year time period analyzed. .

The whole body dose is a result of two principle dose contributors: Se-79 and I-129<sup>51</sup>. The whole body dose from these two radionuclides is principally a result of the ingestion pathway. USEPA (1988) values for ingestion dose conversion factors are utilized to determine doses to other organs by determining the ratio of the organ dose conversion factors to the whole body factor and multiplying by the known whole body dose. The final results show that for salt waste disposal at the SDF the all-pathways doses in the expected case are 2.3 mrem/yr whole body, 4.6 mrem/yr to the thyroid and 5.3 mrem/yr to any other organ. This is compared to 10 CFR 61.41 performance objectives of 25 mrem to the whole body, 75 mrem to the thyroid and 25 mrem to any other organ and demonstrates that the 10 CFR 61.41 performance objectives are met by the SDF.

The NRC general provision at 10 CFR 61.40 calls for "reasonable assurance ... that exposures to humans are within the limits established in the performance objectives" [21]. The analysis provides reasonable assurance that the performance objective for protection of the general population will be met because the 100-meter point of assessment used in the analyses for both the groundwater and air pathways is conservative. The SRS Land Use Plan [40] requires Federal ownership and control of the site well beyond 100 years after closure of SDF. DOE 5400.5 precludes release of the area unless the radiological hazard meets the requirements of DOE 5400.5 Chapter 4<sup>52</sup>. No unrestricted use of the land or groundwater will be permitted for the

---

<sup>51</sup> Approximately 100% of the whole body dose is due to Se-79 and I-129; the contribution of all other radionuclides is negligible [38].

<sup>52</sup> Although for the purposes of this analysis, it is assumed that there is possible loss of institutional control for periods beyond 100 years which results in unrestricted access of the site. DOE requirements do not permit termination of necessary controls or unrestricted access to areas requiring radiological control. The Atomic Energy Act of 1954, as amended (AEA), and the Department of Energy Organization Act (DOA), assigns to the Department the responsibility to protect the public, the environment, and property from the hazards associated with its research, development, production, or other activities. This responsibility, which lacks any limit in time, includes protecting the public and environment from radiation or radioactive material. DOE policy (DOE P 454.1, *Use of Institutional Controls*) and requirements (DOE 5400.5, *Radiation Protection of the Public and Environment*) mandate continued control of property until the radiological hazard associated with this property is reduced to levels at which regulation under the AEA is no longer needed to ensure protection of the public and environment. By these requirements, DOE establishes "durable institutional controls" that are effectively similar to those required in 10 CFR 20.1403(e)(2)(ii)

central portion of the site, which includes SDF. Thus, a member of the public could not contact the groundwater in the vicinity of SDF. Due to the restrictions in the SRS Land Use Plan, a member of the public could only contact potentially contaminated surface water off-site, six miles from the facility at the mouth of Upper Three Runs creek. Furthermore, concentrations of SDF radionuclides in that surface water will be less than that assessed in the SA at 100 meters from SDF due to decay and other natural processes.

The NRC performance objective also provides that reasonable effort should be made to maintain releases of radioactivity in effluents to the general environment as low as reasonably achievable (ALARA). The solidified saltstone waste form and the SDF vault design work together to reduce releases from SDF to the environment to very low levels, as demonstrated by the dose calculations above. The engineered grout and the SDF vaults are designed to retard migration of the radionuclides from the grouted waste form [41]<sup>53</sup>.

Therefore, disposal of the solidified low-activity salt waste streams at SDF will meet the limits in the NRC performance objective in 10 CFR 61.41.

## **7.2.2 Protection of Individuals from Inadvertent Intrusion (10 CFR 61.42)**

10 CFR 61.42 states:

Design, operation, and closure of the land disposal facility must ensure protection of any individual inadvertently intruding into the disposal site and occupying the site or contacting the waste at any time after active institutional controls over the disposal site are removed.

To determine whether disposal of the salt waste in SDF would meet this performance objective, DOE used the 2005 SA in a manner similar to the way it used that document to evaluate compliance with the 10 CFR 61.41 performance objective related to the protection of the general public. As discussed previously, the SA updated the 1992 PA.

As a matter of background, the 1992 PA analyzed two cases for inadvertent intrusion: the degraded case which assumed that the grout and the vaults began to lose their physical integrity immediately upon closure of SDF; and the intact case which assumed that the vault and the grout structure remained intact. Four chronic exposure scenarios were analyzed in detail for both in the PA: two agricultural scenarios, a residential scenario, and a well-drilling scenario. In all exposure scenarios considered for inadvertent intruder, the maximum peak dose was 0.6 mrem per year at greater than 100 years for the intact case. The maximum predicted dose for the degraded case was 50 to 110 mrem per year at greater than 1,000 years.

---

for sites requiring long-term control.

<sup>53</sup> Despite NRC's concerns with DOE's performance assessment methodology, NRC also concluded that there is reasonable assurance that the performance objectives in 10 CFR 61.41 can be met, including the provision of as low as reasonably achievable (ALARA) releases of radioactivity to the general environment, with certain observations concerning more realistic modeling, confirmatory activities and enhanced model support. [8, page 79] DOE will take into account NRC's observations concerning more realistic modeling, confirmatory activities, and enhanced model support as it implements its ongoing statutory responsibilities.

---

The intruder analysis was updated in the 2002 SA, which was then superseded by the intruder analysis in the 2005 SA. The 2005 SA analyzed the residential intruder scenario for chronic exposure<sup>54</sup> based on the then-current design of SDF. Under that design, the vaults would be covered with a closure cap that includes a 12-inch thick erosion barrier near the top of the cap. Because the erosion barrier is assumed to never erode and all the layers between the waste and the erosion barrier always remain in place at their design thickness, 11.5 ft. of material always exists above the waste. Soil/cover layers overlying the vault roof were adjusted to be consistent with the current closure concept [42]. Therefore, this cover system when combined with the structure of the vault would make excavation into the waste during 10,000 years extremely unlikely. Thus, the only dose pathway would be external radiation exposure from radionuclides in the waste while residing in the home because the presence of uncontaminated cover material above the waste would preclude inhalation or ingestion exposure.

The resident scenario is a credible occurrence at any time after institutional control is relinquished<sup>55</sup>. At 100 years after disposal, all engineered barriers above the waste are assumed to be intact. An assumption that the barriers to excavation will not degrade by a significant amount during the 100-year period of institutional control is reasonable when surveillance and maintenance of the cover system presumably will be performed during that time. An inadvertent intruder then is assumed to excavate to the depth of 3 meters, a typical maximum depth of an excavation in digging a foundation for a home. Over time erosion will lower the ground elevation, until the erosion barrier becomes exposed. Thus the amount of shielding will decrease and radioactive decay of long-lived radionuclides will produce increasing quantities of daughter products. The intruder analysis was performed in ten-year steps from year 100 to year 10,000 to find the maximum contribution from each radionuclide. The following figure depicts the resident intruder pathway:

---

<sup>54</sup> The SA [23] evaluates chronic exposure scenarios because, as explained in the SA and the references cited therein, chronic scenarios would bound acute scenarios.

<sup>55</sup> Human intrusion was assumed to be precluded in the first 100 years following closure based on the assumption that SRS boundaries remain unchanged and the land remains under Federal government ownership and control utilizing the existing site security system (e.g., fences, controlled site access, prohibited residential use of the land or groundwater). This assumption is consistent with the SRS Future Land Use Plan [40], which requires continual Federal ownership and control of the site well beyond 100 years. No unrestricted use of the land or groundwater will be permitted for the central portion of the site, which includes SDF.



**Figure 7.2: Resident Intruder Pathways [38]**

**MEMBER OF PUBLIC**

1. Direct irradiation through basement

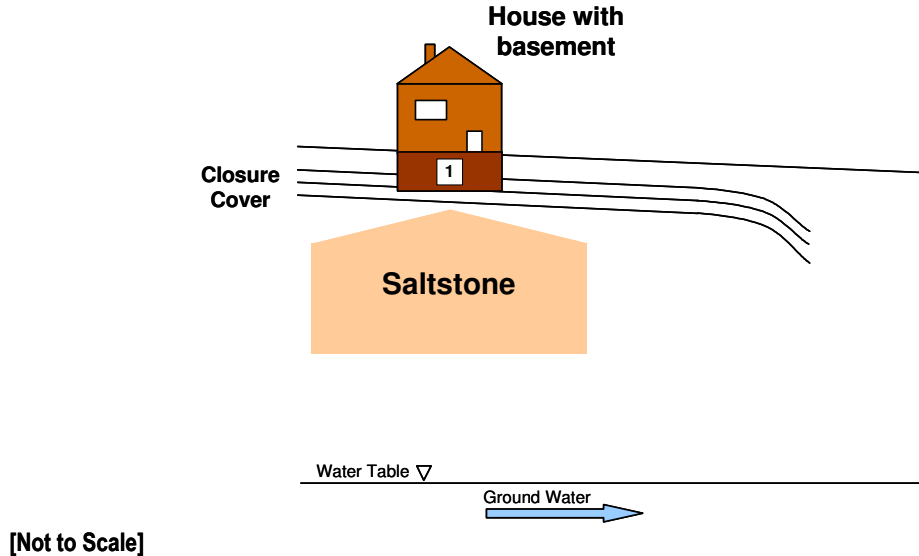

The residential scenario was evaluated in the SA using the DOE 100 mrem per year dose limit to calculate DOE disposal limits for SDF, in a manner similar to the approach used in the SA for calculating disposal limits based on projected dose to the general public (from the groundwater and air pathways). DOE established these limits by calculating the radionuclide concentration in the low-activity salt waste that, when processed into saltstone grout and disposed of in SDF, would result in a dose to the intruder of 100 mrem in a year for each radionuclide. DOE then examined the radionuclide inventory anticipated to be disposed of against those limits and concluded that the inventory was below the limits and; therefore, that there was reasonable assurance that SDF would protect the inadvertent intruder.

For the purposes of this 3116 Determination, DOE has derived estimated doses to the inadvertent intruder over a 10,000 year period using the radionuclide limits developed in the SA and the currently planned radionuclide inventory in the waste streams to be disposed of. DOE conservatively assumed that the entire inventory of salt waste radioactivity (including existing Saltstone inventory in Vaults 1 and 4 and projected inventory for all future vaults) is contained in Vault 4. The resulting maximum estimated dose over the period ending 10,000 years after closure is 21.7 mrem per year. This dose is well within the performance objective of 500 mrem<sup>56</sup> for all times after closure [43], thereby demonstrating that there is reasonable assurance of protection of the inadvertent intruder.

Thus, the disposal of the solidified low-activity salt waste in SDF meets the NRC inadvertent intruder performance objective in 10 CFR 61.42.

---

<sup>56</sup> This dose is also well below the DOE 100 mrem/yr chronic exposure limit.

### 7.2.3 Protection of Individuals During Operations (10 CFR 61.43)

10 CFR 61.43 states:

Operations at the land disposal facility must be conducted in compliance with the standards for radiation protection set out in part 20 of this chapter, except for releases of radioactivity in effluents from the land disposal facility, which shall be governed by Section 61.41 of this part. Every reasonable effort shall be made to maintain radiation exposures as low as is reasonably achievable.

The performance objective in 10 CFR 61.43 cross-references “the standards for radiation protection in Part 20”. Consistent with Section 3116 (a) of the NDAA, the cross-referenced “standards for radiation protection” in 10 CFR Part 20 that are considered in detail in this 3116 Determination are the dose limits for the public and the workers during disposal operations set forth in 10 CFR 20.1101(d), 10 CFR 20.1201(a)(1)(i), 10 CFR 20.1201(a)(1)(ii), 10 CFR 20.1201(a)(2)(i), 10 CFR 20.1201(a)(2)(ii), 10 CFR 20.1201(e), 10 CFR 20.1208(a), 10 CFR 20.1301(a)(1), 10 CFR 20.1301(a)(2), and 10 CFR 20.1301(b)<sup>57</sup>. As will be discussed in the following sections, these dose limits correspond to the dose limits in 10 CFR Part 835 and relevant DOE Orders which establish DOE regulatory and contractual requirements for DOE facilities and activities. The following subsections show that disposal operations at SDF for the solidified salt waste streams meet these dose limits and that doses will be maintained as low as reasonably achievable<sup>58</sup>.

---

<sup>57</sup> The introductory “notwithstanding” phrase to Section 3116 makes it clear that the provisions of Section 3116 (a) are to apply in lieu of other laws that “define classes of radioactive waste”. As is evident from the plain language of this introductory “notwithstanding” phrase, Section 3116 (a) pertains to classification and disposal, and radiation protection standards for disposal, of certain waste at certain DOE sites. Thus, the factors for consideration set forth in subsection (a) 1 through (3) of Section 3116 are those which pertain to classification and disposal of waste, and the radiation protection standards for disposal. The Joint Explanatory Statement of the Committee of Conference in Conference Report 108-767, accompanying H.R. 4200 (the NDAA), also confirms that 3116 (a) concerns classification, disposal, and radiation protection standards associated with disposal, and does not concern general environmental laws or laws regulating radioactive waste for purposes other than disposal. Moreover, in the plain language of Section 3116, Congress directed that the Secretary of Energy consult with the NRC but did not mandate that DOE obtain a license or any other authorization from NRC, and did not grant NRC any general regulatory, administrative, or enforcement authority for disposal of the DOE wastes covered by Section 3116. As such, the “standards for radiation protection” in 10 CFR Part 20 (as cross-referenced in the performance objective at 10 CFR 61.43) which are relevant in the context of Section 3116 of the NDAA are the dose limits for radiation protection of the public and the workers during disposal operations, and not those which address general licensing, administrative, programmatic, or enforcement matters administered by NRC for NRC licensees. Accordingly, this 3116 Determination addresses in detail the radiation dose limits for the public and the workers during disposal operations that are contained in the provisions of 10 CFR Part 20 referenced above. Although 10 CFR 20.1206(e) contains limits for planned special exposures for adult workers, there will not be any such planned special exposures for disposal operations at SDF for the solidified salt waste. Therefore, this limit is not discussed further in this 3116 Determination. Likewise, 10 CFR 20.1207 specifies occupational dose limits for minors. However, there will not be minors working at SDF who will receive an occupational dose. Therefore, this limit is not discussed further in this 3116 Determination.

<sup>58</sup> In addition, 10 CFR Part 835, like Part 20 for NRC licensees, includes requirements that do not set dose limits,

### 7.2.3.1 Air Emissions Limit for Individual Member of the Public (10 CFR 20.1101(d))

The NRC regulation at 10 CFR 20.1101(d) provides in relevant part:

[A] constraint on air emissions of radioactive material to the environment, excluding Radon-222 and its daughters, shall be established ... such that the individual member of the public likely to receive the highest dose will not be expected to receive a total effective dose equivalent in excess of 10 mrem (0.1 mSv) per year from these emissions.

DOE similarly limits doses from air emissions to the public to 10 mrem per year in DOE Order 5400.5. DOE is also subject to and complies with the Environmental Protection Agency requirement in 40 CFR 61.92, which has the same limit<sup>59</sup>. The estimated dose per year from airborne emissions to the maximally exposed individual member of the public located at or beyond the SRS site boundary from all operations at SRS ranged from 0.04 mrem to 0.07 mrem from 1999 through 2004 [44, 45, 46, 47, 48, 49]<sup>60</sup>. These values for all of the SRS operations (not just disposal operations at SDF) are well below the dose limit specified in 10 CFR 20.1101(d). DOE anticipates that the dose from air emissions from SDF following the receipt of the low-activity salt waste streams associated with DDA, ARP/MCU, and SWPF operations will be a small fraction of the dose from all operations at SRS.

### 7.2.3.2 Total Effective Dose Equivalent Limit for Adult Workers (10 CFR 20.1201(a)(1)(i))

The NRC regulation at 10 CFR 20.1201(a), concerning occupational dose limits for adults, provides in relevant part:

- (a) [C]ontrol the occupational dose to individual adults, except for planned special exposures...to the following dose limits.
  - (1) An annual limit, which is the more limiting of –
    - (i) The total effective dose equivalent being equal to 5 rems (0.05 Sv);

\*\*\*

---

such as requirements for radiation protection programs, monitoring, entrance controls for radiation areas, posting, records, reporting, and training.

<sup>59</sup> 40 CFR 61.92 provides as follows: Emissions of radionuclides to the ambient air from DOE facilities shall not exceed those amounts that would cause any member of the public to receive in any year an effective dose equivalent of 10 mrem per year.

<sup>60</sup> It is assumed that the individual is an adult living at the site perimeter that is exposed to the maximum yearly radioactive atmospheric release and maximum radiation concentration in food for 365 days per year. For the airborne pathway the dose is developed by the input of atmospheric release data, vegetation consumption data, milk consumption data, and beef consumption data. The historical doses shown above do not include the incremental increase from disposal of the low-activity salt waste from disposal of DDA, ARP/ MCU, and SWPF in SDF.

---

DOE's regulation at 10 CFR 835.202 (a)(1) has the same annual dose limit for the annual occupational dose to general employees<sup>61</sup>. For the occupational dose to adults during disposal operations at SDF, the TEDE per year will be controlled as low as reasonably achievable below 5 rem [50]. In this regard, occupational doses to workers have been well within the annual limits specified in 10 CFR 1201 (2) for all work activities at SRS [51]. The highest dose received by an SRS worker in 2004 was 974 mrem TEDE. There was close to zero total exposure received by the SRS workforce for SPF and SDF activities. Since 1998, the highest dose received by an SRS worker has been at or below 1808 mrem per year. The total dose received by workers at SPF and SDF since 1998 is 35 mrem, which is well below the limit specified in 10 CFR 20.1201(a). Furthermore, operations will continue to consist predominantly of mechanical mixing of low-activity salt solutions with cementitious material and then mechanical transfer to SDF; therefore, little hands-on work at SDF is anticipated. Thus, the total effective dose equivalent to workers from disposal of the solidified low-activity salt waste at SDF is expected to remain well below the NRC limit.

### **7.2.3.3 Any Individual Organ or Tissue Dose Limit for Adult Workers (10 CFR 20.1201(a)(1)(ii))**

The NRC regulation at 10 CFR 20.1201(a), concerning occupational dose limits for adults, provides in relevant part:

(a)[C]ontrol the occupational dose to individual adults, except for planned special exposures...to the following dose limits.

(1) An annual limit, which is the more limiting of –

\*\*\*

(ii) The sum of the deep-dose equivalent and the committed dose equivalent to any individual organ or tissue other than the lens of the eye being equal to 50 rems (0.5 Sv).

The dose limit specified in 10 CFR 20.1201(a)(1)(ii) is the same as that specified in 10 CFR 835.202 (a)(2). For the occupational dose to adults during disposal operations at SDF, the sum of the deep-dose equivalent and the committed dose equivalent to any individual organ or tissue other than the lens of the eye will be controlled to as low as reasonably achievable below a

---

<sup>61</sup> DOE's regulation requires that the occupational dose per year for general employees shall not exceed both a total effective dose equivalent of 5 rem and the sum of the deep dose equivalent for external exposures and the committed dose equivalent to any other organ or tissue other than the lens of the eye of 50 rem. NRC's regulation specifies that either of these two limits shall be met by NRC licensees, whichever is more limiting. This 3116 Determination will show that DOE will meet the more stringent of the dose limits in 10 CFR Part 835 and the relevant dose limits in 10 CFR Part 20 (see subsection 7.2.3 of this 3116 Determination for listing of relevant dose limits in 10 CFR Part 20). Because DOE imposes stricter, separate requirements, the provisions of 10 CFR 20.1201(a)(1) and (a)(2), which correlate to 10 CFR 835.202(a)(1) and 10 CFR 835.202(a)(2)), are discussed in separate subsections in this 3116 Determination.

maximum of 50 rem per year [50]. SRS Engineering Standard 01064, *Radiological Design Requirements* [52], provides that the design basis annual occupational exposure limits for any organ or tissue other than the eye cannot exceed 10 rem per year, which is well below the NRC limit of 50 rem per year. Furthermore, operations will predominantly consist of mechanical mixing of low-activity salt solutions with cementitious material and then mechanical transfer to SDF, so that little hands-on work, and little, if any, associated exposure, is anticipated for disposal operations in SDF.

#### **7.2.3.4 Annual Dose Limit to the Lens of the Eye for Adult Workers (10 CFR 20.1201(a)(2)(i))**

The NRC regulation at 10 CFR 20.1201(a), concerning occupational dose limits for adults, provides in relevant part:

(a) [C]ontrol the occupational dose to individual adults, except for planned special exposures...to the following dose limits.

\*\*\*

(2) The annual limits to the lens of the eye, to the skin of the whole body or to the skin of the extremities, which are:

(i) A lens dose equivalent of 15 rems (0.15 Sv)

The dose limit specified in 10 CFR 20.1201(a)(2)(i) is the same as that specified in DOE's regulation at 10 CFR 835.202 (a)(3). For the occupational dose to adults during disposal operations at SDF, the annual dose limit to the lens of the eye will be controlled to as low as reasonably achievable below maximum of 15 rem per year [50]. SRS Engineering Standard 01064, *Radiological Design Requirements* [52], provides that the design basis annual occupational exposure limits for the lens of the eye cannot exceed 3 rem per year, which is well below the NRC limit of 15 rem per year. Furthermore, as noted previously, operations predominantly consist of mechanical mixing of low-activity salt solutions with cementitious material and then mechanical transfer to SDF; therefore, little hands-on work or exposure is anticipated during disposal operations at SDF.

#### **7.2.3.5 Annual Dose Limit to the Skin of the Whole Body and to the Skin of the Extremities for Adult Workers (10 CFR 20.1201(a)(2)(ii))**

The NRC regulation at 10 CFR 20.1201(a), concerning occupational dose limits for adults, provides in relevant part:

(a) [C]ontrol the occupational dose to individual adults, except for planned special exposures...to the following dose limits.

\*\*\*

- (2) The annual limits to the lens of the eye, the skin of the whole body, or to the skin of the extremities, which are:

\*\*\*

- (ii) A shallow-dose equivalent of 50 rem (0.5 Sv) to the skin of the whole body or to the skin of any extremity.

This NRC dose limit specified in 10 CFR 20.1201(a)(2)(ii) is the same as the DOE dose limit specified in 10 CFR 835.202 (a)(4). For the occupational dose to adults during disposal operations at SDF, which involve little hands-on activity, the annual dose limit to the skin of the whole body or to the skin of any extremity will be controlled to as low as reasonably achievable below a shallow-dose equivalent of 50 rem per year [50].

#### **7.2.3.6 Limit on Soluble Uranium Intake (10 CFR 20.1201(e))**

The NRC regulation at 10 CFR 20.1201(e), concerning occupational dose limits for adults, provides in relevant part:

- (e) In addition to the annual dose limits, ... limit the soluble uranium intake by an individual to 10 milligrams in a week in consideration of chemical toxicity [.]

In addition to the annual dose limits to adults during disposal operations at SDF, the soluble uranium intake by an individual is controlled to less than 10 milligrams (mg) per week. DOE Order 440.1A requirements for soluble uranium intake are the more restrictive of the concentrations in the American Conference of Governmental Industrial Hygienists Threshold Limit Values (0.2 mg per cubic meter which is the same as noted in 10 CFR 20 Appendix B footnote 3) or the Occupational Safety and Health Administration (OSHA) Permissible Exposure Limit (PEL) (0.05 mg per cubic meter) [53]. The OSHA PEL limit for soluble uranium, which equates to a soluble uranium intake of 2.4 mg per week, is the more restrictive of the two and therefore is the limit imposed for disposal operations at SDF. Accordingly, the soluble uranium intake, if any, during disposal operations at SDF will be controlled to 2.4 mg per week, which is below the NRC limit in 10 CFR 20.1201(e). Moreover, the low-activity waste disposed of in SDF will be in a solid form, and thus there will not be soluble uranium in the solidified waste susceptible to worker intake. In addition, as noted previously, disposal operations will generally be performed mechanically, without worker exposure during normal mechanical operations.

#### **7.2.3.7 Dose Equivalent to an Embryo/Fetus (10 CFR 20.1208(a))**

The NRC regulation at 10 CFR 20.1208(a), concerning the dose equivalent to an embryo/fetus, provides in relevant part:

- (a) [E]nsure that the dose equivalent to the embryo/fetus during the entire pregnancy, due to the occupational exposure of a declared pregnant woman, does not exceed 0.5 rem (5 mSv).

DOE's regulation at 10 CFR 835.206 (a) has the same dose limit. For the occupational dose to an embryo/fetus during disposal operations at SDF, doses will be controlled so that the dose equivalent to the embryo/fetus during the entire pregnancy for a declared pregnant worker will not exceed 0.5 rem [50]. Furthermore, after declaration of pregnancy, DOE provides the option of a mutually agreeable assignment of work tasks, without loss of pay or promotional opportunity, such that further occupational radiation exposure during the remainder of the gestation period is unlikely. In addition, personnel dosimetry is provided and used to carefully track exposure.

### **7.2.3.8 Dose Limits for Individual Members of the Public (10 CFR 20.1301(a)(1))**

The NRC regulation at 10 CFR 20.1301(a), concerning dose limits for individual members of the public, provides in relevant part:

(a) [C]onduct operations so that -

- (1) The total effective dose equivalent to individual members of the public ...does not exceed 0.1 rem (1 mSv) in a year, exclusive of the dose contributions from background radiation, from any medical administration the individual has received, from exposure to individuals administered radioactive material and released...., from voluntary participation in medical research programs, and from the ...disposal of radioactive material into sanitary sewerage [.]

DOE Order 5400.5 II.1.a similarly limits public doses to less than 100 mrem per year. However, DOE's application of the limit is more restrictive in that it requires DOE to make a reasonable effort to ensure that multiple sources (e.g., DOE sources and NRC regulated sources) do not combine to cause the limit to be exceeded. For individual members of the public during disposal operations at SDF, the TEDE limit to an individual member of the public will be controlled to less than 0.1 rem per year. The air pathway is the predominate pathway for doses to the public from SRS operations, including disposal operations at SDF and, as discussed in subsection 7.2.3.1 of this 3116 Determination, doses from the air pathway to members of the public have been, and are expected to continue to be, well below the 0.1 rem annual limit specified in 10 CFR 20.1301(a) [50].

### **7.2.3.9 Dose Limits for Individual Members of the Public (10 CFR 20.1301(a)(2))**

The NRC regulation at 10 CFR 20.1301(a), concerning dose limits for individual members of the public, provides in relevant part:

(a) [C]onduct operations so that -

\* \* \*

- (2) The dose in any unrestricted area from external sources, exclusive of the dose contributions from patients administered radioactive material and released ..., does not exceed 0.002 rem (0.02 millisievert) in any one hour.

DOE's regulation at 10 CFR 835.602 establishes the expectation that the TEDE in Controlled Areas will be less than 0.1 rem in a year. For individual members of the public during disposal operations at SDF, operations will be conducted such that the dose in any unrestricted area from external sources, exclusive of the dose contributions from patients administered radioactive material, will be less than 0.00005 rem per hour above background. Westinghouse Savannah River Company (WSRC) Manual 5Q, Chapter 2, Article 232, also restricts the TEDE in Controlled Areas to less than 0.1 rem in a year. To ensure that these dose limits are met, the following measures have been instituted within Controlled Areas. Per 10 CFR 835.603(g), Radioactive Materials Areas have been established for accumulations of radioactive material that could result in a radiation dose of 100 mrem in a year or greater. In addition, SRS has established Radiological Buffer Areas around posted Radiological Areas. Standard SRS practice is to assume a 2,000 hour per year continuous occupancy at the outer boundary of these areas and; therefore, the dose rate at a Radiological Buffer Area boundary is 0.00005 mrem per hour (0.1 rem/2,000 hour = 0.00005 rem per hour). Since the Controlled Area encompasses a Radiological Buffer Area, it is ensured that the dose in the Controlled Area (but outside of Radioactive Material Areas and Radiological Buffer Areas) will be less than 0.1 rem in a year [54]. Therefore, SRS implementation of the provisions at 10 CFR 835.602 and 10 CFR 835.603 limit provides a more restrictive limit than the dose limit specified in 10 CFR 20.1301(a)(2). Furthermore, training is required for individual members of the public for entry into Controlled Areas. In addition, to ensure no member of the public exceeds radiation exposure limits, use of dosimetry is required if a member of the public is expected to enter a controlled area and receive a dose that may exceed 0.05 rem per year.

#### **7.2.3.10 Dose Limits for Individual Members of the Public (10 CFR 20.1301(b))**

The NRC regulation at 10 CFR 20.1301(b), concerning dose limits for individual members of the public, provides in relevant part:

(b) If ... members of the public [are permitted] to have access to controlled areas, the limits for members of the public continue to apply to those individuals.

DOE's regulation at 10 CFR 835.208 has the same dose limit. The TEDE limit to an individual member of the public granted access to controlled areas<sup>62</sup> during disposal operations at SDF will be controlled to 0.1 rem per year [50]. Furthermore, training is required for individual members of the public for entry into controlled areas. In addition, to ensure no member of the public exceeds radiation exposure limits, use of dosimetry is required if a member of the public is expected to enter a controlled area and receive a dose that may exceed 0.05 rem per year<sup>63</sup>.

---

<sup>62</sup> 10 CFR 20.1003 defines restricted areas as an area, access to which is limited ... for the purpose of protecting individuals against undue risks from exposure to radiation and radioactive materials. This is the same as the definition in 10 CFR 835.2 for a controlled area.

<sup>63</sup> 10 CFR 20.1301(d) allows licensees to request NRC authorization to allow an individual member of the public to operate up to an annual dose limit of 0.5 rem (5 mSv). 10 CFR 835 is more restrictive for the dose to an individual member of the public with a limit of 0.1 rem maximum annual dose as discussed in Subsection 7.2.3.8. Therefore, this limit is not discussed further in this 3116 Determination.



### **7.2.3.11 As Low As Reasonably Achievable (10 CFR 20.1003)**

The NRC regulation at 10 CFR 20.1003 defines ALARA (As Low as Reasonably Achievable) in relevant part:

ALARA ... means making every reasonable effort to maintain exposures to radiation as far below the dose limits ... as is practical consistent with the purpose for which the ... activity is undertaken...[.]

DOE has a similar requirement, and DOE's regulation at 10 CFR 835.2 defines ALARA as "... the approach to radiation protection to manage and control exposures (both individual and collective) to the work force and to the general public to as low as is reasonable...". For radiological work activities during disposal operations at SDF, every reasonable effort will be made to maintain exposures to radiation as far below the dose limits as is practical consistent with the purpose for which the activity is undertaken. Furthermore, DOE's regulation at 10 CFR 835.101(c) requires the contents of each Radiation Protection Program (RPP) to include formal plans and measures for applying the as-low-as-reasonably-achievable process to occupational exposure.

### **7.2.3.12 Reasonable Assurance**

Measures that provide reasonable assurance that disposal operations at SDF will comply with the applicable dose limits and with the ALARA provisions include: (1) the documented RPP; (2) the DSA; (3) design; (4) regulatory and contractual enforcement mechanisms; and (5) access controls, training, and dosimetry. These measures are discussed in the following paragraphs. In addition, the following discusses the exposure history at SRS and at SDF.

### **7.2.3.13 SRS Radiation Protection Program**

The Department of Energy regulates occupational radiation exposure at its facilities through 10 CFR Part 835, *Occupational Radiation Protection*. Part 835 establishes exposure limits and other requirements to ensure that DOE facilities are operated in a manner such that occupational exposure to workers is maintained within acceptable limits and as far below these limits as is reasonably achievable. The requirements in Part 835 are nuclear safety requirements which, if violated, provide a basis for the assessment of civil penalties under the section 234A of the Atomic Energy Act.

Pursuant to Part 835, activities at SRS, including disposal operations at SDF, must be conducted in compliance with the documented RPP for SRS as approved by DOE. The key elements of the RPP include monitoring of individuals and work areas, control of access to areas containing radiation and radioactive materials, use of warning signs and labels, methods to control the spread of radioactive contamination, radiation safety training, objectives for the design of facilities, criteria for levels of radiation and radioactive material in the workplace, and continually

updated records to document compliance with the provisions of Part 835. The RPP also includes formal plans and measures for applying the ALARA process.

The requirements of Part 835 as contained in the approved RPP are incorporated in the WSRC's Standards and Requirements Implementing Document system. The Standards and Requirements Implementing Document system links the requirements of Part 835 to the site-level and lower-level implementing policies and procedures that control radiological work activities conducted across the site. These requirements are primarily contained in the WSRC 5Q Manual, *Radiological Control*, and its lower tier manuals, e.g., WSRC 5Q1.1, *Radiation and Contamination Control Procedures Manual*, and WSRC 5Q1.2, *Radiation Monitoring Procedures Manual*. These procedures control the planning of radiological work, the use of radiation monitoring devices by employees, the bioassay program, the air monitoring program, the contamination control program, the ALARA program, the training of general employees, radiological workers, Radiological Control Inspectors, and health physics professionals and technicians, and the other aspects of an occupational radiation protection program as required by Part 835.

#### **7.2.3.14 Documented Safety Analysis**

A DSA [55] has been approved by DOE for operation of SPF and SDF in accordance with 10 CFR Part 830. As the first step in the development of the DSA, a formal Consolidated Hazards Analysis (CHA) [56] was performed at the Saltstone Facility to evaluate the potential risk of operations to the workers and the public. The CHA was performed by a group of 20 subject matter experts, with expertise in the fields of operations, engineering, industrial hygiene, radiological protection, environmental compliance, and maintenance.

The CHA consisted of three basis phases: hazard identification; hazard classification; and hazard evaluation. During the hazard identification phase, all possible radiological and chemical hazardous materials associated with the normal and abnormal operations of the facility were identified, along with all potential energy sources available to disperse the hazardous materials to the environment.

During the hazard classification phase, the maximum quantities of hazardous materials possible in the Saltstone Facility are evaluated against the criterion listed in DOE-STD-1027-92, *Hazard Categorization and Accident Analysis Techniques for Compliance with DOE Order 5480.23, Nuclear Safety Analysis Reports*, to determine the overall hazard classification of the facility. It was determined by the CHA team that the hazard classification of the Saltstone Facility was Hazard Category 3, which is the lowest hazard classification and denotes a potential for only localized consequences to workers at the facility and no potential for significant consequences to other workers at the site or to members of the public.

During the third and final phase of the CHA, all possible normal and abnormal operational events that could result in exposing facility workers or the public to hazardous material were evaluated to determine the magnitude of the risk. During this hazard evaluation phase, the consequence and frequency of each operational event was qualitatively determined and the resulting level of

risk was identified. The purpose of identifying the level of risk was to determine which operational events posed some level of risk (and thus required additional evaluation) and those events which presented negligible risk to the facility workers and public. As a result of the hazard evaluation for the Saltstone Facility, all normal operational events were determined to present negligible risk to the workers and public (i.e., exposure < 5 rem to facility workers) and were thus removed from further evaluation. For purposes of this CHA, the waste inventory and curie concentrations were assumed to be greater than currently planned for the DDA, ARP/MCU, and SWPF streams.

The DSA analyzed the hazards that were identified in the CHA that could impact facility workers during normal operations and accident conditions and specifically included radiation exposure hazards. The DSA identified the basis for derivation of the Saltstone Facility Technical Safety Requirements (TSR) [57] and also discussed summary descriptions of the key features of safety management programs at SRS as they pertain to SDF.

The Saltstone Facility TSR document identified the administrative controls that are necessary to achieve safe operations at SDF. In part, these TSR administrative controls require: (1) that a facility manager be assigned who is accountable for safe operation and in command of activities necessary to maintain safe operation; (2) that personnel who carry out radiological controls functions for SDF have sufficient organizational freedom to ensure independence from operating pressures; (3) that SDF personnel receive initial and continuing training including radiological control training; and (4) that an RPP shall be prepared consistent with 10 CFR Part 835. The DSA determined that the administrative controls identified in the TSR are sufficient to ensure worker protection in accordance with 10 CFR Part 835.

In addition, the design requirements for SPF and SDF implemented 10 CFR Part 835 [58] and, in particular, implemented ALARA principles. The design has been upgraded to reflect the radionuclide concentrations in the low-activity waste streams to be received at SPF and SDF from planned Interim Salt Processing facilities and SWPF. It is estimated that occupational exposures for SPF and SDF workers will be at least an order of magnitude lower than the 10 CFR Part 835 dose limit of 5 rem per year during both Interim Salt Processing and SWPF operation.

#### **7.2.3.15 Radiological Design for Protection of Occupational Workers and the Public**

New SRS radiological facilities and facility modifications including the ongoing Saltstone Facility modifications are designed to meet the requirements of 10 CFR 835 Subpart K, *Design and Control* [59]. SRS Engineering Standard 01064, *Radiological Design Requirements* [52], provides the requirements necessary to ensure compliance with 10 CFR Part 835. The standard refers to 10 CFR Part 835, DOE orders, DOE standards, DOE handbooks, national consensus standards, SRS manuals, SRS engineering standards, SRS engineering guides, and site operating experience in order to meet the 10 CFR Part 835 specific requirements and additional requirements to ensure the design provides for protection of the worker and the environment.

The standard covers the full spectrum of radiological design requirements and not just radiation exposure limits. The following are the specific areas addressed in the standard: radiation

exposure limits; facility and equipment layout; area radiation levels; radiation shielding; internal radiation exposure; radiological monitoring; confinement; and ventilation.

The design requirements for several of the important sections of the standard are highlighted in order to understand the design limits and philosophy for SRS designs. The first area of interest is the radiation exposure limits. The following is an excerpt of the standard which presents the exposure limits and philosophy for both external and internal radiation exposure.

“During the design of new facilities or modification of existing facilities, the design objective for controlling personnel exposure from external sources of radiation in areas of continuous occupancy (2000 hours per year) shall be to maintain exposure levels below an average of 0.5 mrem per hour and as far below this average as is reasonably achievable. The design objectives for exposure rates for potential exposure to a radiological worker where occupancy differs from the above shall be As Low As Reasonably Achievable (ALARA) and shall not exceed the external limits in Table 5-1. Regarding the control of airborne radioactive material, the design objective shall be, under normal conditions, to avoid releases to the workplace atmosphere and in any situation, to control the inhalation of such material by workers to levels that are ALARA; confinement and ventilation shall normally be used [6.3, 6.12]. Table 5-1 summarizes the design basis external radiation exposure limits.

**Design Basis Annual Occupational Radiation Exposure Limits**

Type of Exposure	Limit (rem)
Whole Body TEDE	1.0
Internal CEDE	0.5
Lens of Eye	3
Extremity	10
Any Organ (other than eye) or Tissue	10

To meet the Site’s no deliberate intake policy, engineered controls will be evaluated and implemented to ensure that, under normal operating conditions, no worker will receive a deliberate intake of radionuclides (i.e., CEDE=0 rem). As a result, the TEDE limit will be independent of the CEDE limit. The 0.5 rem CEDE limit in Table 5.1 is to be applied to potential intakes from anticipated potential releases or anticipated off-normal maintenance. Under these anticipated potential conditions, engineered controls will be evaluated and implemented to minimize the potential for workers to receive intakes that will exceed the 0.5 rem CEDE. This evaluation will not take credit for the use of respiratory protection.

The dose to any member of the public or a minor exposed to radiation at a DOE facility shall not exceed 0.1 rem TEDE in a year.”

The facility design also incorporates radiation zoning criteria in order to ensure the exposure limits presented above are met by providing adequate radiation shielding. Areas in which non-radiological workers are present are assumed to have continuous occupancy (2,000 hours per year) and are designed to a dose rate less than 0.05 mrem per hour to ensure that the annual dose is less than 100 mrem. Other zoning criteria are established to ensure radiological worker doses are ALARA and less than 1,000 mrem per year to meet the 10 CFR 835.1002 design requirements.

The design is also required to provide necessary radiological monitoring or sampling for airborne and surface contamination to ensure the engineered controls are performing their function and, in the event of a failure or upset condition, workers are warned and exposures avoided.

Radiological protection personnel ensure the requirements of the standard are addressed and presented in design summary documentation. The incorporation of all the radiological design criteria in the engineering standard ensures the requirements of 10 CFR Part 835 are met and the design provides for the radiological safety of the workers and environment.

#### **7.2.3.16 Regulatory and Contractual Enforcement**

Any violation of the requirements in 10 CFR Part 835 is subject to civil penalties pursuant to section 234A of the Atomic Energy Act of 1954, as amended, 42 USC 2011 *et seq.*, as implemented by DOE regulations in 10 CFR Part 820. In addition, the requirements in 10 CFR Part 835 and all applicable DOE Orders are incorporated into all contracts with DOE contractors, including WSRC, the DOE contractor for disposal operations at SDF as well as other operations at SRS. DOE enforces these contractual requirements through contract enforcement measures, including the reduction of contract fees.

#### **7.2.3.17 Access Controls, Training, Dosimetry, and Monitoring**

Training or an escort is required for individual members of the public for entry into controlled areas. In addition, use of dosimetry is required if a member of the public is expected to enter a controlled area and exceed 0.05 rem per year to ensure no member of the public exceeds radiation exposure limits [60].

In addition, worker radiation exposure monitoring is performed for all workers expected to receive 100 mrem per year from internal and external sources of radiation to provide assurance that no worker exceeds radiation exposure limits and that all radiation dose are maintained as far below the limits as is reasonably achievable [60].

### **7.2.3.18 Occupational Radiation Exposure History for Savannah River Site**

The effectiveness of the radiation protection programs, including the effectiveness of oversight programs to ensure they are implemented properly, is demonstrated by the occupational radiation exposure results as documented for 2004 [61]. The highest dose received by an SRS worker in 2004 was 974 mrem TEDE compared to the DOE Administrative Control Limit of 2000 mrem per year and the 10 CFR Part 835 limit of 5000 mrem per year. There was close to zero total exposure received by the SRS workforce for SPF and SDF activities. Since 1998, the highest dose received by an SRS worker has been at or below 1808 mrem per year. The total dose received by workers at SPF and SDF since 1998 is 35 mrem.

In addition, for all work activities, the average TEDE exposure for workers receiving a TEDE dose at SRS has been 75 mrem per year or less since 2001 [62]. It is expected that exposures for workers at SDF will be at or below this average based on design requirements and past experience with SDF operation.

### **7.2.4 Long-Term Stability of the Disposal Site (10 CFR 61.44)**

10 CFR 61.44 states:

The disposal facility must be sited, designed, used, operated, and closed to achieve long-term stability of the disposal site and to eliminate to the extent practicable the need for ongoing active maintenance of the disposal site following closure so that only surveillance, monitoring, or minor custodial care are required.

The SDF is currently an operational low-level waste disposal facility to which additional disposal vaults will be constructed on a just-in-time basis. The facility is not scheduled for closure until completion of salt waste disposition currently estimated for 2019. A final closure plan will be developed in the future, as appropriate, to support closure of SDF. As demonstrated below, SDF will meet the performance objective at 10 CFR 61.44 for long-term stability of the disposal site.

### **SITING**

SDF is located within an area designated as Z-Area in the north-central portion of SRS. Z-Area was chosen as a waste disposal site based on considerations of depth to the water table, distance to surface water and the public, available surface area, surface topography, and its proximity to the salt processing facilities. The Saltstone Facility is located 1.0 miles from the salt processing facilities and 6.2 miles from the nearest SRS site boundary. Z-Area lies on a local topographic high, at 290 feet above mean sea level [15]. Land use in the area is classified as heavy industrial. Land within a 5-mile radius of SDF is entirely within the SRS boundaries and is used for either industrial purposes or as forested land. Z-Area is bounded by two streams: Upper Three Runs and McQueen Branch, a tributary to Upper Three Runs. McQueen Branch is located 1.0 miles to the East and 0.75 miles to the Northeast of Z-Area, and Upper Three Runs is located 1.0 miles to the Northwest [15]. Under Z-Area, the minimum depth to the water table from the ground

surface (290 feet elevation) in any given year is estimated to be at 43 feet (i.e., at 247 feet above mean sea level) on the basis of water table fluctuations [16]. Per SCDHEC Regulation R.61-107.16, the bottom of all current and future disposal vaults must be located at least two-feet above this historic high water table.

There are no lakes or flow control structures on Upper Three Runs or its tributaries. The Probable Maximum Flood value for Upper Three Runs is 175 feet above mean sea level, which is substantially below the planned maximum depth of the Saltstone vaults [15]. The 500-year and 100-year flood plains are located at 153.1 feet and 151.7 feet above mean sea level, respectively [17].

Two major earthquakes have occurred within 100 miles of SRS. The largest known earthquake to affect SRS was the Charleston earthquake of 1886, with an epicenter approximately 90 miles from SRS and a magnitude of 6.6 on the Richter Scale. It is estimated that an earthquake of this magnitude would result in a peak ground acceleration of 0.10 g at SRS [18]. A seismic evaluation of Z-Area shows that the soils beneath Z-Area are not susceptible to significant liquefaction for earthquakes having a peak ground acceleration less than or equal to 0.17 g [19]. The second earthquake occurred 90 – 100 miles from SRS, with an estimated magnitude of 4.5.

Most of the soils in the vicinity of SDF are sandy over a loamy or clayey subsoil. The dominant vegetation near SDF is forest with types ranging from scrub oak to cypress with pine being the primary forest in the area [11]. The siting of SDF, including the additional vaults where the solidified low-activity salt streams will be disposed, is such that it provides long-term stability consistent with this performance objective.

## **DESIGN**

SDF currently contains two large concrete vaults divided into cells. Each of the cells will be filled with solidified waste. The grout used to solidify the waste provides primary containment of the waste and the walls, floor, and roof of the vaults provide secondary containment. Approximately 15 feet of overburden have been removed to prepare and level the site for vault construction. All vaults will be built at or slightly below the grade level that exists after the overburden and leveling operations are complete. The bottom of the saltstone grout monoliths will be at least five feet above the historic high water table beneath SDF thus, avoiding disposal of waste in a zone of water table fluctuation.

Run-on and runoff controls are installed to minimize site erosion during the operational period. Approximately 160 acres are bounded by the Saltstone Facility perimeter fence. The impervious portion of this area is approximately 5% of the total Saltstone Facility property. Stormwater runoff from the impervious area of the Saltstone Facility is channeled through a pipe to the Z-01 sedimentation basin. McQueen Branch receives any discharges from the Z-01 basin. The basin is inspected at least once every three months. Because this is a relatively small drainage area, no special measures for runoff control are required [63].

The current vault (Vault #4) has dimensions of 200 feet wide, by 600 feet in length, by 26 feet in height. The vault is divided into 12 cells, with each cell measuring 100 feet by 100 feet. The vault is covered with a sloped, permanent roof that has a minimum thickness of four inches, and a minimum slope of 0.24 inches per foot. The vault walls are 1.5 feet thick, with the base mat having a thickness of two feet. Operationally, the cells of the vault will be filled to a height of 25 feet with solidified waste, and then a layer of uncontaminated grout, with an average thickness of two feet, will be poured to fill in the space between the solidified waste and the sloped roof to provide structural support.

The six cells within Vault #4 that will be used during Interim Salt Processing have a leachate collection system installed within the vault walls. This prevents hydraulic pressure build-up against the vault walls. A sheet drain system is installed on the cell walls with a 12 inch pipe at the bottom of the walls to collect the leachate. Each cell has a drain line that can be accessed from the exterior of the cells. Prior to Interim Salt Processing, modifications have been made to these cells to install a pump and piping system to transfer the collected leachate from the cells to the grout transfer line upstream of the cells. The leachate will be pumped at a low rate into the grout line for re-introduction to the cells during grout-fill operations.

The other current vault (Vault #1) has dimensions of 100 feet wide, by 600 feet in length, by 25 feet in height. The vault is divided into six cells, with each cell measuring 100 feet by 100 feet.

DOE is currently evaluating design alternatives for future SDF vaults. These new vaults will be designed to meet all of the same standards as the existing vaults. The new design will provide the same level or a greater level of protection against infiltration of water, migration of radioactive contaminants, structural integrity, and radiation shielding. New designs are being considered primarily to maximize the processing capacity of the facility, to simplify the operation of the vaults, and to minimize the cost of construction. Therefore, the existing vaults are, and the future vaults will be, designed to achieve the required long-term stability of the disposal site.

The Saltstone Facility was originally designed for processing materials with lower radionuclide concentrations than those currently planned during Interim Salt Processing. In preparation for Interim Salt Processing, several modifications in the design and operation of the facility have been completed. For example, several inches of grout which does not contain the low-activity waste stream will be poured on top of the low-level grout in the inactive vault cells to reduce the amount of exposure to facility workers (which will be primarily in SPF rather than SDF portion of the facility) due to sky shine.

#### **USE/OPERATION**

SDF is permitted as an Industrial Solid Waste Landfill (ISWLF) site, as defined by SCDHEC Regulations R61-66 and R.61-107.16. Active disposal operations are planned to occur at SDF



until around 2019. Following the filling of each vault cell, monitoring of the vaults occurs<sup>64</sup>. Except for erosion control purposes, backfilling around the vaults will likely not be done prior to the completion of disposal activities. This will allow the vaults to be visually monitored<sup>64</sup> for several years prior to closure. Any liquid that may accumulate as a result of rain water infiltration will be drained and returned to the process to avoid creating bulges in the vault walls. Routine surveillances of the filled vaults for structural integrity and soundness are conducted<sup>64</sup> [51].

## **CLOSURE**

The stability of the SDF closure design is an important element for meeting SDF performance objectives. The SDF facility design is focused on minimizing the contact of water with the stabilized waste form. The saltstone grout material in the stabilized waste form will help retard the migration of rainwater to the waste. The existing storm water control systems will be maintained (including monitoring, surveillance, and minor custodial care activities). To further ensure long-term stability of SDF, the land in Z-Area which includes SDF, will remain under the ownership of the Federal Government. The three counties making up SRS have zoning restrictions that prevent the purchase of property or the approval of building permits at SRS. SRS is zoned "Department of Energy ownership". Residential use of this land will be prohibited via continued land use leasing restrictions [40]. No unrestricted use of the land or groundwater will be permitted for SDF.

Closure operations will begin near the end of the active SDF disposal period. Although final closure plans for SDF will be developed in the future, the following actions are contemplated today. Backfill of native soil will be placed around the vaults. The vaults will be covered with a one-meter thick concrete barrier and a clay/gravel drainage system comprised of 1.6 feet of clay with an overlying 0.5 feet layer of gravel. The clay/gravel drainage system is intended to prevent the buildup of perched water above the vaults. Above the clay/gravel drainage system, a geotextile fabric to maintain layer separation from overlying backfill and a minimum of one-foot of backfill will be placed. Above this layer of backfill, a laterally extensive moisture barrier will be installed. This upper moisture barrier will consist of 2.5 feet of clay and an overlying layer of one-foot of gravel. A geotextile fabric will also be placed on this upper gravel layer and a second backfill layer, 2.5 feet thick, will be placed over the moisture barrier. Finally, a 0.5 feet layer of topsoil will be placed on the top layer of backfill to complete closure of SDF. This sequence of layers will provide a minimum of 9.6 feet of cover for each vault [23].

Final closure of SDF will be accomplished by constructing a drainage system and revegetating the site. The drainage system will consist of a system of rip-rap lined ditches that intercept the gravel layer of the moisture barrier. These ditches will divert surface runoff and water intercepted by the moisture barrier away from the disposal site. The drainage ditches will be constructed between rows of vaults and around the perimeter of SDF. The topsoil will be

---

<sup>64</sup> SDF monitoring and surveillance is being undertaken by DOE pursuant to DOE's authority under the Atomic Energy Act of 1954, as amended, and other applicable laws, and is not specifically required by Section 3116 (a) of the NDAA.

revegetated with bamboo which is a shallow-rooted climax species that evapotranspires year-round in the SRS climate, thus removing moisture from the soil and decreasing the infiltration into the underlying disposal system [23]. Therefore, SDF will be closed to achieve long-term stability of the disposal site and to eliminate to the extent practicable the need for ongoing active maintenance of the disposal site so that only surveillance, monitoring, or minor custodial care are required.

Thus, the Saltstone Disposal Facility complies with the NRC long-term stability performance objective in 10 CFR 61.44.

## 8.0 STATE-ISSUED PERMIT

Section 3116 of the NDAA provides in relevant part:

[T]he term “high level radioactive waste” does not include waste from reprocessing of spent nuclear fuel that the Secretary of Energy...in consultation with the Nuclear Regulatory Commission...determines –

(3)(A) ... [W]ill be disposed of-

\*\*\*

- (i) pursuant to a State-approved closure plan or State-issued permit, authority for the approval or issuance of which is conferred on the State outside of this section ...[.]

SDF is operated as a Class 3 Industrial Solid Waste Landfill (Permit #025500-1603). The State of South Carolina permitted SDF under its authority pursuant to Subpart D of the Resource Conservation and Recovery Act and Chapter 61, Article 107 (Solid Waste Management) of the South Carolina Health and Environmental Control Regulations, Subpart 16, Industrial Solid Waste Landfills. DOE is applying for modification of this permit to incorporate disposal of the salt waste discussed in this 3116 Determination. DOE will not dispose of the solidified salt waste covered by this 3116 Determination until SCDHEC issues the appropriate permit modification.

## **9.0 CONCLUSION**

Therefore, as demonstrated in the preceding sections of this 3116 Determination and in consideration of DOE's consultation with the NRC, the solidified low-activity salt waste is not high-level waste and may be disposed of in the Saltstone Disposal Facility at SRS.

DOE will continue to take actions (such as sampling, monitoring, and ensuring vault inventory limits) to confirm the ongoing validity of this 3116 Determination and to explore additional actions to further enhance the protection of workers, members of the public, and the environment.

## 10.0 REFERENCES

---

- 1 *“Ronald W. Reagan National Defense Authorization Act for FY 2005,”* Section 3116, 2004.
- 2 Ledbetter, L. S., CBU-PIT-2004-00024, *“12/01/04 – December Monthly WCS Curie and Volume Inventory Report,”* Revision 0, December 9, 2004.
- 3 Rios-Armstrong, M. A., CBU-PIT-2005-00031, *“Decontaminated Salt Solution Volume to be Transferred to the Saltstone Disposal Facility from Salt Treatment and Disposition Activities,”* Revision 0, February 13, 2005.
- 4 Mahoney, M. J. and D. P. Chew, CBU-PIT-2004-00004, *“Savannah River Site Tank Waste Processing Summary,”* Revision 0, December 9, 2004.
- 5 NRC, *“Request for Additional Information (RAI) on the Draft Section 3116 Determination [for] Salt Waste Disposal [at the] Savannah River Site,”* Scott C. Flanders to Mark A. Gilbertson, May 26, 2005.
- 6 Westinghouse Savannah River Company, CBU-PIT-2005-00131, *“Response to Request for Additional Information on the Draft Section 3116 Determination for Salt Waste Disposal at the Savannah River Site,”* Revision 1, July 14, 2005.
- 7 Westinghouse Savannah River Company, CBU-PIT-2005-00203, Revision 1, *“Response to Action Items from Public Meetings Between NRC and DOE to Discuss RAI for the Savannah River Site,”* September 2005.
- 8 NRC, *“U.S. Nuclear Regulatory Commission Technical Evaluation Report for the U.S. Department of Energy Savannah River Site Draft Section 3116 Waste Determination for Salt Waste Disposal,”* December 2005.
- 9 U. S. Department of Energy, DOE-WD-2005-001-PCR, *“Response to Public Comments on the Draft Section 3116 Determination for Salt Waste Disposal at the Savannah River Site,”* January, 2006.
- 10 Mahoney, M. J. and P. D. d’Entremont, CBU-PED-2004-00027, *“Interim Salt Processing Strategy Planning Baseline,”* Revision 0, August 27, 2004.
- 11 *“Salt Processing Alternatives Final Supplemental Environmental Impact Statement,”* DOE/EIS-0082-S2, June 2001.
- 12 Letter, Roberson, J. H. to G. P. Rudy, *“Savannah River Salt Processing Strategy,”* October 9, 2001.

---

13 Romanowski, L. B., CBU-SPT-2003-00224, “*Tank 41 Low Curie Salt Process History and Data Analysis*,” Revision 0, December 18, 2003.

14 Fowler, R. C., CBU-PED-2004-00013, “*Estimate of Total Tetraphenylborate in Tank 48*,” April 6, 2004.

15 Westinghouse Savannah River Company, WSRC-IM-2004-00008, “*DSA Support Document – Site Characteristics and Program Descriptions*,” Revision 0, October 2004.

16 Cook, J. R., DPST-83-607, “*Estimation of High Water Table Levels at the Saltstone Disposal Site (Z-Area)*,” Revision 0, June 27, 1983.

17 Chen, K. F., WSRC-TR-99-00369, “*Flood Hazard Recurrence Frequencies for C-, F-, E-, S-, H-, Y-, and Z-Areas*,” September 30, 1999.

18 URS/Blume, DPE-3699, “*Update of Seismic Design Criteria for the Savannah River Plant, I Geotechnical*,” 1982.

19 McHood, M., K-CLC-Z-00001, “*Liquefaction Potential for Saltstone Disposal Facility Vault No. 4*,” Revision 0, August 22, 2002.

20 National Academy of Sciences, “*Alternatives for High-Level Waste Salt Processing at the Savannah River Site*,” 2000.

21 “*Code of Federal Regulation 10 CFR 61, Licensing Requirements for Land Disposal of Radioactive Waste*,” 1-1-04 Edition.

22 Dean, W. B., “*10/01/05 –October Monthly WCS Curie and Volume Inventory Report*,” CBU-PIT-2005-00246, October 2005

23 Cook, J. R., Wilhite, E. L., Hiergesell, R. A., and Flach, G. P., “*Special Analysis: Revision of Saltstone Vault 4 Disposal Limits*,” WSRC-TR-2005-00074, Westinghouse Savannah River Company, Aiken, South Carolina, May 2005.

24 P-SPC-J-00001, “*Feed Strategy and Product and Secondary Waste Specification*,” Revision 0, December 22, 2004.

25 WSRC, “*Radionuclides in SRS Salt Waste*,” CBU-PIT-2005-00195, Revision 0, Westinghouse Savannah River Company, Aiken, South Carolina, 2005

26 Peterson, C. A., “*Technical Basis for Classification of Low-Activity Waste Fraction from Hanford Site Tanks*,” WHC-SD-WM-TI-699, Revision 2, 1996.

27 WSRC-RP-2002-00245, “*Environmental Management Program – Performance Management Plan*,” Revision 6, August 7, 2002.

---

---

28 Conway, J. T. to K. E. McSlarrow, Defense Nuclear Facility Safety Board memorandum dated June 18, 2004, "*Safety Impacts of Suspending Salt Disposition at the Savannah River Site.*"

29 Hopkins, M. D. and S. C. Shah, CBU-SPT-2004-00038, "*Curie Calculation for Salt Strategies,*" Revision 0, February 22, 2004.

30 Campbell, S. G., "*Preliminary Material Balance for the Modular CSSX Unit,*" CBU-SPT-2004-00059, Revision 1, June 22, 2004.

31 d'Entremont, P. D., CBU-PIT-2005-00013, "*Radionuclide Concentrations in Saltstone,*" Revision 3, July 21, 2005.

32 NRC, "*Branch Technical Position (BTP) on Concentration Averaging and Encapsulation,*" January 17, 1995.

33 U.S. NRC, "*NUREG-1573, A Performance Assessment Methodology for Low Level Radioactive Waste Disposal Facilities: Recommendations of NRC's Performance Assessment Working Group,*" pp. 3-77, October 31, 2000.

34 Ketusky, E. T., CBU-PIT-2005-00014, "*Sampling Strategy for Tank 50 Point of Compliance Transfers to Saltstone,*" July 25, 2005.

35 Westinghouse Savannah River Company, SSF-ENG-2001, "*Saltstone Facility (SSF) Waste Acceptance Program Requirements (U),*" Revision 0, September 15, 2003.

36 Westinghouse Savannah River Company, WSRC-RP-92-1360, "*Radiological Performance Assessment for the Z-Area Saltstone Disposal Facility (U),*" Revision 0, December 18, 1992.

37 Cook, J. R., Kocher, D. C., McDowell-Boyer, L., and E. L. Wilhite, WSRC-TR-2002-00456, "*Special Analysis: Reevaluation of the Inadvertent Intruder, Groundwater, Air, and Radon Analyses for the Saltstone Disposal Facility,*" Revision 0, October 23, 2002.

38 Rosenberger, K. H., Rogers, B. C. & Cauthen, R. K., June 2005, "*Saltstone Performance Objective Demonstration Document,*" CBU-PIT-2005-00146, Westinghouse Savannah River Company, Aiken, South Carolina, Revision 0, June 2005.

39 National Council on Radiation Protection and Measurements, NCRP Report No. 123, "*Screening Models for Releases of Radionuclides to Atmosphere, Surface Water, and Ground, Volumes 1 and 2,*" 1996.

40 U. S. Department of Energy, "*SRS Long Range Comprehensive Plan,*" December 2000.

---

41 Kaplan, D. I., WSRC-RP-2003-00362, “*Estimated Duration of the Subsurface Reducing Environment Produced by the Z-Area Saltstone Disposal Facility*,” Revision 2, April 25, 2003.

42 Phifer, M. A. and Nelson, E. A., “*Saltstone Disposal Facility Closure Cap Configuration and Degradation Base Case: Institutional Control to Pine Forest Scenario*,” WSRC-TR-2003-00436, September 22, 2003.

43 NUREG-0782, “*Draft Environmental Impact Statement on 10 CFR Part 61 Licensing Requirements for Land Disposal of Radioactive Waste*,” United States Nuclear Regulatory Commission, Washington, D.C., 1981.

44 WSRC-TR-99-00299, “*Savannah River Site Environmental Report for 1999*.”

45 WSRC-TR-2000-00328, “*Savannah River Site Environmental Report for 2000*.”

46 WSRC-TR-2001-00474, “*Savannah River Site Environmental Report for 2001*.”

47 WSRC-TR-2003-00026, “*Savannah River Site Environmental Report for 2002*.”

48 WSRC-TR-2004-00015, “*Savannah River Site Environmental Report for 2003*.”

49 WSRC-TR-2005-00005, “*Savannah River Site Environmental Report for 2004*.”

50 WSRC Radiological Control Manual 5Q, Chapter 2, Part 1, Revision 11, November 2004.

51 200-Z-0001, “*Saltstone Outside Facilities Roundsheets*,” Revision 3, September 12, 2003.

52 WSRC-IM-95-1, *SRS Engineering Standards Manual*, Standard 01064, “*Radiological Design Requirements*,” Revision 2, January 25, 2005.

53 DOE 440.1A, “*Worker Protection Management for DOE Federal and Contractor Employees*.”

54 WSRC, “*Radiological Control Manual 5Q*,” Chapter 2, Article 232, Revision 11, November 2004.

55 Westinghouse Savannah River Company, WSRC-SA-2003-00001, “*Saltstone Facility Documented Safety Analysis*,” Revision 2, November 2004.

56 Westinghouse Savannah River Company, WSRC-TR-2001-00574, “*Saltstone Facility Consolidated Hazards Analysis (U)*,” Revision 4, September 2004.

57 Westinghouse Savannah River Company, S-TSR-Z-00002, “*Saltstone Facility Technical Safety Requirements*,” Revision 1, August 2003.



---

58 White, T. L., WSRC-TR-2003-00348, “*Saltstone Low Curie Salt (LCS) Project Radiological Design Summary Report*,” Revision 0, September 2003.

59 U.S. Department of Energy, Code of Federal Regulations 10 CFR 835, “*Occupational Radiation Protection*.”

60 WSRC, “*Radiological Control Manual 5Q*,” Chapter 5, Article 511, Revision 10, November 2004.

61 ESH-RPS-2005-00032, “*Westinghouse Savannah River Company Radiological Performance Indicators (U)*,” February 2005.

62 DOE/EH-0688, “*DOE Occupational Radiation Exposure*,” 2003.

63 Sutherland, J. M., CBU-PIT-2005-00047, “*Closure Business Unit Pollution Prevention Plan – Saltstone (SS) Z-01 Stormwater Outfall*,” October 14, 2004.

## **APPENDICES**

## APPENDIX 1: SYSTEM DESCRIPTION<sup>65</sup>

### HISTORY

Most of the tank waste inventory currently stored at SRS is a complex mixture of chemical and radioactive waste generated during the acid-side separation of special nuclear materials and enriched uranium from irradiated targets and spent fuel using the Plutonium Recovery and Extraction (PUREX) process in F-Canyon and the modified PUREX process in H-Canyon (HM process). Waste generated from the recovery of Pu-238 in H-Canyon for the production of heat sources for space missions is also included. The variability in both nuclide and chemical content is due to the fact that waste streams from the 1<sup>st</sup> cycle (high heat) and 2<sup>nd</sup> cycle (low heat) extractions from each canyon were stored in separate tanks to better manage waste heat generation. When these streams were neutralized with caustic, the resulting precipitate settled into four characteristic sludges presently found in the tanks where they were originally deposited. The soluble portions of the 1<sup>st</sup> and 2<sup>nd</sup> cycle waste were similarly partitioned but have and continue to undergo blending in the course of waste transfer and staging of salt waste for evaporative concentration to supernate and saltcake. Historically, fresh waste receipts have been segregated into four general categories in the SRS Tank Farms: PUREX high activity waste (HAW), PUREX low activity waste (LAW), HM HAW, and HM LAW. Because of this segregation, settled sludge solids contained in tanks that received fresh waste are readily identified as one of these four categories. Fission product concentrations are about three orders of magnitude higher in both PUREX and HM HAW sludges than the corresponding LAW sludges. Because of differences in the PUREX and HM processes, the chemical compositions of principal sludge components (iron, aluminum, uranium, manganese, nickel, and mercury) also vary over a broad range between these sludges. Combining and blending salt solutions has tended to reduce soluble waste into blended PUREX salt and concentrate and HM salt and concentrate, rather than maintaining four distinct salt compositions. Continued blending and evaporation of the salt solution deposits crystallized salts with overlying and interstitial concentrated salt solution in salt tanks located in both Tank Farms. More recently, with transfers of sludge slurries to sludge washing tanks, removal of saltcakes for tank closure, receipts of DWPF recycle, and space limitations restricting full evaporator operations, salt solutions have been transferred between the two Tank Farms. Intermingling of PUREX and HM salt waste will continue until processing in the SWPF can begin.

---

<sup>65</sup> As explained in footnote 15, this 3116 Determination concerns the disposal as low-level waste of the solidified low-activity salt waste streams in SDF. This appendix provides additional background information to enhance the reader's understanding and includes discussions of other wastes and processes which are not the subject of this 3116 Determination and are not covered by §3116 of the NDAA. Nothing in this appendix should be construed to expand the scope of this 3116 Determination or the scope of §3116 of the NDAA.

## **BACKGROUND**

Approximately 36.4 Mgal [1] of radioactive waste are currently stored in underground waste storage tanks as waste by-products generated from activities conducted at SRS since the site became operational in 1951. Continued long-term storage of these radioactive wastes poses an environmental risk. Therefore, since 1996, DOE and its contractor, WSRC, have been removing waste from tanks, pre-treating it, vitrifying it, and pouring the vitrified waste into canisters for long-term disposal in a Federal repository. As of December 2005, 2,000 canisters of waste have been vitrified for shipment to a Federal repository when the repository is licensed and operational. All canisters vitrified to date contain sludge-only waste.

The Liquid Waste and Waste Solidification System is the integrated series of facilities at SRS that safely manage the existing waste inventory and safely disposition waste stored in the tanks into a final glass or grout form. This system includes facilities for storage, evaporation, waste removal, pre-treatment, vitrification, and disposal. These facilities are briefly described in the text that follows.

## **TANK STORAGE**

Since it became operational in 1951, SRS, a 300-square-mile DOE complex located in the State of South Carolina, has produced nuclear material for national defense, research, medical, and space programs. The separation of fissionable nuclear material from irradiated targets and fuels resulted in the generation of large quantities of radioactive



Tanks under construction. Note tank size relative to construction workers. Later, dirt is backfilled around the tanks to provide shielding.

waste which are currently stored onsite in large underground waste storage tanks. The waste was converted to an alkaline solution, metal oxides settled as sludge, and supernate evaporated to form saltcake.

SRS has a total of 51 underground waste storage tanks, all of which were placed into operation between 1954 and 1986. There are four types of waste tanks – Types I through IV. Type III tanks are the newest tanks and were placed into operation between 1969 and 1986. There are a total of 27 Type III tanks. These tanks meet current Environmental Protection Agency (EPA) requirements for full secondary containment and leak detection. The remaining 24 tanks do

not have full secondary containment and do not meet EPA requirements for secondary

containment. Type I tanks are the oldest tanks and were constructed between 1952 and 1953. Type II waste tanks were constructed between 1955 and 1956. There are eight Type IV tanks that were constructed between 1958 and 1962. Two of these Type IV tanks, Tanks 17 and 20 in F Tank Farm, have been isolated, operationally closed, and grouted. Twelve tanks without secondary containment have a history of leakage [2]. Sufficient waste has been removed from these tanks such that there are currently no active leak sites. The first tank without secondary containment began receiving waste in 1954. This tank is still in service.

Approximately 36.4 Mgal of radioactive waste, containing 426 MCi [1] of radioactivity, are currently stored in 49 active waste storage tanks located in two separate locations, H Tank Farm (29 tanks) and F Tank Farm (20 tanks). This waste is a complex mixture of insoluble metal hydroxide solids, commonly referred to as sludge, and soluble salt supernate. The supernate volume is reduced by evaporation, which also concentrates the soluble salts to their solubility limit. The resultant solution crystallizes as salts. The resulting crystalline solids are commonly referred to as saltcake. The saltcake and supernate combined are referred to as salt waste (combined 33.8 Mgal).



The sludge component of the radioactive waste represents 2.6 Mgal (7% of total) of waste but contains 203 MCi (48% of total). The salt waste makes up the remaining 33.8 Mgal (93% of total) of waste and contains 223 MCi (52% of total). Of that salt waste, the supernate accounts for 17.4 Mgal and 211 MCi of the 223 MCi total salt related curies. The saltcake accounts for the remaining 16.4 Mgal and 12 MCi [1]. The sludge contains the majority of the long-lived (half-life > 30 years) radionuclides (i.e., actinides) and strontium. The sludge is currently being stabilized in DWPF through a vitrification process that immobilizes the waste in a borosilicate glass matrix.



**Salt waste is dissolved in the liquid portion of the waste. It can be in normal solution as Supernate (top picture) or, after evaporation, as salt cake (bottom picture) or concentrated supernate. The pipes in all the pictures are cooling coils.**

Radioactive waste volumes and radioactivity inventories reported herein are based on the WCS [3] database (see Appendix 2), which includes the chemical and radionuclide inventories on a tank-by-tank basis. WCS is a dynamic database frequently updated with new data from ongoing operations such as decanting and concentrating of free supernate via evaporators, preparation of sludge batches for DWPF feed, waste transfers between tanks, waste sample analyses, and influent receipts such as F and H-Canyon waste and DWPF recycle. Volumes and curies referenced in this evaluation are current as of December 1, 2004 [1].

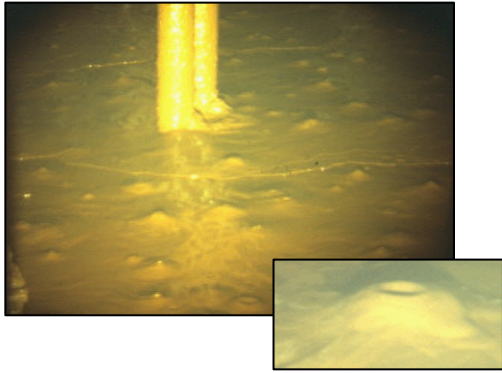

Sludge consists of insoluble solids that settle to the bottom of a tank. Note the offgas bubbles, including hydrogen generated from radiolysis.

Ninety five percent [1] of the salt waste radioactivity is short-lived (half-life 30-years or less) Cs-137 and its daughter product, Ba-137m, along with lower levels of actinide contamination. Depending on the particular waste stream (e.g., canyon waste, DWPF recycle waste), the cesium concentration may vary. The precipitation of salts following evaporation can also change the cesium concentration. The concentration of cesium is significantly lower than non-radioactive salts in the waste, such as sodium nitrate and nitrite; therefore, the cesium does not reach its solubility limit and only a small fraction

precipitates [4]. As a result, the cesium concentration in the saltcake is much lower than that in the liquid supernate and interstitial liquid fraction of the salt waste.

**Waste Tank Composite Inventory (As of 12/01/04) [1]**

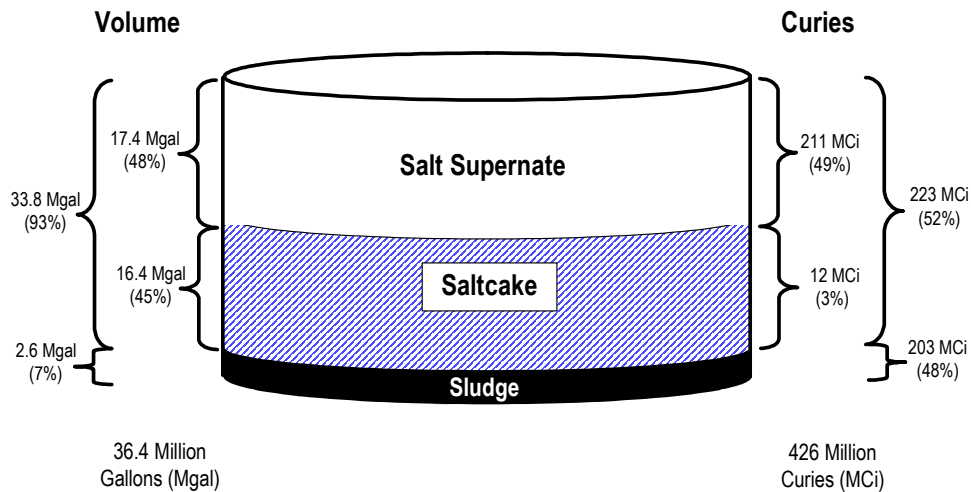

## WASTE TANK SPACE MANAGEMENT

To make better use of available tank storage capacity, incoming liquid waste is evaporated to reduce its volume. This is critical because most of the SRS Type III waste storage tanks are already at or near full capacity. Since 1951, the Tank Farms have received over 140 Mgal of liquid waste, of which over 100 Mgal have been evaporated, leaving 36.4 Mgal in the storage tanks. Projected available tank space is carefully tracked to ensure that the Tank Farms do not become “water logged”, a term meaning that so much of the usable Type III compliant tank space has been filled that normal operations and waste removal and processing operations cannot continue. A portion of tank space must be reserved as contingency space should a new tank leak be realized. Waste receipts and transfers are normal Tank Farm activities as the Tank Farms receive new or “fresh” waste from the H Separations Canyon, stabilization programs from both the F- and H-Canyon facilities, liquid waste from DWPF processing (typically referred to as “DWPF Recycle”), and wash water from sludge washing. The Tank Farms also make routine transfers to and from waste tanks and evaporators. Currently, there is very little “fresh” waste that has not had the water evaporated from it to its maximum extent. The working capacity of the Tank Farms has steadily decreased and this trend will continue until salt processing becomes operational or the system becomes water logged. Three evaporator systems are currently operating at SRS - the 2H, 3H, and 2F systems.

## WASTE REMOVAL FROM TANKS

During waste removal, water that has been chemically treated to prevent corrosion of the carbon steel waste tanks, inhibited water (IW), is added to the waste tanks and agitated by



Typical Waste Removal equipment includes three to four 45-foot long slurry pumps and one transfer pump or jet. Note the substantial structural steel required to support the loads in the picture above.

At right is the typical installation of a transfer pump (Tank 8) requiring difficult, high-risk entries into High Level Waste Tanks.



slurry pumps. If the tank contains salt, this IW, and agitation if required, dilutes the concentrated salt or re-dissolves the saltcake. If the tank contains sludge, this water, and agitation, suspends the insoluble sludge particles. In either case, the resulting liquid slurry, which

now contains the dissolved salt or suspended sludge, can be pumped out of the tanks and transferred to waste treatment tanks.

Waste removal is a multi-year process. First, each waste tank must be retrofitted with slurry and transfer pumps, infrastructure to support the pumps, and various service upgrades (power, water, air, and/or steam). These retrofits can take between two and four years to complete. Then, the pumps are operated to slurry the waste. Initially, the pumps operate near the top of the liquid and are lowered sequentially to the proper depths as waste is slurried and transferred out of the tanks. Waste removal activities remove the bulk of the waste to prepare the tank for closure.

### **SAFE DISPOSAL OF THE WASTE**

The goal is to convert all of the waste into one of two final waste forms: Glass, which will contain 99% of the radioactivity; and saltstone grout, which will contain most of the volume. Each of the waste types at SRS needs to be treated to accomplish disposal in these two waste forms. The sludge must be washed to remove non-radioactive salts that would interfere with glass production. The washed sludge can then be sent to DWPF for vitrification. The salt must be treated to separate the bulk of the radionuclides from the non-radioactive salts in the waste. Starting in 2011, this separation will be accomplished in SWPF. However, until the startup of SWPF, Interim Salt Processing will be used to accomplish this activity.

### **SALT PROCESSING**

A final DOE technology selection for salt solution processing was completed and a Salt Processing Environmental Impact Statement (EIS) ROD was issued in October 2001. The ROD designated CSSX as the preferred alternative to be used to separate cesium from the salt waste. In parallel, SRS evaluated the implementation of other salt processing alternatives for specific waste portions that would not need to be processed in a CSSX facility (SWPF) and could be processed before SWPF was operational.

The Salt Processing Planning Baseline calls for using four different processes to treat salt:

- **Deliquification, Dissolution, and Adjustment** - for salt in selected tanks that are relatively low in radioactive content (e.g., Tank 41), the treatment of deliquification (i.e., extracting the interstitial liquid) is sufficient to produce a salt that meets the Saltstone Facility WAC. Deliquification is an effective decontamination process because the primary radionuclide in salt is Cs-137, which is highly soluble. By exploiting the solubility of Cs-137 and isolating the insoluble fraction, a low-level waste salt stream can be produced.
- **Actinide Removal Process** - for salt in selected tanks (e.g., Tank 28), even though extraction of the interstitial liquid reduces Cs-137 and soluble actinide concentrations, the Cs-137 or actinide concentrations of the resulting salt are too high to meet the Saltstone Facility WAC. Salt from



these tanks first will be sent to ARP. In ARP, MST is added to the waste as a finely divided solid. Actinides are sorbed on the MST and then filtered out of the liquid to produce a low-level waste stream that is sent to MCU. After SWPF startup, ARP will send clarified salt solution to SWPF for cesium removal.

- **Modular CSSX Unit** - for tanks with salt that is too high in activity for deliquification to sufficiently reduce Cs-137 concentrations, the salt in these tanks must be further treated to reduce the concentration of Cs-137 using the CSSX process. After 2011, this will be done in a new facility, SWPF. However, so that some of these wastes can be treated before 2011, DOE will build a small-scale modular CSSX unit. Salt to be processed will first be processed through ARP and then through the modular unit. This unit will allow processing of salt waste with higher Cs-137 concentrations at a relatively low rate.
- **Salt Waste Processing Facility** - this is the full-scale CSSX process. The facility incorporates both the ARP and CSSX process in a full-scale shielded facility capable of handling salt with high levels of radioactivity. After startup of SWPF in 2011, all remaining salt waste will be processed through this facility.

### **SLUDGE PROCESSING**

Sludge is “washed” to reduce the amount of non-radioactive soluble salts remaining in the sludge slurry. The processed sludge is called “washed sludge.” During sludge processing, large volumes of wash water are generated and must be volume-reduced by evaporation. Over the life of the waste removal program, the sludge currently stored in tanks at SRS will be blended into separate sludge “batches” to be processed and fed to DWPF for vitrification.

## DWPF VITRIFICATION



Canisters being received (prior to being filled with radioactive glass)

Final processing for the washed sludge and salt waste occurs at DWPF. This waste includes MST/sludge from ARP or SWPF, the cesium strip effluent from MCU or SWPF, and the washed sludge slurry from Extended Sludge Processing. In a complex sequence of carefully controlled chemical reactions, this waste is blended with glass frit and melted to vitrify it into a borosilicate glass form. The resulting molten glass is poured into stainless steel canisters. As the filled canisters cool,

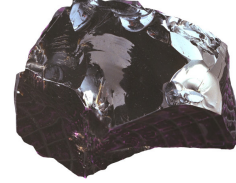

Sample of Vitrified Radioactive Glass

the molten glass solidifies, immobilizing the radioactive waste within the glass structure. After the canisters have cooled, they are permanently sealed, and the external surfaces are decontaminated to meet United States Department of Transportation requirements. The canisters are then ready to be stored on an interim basis on-site in the Glass Waste Storage Building (GWSB), pending shipment to a Federal Repository for permanent disposal. A low-level recycle waste stream from DWPF is returned to the Tank Farms. DWPF has been fully operational since 1996.

## SALTSTONE: ON-SITE DISPOSAL OF LOW-LEVEL WASTE

The Saltstone Facility, located in Z-Area, consists of two facility segments: SPF and

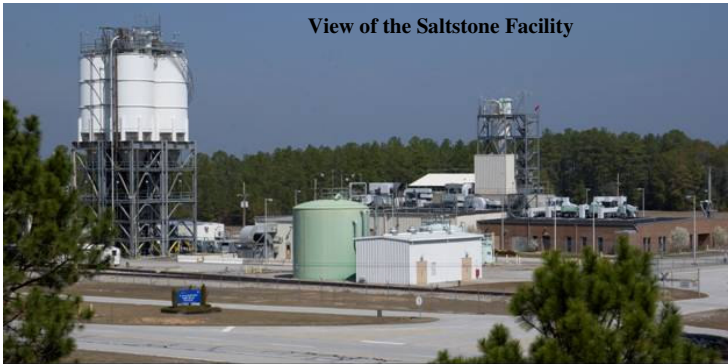

View of the Saltstone Facility

SDF. SPF is permitted as a wastewater treatment facility per SCDHEC Regulations R.61-67. SPF receives and treats the salt solution to produce grout by mixing the LLW liquid stream with cementitious materials (cement, fly ash, and slag). A slurry of the components is pumped into the disposal

vaults, located in SDF, where the saltstone grout solidifies into a monolithic, non-hazardous, solid LLW form. SDF is permitted as an ISWLF site, as defined by SCDHEC Regulations R61-66 and R.61-107.16.

The facility will contain many large concrete vaults divided into cells. Each of the cells will be filled with solid saltstone grout. The grout itself provides primary containment of the waste, and the walls, floor, and roof of the vaults provide secondary containment.

Fifteen feet of overburden were removed to prepare and level the site for vault construction. All vaults will be built at or slightly below the grade level that exists after the overburden and leveling operations are complete. The bottom of the saltstone grout monoliths will be at least 5 feet above the historic high water table beneath the Z-Area site, thus, avoiding disposal of waste in a zone of water table fluctuation. Run-on and runoff controls are installed to minimize site erosion during the operational period.



The current vault (Vault #4) has dimensions of 200 feet wide, by 600 feet in length, by 26 feet in height. The vault is divided into 12 cells, with each cell measuring 100 feet by 100 feet. The vault is covered with a sloped, permanent roof that has a minimum thickness of 4 inches, and a minimum slope of 0.24 inches per foot. The vault walls are 1.5 feet thick, with the base mat having a thickness of 2 feet. Operationally, the cells of the vault will be filled to a height of 25 feet with saltstone, and then a layer of uncontaminated grout, with an average thickness of 2 feet, will be poured to fill in the space between the saltstone grout and the sloped roof. The other current vault (Vault #1) has the dimensions of 100 feet wide, by 600 feet in length, by 25 feet in height. The vault is divided into 6 cells, with each cell measuring 100 feet by 100 feet.

Closure operations will begin near the end of the active disposal period in the SDF, i.e., after most or all of the vaults have been constructed and filled. Backfill of native soil will be placed around the vaults. The present closure concept includes two moisture barriers consisting of clay/gravel drainage systems along with backfill layers and a shallow-rooted bamboo vegetative cover.

Construction of the Saltstone Facility and the first two vaults was completed between February 1986 and July 1988. The Saltstone Facility started radioactive operations June 12, 1990. Future vaults will be constructed on a “just-in-time” basis in coordination with salt processing production rates.

---

## **REFERENCES**

- 1 Ledbetter, L. S., CBU-PIT-2004-00024, "*12/01/04 – December Monthly WCS Curie and Volume Inventory Report*," Revision 0, December 9, 2004.
- 2 Waltz, R. S., CBU-LTS-2004-00104, "*SRS High Level Waste Tank Leaksite Information (8/04)*," August 2004.
- 3 Hester, J. R., WSRC-TR-96-0264, "*High Level Waste Characterization System (WCS)*," Revision 0, December 1996.
- 4 Brooke, J. N., Peters, J. F., and K. Stahell, WSRC-TR-99-00358, "*Hydrological Methods Can Separate Cesium from Nuclear Waste Saltcake*," 1999.

## **APPENDIX 2: WASTE CHARACTERIZATION SYSTEM**

WCS is an electronic information system that tracks waste tank data, including projected radionuclide and chemical inventories, based on sample analyses, process histories, composition studies, and theoretical relationships. The system, initially developed in 1995, tracks the concentrations of 96 chemicals and 41 radioactive nuclides in each of the SRS waste tanks [1]. The 41 nuclides were primarily selected based on their impact to waste tank source term, inhalation dose potential, or on the E-Area vault Waste Acceptance Criteria. WCS consists of two functional areas: a sample data repository and waste characterization. The waste characterization contains inputs and calculations used to represent real-time conditions in the waste tanks. These real-time conditions are used to determine compliance (as input to Safety Basis calculations) with several nuclear safety administrative control programs such as the waste tank Flammability Control Program and the waste tank Corrosion Control Program.

WCS is routinely updated to reflect changes in waste inventory resulting from the receipt of new waste from the SRS Canyon facilities, the Effluent Treatment Facility, or recycle waste from DWPF; the transfer of waste for processing at DWPF or SDF, or from the receipt of new characterization information in the form of sample analysis results, field measurements, waste tank video inspections, or technical reports. The waste tank contents in WCS are also adjusted to reflect the impacts of evaporator operation and to account for waste tank to waste tank transfers.

Prior to new data being entered into WCS, a Data Integrity Review Team evaluates the new data to determine its technical validity. The core team members are engineers or scientists with expertise in relevant fields such as flammability, corrosion, organic chemistry, or criticality [2]. The Data Integrity Review Team routinely meets to perform evaluations of new characterization information. As part of the review the new data is compared to previous measurements of the same parameter in the same waste tank, to previous measurements of the same parameter from other waste tanks, to the expected value for that parameter based on the waste tank's processing history, and to the relative concentrations of other parameters in the same data set to determine if the new data can be accepted as a valid representation of actual conditions. Once the Data Integrity Review Team has deemed the data to be valid, it is approved for entry into the waste characterization portion of WCS and into the data repository.

WCS is a controlled database that complies with strict Quality Assurance requirements. These requirements apply to not only data entry but also to configuration control of the database software itself. All data entries into WCS must be independently verified. A Software Quality Assurance Plan governs the methods that must be utilized to maintain the database baseline configuration and to ensure the proper handling of the database [3]. To address backup and recovery, including disaster recovery, WCS is hosted on a server that provides daily backup of all WCS files.

---

**REFERENCES**

1 Ledbetter, L. A., CBU-PIT-2004-00022, "*Waste Characterization System Radionuclide and Chemical Inventory Selection Technical Basis*," December 2004.

2 Ledbetter, L. A., WSRC-TR-2003-00048, "*Waste Characterization System Program Description Document*," Revision 2, June 2004.

3 Manz, R. W., B-SQP-H-00041, "*Closure Business Unit LWDP Waste Characterization System Software Quality Assurance Plan*," September 2004.