

NASA Technical Memorandum 100824

Experimental Radio Frequency Link for Ka-Band Communications Applications

Gene Fujikawa, Martin J. Conroy, Alan L. Saunders,
and Dale E. Pope
*Lewis Research Center
Cleveland, Ohio*

JUL 18 1988
LAWRENCE J. BROWN
100824

June 1988



EXPERIMENTAL RADIO FREQUENCY LINK FOR Ka-BAND COMMUNICATIONS APPLICATIONS

Gene Fujikawa, Martin J. Conroy,
Alan L. Saunders, and Dale E. Pope
National Aeronautics and Space Administration
Lewis Research Center
Cleveland, Ohio 44135

SUMMARY

An experimental radio frequency link has been demonstrated to provide two-way communication between a remote user ground terminal and ground-based Ka-band transponder. Bit-error-rate performance and radio frequency characteristics of the communication link were investigated.

INTRODUCTION

Present satellite communication systems operating at C- and Ku-band are being pressed into heavier demands as communications in these bands begins to saturate. Satellite communication systems of the future will need to rely on higher frequency bands and increased bandwidths. Developing new technologies to support larger traffic demands and higher data rates is becoming increasingly important. NASA Lewis Research Center has been concentrating on Ka-band technology development over the past decade. With the preparation for the launch of the Advanced Communications Technology Satellite (ACTS) in the early 1990's, much effort has been focused on readying technology at Ka-band. Devices such as baseband processors, switch matrices, solid-state amplifiers, and traveling wave tube high-power amplifiers developed under NASA Lewis sponsorship have significantly advanced the state of the art. Many of these devices have been integrated into a Ka-band satellite communication simulation facility which was built and is operated by NASA Lewis. Many of the experiments and features of this system have been reported in previous literature (refs. 1 to 3).

The NASA Lewis communications facility known as the Systems Integration, Test, and Evaluation (SITE) laboratory was designed for the simulation and evaluation of a complete satellite communications network. A Ka-band satellite transponder, built with components developed under the NASA Lewis proof-of-concept program, is the core of the system. The objective of this experiment was to provide a remote user ground terminal where system experiments could be performed outside of the laboratory. This was readily accomplished with the use of an existing facility known as the Small Earth Terminal Station (SETS). By employing a remote ground station outside of the SITE facility, Ka-band communication experiments could be performed between the two locations. Previous work using the SITE facility had been restricted to the laboratory environment and did not employ an antenna system to transmit or receive signals through the atmosphere. A remote terminal will allow for the expansion into a communications network of two or more ground terminals. Another advantage of the remote terminal is the ability to perform rain attenuation measurements, which are of extreme interest at Ka-band frequencies and above. This report studies the effects on digitally modulated signals as they were transmitted through the link. Bit-error-rate (BER) performance and radio frequency (RF) characterization for the complete link are discussed.

N88-24659

SITE/SETS LINK DESCRIPTION

A diagram of the link is shown in figure 1. Noting the locations of the SITE and SETS areas, it became clear that a method of aligning the antennas was necessary before any testing could be initiated. Building 65 prohibited a direct line-of-sight pointing of the antennas. This obstruction resulted in the use of a precision plane reflector which was designed and built at NASA Lewis. A rectangular, 4- by 5-ft reflector was placed on the roof of the wind tunnel building (bldg. 39) such that a transmitted signal from the 2.44-m SETS parabolic dish could be redirected toward the receiving horn antennas at the SITE location. The horn antennas were mounted in such a manner as to have vertical polarization in the uplink 27.5- to 30-GHz band and horizontal polarization in the downlink 17.7- to 20.2-GHz band. The reflector was aligned by a low-power laser that was directed at the plane reflector from the 2.44-m dish to the horn antennas on the roof of building 54. The reflector was positioned so that the laser beam was aligned with the center of the horn antenna assembly. The upconverter and downconverter units used for the SETS terminal were designed and built at NASA Lewis. Block diagrams of each of these units are shown in figures 2(a) and (b), respectively. The upconverter-downconverter assembly was housed in a weatherproof enclosure and mounted on the back of the 2.44-m parabolic dish. A photograph of the SETS ground station is shown in figure 3.

The SITE laboratory is the location of the Ka-band transponder. The basic operation of the transponder is shown in figure 4. Power meters and frequency counters monitor signals through the transponder. Numerous tests, both RF and BER, have been performed on the transponder and documented (refs. 2 and 3); therefore, no precharacterization of the transponder was necessary. However, long waveguide runs extending to the roof were not in place and had to be built. The waveguides, both WR-42 and WR-28, were constructed using pressure fittings and windows and were securely attached to the horn antennas. A pressurizing system, consisting of an air compressor and dryer, was installed to keep the waveguide purged and dry. This was the final step in preparing the equipment required to operate the link experiment. Table I lists the pertinent system parameters relative to the SITE/SETS link.

SYSTEM OPERATION

Initial testing of the link was performed using continuous wave (cw) signals swept over a 500-MHz intermediate frequency (IF) band. A block diagram of the RF test is shown in figure 5. This test determined the frequency response of the channel, noting any amplitude ripple and gain slope which must be tolerated during the forthcoming BER tests. An RF sweep generator supplied the cw swept-frequency signal from the SETS location. The IF signal was swept over the passband centered at 3.373 GHz. The center frequency of 3.373 GHz was chosen since it matched the center frequency of the serial-minimum-shift-keyed (SMSK) modulators and demodulators used in the experiment. The signal was upconverted to a frequency band centered at 28.873 GHz. Transmission of this signal to SITE was accomplished through the 2.44-m dish. The signal was received at the SITE transponder, where a low-noise receiver amplified and downconverted the signal to an IF band of 3.7 to 6.2 GHz. The signal was routed through the microwave switch matrix and upconverted to the 17.7- to 20.2-GHz band. High-power amplification of the signal was provided by a 20-GHz multimode traveling wave tube amplifier (TWTA). Multimode capability

was provided by controlling the anode voltage of the TWT, thus obtaining three (low, medium, and high) output power modes.

Several modes and operating points of the 20-GHz TWT were investigated. The transponder settings used in the testing are summarized in table II. Since large power levels were not needed in this application, a coupled output port was employed to supply the signal to the horn antennas and remaining power was directed to a waveguide termination. The signal was retransmitted to the SETS terminal, where downconversion and measurement of the frequency response was made.

The bit-error-rate measurements were made possible by the use of a digital ground terminal built by the Digital Systems Branch of NASA Lewis. This unique test instrument was used extensively in previous research done at NASA Lewis (refs. 3 to 5). The BER test setup (fig. 6) is very similar to the RF test setup described above, except that the RF signal source is now replaced with a modulated signal supplied by a ground terminal. The ground terminal consists of a data generator/data checker pair which generates continuous pseudorandom 220-Mb/sec serial data and checks for bit errors upon receipt of incoming data. SMSK modulators and demodulators were used to provide the modulation format. Proper operation of the ground terminal was required before any BER testing could be performed. This was accomplished by transmitting a modulated signal (with no added noise) across the link. A bit error rate of zero was anticipated for this case; however, readout of the data checker indicated a 50-percent BER which meant that the demodulator had not locked onto the carrier. It was determined that an additional delay was required in the ground terminal circuitry to accommodate for the time delay in the link. Upon addition of a delay of 2.4 μ sec to the data present and to the sync gate control signals, a zero bit error rate was obtained. The SMSK signal required a 330-MHz bandwidth, corresponding to 1.5 times the data rate, to transmit the main lobe of the spectrum. A figure of merit in these tests was the BER as a function of the energy-per-bit E_b to noise-density N_0 ratio. The insertion of noise was done at the input to the demodulator. Step attenuators and bandpass filtering provided the means to obtain calibrated values of E_b/N_0 . A calibration set was generated prior to each test by separately measuring the signal power and the added noise power for each step attenuator setting. The signal was demodulated and a bit-error-rate measurement was taken. Five samples of BER readings were taken for each E_b/N_0 setting at intervals of 30 to 120 sec and were averaged to obtain a good BER measurement.

EXPERIMENTAL TEST RESULTS

The frequency response test results are shown in figures 7 to 10. These figures indicate the amount of variation in the amplitude over the 330-MHz band as the 20-GHz TWT mode and operating point are varied. Note that the gain variation is reduced as the TWT is operated more towards saturation. This result is consistent with tests which have been done previously (ref. 3). Table III summarizes the gain variation over the 330-MHz passband. The typical gain slope of the curves ranged from 3.8 to 8.4 dB. Variations such as these will need to be taken into consideration for any future experiments on the link system. The results of the BER testing are shown in the curves of figures 11 to 14. These digital tests determined the energy-per-bit to noise-density ratio required to obtain a satisfactory bit error rate. A bit error rate of 5×10^{-7} was chosen as the benchmark in all of the testing performed. The

dashed curve on the BER figures is the theoretical probability of error for an ideal SMSK channel.

Table IV shows the degradation in E_b/N_0 from theory for all of the cases tested here. The best performance was obtained when the downlink 20-GHz TWT was operating linearly in all modes. As the TWT approached the region of non-linearity (TWT at saturation), the signal to noise ratio needed to be increased to obtain the same BER. In the several cases where the TWT was operated at saturation, the BER failed to reach 5×10^{-7} . This was an interesting result since previous tests done in the lab had indicated a better BER when the TWT was at saturation (ref. 3). Possible causes for the differences in the test results may be attributed to increased intermodulation due to operation in the nonlinear region as well as interferences present in the link. Investigation into these anomalies is a case for further study. Throughout the BER testing, occasional frequency drift of the SETS oscillators became known. Drifts of up to 2 MHz were observed and frequency adjustments were made periodically. Additional bit errors were introduced into the BER measurement because of this drift. The demodulator's ability to lock onto a drifting carrier was checked by varying the transponder local oscillator above and below the carrier frequency of 3317.76 MHz. The results of this test showed that the demodulator could maintain lock onto a carrier frequency which varied -150 KHz or -189 KHz about 3317.76 MHz before unlock. The bit error rate reached 50 percent beyond these frequencies. The replacement of these oscillators with stable, phase-locked oscillators should resolve this problem in the future.

CONCLUDING REMARKS

A versatile, experimental radio frequency link has been demonstrated between a remote user ground terminal and a ground-based Ka-band transponder. Transmission of continuous 220-Mb/sec SMSK signals with 2.6 dB of degradation in the energy-per-bit to noise-density ratio from theory at a bit error rate of 5×10^{-7} has been achieved. Successful implementation of a remote user microwave link expands the test capabilities of the NASA Lewis Systems Integration, Test, and Evaluation (SITE) facility. Future work, such as bursted time-division multiple access (TDMA) signal transmission with a master control station controlling and monitoring a network of ground terminals, is now possible. Experiments involving signal fading at 20 and 30 GHz due to rainfall and other interferences can also be carried out.

REFERENCES

1. Bagwell, J.W.: A System for the Simulation and Evaluation of Satellite Communications Networks. NASA TM-83531, 1984.
2. Leonard, R.F.; and Kerczewski, R.J.: Radiofrequency Testing of Satellite Segment of Simulated 30/20-GHz Satellite Communications System. NASA TM-87163, 1985.
3. Fujikawa, G; and Kerczewski, R.J.: Performance of a Ka-Band Satellite System Under Variable Transmitted Signal Power Conditions. NASA TM-88984, 1987.

4. Shalkhauser, K.A.; and Fujikawa, G.: Bit-Error-Rate Testing of High-Power 30-GHz Traveling Wave Tubes for Ground-Terminal Applications. NASA TP-2635, 1986.
5. Windmiller, M.J.: Unique Bit-Error-Rate Measurement System for Satellite Communication Systems. NASA TP-2699, 1987.

TABLE I. - SYSTEM PARAMETERS

(a) General

Range, SETS antenna to plane reflector, m	231
Range, plane reflector to SITE horns, m	90
Reflector dimensions, ft	4 by 5
Angle of reflection, deg	62.37
Uplink center frequency, GHz	28.873
Downlink center frequency, GHz	19.093
Data rate, Mb/sec	221.184
SMSK channel bandwidth, MHz	331.776

(b) Systems Integration, Test, and Evaluation (SITE) Facility

Transponder frequency range (330-MHz channel), GHz	
Uplink	28.635 to 28.965
Downlink	18.835 to 19.165
Intermediate frequency	4.835 to 5.165
Switch matrix crosspoint (input port, output port)	(7,6)
Receiver input power, dBm	-35
Low-noise receiver intermediate-frequency band, GHz	3.7 to 6.2
Transponder local oscillator frequency, GHz	14.020
Transponder uplink band, GHz	27.5 to 30.0
Transponder downlink band, GHz	17.7 to 20.2
TWT saturated output power (frequency, 18.5 GHz), W	
Low	5.1
Medium	18.6
High	34.7
30-GHz horn gain (frequency, 29 GHz), dB	23.80
20-GHz horn gain (frequency, 19 GHz), dB	23.65

(c) Small Earth Terminal Station (SETS) Facility

Antenna diameter, m	2.44
Antenna gain (frequency, 28.5 GHz), dB	54.11
Upconverter input frequency band, GHz	3.3 to 3.4
Upconverter output frequency band, GHz	28.8 to 28.9
Downconverter input frequency band, GHz	18.5 to 19.5
Downconverter output frequency band, GHz	2.78 to 3.78
Demodulator center frequency, GHz	3.373
Demodulator input power (nominal), dBm	-33

TABLE II. - TRANSPONDER POWER LEVELS AND ATTENUATOR SETTINGS

[Figure 4 shows the locations of attenuators (Attn) and power meters.]

TWT mode	Operating point	Attn AT1, dB	Attn AT2, dB	Attn AT6, dB	Power meter PM4, dBm	Power meter PM5, dBm	Power meter PM6, dBm	Power meter SETS, dBm
Low	Linear	3	0	5.7	-19.2	-13.04	-8.55	-33.30
Low	1-dB Compression			9.8		-7.86	-33.05	
Low	Saturation			12.1		-4.17	-33.45	
Medium	Linear			9.7		-22.32	-4.75	-34.00
Medium	1-dB Compression			16.9		-12.81	2.40	-33.76
Medium	Saturation			18.6		-6.93	4.38	-33.50
High	Linear			14.9		-23.74	-.25	-32.90
High	1-dB Compression			20.4		-13.85	5.65	-33.04
High	Saturation			21.0		-10.07	6.69	-33.02
Low	Baseline ^a	5	14	5.7	-19.2	-11.73	-9.38	-33.05
Medium	Baseline ^a	5	14	13.8	-19.2	-18.30	-1.48	-33.04
High	Baseline ^a	5	14	16.0	-19.2	-21.41	1.08	-32.96

^aEntries marked "Baseline" correspond to the normally used instrument settings of the transponder.

TABLE III. - MAXIMUM GAIN VARIATION OVER 330-MHz BANDWIDTH

Test	TWT mode	TWT operating point	Gain variation over 330 MHz, dB
R1.0	Low	Linear	8.3
R1.1	Low	1-dB Compression	7.7
R1.2	Low	Saturation	5.1
R1.3	Medium	Linear	8.2
R1.4	Medium	1-dB Compression	7.4
R1.5	Medium	Saturation	4.8
R1.6	High	Linear	8.4
R1.7	High	1-dB Compression	6.3
R1.8	High	Saturation	3.8
R1.9	Low	Baseline	7.4
R1.10	Medium	Baseline	6.7
R1.11	High	Baseline	7.3
Mean			6.78
Standard deviation			1.50

TABLE IV. - SUMMARY OF BIT ERROR RATE (BER)

Test	TWT mode	TWT operating point	Required ^a E_b/N_0 for BER = 5×10^{-7} dB	^a E_b/N_0 degradation from theory ⁷ at BER = 5×10^{-7}
B1.0	Low	Linear	15.6	4.8
B1.0	Low	1-dB Compression	15.7	4.9
B1.2	Low	Saturation	-----	-----
B1.3	Medium	Linear	13.4	2.6
B1.4	Medium	1-dB Compression	15.0	4.2
B1.5	Medium	Saturation	-----	-----
B1.6	High	Linear	13.8	3.0
B1.7	High	1-dB Compression	16.0	5.2
B1.8	High	Saturation	-----	-----
B1.9	Low	Baseline	14.4	3.6
B1.9	Medium	Baseline	14.3	3.5
B1.11	High	Baseline	15.7	4.9
Mean ^b			14.88	4.08
Standard deviation ^b			.94	.94

^aRequired energy-per-bit to noise-density ratio.

^bDoes not include saturation cases.

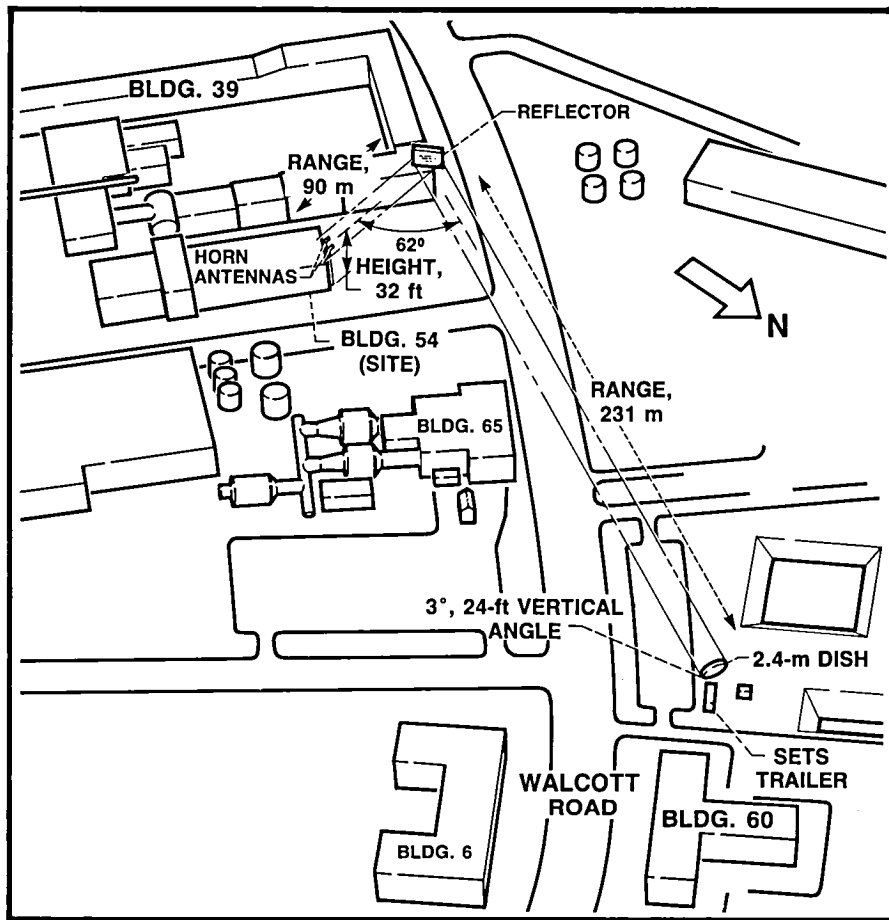

FIGURE 1. - SYSTEMS INTEGRATION, TEST, AND EVALUATION (SITE) TO SMALL EARTH TERMINAL STATION (SETS) MICROWAVE COMMUNICATION LINK.

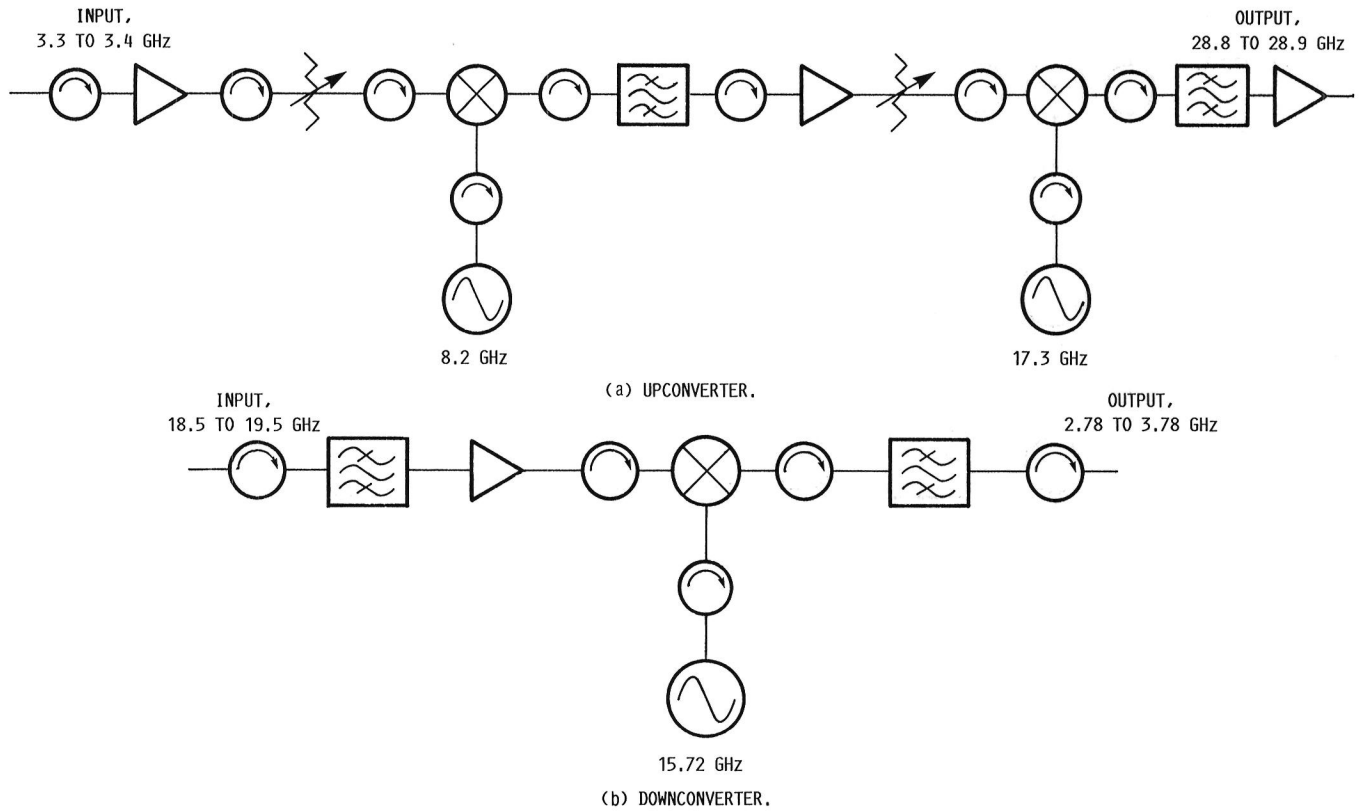

FIGURE 2. - BLOCK DIAGRAM OF SMALL EARTH TERMINAL STATION (SETS).

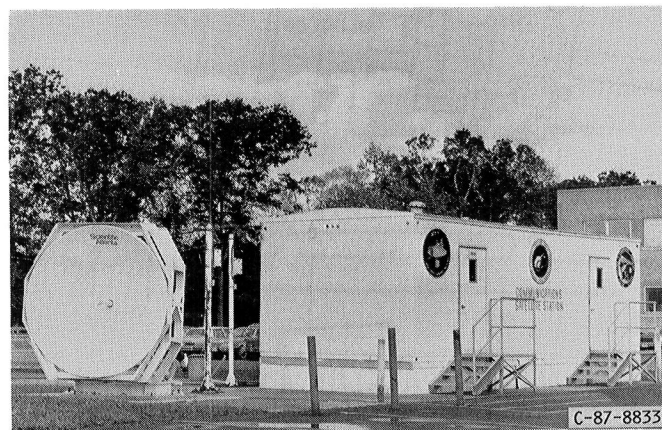

FIGURE 3. - PHOTOGRAPH OF SMALL EARTH TERMINAL STATION (SETS) GROUND STATION.

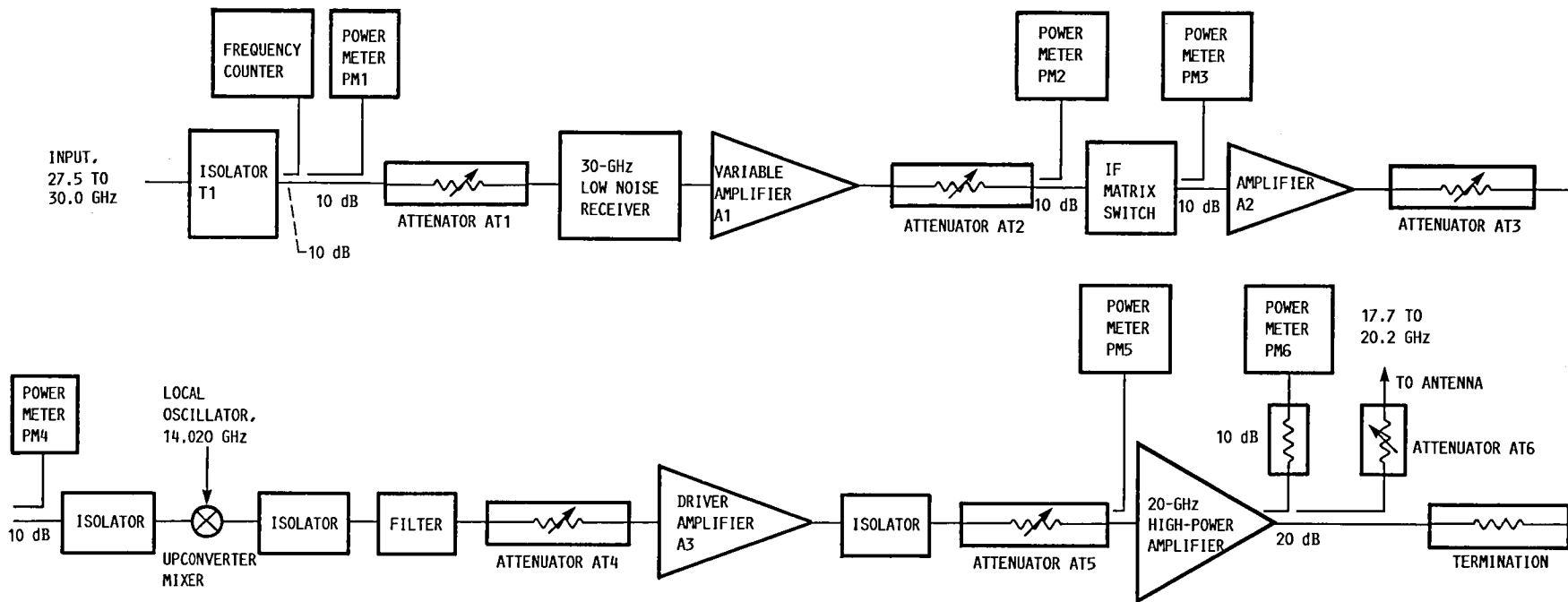

FIGURE 4. - TRANSPONDER BLOCK DIAGRAM.

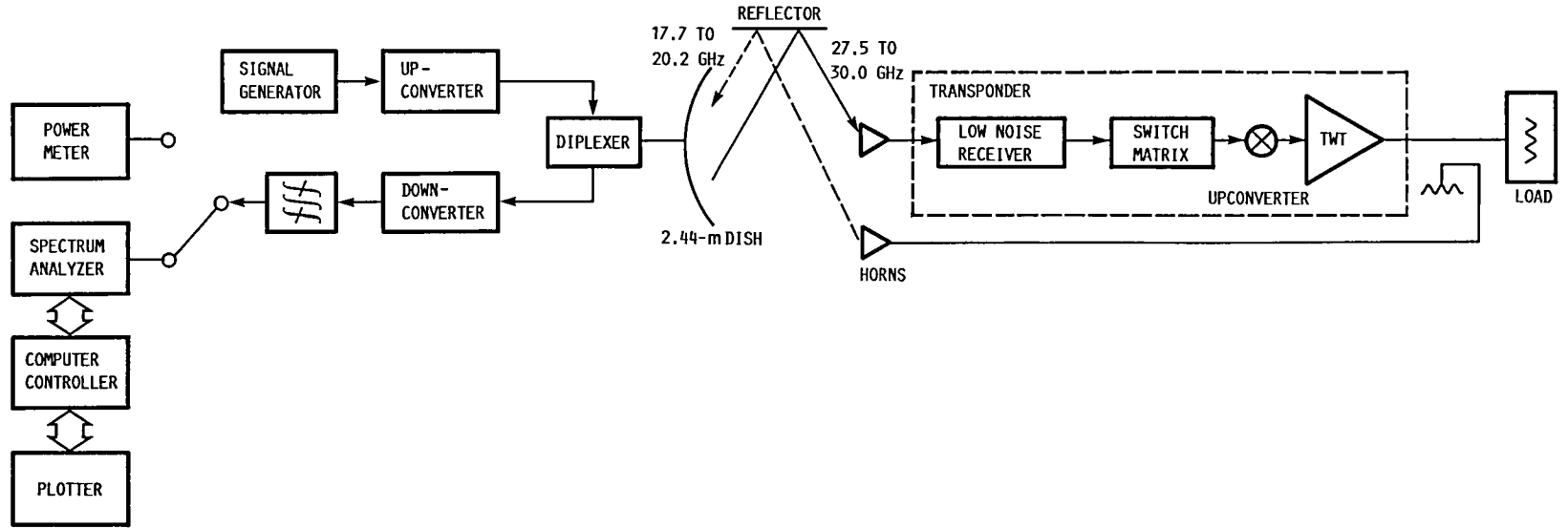

FIGURE 5. - FREQUENCY RESPONSE TEST SETUP.

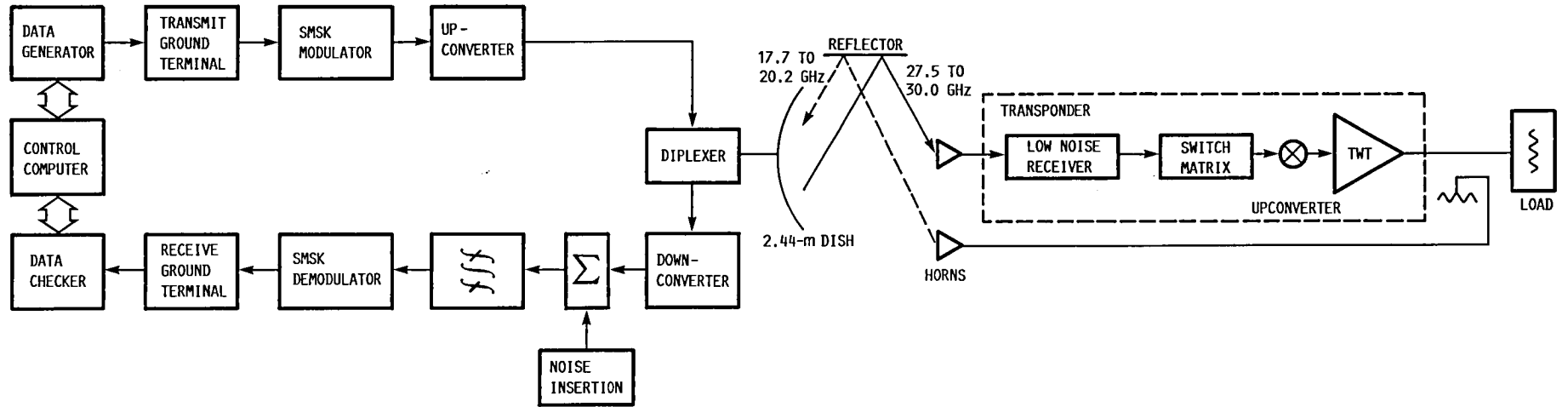
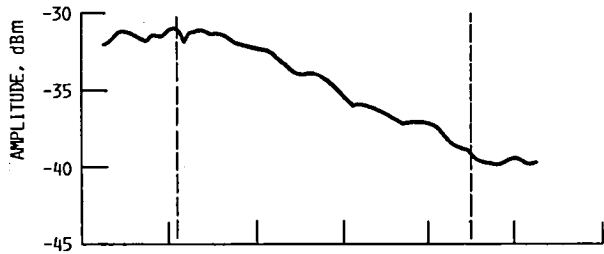

FIGURE 6. - BIT-ERROR-RATE MEASUREMENT TEST SETUP.



(a) TEST R1.0. TWT OPERATING POINT, LINEAR; GAIN VARIATION OVER 330 MHz, 8.3 dB.



(b) TEST R1.1. TWT OPERATING POINT, 1-dB COMPRESSION; GAIN VARIATION OVER 330 MHz, 7.7 dB.

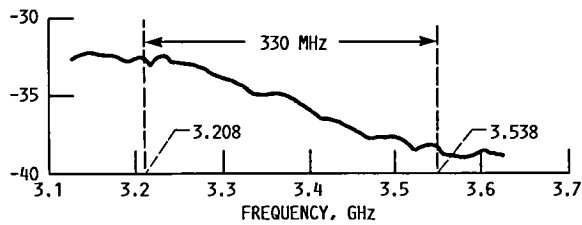

(c) TEST R1.2. TWT OPERATING POINT, SATURATION; GAIN VARIATION OVER 330 MHz, 5.1 dB.

FIGURE 7. - FREQUENCY RESPONSE TESTS FOR TRAVELING WAVE TUBE (TWT) IN LOW MODE.

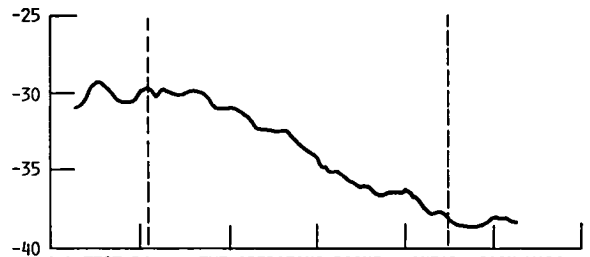

(a) TEST R1.3. TWT OPERATING POINT, LINEAR; GAIN VARIATION OVER 330 MHz, 8.2 dB.

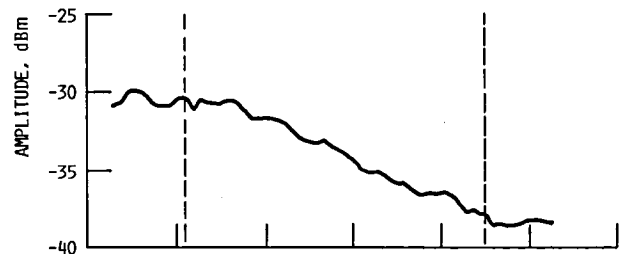

(b) TEST R1.4. TWT OPERATING POINT, 1-dB COMPRESSION; GAIN VARIATION OVER 330 MHz, 7.4 dB.

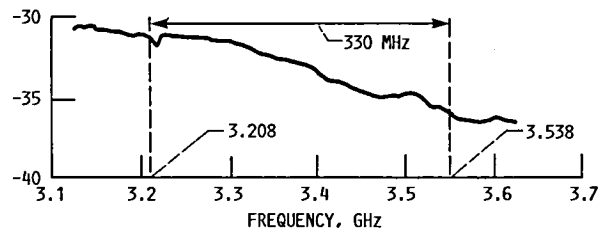

(c) TEST R1.5. TWT OPERATING POINT, SATURATION; GAIN VARIATION OVER 330 MHz, 4.8 dB.

FIGURE 8. - FREQUENCY RESPONSE TESTS FOR TRAVELING WAVE TUBE (TWT) IN MEDIUM MODE.

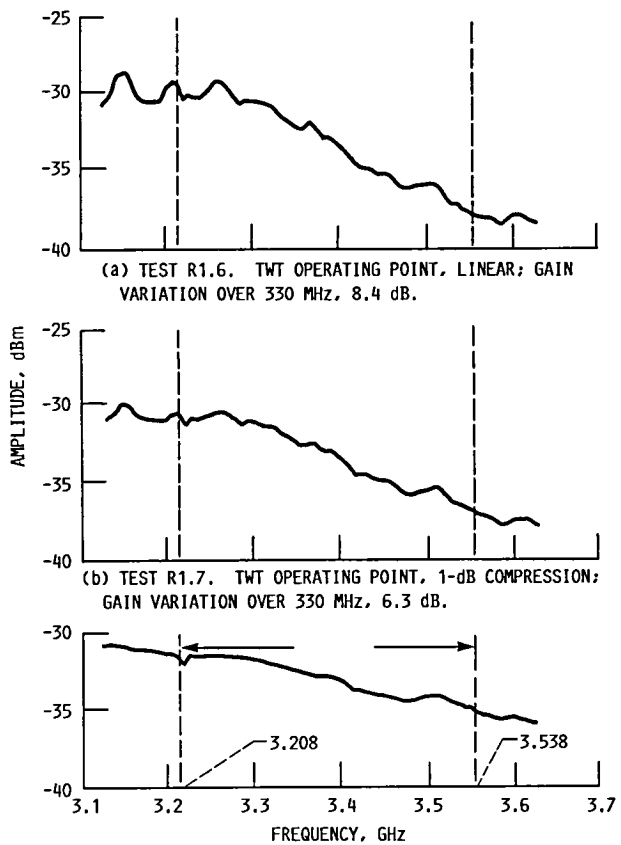

FIGURE 9. - FREQUENCY RESPONSE TESTS FOR TRAVELING WAVE TUBE (TWT) IN HIGH MODE.

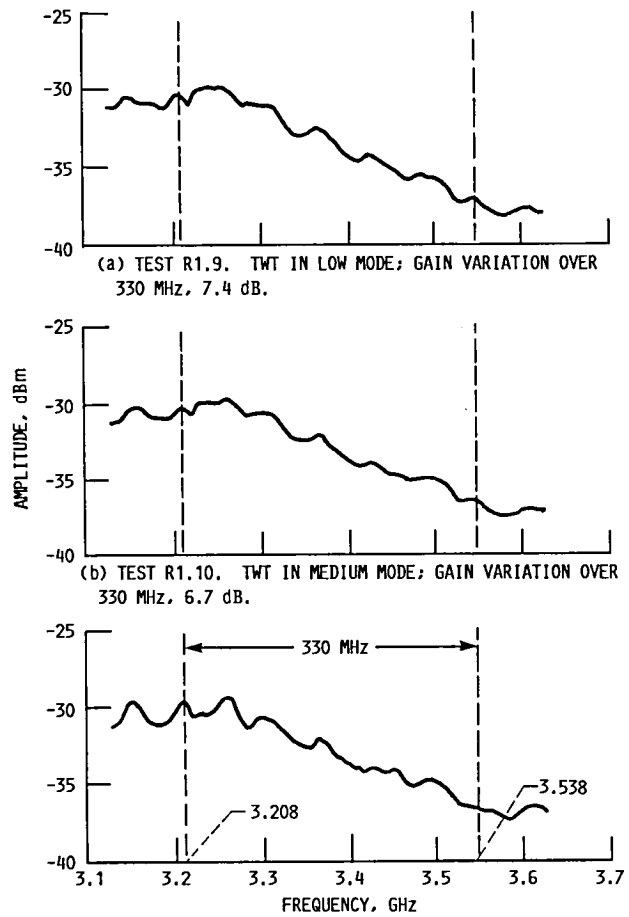

FIGURE 10. - FREQUENCY RESPONSE TESTS FOR TRAVELING WAVE TUBE (TWT) AT BASELINE.

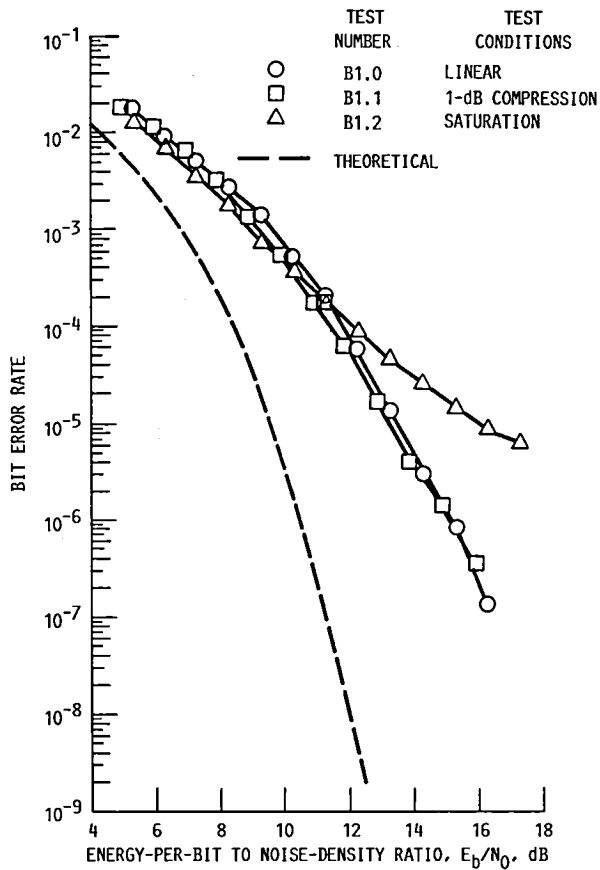

FIGURE 11. - BIT-ERROR-RATE PERFORMANCE FOR TRAVELING WAVE TUBE IN LOW MODE.

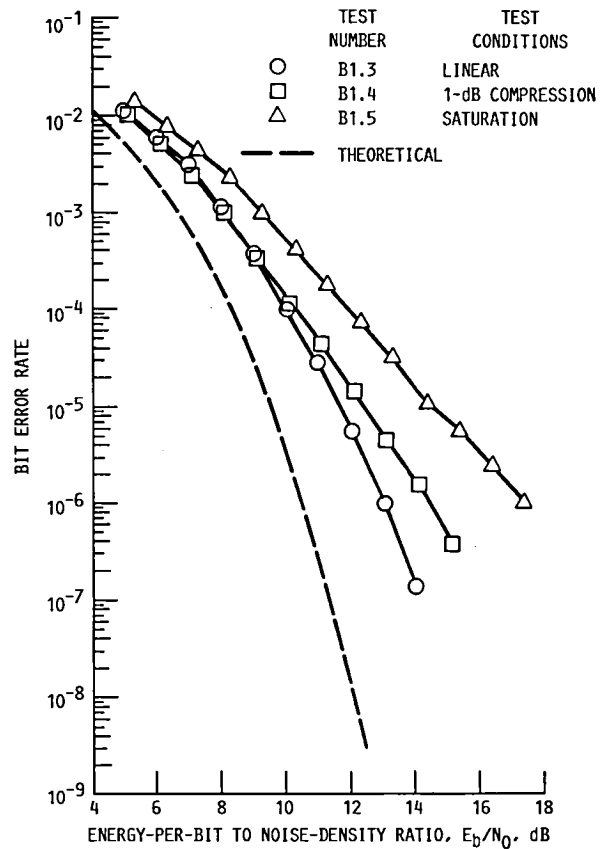

FIGURE 12. - LINK BIT-ERROR-RATE PERFORMANCE FOR TRAVELING WAVE TUBE IN MEDIUM MODE.

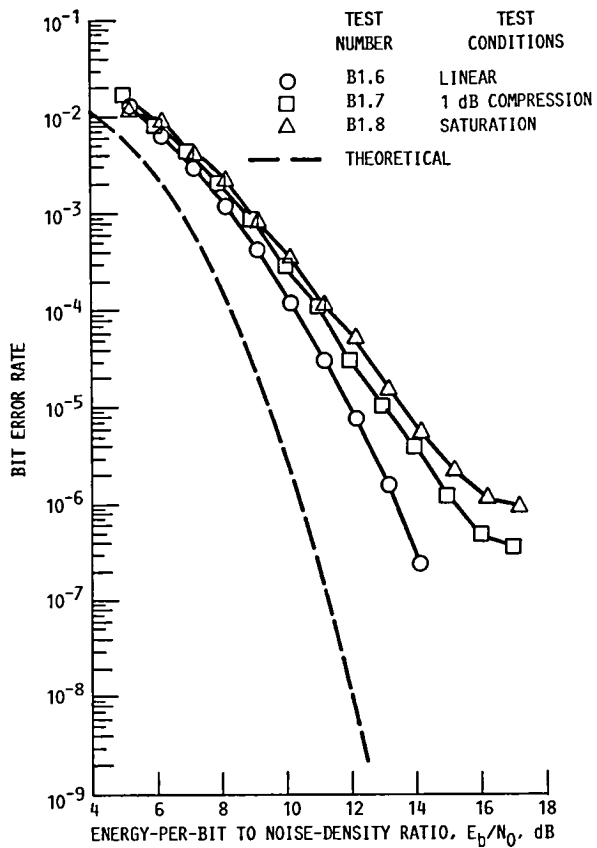

FIGURE 13. - LINK BIT-ERROR-RATE PERFORMANCE FOR TRAVELING WAVE TUBE IN HIGH MODE.

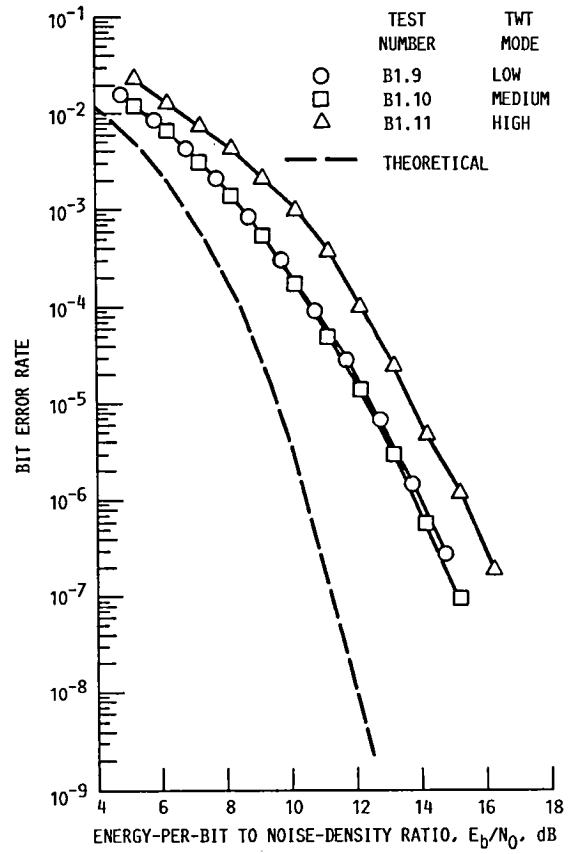

FIGURE 14. - LINK BIT-ERROR-RATE PERFORMANCE FOR TRANSPONDER BASELINE SETTINGS.



Report Documentation Page

1. Report No. NASA TM-100824		2. Government Accession No.		3. Recipient's Catalog No.	
4. Title and Subtitle Experimental Radio Frequency Link for Ka-Band Communications Applications				5. Report Date June 1988	
				6. Performing Organization Code	
7. Author(s) Gene Fujikawa, Martin J. Conroy, Alan L. Saunders, and Dale E. Pope				8. Performing Organization Report No. E-4012	
				10. Work Unit No.	
9. Performing Organization Name and Address National Aeronautics and Space Administration Lewis Research Center Cleveland, Ohio 44135-3191				11. Contract or Grant No.	
				13. Type of Report and Period Covered Technical Memorandum	
12. Sponsoring Agency Name and Address National Aeronautics and Space Administration Washington, D.C. 20546-0001				14. Sponsoring Agency Code	
				15. Supplementary Notes	
16. Abstract An experimental radio frequency link has been demonstrated to provide two-way communication between a remote user ground terminal and ground-based Ka-band transponder. Bit-error-rate performance and radio frequency characteristics of the communication link were investigated.					
17. Key Words (Suggested by Author(s)) Ka-band Bit-error-rate Satellite communications			18. Distribution Statement Unclassified - Unlimited Subject Category 14		
19. Security Classif. (of this report) Unclassified		20. Security Classif. (of this page) Unclassified		21. No of pages 16	22. Price* A02

National Aeronautics and
Space Administration

Lewis Research Center
Cleveland, Ohio 44135

Official Business
Penalty for Private Use \$300

SECOND CLASS MAIL

ADDRESS CORRECTION REQUESTED



Postage and Fees Paid
National Aeronautics and
Space Administration
NASA-451

NASA
