

# CHAPTER 9

## MOBILE CRANES

This chapter specifies operation, inspection, maintenance, and testing requirements for the use of mobile cranes and implements the requirements of ASME B30.5 (“Mobile and Locomotive Cranes”) (for latest ASME standards, see <http://catalog.asme.org/home.cfm?Category=CS>).

9.1	GENERAL .....	9-1
9.1.1	Operator Training/Qualification .....	9-1
9.1.2	Load Limits .....	9-1
9.1.3	Load Rating Chart .....	9-1
9.1.4	Load Hoist Brakes .....	9-6
9.1.5	Power-Controlled Lowering .....	9-6
9.1.6	Booms .....	9-6
9.1.7	Counterweight .....	9-6
9.1.8	Rerating .....	9-6
9.1.9	Maintenance History .....	9-6
9.1.10	Design Standards .....	9-6
9.2	INSPECTIONS .....	9-7
9.2.1	General .....	9-7
9.2.2	Initial Inspection .....	9-7
9.2.3	Daily Preoperational Check .....	9-7
9.2.4	Monthly Inspection .....	9-7
9.2.5	Frequent Inspection .....	9-7
9.2.6	Periodic Inspection .....	9-8
9.2.6.1	Cranes .....	9-8
9.2.6.2	Hydraulic and Pneumatic Hose, Fittings, and Tubing .....	9-9
9.2.6.3	Hydraulic and Pneumatic Pumps and Motors .....	9-9
9.2.6.4	Hydraulic and Pneumatic Valves .....	9-9
9.2.6.5	Hydraulic and Pneumatic Cylinders .....	9-9
9.2.6.6	Hydraulic Filters .....	9-9
9.2.6.7	Wire Rope .....	9-9
9.2.7	Load Hooks/Load Blocks .....	9-11
9.2.8	Cranes Not in Regular Use .....	9-11
9.3	TESTING .....	9-12
9.3.1	Operational Tests .....	9-12
9.3.2	Rated Load Test .....	9-12
9.4	MAINTENANCE .....	9-13
9.4.1	Preventive Maintenance .....	9-13
9.4.2	Maintenance Procedures .....	9-13
9.4.3	Wire-Rope Maintenance .....	9-13
9.5	OPERATION .....	9-15
9.5.1	Conduct of Operator .....	9-15
9.5.1.1	Traveling the Machine .....	9-16
9.5.1.2	Making Adjustments or Repairs .....	9-16
9.5.1.3	Ensuring Stability .....	9-17
9.5.1.4	Further Safety Considerations .....	9-18
9.5.2	Operating Near Power Lines and Transmitter Towers .....	9-18

## CHAPTER 9

# MOBILE CRANES

9.5.2.1	Crane Operations De-Energized and Grounded Electrical Power Lines .....	9-19
9.5.2.2	Power Lines Energized, Crane Operating Less Than Erected/Fully Extended Boom Length Away From Prohibited Zone .....	9-19
9.5.2.3	Crane Operations are Within the Prohibited Zone and the Power Lines are Energized.....	9-22
9.5.2.4	Crane in Transit with no Load and Boom Lowered .....	9-22
9.5.2.5	Crane Operations Near Transmitter Towers .....	9-22
9.5.3	Hoist Limit Switch.....	9-22
9.5.4	Standard Hand Signals .....	9-25
9.5.5	Identification of Signalers.....	9-25
9.5.6	Standard Voice Signals .....	9-25
9.5.7	Special Signals .....	9-25
9.5.8	Size of Load .....	9-25
9.5.9	Attaching the Load.....	9-25
9.5.10	Moving the Load.....	9-25
9.5.11	Ordinary Lifts .....	9-29
9.5.12	Critical Lifts.....	9-30
EXHIBIT I	Mobile Crane Load Test .....	9-33
EXHIBIT II	Mobile Crane Daily Pre-Operational Check .....	9-37
EXHIBIT III	Mobile Crane Frequent Inspection Report.....	9-41
EXHIBIT IV	Mobile Crane Periodic Inspection Report.....	9-43

## 9.1 GENERAL

This chapter applies to commercial truck-mounted cranes; crawler cranes; locomotive cranes; wheel-mounted cranes, multiple control stations; wheel-mounted cranes, single control station; and any variation that retains the same fundamental characteristics. These cranes have a superstructure capable of rotating 360 degrees mounted on a carrier and have boom raising and lowering capabilities.

### 9.1.1 OPERATOR TRAINING/QUALIFICATION

Operators of mobile cranes shall be trained and qualified as required in Chapter 6, "Personnel Qualification and Training."

### 9.1.2 LOAD LIMITS

- a. Since the load rating for mobile cranes may be based on stability and hydraulic or structural competence, load ratings established by the manufacturers shall not be exceeded in operational application.
- b. No crane shall be loaded beyond its rated capacity, except for load test purposes as described in Section 9.3, "Testing."
- c. When loads are to be handled that are limited by hydraulic or structural competence rather than by stability, the appointed person shall ensure that the weight of a load approaching rated capacity has been determined within -10 percent, +0 percent before it is lifted

### 9.1.3 LOAD RATING CHART

- a. Durable rating chart(s) with legible letters and figures shall be provided with each crane and attached in a location accessible to the operator while at the controls. See Table 9-1 for a sample load rating chart. The data and information to be provided on these charts shall include, but not be limited to, the following:
  1. A full and complete range of manufacturer's crane load ratings at all stated operating radii, boom angles, work areas, and all stated boom lengths and configurations, jib lengths and

angles (or offset), as well as alternate ratings for use and nonuse of optional equipment on the crane, such as outriggers and extra counterweights, that affect ratings.

2. A work area chart for which capacities are listed in the load rating chart (see sample in Figure 9-1).
3. Where ratings are limited by structural, hydraulic, or factors other than stability, the limitations shall be shown and emphasized on the rating charts.
4. In areas where no load is to be handled, the work area figure and load rating chart shall state that information.
5. Recommended reeving for the hoist lines shall be shown.
  - b. In addition to the data required on the load rating chart, the following information shall be shown either on the rating chart or in the operating manual:
    1. Recommended parts of the hoist reeving, and size and type of rope for various crane loads.
    2. Recommended boom hoist reeving diagram, where applicable; size, type, and length of rope.
    3. Tire pressure, where applicable.
    4. Cautionary or warning notes relative to limitations on equipment and operating procedures, including indication of the least stable direction.
    5. Position of the gantry and requirements for intermediate boom suspension, where applicable.
    6. Instructions for boom erection and conditions under which the boom, or boom and jib combinations, may be raised or lowered.
    7. Whether the hoist-holding mechanism is automatically controlled or manually

controlled, whether free-fall is available, and whether any combination of those exists.

8. The maximum telescopic travel length of each boom telescopic section.
9. Whether sections are telescoped with power or manually.

**Table 9-1. Sample Load Rating Chart**

This table is an example of the type of load rating chart that should be included in each crane.

Manitowoc Model 3900 Liftcrane Extra-Heavy Boom

Working Radius	50'	60'	70'	80' lbs.	90'	100'	120'	140'
12	120 000	120 000						
14	111 200	110 800	109 000					
16	104 200	103 600	102 700	100 000	95 000			
18	97 800	97 400	97 000	96 600	92 500	90 000		
20	93 200	92 400	91 600	90 600	89 600	86 000	83 000	
22	87 800	86 800	85 800	84 800	83 800	82 800	80 000	
24	<u>83 400</u>	81 200	80 300	79 400	78 700	77 800	75 200	66 500
26	<u>75 900</u>	<u>75 500</u>	<u>74 700</u>	<u>73 900</u>	<u>73 200</u>	<u>72 600</u>	70 500	63 100
28	68 100	<u>67 700</u>	<u>67 300</u>	<u>66 900</u>	<u>66 400</u>	<u>65 800</u>	64 000	59 800
30	61 700	61 300	60 900	60 500	60 000	59 400	<u>58 500</u>	<u>56 400</u>
32	56 500	56 100	55 700	55 300	54 800	54 200	53 300	52 300
34	52 000	51 600	51 200	50 800	50 300	49 700	48 800	47 800
36	48 100	47 700	47 300	46 900	46 400	45 800	44 900	43 900
38	44 700	44 300	43 900	43 500	43 000	42 400	41 500	40 500
40	41 700	41 300	40 900	40 500	40 000	39 400	38 500	37 500
42	39 100	38 700	38 300	37 900	37 400	36 800	35 900	34 900
44	36 800	36 400	36 000	35 600	35 100	34 500	33 600	32 600
46	34 700	34 300	33 900	33 500	33 000	32 400	31 500	30 500
48	32 900	32 500	32 100	31 700	31 200	30 600	29 700	28 700
50	<u>31 200</u>	30 800	30 400	30 000	29 500	28 900	28 000	27 000
52		29 300	28 900	28 500	28 000	27 400	26 500	25 500
54		27 900	27 500	27 100	26 600	26 000	25 100	24 100
56		26 500	26 100	25 700	25 200	24 600	23 700	22 700
58		25 300	24 900	24 500	24 000	23 400	22 500	21 500
60		<u>24 200</u>	23 800	23 400	22 900	22 300	21 400	20 400
65			21 300	20 900	20 400	19 800	18 900	17 900
70			<u>19 300</u>	18 900	18 400	17 800	16 900	15 900
75				17 100	16 600	16 000	15 100	14 100
80				<u>15 700</u>	15 200	14 600	13 700	12 700
85					13 900	13 300	12 400	11 400
90					<u>12 700</u>	12 100	11 200	10 200
95						11 100	10 200	9 200
100						<u>10 200</u>	<u>9 300</u>	<u>8 300</u>
110							6 800	5 600
120							4 500	3 840

## NOTES:

- Above ratings are maximum recommended working loads. Loads between solid lines are computed at 75% of tipping load across treads; with machine on firm, level ground. Loads outside solid lines are limited by strength of boom.
- For booms 80 ft and longer, use cambered center section; for booms 100 ft and longer, use deep section inserts.

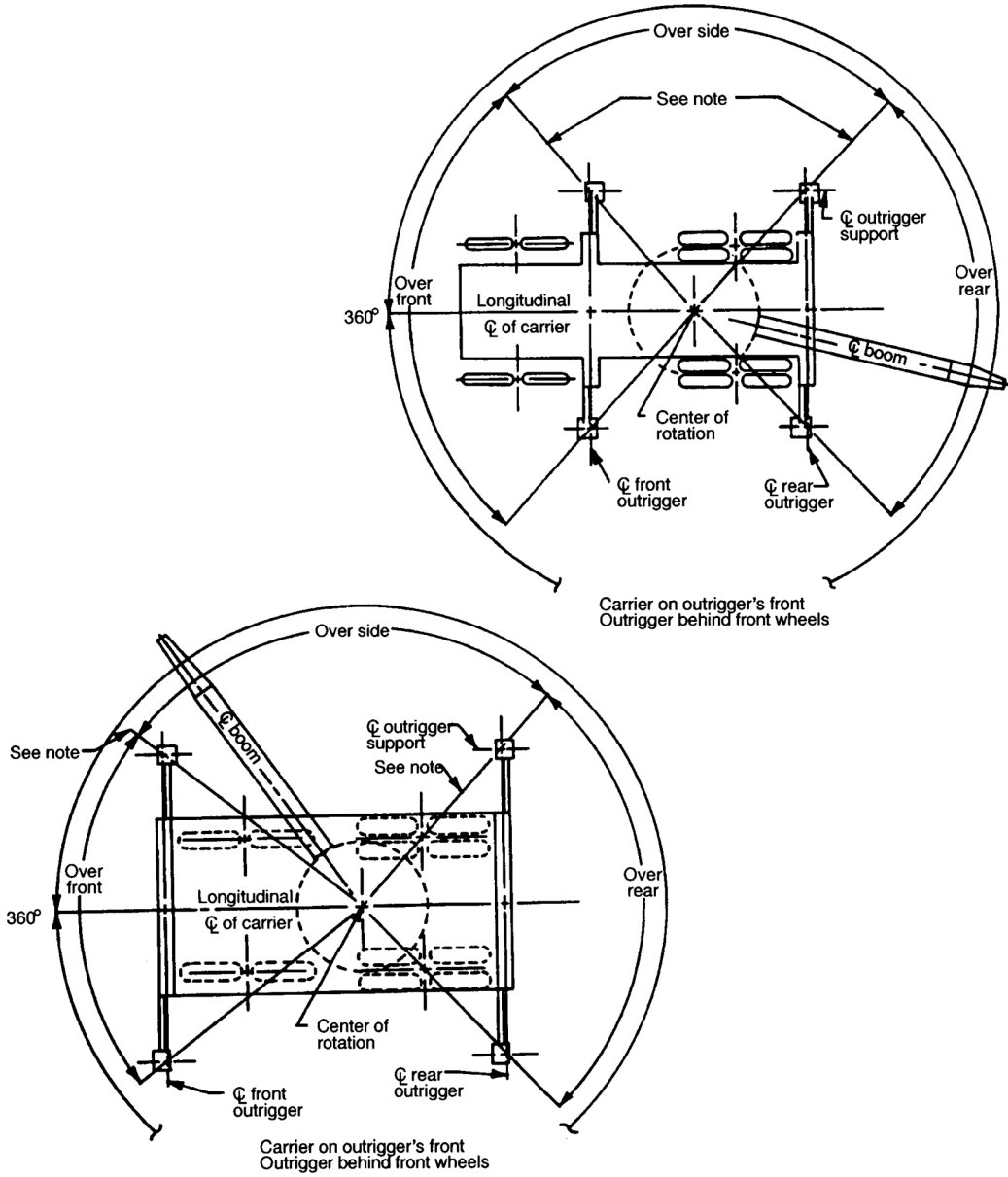

Note: These lines determine the limiting position of any load for operation within working areas indicated.

Reprinted from ASME B30.5-2004 by permission of The American Society of Mechanical Engineers. All rights reserved.

Figure 9-1. Sample work area chart.

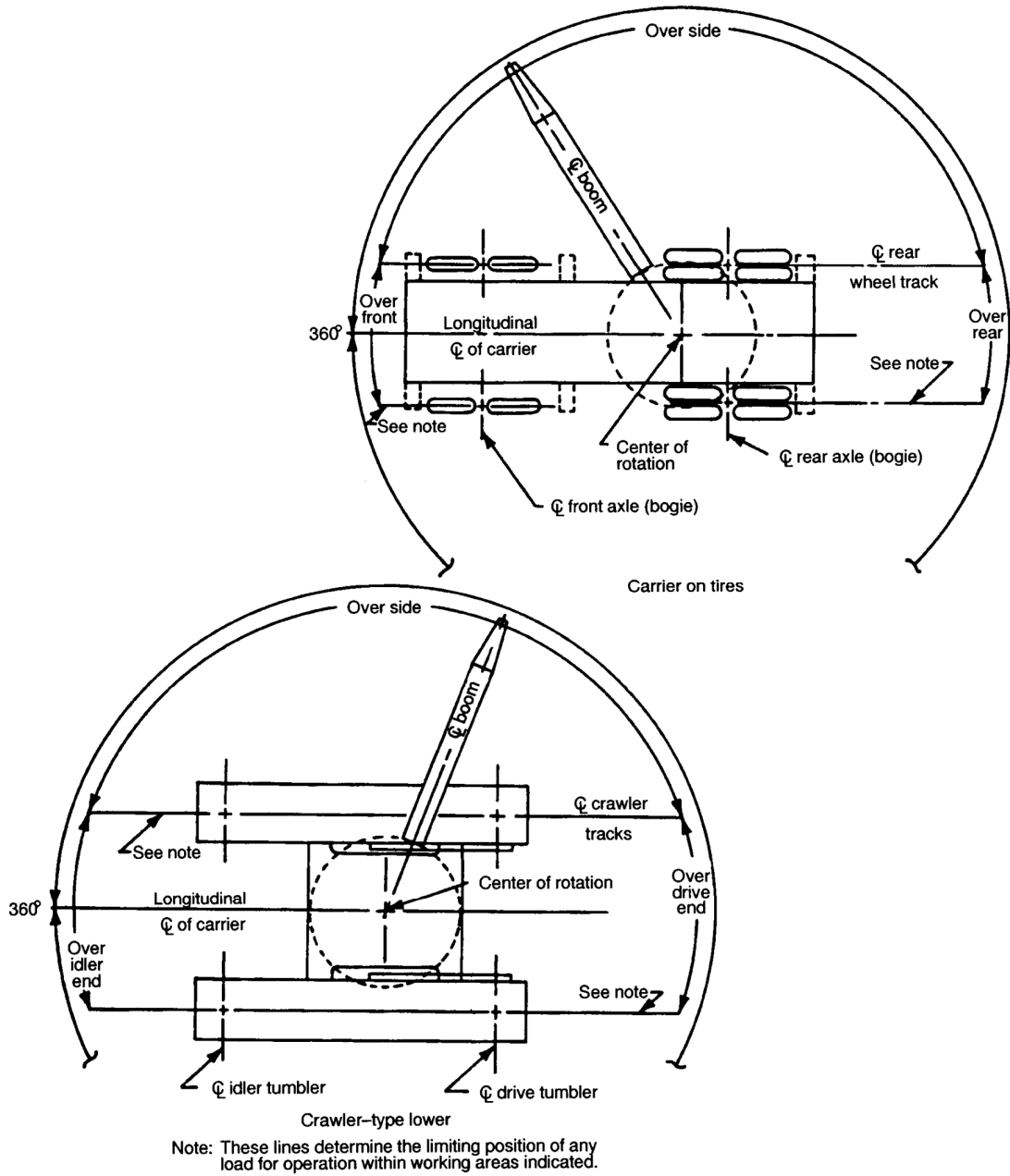

Reprinted from ASME B30.5-2004 by permission of The American Society of Mechanical Engineers. All rights reserved.

Figure 9-1. (continued).

10. The sequence and procedure for extending and retracting the telescopic boom section.
11. Maximum loads permitted during the actual boom-extending operation and any limiting conditions or cautions.
12. Hydraulic relief valve settings specified by the manufacturer.

#### 9.1.4 LOAD HOIST BRAKES

When power-operated brakes that have no continuous mechanical linkage between the actuating and braking means are used, an automatic means shall be provided to set the brake to prevent the load from falling in event of loss of brake-actuating power.

#### 9.1.5 POWER-CONTROLLED LOWERING

A power-controlled lowering system shall be provided and shall be capable of handling rated loads and speeds as specified by the manufacturer of the crane.

#### 9.1.6 BOOMS

- a. Booms, boom sections, and jibs shall be clearly identified and shall be used only for the purpose recommended by the manufacturer.
- b. Lattice booms shall meet the performance requirements of SAE J987, "Crane Structure, Method of Test" (see Chapter 16, "References").

#### 9.1.7 COUNTERWEIGHT

- a. Cranes shall not be operated without the ballast or counterweight being in place as specified by the crane manufacturer. Under specific conditions, such as during crane

assembly, unusual boom configurations, etc., the crane manufacturer's recommendations for the amount of ballast or counterweight shall be adhered to.

- b. Ballast or counterweight as specified by the manufacturer shall not be exceeded.

#### 9.1.8 RERATING

- a. Cranes may be modified or rerated providing such modifications are analyzed thoroughly by a qualified engineer or manufacturer of cranes. Such action must be approved by the cognizant safety organization.
- b. When rerated, crawler, truck, and wheel-mounted cranes shall be tested in accordance with SAE J765, "Crane Load Stability Test Code."
- c. A rerating test report shall be readily available.
- d. No cranes shall be rerated in excess of the manufacturer's original load ratings.

#### 9.1.9 MAINTENANCE HISTORY

The maintenance history of the crane shall be retained throughout its service life.

#### 9.1.10 DESIGN STANDARDS

- a. Structural, mechanical, and electrical components of the crane design shall meet accepted crane design standards, such as PCSA-4, "Mobile Power Crane and Excavator Standards and Hydraulic Crane Standards."
- b. The safety features and operation shall conform, at a minimum, to the provisions of ASME B30.5, "Mobile and Locomotive Cranes."



---

## 9.2 INSPECTIONS

---

### 9.2.1 GENERAL

Equipment shall operate with a smooth, regular motion without any hesitation, abnormal vibration, binding, gross shimmy, or irregularity. There shall be no apparent damage, excessive wear, or deformation of any load-bearing part of the equipment. All safety devices, load indicators, boom angle and radius indicators, controls, and other operating parts of the equipment shall be checked during each inspection and shall be in good working order.

### 9.2.2 INITIAL INSPECTION

Prior to initial use, all new or modified cranes shall be inspected as required in Section 9.2.6, "Periodic Inspection," by a qualified inspector to ensure compliance with the applicable provisions of this chapter. Dated and signed inspection reports shall be kept on file and shall be readily available.

### 9.2.3 DAILY PREOPERATIONAL CHECK

- a. Operators or other designated personnel shall visually inspect items such as the following each day or prior to use if the crane has not been in regular service (records are not required):
  1. All control mechanisms for maladjustment interfering with proper operation.
  2. Crane hooks and latches for deformation, cracks, and wear.
  3. Hydraulic systems for proper oil level.
  4. Lines, tanks, valves, pumps, and other parts of air or hydraulic systems for leakage.
  5. Hoist ropes for kinking, crushing, birdcaging, and corrosion.
  6. Anti-two-block, two-block warning, and two-block damage prevention systems for proper operation.

7. Booms for damage or deformation of structural components.

- b. Operators or other designated personnel shall examine deficiencies and determine whether they constitute a safety hazard.

### 9.2.4 MONTHLY INSPECTION

- a. The operator or other designated person shall visually inspect the following items for damage, wear, or other deficiency that might reduce capacity or adversely affect the safety of the crane:
  1. Critical items such as brakes and crane hooks.
  2. Hoist ropes.

- b. Lower the hook block to its lowest position and examine for any condition that could result in an appreciable loss of strength.

- c. Hooks for cracks, deformation, damage from chemicals, latch engagement (if provided), and evidence of heat damage. (See Chapter 13, "Load Hooks," for additional hook requirements).

- d. A hoist rope with any of the conditions noted in the replacement criteria in Section 9.2.6 shall be removed from service and replaced.

- e. Signed and dated inspection records shall be kept on file and shall be readily available.

- f. Before the crane is returned to service, correct deficiencies that could reduce its capacity or adversely affect its safety.

- F. Before the crane is returned to service, correct deficiencies that could reduce its capacity or adversely affect its safety.

### 9.2.5 FREQUENT INSPECTION

- a. Operators or other designated personnel shall visually inspect the crane at daily to monthly intervals (records are not required).

- b. These inspections shall, in addition to the requirements of Section 9.2.3, "Preoperational Check," include the following:
  1. Critical items such as brakes and crane hooks.
  2. Hoist ropes.

1. All control mechanisms for maladjustment, excessive wear, and contamination by lubricants or other foreign matter that could interfere with proper operation.
  2. All safety devices for malfunction.
  3. Rope reeving for noncompliance with crane manufacturer's recommendations.
  4. Electrical apparatus for malfunctioning, signs of excessive deterioration, and accumulation of dirt or moisture.
  5. Tires for recommended inflation pressure.
  6. Boom sections for damaged, deformed, or missing structural members or parts.
- c. Operators or other designated personnel shall examine deficiencies and determine whether a more detailed inspection is required.

### 9.2.6 PERIODIC INSPECTION

- a. Complete inspections of the crane shall be performed by a qualified inspector at 1- to 12-month intervals, depending on the crane's activity, severity of service, and environment.
- b. The qualified inspector shall examine deficiencies and determine whether they constitute a hazard.
- c. Dated and signed inspection records shall be kept on file and shall be readily available.
- d. A sample load test form is included as Exhibit I, which appears at the end of this chapter. This form is intended to be a sample only and is not intended to be mandatory.
- e. These inspections shall, in addition to the requirements of Sections 9.2.4, "Monthly Inspection," and 9.2.5, "Frequent Inspection," include the following.

### 9.2.6.1 Cranes

Inspect for:

- a. Deformed, cracked, or corroded members in the crane structure and entire boom.
- b. Bolts, rivets, nuts, and pins for being loose or absent.
- c. Check for suspect/counterfeit parts (see Terminology and Definitions, Chapter 1).
- d. Cracked or worn sheaves and drums.
- e. Hooks damaged from chemicals, deformation, or cracks, any visibly apparent bend or twist from the plane of the unbent hook, or any distortion causing an increase in throat opening of 5% not to exceed 1/4 in. unless otherwise recommended by the manufacturer. Dye-penetrant, magnetic-particle, or other suitable crack-detecting inspections should be performed at least once a year. See Chapter 13, "Load Hooks," for additional hook requirements.
- f. Worn, cracked, or distorted parts such as pins, bearings, shafts, gears, rollers, and locking devices.
- g. Excessive wear on brake and clutch system parts, linings, pawls, and ratchets.
- h. Load, boom angle, and other operating aids over their full ranges for any significant inaccuracies (if calibration is required, it shall be done by a qualified person).
- i. Gasoline, diesel, electrical, or other power plants for improper performance or noncompliance with safety requirements.
- j. Radiators and oil coolers, for leakage, improper performance, or blockage of air passages.
- k. Excessive wear of chain drive sprockets and excessive chain stretch.
- l. Steering, braking, and locking devices, for malfunctioning.
- m. Excessively worn or damaged tires.

- n. Rust on piston rods and control valves when crane has been idle.

### 9.2.6.2 Hydraulic and Pneumatic Hose, Fittings, and Tubing

Inspect for:

- a. Evidence of leakage at the surface of the flexible hose or its junction with the metal couplings.
- b. Blistering or abnormal deformation of the outer covering of the hydraulic or pneumatic hose.
- c. Leakage at threaded or clamped joints that cannot be eliminated by normal tightening or recommended procedures.
- d. Evidence of excessive abrasion or scrubbing on the outer surface of a hose, rigid tube, or fitting (means shall be taken to eliminate the interface of elements in contact or to otherwise protect the components).

### 9.2.6.3 Hydraulic and Pneumatic Pumps and Motors

Inspect for:

- a. Loose bolts or fasteners.
- b. Leaks at joints between sections.
- c. Shaft seal leaks.
- d. Unusual noises or vibration.
- e. Loss of operating speed.
- f. Excessive heating of the fluid.
- g. Loss of pressure.

### 9.2.6.4 Hydraulic and Pneumatic Valves

Inspect for:

- a. Cracks in valve housing.
- b. Improper return of spool to neutral position.
- c. Leaks at spools or joints.

- d. Sticking spools.
- e. Failure of relief valves to attain correct pressure setting (relief valve pressures shall be checked as specified by the manufacturer).

### 9.2.6.5 Hydraulic and Pneumatic Cylinders

Inspect for:

- a. Drifting caused by fluid leaking across the piston.
- b. Rod seal leakage.
- c. Leaks at welded joints.
- d. Scored, nicked, or dented cylinder rods.
- e. Dented case (barrel).
- f. Loose or deformed rod eyes or connecting joints.

### 9.2.6.6 Hydraulic Filters

Evidence of rubber particles on the filter element may indicate deterioration of the hose, "O" ring, or other rubber components. Metal chips or pieces on the filter may denote failure in pumps, motors, or cylinders. Further checking will be necessary to determine the origin of the problem before corrective action can be taken.

### 9.2.6.7 Wire Rope

- a. A qualified inspector shall inspect wire ropes at least annually. More frequent intervals shall be determined by a qualified person and shall be based on such factors as expected rope life as determined by severity of environment, percentage of capacity lifts, frequency rates of operation, and exposure to shock loads. The qualified inspector shall carefully note any deterioration, such as described below, that results in appreciable loss of original strength and determine whether further use of the rope constitutes an acceptable risk. This inspection shall include examination of the entire rope length without detaching it from the drum.
  - 1. Reduction of rope size below nominal diameter, whether due to loss of core

support, internal or external corrosion, or wear of outside wires (see Table 9-2).

**Table 9-2. Maximum allowable rope reductions.**

Rope diameter	Maximum allowable reduction from nominal diameter
Up to 5/16 in. (8 mm)	1/64 in. (0.4 mm)
Over 5/16 in. to 1/2 in. (13 mm)	1/32 in. (0.8 mm)
Over 1/2 in. to 3/4 in. (19 mm)	3/64 in. (1.2 mm)
Over 3/4 in. to 1 1/8 in. (29 mm)	1/16 in. (1.6 mm)
Over 1 1/8 in. to 1 1/2 in. (38 mm)	3/32 in. (2.4 mm)

Reprinted from ASME B30.5-2004 by permission of The American Society of Mechanical Engineers. All rights reserved.

2. The number and distribution or concentration of broken outside wires.
  3. Worn outside wires.
  4. Corroded or broken wires at end connections.
  5. Corroded, cracked, bent, worn, or improperly applied end connections.
  6. Kinking, crushing, cutting, or unstranding.
- b. The qualified inspector shall take care when inspecting running rope where rapid deterioration could occur, such as in the following:
1. Sections in contact with saddles, equalizer sheaves, or other sheaves where rope travel is limited.

2. Sections of the rope at or near terminal ends where corroded or broken wires may protrude.
- c. The qualified inspector shall take care when inspecting certain ropes such as the following:
1. Rotation-resistant ropes, because of their higher susceptibility to damage. The internal deterioration of rotation-resistant ropes may not be readily observable.
  2. Boom hoist ropes, because of the difficulties of inspection and the important nature of these ropes.
- d. No precise rules can be given for determining the exact time to replace wire rope because many factors are involved. Safety in this respect depends largely on the use of good judgment by an appointed person in evaluating remaining strength in a used rope, after allowance for deterioration disclosed by inspection. Safety of rope operation depends on this remaining strength.
- e. Removal criteria for wire rope replacement shall be as follows:
1. In running ropes, 6 randomly distributed broken wires in one rope lay, or 3 broken wires in one strand in one rope lay.
  2. In standing ropes, more than two broken wires in one lay in sections beyond end connections or more than one broken wire at an end connection.
  3. In rotation resistant ropes, two randomly distributed broken wires in six rope diameters or four randomly distributed broken wires in thirty rope diameters.
  4. One outer wire broken at the point of contact with the core of the rope that has worked its way out of the rope structure and protrudes or loops out from the rope structure; additional inspection of this part of the rope is required.

5. Wear of one-third the original diameter of outside individual wires.
  6. Kinking, crushing, birdcaging, or any other damage resulting in distortion of the rope structure.
  7. Evidence of heat damage from any cause.
  8. Reduction from nominal diameter greater than the amounts listed in Table 9-2.
- f. All rope that has been idle for a month or more due to shutdown or storage of a crane on which it is installed shall be inspected before it is placed in service. This inspection shall be for all types of deterioration and shall be performed by an appointed person whose approval shall be required before further use of the rope. A written and dated report of the rope condition shall be filed.
- g. In order to establish data as a basis for judging the proper time for replacement, a continuing inspection record shall be maintained.
- h. Replacement rope shall be the same size, grade, and construction as recommended by the crane manufacturer, unless otherwise recommended by a rope or crane manufacturer due to actual working-condition requirements.
- i. Never use discarded wire rope for slings.

## 9.2.7 LOAD HOOKS/LOAD BLOCKS

Load hooks/load blocks that have been changed out shall be inspected by a qualified inspector before returning the crane to service. Inspection records shall be retained throughout the service life of the hook or load block and shall be readily available.

## 9.2.8 CRANES NOT IN REGULAR USE

- a. A crane that has been idle for 1 month or more but less than 6 months shall be given an inspection according to the requirements of Section 9.2.5 before being placed in service.
- b. A crane that has been idle for more than 6 months shall be given a complete inspection according to the requirements of Section 9.2.6 before being placed in service.
- c. Standby cranes shall be inspected at least semiannually, according to the requirements of Section 9.2.6. Cranes exposed to adverse environments should be inspected more frequently.
- d. The determination supporting these alternate inspection frequencies and procedures shall be made by a qualified person for each affected crane. Documentation supporting this determination shall be kept readily available.

---

## 9.3 TESTING

---

### 9.3.1 OPERATIONAL TESTS

The following shall be tested during an initial test:

- a. Load lifting and lowering mechanisms.
- b. Boom lifting and lowering mechanisms.
- c. Boom extension and retraction mechanism.
- d. Swinging mechanism.
- e. Travel mechanism.
- f. Safety devices.

### 9.3.2 RATED LOAD TEST

- a. Prior to initial use, all cranes in which load-sustaining parts have been modified, replaced, or repaired shall be load-tested by a qualified inspector or under the direction of that inspector. All rated load tests shall be performed in accordance with manufacturer's recommendations. A

designated or authorized person shall determine if repairs made to a crane are extensive and require a rated load test, or if repairs are routine maintenance and require only operational testing. The replacement of rope is excluded from this requirement. However, a functional test of the crane under a normal operating load should be made prior to putting it back in service.

- b. Test weights shall not exceed 110 percent of the rated capacity and shall be accurate to within -5 percent, +0 percent of stipulated values.

NOTE: Load tests shall not be conducted in locations where the lift meets the definition of a critical lift (see Chapter 1, "Terminology and Definitions").

- c. A written report shall be furnished by the inspector showing test procedures and confirming the adequacy of repairs or alterations. Test reports shall be kept on file and shall be readily available to appointed personnel.

---

## 9.4 MAINTENANCE

---

### 9.4.1 PREVENTIVE MAINTENANCE

- a. A preventive maintenance program shall be established and based on the recommendation of the crane manufacturer. If equipment maintenance procedures deviate from published manufacturer's recommendations, the alternate procedures shall be approved in advance by the manufacturer or another qualified person and be kept readily available. Dated maintenance records should be kept where readily available to appointed personnel.
- b. Replacement parts shall be at least equal to the original manufacturer's specifications.
- c. All moving parts of the crane for which lubrication is specified shall be regularly lubricated. Lubricating systems should be checked for proper delivery of lubricant. Operators and maintenance personnel shall follow the manufacturer's recommendations as to the points and frequency of lubrication, maintenance of lubricant levels, and types of lubricant to be used.

### 9.4.2 MAINTENANCE PROCEDURES

- a. Before starting adjustments or repairs on a crane, maintenance personnel shall take the following precautions as applicable:
  1. Place the crane where it will cause the least interference with other equipment or operations in the area.
  2. Lower the lower load block to the ground or otherwise secure it against dropping.
  3. Lower the boom to the ground, if possible, or otherwise secure it against dropping.
  4. Place all controls in the OFF position and secure all operating features from inadvertent motion by brakes, pawls, or other means.
  5. Ensure starting means are rendered inoperative.

6. Stop the power plant or disconnect it at the power takeoff.
7. Relieve hydraulic oil pressure from all hydraulic circuits before loosening or removing hydraulic components.
- b. Warning or out-of-order signs shall be placed on the crane controls. Signs or flags shall be removed only by authorized personnel.
- c. After adjustments and repairs have been made, the crane shall not be returned to service until all guards have been reinstalled, trapped air has been removed from the hydraulic system, safety devices are reactivated, and maintenance equipment is removed.
- d. For locomotive cranes:
  1. Employ blue flag protection on each side of the crane (except dead ends).
  2. Place derails not less than 50 ft from the crane on each side (except dead ends).
  3. Allow only authorized personnel to remove warning signs, flags, and derails.

### 9.4.3 WIRE-ROPE MAINTENANCE

Personnel using wire rope shall ensure proper care by doing the following:

- a. Store rope to prevent damage or deterioration.
- b. Unreel or uncoil rope as recommended by the rope manufacturer and with care to avoid kinking or inducing a twist.
- c. Before cutting a rope, use some method to prevent unlaying the strands. Heat-affected zones of flame cut wire rope shall not be allowed to bear load.
- d. During installation, avoid dragging the rope in the dirt or around objects which will scrape, nick, crush, or induce sharp bends in it.

---

## 9.4 MAINTENANCE

---

- e. Maintain rope in a well-lubricated condition to reduce internal friction and to prevent corrosion. Ensure that lubricant applied as part of a maintenance program is compatible with the original lubricant. Consult the rope manufacturer when in doubt. Lubricant applied shall be of the type that does not hinder visual inspection. Those sections or rope that operate over sheaves or are otherwise hidden during inspection and maintenance procedures require special attention when the rope is lubricated.
- f. When an operating rope shows greater wear at its ends than on the remainder, its life can be extended (in cases where a reduced rope length is adequate) by cutting off the worn end, thus shifting the wear to different areas of the rope.



## 9.5 OPERATIONS

- a. The following shall apply to all personnel involved in mobile crane operation.
- b. At the initial stage of the planning process, an appointed person shall classify each lift into one of the DOE-specified lift categories (ordinary, critical, or preengineered production).
- g. Determine that no one is working on the crane or is close to it before starting the engine or beginning to operate the crane.
- h. Barricade accessible areas within the swing radius of the rear of the rotating superstructure of the crane to prevent anyone from being struck or crushed by the crane.

### 9.5.1 CONDUCT OF OPERATOR

- a. Cranes shall only be operated by personnel qualified per Chapter 6 of this Standard for the type of crane being operated..
- b. Do not engage in any practice that will divert your attention while operating the crane.
- c. Keep the operating area free of water, snow, ice, oil, and debris that could cause your hands or feet to slip from the controls.
- d. Keep the operating cab windshields clean and free of anything that obstructs vision. Replace broken windows.
- e. Ensure proper functioning of tires, horn, lights, battery, controller, lift system (including load-engaging means, chains, hoist rope, and limit switches), brakes, and steering mechanisms. If at any time a lifting device is found to be in need of repair, is defective, or is in any way unsafe, report it immediately to the designated authority and take the unit out of service until it has been restored to safe-operating condition or a determination has been made by the responsible manager that the deficiency will not adversely affect the safe operation of the unit.
- f. When two or more cranes are used to lift one load, one designated person shall be responsible for the operation. That person shall analyze the operation and instruct all personnel involved in the proper positioning, rigging of the load, and the movements to be made. That person shall also determine the necessity to reduce crane ratings, position of load, boom location, ground support, and speed of movement.
- i. Do not hoist two or more separately rigged loads in one lift, even though the combined load is within the crane's rated capacity. Refer to Section 15.5.8 for the exception granted for steel erection in construction.
- j. When fueling the crane, stop the engine(s) and ensure that smoking or open flames are not permitted within 25 ft of the fueling area.
- k. Ensure that a 10BC or larger fire extinguisher is installed at all operator stations. Fire extinguishers shall be maintained in a serviceable condition.
- l. Do not store gasoline, acids, caustics, or cleaning solvents that emit toxic fumes in operating cabs. Store fuel in safety cans in safe locations.
- m. Ensure that alternate egress routes are not locked on mobile units with operating enclosures.
- n. Position the crane on a solid and level footing. It may be necessary in certain situations to use heavy timber mats to build a good working foundation.
- o. When swinging the crane, watch out for centrifugal force. Swing the crane slowly to avoid an outward swing of the load. Attach a tag-line to the load if necessary to control the swing.
- p. Watch for boom kickback. Never operate with the boom at a higher angle than shown on the capacity charts.
- q. Use extreme caution when operating the crane near workers in elevated areas.

- r. Use power lowering when lowering loads. When lowering heavy loads, keep the hoist brake as reserve. Use a safety pawl on the boom-hoist drum when not lowering.
- s. Avoid two-blocking, caused when the hook block makes contact with boom-point sheaves. A continuing pull on the hoist lines can break the rope or pull the boom back over the cab on some types of booms. On hydraulically telescoping booms, be sure to play out the hoist line when extending and spool in the hoist line when retracting.
- t. Lock carrier air brakes ON when operating, and check the pressure of the air brakes frequently.
- u. Watch out for the carrier-cab on truck-mounted units when swinging the boom. Keep boom high enough to swing clear of cab.
- v. In the absence of crane manufacturer's instructions regarding maximum wind speeds for operation, operations undertaken at wind speeds in excess of 25 mph should be evaluated by a qualified person to determine if the size, shape and weight of the load can be safely lifted.
- w. When a crane is to be operated at a fixed radius, the boom-hoist pawl or other positive locking device shall be engaged.
- x. On truck-mounted cranes, no loads shall be lifted over the front area, except as approved by the crane manufacturer.
- y. Crane cabs, necessary clothing and personal belongings shall not interfere with access or operations.
- z. Tools, oil cans, waste, extra fuses, and other necessary articles shall be stored in the tool box, and shall not be permitted to lie loose in or about the cab.
- c. Check river depths before fording.
- d. Check clearances under overpasses, overhead lines, or any overhead obstruction; when side clearances are tight, install a barrier or post a lookout, and make certain there is sufficient clearance for tail swing.
- e. When traveling with a load, snub the load to prevent swaying if possible; never travel with near-capacity loads.
- f. Never travel a rubber-tired unit with a load over the side.
- g. On soft surfaces, always move with the load behind; it helps to raise the leading end of the crawlers, and makes traveling safer.
- h. Always set swing brakes when the unit is idle or holding loads for a period of time, especially on slopes; if swinging during travel is necessary, engage swing-jaw clutch before releasing brakes.
- i. Never back up until it is determined that everyone is clear of the machine.
- j. Position the boom in the direction of travel for long moves.
- k. Block treads when moving uphill; be sure they are blocked to prevent downhill movement before shifting steering clutches.
- l. Lock the turntable before traveling on a highway. Use a house lock or swing brake, and lower boom into the rack to prevent swing.
- m. When loading machine on the trailer, always use a ramp; if a ramp is not available use blocking to build one.

### 9.5.1.2 Making Adjustments or Repairs

#### 9.5.1.1 Traveling the Machine

When traveling the machine:

- a. Secure the boom and book block.
  1. Stop the machine.
  2. Lower the boom or secure it against dropping.
  3. Neutralize all controls.
- b. Check bridges before crossing; make sure they will support the weight of the machine.

4. Lock starter and remove ignition key to make the machine inoperative.
  5. Display proper warning signs on controls of machine.
  6. Keep hands, feet, and clothing away from gears, ropes, drums, and sheaves.
  7. Never put hands on wire rope when climbing to the top of the cab.
  8. Use a bar or stick to guide wire rope onto drums.
  9. Keep hands well away from the fan drive while engine is running.
  10. Safeguard the crane oiler; do not resume operation until a positive ALL CLEAR signal has been given.
  11. Replace all guards and shields before resuming operation.
- b. Place blocking or other adequate supports under the boom before beginning boom disassembly operations. Never stand under or on the boom during this work.
  - c. Before disconnecting oil lines, if machine has hydraulic controls, be sure to place boom on the ground or in the boom rest; then move the pedals and control levers to equalize pressures within the cylinders. Always release any air supercharge on the hydraulic reservoir and shut off the engine (or declutch pumps) before disconnecting oil lines.
  - d. Do not reach into hydraulic-boom holes unless the sections are securely anchored together.

#### 9.5.1.3 Ensuring Stability

- a. Know the rated capacity of the crane and the weight of the load. A safe lift depends on many factors including boom length, boom angle, and load radius. Follow these requirements to avoid buckling the boom or tipping:
    1. Know the radius of the load; the radius is measured from center of rotation, not from the boom foot pin.
2. Always operate within the rated capacity of the machine.
  3. The gross capacity includes weight of hook, block, and any material-handling devices, (i.e., slings, concrete bucket, magnet lifter, etc.); subtract the weight of all these to find the true weight (net capacity) the crane can handle safely.
  4. Ratings are based on operating the machine on firm, level ground; outriggers should be properly extended and lowered before operation.
  5. Avoid fast swings, hoists, or sudden braking; these can cause overloads.
  6. Do not handle large, heavy loads in strong winds; the wind can catch the load and create an unstable condition.
  - b. Test stability before lifting heavy loads. Check outrigger footing. Lift load slightly off the ground and stop. Check the machine for movement and check to be sure the brakes hold with the load elevated.
  - c. Never use machine stability to determine capacity.
  - d. If there are any indications of tipping, the machine is already overloaded for that working radius.
  - e. Do not back crane away from the load while carrying a maximum load; this may cause the crane to tip.
  - f. Always use outriggers when making lifts (with pick-and-carry units), and never lift a load forward of the front outriggers, unless allowed on manufacturer's load chart.
  - g. Lower outrigger jacks until the tires clear the ground, and level the unit to reach the machine's full capacity. Recheck and, if necessary, reset outriggers between heavy lifts.
  - h. Always fully extend outrigger beams unless otherwise specified on the manufacturer's load charts for the crane.

**9.5.1.4 Further Safety Considerations**

- a Make only vertical lifts; never pull the load sideways.
- b Keep speed slow in lifting and lowering loads.
- c Swing carefully and slowly, and avoid boom or jib “whipping”; check counterbalance clearance.
- d Do not let the load strike the boom or outriggers.
- e Allow maximum clearance between the hook block and boom-point sheaves.

- f Keep near-capacity loads as close to the ground as possible.
- g Avoid hitting anything with the boom; an engineering analysis shall be made before putting the crane back in service if this occurs.

**9.5.2 OPERATING NEAR POWER LINES AND TRANSMITTER TOWERS**

It is recognized that operating mobile cranes where they can become electrified from electric power lines is an extremely hazardous practice. It is advisable to perform the work so there is no possibility of the crane, load line, or load becoming a conductive path, (Figure 9-2).

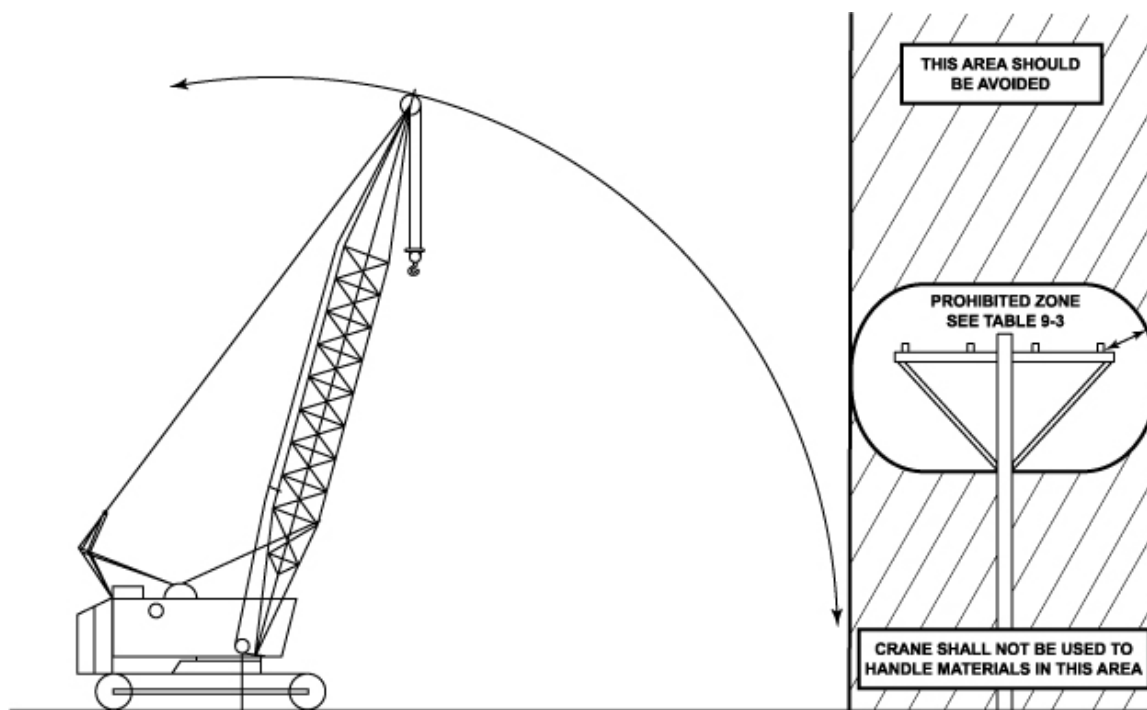

Reprinted from ASME B30.5-2004 by permission of The American Society of Mechanical Engineers. All rights reserved.

**Figure 9-2. Danger zone for cranes and lifted loads  
Operating near electrical transmission line.**

The following steps shall be taken to minimize the hazard of electrocution or serious injury as a result of contact between the energized power lines and the crane, load line, or load:

- a. The (electric) Power Marketing Administrations in DOE may deviate from the requirements of Table 9-3, providing the work is done according to line management-approved procedures that do not conflict with statutory or approved variances from these regulations.
- b. Any overhead wire shall be considered to be an energized line unless and until the person owning the line or the electrical utility authorities indicate that it is not an energized line.
- c. Durable signs shall be installed at the operator's station and on the outside of the crane, warning that electrocution or serious bodily injury may occur unless a minimum clearance of 10 ft (3.1m) is maintained between the crane or the load being handled and energized power lines. Greater clearances are required because of higher voltage as stated in Table 9-3. These signs shall be revised, but not removed when a local jurisdiction requires greater clearances.
- d. Exercise caution when working near overhead lines having long spans as they tend to move laterally or vertically due to the wind, which could cause them to breach the safety zone.
- e. Cranes shall not be used to handle materials stored under electric power lines unless any combination of the boom, load, load line, or machine component cannot enter the prohibited zone.
- f. Crane operators shall not rely on the coverings of wires for their protection.

#### **9.5.2.1 Crane Operation Near De-energized and Grounded Electric Power Lines**

This is the preferred condition under which the operation can be performed safely. The hazard of injury or death due to electrocution has been removed. The following steps shall be taken to assure de-energization of the power lines has occurred:

- a. The power company or owner of the power lines shall de-energize the lines.
- b. The lines shall be visibly grounded to avoid electrical feedback and appropriately marked at the job-site location.
- c. A qualified representative of the owner of the lines or a designated representative of the electrical utility shall be on site to verify that steps (a) and (b) have been completed and that the lines are not energized.

#### **9.5.2.2 Power Lines Energized, Crane Operating Less than Erected/Fully Extended Boom Length away from the Prohibited Zone (see Figure 9-3)**

- a. An on-site meeting between project management and a qualified representative of the owner of the lines or a designated representative of the electrical utility shall take place to establish the procedures to safely complete the operations.
- b. The specified clearance between the power lines and the crane, load line, and load shall be maintained at all times as specified in Table 9-3.
- c. Load control, when required, shall utilize tag lines of a non-conductive type.
- d. A designated signaler, whose sole responsibility is to verify that the required clearance is maintained, shall be in constant contact with the crane operator.
- e. No one shall be permitted to touch the crane or the load unless the designated signaler indicates it is safe to do so.
- f. Operation of boom and load over electric power lines is extremely dangerous, due to perception of distance and multiple contact points as viewed from the position of the operator and/or position of the designated signaler. The operator should avoid operating the crane, with or without a load, in this area.
- g. The horizontal and vertical distance of movement of long span lines due to the wind shall be added to the minimum clearance

distance as specified in Table 9-3. A qualified representative of the owner of the lines or a designated representative of the electrical utility shall be consulted for specific distances.

- h. Devices such as ribbons, balls, etc., should be attached by a qualified person to the power lines to improve visibility, or equivalent means employed to aid in location of the prohibited zone.

**Table 9-3. Safe working distance from power lines.**

<b>a. When operating near high-voltage power lines:</b>				
<b>Normal voltage (phase to phase)</b>				<b>Minimum required clearance</b>
Up		to	50 kV	10 ft ( 3.1 m)
Over	50	to	200 kV	15 ft ( 4.6 m)
Over	200	to	350 kV	20 ft ( 6.1 m)
Over	350	to	500 kV	25 ft ( 7.6 m)
Over	500	to	750 kV	35 ft (10.7 m)
Over	750	to	1000 kV	45 ft (13.7m)

<b>b. While in transit with no load and boom or mast lowered:</b>				
<b>Normal voltage (phase to phase)</b>				<b>Minimum required clearance</b>
Up		to	0.75 kV	4 ft (1.2 m)
Over	0.75	to	50 kV	6 ft (1.8 m)
Over	50	to	345 kV	10 ft (3.1 m)
Over	345	to	750 kV	16 ft (4.9 m)
Over	750	to	1000 kV	20 ft (6.1 m)

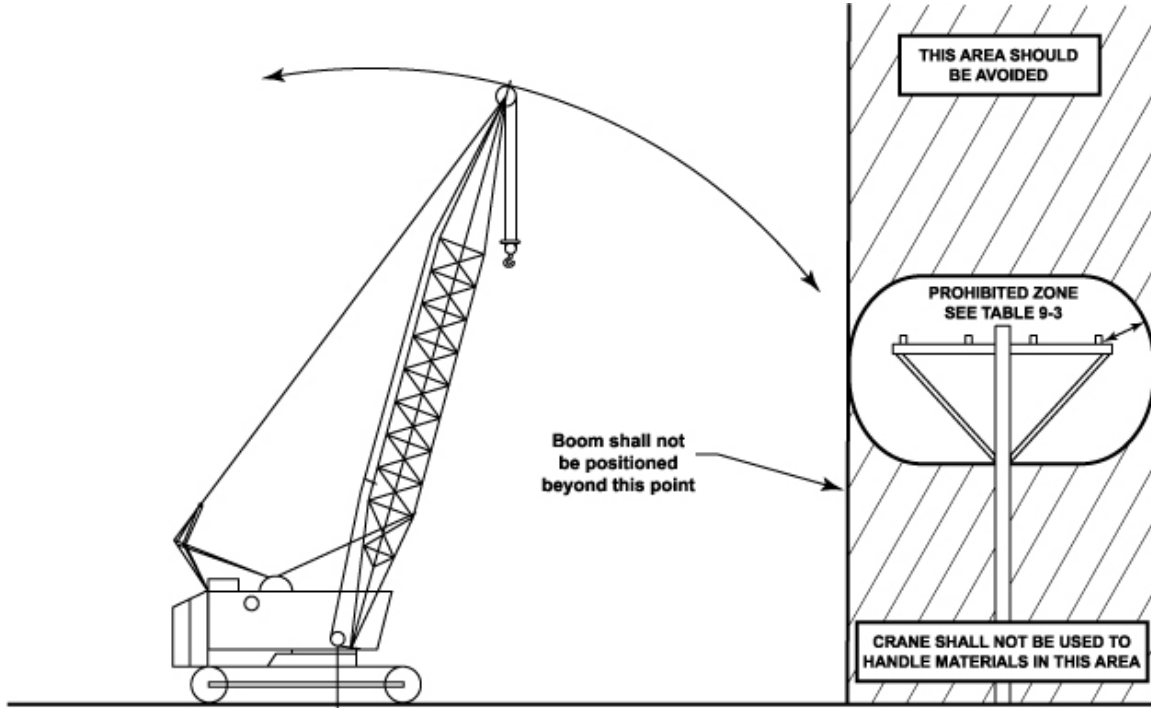

Reprinted from ASME B30.5-2004 by permission of The American Society of Mechanical Engineers. All rights reserved.

**Figure 9-3. Danger zone for cranes and lifted loads  
Operating near electrical transmission line.**

### 9.5.2.3 Crane Operations are Within the Prohibited Zone and the Power Lines are Energized

- a. Before such operations take place, a qualified person together with a qualified representative of the utility or an engineer qualified in power line transmission shall after visiting the site, determine if this is the most feasible way to complete the operation, and set minimum required clearances and procedures for safe operations. These operations shall be under their supervision.

The following guidelines should be required:

1. Crane/load grounded to a neutral line by the utility.
  2. Electrical system protective devices that automatically re-energize the circuit after a power line contact occurrence should be blocked or disengaged to inhibit this function.
  3. Insulated barriers, which are not a part of nor an attachment to the crane and which will not allow contact between the energized electric power lines and the crane, load lines, or load.
  4. Non-conductive barricades to restrict access to the crane work area.
- b. Load control, when required, shall utilize tag lines of a non-conductive type.
  - c. A designated signaler, whose sole responsibility is to verify that the clearances established are maintained, shall be in constant contact with the crane operator.
  - d. The person responsible for the operation shall alert and warn the crane operator and all persons working around or near the crane about hazard of electrocution or serious injury and instruct them on how to avoid the hazard.
  - e. All non-essential personnel shall be removed from the crane work area.
  - f. No one shall be permitted to touch the crane or the load unless the signaler indicates it is safe to do so.

### 9.5.2.4 Crane in Transit With No Load and Boom Lowered (see Figure 9-4)

- a. Cranes in transit with no load and boom lowered shall maintain clearance as specified in Table 9-3.
- b. A designated signaler shall be assigned to observe the clearance and give warning before the crane approaches the above limits.
- c. When planning transit of the crane, the effect of speed and terrain on the boom and crane movement shall be considered.

### 9.5.2.5 Crane Operation Near Transmitter Towers (see Figure 9-5)

- a. Prior to work near transmitter towers where an electrical charge can be induced in the equipment or materials being handled, the transmitter shall be deenergized or tests shall be made to determine if electrical charge is induced on the crane. The following precautions shall be taken when necessary to dissipate induced voltages:
  1. The equipment shall be provided with an electrical ground directly to the upper rotating structure supporting the boom.
  2. Ground jumper cables shall be attached to materials being handled by boom equipment when electrical charge is induced while working near energized transmitters; crews shall be provided with nonconductive poles having large alligator clips or other similar protection to attach the ground cable to the load.
  3. Combustible and Flammable materials shall be removed from the immediate area prior to operations.

### 9.5.3 HOIST-LIMIT SWITCH

Check all limit switches, if supplied, without a load on the hook at the beginning of each work shift or the first time the crane is used that shift. Inch each motion into its limit switch to ensure that two-blocking does not occur during the test. If a lift is in progress during a shift change, this testing requirement is considered to have been



satisfied for the completion of that lift.  
However, test the limit switch again before the  
next lift.

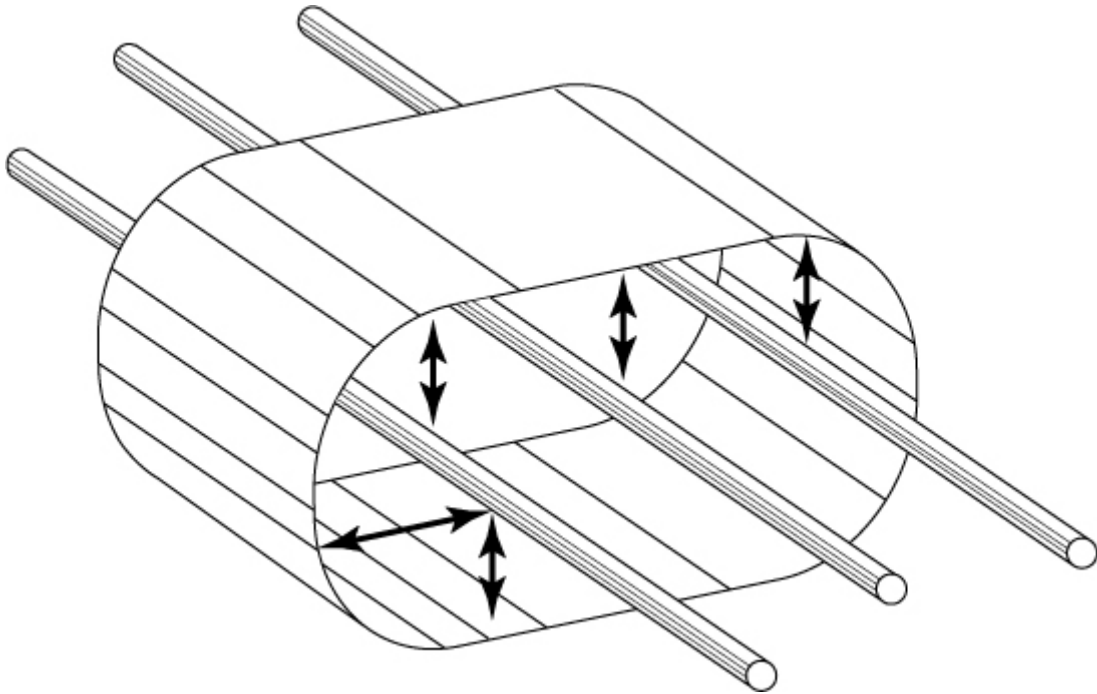

Reprinted from ASME B30.5-2004 by permission of The American Society of Mechanical Engineers. All rights reserved.

**Figure 9-4. Danger zone for cranes and lifted loads  
Operating near electrical transmission line.**

(See Table 9-3 for minimum radial distance of prohibited zone.)

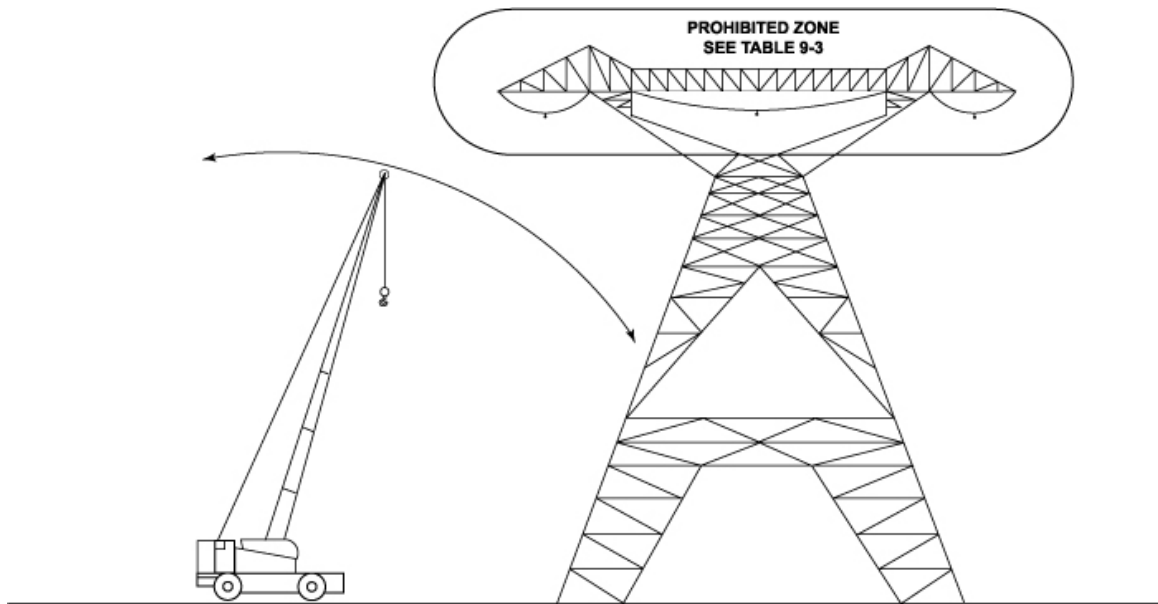

Reprinted from ASME B30.5-2004 by permission of The American Society of Mechanical Engineers. All rights reserved.

**Figure 9-5. Danger zone for cranes and lifted loads operating near electrical transmission line.**

#### 9.5.4 STANDARD HAND SIGNALS

The standard hand signals for DOE use shall be as specified in the latest edition of the ASME B30 standards for the particular type of crane or hoist being used (see Figure 9-6).

#### 9.5.5 IDENTIFICATION OF SIGNALERS

- a. All personnel acting as signalers during crane operations shall be clearly identified to the crane operator. Options for improving signaler visibility include using an orange hardhat, orange gloves or an orange vest.
- b. In those cases where the crane operator cannot see the signaler, a second person (relay signaler) shall be stationed where he or she can see both the signaler and the crane operator, and can relay the signals to the operator. The relay signaler shall also be clearly identified to the crane operator.
- c. The operator shall obey signals only from the designated signaler. *Obey a STOP signal no matter who gives it.*

#### 9.5.6 STANDARD VOICE SIGNALS

- a. Prior to beginning lift operations using voice signals, the signals shall be discussed and agreed upon between the person-in-charge, the crane operator, the appointed signal person and the riggers.
- b. Radios or equivalent shall be tested before lifting operations begin.
- c. Prior to commencing a lift, the crane operator and the signal person shall contact and identify each other.
- d. All directions given to the crane operator by the signal person shall be given from the crane operator's direction perspective (e.g., right swing).
- e. Each series of voice signals shall contain three elements stated in the following order:
  1. Function and direction
  2. Distance and/or speed

3. Function stop

#### 9.5.7 SPECIAL SIGNALS

For operations or crane attachments not covered by standard hand, voice or audible signals, additions to or modifications of the standard signal procedures may be required. In all such cases, the required special signals shall be agreed upon in advance by the manager, person-in-charge, crane operator, signal person and riggers. These special signals shall not be in conflict with the standard signals.

#### 9.5.8 SIZE OF LOAD

The crane shall not be loaded beyond its rated capacity, except of authorized testing described in Section 9.3.

#### 9.5.9 ATTACHING THE LOAD

- a. Ensure that the hoist rope is free from kinks or twists. Do not wrap the hoist rope around the load.
- b. Ensure that the load is attached to the load-block hook by means of slings or other approved devices.
- c. Ensure the load is well secured and properly balanced in the sling or lifting device before it is lifted more than a few inches.
- d. Take care to make certain that the sling clears all obstacles.





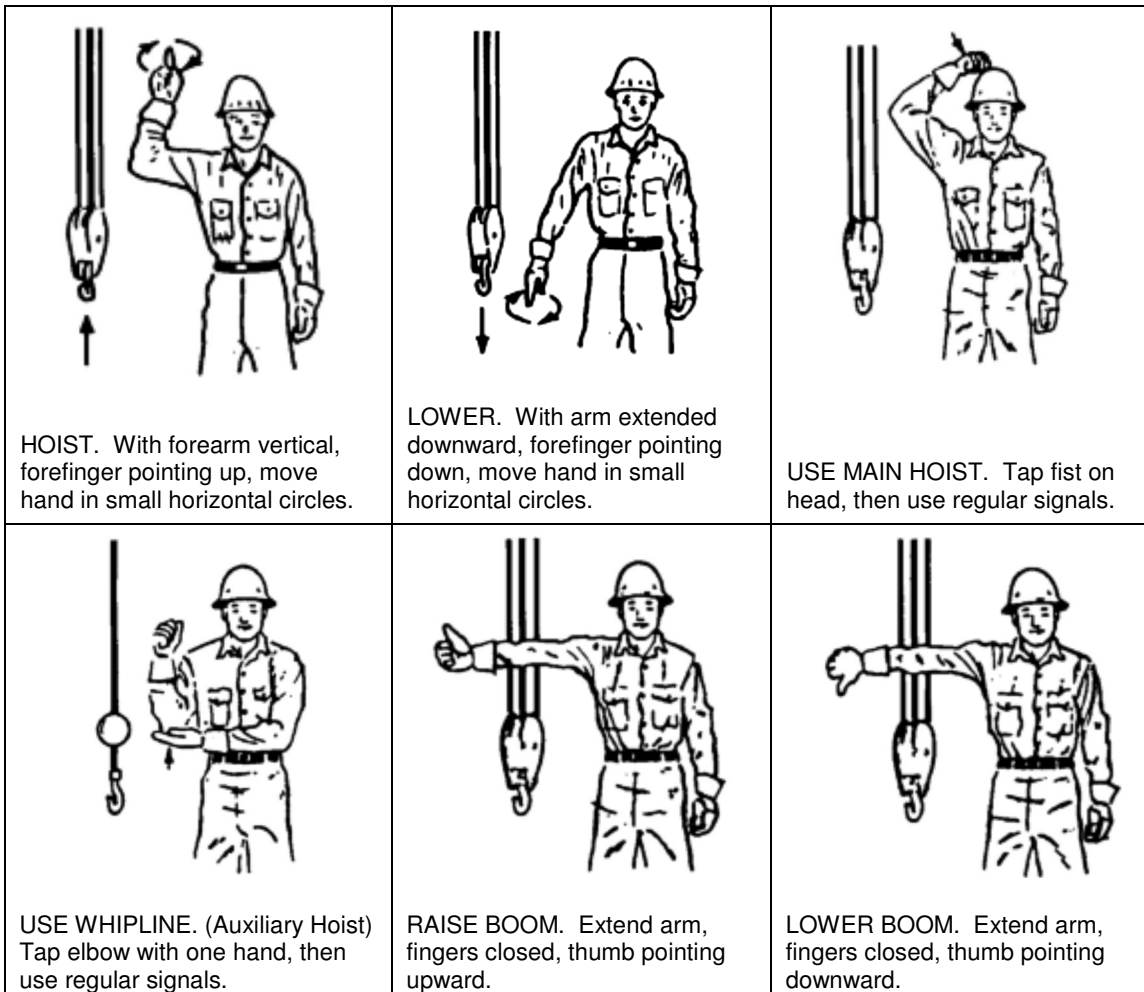

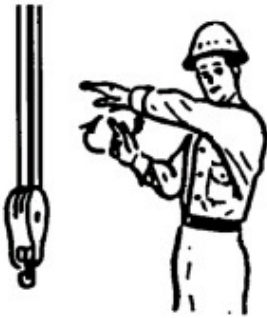

#### 9.5.10 MOVING THE LOAD

- a. The appointed person directing the lift shall make certain that the load is well secured and properly balanced in the sling or lifting device before it is lifted more than a few inches.
- b. Before starting to hoist, not the following conditions:
  1. Hoist rope shall not be kinked.
  2. Multiple-part lines shall not be twisted around each other.

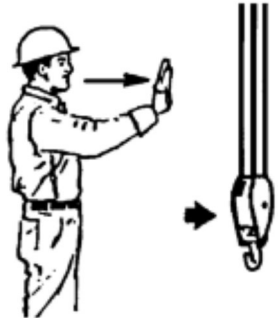

Reprinted from ASME B30.5-2004 by permission of The American Society of Mechanical Engineers. All rights reserved.

**Figure 9-6. Standard hand signals for controlling mobile crane operation.**

 <p>MOVE SLOWLY. Use one hand to give any motion signal and place other hand motionless above the hand giving the motion signal. (Hoist slowly shown as example.)</p>	 <p>RAISE THE BOOM AND LOWER THE LOAD. With arm extended, thumb pointing up, flex fingers in and out as long as load movement is desired.</p>	 <p>LOWER THE BOOM AND RAISE THE LOAD. With arm extended, thumb pointing down, flex fingers in and out as long as load movement is desired.</p>
 <p>SWING. Extend arm, point with finger in direction of swing of boom.</p>	 <p>STOP. Extend arm, palm down; move arm back and forth horizontally.</p>	 <p>EMERGENCY STOP. Both arms extended, palms down, move arms back and forth horizontally.</p>
 <p>TRAVEL. Extend arm forward, hand open and slightly raised; make pushing motion in direction of travel.</p>	 <p>DOG EVERYTHING. Clasp hands in front of body.</p>	 <p>TRAVEL (Both Tracks). Use both fists in front of body, making a circular motion about each other, indicating direction of travel, forward or backward (for land cranes only).</p>

Reprinted from ASME B30.5-2004 by permission of The American Society of Mechanical Engineers. All rights reserved.

Figure 9-6. (continued).

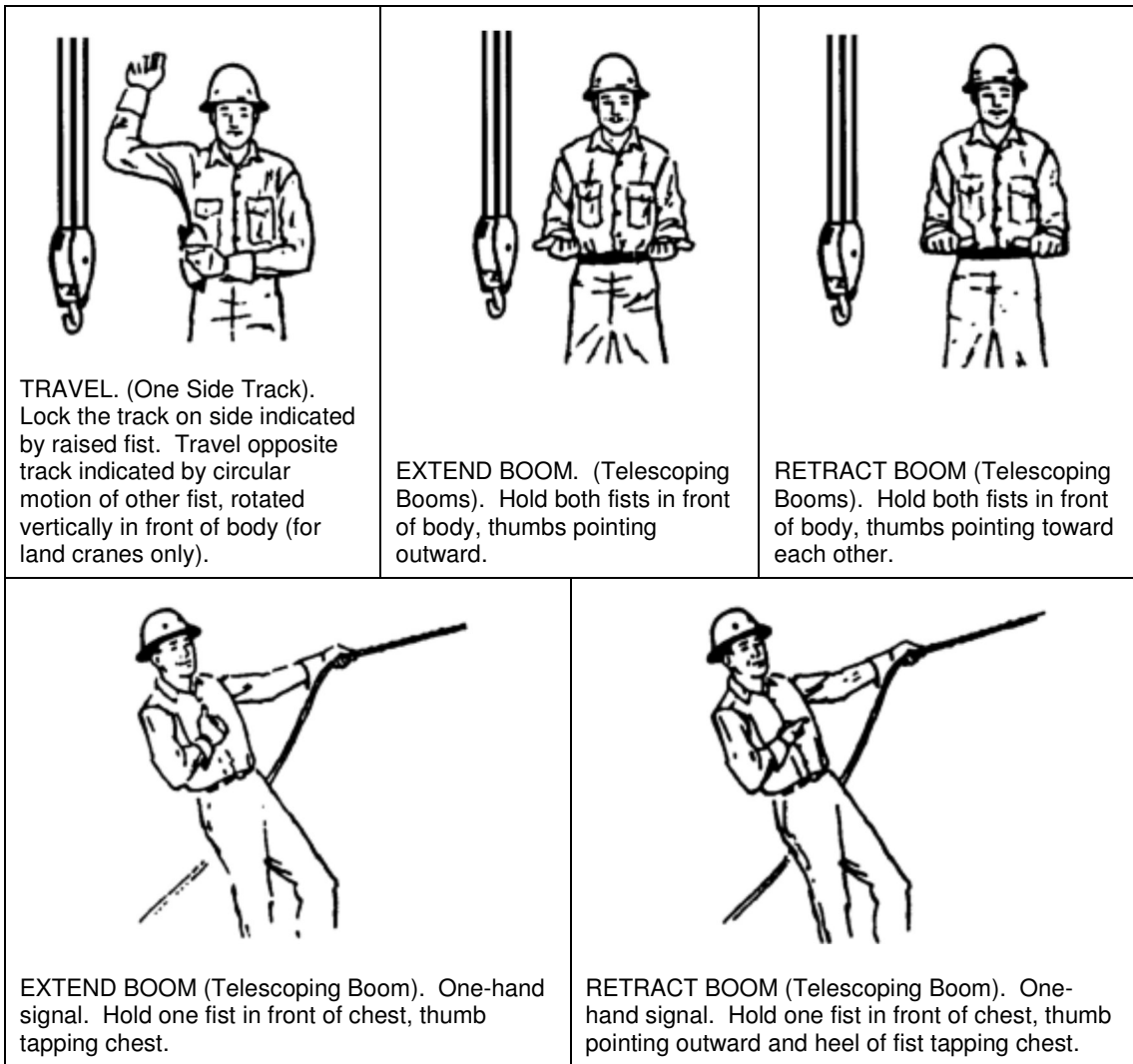

Reprinted from ASME B30.5-2004 by permission of The American Society of Mechanical Engineers. All rights reserved.

**Figure 9-6. (continued).**

3. The hook shall be positioned above the center of gravity of the load in such a manner as to minimize swinging when the load is lifted.
  4. Following any slack-rope condition, it should be determined that the rope is properly seated on the drum and in the sheaves.
  5. All personnel including the qualified rigger shall be clear of the load.
- c. During hoisting, take care to ensure that:
1. There is no sudden acceleration or deceleration of the moving load.
  2. Load does not contact any obstructions. A “dry run” shall be conducted in areas where clearance is limited.
- d. Cranes shall not be used for side pulls, except when specifically authorized by a designated person who has determined that the stability of the crane is not endangered and that various parts of the crane will not be over stressed.
- e. Avoid carrying loads over people.
- f. No hoisting, lowering, swinging, or traveling shall be done while anyone is on the load hook, except as noted in Chapter 4, “Lifting Personnel.”
- g. Test the brakes each time a load approaching the rated capacity is handled by raising the load a few inches and applying the brakes.
- h. Do not lower the load below the point where less than two full wraps of rope remain on the hoist drum.
- i. Do not leave your position at the controls while the load is suspended, unless required to do so by an approved emergency procedure.
- j. If the load must remain suspended for any considerable length of time, the operator shall hold the drum from rotating in the lowering direction by activating the positive controllable means of the operator’s station.
- k. Work on suspended loads is prohibited under normal conditions. When the responsible manager decides that it is necessary to work on a suspended load, guidelines for ensuring safety of the work shall be established through consultation with the appropriate safety organization. Suspended loads that must be worked on shall be secured against unwanted movement.
- l. Tag lines should be used as required to guide, snub, or otherwise control the load.

#### 9.5.11 ORDINARY LIFTS

- a. The requirements of all preceding paragraphs in Section 9.5, “Operation,” also shall apply to ordinary lifts.
- b. An appointed person shall classify each lift into one of the DOE categories (ordinary, critical or preengineered production) before the lift is planned.
- c. Hoisting and rigging operations for ordinary lifts require a designated leader who shall be present at the lift site during the entire lifting operation. If the lift is being made by only one person, that person assumes all responsibilities of the designated leader.
- d. Leadership designation may be by written instructions, specific verbal instructions for the particular job, or clearly defined responsibilities within the crew’s organizational structure.
- e. The designated leader’s responsibility shall include the following:
  1. Ensure that personnel involved understand how the lift is to be made.
  2. Ensure that the weight of the load is determined, that proper equipment and accessories are selected, and that rated capacity is not exceeded.
  3. Survey the lift site for hazardous/unsafe conditions.
  4. Ensure that equipment is properly set up and positioned.

5. Ensure that a signaler is assigned, if required, and is identified to the operator. qualified person shall examine deficiencies and determine whether they constitute a hazard.
  6. Direct the lifting operation to ensure that the lift is completed safely and efficiently. i. Check hoist-limit switches, if provided, according to Section 9.5.3, "Hoist-Limit Switch."
  7. Stop the job when any potentially unsafe condition is recognized. j. Ensure that basic operating instructions of power-operated equipment, together with charts, tables, or diagrams showing the rated capacity, boom angle, swing, and stability data are posted in convenient view of the operator.
  8. Direct operations if an accident or injury occurs. k. Check load lines after strain is put on them but before the load is lifted clear of the ground; if load lines are not plumb, reposition the slings or equipment so that the lines are plumb before continuing.
- f. The designated leader shall inspect all cranes to ensure that they are still within the inspection interval.
- g. The designated leader shall inspect all lifting devices to ensure that the rated capacity of these items of equipment will not be exceeded.
- h. The operator shall inspect for damage and defects in accordance with Section 9.2.3, including observations during operation. A

#### 9.5.12 CRITICAL LIFTS

See Chapter 2, "Critical Lifts," for critical-lift requirements.



Exhibit I is intended to be a sample form only.  
The equipment manufacturer's inspection/testing  
criteria supercede any other criteria.  
In cases where the equipment manufacturer does not include  
inspection/testing criteria, other forms developed to facilitate  
required inspection/testing are acceptable.

INTENTIONALLY BLANK

EXHIBIT I  
(SAMPLE FORM)

MOBILE CRANE LOAD TEST

LICENSE OR EQUIPMENT NO. \_\_\_\_\_ MAKE \_\_\_\_\_ DATE \_\_\_\_\_

HOUR METER-ODOMETER TOTAL \_\_\_\_\_ RATED CAPACITY \_\_\_\_\_

LOAD TEST INSPECTION REPORT

The following checklist identifies the items to be inspected prior to the load test. Any unusual conditions observed during the inspection should be noted in the Remarks section. Equipment shall be inspected by maintenance personnel prior to load test.

- NOTES: 1. Qualified inspector shall verify the inspection is completed.  
2. Craftsmen shall initial and date all tests, work, and inspections completed below.

NO.	CRANE ITEM	DEFECT	OK	NA	NO.	CRANE ITEM	DEFECT	OK	NA
1	Wire Rope				13	Hoist Clutch Lining			
2	Cracked or Worn Sheaves & Drums				14	Hoist Drum Brake Bands			
3	Limit Switch (Anti-Two-Blocking)				15	Open Gears			
4	Boom				16	Boom Jibs (Where Applicable)			
5	Master Clutch				NO.	CARRIER ITEM	DEFECT	OK	NA
6	Steering Clutches				1	Steering Gears and Connections			
7	Hydraulic Pump				2	Brakes (Service and Hand)			
8	Hydraulic Controls				3	Tires and Wheels			
9	Hydraulic Hoses				4	General Lubrication			
10	Mechanical Controls					OPERATING TEST			
11	Drive Chains					OVERALL CONDITION			
12	Swing Clutches								

REMARKS (Unusual conditions – noises, structural cracks, misalignment, etc.)

---



---

SAFETY ITEMS: (Fire extinguisher, signs, guards, etc.)

EXHIBIT I (continued)  
(SAMPLE FORM)MOBILE CRANE LOAD TEST AND FOLLOW-UP CHECKS

- NOTES:**
1. Craftsman shall initial all steps completed below.
  2. Qualified inspector shall verify all steps below.
- \_\_\_\_\_ 1. Set crane up for load test and inspection.
  - \_\_\_\_\_ 2. Perform operations test without load to verify proper function of the following:
    - Load lifting and lowering mechanisms
    - Boom lifting and lowering mechanism
    - Boom extension and retraction mechanisms
    - Swinging mechanism
    - Travel mechanism
    - Safety devices.
  - \_\_\_\_\_ 3. Test loads shall not exceed 110% of rated capacity. Refer to load chart for load test capacity at maximum and minimum working radius. Check boom angle indicators for accuracy.
  - \_\_\_\_\_ 4. Rig test weights to hook using appropriate slings.
  - \_\_\_\_\_ 5. Hoist the test load a sufficient distance to ensure that the load is supported by the crane and held by the hoist brakes. Hold the load for 10 min or the time required to check all primary load-bearing parts while under load without slippage, damage, or permanent deformation.
  - \_\_\_\_\_ 6. At least once during the lifting portion of the hoisting cycle and once during the lowering cycle, power to the hoisting equipment shall be completely turned off. There shall be no slippage of the load or overheating of the brakes.
  - \_\_\_\_\_ 7. Lower the load to approximately 2 in. off the ground to check for swing-roller operation and outrigger stability. Slowly swing test load between outrigger locations.
  - \_\_\_\_\_ 8. Move the load back to the original position and slowly lower to ground.
  - \_\_\_\_\_ 9. At the completion of the load test, inspect the following:
 

Visually inspect rope in accordance with Section 9.2.6.

EXHIBIT I (continued)  
(SAMPLE FORM)

MOBILE CRANE LOAD TEST AND FOLLOW-UP CHECKS

DEFECTIVE/OK/NA

- \_\_\_\_\_ a. Rope diameter: (Previous) \_\_\_\_\_ (Present) \_\_\_\_\_
- \_\_\_\_\_ b. Wear
- \_\_\_\_\_ c. Kinks
- \_\_\_\_\_ d. Broken wires
- \_\_\_\_\_ e. Other signs of deterioration.

Visually inspect the rope drum for:

- \_\_\_\_\_ a. Wear
- \_\_\_\_\_ b. Deformation
- \_\_\_\_\_ c. Deterioration
- \_\_\_\_\_ d. Have qualified inspector perform nondestructive tests on hook by visual examination, liquid penetrant examination, or magnetic-particle examination.  
Acceptance: No cracks, linear indications, laps, or seams.

Hooks with more than 5% normal (new hook) throat opening not to exceed 1/4 in. (or as recommended by the manufacturer) shall be replaced. Hooks with any visibly apparent bend or twist from the plane of the unbent hook (new hook) shall be replaced. Hooks having more than 10% wear in the bowl section or 5% elongation of the shank shall be replaced. Lubricate hook bearing and latch pin, as applicable.

Establish three marks; A, B, and C, with a center punch. For ease in measuring, set distances on an even number of inches.

BEFORE LOAD TEST

- Length AB \_\_\_\_\_ in.
- Length BC \_\_\_\_\_ in.

AFTER LOAD TEST

- Length AB \_\_\_\_\_ in.
- Length BC \_\_\_\_\_ in.

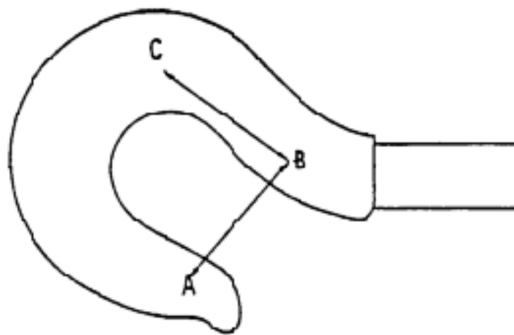

Check for:

1. Wear and deformation
2. Cracks and twisting
3. Signs of opening between Point A and Point B

EXHIBIT I (continued)  
**(SAMPLE FORM)**

MOBILE CRANE LOAD TEST LOAD AND FOLLOW-UP CHECKS

This information should be retained with the equipment.

Record the following:

BLOCK WEIGHT \_\_\_\_\_ lb.

TEST WEIGHT \_\_\_\_\_ lb.

RADIUS/CENTER PIN TO LOAD \_\_\_\_\_ ft.

PARTS LINE \_\_\_\_\_ quantity

BOOM LENGTH \_\_\_\_\_ ft.

Load Test Inspection Date \_\_\_\_\_

Qualified Inspector \_\_\_\_\_

Operated By \_\_\_\_\_

EXHIBIT II  
(SAMPLE FORM)

MOBILE CRANE PRE-OPERATIONAL CHECKLIST  
(Records Are Not Required)

<b>STATUS CODE: SAT – Satisfactory    UNSAT – Unsatisfactory    R – Repaired    N/A – Not Applicable</b>		
EXTERNAL	CODE	COMMENT
Check Fuel Cap		
Crankcase Oil Level		
Cold Weather Starting Aid		
Radiator		
Antifreeze & Coolant		
Cleaners		
Fan Belts		
Pumps & Motors		
Battery		
Muffler		
Brake & Air System (Bleed)		
Hydraulic Reservoir		
Hydraulic Oil Filter		
All Hydraulic Hoses & Fittings		
Auto Transmission Oil Level		
Air Compressor Oil Level		
Outriggers & Boxes		
Outriggers Float Pads		
Tire Condition & Pressure		
Wheel Lugs		
Hoists		
Boom Attachments		
Lubrication/Grease or Oil Leaks		
All Sheaves Lubed		

EXHIBIT II (continued)  
**(SAMPLE FORM)**

MOBILE CRANE PRE-OPERATIONAL CHECKLIST  
 (Records Are Not Required)

EXTERNAL	CODE	COMMENT
Wire Rope Kinks or Breaks		
Wire Rope Dirt & Lube		
Hook & Hook Block		
Counterweight & Torque		
Handrails		
Lamps:		
• Turn Signals		
• Flashers		
• Headlamps		
• Cab		
• Boom		
• Backup		
Welds & Cracks:		
• Hoists		
• Boom		
• Sheaves		
• Sheaves		
• Hook		
• Block		
• Motor		
• Valves		
• Cylinders		
<b>REMARKS</b>		



EXHIBIT II (continued)  
**(SAMPLE FORM)**

MOBILE CRANE PRE-OPERATIONAL CHECKLIST  
 (Records Are Not Required)

INSIDE CAB	CODE	COMMENT
Fire Extinguisher Pressure		
Operator Manual & Load Chart		
Hand Signal Chart		
Glass		
Windshield Wiper		
GAUGES: Oil, Fuel, Amp		
Lights & Horn		
Backup Alarm		
Heater		
Boom Angle Indicator (PAT)		
Load Moment Indicator		
Anti Two Block		
Boom Stops		
Gearshift Control		
Foot & Parking Brakes		
Swing Brake		
Control Lever Linkage		
Throttle Linkage		
Engine RPM		
<b>REMARKS</b>		

INTENTIONALLY BLANK

EXHIBIT III  
(SAMPLE FORM)

MOBILE CRANE FREQUENT INSPECTION REPORT

MODEL #: _____ SERIAL #: _____ HOUR METER: _____		
STATUS CODE: SAT – Satisfactory UNSAT – Unsatisfactory R – Repaired N/A – Not Applicable		
FREQUENT	CODE	COMMENT
Check Bolt Torque:		
• Transmission Mount		
• Turntable		
• Engine Mount		
• Hoist Mount		
• Axle Mount		
Engine RPM		
Muffler Connections		
Wiring harness		
Battery Cable		
Battery Water Level		
Master Cylinders		
Pump Drive Gearbox		
Swing Gearbox		
Axle Lockout		
Axle Differential		
Axle Planetary Oil		
Welds & Cracks		
• Hoist		
• Boom		
• Sheaves		
• Hook		
• Block		

EXHIBIT III (continued)

(SAMPLE FORM)

MOBILE CRANE FREQUENT INSPECTION REPORT

FREQUENT	CODE	COMMENT
• Motor		
• Valves		
• Cylinders		
Lamps:		
• Turn Signals		
• Headlamps		
• Cab		
• Boom		
• Backup		
Boom Sheaves		
Boom Alignment		
Jib Alignment		
Machine Structure		
Clean/Change:		
• Differential Breather		
• Fuel Filter Screen		
• Compressor Strainer		
• Transmission Filter		
Drum		
Wire Rope: Dirt/Lube/Kinks		
Hook & Latch		
Block & Sheaves		
Guards in Position		
Emergency Stop		
Comments: Note Any Potential Hazards or Malfunctions		

EXHIBIT IV  
(SAMPLE FORM)

MOBILE CRANE PERIODIC INSPECTION REPORT

MODEL #: _____ SERIAL #: _____ HOUR METER: _____		
STATUS CODE: SAT – Satisfactory UNSAT – Unsatisfactory R – Repaired N/A – Not Applicable		
PERIODIC	CODE	COMMENT
Check Bolt Torque:		
• Transmission Mount		
• Turntable		
• Engine Mount		
• Gearbox Mount		
• Axle Mount		
Engine RPM		
Muffler Connections		
Wiring harness		
Battery Cable		
Battery Water Level		
Master Cylinders		
Pump Drive Gearbox		
Swing Gearbox		
Axle Lockout		
Axle Differential		
Axle Planetary Oil		
Boom Sheaves		
Boom Alignment		
Jib Alignment		
Machine Structure		
Drum		
Wire Rope Dirt/Lube/Kinks		

EXHIBIT IV (continued)  
**(SAMPLE FORM)**  
MOBILE CRANE PERIODIC INSPECTION REPORT

PERIODIC	CODE	COMMENT
Clean/Change		
• Differential Breather		
• Fuel Filter Screen		
• Compressor Strainer		
• Transmission Filter		
Drum		
Wire Rope: Dirt/Lube/Size/Kink		
Hook & Latch		
Block & Sheave		
Guards in Position		
Emergency Stop		
Welds & Cracks:		
• Hoists		
• Boom		
• Sheaves		
• Hook		
• Block		
• Motor		
• Valves		
• Cylinders		
Lamps:		
• Turn Signals		
• Headlamps		
• Flashers		
• Cab		
• Boom		

EXHIBIT IV (continued)  
**(SAMPLE FORM)**  
MOBILE CRANE PERIODIC INSPECTION REPORT

PERIODIC	CODE	COMMENT
• Backup		
Paint		
Cracks or Leaks:		
• Swing Gearbox Case		
• Transmission Case		
• Pump Drive Box		
• Engine Intake		
Boom Wear Pads		
Brake Liners		
Axle Planetary Hubs		
Cleaner		
Clutch Release Bearing		
Gear Shift Control		
Steering System Oil		
Crankcase Breather		
Tie Rod Ball Joints		
Steering Knuckles		
Drag Link Ends		
Drag Link U-Joint		
Windshield Wiper		
Lever Indicator		
Emergency Brake		
Gauges: Oil, Fuel, Amp		
<b>CIRCLE ONE:</b>	<b>PASS</b>	<b>FAIL</b>
INSPECTOR (Print): _____ Signature: _____ Date: _____		

INTENTIONALLY BLANK