

DOT/FAA/AR-95/109

Office of Aviation Research
Washington, D.C. 20591

Comparative Evaluation of Failure Analysis Methods for Composite Laminates

May 1996

Final Report

This document is available to the U.S. public
through the National Technical Information
Service, Springfield, Virginia 22161.



U.S. Department of Transportation
Federal Aviation Administration

NOTICE

This document is disseminated under the sponsorship of the U.S. Department of Transportation in the interest of information exchange. The United States Government assumes no liability for the contents or use thereof. The United States Government does not endorse products or manufacturers. Trade or manufacturer's names appear herein solely because they are considered essential to the objective of this report. This document does not constitute FAA certification policy. Consult your local FAA aircraft certification office as to its use.

This report is available at the Federal Aviation Administration William J. Hughes Technical Center's Full-Text Technical Reports page: www.tc.faa.gov/its/act141/reportpage.html in Adobe Acrobat portable document format (PDF).

Technical Report Documentation Page

1. Report No. DOT/FAA/AR-95/109		2. Government Accession No.		3. Recipient's Catalog No.	
4. Title and Subtitle COMPARATIVE EVALUATION OF FAILURE ANALYSIS METHODS FOR COMPOSITE LAMINATES				5. Report Date May 1996	
				6. Performing Organization Code	
7. Author(s) C.T. Sun, B.J. Quinn, J. Tao, Purdue University, D.W. Oplinger, William J. Hughes Technical Center				8. Performing Organization Report No.	
9. Performing Organization Name and Address School of Aeronautics and Astronautics Purdue University West Lafayette, IN 47907-1282				10. Work Unit No. (TRAIS)	
				11. Contract or Grant No.	
12. Sponsoring Agency Name and Address U.S. Department of Transportation Federal Aviation Administration Office of Aviation Research Washington, D.C. 20591				13. Type of Report and Period Covered Final Report	
				14. Sponsoring Agency Code AAR-431	
15. Supplementary Notes Analysis performed and report prepared by: Galaxy Scientific Corporation 2500 English Creek Ave., Building 11 Egg Harbor Township, NJ 08234-5562 FAA COTR: Donald Oplinger					
16. Abstract Over the last three decades, there have been continuous efforts in developing failure criteria for unidirectional fiber composites and their laminates. Currently, there exist a large number of lamina failure criteria and laminate failure analysis methods. In this project, a comprehensive and objective study of lamina and laminate failure criteria was performed. Comparisons among the commonly used failure criteria were made for failure in unidirectional composites under various loading cases. From these comparisons, the characteristics of these criteria were identified and discussed. Further, with the aid of some limited experimental lamina and laminate strength data available in the literature and new data generated by the authors, an attempt was made to select the failure criteria and laminate analysis methods that are mechanistically sound and are capable of accurately predicting lamina and laminate strengths for states of combined stresses. It was found that those lamina failure criteria which separate fiber and matrix failure modes most accurately predict lamina and laminate strength.					
17. Key Words Fiber composites, Strength Failure rules, Failure analysis			18. Distribution Statement This document is available to the public through the National Technical Information Service (NTIS), Springfield, Virginia 22161.		
19. Security Classif. (of this report) Unclassified		20. Security Classif. (of this page) Unclassified		21. No. of Pages 132	22. Price

TABLE OF CONTENTS

	Page
EXECUTIVE SUMMARY	ix
1. INTRODUCTION	1
2. LAMINA FAILURE ANALYSIS	1
2.1 Lamina Failure Criteria	2
2.2 Comparison among Lamina Failure Criteria	6
2.2.1 Bidirectional Stress Plane	6
2.2.2 Off-Axis Loading	10
2.2.3 Pure Shear	12
2.3 Comparison with Experimental Data	15
2.3.1 Lamina Failure Criteria Comparison With Off-Axis Tension Data	15
2.3.2 Lamina Failure Criteria Comparison with Tubular Specimens	17
2.4 Analysis of the Physical Basis for Lamina Failure Criteria	23
2.4.1 Fiber Failure	24
2.4.2 Matrix Failure	24
2.4.3 Generation of Failure Envelopes in the Stress Planes	25
2.4.4 On the Maximum Strain Criterion	26
2.4.5 Dependence of Shear Strength on Compressive Normal Stress σ_{22}	26
2.4.6 Concluding Observations on Lamina Failure Criteria	29
3. LAMINATE FAILURE ANALYSIS	30
3.1 Stiffness Reduction	30
3.1.1 Parallel Spring Model	31
3.1.2 Incremental Stiffness Reduction Model	32
3.2 Laminate Failure Analysis Methods	33
3.2.1 Ply-By-Ply Discount Method	33
3.2.2 Sudden Failure Method	33
3.2.3 Hart-Smith Criterion: The Truncated Maximum Strain Envelope	34

3.3 Laminate Failure Analysis under Biaxial Loading	36
3.3.1 Comparison of Data for Biaxial Loading	41
3.3.2 Biaxial Failure in the Strain Plane	42
3.3.3 Biaxial Testing Data for Glass Woven Fabric Composite	44
3.4 Laminate Strength Analysis for Unidirectional Off-Axis Loading	44
3.4.1 Generation of Laminate Failure Curve for Off-Axis Loading	45
3.4.2 Selection of Laminates and Off-Axis Loading Angles	45
3.4.3 Consideration of Curing Stresses and In-Situ Lamina Strength	45
3.4.4 Laminate Coupon Specimens	46
3.4.5 Testing Procedure	48
3.4.6 Comparison with Test Data	50
3.5 Observations on Laminated Failure Criteria	56
4. CONCLUSIONS	58
5. RECOMMENDATIONS	59
6. REFERENCES	60
APPENDICES	
A—A List of Failure Criteria	
B—A Computer Code for Strength Analysis of Laminated Composites	

LIST OF ILLUSTRATIONS

Figure		Page
1	Results of AIAA Failure Criteria Survey	5
2	Comparison of Lamina Failure Criteria under $\sigma_{11} - \sigma_{22}$ Biaxial Stress	7
3	Comparison of Lamina Failure Criteria under $\sigma_{11} - \tau_{12}$ Biaxial Stress	8
4	Comparison of Lamina Failure Criteria under $\sigma_{22} - \tau_{12}$ Biaxial Stress	9
5	Off-Axis Loading of a Lamina	10
6	Comparison of Lamina Failure Criteria for Off-Axis Loading	10
7	Detailed Comparison of Lamina Failure Criteria for Off-Axis Loading	11
8	Comparison of Lamina Failure Criteria for Positive Pure Shear	13
9	Comparison of Lamina Failure Criteria for Negative Pure Shear	15
10	Comparison of Lamina Failure Criteria to Off-Axis Data	16
11	Comparison of Lamina Failure Criteria to $\sigma_{11} - \sigma_{22}$ Data from Wu and Scheublein	17
12	Comparison of Lamina Failure Criteria to $\sigma_{11} - \sigma_{12}$ Data from Jiang and Tennyson	18
13	Comparison of Lamina Failure Criteria to $\sigma_{11} - \sigma_{12}$ Data from Jiang and Tennyson	19
14	Comparison of Lamina Failure Criteria to $\sigma_{22} - \sigma_{12}$ Data from Jiang and Tennyson	20
15	Comparison of Lamina Failure Criteria to $\sigma_{22} - \tau_{12}$ AS4/55A Data from Swanson, Messick, and Tian	21
16	Comparison of Lamina Failure Criteria to $\sigma_{22} - \tau_{12}$ T800 Data from Swanson and Quian	22
17	Comparison of Lamina Failure Criteria to $\sigma_{22} - \tau_{12}$ Glass-Epoxy Data from Voloshin and Arcan	23
18	Comparison of Lamina Failure Criteria and the Modified Matrix Criterion to $\sigma_{22} - \tau_{12}$ AS4/55A Data from Swanson, Messick, and Tian	27

19	Comparison of Lamina Failure Criteria and the Modified Matrix Criterion to $\sigma_{22} - \tau_{12}$ T800 Data from Swanson, Messick, and Tian	28
20	Comparison of Lamina Failure Criteria and the Modified Matrix Criterion to $\sigma_{22} - \tau_{12}$ Glass-Epoxy Data from Voloshin and Arcan	29
21	Schematic of the Parallel Stiffness Model	31
22	Schematic of Laminate with Matrix Cracks	32
23	Hart-Smith's Truncated Maximum Strain Failure Envelope for Laminates	35
24	Failure Strain Envelope Proposed by Hart-Smith for Fibers	36
25	Failure Envelope of $[0/\pm 45/90]_s$ Laminate Using Ply-by-Ply Discount Method and PSM Stiffness Reduction	37
26	Failure Envelope of $[0/\pm 45/90]_s$ Laminate Using Ply-by-Ply Discount Method and Hill-Tsai Lamina Failure Criterion	38
27	Failure Stress Envelope for an AS4-3501-6 $[0/\pm 45/90]_s$ Laminate under Biaxial Loads Using Ply-by-Ply Discount (the PSM) and Sudden Failure Methods	40
28	Failure Strain Envelopes Corresponding to the Failure Stress Envelope of Figure 27	41
29	Comparison of Ultimate Stress Envelopes with Experimental Data for a $[0/\pm 45/90]_s$ Laminate under Biaxial Loads	42
30	Comparison of Ultimate Strain Envelopes with Experimental Data for a $[0/\pm 45/90]_s$ Laminate under Biaxial Loads	43
31	Comparison of Maximum Strain and Hart-Smith's Ultimate Strain Envelopes with Experimental Data for a $[0/\pm 45/90]_s$ Laminate under Biaxial Loads	44
32	Example of Oblique End Tabs	47
33	Stress-Strain Curves Characterizing Fiber and Matrix Failures	50
34	Comparison of Ultimate Strengths for a $[0/A/+45/A/-45/A/90]_s$ Laminate under Unidirectional Loading Using Different Lamina Failure Criteria (with the PSM)	51
35	Comparison of Ultimate Strengths for a $[0/A/+45/A/-45/A/90]_s$ Laminate under Unidirectional Loading Using Different Lamina Failure Criteria (with the PSM _s)	51

36	Comparison of Ultimate Strengths for a $[90/A/0/A/90/A/0]_s$ Laminate under Directional Loading Using Different Lamina Failure Criteria (with the PSM)	52
37	Comparison of Ultimate Strengths for a $[90/A/0/A/90/A/0]_s$ Laminate under Unidirectional Loading Using Different Lamina Failure Criteria (with the PSM _s)	53
38	Comparison of Ultimate Strengths for a $[0/A/+45/A/-45]_s$ Laminate under Unidirectional Loading Using Different Lamina Failure Criteria (with the PSM)	54
39	Comparison of Ultimate Strengths for a $[0/A/+45/A/45-45]_s$ Laminate under Unidirectional Loading Using Different Lamina Failure Criteria (with the PSM _s)	54
40	Comparison of Ultimate Strengths for a $[90/A/+30/A/-30]_s$ Laminate under Unidirectional Loading Using Different Lamina Failure Criteria (with the PSM)	55
41	Comparison of Ultimate Strengths for a $[90/A/+30/A/-30]_s$ Laminate under Unidirectional Loading Using Different Lamina Failure Criteria (with the PSM _s)	56
42	Comparison of Ultimate Strengths for a $[0/A/+45/A/-45/A/90]_s$ with Different Lamina Shear Strengths Using Hill-Tsai Criterion	57
43	Evidence of 90° Ply Matrix Cracks in $[0/90/0]$ and $[0/90/0]_s$ Laminates of AS4/3501-6 Graphite-Epoxy Composite	58

LIST OF TABLES

Table		Page
1	Moduli and Strength Values for the AS4/3501-6 Graphite-Epoxy System [7]	6
2	Strength Values for the Boron-Epoxy Material System in [8]	16
3	Strength Values for the Graphite-Epoxy Material System in [11]	17
4	Moduli and Strength Values for the IM7/8551-7 Graphite-Epoxy System in [12]	18
5	Strength Values for Material Systems from [13-15] used in $\sigma_{22} - \tau_{12}$ Biaxial Failure Comparisons	21
6	Moduli and Strength Values of AS4/3501-6 Graphite-Epoxy System in [19, 21]	41
7	Laminates and Off-Axis Loading Angles Tested	45
8	Material Properties for FM 1000 Film Adhesive	46
9	Moduli and Strength Values for the Tested AS4/3501-6 Graphite-Epoxy System	48
10	Ultimate Laminate Stresses (MPa)	49

EXECUTIVE SUMMARY

Over the last three decades, there have been continuous efforts in developing failure criteria for unidirectional fiber composites and their laminates. Currently, there exist a large number of lamina failure criteria and laminate failure analysis methods. In this project, a comprehensive and objective study of lamina and laminate failure criteria was performed. Comparisons among the commonly used failure criteria were made for failure in unidirectional composites under various loading cases. From these comparisons, the characteristics of these criteria were identified and discussed. Further, with the aid of some limited experimental lamina and laminate strength data available in the literature and new data generated by the authors, an attempt was made to select the failure criteria and laminate analysis methods that are mechanistically sound and are capable of accurately predicting lamina and laminate strengths for states of combined stresses. It was found that those lamina failure criteria which separate fiber and matrix failure modes most accurately predict lamina and laminate strength.

1. INTRODUCTION.

Over the last three decades, there have been continuous efforts in developing failure criteria for unidirectional fiber composites and their laminates. Currently, there exist a large number of lamina failure criteria and laminate failure analysis methods. A comprehensive evaluation of the accuracy of these failure criteria in the light of available experimental data seems to be overdue.

There are two major elements in the analysis of composite laminates, i.e., lamina failure criteria and laminate stress analysis with lamina stiffness reduction. Between the two, the accuracy of the failure criterion is the most crucial issue.

Evaluating these lamina failure criteria is a two part process. The first step is to characterize the criteria in their ability to predict failure in a unidirectional composite or a lamina. These are the precise conditions for which the criteria were designed. Those criteria which correlate with experimental data and those criteria which are mechanistically sound can be identified.

Secondly, the lamina failure criteria must be evaluated in their ability to predict the failure strength of a laminate comprised of laminae with varying fiber orientations. Endorsing a lamina failure criteria based on its success with unidirectional failure predictions is premature. In a laminate, failure mechanisms are more complicated (i.e., in situ laminae can exhibit considerably higher matrix strength than experimentally determined through unidirectional lamina tests). A lamina failure criterion must be flexible and accommodate the more complicated nature of laminate analysis.

In this study, six failure criteria which appear representative of those that have been proposed over the years are investigated. These failure criteria which appear representative of most of those which have been proposed over the years are maximum stress, maximum strain, Hill-Tsai, Tsai-Wu, Hashin-Rotem, and Hashin criteria. Maximum stress and maximum strain criteria assume no stress interaction. Hill-Tsai and Tsai-Wu criteria include full stress interaction. Hashin-Rotem and Hashin criteria involve partial stress interaction. Existing lamina and laminate strength data are used to evaluate these failure criteria. For some laminates under certain loading conditions, all six criteria may predict similar results, and their performance cannot be ranked. Therefore, a number of laminates are identified for which the strength predictions according to these six criteria are substantially different. Off-axis coupon specimens were cut from those laminates and tested in uniaxial tension. Adhesive film was placed along all the interfaces of the laminae to suppress failure due to free edge stresses. To avoid complications arising from extension-shear coupling in some of the off-axis specimens, special oblique end tabs were used. These additional strength data are used to help rank the six strength criteria.

2. LAMINA FAILURE ANALYSIS.

The purpose of the lamina failure criterion is to determine the strength and mode of failure of a unidirectional composite or lamina in a state of combined stress. All the existing lamina failure criteria are basically phenomenological in which detailed failure processes are not described (macromechanical). Further, they are all based on linear elastic analysis. Nahast [1] and

Labossiere and Neal [2] have made an extensive literature survey of existing lamina failure criteria for composites.

A list of the lamina failure criteria taken from references 1 and 2 is presented in appendix A.

The majority of the lamina failure criteria were developed for two-dimensional stress states in orthotropic materials. Some of the criteria, such as the Tsai-Wu criterion which is a completely general tensor polynomial failure equation, have reduced forms in order to utilize two strength properties for two-dimensional stress states. In this study, only such 2-D criteria are included. The in-plane principal strengths in a composite system are denoted as follows:

- X & X' : tensile and compressive strengths, respectively, in fiber direction.
-
- Y & Y' : tensile and compressive strengths, respectively, in transverse direction (perpendicular to fibers).
-
- S : shear strength

For a strain based analysis, the corresponding failure strains are X_ϵ , X'_{ϵ} , Y_ϵ , Y'_{ϵ} , and S_ϵ .

The ability of a lamina failure criterion to determine mode of failure is essential in bringing this analysis tool to the laminate level (an individual lamina failure within a laminate does not necessarily constitute ultimate failure). Modes of failure are defined as

- Fiber Breakage (mode 1): longitudinal stress (σ_{11}) or longitudinal strain (ϵ_{11}) dominates lamina failure.
-
- Transverse Matrix Cracking (mode 2): transverse stress (σ_{22}) or transverse strain (ϵ_{22}) dominates lamina failure.
-
- Shear Matrix Cracking (mode 3): shear stress (τ_{12}) or shear strain (γ_{12}) dominates lamina failure.

It is important to point out that both mode 2 and mode 3 are matrix failures. The two modes are separated because they are caused by different stress components according to some criteria. For example, according to the Maximum Stress Criterion, mode 2 should be interpreted as matrix cracking due to σ_{22} , and mode 3 should be interpreted as matrix cracking due to τ_{12} .

2.1 LAMINA FAILURE CRITERIA.

Lamina failure criteria can be categorized into three groups.

- Limit Criteria: These criteria predict failure load and mode by comparing lamina stresses σ_{11} , σ_{22} , and τ_{12} (or strains ϵ_{11} , ϵ_{22} , and γ_{12}) with corresponding strengths separately. Interaction among the stresses (or strains) is not considered.

- □ Interactive Criteria: These criteria predict the failure load by using a single quadratic or higher order polynomial equation involving all stress (or strain) components. Failure is assumed when the equation is satisfied. The mode of failure is determined indirectly by comparing the stress/strength ratios.

□

- □ Separate Mode Criteria: These criteria separate the matrix failure criterion from the fiber failure criterion. The equations can be dependent on either one or more stress components; therefore, stress interaction varies from criterion to criterion within this group. If the failure equation contains only one stress component, then the failure mode corresponds to that particular direction; otherwise, the failure mode can be determined as is done with the interactive criteria by comparing stress/strength ratios of the satisfied equation.

In the interest of keeping the project manageable, it was necessary to choose only a representative subset of the criteria listed in appendix A. In total, six lamina failure criteria were selected to be examined in further detail. From the limit criteria group, Maximum Stress and Maximum Strain were chosen. From the interactive criteria group, Hill-Tsai (also called Tsai-Hill or Azzi-Hill) and Tsai-Wu were chosen. In an AIAA Failure Criteria Survey [3], 80% of the respondents said they utilized one of these four lamina failure criteria. Figure 1 shows the breakdown for each criterion. Maximum Strain is most commonly used at 30% with Maximum Stress next at 22%. Hill-Tsai and Tsai-Wu usage came in at 17% and 12% respectively. The popularity of these four criteria and the fact that they are the most generalized and representative of their respective groups was the basis for their inclusion.

The final two criteria come from the separate mode group. Both Hashin and Hashin-Rotem criteria provide for separate treatment of matrix and fiber failure modes while maintaining some degree of stress interaction for the individual modes.

The six lamina failure criteria which are considered are:

- □ Limit Criteria:

Maximum Stress:

$$\frac{\sigma_{11}}{X} = 1 \quad \text{fiber failure}$$

$$\frac{\sigma_{22}}{Y} = 1 \quad \text{transverse matrix cracking} \tag{1}$$

$$\frac{\tau_{12}}{S} = 1 \quad \text{shear matrix cracking}$$

Maximum Strain:

$$\frac{\varepsilon_{11}}{X_\varepsilon} = 1 \quad \text{fiber failure}$$

$$\frac{\varepsilon_{22}}{Y_\varepsilon} = 1 \quad \text{transverse matrix cracking} \quad (2)$$

$$\frac{\gamma_{12}}{S_\varepsilon} = 1 \quad \text{shear matrix cracking}$$

• □ Interactive Criteria:

Hill-Tsai:

$$\left(\frac{\sigma_{11}}{X}\right)^2 + \left(\frac{\sigma_{22}}{Y}\right)^2 - \left(\frac{\sigma_{11}}{X}\right)\left(\frac{\sigma_{22}}{X}\right) + \left(\frac{\tau_{12}}{S}\right)^2 = 1 \quad (3)$$

Tsai-Wu:

$$F_1\sigma_{11} + F_2\sigma_{22} + F_{11}\sigma_{11}^2 + F_{22}\sigma_{22}^2 + 2F_{12}\sigma_{11}\sigma_{22} + F_{66}\tau_{12}^2 = 1 \quad (4)$$

where

$$F_1 = \frac{1}{X} + \frac{1}{X'}, \quad F_2 = \frac{1}{Y} + \frac{1}{Y'}, \quad F_{11} = \frac{-1}{XX'}, \quad F_{22} = \frac{-1}{YY'}, \quad F_{66} = \frac{1}{S}, \quad F_{12} = \text{experimentally determined}$$

• □ Separate Mode Criteria:

Hashin-Rotem:

$$\frac{\sigma_{11}}{X} = 1 \quad \text{fiber failure}$$

$$\left(\frac{\sigma_{22}}{Y}\right)^2 + \left(\frac{\tau_{12}}{S}\right)^2 = 1 \quad \text{matrix failure} \quad (5)$$

Hashin:

$$\left(\frac{\sigma_{11}}{X}\right)^2 + \left(\frac{\tau_{12}}{S}\right)^2 = 1 \quad \text{fiber failure (tension)}$$

$$\frac{\sigma_{11}}{X'} = 1 \quad \text{fiber failure (compression)} \quad (6)$$

$$\left(\frac{\sigma_{22}}{Y}\right)^2 + \left(\frac{\tau_{12}}{S}\right)^2 = 1 \quad \text{matrix failure}$$

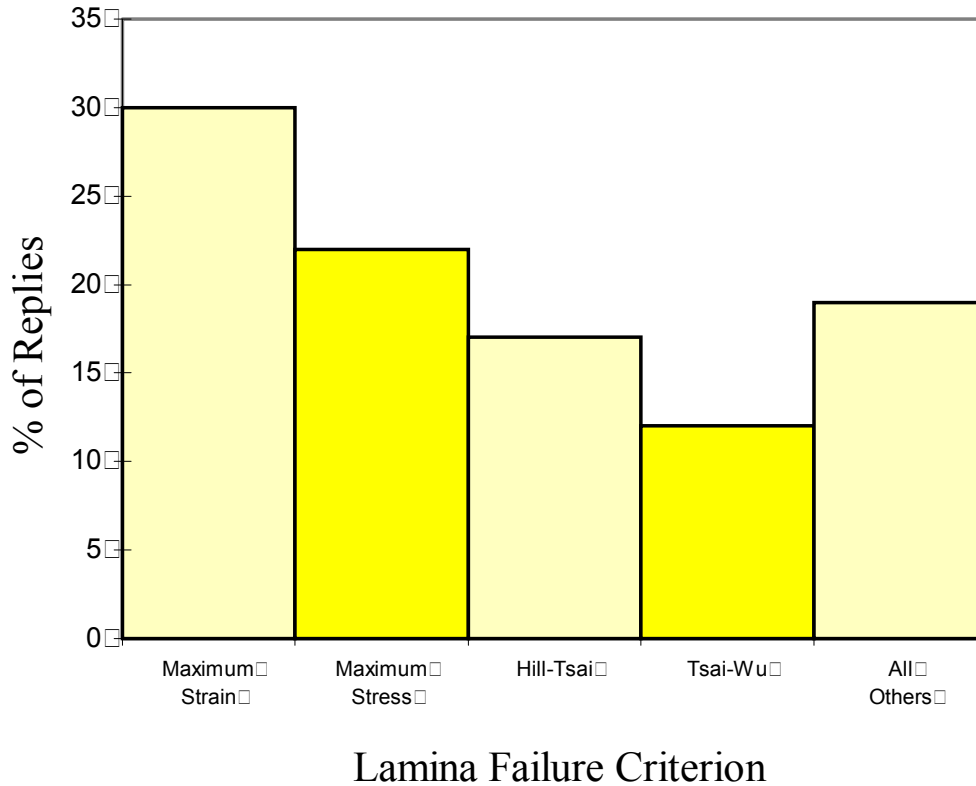

FIGURE 1. RESULTS OF AIAA FAILURE CRITERIA SURVEY

For Maximum Stress, Maximum Strain, Hill-Tsai, and Hashin-Rotem, the criterion is generalized for either tensile or compressive stresses; the corresponding (tensile or compressive) strength value must be chosen based on the sign of the applied stress. The Tsai-Wu criterion is designed for use in all quadrants of the stress plane; thus, it may be used directly without modification for different stress signs. The Tsai-Wu criterion requires a biaxial test to experimentally determine the interaction term F_{12} . It has been suggested to use $F_{12} = 1/(2XX')$, which reduces Tsai-Wu down to the Hoffman criterion. Narayanaswami and Adelman [4] found this term to be insignificant for the most part, and suggested setting it equal to zero. Cui et al. [5] also found that $F_{12} = 0$ gave adequate accuracy for engineering purposes. Thus, to avoid ambiguity, F_{12} is set equal to zero in the present study.

The Hashin criterion listed here is a slight modification of the 2-D criterion presented in his 1980 paper [6]. In that paper, Hashin suggested using a combination of both axial and transverse shear strengths S_A and S_T for the compressive matrix equation. Since it is difficult to find transverse shear strength values in the literature, the tensile equation given is used as the compressive equation by simply replacing Y with Y' .

2.2 COMPARISON AMONG LAMINA FAILURE CRITERIA.

The theoretical comparisons of the six lamina failure criteria discussed in the following paragraphs allow each criterion to be evaluated on the basis of purely mechanistic reasoning. Separating the theoretical comparisons from the correlation with experimental data helps focus on objectively evaluating just the mechanics of the criteria. The ability to accurately predict data is addressed in later sections.

A FORTRAN program was written in order to efficiently analyze all six lamina failure criteria under all possible loading conditions. The code was designed to be flexible. It allows for an expandable database of different material properties. Laminate configurations and loading conditions are easily manipulated. The user has a variety of output files to choose from. Ready-to-plot output files allow the user to immediately plot and interpret the results. The code together with representative examples is included in appendix B.

2.2.1 Bidirectional Stress Plane.

A series of failure envelopes for combined stresses is presented to graphically show the characteristics of the six selected lamina failure criteria. These envelopes are composed of failure stresses normalized by the lamina's respective tensile strengths X and Y or shear strength S . For these graphs, the material properties of the AS4/3501-6 graphite/epoxy system tested by Sun and Zhou [7] is used. Table 1 lists elastic and strength constants.

TABLE 1. MODULI AND STRENGTH VALUES FOR THE AS4/3501-6 GRAPHITE-EPOXY SYSTEM [7]

E_1	138.90 GPa		X	2206.0 MPa
E_2	9.86 GPa		X'	-2013.0 MPa
G_{12}	5.24 GPa		Y	56.5 MPa
ν_{12}	0.30		Y'	-206.8 MPa
Ply Thickness:	0.132 mm		S	110.3 MPa

Figure 2 is a plot of the selected criteria in a $\sigma_{11} - \sigma_{22}$ stress plane ($\tau_{12} = 0$). The Maximum Stress envelope is a simple rectangle bounded by the failure loads $\pm\sigma_{11}$ and $\pm\sigma_{22}$. Again, because these loads are normalized with X and Y , compressive σ_{11} (quadrants II and III), and compressive σ_{22} (quadrants III and IV) failure segments do not equal unity (i.e., $X > |X'|$ and $Y < |Y'|$ for this case).

For the analysis using the Maximum Strain criterion, failure strains were calculated from the strength parameters using a linear relationship:

$$X_\epsilon = \frac{X}{E_1}, \quad X'_\epsilon = \frac{X'}{E_1}, \quad Y_\epsilon = \frac{Y}{E_2}, \quad Y'_\epsilon = \frac{Y'}{E_2}, \quad S_\epsilon = \frac{S}{G_{12}} \quad (7)$$

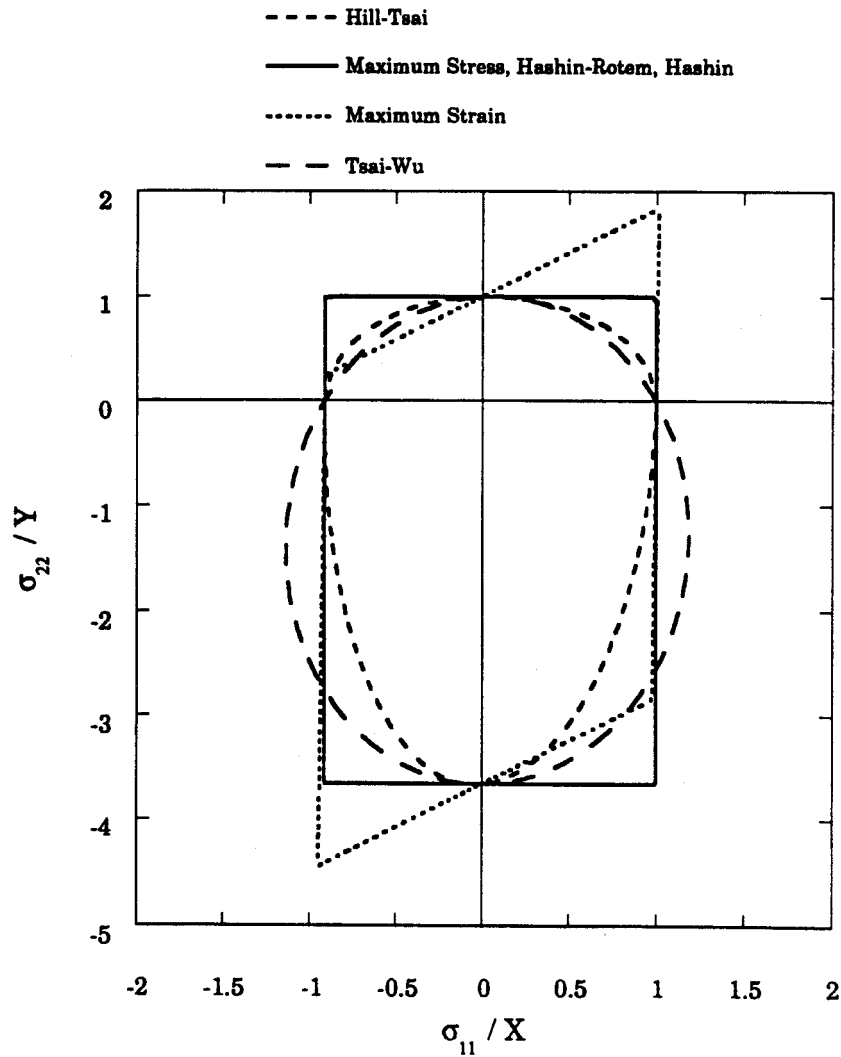

FIGURE 2. COMPARISON OF LAMINA FAILURE CRITERIA UNDER $\sigma_{11} - \sigma_{22}$ BIAXIAL STRESS

The Maximum Strain envelope is close to that of the Maximum Stress but is slightly skewed due to the effect of Poisson's ratio. There is considerably more skewing in the vertical (σ_{22}) direction because $\nu_{12} \gg \nu_{21}$ in unidirectional fiber composites.

Both the Hill-Tsai and Tsai-Wu criteria allow quadratic stress interactions; therefore, each has a curved failure envelope. Both of these criteria match up with the two limit criteria for all four unidirectional loading cases ($\pm\sigma_{11}$ with $\sigma_{22} = 0$ and $\pm\sigma_{22}$ with $\sigma_{11} = 0$) as expected. The Tsai-Wu criterion is a continuous curve throughout all four quadrants. The only parameters that vary are the stress terms. The Tsai-Wu criterion includes linear stress terms. Hill-Tsai, on the other hand, is a purely quadratic criterion. In order to account for differences in tensile and compressive strengths commonly found in fiber composites, this criterion uses the appropriate strength values

in each quadrant (X or X' and Y or Y' accordingly). Though both are interactive, Tsai-Wu and Hill-Tsai produce different failure envelopes in the stress plane. In the compressive σ_{22} quadrants, the Tsai-Wu failure envelope extends beyond the longitudinal strengths X and X' .

Finally, both the Hashin and Hashin-Rotem criteria reduce to the Maximum Stress criterion in the $\sigma_{11} - \sigma_{22}$ plane since $\tau_{12} = 0$.

A plot of the selected criteria in a $\sigma_{11} - \tau_{12}$ stress plane ($\sigma_{22} = 0$) is shown in figure 3. The Maximum Stress envelope in this stress plane is again a rectangle, bounded by the failure loads $\pm\sigma_{11}$ normalized by X and $\pm\tau_{12}$ normalized by S . The Maximum Strain criterion predicts exactly the same loads as the Maximum Stress criterion. The Hashin-Rotem criterion also reduces to the Maximum Stress criterion in this stress plane. Again, Hill-Tsai and Tsai-Wu failure envelopes intersect the other three criteria for the four unidirectional loading cases ($\pm\sigma_{11}$ with $\tau_{12} = 0$ and $\pm\tau_{12}$ with $\sigma_{11} = 0$). In the biaxial loading regions, the two interactive criteria are nearly identical.

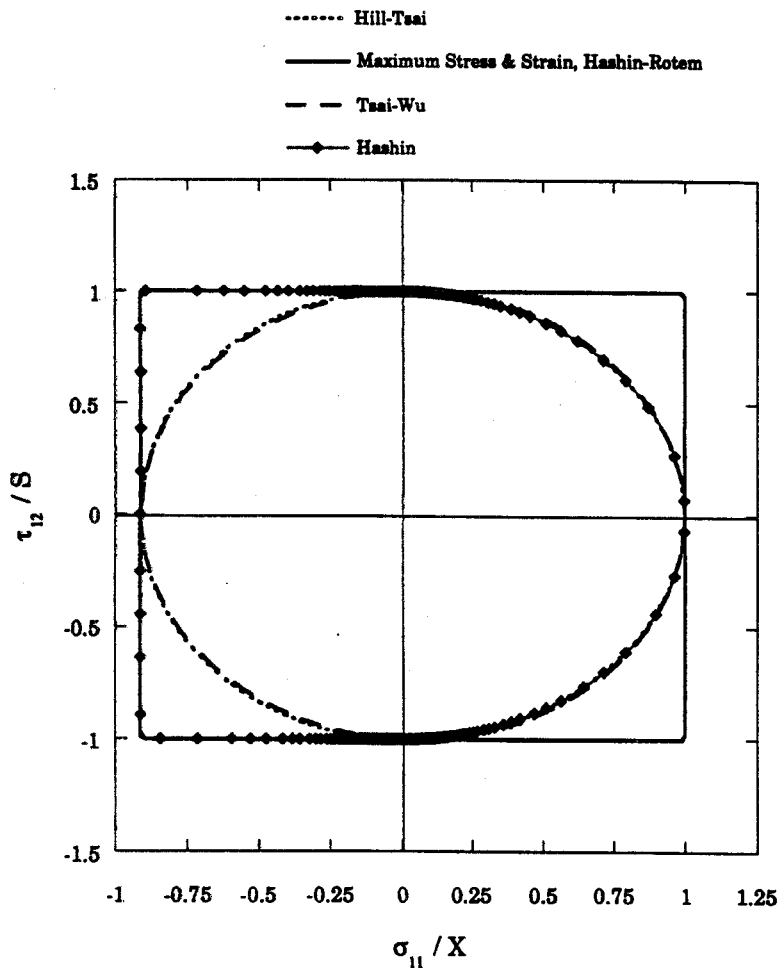

FIGURE 3. COMPARISON OF LAMINA FAILURE CRITERIA UNDER $\sigma_{11} - \tau_{12}$ BIAxIAL STRESS

The linear stress term σ_{11} in Tsai-Wu produces a slightly higher or lower failure load than in Hill-Tsai, depending on the quadrant. Interestingly, the Hashin criterion reduces to Maximum Stress with a compressive σ_{11} and reduces to Hill-Tsai with tensile σ_{11} .

Figure 4 contains a plot of the six criteria in the $\sigma_{22} - \tau_{12}$ stress plane ($\sigma_{11} = 0$). Maximum Stress and Maximum Strain are identical rectangles showing $\pm\sigma_{22}$ normalized by Y and $\pm\tau_{12}$ normalized by S . Tsai-Wu and Hill-Tsai produce curved envelopes due to σ_{22} - τ_{12} interaction. Again, the linear σ_{22} term in Tsai-Wu produces a different shape than Hill-Tsai, pushing the failure envelope beyond the lamina shear strength S . Hashin and Hashin-Rotem in this stress plane match Hill-Tsai exactly considering $\sigma_{11} = 0$. As expected, all six criteria intersect at the four unidirectional loading cases ($\pm\sigma_{22}$ with $\tau_{12} = 0$ and $\pm\tau_{12}$ with $\sigma_{22} = 0$).

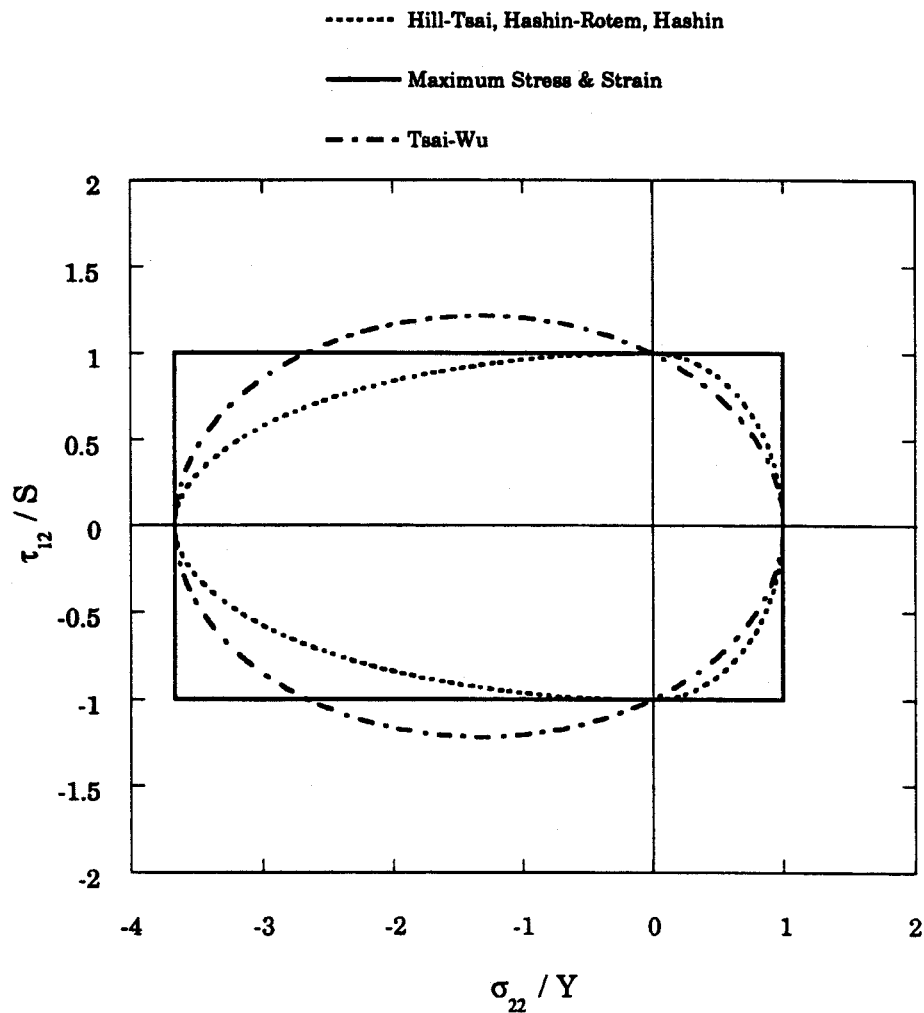

FIGURE 4. COMPARISON OF LAMINA FAILURE CRITERIA UNDER $\sigma_{22} - \tau_{12}$ BIAXIAL STRESS

2.2.2 Off-Axis Loading.

The six lamina failure criteria may also be characterized by their failure predictions of a lamina subjected to off-axis loading. Figure 5 shows a schematic defining off-axis loading in this case. The angle between the applied load σ_{xx} and the lamina fibers is defined as θ , thus, the lamina stresses σ_{11} , σ_{22} , and τ_{12} must be determined through transformation of σ_{xx} to the lamina coordinate system. For instance, $\sigma_{11} = \sigma_{xx}$ and $\sigma_{22} = 0$ for $\theta = 0^\circ$. Likewise, $\sigma_{22} = \sigma_{xx}$ and $\sigma_{11} = 0$ for $\theta = 90^\circ$. Figure 6 shows the predictions of the six criteria for a graphite epoxy lamina having the material properties given in table 1. It is immediately evident all six criteria predict very similar failure stress σ_{xx} over the entire off-axis range. Figure 7 zooms in on the region $\theta \in 0^\circ - 10^\circ$ to facilitate the discussion.

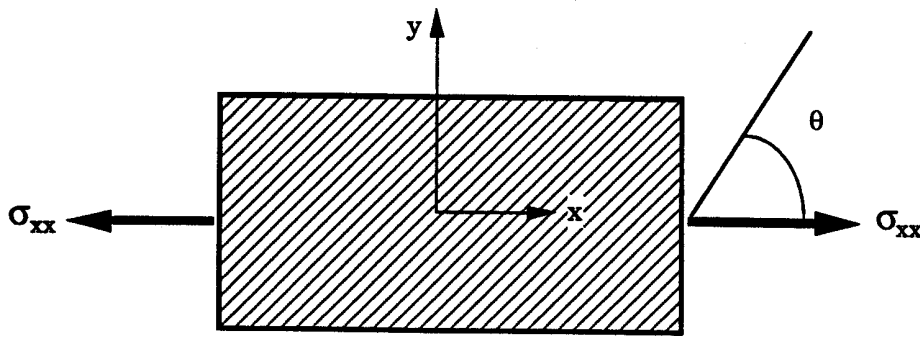

FIGURE 5. OFF-AXIS LOADING OF A LAMINA

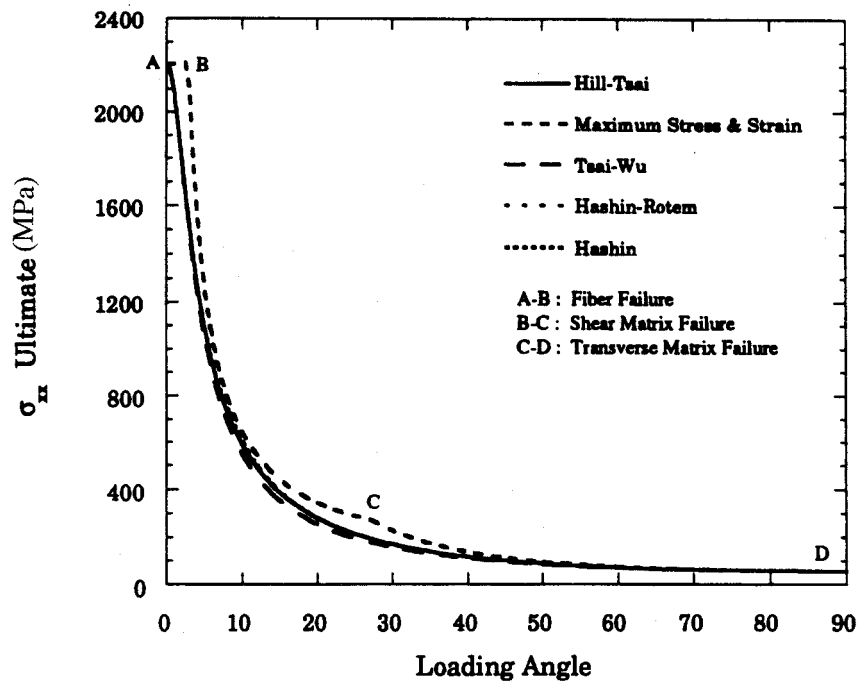

FIGURE 6. COMPARISON OF LAMINA FAILURE CRITERIA FOR OFF-AXIS LOADING

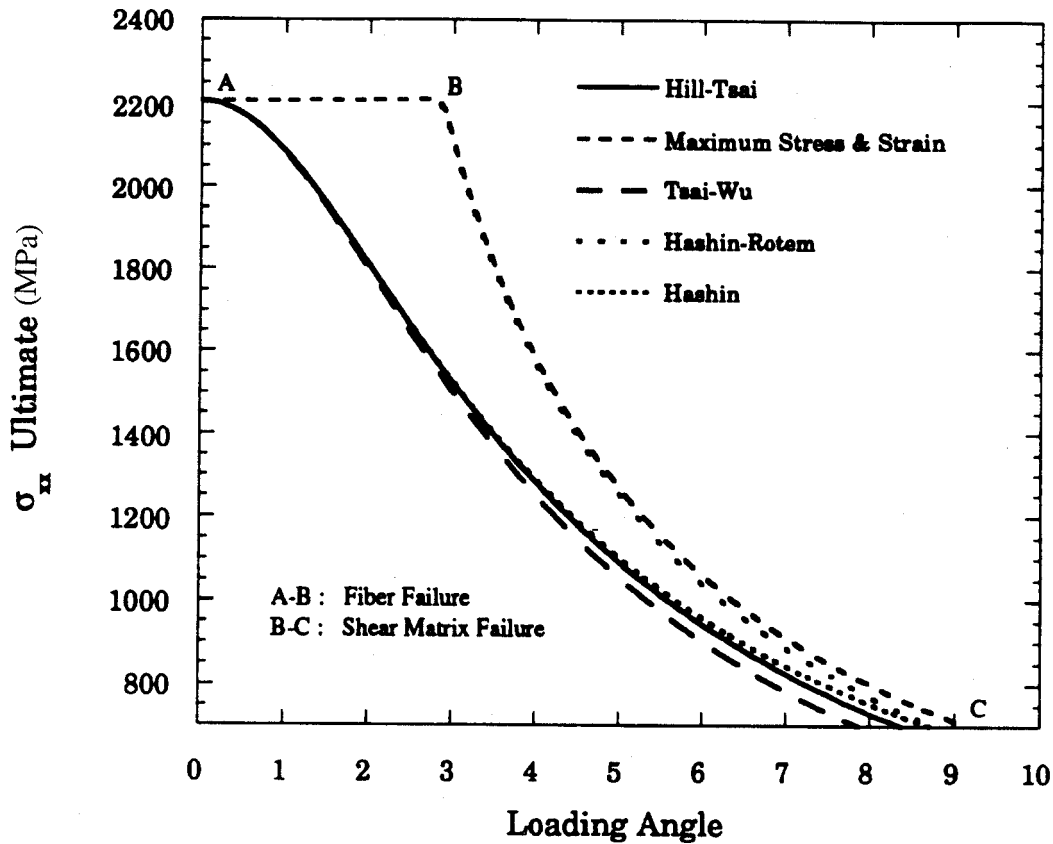

FIGURE 7. DETAILED COMPARISON OF LAMINA FAILURE CRITERIA FOR OFF-AXIS LOADING

All six lamina failure criteria predict a failure load of X at $\theta = 0^\circ$ and Y at $\theta = 90^\circ$. The Maximum Stress criterion predicts three separate failure regions representing the three possible modes of failure; fiber breakage, transverse matrix cracking, and shear matrix cracking. As the off-axis angle rotates from 0° to 90° , the stress distribution in the lamina varies. Over the course of fiber rotation, failure is predicted by three different equations thus producing the three separate regions. Between $\theta = 0^\circ$ and 2.9° , fiber breakage is predicted (mode 1). At $\theta = 0^\circ$, the failure load is simply X . As θ increases in this region, the predicted failure load actually increases only slightly, see figure 7. This is because the σ_{11}/X ratio remains dominant even though the σ_{11} component in the lamina decreases; thus, a larger applied load is necessary to satisfy the dominant equation. At the critical angle $\theta = 2.9^\circ$, the τ_{12}/S ratio becomes dominant; therefore, the failure mode switches to shear matrix cracking (mode 3). This region continues until $\theta = 27.1^\circ$ where failure mode switches again to transverse matrix cracking (mode 2) with the σ_{22}/Y ratio becoming dominant. This region continues through 90° where the failure load is simply Y . It is important to note that these critical angles representing changes in failure mode are specific to this material system. Using a different system would change these critical angles, though for most fiber reinforced composites, similar transition angles should be expected.

The Maximum Strain criterion produces a failure curve similar to that of Maximum Stress. From $\theta = 0^\circ$ to 2.9° , failure occurs in mode 1. Due to Poisson's effect, Maximum Strain predicts a slightly higher failure load than Maximum Stress in this region. In the shear region (mode 3), Maximum Strain results are identical to the Maximum Stress results. Maximum Strain's shear region extends to 29° where failure switches to mode 2. Again, Poisson's effect slightly increases the Maximum Strain prediction compared with Maximum Stress until they meet at $\theta = 90^\circ$. Using measured ultimate strains that include nonlinear effects would insignificantly alter the character of this failure curve. Since the differences in the failure predictions of Maximum Strain and Maximum Stress are so slight, they are plotted as one curve in both figures 6 and 7.

The two interactive criteria, Hill-Tsai and Tsai-Wu, give exactly the same predictions in the three failure regions as the Maximum Stress criterion, with critical angles at 2.9° and 27.1° for mode 1-3 and mode 3-2 transitions, respectively. Because these criteria are completely interactive, their failure curves remain smooth throughout the entire off-axis loading case. This is of special note in the fiber-shear dominated region from $\theta = 0^\circ$ to roughly $\theta = 10^\circ$ seen in figure 7. In this area, both σ_{11} and τ_{12} have significant contributions. Because $X \gg S$, a criterion which couples these stress components (e.g., Hill-Tsai and Tsai-Wu) will predict a noticeably lower value in this area than a limit criterion (Maximum Stress and Strain). For the region where both τ_{12} and σ_{22} have significant contributions, the difference between the limit and interactive criteria diminishes because Y and S are of similar magnitude. The two interactive criteria eventually converge with the two limit criteria at $\theta = 90^\circ$ (only σ_{22} exists).

The two separate mode criteria exhibit characteristics of both the limit and interactive criteria. They yield the same three failure regions as the other criteria. Due to its ability to separate modes, Hashin-Rotem's failure prediction is identical to Maximum Stress in the fiber (σ_{11}) dominated region $\theta = 0^\circ$ to 2.9° . After the mode 1-3 transition at 2.9° , Hashin-Rotem's failure prediction begins to move away from Maximum Stress and towards the prediction of Hill-Tsai (See figure 7). Note that as θ approaches 90° , the σ_{11} component becomes insignificant, leaving only the σ_{22} and τ_{12} components. Hill-Tsai and Hashin-Rotem are identical in the $\sigma_{22} - \tau_{12}$ plane, thus the merging. A final failure load of Y is predicted at $\theta = 90^\circ$ as expected.

The Hashin predictions initially coincide with Hill-Tsai's predictions since they both couple σ_{11} and τ_{12} . After the mode 1-3 transition, the Hashin criterion continues to predict the fiber dominant behavior which couples σ_{11} and τ_{12} , suggesting shear failure instead of fiber failure. Since Hill-Tsai begins to account for the growing σ_{22} term, the Hashin prediction becomes slightly higher. At about $\theta = 10^\circ$, the predicted failure mode of the Hashin criterion switches to matrix failure and, with σ_{11} vanishing, the prediction merges with Hill-Tsai at $\theta = 90^\circ$.

2.2.3 Pure Shear.

The six lamina failure criteria are compared by their failure predictions in a pure shear loading situation. The angle between the applied shear load and the lamina fibers is defined as θ as in the unidirectional off-axis loading previously discussed. The shear loading is given by $\pm\tau_{xy}$ ($\sigma_{xx} = \sigma_{yy} = 0$). A lamina composed of the material in table 1 is used for this analysis.

Figure 8 shows a $+\tau_{xy}$ loading case for a single lamina rotated at an angle θ . All six criteria predict a failure load of S at $\theta = 0^\circ$ and 90° as expected. The criteria are all symmetric about $\theta = 45^\circ$ where a failure load of approximately $-Y'$ (compressive) is predicted. Due to this symmetry, the discussion will go through $\theta = 45^\circ$ only. The criteria all predict shear matrix cracking from 0° to 30.8° and transverse matrix cracking from 30.8° to 45° . As the lamina fiber direction rotates from 0° to 90° , the lamina shear stress $+\tau_{12}$ goes down as the other two components σ_{11} and σ_{22} become larger; for positive shear, σ_{11} becomes more tensile and σ_{22} becomes more compressive though they have equal magnitudes. For $\theta = 0^\circ$, $\tau_{12} = \tau_{xy}$ and $\sigma_{11} = \sigma_{22} = 0$. For $\theta = 45^\circ$, $\tau_{12} = 0$ and $\sigma_{11} = -\sigma_{22} = \tau_{xy}$. The stress components σ_{11} and σ_{22} always remain of equal magnitude, thus fiber failure never occurs ($Y' \ll X$).

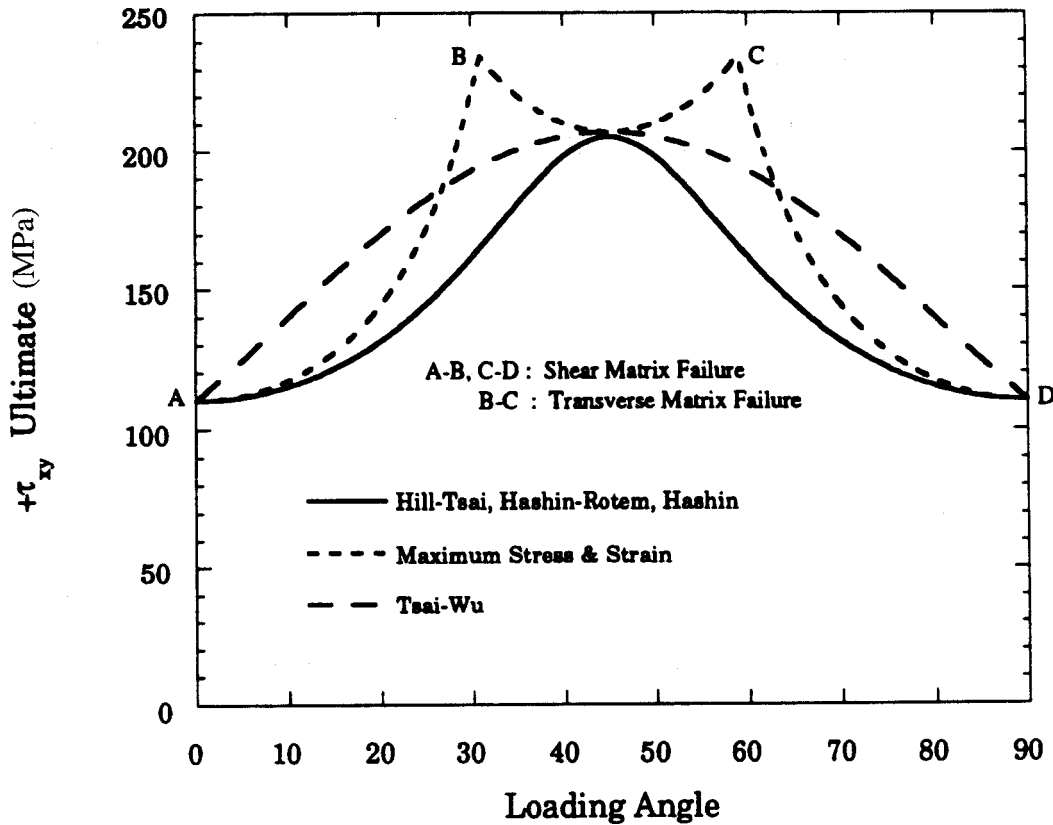

FIGURE 8. COMPARISON OF LAMINA FAILURE CRITERIA FOR POSITIVE PURE SHEAR

For the Maximum Stress criterion, the mode 3-2 transition point dramatically alters the failure prediction. The σ_{22}/Y' equation becomes dominant after the transition at $\theta = 30.8^\circ$. Because σ_{22} is smaller at 30.8° than at 45° , this equation actually requires a larger ultimate τ_{xy} to satisfy the dominant equation. This explains the drastic change in the failure curve. Maximum Stress and Maximum Strain differ only in this transverse failure region due to Poisson's effect and are plotted as one curve. They both predict a maximum failure load at the shear-transverse failure transition.

The interactive criteria produce smooth curves for this loading case, even though they do differentiate between modes of failure. The linear terms in Tsai-Wu gives its failure curve a different character than Hill-Tsai, though both clearly eliminate the cusp formed by the limit criteria. Both separate mode criteria and Hashin and Hashin-Rotem match up closely with Hill-Tsai. The separate mode criteria deviate slightly due to the small σ_{11}/X contribution found in the Hill-Tsai criterion near $\theta = 45^\circ$ where σ_{11} becomes a maximum. All four interactive and separate mode criteria reach a maximum at 45° where σ_{22} is dominant and at its maximum ($\tau_{xy} = -Y'$).

Figure 9 shows a $-\tau_{xy}$ loading case for a single lamina rotated to an angle θ . Like the $+\tau_{xy}$ loading case, all criteria are symmetric about $\theta = 45^\circ$ and switch from a shear matrix cracking failure to transverse matrix cracking at $\theta = 13.4^\circ$. At $\theta = 0^\circ$ and 90° , a strength of $-S$ is predicted for all criteria while a strength of approximately $-Y$ (tensile) is predicted at $\theta = 45^\circ$. The applied load τ_{xy} transforms into lamina stress components as in the $+\tau_{xy}$ case, but because the sign of the applied shear is opposite, σ_{11} is compressive and σ_{22} is tensile after transformation. It is interesting to note that the mode 3-2 transition occurs much quicker in the $-\tau_{xy}$ case than that of $+\tau_{xy}$ because $Y < Y'$. This allows the dominate shear region to switch over to transverse failure sooner.

The limit criteria predict an increasing failure load in the shear failure region. This is due to a decrease in the magnitude of the component τ_{12} , even though the τ_{12}/S ratio is dominant; higher loads are predicted in order to satisfy the dominant equation. Maximum Stress and Maximum Strain differ slightly in the transverse failure region due to Poisson's effect. Hill-Tsai, Tsai-Wu, Hashin-Rotem, and Hashin, due to their allowance of stress interaction between σ_{22} and τ_{12} , all predict smooth failure curves, eliminating the sharp jumps seen in the limit criteria. Hill-Tsai, Hashin-Rotem, and Hashin are nearly identical with only a small σ_{11}/X contribution in the Hill-Tsai criterion separating them. Tsai-Wu's failure curve varies from the other interactive criteria due to its linear terms, primarily the σ_{22} term. Again, because the shear loading is negative, the lamina is weakest at $\theta = 45^\circ$, in contrast with the positive shear case in which it is strongest at 45° .

In contrast to off-axis loading, in the case of pure shear loading these criteria predict quite different lamina strengths.

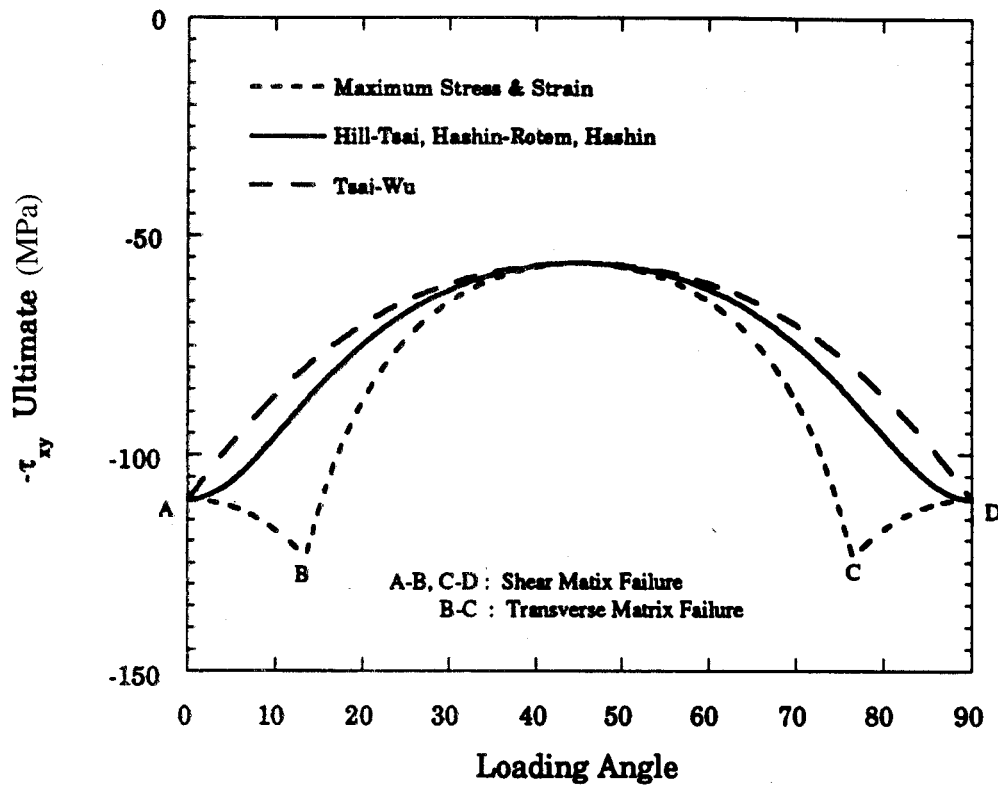

FIGURE 9. COMPARISON OF LAMINA FAILURE CRITERIA FOR NEGATIVE PURE SHEAR

2.3 COMPARISON WITH EXPERIMENTAL DATA.

The ability of the lamina failure criteria to correctly predict failure strength can be evaluated by comparing with experimental results. Among other factors, the accuracy of these criteria depends on availability of reliable material strength data, i.e., X , X' , Y , Y' and S , or the corresponding ultimate strains. Except for longitudinal and transverse tensile strengths X and Y , good measurements of the compressive and shear strengths are not easy to obtain, which makes an objective assessment of the lamina failure criteria all the more difficult.

Assuming that reliable uniaxial strength properties are available evaluating the failure criteria, failure loads of a lamina must be determined for a combined state of stress; i.e., at least two of the three stress components, σ_{11} , σ_{22} and τ_{12} must be present. The off-axis tension test offers the simplest way to produce a combined state of stress.

2.3.1 Lamina Failure Criteria Comparison With Off-Axis Tension Data.

Many authors have performed off-axis unidirectional lamina tensile tests. This test is performed by loading a uniform coupon specimen to failure. Because all the lamina failure criteria predict very similar failure loads, correlation with experimental data can't be used as a means of ranking

these criteria. Tests of a boron-epoxy system by Pipes and Cole [8] illustrate this point. The strength properties of this material system are provided in table 2. Using those values, the theoretical predictions of the six lamina failure criteria along with the experimental data are plotted in figure 10. Only angles of 15°, 30°, 45°, and 60° were tested. For this range of angles, matrix failure dominates the strength. It is seen that the interactive and separate mode criteria yielded better predictions than the limit criteria.

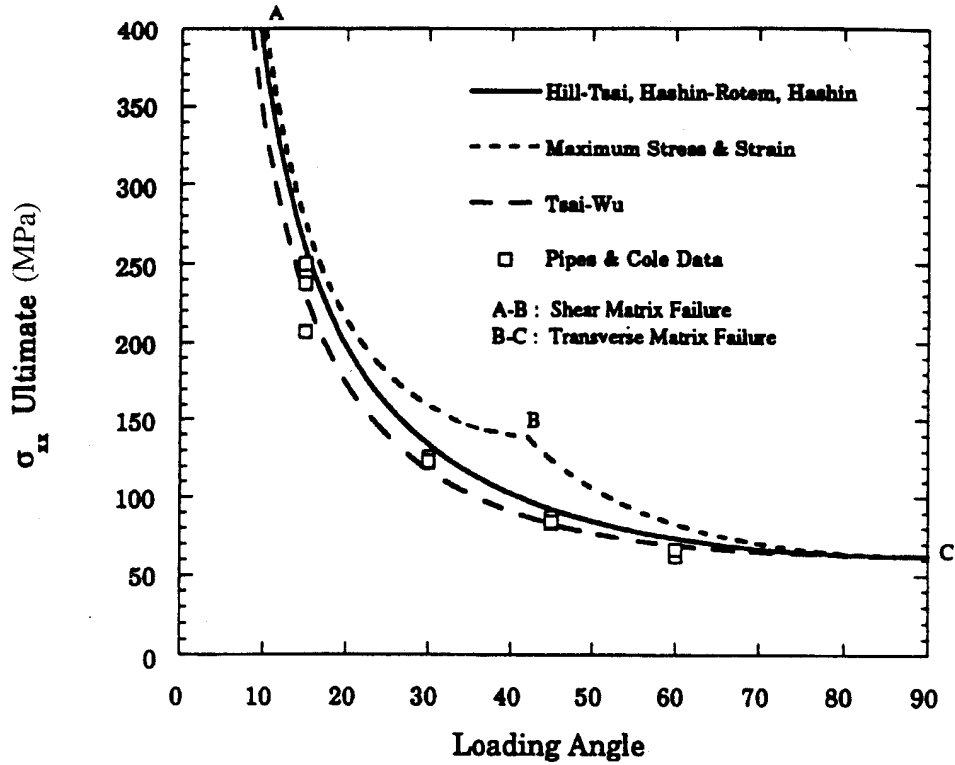

FIGURE 10. COMPARISON OF LAMINA FAILURE CRITERIA TO OFF-AXIS DATA

TABLE 2. STRENGTH VALUES FOR THE BORON-EPOXY MATERIAL SYSTEM IN [8].

X	1296.2 MPa
X'	-2489.0 MPa
Y	62.1 MPa
Y'	-310.3 MPa
S	68.5 MPa

Other sets of off-axis unidirectional data yield similar conclusions. Hashin and Rotem [9] tested a glass-epoxy system at a number of off-axis angles. The Hashin-Rotem criterion correlates with the data nearly perfectly, though other criteria (such as Hill-Tsai and Hashin) would have been just as close.

2.3.2 Lamina Failure Criteria Comparison With Tubular Specimens.

In this section the use of uniaxial (hoop wound) tubular specimens is discussed. Use of a tubular specimen allows a biaxial state of stress to be applied to a composite laminate. Tubular specimens also eliminate the free edge effect found in flat coupon specimens, as has been verified by many authors including Colvin and Swanson [10].

Wu and Scheublein [11] generated biaxial lamina data using a graphite-epoxy (Morganite II) system with material constants shown in table 3. Figure 11 shows the predictions for the material system versus experimental data ($\sigma_{11} - \sigma_{22}$ plane). Clearly all criteria match up at the four axis intercepts since those data points were used to generate the failure envelopes. The data in the tensile-compressive quadrant are not sufficient to show any distinction between the various criteria.

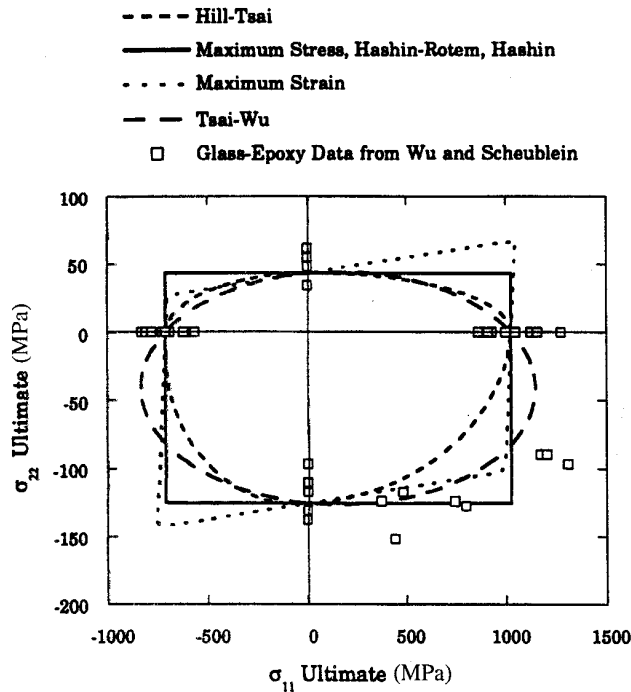

FIGURE 11. COMPARISON OF LAMINA FAILURE CRITERIA TO $\sigma_{11} - \sigma_{22}$ DATA FROM WU AND SCHEUBLEIN

TABLE 3. STRENGTH VALUES FOR THE GRAPHITE-EPOXY MATERIAL SYSTEM IN [11].

X	1027.3 MPa
X'	-710.2 MPa
Y	43.4 MPa
Y'	-125.5 MPa
S	72.4 MPa

Jiang and Tennyson [12] used tubular specimens to characterize the failure of an IM7/8551-7 graphite-epoxy material system. The elastic and strength constants for this system are shown in table 4. The tubes were tested in all three biaxial planes, $\sigma_{11} - \sigma_{22}$, $\sigma_{11} - \tau_{12}$, and $\sigma_{22} - \tau_{12}$.

TABLE 4. MODULI AND STRENGTH VALUES FOR IM7/8551-7 GRAPHITE-EPOXY [12].

E_1	162.0 GPa	X	2417.39 MPa
E_2	8.34 GPa	X'	-1034.94 MPa
G_{12}	2.07 GPa	Y	73.09 MPa
ν_{12}	0.339	Y'	-175.82 MPa
Ply Thickness:	not provided	S	183.41 MPa

Figures 12, 13, and 14 show the predictions based on the material properties versus the experimental strengths. Again, the limited data inhibits any attempt to distinguish the performance among the criteria.

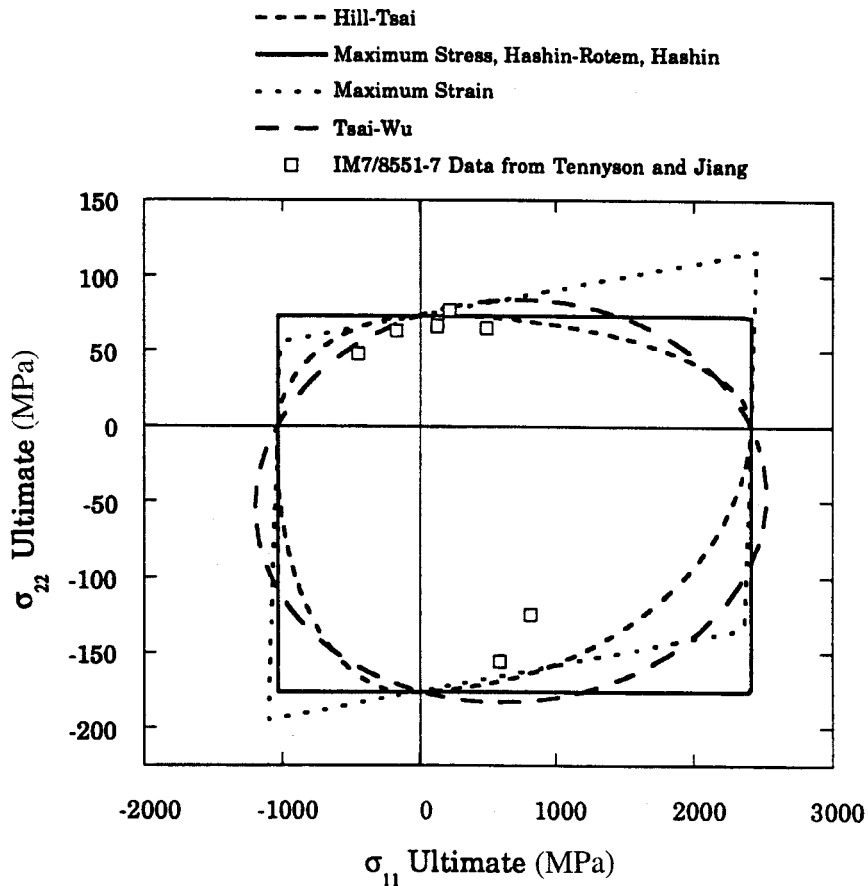

FIGURE 12. COMPARISON OF LAMINA FAILURE CRITERIA TO $\sigma_{11} - \sigma_{12}$ DATA FROM JIANG AND TENNYSON [12]

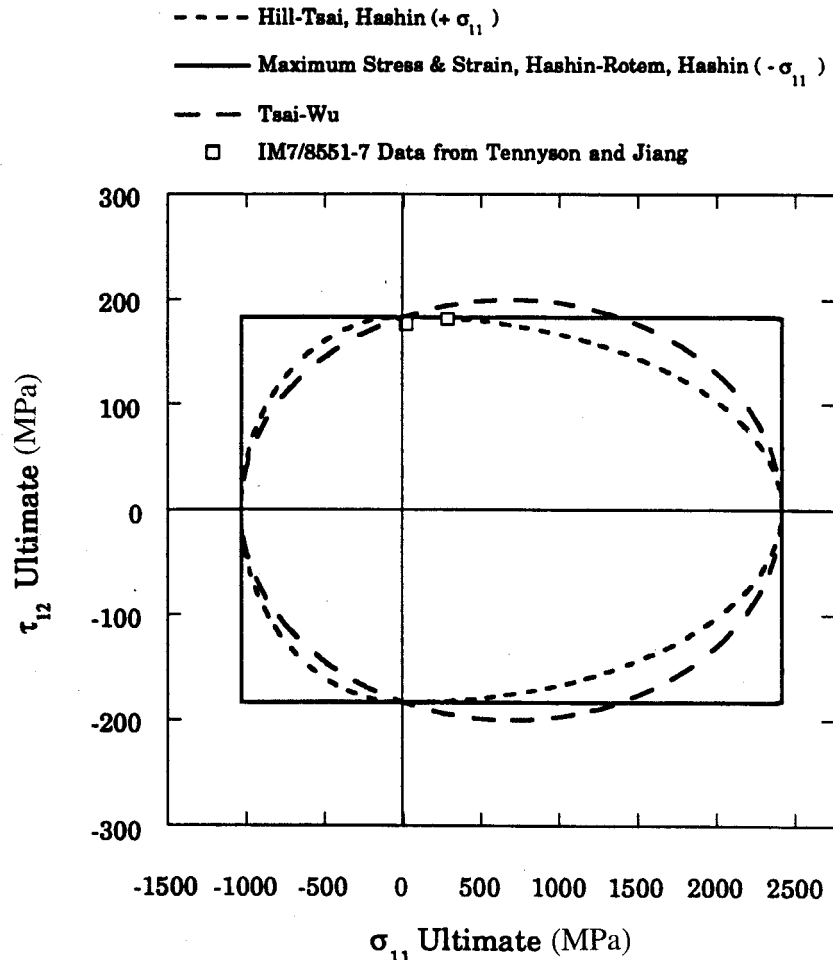

FIGURE 13. COMPARISON OF LAMINA FAILURE CRITERIA TO $\sigma_{11} - \sigma_{12}$ DATA FROM JIANG AND TENNYSON[12]

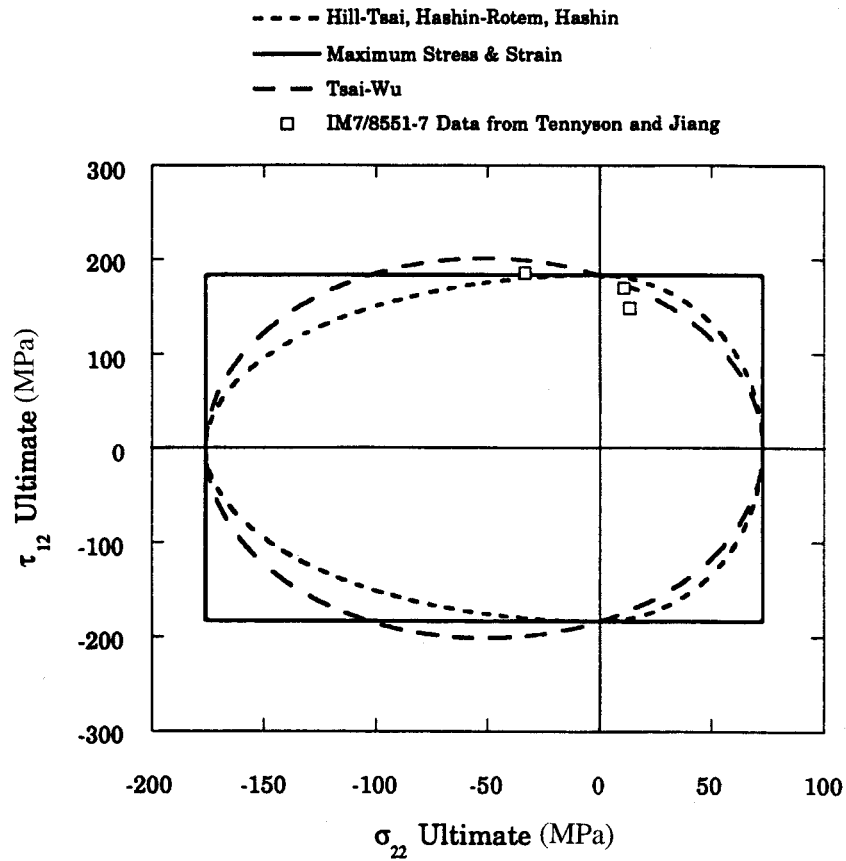

FIGURE 14. COMPARISON OF LAMINA FAILURE CRITERIA TO σ_{22} - σ_{12} DATA FROM TENNYSON AND JIANG

Swanson et al. [13] obtained strength data for an AS4/55A unidirectional composite in the $\sigma_{22} - \tau_{12}$ plane. Table 5 lists the strength properties. Figure 15 contains theoretical predictions of the six lamina failure criteria compared with the experimental data. The plot shows that Hill-Tsai, Tsai-Wu, Hashin-Rotem and Hashin (all including $\sigma_{22} - \tau_{12}$ stress interaction) predict the data very well for tensile σ_{22} . However, for the combination of $-\sigma_{22}$ and τ_{12} , only Tsai-Wu performs well. In fact, the test data indicate that lamina shear strength increases as the σ_{22} component becomes compressive.

In order to verify the aforementioned phenomenon, two more independent sets of $\sigma_{22} - \tau_{12}$ biaxial data were analyzed. The first set is a T800/3900-2 graphite-epoxy tested by Swanson and Qian [14]. The second set is from tests by Voloshin and Arcan [15] using glass-epoxy (Scotch-Ply Type 1002). Both sets of material strength constants are also given in table 5. Figures 16 and 17 show the predictions from the six lamina failure criteria versus experimental data. The trend of an increasing shear strength as the σ_{22} term becomes more compressive is again seen. Further discussion on this phenomenon will be given in the next section.

TABLE 5. STRENGTH VALUES FOR MATERIAL SYSTEMS [13-15] USED IN $\sigma_{22} - \tau_{12}$ BIAXIAL FAILURE COMPARISONS

AS4/55A		Scotch-Ply (Type 1002)		T800/3900-2	
X	not provided	X	1108.0 MPa	X	not provided
X'	not provided	X'	-617.8 MPa	X'	not provided
Y	26.7 MPa	Y	19.61 MPa	Y	65.0 MPa
Y'	-94.7 MPa	Y'	-137.30 MPa	Y'	-200.0 MPa
S	51.8 MPa	S	36.92 MPa	S	100.0 MPa

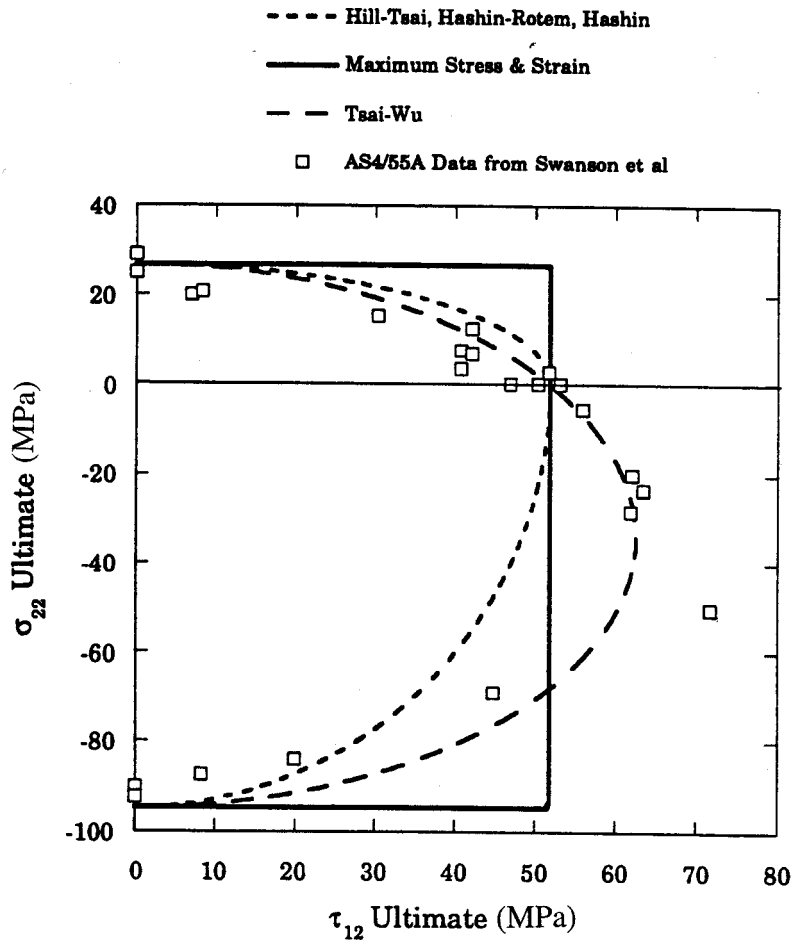

FIGURE 15. COMPARISON OF LAMINA FAILURE CRITERIA TO $\sigma_{22} - \tau_{12}$ AS4/55A DATA FROM SWANSON, MESSICK, AND TIAN

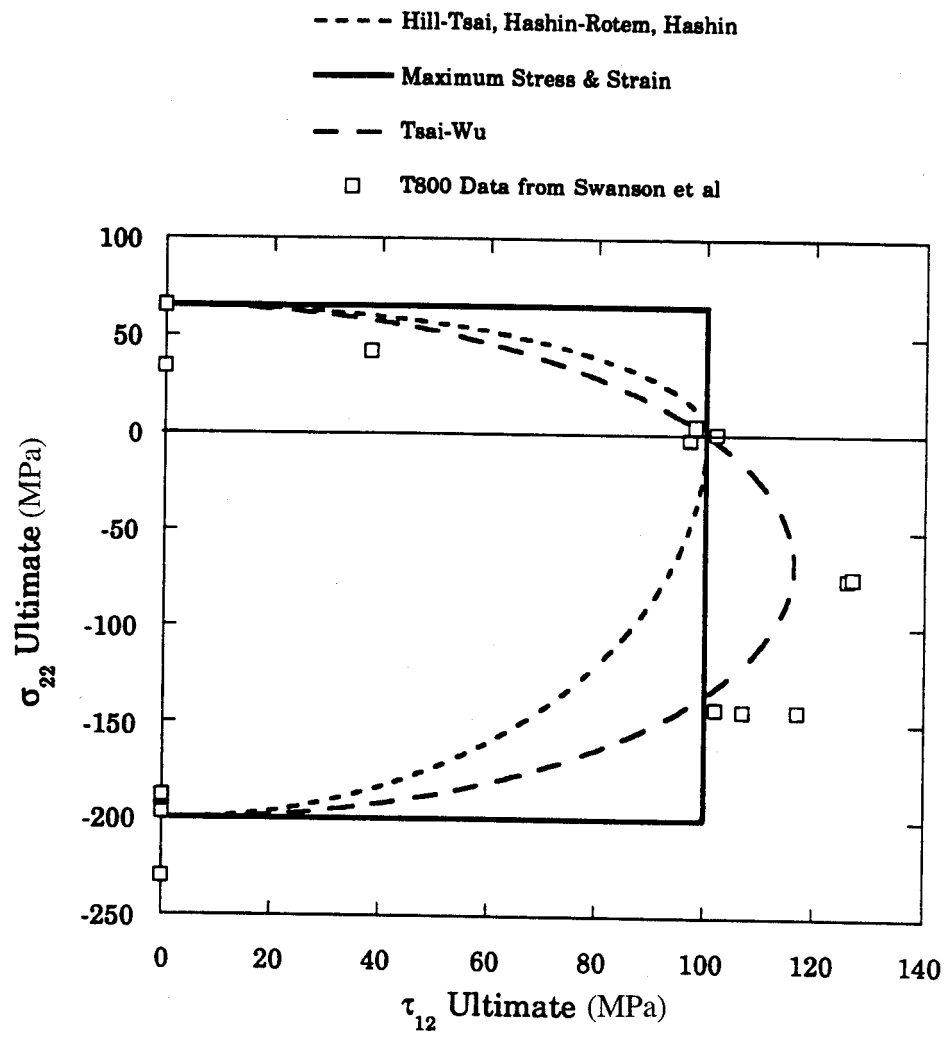

FIGURE 16. COMPARISON OF LAMINA FAILURE CRITERIA TO σ_{22} - τ_{12} T800 DATA FROM SWANSON AND QUIAN

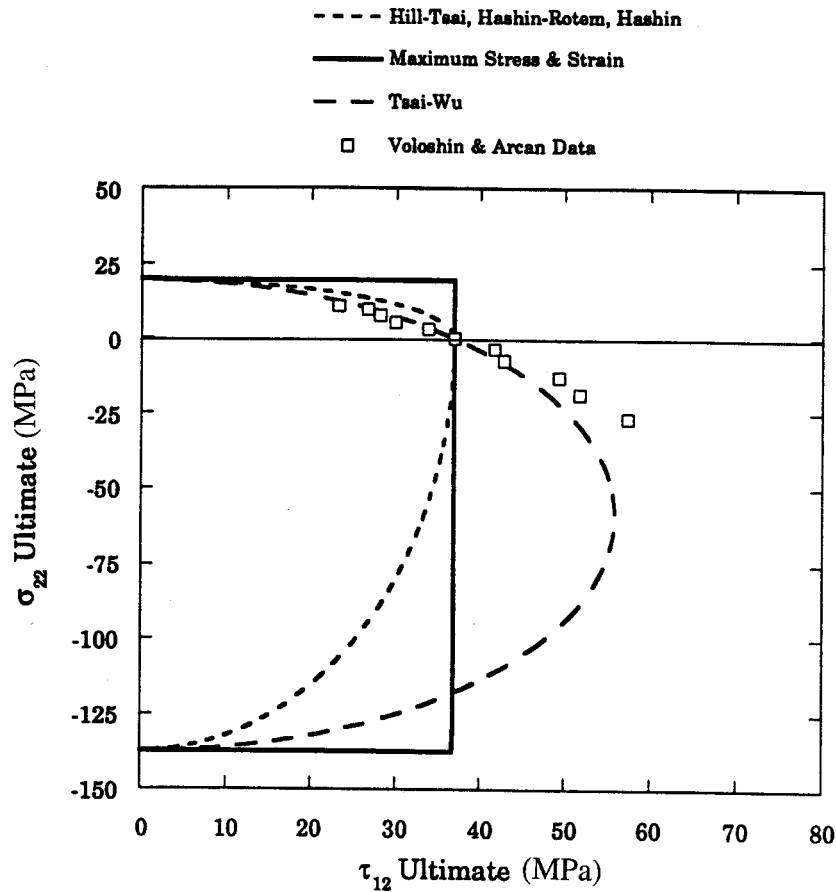

FIGURE 17. COMPARISON OF LAMINA FAILURE CRITERIA TO $\sigma_{22} - \tau_{12}$ GLASS-EPOXY DATA FROM VOLOSHIN AND ARCAN

2.4 ANALYSIS OF THE PHYSICAL BASIS FOR LAMINA FAILURE CRITERIA.

All existing lamina failure criteria for composites are phenomenological or macromechanical in approach. In other words, they are more or less curve-fitting techniques. In order to judge their adequacy in failure prediction, we need to understand the failure mechanisms in the fiber/matrix system.

It is reasonable to say that there are three failure modes in composites, namely, fiber failure, matrix failure, and fiber/matrix interfacial failure. Since, in general, the stresses in the fiber and matrix are different, their respective failures are determined by different strengths. Thus, a conceptually sound lamina failure criterion must start by separating the stress states in the fiber and matrix.

2.4.1 Fiber Failure.

Assume that the stresses in the fiber are σ_{11}^f , σ_{22}^f and τ_{12}^f . For convenience of discussion, we take the stress quadratic form as the failure criterion:

$$\left(\frac{\sigma_{11}^f}{X_f}\right)^2 + \left(\frac{\sigma_{22}^f}{Y_f}\right)^2 - \left(\frac{\sigma_{11}^f}{X_f}\right)\left(\frac{\sigma_{22}^f}{X_f}\right) + \left(\frac{\tau_{12}^f}{S_f}\right)^2 = 1 \quad (8)$$

where X_f , Y_f , and S_f are the fiber strengths. Transverse isotropy in the strength of the fiber is assumed.

For unidirectional fiber composites with fiber volume fraction C_f , the fiber stresses are approximately related to the composite stresses as

$$\sigma_{11}^f = \frac{\sigma_{11}}{C_f}, \quad \sigma_{22}^f = \sigma_{22}, \quad \tau_{12}^f = \tau_{12} \quad (9)$$

The longitudinal composite strength X is related to the longitudinal composite strength X_f as

$$X_f = \frac{X}{C_f} \quad (10)$$

Using equations 9 and 10, equation 8 can be expressed in the form

$$\left(\frac{\sigma_{11}}{X}\right)^2 + \left(\frac{\sigma_{22}}{Y_f}\right)^2 - C_f \left(\frac{\sigma_{11}}{X}\right)\left(\frac{\sigma_{22}}{X}\right) + \left(\frac{\tau_{12}}{S_f}\right)^2 = 1 \quad (11)$$

The values of σ_{22} and τ_{12} are limited by Y and S , respectively. Since $Y_f \gg Y$, $X \gg Y$, and $S_f \gg S$, the fiber failure criterion of equation 11 can be approximated by

$$\left(\frac{\sigma_{11}}{X}\right)^2 = 1 \quad \text{or} \quad \frac{\sigma_{11}}{X} = 1 \quad (12)$$

This justifies the fiber failure criterion (equation 8) used in Maximum Stress, Maximum Strain, and Hashin-Rotem.

2.4.2 Matrix Failure.

Matrix failure is recognized as matrix cracking along the fiber direction. If cracking occurs in the matrix, then all three matrix stress components σ_{11}^m , σ_{22}^m , and τ_{12}^m are to be included in the

matrix quadratic failure criterion:

$$\left(\frac{\sigma_{11}^m}{X_m}\right)^2 + \left(\frac{\sigma_{22}^m}{Y_m}\right)^2 - \left(\frac{\sigma_{11}^m}{X_m}\right)\left(\frac{\sigma_{22}^m}{X_m}\right) + \left(\frac{\tau_{12}^m}{S_m}\right)^2 = 1 \quad (13)$$

It is generally agreed that the fiber/matrix interface is the weaker surface, and so-called matrix cracking may actually occur along the fiber/matrix interface. Hence, failure is governed by the interfacial stresses σ_{22}^m and τ_{12}^m . If σ_{11}^m is neglected and matrix stresses and strengths are assumed as

$$\sigma_{22}^m = \sigma_{22}, \quad \tau_{12}^m = \tau_{12}, \quad Y_m = Y, \quad S_m = S \quad (14)$$

equation 13 reduces to

$$\left(\frac{\sigma_{22}}{Y}\right)^2 + \left(\frac{\tau_{12}}{S}\right)^2 = 1 \quad (15)$$

From the above discussion, it is obvious that Y and S in equation 15 should not be interpreted as only the tensile and shear strengths, respectively, of the neat resin.

Thus, from the consideration of failure mechanisms in the composite system, the criteria for fiber failure and matrix failure should be separated. Equations 12 and 15 turn out to be exactly those proposed by Hashin and Rotem in equation 5.

2.4.3 Generation of Failure Envelopes in the Stress Planes.

In composites, tensile strengths X and Y are very different from the compressive strengths X' and Y' . For example, in using the Hill-Tsai criterion, proper strength values X or X' and Y or Y' must be selected based on the stress quadrant to be analyzed. This has been considered inadequate, and a single equation was desired with the result of the Tsai-Wu failure criterion. In 2-D plane stress, Tsai-Wu is essentially Hill-Tsai with additional linear terms in σ_{11} and σ_{22} . These linear terms allow Tsai-Wu to account for compressive and tensile stresses. Such a polynomial cannot be related to the concept of deformation energy.

In view of the different tensile and compressive failure mechanisms, there is no reason for the lamina failure envelope to be described by a single equation as suggested by Tsai-Wu. It is difficult to argue that, for example, failure of a composite under biaxial tension should depend on its compressive strength properties and vice versa. Although mathematically more convenient, such a practice as adopted by Tsai-Wu may cause unreasonable failure predictions. As shown in figure 2, Tsai-Wu suggests that a compressive stress σ_{22} would increase the longitudinal strength of the composite. There are no known mechanistic reasons to support this. The fact $|Y'| > |Y|$ causes the translation of the failure ellipse to the said position.

2.4.4 On the Maximum Strain Criterion.

On the $\sigma_{11} - \tau_{12}$ and $\sigma_{22} - \tau_{12}$ planes (see figures 3 and 4), the Maximum Stress and Maximum Strain criteria predict identical results. However, for biaxial loading in the $\sigma_{11} - \sigma_{22}$ plane (see figure 2), these two criteria differ significantly. The Maximum Strain criterion predicts that for a tensile longitudinal stress σ_{11} , the tensile transverse stress σ_{22} would be greater than Y in order to fail the composite. Specifically, for σ_{11} near X , the σ_{22} required to cause failure is approaching $2Y$. If the transverse strength of the composite is controlled by the fiber/matrix interfacial strength, then this is not possible.

It is concluded that the Maximum Strain criterion is not adequate for predicting the transverse matrix cracking failure mode where σ_{11} is present.

2.4.5 Dependence of Shear Strength on Compressive Normal Stress σ_{22} .

In all the existing lamina failure criteria, the lamina strengths X , Y , and S are assumed to be constants. However, from the three $\sigma_{22} - \tau_{12}$ biaxial plots in section 2.3.2.1 (figures 15-17), there is strong evidence that when the composite is subjected to a combined $\sigma_{22} - \tau_{12}$ loading, it becomes stronger when σ_{22} is compressive. More specifically, for given $\sigma_{22} = \pm\sigma_o$, the shear stress τ_{12} at failure corresponding to $\sigma_{22} = -\sigma_o$ is appreciably greater than the shear stress τ_{12} corresponding to $\sigma_{22} = +\sigma_o$.

This behavior indicates that a compressive fiber/matrix interfacial normal stress (which is proportional to σ_{22}) would create a greater fiber/matrix interfacial shear strength. To reflect this behavior, the matrix failure criterion of equation 15 may be modified to

$$\left(\frac{\sigma_{22}}{Y}\right)^2 + \left(\frac{\tau_{12}}{S - \mu\sigma_{22}}\right)^2 = 1 \quad (16)$$

where

$$\mu = \begin{cases} \mu_o & \sigma_{22} < 0 \\ 0 & \sigma_{22} > 0 \end{cases}$$

The term μ plays a role similar to friction coefficients. Equation 16, denoted the modified matrix criterion, still yields the expected values of $\sigma_{22} = Y$ at $\tau_{12} = 0$ and $\tau_{12} = S$ at $\sigma_{22} = 0$.

In the absence of σ_{11} , the linear stress terms in the Tsai-Wu criterion (see equation 4) produce a failure envelope in the $\sigma_{22} - \tau_{12}$ plane that exhibits a characteristic strengthening effect similar to that of equation 16. However, this effect would be reversed in the Tsai-Wu criterion in cases in which the transverse compressive strength $|Y'|$ is less than the transverse tensile strength $|Y|$. Thus the Tsai-Wu criterion can be made to fit the data reasonably well, although with no physical basis. In fact, simply increasing the transverse tensile strength of the composite system would translate the half ellipse in figures 15-17 up and away from the data. The use by the Tsai-Wu of

the same compressive and tensile strengths criterion in all four stress quadrants is again considered suspect.

Figure 18 shows AS4/55A data of [13] (from figure 15) plotted with the Tsai-Wu criterion and the modified matrix criterion, equation 16. It is clear from the comparison that the modified matrix criterion fits the data as well as Tsai-Wu. In this particular case, $\mu = 0.6$ fits the data well. Figures 19 and 20 are simply replots of figures 16 and 17, respectively, with the modified matrix criterion added. Only one μ value (which most closely fits the data) is chosen for plotting. These plots also show the accuracy of this modified matrix approach in the $\sigma_{22} - \tau_{12}$ plane. More work in this area must be done to correlate μ with S and Y' .

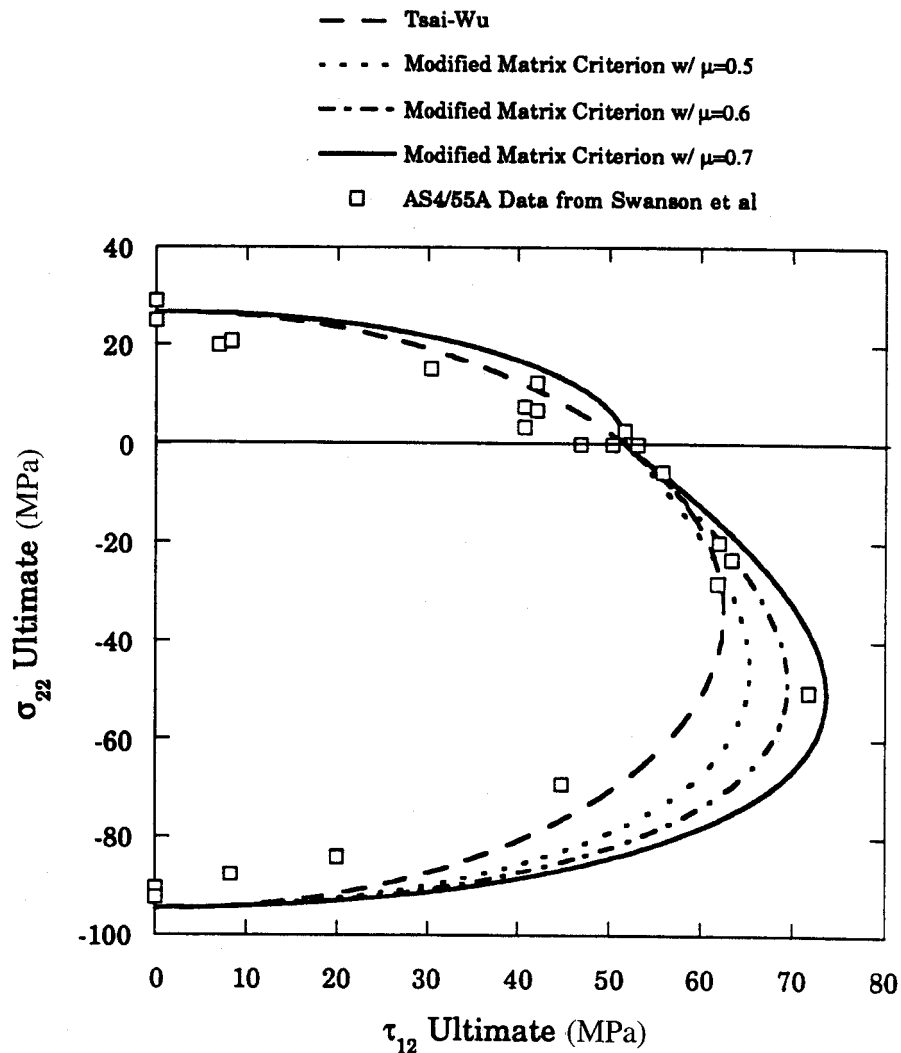

FIGURE 18. COMPARISON OF LAMINA FAILURE CRITERIA AND THE MODIFIED MATRIX CRITERION TO $\sigma_{22} - \tau_{12}$ AS4/55A DATA FROM SWANSON, MESSICK, AND TIAN

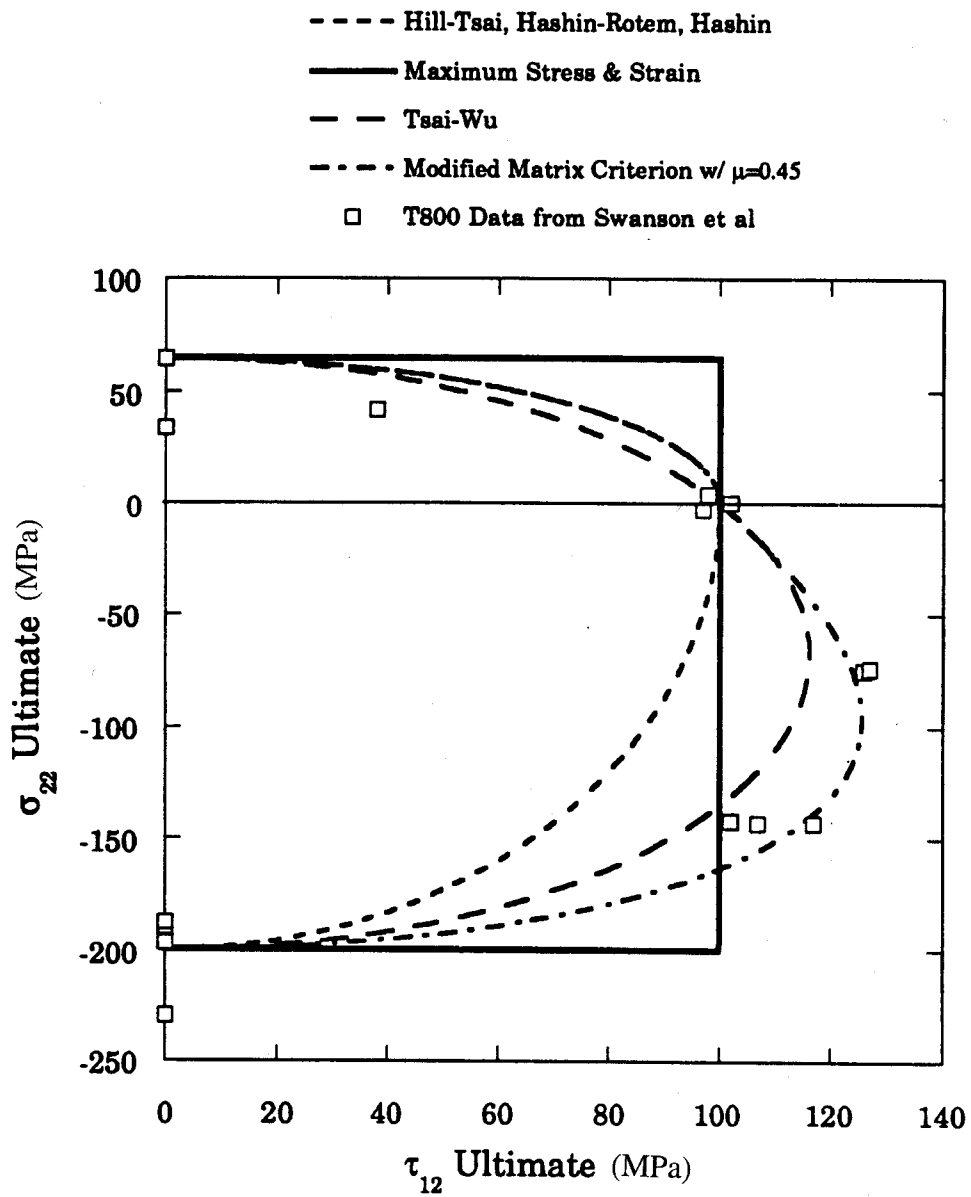

FIGURE 19. COMPARISON OF LAMINA FAILURE CRITERIA AND THE MODIFIED MATRIX CRITERION TO $\sigma_{22} - \tau_{12}$ T800 DATA FROM SWANSON, MESSICK, AND TIAN

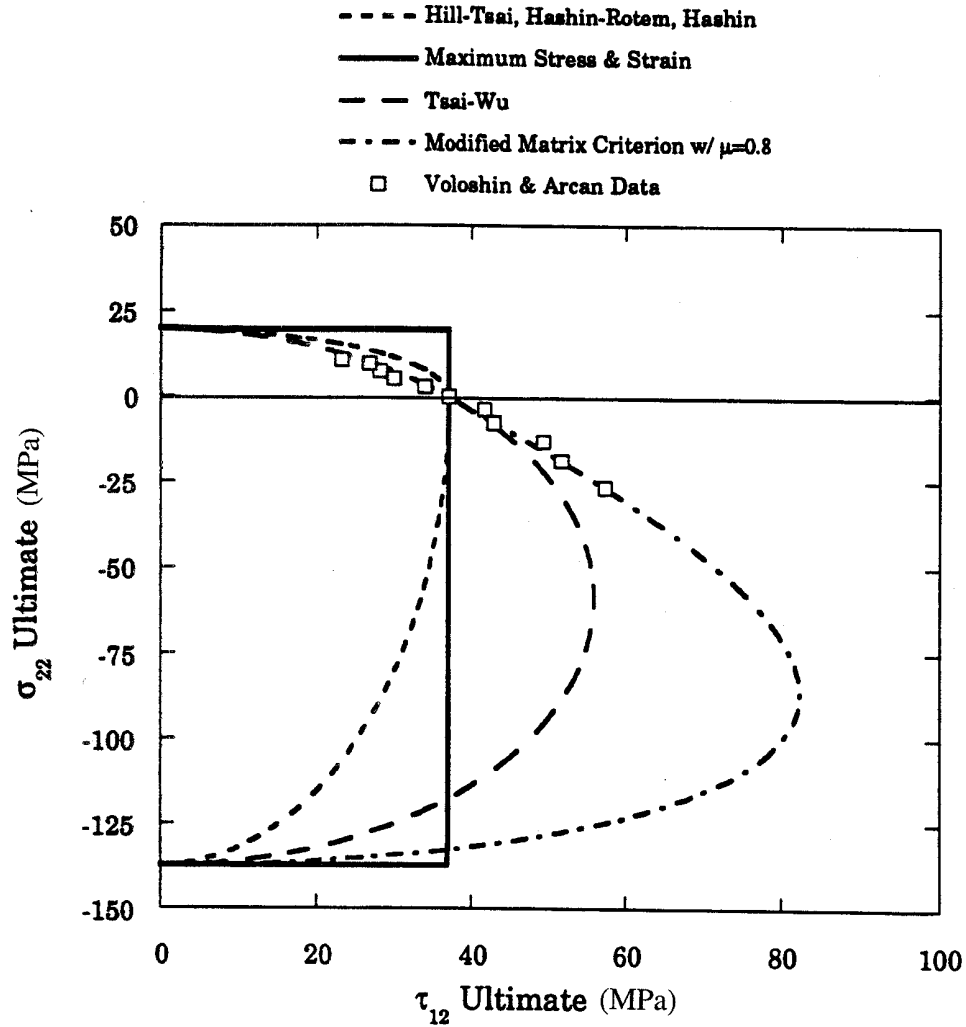

FIGURE 20. COMPARISON OF LAMINA FAILURE CRITERIA AND THE MODIFIED MATRIX CRITERION TO $\sigma_{22} - \tau_{12}$ GLASS-EPOXY DATA FROM VOLOSHIN AND ARCAN

2.4.6 Concluding Observations on Lamina Failure Criteria.

From the comparison with experimental data and mechanistic reasoning, we conclude that a Separate Mode Failure criterion in the form

$$\frac{\sigma_{11}}{X} = |1| \quad \text{for fiber failure}$$

$$\left(\frac{\sigma_{22}}{Y}\right)^2 + \left|\left(\frac{\tau_{12}}{S - \mu\sigma_{22}}\right)^2 = |1| \quad \text{for matrix failure} \quad (17)$$

is most suitable for lamina failure prediction.

A modified form of Tsai-Wu failure criterion,

$$\frac{\sigma_{11}}{X} = 1 \quad \text{for fiber failure}$$

$$F_2\sigma_{22} + F_{22}\sigma_{22}^2 + 2F_{12}\sigma_{11}\sigma_{22} + F_{66}\tau_{12}^2 = 1 \quad \text{for matrix failure} \quad (18)$$

is also adequate for most advanced composites (for which $|Y'| > |Y|$) based purely on its relative success in matching test data rather than mechanistic reasoning.

3. LAMINATE FAILURE ANALYSIS.

Classical laminate strength analysis is based on the assumption of a two-dimensional stress field in the laminate. Laminate failure is the eventual result of progressive failure processes taking place in the constituent laminae under loading. Conceptually, a ply-by-ply failure analysis should yield the desired failure load for the laminate. In reality, however, the failure mechanisms in laminates are a great deal more complicated than those in a unidirectional composite under plane stress. In addition to the three intralaminar failure modes (fiber failure, matrix tension, and matrix shear failure) occurring at the lamina level, three-dimensional failure mechanisms are present in the laminate, the most notable of which include delamination and failure induced by free edge singular stresses. Classical laminate strength analysis is restricted to those laminates whose failure is not dominated by 3-D failure modes.

The effects of free edge stresses are usually treated separately from classical laminate failure analysis. It is thus generally assumed that the laminate is either free from free edge stresses or laminate failure does not initiate from the free edge. Some authors have utilized tubular specimens to avoid the effect of free edge stresses. The use of layers of film adhesive at the interlayers can also toughen the interface, forcing failure to occur in in-plane modes. This latter approach is taken in this study to enable the use of laminate coupon specimens for testing laminate strength.

As lamina failure is progressive in nature, the progressive loss of lamina stiffnesses must also be accounted for in the laminate analysis. However, the local stress concentration effect due to matrix cracks is usually neglected except for laminates with thick laminae such as a [0/90g/0] laminate. This local stress concentration effect on laminate strength was discussed by Sun and Jen [16].

3.1 STIFFNESS REDUCTION.

Some of the laminate failure analysis methods consider a laminate capable of load bearing after an individual ply within the laminate has failed. These methods require a procedure for “discounting” the failed ply and reducing the laminate stiffness. Two methods for achieving this were developed for the present study, the Parallel Spring Model and the Incremental Stiffness Reduction Model.

3.1.1 Parallel Spring Model.

Each lamina is modeled with a pair of springs representing the fiber (longitudinal) and matrix (shear and transverse) deformation modes. The entire laminate is modeled by grouping together a number of parallel lamina spring sets as shown in figure 21. When fiber breakage occurs, the longitudinal modulus is reduced. When matrix cracking occurs, the shear and transverse moduli are reduced. The value to which the moduli are reduced was arbitrary although it was commonly set equal to zero.

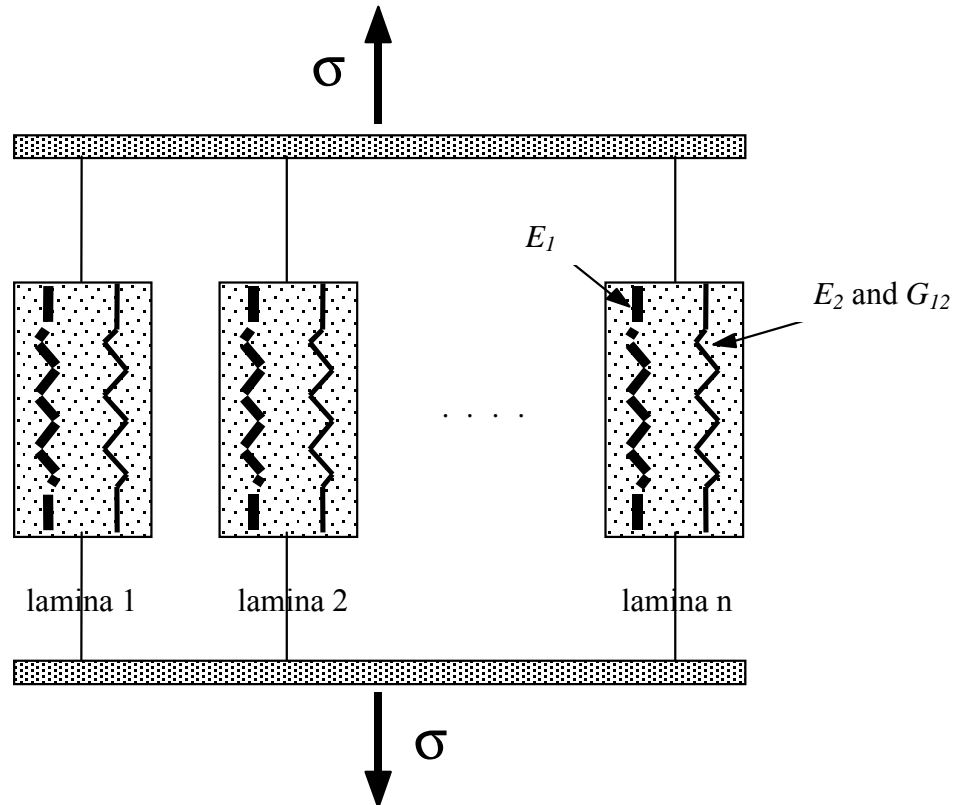

FIGURE 21. SCHEMATIC OF THE PARALLEL STIFFNESS MODEL

This model is also capable of differentiating between types of matrix failure if desired; i.e., the transverse and shear moduli can be reduced separately depending on the specific type of matrix failure mode. The model which reduces E_1 for fiber failure and E_2 and G_{12} for either transverse or shear matrix failure is denoted the PSM. The model which reduces E_1 for fiber failure, E_2 for transverse matrix failure, and E_2 and G_{12} for shear matrix failure is denoted the PSM_s. The idea behind the PSM_s is that a transverse matrix failure doesn't necessarily inhibit the ability of the lamina to carry significant shear loads. Creating these two different reduction models has little micromechanical basis and is done mainly for curve fitting purposes.

3.1.2 Incremental Stiffness Reduction Model.

To avoid the sudden jump in strain at ply failure seen in the Parallel Spring Model, a model resembling the bilinear hardening rule in classical plasticity can be formulated. Laminate stiffness reduction is achieved similar to the Parallel Spring Model. However, it is assumed that the reduced laminate stiffness governs only the incremental load-deformation relations beyond immediate ply failure.

Both of these stiffness reduction models have flexibility. Instead of reducing the appropriate moduli suddenly after a ply failure, a nonlinear function such as exponential function may be used to gradually reduce these values. This progressive softening approach may model certain laminates better than others, i.e., those laminates whose failure is dominated by matrix cracking.

For most fiber-dominated composites, setting the stiffness constants directly to zero after the corresponding mode of failure is simple and unambiguous. The use of such reduction can be justified by regarding the laminate analysis to be at the in-plane (x, y) location where all ply failures would occur. Consider a 90° lamina (within a laminate) containing a number of transverse matrix cracks, as shown in figure 22. The 90° ply still retains some stiffness in the loading direction (E_2 direction locally). However, the assumption is made that ensuing 0° fiber failure will occur at the weakest point. This point is where matrix cracking has occurred in the 90° plies or where locally $E_2 = 0$. Thus, it is acceptable to reduce E_2 directly to zero after transverse matrix cracking for the ultimate strength analysis.

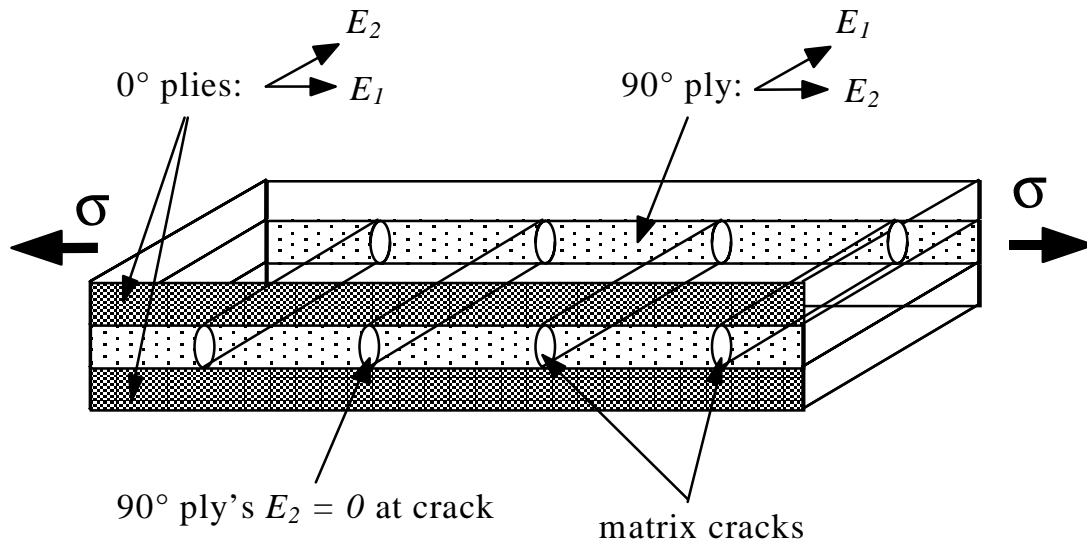

FIGURE 22. SCHEMATIC OF LAMINATE WITH MATRIX CRACKS

Since matrix cracks are discrete, the portion of a failed lamina between two cracks would still contribute substantially to the laminate stiffnesses. It is obvious that such drastic lamina stiffness reduction, if assumed to be true over the whole laminate, would overestimate the ultimate strains of the laminate. In fiber-dominated laminates, the effect of matrix cracks on the overall laminate

stiffness is usually very small. It is reasonable to estimate the laminate ultimate strains by using the virgin laminate stress-strain relations and the laminate failure stresses obtained from the laminate failure analysis.

3.2 LAMINATE FAILURE ANALYSIS METHODS.

As with lamina failure analysis, a variety of laminate failure analysis methods have been proposed. Following is a description of each methodology.

3.2.1 Ply-By-Ply Discount Method.

This is a very common method for laminate failure analysis. The laminate is treated as a homogeneous material and is analyzed with a lamina failure criterion. Laminated plate theory is used to initially calculate stresses and strains in each ply. A lamina failure criterion is then used to determine the particular ply which will fail first and the mode of that failure. A stiffness reduction model is used to reduce the stiffness of the laminate due to that individual ply failure. The laminate with reduced stiffnesses is again analyzed for stresses and strains. The lamina failure criterion predicts the next ply failure and laminate stiffness is accordingly reduced again. This cycle continues until ultimate laminate failure is reached.

A number of definitions have been proposed on how to determine ultimate laminate failure. One common way is to assume ultimate laminate failure when fiber breakage occurs in any ply. Another way is to check if excessive strains occur (i.e., yielding of the laminate stiffness matrix). Matrix-dominated laminates such as $[\pm 45]_s$ may fail without fiber breakage. Others have suggested a “last ply” definition in which the laminate is considered failed if every ply has been damaged. For this project, the laminate failure is defined as occurring when either fiber breakage occurs in any ply or the reduced stiffness matrix becomes singular.

3.2.2 Sudden Failure Method.

In highly fiber dominated composite laminates, effect of the laminate stiffness reduction due to progressive matrix failures on the laminate ultimate strength is insignificant. This suggests that in such laminates the progressive stiffness reduction seen in the previous method may be unnecessary, and laminate failure may be taken to coincide with the fiber failure of the load-carrying ply (the ply with fibers oriented closest to the loading direction). To perform this analysis, a lamina failure criterion is chosen and the failure load is determined by calculating the load required for fiber failure in the dominant lamina. No stiffness reductions are included in the process. The laminate strength predicted by the sudden failure method is usually higher than the laminate strength predicted by the ply-by-ply discount method.

The strength analysis program listed in appendix B includes both the ply-by-ply discount method and the sudden failure method.

3.2.3 Hart-Smith Criterion:[17-19] The Truncated Maximum Strain Envelope.

A laminate failure criterion was proposed by Hart-Smith [17-19] based on the assumption that for a fiber dominated laminate, failure can be attributed to shear failures of the fibers, and that laminate failure can be treated as a projection of a multiaxial fiber failure criterion onto laminate stress space. The Hart-Smith criterion does not require a ply-by-ply discount procedure. The failure envelope is given in the strain space that corresponds to an “extended” Tresca (maximum shear stress) yield criterion.

Initially, the Hart-Smith failure criterion was based on experimental results (see reference 17 and figure 14 of reference 19) on in-plane shear failures in $\pm 45^\circ$ laminates which gave strengths about half of what is expected when the shear stress is resolved into pure tension and compression in the fiber directions. Hart-Smith attributed the low laminate strength measurements to the presence of biaxial stresses which were believed to induce shear failures in the fibers. Hart-Smith also makes frequent reference to observations such as those described in reference 17 on conically shaped fracture surfaces of tension loaded carbon fibers that were interpreted as shear failures. From these observations Hart-Smith concluded that in many cases laminate failure can be reduced to shear failures in the fibers. Denoting L and T as the in-plane longitudinal and transverse directions with respect to the fibers and N the out-of-plane normal direction, it was suggested that these shear failures could be characterized as “L-T” failures, “L-N” failures, and “T-N” failures corresponding to differences between principal stresses in the L and T directions, the L and N directions, and the T and N directions; these stress differences resolve into shear stresses in the three planes lying at 45 degrees to the three pairs of coordinate directions.

Application to a laminate containing 0° and 90° laminae under biaxial loadings in the 0° and 90° directions is illustrated in figure 23. In the figure, ϵ_0 is the tensile failure strain of the fiber and ϵ_0' is the compressive failure strain of the 0° lamina which may be less than ϵ_0 because of microbuckling which precedes the fiber rupture under compression. (A method for modifying the failure criterion for matrix failure under transverse tensile stresses has also been described in references 17-19 and elsewhere.) The strain coordinates ϵ_x and ϵ_y are laminate strains which are assumed to be the same as the strains in the fiber. In general the Hart-Smith criterion is intended for fiber dominated laminates which contain more than two reinforcement directions. A procedure for applying the criterion to more general laminates which include $\pm 45^\circ$ reinforcement as well as to loadings which include in-plane shear is discussed in the pertinent references (see reference 17, for example).

The failure envelope (called truncated maximum strain criterion by Hart-Smith) shown in figure 23 in terms of strains in the 0/90 laminate is based on superposition of the individual lamina failure envelopes such as the one shown in figure 24 for the 0 degree lamina, and is essentially the same as the Sudden failure method (no matrix failure is assumed) in conjunction with the Maximum Strain criterion. The only difference between figure 23 and the conventional Maximum Strain criterion is the 45° cutoff lines in the 2nd and 4th quadrants. The lamina failure envelope shown in figure 24 represents the projection onto lamina strain space of the fiber failure surface based on the three shear failure modes. The discussion in references 17-19 indicates that

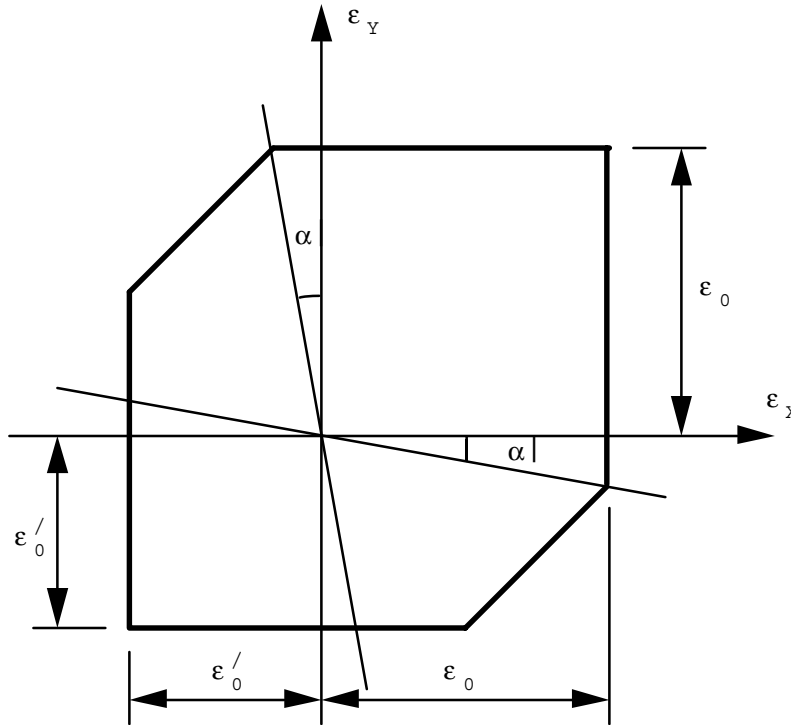

FIGURE 23. HART-SMITH'S TRUNCATED MAXIMUM STRAIN FAILURE ENVELOPE FOR LAMINATES

the 45 degree lines in the second and fourth quadrants in figure 24 correspond to L-T failures, while those in the first and third quadrants corresponding to the lines at angles $-\alpha$ to the horizontal and $-\beta$ to the vertical represent T-N and L-N failures, respectively. With the out-of-plane stress σ_N equal to zero in typical laminate applications, the latter conditions amount to constant σ_T and constant σ_L cutoffs, respectively. (As indicated in the notation at the upper left of figure 24, α and β are related to the Poisson ratios of the lamina as required to produce these constant stress conditions.)

The translation from the fiber failure surface to the lamina strain surface depends on the assumption made by Hart-Smith that the longitudinal and transverse strains in the lamina are the same as those in the fiber. For the longitudinal strains this is obviously a valid assumption. However, for the transverse strains it is suspect, since except for aramid fibers, typical reinforcements are much stiffer than the usual polymer matrices so that the fiber strains will tend to be considerably less than the effective lamina strain except for high-volume fractions for which the fibers are nearly in contact. This will have the effect of distorting the lamina strain envelope in figure 24 and the corresponding laminate strain envelope in figure 23 to some extent, although a precise assessment of the modification would require a micromechanics analysis.

There are certain issues that need to be resolved in connection with the Hart-Smith approach to failure. The most crucial is that of whether or not there are 45-degree cutoffs of the lamina failure envelope in the second and fourth quadrants. As indicated previously, without the cutoffs

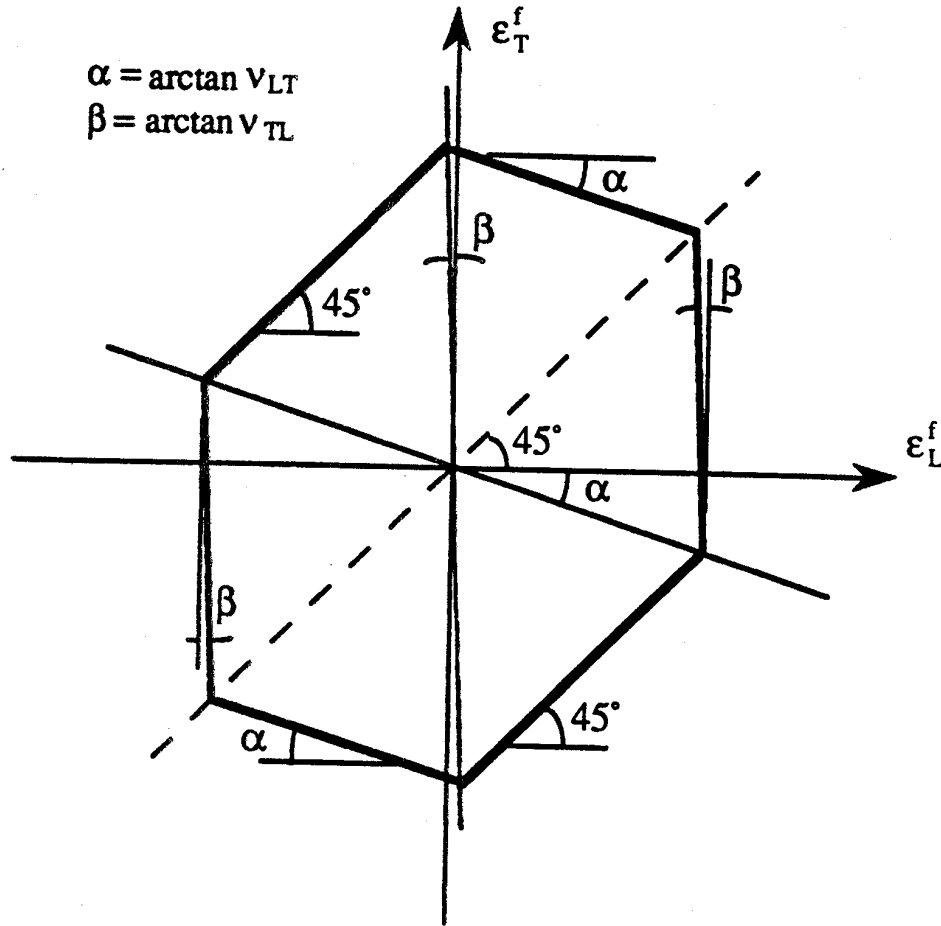

FIGURE 24. FAILURE STRAIN ENVELOPE PROPOSED BY HART-SMITH FOR FIBERS

the Hart-Smith criterion reduces to the maximum Strain or Maximum Stress criterion. Data on failure of laminates under biaxial loading which is discussed later will throw light on this issue.

In addition, the evidence for shear failures in fibers under normal stress loading as well as the implications of low shear strength in ± 45 -degree laminates need to be explored more fully. The experimental results cited by Hart-Smith for these phenomena are somewhat limited and have not been confirmed to any extent by other workers. Further work in this area appears to be warranted. In this regard data on torsion tests of ± 45 -degree filament wound tubes are available [20] which may throw some light on the issue of low shear strength in ± 45 -degree laminates.

3.3 LAMINATE FAILURE ANALYSIS UNDER BIAXIAL LOADING.

Given the laminate failure analysis methods discussed, the six lamina failure criteria can be characterized by their ability to predict failure in a laminate under biaxial loading. Since data for quasi-isotropic laminates under biaxial $\sigma_{xx} - \sigma_{yy}$ loading are readily available, it is appropriate to start the evaluation here.

A quasi-isotropic $[0/\pm 45/90]_s$ laminate is examined using the ply-by-ply discount method in conjunction with the Parallel Spring Model (PSM) for laminate stiffness reduction. In this analysis, the appropriate lamina moduli reduce directly to zero at the individual ply failures. The laminate is assumed to reach ultimate failure when any ply within the laminate fails by fiber breakage. Figure 25 shows the predictions of the six lamina failure criteria assuming the laminate is made up of the material system found in table 1. This laminate is subjected to pure $\sigma_{xx} - \sigma_{yy}$ biaxial loading with $\tau_{xy} = 0$.

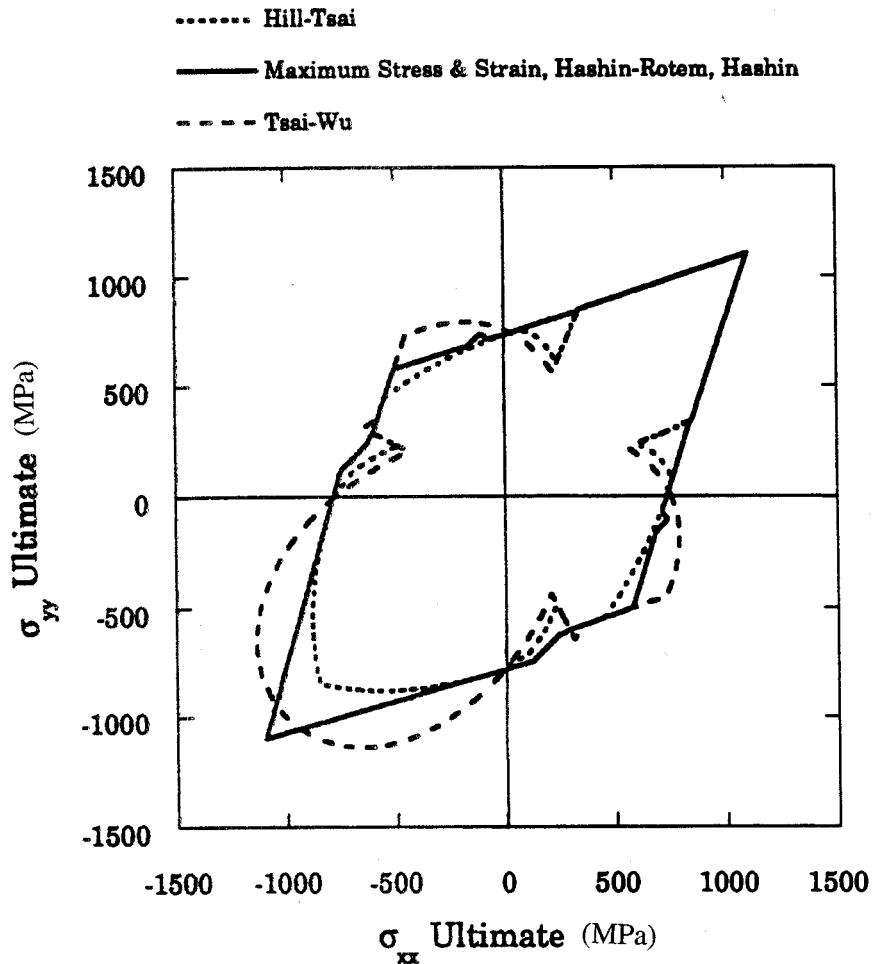

FIGURE 25. FAILURE ENVELOPE OF $[0/\pm 45/90]_s$ LAMINATE USING PLY-BY-PLY DISCOUNT METHOD AND PSM STIFFNESS REDUCTION

Before the ply-by-ply discount method can be properly assessed with different lamina failure criteria, it is important to understand the sensitivity of this method to the applied loads. Figure 26 examines the Hill-Tsai envelope from figure 25. Just the tensile σ_{xx} quadrants I and IV are shown here since they suitably illustrate the characteristics to be discussed. Indeed, this failure envelope contains both linear and quadratic regions with significant jumps in predicted failure loads as the biaxial loading sweeps through the two quadrants. As the biaxial $\sigma_{xx} - \sigma_{yy}$ load changes, the stresses and strains in each lamina change. This fact compounded with large

differences in tensile and compressive strengths for the material used produces different ply failure combinations in each region of the failure envelope.

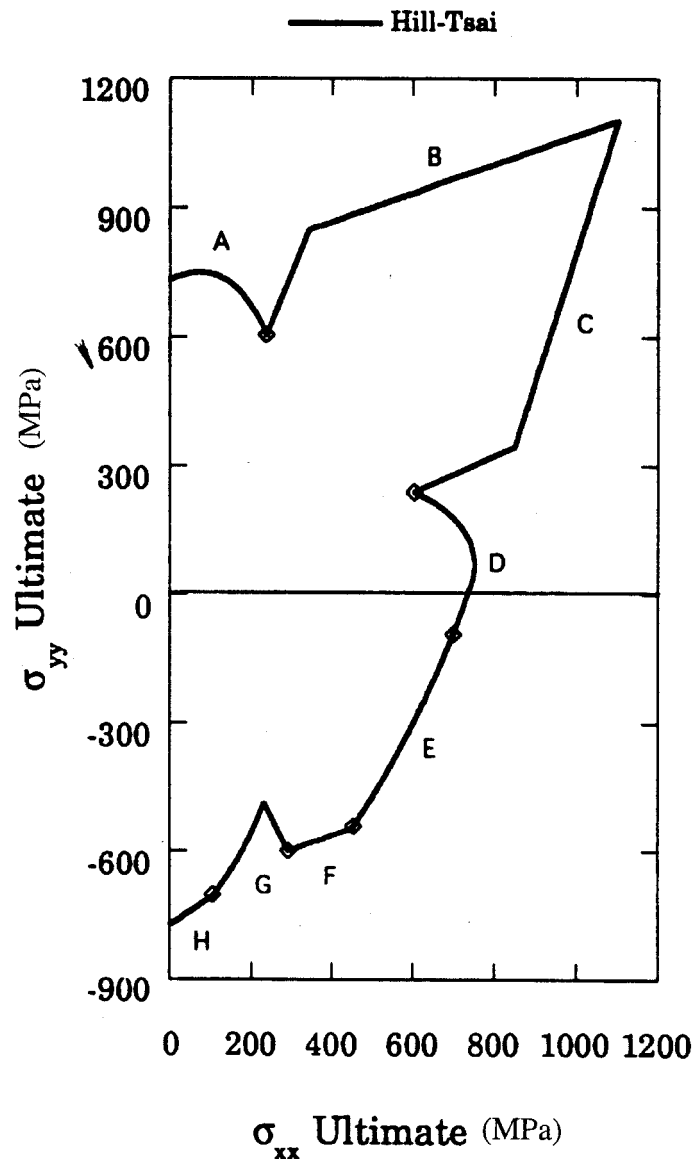

FIGURE 26. FAILURE ENVELOPE OF $[0/\pm 45/90]_s$ LAMINATE USING PLY-BY-PLY DISCOUNT METHOD AND HILL-TSAI LAMINA FAILURE CRITERION

The first quadrant is completely symmetrical about 45° ($\sigma_{xx} = \sigma_{yy}$), due to the nature of this quasi-isotropic laminate. Regions A and D are quadratic because when the fiber dominant ply fails, there is still coupling among all components in that ply. For example, in region D, the 0° ply still carries σ_{11} , σ_{22} , and τ_{12} when it finally fails. In regions B and C on the other hand, every ply in the laminate experiences matrix failure before the final ply failure. Therefore, $\sigma_{22} = \tau_{12} = 0$ for every ply in the laminate. This will result in a linear relationship since there is no coupling

of the stress components, only σ_{11} exists in each lamina. Comparison of regions D and E shows how differences in intermediate ply failures do not necessarily alter the ultimate failure of the laminate. The second ply failure in regions D and E take place in the $\pm 45^\circ$ degree plies in both mode 2 and 3. The Parallel Spring Model used in this analysis method does not discriminate between types of matrix failure; thus, the laminate stiffness is reduced similarly in both regions. In region F, the final failure in the 90° ply is linear because there was previous failure in the 90° ply's matrix, therefore $\sigma_{22} = \tau_{12} = 0$ for that ply. Region G shows how a laminate in certain loading situations can be very fiber dominant. In region H, the addition of an initial $\pm 45^\circ$ ply failure slightly changes the character of the previous curve in region G.

Again, a comparison of all the lamina failure criteria used with this particular laminate failure analysis method is shown in figure 25. The Tsai-Wu lamina failure criterion yields a combination of quadratic and linear regions, which is similar to the Hill-Tsai criterion for the same reasons. The characteristic of the Tsai-Wu failure envelope for this laminate is different from the Hill-Tsai prediction because of the linear terms contained in Tsai-Wu, though similar trends are seen between the two criteria. The limit criteria (Maximum Stress and Maximum Strain) produce a nearly linear laminate failure envelope as expected. The Maximum Stress criterion contains a small jump in predicted failure load near the tensile uniaxial loading cases. This occurs because Maximum Stress considers the $\pm 45^\circ$ ply as the critical ply of the laminate in this particular loading situation. Ultimate failure is predicted when the $\pm 45^\circ$ ply has matrix failure. Unrealistic laminate strains occur if the analysis attempts to continue by looking for a fiber failure.

Since Maximum Strain, Hashin, and Hashin-Rotem criteria predict virtually the same failure envelope as Maximum Stress, they are plotted as one curve. Maximum Strain produces a slightly larger failure envelope due to Poisson's effect. The Hashin and Hashin-Rotem criteria match up almost exactly with the limit criteria in the analysis of this particular laminate. Because Hashin and Hashin-Rotem allow for stress interaction between σ_{22} and τ_{12} , the jumps in failure seen in Maximum Stress and Maximum Strain do not occur; though not seen in the figure, the curve would maintain the same slope through this critical region.

It is clearly shown in figure 25 that except in the third stress quadrant, all failure criteria yield roughly the same laminate strengths. We note that in the first quadrant all plies have failed in matrix mode before the laminate fails by fiber breakage. Although the ply failure sequences predicted by the failure criteria could be different, the end results are the same. On the other hand, in the third stress quadrant, there are no ply matrix failures preceding fiber failure, and all the stress components are fully "active" in the failure criteria, resulting in very different laminate strength predictions between the fully interactive criteria (Hill-Tsai and Tsai-Wu) and other criteria.

Figure 27 shows the comparison between the sudden failure method and the ply-by-ply discount method for the quasi-isotropic laminate under biaxial loading. The Maximum Stress criterion is used in the analysis. As expected, the sudden failure method predicts higher laminate strength except in quadrant III where ply-by-ply discount laminate failure matches the sudden failure assumptions.

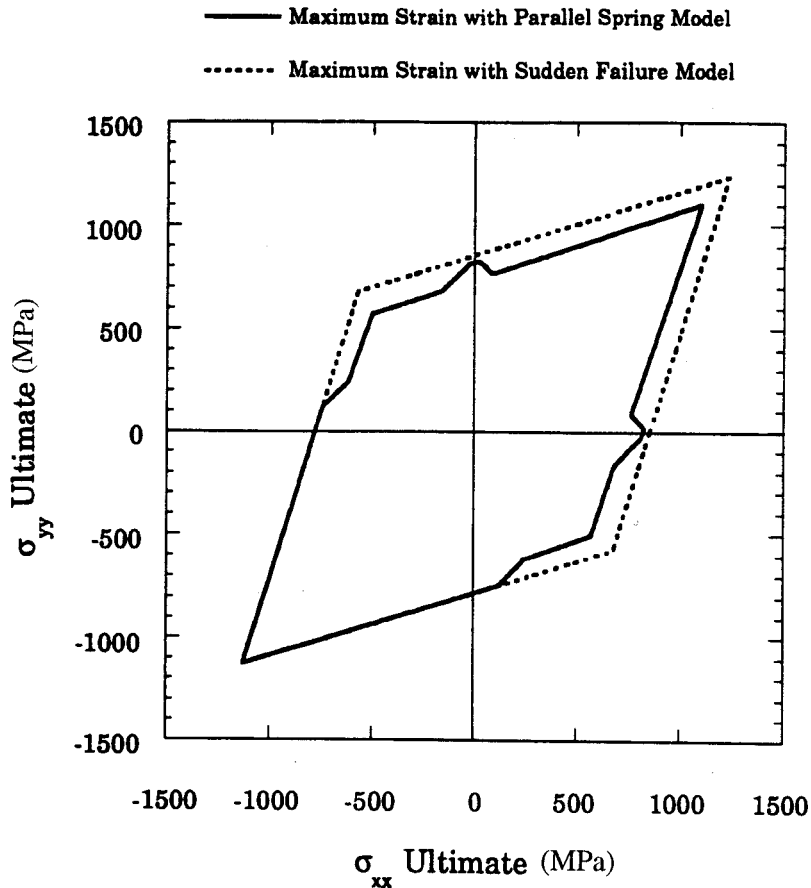

FIGURE 27. FAILURE STRESS ENVELOPE FOR AN AS4-3501-6 $[0/\pm 45/90]_s$
 LAMINATE UNDER BIAXIAL LOADS USING PLY-BY-PLY
 DISCOUNT (THE PSM) AND SUDDEN FAILURE METHODS

Figure 28 shows the failure strain envelope corresponding to the failure stresses of figure 27. In the strain plane, the predictions of the ply-by-ply discount method and the sudden failure method agree everywhere except for a few locations where the ply-by-ply discount method exhibits some kinks. A careful examination of the computer output reveals a special failure process as follows. For the loading condition in these regions (kinks), the 0° (or 90°) ply suffers matrix failure first. When the load reaches some critical value, the $\pm 45^\circ$ plies fail in matrix mode, followed immediately by the fiber failure of the 0° (or 90°) ply without any increase of loading. In other words, the matrix failure of $\pm 45^\circ$ plies leads to catastrophic failure of the laminate. Thus, the ultimate failure strain of the laminate for the loading ratios in that range is the failure strain corresponding to the matrix failure of $\pm 45^\circ$ plies, which is smaller than the fiber failure strain.

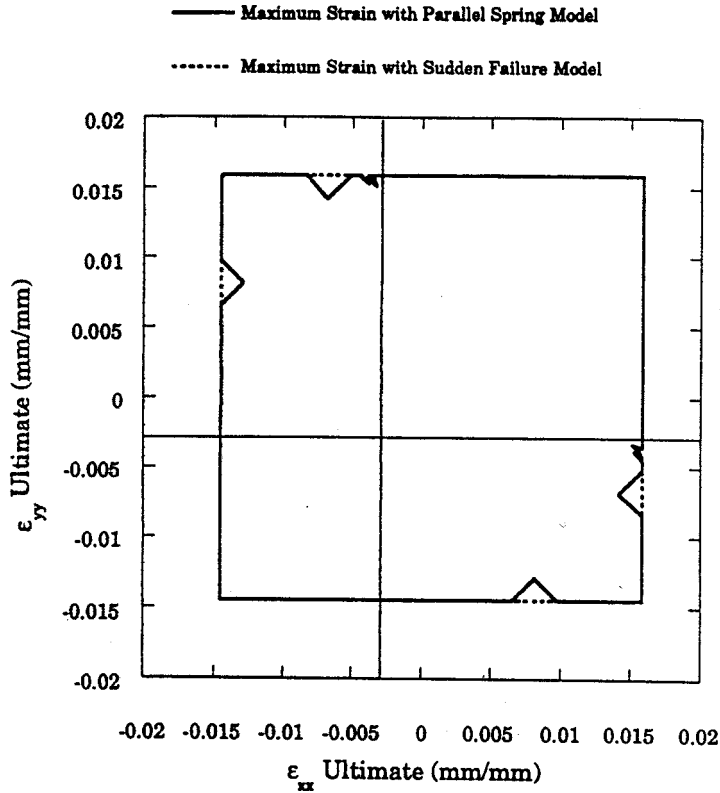

FIGURE 28. FAILURE STRAIN ENVELOPES CORRESPONDING TO THE FAILURE STRESS ENVELOPE OF FIGURE 27

3.3.1 Comparison of Data for Biaxial Loading.

Recently Swanson et al. [19, 21] performed biaxial testing on an AS4/3501-6 graphite-epoxy $[0/\pm 45/90]_s$ laminate using tubular specimens. The ply properties given by Swanson are listed in table 6. Note that they are slightly different from those given by table 1. Also, the longitudinal modulus E_1 is taken as the average of the initial modulus and the secant modulus reported in [21].

TABLE 6. MODULI AND STRENGTH VALUES OF AS4/3501-6 GRAPHITE-EPOXY SYSTEM IN [19, 21].

E_1	134.60 GPa	X	1986.0 MPa
E_2	11.03 GPa	X'	-1193.0 MPa
G_{12}	5.52 GPa	Y	47.9 MPa
ν_{12}	0.28	Y'	-168.0 MPa
Ply Thickness:	0.13 mm	S	95.7 MPa

Figure 29 shows Swanson's data in the first and fourth quadrants of the $\sigma_{xx} - \sigma_{yy}$ plane plotted against various failure envelopes. The predicted envelopes are generated with the six lamina

failure criteria in conjunction with the ply-by-ply discount method. Comparing with the data, it is evident that the predictions of all six lamina failure criteria agree with the data very well. However, as discussed in section 3.3, the fully interactive criteria such as Hill-Tsai and Tsai-Wu are very sensitive to the sequence of lamina matrix failures and can be significantly affected by the sudden reduction of matrix stiffness, resulting in jumps in strength, as shown in figure 29.

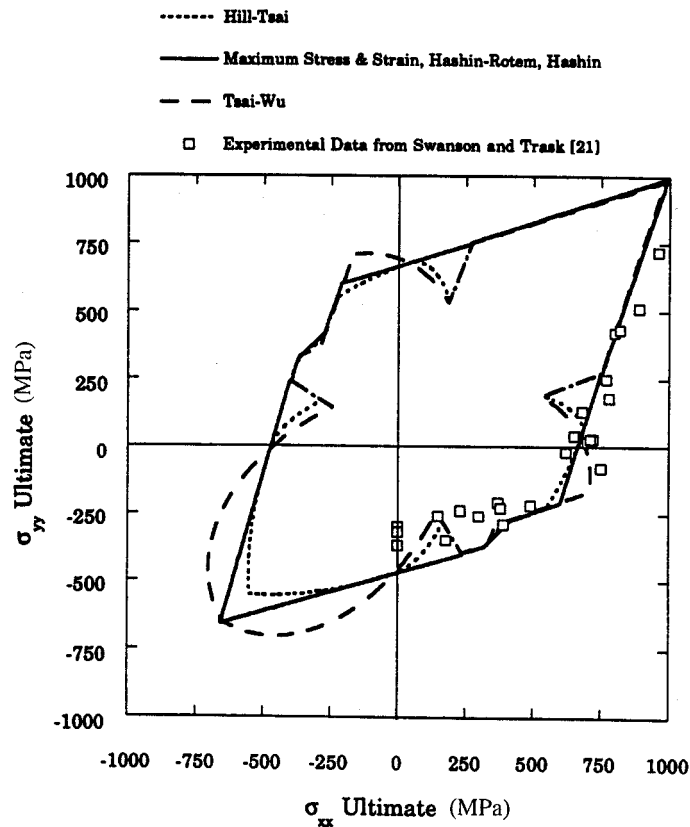

FIGURE 29. COMPARISON OF ULTIMATE STRESS ENVELOPES WITH EXPERIMENTAL DATA FOR A $[0/\pm 45/90]_s$ LAMINATE UNDER BIAXIAL LOADS

Swanson and Qian [14] also tested laminate tubes in the $\sigma_{xx} - \sigma_{yy}$ plane. The $[0/\pm 45/90]_s$, $[0_3/\pm 45/90]_s$, and $[0/(\pm 45)_2/90]_s$ data presented in reference 14 (I and IV quadrants only) matched well with the Maximum Strain analysis. Considering that all lamina failure criteria are in close agreement in these quadrants for the $\pi/4$ laminate, it is clear that they should all be adequate for these laminates.

3.3.2 Biaxial Failure in the Strain Plane.

The failure strains corresponding to the failure stress envelopes of figure 29 are plotted in figure 30. It is interesting to note that the failure strain envelopes predicted by Maximum Stress, Maximum Strain, Hashin, and Hashin-Rotem criteria essentially coincide with the limits set by the ultimate tensile strain (X_{ϵ}) and compressive strain (X_{ϵ}^c) of the unidirectional composite.

However, these limit strains should not be automatically taken as the ultimate strains of the laminate at failure. For the $\pi/4$ quasi-isotropic laminate under biaxial loading in the third stress quadrant (compressive σ_{xx} and σ_{yy}), there are no ply matrix failures before ultimate laminate failure. Thus, there is no stiffness reduction before laminate failure, and the calculated failure strain is the laminate failure strain.

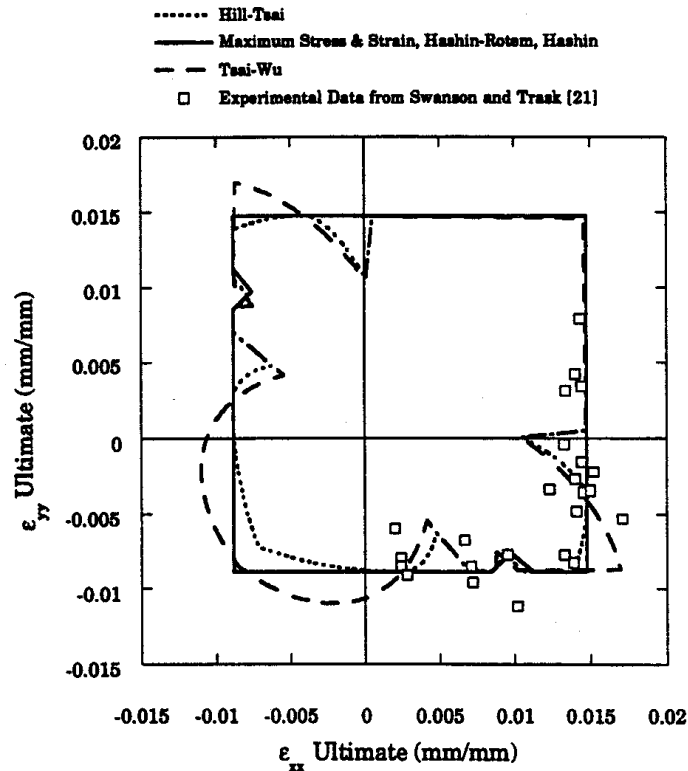

FIGURE 30. COMPARISON OF ULTIMATE STRAIN ENVELOPES WITH EXPERIMENTAL DATA FOR A $[0/\pm 45/90]_s$ LAMINATE UNDER BIAXIAL LOADS

Under tensile biaxial loading (tensile σ_{xx} and σ_{yy}), all plies in the laminate have suffered matrix failure before laminate final failure. The drastic reduction (to zero) of ply transverse and shear stiffnesses tends to overestimate the ultimate strains. Therefore, the strain failure envelope as shown in figure 30 should not be used directly in laminate strength design without accounting for the stiffness reductions.

In figure 31, the Hart-Smith criterion is compared with the Maximum Strain criterion (with the ply-by-ply discount method) and the experimental data of Swanson and Trask [21]. Hart-Smith [17] used different strength data; otherwise his prediction would have coincided with the Maximum Strain criterion except for the 45° shear cutoffs. From the data, the 45° cutoff does not seem to be necessary.

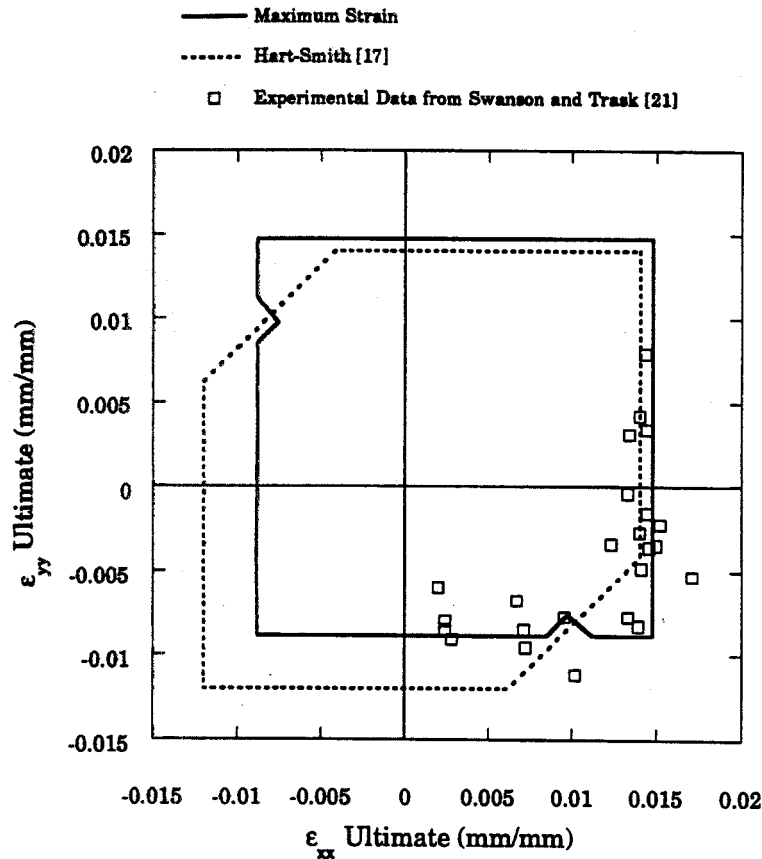

FIGURE 31. COMPARISON OF MAXIMUM STRAIN AND HART-SMITH'S ULTIMATE STRAIN ENVELOPES WITH EXPERIMENTAL DATA FOR A $[0/\pm 45/90]_s$ LAMINATE UNDER BIAxIAL LOADS

3.3.3 Biaxial Testing Data For Glass Woven Fabric Composite.

Recently, Wang and Socie [23-24] performed biaxial testing on NEMA G-10 E-glass plain woven fabric composite laminates. They used both tubular specimens and flat square specimens. Strength data were obtained for all four biaxial loading quadrants. Their test results clearly indicate that the laminate failure strain envelope is bounded by the uniaxial ultimate strains of the laminate. Specifically, they found that failure in one direction was not affected by loading in the transverse direction. Hence, the failure strain envelope appears to be rectangular as predicted by the Maximum Strain and Maximum Stress criteria. For this composite laminate, the 45° shear cutoff as proposed by Hart-Smith was not observed.

3.4 LAMINATE STRENGTH ANALYSIS FOR UNIDIRECTIONAL OFF-AXIS LOADING.

Laminate strength data are available for coupon specimens under uniaxial loading. In most cases though, free edge stresses control the initiation and final failure of these laminates. Data as such are not suitable for evaluating the laminate failure analysis methods as attempted here. However, by placing film adhesive at the interfaces of laminate coupon specimens, it is possible to suppress

these 3-D effects. This type of coupon specimen is used to generate additional laminate strength data for the purpose of evaluating the failure criteria.

3.4.1 Generation of Laminate Failure Curve for Off-Axis Loading.

Theoretically predicting laminate strength under off-axis loading is similar to the lamina case (see figure 5). All plies of the laminate are simply rotated the same amount as the angle of loading. The newly created laminate is then subjected to a unidirectional load in the global x-direction. For example, a $[0/\pm 45]_s$ laminate under 10° off-axis loading would be analyzed as a $[10/+55/-35]_s$ laminate under a unidirectional load in the x-direction. The failure curve for a laminate under such loading is generated by calculating the ultimate strength at each off-axis loading angle in a desired range. Typical laminate symmetry requires only a portion of the entire 360° range to be analyzed.

3.4.2 Selection of Laminates and Off-Axis Loading Angles.

A variety of laminates was theoretically examined in advance of actual strength testing. Only the ply-by-ply discount method was used to determine ultimate laminate strength. Laminate layups and loading angles were chosen so as to provide a comparison of the six lamina failure criteria. The focus of the experiment was to examine whether these failure criteria could predict the correct trend of the laminate strength versus the loading angle. It was not necessary to evaluate the ability of the lamina failure criteria to predict laminate strength over the entire possible range of loading angles.

Table 7 shows the laminates and off-axis loading angles selected. Included in these tests were unidirectional laminate specimens for principal material. Five or more tests were performed at each off-axis loading angle to provide accurate mean results. In the table, “A” indicates the location of an adhesive film in the laminate.

TABLE 7. LAMINATES AND OFF-AXIS LOADING ANGLES TESTED

Laminate	Off-Axis Angles Tested
$[0]_g$	0° & 90°
$[0/A/+45/A/-45/A/90]_s$	$0^\circ - 22.5^\circ$ every 7.5°
$[90/A/0/A/90/A/0]_s$	$0^\circ - 7.5^\circ$ every $1.5^\circ, 15^\circ, 22.5^\circ$
$[0/A/+45/A/-45]_s$	$0^\circ - 30^\circ$ every $7.5^\circ, 26^\circ, 45^\circ$
$[90/A/+30/A/-30]_s$	$0^\circ - 22.5^\circ$ every 7.5°

3.4.3 Consideration of Curing Stresses and in Situ Lamina Strength.

The mismatch of thermal expansion coefficients of the fiber and matrix can cause residual thermal stresses (curing stresses) to form within the laminate during the manufacturing process. Typically these stresses place the matrix in tension. These stresses can be significant; thus, they should not be neglected if prediction of matrix failure is of importance.

Another issue in laminate analysis is the in situ strength of constituent laminae. Flaggs and Kural [25] found that the in situ transverse strength Y could be as high as 2.5 times the unidirectional transverse strength. This can clearly be a cause of inaccurate strength predictions.

As it turns out, curing stresses in graphite/epoxy composite laminates are typically of a magnitude similar to the unidirectional transverse strength Y . Since the in situ lamina strength is not available, in this study, the effect of curing stresses is neglected. The rationale is that the underestimation of in situ strength Y will be offset by neglecting the effect of curing stresses.

3.4.4 Laminate Coupon Specimens.

The material used for testing was AS4/3501-6 graphite-epoxy from Hercules. A 0.13-mm-thick ply of film adhesive was added at each lamina interface except the middle interface because of symmetry. The adhesive was FM 1000 marketed by AmericanCyanamid. The elastic and strength properties of this material were determined by Sun and Zhou [7] and are listed in table 8.

TABLE 8. MATERIAL PROPERTIES FOR FM 1000 FILM ADHESIVE

σ_{ult}	38 MPa
E	1.724 GPa
G	0.648 GPa
ν	0.33
Ply Thickness:	0.127 mm

Guidelines given by ASTM [26] were followed in the preparation of the coupon specimens. Specimens were cut, using a water jet, from 12- by 12-inch square laminate panels manufactured in the manner recommended by Hercules. All specimens were 0.75 inch wide with a 6.75 inch gage section. This yielded a 9 to 1 aspect ratio. Water-jet cutting gave smooth edges which were free from initial matrix cracks and delamination. X-ray photography was used to verify the free edge condition for a few individual specimens.

End tabs were used to protect them from being damaged in the test machine grips. A standard epoxy adhesive was used for this purpose. For those laminate specimens with anisotropic stiffness, it was important not to overlook the effect of shear-extension coupling. Highly anisotropic laminate coupon specimens can fail prematurely due to stress concentrations in the tab region if rectangular tabs are used. In order to accommodate the deformation induced by the extension-shear coupling, oblique end tabs suggested by Sun and Chung [27] were used. See figure 32. The oblique angle ϕ was derived using extensional laminate stiffnesses A_{11} and A_{16} as

$$\cot \phi = -A_{16}/A_{11} \quad (27)$$

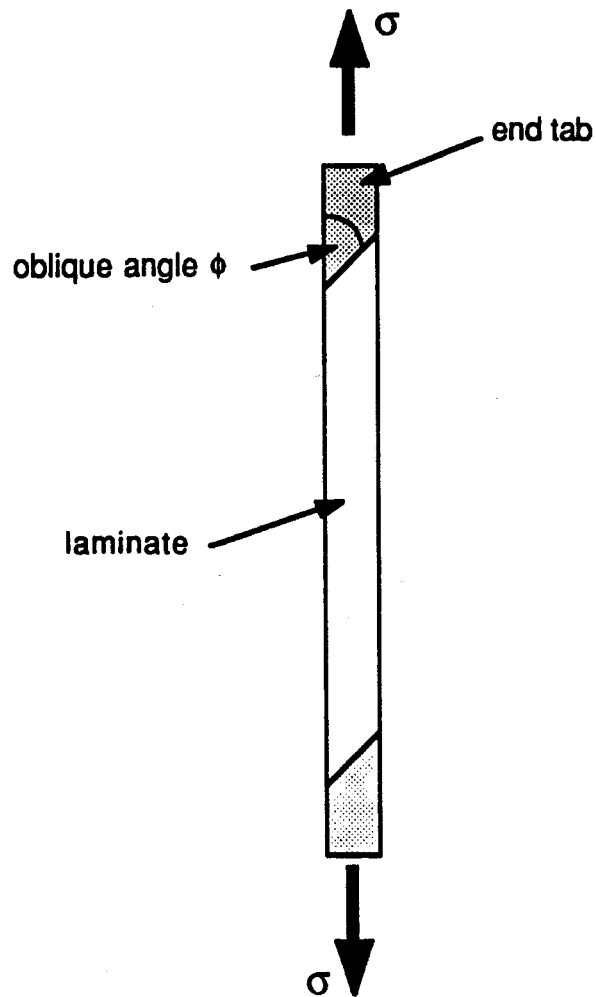

FIGURE 32. EXAMPLE OF OBLIQUE END TABS

It was demonstrated by Sun and Chung [27] that, using oblique end tabs, an almost uniform state of stress corresponding to uniaxial loading could be generated in off-axis laminate coupon specimens rigidly gripped during loading. In quasi-isotropic laminates, extension-shear coupling is absent and standard rectangular tabs were used.

Glass-epoxy and graphite-epoxy quasi-isotropic laminates were used for oblique end tabs. For the rectangular tabs, material stiffness is not as critical, and chopped-fiberglass circuit board was used. The tab length was determined by assuming an ultimate failure load and then sizing the necessary tab area based on the strength of the epoxy system used for tab bonding. In all cases, the tabs measured 0.75 inch wide and a minimum of 1.25 inches long. Some oblique tabs were extended to 2.25 inches in order to assure good adhesion to the coupon specimen.

3.4.5 Testing Procedure.

Tests were performed in the Composite Materials Laboratory (CML) at Purdue University. All specimens were mechanically loaded in tension at a stroke rate of 0.1 inch/min on an MTS 810 servohydraulic test machine. This was equal to a strain rate of approximately 1.5% per minute, which adheres to ASTM guidelines for fiber composites. Tests were performed at room temperature. The majority of tests were designed to determine ultimate load and in some cases ultimate strain. Hence, only load, displacement, and strain (if applicable) were measured during tensile loading. These values were displayed in real time through a data acquisition package on a personal computer.

The first set of coupons tested were 0° and 90° unidirectional laminates. All specimens were strain gauged to determine the appropriate elastic constants. Table 9 lists the results. Only the moduli E_1 , E_2 , ν_{12} and the strength values X and Y were determined in the present test. The strengths S , X' , and Y' were taken from a similar AS4/3501-6 material system given by Sun and Zhou [7]. The shear modulus G_{12} in [7] was obtained from testing $[\pm 45]_s$ laminate and is lower than 6.9 GPa as obtained by Daniel [28] using a more reliable method. This value is listed in table 9.

TABLE 9. MODULI AND STRENGTH VALUES FOR THE TESTED AS4/3501-6 GRAPHITE-EPOXY SYSTEM

$E_{1\Box}$	153.7 GPa		$X\Box$	2171.0 MPa
$E_{2\Box}$	11.0 GPa		$X\Box$	-2013.0 MPa
$G_{12\Box}$	6.9 GPa		$Y\Box$	67.0 MPa
$\nu_{12\Box}$	0.32		$Y\Box$	-206.8 MPa
Ply Thickness:	0.13 mm		$S\Box$	110.3 MPa

Ultimate laminate stress for the unidirectional laminate coupon specimens (0° and 90°) was determined by dividing the measured ultimate load by the cross-sectional area (width by thickness). The 8-ply unidirectional laminates had an average thickness of 1.04 mm; thus the nominal ply thickness was assumed as 0.13 mm (0.0051 in.).

For laminates containing layers of film adhesive, the calculation of ultimate stress must account for the thickness and stiffness of the film adhesive in determining the true graphite-epoxy laminate strength. First, it is assumed that the total measured ultimate load is the summation of the load carried by the composite and the load carried by the adhesive, i.e.,

$$P_{exp\Box} = P_{C\Box} + P_{A\Box} \quad (28)$$

It is also assumed that the composite and adhesive loads can be separated by the rule of mixtures:

$$P_A = \left(\frac{E_A h_A \Box}{A_{11} + E_A h_A \Box} \right) P_{exp\Box} \quad (29)$$

$$P_C = \left(\frac{A_{II}}{A_{II} + E_A h_A} \right) P_{exp} \quad (30)$$

where E_A is the adhesive modulus, h_A is total thickness of all adhesive layers in the laminate, and A_{II} is the total extensional stiffness calculated just for the graphite-epoxy plies. Equation 30 is used to obtain the true composite ultimate load from the experimental load. The laminate strength is then determined by dividing P_C by the total cross-sectional area of the composite plies. Table 10 shows all the averaged ultimate stress data for the tested laminates.

TABLE 10. ULTIMATE LAMINATE STRESSES (MPa)

Off-Axis Loading Angle	0°	7.5°	15°	22.5°	26°	30°	45°	-
[0/A/+45/A/-45/A/90] _s	765	752	774	832	-	-	-	-
[0/A/+45/A/-45] _s	883	843	929	1028	1129	1074	818	-
[90/A/+30/A/-30] _s	966	908	837	807	-	-	-	-
Off-Axis Loading Angle	0°	1.5°	3°	4.5°	6°	7.5°	15°	22.5°
[90/A/0/A/90/A/0] _s	1126	1140	1074	1018	861	713	394	288

Though the majority of ultimate failures were caused by fiber rupture, a few specimens were matrix dominated in which fiber failure did not occur. In the matrix dominated coupon tests, the specimen never fractured into two (or more) pieces. Instead, the deformation continued until reaching a strain of approximately 3% at which the test was stopped. As seen in figure 33, a [90/A/0/A/90/A/0]_s laminate loaded at 22.5° exemplifies this behavior. For comparison, the stress-strain curve for a [0/A/+45/A/-45]_s laminate loaded at 45° is also plotted, which demonstrates the behavior involving typical fiber failure.

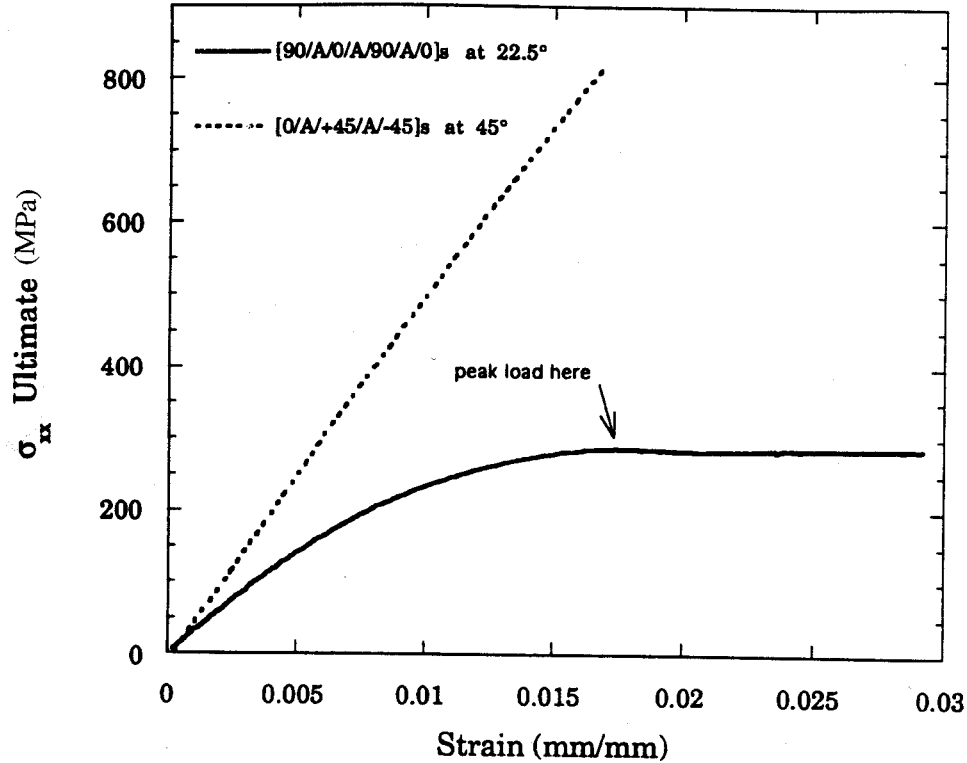

FIGURE 33. STRESS-STRAIN CURVES CHARACTERIZING FIBER AND MATRIX FAILURES

3.4.6 Comparison With Test Data.

Theoretical predictions of the different lamina failure criteria using the ply-by-ply discount method for laminates under off-axis loading are compared with the experimental data. Both the PSM and PSM_s are considered to assist in analyzing experimental trends.

Figures 34 and 35 show theoretical predictions for the [0/A/+45/A/-45/A/90]_s laminate obtained using the PSM and PSM_s stiffness reduction procedures, respectively. The theoretical predictions with the PSM_s are slightly higher in regions where transverse matrix cracking has occurred. This is because the transversely failed lamina retain shear stiffness which results in higher lamina stiffness and, consequently, laminate strength.

The experimental data (CML data) for the [0/A/+45/A/-45/A/90]_s laminate shows an increase in strength as the off-axis loading angle rotates from 0° to 22.5°. Maximum Stress, Maximum Strain, and Hashin-Rotem all theoretically predict this increase, supporting the idea of separating fiber failure (governed by fiber stress σ_{11}) from matrix failure (governed by matrix stresses σ_{22} and τ_{12}).

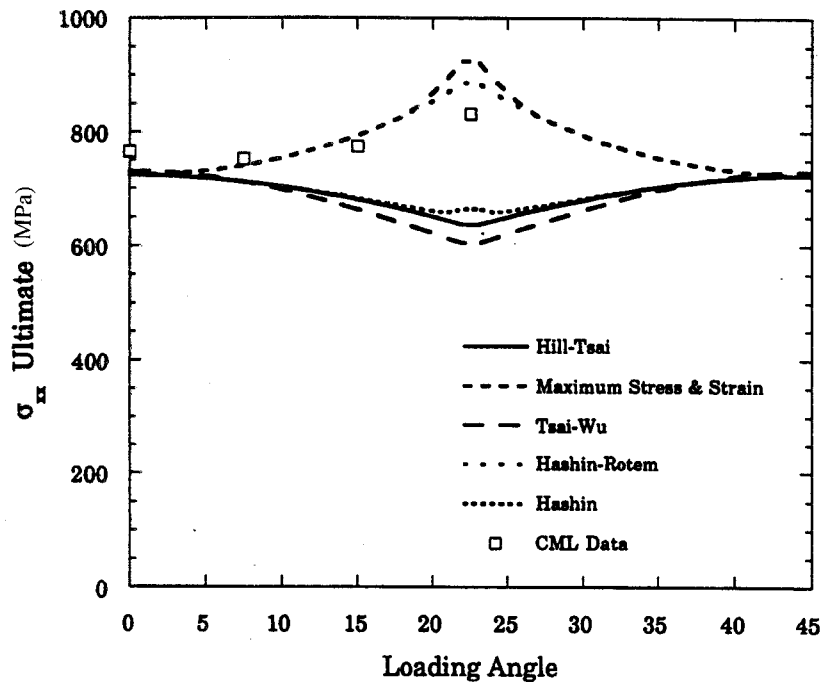

FIGURE 34. COMPARISON OF ULTIMATE STRENGTHS FOR A $[0/A/+45/A/-45/A/90]_s$ LAMINATE UNDER UNIDIRECTIONAL LOADING USING DIFFERENT LAMINA FAILURE CRITERIA (WITH THE PSM)

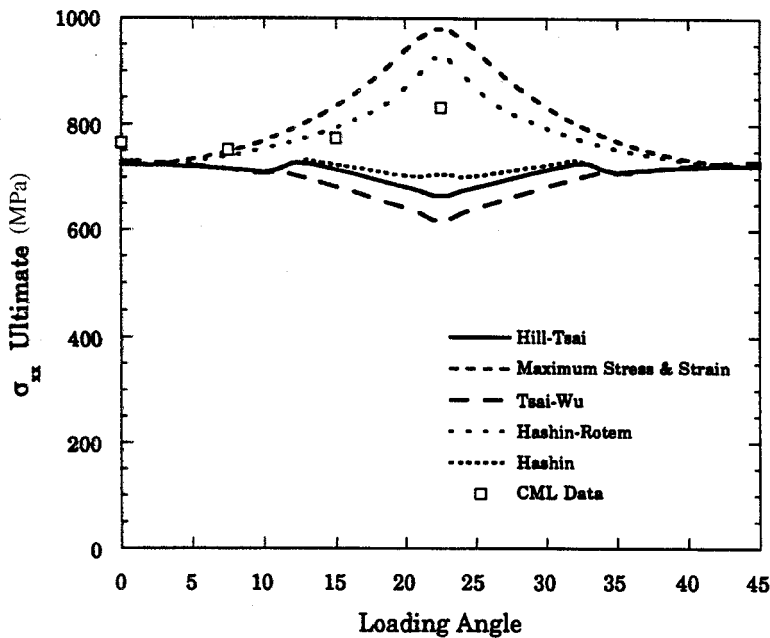

FIGURE 35. COMPARISON OF ULTIMATE STRENGTHS FOR A $[0/A/+45/A/-45/A/90]_s$ LAMINATE UNDER UNIDIRECTIONAL LOADING USING DIFFERENT LAMINA FAILURE CRITERIA (WITH THE PSM_s)

Figures 36 and 37 compare CML data with the theoretical predictions for the $[90/A/0/A/90/A/0]_s$ laminate, using the PSM and PSM_s procedures, respectively. The data favor the use of the PSM, suggesting that this laminate at small off-axis angles retains its shear stiffness after transverse matrix cracking in the 90° plies. The fully interactive criteria of Hill-Tsai and Tsai-Wu underestimate the strength of the laminate. The Hashin criterion is closer to the data than the fully interactive criteria. Again, the criteria (Maximum Stress, Maximum Strain, and Hashin-Rotem) which separate fiber failure from matrix failure best match the data.

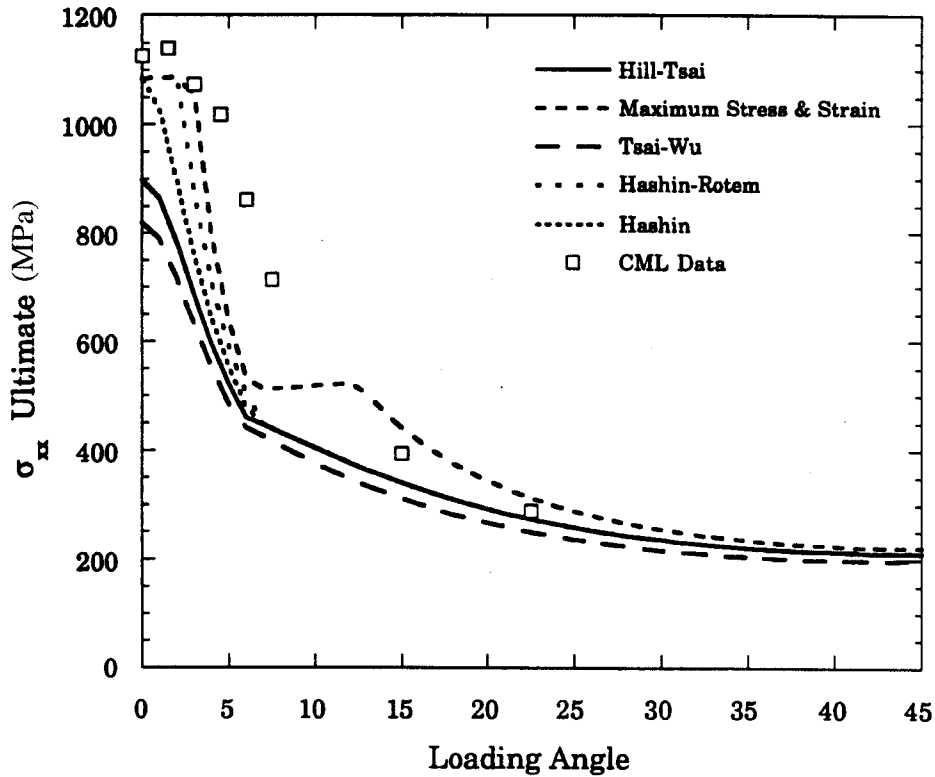

FIGURE 36. COMPARISON OF ULTIMATE STRENGTHS FOR A $[90/A/0/A/90/A/0]_s$ LAMINATE UNDER DIRECTIONAL LOADING USING DIFFERENT LAMINA FAILURE CRITERIA (WITH THE PSM)

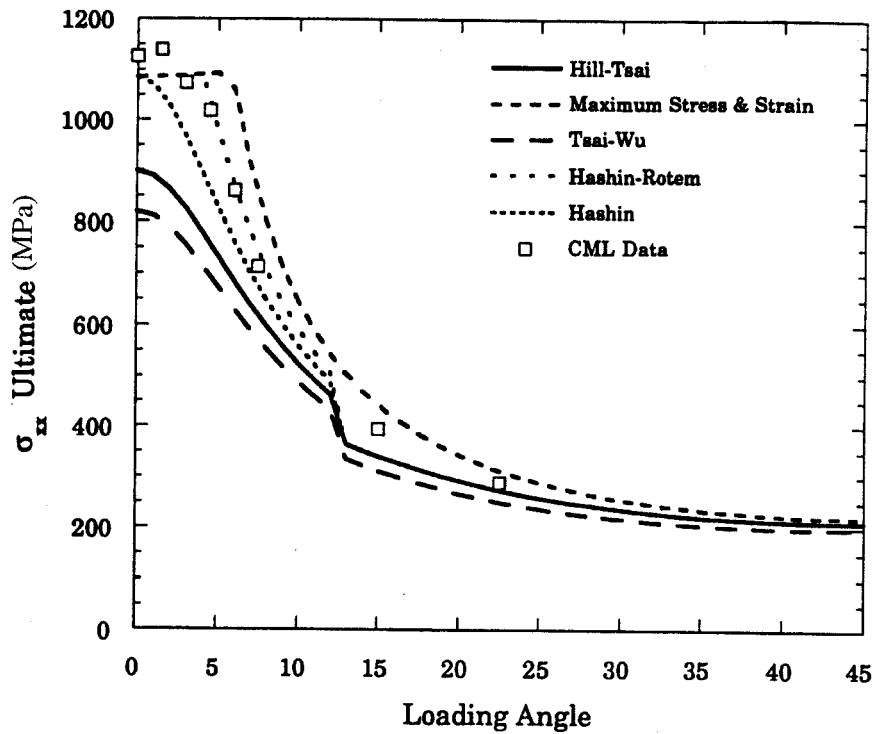

FIGURE 37. COMPARISON OF ULTIMATE STRENGTHS FOR A $[90/A/0/A/90/A/0]_s$ LAMINATE UNDER UNIDIRECTIONAL LOADING USING DIFFERENT LAMINA FAILURE CRITERIA (WITH THE PSM_s)

Data from the $[0/A/+45/A/-45]_s$ laminate are displayed in figures 38 and 39. The difference between the PSM and the PSM_s is slight due to the fact that the laminate is dominated by shear matrix failure (for which both reduction models treat the same). Overall, Maximum Stress, Maximum Strain, and Hashin-Rotem are clearly the best fit for the data. In the off-axis region from 0° to 20° , the Tsai-Wu criterion closely fits the data. However, the overall trend of Tsai-Wu's prediction is quite different from the experimental data.

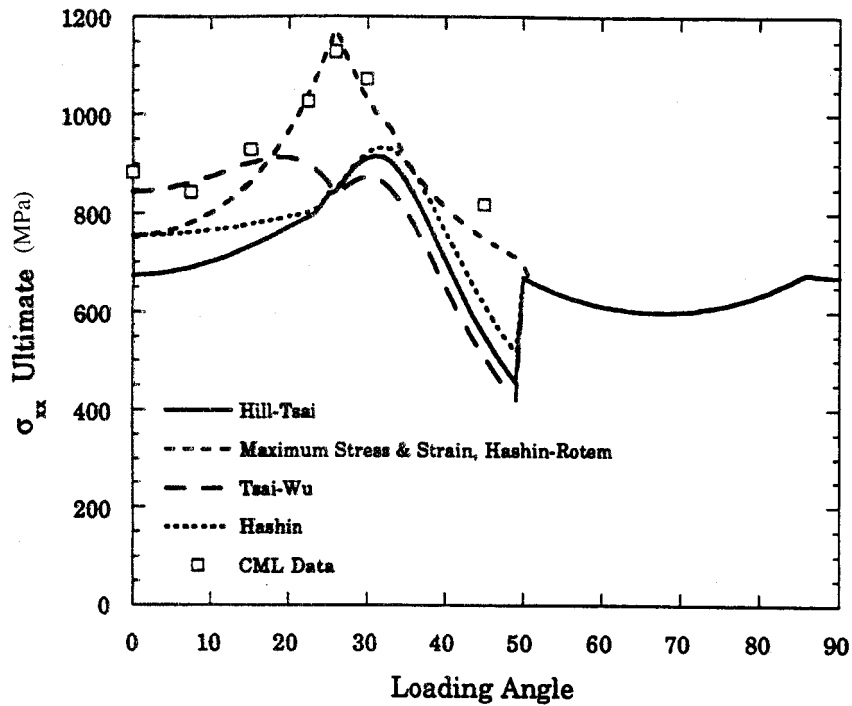

FIGURE 38. COMPARISON OF ULTIMATE STRENGTHS FOR A $[0/A/+45/A/-45]_s$ LAMINATE UNDER UNIDIRECTIONAL LOADING USING DIFFERENT LAMINA FAILURE CRITERIA (WITH THE PSM)

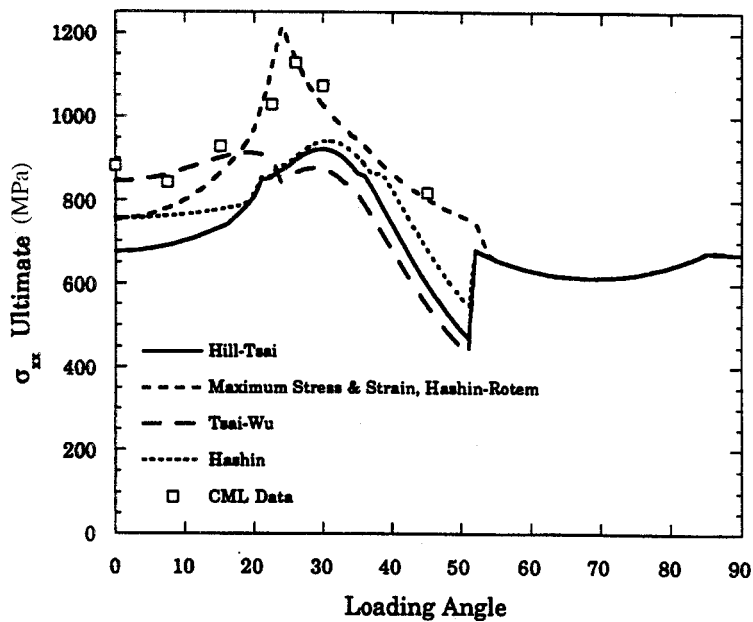

FIGURE 39. COMPARISON OF ULTIMATE STRENGTHS FOR A $[0/A/+45/A/45-45]_s$ LAMINATE UNDER UNIDIRECTIONAL LOADING USING DIFFERENT LAMINA FAILURE CRITERIA (WITH THE PSM_s)

Data from the $[90/A/+30/A/-30]_s$ laminate are displayed in figures 40 and 41. As with the $[0/A/+45/A/-45]_s$ laminate, differences between the PSM and the PSM_s are slight. Once again, Maximum Stress, Maximum Strain, and Hashin-Rotem match both the magnitude and the trend of the data.

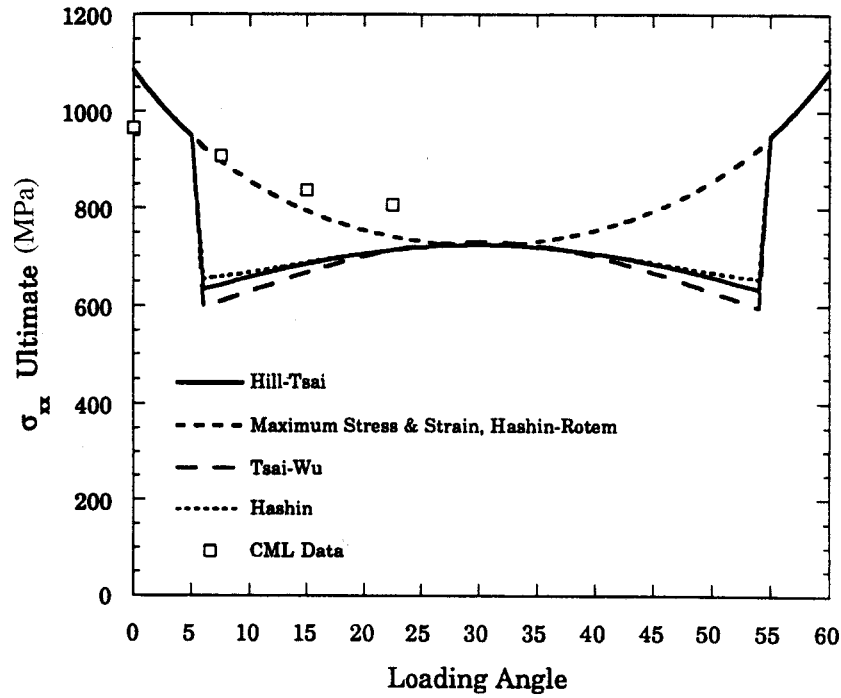

FIGURE 40. COMPARISON OF ULTIMATE STRENGTHS FOR A $[90/A/+30/A/-30]_s$ LAMINATE UNDER UNIDIRECTIONAL LOADING USING DIFFERENT LAMINA FAILURE CRITERIA (WITH THE PSM)

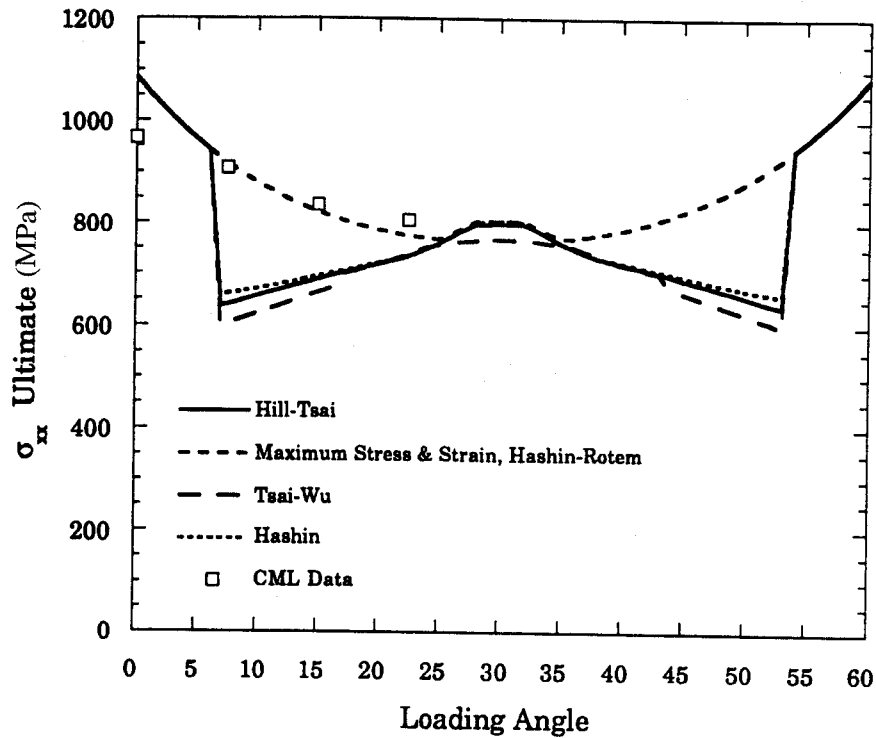

FIGURE 41. COMPARISON OF ULTIMATE STRENGTHS FOR A $[90/A/+30/A/-30]_s$ LAMINATE UNDER UNIDIRECTIONAL LOADING USING DIFFERENT LAMINA FAILURE CRITERIA (WITH THE PSM_s)

3.5 OBSERVATIONS ON LAMINATE FAILURE CRITERIA.

From the four different sets of laminate strength data presented in the previous section, it is clear that the interactive criteria (Hill-Tsai and Tsai-Wu) and Hashin criterion (which couples σ_{11} and τ_{12}) not only underestimate ultimate laminate failure but cannot correctly predict the trend of the data. On the other hand, Maximum Stress, Maximum Strain, and Hashin-Rotem criteria all perform quite well.

Simply put, those criteria which separate fiber failure completely from matrix failure are relatively insensitive to inaccurate lamina strengths Y and S . There is some matrix strength sensitivity in these criteria from the effects of intermediate ply failures (failure preceding ultimate fiber failure). However, the fully interactive criteria and the Hashin criterion are considerably more sensitive to inaccurate matrix strengths. This can be illustrated by increasing the lamina matrix strengths used in the theoretical analysis of the tested laminates.

The sensitivity of the interactive criteria to matrix strength is demonstrated by the ultimate strength curves of the $[0/A/+45/A/-45/A/90]_s$ laminate in figure 42. The Hill-Tsai failure criterion is plotted using three different lamina shear strength values. The PSM is used for this analysis. Thus, the curve labeled "Hill-Tsai with $S = 1.0$ " is the same as the Hill-Tsai curve from figure 34. The other two curves in figure 42 are for the strengths $2 \times S$ and $2.5 \times S$, respectively.

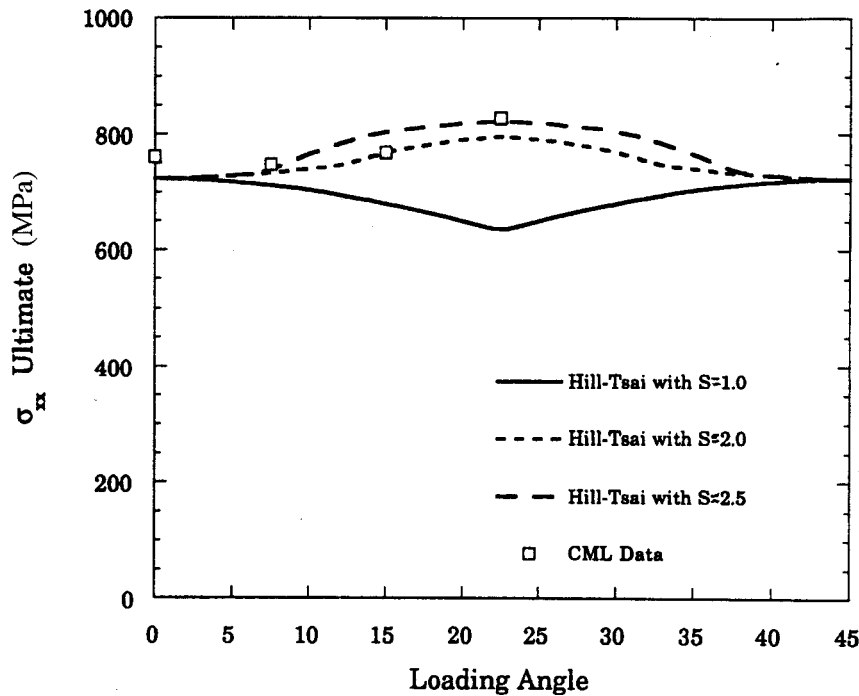

FIGURE 42. COMPARISON OF ULTIMATE STRENGTHS FOR A $[0/A/+45/A/-45/A/90]_s$ WITH DIFFERENT LAMINA SHEAR STRENGTHS USING HILL-TSAI CRITERION

All other material constants remain the same. It is clear that by simply increasing the shear strength of the lamina, the Hill-Tsai criterion takes on a completely different trend, predicting an increase in strength instead of a decrease as the off-axis loading angle increases from 0° to 22.5° . With these high shear strengths, this criterion now correctly predicts the trend and magnitude of the experimental data.

Another issue often raised is whether matrix cracking actually occurs in composite laminates with well dispersed laminae. To answer this question, we tested $[0/90/0]$ and $[0/90/0]_s$ laminates of AS4/3501-6 graphite/epoxy composite. Coupon specimens were tested under tension. Figure 43 clearly shows the presence of matrix cracks in the 90° plies at the load about 95% of the laminate strength. Thus, we conclude that matrix cracking does occur and the ply-by-ply discount process in laminate failure analysis is justified.

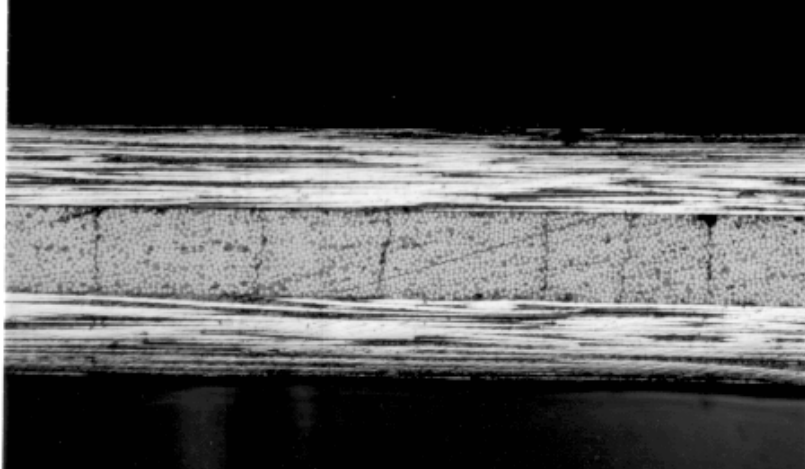

FIGURE 43. EVIDENCE OF 90° PLY MATRIX CRACKS IN $[0/90/0]$ AND $[0/90/0]_s$ LAMINATES OF AS4/3501-6 GRAPHITE-EPOXY COMPOSITE

4. CONCLUSIONS.

In this study, the following conclusions were obtained.

- At the lamina level, those criteria (such as the Hashin-Rotem criterion) which separate the fiber failure mode from the matrix failure mode are the most reasonable and accurate. This is supported by test data and a micromechanical consideration which indicates that fiber failure and matrix failure should be governed by different failure criteria.
- For fiber-dominated laminates, Maximum Stress, Maximum Strain, and Hashin-Rotem failure criteria outperform other criteria. These criteria are insensitive to variations in matrix strengths (Y and S) which are very difficult to obtain in situ.

- The interactive failure criteria (Hill Tsai, Tsai-Wu, and Hashin) are sensitive to variation of the matrix-dominated lamina strengths (i.e., Y and S). Accurate in situ composite strengths are critical to the use of these criteria. Because of the interaction among all stress components, sudden switching of failure modes makes the failure envelope (in stress or strain) very jumpy.
- Experimental results indicate that matrix cracking does take place even in laminates with well dispersed laminae. Thus, the ply-by-ply discount of stiffnesses in failed laminae is justified.
- The Parallel Spring model for stiffness reductions is adequate for analysis of laminate strengths. The drastic ply stiffness reduction (the concerned stiffness is set equal to zero after ply failure) does not cause appreciable errors in the predicted laminate strength for fiber-dominated laminates.
- At this point, available failure data does not appear to support the 45-degree fiber shear failure cutoffs of the Hart-Smith lamina failure criterion, although further effort on this issue appears warranted. In addition, data supporting Hart-Smith's contention of shear failures in tension loaded fibers together with low shear strength values of ± 45 -degree laminates is somewhat limited and needs to be further developed. Failure data on ± 45 -degree filament wound tubes tested in torsion such as that in reference 20 is relevant to the issue of low shear strength in ± 45 -degree laminates and should be examined further.

5. RECOMMENDATIONS.

- For fiber-dominated laminates, maximum stress, maximum strain, and Hashin-Rotem failure criteria should be used to obtain most reliable laminate strength prediction.
- To predict lamina matrix failure in a laminate, the in situ transverse strength (Y) and shear strength (S) should be used.
- For matrix-dominated laminates and loadings, all six failure criteria can be used. Laminate failure should be declared when excessive strains occur.
- None of the laminate failure criteria investigated here based on the assumption of a 2-D stress state are valid for strength prediction at free edges in a composite structure.

6. REFERENCES.

1. Nahas, M. N., "Survey of Failure and Post-Failure Theories of Laminated Fiber-Reinforced Composites," Journal of Composites Technology & Research, Vol. 8, No. 4, Winter 1986, pp. 138-153.
2. Labossiere, P. and Neale, K. W., "Macroscopic Failure Criteria for Fiber-Reinforced Composite Materials," Solid Mechanics Archives, Vol. 12, No. 2. 1987, pp. 65-95.
3. Burk, R. C., "Standard Failure Criteria Needed for Advanced Composites," AIAA. 1983, Vol. 21, pp. 58-62.
4. Narayanaswami, R. and Adelman, H. M., "Evaluation of the Tensor Polynomial and Hoffman Strength Theories for Composite Materials," Journal of Composite Materials, Vol. 11, Oct. 1977, pp. 366-377.
5. Cui, W. C., Wisnom, M. R., and Jones, M., "A Comparison of Failure Criteria to Predict Delamination of Unidirectional Glass/Epoxy Specimens Waisted Through the Thickness," Composites. Vol. 23, No. 3, May 1992, pp. 158-166.
6. Hashin, Z., "Failure Criteria for Unidirectional Fiber Composites," Journal of Applied Mechanics, Vol. 47, June 1980, pp. 329-334.
7. Sun, C. T. and Zhou, S. G., "Failure of Quasi-Isotropic Composite Laminates with Free Edges," Journal of Reinforced Plastics and Composites, Vol. 7, November 1988, pp. 515-557.
8. Pipes, R. B. and Cole, B. W., "On the Off-Axis Strength Test for Anisotropic Materials," Journal of Composite Materials, Vol. 7, April 1973, pp. 246-256.
9. Hashin, Z. and Rotem, A., "A Fatigue Failure Criterion for Fiber Reinforced Materials," Journal of Composite Materials, Vol. 7, Oct. 1973, pp. 448-464.
10. Colvin, G. E. and Swanson, S. R., "Mechanical Characterization of IM7/8551-7 Carbon/Epoxy Under Biaxial Stress," Journal of Engineering Materials and Technology, Vol. 112, Jan. 1990, pp. 61-67.
11. Wu, E. M. and Scheublein, J. K., "Laminate Strength - A Direct Characterization Procedure," Composite Materials: Testing and Design (3rd Conference), ASTM STP 546, 1974, pp. 188-206.
12. Jiang, A. and Tennyson, R. C., "Closure of the Cubic Tensor Polynomial Failure Surface," Journal of Composite Materials, Vol. 23, March 1989, pp. 208-231.

13. Swanson, S. R., Messick, M. J., and Tian, Z., "Failure of Carbon/Epoxy Lamina Under Combined Stress," Journal of Composite Materials, Vol. 21, July 1987, pp. 619-630.
14. Swanson, S. R. and Qian, Y., "Multiaxial Characterization of T800/3900-2 Carbon/Epoxy Composites," Composites Science and Technology, Vol. 43, 1992, pp. 197-203.
15. Voloshin, A. and Arcan, M., "Failure of Unidirectional Fiber-Reinforced Materials: New Methodology and Results," Experimental Mechanics, Vol. 20, Aug. 1980, pp. 280-284.
16. Sun, C. T. and Jen, K. C., "On the Effect of Matrix Cracks on Laminate Strength," Journal of Reinforced Plastics and Composites, Vol. 21, No. 10, October 1987, pp. 969-985.
17. Hart-Smith, L. J., "A Strain-Based Maximum-Shear-Stress Failure Criterion for Fibrous Composites," Paper DP 8376, Douglas Aircraft Company. Also in Proceedings of 31st AIAA/ASME/ASCE/AHS/ASC Structures, Structural Dynamics and Materials Conference, Long Beach, CA, April 2-4, 1990, pp. 714-722.
18. Hart-Smith, L. J., "A Scientific Approach to Composite Laminate Strength Prediction," Composite Materials: Testing and Design (10th Volume), ASTM STP 1120, 1992, pp. 142-169.
19. Hart-Smith, L. J., "Fibrous Composite Failure Criteria - Fact and Fantasy." Proceedings of the 7th International Conference on Composite Structures, Paisley, Scotland, July 5-7, 1993.
20. Foley, G.E., Roylance, M., and Houghton, W.W., "Use of Torsion Tubes to Measure In-Plane Shear Properties of Filament Wound Composites," ASTM STP 1003, pp. 208-223, American Society for Testing and Materials, 1989.
21. Swanson, S. R. and Trask, B. C., "An Examination of Failure Strength in $[0/\pm 60]$ Laminates under Biaxial Stress," Composites, September 1988, pp. 400-406.
22. Swanson, S. R. and Trask, B. C., "Strength of Quasi-Isotropic Laminates under Off-Axis Loading," Composite Science and Technology, Vol. 34, 1989, pp. 19-34.
23. Wang, J. Z. and Socie, D. F., "Biaxial Testing and Failure Mechanisms in Tubular G-10 Composite Laminates," Composite Materials: Testing and Design (Eleventh Volume), ASTM STP 1206, American Society for Testing and Materials, 1992, pp. 136-149.
24. Wang, J. Z. and Socie, D. F., "A Biaxial Tension-Compression Test Method for Composite Laminates," J. Composite Technology Research, October 1994 (to appear).

25. Flaggs, D. L. and Kural, M. H., "Experimental Determination of the In Situ Transverse Lamina Strength in Graphite/Epoxy Laminates," Journal of Composite Materials, Vol. 16, March 1982, pp. 103-116.
26. ASTM Standard D3039-76, "Standard Test Methods for Tensile Properties of Fiber-Resin Composites," Reapproved 1989.
27. Sun, C. T. and Chung, I. "An Oblique End Tab Design for Testing Off-Axis Composite Specimens," to appear in Composites.
28. Daniel, I. M. Private communication.

APPENDIX A—A LIST OF FAILURE CRITERIA [1, 2]

The Limit Criteria:

Maximum Stress:

$$\frac{\sigma_{11}}{X} = 1$$

$$\frac{\sigma_{22}}{Y} = 1$$

$$\frac{\tau_{12}}{S} = 1$$

Kelly-Davies:

$$\frac{\sigma_{11}}{X_f} = 1$$

$$\frac{\sigma_{22}}{1.15Y_m} = 1$$

$$\frac{\tau_{12}}{1.5S_m} = 1$$

Maximum Strain:

$$\frac{\varepsilon_{11}}{X_\varepsilon} = 1$$

$$\frac{\varepsilon_{22}}{Y_\varepsilon} = 1$$

$$\frac{\gamma_{12}}{S_\varepsilon} = 1$$

Prager:

$$\frac{\sigma_{11}}{X_f} = 1$$

$$\frac{\sigma_{22}}{f_1(Y_m, S_m)} = 1$$

$$\frac{\tau_{12}}{f_2(Y_m, S_m)} = 1$$

Stowell-Lin:

$$\frac{\sigma_{11}}{X_f} = 1$$

$$\frac{\sigma_{22}}{Y_m} = 1$$

$$\frac{\tau_{12}}{S_m} = 1$$

Maximum Shear Stress:

$$\frac{1}{2} |(\sigma_{11} - \sigma_{22}) \sin 2\theta| = S_a$$

$$\frac{1}{2} |(\sigma_{11} \cos^2 \theta + \sigma_{22} \cos^2 \theta)| = S_t$$

$$\frac{1}{2} |(\sigma_{11} \cos^2 \theta + \sigma_{22} \sin^2 \theta)| = S_t$$

$$\frac{1}{2} |(\sigma_{11} - \sigma_{22}) \cos 2\theta| = S_s$$

The Interactive Criteria:

Hill:

$$\begin{aligned} & \left(\frac{\sigma_1}{X}\right)^2 + \left(\frac{\sigma_{22}}{Y}\right)^2 + \left(\frac{\sigma_{33}}{Z}\right)^2 - \left(\frac{1}{X^2} + \frac{1}{Y^2} - \frac{1}{Z^2}\right)\sigma_1\sigma_{22} - \left(\frac{1}{X^2} + \frac{1}{Z^2} - \frac{1}{Y^2}\right)\sigma_1\sigma_{33} \\ & - \left(\frac{1}{Y^2} + \frac{1}{Z^2} - \frac{1}{X^2}\right)\sigma_{22}\sigma_{33} + \left(\frac{\tau_{12}}{S}\right)^2 + \left(\frac{\tau_{23}}{T}\right)^2 + \left(\frac{\tau_{13}}{R}\right)^2 = 1 \\ & \left(\frac{\sigma_{11}}{X}\right)^2 + \left(\frac{\sigma_{22}}{Y}\right)^2 - \left(\frac{1}{X^2} + \frac{1}{Y^2} - \frac{1}{Z^2}\right)\sigma_{11}\sigma_{22} + \left(\frac{\tau_{12}}{S}\right)^2 = 1 \end{aligned}$$

Tsai-Hill:

$$\left(\frac{\sigma_{11}}{X}\right)^2 + \left(\frac{\sigma_{22}}{Y}\right)^2 - \left(\frac{\sigma_{11}}{X}\right)\left(\frac{\sigma_{22}}{X}\right) + \left(\frac{\tau_{12}}{S}\right)^2 = 1$$

Marin:

$$\begin{aligned} & (\sigma_1 - a)^2 + (\sigma_{22} - b)^2 + (\sigma_{33} - c)^2 + \\ & q[(\sigma_1 - a)(\sigma_{22} - b) + (\sigma_{22} - b)(\sigma_{33} - c) + (\sigma_{33} - c)(\sigma_1 - a)] = \sigma^2 \\ & \sigma_1^2 + K_1\sigma_1\sigma_{22} + \sigma_{22}^2 + K_2\sigma_1 + K_3\sigma_{22} = K_4 \\ & K_1 = 2 - \frac{XX' - S[X' - X - X'(X/Y) + Y]}{S^2} \\ & K_2 = X' - X \quad K_3 = X'(X/Y) - Y \quad K_4 = XX' \end{aligned}$$

Franklin:

$$K_1\sigma_{11}^2 + K_2\sigma_{11}\sigma_{22} + K_3\sigma_{22}^2 + K_4\sigma_{11} + K_5\sigma_{22} + K_6\tau_{12}^2 = 1$$

Stassi D'Alia:

$$\sigma_{11}^2 + \sigma_{22}^2 + \sigma_{11}\sigma_{22} + X(X'/X - 1)(\sigma_{11} + \sigma_{22}) = X'$$

Norris-Mckinnon:

$$\left(\frac{\sigma_{11}}{X}\right)^2 + \left(\frac{\sigma_{22}}{Y}\right)^2 + \left(\frac{\tau_{12}}{S}\right)^2 = 1$$

Norris:

$$\left(\frac{\sigma_{11}}{X}\right)^2 - \left(\frac{\sigma_{11}}{X}\right)\left(\frac{\sigma_{22}}{Y}\right) + \left(\frac{\sigma_{22}}{Y}\right)^2 + \left(\frac{\tau_{12}}{S}\right)^2 = 1 \quad \left(\frac{\sigma_{11}}{X}\right)^2 - \left(\frac{\sigma_{11}}{X}\right)\left(\frac{\sigma_{22}}{Y}\right) + \left(\frac{\sigma_{22}}{Y}\right)^2 + \left(\frac{\tau_{12}}{S}\right)^2 = 1$$

$$\left(\frac{\sigma_{22}}{Y}\right)^2 - \left(\frac{\sigma_{22}}{Y}\right)\left(\frac{\sigma_{33}}{Z}\right) + \left(\frac{\sigma_{33}}{Z}\right)^2 + \left(\frac{\tau_{23}}{T}\right)^2 = 1 \quad \left(\frac{\sigma_{22}}{Y}\right)^2 = 1$$

$$\left(\frac{\sigma_{33}}{Z}\right)^2 - \left(\frac{\sigma_{33}}{Z}\right)\left(\frac{\sigma_{11}}{X}\right) + \left(\frac{\sigma_{11}}{X}\right)^2 + \left(\frac{\tau_{13}}{R}\right)^2 = 1 \quad \left(\frac{\sigma_{11}}{X}\right)^2 = 1$$

Fischer:

$$\left(\frac{\sigma_{11}}{X}\right)^2 + \left(\frac{\sigma_{22}}{Y}\right)^2 + \left(\frac{\tau_{12}}{S}\right)^2 - \frac{E_1(1 + \nu_{21}) + E_2(1 + \nu_{12})}{2\sqrt{E_1 E_2(1 + \nu_{12})(1 + \nu_{21})}} \frac{\sigma_{11}\sigma_{22}}{XY} = 1$$

Yamada-Sun:

$$\left(\frac{\sigma_{11}}{X}\right)^2 + \left(\frac{\tau_{12}}{S}\right)^2 = 1$$

Griffith-Baldwin:

$$U_d = \frac{\sigma_{11}^2}{3} \left(S_{11} - \frac{S_{12} + S_{13}}{2} \right) + \frac{\sigma_{22}^2}{3} \left(S_{22} - \frac{S_{12} + S_{23}}{2} \right) + \frac{\sigma_{11}\sigma_{22}}{3} \left(2S_{12} - \frac{S_{11} + S_{22} + S_{13} + S_{23}}{2} \right) + S_{66}\tau_{12}^2$$

Chamis:

$$\left(\frac{\sigma_{11}}{X}\right)^2 + \left(\frac{\sigma_{22}}{Y}\right)^2 + \left(\frac{\tau_{12}}{S}\right)^2 - KK' \frac{\sigma_{11}\sigma_{22}}{XY} = 1$$

$$K = \frac{(1 + 4\nu_{12} - \nu_{13})E_2 + (1 - \nu_{23})E_1}{\sqrt{E_1} E_2 (2 + \nu_{12} + \nu_{13})(2 + \nu_{21} + \nu_{23})}$$

Hoffman:

$$K_1(\sigma_{22} - \sigma_{33})^2 + K_2(\sigma_{33} - \sigma_{11})^2 + K_3(\sigma_{11} - \sigma_{22})^2 + K_4\sigma_{11} + K_5\sigma_{22} + K_6\sigma_{33} + K_7\tau_{23}^2 + K_8\tau_{13}^2 + K_9\tau_{12}^2 = 1$$

$$\frac{\sigma_{11}^2 - \sigma_{11}\sigma_{22}}{XX'} + \frac{\sigma_{22}^2}{YY'} + \frac{X' - X}{XX'}\sigma_{11} + \frac{Y' - Y}{YY'}\sigma_{22} + \frac{\tau_{12}^2}{S^2} = 1$$

Puck-Schneider:

$$\frac{\sigma_{11}}{X_f} = 1$$

$$\left(\frac{\sigma_{11}}{X_m}\right)^2 + \left(\frac{\sigma_{22}}{Y_m}\right)^2 - \frac{1}{3} \frac{\sigma_{11}\sigma_{22}}{X_m Y_m} + \left(\frac{\tau_{12}}{S_m}\right)^2 = 1$$

$$\frac{\sigma_{22}}{Y_i} + \left(\frac{\tau_{12}}{S_i}\right)^2 = 1$$

Gol'denblat-Kopnov:

$$(F_{ij}\sigma_{ij})^\alpha + (F_{ijkl}\sigma_{ij}\sigma_{kl})^\beta + (F_{ijklmn}\sigma_{ij}\sigma_{kl}\sigma_{mn})^\gamma + \dots = 1$$

Ashkenazi:

$$\left[\frac{\sigma_{11}^2}{X} + \frac{\sigma_{22}^2}{Y} + \sigma_{11}\sigma_{22} \left(\frac{4}{X_{45}} - \frac{1}{X} - \frac{1}{Y} - \frac{1}{S} \right) + \frac{\tau_{12}^2}{S} \right]^2 +$$

$$2 \frac{\sigma_{11}\sigma_{22} - \tau_{12}^2}{S} \left[\sigma_{11}\sigma_{22} \left(\frac{1}{X} + \frac{1}{Y} \right) + \frac{\sigma_{11}^2}{X} + \frac{\sigma_{22}^2}{Y} \right] -$$

$$(\sigma_{11}\sigma_{22} - \tau_{12}^2) [\sigma_{11}\sigma_{22}(\lambda + \mu) + \lambda\sigma_{11}^2 + \mu\sigma_{22}^2 - \rho(\sigma_{11} + \sigma_{22})] -$$

$$(\sigma_{11}^2 + \sigma_{22}^2 + \sigma_{11}\sigma_{22} + \tau_{12}^2) = 1$$

Malmeister:

$$F_{ij}\sigma_{ij} + F_{ijkl}\sigma_{ij}\sigma_{kl} + F_{ijklmn}\sigma_{ij}\sigma_{kl}\sigma_{mn} + \dots = 1$$

Tsai-Wu:

$$F_i\sigma_i + F_{ij}\sigma_i\sigma_j = 1$$

$$F_1\sigma_{11} + F_2\sigma_{22} + F_6\tau_{12} + F_{11}\sigma_{11}^2 + F_{22}\sigma_{22}^2 + 2F_{12}\sigma_{11}\sigma_{22} + F_{66}\tau_{12}^2 = 1$$

$$F_1 = \frac{1}{X} + \frac{1}{X'}, \quad F_2 = \frac{1}{Y} + \frac{1}{Y'}, \quad F_{11} = \frac{-1}{XX'}, \quad F_{22} = \frac{-1}{YY'}, \quad F_{66} = \frac{1}{S^2}, \quad F_{12} = \text{experimentally determined}$$

Huang-Kirmser:

$$(F_i\sigma_i)^\alpha + (F_{ij}\sigma_i\sigma_j)^\beta + (F_{ijk}\sigma_i\sigma_j\sigma_k)^\gamma = 1$$

The Separate Mode Criteria:

Hashin-Rotem:

$$\frac{\sigma_{11}}{X} = 1$$
$$\left(\frac{\sigma_{22}}{Y}\right)^2 + \left(\frac{\tau_{12}}{S}\right)^2 = 1$$

Hashin:

$$\left(\frac{\sigma_{11}}{X}\right)^2 + \left(\frac{\tau_{12}}{S}\right)^2 = 1$$

$$\frac{\sigma_{11}}{X'} = 1$$

$$\left(\frac{\sigma_{22}}{Y}\right)^2 + \left(\frac{\tau_{12}}{S}\right)^2 = 1$$

$$\left(\frac{\sigma_{22}}{2S_T}\right)^2 + \left[\left(\frac{Y'}{2S_T}\right)^2 - 1\right] \frac{\sigma_{22}}{Y'} + \left(\frac{\tau_{12}}{S}\right)^2 = 1$$

APPENDIX B—A COMPUTER CODE FOR STRENGTH ANALYSIS OF
LAMINATED COMPOSITES

S A L C v1.1

Strength Analysis of Laminated Composites

User's Guide

Written in FORTRAN

Overview

The purpose of this program is to provide a thorough analysis of the failure progression leading to ultimate failure in laminated composites. The program utilizes 2-D classical laminated plate theory with a Ply-by-Ply Discount laminate analysis method. Ultimate laminate stress or strain can be calculated for any fiber reinforced material system under any combination of applied stresses σ_{xx} , σ_{yy} and τ_{xy} .

THEORETICAL DISCUSSION

1. LAMINA FAILURE ANALYSIS.

The purpose of the lamina failure criterion is to determine the strength and mode of failure of a unidirectional composite or lamina in a state of combined stress. All the existing lamina failure criteria are basically phenomenological in which detailed failure processes are not described (macromechanical). Further, they are all based on linear elastic analysis. The failure load (lamina strength) is determined by evaluating the set of equations provided in each criterion. These equations compare lamina stresses (or strains) to material strengths in the principal directions.

The majority of the lamina failure criteria assume a 2D orthotropic material which is transversely isotropic. Lamina strengths are defined in a composite system as follows (values in stress):

X & X' : tensile and compressive strengths in fiber direction.

Y & Y' : tensile and compressive strengths in transverse direction (perpendicular to fibers).

S : shear strength

For a strain based analysis, similar strain strengths may be used: X_ϵ , X'_ϵ , Y_ϵ , Y'_ϵ , and S_ϵ . The ability of the lamina failure criterion to determine mode of failure is essential in bringing this analysis tool to the laminate level (an individual lamina failure within a laminate doesn't necessarily constitute ultimate failure). Modes of failure are defined as:

Fiber Breakage (mode 1): longitudinal stress (σ_{11}) or longitudinal strain (ϵ_{11}) dominates lamina failure.

Transverse Matrix Cracking (mode 2): transverse stress (σ_{22}) or transverse strain (ϵ_{22}) dominates lamina failure.

Shear Matrix Cracking (mode 3): shear stress (τ_{12}) or shear strain (γ_{12}) dominates lamina failure.

It is important to point out that both mode 2 and mode 3 are matrix failures. The two modes are separated because different stress components cause the failure, though the result is the same. Hence, mode 2 should be interpreted as matrix cracking due to σ_{22} , and mode 3 should be interpreted as matrix cracking due to τ_{12} . The notation is for convenience, and it should be assumed that the resulting matrix crack is the same regardless of "failure mode."

1.1 A SURVEY OF LAMINA FAILURE CRITERIA.

Lamina failure criteria can be categorized into three groups:

- Limit Criteria: These criteria predict failure load and mode by comparing lamina stresses σ_{11} , σ_{22} , and τ_{12} (or strains ϵ_{11} , ϵ_{22} , and γ_{12}) separately. Interaction between the stresses (or strains) is not considered.
- Interactive Criteria: These criteria predict the failure load by using a single quadratic or higher order polynomial equation involving all stress (or strain) components. Failure is assumed when the equation is satisfied. The mode of failure is determined indirectly by comparing the stress/strength ratios.
- Separate Mode Criteria: These criteria separate the matrix failure criterion from the fiber failure criterion. The equations can be dependent on either one or more stress components; therefore, stress interaction varies from criterion to criterion within this group. If the satisfied equation contains only one stress component, then the failure mode corresponds to that particular direction; otherwise, the failure mode can be determined as is done with the interactive criteria by comparing stress/strength ratios of the satisfied equation.
- Six commonly used lamina failure criteria are available in the program SALC.

Limit Criteria

- Maximum Stress:

$$\begin{aligned}\frac{\sigma_{11}}{X} &= 1 && \text{fiber failure} \\ \frac{\sigma_{22}}{Y} &= 1 && \text{transverse matrix cracking} \\ \frac{\tau_{12}}{S} &= 1 && \text{shear matrix cracking}\end{aligned}\tag{1}$$

- Maximum Strain:

$$\begin{aligned}\frac{\epsilon_{11}}{X_\epsilon} &= 1 && \text{fiber failure} \\ \frac{\epsilon_{22}}{Y_\epsilon} &= 1 && \text{transverse matrix cracking} \\ \frac{\gamma_{12}}{S_\epsilon} &= 1 && \text{shear matrix cracking}\end{aligned}\tag{2}$$

Interactive Criteria

- Hill-Tsai:

$$F_1\sigma_{11} + F_2\sigma_{22} + F_{11}\sigma_{11}^2 + F_{22}\sigma_{22}^2 + 2F_{12}\sigma_{11}\sigma_{22} + F_{66}\tau_{12}^2 = 1 \quad (3)$$

- Tsai-Wu:

$$F_1\sigma_{11} + F_2\sigma_{22} + F_{11}\sigma_{11}^2 + F_{22}\sigma_{22}^2 + 2F_{12}\sigma_{11}\sigma_{22} + F_{66}\tau_{12}^2 = 1 \quad (4)$$

where

$$F_1 = \frac{1}{X} + \frac{1}{X'}, \quad F_2 = \frac{1}{Y} + \frac{1}{Y'}, \quad F_{11} = \frac{-1}{XX'}, \quad F_{22} = \frac{-1}{YY'}, \quad F_{66} = \frac{1}{S^2}, \quad F_{12} = \begin{matrix} \text{experimenta} \\ \text{determine} \end{matrix}$$

Separate Mode Criteria

- Hashin-Rotem:

$$\begin{aligned} \frac{\sigma_{11}}{X} &= 1 && \text{fiber failure} \\ \left(\frac{\sigma_{22}}{Y}\right)^2 + \left(\frac{\tau_{12}}{S}\right)^2 &= 1 && \text{matrix failure} \end{aligned} \quad (5)$$

- Hashin:

$$\begin{aligned} \left(\frac{\sigma_{11}}{X}\right)^2 + \left(\frac{\tau_{12}}{S}\right)^2 &= 1 && \text{fiber failure (tension)} \\ \frac{\sigma_{11}}{X'} &= 1 && \text{fiber failure (compression)} \\ \left(\frac{\sigma_{22}}{Y}\right)^2 + \left(\frac{\tau_{12}}{S}\right)^2 &= 1 && \text{matrix failure} \end{aligned} \quad (6)$$

For Maximum Stress, Maximum Strain, Hill-Tsai, and Hashin-Rotem, the criterion is generalized for either tensile or compressive stresses: the corresponding (tensile or compressive) strength constant must be chosen based on the sign of the applied stress. The Tsai-Wu criterion is designed for use in all stress quadrants of any stress plane, thus may be used directly without modification for different stress signs. Tsai-Wu's criterion requires a biaxial test to experimentally determine the interaction term F_{12} . It has been suggested to use $F_{12} = 1/(2XX')$, which reduces Tsai-Wu down to the Hoffman criterion. Some researchers have found the term to be insignificant, and suggest setting it equal to zero.

There is strong evidence that when a unidirectional composite is subjected to a combined $\sigma_{22} - \tau_{12}$ loading, it becomes stronger when σ_{22} is compressive. More specifically, for given $\sigma_{22} = \pm\sigma_0$, the shear stress τ_{12} at failure corresponding to $\sigma_{22} = -\sigma_0$ is appreciably greater than the shear stress τ_{12} corresponding to $\sigma_{22} = +\sigma_0$. This behavior indicates that a compressive fiber/matrix interfacial

normal stress (which is proportional to σ_{22}) would create a greater fiber/matrix interfacial shear strength. To reflect this behavior, the matrix failure criterion of equation 5 may be modified to

$$\left(\frac{\sigma_{22}}{Y}\right)^2 + \left(\frac{\tau_{12}}{S - \mu \sigma_{22}}\right)^2 = 1 \quad (7)$$

where

$$\mu = \begin{cases} \mu_o & \sigma_{22} < 0 \\ 0 & \sigma_{22} > 0 \end{cases}$$

The term μ plays a role similar to friction coefficients.

2. LAMINATE FAILURE ANALYSIS METHODS.

As with lamina failure analysis, a variety of laminate failure analysis methods have been proposed. Following is a description of each methodology:

Ply-by-Ply Discount Method

This is a very common method for laminate failure analysis. The laminate is treated as a homogeneous material and is analyzed with a lamina failure criterion at a mechanistic level. Laminated plate theory is used to initially calculate the state of stress and strain in each ply given the global loading situation and the material's elastic and strength properties. A lamina failure criterion is then used to determine the particular ply which will fail first and the mode of that failure. A stiffness reduction model is used to reduce the stiffness of the laminate, due to that individual ply failure. The laminate with reduced stiffnesses is again analyzed for stresses and strains. Lamina failure criterion predicts the next ply failure and laminate stiffness is accordingly reduced again. This cycle continues until ultimate laminate failure is reached.

There has been a number of definitions proposed on how to determine ultimate laminate failure. One common way is to assume ultimate laminate failure when fiber breakage occurs in any ply. Another way is to check if excessive strains occur (i.e., a singular laminate stiffness matrix). Matrix-dominated laminates such as $[\pm 45]_s$ may fail without fiber breakage. Others have suggested a "last ply" definition in which the laminate is considered failed if every ply has been damaged. For this program, the laminate is loaded until fiber breakage occurs in any ply, unless the reduced stiffness matrix is singular which denotes a matrix dominated ultimate failure.

Sudden Failure Method

In highly fiber-dominated composite laminates, the laminate stiffness reduction due to progressive matrix failures insignificantly affects the laminate ultimate strength. This suggests that in such laminates the progressive stiffness reduction seen in the previous method may be

unnecessary, and laminate failure may be taken to coincide with the fiber failure of the load carrying ply (the ply with fibers oriented closest to the loading direction). To perform this analysis, a lamina failure criterion is chosen and the failure load is determined by calculating the load required for fiber failure in the dominant lamina. No stiffness reductions are included in the process. The laminate strength predicted by the Sudden Failure method is usually higher than by the Ply-by-Ply Discount method.

Direct Laminate Method

This method examines the laminate as a whole, using effective strength values in the laminate principal directions. An equation or set of equations using these values and the applied stresses predict the failure of the laminate in a similar fashion to the lamina failure criteria, but at a laminate level. Of course, the laminate strength values are applicable to just the particular laminate being analyzed, hence a change in layup could require a different set of laminate strengths. There seems little reason to justify such an inflexible phenomenological approach to laminate analysis. This method is not offered in SALC.

2.1 STIFFNESS REDUCTION

After an individual ply within the laminate has failed, the following two methods offer a way to “discount” the failed ply and reduce the laminate stiffness accordingly:

Parallel Spring Model

Each lamina is modeled with a pair of springs representing the fiber (longitudinal) and matrix (shear and transverse) deformation modes. The entire laminate is modeled by grouping together a number of parallel lamina spring sets as shown in Figure B-1. When fiber breakage occurs, the longitudinal modulus is reduced. When matrix cracking occurs, the shear and transverse moduli are reduced. The value to which the moduli are reduced is arbitrary.

This model is also capable of differentiating between types of matrix failure if desired; i.e., the transverse and shear moduli can be reduced separately depending on the specific type of matrix failure mode. The model which reduces E_1 for fiber failure and E_2 and G_{12} for either transverse or shear matrix failure is denoted the PSM. The model which reduces E_1 for fiber failure, E_2 for transverse matrix failure, and E_2 and G_{12} for shear matrix failure is denoted the PSM_S. The idea behind the PSM_S is that a transverse matrix failure doesn't necessarily inhibit the ability of the lamina to carry loading in the shear direction. Creating these two different reduction models has little micromechanical basis, and is done mainly for curve fitting purposes.

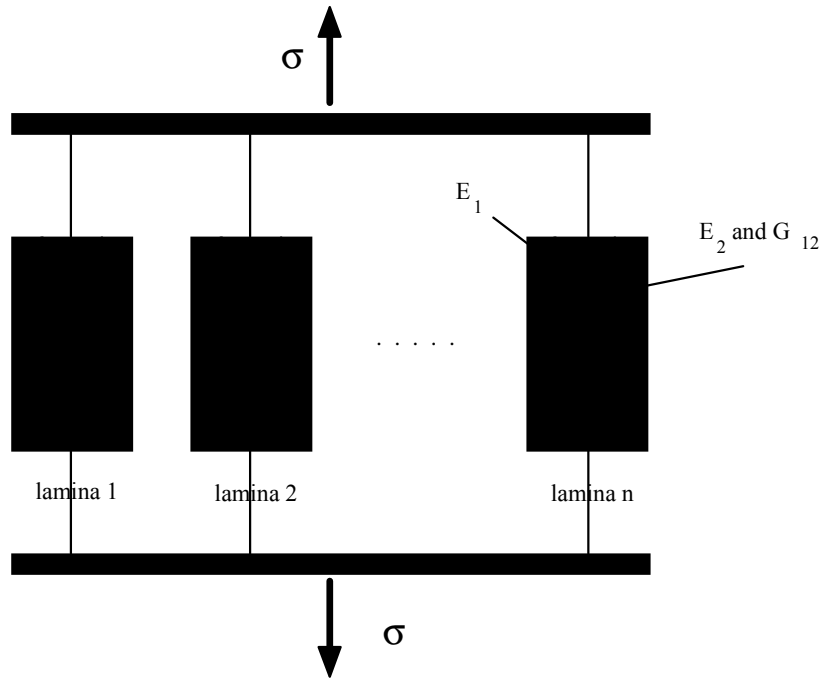

FIGURE B-1. SCHEMATIC OF THE PARALLEL STIFFNESS MODEL

Incremental Stiffness Reduction Model

To avoid the sudden jump in strain at ply failure seen in the Parallel Spring Model, a model resembling the bilinear hardening rule in classical plasticity can be formulated. Laminate stiffness reduction is achieved similar to the Parallel Spring Model. However, it is assumed that the reduced laminate stiffness governs only the incremental load-deformation relations beyond immediate ply failure. This model is not available in SALC.

For most fiber-dominated composites, setting the stiffness constants directly to zero after the corresponding mode of failure is simple and unambiguous. The use of such reduction can be justified by regarding the laminate analysis to be at the in-plane (x, y) location where all ply failures would occur. Consider a 90° lamina (within a laminate) containing a number of transverse matrix cracks, as shown in Figure B-2. The 90° ply still retains some stiffness in the loading direction (E_2 direction locally). However, the assumption is made that ensuing 0° fiber failure will occur at the weakest point. This point is where matrix cracking has occurred in the 90° plies, or where locally $E_2 = 0$. Thus, it is acceptable to reduce E_2 directly to zero after transverse matrix cracking for an ultimate strength analysis. This is the approach used in SALC. Since matrix cracks are discrete, between two cracks a failed lamina would still contribute fully to the laminate stiffnesses. It is obvious that such drastic lamina stiffness reduction, if assumed to be true over the whole laminate, would greatly overestimate the ultimate strains of the laminate. In fiber-dominated laminates, the effect of matrix cracks on the overall laminate stiffnesses is usually very small. It is reasonable to estimate the laminate ultimate strains by

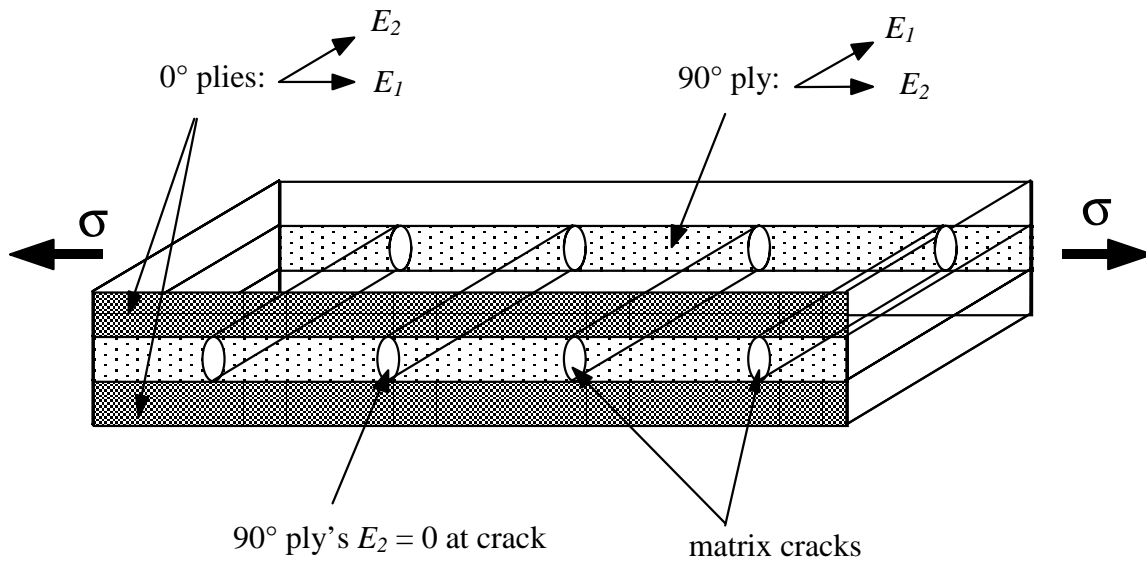

FIGURE B-2. SCHEMATIC OF LAMINATE WITH MATRIX CRACKS

using the virgin laminate stress-strain relations and the laminate failure stresses obtained from the laminate failure analysis.

Using the Program

The program is designed to calculate ultimate laminate stress and strain for any type of laminate under inplane applied stresses σ_{xx} , σ_{yy} and τ_{xy} . Thermal stresses arising from the manufacturing process may also be calculated (but not included in the failure analysis). Following below is a step by step explanation of how to run the program. Input, output, or file names associated with the program are identified with the font `courier`.

1. Input

These instructions are provided for a unix operating system, though the program should run similarly on any platform. The executable (program) requires these additional text files in order to run (examples at end of guide):

`mat.info` Text file containing the number and names of other text files listing material properties to be used by the code. First line is the number of text files with the names of the material files following.

`lam.info` Text file containing the number and type of laminates to be used by program. First line is the number of laminates followed by a blank line. Then each laminate is entered, first with the number of plies, followed by the name of the laminate, followed by each ply angle in order as found in the laminate.

????? Any file listed in `mat.info` which is a material property file. See example at end of guide for order of material constants.

The user can customize these files. The idea for this setup is to allow each user to generate a list of material properties and laminate families frequently used.

Once the program is executed, it reads in `mat.info` and provides a list of material files to choose from:

```
Enter material data file for analysis (#) ...
```

Enter in the file # desired. Next the program asks what type of laminate to analyze:

```
Enter # of laminate/ply choice...
```

Likewise, enter in the desired laminate. Next the program asks if thermal stresses (strains) should be calculated. NOTE, these are **not** included in the failure analysis. Only the mechanical strains are considered in the failure analysis:

```
Do you want to calculate thermal stresses?
```

```
1:yes      other:no
```

If yes, the program then prompts,

```
Enter delta T:
```

Enter the effective thermal drop during the curing cycle. Next the program asks what type of loading to place the laminate under:

```
Enter Mechanical Loading Envelope #:
```

```
1: Nx/Ny      2: Nx/Nxy     3: Ny/Nxy     4: Pure Thermal
```

Enter in the desired biaxial loading envelope in options #1-3. Or the user may opt to just examine the thermal stresses and strains by choosing option #4 (no mechanical loading nor failure analysis is performed). Option #1 assumes $N_{xy} = 0$. Option #2 assumes $N_y = 0$. Option #3 assumes $N_x = 0$. Once a biaxial loading plane is chosen, the program prompts

```
Enter load-angle range and step, (i.e., 0,90,10)
```

Figure B-3. shows a schematic of how to apply a biaxial load. Consider option #1 (N_x and N_y applied with $N_{xy} = 0$). The load is applied as a vector pointing in any circular direction. By

changing the angle (β) of the vector, the components N_x and N_y are altered. These components may be either in tension or compression. Examples:

- pure unidirectional tensile N_x : enter 0, 0, 1 (zero to zero degrees, one step)
- pure unidirectional compressive N_y : enter 270, 270, 1
- complete N_x - N_y biaxial failure envelope: enter 0, 360, 5 (failure point every 5°)

In the last example, the program calculates an ultimate laminate failure at 72 points ($360^\circ/5^\circ$) around the N_x - N_y biaxial envelope. The user may choose a finer or coarser number of steps, or may choose just to examine any subsection of the entire envelope. The other two biaxial planes would operate in a similar fashion. For all three biaxial cases, the first component listed is on the x-axis (0° and 180°) and the second component listed is on the y axis (90° and 270°).

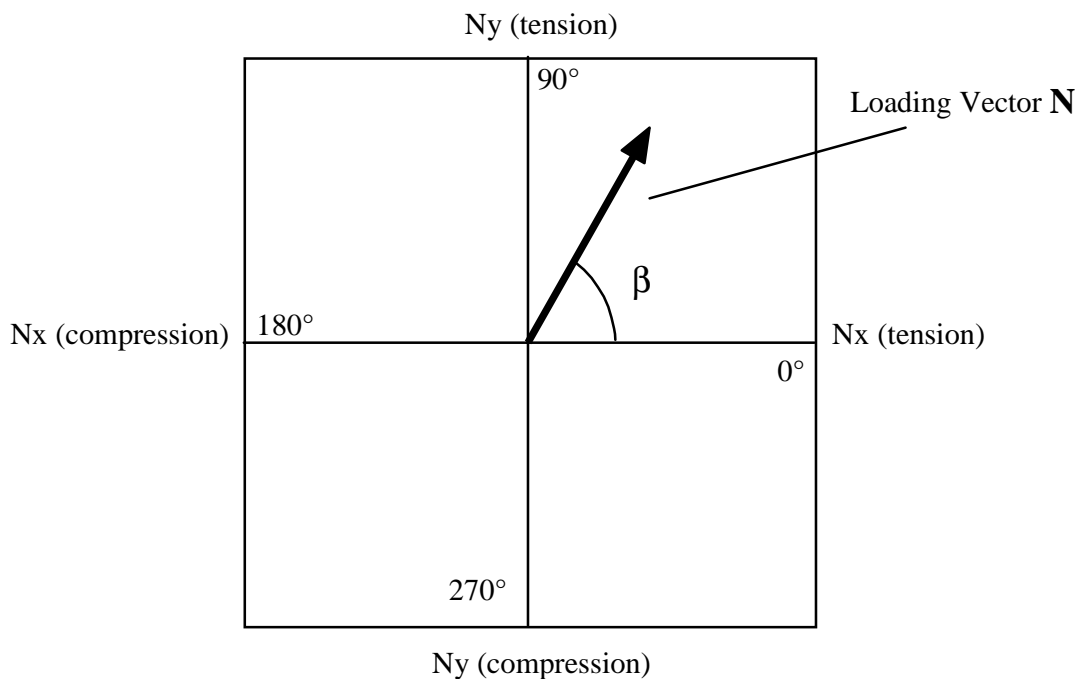

FIGURE B-3. SCHEMATIC OF APPLIED LOADING VECTOR

Once the applied loading is set, the program asks for a lamina failure criterion and stiffness reduction model to be used in the failure analysis:

Enter failure criterion and reduction model (i.e., 1,1)

- | | |
|-------------------|-----------------------------|
| 1: Hill-Tsai | 1: Parallel Spring Model |
| 2: Maximum Stress | 2: Parallel Spring Model(s) |
| 3: Maximum Strain | 3: Sudden Failure Model |
| 4: Tsai-Wu | 4: |
| 5: Hashin-Rotem | 5: |

6: Hashin
7: all

6:
7:

If option #7 is entered for the failure criterion, the program analyzes the chosen laminate with all six available lamina failure criterion (i.e., entering 7, 1 does an analysis using all six lamina failure criteria along with the Parallel Spring Model for stiffness reduction). See the theory section for explanation of reduction models #1 PSM and #2 PSM_s. If option #3 is chosen as the reduction model, the program simply calculates the “dominant” ply’s fiber failure strength and ends the analysis in one step.

If Tsai-Wu is chosen, the program asks for the interactive coefficient F_{12} found in equation 4:

Enter F12 interaction factor for Tsai-Wu:
Return = default of 0.0

The value that is entered is then multiplied by $1/(XX')$. This is done since those terms are frequently found in F_{12} . For example, if 0.5 is entered, $F_{12} = 1/(2XX')$ which would reduce Tsai-Wu to the Hoffman criterion (not offered in SALC). As explained in the theory section previously, many researchers suggest setting F_{12} to zero.

If Hashin-Rotem is chosen, the program asks whether or not to include the interaction factor μ (as described in equation 7):

Include mu factor with Hashin-Rotem criterion?
1:yes other:no

If yes, the program prompts for the value

Enter mu:

Enter a value for μ (typically between 0.0 and 1.0).

At this point, the program is capable of varying the angle of the chosen laminate’s plies. If the loading angle β has been varied, it is not suggested to vary any ply angles: this will produce a 3-D data file which *can* be difficult to work with. The user is prompted with

Do you want to vary any ply angle theta?
1:yes other:no

If yes, the program asks

Off-Axis Laminate Loading? 1:yes other:no

Off-axis laminate loading simply rotates the entire laminate at an angle θ . If yes

Enter off-axis range and step:

Just as in the loading case, the program requires an angle range and step. For example, if you entered 0,45,1 the program would rotate the entire laminate in 1° increments from 0° to 45° and calculate ultimate laminate failure at each point.

If you choose “no” to off-axis laminate loading, the program reminds you of the chosen laminate:

Here is the original laminate: ([0/±45/90]_s for example)

Enter angle of ply to vary...

The program is able to vary only one ply's theta. Enter the angle of the ply to change. Both ± values of a ply may be changed (i.e., ±60 or ±45).

Vary both signs of this ply (if applicable)?

1:yes other:no

This allows, for example, the ±45° plies to become ±θ° plies if desired.

Enter range of theta with step:

As before, enter the angle range and step of the ply to vary. A typical example of this feature would be to change a [0/±45]_s laminate to [0/±θ]_s, and vary θ.

Lastly, the program asks

Do you want to create a detailed file 'analysis'?

1:yes other:no

This is a very large file detailing all steps in the failure analysis. Beware that this file can grow very large (many megabytes if not careful) and slow down the program. If either the loading angle β or ply angle θ is varied over 10 steps or more, it is suggested that analysis not be generated.

2. OUTPUT

The program creates a variety of output files. All are automatically generated with the exception of analysis.

out.file,	Simple output file which gives laminate stresses and strains at each ply failure (including ultimate failure).
bistrs,	Data file for graphing. Intended for plotting biaxial failure envelopes. Contains 20 columns in the order: ply angle θ , loading angle β , Hill-Tsai's ultimate σ_{xx} , σ_{yy} and τ_{xy} ; Max. Stress' ultimate σ_{xx} , σ_{yy} and τ_{xy} ; Max. Strains' ultimate σ_{xx} , σ_{yy} and τ_{xy} ; Tsai-Wu's ultimate σ_{xx} , σ_{yy} and τ_{xy} ; Hashin-Rotem's ultimate σ_{xx} , σ_{yy} and τ_{xy} ; Hashin's ultimate σ_{xx} , σ_{yy} and τ_{xy} .
bistrn,	Data file for graphing. Identical to bistrs but replaces ultimate stresses σ_{xx} , σ_{yy} , and τ_{xy} with ultimate strains ϵ_{xx} , ϵ_{yy} , and γ_{xy} .
unstrs,	Data file for graphing. Intended for plotting off-axis laminate failure loads under unidirectional N_x . Contains eight columns in the order: ply angle θ , loading angle β , Hill-Tsai's ultimate σ_{xx} , Max. Stress' ultimate σ_{xx} , Max. Strains' ultimate σ_{xx} , Tsai-Wu's ultimate σ_{xx} , Hashin-Rotem's ultimate σ_{xx} , Hashin's ultimate σ_{xx} .
unstrn	Data file for graphing. Identical to unstrs but replaces ultimate stress σ_{xx} with ultimate strain ϵ_{xx} .
analysis,	Very detailed file containing step by step analysis of laminate failure. Includes all stiffness matrices, stresses and strains in each ply, and failure analysis summary.

APPENDIX □

Following are examples of SALC's input and outputs. In order they are: □

mat.info	available material input•
example.data	material system file explaining order of constants•
aae555.data	available material system (in psi)•
exp.data	available material system (in MPa)•
lam.info	available laminate data file•
ex1	example of input for $[0/\pm 45/90]_s$ laminate under tensile N_x •
out.file	output from ex1
analysis.1	detailed output from ex1
ex2	example of input for $[90/0]_s$ laminate's thermal stress calculation•
analysis.2	detailed output from ex2

94/03/02
15:00:24

mat.info

1

2
exp.data
aae555.data

94/03/02
15:00:24

```
20e6      E1
1.5e6     E2
1e6       G12
.29       v12
.005      ply thickness
310e3     X
-310e3    X'
9e3       Y
-30e3     Y'
14e3      S
1         Xe
1         Xe'
1         Ye
1         Ye'
1         Se
2e-6      alpha11
15e-6     alpha22
0.0       alpha12
```

example.data

1

AAE555 Class Notes Data : stress values in psi.

Any additional comments about the material system may be placed after the list of constants. This printout gives a label to each value; the actual file used with SALC should not contain any labels.

NOTE: if ultimate strain values are unavailable, SALC will calculate the value if a value of 1 is used. The ultimate strain is calculate from the ultimate stress and modulus values given.

94/03/02
22:18:39

exp.data

1

153750
11031
6900
.32
.0129
2171
-2013
67
-206.8
110.3
1
1
1
1
1
2e-6
15e-6
0.

Tested at the Composite Materials Lab at Purdue University.
AS4/3501-6 Graphite Epoxy from Hercules.
Fall 1993
Stress values in MPa
Ply thickness in cm

strain / v12:
.001 / .333
.002 / .320
.003 / .324
.004 / .317
.005 / .333
.006 / .327
.007 / .322
.008 / .318
.009 / .315

Order of material properties:
E1
E2
G12
v12
ply thickness

04/03/02
22:28:39

exp.data

1

153750
11031
6900
.32
.0129
2171
-2013
67
-206.8
110.3
1
1
1
1
1
2e-6
15e-6
0.

Tested at the Composite Materials Lab at Purdue University.
AS4/3501-6 Graphite Epoxy from Hercules.
Fall 1993
Stress values in MPa
Ply thickness in cm

strain / v12:
.001 / .333
.002 / .320
.003 / .324
.004 / .317
.005 / .333
.006 / .327
.007 / .322
.008 / .318
.009 / .315

Order of material properties:

E1
E2
G12
v12
ply thickness
X
X'
Y
Y'
S
Xe
Xe'
Ye
Ye'
Se
alpha11
alpha22
alpha12

10

1
0 degree ply
0.0

8
[0/+-45/90]s
0.0
45.0
-45.0
90.0
90.0
-45.0
45.0
0.0

4
[90/0]s
90.
0.
0.
90.

8
[90/0]2s
90.
0.
90.
0.
0.
90.
0.
90.

6
[0/+-60]s
0
60
-60
-60
60
0

6
[90/+-30]s
90
30
-30
-30
30
90

6
[0/+-45]s
0
45.0
-45.0
-45.0
45.0
0

6
[+-45/90]s

94/03/02
16:05:35

2

lam.info

45
-45
90
90
-45
45

4
[+-45]s
45.
-45.
-45.
45.

10
[0/90/90/90/90]s
0
90
90
90
90
90
90
90
90
0

1

04/03/92
21:38:56

ex1

Percent Complete: \$ 0.0
Percent Complete: \$ 0.0
Percent Complete: \$ 0.0
Percent Complete: \$ 0.0
Percent Complete: \$ 0.0
Percent Complete: \$ 0.0
Done!

Enter material data file for analysis (#) ...
1: exp.data
2: aae555.data

Enter # of laminate/ply choice...

1: 0 degree ply
2: [0/+45/90]s
3: [90/0]s
4: [90/0]2s
5: [0/+60]s

Enter material data file for analysis (#) ...
1: exp.data
2: aae555.data

Enter # of laminate/ply choice...

1: 0 degree ply
2: [0/+45/90]s
3: [90/0]s
4: [90/0]2s
5: [0/+60]s
6: [90/+30]s
7: [0/+45]s
8: [+45]s
9: [-45]s
10: [0/90/90/90]s

Do you want to calculate thermal stresses?
1: yes
other: no

Enter Mechanical Loading Envelope #:
1: Nx/Ny 2: Nx/Nxy 3: Ny/Nxy 4: Pure Thermal

Enter load-angle range and step, (i.e. 0,90,10)

0,0,1

Enter failure criterion and reduction model (i.e. 1,1)

1: Hill-Tsai
2: Maximum Stress
3: Maximum Strain
4: Tsai-Wu
5: Hashin-Rotem
6: Hashin
7: all
1,1

Do you want to vary any ply angle theta?
1: yes
other: no

Do you want to create a detailed file 'analysis'?
1: yes
other: no

Starting Analysis of: [0/+45/90]s
Using material system: aae555.data

Percent Complete: \$ 0.0
Percent Complete: \$ 0.0

94/03/02
22:36:48

out.file

1

Starting Analysis of: [0/+45/90]s
Using material system: aae555.data

Hill-Tsai Ply	Mode	w/ Parallel Spring Model SigmaXX	SigmaYY	Beta: TauXY	0.00 eXX	Theta: eYY	0.00 gXY
90.00	2	51586.7	0.0	0.0	0.0065	-0.0019	0.0000
-45.00	3	62732.7	0.0	0.0	0.0082	-0.0023	0.0000
45.00	3	62732.7	0.0	0.0	0.0087	-0.0027	0.0002
0.00	1	103223.0	0.0	0.0	0.0155	-0.0051	0.0000

Fiber Failure

Done!



analysis.1

94113002
22:36:48

Starting Analysis of: [0/+45/90]s
Using material system: aae555.data

Hill-Tsai w/ Parallel Spring Model Beta: 0.00 Theta: 0.00

Qbar matrix: 0.00 20126950.7418 437761.1786 0.0000 0.0000 0.0000
437761.1786 1509521.3056 1000000.0000 0.0000 0.0000 0.0000

Qbar matrix: 45.00 6627998.6012 4627998.6012 4654357.3590 4654357.3590 4654357.3590
4627998.6012 6627998.6012 4654357.3590 5190237.4225 5190237.4225 5190237.4225
4627998.6012 4654357.3590 -4654357.3590 5190237.4225 5190237.4225 5190237.4225

Qbar matrix: -45.00 6627998.6012 4627998.6012 4654357.3590 4654357.3590 4654357.3590
4627998.6012 6627998.6012 4654357.3590 5190237.4225 5190237.4225 5190237.4225
4627998.6012 4654357.3590 -4654357.3590 5190237.4225 5190237.4225 5190237.4225

Qbar matrix: 90.00 1509521.3056 437761.1786 0.0000 0.0000 0.0000
437761.1786 1509521.3056 1000000.0000 0.0000 0.0000 0.0000
437761.1786 437761.1786 1000000.0000 0.0000 0.0000 0.0000

Qbar matrix: 90.00 1509521.3056 437761.1786 0.0000 0.0000 0.0000
437761.1786 1509521.3056 1000000.0000 0.0000 0.0000 0.0000
437761.1786 437761.1786 1000000.0000 0.0000 0.0000 0.0000

Qbar matrix: -45.00 6627998.6012 4627998.6012 4654357.3590 4654357.3590 4654357.3590
4627998.6012 6627998.6012 4654357.3590 5190237.4225 5190237.4225 5190237.4225
4627998.6012 4654357.3590 -4654357.3590 5190237.4225 5190237.4225 5190237.4225

Qbar matrix: 45.00 6627998.6012 4627998.6012 4654357.3590 4654357.3590 4654357.3590
4627998.6012 6627998.6012 4654357.3590 5190237.4225 5190237.4225 5190237.4225
4627998.6012 4654357.3590 -4654357.3590 5190237.4225 5190237.4225 5190237.4225

Qbar matrix: 0.00 20126950.7418 437761.1786 0.0000 0.0000 0.0000
437761.1786 1509521.3056 1000000.0000 0.0000 0.0000 0.0000
437761.1786 437761.1786 1000000.0000 0.0000 0.0000 0.0000

Effective laminate moduli:
Ex = 7987659.9860
Ey = 7987659.9860
Vxy = 0.2904
Vyx = 0.2904
Gxy = 3095118.7113

A matrix: 348924.6925 101315.1956 0.0000
101315.1956 348924.6925 0.0000
0.0000 0.0000 123804.7485

A Inverse matrix: 0.0000031298 -0.0000009088 0.0000000000
-0.0000009088 0.0000031298 0.0000000000
0.0000000000 0.0000000000 0.0000080772

B matrix: 0.0000 0.0000 0.0000
0.0000 0.0000 0.0000
0.0000 0.0000 0.0000

D matrix: 76.5446 11.4136 0.0000 0.0000
11.4136 20.6923 0.0000 0.0000
4.6544 4.6544 0.0000 0.0000

Mechanical Stresses and Strains on each ply:
Ply Strain(xy) Strain(12) Stress(xy) Stress(12)
0.00 0.0000031 0.0000011 62.596 62.596
0.00 -0.0000009 -0.0000009 -0.002 -0.002
0.00 0.0000000 0.0000000 0.000 0.000
45.00 0.0000031 0.0000011 16.539 22.838
45.00 -0.0000009 0.0000011 8.461 2.162
45.00 0.0000000 -0.0000040 10.338 -4.039
-45.00 0.0000031 0.0000011 16.539 22.838
-45.00 -0.0000009 0.0000011 8.461 2.162
-45.00 0.0000000 0.0000040 -10.338 4.039
90.00 0.0000031 -0.0000009 4.327 -16.921
90.00 -0.0000009 0.0000031 -16.921 4.327
90.00 0.0000000 0.0000000 0.000 0.000
90.00 0.0000031 -0.0000009 4.327 -16.921
90.00 -0.0000009 0.0000031 -16.921 4.327
90.00 0.0000000 0.0000000 0.000 0.000
-45.00 0.0000031 0.0000011 16.539 22.838
-45.00 -0.0000009 0.0000011 8.461 2.162
-45.00 0.0000000 0.0000040 -10.338 4.039
45.00 0.0000031 0.0000011 16.539 22.838
45.00 -0.0000009 0.0000011 8.461 2.162
45.00 0.0000000 0.0000040 -10.338 4.039
-45.00 0.0000031 0.0000011 16.539 22.838
-45.00 -0.0000009 0.0000011 8.461 2.162
-45.00 0.0000000 0.0000040 -10.338 4.039

Hill-Tsai critical ratios:
Ply Fiber Transverse Shear
0.00 4952.320414
45.00 2618.349584
-45.00 2618.349584
90.00 2063.468548
90.00 2063.468548
-45.00 2618.349584
45.00 2618.349584
0.00 4952.320414

Critical ply strength ratios:
Fiber Transverse Shear
0.1126 0.9920 0.0000

Ply Failure:
Ply Mode N(xy) Sigma(xy)

94/03/02
22:36:48

90.00 2 2063.5 51586.7
0.0 0.0
0.0 0.0

Laminate Strains:
Before ply failure

0.00000 0.00646
0.00000 -0.00188
0.00000 0.00000

----- Reduced laminate stiffness-----

Qbar matrix: 0.00
20126950.7418
437761.1786
0.0000

Qbar matrix: 45.00
6627998.6012
4627998.6012
4654357.3590

Qbar matrix: -45.00
6627998.6012
4627998.6012
-4654357.3590

Qbar matrix: 90.00
0.0000
0.0000
0.0000

Qbar matrix: 90.00
0.0000
0.0000
0.0000

Qbar matrix: -45.00
6627998.6012
4627998.6012
-4654357.3590

Qbar matrix: 45.00
6627998.6012
4627998.6012
4654357.3590

Qbar matrix: 0.00
20126950.7418
437761.1786
0.0000

Effective laminate moduli:

Ex = 7870003.1298
Ey = 7987659.9337
Vxy = 0.2788
Vyx = 0.2904
Gxy = 2845118.7113

A matrix:
333829.4794
96937.5838
347655.1851

analysis.1

113804.7485

0.0000

A Inverse matrix:

0.0000032595
-0.0000009088
0.0000000000

B matrix:

0.0000 0.0000
0.0000 0.0000
0.0000 0.0000

D matrix:

76.4188 11.3771
11.3771 20.6817
4.6544 4.6544

Mechanical Stresses and Strains on each ply:

Ply	Strain(xy)	Strain(12)	Stress(xy)	Stress(12)
0.00	0.0067258	0.0067258	134548.376	134548.376
0.00	-0.0018754	-0.0018754	113.380	113.380
0.00	0.0000000	0.0000000	0.000	0.000
45.00	0.0067258	0.0024252	35899.239	49873.640
45.00	-0.0018754	0.0024252	18696.960	4722.559
45.00	0.0000000	-0.0086011	22575.541	-8601.140
-45.00	0.0067258	0.0024252	35899.239	49873.640
-45.00	-0.0018754	0.0024252	18696.960	4722.559
-45.00	0.0000000	0.0086011	-22575.541	8601.140
90.00	0.0067258	-0.0018754	0.000	-37507.300
90.00	-0.0018754	0.0067258	-37507.300	0.000
90.00	0.0000000	0.0000000	0.000	0.000
90.00	0.0067258	-0.0018754	0.000	-37507.300
90.00	-0.0018754	0.0067258	-37507.300	0.000
90.00	0.0000000	0.0000000	0.000	0.000
-45.00	0.0067258	0.0024252	35899.239	49873.640
-45.00	-0.0018754	0.0024252	18696.960	4722.559
-45.00	0.0000000	0.0086011	-22575.541	8601.140
0.00	0.0067258	0.0067258	134548.376	134548.376
0.00	-0.0018754	-0.0018754	113.380	113.380
0.00	0.0000000	0.0000000	0.000	0.000

Hill-Tsai critical ratios:

Ply	N-critical
0.00	2.304004
45.00	1.216063
-45.00	1.216063
90.00	8.265058
90.00	8.265058
-45.00	1.216063
45.00	1.216063
0.00	2.304004



94/03/02
22:36:48

analysis.1

Critical ply strength ratios:
 Fiber Transverse Shear
 0.1956 0.6381 0.7471

Ply Failure:
 Ply Mode N(xy) Sigma(xy)
 -45.00 3 2509.3 62732.7
 0.0 0.0
 0.0 0.0

Laminate Strain:
 Before ply failure After ply failure
 0.00673 0.00818
 -0.00188 -0.00228
 0.00300 0.00000

----- Reduced laminate stiffness... -----
 Qbar matrix: C.00 20126950.7416 437761.1786 0.0000
 1509521.3056 0.0000 1000000.0000

Qbar matrix: 45.00 6627998.6012 4654357.3590 0.0000
 4627998.6012 4654357.3590 5190237.4225 0.0000
 4654357.3590 5190237.4225 5000000.0000 0.0000
 -5000000.0000 -5000000.0000 5000000.0000 0.0000

Qbar matrix: -45.00 5000000.0000 0.0000 0.0000
 5000000.0000 0.0000 20000000.0000 0.0000
 -5000000.0000 0.0000 20000000.0000 0.0000

Qbar matrix: 90.00 0.0000 0.0000 0.0000
 0.0000 0.0000 20000000.0000 0.0000
 0.0000 0.0000 20000000.0000 0.0000

Qbar matrix: -45.00 5000000.0000 0.0000 0.0000
 5000000.0000 0.0000 -5000000.0000 0.0000
 -5000000.0000 0.0000 -5000000.0000 0.0000

Qbar matrix: 45.00 6627998.6012 4654357.3590 0.0000
 4627998.6012 4654357.3590 5190237.4225 0.0000
 4654357.3590 5190237.4225 5000000.0000 0.0000
 -5000000.0000 -5000000.0000 5000000.0000 0.0000

Qbar matrix: C.00 20126950.7416 437761.1786 0.0000
 1509521.3056 0.0000 1000000.0000 0.0000

Effective laminate moduli:
 Hill-Tsai critical ratios:
 Ply N-critical

Ex = 7174350.6207
 Ey = 7486712.8253
 Vxy = 0.3038
 Vyx = 0.3170
 Cxy = 2797559.3556

A matrix:
 317549.4914 100657.5978 -3456.4264
 100657.5978 331375.1891 -3456.4264
 -3456.4264 -3456.4264 111902.3742

A inverse matrix:
 -0.0000034853 0.0000010579 0.0000000750
 0.0000010579 -0.0000033398 0.0000000705
 0.0000000750 0.0000000705 0.0000089409

B matrix:
 0.0000 0.0000 0.0000
 0.0000 0.0000 0.0000
 0.0000 0.0000 0.0000

D matrix:
 75.4691 11.5941 4.4527
 11.5941 19.7320 4.4527
 4.4527 4.4527 14.2179

Ply	Strain(xy)	Strain(12)	Stress(xy)	Stress(12)
0.00	0.0087456	0.0087456	174860.241	174860.241
0.00	-0.0026546	-0.0026546	-178.656	-178.656
0.00	0.0001881	0.0001881	188.139	188.139
45.00	0.0087456	0.0031396	46556.127	64482.241
45.00	-0.0026546	0.0029514	23765.768	5829.654
45.00	0.0001881	-0.0114002	29326.294	-11400.180
-45.00	0.0087456	0.0029514	29514.433	59028.865
-45.00	-0.0026546	0.0031396	29514.433	0.000
-45.00	0.0001881	0.0114002	-29514.433	0.000
90.00	0.0087456	-0.0026546	0.000	-53091.545
90.00	-0.0026546	0.0087456	-53091.545	0.000
90.00	0.0001881	-0.0001881	0.000	0.000
90.00	0.0087456	-0.0026546	0.000	-53091.545
90.00	-0.0026546	0.0087456	-53091.545	0.000
90.00	0.0001881	0.0001881	0.000	0.000
-45.00	0.0087456	0.0029514	29514.433	59028.865
-45.00	-0.0026546	0.0031396	29514.433	0.000
-45.00	0.0001881	-0.0114002	-29514.433	0.000
45.00	0.0087456	0.0031396	46556.127	64482.241
45.00	-0.0026546	0.0029514	23765.768	5829.654
45.00	0.0001881	-0.0114002	29326.294	-11400.180
0.00	0.0087456	0.0087456	174860.241	174860.241
0.00	-0.0026546	-0.0026546	-178.656	-178.656
0.00	0.0001881	0.0001881	188.139	188.139

94/03/02
22:36:43

0.00
45.00
-45.00
90.00
90.00
-45.00
45.00
0.00

Critical ply strength ratios:
Fiber Transverse Shear

0.2080	0.6477	0.8143
--------	--------	--------

Ply Failure:
Ply Mode N(x,y) Sigma(xy)

45.00	3	2509.3	67732.7
0.0		0.0	0.0
0.0		0.0	0.0

Laminate Strains:
Before ply failure After ply failure

0.00875	0.00875
-0.00265	-0.00265
0.00019	0.00019

----- Reduced laminate stiffness.-----

Qbar matrix: 0.00 20126950.7418 437761.1786 0.0000 0.0000
437761.1786 1509521.3056 0.0000 1000000.0000

Qbar matrix: 45.00 5000000.0000 5000000.0000 5000000.0000 5000000.0000
5000000.0000 5000000.0000 5000000.0000 5000000.0000

Qbar matrix: -45.00 5000000.0000 5000000.0000 -5000000.0000 -5000000.0000
5000000.0000 5000000.0000 -5000000.0000 -5000000.0000

Qbar matrix: 90.00 0.0000 0.0000 0.0000 0.0000
0.0000 0.0000 0.0000 0.0000 0.0000
0.0000 0.0000 0.0000 0.0000 0.0000

Qbar matrix: -45.00 5000000.0000 5000000.0000 -5000000.0000 -5000000.0000
5000000.0000 5000000.0000 -5000000.0000 -5000000.0000

Qbar matrix: 45.00 5000000.0000 5000000.0000 5000000.0000 5000000.0000

4

analysis.1

5000000.0000 5000000.0000 5000000.0000
5000000.0000 5000000.0000 5000000.0000

Qbar matrix: 0.00 20126950.7418 437761.1786 0.0000
437761.1786 1509521.3056 0.0000 1000000.0000

Effective laminate moduli:
Ex = 6667341.3545
Ey = 6973315.5626
Vxy = 0.3313
Vyx = 0.3465
Gxy = 2750000.0000

A matrix:
301269.5074 104377.6118 0.0000
104377.6118 315095.2131 0.0000
0.0000 0.0000 1100000.0000

A inverse matrix:
0.0000037496 -0.0000012421 0.0000000000
-0.0000012421 0.0000035851 0.0000000000
0.0000000000 0.0000000000 0.0000090909

B matrix:
0.0000 0.0000 0.0000
0.0000 0.0000 0.0000
0.0000 0.0000 0.0000

D matrix:
72.1831 12.1831 5.0000
12.1831 17.1544 5.0000
5.0000 5.0000 13.9167

Mechanical Stresses and Strains on each ply:

Ply	Strain(x,y)	Strain(lz)	Stress(xy)	Stress(lz)
0.00	0.0094090	0.0094090	188009.123	188009.123
0.00	-0.0031168	-0.0031168	-585.979	-585.979
0.00	0.0000000	0.0000000	0.000	0.000
45.00	0.0094090	0.0031461	31460.839	62921.679
45.00	-0.0031168	0.0031461	31460.839	0.000
45.00	0.0000000	-0.0125257	31460.839	0.000
-45.00	0.0094090	0.0031461	31460.839	62921.679
-45.00	-0.0031168	0.0031461	31460.839	0.000
-45.00	0.0000000	0.0125257	-31460.839	0.000
90.00	0.0094090	-0.0031168	0.000	-62335.699
90.00	-0.0031168	0.0094090	0.000	0.000
90.00	0.0000000	0.0000000	0.000	0.000
90.00	0.0094090	-0.0031168	0.000	-62335.699
90.00	-0.0031168	0.0094090	0.000	0.000
-45.00	0.0094090	0.0031461	31460.839	62921.679
-45.00	-0.0031168	0.0031461	31460.839	0.000
-45.00	0.0000000	0.0125257	-31460.839	0.000

94/03/02
22:36:48

5

analysis.1

45.00	-0.0031168	0.0031161	31460.839	0.000
45.00	0.0000000	-0.0125257	31460.839	0.000
0.00	0.0094090	0.0094090	188009.123	188009.123
0.00	-0.0031168	-0.0031168	-585.979	-585.979
0.00	0.0000000	0.0000000	0.000	0.000

Hill-Tsai critical ratios:
Ply N-critical

0.00	1.645442
45.00	4.926760
-45.00	4.926760
90.00	4.973073
90.00	4.973073
-45.00	4.926760
45.00	4.926760
0.00	1.645442

Critical ply strength ratios:
fiber Transverse Shear

0.9979	0.0321	0.0000
--------	--------	--------

Ply Failure:

Ply	Mode	N(xy)	Sigma(xy)
0.00		4128.9	103223.0
		0.0	0.0
		0.0	0.0

Laminate Strains:

Before ply failure	After ply failure
0.00941	0.01548
-0.00312	-0.00513
0.00000	0.00000

..... End of analysis

Done!

94/03/02
23:11:27

1

ex2

Enter material data file for analysis (#) ...

- 1: exp.data
- 2: aae555.data

2

Enter # of laminate/ply choice...

- 1: 0 degree ply
- 2: [0/+45/90]s
- 3: [90/0]s
- 4: [90/0]2s
- 5: [0/+60]s
- 6: [90/+30]s
- 7: [0/+45]s
- 8: [+45/90]s
- 9: [+45]s
- 10: [0/90/90/90/90]s

3

Do you want to calculate thermal stresses?

- 1:yes
- other:no

1

Enter delta T:

-250

Enter Mechanical Loading Envelope #:

- 1: Nx/Ny
- 2: Nx/Nxy
- 3: Ny/Nxy
- 4: Pure Thermal

4

Enter failure criterion and reduction model (i.e. 1,1)

- | | |
|-------------------|-----------------------------|
| 1: Hill-Tsai | 1: Parallel Spring Model |
| 2: Maximum Stress | 2: Parallel Spring Model(s) |
| 3: Maximum Strain | 3: Sudden Failure Model |
| 4: Tsai-Wu | 4: |
| 5: Hashin-Rotem | 5: |
| 6: Hashin | 6: |
| 7: all | 7: |

1,1

Do you want to vary any ply angle theta?

- 1:yes
- other:no

2

Do you want to create a detailed file 'analysis'?

- 1:yes
- other:no

1

Starting Analysis of: [90/0]s
Using material system: aae555.data

Percent Complete: % 0.0
Percent Complete: % 0.0
Percent Complete: % 0.0
Percent Complete: % 0.0
Percent Complete: % 0.0
Percent Complete: % 0.0
Percent Complete: % 0.0
Percent Complete: % 0.0
Percent Complete: % 0.0
Percent Complete: % 0.0
Done!

04/03/02
23:09:59

Starting Analysis of: [90/0]s
Using material system: aae555.data

Hill-Desai w/ Parallel Spring Model Beta: 0.00 Theta: 0.00

Qbar matrix: 90.00 1509521.3056 437761.1786 20126950.7418 0.0000 0.0000
 437761.1786 0.0000 1000000.0000

Qbar matrix: 0.00 20126950.7418 437761.1786 1509521.3056 0.0000 0.0000
 437761.1786 0.0000 1000000.0000

Qbar matrix: 0.00 20126950.7418 437761.1786 1509521.3056 0.0000 0.0000
 437761.1786 0.0000 1000000.0000

Qbar matrix: 90.00 1509521.3056 437761.1786 20126950.7418 0.0000 0.0000
 437761.1786 0.0000 1000000.0000

Alpha's in x-y coordinates:

Ply	Alpha x	Alpha y	Alpha xy
90.0	0.1500E-04	0.2000E-05	0.0000E+00
0.0	0.2000E-05	0.1500E-04	0.0000E+00
0.0	0.2000E-05	0.1500E-04	0.0000E+00
90.0	0.1500E-04	0.2000E-05	0.0000E+00

Thermal loads:

Nx	Ny	Nxy
-175.85	-175.85	0.00

Effective laminate moduli:

Ex = 10800521.9667
 Ey = 10800521.9667
 Vxy = 0.0405
 Vyx = 0.0405
 Gxy = 1000000.0000

A matrix:

216364.7205	8755.2236	0.0000
8755.2236	216364.7205	0.0000
0.0000	0.0000	20000.0000

A Inverse matrix:

0.0000046294	-0.0000001873	0.0000000000
-0.0000001873	0.0000046294	0.0000000000
0.0000000000	0.0000000000	0.0000500000

B matrix:

0.0000	0.0000	0.0000
0.0000	0.0000	0.0000
0.0000	0.0000	0.0000

D matrix:

2.5578	0.2918	0.0000
0.2918	11.8665	0.0000
0.0000	0.0000	0.6667



analysis.2

Effective Laminate Thermal Coefficients:

Alpha x (bar)	Alpha y (bar)	Alpha xy (bar)
0.3124E-05	0.3124E-05	0.0000E+00

Thermal Stresses and Strains on each ply:

Ply	Strain(xy)	Strain(lz)	Stress(xy)	Stress(lz)
90.00	-0.0007811	-0.0007811	4358.516	-4358.516
90.00	-0.0007811	-0.0007811	-4358.516	4358.516
90.00	0.0000000	0.0000000	0.000	0.000
0.00	-0.0007811	-0.0007811	-4358.516	4358.516
0.00	-0.0007811	-0.0007811	4358.516	-4358.516
0.00	0.0000000	0.0000000	0.000	0.000
0.00	-0.0007811	-0.0007811	-4358.516	4358.516
0.00	-0.0007811	-0.0007811	4358.516	-4358.516
90.00	-0.0007811	-0.0007811	4358.516	-4358.516
90.00	-0.0007811	-0.0007811	-4358.516	4358.516
90.00	0.0000000	0.0000000	0.000	0.000

***** End of Analysis *****

Done!

```

C *****
C
C          *
C Strength Analysis of Laminated Composites (SALC)          *
C
C          *
C          Version 1.1          *
C
C          *
C          June 1994          *
C
C          *
C          Brian J. Quinn / C. T. Sun / J. Tao          *
C          *
C *****
C
C double precision thick,e1(40),e2(40),g12(40),v12,theat(40),
C & fmr(3),ststrs(5),ststrn(5),langle,pi,temp,v21
C double precision ang1,ang2,step,pangle,theat1,theat2,tstep,
C & intfac,angvar,otheat(40),mu,guess,endstrn(3),xfmr(3)
C double precision dbstrs(6,3,3000),dbang(2,3000)
C double precision dbstrn(6,3,3000),alph12(3),delt
C character*35 rmodel(10),fmodel(10),indata,lamcho
C character*1 dothet,panal
C integer fmod,rmod,chfile,f1,f2,lodsit,mufac,thanal
C common panal
C
C ***** Input Data *****
C
C call system("clear")
C
C open(unit=10,file='mat.info',access='sequential')
C write(6,*)"Enter material data file for analysis (#) ..."
C read(10,*)numfile
C do 15 k=1,numfile
C read(10,10)indata
10 format(a20)
C write(6,*)k," ": ",indata
15 continue
C read(5,*)chfile
C rewind(10)
C do 25 j=0,chfile
C read(10,20)indata
20 format(a20)
25 continue
C write(6,*)
C
C open(unit=15,file=indata,access='sequential')
C open(unit=25,file='out.file')
C open(unit=40,file='analysis')
C open(unit=50,file='lam.info',access='sequential')
C open(unit=70,file='bistrs')
C open(unit=71,file='bistrn')
C open(unit=80,file='unstrs')
C open(unit=81,file='unstrn')
C
C read(15,*) e1(1),e2(1),g12(1),v12
C read(15,*) thick
C read(15,*) (ststrs(i),i=1,5)
C read(15,*) (ststrn(i),i=1,5)
C read(15,*) (alph12(i),i=1,3)
C
C call CHOLAM(n,theat,lamcho)
C
C do 27 j=1,n
C e1(j)=e1(1)
C e2(j)=e2(1)
C g12(j)=g12(1)

```

```

oheat(j)=theat(j)
27 continue
C
    delt=0.0
    write(6,*)
    write(6,*)"Do you want to calculate thermal stresses?"
    write(6,*)" 1:yes  other:no"
    read(5,39)thanal
    if(thanal.eq.1) then
        write(6,*)"Enter delta T:"
        read(5,*)delt
    endif
C
    if(ststrn(1).eq.1) then
        ststrn(1)=ststrs(1)/e1(1)
    endif
    if(ststrn(2).eq.1) then
        ststrn(2)=ststrs(2)/e1(1)
    endif
    if(ststrn(3).eq.1) then
        ststrn(3)=ststrs(3)/e2(1)
    endif
    if(ststrn(4).eq.1) then
        ststrn(4)=ststrs(4)/e2(1)
    endif
    if(ststrn(5).eq.1) then
        ststrn(5)=ststrs(5)/g12(1)
    endif
C
    pi=3.14159265359
    intfac=0.0
    theat1=0.0
    theat2=0.0
    tstep=1.0
        ang1=0.0
        ang2=0.0
        step=1.0
C
        do 29 i=1,6
            do 29 j=1,3
                do 29 k=1,1000
                    dbstrs(i,j,k)=0.0
                    dbstrn(i,j,k)=0.0
                    dbang(1,k)=0.0
                    dbang(2,k)=0.0
29          continue
C
        fmodel(1)='Hill-Tsai'
        fmodel(2)='Maximum Stress'
        fmodel(3)='Maximum Strain'
        fmodel(4)='Tsai-Wu'
        fmodel(5)='Hashin-Rotem'
        fmodel(6)='Hashin'
        fmodel(7)='all'
C
        rmodel(1)='Parallel Spring Model'
        rmodel(2)='Parallel Spring Model(s)'
        rmodel(3)='Sudden Failure Model'
        rmodel(4)=' '
        rmodel(5)=' '
        rmodel(6)=' '
        rmodel(7)=' '
C
        write(6,*)

```

```

write(6,*)"Enter Mechanical Loading Envelope #:"
write(6,*)" 1: Nx/Ny  2: Nx/Nxy  3: Ny/Nxy  ",
&" 4: Pure Thermal"
read(5,39)loadsit
  if(loadsit.eq.4) goto 100
write(6,*)
write(6,*)"Enter load-angle range and step, (i.e. 0,90,10)"
write(6,*)
read(5,*)ang1,ang2,step
C
  write(6,*)
write(6,*)"Enter failure criterion and reduction model (i.e. 1,1)"
write(6,*)
do 35 j=1,7
write(6,30)j,fmodel(j),j,rmodel(j)
30 format(i2,' ',a35,2x,i2,' ',a35)
35 continue
  read(5,*)fmod,rmod
  if(fmod.eq.7) then
    f1=1
    f2=6
  else
    f1=fmod
    f2=fmod
  endif
C
  if(fmod.eq.7.or.fmod.eq.4) then
    write(6,*)
    write(6,*)"Enter F12 interaction factor for Tsai-Wu:"
    write(6,*)" Return = default of 0.0"
    read(5,37)intfac
37 format(f6.3)
    write(6,*)
    write(6,38)intfac
38 format('Interaction factor = ',f6.3)
    endif

C
  write(6,*)
C
  write(6,*)"Classify final failure:"
C
  write(6,*)" Return: fiber breakage  1: all ply's damaged"
C
  read(5,39)idamge
39 format(i1)
C
  if(fmod.eq.7.or.fmod.eq.5) then
    write(6,*)
    write(6,*)"Include mu factor with Hashin-Rotem criterion?"
    write(6,*)" 1:yes  other:no"
    read(5,39)mufac
    if(mufac.eq.1) then
      write(6,*)"Enter mu:"
      read(5,*)mu
      guess=30000
    endif
  endif
C
41  write(6,*)
  write(6,*)"Do you want to vary any ply angle theta?"
  write(6,*)" 1:yes  other:no"
  read(5,40)dothet
40 format(a1)
  if(dothet.ne.'1') goto 100
C
  write(6,*)"Off-Axis Laminate Loading? 1:yes  other:no"
  read(5,39)ioffax

```

```

if(ioffax.eq.1) then
  write(6,*)"Enter off-axis range and step:"
  read(5,*)theat1,theat2,tstep
  goto 100
endif
C
write(6,42)lamcho
42 format('Here is the original laminate: ',a30)
write(6,*)
C
write(6,*)"Enter angle of ply to vary..."
read(5,*)angvar
write(6,*)
write(6,*)"Vary both signs of this ply (if applicable)?"
write(6,*)" 1:yes  other:no"
read(5,39)nsign
C
write(6,*)
write(6,*)"Enter range of theta with step:"
read(5,*)theat1,theat2,tstep
write(6,*)
C
100 write(6,*)
write(6,*)"Do you want to create a detailed file 'analysis'?"
write(6,*)" 1:yes  other:no"
read(5,110)panal
110 format(a1)
C
C
C***** Start Analysis *****
C
write(25,112) lamcho
write(6,112) lamcho
112 format('Starting Analysis of: ',a30)
write(25,*)"Using material system: ",indata
write(6,*)"Using material system: ",indata
write(6,*)
if(panal.eq.'1') then
  write(40,112) lamcho
  write(40,*)"Using material system: ",indata
  write(40,*)
endif
C
do 200 nfmof=f1,f2
C
  jj=1
C
do 200 pangle=theat1,theat2,tstep
if(dothet.eq.'1'.and.ioffax.ne.1) then
do 120 k=1,n
if(nsign.eq.1) then
if(abs(otheat(k)).eq.abs(angvar)) then
if(otheat(k).lt.0.0) then
theat(k)=-1.0*pangle
else
theat(k)=pangle
endif
endif
else
if(otheat(k).eq.angvar) then
theat(k)=pangle
endif
endif
endif
120 continue

```

```

endif
if(dothet.eq.'1'.and.ioffax.eq.1) then
do 135 k=1,n
theat(k)=otheat(k)+pangle
135 continue
endif
C
150 do 200 langle=ang1,ang2,step
temp=langle*pi/180.0
C
if(lodsit.eq.1) then
fmr(1)=dcos(temp)
fmr(2)=dsin(temp)
fmr(3)=0.0
if(abs(langle).eq.90.0) then
fmr(1)=0.0
endif
C
else if(lodsit.eq.2) then
fmr(1)=dcos(temp)
fmr(2)=0.0
fmr(3)=dsin(temp)
if(abs(langle).eq.90.0) then
fmr(1)=0.0
endif
C
else if(lodsit.eq.3) then
fmr(1)=0.0
fmr(2)=dcos(temp)
fmr(3)=dsin(temp)
if(abs(langle).eq.90.0) then
fmr(2)=0.0
endif
C
else if(lodsit.eq.4) then
fmr(1)=0.0
fmr(2)=0.0
fmr(3)=0.0
endif
C
write(25,*)
write(25,130)fmodel(nfmod),rmodel(rmod),langle,pangle
write(25,125)
write(25,*)
125 format(' Ply Mode SigmaXX SigmaYY TauXY',
& 7x,'eXX eYY gXY')
C
if(panal.eq.'1') then
write(40,130)fmodel(nfmod),rmodel(rmod),langle,pangle
write(40,*)
endif
130 format(a15,' w/ ',a26,' Beta:',f7.2,' Theta:',f7.2)
C
call STATUS(nfmod,fmod,theat1,theat2,tstep,ang1,ang2,step,
& pangle,langle)
C
call ANALYS(e1,e2,g12,v12,v21,n,thick,theat,fmr,ststrs,ststrn,
& nfmod,rmod,langle,pangle,intfac,idamge,ismred,mu,guess,mufac,
& xfmr,endstn,alph12,delt,lodsit,thanal)
C
if(panal.eq.'1') then
write(40,*)
write(40,*)"***** End of analysis *****"
write(40,*)"*****"

```

```

        write(40,*)
    endif
C
    do 190 ii=1,3
        dbstrs(nfmod,ii,jj)=xfmr(ii)
        dbstrn(nfmod,ii,jj)=endstrn(ii)
190    continue
        dbang(1,jj)=pangle
        dbang(2,jj)=langle
        jj=jj+1
C
200 continue
C
    call DBASE(dbstrs,dbstrn,dbang,n,thick,jj-1,ststrs)
C
    write(25,*)
    write(40,*)
    write(25,*)"Done!"
    write(6,*)"Done!"
    write(40,*)"Done!"
C
    close(10)
    close(15)
    close(25)
    close(40)
    close(50)
        close(70)
        close(71)
        close(80)
        close(81)
C
    end
C
C-----
C      subroutine DBASE(dbstrs,dbstrn,dbang,n,thick,numel,ststrs)
C-----
C
    double precision dbstrs(6,3,3000),dbang(2,3000),thick
    double precision dbstrn(6,3,3000),ststrs(5),strnth(3)
C
    strnth(1)=ststrs(1)
    strnth(2)=ststrs(3)
    strnth(3)=ststrs(5)
C
    do 10 m=0,1
        write(80+m,*)"blank Theta Beta Hill-Tsai Maximum-Stress ",
        &" Maximum-Strain Tsai-Wu Hashin-Rotem Hashin"
        write(70+m,*)"blank Theta Beta Hill-Tsai Hill-Tsai ",
        &" Hill-Tsai Maximum-Stress Maximum-Stress Maximum-Stress ",
        &" Maximum-Strain Maximum-Strain Maximum-Strain ",
        &" Tsai-Wu Tsai-Wu Tsai-Wu Hashin-Rotem Hashin-Rotem ",
        &" Hashin-Rotem Hashin Hashin Hashin"
10    continue
C
    do 200 k=1,numel
        write(80,100) dbang(1,k),dbang(2,k),
        & (dbstrs(i,1,k)/n/thick,i=1,6)
        write(81,100) dbang(1,k),dbang(2,k),
        & (dbstrn(i,1,k),i=1,6)
        write(70,150) dbang(1,k),dbang(2,k),
        & ((dbstrs(i,j,k)/n/thick,j=1,3),i=1,6)
        write(71,150) dbang(1,k),dbang(2,k),
        & ((dbstrn(i,j,k),j=1,3),i=1,6)
100    format(2f8.2,2x,6f15.5)

```

```

150  format(2f8.2,2x,18f15.5)
200  continue
C
    return
    end

C
C
C-----
subroutine STATUS(nfmod,fmod,theat1,theat2,tstep,ang1,ang2,step,
& pangle,langle)
C-----
C
double precision theat1,theat2,tstep,ang1,ang2,step,pangle,
& langle,percnt,fac1,currnt,dem,num,temp
integer nfmod,fmod

C
    fac1=1.0

C
    if(theat1.ne.theat2) then
        fac1=1+abs(theat1-theat2)/abs(tstep)
        currnt=abs(pangle-theat1)/abs(tstep)
    endif
    if(ang1.ne.ang2) then
        fac1=1+abs(ang1-ang2)/abs(step)
        currnt=abs(langle-ang1)/abs(step)
    endif

C
    if(fmod.eq.7) then
        num=currnt+(nfmod-1)*fac1
        dem=fac1*6.0
    else
        num=currnt
        dem=fac1
    endif

C
    do 200 x=1.0,10.0
        temp=dem/10.0*x
        if(dint(num).eq.dint(temp)) then
            percnt=num/dem*100.0
            write(6,100)percnt
100    format('Percent Complete: % f4.1)
        endif
200    continue

C
    return
    end

C
C-----
subroutine CLPT(e1,e2,g12,v12,v21,n,thick,theat,fmr,strs12,
& strn12,lamstn,a,blow,alph12,delt,lodsit,thanal,thst12,thsn12)
C-----
double precision a(3,3),b(3,3),d(3,3),thick,theat(40),
& fmr(3),e1(40),e2(40),g12(40),v12,v21,pi,temp,q(3,3),qbar(3,3)
double precision tr,c1,c2,c3,c4,q11,q12,q22,q66,s1,s2,
& s3,s4,qq11,qq12,qq22,qq66,qq16,qq26,qt(3,3,40),tm1(3,3,40)
double precision tm2(3,3,40),t(40),z(40),zb(40),h,abd(6,6),
& lamstn(3),strsxy(3,40),strs12(3,40),strn12(3,40),ainv(3,3)
double precision alph12(3),alphxy(3,40),delt,
& thrmst(3),nthrm(3),thstxy(3,40),thst12(3,40),thsn12(3,40)
integer lodsit,thanal
character*1 panal
common panal

C
pi=3.14159265359

```



```

        blow=0.0
C
    do 25 i=1,3
        ntherm(i)=0.0
    25 continue
C
C***** Calculate Thicknesses and Centroids *****
C
    h=n*thick
    z(1)=h/2.
    n1=n+1
    do 50 i=2,n1
        t(i-1)=thick
        z(i)=z(1)-thick*(i-1)
        zb(i-1)=(z(i)+z(i-1))/2.
    50 continue
C
C***** Calculate Q Matrices *****
C
    do 100 k=1,n
C
        v21=e2(k)*v12/e1(k)
        temp=1.0-v12*v21
C
        q11=e1(k)/temp
        q12=e2(k)*v12/temp
        q22=e2(k)/temp
        q66=g12(k)
C
        q(1,1)=q11
        q(1,2)=q12
        q(2,1)=q12
        q(2,2)=q22
        q(3,3)=q66
        q(1,3)=0.0
        q(2,3)=0.0
        q(3,1)=0.0
        q(3,2)=0.0
C
        if(pandl.eq.'2') then
            write(40,55)theat(k)
55         format('Q matrix:',f7.2)
            call PMATRX(q)
            write(40,*)
        endif
C
        tr=theat(k)*pi/180.0
        c1=dcos(tr)
        s1=dsin(tr)
C
        if(abs(theat(k)).eq.90.0) then
            c1=0.0
        endif
C
        c2=c1*c1
        s2=s1*s1
        c3=c1*c2
        s3=s1*s2
        c4=c2*c2
        s4=s2*s2
C
        qq11=q11*c4+2.*(q12+2.*q66)*s2*c2+q22*s4
        qq12=(q11+q22-4.*q66)*s2*c2+q12*(s4+c4)
        qq22=q11*s4+2.*(q12+2.*q66)*s2*c2+q22*c4

```

```

qq16=(q11-q12-2.*q66)*s1*c3+(q12-q22+2.*q66)*s3*c1
qq26=(q11-q12-2.*q66)*s3*c1+(q12-q22+2.*q66)*s1*c3
qq66=(q11+q22-2.*q12-2.*q66)*s2*c2+q66*(s4+c4)
C
qt(1,1,k)=qq11
qt(1,2,k)=qq12
qt(2,1,k)=qq12
qt(1,3,k)=qq16
qt(3,1,k)=qq16
qt(2,2,k)=qq22
qt(2,3,k)=qq26
qt(3,2,k)=qq26
qt(3,3,k)=qq66
C
do 60 i=1,3
do 60 j=1,3
qbar(i,j)=qt(i,j,k)
60 continue
C
if(panal.eq.'1') then
write(40,65)theat(k)
65 format('Qbar matrix:',f7.2)
call PMATRIX(qbar)
write(40,*)
endif
C
***** Form Transformation Matrices *****
C
tm1(1,1,k)=c2
tm1(2,2,k)=c2
tm2(1,1,k)=c2
tm2(2,2,k)=c2
tm1(1,2,k)=s2
tm1(2,1,k)=s2
tm2(1,2,k)=s2
tm2(2,1,k)=s2
tm1(1,3,k)=2.*s1*c1
tm2(3,2,k)=2.*s1*c1
tm2(3,1,k)=-tm1(1,3,k)
tm1(2,3,k)=-tm1(1,3,k)
tm2(1,3,k)=s1*c1
tm1(3,2,k)=s1*c1
tm2(2,3,k)=-tm1(3,2,k)
tm1(3,1,k)=-tm1(3,2,k)
tm2(3,3,k)=c2-s2
tm1(3,3,k)=c2-s2
C
if(abs(theat(k)).eq.45.0) then
tm1(3,3,k)=0.0
tm2(3,3,k)=0.0
endif
C
***** Calculate Nthermal *****
C
alphxy(1,k)=alph12(1)*c2+alph12(2)*s2
alphxy(2,k)=alph12(1)*s2+alph12(2)*c2
alphxy(3,k)=2.0*(alph12(1)-alph12(2))*s1*c1
C
do 75 i=1,3
do 75 j=1,3
ntherm(i)=ntherm(i)+qt(i,j,k)*alphxy(j,k)*t(k)*delt
75 continue
C
100 continue

```

```

C      if(thanal.eq.1) then
C
C      if(panal.eq.'1') then
          write(40,*)"Alpha's in x-y coordinates:"
          write(40,*)" Ply  Alpha x  Alpha y  Alpha xy"
          write(40,*)
          do 110 k=1,n
          write(40,105) theat(k),alphxy(1,k),alphxy(2,k),alphxy(3,k)
105      format(7.1,2x,3e13.4)
110      continue
          endif
C
C      if(panal.eq.'1') then
          write(40,*)
          write(40,*)"Thermal loads:"
          write(40,*)"      Nx      Ny",
&"      Nxy"
          write(40,*)
          write(40,80) ntherm(1),ntherm(2),ntherm(3)
80      format(3f16.2)
          write(40,*)
          endif
C
C      endif
C
C***** Calculate A,B,D Matrices *****
C
C      do 200 i=1,3
          do 200 j=1,3
          a(i,j)=0.0
          b(i,j)=0.0
          d(i,j)=0.0
200      continue
C
C      do 250 i=1,3
          do 250 j=1,3
          do 250 k=1,n
          a(i,j)=a(i,j)+qt(i,j,k)*t(k)
          b(i,j)=b(i,j)+qt(i,j,k)*t(k)*zb(k)
          d(i,j)=d(i,j)+qt(i,j,k)*(t(k)*zb(k)**2+t(k)**3/12.)
250      continue
C
C      call matinv(a,ainv,blow)
          if(blow.eq.1.0) then
          if(panal.eq.'1') then
          write(40,*)"A matrix:"
          call PMATRIX(a)
          write(40,*)
          write(40,*)"The A matrix has become singular:"
          write(40,*)"The laminate is failed by matrix cracking."
          write(40,*)
          endif
          goto 500
          endif
C
C      do 300 i=1,3
          do 300 j=1,3
          ii=i+3
          jj=j+3
          abd(i,j)=a(i,j)
          abd(i,jj)=b(i,j)
          abd(ii,j)=b(i,j)
          abd(ii,jj)=d(i,j)

```

```

300 continue
C
  if(panal.eq.'1') then
    write(40,*)"Effective laminate moduli:"
    write(40,325)"Ex = ",(a(1,1)*a(2,2)-a(1,2)**2)/h/a(2,2)
    write(40,325)"Ey = ",(a(1,1)*a(2,2)-a(1,2)**2)/h/a(1,1)
    write(40,325)"Vxy = ",a(1,2)/a(2,2)
    write(40,325)"Vyx = ",a(1,2)/a(1,1)
    write(40,325)"Gxy = ",a(3,3)/h
325   format(a10,f15.4)
    write(40,*)
  endif
C
  if(panal.eq.'1') then
    write(40,*)"A matrix:"
    call PMATRIX(a)
    write(40,*)
    write(40,*)"A Inverse matrix:"
    call PIMTRX(ainv)
    write(40,*)
    write(40,*)"B matrix:"
    call PMATRIX(b)
    write(40,*)
    write(40,*)"D matrix:"
    call PMATRIX(d)
    write(40,*)
  endif
C
C***** Calculate Laminate Strains (xy) *****
C
  do 350 i=1,3
    lamstn(i)=0.0
    thrmst(i)=0.0
    do 350 j=1,3
      lamstn(i)=lamstn(i)+ainv(i,j)*fmr(j)
      thrmst(i)=thrmst(i)+ainv(i,j)*nthrm(j)
350 continue
C
  if(thanal.eq.1) then
    if(panal.eq.'1') then
      write(40,*)"Effective Laminate Thermal Coefficients:"
      write(40,*)" Alpha x (bar) Alpha y (bar)",
&" Alpha xy (bar)"
      write(40,*)
      write(40,390)thrmst(1)/delt,thrmst(2)/delt,thrmst(3)/delt
390   format(3e17.4)
      write(40,*)
    endif
  endif
C
C***** Calculate Laminar Stresses (x-y) *****
C
  do 400 k=1,n
    do 400 i=1,3
      strsx(i,k)=0.0
      thstxy(i,k)=0.0
      do 400 j=1,3
        strsx(i,k)=strsx(i,k) + lamstn(j)*qt(i,j,k)
        thstxy(i,k)=thstxy(i,k) + qt(i,j,k)*(thrmst(j)-delt*alphxy(j,k))
400 continue
C
C***** Calculate Laminar Stresses and Strains (1-2) *****
C

```

```

do 450 k=1,n
do 450 l=1,3
strs12(l,k)=0.0
strn12(l,k)=0.0
    thst12(l,k)=0.0
    thsn12(l,k)=0.0
do 450 j=1,3
strs12(l,k)=strs12(l,k)+strsxy(j,k)*tm1(l,j,k)
strn12(l,k)=strn12(l,k)+lamstn(j)*tm2(l,j,k)
    thst12(l,k)=thst12(l,k)+thstxy(j,k)*tm1(l,j,k)
    thsn12(l,k)=thsn12(l,k)+thrmst(j)*tm2(l,j,k)
450 continue
C
    if(panal.eq.'1') then
        if(thanal.eq.1) then
            if(lodsit.eq.4) then
                call PHERM(thrmst,thstxy,thst12,thsn12,n,theat)
            else
                call PMECH(lamstn,strsxy,strs12,strn12,n,theat)
                call PHERM(thrmst,thstxy,thst12,thsn12,n,theat)
            endif
        else
            call PMECH(lamstn,strsxy,strs12,strn12,n,theat)
        endif
    endif
C
500 return
end
C
C-----
subroutine ANALYS(ie1,ie2,ig12,v12,iv21,n,thick,theat,ifmr,ststrs,
& ststrn,fmodel,rmodel,langle,pangle,intfac,idamge,ismred,mu,guess,
& mufac,xfmr,endsfn,alph12,delt,lodsit,thanal)
C-----
double precision e1(40),e2(40),g12(40),v12,thick,theat(40),fmr(3),
& ststrs(5),ststrn(5),strs12(3,40),strn12(3,40),v21,iv21,scalar,
$ scalar0,scalar00,fmr0(3),endsfn0(3),endsfn00(3),ratio,theat0
double precision crrat(3,40),ie1(40),scalar,mu,guess,thsn12(3,40),
& ie2(40),ig12(40),ifmr(3),lamstn(3),a(3,3)
double precision endsfn(3),langle,
& pangle,intfac,lt,xfmr(3),alph12(3),delt,thst12(3,40)
integer fmodel,rmodel,fply,pmode(40),pply(40),rtemp,lodsit,
& thanal,fply0
character*1 panal
common panal
C
C***** Set up Data for Subroutine *****
C
    fload=1.0
    nloop=1
    mode=0
    fply=0
    fply0=0
    lt=n*thick
    scalar00=1.0
    scalar0=1.0
C
do 10 j=1,3
fmr(j)=ifmr(j)
fmr0(j)=fmr(j)
endsfn0(j)=0.
endsfn00(j)=0.
10 continue
C

```

```

v21=iv21
C
do 20 j=1,40
  e1(j)=ie1(j)
  e2(j)=ie2(j)
  g12(j)=ig12(j)
20 continue
C
C***** Determine Stresses and Strains *****
C
50 call CLPT(e1,e2,g12,v12,v21,n,thick,theat,fmr, strs12, strn12,
& lamstrn,a,blow,alph12,delt,loadsit,thanal,thst12,thsn12)
C
  if(loadsit.eq.4) then
    mode=5
    goto 666
  endif
C
C***** Check for Unrealistic Strains (singular A) *****
C
  if(blow.eq.1.0) goto 1000
C
C***** Call Failure Criterion *****
C
  pmode(nloop)=mode
  pply(nloop)=fply
C
  if(fmodel.eq.1) then
    call HLTAI(strs12, strn12, ststrs, ststrn, n, fply, mode,
& crrat, scalar, scalar0, theat, thst12, thanal)
  else if(fmodel.eq.2) then
    call MXSTRS(strs12, strn12, ststrs, ststrn, n, fply, mode,
& crrat, scalar, scalar0, theat, thst12, thanal)
  else if(fmodel.eq.3) then
    if(rmodel.eq.4) then
      rtemp=ismred
    else
      rtemp=rmodel
    endif
C
  call MXSTRN(strs12, strn12, ststrs, ststrn, n, fply, mode,
& crrat, scalar, scalar0, theat, nloop,
& pmode, pply, rtemp, thsn12, thanal)
  else if(fmodel.eq.4) then
    call TSAIWU(strs12, strn12, ststrs, ststrn, n, fply, mode,
& crrat, scalar, scalar0, theat, infac, thst12, thanal)
  else if(fmodel.eq.5) then
    call HASROT(strs12, strn12, ststrs, ststrn, n, fply, mode,
& crrat, scalar, scalar0, theat, mufac, mu, guess, thst12, thanal)
  else if(fmodel.eq.6) then
    call HASHIN(strs12, strn12, ststrs, ststrn, n, fply, mode,
& crrat, scalar, scalar0, theat, thst12, thanal)
  endif
C
  pmode(nloop)=mode
  pply(nloop)=fply
C
C***** Call Stiffness Reduction Model *****
C
  if(rmodel.eq.1) then
    call PSMA(e1,e2,g12,fply,theat,n,mode)
  else if(rmodel.eq.2) then
    call PSMB(e1,e2,g12,fply,theat,n,mode)
  else if(rmodel.eq.3) then

```

```

        mode=1
        call SFM(fply,theat,crat,n,scalar)
    endif
250 continue
C
C***** Calculate Strains after Ply Failure *****
C
    do 100 j=1,3
        endstn(j)=lamstn(j)*scalar
    100 continue
C
***** Record the Maximum Loads and Strains *****
C
    if(scalar00.le.1.0.and.scalar0.gt.1.0) then
        write(40,*)
        write(40,*)"***** Stress Redistribution at the Same Loading ****"
        write(40,*)
        theat0=theat(fply0)
        do 333 j=1,3
            fmr0(j)=fmr(j)
            endstn0(j)=endstn00(j)
        333 continue
    endif
C
    scalar00=scalar0
    fply0=fply
    do 444 j=1,3
        endstn00(j)=endstn(j)
    444 continue
C
C***** Increase FMR and Print Info *****
C
    do 300 i=1,3
        fmr(i)=fmr(i)*scalar
        xfmr(i)=fmr(i)
    300 continue
C
C
    call PDATA(theat,fply,mode,fmr,n,thick,endstn)
C
    if(panal.eq.'1') then
        write(40,*)
        write(40,*)"Laminate Strains:"
        write(40,*)"Before ply failure    After ply failure"
        write(40,*)
        write(40,360)lamstn(1),endstn(1)
        write(40,360)lamstn(2),endstn(2)
        write(40,360)lamstn(3),endstn(3)
    360 format(2x,f10.5,15x,f10.5)
        write(40,*)
    endif
C
C***** Check for Fiber Failure/Unidirectional Failure ****
C
    if(rmodel.eq.3) then
        mode=4
        goto 1000
    endif
C
    if(mode.eq.1.or.n.eq.1) then
        goto 1000
    endif
C
    if(idamge.eq.1) then

```

```

    itemp=0
    do 370 j=1,n
    do 365 k=1,nloop
        if(abs(theat(j)).eq.abs(theat(pply(k)))) then
            itemp=itemp+1
        endif
    365 continue
        if(itemp.eq.0) goto 380
        itemp=0
    370 continue
    C
        goto 1000
    endif
    C
    380 continue
        nloop=nloop+1
    C
        if(panal.eq.'1') then
            write(40,*)
            write(40,*)"----- Reduced laminate stiffness... -----"
            write(40,*)
        endif
    C
        goto 50
    C
    C *****
    C
    1000 continue
    C
        ratio=(abs(fmr(1))+abs(fmr(2))+abs(fmr(3)))/
        $ (abs(fmr0(1))+abs(fmr0(2))+abs(fmr0(3)))
        if (ratio.le.1.0) then
            do 111 j=1,3
                endstn(j)=endstn0(j)
    111 continue
        endif
    C
        write(40,*)"$$$$$$$$$$$$$$$$$$$$$$$$$$$$$$$$$$$$$$$$$$$$$$$$$$$$$$$$$$$$"
        write(40,*)"$
        write(40,*)"$ FINAL FAILURE STRAINS "$
        write(40,*)"$
        write(40,*)"$
        write(40,*)"$
        write(40,222)endstn(1)
        write(40,222)endstn(2)
        write(40,222)endstn(3)
        write(40,*)"$
        write(40,*)"$
        write(40,*)"$$$$$$$$$$$$$$$$$$$$$$$$$$$$$$$$$$$$$$$$$$$$$$$$$$$$$$$$$$$$"
    222 format(10x,f10.5)
    C
        call PSBEND(mode,ratio,theat0,endstn)
    C
    666 return
        end
    C
    C-----
    C
    C subroutine HLTSAI(strs12,stm12,ststrs,ststrn,n,fply,mode,
    & crrat,scalar,scalar0,theat,thst12,thanal)
    C-----
    C
    double precision strs12(3,40),stm12(3,40),xx(40),yy(40),
    & ststrs(5),ststrn(5),c1,c2,c3,c4,crrat(3,40),temp,scalar
    double precision theat(40),thst12(3,40),scalar0
    integer fply,mode,thanal
    character*1 panal

```



```

common panel
C
C***** Determine Sign of Strength Constants *****
C
C    call STRNTH(strs12,ststrs,n,xx,yy,theat)
C
C***** Find Critical Ratio and Load *****
C
C    if(panel.eq.'1') then
C      write(40,*)
C      write(40,*)"Hill-Tsai critical ratios:"
C      write(40,*)" Ply      N-critical"
C      write(40,*)
C    endif
C
C    do 100 i=1,n
C      c1=strs12(1,i)/xx(i)
C      c2=strs12(2,i)/yy(i)
C      c3=strs12(2,i)/xx(i)
C      c4=strs12(3,i)/ststrs(5)
C      crrat(1,i)=dsqrt(1.0/(c1**2+c2**2-c1*c3+c4**2))
C      if(panel.eq.'1') write(40,50)theat(i),crrat(1,i)
50    format(f7.2,2x,f20.6)
100  continue
C
C    fply=1
C    temp=crrat(1,1)
C    do 150 i=1,n
C      if(crrat(1,i).lt.temp) then
C        temp=crrat(1,i)
C        fply=i
C      endif
150  continue
C
C    if(crrat(1,fply).lt.1.0) then
C      scalar0=1./crrat(1,fply)
C      crrat(1,fply)=1.0
C    endif
C    scalar=crrat(1,fply)
C
C***** Find Mode of Failure *****
C
C    do 200 k=1,3
C      strs12(k,fply)=strs12(k,fply)*scalar
200  continue
C
C    c1=strs12(1,fply)/xx(fply)
C    c2=strs12(2,fply)/yy(fply)
C    c3=abs(strs12(3,fply)/ststrs(5))
C    mode=1
C    if(c2.gt.c1 .and. c2.gt.c3) then
C      mode=2
C    endif
C    if(c3.gt.c1 .and. c3.gt.c2) then
C      mode=3
C    endif
C
C    if(panel.eq.'1') then
C      write(40,*)
C      write(40,*)"Critical ply strength ratios:"
C      write(40,*)"      Fiber      Transverse",
C      &"      Shear"
C      write(40,*)
C      write(40,250)c1,c2,c3

```

```

250 format(3f14.4)
   write(40,*)
   endif
C
   return
   end
C
-----
C
subroutine MXSTRS(strs12, strn12, ststrs, ststrn, n, fply, mode,
& crrat, scalar, scalar0, theat, thst12, thanal)
C
-----
C
double precision strs12(3,40), strn12(3,40), xx(40), yy(40),
& ststrs(5), ststrn(5), crrat(3,40), temp, scalar, theat(40)
double precision thst12(3,40), scalar0
integer fply, mode, thanal
character*1 panal
common panal
C
C***** Determine Sign of Strength Constants *****
C
call STRNTH(strs12, ststrs, n, xx, yy, theat)
C
C***** Find Critical Ratio, Load, Ply, and Mode *****
C
if(panal.eq.'1') then
write(40,*)
write(40,*)"Maximum Stress critical ratios:"
write(40,*)" Ply      Fiber      Transverse",
&"      Shear"
write(40,*)
endif
C
do 100 i=1, n
crrat(1,i)=strs12(1,i)/xx(i)
crrat(2,i)=strs12(2,i)/yy(i)
crrat(3,i)=abs(strs12(3,i))/ststrs(5)
if(panal.eq.'1') write(40,50) theat(i), crrat(1,i), crrat(2,i),
& crrat(3,i)
50 format(f7.2,2x,3f15.8)
100 continue
C
temp=crrat(1,1)
fply=1
mode=1
do 200 i=1, n
do 200 j=1, 3
if (crrat(j,i).gt.temp) then
temp=crrat(j,i)
fply=i
mode=j
endif
200 continue
C
if(crrat(mode, fply).gt.1.0) then
scalar0=crrat(mode, fply)
crrat(mode, fply)=1.0
endif
crrat(mode, fply)=1.0/crrat(mode, fply)
scalar=crrat(mode, fply)
C
if(panal.eq.'1') write(40,*)
return
end

```

```

C
C-----
C      subroutine MXSTRN(strs12,strn12,ststrs,ststrn,n,fply,mode,
C      & crrat,scalar,scalar0,theat,nloop,pmode,pply,redmod,thsn1
C-----
C
C      double precision strs12(3,40),strn12(3,40),xx(40),yy(40),
C      & ststrs(5),ststrn(5),crrat(3,40),temp,scalar,theat(40),
C      & thsn12(3,40),scalar0
C      integer fply,mode,pmode(40),pply(40),redmod,thanal
C      character*1 panal
C      common panal
C
C***** Determine Sign of Strength Constants *****
C
C      call STRNTH(strn12,ststrn,n,xx,yy,theat)
C
C***** Find Critical Ratio,Load,Ply,and Mode *****
C
C      if(panal.eq.'1') then
C      write(40,*)
C      write(40,*)"Maximum Strain critical ratios:"
C      write(40,*)" Ply      Fiber      Transverse",
C      &"      Shear"
C      write(40,*)
C      endif
C
C      do 100 i=1,n
C      crrat(1,i)=strn12(1,i)/xx(i)
C      crrat(2,i)=strn12(2,i)/yy(i)
C      crrat(3,i)=abs(strn12(3,i))/ststrn(5)
C      if(panal.eq.'1') write(40,50) theat(i),crrat(1,i),crrat(2,i),
C      & crrat(3,i)
C      50 format(f7.2,2x,3f15.8)
C      100 continue
C
C      temp=0.0
C      fply=1
C      mode=1
C      do 200 i=1,n
C      do 200 j=1,3
C      do 150 k=1,nloop
C      if (theat(i).eq.theat(pply(k)).and.pmode(k).ne.0) then
C      if(j.ne.1) then
C      if(redmod.eq.2.and.pmode(k).eq.2) then
C      crrat(2,i)=0.0
C      else
C      crrat(2,i)=0.0
C      crrat(3,i)=0.0
C      endif
C      endif
C      endif
C      150 continue
C
C      if (crrat(j,i).gt.temp) then
C      temp=crrat(j,i)
C      fply=i
C      mode=j
C      endif
C      200 continue
C
C      if(panal.eq.'1') then
C      do 300 i=1,n
C      write(40,50) theat(i),crrat(1,i),crrat(2,i),

```

```

& crrat(3,i)
300 continue
write(40,*)
endif
C
if(crrat(mode,fply).gt.1.0) then
  scalar0=crrat(mode,fply)
  crrat(mode,fply)=1.0
endif
crrat(mode,fply)=1.0/crrat(mode,fply)
scalar=crrat(mode,fply)
C
return
end
C
-----
C-----
subroutine TSAIWU(strs12,strn12,ststrs,ststrn,n,fply,mode,
& crrat,scalar,scalar0,theat,intfac,thst12,thanal)
C-----
C
double precision strs12(3,40),strn12(3,40),xx(40),yy(40),
& ststrs(5),ststrn(5),crrat(3,40),temp,scalar,theat(40)
double precision f1,f2,f11,f22,f12,f66,c1,c2,c3,c4,c5,c6,
& a,b,c,prod,intfac,thst12(3,40),scalar0
integer fply,mode,thanal
character*1 panal
common panal
C
C***** Find Critical Ratio and Load *****
C
if(panal.eq.'1') then
write(40,*)
write(40,10)intfac
10 format('Interaction factor = ',f6.3)
write(40,*)
write(40,*)"Tsal-Wu critical ratios:"
write(40,*)" Ply N-critical"
write(40,*)
endif
C
f1=1.0/ststrs(1) + 1.0/ststrs(2)
f2=1.0/ststrs(3) + 1.0/ststrs(4)
f11=1.0/ststrs(1)/ststrs(2)
f22=-1.0/ststrs(3)/ststrs(4)
f12=intfac/ststrs(1)/ststrs(2)
f66=1.0/ststrs(5)**2
C
do 100 i=1,n
C
c1=f1*strs12(1,i)
c2=f2*strs12(2,i)
c3=f11*strs12(1,i)**2
c4=f22*strs12(2,i)**2
c5=2.0*f12*strs12(1,i)*strs12(2,i)
c6=f66*strs12(3,i)**2
C
a=1.0
b=(c1+c2)/(c3+c4+c5+c6)
c=-1.0/(c3+c4+c5+c6)
prod=b*b-4.0*a*c
crrat(1,i)=(-b+dsqrt(prod))/2/a
if(panal.eq.'1') write(40,50)theat(i),crrat(1,i)
50 format(f7.2,2x,f20.6)

```

```

C
100 continue
C
  fply=1
  temp=crrat(1,1)
  do 150 i=1,n
    if(crrat(1,i).lt.temp) then
      temp=crrat(1,i)
      fply=i
    endif
  150 continue
C
  if(crrat(1,fply).lt.1.0) then
    scalar0=1./crrat(1,fply)
    crrat(1,fply)=1.0
  endif
  scalar=crrat(1,fply)
C
C***** Determine Sign of Strength Constants *****
C
  call STRNTH(strs12,ststrs,n,xx,yy,theat)
C
C***** Find Mode of Failure *****
C
  do 200 k=1,3
    strs12(k,fply)=strs12(k,fply)*scalar
  200 continue
C
  c1=strs12(1,fply)/xx(fply)
  c2=strs12(2,fply)/yy(fply)
  c3=abs(strs12(3,fply)/ststrs(5))
  mode=1
  if(c2.gt.c1 .and. c2.gt.c3) then
    mode=2
  endif
  if(c3.gt.c1 .and. c3.gt.c2) then
    mode=3
  endif
C
  if(panal.eq.'1') then
    write(40,*)
    write(40,*)"Critical ply strength ratios:"
    write(40,*)"  Fiber  Transverse",
    &"  Shear"
    write(40,*)
    write(40,250)c1,c2,c3
  250 format(3f14.4)
  write(40,*)
  endif
C
  return
  end
C
C-----
C
  subroutine HASROT(strs12,strn12,ststrs,ststrn,n,fply,mode,
    & crrat,scalar,scalar0,theat,mufac,mu,guess,thst12,thanal)
C-----
C
  double precision strs12(3,40),strn12(3,40),xx(40),yy(40),
    & ststrs(5),ststrn(5),c1,c2,crrat(3,40),temp,scalar,scalar0
  double precision theat(40),mu,sol,guess,thst12(3,40)
  integer fply,mode,mufac,thanal
  character*1 panal
  common panal

```

```

C
C***** Determine Sign of Strength Constants *****
C
  call STRNTH(strs12,ststrs,n,xx,yy,theat)
C
C***** Find Critical Ratio and Load *****
C
  if(panal.eq.'1') then
    write(40,*)
    write(40,*)"Hashin-Rotem critical ratios:"
    write(40,*)" Ply      Fiber      Matrix"
    write(40,*)
  endif
C
  do 100 i=1,n
    crrat(1,i)=strs12(1,i)/xx(i)
    if(muufac.ne.1.or.strs12(2,i).ge.0.0) then
      c1=strs12(2,i)/yy(i)
      c2=abs(strs12(3,i)/ststrs(5))
      crrat(2,i)=dsqrt(c1**2+c2**2)
      crrat(3,i)=crrat(2,i)
    else
      call NEWTON(strs12(2,i),strs12(3,i),mu,ststrs(5),yy(i),
& guess,sol)
      crrat(2,i)=1.0/sol
    endif
C
  if(panal.eq.'1') write(40,50) theat(i),crrat(1,i),crrat(2,i)
50  format(f7.2,2x,2f15.8)
100 continue
C
  temp=crrat(1,1)
  fply=1
  mode=1
  do 150 i=1,n
    do 150 j=1,2
      if (crrat(j,i).gt.temp) then
        temp=crrat(j,i)
        fply=i
        mode=j
      endif
150 continue
C
  if(crrat(mode,fply).gt.1.0) then
    scalar0=crrat(mode,fply)
    crrat(mode,fply)=1.0
  endif
  crrat(mode,fply)=1.0/crrat(mode,fply)
  scalar=crrat(mode,fply)
C
C***** Find Mode of Failure *****
C
  do 200 k=1,3
    strs12(k,fply)=strs12(k,fply)*scalar
200 continue
C
  c1=strs12(1,fply)/xx(fply)
  c2=strs12(2,fply)/yy(fply)
  c3=abs(strs12(3,fply)/ststrs(5))
C
  if(mode.eq.2) then
    if(c3.gt.c2) mode=3
  endif
C

```

```

    if(panal.eq.'1') then
    write(40,*)
      write(40,*)"Critical ply strength ratios:"
      write(40,*)"  Fiber  Transverse",
    &"  Shear"
      write(40,*)
    write(40,250)c1,c2,c3
250 format(3f14.4)
    write(40,*)
    endif
C
    return
    end
C
-----
    subroutine HASHIN(strs12, strn12, ststrs, ststrn, n, fpoly, mode,
    & crrat, scalar, scalar0, theat, thst12, thanal)
C
-----
C
    double precision strs12(3,40), strn12(3,40), xx(40), yy(40),
    & ststrs(5), ststrn(5), c1, c2, c3, crrat(3,40), temp, scalar, scalar0
    double precision theat(40), thst12(3,40)
    integer fpoly, mode, thanal
    character*1 panal
    common panal
C
C***** Determine Sign of Strength Constants *****
C
    call STRNTH(strs12, ststrs, n, xx, yy, theat)
C
C***** Find Critical Ratio and Load *****
C
    if(panal.eq.'1') then
    write(40,*)
    write(40,*)"Hashin critical ratios:"
      write(40,*)" Ply      Fiber      Matrix"
    write(40,*)
    endif
C
    do 100 i=1, n
    c1=strs12(1,i)/xx(i)
    c2=strs12(2,i)/yy(i)
    c3=abs(strs12(3,i)/ststrs(5))
C
      if(strs12(1,i).gt.0.0) then
        crrat(1,i)=dsqrt(c1**2+c3**2)
      else
        crrat(1,i)=c1
      endif
C
    crrat(2,i)=dsqrt(c2**2+c3**2)
C
    if(panal.eq.'1') write(40,50) theat(i), crrat(1,i), crrat(2,i)
50 format(f7.2,2x,2f15.8)
100 continue
C
    temp=crrat(1,1)
    fpoly=1
    mode=1
    do 150 i=1, n
    do 150 j=1, 2
    if (crrat(j,i).gt.temp) then
      temp=crrat(j,i)
      fpoly=i

```

```

        mode=j
    endif
150 continue
C
    if(crrat(mode,fply).gt.1.0) then
        scalar0=crrat(mode,fply)
        crrat(mode,fply)=1.0
    endif
    crrat(mode,fply)=1.0/crrat(mode,fply)
    scalar=crrat(mode,fply)
C
C***** Find Mode of Failure *****
C
    do 200 k=1,3
        strsl2(k,fply)=strsl2(k,fply)*scalar
200 continue
C
    c1=strsl2(1,fply)/xx(fply)
    c2=strsl2(2,fply)/yy(fply)
    c3=abs(strsl2(3,fply)/ststrs(5))
C
    if(mode.eq.1) then
        if(c3.gt.c1) mode=3
    endif
    if(mode.eq.2) then
        if(c3.gt.c2) mode=3
    endif
C
    if(panal.eq.'1') then
        write(40,*)
        write(40,*)"Critical ply strength ratios:"
        write(40,*)"      Fiber      Transverse",
        &"      Shear"
        write(40,*)
        write(40,250)c1,c2,c3
250 format(3f14.4)
        write(40,*)
    endif
C
    return
    end
C
C-----
C      subroutine STRNTH(value,stren,n,xx,yy,theat)
C-----
    double precision value(3,40),stren(5),xx(40),yy(40),theat(40)
    character*1 panal
    common panal
C
    do 100 i=1,n
C
    if(value(1,i).gt.0.0) then
        xx(i)=stren(1)
    else
        xx(i)=stren(2)
    endif
C
    if(value(2,i).gt.0.0) then
        yy(i)=stren(3)
    else
        yy(i)=stren(4)
    endif
C
100 continue

```



```

C
  return
  end
C
-----
C
  subroutine PSMA(e1,e2,g12,fply,theat,n,mode)
C
  double precision e1(40),e2(40),g12(40),theat(40)
  integer fply,mode
C
  do 100 k=1,n
C
  if(abs(theat(fply)).eq.abs(theat(k))) then
    if(theat(fply).eq.theat(k)) then
      e2(k)=0.01*e2(k)
      g12(k)=0.01*g12(k)
    endif
  100 continue
C
  return
  end
C
-----
C
  subroutine PSMB(e1,e2,g12,fply,theat,n,mode)
C
  double precision e1(40),e2(40),g12(40),theat(40)
  integer fply,mode
C
  do 100 k=1,n
C
  if(abs(theat(fply)).eq.abs(theat(k))) then
    if(theat(fply).eq.theat(k)) then
      if(mode.eq.3) then
        e2(k)=0.01*e2(k)
        g12(k)=0.01*g12(k)
      else
        e2(k)=0.01*e2(k)
      endif
    endif
  100 continue
C
  return
  end
C
-----
C
  subroutine SFM(fply,theat,crrat,n,scalar)
C
  double precision theat(40),crrat(3,40),temp,scalar
  integer fply
C
  temp=crrat(1,1)
  fply=1
  do 100 i=1,n
  write(40,*)crrat(1,i),temp,fply
  if(crrat(1,i).gt.temp) then
    temp=crrat(1,i)
    fply=i
  endif
  100 continue
C
  scalar=temp
  if(scalar.lt.1.0) then
    scalar=1.0/scalar
  endif
C

```

```

return
end
C-----
C  subroutine PSBEND(mode,ratio,theat0,endstn)
C-----
C
C      double precision endstn(3),ratio,theat0
C      integer mode
C      if(ratio.le.1.0) then
C          write(25,5)theat0
5          format('*** The failure of ',F6.1,' deg ply is catastrophic!')
C          write(25,*)"*** FINAL FAILURE STRAINS: "
C          write(25,10)(endstn(i), i=1,3)
10         format(51x,3f9.4)
C      else if(mode.eq.1) then
C          write(25,*)"Fiber Failure"
C      else if(mode.eq.5) then
C          write(25,*)"Only Thermal Stresses Calculated - No Failure",
C          &" Analysis Performed"
C      else if(mode.eq.4) then
C          write(25,*)"Sudden Failure"
C      else if(mode.eq.2.or.mode.eq.3) then
C          write(25,*)"Matrix Failure"
C      else
C          write(25,*)"Infinite Loop or Error Occurred"
C      endif
C
C      return
C      end
C-----
C  subroutine PDATA(theat,fply,mode,fmr,n,thick,endstn)
C-----
C
C      double precision theat(40),fmr(3),thick,endstn(3)
C      integer fply,mode
C      character*1 panal
C      common panal
C
C
C          write(25,10) theat(fply),mode,fmr(1)/n/thick,fmr(2)/n/thick,
C          & fmr(3)/n/thick,(endstn(i), i=1,3)
10         format(f7.2,i4,2x,3f12.1,2x,3f9.4)
C
C      if(panal.eq.'1') then
C          write(40,*)"Ply Failure:"
C          write(40,*)" Ply Mode      N(xy)   Sigma(xy)"
C          write(40,*)
C          write(40,20) theat(fply),mode,fmr(1),fmr(1)/n/thick
C          write(40,30) fmr(2),fmr(2)/n/thick
C          write(40,30) fmr(3),fmr(3)/n/thick
20         format(f7.2,i4,2x,2f12.1)
30         format(13x,2f12.1)
C      endif
C
C      return
C      end
C-----
C  subroutine PMATRIX(m)
C-----
C
C      double precision m(3,3)
C

```

```

        write(40,10)m(1,1),m(1,2),m(1,3)
        write(40,10)m(2,1),m(2,2),m(2,3)
        write(40,10)m(3,1),m(3,2),m(3,3)
10    format(17x,3f20.4)
C
    return
    end
C
C-----
    subroutine PIMTRX(m)
C-----
C
    double precision m(3,3)
C
    write(40,10)m(1,1),m(1,2),m(1,3)
    write(40,10)m(2,1),m(2,2),m(2,3)
    write(40,10)m(3,1),m(3,2),m(3,3)
10    format(15x,3f20.10)
C
    return
    end
C
C-----
    subroutine PMECH(lamstn, strsx, str12, strn12, n, theat)
C-----
C
    double precision lamstn(3), strsx(3,40), str12(3,40),
    & strn12(3,40), theat(40)
C
    write(40,*)
    write(40,*)"Mechanical Stresses and Strains on each ply:"
    write(40,*)" Ply   Strain(xy) Strain(12) ",
    &" Stress(xy) Stress(12)"
    do 100 i=1,n
        write(40,*)
        do 100 j=1,3
            write(40,10)theat(i), lamstn(j), str12(j,i), strsx(j,i), strn12(j,i)
10        format(f7.2,2x,2f12.7,3x,2f15.3)
100    continue
C
200    return
    end
C
C-----
    subroutine PHERM(thrmst, thstxy, thst12, thsn12, n, theat)
C-----
C
    double precision thrmst(3), thstxy(3,40), thst12(3,40),
    & thsn12(3,40), theat(40)
C
    write(40,*)
    write(40,*)"Thermal Stresses and Strains on each ply:"
    write(40,*)" Ply   Strain(xy) Strain(12) ",
    &" Stress(xy) Stress(12)"
    do 100 i=1,n
        write(40,*)
        do 100 j=1,3
            write(40,10)theat(i), thrmst(j), thsn12(j,i), thstxy(j,i), thst12(j,i)
10        format(f7.2,2x,2f12.7,3x,2f15.3)
100    continue
C
200    return
    end
C

```

```

C-----
subroutine MATINV(a,ai,blow)
C-----
C
double precision a(3,3),ai(3,3),deta
C
deta = a(1,1)*( a(2,2)*a(3,3)-a(2,3)*a(3,2) )
# - a(1,2)*( a(2,1)*a(3,3)-a(2,3)*a(3,1) )
# + a(1,3)*( a(2,1)*a(3,2)-a(2,2)*a(3,1) )
C
write(40,*)"deta=",deta
if(abs(deta).lt.1000) then
blow=1.0
goto 100
endif
C
deta=1.0/deta
ai(1,1) = (a(2,2)*a(3,3) - a(2,3)*a(3,2))*deta
ai(1,2) = -(a(2,1)*a(3,3) - a(3,1)*a(2,3))*deta
ai(1,3) = (a(2,1)*a(3,2) - a(2,2)*a(3,1))*deta
C
ai(2,1) = -(a(1,2)*a(3,3) - a(1,3)*a(3,2))*deta
ai(2,2) = (a(1,1)*a(3,3) - a(1,3)*a(3,1))*deta
ai(2,3) = -(a(1,1)*a(3,2) - a(1,2)*a(3,1))*deta
C
ai(3,1) = (a(1,2)*a(2,3) - a(2,2)*a(1,3))*deta
C
ai(3,2) = -(a(1,1)*a(2,3) - a(2,1)*a(1,3))*deta
ai(3,3) = (a(1,1)*a(2,2) - a(1,2)*a(2,1))*deta
ai(2,1) = ai(1,2)
ai(3,1) = ai(1,3)
ai(3,2) = ai(2,3)
C
100 return
end
C
C-----
subroutine CHOLAM(n,theat,lamcho)
C-----
C
double precision theat(40),theata(20,40)
character*30 lamtyp(20),lamcho
integer choice,nplys(20)
C
read(50,*)nlams
C
do 200 j=1,nlams
read(50,*)nplys(j)
do 100 i=1,nplys(j)+1
if(i.eq.1) then
read(50,10)lamtyp(j)
10 format(a30)
else
read(50,*)theata(j,i-1)
endif
100 continue
200 continue
C
write(6,*)"Enter # of laminate/ply choice..."
do 300 j=1,nlams
write(6,250)j,lamtyp(j)
250 format(i3,': ',a30)
300 continue
C
read(5,*)choice
n=nplys(choice)
lamcho=lamtyp(choice)

```

```

C
do 400 k=1,n
  theat(k)=theata(choice,k)
400 continue
C
  return
  end
C
C-----
  subroutine NEWTON(sig22,tau,mu,S,Y,guess,sol)
C-----
C
  double precision sig22,tau,mu,S,Y,sol,a,b,c,d,g,num,dem,ans,
& del,guess
C
  a=mu**2*sig22**4/Y**2
  b=-2.0*S*mu*sig22**3/Y**2
  c=S**2*sig22**2/Y**2+tau**2-mu**2*sig22**2
  d=2.0*S*mu*sig22
C
  g=guess
  ans=0.0
  del=g-ans
C
  do 100 i=1,50
    num=a*g**4+b*g**3+c*g**2+d*g-S**2
    dem=4*a*g**3+3*b*g**2+2*c*g+d
    ans=g-num/dem
    del=g-ans
    g=ans
    if(abs(del).lt.0.01) goto 150
  100 continue
C
  150 sol=ans
C
  return
  end
C

```