

# **Designing Sidewalks and Trails for Access**

## **Part I of II: Review of Existing Guidelines and Practices**

### **Program Manager:**

Barbara McMillen

### **Authors:**

*Beneficial Designs, Inc.*

Peter W. Axelson, M.S.M.E., A.T.P.

Denise A. Chesney, M.E., B.M.E.

Dorothy V. Galvan

Julie B. Kirschbaum, B.A.

Patricia E. Longmuir, M.S.C.

Camille Lyons, B.A.

Kathleen M. Wong, B.A.

### **Illustrations:**

Matthew J. Boisseau, B.S.

Clay Butler

### **Date:**

July 1999

---

## Notice:

This document is disseminated under the sponsorship of the U.S. Department of Transportation in the interest of information exchange. The United States Government assumes no liability for its contents or use thereof.

The contents of this report reflect the views of the contractor, who is responsible for the accuracy of the data presented herein. The contents do not necessarily reflect the official policy of the Department of Transportation.

This report does not constitute a standard, specification, or regulation. The United States Government does not endorse products or manufacturers. Trade or manufacturers' names appear herein only because they are considered essential to the object of this document.

---

### **Designing Sidewalks and Trails for Access**

#### **Part I of II: Review of Existing Guidelines and Practices**

**Acknowledgement:** *Julie Kirschbaum was the project coordinator for this report, and for the last two years, has focused on the development of this document.*

# Table of Contents

<i>List of Figures</i> .....	v
<i>List of Tables</i> .....	ix
<i>Introduction</i> .....	xi
<b>1. Disability Rights Legislation and Accessibility Guidelines and Standards in the United States</b> .....	<b>1</b>
1.1 Accessibility Legislation and Access Design Standards Prior to the ADA .....	1
1.1.1 American National Standards Institute (ANSI) A117.1 .....	1
1.1.2 The Architectural Barriers Act (ABA) .....	2
1.1.3 The Rehabilitation Act .....	3
1.2 The Americans with Disabilities Act (ADA) .....	4
1.2.1 Americans with Disabilities Act Accessibility Guidelines (ADAAG) .....	4
1.2.2 Implementing Regulations for Title II and Title III .....	5
1.2.3 ADA Regulations that Apply to Public Entities .....	6
1.2.4 ADA Regulations for Places of Public Accommodation and Commercial Facilities .....	6
1.3 Accessibility Guidelines, Requirements, and Standards for Sidewalks and Trails .....	8
1.3.1 Sidewalks .....	8
1.3.2 Trails .....	9
1.3.3 Access to Wilderness Areas .....	10
1.4 Conclusion .....	11
<b>2. Characteristics of Pedestrians</b> .....	<b>13</b>
2.1 Older Adults .....	14
2.1.1 Safety .....	14
2.1.2 Ambulation .....	15
2.1.3 Object Manipulation .....	15
2.1.4 Visual and Cognitive Processing .....	15
2.2 Children .....	15
2.3 People with Disabilities .....	16
2.3.1 People with Mobility Impairments .....	16
2.3.1.1 Wheelchair and scooter users .....	16
2.3.1.2 Walking-aid users .....	19

2.3.1.3	Prosthesis users .....	20
2.3.2	People with Sensory Impairments .....	20
2.3.2.1	People with visual impairments .....	21
2.3.2.2	People with hearing impairments .....	23
2.3.3	People with Cognitive Impairments .....	23
2.4	Conclusion .....	23
<b>3</b>	<b>Summary of the Planning Process .....</b>	<b>25</b>
3.1	Intermodal Surface Transportation Efficiency Act and Transportation Equity Act for the 21st Century .....	25
3.2	Building a Multi- and Intermodal System .....	25
3.3	Federal Transportation Funding Opportunities .....	26
3.4	Planning under Federal Transportation Legislation .....	27
3.5	Transportation Agencies .....	27
3.6	Land Management Agencies .....	28
3.7	Pedestrian/Bicycle Coordinators .....	28
3.8	Other Transportation Planning Participants .....	28
3.9	Strategies for Public Involvement .....	29
3.10	Community Impact Assessment .....	30
3.11	Conclusion .....	30
<b>4</b>	<b>Sidewalk Design Guidelines and Existing Practices .....</b>	<b>31</b>
4.1	Location Research .....	31
4.2	Design Guideline Comparisons .....	32
4.3	Access Characteristics .....	32
4.3.1	Grade .....	32
4.3.2	Cross-Slope .....	35
4.3.3	Width .....	36
4.3.4	Passing Space and Passing Space Interval .....	38
4.3.5	Vertical Clearance .....	38
4.3.6	Changes in Level .....	39
4.3.7	Grates and Gaps .....	39
4.3.8	Obstacles and Protruding Objects .....	40
4.3.9	Surface .....	41
4.4	Sidewalk Elements .....	41
4.4.1	Curb Ramps .....	41

4.4.1.1	Curb ramp components .....	42
4.4.1.2	Curb ramp specifications .....	42
4.4.1.3	Curb ramp types .....	44
4.4.1.4	Curb ramp placement .....	46
4.4.1.5	Curb ramps and people with visual impairments .....	48
4.4.2	Conveying Information to Pedestrians with Visual Impairments .....	48
4.4.2.1	Raised tactile surfaces used as detectable warnings .....	50
4.4.2.2	Raised tactile surfaces used for wayfinding .....	51
4.4.2.3	Materials with contrasting sound properties .....	52
4.4.2.4	Grooves .....	52
4.4.2.5	Contrasting colors for people with low vision .....	52
4.4.2.6	Audible and vibrotactile pedestrian signals .....	53
4.4.2.7	ADAAG requirements for detectable warnings .....	54
4.4.3	Driveway Crossings .....	55
4.4.4	Medians and Islands .....	57
4.4.5	Crosswalks .....	57
4.4.6	Crossing Times .....	59
4.4.7	Pedestrian-Actuated Traffic Controls .....	59
4.4.8	Midblock Crossings .....	60
4.4.9	Sight Distances .....	61
4.4.10	Grade-Separated Crossings .....	62
4.4.11	Roadway Design .....	63
4.4.12	Drainage .....	64
4.4.13	Building Design .....	65
4.4.14	Maintenance .....	66
4.4.15	Signs .....	68
4.5	Conclusion .....	69
<b>5.</b>	<b>Trail Design for Access .....</b>	<b>75</b>
5.1	Universal Trail-Assessment Process .....	75
5.2	Design Guideline Comparisons .....	75
5.3	Trail Types .....	76
5.4	Access Characteristics .....	77
5.4.1	Grade .....	77
5.4.2	Rest Areas .....	79

5.4.3	Cross-Slope .....	79
5.4.4	Width .....	80
5.4.5	Passing Space .....	81
5.4.6	Changes in Level .....	81
5.4.7	Vertical Clearance .....	82
5.4.8	Surface .....	82
5.4.9	Trail Information .....	83
5.4.10	Maintenance .....	84
5.5	Design Conflicts .....	85
5.5.1	Trail Elements .....	85
5.5.2	Built Facilities Along Trails .....	85
5.5.3	Designing Trail Amenities for Multiple User Groups .....	86
5.5.4	Drainage Control Measures and Access .....	86
5.5.5	Complying with Design Standards .....	87
5.5.6	Difficulty Ratings for Trails .....	87
5.6	User Conflicts .....	87
5.6.1	Experience Level .....	87
5.6.2	Expectations .....	88
5.6.3	Conflicts Among User Groups .....	88
5.6.3.1	Technology differences .....	88
5.6.3.2	Movement patterns .....	88
5.6.3.3	Perceived environmental impact .....	89
5.6.3.4	New and newly popularized sports .....	89
5.6.4	Lack of Communication Among Trail Users .....	89
5.6.5	Number of Users .....	90
5.6.6	Minimizing User Conflicts on Trails .....	90
5.7	Conclusion .....	91
<b>Appendix A: Abbreviations and Acronyms .....</b>		<b>111</b>
<b>Appendix B: Glossary .....</b>		<b>113</b>
<b>Appendix C: Bibliography .....</b>		<b>121</b>

# List of Figures

Figure 2-1: Wheelchair and scooter dimensions (in mm) (based on Architecture and Engineering for Parks Canada and Public Works and Government Services Canada, 1994). .....	17
Figure 2-2: Circle diameter of a standard manual wheelchair [ADAAG, Figure 4.3(a), U.S. Access Board, 1991]. .....	17
Figure 2-3: High and low side-reach limits (Barrier Free Environments, Inc., 1996). .....	18
Figure 2-4: Maximum side-reach over an obstruction [ADAAG, Figure 4.6(c), U.S. Access Board, 1991]. .....	18
Figure 2-5: High and low forward-reach limits (Barrier Free Environments, Inc., 1996). .....	18
Figure 2-6: Maximum forward-reach over an obstruction (PLAE, Inc., 1993). .....	19
Figure 3-1: Sources of input during the project development process (based on FHWA, 1997a). .....	29
Figure 4-1: Maximum grades can make a sidewalk difficult to traverse, even if the overall running grade is moderate. ....	33
Figure 4-2: The gutter slopes counter to the slope of the curb ramp to promote drainage. ....	33
Figure 4-3: Excessive slope differences between gutter and ramp can cause a wheelchair to tip forward. ....	34
Figure 4-4: Excessive slope differences between a gutter and a ramp can cause wheelchairs to flip over backward. ....	34
Figure 4-5: Ramps must have level landings (based on ADAAG Figure 16, U.S. Access Board, 1991). ....	35
Figure 4-6: When cross-slopes change rapidly over a short distance, wheelchair use becomes extremely unstable. ....	36
Figure 4-7: Most pedestrians prefer to travel in the center of the sidewalk. ....	37
Figure 4-8: Passing spaces should be included at intervals on narrow sidewalks to allow wheelchair users to pass one another. ....	38
Figure 4-9: Wheelchair users require 1.525 m x 1.525 m (60 in x 60 in) to maneuver in a complete circle. ....	38
Figure 4-10: Changes in level are often caused by tree roots that break through the sidewalk surface. ....	39
Figure 4-11: Vertical and beveled changes in level [ADAAG, Figure 7(c, d), U.S. Access Board, 1991]. ....	39
Figure 4-12: Wheelchair casters and cane and crutch tips can easily get caught in wide grates. ....	39

Figure 4-13: Obstacles mounted on posts should not protrude more than 0.305 m (12 in) into a circulation corridor [ADAAG, Figure 8(d), U.S. Access Board, 1991].	40
Figure 4-14: Components of a curb ramp.	42
Figure 4-15: Alternative slope profiles for alterations when an 8.33 percent slope is not achievable.	42
Figure 4-16: This wheelchair user is maneuvering successfully at a curb ramp because a level landing is provided.	43
Figure 4-17: This wheelchair user will have difficulty entering the sidewalk because the curb ramp lacks a landing.	43
Figure 4-18: This wheelchair user will have difficulty traveling around the corner because the curb ramp lacks a landing.	43
Figure 4-19: Flares provide a sloped transition between the ramp and the surrounding sidewalk and are designed to prevent ambulatory pedestrians from tripping.	44
Figure 4-20: Returned curbs may be used when the curb ramp is located outside the pedestrian walkway, such as in a planting strip.	44
Figure 4-21: Without level landings, perpendicular curb ramps are problematic for wheelchair users and others to travel across.	44
Figure 4-22: Two perpendicular curb ramps with level landings maximize access for pedestrians at intersections.	45
Figure 4-23: If diagonal curb ramps are installed, a 1.220-m (48-in) clear space should be provided to allow wheelchair users enough room to maneuver into the crosswalk.	45
Figure 4-24: Parallel curb ramps work well on narrow sidewalks but require users continuing on the pathway to negotiate two ramp grades.	46
Figure 4-25: A combination curb ramp is a creative way to avoid steep curb ramps and still provide level landings.	46
Figure 4-26: Built-up curb ramp with drainage inlets.	46
Figure 4-27: Built-up curb ramp with a drainage pipe.	46
Figure 4-28: To avoid having to negotiate changing grades and changing cross-slope simultaneously, a wheelchair user has to turn at the grade transition.	47
Figure 4-29: Curb ramps designed with the ramp perpendicular to the curb eliminate rapidly changing grades and cross-slopes at the grade transition.	48
Figure 4-30: Truncated domes are an effective way of indicating a drop-off at transit platform.	50
Figure 4-31: Colored stone sidewalks with concrete curb ramps have a detectable color change.	52
Figure 4-32: Driveway crossings without landings confront wheelchair users with severe and rapidly changing cross-slopes at the driveway flare.	55



Figure 4-33: When sidewalks have a planter strip, the ramp of the driveway does not interfere with a pedestrian's path of travel. ....	55
Figure 4-34: On wide sidewalks, there is enough room to provide a ramp for drivers and retain a level landing for pedestrians. ....	56
Figure 4-35: Jogging the sidewalk back from the street provides a level landing for pedestrians on narrow sidewalks. ....	56
Figure 4-36: Although parallel driveway crossings provide users with level landings, users continuing on the sidewalk are forced to negotiate two ramps. ....	56
Figure 4-37: Inaccessible sidewalk caused by many individual parking lots. ....	56
Figure 4-38: Improved accessibility created by combining parking lots and reducing the number of entrances and exits. ....	56
Figure 4-39: Cut-through corner island and center median (based on OR DOT, 1995). ....	57
Figure 4-40: Ramped corner island and cut-through median (based on OR DOT, 1995). ....	57
Figure 4-41: Two horizontal lines are the most common crosswalk markings. ....	58
Figure 4-42: A ladder design was found to be the most visible type of pedestrian crosswalk marking. ....	58
Figure 4-43: Diagonal markings enhance visibility. ....	58
Figure 4-44: A large, easy-to-press button makes pedestrian-actuated traffic controls more usable for people with limited hand strength and dexterity. ....	60
Figure 4-45: Curb extensions at midblock crossings help reduce crossing distance. ....	61
Figure 4-46: Sight line obstructed by parked cars prevents drivers from seeing pedestrians starting to cross the street. ....	61
Figure 4-47: Partial curb extensions improve visibility between pedestrians and motorists. ....	62
Figure 4-48: Full curb extensions improve visibility between pedestrians and motorists. ....	62
Figure 4-49: Pedestrian and biker underpass. ....	62
Figure 4-50: When roads are not milled, layers of asphalt build up and make the crossing difficult for wheelchair users and others. ....	64
Figure 4-51: Milling roads from gutter to gutter prevents rapidly changing grades and makes intersections easier for wheelchair users to negotiate. ....	64
Figure 4-52: Stairs bridging low street elevation and high finished-floor elevation prevent wheelchair access into the building. ....	65
Figure 4-53: Steep cross-slopes bridging low street elevation and high finished-floor elevation make the sidewalk difficult for wheelchair users to travel across. ....	65

Figure 4-54: A level area at least 0.915 m (36 in) wide improves access when there is a low street elevation and high finished-floor elevation. ....	66
Figure 4-55: A higher curb provides a level pathway but might increase the slope of curb ramps if the sidewalk is narrow. ....	66
Figure 4-56: Traffic sign indicating upcoming steep grade (US DOT, 1988). ....	68
Figure 4-57: Pedestrian sign indicating upcoming steep grade. ....	68
Figure 5-1: Outdoor recreation access routes (ORARs) link accessible elements at a recreation site. ....	76
Figure 5-2: Trails often have maximum grades that are significantly steeper than typical running grades. ....	77
Figure 5-3: Well-designed switchbacks reduce the grade of a trail and make hiking easier for people with mobility disabilities. ....	78
Figure 5-4: Rest areas enhance the trail for all users. ....	79
Figure 5-5: Tree roots that break up the surface of the trail should be removed because they can cause users to trip. ....	82
Figure 5-6: The vertical clearance of a trail should depend on the designated user groups. ....	82
Figure 5-7: Soft surfaces are difficult for people with mobility impairments to negotiate and therefore should be avoided. ....	83
Figure 5-8: If a trail is accessible, the trail elements along the path also should be accessible. ....	85
Figure 5-9: Rubber waterbars are difficult for wheelchair users and bikers to push down when traveling uphill, but they are still more desirable than inflexible waterbars. ....	86
Figure 5-10: Swales can control drainage and eliminate the need for waterbars. ....	86
Figure 5-11: Separate pathways and clear signage can help reduce conflicts between users who travel at different speeds. ....	89
Figure 5-12: Trail signs can help clarify trail etiquette. ....	90

# List of Tables

Table 1-1: Developments in Disability Rights Legislation and Accessibility Guidelines from 1961 to 1998 .....	2
Table 2-1: Highest Reach for Wheelchair Users (based on Steinfeld, Schroeder, and Bishop, 1979) .....	18
Table 2-2: Eye-Level Measurements for Wheelchair Users (based on Steinfeld, Schroeder, and Bishop, 1979) .....	19
Table 4-1: Grade, Cross-Slope, and Curb Height Guidelines by Functional Class of Roadway (based on information contained in AASHTO, 1995) .....	63
Table 4-2.1: Federal Accessibility Guidelines for Accessible Routes .....	70
Table 4-2.2: ADAAG-Proposed Section 14 (1994) Accessibility Guidelines for Public Rights-of-Way .....	70
Table 4-2.3: State Guidelines for Sidewalks .....	71
Table 4-2.4: Additional Recommendations for Sidewalks .....	71
Table 4-3.1: Federal Accessibility Guidelines for Curb Ramps (CR) .....	72
Table 4-3.2: ADAAG-Proposed Section 14 (1994) Accessibility Guidelines for Curb Ramps (CR) .....	72
Table 4-3.3: State and City Guidelines for Curb Ramps (CR) .....	73
Table 4-3.4: Additional Recommendations for Curb Ramps (CR) .....	73
Table 5-1: Results of 10 Trail Assessments Show That on Many Trails, the Maximum Grade and Cross-Slope Significantly Exceed the Typical Average Grade and Cross-Slope (Chesney and Axelson, 1994) .....	77
Table 5-2: Cross-Slope Ranges by Surface Type (AASHTO, 1995) .....	80
Table 5-3: Scoping Requirements for Accessible Parking Spaces .....	85
Table 5-4.1: Federal Accessibility Guidelines for Maximum Allowable Running Slope without Landings and Handrails .....	92
Table 5-4.2: Federal Advisory Committee Recommendations for Maximum Allowable Running Grade .....	92
Table 5-4.3: Federal Guidelines for Maximum Allowable Running Grade .....	92
Table 5-4.4: State, County, and City Guidelines for Maximum Allowable Running Grade .....	93
Table 5-4.5: Additional Recommendations for Maximum Allowable Running Grade .....	94
Table 5-5.1: Federal Accessibility Guidelines for Maximum Slope for a Specified Ramp Run with Landings and Handrails .....	95
Table 5-5.2: Federal Advisory Committee Recommendations for Maximum Grade for a Specified Distance (Run) .....	95

Table 5-5.3: Federal Guidelines for Maximum Grade for a Specified Distance (Run) .....	95
Table 5-5.4: State, County, and City Guidelines for Maximum Grade for a Specified Distance (Run) .....	96
Table 5-5.5: Additional Recommendations for Maximum Grade for a Specified Distance (Run) .....	97
Table 5-6.1: Federal Accessibility Guidelines for Maximum Allowable Running Cross-Slope .....	98
Table 5-6.2: Federal Advisory Committee Recommendations for Maximum Allowable Running Cross-Slope .....	98
Table 5-6.3: Federal Guidelines for Maximum Allowable Running Cross-Slope .....	98
Table 5-6.4: State, County, and City Guidelines for Maximum Allowable Running Cross-Slope .....	99
Table 5-6.5: Additional Recommendations for Maximum Allowable Running Cross-Slope .....	100
Table 5-7.1: Federal Accessibility Guidelines for Minimum Clearance Width .....	101
Table 5-7.2: Federal Advisory Committee Recommendations for Minimum Clearance Width .....	101
Table 5-7.3: Federal Guidelines for Minimum Clearance Width.....	101
Table 5-7.4: State, County, and City Guidelines for Minimum Clearance Width .....	102
Table 5-7.5: Additional Recommendations for Minimum Clearance Width .....	103
Table 5-8.1: Federal Accessibility Guidelines for Vertical Changes in Level .....	104
Table 5-8.2: Federal Advisory Committee Recommendations for Vertical Changes in Level.....	104
Table 5-8.3: Federal Guidelines for Vertical Changes in Level .....	104
Table 5-8.4: State, County, and City Guidelines for Vertical Changes in Level .....	105
Table 5-8.5: Additional Recommendations for Vertical Changes in Level .....	106
Table 5-9.1: Federal Accessibility Guidelines for Vertical Clearance (Head Room) .....	107
Table 5-9.2: Federal Advisory Committee Recommendations for Vertical Clearance .....	107
Table 5-9.3: Federal Guidelines for Vertical Clearance .....	107
Table 5-9.4: State, County, and City Guidelines for Vertical Clearance .....	108
Table 5-9.5: Additional Recommendations for Vertical Clearance .....	109

# Introduction

Sidewalks and trails serve as critical links in the transportation network by providing pedestrian access to commercial districts, schools, businesses, government offices, and recreation areas. Because sidewalks and trails provide such fundamental services to the public, they should be designed to meet the needs of the widest possible range of users.

Accessible sidewalks and trails enrich a community's quality of life on many levels. People with disabilities are better able to participate in the community if accessible facilities are available because it is easier for them to reach their desired destinations. Accessible sidewalk and trail networks are cost-effective because they promote independence for people with disabilities and reduce the need for social services in many cases. Commercial districts with accessible facilities have a customer base that includes people with disabilities. People with temporary disabilities such as broken legs also will be able to continue their daily functions with less inconvenience.

More accessible sidewalks and trails also mean better pedestrian facilities for everyone. Sidewalks and trails with curb ramps and benches invite strolling and shopping. Neighborhoods with well-designed pedestrian facilities are generally safer because more people are out walking in the community. In addition, a broader range of consumer, social, and recreational opportunities is available in areas catering to pedestrians.

Unfortunately, many sidewalks and trails do not adequately meet the needs of people with disabilities, who make up nearly one-fifth of the American population (U.S. Census Bureau, 1994). People with disabilities who live in areas without accessible facilities and do not have access to automobiles face a greater

risk of becoming isolated from the community and unnecessarily dependent upon others to perform errands such as grocery shopping.

The Americans with Disabilities Act (ADA) of 1990 is a civil rights law that identifies and prohibits discrimination on the basis of disability. The ADA prohibits public entities from designing new facilities or altering existing facilities, including sidewalks and trails, that are not accessible to people with disabilities. Although the current ADA Accessibility Guidelines (ADAAG) do not specifically address sidewalk and trail design, the guidelines do contain provisions that are applicable to sidewalks and trails. To best serve people with disabilities and meet the legal obligations of the ADA, designers should follow the applicable guidelines in ADAAG whenever possible.

In an effort to determine when ADAAG provisions apply to sidewalks and trails, and to bridge the remaining gaps, the Federal Highway Administration sponsored a project to research existing conditions on sidewalks and trails for people with disabilities. As part of Phase I of this project, an extensive literature review was conducted, and existing guidelines and recommendations for developing sidewalks and trails were compiled and analyzed. In addition, site visits were made to many towns and cities across the United States. The locations included areas known for providing excellent accommodations for people with disabilities, as well as locations with less accessible facilities. Quantitative measurements of sidewalk and trail characteristics that affect accessibility were taken at the sites. Experts also were interviewed to obtain the most current information on sidewalk and trail access as it relates to people with disabilities.

This report presents the findings of the Phase I study. A number of factors that affect the accessibility of sidewalks and trails in the United States are presented. The history of accessibility legislation and an overview of current accessibility laws are provided as a social backdrop to the study. The travel characteristics of people with disabilities, children, and older adults are analyzed in relation to their use of sidewalks and trails. The effects of current legislation pertaining to sidewalk and trail project planning and funding are reviewed. Current design practices used in the design of sidewalks and trails are described and analyzed in terms of accessibility, engineering, and construction.

Definitions for most of the terms in this report can be found in Appendix B. For the purposes of this report, *path or pathway* may refer to either a sidewalk or a trail. A *sidewalk* is defined in this report as the portion of a highway, road, or street intended for pedestrians. A *trail* is defined

as a path of travel for recreation and/or transportation within a park, natural environment, or designated corridor that is not classified as a highway, road, or street. A *shared-use path* is defined as a trail permitting more than one type of user, such as a trail specifying both pedestrians and bicyclists as designated users. An equestrian-only trail would not be considered a shared-use path.

Part II of this project, a guidebook, will produce a manual recommending accessible designs for sidewalk and trail facilities. Guidebook recommendations will draw upon information gathered for this report and will provide specific practices that can improve the accessibility of outdoor pathways. General principles of accessible design, accessibility requirements, facility design suggestions, and other considerations will be discussed. Sufficient detail will be included to allow planners and designers to improve the accessibility of sidewalks and trails in their communities.

# Disability Rights Legislation and Accessibility Guidelines and Standards in the United States

The Americans with Disabilities Act of 1990 (ADA) is a landmark civil rights law that both identifies and prohibits discrimination on the basis of disability. The Act prohibits discrimination in employment, telecommunications, transportation, access to facilities and programs provided by State and local government entities, and access to the goods and services provided by places of public accommodation such as lodging, health, and recreation facilities. People who design and construct buildings and facilities are responsible under the ADA to make them accessible to and usable by people with disabilities.

## 1.1 Accessibility Legislation and Access Design Standards Prior to the ADA

Although the ADA is the most comprehensive Federal law protecting the rights of people with disabilities, several important pieces of legislation and accessible design standards helped pave the way for passage of the ADA. Major milestones in the evolution of accessibility regulations are listed in Table 1-1.

### 1.1.1 American National Standards Institute (ANSI) A117.1

In 1959, the President's Committee on Employment of the Physically Handicapped and the National Society for Crippled Children co-sponsored the development of ANSI A117.1, the first national standard for accessibility (PLAE, Inc., 1993). ANSI standards are developed through a consensus process involving all directly and materially affected interests. Compliance with ANSI Standards is voluntary (ANSI A117.1, Council of American Building Officials, 1992).

The technical provisions of ANSI A117.1 are intended for "the design and construction of new buildings and facilities," as well as the "remodeling, alteration, and rehabilitation of existing conditions" (ANSI A117.1, Council of American Building Officials, 1992). Technical provisions delineate how features should be designed and installed. Technical information in ANSI A117.1 is largely based on anthropometric, ergonomic, and human performance data. ANSI A117.1 does not include scoping provisions, which describe where accessibility is appropriate; when it is required; and what features of a building, facility, or site must be accessible.

ANSI A117.1 was first published in 1961 and reaffirmed without changes in 1971. A completely new and more comprehensive version of ANSI A117.1 was published in 1980. Later editions were published in 1986, 1992, and 1998.

Although ANSI A117.1 is a voluntary standard, it has been adopted as an enforceable code by many State and local agencies that regulate the design and construction of built facilities. The technical requirements in ANSI A117.1 are also referenced in the model building codes established by regional organizations such as the following:

- Building Officials and Code Administrators International (BOCA)
- International Conference of Building Officials (ICBO)
- Southern Building Code Congress International (SBCCI)

Agencies and organizations that reference ANSI A117.1 must establish scoping specifications because the ANSI guidelines

contain only technical requirements. ANSI A117.1 has served as the basis for most of the accessibility standards subsequently adopted by Federal and State governments.

### **1.1.2 The Architectural Barriers Act (ABA)**

Congress passed the Vocational Rehabilitation Amendment Act of 1965 to encourage public facilities to comply with ANSI A117.1. The Act established the National Commission on Architectural Barriers to Rehabilitation of the Handicapped to study how and to what extent architectural barriers impeded access to or use of facilities in buildings, and what, if anything, was being done to eliminate barriers. The Commission concluded that the public was largely ignorant of disability access problems and that little was being done to provide access (PLAE, Inc., 1993).

Recognizing the ineffectiveness of voluntary compliance, Congress passed the Architectural Barriers Act (ABA) in 1968. The ABA requires that buildings and facilities designed, constructed, or altered with Federal funds, or leased by a Federal agency, must comply with standards for physical accessibility. The ABA signaled the first time physical access to buildings was required by Federal law.

The ABA required the U.S. Department of Defense (DoD), the U.S. Department of Housing and Urban Development, the U.S. General Services Administration, and the U.S. Postal Service to develop accessibility standards for all buildings and facilities covered by the ABA. Initially, ANSI A117.1 1961/71 was referenced as the accessibility standard, until 1984, when the four agencies published the Uniform Federal Accessibility Standards (UFAS).

---

**Table 1-1:**

***Developments in Disability Rights Legislation and Accessibility Guidelines from 1961 to 1998***

1961	ANSI publishes ANSI A117.1, Making Buildings Accessible to and Usable by the Physically Handicapped.
1965	Congress passes the Vocational Rehabilitation Amendment Act (P.L. 89-333).
1968	Congress passes the Architectural Barriers Act (ABA) (P.L. 90-480).
1973	Congress passes the Rehabilitation Act (P.L. 93-112).
1978	Sections 502 and 504 of the Rehabilitation Act of 1973 (P.L. 93-112) are amended.
1980	ANSI publishes a revised version of ANSI A117.1, designated ANSI A117.1-1980.
1982	U.S. Access Board publishes Minimum Guidelines and Requirements for Accessible Design (MGRAD).
1984	Federal ABA rule-making agencies publish Uniform Federal Accessibility Standard (UFAS).
1986	ANSI publishes revised version of ANSI A117.1, designated ANSI A117.1-1986.
1988	Congress passes the Fair Housing Amendments Act (P.L. 100-430).
1990	Congress passes the Americans with Disabilities Act (P.L. 101-336).
1991	U.S. Access Board publishes Americans with Disabilities Act Accessibility Guidelines for Buildings and Facilities (ADAAG).
1991	U.S. Departments of Justice and Transportation publish the ADA Standards for Accessible Design.
1992	ANSI publishes a revised version of ANSI A117.1, designated CABO/ANSI A117.1-1992.
1995	Congress passes the Congressional Accountability Act.
1998	ANSI publishes a revised version of ANSI A117.1, designated CABO/ANSI A117.1-1998.
1998	Congress reauthorizes the Rehabilitation Act.

---



### 1.1.3 The Rehabilitation Act

The drive to achieve access for people with disabilities gained momentum with the passage of the Rehabilitation Act in 1973. The Act signaled a profound shift in Federal public policy for people with disabilities. It requires nondiscrimination in the employment practices of Federal agencies of the executive branch (Section 501) and Federal contractors (Section 503). In addition, it requires all federally assisted programs, services, and activities to be available to people with disabilities (Section 504).

The Rehabilitation Act recognized that unemployment, lack of education, and poverty were not inevitable consequences of physical limitation. The Act identified societal prejudices and the inaccessibility of the environment as the sources of many of these problems. In addition, for the first time, people with disabilities were considered a unified group rather than a collection of different groups separated by diagnosis. The Act recognized that people with disabilities, as a group, face similar discrimination in employment, education, and access to society, and as such, constitute a legitimate minority group deserving basic civil rights protection (Golden, Kilb, and Mayerson, 1993).

Section 504 of the Rehabilitation Act introduced the concept of program access to federally conducted programs by prohibiting discrimination in any program, service, or activity of the Federal government. Program access allows “recipients to make their federally assisted programs and activities available to individuals with disabilities without extensive retrofitting of their existing buildings and facilities, by offering those programs through alternative methods” (US DOJ, 1994b). There are many ways to achieve program access. For example, if a private interview is to be conducted on the third floor, a first-floor interview would be acceptable if a comparable level of privacy could be obtained. Structural

modifications are required only for program access if there is no other feasible way to make a program accessible (*ibid.*). The requirement for program access reappears in Title II of the ADA (see Section 1.2.3).

Each Federal agency applies a unique set of Section 504 regulations to its own programs. Agencies that provide Federal financial assistance also have Section 504 regulations covering entities that receive Federal aid. Requirements common to these regulations include reasonable accommodation for employees with disabilities, program accessibility, effective communication with individuals who have disabilities, and accessible new construction and alterations. Each agency enforces its own regulations. Section 504, as it applies to entities that receive Federal assistance, also may be enforced through private lawsuits.

Section 502 of the Rehabilitation Act established the U.S. Architectural and Transportation Barriers Compliance Board (U.S. Access Board or U.S. ATBCB) as an independent regulatory agency with authority to enforce the ABA. In addition to its enforcement role, the U.S. Access Board developed the guidelines that formed the Uniform Federal Accessibility Standards (UFAS) and works with the four Federal agencies that set accessibility standards under the ABA.

In 1982, the U.S. Access Board published the *Minimum Guidelines and Requirements for Accessible Design* (MGRAD). The technical specifications of MGRAD were largely based on ANSI A117-1980. Scoping specifications were derived from State accessibility codes, U.S. Access Board research, public comment, and existing Federal agency standards. The four Federal agencies charged with developing accessibility standards for the ABA used the specifications in MGRAD to develop UFAS. All Federal agencies also have designated UFAS as the accessibility

standard for new construction and alterations under Section 504 of the Rehabilitation Act.

## 1.2 The Americans with Disabilities Act (ADA)

Passage of the Americans with Disabilities Act in 1990 gave civil rights protection to individuals with disabilities. The ADA defines an individual with a disability (ADA, 1990) as a person who

1. has a physical or mental impairment that substantially limits one or more major life activities,
2. has a record of such an impairment, or
3. is regarded by others as having such an impairment.

The ADA is divided into the following five titles, which prohibit discrimination on the basis of disability:

- Title I Employment
- Title II Public Services
- Title III Public Accommodations and Commercial Facilities
- Title IV Telecommunications
- Title V Miscellaneous

In 1995, Congress passed the Congressional Accountability Act, which extended the rights and protections of 11 employment and labor laws, including the ADA, to the legislative branch of the Federal government. The executive branch of the Federal government is not covered by the ADA but must comply with the Architectural Barriers Act and the Rehabilitation Act and must meet UFAS requirements.

### 1.2.1 Americans with Disabilities Act Accessibility Guidelines (ADAAG)

Title V of the ADA requires the U.S. Access Board to issue minimum guidelines for accessible design to ensure that

buildings, facilities, rail passenger cars, and vehicles are accessible in terms of architecture and design, transportation, and communication to individuals with disabilities (ADA, 1990, Section 504). The U.S. Department of Justice (US DOJ) and the U.S. Department of Transportation (US DOT) use the U.S. Access Board guidelines as a basis to establish accessibility standards. Although the DOJ and DOT may create standards that exceed the recommendations published by the U.S. Access Board, they must be consistent with the minimum guidelines. The DOJ and DOT standards are enforceable under the ADA; however, the U.S. Access Board guidelines are only advisory.

Sections 1–10 of ADAAG were completed by the U.S. Access Board in 1991 and were concurrently published by the DOJ and DOT as the ADA Standards for Accessible Design. The ADA Standards for Accessible Design are identical in content to ADAAG Sections 1–10; however, the ADA Standards for Accessible Design are enforceable under the ADA.

ADAAG is based on specifications established in UFAS and ANSI A117.1-1980 and -1986. In 1998, the U.S. Access Board published final guidelines for Section 11: *Judicial, Regulatory, and Legislative Facilities* and Section 12: *Detention and Correctional Facilities*. Section 13: *Accessible Residential Housing*, and Section 14: *Public Rights-of-Way*, which had been published previously as interim guidelines, were withdrawn and reserved for future rulemaking. To date, the DOJ or the DOT has not developed standards based on Sections 11 and 12.

ADAAG and UFAS provide specific information on dimensions and details for new construction and alterations. The specifications of ADAAG and UFAS establish minimum levels of accessibility. Architects and building owners may

choose to design alternative but equally accessible facilities. However, if an alternative design is used, it must provide a level of access equivalent to the requirements in the ADA Standards for Accessible Design or UFAS.

In addition to the Federal standards, almost all States have adopted accessibility guidelines as part of their building codes. Although States may adopt and enforce standards that are more stringent than Federal standards, covered entities must comply with Federal minimum standards. State and local governments may apply to the DOJ Assistant Attorney General for Civil Rights to certify that a State or local building code meets or exceeds the ADA's minimum requirements.

### **1.2.2 Implementing Regulations for Title II and Title III**

Title II, Subpart A, and Title III of the ADA are implemented by the DOJ in the Code of Federal Regulations (CFR). Title II, Subpart B is implemented by the DOT. The DOJ implementing regulations for Titles II and III of the ADA are in CFR Title 28, Parts 35 and 36, respectively. The DOT implementing regulations for Title II, Subpart B, are published in CFR 49, Part 37.

The DOJ regulations for Titles II and III are very similar in their general requirements. The DOJ developed technical assistance manuals for Titles II and III to help public and private entities comply with the ADA implementation regulations. The information line of the Disability Rights Section of the DOJ may be contacted at (800) 514-0301 (V) or (800) 514-0383 (TTY), or on the Internet at [www.usdoj.gov/crt/ada/adahom1.htm](http://www.usdoj.gov/crt/ada/adahom1.htm).

Both Titles II and III prohibit exclusion of people with disabilities from services, programs, and activities. Both titles also stipulate that the equal participation of individuals with disabilities in the

mainstream of society is a primary goal. Therefore, to prevent segregation, entities covered by Titles II and III must make every effort to integrate people with disabilities to the maximum extent possible. The type of program provided must be appropriate to the needs of the particular individual. For example, an appropriate program for a hearing wheelchair user could include a videotape of a tour through the upper floors of a historic house museum that could not be made physically accessible. However, a program providing sign-language interpretation for a hearing wheelchair user would not be appropriate. Individuals with disabilities are not required to use separate services, even if a qualified separate program exists (US DOJ, 1993b; US DOJ, 1993c).

State and local governments and places of public accommodation are required to make reasonable modifications to their policies, practices, and procedures to avoid discriminating against people with disabilities. Reasonable modifications might include permitting service animals into food establishments, even if other animals are not allowed or granting a variance to a zoning requirement so a business may encroach on the sidewalk to install a storefront ramp (US DOJ, 1993b; US DOJ, 1993c).

Exceptions in both titles are made for historic sites or programs for which providing physical access would “threaten or destroy the historic significance” (ADA, 1990). In such cases, architectural access should be provided to the maximum extent possible, even if full compliance with the ADA standards cannot be met. Examples of partial compliance include providing a steeper-than-average ramp or ground-floor-only access. In situations where no architectural modifications are possible, auxiliary aids such as films, models, or activities representative of the inaccessible area must be provided (US DOJ, 1993b; US DOJ, 1993c).

### **1.2.3 ADA Regulations that Apply to Public Entities**

Title II, Subpart A of the ADA prohibits State and local governments (public entities) from discriminating against people with disabilities in all programs, services, and activities. Title II, Subpart B prohibits discrimination against people with disabilities in public transportation provided by public entities (private transportation is covered in Title III).

Similar to Section 504 of the Rehabilitation Act, Title II requires public entities to provide people with disabilities with program access in existing facilities. Program access for people with mobility disabilities may be achieved by relocating a program to an accessible building or changing the way a service is delivered. Structural modifications are required only if there is no other feasible way to make a program accessible (US DOJ, 1994b). Effective communication for people who have hearing, vision, or speech disabilities can be achieved by providing appropriate means of communication. The requirements for program access are published in the DOJ and DOT regulations.

New construction is held to the highest standard of accessibility because the cost of including accessibility is minimal compared to the overall cost of construction. The current implementing regulations for Title II allow public entities the flexibility to use either UFAS or the ADA Standards for Accessible Design for new construction and alterations. Once a standard has been chosen, it must be followed completely for a given facility or project in both new construction and subsequent alterations (US DOJ, 1993b).

If a public entity follows the ADA Standards for Accessible Design, alterations and new additions must meet the minimum specifications for new construction unless it is “technically infeasible” to do so. An improvement is technically infeasible only

if “existing structural conditions would require removing or altering a load-bearing member which is an essential part of the structural frame; or because other existing physical or site constraints prohibit modification or addition of elements, spaces, or features which are in full and strict compliance with the minimum requirements for new construction and which are necessary to provide accessibility” (US DOJ, 1991). According to UFAS, alterations and new additions must meet the minimum specifications for new construction unless it is “structurally impracticable” to do so (UFAS, U.S. DoD et al., 1984). Structurally impracticability is defined in UFAS as “changes having little likelihood of being accomplished without removing or altering a load-bearing structural member and/or incurring an increased cost of 50 percent or more of the value of the element of the building or facility involved” (UFAS, U.S. DoD et al., 1984). Special technical provisions may be applied where constraints prohibit full compliance with new construction standards. However, this decision must be made carefully, and the accessibility standards must be met to the maximum extent feasible.

New construction or alteration work commenced after January 26, 1992, must meet the requirements outlined in the ADA Standards for Accessible Design or UFAS.

### **1.2.4 ADA Regulations for Places of Public Accommodation and Commercial Facilities**

Title III prohibits discrimination on the basis of disability in places of public accommodation and in commercial facilities. Places of public accommodation are facilities operated by private entities that fall within the following 12 broad categories defined by Congress [ADA, Section 301(7), 1990]:

1. Places of lodging
2. Establishments serving food or drink

3. Places of exhibition or entertainment
4. Places of public gathering
5. Sales or rental establishments
6. Service establishments
7. Stations used for specified public transportation
8. Places of public display or collection
9. Places of recreation
10. Places of education
11. Social service center establishments
12. Places of exercise or recreation

Private entities who own, lease, lease to, and/or operate places of public accommodation are responsible for compliance with all Title III requirements.

Title III of the ADA requires that new or altered places of public accommodation be “readily accessible to and usable by” people with disabilities [ADA, 1990, Section 303(2)]. Places of public accommodation are required to provide auxiliary aids, such as interpreters for people who are deaf. Places of public accommodation are also required to remove architectural barriers in existing facilities where it is readily achievable to do so. Readily achievable is defined by the ADA as “easily accomplishable and able to be carried out without much difficulty or expense” (US DOJ, 1991). Architectural barriers include elements such as steps, doorways that are very narrow, deep pile carpeting on floors, and objects positioned in a manner that impedes access. Modifications that may be considered readily achievable include installing ramps, restriping parking lots, placing Braille in elevators, repositioning shelves, rearranging furniture, and other actions. Rearranging furniture or equipment to provide access is not considered readily achievable if it results

in a significant loss of selling or serving space. If architectural modifications are made to meet barrier-removal requirements, the ADA Standards for Accessible Design should be used as a guide. However, when it is not readily achievable to install architectural improvements that comply with the ADA Standards, alternative designs that increase access but do not meet all the specifications are acceptable.

If barrier removal is not readily achievable, a public accommodation must make goods, services, facilities, privileges, advantages, or accommodations available through alternative measures, if those measures are readily achievable. Alternative measures include providing curb service or home delivery, retrieving merchandise from inaccessible areas, or relocating activities to accessible locations (US DOJ, 1991).

Barrier removal is an ongoing obligation. However, places of public accommodation may not be required to complete access improvements to all their facilities immediately. The DOJ implementing regulations for Title III strongly recommend that places of public accommodation comply with barrier-removal requirements according to the following priorities (US DOJ, 1991):

1. Access to a place of public accommodation from public sidewalks, parking, or public transportation
2. Access to those areas of a place of public accommodation where goods and services are made available to the public
3. Access to and usability of restroom facilities
4. Any other measures necessary to provide access to the goods, services, facilities, privileges, advantages, or accommodations of a place of public accommodation

Commercial facilities (US DOJ, 1991) are facilities operated by private entities

1. whose operations will affect commerce;
2. that are intended for nonresidential use by a private entity; and
3. that are not
  - i. facilities that are covered or expressly exempted from coverage under the Fair Housing Act of 1968, as amended (42 U.S.C. 3601–3631);
  - ii. aircraft; or
  - iii. railroad locomotives, railroad freight cars, railroad cabooses, commuter or intercity passenger rail cars.

Examples of commercial facilities include factories and warehouses that are not open to the public. Commercial facilities do not have to make auxiliary aids available, nor are they obligated to meet barrier-removal requirements.

Both places of public accommodation and commercial facilities must comply with the ADA Standards for Accessible Design for new construction and alterations. New construction must be in full compliance with the requirements specified in the ADA Standards for Accessible Design unless compliance would be structurally impracticable. Full compliance is considered “structurally impracticable only in those rare circumstances when the unique characteristics of terrain prevent the incorporation of accessible features” (US DOJ, 1991).

Alterations must be readily accessible to and usable by individuals with disabilities in accordance with the ADA Standards for Accessible Design to the maximum extent feasible. Alterations are considered to be any change to the facility that affects usability, such as renovation of walls and remodeling, but does not include normal maintenance, such as painting or electrical work, unless it affects usability. When alterations are made to an area of primary function, up to an additional 20 percent

of total spending must be allocated to make the path of travel to the altered area accessible. The path of travel includes elements such as toilets, drinking fountains, and telephones serving the altered area.

### **1.3 Accessibility Guidelines, Requirements, and Standards for Sidewalks and Trails**

It is critical for sidewalks and trails to be accessible because such paths often link individually accessible facilities. For example, a person may wish to do business with a bank in an accessible building but may be unable to use the bank’s services if he or she cannot negotiate the curbs, intersections, and other public rights-of-way required to reach the bank.

#### **1.3.1 Sidewalks**

The implementing regulations for Titles II and III of the ADA require curb ramps to be provided in all existing facilities and for new construction and alterations. The implementing regulations also require public entities that have responsibility for or authority over streets, roads, sidewalks, and/or other areas meant for pedestrian use to develop a transition plan within 6 months of January 26, 1992 (by July 26, 1992). Structural changes identified in the transition plan were to be completed within 3 years of the transition plan (by January 26, 1995) (US DOJ, 1994b). A transition plan should include an assessment of the existing sidewalks requiring access improvements and present a schedule for curb ramp installations where an existing pedestrian walkway crosses a curb or other barrier.

The DOJ Title II implementing regulations [28 CFR Section 35.105(d)(2), US DOJ, 1994b] require State and local government entities to prioritize the installation of curb ramps on walkways serving

1. State and local government offices and facilities;
2. Transportation;
3. Places of public accommodation (private-sector facilities covered by Title III); and
4. Places of employment.

With the exception of the curb ramp requirement, accessibility standards specifically applicable to public sidewalks have not yet been developed by the DOJ. In 1994, the U.S. Access Board published four additional sections of ADAAG, including proposed public right-of-way guidelines (Section 14) now reserved. The proposed 1994 guidelines were circulated for a public review period, during which the U.S. Access Board received some negative feedback relating to specific sections of the document. Based on the comments received, the U.S. Access Board decided to withdraw the guidelines and focus on a public awareness campaign for the transportation industry. Section 14 was reserved to allow the possibility of developing accessibility guidelines for public sidewalks in the future. Although Section 14 was withdrawn, it was reviewed for this report because it made an impact on the transportation industry and because it is still being used by many State and local transportation agencies.

Despite the current lack of enforceable standards for public sidewalks and trails, public and private entities who design and construct sidewalks and trails are still obligated under the ADA to make them accessible to and usable by people with disabilities. In the absence of accessibility guidelines for public sidewalks and trails, planners, designers, and builders should adhere to appropriate sections of the ADA Standards for Accessible Design or UFAS and applicable State and local accessibility provisions. The ADA Standards for Accessible Design contain many sections that are potentially applicable to elements found in sidewalks. For example, Section 4.7 of the ADA Standards provides design specifications for curb ramps on accessible

routes. Some State and local governments have expanded the ADA Standards for Accessible Design to develop their own accessibility standards for sidewalks.

If a sidewalk is significantly altered, accessibility improvements must be made. However, there has been extensive debate about whether modifying a street triggers the same requirement to make accessibility improvements to the sidewalk. Altered or new facilities must be readily accessible and usable by individuals with disabilities. Under the ADA, modifications that affect usability are considered alterations. In *Kinney v. Yerusalim*, a Federal district appeals court ruled that if the depth of the resurfacing overlay is at least 38 mm (1.5 in), the usability of a street is affected. The court further ruled that because a street and its curbs are interdependent facilities, alteration of a street triggers the installation of curb ramps (U.S. District Court, Eastern District of Pennsylvania, 1993). According to the DOJ Technical Assistance Manual, “resurfacing beyond normal maintenance” is an alteration; construction limited in scope to a spot repair, such as patching potholes, is considered maintenance and does not trigger additional access retrofit requirements (US DOJ, 1993c).

### 1.3.2 Trails

Outdoor trail facilities should be accessible to the full range of potential users to ensure that people with disabilities will have access to the same recreational experiences available to those without disabilities. The U.S. Access Board established the Recreation Access Federal Advisory Committee in 1993 to examine accessibility in outdoor facilities. The Committee published its recommendations in 1994. The report divided outdoor recreation into six categories:

- Sports facilities
- Amusement areas
- Play settings

- Golf
- Boating and fishing facilities
- Developed outdoor recreation facilities

Access recommendations for these categories are being addressed by the U.S. Access Board in different ways. Methods for making play settings and outdoor developed areas accessible are being addressed by regulatory negotiation committees. The two committees are composed of experts and interested parties and are working toward consensus guidelines for these areas. The play settings committee has completed and forwarded its recommendations to the U.S. Access Board. The U.S. Access Board published a national public rulemaking for access to play areas in April 1998 to seek public comment on the play areas document. A public hearing was held in Denver, Colorado, to receive additional feedback during the comment period. The outdoor developed areas committee continues to meet and is scheduled to submit recommendations to the U.S. Access Board by September 1999.

Even though the DOJ has not adopted specific standards, recreation areas are covered by the ADA. For new construction and alterations, recreation area managers should apply applicable sections of the ADA Standards for Accessible Design or UFAS, as well as any appropriate State or local accessibility provisions. Public entities responsible for recreation areas also must provide program access to existing facilities and develop a written plan and schedule to implement access improvements.

### 1.3.3 Access to Wilderness Areas

A significant number of trails in the United States are administered by the U.S. Department of Agriculture (USDA, including the U.S. Forest Service), the U.S. Department of the Interior (USDI, including the National Park Service, the Bureau of

Land Management, and the U.S. Fish and Wildlife Service), and the Army Corps of Engineers. Some lands managed by these executive-branch agencies bear an additional Wilderness Area designation. In 1964, Congress passed the Wilderness Act to ensure that certain lands would remain free of roads and other types of development and that unimproved trails would constitute the only paths of access to these areas. Such wilderness lands were identified by Congress and were designated as the National Wilderness Preservation System (NWPS).

The Wilderness Act was enacted in 1964, before the recent gains in disability rights, and makes no mention of people with disabilities. Because the Wilderness Act prohibits the use of motorized vehicles and mechanized transport within federally designated wilderness areas (Wilderness Inquiry, Inc., 1992), some people have claimed that it discriminates against the rights of persons with disabilities, especially those who use electric-powered wheelchairs or scooters.

Congress sought to clarify the issue of access for people with disabilities to wilderness areas in Title V, Section 507(c) of the ADA (ADA, 1990):

Congress reaffirms that nothing in the Wilderness Act is construed as prohibiting the use of a wheelchair in a wilderness area by an individual whose disability requires use of a wheelchair, and consistent with the Wilderness Act no agency is required to provide any form of special treatment or accommodation, or to construct any facilities or modify any conditions of lands within a wilderness area to facilitate such use.

Thus, only assistive devices such as wheelchairs or scooters suitable for indoor use are eligible to enter wilderness



areas. For example, a manual or powered wheelchair capable of traveling on off-road terrain would be permitted, while motorcycles, all-terrain vehicles (ATVs), off-highway vehicles (OHVs), and other vehicles with internal combustion engines are prohibited. Although wheelchair users are permitted to enter wilderness areas, land management agencies “are not required to construct any facilities or modify any conditions of lands within Wilderness to facilitate use by persons with disabilities” (Wilderness Inquiry, Inc., 1995). However, when modifications to protect the resource are made, land managers are encouraged to use accessible designs. For example, when a toilet is necessary to protect the resource from the impact of many visitors, land managers are “encouraged to make the toilet as accessible as possible within a primitive design” (ibid.).

## 1.4 Conclusion

The ADA was passed to prohibit discrimination against people with disabilities. Title II of the ADA requires public entities that build sidewalks and trails to provide program access to existing facilities and to design and construct new facilities and altered facilities to be readily accessible to individuals with disabilities. Title III of the ADA requires places of public accommodation to remove barriers to access when it is readily achievable to do so and to meet the requirements for new construction and alteration in the ADA Standards for Accessible Design. Designers and planners of outdoor facilities should apply applicable sections of the ADA Standards for Accessible Design or UFAS and employ good design principles to ensure that facilities are accessible to and usable by people with disabilities.



# Characteristics of Pedestrians

Public sidewalks and trails are more effective when designed to accommodate the needs of all potential users. To develop effective transportation networks, people responsible for designing public sidewalks and trails must understand the needs of the full range of route users. The concept of the “standard pedestrian” is a myth; in reality, the travel speeds, endurance limits, physical strength, stature, and judgmental abilities of pedestrians vary tremendously. Sidewalk and trail users include children, older adults, families, and people with and without disabilities.

Pedestrians are defined in this report as people who travel on foot or who use assistive devices, such as wheelchairs, for mobility. Many people have conditions that limit their ability to negotiate public sidewalks and trails. According to the 1990 U.S. Census, an estimated 49 million noninstitutionalized Americans (about one in five) have a disability (U.S. Department of Commerce, Bureau of the Census, 1994). Many of these individuals have needs characteristic of more than one type of limitation. For example, a wheelchair user might also have a hearing impairment.

Different individuals are capable of varying degrees of mobility. Some people are able to climb mountains, whereas others cannot cross a room independently, even with the aid of an assistive device such as crutches or a wheelchair. In general, the ability to reach a destination depends on a person’s speed, coordination, endurance, and the types of obstacles, grades, and cross-slopes he or she encounters along the way. Accessibility guidelines, such as ADAAG or UFAS, provide minimum specifications for accessibility that meet the needs of most people. However, exceeding the minimum standards whenever possible will increase a facility’s overall ease of use and will make environments accessible to more

people. For example, routing a trail to minimize grades, rather than installing an 8.3 percent ramp, would enable more people who cannot negotiate steep grades to use that trail.

The physical fitness of pedestrians spans a wide range and affects mobility in a number of ways. Strength and flexibility, for example, are required to open doors, press control switches, and travel up curbs and stairs. Stamina, or the ability to repeat a movement, is required to travel for extended distances.

More than 50 percent of American adults are considered overweight or obese. Excess body weight increases strain on the body during physical activity and intensifies the risk of joint injury, temperature regulation problems, and heart disease (American College of Sports Medicine, 1997). Cardiac conditions such as atherosclerosis and angina, pulmonary diseases such as emphysema, circulatory problems such as hypertension and peripheral vascular disease, and degenerative joint diseases such as arthritis are other examples of long-term medical conditions that may limit the individual’s capacity for walking. Cardiac conditions also might limit an individual’s ability to perform sudden movements such as moving out of the path of an oncoming car.

Carrying packages or luggage, pushing children in strollers, pulling delivery dollies, or otherwise transporting items can also limit the physical capabilities of pedestrians. Pedestrians who are transporting additional items cannot react as quickly to potential hazards as other pedestrians because they are more physically taxed and distracted. They might walk more slowly, tire more easily, and require larger spaces to turn or maneuver than other pedestrians.

Facilities that are accessible to people with disabilities are generally safer and more

user-friendly for all pedestrians. Most people will become temporarily disabled by injury at some point in their lives. People with temporary disabilities, such as a broken arm or sprained ankle, will be able to continue their daily functions with less inconvenience if accessible features, such as curb ramps, are available in their communities.

Some design approaches might benefit one group but inhibit access for another. For example, installing ramps to accommodate wheelchair users might make walking more difficult for many cane and crutch users who may have an easier time negotiating short steps. To accommodate both user groups, steps and a ramp should be provided whenever possible. The needs and capabilities of all potential users should be considered and balanced when designing pedestrian facilities.

## 2.1 Older Adults

Improvements in quality of life, nutrition, and health care have lengthened the average American lifespan and increased the ranks of older adults. By the year 2020, it is estimated that 17 percent or more of the U.S. population (nearly one in five) will be older than 65 (Staplin, Lococo, and Byington, 1998). Although aging itself is not a disability, according to the U.S. Census, in 1990 “most persons aged 75 or older had a disability” (U.S. Department of Commerce, Bureau of the Census, 1994). Many of the characteristics commonly associated with aging might limit mobility. Because the attenuated reflexes and physical limitations of older adults might prohibit them from driving automobiles, they are more likely to rely on public transit or walking than other adults (FHWA and NHTSA, 1996). Although not all older adults have disabilities, those who do benefit from accessible designs.

The aging process frequently causes a general deterioration of physical, cognitive, and sensory abilities. These

changes intensify over time and are most pronounced for individuals over 75 years of age (ibid.). Characteristics of many older adults may include the following (FHWA and NHTSA, 1996; University of North Carolina Highway Safety Research Center, 1996; Knoblauch, Nitxburg, Dewar, Templer, and Pietrucha, 1995; and Staplin, Lococo, and Byington, 1998):

- Vision problems, such as degraded acuity, poor central vision, and reduced ability to scan the environment
- Reduced range of joint motion
- Reduced ability to detect, localize, and differentiate sounds
- Limited attention span, memory, and cognitive abilities
- Reduced endurance
- Reduced tolerance for extreme temperature and environments
- Decreased agility, balance, and stability
- Inability to quickly avoid dangerous situations
- Excessive trust that fellow drivers will obey traffic rules
- Slower reflexes
- Impaired judgment, confidence, and decision-making abilities

### 2.1.1 Safety

Older adults are more likely to suffer serious consequences or fatalities from falling or traffic crashes than other pedestrians (Burden and Wallwork, 1996). Older people generally need frequent resting places and prefer more sheltered environments. Surveys of older pedestrians indicate that many have an increased fear for personal safety. Their fears are confirmed by statistics indicating that older pedestrians appear to be at increased risk for crime and crashes at places with no sidewalks, sidewalks on only one side, and places with no street lighting.

Older people would thus benefit from accessible paths that are well lit and policed (Knoblauch, Nitxburg, Dewar, Templer, and Pietrucha, 1995).

### 2.1.2 Ambulation

Because older people tend to move more slowly than other pedestrians, they require more time to cross streets than other sidewalk users. One survey revealed that the most common complaint among older pedestrians was not having sufficient time to cross intersections before signal changes (*ibid.*). The *Manual on Uniform Traffic Control Devices* (MUTCD) assumes that the average pedestrian walking rate is 1.2 m/s (4 ft/s) (US DOT, 1988). However, adjusting signal timing based on an assumed walking speed of 0.85 m/s (2.8 ft/s) might better accommodate older pedestrians (Staplin, Lococo, and Byington, 1998).

The ambulation of older adults is also affected by their reduced strength. Traveling over changes in level, such as high curbs, can be difficult or impossible for older adults (Knoblauch, Nitxburg, Dewar, Templer, and Pietrucha, 1995). However, some older people may prefer the direct path of short stair steps to the gradual grades of lengthy ramps.

### 2.1.3 Object Manipulation

The reduced manual dexterity, grip force, and coordination experienced by many older people can affect their ability to operate common mechanisms such as doors and door handles, phones, drinking fountains, pedestrian-actuated traffic signals, and parking meters.

### 2.1.4 Visual and Cognitive Processing

Older people are likely to experience a reduction in visual ability. The reduced visual acuity of older people can make it difficult for them to read signs or to detect curbs. Visual changes that occur with age

make older people more dependent on high contrast between sign backgrounds and lettering. Older people are also more susceptible to glare. Reduction in pupil size with age also makes night travel more difficult for older people. Contrast-resolution losses in older people can cause them to have difficulty seeing small changes in level, causing trips and falls on irregular surfaces (Staplin, Lococo, and Byington, 1998).

A reduced capacity for sensory processing or problem solving can cause older adults increased difficulties when negotiating unfamiliar environments. Older adults tend to require more time to make decisions and often start moving later than other pedestrians when crosswalk signals indicate a walk phase. These limitations, plus reductions in peripheral vision capabilities, the tendency to underestimate traffic speeds, and a diminishing ability to process multiple sources of information, make it difficult for older adults to use wide, complex intersections (Staplin, Lococo, and Byington, 1998). Several studies indicate that the majority of older people do not correctly understand many traffic signals. This confusion was attributed to inconsistent meaning and insufficient clarity of the signals (Knoblauch, Nitxburg, Dewar, Templer, and Pietrucha, 1995).

## 2.2 Children

Children have fewer capabilities than adults because of their developmental immaturity and lack of experience. Compared to adults, children tend to exhibit the following characteristics (FHWA and NHTSA, 1996):

- One-third less peripheral vision
- Less accuracy in judging speed and distance
- Difficulty localizing the direction of sounds
- Overconfidence
- Inability to read or comprehend warning signs and traffic signals

- Unpredictable or impulsive actions
- Lack of familiarity with traffic patterns and expectations
- Trust that others will protect them
- Inability to understand complex situations

Like older adults, children rely on public transit and walking more than other people because they cannot drive. Routes frequently traveled by children, including areas near schools or playgrounds, should have traffic flow patterns that are simple and easy to understand.

Children are involved in more than 30 percent of traffic crashes involving pedestrians. In 1991, entering the street midblock was by far the leading cause of traffic accident fatalities for children (54 percent for ages 5 to 9 years, 26 percent for ages 10 to 14 years). These large proportions may indicate a need to add more midblock crossings in areas frequented by children (Burden and Wallwork, 1996).

Children benefit from facilities such as lower drinking fountains, lower sign placement, and doors that are easier to open because they lack the physical stature and strength of adults. In addition, because many children have not yet learned to read, symbol-based pedestrian signals might be easier for them to understand than signals that contain words.

## 2.3 People with Disabilities

According to the 1990 U.S. Census, one in every five Americans has a disability (U.S. Department of Commerce, Bureau of the Census, 1994). Anyone can experience a temporary or permanent disability at any time due to age, illness, or injury. In fact, 85 percent of Americans living to their full life expectancy will suffer a permanent disability (University of North Carolina Highway Safety Research Center, 1996).

People with disabilities are also more likely to be pedestrians than other adults because some physical limitations can make driving difficult and because they experience financial hardship at a higher rate than other adults (Golden, Kilb, and Mayerson, 1993).

For the purposes of this report, disabilities have been divided into the following three categories:

- Mobility
- Sensory
- Cognitive

### 2.3.1 People with Mobility Impairments

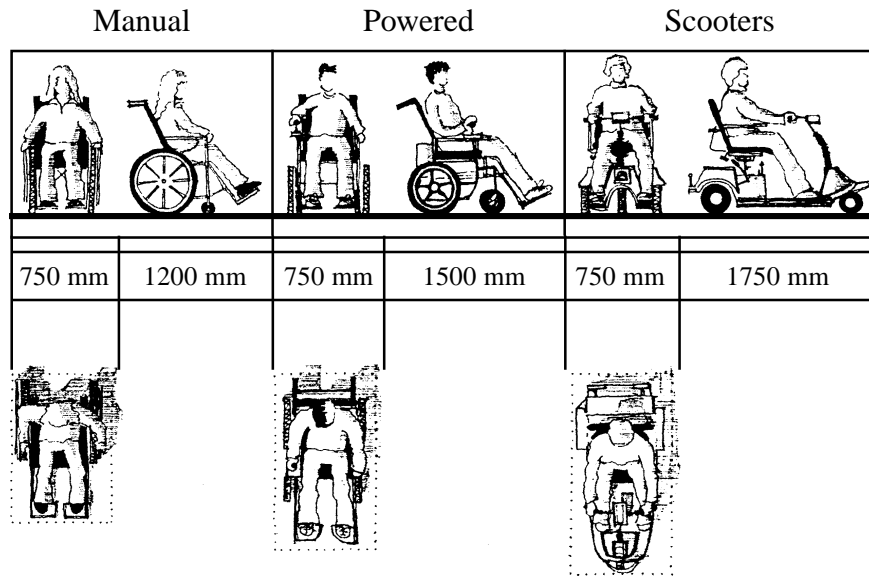
People with mobility impairments include those who use wheelchairs, crutches, canes, walkers, orthotics, and prosthetic limbs. However, there are many people with mobility impairments who do not use assistive devices. Characteristics common to people with mobility limitations include substantially altered space requirements to accommodate assistive device use, difficulty negotiating soft surfaces, and difficulty negotiating surfaces that are not level.

#### 2.3.1.1 Wheelchair and scooter users

In 1990, 1.9 million Americans identified themselves as wheelchair users for the U.S. Census (U.S. Department of Commerce, Bureau of the Census, 1994).

Wheelchair and scooter users often travel much faster than walking pedestrians, especially on level surfaces or downgrades, but they can be much slower when traveling uphill. In addition, their stability and control can be affected by surfaces with cross-slopes, grades, or rough terrain. Wheelchair and scooter users require a wider path of travel than ambulatory pedestrians. Therefore, sufficient passing space should be provided to allow wheelchair users to pass one another and to turn around.

**Figure 2-1:**  
**Wheelchair and scooter dimensions (in mm)**  
(based on *Architecture and Engineering for Parks Canada and Public Works and Government Services Canada, 1994*).



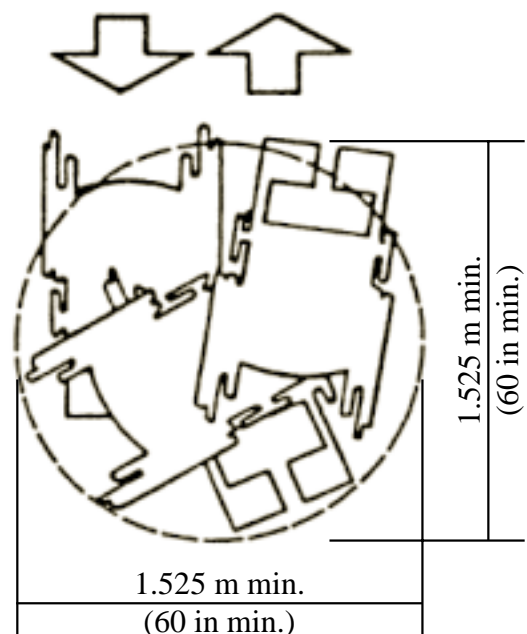
Wheelchair and scooter users require more space to turn around than other pedestrians. Furthermore, people who are unable to pull backward on their wheelchair wheels require a larger maneuvering space than those who can move one wheel forward and the other backward while turning. The turning diameter of a wheelchair or scooter is dependent upon the length of its wheelbase. Powered wheelchairs and scooters are generally longer than manual wheelchairs (Figure 2-1). Research at the Georgia Institute of Technology by John Templer (1980c) found that the turning radii of manual wheelchairs ranged from 0.635 to 1.270 m (25 to 50 in). Powered wheelchairs tended to have larger turning radii than manual wheelchairs because of the longer wheelbase (Templer, 1980c). The Templer research did not address scooters because they were relatively new in 1980.

ADAAG Section 4.2.3 specifies a 1.525 m x 1.525 m (60 in x 60 in) area for a wheelchair user to make a 180-degree turn (Figure 2-2). According to ADAAG, a T-intersection of two walkways is also an acceptable turning space (ADAAG, U.S. Access Board, 1991). The ADAAG specifications for turning

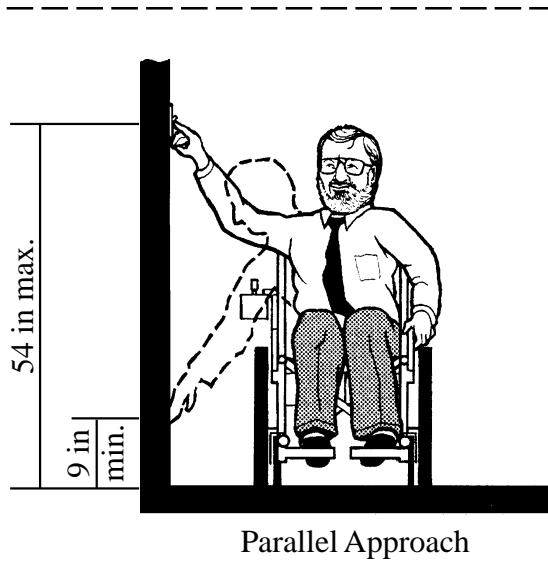
space are consistent with the findings from the Templer research.

The U.S. Department of Housing and Urban Development (HUD) sponsored a study comparing the reach and physical capabilities of a number of wheelchair users and walking pedestrians. Many of

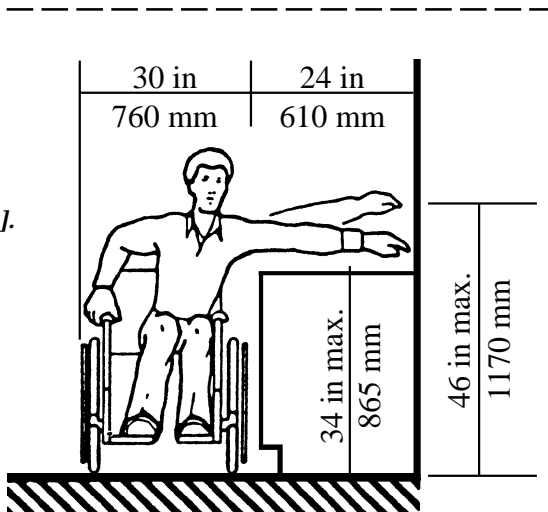
**Figure 2-2:**  
**Circle diameter of a standard manual wheelchair**  
[ADAAG, *Figure 4.3(a)*, *U.S. Access Board, 1991*].



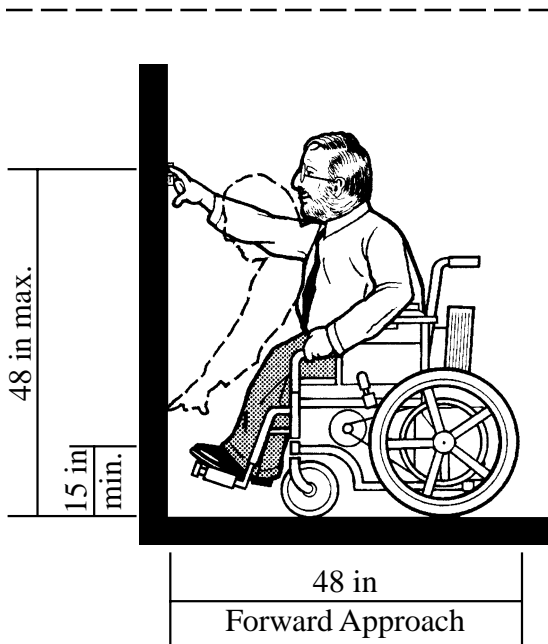
**Figure 2-3:**  
**High and low side-reach limits**  
(Barrier Free Environments, Inc., 1996).



**Figure 2-4:**  
**Maximum side-reach over an obstruction**  
[ADAAG, Figure 4.6(c), U.S. Access Board, 1991].



**Figure 2-5:**  
**High and low forward-reach limits**  
(Barrier Free Environments, Inc., 1996).



the specifications in ADAAG and UFAS are based on the anthropometric data obtained in the HUD study. Of the wheelchair users who participated, 87 percent had a maximum high side-reach of at least 1.370 m (54 in), when the clear floor space allowed a parallel approach to an object (Table 2-1) (Steinfeld, Schroeder, and Bishop, 1979). ADAAG specifies a maximum high side-reach of 1.370 m (54 in) and a minimum low side-reach of 0.230 m (9 in) when a parallel approach is possible (ADAAG, U.S. Access Board, 1991). Figure 2-3 illustrates maximum high side-reach and maximum low side-reach. If the side-reach is over an obstruction, such as a pedestrian-actuated signal positioned next to a trash receptacle, the reach and clearances should be consistent with Figure 2-4.

ADAAG Section 4.2.5 specifies a maximum high forward-reach of 1.220 m (48 in) and a minimum low forward-reach of 0.380 m (15 in) if an object can be approached only from the front (ADAAG, U.S. Access Board, 1991). Figure 2-5 illustrates maximum high forward-reach and maximum low forward-reach. If the

**Table 2-1:**  
**Highest Reach for Wheelchair Users**  
(based on Steinfeld, Schroeder, and Bishop, 1979)

Maximum High Side-Reach (m)	Number of Subjects	Percent of Subjects
<0.915	1	2
0.915–1.065	0	0
1.065–1.220	1	2
1.220–1.370	4	7
1.370–1.525	19	31
1.525–1.675	30	51
1.675–1.830	3	5
Missing data	1	2
<b>Total</b>	<b>59</b>	<b>100</b>



forward-reach is over an obstruction, the reach and clearances should be consistent with Figure 2-6.

The seated position of wheelchair users also impacts the height of their line of sight, which is important when looking for traffic and reading street signs. Based on the results in Table 2-2, the HUD study recommended that the eye level for wheelchair users be considered as a range from 0.890 to 1.320 m (35 to 52 in) (Steinfeld, Schroeder, and Bishop, 1979).

**Table 2-2:**

**Eye-Level Measurements for Wheelchair Users (based on Steinfeld, Schroeder, and Bishop, 1979)**

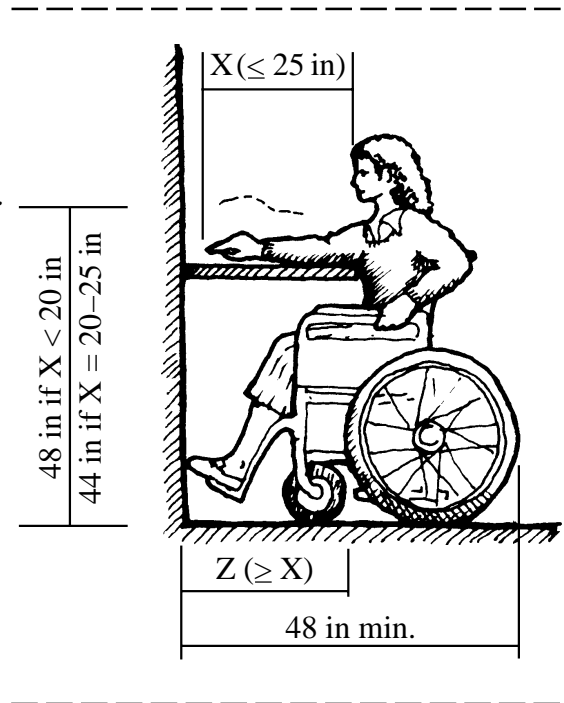
Eye-Level Height (m)	Number of Subjects	Percent of Subjects
<0.915	0	0
0.915–1.015	1	2
1.015–1.120	12	20
1.120–1.220	37	62
1.220–1.320	8	14
>1.320	0	0
Missing data	1	2
Total	59	100

Because wheels are difficult to propel over uneven or soft surfaces, wheelchair and scooter users need firm, stable surfaces and structures such as ramps or beveled edges to negotiate changes in level. Curb ramps allow wheelchair users to negotiate curbs more easily.

Because cross-slopes tend to cause wheelchairs and scooters to veer downhill, manual wheelchair users must perform additional work to continue traveling in a straight line over areas such as driveway crossings. Severe cross-slopes can cause wheelchairs to tip over sideways, especially during a turn (FHWA and NHTSA, 1996).

Cross-slopes that change very rapidly cause additional problems for wheelchair

**Figure 2-6:**  
**Maximum forward-reach over an obstruction (PLAE, Inc., 1993).**



users. The rate of change of cross-slope is most problematic when it occurs over a distance of less than 0.610 m (2 ft), the approximate distance covered by a wheelchair wheelbase. As the wheelchair moves over the surface of a severely warped driveway flare, it will first balance on the two rear wheels and one front caster. As the wheelchair moves forward, it then tips onto both front casters and one rear wheel. This transition may cause the wheelchair user to lose control and possibly tip over. A rapid change in cross-slope can also cause people with walkers to stumble. For more information on rate of change of cross-slope, refer to Section 4.3.2.

### 2.3.1.2 Walking-aid users

People who employ walking aids include those who use canes, crutches, or walkers to ease their ambulation. According to the 1990 U.S. Census, 4 million adult Americans reported having used a cane for longer than 6 months (U.S. Department of Commerce, Bureau of the Census, 1994). The limitations of walking-aid users might include the following (Bhambhani and Clarkson, 1989):

- Difficulty negotiating steep grades
- Difficulty negotiating steep cross-slopes
- Decreased stability
- Slower walking speed
- Reduced endurance
- Inability to react quickly to dangerous situations
- Reduced floor reach

People who use walking aids are often able to negotiate small steps and might even prefer steps to a longer ramp. In these situations, railings can be extremely helpful. Tall steps are generally quite difficult for cane, crutch, and walker users to negotiate. People who use walkers and crutches also benefit from stairs deep enough to accommodate all four legs of the walker or crutches positioned in front of the feet.

Surface quality significantly affects ease of travel for walking-aid users. Grates and cracks wide enough to catch the tip of a cane can be potentially dangerous for walking-aid users. Icy or uneven surfaces can also be hazardous because they further reduce the already precarious stability of walking-aid users.

People who use walking aids tend to travel more slowly than other pedestrians. As a result, they benefit from longer pedestrian signal cycles at intersections and the presence of passing spaces to allow others to travel around them. According to ADAAG Section A4.2.1(2), people who use crutches or walkers can maneuver through clear width openings that are 0.815 m (32 in); however, at least 0.915 m (36 in) is necessary if the passageway is restricted for more than 0.610 m (24 in) (ADAAG, U.S. Access Board, 1991).

Walking-aid users also require significantly more energy for ambulation than pedestrians who do not use walking aids (Fisher and Patterson, 1981; Fisher and Gullickson,

1978). As a result, they benefit from sidewalks and trails that have frequent rest areas.

### **2.3.1.3 Prosthesis users**

People lacking one or more limbs, hands, and/or feet often use prostheses such as metal hooks or molded plastic limbs to help them walk or grip items. Prosthesis users with amputations due to diabetes, cardiovascular problems, or other diseases might have a more limited capacity for exercise than prosthesis users whose missing limbs resulted from developmental difficulty or traumatic injury (Shephard, 1990).

Although people using leg prostheses can achieve levels of fitness similar to their peers', their most comfortable walking speeds are typically slower than those of individuals without disabilities (Ward and Meyers, 1995). People who use above-knee prostheses move more slowly and expend more energy in ambulation than individuals with below-knee prostheses (ibid.). In general, prosthesis users benefit from extended signal timing at wide intersections. Some people with lower limb prostheses might have greater difficulty than other pedestrians maintaining balance on grades or cross-slopes.

Some electric devices, such as computerized information kiosks, use screens sensitive to the body's electric potential to interact with the user. Although these heat-sensitive devices can be helpful for people with little manual dexterity, people who use metal hooks or plastic hands cannot trigger these sensors with their prostheses.

### **2.3.2 People with Sensory Impairments**

Although sensory disabilities are commonly thought of as total blindness or deafness, partial hearing or vision loss is much more common. Other types

of sensory disabilities can affect touch, balance, or the ability to detect the position of one's own body in space. Color blindness is also considered a sensory deficit (University of North Carolina Highway Safety Research Center, 1996).

### 2.3.2.1 People with visual impairments

In 1990 the U.S. Census reported that 1.8 million noninstitutionalized Americans over the age of 15 had a visual disability that prevented them from seeing words or letters in ordinary newspaper. (U.S. Department of Commerce, Bureau of the Census, 1994). Visual disabilities can cause the following impediments to mobility (Clark–Carter, Heyes, and Howarth, 1987):

- Limited perception of the path ahead (preview)
- Navigation with limited information about surroundings, providing less protection against obstacles and other dangers
- Reliance on memory and unchanging conditions in familiar terrain
- The need to assimilate information obtained through nonvisual sources such as texture and sound.

Because many people with visual disabilities have diminished peripheral vision, they may have difficulty perceiving or reacting quickly to approaching dangers, obstacles, and changing conditions (Clark–Carter, Heyes, and Howarth, 1987).

#### 2.3.2.1.1 Cane users

Many people who are blind use long canes to navigate. There are two principal cane techniques: touch and diagonal. In the touch technique, the cane arcs from side to side and touches points outside both shoulders. In the diagonal technique,

the cane is held out stationary across the body or just above the ground at a point outside one shoulder. The cane handle or grip then extends to a point outside the other shoulder. The touch technique is generally used in uncontrolled areas such as on a sidewalk, while the diagonal technique is used primarily in controlled and familiar environments. Cane users are often trained in both techniques (Park, 1989a; Jacobson, 1993).

The touch and diagonal techniques are typically used in conjunction with the constant-contact technique. When the cane user wants to explore an area more completely, he or she will drag the cane tip across the surface. The constant contact between the cane and the ground provides very detailed information about the area explored (ibid.).

#### 2.3.2.1.2 Dog-guide users

Some people who are blind use dog guides to navigate. “Dogs guide in response to a specific set of commands given by voice and hand signals” (Whitstock, Franck, and Haneline, 1997, in Blasch et al.). A common misconception about dog guides is that they are capable of making decisions for their owners. Dog guides are trained to avoid obstacles, including those overhead that would not be detected by a long cane. Dog guides are also taught to pause at stairs, curbs, and other significant changes in elevations. When traveling along a sidewalk, dog guides tend to follow the left border of a sidewalk or trail. Because dog guides crossing an intersection generally aim for the opposite curb, they may guide their owners outside the marked crosswalk path, missing medians and pedestrian refuge islands, to take the shortest path to the opposite curb. (*The Seeing Eye*, 1996). Intersections are easiest to negotiate for dog-guide users when the line of travel from the edge of the sidewalk to the opposite curb is straight rather than skewed, as it is at some irregularly shaped intersections.

### **2.3.2.1.3 Information for people with visual impairments**

People with visual impairments benefit from two distinct types of information along sidewalks and trails: detectable warnings, which are intended to identify potentially hazardous situations, such as the transition from the sidewalk to the street; and wayfinding information, which allows users to orient themselves within their environment.

Detectable warnings are surfaces that can be detected underfoot and by a person using a cane through texture, color, and resilience. Detectable warnings should convey a “stop” message to people with visual impairments. Once the user has stopped and identified the hazard, he or she can determine if it is safe to proceed. Detectable warnings are not required on sidewalks. However, if they are installed, they should be consistent with the specifications in ADAAG Section 4.29. Use of a consistent formula to indicate detectable warnings will prevent people with visual impairments from misinterpreting warning messages as orientation information.

Wayfinding information does not convey a warning, but rather provides orientation information to the user. People with visual impairments use a variety of cues to orient themselves within their environment. However, many of the cues, such as the sound of traffic, are not consistently available. To provide people with visual impairments with accessible wayfinding information, environmental modifications should be provided. Visual cues, tactile surfaces, and audible pedestrian signals can make information about traffic flow and street crossings accessible to people with visual impairments. Examples of accessible wayfinding information include audible pedestrian signals and tactile guidestrips at crosswalks. Visual information, such as painted crosswalks, are beneficial to the 80 percent of the people who are legally blind but have some residual vision. If a detectable surface is used to provide wayfinding

information, it should be distinct from the surface used to convey a warning message. For more information on detectable warnings and wayfinding information, refer to Section 4.4.2.

### **2.3.2.1.4 Crossing intersections**

Where pedestrian signals are not accessible, people with visual impairments might start to cross an intersection later than other pedestrians because they might wait for the sound of parallel traffic and/or other crossing pedestrians to identify the crossing interval. In addition, people with visual impairments might have difficulty identifying and maintaining the correct path across the intersection. In combination, these factors increase the amount of time that people with visual impairments might need to complete street crossings.

People with severe visual impairments take the following steps to cross an intersection:

1. Detect arrival at an intersection by using a combination of cues such as a raised curb, the slope of a curb ramp, the absence of a building shoreline, detectable indicators, remembered landmarks, traffic sounds, and any other available wayfinding cues.
2. Determine whether a pedestrian signal must be actuated to get the walk signal and actuate it if necessary.
3. Determine when it is safe to walk by using traffic or pedestrian surge noise cues or audible traffic signal cues.
4. Orient themselves toward the crosswalk by using cues such as traffic noise, audible or otherwise detectable beacons (see Chapter 4), and physical features of the environment, such as the boundary between a sidewalk and an adjacent planting strip, that are known to be parallel to the crosswalk, or curb lines that are known to be perpendicular to the crosswalk.

5. Navigate to the opposite curb through any medians, islands, crosswalk angles, or other obstacles.

### **2.3.2.2 People with hearing impairments**

Although as many as 40 percent of older adults have hearing impairments, hearing loss is not generally believed to be a significant barrier to sidewalk and trail use. However, hearing loss can limit a person's ability to use cues such as the increasing noise of an approaching vehicle to detect impending dangers. Hearing loss thus forces users to rely heavily on visual indicators or vibrations caused by passing traffic. Areas with long sight distances relatively free of visual obstructions, such as landscaping, may be useful to people with hearing impairments (FHWA and NHTSA, 1996).

### **2.3.3 People with Cognitive Impairments**

Cognition is the ability to perceive, recognize, understand, interpret, and respond to information. It relies on complex processes such as thinking, knowing, memory, learning, and recognition. Cognitive disabilities can hinder the ability to think, learn, respond, and perform coordinated motor skills.

The movement skills of people with cognitive disabilities vary tremendously. However, the motor skills and fitness potential of people with cognitive disorders are often hampered by a lack of opportunity to learn and practice appropriate physical activity movements. As a result, walking speed has been shown to decrease with the presence of cognitive or depressive disabilities (Woo, Ho, Lau, Chan, and Yuen, 1995). People with cognitive disabilities also might have difficulty navigating through complex environments

such as city streets and might become lost more easily than other people.

Design approaches for people with cognitive impairments also might benefit children and the more than 20 percent of American adults who do not read English (National Library of Education, Office of Educational Research and Improvement, personal communication, 1998). Signs that use pictures, universal symbols, and colors convey meaning to a broad range of people. For example, pedestrian crossing signals that display a picture of a person walking may be more universally understood than signs reading WALK. Always placing the DON'T WALK signal above the WALK signal also increases the clarity of pedestrian signals for users because people who cannot read can derive meaning from the order of the signals. Traffic signals for automobiles are also placed in a consistent order to benefit people who are color blind and cannot distinguish between red and green. Additional research is needed to determine if the contrasting colors of the WALK and DON'T WALK lights play a significant role in people's understanding of pedestrian signals. However, people who are color blind do not benefit from pedestrian signals that use distinct colors.

## **2.4 Conclusion**

A good understanding of how all pedestrians, including people with disabilities, older people, and children, perform in sidewalk and trail environments can help designers determine how best to implement accessibility improvements to outdoor facilities. Sidewalk and trail designers who have a solid background in the capabilities and travel habits of their design audience can make more informed decisions to create pathways that serve the entire community.



# Summary of the Planning Process

Before passage of the Intermodal Surface Transportation Efficiency Act (ISTEA) in 1991, transportation planning and investment decisions were focused on national transportation priorities that favored automobile travel, such as the completion of the Interstate system. In recent years, transportation planners have shifted emphasis to address more State and local concerns, including alternatives to the car. Planners have started to obtain more input from local users. Projects planned with local citizen involvement have led to the development of transportation facilities that better meet the needs of local users, including underserved communities such as minorities and people with disabilities. These projects have also tended to encourage more pedestrian use. Federal, State, and regional transportation agencies now routinely assess both the positive and negative impacts of a planned project by holding community meetings, distributing surveys, and interviewing individuals from a wide variety of user groups.

## **3.1 Intermodal Surface Transportation Efficiency Act and Transportation Equity Act for the 21st Century**

The 1956 Federal-Aid Highway Act directed Federal transportation policy to construct “an extensive network of roads across America” (DiStefano and Raimi, 1996), including the 42,000-mile Interstate highway system. For the next 35 years, most Federal and State transportation plans and funding focused on this primary task. In 1991, with the system almost complete, Congress shifted the focus of national transportation policy to the efficient movement of people and goods. As part of this shift, Congress gave States and metropolitan planning organizations (MPOs) greater flexibility to use their transportation funds on State and local

priorities as part of an enhanced transportation planning process that ensured the involvement of all affected agencies, as well as the community.

ISTEA placed a greater focus on the concepts of intermodalism and multimodalism, increased funding opportunities for transportation projects promoting alternatives to the automobile, and emphasized the importance of involving the community in the planning process. After the enactment of ISTEA, the US DOT undertook a major effort to develop a national policy to promote bicycling and walking as viable transportation options. This work is published in *The National Bicycling and Walking Study — Transportation Choices for a Changing America* (1994). The study established goals to double the number of walking and bicycling trips and to reduce traffic injuries and crashes affecting pedestrians and bicyclists. Ongoing strategies were developed for Federal, State, and local governments to improve bicycling and walking conditions. The Transportation Equity Act for the 21st Century (TEA-21), signed into law on June 9, 1998, builds on the many changes made by ISTEA.

## **3.2 Building a Multi- and Intermodal System**

A multimodal transportation system allows people to choose to walk, bicycle, use transit, or drive according to the type of trip they wish to make. Short trips can be made by foot or bicycle, while transit and driving options exist for longer trips or those involving heavy loads. Such a system helps promote choice, ensures equitable access to transportation, and reduces societal reliance on a single mode of transportation. Creating such a multimodal system challenges planners and decision makers to create innovative

solutions to current transportation problems. These strategies, such as telecommuting and ridesharing, can go beyond traditional infrastructure investments.

A multimodal system must also be intermodal. Intermodalism integrates all forms of transportation, such as highways, public transit systems, sidewalks, and bicycle facilities, into one seamless system. In an intermodal system, two or more distinct modes of travel are coordinated so that people can reach their destinations by transferring quickly and easily from one mode to the next. For example, for a public transit system to be a viable transportation alternative, it must provide frequent connections to an extensive network of accessible sidewalks and shared-use paths.

The trend toward more integrated, multimodal transportation systems has improved transportation options for people with disabilities, especially those who do not drive automobiles. The additional requirement that all new construction must comply with the ADA to the fullest extent possible has brought about an overall increase in the number of accessible pedestrian and public transit facilities.

### **3.3 Federal Transportation Funding Opportunities**

Since ISTEA was passed, budgets for pedestrian facilities have increased dramatically. Projects improving walking opportunities are eligible for all major Federal highway funding categories. Furthermore, TEA-21 clarifies that projects intended for the “modification of sidewalks to comply with the Americans with Disabilities Act of 1990” are eligible for Surface Transportation Program funds, the biggest single source of transportation funding for States in the legislation (TEA-21, 1998). Other categories include the National Highway System (NHS) funding program, which may be used to build sidewalks and trails as

integral parts of major highways, including Interstate corridors; the Congestion Mitigation and Air Quality Improvement (CMAQ) program, which may be used to make improvements to curb ramps, sidewalks, and intersections; and the Recreational Trails Program, which may be used to sponsor accessible off-road trail opportunities and improvements.

In recent years, the biggest source of funds for pedestrian and bicycle improvements has been the Transportation Enhancements program, which requires States to spend 10 percent of their Surface Transportation Program funds on a specific list of eligible projects. This list includes the development of pedestrian and bicycle facilities and the conversion of abandoned railroad corridors to trails. More than half of the funds available under this program have been used for these two activities. Pedestrian projects designed to improve the accessibility of a sidewalk or trail are also eligible for transportation enhancement funding.

Most States have appointed a transportation enhancement coordinator to oversee the management of these funds. States typically invite applications for enhancement funding each year and appoint a committee to select the projects that will be funded.

TEA-21 created two new funding opportunities for pedestrian and bicycle projects. The law established a Transit Enhancement Program that is similar to the Transportation Enhancement Program. One percent of the funds for urban transit projects is set aside for a prescribed list of activities that include “pedestrian access and walkways. . . and enhanced access for people with disabilities to mass transportation” (TEA-21, 1998). TEA-21 also made pedestrian, bicycling, and traffic calming measures eligible for Hazard Elimination Program funds. This program was designed to improve the safety of locations that present a danger to pedestrians, bicyclists, and motorists.



Like the Transportation Enhancement Program, this program consists of 10 percent of a State's Surface Transportation Program funds.

Transportation projects using Federal funds must be included in an approved transportation plan developed by a State or Metropolitan Planning Organization (MPO). Most federally funded pedestrian and bicycle projects require a certain level of matching State or local dollars, and a State or local agency must assume responsibility for maintaining facilities built with these funds.

### **3.4 Planning under Federal Transportation Legislation**

States and Metropolitan Planning Organizations (planning agencies established for each urbanized area of more than 50,000 population) are required to develop a transportation plan that provides for the development, integrated management, and operation of transportation systems and facilities, including pedestrian walkways and bicycle transportation facilities. Both statewide and MPO plans include projects and strategies that increase the safety and security of the transportation system for nonmotorized users.

States and MPOs are required to develop two types of transportation planning documents: a long-range plan with a 20-year horizon, and a Transportation Improvement Program (TIP) listing proposed projects to be completed over the next 3 years with Federal funding. Projects that appear in the TIP should be consistent with, or drawn from, the long-range plan. Both documents must be developed with significant public input and updated at least every 3 years.

Federal transportation legislation further requires that the needs of pedestrians and bicyclists be considered in these planning documents. TEA-21 specifies

that "bicycle transportation facilities and pedestrian walkways shall be considered, where appropriate, in conjunction with all new construction and reconstruction of transportation facilities, except where bicycle and pedestrian use are not permitted" (TEA-21, 1998). Transportation plans and projects must also provide due consideration of safe and contiguous pedestrian and bicycle routes. These safety considerations should include "the installation, where appropriate, and maintenance of audible traffic signals and audible signs at street crossings" (TEA-21, 1998).

Involvement in the planning process is critical to improving the transportation system for people with disabilities. States and MPOs are required to provide citizens, affected public agencies, and other interested parties with a reasonable opportunity to comment on the long-range plans and TIPs before they are approved; many agencies go further than this by including users and user groups on project selection committees and advisory boards.

During the development of the long-range plans and the TIPs, citizens can request funding for sidewalk and trail projects. Each revision and update to these documents is an opportunity to protect existing projects or promote new pedestrian improvements. Opportunities to affect the design and implementation of the project to benefit sidewalk users may continue to occur even after a project has been approved. As a result, interest groups must remain engaged throughout the planning process to ensure the usability of final designs.

### **3.5 Transportation Agencies**

Various Federal, State, and local government agencies are responsible for developing and maintaining transportation networks that link cities and towns. The Federal Highway Administration (FHWA) provides funding and technical assistance to States developing their transportation systems. Each State has a department of

transportation (DOT) that plans, designs, and maintains State roadway systems and other transportation. Jurisdiction over roadways and funding processes varies greatly from State to State.

Urbanized areas with populations larger than 50,000 have regional planning agencies, or MPOs, that are responsible for transportation planning and policy within their areas. Some MPOs also conduct other types of regional planning. MPOs and State DOTs should collaborate closely with each other, local transportation agencies, and community residents during the planning process.

### 3.6 Land Management Agencies

Land management agencies include Federal entities such as the USDA Forest Service, the USDI Bureau of Land Management, the USDI National Park Service, and the USDI Fish and Wildlife Service, as well as State and local entities responsible for parks, forests, or other public lands. Typically, such agencies have jurisdiction over tracts of land encompassing urban to wilderness environments. Like their civic counterparts, Federal land management agencies often delegate decisions to their regional and local divisions. Land management agencies are responsible for transportation planning within their own jurisdictions. However, if a land management agency uses Federal highway funding for its transportation projects, it must follow a planning process similar to that of the State DOT, which includes coordinating with appropriate State and local planning agencies. Although land management agencies construct some sidewalks, they are more likely to be involved in constructing trails.

### 3.7 Pedestrian/Bicycle Coordinators

Each State DOT is required to have a pedestrian/bicycle coordinator position.

In most States, this position is full time with sufficient authority to make pedestrian and bicycling issues a priority with other agencies, State offices, and divisions within the State DOT. Duties of the coordinator may include the following (Associate Administrator for Program Development, Federal Highway Administration, 1992):

- Planning and managing new nonmotorized facilities and programs
- Creating safety and promotional information for the public
- Helping to develop State and MPO pedestrian and bicycle facility plans
- Serving as the principal liaison among Federal, State, and local agencies and the press, citizen organizations, and individuals on bicycling and walking issues

### 3.8 Other Transportation Planning Participants

Federal legislation requires transportation agencies to engage the public throughout the planning process. The “public” consists of a diverse web of people whose varied activities and presence make up the fabric of a community. The following are segments of the public that are involved in the planning process:

**Individual citizens** — members of the community unaffiliated with advocacy groups

**Citizens’ groups** — citizen-organized volunteer groups, including neighborhood organizations and business coalitions

**Advocacy groups** — grassroots organizations dedicated to representing the needs of a particular interest group, such as people with disabilities

**Land developers** — professionals who are not part of a State or local agency employed in the real estate, construction, or development industry

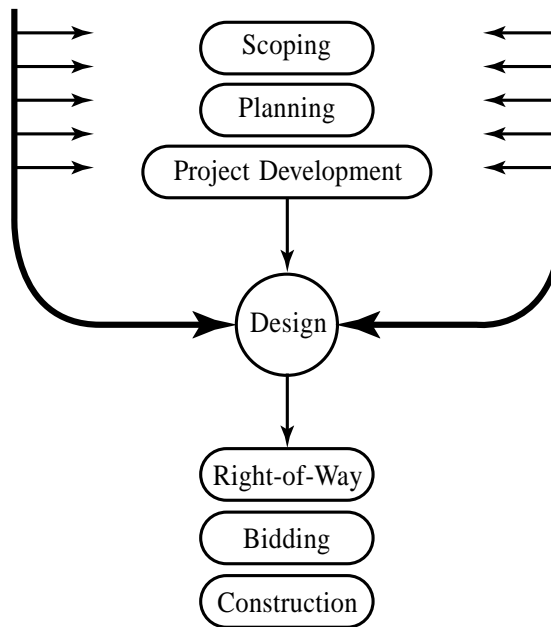
**Figure 3-1:**  
**Sources of input during the project development process (based on FHWA, 1997a).**

### Professional Input

- Engineers
- Landscape Architects
- Urban Planners
- Archaeologists
- Historians
- Environmental Specialists

### User Input

- Citizens' Groups
- Public Meeting Participants
- Bicycle and Other Interest Groups
- Historical Associates
- Public Officials



**Advisory committees** — groups convened by agencies to provide planning advice

**Elected local officials** — people who represent the public interest and are responsible to a geographically close but often highly diverse constituency. Elected officials such as city council members and legislative representatives serve as repositories for the opinions of a wide cross-section of the public.

Although citizens are not directly responsible for construction of public sidewalks and trails, they imbue the planning process with a unique local perspective. For example, a resident might know of a better location for a playground or sidewalk than a regional planner less familiar with the area. Citizens who travel around their communities are often best qualified to identify when the transportation network breaks down and where problems exist. Ideally, the public involvement process will result in decisions that best reflect the community's mobility and accessibility needs. Public involvement should pervade all aspects of the overall project development process, including

the choice of priorities and investment decisions, as shown in Figure 3-1 (FHWA and FTA, 1995).

### 3.9 Strategies for Public Involvement

ISTEA's increased acknowledgment of public involvement became the impetus for the development of more innovative and friendly public involvement strategies. While past public involvement efforts have emphasized "telling" or "selling" something to the public, the operative phrase is now "consulting with" the public (US DOT, 1995c). According to Siwek and Associates (1996), "users, transportation providers, and the public should be given sufficient opportunity to provide input to the plan's development, not just to comment on a draft final project."

Transportation agencies need to implement effective procedures for involving the public. The public involvement technique selected depends on the results the agency wants to achieve, but techniques used should always involve the full range of users. For example,

an MPO may elect to use surveys in the early stages of planning, while relying on the input of an advisory committee for more in-depth planning discussions, such as those of a corridor master planning process.

It is important to provide opportunities for all segments of the community to participate in the planning process. Proactive outreach techniques are effective ways to consult with underserved communities, such as people with disabilities. Inviting the clients of retirement homes, Veterans Administration offices, and independent living facilities to a public planning meeting is a more productive strategy for obtaining input from people with disabilities than merely announcing the meeting in the local newspaper. In addition, holding planning meetings in venues accessible to people with disabilities should be a routine part of inviting all citizens to the planning table (US DOT, 1994c). MPOs should determine what public involvement techniques will work best given their local circumstances.

### **3.10 Community Impact Assessment**

When a new transportation facility is built or an existing facility is significantly expanded using Federal funds, Federal environmental legislation requires agencies to conduct a community impact assessment. The assessment process alerts affected businesses and residents, as well as transportation planners and decision makers, to the potential effects of a project (Brock et al., 1996). An agency considering a project must review the

potential positive and negative effects on the community and specific populations before proceeding to the construction stage. The potential impact of the project on accessibility should always be considered during the community impact assessment.

The information obtained during the community assessment process should be used to develop better projects and limit negative side effects. Perceived negative impacts can be overcome by involving the public from the start of the planning process. Agencies should be aware that mitigating the effects of one impact might create unanticipated new problems (*ibid.*). For example, the disturbance involved in rerouting a road through a residential neighborhood to avoid demolishing a historic downtown area might anger home owners.

### **3.11 Conclusion**

ISTEA signaled a dramatic change in national transportation policy. It increased community involvement in the planning process, expanded intermodal transportation facilities, and broadened opportunities for funding alternatives to the automobile. TEA-21 built on the foundation of ISTEA, and together, these two instrumental pieces of legislation have led to the development of a more comprehensive, locally determined, and flexible transportation system. The increased availability of pedestrian and bicycle facilities, combined with better outreach policies, will lead to more accessible communities.

# Sidewalk Design Guidelines and Existing Practices

Sidewalks form the backbone of the pedestrian transportation network. According to the Institute of Transportation Engineers, Technical Council Committee 5A-5 (1998), sidewalks “reduce the incidence of pedestrian collisions, injuries, and deaths in residential areas and along two-lane roadways.” Without sidewalks, public rights-of-way are inaccessible to all pedestrians, including people with disabilities. When sidewalks are not available, pedestrians are forced to share the street with motorists, access to public transportation is restricted, and children might not have safe play areas. Because Federal regulations do not require agencies to build sidewalks, the decision is left to States and local agencies. Some agencies prioritize sidewalk installation, while others do not.

Accessible pedestrian facilities should be considered part of every new public right-of-way project where pedestrians are permitted. Sidewalk installation and the linking of pedestrian routes to transportation stops and major corridors should always be a priority. The decision to install sidewalks should not be optional. “Sidewalks should be built and maintained in all urban areas, along non-Interstate public highway rights-of-way, in commercial areas where the public is invited, and between all commercial transportation stops and public areas” (Institute of Transportation Engineers, Technical Council Committee 5A-5, 1998). This chapter examines the elements and characteristics of sidewalks that have the greatest impact on access. These characteristics include grade, cross-slope, and the design of specific elements such as curb ramps, driveway crossings, and intersections.

## 4.1 Location Research

The researchers visited a variety of sidewalk locations to determine what

access provisions were being made for pedestrians. Eighteen jurisdictions across the United States were selected; some were chosen for their pedestrian-friendly reputations, while others were visited because the researchers had other business in the area. Measurements were taken during these visits to determine if the access needs of people with disabilities were being addressed and where improvements needed to be made.

During the site visits, local transportation officials responsible for sidewalk design and construction were interviewed about the ways their agencies were making sidewalks more accessible. Officials contacted included engineers responsible for implementing access improvements, ADA compliance officers, pedestrian/bicycle coordinators, and planners overseeing the construction of access features for new construction and renovations.

The interviews indicated that many sidewalk professionals have a desire to make sidewalks accessible. Designers and builders are beginning to realize that the standard pedestrian is a myth and that, in reality, sidewalk users are very diverse. However, there remains a need to provide information to designers and builders on ways to develop accessible facilities within the constraints of existing facilities, as well as in new construction.

During the visits, it became clear that techniques needed to be developed to accurately measure sidewalk elements such as curb ramps, driveway crossings, and medians. Techniques to quickly and accurately assess sidewalk environments were adapted from the Universal Trail Assessment Process (UTAP), originally developed to assess access conditions on recreational trails. The tools used to measure sidewalks were identical to those used in the UTAP, with the addition of a profile gauge to record small changes

in level and raised tactile surfaces (see Section 5.1 for more information about the UTAP). The terminology and measurement process was standardized to ensure consistency among personnel.

General information about each sidewalk feature was recorded, including type, dimensions, and location with respect to other sidewalk elements. A data sheet was developed for quick recording of general access information. More detailed measurements of curb ramps, driveway crossings, and medians were recorded on a separate form. Up to 10 grade segments, 8 lengths, and 6 transition heights were recorded for these elements for full characterization of the dimensions and grades of each ramp, street, and gutter.

## 4.2 Design Guideline Comparisons

In addition to visiting a variety of sidewalk locations, the researchers identified existing guidelines that could be applied to public rights-of-way. The guidelines were collected from Federal, State, and city agencies, as well as private research and advocacy organizations. Guidelines for sidewalks were compiled in Tables 4-2.1 to 4-2.4. Guidelines for curb ramps were compiled in Tables 4-3.1 to 4-3.4. Both sets of tables are located at the end of this chapter.

The degree of accessibility provided by each guideline depends on the focus of the authorizing agency or organization. For example, the design guidelines produced by the American Association of State Highway and Transportation Officials (AASHTO) focus primarily on vehicle use, whereas ADAAG emphasizes accessible design for pedestrians. The AASHTO guidelines for public rights-of-way are titled *A Policy on Geometric Design of Highways and Streets*; however, the document is commonly referred to as the *AASHTO Green Book*. This terminology will be used throughout this report to avoid confusion with the

AASHTO guidelines for bicycle and shared-use paths.

The Federal accessibility guidelines (the ADA Standards for Accessible Design and UFAS) were originally developed for accessible routes in buildings and on building sites. Many of the requirements for accessible routes can be extrapolated to public rights-of-way. In 1994, the U.S. Access Board developed draft accessibility guidelines, proposed by ADAAG (1994), that specifically applied to public rights-of-way. Even though proposed Section 14 (1994) is now reserved, some State DOTs have adopted it as their accessibility standard for public rights-of-way. Some State and local transportation agencies have also developed their own standards for sidewalk design because traditional guidelines, such as the *AASHTO Green Book*, do not include comprehensive sidewalk recommendations. Other organizations, such as the Institute of Transportation Engineers and the Federal Highway Administration, have also developed sidewalk and curb ramp design recommendations.

## 4.3 Access Characteristics

The design of a sidewalk can be described by a variety of characteristics. This report focuses on sidewalk characteristics that have the greatest impact on accessibility, such as grade and surface type. Other characteristics such as location, type of street, and climate also affect the pedestrian friendliness of a sidewalk but do not directly impact access. Access characteristics directly affect usability of a sidewalk. The amount of attention paid to these details will determine whether a facility is accessible or not. Even mildly difficult features in combination can add up to an inaccessible pathway.

### 4.3.1 Grade

*Grade* (slope) is defined as the slope parallel to the direction of travel and is calculated by dividing the vertical change in elevation by the horizontal distance

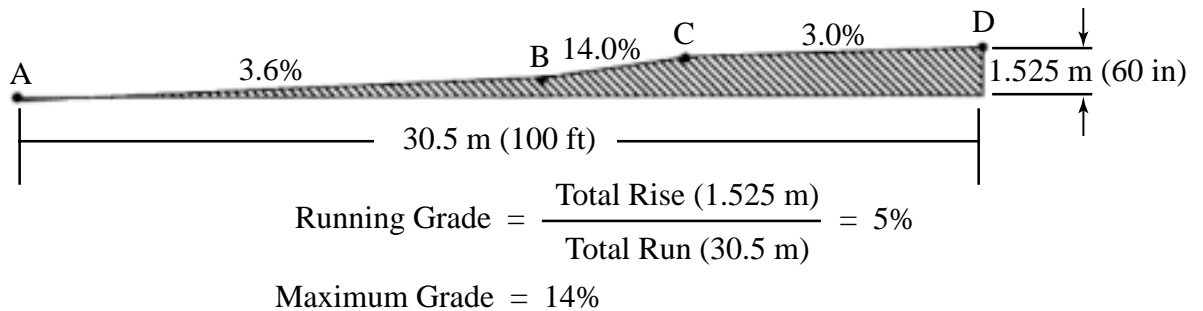
covered. For example, a path that gains 2 m in elevation over 50 m of horizontal distance has a grade of 4 percent. Although some guidelines use the term “slope” instead of “grade,” the term “grade” is used in this report to avoid confusion with cross-slope.

*Running grade* is defined as the average grade along a contiguous grade. *Maximum grade* is defined as a limited section of path that exceeds the typical running path grade. In the pedestrian environment, maximum grade should be measured over 0.610 m (24 in) intervals (the approximate length of a wheelchair wheelbase, or a single walking pace). When measuring sidewalk grade, both running grade and maximum grade should be determined. Measuring running grade only does not give an accurate understanding of the sidewalk environment because small steep sections may not be detected. Figure 4-1

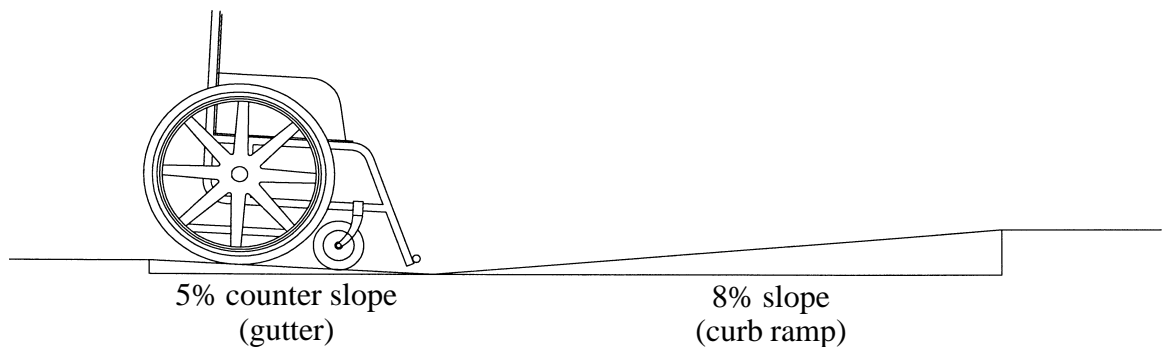
provides an example of a typical grade that is fairly negotiable, with a maximum grade that could be very difficult for some users to traverse. In the illustration, the running grade between Points A and D is 5 percent, but the grade between Points B and C is 14 percent. A person who could negotiate a 5 percent grade might not be able to negotiate a 14 percent grade, even for short distances.

The *rate of change of grade* is defined as the change in grade over a given distance. The rate of grade change is determined by measuring the grade and the distance over which it occurs for each segment of the overall distance. For the purposes of this report, rate of change of grade is measured over 0.610 m (2 ft) intervals, which represent the approximate length of a single walking pace and a wheelchair wheelbase (Figure 4-2). In the sidewalk environment, rate of change of grade

**Figure 4-1:**  
**Maximum grades can make a sidewalk difficult to traverse, even if the overall running grade is moderate.**



**Figure 4-2:**  
**The gutter slopes counter to the slope of the curb ramp to promote drainage.**



should not exceed 13 percent. An example of a 13 percent change in grade occurs at a curb ramp if the slope of the gutter is 5 percent and the slope of the curb ramp is 8 percent (Figure 4-2).

If the rate of change of grade exceeds 13 percent over a 0.610 m (2 ft) interval, the ground clearance of the footrests and or antitip wheels might be compromised. Antitip wheels are placed on the back of some wheelchairs to improve stability and prevent tipping. Even wheelchair users traveling slowly can get stuck if the footrest or antitip wheels get caught.

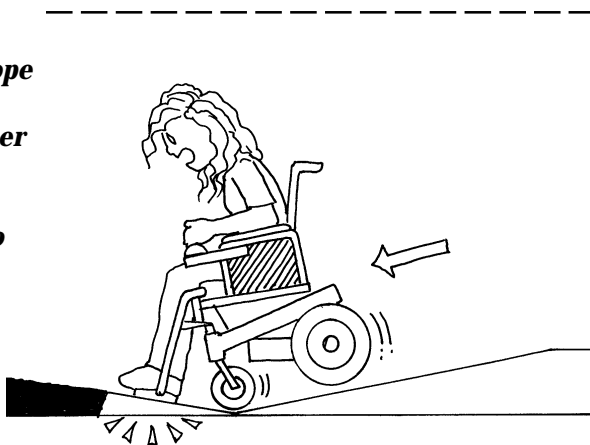
If the rate of change of grade exceeds 13 percent, the dynamic stability of the sidewalk user can also be significantly

compromised, depending on the speed at which the wheelchair user goes through the curb ramp. Dynamic stability is compromised because the negative slope of the gutter causes the wheelchair to rotate forward. However, upon reaching the bottom of the transition, the wheelchair begins to pitch back rapidly as the wheelchair travels up onto the positive slope in front of the chair (Figure 4-3). Rapid changes in grade can also cause a wheelchair user traveling with speed to flip over backward, as illustrated in Figure 4-4. Any amount of height transition between the curb ramp and the gutter can intensify problems for wheelchair users.

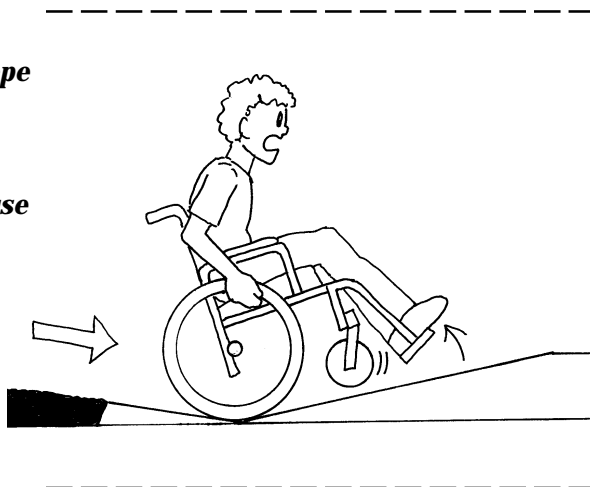
*Counter slope* is defined as a grade that is opposite to the general running grade of a path. For example, at a curb ramp, the slope of the gutter is generally counter to the slope of the ramp (Figure 4-2). According to ADAAG, the counter slope to a curb ramp should not exceed 5 percent (ADAAG, U.S. Access Board, 1991). If the counter slope of a curb ramp exceeds 5 percent, the rate of change of grade is likely to exceed 13 percent, depending upon the grade of the ramp.

The guidelines and recommendations that were reviewed for running grade and maximum grade are included in Tables 4-2.1 through 4-2.4, located at the end of this chapter. ADAAG and UFAS specify that the maximum grade of an accessible route on a building site be no more than 8.33 percent with a maximum rise of 0.760 m (30 in). Grades greater than 5 percent require handrails and level landings at least 1.525 m (60 in) wide. If the ramp turns, the landing dimensions should be 1.525 m x 1.525 m (60 in x 60 in). A ramp with level landings at both ends is illustrated in Figure 4-5. The distance between level landings is dependent on the grade of the ramp. For example, if the ramp grade is 8.33 percent, a level landing is required at least every 9.1 m (30 ft). However, if the grade of

**Figure 4-3:**  
**Excessive slope differences between gutter and ramp can cause a wheelchair to tip forward.**

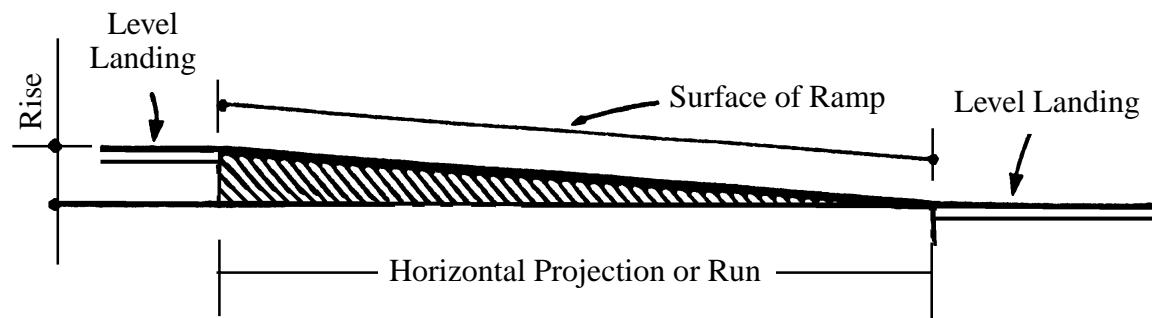


**Figure 4-4:**  
**Excessive slope differences between a gutter and a ramp can cause wheelchairs to flip over backward.**





**Figure 4-5:**  
**Ramps must have level landings**  
 (based on ADAAG Figure 16, U.S. Access Board, 1991).



the ramp is 6.5 percent, a level landing is required only every 12 m (40 ft). (ADAAG, U.S. Access Board, 1991; UFAS, U.S. DoD et al., 1984). Level landings provided at regular intervals allow wheelchair users and others a place to rest, turn around, and gain relief from prevailing grade demands. Level landings at storefronts and driveway crossings can also provide valuable resting spots for sidewalk users.

The *AASHTO Green Book* recommends that the running grade of sidewalks be consistent with the running grade of adjacent roadways. Section 14.2.1 (2a) in ADAAG proposed Section 14 (1994), now reserved, permits the running grade of the sidewalk to be consistent with the grade of adjacent roadways but recommends that the minimum feasible slope be used (U.S. Access Board, 1994b). State guidelines examined concur with the Federal accessibility standards, proposed Section 14 (1994), or the *AASHTO Green Book*.

### 4.3.2 Cross-Slope

*Cross-slope* is defined as the slope measured perpendicular to the direction of travel. Unlike grade, cross-slope can be measured only at specific points. Steep cross-slopes can make it difficult for wheelchair or crutch users to maintain lateral balance and can cause wheelchairs

to veer downhill or into the street. Cross-slope is determined by taking measurements at intervals throughout a section of sidewalk and then averaging the values.

*Running cross-slope* is defined as the average cross-slope of a contiguous section of sidewalk. Often within the typical running cross-slope, there are inaccessible *maximum cross-slopes* that exceed the running cross-slope. The distance over which a maximum cross-slope occurs significantly influences how difficult a section of sidewalk is to negotiate.

*Rate of change of cross-slope* is defined as the change in cross-slope over a given distance. Rate of change of cross-slope can be measured by placing a digital level a specified distance before and after a maximum cross-slope. The specified distance should be about 0.610 m (2 ft) to represent the approximate stride of a pedestrian or the wheelbase of a wheelchair.

A cross-slope that changes so rapidly that there is no planar surface within 0.610 m (2 ft) could create a safety hazard. As the wheelchair moves over a surface that is severely warped, it will first balance on the two rear wheels and one front caster. As the wheelchair moves forward, it then

tips onto both front casters and one rear wheel. This transition could cause the wheelchair user to lose control and tip over.

Proposed Section 14 (1994) specifies that sidewalks should lie in a continuous plane with a minimum of surface warping. Nonplanar surfaces are frequently found at driveway crossing flares and curb ramps without landings. Rapidly changing cross-slopes can cause one wheel of a wheelchair or one leg of a walker to lose contact with the ground (Figure 4-6) and also can cause walking pedestrians to stumble or fall.

Most sidewalks are built with some degree of cross-slope, to allow water to drain into the street and to prevent water from collecting on the path. Water puddles pose a slipping hazard to sidewalk users and are even more difficult to negotiate when frozen into ice sheets in colder climates.

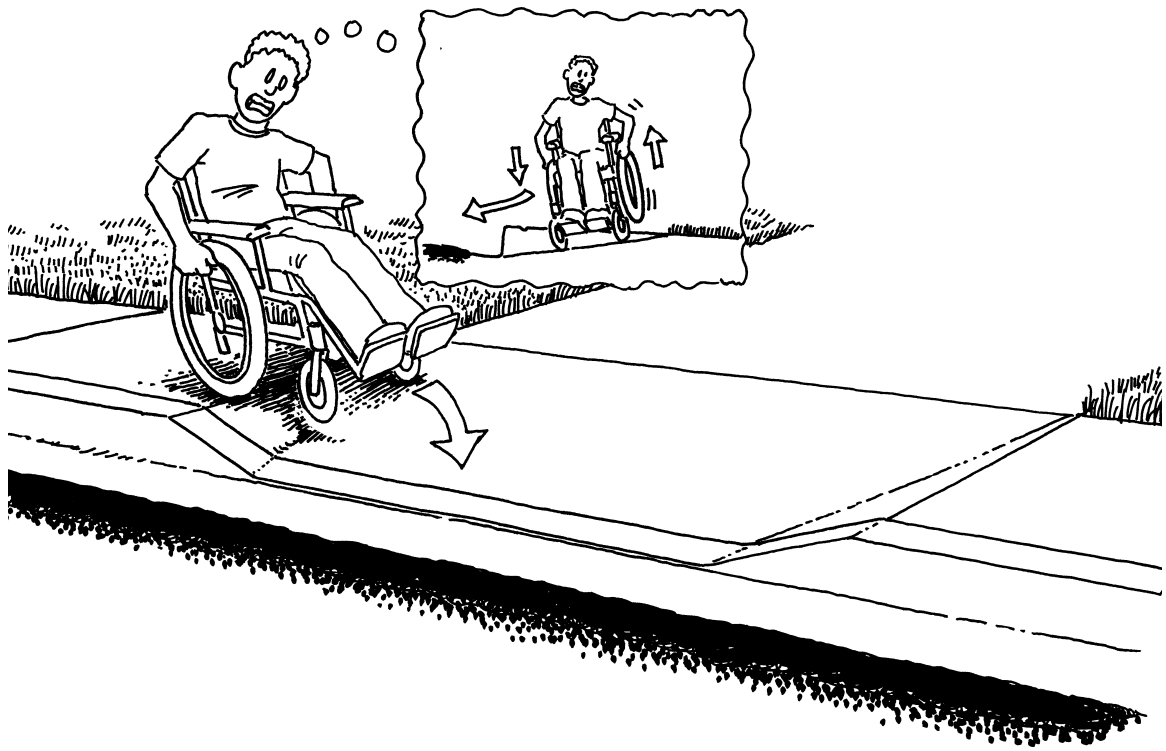
The guidelines and recommendations that were reviewed for running cross-slope are

included in Tables 4-2.1 through 4-2.4 at the end of this chapter. ADAAG and the State pedestrian facility guidelines reviewed for this report do not permit cross-slopes to exceed 2 percent. The *AASHTO Green Book* requires the cross-slope of roads to be at least 1.5 percent to permit adequate drainage. The *AASHTO Green Book* does not provide cross-slope specifications for sidewalks. No guidelines or recommendations for maximum cross-slopes on sidewalks were identified.

### 4.3.3 Width

The widths of sidewalks not only affect pedestrian usability but also determine the types of access and other pedestrian elements that can be installed. For example, a 1.525-m (60-in) sidewalk is probably wide enough to accommodate pedestrian traffic in a residential area, but a much wider sidewalk would be necessary to include amenities such as street furniture or newspaper stands. *Design width* is defined as the width

**Figure 4-6:**  
**When cross-slopes change rapidly over a short distance, wheelchair use becomes extremely unstable.**



specification the sidewalk was intended to meet; it extends from the curb or planting strip to any buildings or landscaping that form the opposite borders of the sidewalk. *Minimum clearance width* is defined as the narrowest point on a sidewalk. An inaccessible minimum clearance width is created when obstacles such as utility poles protrude into the sidewalk and reduce the design width. A reduction in the design width could also create a minimum clearance width.

Although most guidelines require sidewalk design widths to be at least 1.525 m (60 in) wide, larger design widths can accommodate more pedestrians and improve ease of access. The *AASHTO Green Book*, the Oregon Department of Transportation guidebook, and other guidelines recommend wider design widths in areas with high volumes of pedestrians. The sidewalk width often depends on the type of street. In general, residential streets have narrower sidewalks than commercial streets.

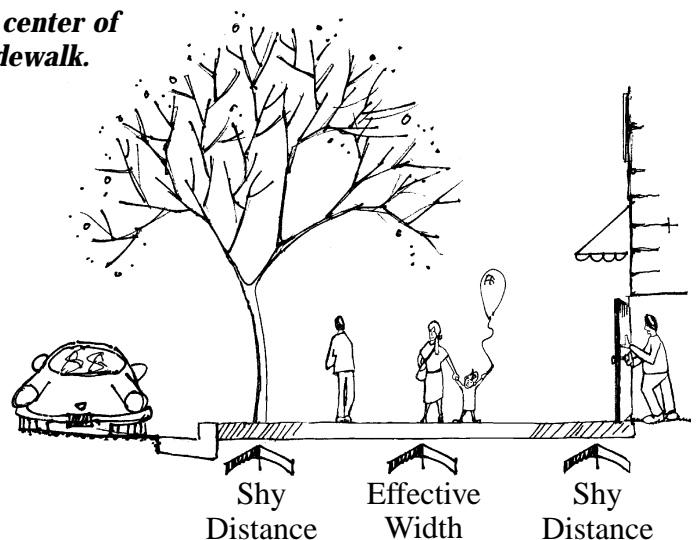
The guidelines and recommendations that were reviewed for minimum clearance width are included in Tables 4-2.1 through 4-2.4 at the end of this chapter. Most of the guidelines reviewed concur with ADAAG, which specifies that the minimum passage width for wheelchairs should be 0.815 m (32 in) at a point and 0.915 m (36 in) continuously (ADAAG, U.S. Access Board, 1991). Additional width is necessary for turning and maneuvering.

The width of the sidewalk is also affected by pedestrian travel tendencies. Pedestrians tend to travel in the center of sidewalks to separate themselves from the rush of traffic and avoid street furniture, vertical obstructions, and other pedestrians entering and exiting buildings. Pedestrians avoid the edge of the sidewalk close to the street because it often contains utility poles, bus shelters, parking meters, sign poles, and other street furniture. Pedestrians also avoid traveling

in the 0.610 m (24 in) of the sidewalk close to buildings to avoid retaining walls, street furniture, and fences (OR DOT, 1995). The sidewalk area that pedestrians tend to avoid is referred to as the *shy distance*. Taking into account the shy distance, only the center 1.830 m (6 ft) of a 3.050-m (10-ft) sidewalk is used by pedestrians for travel, as shown in Figure 4-7. Thus, the effective width of a sidewalk, not the design width, constitutes the sidewalk area needed to accommodate anticipated levels of pedestrian traffic.

When right-of-way is acquired for sidewalk construction, it is important that adequate width be included to make the facility accessible. If sidewalks are not currently included, the agency responsible for sidewalk construction might consider purchasing additional right-of-way to anticipate future construction. When improving existing facilities, designers should consider purchasing additional right-of-way or narrowing the vehicle portion of the roadway.

**Figure 4-7:**  
***Most pedestrians prefer to travel in the center of the sidewalk.***



### 4.3.4 Passing Space and Passing Space Interval

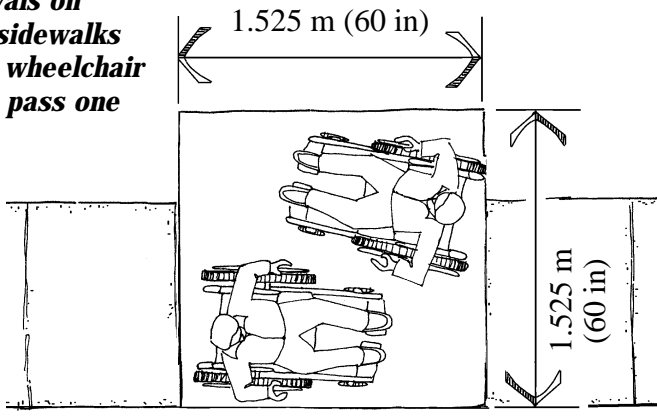
*Passing space* is defined as a section of path wide enough to allow two wheelchair users to pass one another or travel abreast (Figure 4-8). The passing space provided should also be designed to allow one wheelchair user to turn in a complete circle (Figure 4-9).

*Passing space interval* is defined as the distance between passing spaces. Passing

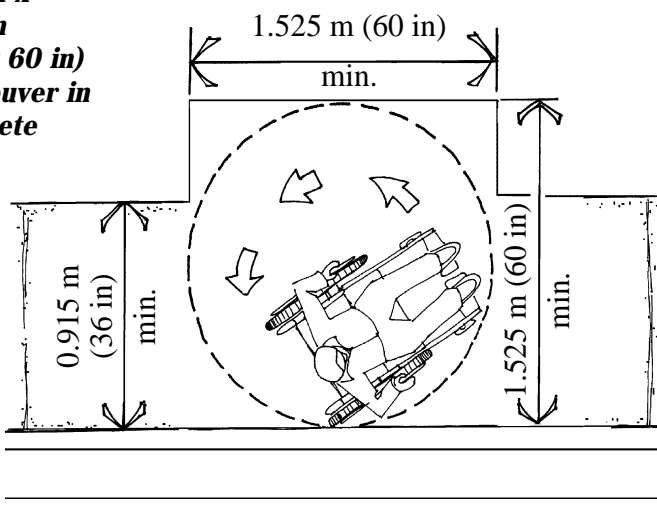
spaces should be provided when the sidewalk width is narrow for a prolonged extent because of a narrow design width or continuous obstacles.

Many agencies and private organizations do not provide guidelines for passing space or passing space intervals. Those that do provide guidelines concur with ADAAG Section 4.3.4, which specifies that accessible routes with less than 1.525 m (60 in) of clear width must provide passing spaces at least 1.525 m (60 in) wide at reasonable intervals not exceeding 61 m (200 ft). If turning or maneuvering is necessary, a turning space of 1.525 m x 1.525 m (60 in x 60 in) should be provided (ADAAG, U.S. Access Board, 1991).

**Figure 4-8:**  
*Passing spaces should be included at intervals on narrow sidewalks to allow wheelchair users to pass one another.*



**Figure 4-9:**  
*Wheelchair users require 1.525 m x 1.525 m (60 in x 60 in) to maneuver in a complete circle.*



### 4.3.5 Vertical Clearance

*Vertical clearance* is defined as the minimum unobstructed vertical passage space required along a sidewalk. Vertical clearance is often limited by obstacles such as building overhangs, tree branches, signs, and awnings.

The guidelines and recommendations that were reviewed for minimum allowable vertical clearance are included in Tables 4-2.1 through 4-2.4 at the end of this chapter. The majority of guidelines require a minimum of 2.030 m (80 in) of unobstructed vertical passage space. However, Oregon and Pennsylvania require 2.1 and 2.4 m (83 and 94 in) of vertical passage space, respectively (OR DOT, 1995; PA DOT, 1996). ADAAG states that circulation spaces, such as corridors, should have at least 2.030 m (80 in) of head room. ADAAG further specifies that if the vertical clearance of an area next to a circulation route is less than 2.030 m (80 in), elements that project into the circulation space must be protected by a barrier to warn people who are visually disabled or blind (ADAAG, U.S. Access Board, 1991).

### 4.3.6 Changes in Level

*Changes in level* are defined as vertical height transitions between adjacent surfaces or along the surface of a path. In the sidewalk environment, curbs without curb ramps, cracks (Figure 4-10), and dislocations in the surface material are common examples of changes in level. Changes in level also can result at expansion joints between elements such as curb ramps and gutters.

Changes in level can cause ambulatory pedestrians to trip or catch the casters of a manual wheelchair, causing the chair to come to an abrupt stop. People who are blind or who have low vision might not anticipate changes in level such as a buckling brick sidewalk.

The following conditions were observed to cause changes in level:

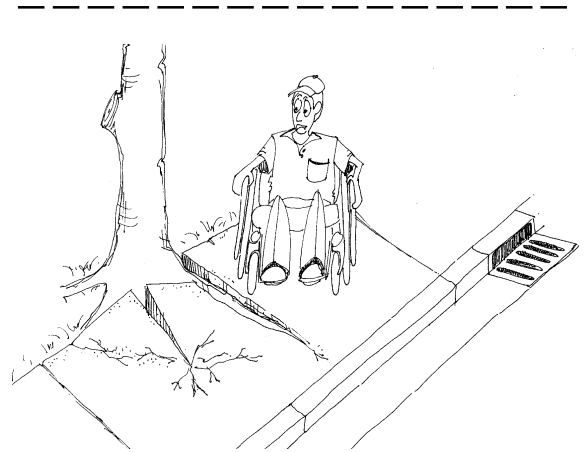
- Buckled bricks
- Cracks
- Curbs without ramps
- Drainage grates
- Grooves in concrete
- Heaving and settlement due to frost
- Lips at curb ramp frames
- Railroad tracks
- Roots
- Small steps
- Tree grates
- Uneven transitions between streets, gutters, and ramps

The guidelines and recommendations that were reviewed for changes in level are included in Tables 4-2.1 through 4-2.4 at the end of this chapter. The Federal accessibility standards permit changes in level less than 6 mm (0.25 in) high to be vertical but require changes in level between 6 mm and 13 mm (0.25 in and 0.50 in) to have a maximum bevel of 50 percent, as shown in Figure 4-11. A ramp is required for changes in level that exceed 13 mm (0.50 in) (US DOJ, 1991; UFAS, U.S. DoD et al., 1984).

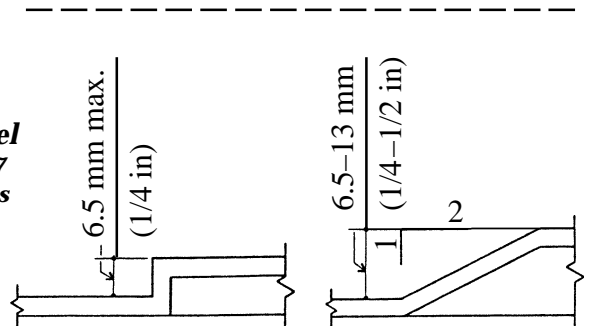
### 4.3.7 Grates and Gaps

A *grate* is a framework of latticed or parallel bars that prevents large objects from falling through a drainage inlet but permits water and some debris to fall through the slots (Figure 4-12). A *gap* is defined as a single channel embedded in the travel surface of a path. Gaps are often found at intersections where railroad tracks are embedded into the road surface.

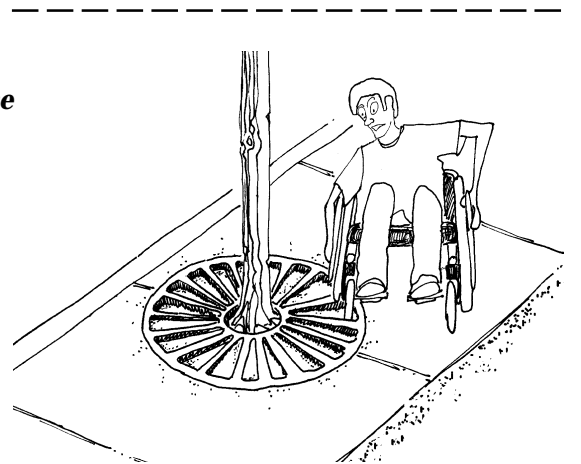
**Figure 4-10:**  
*Changes in level are often caused by tree roots that break through the sidewalk surface.*



**Figure 4-11:**  
*Vertical and beveled changes in level [ADAAG, Figure 7 (c, d), U.S. Access Board, 1991].*



**Figure 4-12:**  
*Wheelchair casters and cane and crutch tips can easily get caught in wide grates.*



Wheelchair casters and crutch tips can get caught in poorly aligned grate and gap openings. ADAAG specifies that grates located in walking surfaces should have spaces no greater than 13 mm (0.5 in) wide in one direction. It also states that gratings with elongated openings should be oriented so that the long dimension is perpendicular to the dominant direction of travel (ADAAG, U.S. Access Board, 1991). Although ADAAG does not directly address gaps, the similarity of a gap to a single grate slot suggests that ADAAG’s grate specifications also apply to gaps.

### 4.3.8 Obstacles and Protruding Objects

*Obstacles* in the pedestrian environment are defined as objects that limit the vertical passage space, protrude into the circulation route, or reduce the clearance width of the sidewalk. Obstacles with large overhangs that protrude into the path of travel can be hazardous for people with visual impairments if they are difficult to detect. The full width of the circulation path should be free of protruding objects. Obstacles that reduce the minimum clearance width, such as decorative

planters on a narrow sidewalk, can create significant barriers for wheelchair or walker users.

Most guidelines for accessibility concur with the ADAAG specifications for protruding objects. ADAAG states that objects projecting from walls that have leading edges between 0.685 m and 2.030 m (27 in and 80 in) should not protrude more than 100 mm (4 in) into walks and passageways. Freestanding objects mounted on posts or pylons may overhang a maximum of 0.305 m (12 in) from 0.685 m to 2.030 m (27 in to 80 in) above the ground (ADAAG, U.S. Access Board, 1991), as shown in Figure 4-13.

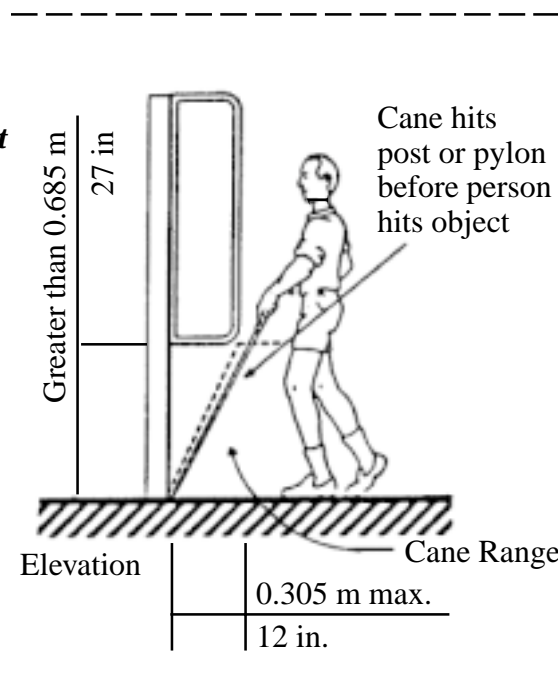
During the sidewalk assessments, potential obstacles and protruding objects were measured as they occurred along the sidewalk. Characteristics of obstacles measured in the sidewalk assessment include height, amount of overhang over the supporting structure (if any), and minimum clearance width around the obstacle.

The following objects can make a sidewalk difficult for some users to traverse if they protrude into the pathway or reduce the vertical or horizontal clear space:

- Awnings
- Benches
- Bike racks
- Bollards
- Cafe tables and chairs
- Drinking fountains
- Fire hydrants
- Folding business signs
- Grates
- Guy wires
- Landscaping
- Mailboxes (public and private)
- Newspaper vending machines

**Figure 4-13:**

**Obstacles mounted on posts should not protrude more than 0.305 m (12 in) into a circulation corridor**  
[ADAAG, Figure 8(d), U.S. Access Board, 1991].



- Parking meters
- Planters
- Public telephones (mounted)
- Puddles
- Signal control boxes
- Sign poles
- Snow
- Street vendors' carts
- Street light poles
- Street sculptures
- Telephone booths
- Telephone/utility poles and their stabilizing wires
- Traffic sign poles
- Transit shelters
- Trash bags and cans
- Tree, bush, and shrub branches
- Utility boxes

### 4.3.9 Surface

*Surface* is defined as the material on which a person walks or wheels in the pedestrian environment. The type of surface often determines how difficult an area is to negotiate. For example, wood floors can be traversed without much difficulty by most people, while a gravel surface can be impossible for some people, especially wheelchair users, to cross. Surfaces in sidewalk environments are generally concrete or asphalt but commonly include tile, stone, and brick.

Most guidelines for accessibility adhere to ADAAG, which defines accessible surfaces as firm, stable, and slip-resistant. Firm and stable surfaces resist deformation, especially by indentation or the movement of objects. For example, a firm and stable surface, such as concrete, resists indentation from the forces applied by a walking person's feet and reduces the rolling resistance experienced by a wheelchair (U.S. Access Board, 1994a). When a

pedestrian or wheelchair user crosses a surface that is not firm or stable, energy that would otherwise cause forward motion deforms or displaces the surface instead.

A slip-resistant surface provides enough frictional counterforce to the forces exerted in ambulation to permit effective travel (*ibid.*). For example, a slip-resistant surface prevents a person's shoes, crutch tips, or tires from sliding across the surface while bearing weight. A broom finish is used on many concrete sidewalks to provide sufficient slip resistance for pedestrians. The *AASHTO Green Book* requires sidewalks to have all-weather surfacing. The surface texture of curb ramps should be coarse enough to provide slip resistance when wet.

Although asphalt and concrete are the most common surfaces for sidewalks, many sidewalks are designed using brick or cobblestones. Although these surfaces are decorative, they increase the amount of work required for mobility. In addition, brick and cobblestone have inherent changes in level that are often tripping hazards. Alternatives to brick sidewalks include colored concrete stamped to look like brick, and asphalt or concrete paths with brick trim. Both alternatives preserve the decorative quality of brick but are easier for people with disabilities to negotiate.

## 4.4 Sidewalk Elements

### 4.4.1 Curb Ramps

Curb ramps provide critical access between the sidewalk and the street for people with mobility impairments. Without curb ramps, people who use wheelchairs cannot access the sidewalk. Curb ramps are most commonly found at intersections but may also be used at midblock crossings and medians. The implementing regulations for Title II of the ADA require curb ramps to be included in all new construction of sidewalks. The

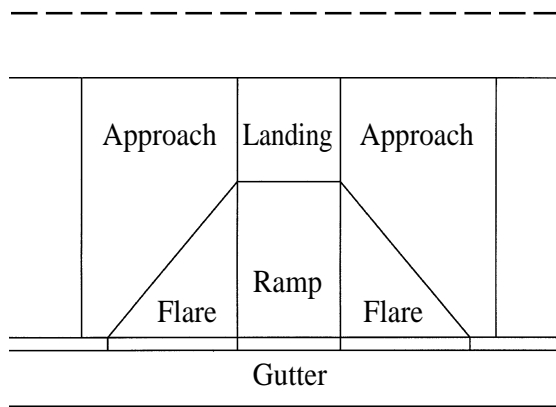
regulations also require curb ramps to be installed where existing pedestrian walkways cross a curb or other barrier (US DOJ, 1994b). Although no city surveyed has installed curb ramps in all existing pedestrian walkways, some cities have initiated aggressive plans calling for up to 500 curb ramp installations per year.

#### 4.4.1.1 Curb ramp components

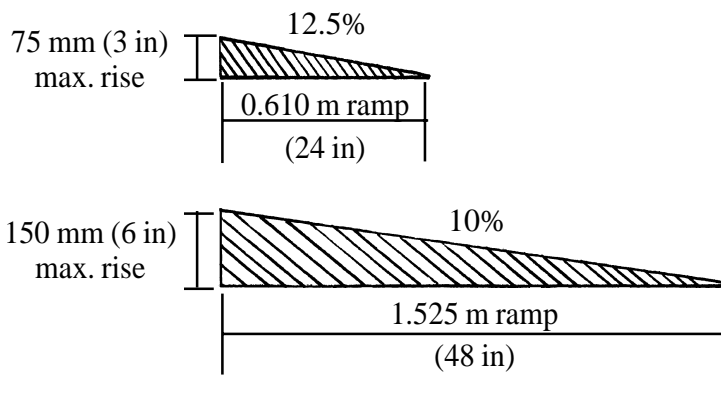
Although there are a variety of curb ramp designs, each type of curb ramp comprises some or all of the following elements, which are illustrated in Figure 4-14:

- **Landing** — level area of sidewalk at the top of a curb ramp facing the ramp path.

**Figure 4-14:**  
**Components of a curb ramp.**



**Figure 4-15:**  
**Alternative slope profiles for alterations when an 8.33 percent slope is not achievable.**



- **Approach** — section of the accessible route flanking the landing of a curb ramp. The approach may be slightly graded if the landing level is below the elevation of the adjoining sidewalk.
- **Flare** — sloped transition between the curb ramp and the sidewalk. The path along the flare has a significant cross-slope and is not considered an accessible path of travel. When the sidewalk is set back from the street, returned curbs often replace flares (see Figure 4-20, p. 44).
- **Ramp** — sloped transition between the street and the sidewalk where the grade is constant and the cross-slope is at a minimum (preferably less than 2 percent).
- **Gutter** — trough or dip used for drainage purposes that runs along the edge of the street and the curb or curb ramp.

#### 4.4.1.2 Curb ramp specifications

Curb ramps should be designed to minimize the grade, cross-slope, and changes in level experienced by users. Most agencies use standard drawings to design curb ramps. Some of these guidelines are compiled in Tables 4-3.1 to 4-3.4 at the end of this chapter. The majority of the guidelines reviewed agree with ADAAG Section 4.7 specifications for curb ramps.

##### 4.4.1.2.1 Ramps

According to ADAAG, the slope of a curb ramp should not exceed 8.33 percent, and the cross-slope should not exceed 2 percent. ADAAG also states that the least severe slope should be used in every situation. In retrofitting situations in which space prohibits the installation of an 8.33 percent ramp, ADAAG allows a slope between 8.33 percent and 10 percent for a maximum rise of 150 mm (6 in) or a slope between 10 percent and 12.5 percent for a maximum rise of 75 mm (3 in) (ADAAG, U.S. Access Board, 1991), as demonstrated in Figure 4-15.



Curb ramp widths should depend on the volume of pedestrian traffic at the specified intersection. Although ramp widths are permitted to vary, they must always be wide enough for comfortable use by wheelchair users. For this reason, ADAAG specifies that curb ramps should be at least 0.915 m (36 in) wide, not including the width of the flared sides (ADAAG, U.S. Access Board, 1991). The *AASHTO Green Book* states that curb ramps, a minimum of 1.0 m (39 in) wide or of the same width as the approach sidewalk, should be provided at crosswalks (AASHTO, 1995).

Curb ramps that are too wide and curb ramps with gradual slopes are difficult for pedestrians with visual impairments to detect. Adding a 0.610 m (2 ft) detectable warning at the bottom of these types of ramps will improve detectability. In many cities, grooves, which are intended to work as detectable warnings, are placed along the top of the ramp and/or on the ramp surface. However, grooves are difficult for people with visual impairments to detect. In addition, detectable warnings are most effective if placed at the location of the hazard. For sidewalks, the hazard occurs at the transition point between the sidewalk and the street. Section 4.4.2 contains additional information for pedestrians with visual impairments.

#### 4.4.1.2.2 Gutters

The slopes of adjacent gutters and streets significantly affect the overall accessibility of curb ramps. When the rate of change of grade between the gutter and the ramp exceeds 13 percent over a 0.610-m (2-ft) interval, wheelchair users can lose their balance. Any amount of height transition between the curb ramp and the gutter can compound the difficulties caused by rapidly changing grades. According to ADAAG, the slope of the road or gutter surface immediately adjacent to the curb ramp should not exceed 5 percent, and the transition between the ramp and the gutter should be smooth (ADAAG, U.S. Access Board, 1991). Section 4.3.1 contains

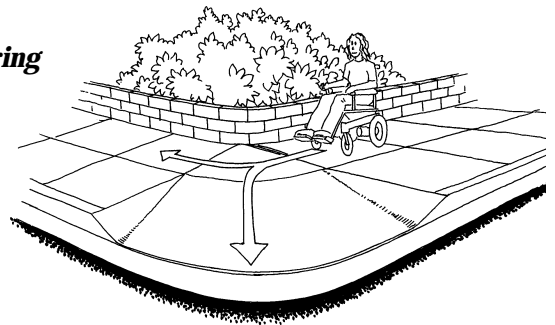
additional information on rate of change of grade.

#### 4.4.1.2.3 Landings

Curb ramp landings allow people with mobility impairments to move completely off the curb ramp and onto the sidewalk, as shown in Figure 4-16. Curb ramps without landings force wheelchair users entering the ramp from the street, as well as people turning the corner, to travel on the ramp flares (Figures 4-17 and 4-18). According to ADAAG, the landing should be a level surface at least 0.915 m (36 in)

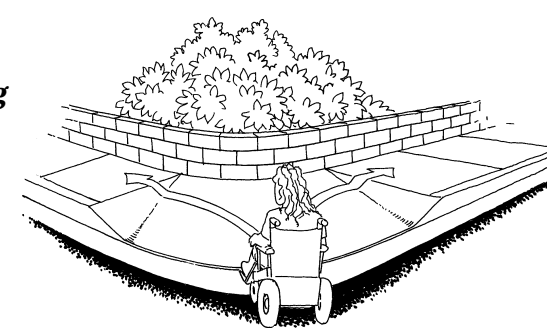
**Figure 4-16:**

***This wheelchair user is maneuvering successfully at a curb ramp because a level landing is provided.***



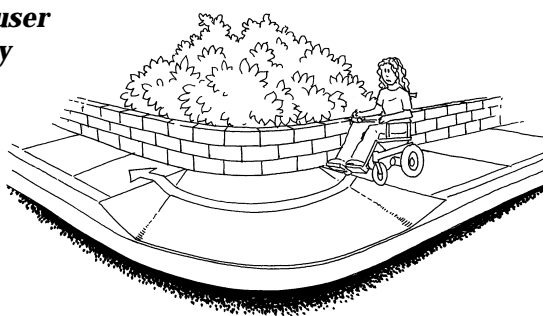
**Figure 4-17:**

***This wheelchair user will have difficulty entering the sidewalk because the curb ramp lacks a landing.***



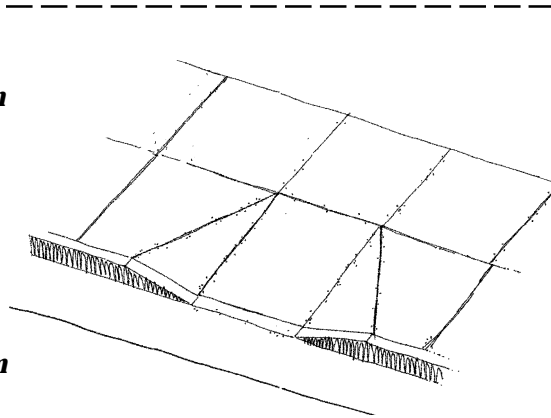
**Figure 4-18:**

***This wheelchair user will have difficulty traveling around the corner because the curb ramp lacks a landing.***

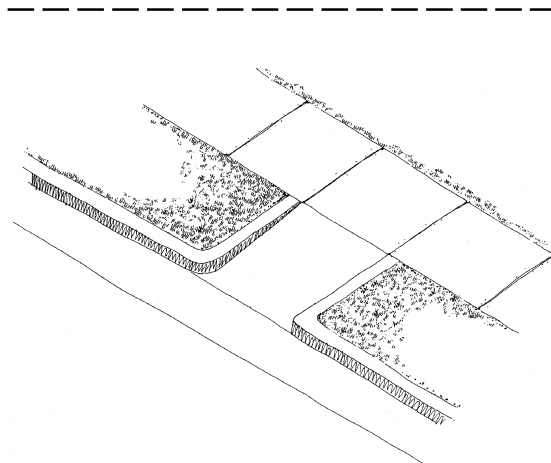


wide to prevent pedestrians from having to cross the curb ramp flare. ADAAG Section 14 (1994) recommends a 1.220-m (48-in) landing for perpendicular curb ramps and a 1.525-m (60-in) landing for parallel curb ramps (U.S. Access Board, 1994b).

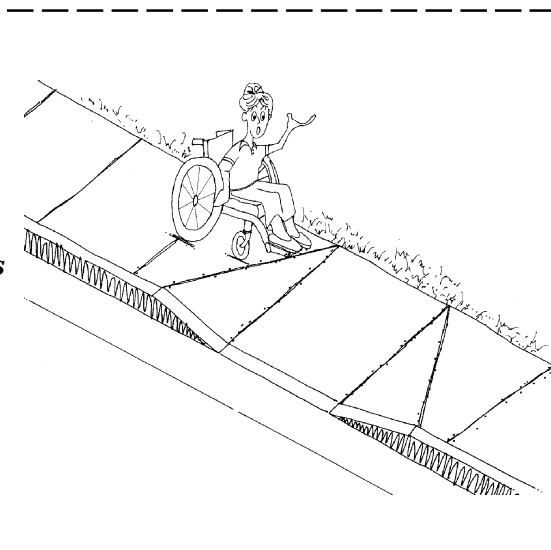
**Figure 4-19:**  
Flares provide a sloped transition between the ramp and the surrounding sidewalk and are designed to prevent ambulatory pedestrians from tripping.



**Figure 4-20:**  
Returned curbs may be used when the curb ramp is located outside the pedestrian walkway, such as in a planting strip.



**Figure 4-21:**  
Without level landings, perpendicular curb ramps are problematic for wheelchair users and others to travel across.



#### 4.4.1.2.4 Flares

The flared sides of curb ramps provide a graded transition between the ramp and the surrounding sidewalk (Figure 4-19). Flares are not considered an accessible path of travel because they are generally steeper than the ramp and often feature significant cross-slopes with excessive rate of change of cross-slope. According to ADAAG, if the landing width is less than 1.220 m (48 in), then the slope of the flares at the curb face should not exceed 8.33 percent. If the landing width is greater than 1.220 m (48 in), a 10 percent slope is acceptable (ADAAG, U.S. Access Board, 1991). If the curb ramp is located where a pedestrian might normally walk, flares are useful indicators to people with visual disabilities. Flares may be replaced with returned curbs if the curb ramp is located where a pedestrian does not have to walk across the ramp or if the sides are protected by guardrails or handrails (Figure 4-20).

#### 4.4.1.3 Curb ramp types

Curb ramps can be configured in a variety of patterns, depending on the location, type of street, and existing design constraints. Curb ramps are often categorized by their position relative to the curb line. The three most common and basic configurations are termed perpendicular, parallel, and diagonal.

##### 4.4.1.3.1 Perpendicular curb ramps

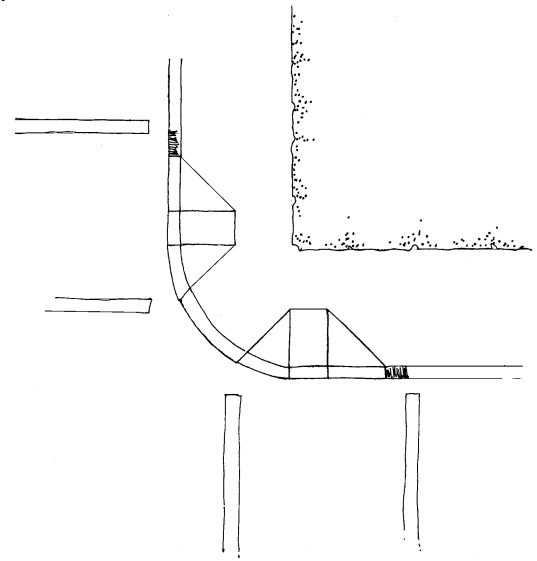
The path of travel along a perpendicular curb ramp is oriented at a 90-degree angle to the curb face. Perpendicular curb ramps are difficult for wheelchair users to negotiate if they do not have a level landing (Figure 4-21). When the sidewalk is very narrow, it can be costly to purchase additional right-of-way to accommodate a landing for perpendicular curb ramps. An alternative to purchasing more land is to extend the corner into the parking lane with a curb extension (also known as a *bulbout*). In addition

to providing space for a level landing, curb extensions calm traffic, reduce the crossing distance, and provide a larger refuge for pedestrians to congregate while waiting to cross the street (reference Section 4.4.9 for additional information on curb extensions). An additional option for providing landings is to increase the overall width of the sidewalk by adding right-of-way from the roadway. Perpendicular curb ramps are often installed in pairs at a corner (Figure 4-22). For new construction, Section 14 (1994) proposed that two perpendicular curb ramps with level landings should be provided at street crossings. This recommendation was included because two accessible perpendicular curb ramps are generally safer and more usable for pedestrians than a single curb ramp.

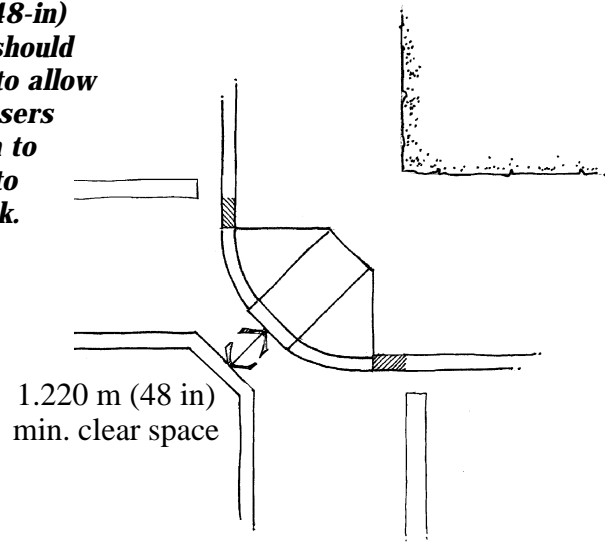
#### 4.4.1.3.2 Diagonal curb ramps

Diagonal curb ramps are single curb ramps installed at the apex of a corner (Figure 4-23). Diagonal curb ramps force pedestrians descending the ramp to proceed into the intersection before turning to the left or right to cross the street. This puts them in danger of being hit by turning cars. A marked clear space of 1.220 m (48 in) at the base of diagonal curb ramps is necessary to allow ramp users in wheelchairs enough room to maneuver into the crosswalk (Figure 4-23) (ADAAG, U.S. Access Board, 1991). A designer's ability to create a clear space at a diagonal curb ramp might depend on the turning radius of the corner. For example, a tight turning radius requires the crosswalk line to extend too far into the intersection and exposes pedestrians to being hit by oncoming traffic. In many situations, diagonal curb ramps are less costly to install than two perpendicular curb ramps. Although diagonal curb ramps might save money, they create potential safety and mobility problems for pedestrians, including reduced maneuverability and increased interaction with turning vehicles, particularly in areas with high traffic volumes. Diagonal curb ramps are not

**Figure 4-22:**  
**Two perpendicular curb ramps with level landings maximize access for pedestrians at intersections.**



**Figure 4-23:**  
**If diagonal curb ramps are installed, a 1.220-m (48-in) clear space should be provided to allow wheelchair users enough room to maneuver into the crosswalk.**

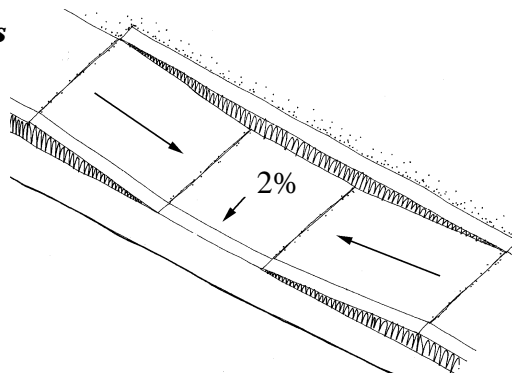


desirable in new construction but might be effective in retrofitting if there is not enough space for two accessible perpendicular curb ramps.

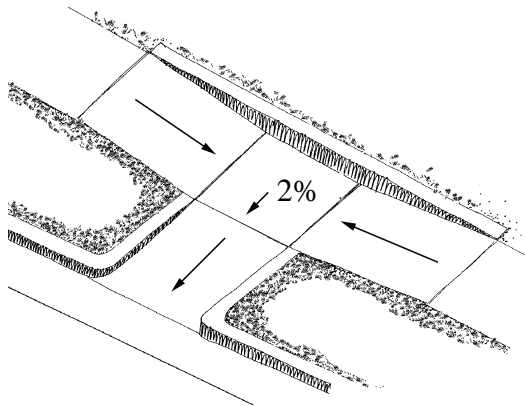
#### 4.4.1.3.3 Parallel curb ramps

The path of travel along a parallel curb ramp is a continuation of the sidewalk, as

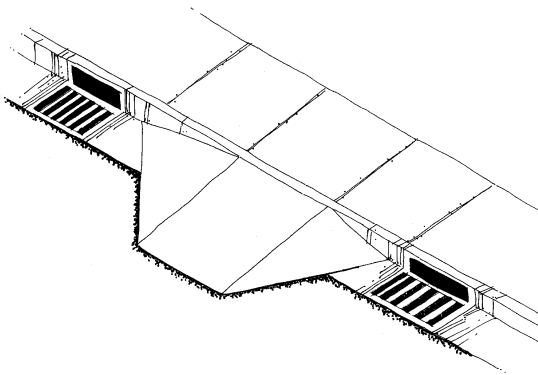
**Figure 4-24:**  
**Parallel curb ramps work well on narrow sidewalks but require users continuing on the pathway to negotiate two ramp grades.**



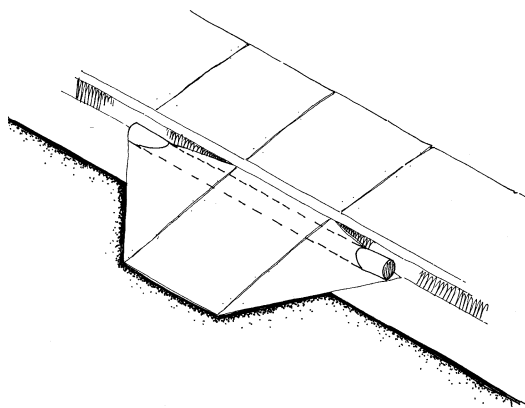
**Figure 4-25:**  
**A combination curb ramp is a creative way to avoid steep curb ramps and still provide level landings.**



**Figure 4-26:**  
**Built-up curb ramp with drainage inlets.**



**Figure 4-27:**  
**Built-up curb ramp with a drainage pipe.**



shown in Figure 4-24. Parallel curb ramps provide an accessible transition to the street on narrow sidewalks. However, if the landing on parallel curb ramps is not sloped toward the gutter (no more than 2 percent), water and debris can pool there and obstruct passage along the sidewalk. Parallel curb ramps also require those wishing to continue along the sidewalk to negotiate two ramp grades, unless a wide buffer zone permits the sidewalk to be set back behind the ramps. A combination perpendicular and parallel ramp will significantly reduce the ramp grades for people who wish to continue along the sidewalk (Figure 4-25).

#### 4.4.1.3.4 Built-up curb ramps

Built-up curb ramps are oriented in the same direction as perpendicular curb ramps but project out from the curb. For this reason, built-up curb ramps can be installed on narrow sidewalks but are most often installed in parking lots. If an edge protection is not provided on built-up curb ramps between the ramp and the sidewalk, people with visual disabilities might not be able to distinguish between the sidewalk and the street. According to ADAAG, built-up curb ramps should not extend into a vehicular traffic lane (ADAAG, U.S. Access Board, 1991). Built-up curb ramps also should not extend into bicycle lanes because they might present a hazard for cyclists.

Built-up curb ramps have additional drainage requirements because they block the gutter. Possible solutions include providing drainage inlets or placing a drainage pipe under the curb ramp (Figures 4-26 and 4-27).

#### 4.4.1.4 Curb ramp placement

In addition to specifying curb ramp designs, most transportation agencies provide specifications for their placement. Curb ramp placement can be especially complicated in retrofit situations.

Relocating or redesigning the intersection and street furniture can be expensive. Many sidewalk characteristics, including width, elevation of buildings, and position of street furniture, can affect the curb ramp design chosen. In retrofit situations in which sidewalk width is limited, parallel curb ramps might provide more gradual slopes and landings.

Curb ramps that force users to cross storm drain inlets often present hidden risks to pedestrians. The grates covering such inlets can catch the casters of wheelchairs or the tips of canes and walkers, causing falls and injuries. Water at the base of curb ramps can obscure the transition from the ramp to the gutter and cause pedestrians to misjudge the terrain. Puddles at the base of curb ramps can also freeze and cause users to slip. Locating drain inlets uphill from curb ramps will reduce the amount of water that collects at the base.

Curb ramps ending in parking spaces are not usable when blocked by parked vehicles. This situation can be prevented through parking enforcement and warning signs but perhaps more effectively through the use of curb extensions (see Section 4.4.9 for additional information on curb extensions).

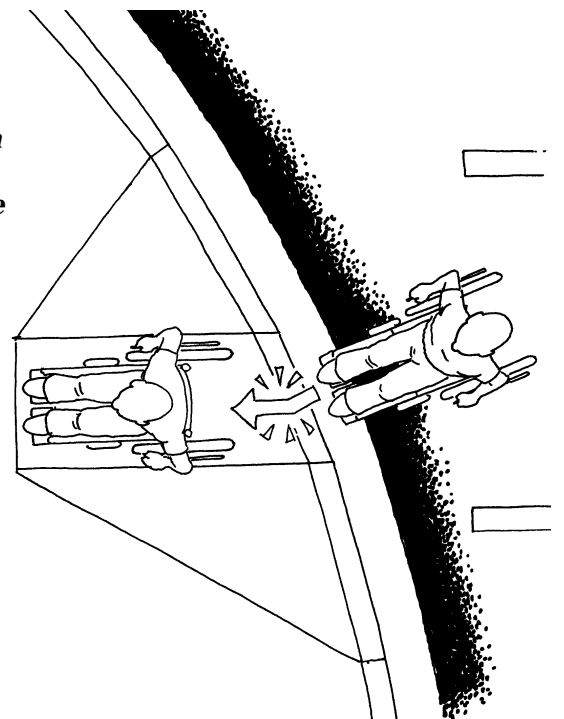
Perpendicular curb ramps should be built 90 degrees to the curb face. At a corner with a tight turning radius, a perpendicular curb ramp built 90 degrees to the curb face will be oriented toward the crosswalk. This is helpful to users because they can follow the ramp path directly across the street. Curb ramps aligned with the crosswalk also reduce the maneuvering that wheelchair users must perform to use the ramp.

At corners with larger turning radii, the curb ramp cannot always point in the direction of the crosswalk and be perpendicular to the curb face. In some cities, designers

align curb ramps parallel to the crosswalk, causing the ramp face to be skewed. This design has some benefit to people with visual impairments because they can use the path of the curb ramp to direct them across the street. However, people with visual impairments tend not to rely on the direction of curb ramps because of the abundance of diagonal curb ramps that point into the center of the street.

In addition, if the curb ramp is not perpendicular to the curb, as illustrated in Figure 4-28, wheelchair users have to negotiate changing cross-slopes and changing grades simultaneously, or they have to turn while making the grade transition. Turning at the grade transition requires a wheelchair user traveling down a curb ramp to go down one edge of the ramp and try to turn while on a significant grade. Curb ramps that are perpendicular to the curb prevent wheelchair users from

**Figure 4-28:**  
**To avoid having to negotiate changing grades and changing cross-slope simultaneously, a wheelchair user has to turn at the grade transition.**



having to turn at the ramp to a gutter transition (Figure 4-29).

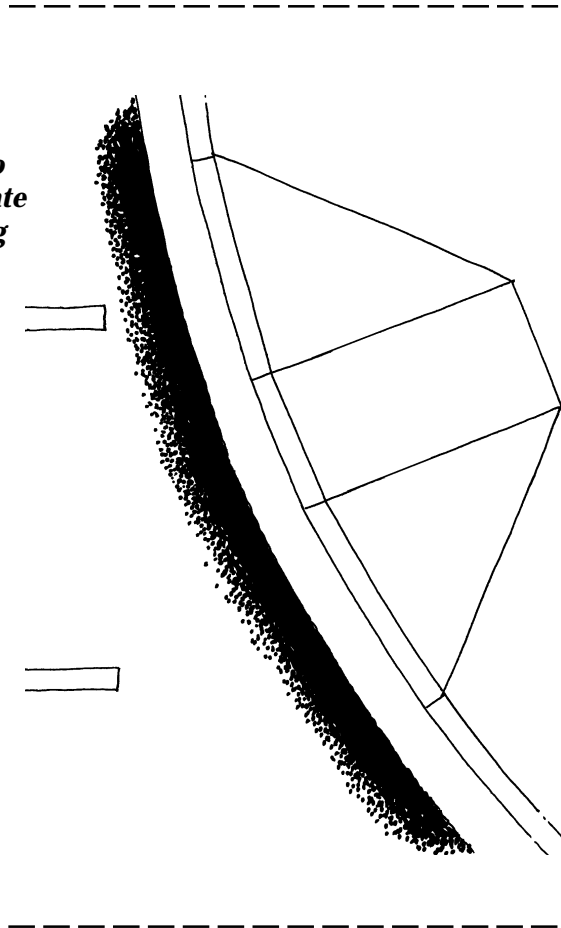
#### 4.4.1.5 Curb ramps and people with visual impairments

People with visual impairments do not use curb ramps in the same manner as people with mobility impairments. Although people with visual impairments can obtain helpful navigational cues from perpendicular curb ramps, they can learn the same information from the edge of the curb. Curb ramps and flare slopes that are steep enough relative to the grade of the surrounding sidewalk are more detectable than gradually sloped curb ramps or depressed corners (GA Institute of Technology, 1979). If people with visual impairments are unable to detect a curb ramp, they will not know that they are moving into the street. Installing detectable warnings on ramps can help people with visual impairments detect the

upcoming intersection (see Section 4.4.2). Some States also require minimum curb ramp slopes to improve detectability for people with visual impairments.

It is commonly believed that the orientation of curb ramps helps people with visual impairments determine the direction of the crosswalk. However, this technique is generally not taught or used because many curb ramps are not aligned with the path of travel across the street. The skew of diagonal curb ramps can be a particular source of confusion to people with visual impairments if other sidewalk cues present conflicting information about the intersection. Some dog-guide users interviewed for this project said they were most wary of diagonal curb ramps because their dogs might follow the curb ramp path out into the middle of the intersection. However, most people with visual impairments interviewed said that while a diagonal slope to the sidewalk indicated the presence of an intersection, they used other cues, such as the sound of traffic, to orient for the crossing.

**Figure 4-29:**  
**Curb ramps designed with the ramp perpendicular to the curb eliminate rapidly changing grades and cross-slopes at the grade transition.**



#### 4.4.2 Conveying Information to Pedestrians with Visual Impairments

All pedestrians must obtain a certain amount of information from the environment to travel along sidewalks safely and efficiently. Most pedestrians obtain this essential information visually, by seeing such cues as intersections, traffic lights, street signs, and traffic movements. People with visual impairments also use cues in the environment to travel along sidewalks. For example, the sound of traffic, the slope of curb ramps, changes in surface texture, and a shadow from an overhead awning serve as primary indicators of an upcoming intersection for people with visual impairments. Blind pedestrians also use their ability to estimate distances and directions they have walked (dead reckoning) to determine their location relative to desired destinations (Long and Hill, in Blasch et al., 1997).

Good design in the form of regularly aligned streets, simple crossing patterns, and easy-to-understand city layouts is generally the best method to provide good orientation cues for pedestrians with visual impairments. However, accessible information might be needed in some situations to supplement existing information. Locations where supplementary information is most beneficial include irregular intersections, open spaces such as plazas, raised intersections, and curb ramps with a slope less than 8.33 percent.

Some cues that people with visual impairments use are permanent, such as the edge of the curb; other cues, such as the sound of traffic, are intermittent. Although the sound of traffic is a very effective way for people with visual impairments to identify an intersection, it is unreliable because cars are not always present. Another issue that affects the usefulness of cues is a person's familiarity with the environment. For example, a person who lives near an intersection with a pedestrian-actuated control signal might be able to identify it easily because of repeated use and familiarity with its presence. However, a person who is unfamiliar with the intersection would be less likely to detect such a device. The most reliable cues for people with visual impairments are permanent and can be detected even in unfamiliar environments.

People with visual impairments should have access to the same information as sighted pedestrians when traveling in unfamiliar areas. To accommodate all pedestrians, it is important to provide information that can be assimilated using more than one sense. For example, an intersection that contains a raised tactile surface warning, a WALK signal light, and an audible pedestrian signal would be more accessible than an intersection that provides only a WALK signal light. Redundancy and multiplicity of formats increase the likelihood that people with

impairments and others will be able to make informed traveling decisions.

The most effective accessible information is easy to locate and intuitive to understand, even for pedestrians who are unfamiliar with an area. People with visual impairments stress the importance of consistency in design because accessible information added to the environment is most useful "when used in consistent locations so that the traveler can rely on their existence" and find them reliably (Peck and Bentzen, 1987). Users would benefit if each type of accessible indicator were exclusively reserved to indicate a specific situation in the pedestrian environment and consistently installed to avoid conveying conflicting and confusing information. Studies in the United Kingdom have shown that pedestrians with visual impairments can reliably detect, distinguish, and remember a limited number of different tactile paving surfaces and the distinct meanings assigned to them (Department of the Environment, Transport, and the Regions, Scottish Office, Notified Draft, 1997).

Visual, auditory, and tactile perceptual information is very useful in detecting cues and landmarks essential to wayfinding and is also important in detecting obstacles and hazards. Mobility is defined as "the act or ability to move from one's present position to one's desired position in another part of the environment safely, gracefully, and comfortably." Wayfinding is defined as "the process of navigating through an environment and traveling to places by relatively direct paths" (Long and Hill, in Blasch et al., 1997). The long cane is a primary example of an environmental probe that allows blind pedestrians to acquire perceptual information about their immediate environment systematically and efficiently. The long cane helps users establish and maintain orientation, as well as detect and avoid hazards.

Because people with visual impairments obtain information about the environment

in many ways, the most effective cues convey information in more than one format. For example, truncated domes can be detected not only by texture but by sound and color contrast as well. The greater number of sensory qualities (color, texture, resilience, and sound) the cue has, the more likely it will be detected and understood (Sanford and Steinfeld, 1985). The following are common types of accessible information added to sidewalk environments:

- Raised tactile surfaces used as detectable warnings
- Raised tactile surfaces used for wayfinding
- Materials with contrasting sound properties
- Grooves
- Contrasting colors for people with low vision
- Audible and vibrotactile pedestrian signals

#### 4.4.2.1 Raised tactile surfaces used as detectable warnings

Raised tactile surfaces used as warnings employ textures detectable with the touch of a foot or sweep of a cane to indicate

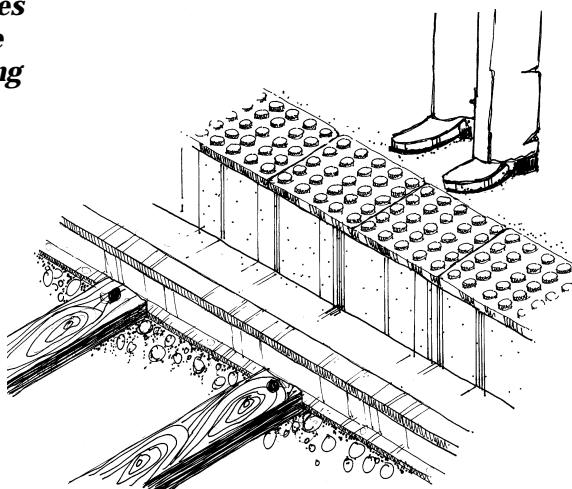
upcoming hazards or changes in the pedestrian environment. Many different types of raised tactile surfaces have been proven to be detectable by people with visual disabilities. However, tactile surfaces used as detectable warnings should meet the technical specifications in ADAAG (see Section 4.4.2.7) to avoid confusion with tactile surfaces used for wayfinding. Raised tactile surfaces include truncated domes, patterned panels, and other textured designs. Tactile surfaces used as detectable warnings must also provide color contrast with surrounding surface materials.

Raised tactile surfaces have been shown to be very effective in actual application. BART in the San Francisco Bay Area and METRO DADE transit in Miami have used raised tactile surfaces as systemwide warnings on platform edges since 1989 and have documented no instances of rider dissatisfaction with truncated dome surfaces (Figure 4-30). In contrast, the overall incidence of trips, slips, and falls at platform edges has been significantly reduced. In addition, BART riders exhibit an increased sense of drop-off awareness by tending to “stand farther from the platform edge than MUNI (San Francisco) riders standing at different tracks in the same stations but lacking detectable warnings” (Bentzen, Nolin, and Easton, 1994).

Domes with truncated tops are generally more comfortable than other dome designs for pedestrians to travel across (O’Leary, Lockwood, Taylor, and Lavelly, 1995). Low truncated domes have been used to provide warning information in a number of countries, including the United Kingdom (Department of the Environment, Transport, and the Regions, Scottish Office, Notified Draft, 1997), and Japan (Sawai, Takato, and Tauchi, 1998). In the United States, truncated domes are required at transit platform drop-offs (US DOJ, 1991; US DOT, 1991).

The detectability of raised tactile surfaces can depend upon the degree of contrast

**Figure 4-30:**  
**Truncated domes are an effective way of indicating a drop-off at transit platform.**





between the surface and the surrounding surface materials. For example, raised detectable surfaces have been shown to be significantly less detectable when located adjacent to coarse aggregate concrete (Bentzen, Nolin, Easton, Desmarais, and Mitchell, 1994). Raised surfaces are thus much more effective when placed next to smooth paving materials such as brushed concrete.

Climate can determine what type of detectable surface is most appropriate for a region. For example, ice was found to obscure the textural contrast of some raised surface materials (U.S. Access Board, 1985). Surfaces that withstand scraping by snowplows, minimize the collection of precipitation such as snow and ice, and resist degradation by snow-melting additives such as salt are most effective in colder areas. Some cities in the United States have discontinued the use of truncated domes at curb ramps because the materials used wore down quickly and could not be plowed free of snow. However, New York and New Jersey, both areas that experience significant amounts of snow and ice, continue to use raised tactile surfaces (O’Leary, Lockwood, Taylor, and Lavelly, 1995).

The length of raised tactile surfaces in the path of travel is most effective when “beyond the average stride in length” so that pedestrians with visual disabilities can “sense it physically, understand its meaning, and react appropriately” before the hazard is encountered (U.S. Access Board, 1995). However, there is a definite trade-off between the high detectability of raised tactile surfaces for people with visual disabilities and ease of movement for people with mobility disabilities (O’Leary, Lockwood, Taylor, and Lavelly, 1995).

Several researchers suggested limiting the width of detectable warnings to no more than that required to provide effective warning for people with visual impairments “given the moderately increased level of difficulty and decrease

in safety” that raised tactile surfaces on slopes pose for people with physical disabilities (Bentzen, Nolin, Easton, Desmarais, and Mitchell, 1994; Rabelle, Zabihaylo, and Gresset, 1998; Hughes, 1995). Truncated domes that are uneven or too high can cause navigation difficulties for certain sidewalk users, including some bicyclists and in-line skaters. People who use walking aids and pedestrians wearing high heels might lose some stability along ramps covered with raised tactile surfaces. Neither manual nor powered wheelchair users appear to be at significant risk of instability when traveling on ramps with raised warnings (Hughes, 1995).

#### **4.4.2.2 Raised tactile surfaces used for wayfinding**

Raised tactile surfaces also might provide wayfinding information to people with visual impairments, delineating paths across open plazas, crosswalks, and complex indoor environments such as transit stations. Wayfinding cues include raised tactile surfaces covered with bar patterns laid out in a path to indicate the appropriate walking direction, especially along routes where traditional cues such as property lines, curb edges, and building perimeters are unavailable. In Japan, bar tile has been used to direct pedestrians with visual impairments along transit stations and other heavily used pedestrian areas (Sawai, Takato, and Tauchi, 1998).

The city of Sacramento, California, uses a tactile guidestrip located in the center of some crosswalks to direct people with visual impairments across “irregular and complex” intersections. A San Francisco report recommended guidestrips at intersections with more than two streets, unusual crosswalks, right-turn lanes, diagonal crossings, exceptionally wide streets, and intersections with other unusual geometric designs (San Francisco Bureau of Engineering, 1996).

Hughes (1995) recommended that “mixed” patterns of both bar tiles and

dome tiles be developed for use on curb ramps to provide orientation, as well as warning information, at intersections. However, research in Japan indicated that subjects who were blind had difficulty distinguishing between detectable surfaces with bars and dots or domes. In fact, confusion between warning and guiding tiles was suspected as the cause of several train platform accidents in Japan (Bentzen, Nolin, and Easton, 1994).

#### 4.4.2.3 Materials with contrasting sound properties

Adjacent surfacing materials that make different sounds when tapped by a cane can also serve as navigation cues (U.S. Access Board, 1985). Examples of materials with contrasting sound properties include concrete sidewalks next to textured metal, or paving tiles next to rubberized raised tactile surfaces. Materials with contrasting sound properties are used along curb ramps, crosswalks, and transportation platforms. Contrasting materials can also be colored differently from the surrounding paving material (Figure 4-31) or textured to provide visual and tactile information as well.

Materials used to provide sound contrasts should be appropriate to the given setting. For example, materials that degrade in

harsh weather conditions or become slippery or hazardous when icy should not be installed outdoors but might be appropriate for indoor environments such as transit stations. People who use dog guides have a reduced opportunity to use sound cues, as described in this section.

#### 4.4.2.4 Grooves

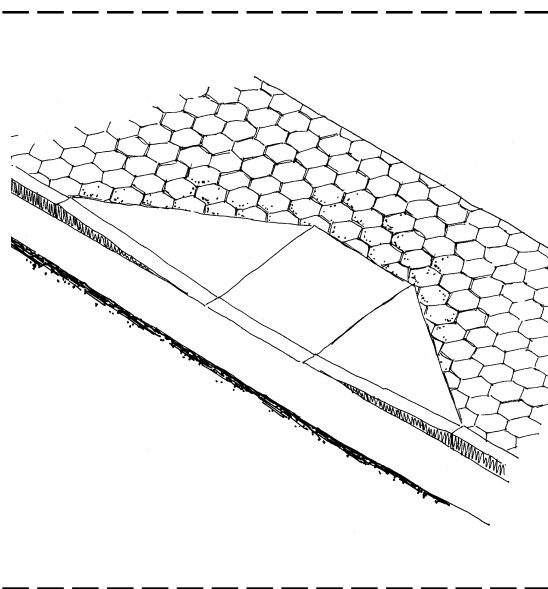
Grooves are common and inexpensive to install, but there is little evidence that they can be detected or used by people with visual disabilities. One study indicated that concrete panels with various groove configurations had only a 9 to 40 percent detectability rate (Templer, Wineman, and Zimring, 1982). Cane users could confuse them with the grooves between sidewalk panels and cracks in the sidewalk.

Long-cane users typically travel using a “two-point touch” technique and only scrape the tip of the cane along the ground in the “constant contact” technique when more in-depth exploration of an area is warranted. However, in general, grooves can be detected only by a cane if the constant-contact technique is used to scan the environment. For this reason, grooves are generally ineffective to warn of a potentially hazardous situation such as an intersection. In addition, dirt, snow, ice, weeds, and other debris in the sidewalk environment are likely to collect in grooves and obscure any warning provided.

#### 4.4.2.5 Contrasting colors for people with low vision

Contrasting colors such as yellow paint against black asphalt can indicate a change in environment for people with low vision. Texture differences may also be detected by people with low vision. For example, although sidewalk grooves do not provide a significant tactile contrast, some people with low vision can detect groove patterns visually. The color contrast of visual warnings helps both sighted and partially sighted pedestrians

**Figure 4-31:**  
**Colored stone sidewalks with concrete curb ramps have a detectable color change.**



to identify potentially hazardous areas. Colorized warnings are particularly useful for all pedestrians at night, when visual acuity and contrast sensitivity are impaired. Variations in surface coloring between the crosswalk and the street can also be used to mark the best path across an intersection. Reflective paint and building materials of contrasting colors are common methods used to provide visual warnings.

ADAAG Section 4.29.2 specifies that detectable warnings “shall contrast visually with adjoining surfaces, either light-on-dark, or dark-on-light.” ADAAG Section A4.29.2 further specifies that “the material used to provide contrast should contrast by at least 70%” (ADAAG, U.S. Access Board, 1991). The effectiveness of ADAAG’s recommendations for color contrast was evaluated by Bentzen, Lolin, and Easton (1994). The study concluded that the ADAAG 70 percent contrast recommendation “appears adequate to provide high visual detectability” but cautioned that minimum reflectance values should also be specified for the lighter surface to limit the effects of glare. The study also reported that surfaces colored safety yellow (ISO 3864) were most frequently chosen by low vision subjects as “most visually detectable” (Bentzen, Nolin, and Easton, 1994).

During the sidewalk assessments, visual warnings used on sidewalks were observed to include painted curb edges, tinted curb ramps, colored sidewalks (Figure 4-31), colorized raised tactile warnings, and painted crosswalks.

#### **4.4.2.6 Audible and vibrotactile pedestrian signals**

Although people with visual impairments generally rely on traffic surges to determine when it is safe to cross an intersection, additional information about crossing conditions can be very useful when traffic sounds are sporadic or masked by ambient noise, the geometry of the intersection is irregular, or acoustics

are poor. Accessible pedestrian signals can provide supplementary information, such as timing (when the signal cycle allows pedestrians to cross the street), wayfinding (which roads intersect at the junction), and orientation (the directional heading of each crosswalk). Accessible pedestrian signals are generally installed at complex intersections; intersections experiencing high volumes of turning traffic; major corridors leading to areas of fundamental importance such as post offices, courthouses, and hospitals; and places where people with visual impairments request them (Bentzen, 1998).

A number of different types of accessible pedestrian signals have been developed and were analyzed in a 1998 synthesis by B.L. Bentzen. These include audible broadcast, tactile, vibrotactile, and receiver-based systems, many of which may be integrated with each other to provide additional sources of information.

Audible traffic signals (ATSs) include devices that emit audible sounds when the signal permits pedestrians to cross. ATSs “comprise a warning system that alerts the pedestrian to the onset of a green light” (Hall, Rabelle, and Zabihaylo, 1994). Simple systems use a consistent sound to indicate when the signal has changed. More complex systems use one sound pattern to indicate north/south streets, and another sound to indicate east/west streets, providing both timing and orientation information. Others broadcast prerecorded speech messages telling the name of the street being crossed and the status of the signal cycle (Bentzen, 1998). Street crossings that can be negotiated easily by people with visual impairments are preferred to ATS systems. These systems should be installed only “as a last resort, and only when the installation will guarantee the safety of the visually impaired pedestrian” (Hall, Rabelle, and Zabihaylo, 1994).

Alternating ATS systems, in which speakers on either side of the street

alternate indicator sounds, provide alignment assistance for pedestrians with visual impairments. “An alternating signal counters the masking effect of the nearby signal [and] promotes more accurate alignment before crossing and straight-line travel throughout the crossing” (Hall, Rabelle, and Zabihaylo, 1994). Alternating ATS systems result in a straighter line of travel because they allow people with visual disabilities “to align themselves more accurately before and during the crossing. . . .” (Hall, Rabelle, and Zabihaylo, 1994).

Audible information is also useful to identify pedestrian-actuated control signals. Audible pedestrian signals that alert pedestrians to the existence and location of the signal actuator include push-button devices that emit sounds. Tactile pedestrian signals include raised arrows on the signal actuator that indicate which street is controlled by the push button. Tactile pedestrian signals can also provide map information, using raised dot and line symbols to indicate details such as the number of lanes to be crossed, the direction of traffic in each lane, and whether there is a median (Bentzen, 1998).

Vibrotactile traffic devices also can provide information about the presence and location of a pedestrian-actuated signal. In vibrotactile systems, the push-button apparatus will vibrate while pedestrians are permitted to cross. Such systems allow deaf-blind pedestrians to identify the WALK interval and can be installed at medians to prevent signal overlap when audible broadcast signals are in effect (Bentzen, 1998).

Receiver-based systems provide audible or other accessible information only when triggered by a nearby pedestrian-carried receiver. The Talking Signs® system, for example, uses transmitters that emit infrared beams containing prerecorded speech information. The speech message can label streets, transit kiosks, and other areas. The transmitters can be mounted on

traffic poles, buildings, and other significant locations. Pedestrians using the system carry a receiver that picks up the infrared signals and plays them back as audible messages. This system provides both orientation and wayfinding information. The user can hone in on the transmitter’s location because the messages are played most clearly when the receiver is oriented directly toward the transmitter (Bentzen, 1997, in Blasch et al.)

#### **4.4.2.7 ADAAG requirements for detectable warnings**

When ADAAG was first approved in 1991, it contained requirements for detectable warnings at curb ramps, transit platforms, reflecting pools, and hazardous vehicular areas. ADAAG defined a detectable warning as “a standardized surface feature built in or applied to walking surfaces or other elements to warn visually impaired people of hazards on a circulation path.” Detectable warnings on walking surfaces were required to be truncated domes with a diameter of 23 mm (0.9 in.), a height of 5 mm (0.2 in.) and a center-to-center spacing of 60 mm (2.35 in.). In addition, detectable warnings had to offer a strong visual contrast to adjacent pedestrian surfaces and had to be an integral part of the walking surface (ADAAG, U.S. Access Board, 1991).

On April 1, 1994, the ADAAG scoping provisions for detectable warnings at curb ramps, hazardous vehicular areas, and reflecting pools were initially suspended until July 1996, and were later extended until July 26, 1998, and 2001, while the requirements for detectable warnings at transit platforms remained in effect. The requirement was initially suspended to allow the U.S. Access Board, the US DOJ, and the US DOT to consider the results of additional research on the need for and safety effects of detectable warnings at vehicular–pedestrian intersections.

The study found that, although detectable warnings were not shown to be needed at all curb ramp locations, they did provide “the blind traveler with one potential additional cue that is especially useful in a low-cue environment.” Many nonvisual cues used to detect streets are intermittent, such as the sound of traffic. Detectable warning surfaces provide a permanent cue that identifies the transition between the sidewalk and the street. The study concluded that “the effectiveness of detectable warning surfaces on curb ramps depends greatly on other aspects of the design of the intersection, as well as on such social factors as the density of traffic and the skills of the traveler.” The study recommended the installation of a 2-foot-wide strip of detectable surface at the curb line as an alternative to covering the entire surface of the ramp (Hauger et al., 1996).

#### 4.4.3 Driveway Crossings

Driveway crossings permit cars to cross the sidewalk and enter the street, and they consist of the same components found in curb ramps. It is the driver’s responsibility to yield to the pedestrian at the driveway–sidewalk interface.

Intersections of driveways and sidewalks are the most common locations of severe cross-slopes for sidewalk users. Some inaccessible driveway crossings have cross-slopes that match the grade of the driveway because a level area is not provided for the crossing pedestrian. This type of crossing can be very difficult for people who use wheelchairs or walking aids (Figure 4-32).

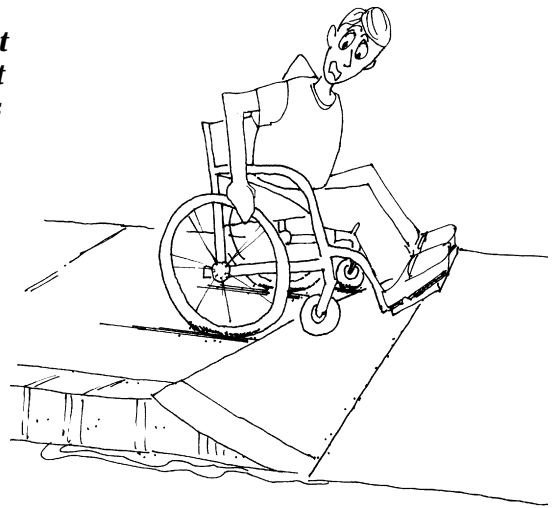
Rapid changes in cross-slope usually occur at driveway flares and are most problematic when they occur over a distance of less than 0.610 m (24 in), or the approximate length of a wheelchair wheelbase. As the wheelchair moves over the surface of a severely warped driveway flare, it will first balance on the two rear wheels and one front caster. As the

wheelchair continues to move forward, it then tips onto both front casters and one rear wheel (Figure 4-32). Rapidly changing cross-slopes also can cause wheelchair users to lose directional control, veer downhill toward the street, and potentially tip over. This phenomenon can also cause pedestrians who use walking aids to stumble. For more information on rate of change of cross-slope, refer to Section 4.3.2.

Well-designed driveway crossings eliminate severe cross-slope along the path of travel. Driveway crossings designed along setback sidewalks can easily be made accessible because the setback permits designers to maintain a level path of travel along the sidewalk. The driveway ramp then resumes sloping at the setback (Figure 4-33).

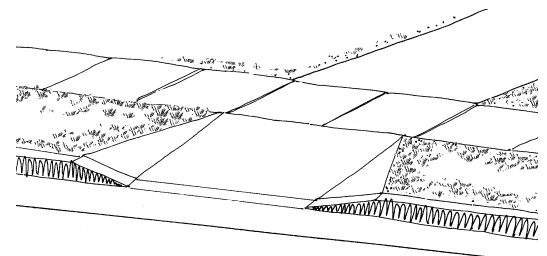
**Figure 4-32:**

***Driveway crossings without landings confront wheelchair users with severe and rapidly changing cross-slopes at the driveway flare.***

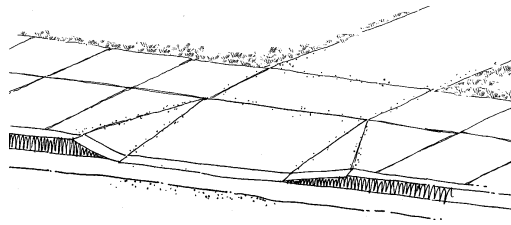


**Figure 4-33:**

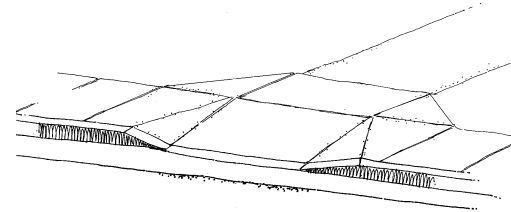
***When sidewalks have a planter strip, the ramp of the driveway does not interfere with a pedestrian’s path of travel.***



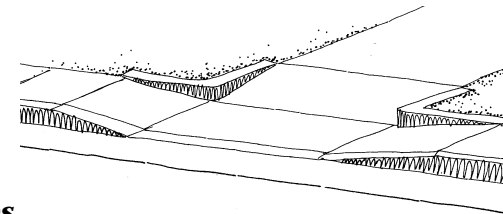
**Figure 4-34:**  
**On wide sidewalks, there is enough room to provide a ramp for drivers and retain a level landing for pedestrians.**



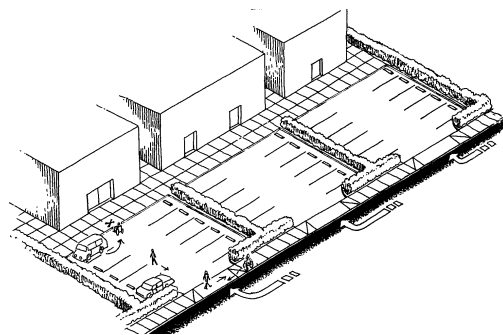
**Figure 4-35:**  
**Jogging the sidewalk back from the street provides a level landing for pedestrians on narrow sidewalks.**



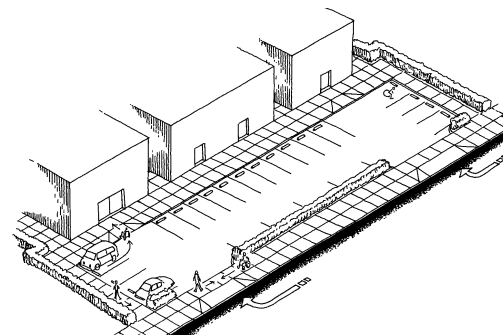
**Figure 4-36:**  
**Although parallel driveway crossings provide users with level landings, users continuing on the sidewalk are forced to negotiate two ramps.**



**Figure 4-37:**  
**Inaccessible sidewalk caused by many individual parking lots.**



**Figure 4-38:**  
**Improved accessibility created by combining parking lots and reducing the number of entrances and exits.**



Wide sidewalks can be designed similar to sidewalks with a setback if the upper portion of the sidewalk is leveled for pedestrians and the bottom portion is sloped for automobiles (Figure 4-34).

A level landing area can be achieved on narrow sidewalks if the sidewalk is jogged back from the street as it crosses the driveway (Figure 4-35). Purchasing additional land to jog the sidewalk back should be strongly considered when there is not enough space for a level sidewalk.

Similar to a parallel curb ramp, a parallel driveway crossing provides a level landing by lowering the sidewalk to the grade of the street (Figure 4-36). This design is preferable to the severe cross-slopes at some driveway crossings, but it is not as easy to negotiate as setback and wide sidewalk designs. With this type of crossing, drivers assume that they can speed up on the level portion next to the street. In addition, the parallel ramp can produce steep grades on both sides of the driveway and initiate drainage problems on the landing.

Commercial districts with front parking between the sidewalk and the buildings are often designed with a series of individual lots with individual entrances and exits (Figure 4-37). This design increases the number of driveway crossings and forces pedestrians to encounter automobiles repeatedly. If the driveway crossings do not have level landings, people with mobility disabilities must also repeatedly negotiate severe cross-slopes. To improve access for all pedestrians, including pedestrians with mobility disabilities, individual parking lots should be combined to reduce the number of entrances and exits. The remaining driveway crossings should be retrofitted to include level landings (Figure 4-38).

#### 4.4.4 Medians and Islands

Medians and islands help pedestrians cross streets by providing refuge areas that are physically separated from the automobile path of travel. A *median* separates opposing lanes of traffic. An *island* is a protected spot within a crosswalk for pedestrians to wait to continue crossing the street or to board transportation such as a bus. Medians and islands are useful at irregularly shaped intersections, such as where two roads converge into one (Earnhart and Simon, 1987).

Medians and islands reduce the crossing distance from the curb and allow pedestrians to cross during smaller gaps in traffic. Examples of cut-through medians and ramped and cut-through islands are shown in Figure 4-39 and 4-40. Medians and islands are useful to pedestrians who are unable to judge distances accurately. Medians and islands also help people with slow walking speeds cross long intersections with short signal cycles. Because medians and islands separate traffic into channels going in specific directions, they require crossing pedestrians to watch for traffic coming in only one direction.

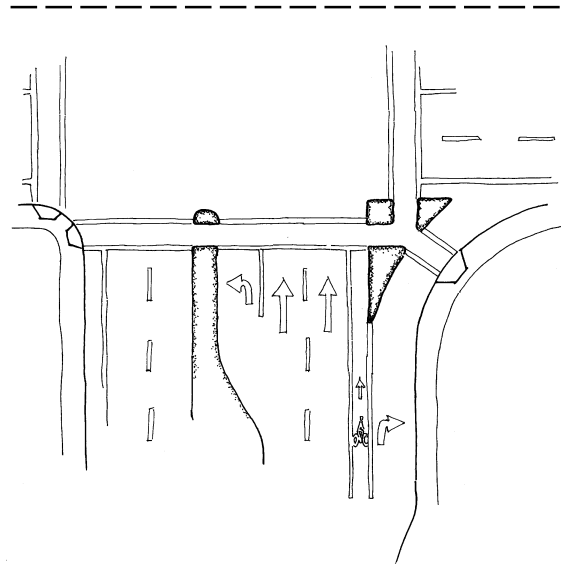
According to ADAAG, a raised island or median should be level with the street or have curb ramps at all sides and a level area 1.220 m (48 in) long in all directions. If a cut-through design is used, it should be at least 0.915 m (36 in) wide. Cut-through medians are easier for wheelchair users and other people with mobility impairments to negotiate than ramps. In addition, the edge of a cut-through can provide directional information to people with visual impairments. However, if the cut-through is too wide, people with visual impairments might not detect the presence of a median or island. For this reason, the width of the cut-through should be limited to ensure detection by people with visual impairments. A detectable warning on the surface of the cut-through will also improve detectability.

#### 4.4.5 Crosswalks

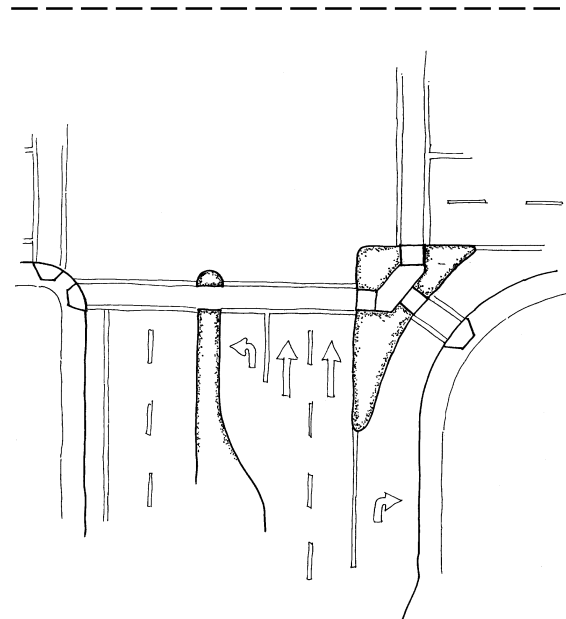
Crosswalks are a critical part of the pedestrian network. A crosswalk is defined as “the portion of a roadway designated for pedestrians to use in crossing the street” and may be either marked or unmarked (Institute of Transportation Engineers, Technical Council Committee 5A-5, 1998).

Marked crosswalks are most effective when they can be identified easily by motorists. However, many pedestrians,

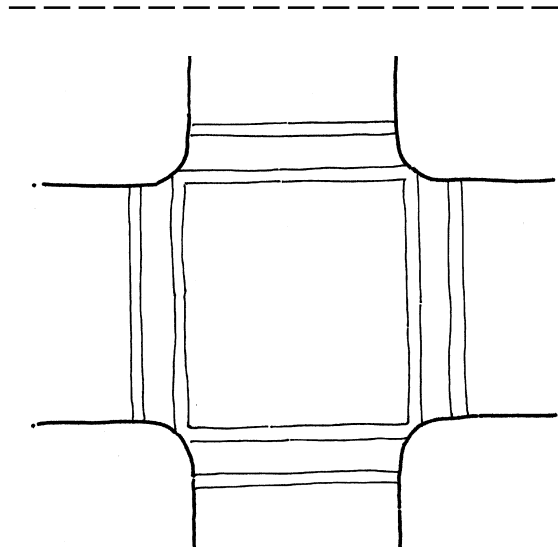
**Figure 4-39:**  
***Cut-through corner island and center median***  
(based on OR DOT, 1995).



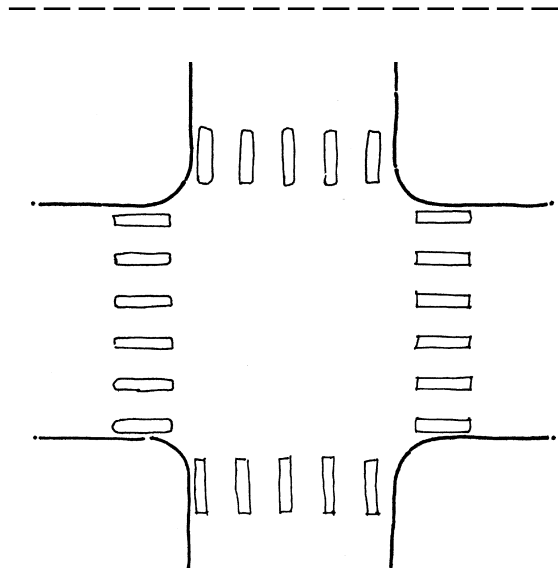
**Figure 4-40:**  
***Ramped corner island and cut-through median***  
(based on OR DOT, 1995).



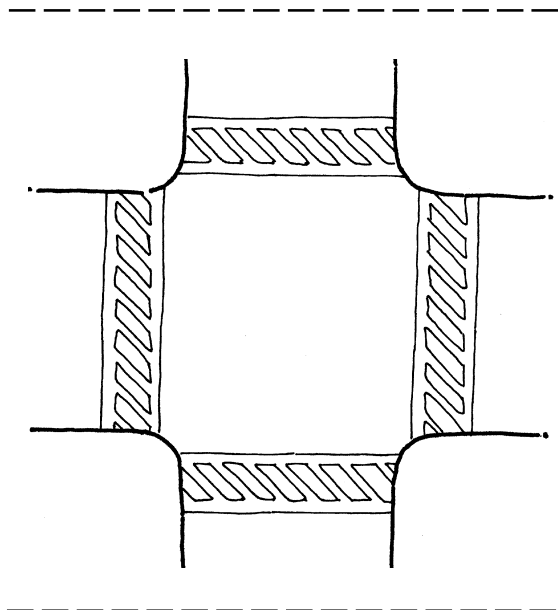
**Figure 4-41:**  
Two horizontal lines are the most common crosswalk markings.



**Figure 4-42:**  
A ladder design was found to be the most visible type of pedestrian crosswalk marking.



**Figure 4-43:**  
Diagonal markings enhance visibility.



including pedestrians with low vision, benefit from clearly marked crosswalks. For this reason, proposed Section 14 (1994) required marked crossings to be “delineated in materials or markings that provide a visual contrast with the surface of the street” (U.S. Access Board, 1994b). Most State DOTs follow the *Manual of Uniform Traffic Control Devices (MUTCD)* guidelines for marking crosswalks. Although the MUTCD does permit some variations for additional visibility, the basic specifications call for solid white lines not less than 150 mm (6 in) marking both edges of the crosswalk and spaced at least 1.830 m (72 in) apart (US DOT, 1988) (Figure 4-41). A study by Knoblauch, Testin, Smith, and Pietrucha (1988) found the ladder design, shown in Figure 4-42, to be the most visible type of crosswalk marking for drivers. Diagonal striping can also enhance the visibility of a pedestrian crossing (Figure 4-43).

When a diagonal curb ramp is used at an intersection, a 1.220-m (48-in) clear space should be provided to allow ramp users enough room to maneuver into the crosswalk.

In some situations, marked crosswalks might not be enough to ensure pedestrian safety. For example, at high-speed intersections without traffic signals, drivers often cannot perceive a marked crosswalk quickly enough to react to pedestrians in the roadway. This problem is compounded by the fact that “pedestrians may ‘feel safer’ within a marked crosswalk and expect motorists to act more cautiously” (Institute of Transportation Engineers, Technical Council Committee 5A-5, 1998). Some agencies around the United States consider that removing crosswalk markings improves pedestrian safety. Alternative treatments such as electronically activated crosswalks, pedestrian-actuated traffic controls, flashing traffic signals, light guard flashing crosswalks, traffic calming measures, raised crosswalks, and traffic



signals are also being used. FHWA studies are currently being conducted to determine if these measures provide safer crossing for pedestrians.

Most marked crosswalks observed during the sidewalk assessments were marked with paint. Others were built with contrasting materials such as red brick inside the crosswalk, bordered with gray concrete. Contrasting textures can provide tactile guidance for people with visual impairments, as well as visible colorized warnings.

#### 4.4.6 Crossing Times

People's walking pace and starting pace varies depending on their personal situation. Older pedestrians might require longer starting times to verify that cars have stopped. They also might have slower reaction times and slower walking speeds. Powered wheelchair users and manual wheelchair users on level or downhill slopes might travel faster than other pedestrians. But on uphill slopes, manual wheelchair users might have slower travel speeds. At intersections without audible pedestrian signals, people with visual impairments generally require longer starting times because they rely on the sound of traffic for signal-timing information.

The *AASHTO Green Book* indicates that "average walking speeds range from 0.8 to 1.8 m/s." The MUTCD assumes an average walking speed of 1.220 m/s (4 ft/s). However, research on pedestrian walking speeds has demonstrated that more than 60 percent of pedestrians walk more slowly and that 15 percent of pedestrians walk at less than 1.065 m/s (3.5 ft/s) (Kell and Fullerton, 1982). The *AASHTO Green Book* recommends a walking rate of 1.0 m/s (39 in/s) for older pedestrians (AASHTO, 1995).

Pedestrians of all mobility levels need to cross intersections. However, when

crossing times accommodate only people who walk at or above the average walking speed, intersections become unusable for people who walk at a slower pace. To accommodate the slower walking speeds of some pedestrians, transportation agencies should consider extending their pedestrian signal cycles. Signal timing should be determined on a case-by-case basis, although extended signal cycles are strongly recommended at busy intersections that are unusually long or difficult to negotiate.

#### 4.4.7 Pedestrian-Actuated Traffic Controls

Pedestrian-actuated traffic controls require the user to push a button to activate a walk signal. According to the MUTCD, pedestrian-actuated traffic controls should be installed when a traffic signal is installed under the Pedestrian Volume or School Crossing warrant, when an exclusive pedestrian phase is provided, when vehicular indications are not visible to pedestrians, and at any established school crossings with a signalized intersection (US DOT, 1988). If the intersection has a median, a button should be added to the median and both corners.

Unfortunately, pedestrian-actuated control signals are often inaccessible to people with mobility impairments and people with visual impairments. To be accessible to wheelchair users and people with limited mobility, pedestrian-actuated traffic controls need to be located as close as possible to the curb ramp without reducing the width of the path. They also need to be mounted low enough to permit people in wheelchairs to reach the buttons. ADAAG does not specify a height for pedestrian-actuated control systems. However, ADAAG Section 4.10.3 states that elevator buttons should be located no higher than 1.065 m (42 in) (ADAAG, U.S. Access Board, 1991).

The size and type of the button also affect the accessibility of the control. Larger raised buttons are easier for people with visual impairments to identify (Figure 4-44). According to proposed Section 14 (1994), buttons should be raised above or flush with their housings and be at least 50 mm (2 in) in the smallest dimension (U.S. Access Board, 1994b).

Pedestrian-actuated control buttons require more force to operate than most indoor buttons. However, people with limited hand strength or dexterity might be able to exert only a limited amount of force. To address this need, proposed Section 14 (1994) recommended that the force required to activate controls should not be greater than 22.2 N (5 lbf) (U.S. Access Board, 1994b).

People with visual impairments might be at a disadvantage at intersections with pedestrian-actuated crossing controls if they are unaware that they need to use a

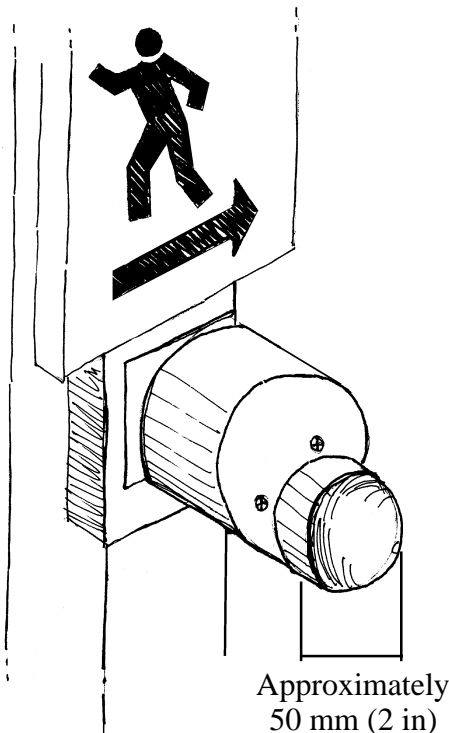
control to initiate a pedestrian crossing signal. At an intersection with a pedestrian-actuated control button, a person with a visual impairment must detect whether a signal button is present, then push it and return to the curb to align for the crossing. This process might require several signal cycles if the button is not located within easy reach of the curb edge. People with visual impairments can confirm the presence of and locate pedestrian-actuated crossing controls more easily if the controls emit sounds and/or vibrations. To address the need for pedestrian-actuated control signals that are accessible to people with visual impairments, TEA-21 provides funding for “the installation, where appropriate, and maintenance of audible traffic signals and audible signs at street crossings” (TEA-21, 1998). Accessible pedestrian signals that accommodate people with visual impairments are discussed in Section 4.4.2.6 of this report.

Many varieties of controls were observed during the sidewalk assessments. The most accessible were relatively large and could be activated with little force. Those that were least accessible were small, required significant force to activate, and were located far from the logical crossing point. Some pedestrian-actuated traffic controls were positioned so that users standing at the edge of the sidewalk had to walk around traffic poles to reach the control button. In other instances, obstacles such as newspaper stands were placed in front of the controls, blocking access to the trigger mechanism. Intersections with awkwardly placed pedestrian-actuated controls can be made more accessible by moving the control to a more easily reached location or altering the signal timing to allow pedestrians to realign themselves for a crossing before the light changes.

#### 4.4.8 Midblock Crossings

Midblock crossings are pedestrian crossing points that do not occur at

**Figure 4-44:**  
**A large, easy-to-press button makes pedestrian-actuated traffic controls more usable for people with limited hand strength and dexterity.**



intersections. They are often installed in areas with heavy pedestrian traffic to provide more frequent crossing opportunities. For midblock crossings to be accessible to people with mobility impairments, a curb ramp needs to be installed at both ends of the crossing along a direct line of travel. If the curb ramps are offset, pedestrians who rely on the curb ramps are forced to travel in the street.

For midblock crossings to be accessible to people with visual impairments, they need to be detectable. At midblock crossings, pedestrians with visual impairments do not have the sound of parallel traffic available to identify a midblock crossing opportunity. If a traffic signal is installed, an audible indicator that provides timing information should also be included. Audible or vibrotactile information is effective in alerting people with visual impairments of a midblock crossing.

Midblock crossings spanning multiple lanes can be difficult for some pedestrians to cross. In these situations, curb extensions can be effective in reducing crossing times and increasing visibility between pedestrians and motorists (Figure 4-45). A median is another effective method to reduce crossing distances.

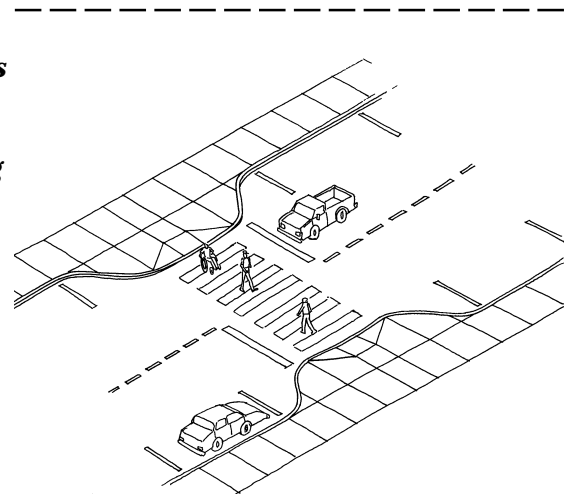
#### 4.4.9 Sight Distances

Sight distance is defined as “the distance a person can see along an unobstructed line of sight” (University of North Carolina, Highway Safety Research Center, 1996). Adequate sight distances between pedestrians and motorists increase pedestrian safety. Motorists also need appropriate sight distances to see traffic signals in time to stop. Vertical sight distance can be important for drivers of high vehicles such as trucks and buses, whose sight lines might be blocked by trees or signs (ibid.). Although bollards, landscaping, parking, benches, or bus shelters make pedestrian areas more

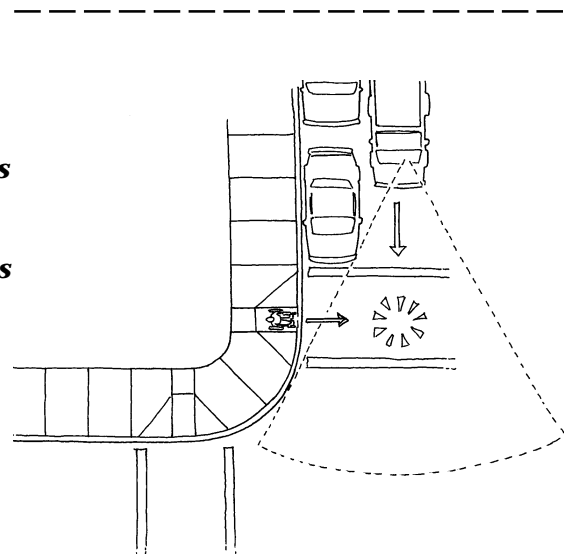
inviting by calming traffic and providing amenities, they can also clutter the environment and block sight lines between motorists and pedestrians waiting to cross the intersection.

Trimming vegetation, relocating signs, and hanging more than one sign or traffic signal on one arm pole where permitted by MUTCD can improve sight distances at corners. Parked cars near the intersection or midblock crossing can also reduce sight distances (Figure 4-46). Installing curb extensions physically deters parking at intersection corners and improves the visibility of pedestrians, as

**Figure 4-45:**  
**Curb extensions at midblock crossings help reduce crossing distance.**

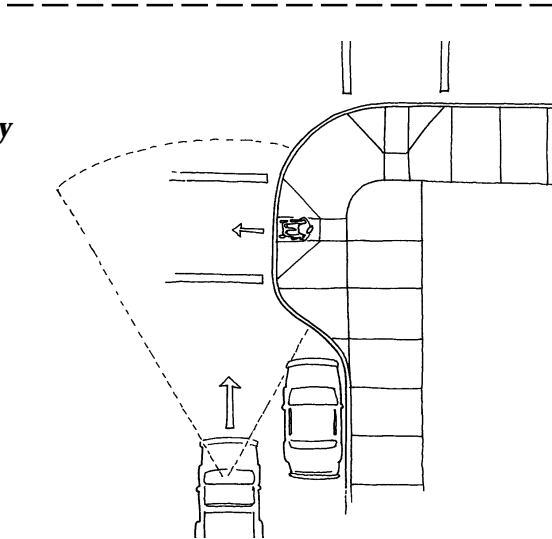


**Figure 4-46:**  
**Sight line obstructed by parked cars prevents drivers from seeing pedestrians starting to cross the street.**

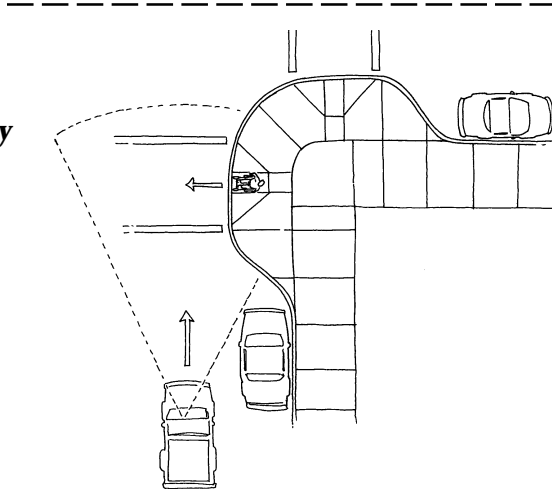


shown in Figures 4-47 and 4-48. Curb extensions can also increase the angle at which pedestrians meet motor vehicles, improving the visibility of both (OR DOT, 1995). In addition, curb extensions shorten crossing distances and provide sidewalk space for curb ramps with landings.

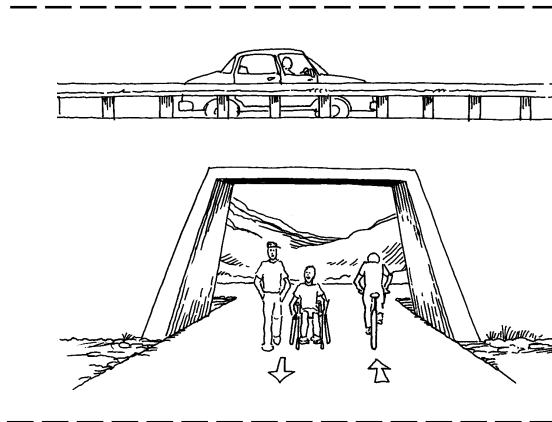
**Figure 4-47:**  
**Partial curb extensions improve visibility between pedestrians and motorists.**



**Figure 4-48:**  
**Full curb extensions improve visibility between pedestrians and motorists.**



**Figure 4-49:**  
**Pedestrian and biker underpass.**



#### 4.4.10 Grade-Separated Crossings

Grade-separated crossings are facilities that allow pedestrians and motor vehicles to cross at different levels. Some grade separated crossings are very steep and are difficult for people with mobility impairments to negotiate. In addition, grade-separated crossings are extremely costly to construct and are often not considered pedestrian-friendly because pedestrians are forced to travel out of their way to use the underpass or overpass. The effectiveness of a grade-separated crossing depends on whether or not pedestrians perceive that it is easier to use than a street crossing (Bowman, Fruin, and Zegeer, 1989).

Examples of grade-separated crossings include the following (Institute of Transportation Engineers Technical Council Committee 5A-5, 1998):

- *Overpasses* — bridges, elevated walkways, and skywalks or skyways
- *Underpasses* — pedestrian tunnels and below-grade pedestrian networks

Figure 4-49 illustrates a pedestrian underpass.

The needs of pedestrians should be a high priority at grade-separated crossings. If designed correctly, grade-separated crossings can reduce pedestrian-vehicle conflicts and potential accidents by allowing pedestrians to avoid crossing the path of traffic. They can also limit vehicle delay, increase highway capacity, and reduce vehicle accidents when appropriately located and designed. Grade-separated crossings can improve pedestrian safety, reduce travel time, and serve to maintain the continuity of a neighborhood in which high-traffic roads run through residential areas (University of North Carolina, Highway Safety Research Center, 1996).

Grade-separated crossings are most efficient in areas where pedestrian attractions such as shopping centers, large schools, recreational facilities, parking garages, and other activity centers are separated from pedestrian generators by high-volume and/or high-speed arterial streets.

Well-designed grade-separated crossings minimize slopes, feel open and safe, and are well lit. Minimizing the slope of a grade-separated crossing is often difficult because a significant rise, generally from 4.3 to 5.5 m (14 to 18 ft), must be accommodated. Inaccessible grade-separated crossings should not be constructed. In some situations, elevators can be installed to accommodate people with mobility impairments.

Underpasses might invite crime if insufficiently lit and seldomly traveled. Underpasses can also be more expensive to install than other pedestrian facilities

because a tunnel must be dug and utility lines relocated. Tunnels are more inviting to use when they are brightened with skylights or artificial lighting and are wide and high enough to feel open and airy (ibid.).

#### 4.4.11 Roadway Design

Sidewalk accessibility is intimately affected by the design of roads. Factors affecting roadway safety and accessibility for pedestrians include sight distance, design speed, location, cross-slope, grade, and the functional class of the road. Although some States have their own guidelines, most roadway designers rely on the *AASHTO Green Book* for street development specifications. The *AASHTO Green Book* recognizes several general factors as important to the functionality of public rights-of-way, including the grade of the road, cross-slopes, traffic control devices, curbs, drainage, the road crown, and roadway width (Table 4-1).

**Table 4-1:**

**Grade, Cross-Slope, and Curb Height Guidelines by Functional Class of Roadway (based on information contained in AASHTO, 1995)**

Road Type	Maximum Grade (%) <sup>1</sup> Level/Rolling/Mountain	Cross-Slope <sup>3</sup> (%)	Curb Height (mm)	Sidewalk Coverage
Urban local	Consistent with terrain  <15.0/<8.0 <sup>2</sup>	1.5–6.0 <sup>4</sup>	100–225	Commercial — both sides  Residential — at least one side
Rural local	8.0/11.0/16.0	1.5–6.0 <sup>4</sup>	n/a	n/a <sup>5</sup>
Urban collector	9.0/12.0/14.0	1.5–3.0	150–225	Same as Urban local
Rural collector	7.0/10.0/12.0	1.5–3.0	n/a	n/a <sup>5</sup>
Urban arterial	8.0/9.0/11.0	1.5–3.0	150–225	n/a <sup>5</sup>
Rural arterial	5.0/6.0/8.0	1.5–2.0	n/a	n/a <sup>5</sup>
Recreational	8.0/12.0/18.0	n/a	n/a	n/a <sup>5</sup>

Chart does not include figures for freeways or divided arterials, which are not designed for pedestrians and are not built with sidewalks.

<sup>1</sup> The lower the maximum speed permitted on the road, the steeper the grade is permitted to be. The numbers listed in the chart represent the lowest road speeds indicated in the *AASHTO Green Book*.

<sup>2</sup> Residential/commercial or industrial.

<sup>3</sup> The numbers listed in the chart indicate what the cross-slope should generally be for proper drainage.

<sup>4</sup> Cross-slopes ranging from 3.0 to 6.0 percent should be used only for low surface types such as gravel, loose earth, and crushed stone.

<sup>5</sup> Sidewalks are still needed, even though the *AASHTO Green Book* does not specify guidelines for sidewalk coverage along this road.

The functionality of a roadway should be balanced with the needs of pedestrians. Too often, roadway design prioritizes the needs of motorists, and pedestrians are put at risk. Pedestrians would be well accommodated if they received the same design considerations as drivers. When a sidewalk is included along a roadway, it must be accessible according to the ADA regulations. To accomplish this task, roadway designers must understand how roadway designs impact pedestrians and prioritize accessible road development.

The manner in which roads are maintained also impacts pedestrians. Asphalt, an economical and durable material, is used to pave most roads. In the past, repairing damage to asphalt roads typically entailed overlaying the existing pavement with more asphalt. Over time, the asphalt layers build up the roadway crown and can create steep slopes on either side of the centerline. These slopes can be difficult for crossing pedestrians to negotiate (Figure 4-50) and create rapidly changing grades at curb ramps. Because

used asphalt can now be recycled, it is currently more common for roads to be milled before they are resurfaced. To improve accessibility, roads should always be milled before being resurfaced. The same amount of asphalt to be added to a road should be milled away prior to any resurfacing project. Milling should be completed from gutter to gutter to avoid crowning (Figure 4-51). In addition, because the US DOJ has indicated that “resurfacing beyond normal maintenance is an alteration,” accessibility improvements such as curb ramp installations must also be incorporated into road resurfacing projects (US DOJ, 1994).

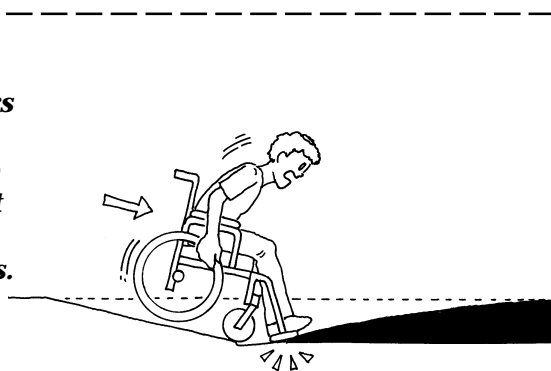
#### 4.4.12 Drainage

Sidewalks and sidewalk elements, such as curb ramps and driveway crossings, must be designed to provide efficient drainage as well as good access. Sidewalks provide the main conduit for draining the walking surface, adjacent properties, and, in some cases, the roadway. Sidewalks with poor drainage can accumulate precipitation that is not only a nuisance but might impede access or endanger the health, safety, and welfare of all pedestrians. For example, poorly drained sidewalks in cold climates can freeze over with ice and cause a hazard for pedestrians. Poorly drained sidewalks also permit the accumulation of silt and debris, further impeding access. The *AASHTO Green Book*, adopted by most States, provides slope ranges based on street type (Table 4-1).

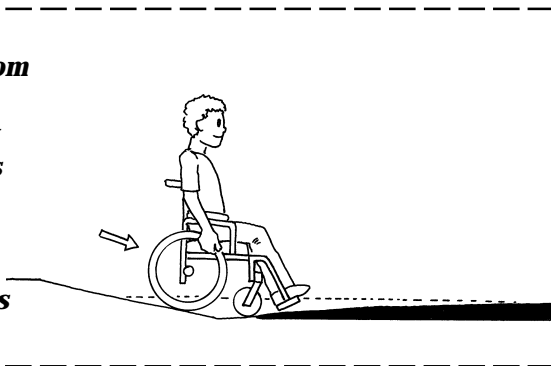
Local topography and weather conditions also affect how steeply sidewalks, gutters, and roads should be sloped to provide adequate drainage. According to the *AASHTO Green Book*, a cross-slope between 1.5 to 2.0 percent provides effective drainage on paved surfaces in most weather conditions (AASHTO, 1995).

Gutters are generally sloped more steeply than the roadway to increase runoff velocity. Concrete gutters are smoother,

**Figure 4-50:**  
**When roads are not milled, layers of asphalt build up and make the crossing difficult for wheelchair users and others.**



**Figure 4-51:**  
**Milling roads from gutter to gutter prevents rapidly changing grades and makes intersections easier for wheelchair users to negotiate.**



offer less resistance to runoff, and are more water-resistant than asphalt, but they are also more expensive to install. According to the *AASHTO Green Book*, gutters should have “a cross-slope of 5 to 8 percent to increase the hydraulic capacity of the gutter section” (AASHTO, 1995). ADAAG specifies a 5 percent maximum slope at gutters (ADAAG, U.S. Access Board, 1991). This provision helps prevent wheelchair users from hitting their footrests on the ramp or gutter and potentially being thrown forward out of their wheelchairs. Section 4.3.1 contains additional information on rate of change of grade and gutter design.

A wider gutter can be used to drain larger volumes of water without increasing the slope experienced by curb ramp users. However, widening the gutter might require the purchase of additional right-of-way. According to the *AASHTO Green Book*, gutters formed in combination with curbs should range from 0.3 m to 1.8 m (12 in to 71 in) wide (AASHTO, 1995).

Barrier curbs are higher than other types of curbs to discourage vehicles from leaving the roadway (AASHTO, 1995). The height and more perpendicular face of barrier curbs also help sidewalks from being inundated in areas prone to flooding. High curbs can also cause curb ramps to be longer and occupy more sidewalk or street space. These restrictions make it more difficult to install accessible ramps on narrower sidewalks.

Storm drains and catch basins are normally placed where they will intercept surface water runoff. Installing a curb ramp at a point of strategic runoff interception can compromise effective drainage. Regrading the section of road or curb ramp location to alter drainage patterns can resolve some situations in which drainage concerns conflict with accessibility requirements. Ideally, inlets should be placed uphill of crossings or curb ramps to drain water before it can puddle where pedestrians are crossing. In locations with heavy rainfall,

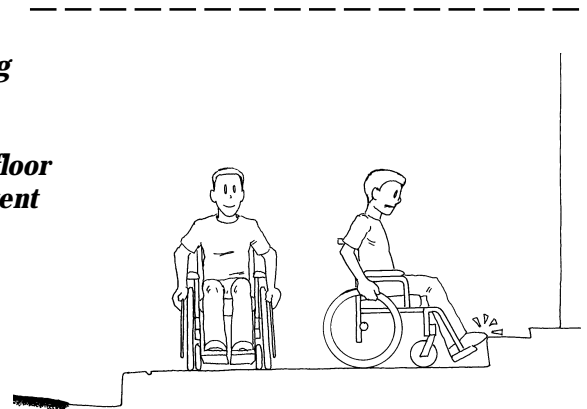
more frequent drainage inlets, more strategic placement of inlets, and basin pickups will also reduce the frequency of puddles.

#### 4.4.13 Building Design

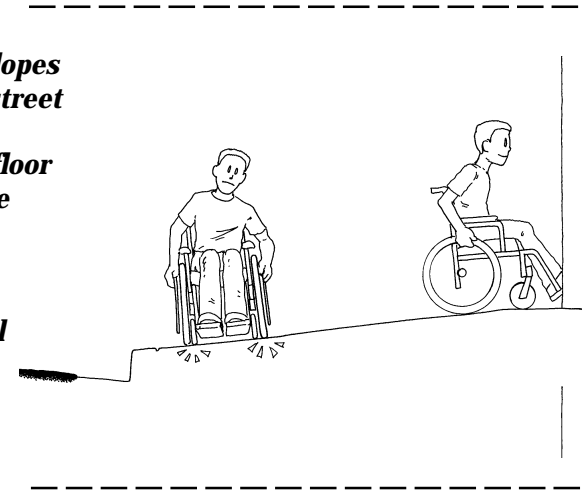
Newly constructed buildings are required to be accessible under Titles II and III of the ADA. Building entrances must be at grade with the sidewalk or provide accessible ramps to bridge elevation changes between the building and the street. In some existing facilities, a significant elevation difference exists between the street and the finished floor elevation (FFE) of the building. Inaccessible building entrances with stairs or sidewalks with significant cross-slopes are often the result (Figures 4-52 and 4-53).

Factors influencing the FFE of a building can include zoning ordinances, building

**Figure 4-52:**  
*Stairs bridging low street elevation and high finished-floor elevation prevent wheelchair access into the building.*



**Figure 4-53:**  
*Steep cross-slopes bridging low street elevation and high finished-floor elevation make the sidewalk difficult for wheelchair users to travel across.*



codes, and conditions such as geologic formations, topography, and the hydrologic makeup of an area. The requirements of other agencies, including the Federal Emergency Management Agency (FEMA), the Army Corps of Engineers, and the Federal Aviation Administration, as well as wetland laws, can also influence the FFE of buildings in a given region. For example, FEMA requires communities located within flood plains to elevate buildings above expected water rise levels. Such safety recommendations are commonly included in local building codes. Insurance companies might demand higher FFEs if coverage for flood damage is desired.

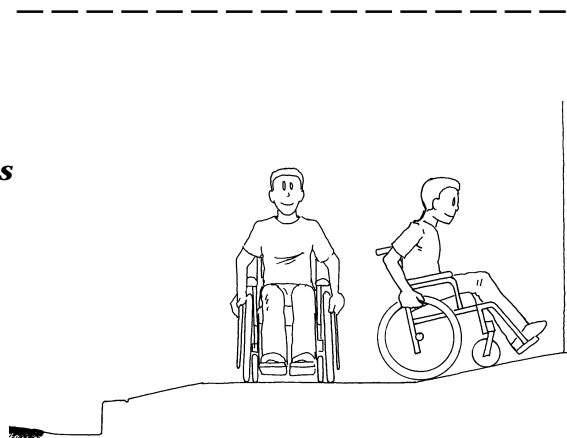
When sidewalk design is not given sufficient emphasis by transportation planning and review processes, sidewalk

designers are left to bridge the gap between building and street elevations. Creative solutions include providing a level area and sloping the edge of the path, or raising the curb to level the sidewalk (Figures 4-54 and 4-55).

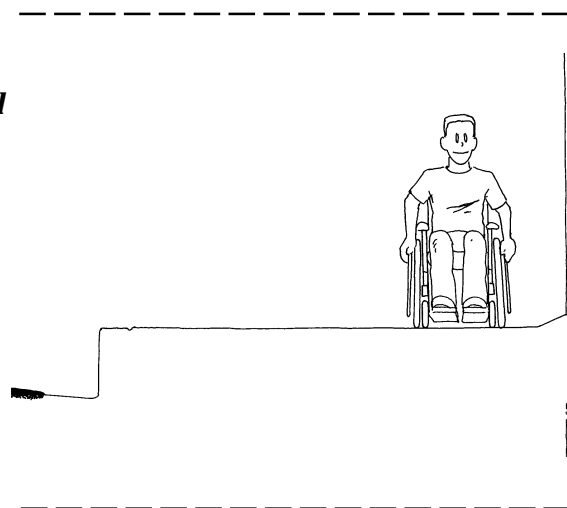
Road, sidewalk, and building designers should coordinate their efforts to ensure that accessible sidewalks are developed in new construction and alterations. Good review processes, including a variety of interest groups, can ensure that construction plans for accessible sidewalks are implemented.

Transportation agencies differ greatly in the degree to which they address pedestrian facilities. Some areas permit developers to exclude sidewalk plans from the review of the overall construction plan and create inaccessible pathways and noncompliant buildings, while others make consideration of sidewalk plans mandatory. The disparity in the types of requirements builders and developers must meet was illustrated in a 1995 National Association of Home Builders (NAHB) survey. The survey revealed that, while 94 percent of builders and developers had to obtain building permits, only 36 percent were required to undergo plan checking, and only 19 percent were required to design sidewalks more than 1.220 m (48 in) wide (NAHB, 1995).

**Figure 4-54:**  
A level area at least 0.915 m (36 in) wide improves access when there is a low street elevation and high finished-floor elevation.



**Figure 4-55:**  
A higher curb provides a level pathway but might increase the slope of curb ramps if the sidewalk is narrow.



#### 4.4.14 Maintenance

Sidewalks are prone to damage caused by environmental conditions. Maintaining sidewalk elements in good condition is an essential part of providing access to public rights-of-way. Sidewalks in poor repair can limit access and threaten the health and safety of pedestrians. If sidewalks are in poor condition or nonexistent, pedestrians are forced to travel in the street.

A public information program by the Campaign to Make America Walkable indicated that 3 of the top 10 most frequently cited roadway safety and



sidewalk design problems were the following maintenance issues (The Campaign to Make America Walkable, 1997):

1. Missing sections of sidewalk, especially on key walking routes
2. Bad sidewalk surfaces, i.e., uneven or broken concrete or uplifted slabs over tree roots
3. Bad sidewalk maintenance, i.e., overhanging bushes or trees or unshoveled snow on sidewalks

Maintenance problems are usually identified by pedestrians who report the location to the municipal authorities. Identification of locations requiring maintenance may be done in conjunction with a city's accessibility improvement program. Effective maintenance programs are quick to identify conditions that can impede access and respond with repairs. Some cities survey and repair all sidewalks in regular cycles. Other cities make or enforce repairs only if a complaint is filed. Cities also might have pavement management programs and personnel devoted entirely to inspecting and repairing damaged access routes. Assessing sidewalks for accessibility should be an integral part of maintenance survey programs.

Sidewalk inspectors typically look for conditions that are likely to inhibit access or cause pedestrians to injure themselves. The following list of common sidewalk maintenance problems was generated from promotional material created for home owners by the Bureau of Maintenance in the City of Portland, Oregon (1996) and the Division of Engineering for the Lexington–Fayette County Urban Government (1993):

- *Step separation* — a vertical displacement of 13 mm (0.5 in) or greater at any point on the walkway that could cause pedestrians to trip, lock up the wheels of a wheelchair, or prevent the wheels of a wheelchair from rolling smoothly

- *Badly cracked concrete* — holes and rough spots ranging from hairline cracks to indentations wider than 25 mm (1 in)
- *Spalled areas* — fragments of concrete or other building material detached from larger structures; also losses of aggregate and cement leaving holes or depressions greater than 50 mm x 50 mm (2 in x 2 in) in the sidewalk
- *Settled areas that trap water* — sidewalk panels with depressions, reverse cross-slopes, or other indentations that cause the sidewalk path to be lower than the curb; these depressions cause silt and water to settle on the walkway path and might require replacement.
- *Tree root damage* — roots from trees growing in adjacent landscaping that cause the walkway surface to buckle and crack, impeding access
- *Vegetation overgrowth* — ground cover, trees, or shrubs on properties or setbacks adjacent to the sidewalk that have not been pruned. Overgrown vegetation can encroach onto the walkway and pose obstacles, inhibiting pedestrian access.
- *Obstacles* — objects located on the sidewalk, in setbacks, or on properties adjacent to the sidewalk that obstruct passage space. Obstacles commonly include trash receptacles, parked cars, and private mailboxes.
- *Sidewalks of materials other than specified by the municipality* — the use of materials other than those specified by the municipality in the construction of sidewalks and driveway aprons. Materials not approved for sidewalk construction can erode quickly, cause excessive slippage, or be inappropriate to the atmosphere of a particular area.
- *Driveway flares* — that do not comply with standard criteria set by the municipality
- *Any safety issue* — that a pedestrian or sidewalk inspector believes merits attention

Although sidewalks are elements of the public right-of-way, many city charters assign the owner of the adjacent property with responsibility for sidewalk upkeep. It is common for city charters to specify that the city cannot be held liable for any accident or injury due to sidewalk conditions.

Home owners are commonly allowed to decide whether to hire a contractor, perform repairs on their own, or have the city do the repair. The home owners' association in some neighborhoods

address right-of-way maintenance to minimize the cost to individual members. Some cities subsidize property owners for repairing sidewalks. Local laws also might dictate whether a home owner must engage a professional contractor to undertake sidewalk repair. If municipal inspectors review and approve sidewalk repairs, the finished sidewalks are more likely to meet pedestrian access needs.

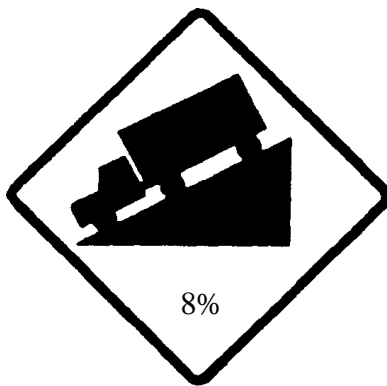
#### 4.4.15 Signs

Most agencies rely on the MUTCD for sign guidelines. For font recommendations, the MUTCD references the *Standard Alphabets for Highway Signs and Pavement Markings*, which permits a series of six letter types on signs. Each letter type features a different stroke width-to-height ratio (Office of Traffic Operations, FHWA, 1982). Various sign shapes, colors, and lettering are used for each type of sign (warning, street, regulatory, etc.) (US DOT, 1988). Braille and raised lettering are not addressed in the MUTCD.

ADAAG Section 4.30 also provides guidelines for signage. ADAAG specifications are targeted at indoor facilities and might not be applicable to all outdoor spaces. According to ADAAG, "letters and numbers on signs shall have a width-to-height ratio between 3:5 and 1:1 and a stroke width-to-height ratio between 1:5 and 1:10" (ADAAG, U.S. Access Board, 1991). MUTCD requirements for size and stroke meet and might even exceed ADAAG specifications. ADAAG Section 4.30 also provides guidelines for character height, raised and brailled characters and pictorial symbol signs, finish and contrast, mounting location and height, and symbols of accessibility.

Pedestrian signs should not be placed in locations where they obstruct the minimum clearance width or protrude into the pathway.

**Figure 4-56:**  
Traffic sign indicating upcoming steep grade (US DOT, 1988).



**Figure 4-57:**  
Pedestrian sign indicating upcoming steep grade.<sup>1</sup>



<sup>1</sup>This sign is not currently included in the *Manual on Uniform Traffic Control Devices* (MUTCD). Before using any traffic control device that is not included in the MUTCD, the interested State or locality should submit a request for permission to experiment to FHWA's Office of Highway Safety (HHS-10), 400 Seventh Street, SW, Washington, DC 20590. Guidelines for conducting an experiment can be found in Part 1A-6 of the MUTCD.

The majority of signs in the public right-of-way are directed at the motorist. Although these signs often affect pedestrians, they are usually not intended for or positioned to be seen by sidewalk users. For example, the street name signs on many large arterials are hung in the center of the intersection. This location is essentially invisible to pedestrians traveling along the sidewalk. Pedestrians might even be put in danger because important safety information, such as yield signage, is not easily visible.

Targeting more signs toward pedestrians would improve safety and permit them to identify routes requiring the least effort for travel. Warning signs similar to standard traffic warning signs (Figure 4-56) would provide information on sidewalk characteristics such as steep grades (Figure 4-57). To date, these types of signs have not been introduced into the MUTCD. Inclusion in this report does not constitute FHWA endorsement. Pedestrian-oriented signage containing access information for trails has been

developed as part of the Universal Trail Assessment Process (UTAP) (see Sections 5.1 and 5.4.9). Objective signage provides users with reliable information they can use to make informed choices about their travel routes. In the sidewalk environment, signage should be supplemented with audible or tactile information to be accessible to people with visual impairments.

## 4.5 Conclusion

Many factors work in concert to make sidewalks and sidewalk elements accessible. Although it is important to make individual features accessible, such improvements will not be useful unless the conditions of the sidewalk as a whole can be negotiated. Accessible sidewalks must be included as part of all new construction and alterations. In addition, regular maintenance programs should be implemented to keep existing routes safe and usable.

**Table 4-2.1:**  
**Federal Accessibility Guidelines for Accessible Routes**

Source	Maximum Allowable Running Grade without Handrails	Maximum Grade with Handrails and Landings	Maximum Allowable Running Cross-Slope	Minimum Clearance Width	Maximum Allowable Vertical Change in Level	Minimum Allowable Vertical Clearance (Overhead)
	%	% m	%	m	mm	m
ADA Standards for Accessible Design <sup>1</sup> (US DOJ, 1991)	5.0 <sup>2</sup>	8.33 <sup>2</sup> 9.1	2.0	0.915 <sup>3</sup>	6 <sup>4</sup>	2.030
UFAS (US DoD, et al., 1984)	5.0 <sup>2</sup>	8.33 <sup>2</sup> 9.1	2.0	0.915 <sup>3</sup>	6 <sup>4</sup>	2.030

<sup>1</sup> The ADA Standards for Accessible Design are identical in content to ADAAG Sections 1–10. However, the Design Standards are enforceable by the U.S. Department of Justice.

<sup>2</sup> The ADA Standards for Accessible Design require people to use the least slope possible on accessible routes.

<sup>3</sup> Minimum clearance width may be reduced to 0.815 m (32 in) at an obstruction for a maximum length of 0.610 m (24 in).

<sup>4</sup> Changes in level between 6 mm (.25 in) and 13 mm (.5 in) are permitted if beveled with a maximum slope of 50 percent.

**Table 4-2.2:**  
**ADAAG-Proposed Section 14 (1994) Accessibility Guidelines for Public Rights-of-Way**

Source	Maximum Allowable Running Grade	Maximum Grade for a Specified Distance (Run)	Maximum Allowable Running Cross-Slope	Minimum Clearance Width	Maximum Allowable Vertical Change in Level	Minimum Allowable Vertical Clearance (Overhead)
	%	% m	%	m	mm	m
ADAAG-proposed Section 14 (1994) (U.S. Access Board, 1994b)	n/a <sup>1</sup>	n/a n/a	2.0	0.915	6 <sup>2</sup>	2.030

<sup>1</sup> Sidewalk slopes may be consistent with the slope of the adjacent roadway.

<sup>2</sup> Changes in level between 6 mm (.25 in) and 13 mm (.5 in) are permitted if beveled with a maximum slope of 50 percent.

**Table 4-2.3:**  
**State Guidelines for Sidewalks**

Source	Maximum Allowable Running Grade	Maximum Grade for a Specified Distance (Run)	Maximum Allowable Running Cross-Slope	Minimum Clearance Width	Maximum Allowable Vertical Change in Level	Minimum Allowable Vertical Clearance (Overhead)
	%	% m	%	m	mm	m
FL Ped. Planning and Dgn. Guidelines (University of NC Hwy. Safety Research Ctr., 1996)	5.0	n/a <sup>1</sup> n/a <sup>1</sup>	2.0	1.220	n/a	n/a
Oregon Pedestrian Design Guidelines	5.0	8.33 9.1	2.0	1.0	n/a	2.1
Architectural Barriers Act (Texas Department of Licensing and Regulation, 1997)	5.0	8.33 9.1	2.0	0.915	6 <sup>2</sup>	2.030

<sup>1</sup> Florida directs people to the ADA for maximum grade requirements.

<sup>2</sup> Changes in level between 6 mm (.25 in) and 13 mm (.5 in) are permitted if beveled with a maximum slope of 50 percent.

**Table 4-2.4:**  
**Additional Recommendations for Sidewalks**

Source	Maximum Allowable Running Grade without Handrails	Maximum Grade with Handrails and Level Landings	Maximum Allowable Running Cross-Slope	Minimum Clearance Width	Maximum Allowable Vertical Change in Level	Minimum Allowable Vertical Clearance (Overhead)
	%	% m	%	m	mm	m
Accessibility for Elderly and Handicapped Peds. (Earnhart and Simon, 1987)	5.0	8.33 9.1	2.0	0.915	6 <sup>1</sup>	2.030
ANSI A117.1-1980 (ANSI, 1980)	5.0	8.33 9.1	2.0	0.915	6 <sup>1</sup>	2.030
ANSI A117.1-1992 (Council of American Building Officials, 1992)	5.0	8.33 9.1	2.1	0.915	6 <sup>1</sup>	2.030
Dgn. and Safety of Ped. Facilities (ITE Tech. Council Comm. SA-5, 1998)	8.0	8.0 9.1	2.1	0.915	n/a	n/a

<sup>1</sup> Changes in level between 6 mm (.25 in) and 13 mm (.5 in) are permitted if beveled with a maximum slope of 50 percent.

**Table 4-3.1:**  
**Federal Accessibility Guidelines for Curb Ramps (CR)**

Source	Maximum Slope of Curb Ramps %	Maximum Cross-Slope of Curb Ramps %	Maximum Slope of Flared Sides %	Minimum Ramp Width m	Minimum Landing Length m
ADA Standards for Accessible Design <sup>1</sup> (US DOJ, 1991)	8.33 <sup>2, 3</sup>	2.0	10.0 <sup>4, 5</sup>	0.915 <sup>6</sup>	0.915
UFAS (US DoD, et al., 1984)	8.33 <sup>2, 3</sup>	2.0	10.0 <sup>4, 5</sup>	0.915 <sup>6</sup>	0.915

<sup>1</sup> The ADA Standards for Accessible Design are identical in content to ADAAG Sections 1–10. However, the Design Standards are enforceable by the U.S. Department of Justice.

<sup>2</sup> The ADA Standards for Accessible Design require people to use the least slope possible on curb ramps that are part of accessible routes.

<sup>3</sup> If space prohibits a slope less than 8.33%, curb ramps to be constructed on existing sites may have a slope of 8.33% to 10% with a maximum rise of 150 mm (6 in) or a slope of 10% to 12.5% with a maximum rise of 75 mm (3 in).

<sup>4</sup> The flare guidelines do not apply if the curb ramp is located where a pedestrian does not have to walk across the ramp or if the flared sides are protected by handrails or guardrails.

<sup>5</sup> If the landing is less than 1.220 m long, the slope of the flared sides must not exceed 8.33%.

<sup>6</sup> Exclusive of flared sides.

**Table 4-3.2:**  
**ADAAG-Proposed Section 14 (1994) Accessibility Guidelines for Curb Ramps (CR)**

Source	Maximum Slope of Curb Ramps %	Maximum Cross-Slope of Curb Ramps %	Maximum Slope of Flared Sides %	Minimum Ramp Width m	Minimum Landing Length m
ADAAG-Proposed Section 14 (1994) (U.S. Access Board, 1994b)	8.33 <sup>1, 2</sup>	2.0	10.0 <sup>3</sup>	0.915 <sup>4</sup>	0.915 <sup>5</sup>

<sup>1</sup> The U.S. Access Board recommends using the least slope possible.

<sup>2</sup> The slope of a parallel curb ramp should not exceed 8.33%, but is not expected to exceed 2.440 m in length.

<sup>3</sup> The flare guidelines do not apply if the curb ramp is located where a pedestrian does not have to walk across the ramp or if the flared sides are protected by handrails or guardrails.

<sup>4</sup> Exclusive of flared sides.

<sup>5</sup> The minimum allowable landing length is 0.915 m for parallel curb ramps and 1.220 m for perpendicular curb ramps.

**Table 4-3.3:**  
**State and City Guidelines for Curb Ramps (CR)**

Source	Maximum Slope of Curb Ramps %	Maximum Cross-Slope of Curb Ramps %	Maximum Slope of Flared Sides %	Minimum Ramp Width m	Minimum Landing Length m
FL Ped. Planning and Dgn. Guidelines (University of NC Hwy. Safety Research Ctr., 1996)	8.33	n/a	8.33 <sup>1</sup>	1.0	1.220
Ped. Compatibility Planning and Dgn. Guidelines (NJ DOT, 1996)	8.33 <sup>2</sup>	2.0 <sup>2</sup>	10.0 <sup>1</sup>	1.220	1.220
Ped. Dgn. Guide (City of Portland, 1997)	8.33	2.0	n/a	0.915	1.220
Architectural Barriers Act (Texas Department of Licensing and Regulation, 1997)	8.33 <sup>2, 3</sup>	2.0	10.0 <sup>1, 4</sup>	0.915 <sup>5</sup>	0.915

<sup>1</sup> The flare guidelines do not apply if the curb ramp is located where a pedestrian does not have to walk across the ramp or if the flared sides are protected by handrails or guardrails.

<sup>2</sup> The least possible slope should be used.

<sup>3</sup> If space prohibits a slope less than 8.33%, curb ramps to be constructed on existing sites may have a slope of 8.33 to 10% with a maximum rise of 150 mm (6 in) or a slope of 10 to 12.5% with a maximum rise of 75 mm (3 in).

<sup>4</sup> If the landing is less than 1.220 m long, the slope of the flared sides must not exceed 8.33%.

<sup>5</sup> Exclusive of flared sides.

**Table 4-3.4:**  
**Additional Recommendations for Curb Ramps (CR)**

Source	Maximum Slope of Curb Ramps %	Maximum Cross-Slope of Curb Ramps %	Maximum Slope of Flared Sides %	Minimum Ramp Width m	Minimum Landing Length m
Accessibility for Elderly and Handicapped Peds. (Earnhart and Simon, 1987)	8.33 <sup>1</sup>	n/a	10.0 <sup>2, 3</sup>	0.915	n/a
ANSI A117.1-1980 (ANSI, 1980)	8.33 <sup>1, 4</sup>	2.0	10.0 <sup>2</sup>	0.915 <sup>5</sup>	0.915
ANSI A117.1-1992 (Council of American Building Officials, 1992)	8.33 <sup>1, 4</sup>	2.1	10.0 <sup>2</sup>	0.915 <sup>5</sup>	0.915
Dgn. and Safety of Ped. Fac. (ITE Tech Council Comm SA-5, 1998)	8.33	n/a	10.0	0.915	n/a
Planning Dgn. and Maintenance of Ped. Facilities (Bowman, Fruin, and Zegeer, 1989)	8.33 <sup>1</sup>	n/a	10.0 <sup>2, 3</sup>	0.915 <sup>6</sup>	n/a

<sup>1</sup> If space prohibits a slope less than 8.33%, curb ramps to be constructed on existing sites may have a slope of 8.33 to 10% with a maximum rise of 150 mm (6 in) or a slope of 10% to 12.5% with a maximum rise of 75 mm (3 in).

<sup>2</sup> The flare guidelines do not apply if the curb ramp is located where a pedestrian does not have to walk across the ramp or if the flared sides are protected by handrails or guardrails.

<sup>3</sup> If the landing is less than 1.220 m long, the slope of the flared sides must not exceed 8.33%.

<sup>4</sup> The least possible slope should be used.

<sup>5</sup> Exclusive of flared sides.

<sup>6</sup> In areas with snow removal, 1.220 m is the minimum recommended ramp width.





# Trail Design for Access

Trails provide both recreation and transportation routes through natural environments and urban areas. A wide variety of people with a range of mobility and physical endurance enjoy visiting outdoor trails. Trail users include people with and without disabilities, children, families, and older adults. Trail users participate in a variety of activities, including biking, cross-country skiing, and hiking.

This chapter examines elements and characteristics, such as grade, cross-slope, surface type, and signage, that have the greatest impact on access. Design and user conflicts that result from having multiple user groups on the same trails are addressed as well.

## 5.1 Universal Trail-Assessment Process

To gain a better understanding of existing trail conditions, the researchers visited several trail and shared-use-path facilities within the United States. During these visits, trail characteristics were measured using the Universal Trail Assessment Process (UTAP). The UTAP was chosen because it collects objective mapping, usage, and maintenance information about trails, as well as information about characteristics that significantly influence user safety and access. It is critical to obtain quantitative information about trail characteristics to determine how access can be improved through maintenance, reconstruction, and/or dissemination of information. The National Park Service, the California State Park System, and the Minnesota Department of Natural Resources are among the land management agencies that have implemented the UTAP in their jurisdictions.

The UTAP utilizes the following simple surveying tools to measure trail characteristics:

- A compass to measure bearing
- A rolatape to measure distance
- A clinometer to measure running grade
- A tape measure to determine width, clearance, and obstacle dimensions
- A level to measure maximum grade, running cross-slope, and maximum cross-slope

The Global Positioning System (GPS) can be used as an alternative to the compass and clinometer to track positioning and elevation. GPS was not used during the sidewalk assessments because it has several drawbacks. These disadvantages include increased expense, reliance on battery power, problems obtaining signals in forested areas or narrow canyons, the requirement to wait before a reading can be obtained, and grade measurements that are significantly less accurate than those obtained by a clinometer (unless a base station providing differential signal correction is used).

## 5.2 Design Guideline Comparisons

The researchers compiled existing guidelines and recommendations related to trail design and construction. Guidelines published by Federal and State governments, counties, cities, private organizations, and advocacy groups were collected and summarized in Tables 5-4 through 5-9, which are located at the end of this chapter.

Consideration of the needs of bicyclists, pedestrians, people with disabilities, and other user groups differ greatly among guidelines. This variation is primarily due to the mission and constituency that each agency or organization serves. For example, the U.S. Access Board focuses primarily on the needs of people with disabilities, while State DOTs serve a

more varied group of people and might focus on design issues that do not relate to access. Recommendations for trails intended for use by a single recreation group, such as motorcyclists, are sometimes written by advocacy groups such as the American Motorcyclists Association.

Some design guidelines make provisions for different levels of difficulty to provide a variety of trail experiences within a single recreation area. Guidelines and recommendations for trails designed at multiple difficulty levels are represented in the tables as Multiple Levels. These levels are termed Easier, Moderate, and Difficult. If a fourth level of difficulty, equivalent to Most Difficult, was included in a guideline or recommendation, it was not listed in the table. Guidelines and recommendations recognizing only one level of difficulty are represented in the tables as Single Level. The tables are organized by trail type. Abbreviated bibliographical information for each document is included in the Source column of the tables; however, complete bibliographical information is included at the end of this report.

Although trail designers may find it helpful to adhere to guidelines for easier,

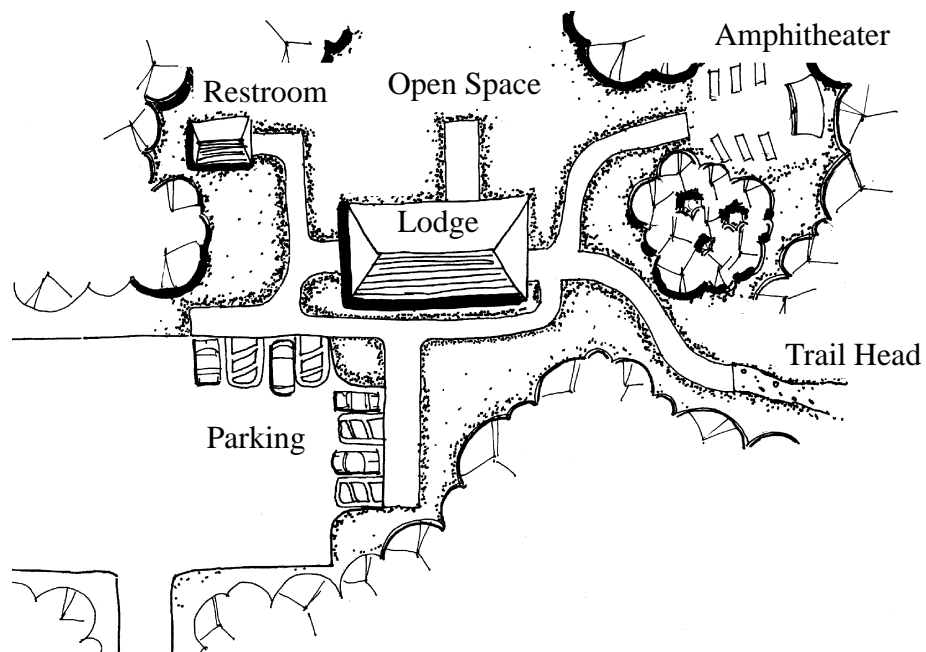
moderate, and difficult trails during the design process, rating trails as such can be misleading for users. What is considered easier, moderate, and difficult varies between areas and can be hard for users to interpret. Alternatively, conveying the dimensions and magnitudes of trail characteristics to users through signage would provide visitors with reliable and comparable information.

### 5.3 Trail Types

Trail design guidelines are generally written to accommodate a specific type of user. For example, guidelines developed solely for snow machine use will not meet the needs of a cross-country skier. In practice, most trails are used by more than one type of user and should be considered shared-use paths. Only trails with features and strict enforcement practices that effectively exclude other users are single-user paths. For this reason, the design needs of all potential user groups should be considered when planning a trail.

Guidelines for the following types of paths were compiled and considered in

**Figure 5-1:**  
**Outdoor recreation access routes (ORARs) link accessible elements at a recreation site.**



this report; definitions for each are listed in the Glossary (Appendix B):

- Accessible Routes
- Outdoor Recreation Access Routes (Figure 5-1)
- Recreational Trails
- Hiking Trails
- Shared-Use Paths
- Bicycle Paths
- Mountain Biking Trails
- Equestrian Trails
- Cross-Country Ski Trails
- Snow Machine Trails
- All-Terrain Vehicle Trails
- Off-Highway Vehicle Trails
- Motorcycle Trails

## 5.4 Access Characteristics

### 5.4.1 Grade

*Grade* (slope) is defined as the slope parallel to the direction of travel and is calculated by dividing the vertical change in elevation by the horizontal distance covered. For example, a trail that gains 2 m in elevation over 40 m of horizontal distance has a grade of 5 percent. Some guidelines use the term “slope” to refer to grade. However, the term “grade” is used in this report to avoid confusion with cross-slope. *Average grade* is defined as the average of many contiguous running grades. Running grade is usually measured over the maximum distance afforded by sight lines when grades are continuous. However, more detailed grade information can be obtained if measurement distances do not exceed 30 m (100 ft). Running grade is also measured on shorter trail segments between changes on grade. *Maximum grade* is defined as a limited section of trail that exceeds the typical running grade. Maximum grade values can differ significantly from the running

grade values. For example, a trail that gains 15 m in elevation gradually over 1 km has the same running grade as a trail that is flat for 0.75 km and then climbs 15 m over the last 0.25 km; however, the two trails make very different strength and endurance demands of users. The steeper segment in Figure 5-2 is an example of a maximum grade that occurs over a short distance and significantly exceeds the typical running grade. Table 5-1 contains

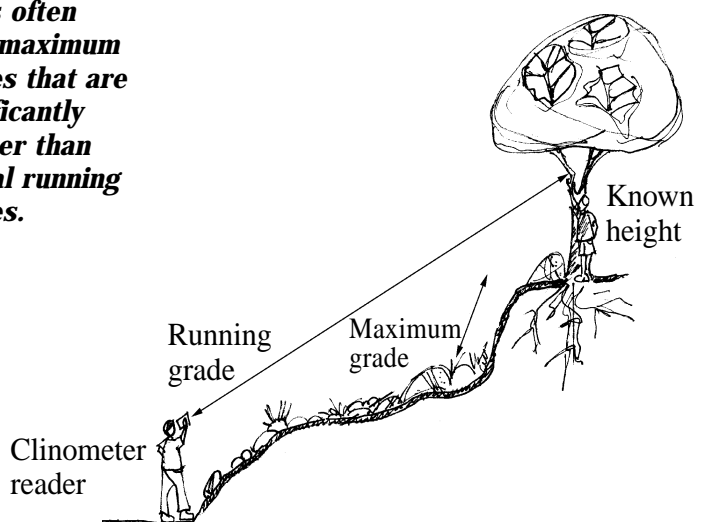
**Table 5-1:**

**Results of 10 Trail Assessments Show That on Many Trails, the Maximum Grade and Cross-Slope Significantly Exceed the Typical Average Grade and Cross-Slope (Chesney and Axelson, 1994)**

Trail	Average Grade (%)	Maximum Grade (%)	Average Cross-Slope (%)	Maximum Cross-Slope (%)
Beehive	10	47	9	34
Boiling River	4	62	7	32
Fairy Falls	3	40	10	25
Grotto Falls	4	19	2	12
Ice Lake	3	14	6	9
Kersey Lake	5	70	11	32
Mystic Falls	6	62	9	38
Palisades Falls	10	32	3	14
Pine Creek Falls	8	75	16	47
Wraith Falls	6	42	6	18

**Figure 5-2:**

**Trails often have maximum grades that are significantly steeper than typical running grades.**



the typical running grade and the maximum grade from 10 trail assessments. The maximum grade significantly exceed the typical running grade in all 10 examples.

The *rate of change of grade* is defined as the change in grade over a given distance. The rate of grade change is determined by measuring the grade and the distance over which it occurs for each segment of the overall distance. For the purposes of this report, rate of change of grade is measured over 0.610 m (2 ft) intervals, which represent the approximate length of a single walking pace and a wheelchair wheelbase.

In the trail environment, rate of change of grade should not exceed 13 percent. If the rate of change of grade exceeds 13 percent over a 0.610 m (2 ft) interval, the ground clearance of the footrests and or antitip wheels may be compromised. Antitip wheels are placed on the back of some wheelchairs to improve stability and prevent tipping. Even wheelchair users traveling slowly can get stuck if the footrest or antitip wheels get caught.

If the rate of change of grade exceeds 13 percent, the dynamic stability of the trail user can also be significantly compromised, depending on the speed at which the wheelchair user goes through the rapidly changing grade. Dynamic stability is compromised because the

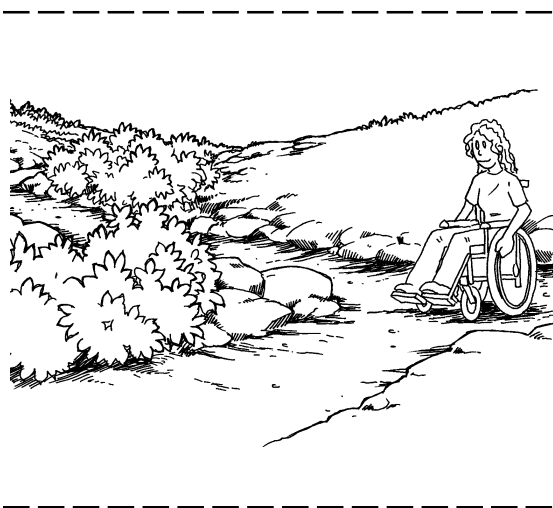
negative grade of the first sloped surface causes the wheelchair to rotate forward. However, upon reaching the bottom of the transition, the wheelchair begins to rapidly pitch back as the wheelchair transitions up onto the positive grade of the second sloped surface. Rapid changes in grade can also cause a wheelchair user traveling with speed to flip over backward. Any amount of height transition between the two sloped surfaces can further contribute to problems for wheelchair users.

Most design guidelines provide specifications for maximum allowable running grade over long distances and maximum grade between level areas. Tables 5-4.1 through 5-4.5 list design guidelines for maximum allowable running grade. Tables 5-5.1 through 5-5.5 list design guidelines for maximum grade between level landings.

The recommendations for running grade and maximum grade usually depend on the designated users of the trail. For example, grades up to 25 percent are typically permitted for snow machine trails, while the recommended running grade for Outdoor Recreation Access Routes is only 5 percent. The distances over which maximum grades are permitted to occur also vary by the type of user group. For example, the USDA Forest Service guidelines recommend a 20 percent maximum grade for 30 m (100 ft) on hiking trails, but a 20 percent maximum grade is permitted to extend for 61 m (200 ft) on ATV trails. In some instances, the location of the trail also might impact the running grade. For example, a trail that follows a stream may be permitted to have grades similar to those of the land contours.

Long switchbacks are often recommended in steep terrain to reduce grades (Figure 5-3). The steeper the terrain, the longer the switchbacks should be. In open areas, hikers and other user groups often create way trails to avoid traversing the entire switchback. A way trail is an informal

**Figure 5-3:**  
**Well-designed switchbacks reduce the grade of a trail and make hiking easier for people with mobility disabilities.**



path that allows users to travel a shorter distance by cutting across the land between the switchbacks. Way trails hasten soil erosion and destroy surrounding vegetation.

Installing landscaping barriers, such as shrubs, along switchbacks is one method to prevent hikers from creating way trails. However, a more cost-effective solution involves choosing switchback points with natural barriers, such as rocks or thick vegetation, as illustrated in Figure 5-3. Wherever possible, trails should be designed on more level terrain to maintain minimum design guidelines for grade and avoid the need for switchbacks.

### 5.4.2 Rest Areas

*Rest areas* are defined as level portions of a trail wide enough to provide wheelchair users and others a place to rest and gain relief from prevailing grade and cross-slope demands. Users can benefit from rest stops on steep or very exposed trails to pause from their exertions and enjoy the environment. Rest areas are most effective when placed at intermediate points, scenic lookouts, or near trail amenities. Rest areas located off the trail allow stopped trail users to move out of the way of continuing traffic (Figure 5-4). The most inviting rest areas have a bench, shade, a place to rest bicycles, and a trash receptacle. Water fountains and washroom facilities are also useful on long trails (FL DOT, 1997).

*Rest area interval* is defined as the distance between rest areas. Most agencies and private organizations that provide recommendations for rest area intervals concur with the 1994 Recreation Access Advisory Committee, which recommends that easier, moderate, and difficult trails should have rest areas at maximum intervals of 121.9 m, 274.3 m, and 365.8 m (400 ft, 900 ft, and 1200 ft), respectively. The California State Parks Guidelines call for rest areas on easier, moderate, and difficult ORARs

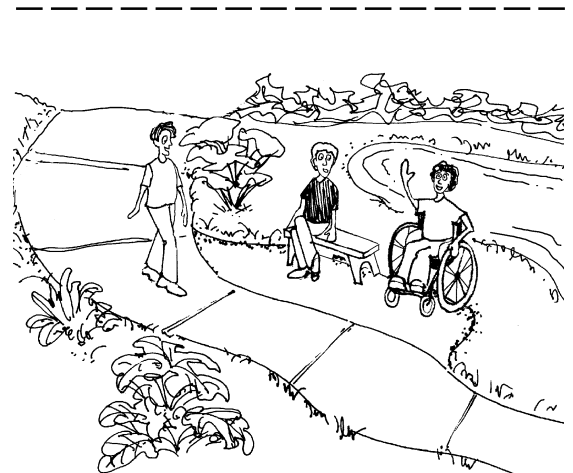
at maximum intervals of 61.0 m, 121.9 m, and 182.9 m (200 ft, 400 ft, and 600 ft), respectively. The New Mexico Plan specifies 402.5 m (1,321 ft) as the maximum allowable interval between rest areas on difficult trails.

### 5.4.3 Cross-Slope

*Cross-slope* is defined as the slope measured perpendicular to the direction of travel. Cross-slope must be measured at specific points. The average cross-slope is the average of cross-slopes measured at regular intervals along the trail. *Running cross-slope* is defined as the average cross-slope of a contiguous section of trail. The running cross-slope can be determined by taking periodic measurements throughout a section of trail and then averaging the values. *Maximum cross-slope* is defined as a limited section of the trail that exceeds the typical running cross-slope of the path.

*Rate of change of cross-slope* is defined as the change in cross-slope over a given distance. For the purposes of this report, rate of change of cross-slope was measured over 0.610 m (2 ft) intervals, which is the approximate length of a single walking pace and the wheelbase of a wheelchair. Rate of change of cross-slope can be measured by placing a level 0.610 m (2 ft) before and after a

**Figure 5-4:**  
**Rest areas enhance the trail for all users.**



maximum cross-slope. Rapidly changing cross-slopes can cause one wheel of a wheelchair or one leg of a walker to lose contact with the ground and also can cause walking pedestrians to stumble or fall.

A summary of the guidelines and recommendations for running cross-slope can be found at the end of the chapter in Tables 5-6.1 through 5-6.5. Most of the trail design specifications address maximum allowable running cross-slope but do not address maximum cross-slope for short distances. Table 5-1 contains the average and maximum cross-slope from 10 trail assessments. The maximum cross-slope significantly exceeds the average cross-slope in all 10 examples. Some trail users, including people in wheelchairs, may have difficulty negotiating extreme cross-slopes even for short distances. To address this concern, Axelson, Chesney, and Longmuir (1995) made recommendations for both average and maximum cross-slope. The recommendations differ from the majority of existing recommendations because they suggest maximum average grades and cross-slopes rather than maximum running grades and cross-slopes. On easier ORARs, they recommend a maximum cross-slope of 5 percent for a distance of 3.050 m (10 ft); and on easier recreational trails they recommend a maximum cross-slope of 5 percent for 3.660 m (12 ft).

The accessibility guidelines and most State guidelines for ORARs, access routes, recreational trails, and hiking trails require running cross-slopes that do not exceed 2 percent; however, some nongovernmental organizations recommend cross-slopes that exceed 2 percent. For example, Rathke and Baughman (1994) specify a maximum running cross-slope of 4 percent for hiking trails. Plae, Inc. (1993) and the Recreation Access Advisory Committee (1994) recommend a maximum running cross-slope of 3 percent for easy-level ORARs and recreational trails.

Table 5-2 contains the *AASHTO Green Book's* specifications for cross-slopes

**Table 5-2:**  
**Cross-Slope Ranges by Surface Type**  
(AASHTO, 1995)

Surface Type	Cross-Slope Range
High (highest pavement standard)	1.5–2.0%
Intermediate (slightly below high)	1.5–3.0%
Low (loose surface; earth, gravel, etc.)	2.0–6.0%

based on surface type. According to the *AASHTO Green Book*, a 1.5 percent cross-slope provides effective drainage in most weather conditions for surfaces with the highest pavement standards. Intermediate and low surface types, such as gravel, may require larger cross-slopes to enable adequate drainage (AASHTO, 1995).

A recently conducted pilot study has concluded that adults with and without disabilities are unable to distinguish between 2 and 3 percent cross-slopes (Axelson, Chesney, and Longmuir, 1995). Maintaining minimal cross-slope values can significantly increase the cost and environmental modifications required to build trails on steep terrain.

#### 5.4.4 Width

Two measurements, the *design width* and the *minimum clearance width*, are used to characterize trail width. *Design width* is defined as the width specification the trail was intended to meet. Some guidelines refer to design width as tread width. Some agencies recommend clearing brush from an area wider than the design width. *Minimum clearance width* is defined as the narrowest point on a trail. A minimum clearance width is created when the actual “usable surface” of the trail is substantially smaller than the full trail width. This can result from obstacles such as trees

protruding into the trail and reducing the clear space or from a reduction in the design width.

Trail features such as large rocks and fallen trees can be obstacles to trail users if they limit the passage space (the vertical clear space or clear width) of the trail. Although some obstacles might not impede a hiker or equestrian, they might impede the progress of those using strollers, wheelchairs, walkers, snow machines, or off-highway vehicles. Maintenance, reconstruction, and signage posted on the trail can help visitors avoid frustration and potential safety hazards when encountering obstacles such as a landslide that blocks a portion of the trail.

The types of user groups permitted on a trail affect its optimal design width. In general, the faster a user travels, the wider the trail must be to accommodate turns and limit collisions. For example, snow machines can attain speeds equivalent to those of automobiles and require the widest types of trails. Other user groups capable of faster travel than most pedestrians include OHVs, motorcycles, ATVs, bicyclists, equestrians, skaters, and skateboarders. Trails that accommodate such fast-moving technologies may be made narrower to increase the challenge to users, as with single-track mountain bike trails, or to limit user speed. However, more trail crashes and conflicts might occur on narrow trails if users travel fast despite width limitations.

The movement patterns of user groups also affect the design width of a trail. For example, skaters use a lateral foot motion for propulsion that is wider than the stride of most pedestrians. The width required to accommodate this motion increases when skiers and skaters wish to ascend grades or pick up speed. As a result, trails permitting these user groups should be wider than trails that permit only pedestrians.

Guidelines for minimum clearance width are presented in Tables 5-7.1 through 5-7.5, located at the end of this chapter. Many guidelines do not include recommendations for minimum clearance width. Guidelines that do address minimum clearance width generally concur with ADAAG, which specifies 0.915 m (36 in) of clear space (the passage space required for a wheelchair user) (ADAAG, U.S. Access Board, 1991).

### 5.4.5 Passing Space

*Passing space* is defined as a section of path wide enough to allow two wheelchair users to pass one another or travel abreast. *Passing space interval* is defined as the distance between passing spaces. Accessible passing spaces allow two wheelchairs to pass one another, or for one wheelchair user to turn in a complete circle. Passing spaces are recommended at regular intervals when the trail is narrow for long distances.

Many agencies and private organizations do not provide guidelines or recommendations for passing space or passing space intervals because their design width specifications are usually wide enough to allow for users to pass one another. Most guidelines that do address passing space concur with ADAAG's guidelines for accessible routes, which specify a passing space of at least 1.525 m x 1.525 m (60 in by 60 in) whenever an accessible route provides less than 1.525 m (60 in) of clear space. According to ADAAG, a T-intersection of two walkways is also an acceptable passing space (ADAAG, U.S. Access Board, 1991).

### 5.4.6 Changes in Level

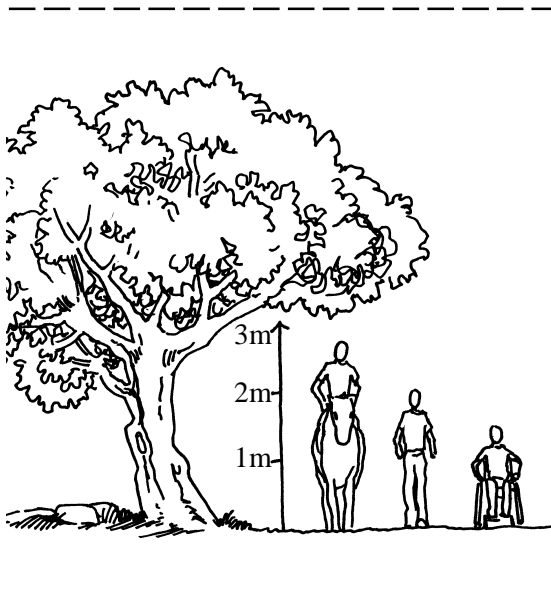
*Changes in level* are vertical height transitions between adjacent surfaces or along the surface of a path. Ruts caused by weather erosion, tree roots

**Figure 5-5:**  
**Tree roots that break up the surface of the trail should be removed because they can cause users to trip.**



(Figure 5-5), and rocks protruding from the trail surface are common sources of changes in level on trails. Trails with surface materials such as soil and crushed rock almost always have small changes in level. Changes in level can cause many difficulties for people with mobility impairments, such as cane or crutch users. Many cane and crutch users have difficulty lifting their feet high up off the ground, and abrupt changes in level can cause them to trip or fall. People using wheeled

**Figure 5-6:**  
**The vertical clearance of a trail should depend on the designated user groups.**



devices such as bicycles, wheelchairs, and scooters can easily catch their wheels in small changes in level, which can cause them to tip over.

Guidelines for changes in level are listed in Tables 5-8.1 through 5-8.5, located at the end of this chapter. The ADA Standards for Accessible Design and UFAS permit changes in level of less than 6 mm (0.24 in) to be vertical but changes in level between 6 mm (0.25 in) and 13 mm (0.5 in) to have a 50 percent bevel (US DOJ, 1991; UFAS, US DoD et al., 1984). An accessible ramp is required for changes in level that exceed 13 mm (0.5 in). Some States and private organizations allow vertical changes in level up to 13 mm (0.5 in).

### 5.4.7 Vertical Clearance

*Vertical clearance* is the minimum unobstructed vertical passage space required along a trail. Guidelines and recommendations for vertical clearance are contained in Tables 5-9.1 through 5-9.5, located at the end of this chapter. Specifications for vertical clearance vary depending on the designated trail users (Figure 5-6). For example, guidelines for trails that permit equestrians typically specify a vertical clearance of 3.050 m (10 ft), while trails that permit only hikers typically require a vertical clearance of 2.030 m (80 in). Because cane or crutch users might have difficulty ducking under vertical obstructions, sufficient vertical clearance is necessary to allow them to remain upright while proceeding along a trail. The height of the average blanket of snow added each winter should also be taken into account for trails that allow cross-country skiing and snow machining.

### 5.4.8 Surface

The surfacing material on a trail significantly affects which user groups will be capable of negotiating the path. Soft surfaces, e.g., sand and gravel, are



more difficult for all users to negotiate (Figure 5-7). They present particular hazards for those using wheeled devices such as road bicycles, strollers, and wheelchairs not designed for outdoor terrain. In contrast, unpaved surfaces might be preferred by equestrians and runners to prevent excessive jarring of the joints and skeleton. Others, such as mountain bikers and off-road wheelchair users, often prefer unpaved surfaces for the thrill and challenge of negotiating rough terrain.

Local conditions also determine the choice of trail surfaces. Recreational trail surfaces are most commonly composed of naturally occurring soil; however, surfaces ranging from concrete to wood chips may be used depending on the designated user types, the anticipated volume of traffic, the climate, and the conditions of the surrounding environment. High-use trails passing through developed areas and fragile environments are commonly surfaced with pavement, crushed rock, or soils mixed with stabilizing agents to minimize the impact of human traffic on the path.

Locations where the surface changes unexpectedly can frustrate or even endanger trail users unable to negotiate the new surface. This is especially critical in areas where surface conditions change dramatically, i.e., from a paved trail to a sandy beach. Providing information about surface changes through signage or other trail guide products can help visitors avoid such problems.

#### 5.4.9 Trail Information

People select trails based on a variety of criteria, including personal interest, destination, environment, and desired difficulty. Accurate and detailed trail information can provide users with sufficient data to choose routes appropriate to their skill level and desired experience. Trail information can be provided in many formats, including signs, maps, computer

**Figure 5-7:**  
**Soft surfaces are difficult for people with mobility impairments to negotiate and therefore should be avoided.**



programs, posters at park information stations, audio descriptions, and published travel guides. Trail information has traditionally been limited to the trail length, elevation change, usage rules, destination, and descriptive information about points of interest. Signage that provides objective and detailed information about potential obstacles, surface type, grade, cross-slope, and other trail features further benefits users by allowing them to accurately assess whether or not a trail meets their personal level of safety, comfort, and access. Trail users with visual impairments benefit from signs with large lettering, Braille panels, raised lettering, or audio boxes that play prerecorded trail information at the push of a button.

According to ADAAG, “Letters and numbers on signs shall have a width-to-height ratio between 3:5 and 1:1 and a stroke-width-to-height ratio between 1:5 and 1:10.” ADAAG also indicates that the letters and numbers of signs designating permanent locations, such as the woman or man indicators on a bathroom door, be raised 0.8 mm (0.03 in) from the surrounding surface and be in upper case, sans serif, or simple serif type. Type should always be accompanied by Grade 2 Braille. The background color of a sign should contrast with the color of the lettering (ADAAG, U.S. Access Board, 1991). Signs should not be placed

in locations where they obstruct the minimum clearance width or vertical clearance of the trail.

The MUTCD references the *Standard Alphabets for Highway Signs and Pavement Markings*, which permits a series of six letter types on signs. Each letter type features a different-stroke width-to-height ratio (Office of Traffic Operations, FHWA, 1982). Various sign, shapes, colors, and lettering are reserved for different types of information such as warnings, destinations, and regulatory functions. The MUTCD does not address the use of Braille and raised lettering (US DOT, 1988).

In a report to the U.S. Access Board, the Recreation Access Advisory Committee recommended that trail type and difficulty level be displayed for all ORARs and recreational trails. The Committee further recommended that maps and signage be provided to users with information on running and maximum grade, maximum cross-slope, minimum trail width, surface type, and magnitude of obstacles (Recreation Access Advisory Committee, 1994).

Trail signs should be appropriate for the environment in which they are located. For example, recreational trails could provide signs on wooden posts to meet user expectations of a “natural” environment.

#### **5.4.10 Maintenance**

Trail maintenance keeps trails at or near constructed or intended conditions. Regular trail maintenance can enhance visitor safety, protect resources, and provide continued access to the public.

Regular inspections to identify public safety issues, routine maintenance needs, and resource management problems help ensure that trails remain safe, accessible, and in good condition. Once problems are identified, managers can schedule corrections through a maintenance program.

A system to assess and catalog problems on trails can be used to obtain a comprehensive list of potential maintenance items. All human-built structures on the trail, such as bridges and retaining walls, should be inventoried. The structural integrity and general condition of all features may be assessed at the same time as needed repairs, upgrading, or replacements are recorded. The inspection may include an analysis of the trail surface conditions to identify and measure the extent of entrenchment, drainage, and obstacle problems. A comprehensive list of maintenance items also helps trail managers prioritize and budget for trail repair and improvement projects. When a trail is severely deteriorated, rerouting might be the best alternative to attempting maintenance.

Trail maintenance activities entail a number of preventative and corrective actions (Beers, 1993):

1. Checking the structural integrity of trail features, such as bridges, steps, and railings, and repairing damages.
2. Keeping the tread surface free of obstacles or hazards, such as downed trees and landslides. Loose rocks and earth in a disturbed area should be removed and the trail tread restored to its intended state.
3. Clearing and maintaining drainage features to minimize trail erosion and environmental damage. Drainage methods causing the least impact on the natural environment should be used. In order of least to most damaging, these methods include clearing drainage channels, maintaining outslope of the trail bed, cleaning drain dips or water bars, clearing parallel ditches, and cleaning culverts through or beneath the trail.
4. Cutting vegetation to define the established trail tread and/or protect resources adjacent to the trail.
5. Maintaining the tread in a condition that can be negotiated by trail users.

Tread maintenance can include restoring sloped or crowned surfaces to facilitate drainage, extending the trail back to its original width, filling ruts and holes, and restoring raised approaches to bridges.

## 5.5 Design Conflicts

The many types of users and varied terrain along which trails are constructed can place competing demands upon trail designers. To minimize impact on the environment while maintaining user safety and avoiding potential user conflicts, trail designers must understand how design specifications affect user interactions and activities. The following discussions provide examples of design conflicts that can occur in trail environments.

### 5.5.1 Trail Elements

The scope and design of trail elements, e.g., bridges and water bars, should be appropriate to the conditions of the trail and the needs of the full range of users. The accessibility and safety of a trail might be significantly compromised if trail elements do not provide a level of accommodation consistent with the surrounding environment. For example, a trail user negotiating a paved, level path would expect to use an accessible bridge, not a fallen log, when crossing a stream (Figure 5-8). When a trail element along an accessible trail is not consistent with the trail’s overall design, a user might be forced to turn back in frustration before reaching his or her destination. If the trail user chooses not to turn back and attempts to continue along the path, he or she risks possible injury.

### 5.5.2 Built Facilities Along Trails

People with disabilities participate in all types of trail activities at a wide range of skill levels. For example, a person with a mobility impairment might be an advanced horse rider. In addition, a person with a mobility impairment might use a

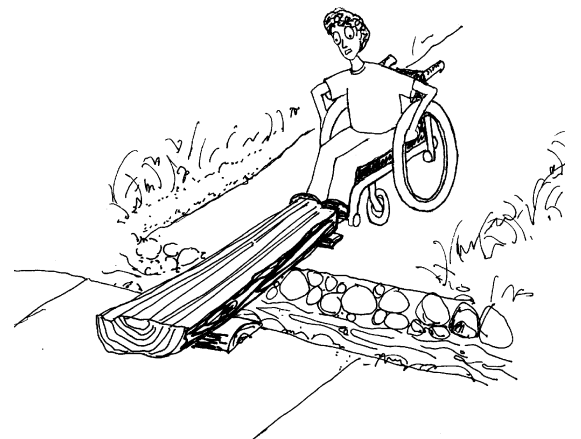
mechanical device, such as an ATV, to reach trail segments that would not ordinarily be accessible to him or her.

It is critical that built facilities, such as restrooms and parking lots at the trailhead and along the trail, be accessible, to address the reality that people with disabilities use all types of trails. ADAAG provides scoping requirements for all built facilities along an accessible route, including restrooms, drinking fountains, and parking lots. The number of accessible spaces required in parking lots, for example, is listed in Table 5-3. All new or remodeled

**Table 5-3:**  
**Scoping Requirements for Accessible Parking Spaces**

Total Parking in Lot	Required Minimum No. of Accessible Spaces
1 to 25	1
26 to 50	2
51 to 75	3
76 to 100	4
101 to 150	5
151 to 200	6
201 to 300	7
301 to 400	8
401 to 500	9
501 to 1000	2 percent of total
over 1000	20 plus 1 for each 100

**Figure 5-8:**  
**If a trail is accessible, the trail elements along the path also should be accessible.**



built trail facilities provided along a trail or at the trailhead should be built to ADAAG specifications, regardless of the user types permitted or the difficulty level of the trail.

### 5.5.3 Designing Trail Amenities for Multiple User Groups

Different types of users have distinct needs for trail amenities. For example, bicyclists might need facilities such as bike racks that are easy to use and highly visible (Ryan, 1993). Equestrians require hitching posts and water troughs near stopping points such as picnic tables. Equestrians also need staging and rest areas large enough to accommodate the movements of a horse (ibid.). OHV users require a testing circle, or “landing,” to determine if their equipment is operating correctly. The needs of all user groups should be included during the development stage of a trail facility to ensure that adequate amenities are available.

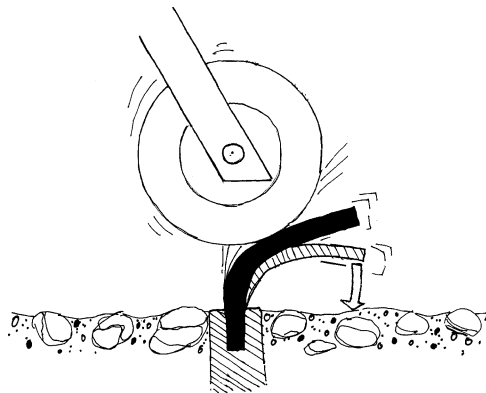
### 5.5.4 Drainage Control Measures and Access

Excessive water on a trail can significantly limit trail use, creating conditions harmful to the trail and hazardous to the user. In addition, excess water accelerates erosion and damages the trail surface. Users seeking to avoid the wet conditions might trample adjacent vegetation or cut damaging way trails.

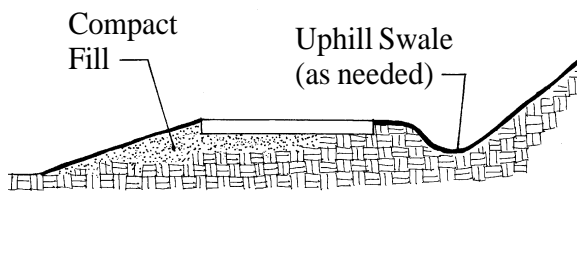
Some cross-slope is needed along a trail to allow water to drain off the path. However, excessive cross-slopes are difficult for people with mobility disabilities to negotiate. For more information on cross-slope, refer to Section 5.4.3.

Drainage bars are often used to encourage the flow of water off the trail. The presence of drainage bars can significantly impact access for trail users. Drainage bars consist of rock, wood, or rubber structures placed across the trail tread to divert water off the trail on steep slopes. All drainage bars can be difficult for people using wheelchairs and other wheeled devices to cross. However, thin rubber drainage bars that flex (Figure 5-9) are easier to travel over than drainage bars made of inflexible materials such as rock. Trails where many users are expected to use wheeled devices, such as shared-use paths in urban areas, should never have drainage bars. Wheeled trail users often attempt to travel around the ends of drainage bars rather than over them, cutting a channel that renders the drainage bar ineffective. Swales (Figure 5-10) and drainage channels can provide the same degree of water runoff while affording better access than drainage bars. However, building trails with less extreme slopes is the easiest manner to avoid the need for drainage bars.

**Figure 5-9:**  
*Rubber waterbars are difficult for wheelchair users and bikers to push down traveling uphill, but they are still more desirable than inflexible waterbars.*



**Figure 5-10:**  
*Swales can control drainage and eliminate the need for waterbars.*



Where water flow is consistent, culverts, short sections of boardwalk, or bridging can be provided. Swamps and other areas that drain poorly might be closed during

certain times such as spring thaw. Porous surfacing materials such as gravel, wood chips, or corduroys (logs or rocks laid on or in the path of travel) may be used to improve drainage and mitigate trail erosion.

### **5.5.5 Complying with Design Standards**

Flexibility in applying guideline specifications might be necessary to acknowledge the diversity of outdoor environments. Variations in terrain, changing outdoor conditions, time periods between access and maintenance reviews, and conflicts between design standards for different user groups are among the factors that can affect the implementation of design guidelines. Design guidelines that cannot realistically be met in some natural environments create an unworkable situation for trail designers. In the worst-case scenario, trail designers might feel that meeting rigid guidelines is impossible and ultimately ignore all design recommendations. For this reason, design guidelines for trails are most effective when they contain provisions to address situations when full compliance is not feasible or desirable.

### **5.5.6 Difficulty Ratings for Trails**

Subjective trail difficulty ratings can be misleading because challenge levels are often determined relative to the trails within a given park or forest area, instead of being based on objective information. As a result, visitors cannot be certain that a trail rated difficult in one area will provide the same challenge as one with the same rating at another area.

Furthermore, most trail rating systems do not allow changes in the design parameters of a trail, and the same difficulty rating can be unrealistic to apply over the full length of a trail. This is especially true for trails that meander through extremely varied terrain. For

example, Pine Creek Trail in the Gallatin National Forest in Montana provides access from a campground to a creek, then climbs out of a canyon and across a plateau to a lake. The hike to the creek access is paved and level, requiring approximately 10 minutes to complete, while the rest of the trail is about 8 km long and requires many hours to finish. If considered across its full length, Pine Creek Trail would most likely be categorized as “most difficult,” even though the segment from the trailhead to the creek provides an easier level of access.

Instead of labeling trails with difficulty ratings, trail managers should consider disclosing objective measurement information about trail conditions to visitors. Trail information provided via formats such as signage can convey surface type, grade, cross-slope, and width information. Such information can help visitors determine for themselves which trails will help them achieve their desired experience.

## **5.6 User Conflicts**

When a trail user fails to achieve his or her desired experience from the trip and determines that it is due to someone else’s behavior, conflict results and satisfaction suffers. Conflict is not the same as competition for scarce resources. If people attribute not getting a parking place to their own lack of planning, there is no conflict (Moore, 1994). Conflicts among trail users can stem from a variety of sources, including personal expectations, clashes between different skill levels and speeds, attitudes toward other types of trail users, and intrinsic differences in movement patterns.

### **5.6.1 Experience Level**

Conflicts can arise when trail users with different levels of experience interact

because experts and novices often do not mix well. Skill level affects how well a trail user can maneuver a vehicle or animal. For example, some equestrians might not have sufficient skill to prevent their mounts from running away or kicking other trail users. Similarly, new cyclists might not be aware of the custom of ringing a bell or providing an audible warning before passing other trail users.

The level of intensity at which an activity is pursued also generates user conflicts. For example, fit and experienced bicyclists tend to travel quickly and aggressively. Their approach from behind might frighten less experienced bicyclists.

### **5.6.2 Expectations**

Discrepancies between trail expectations can cause conflicts between users. Many people enjoy trails because they desire a quiet respite from their busy lives. Other people expect an area where they can seek adventure and make noise without disturbing neighbors. When these groups encounter one another on a trail, conflict over expectations often ensues. For example, bird watchers expecting tranquil, undisturbed surroundings might be angry to encounter noise from OHV riders along a trail. Large groups, such as classes of excited schoolchildren, also might disturb other trail users by foiling their expectations of privacy and relaxation. People who view trails as a largely natural environment might become hostile toward trail users who litter or play loud music.

### **5.6.3 Conflicts Among User Groups**

Conflicts on trails most frequently stem from the attitudes of different user groups. Trail users traveling at different speeds and following different movement patterns might clash in attitude and expectation.

#### **5.6.3.1 Technology differences**

Discrepancies in the level of technology used on a trail can be a major source of friction between trail users. Those hiking or using nonmotorized technologies such as cross-country skis tend to have more conflicts with users of motorized vehicles, such as snow machines, than vice versa. Recreational technologies such as mountain bikes and OHVs permit trail users to travel faster than pedestrians, who might complain of being startled by the sudden appearance and fast approach of these users. The speeds attained and the surface disturbance caused by motorized technologies can make hikers or those using a quiet mobility device such as a wheelchair feel threatened and overwhelmed. In general, the greater the difference in the level of technology used, the more likely the “low-tech” user will be to develop hostilities (Moore, 1994).

#### **5.6.3.2 Movement patterns**

Movement patterns vary significantly between user groups and is another potential source of trail conflict. Trail users travel at different speeds and require different amounts of space to move forward, stop, and turn. For example, skaters might occupy a larger width of trail than other users due to their kick-out propulsion method. Users who move at high speeds, e.g., snow machine users and bicyclists, require longer stopping and maneuvering distances. Those who use larger devices, such as OHVs or recumbent bicycles, also require more space to turn than pedestrians or wheelchair users, who are quite maneuverable. Sudden changes in direction can leave other trail users without sufficient time to react. Resulting collisions or near-misses can lead to hostilities. Separating different types of trail users (Figure 5-11), limiting speeds using design techniques such as shorter sight distances, and designing wider trails might mitigate movement pattern conflicts.

### 5.6.3.3 Perceived environmental impact

Perceived environmental disturbance also creates conflict between hikers and those who use recreation technologies to enjoy trails. Because equestrian, OHV, and mountain bike use can hasten erosion of soft surfaces so that they become more difficult to negotiate for other users (Cimarron Designs, 1994), hikers often perceive these groups as “ruining” trails or surrounding natural areas (Ryan, 1993). This perception, however, does not take into consideration the fact that hikers damage trails and soils as well.

The combined size and power of some trail users and their mode of transport can frighten or intimidate others. For example, a cross-country skier might feel that encounters with large, loud snow machines are unsafe and overwhelming (Moore, 1994). Conflicts between equestrians and other trail users can occur because horses are often skittish and can startle or bolt, creating a hazard for other trail users. Those unaccustomed to being around horses might unwittingly provoke them to bite, rear, or flee by petting or otherwise approaching them. Other trail users might feel threatened by the size or proximity of a horse.

### 5.6.3.4 New and newly popularized sports

People encountering an activity or technology for the first time on a trail can be suspicious and wary of the behavior, appropriateness, and demeanor of the newcomers. For example, new sports often attract young people; their boisterous behavior can often antagonize older trail users disturbed by the noise. When an activity such as in-line skating suddenly becomes popular, many people with little control over their speed and maneuverability appear on trails. The seemingly reckless and irresponsible behavior of novices often causes other trail users to develop negative stereotypes

about those who practice the activity. New and newly popularized sports also tend to lack established standards of etiquette. As a result, those who encounter people using the new technology do not know how to react to the newcomers.

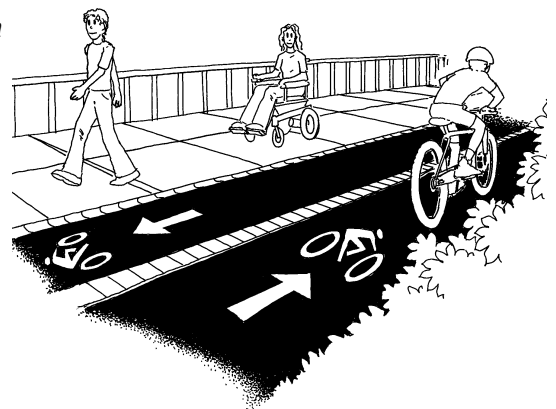
As more people participate in a new sport, other trail users gain experience interacting with the newcomers. As the new activity becomes established, etiquette standards become more widely known, followed, and understood by all trail users. For example, good trail-user ethics have recently been developed and publicized for mountain biking, a relatively new trail activity. Once learned by more users, these etiquette standards will help mitigate the conflicts between bikers and other trail users. Another method of blending new users into an established trail community is to encourage use of appropriate equipment and behavior in promotional programs (Moore, 1994).

### 5.6.4 Lack of Communication Among Trail Users

A lack of communication between different trail users is the root of many clashes and collisions on trails. Users must realize that communication is a two-way interaction and make an effort

**Figure 5-11:**

***Separate pathways and clear signage can help reduce conflicts between users who travel at different speeds.***



to warn others of their needs and intentions. For example, cyclists overtaking a pedestrian might communicate their approach through an audible signal such as their voice or a bell but might also opt to use hand and arm turning signals. For communication to be successful, those receiving the signal must understand its meaning. For instance, a person who is Deaf or hard of hearing might not detect the ringing of a bicycle bell, or some people might not understand that an outstretched, bent arm indicates a right turn. If trail users are schooled in a basic and universal system of communication, such as what ringing a bike bell means, chances for conflict and crashes are minimized. Signs, speed limits, and good user etiquette can also help minimize hostility between groups (Ryan, 1993).

### 5.6.5 Number of Users

The number of trail users will increase the chances of conflicts, regardless of the mix of user groups. For example, if backpackers seeking solitude encounter more users on the trail than expected, their frustration at being unable to find an uncrowded area might spur them to initiate a conflict with other users.

### 5.6.6 Minimizing User Conflicts on Trails

Promoting responsible behavior on trails can minimize user conflict. Trail etiquette

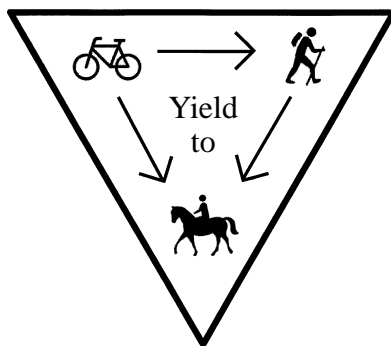
standards can be publicized on trail signs (Figure 5-12) and in existing educational materials (Orwig, 1995). Trail users might be less likely to become offended at the actions of other people once they understand how each group is supposed to act. Trail users also might be less likely to violate an established code of behavior if they believe the rules will be enforced by trail personnel.

Minimizing contact between conflicting types of trail users, especially in congested areas such as trailheads, can be the best method to avoid trail problems. Providing several entrances to a single trail, or several trails at a variety of difficulty levels, can help reduce conflicts between individual user types (Orwig, 1995). Trails that permit only trail users that have similar needs and expectations might have fewer incidences of user conflicts than trails that permit motorized users to mix with nonmotorized users. A good understanding of the needs and behavior of different groups is essential to make wise trail-use decisions.

Ultimately, trail managers must have a good understanding of the motivations, desired experiences, and points of view of various trail user groups (Moore, 1994). This information can help trail managers anticipate conflicts before they arise and identify solutions satisfactory to the majority of trail users. Trail managers can obtain information on existing conflicts and gather proposed solutions by meeting with individual user groups, including people with disabilities. These contacts can be used to call a negotiation meeting if conflicts arise in the future. Such a meeting can help all parties arrive at a consensus on how to address the problem.

Although eliminating all trail conflicts on very crowded or otherwise problematic trails might not be possible, conflict-mitigation techniques will usually help reduce the effects of such dilemmas.

**Figure 5-12:**  
*Trail signs can help clarify trail etiquette.*





## **5.7 Conclusion**

Everyone should have the opportunity to experience and enjoy the natural environment. People with and without disabilities, older people, families, and children all benefit from being able to enjoy parks and forests. To the maximum extent feasible, trails should be designed to accommodate the access needs of all designated users. Considering accessibility when designing trails and installing accessible built facilities such as wheelchair-accessible toilets, Braille displays in visitor centers, and lowered

drinking fountains will permit more people to enjoy the outdoors. In addition, providing detailed information about existing path conditions and available facilities can help visitors select trails. Such trail information reduces the likelihood that a trail user will become stranded or endangered and can improve safety and visitor enjoyment. Although increased use might be accompanied by increased conflicts between different types of trail users, land managers can minimize friction between groups by using good trail-management techniques.

**Table 5-4.1:**  
**Federal Accessibility Guidelines for Maximum Allowable Running Slope without Landings and Handrails**

Source	Path Type	Single Level %	Multiple Levels		
			Easier %	Moderate %	Difficult %
ADA Standards for Access. Design <sup>1</sup> (US DOJ, 1991)	AR	5 <sup>2</sup>			
UFAS (US DoD, et al., 1984)	AR	5 <sup>2</sup>			

<sup>1</sup> The ADA Standards for Accessible Design are identical in content to ADAAG Sections 1–10. However, the Design Standards are enforceable by the U.S. Department of Justice.

<sup>2</sup> The ADA Standards for Accessible Design and UFAS both require people to use the least slope possible on accessible routes. An accessible route with a running slope greater than 5% is considered a ramp whose slope should be the least possible but may not exceed 8.33% (see Table 5-5.1).

**Table 5-4.2:**  
**Federal Advisory Committee Recommendations for Maximum Allowable Running Grade**

Source	Path Type	Single Level %	Multiple Levels		
			Easier %	Moderate %	Difficult %
Recommendations for Accessibility Guidelines: Recreational Facilities. . . (Rec. Access. Adv. Comm., 1994)	ORAR		5	5	8
Recommendations for Accessibility Guidelines: Recreational Facilities. . . (Rec. Access. Adv. Comm., 1994)	RT		5	8	12

**Table 5-4.3:**  
**Federal Guidelines for Maximum Allowable Running Grade**

Source	Path Type	Single Level %	Multiple Levels		
			Easier %	Moderate %	Difficult %
USDA FS Trails Mgt. Handbook (USDA FS, 1985)	H		n/a	n/a	n/a
Guide for the Dev. of Bicycle Facilities (AASHTO, 1997, Draft)	S	5			
Guide for the Dev. of Bicycle Facilities (AASHTO, 1991)	B	5			
USDA FS Trails Mgt. Handbook (USDA FS, 1985)	E		n/a	n/a	n/a
USDA FS Trails Mgt. Handbook (USDA FS, 1985)	X		7.5	12	17
USDA FS Trails Mgt. Handbook (USDA FS, 1985)	SM		8	n/a	15
USDA FS Trails Mgt. Handbook (USDA FS, 1985)	ATV		15	25	35

AR = Accessible Route  
H = Hiking Trail  
MB = Mountain Biking Trail  
SM = Snow Machine Trail  
OHV = Off-Highway Vehicle Trail  
ORAR = Outdoor Recreation Access Route  
S = Shared-Use Path  
E = Equestrian Trail  
ATV = All-Terrain Vehicle Trail  
M = Motorcycle Trail  
RT = Recreational Trail  
B = Bicycle Path  
X = Cross-Country Ski Trail

**Table 5-4.4:**  
**State, County, and City Guidelines for Maximum Allowable Running Grade**

Source	Path Type	Single Level %	Multiple Levels		
			Easier %	Moderate %	Difficult %
Klamath District's Trail . . . (Beers, 1993, Draft)	ORAR	5			
NM Plan for Accessible Fishing (Nordhaus, et al., 1984)	ORAR		5	6.3	8.33
Access to Parks Guidelines (CA State Parks, 1997)	RT		< 5	5	6.3
Ped. Facilities Guidebook for WA DOT (WA DOT, 1997)	RT		5	8.33	12.5
Alaska Region Trails Const. (USDA FS, AK Reg. FS, 1991)	H		n/a	n/a	n/a
MO St. Parks Trail Const. Guidelines (MO DNR, 1975)	H	10			
PA Plan for Nonmotorized Trails (PA Trails Pgm., 1980b)	H	10			
FL Bicycle Facilities Planning. . . (FL DOT. . ., 1997)	S	5			
Oregon Bicycle and Ped. Plan (OR DOT, 1995)	S	5			
Pitkin City Trails Dgn. and Mgt. . . . (Cimarron Designs, 1994)	S	5			
KY Dept. of Parks Trail Construction. . . (KY Dept. of Parks, 1989)	B	15			
MO St. Parks Trail Const. Guidelines (MO DNR, 1975)	B	n/a			
PA Plan for Nonmotorized Trails (PA Trails Pgm., 1980b)	B	5			
Wisconsin DNR Design Standards (WI DNR, 1994)	B	15			
KY Dept. of Parks Trail Construction. . . (KY Dept. of Parks, 1989)	E	15			
MO St. Parks Trail Const. Guidelines (MO DNR, 1975)	E	10			
PA Plan for Nonmotorized Trails (PA Trails Pgm., 1980b)	E	15			
Wisconsin DNR Design Standards (WI DNR, 1994)	E	15			
PA Plan for Nonmotorized Trails (PA Trails Pgm., 1980b)	X			8	17
PA Plan for Motorized Trails (PA Trails Pgm., 1980a)	SM	25			
Wisconsin DNR Design Standards (WI DNR, 1994)	SM	25			
PA Plan for Motorized Trails (PA Trails Pgm., 1980a)	ATV	75			
Wisconsin DNR Design Standards (WI DNR, 1994)	ATV	n/a			

AR = Accessible Route  
H = Hiking Trail  
MB = Mountain Biking Trail  
SM = Snow Machine Trail  
OHV = Off-Highway Vehicle Trail

ORAR = Outdoor Recreation Access Route  
S = Shared-Use Path  
E = Equestrian Trail  
ATV = All-Terrain Vehicle Trail  
M = Motorcycle Trail

RT = Recreational Trail  
B = Bicycle Path  
X = Cross-Country Ski Trail

**Table 5-4.5:**  
**Additional Recommendations for Maximum Allowable Running Grade**

Source	Path Type	Single Level %	Multiple Levels		
			Easier %	Moderate %	Difficult %
ORAR and RT Design Specification (Axelson et al., 1995) <sup>1</sup>	ORAR		5	8	10
Universal Access. to Outdoor Rec. (PLAE, Inc., 1993)	ORAR		5	5	8.33
ORAR and RT Design Specification (Axelson et al., 1995) <sup>1</sup>	RT		8	10	14
Universal Access. to Outdoor Rec. (PLAE, Inc., 1993)	RT		5	8.33	12.5
Recreational Trail Design and Const. (Rathke and Baughman, 1994)	H	15			
Trails for the 21st Century (Ryan, 1993)	S	5			
Recreational Trail Design and Const. (Rathke and Baughman, 1994)	B	10			
Trails for the 21st Century (Ryan, 1993)	B	8			
Mountain Bike Trails: Tech for. . . (McCoy and Stoner, 1992)	MB		5	10	15
Recreational Trail Design and Const. (Rathke and Baughman, 1994)	E	10			
Trails for the 21st Century (Ryan, 1993)	E	10			
Recreational Trail Design and Const. (Rathke and Baughman, 1994)	X	10			
Trails for the 21st Century (Ryan, 1993)	X	5			
Recreational Trail Design and Const. (Rathke and Baughman, 1994)	SM	25			
Trails for the 21st Century (Ryan, 1993)	SM	n/a			
OHM and ATV Trails Guidelines for Dgn. . . . (Wemex, 1994)	ATV		8	12	15

<sup>1</sup> Maximum allowable average grade not running grade.

AR = Accessible Route                      ORAR = Outdoor Recreation Access Route                      RT = Recreational Trail  
H = Hiking Trail                              S = Shared-Use Path                              B = Bicycle Path  
MB = Mountain Biking Trail                      E = Equestrian Trail                              X = Cross-Country Ski Trail  
SM = Snow Machine Trail                      ATV = All-Terrain Vehicle Trail  
OHV = Off-Highway Vehicle Trail                      M = Motorcycle Trail

**Table 5-5.1:****Federal Accessibility Guidelines for Maximum Slope for a Specified Ramp Run with Landings and Handrails**

Source	Path Type	Single Level		Multiple Levels					
				Easier		Moderate		Difficult	
		Grade %	Run m	Grade %	Run m	Grade %	Run m	Grade %	Run m
ADA Standards for Access. Design (US DOJ, 1991)	AR	8.33 <sup>1</sup>	9.1						
UFAS (US DoD, et al., 1984)	AR	8.33 <sup>1</sup>	9.1						

<sup>1</sup> ADA Standards for Accessible Design and UFAS both require people to use the least slope possible on accessible routes.

**Table 5-5.2:****Federal Advisory Committee Recommendations for Maximum Grade for a Specified Distance (Run)**

Source	Path Type	Single Level		Multiple Levels					
				Easier		Moderate		Difficult	
		Grade %	Run m	Grade %	Run m	Grade %	Run m	Grade %	Run m
Recommendations for Accessibility Guidelines: Recreational Facilities... (Rec. Access. Adv. Comm., 1994)	ORAR			8	9.1	10	15.2	10	15.2
Recommendations for Accessibility Guidelines: Recreational Facilities... (Rec. Access. Adv. Comm., 1994)	RT			10	9.1	14	15.2	20	15.2

**Table 5-5.3:****Federal Guidelines for Maximum Grade for a Specified Distance (Run)**

Source	Path Type	Single Level		Multiple Levels					
				Easier		Moderate		Difficult	
		Grade %	Run m	Grade %	Run m	Grade %	Run m	Grade %	Run m
USDA FS Trails Mgt. Handbook (USDA FS, 1985)	H			20	30.5	30	91.4	+30	152.4
Guide for the Dev. of Bicycle Facilities (AASHTO, 1997, Draft)	S	+11	15						
Guide for the Dev. of Bicycle Facilities (AASHTO, 1991)	B	n/a	n/a						
USDA FS Trails Mgt. Handbook (USDA FS, 1985)	E			15	61	25	91.4	+30	152.4
USDA FS Trails Mgt. Handbook (USDA FS, 1985)	X			10	30.5	20	30.5	n/a	n/a
USDA FS Trails Mgt. Handbook (USDA FS, 1985)	SM			25	n/a <sup>1</sup>	n/a	n/a	35	n/a <sup>1</sup>
USDA FS Trails Mgt. Handbook (USDA FS, 1985)	ATV			20	61.0	30	91.4	50	152.4

<sup>1</sup> The requirement was for maximum pitch, no distance was specified.

AR = Accessible Route	ORAR = Outdoor Recreation Access Route	RT = Recreational Trail
H = Hiking Trail	S = Shared-Use Path	B = Bicycle Path
MB = Mountain Biking Trail	E = Equestrian Trail	X = Cross-Country Ski Trail
SM = Snow Machine Trail	ATV = All-Terrain Vehicle Trail	
OHV = Off-Highway Vehicle Trail	M = Motorcycle Trail	

**Table 5-5.4:**  
**State, County, and City Guidelines for Maximum Grade for a Specified Distance (Run)**

Source	Path Type	Single Level		Multiple Levels					
		Grade %	Run m	Easier		Moderate		Difficult	
				Grade %	Run m	Grade %	Run m	Grade %	Run m
Klamath District's Trail . . . (Beers, 1993, Draft)	ORAR	8.33	9.1						
NM Plan for Accessible Fishing (Nordhaus, et al., 1984)	ORAR			8.33	9.1	8.33	9.1	8.33	9.1
Access to Parks Guidelines (CA State Parks, 1997)	RT			5	15.2	6.3	12.2	8.33	9.1
Ped. Facilities Guidebook for WA DOT (WA DOT, 1997)	RT			8.33	9.1	14	15.2	20	15.2
Alaska Region Trails Const. (USDA FS, AK Reg. FS, 1991)	H			20	30.5	30	91.4	+30	152.4
MO St. Parks Trail Const. Guidelines (MO DNR, 1975)	H	15	n/a <sup>1</sup>						
PA Plan for Nonmotorized Trails (PA Trails Pgm., 1980b)	H	20	n/a <sup>2</sup>						
FL Bicycle Facilities Planning. . . (FL DOT. . ., 1997)	S	11	15.2						
Oregon Bicycle and Ped. Plan (OR DOT, 1995)	S	8.33	9.1						
Pitkin City Trails Dgn. and Mgt. . . . (Cimarron Designs, 1994)	S	10	15.2						
KY Dept. of Parks Trail Construction. . . (KY Dept. of Parks, 1989)	B	30	152.4						
MO St. Parks Trail Const. Guidelines (MO DNR, 1975)	B	5	91.4						
PA Plan for Nonmotorized Trails (PA Trails Pgm., 1980b)	B	n/a	n/a						
Wisconsin DNR Design Standards (WI DNR, 1994)	B	30	30.5						
KY Dept. of Parks Trail Construction. . . (KY Dept. of Parks, 1989)	E	25	30.5						
MO St. Parks Trail Const. Guidelines (MO DNR, 1975)	E	15	45.7						
PA Plan for Nonmotorized Trails (PA Trails Pgm., 1980b)	E	n/a	n/a						
Wisconsin DNR Design Standards (WI DNR, 1994)	E	25	30.5						
PA Plan for Nonmotorized Trails (PA Trails Pgm., 1980b)	X			n/a	n/a	10	n/a <sup>1</sup>	20	n/a <sup>1</sup>
PA Plan for Motorized Trails (PA Trails Pgm., 1980a)	SM	n/a	n/a						
Wisconsin DNR Design Standards (WI DNR, 1994)	SM	n/a	n/a						
PA Plan for Motorized Trails (PA Trails Pgm., 1980a)	ATV	n/a	n/a						
Wisconsin DNR Design Standards (WI DNR, 1994)	ATV	n/a							

<sup>1</sup> For short distances.

<sup>2</sup> In extreme circumstances, 20% is permitted. In general 15% should be observed as the maximum grade and should only be used over short distances.

AR = Accessible Route	ORAR = Outdoor Recreation Access Route	RT = Recreational Trail
H = Hiking Trail	S = Shared-Use Path	B = Bicycle Path
MB = Mountain Biking Trail	E = Equestrian Trail	X = Cross-Country Ski Trail
SM = Snow Machine Trail	ATV = All-Terrain Vehicle Trail	
OHV = Off-Highway Vehicle Trail	M = Motorcycle Trail	

**Table 5-5.5:**  
**Additional Recommendations for Maximum Grade for a Specified Distance Run**

Source	Path Type	Single Level		Multiple Levels					
		Grade %	Run m	Easier		Moderate		Difficult	
				Grade %	Run m	Grade %	Run m	Grade %	Run m
ORAR and RT Design Specification (Axelson et al., 1995)	ORAR			8	3.0	12	9.1	14	9.1
Universal Access. to Outdoor Rec. (PLAE, Inc., 1993)	ORAR			8.33	9.1	10	15.2	10	15.2
ORAR and RT Design Specification (Axelson et al., 1995)	RT			14	3.0	14	9.1	20	9.1
Universal Access. to Outdoor Rec. (PLAE, Inc., 1993)	RT			10	15.2	14	15.2	20	15.2
Recreational Trail Design and Const. (Rathke and Baughman, 1994)	H	40	45.7						
Trails for the 21st Century (Ryan, 1993)	S	8.0	9.1						
Recreational Trail Design and Const. (Rathke and Baughman, 1994)	B	15	45.7						
Trails for the 21st Century (Ryan, 1993)	B	n/a	n/a						
Mountain Bike Trails: Tech for. . . (McCoy and Stoner, 1992)	MB			10	30.5	30	91.4	+30	152.4
Recreational Trail Design and Const. (Rathke and Baughman, 1994)	E	20	45.7						
Trails for the 21st Century (Ryan, 1993)	E	n/a	n/a						
Recreational Trail Design and Const. (Rathke and Baughman, 1994)	X	40	45.7						
Trails for the 21st Century (Ryan, 1993)	X	n/a	n/a						
Recreational Trail Design and Const. (Rathke and Baughman, 1994)	SM	40	45.7						
Trails for the 21st Century (Ryan, 1993)	SM	n/a	n/a						
OHM and ATV Trails Guidelines for Dgn. . . . (Wemex, 1994)	ATV			15	n/a	30	n/a	50	n/a

AR = Accessible Route  
H = Hiking Trail  
MB = Mountain Biking Trail  
SM = Snow Machine Trail  
OHV = Off-Highway Vehicle Trail

ORAR = Outdoor Recreation Access Route  
S = Shared-Use Path  
E = Equestrian Trail  
ATV = All-Terrain Vehicle Trail  
M = Motorcycle Trail

RT = Recreational Trail  
B = Bicycle Path  
X = Cross-Country Ski Trail

**Table 5-6.1:**  
**Federal Accessibility Guidelines for Maximum Allowable Running Cross-Slope**

Source	Path Type	Single Level %	Multiple Levels		
			Easier %	Moderate %	Difficult %
ADA Standards for Access. Design (US DOJ, 1991)	AR	2 <sup>1</sup>			
UFAS (US DoD, et al., 1984)	AR	2 <sup>1</sup>			

<sup>1</sup> ADA Standards for Accessible Design and UFAS both require people to use the least slope possible on accessible routes.

**Table 5-6.2:**  
**Federal Advisory Committee Recommendations for Maximum Allowable Running Cross-Slope**

Source	Path Type	Single Level %	Multiple Levels		
			Easier %	Moderate %	Difficult %
Recommendations for Accessibility Guidelines: Recreational Facilities. . . (Rec. Access. Adv. Comm., 1994)	ORAR		3	3	3
Recommendations for Accessibility Guidelines: Recreational Facilities. . . (Rec. Access. Adv. Comm., 1994)	RT		3	5	8

**Table 5-6.3:**  
**Federal Guidelines for Maximum Allowable Running Cross-Slope**

Source	Path Type	Single Level %	Multiple Levels		
			Easier %	Moderate %	Difficult %
USDA FS Trails Mgt. Handbook (USDA FS, 1985)	H		n/a	n/a	n/a
Guide for the Dev. of Bicycle Facilities (AASHTO, 1997, Draft)	S	2			
Guide for the Dev. of Bicycle Facilities (AASHTO, 1991)	B	2			
USDA FS Trails Mgt. Handbook (USDA FS, 1985)	E		n/a	n/a	n/a
USDA FS Trails Mgt. Handbook (USDA FS, 1985)	X		n/a	n/a	n/a
USDA FS Trails Mgt. Handbook (USDA FS, 1985)	SM		15	30	40
USDA FS Trails Mgt. Handbook (USDA FS, 1985)	ATV		20	30	40

AR = Accessible Route      ORAR = Outdoor Recreation Access Route      RT = Recreational Trail  
 H = Hiking Trail          S = Shared-Use Path              B = Bicycle Path  
 MB = Mountain Biking Trail      E = Equestrian Trail              X = Cross-Country Ski Trail  
 SM = Snow Machine Trail      ATV = All-Terrain Vehicle Trail  
 OHV = Off-Highway Vehicle Trail      M = Motorcycle Trail



**Table 5-6.4:**  
**State, County, and City Guidelines for Maximum Allowable Running Cross-Slope**

Source	Path Type	Single Level %	Multiple Levels		
			Easier %	Moderate %	Difficult %
Klamath District's Trail . . . (Beers, 1993, Draft)	ORAR	1			
NM Plan for Accessible Fishing (Nordhaus, et al., 1984)	ORAR		2	3.3	5
Access to Parks Guidelines (CA State Parks, 1997)	RT		1	2	n/a
Ped. Facilities Guidebook for WA DOT (WA DOT, 1997)	RT		2	3	5
Alaska Region Trails Const. (USDA FS, AK Reg. FS, 1991)	H		n/a	n/a	n/a
MO St. Parks Trail Const. Guidelines (MO DNR, 1975)	H	n/a			
PA Plan for Nonmotorized Trails (PA Trails Pgm., 1980b)	H	n/a			
FL Bicycle Facilities Planning. . . (FL DOT. . ., 1997)	S	2			
Oregon Bicycle and Ped. Plan (OR DOT, 1995)	S	2			
Pitkin City Trails Dgn. and Mgt. . . (Cimarron Designs, 1994)	S	2			
KY Dept. of Parks Trail Construction. . . (KY Dept. of Parks, 1989)	B	n/a			
MO St. Parks Trail Const. Guidelines (MO DNR, 1975)	B	n/a			
PA Plan for Nonmotorized Trails (PA Trails Pgm., 1980b)	B	n/a			
Wisconsin DNR Design Standards (WI DNR, 1994)	B	n/a			
KY Dept. of Parks Trail Construction. . . (KY Dept. of Parks, 1989)	E	n/a			
MO St. Parks Trail Const. Guidelines (MO DNR, 1975)	E	n/a			
PA Plan for Nonmotorized Trails (PA Trails Pgm., 1980b)	E	n/a			
Wisconsin DNR Design Standards (WI DNR, 1994)	E	n/a			
PA Plan for Nonmotorized Trails (PA Trails Pgm., 1980b)	X		n/a	n/a	n/a
PA Plan for Motorized Trails (PA Trails Pgm., 1980a)	SM	n/a			
Wisconsin DNR Design Standards (WI DNR, 1994)	SM	n/a			
PA Plan for Motorized Trails (PA Trails Pgm., 1980a)	ATV	n/a			
Wisconsin DNR Design Standards (WI DNR, 1994)	ATV	n/a			

AR = Accessible Route  
H = Hiking Trail  
MB = Mountain Biking Trail  
SM = Snow Machine Trail  
OHV = Off-Highway Vehicle Trail

ORAR = Outdoor Recreation Access Route  
S = Shared-Use Path  
E = Equestrian Trail  
ATV = All-Terrain Vehicle Trail  
M = Motorcycle Trail

RT = Recreational Trail  
B = Bicycle Path  
X = Cross-Country Ski Trail

**Table 5-6.5:**  
**Additional Recommendations for Maximum Allowable Running Cross-Slope**

Source	Path Type	Single Level %	Multiple Levels		
			Easier %	Moderate %	Difficult %
ORAR and RT Design Specification (Axelson et al., 1995) <sup>1</sup>	ORAR		3	5	8
Universal Access. to Outdoor Rec. (PLAE, Inc., 1993)	ORAR		3	3	3
ORAR and RT Design Specification (Axelson et al., 1995) <sup>1</sup>	RT		5	8	12
Universal Access. to Outdoor Rec. (PLAE, Inc., 1993)	RT		3	5	8.33
Recreational Trail Design and Const. (Rathke and Baughman, 1994)	H	4			
Trails for the 21st Century (Ryan, 1993)	S	2			
Recreational Trail Design and Const. (Rathke and Baughman, 1994)	B	4			
Trails for the 21st Century (Ryan, 1993)	B	4			
Mountain Bike Trails: Tech for. . . (McCoy and Stoner, 1992)	MB		n/a	n/a	n/a
Recreational Trail Design and Const. (Rathke and Baughman, 1994)	E	4			
Trails for the 21st Century (Ryan, 1993)	E	4			
Recreational Trail Design and Const. (Rathke and Baughman, 1994)	X	2			
Trails for the 21st Century (Ryan, 1993)	X	4			
Recreational Trail Design and Const. (Rathke and Baughman, 1994)	SM	2			
Trails for the 21st Century (Ryan, 1993)	SM	n/a			
OHM and ATV Trails Guidelines for Dgn. . . . (Wemex, 1994)	ATV		n/a	n/a	n/a

<sup>1</sup> Maximum allowable average cross-slope not running cross-slope.

AR = Accessible Route  
H = Hiking Trail  
MB = Mountain Biking Trail  
SM = Snow Machine Trail  
OHV = Off-Highway Vehicle Trail

ORAR = Outdoor Recreation Access Route  
S = Shared-Use Path  
E = Equestrian Trail  
ATV = All-Terrain Vehicle Trail  
M = Motorcycle Trail

RT = Recreational Trail  
B = Bicycle Path  
X = Cross-Country Ski Trail

**Table 5-7.1:****Federal Accessibility Guidelines for Minimum Clearance Width**

Source	Path Type	Single Level m	Multiple Levels		
			Easier m	Moderate m	Difficult m
ADA Standards for Access. Design (US DOJ, 1991)	AR	0.915			
UFAS (US DoD, et al., 1984)	AR	0.915			

**Table 5-7.2:****Federal Advisory Committee Recommendations for Minimum Clearance Width**

Source	Path Type	Single Level m	Multiple Levels		
			Easier m	Moderate m	Difficult m
Recommendations for Accessibility Guidelines: Recreational Facilities. . . (Rec. Access. Adv. Comm., 1994)	ORAR		1.220	0.915	0.915
Recommendations for Accessibility Guidelines: Recreational Facilities. . . (Rec. Access. Adv. Comm., 1994)	RT		1.220	0.915	0.760

**Table 5-7.3:****Federal Guidelines for Minimum Clearance Width**

Source	Path Type	Single Level m	Multiple Levels		
			Easier m	Moderate m	Difficult m
USDA FS Trails Mgt. Handbook (USDA FS, 1985)	H		n/a	n/a	n/a
Guide for the Dev. of Bicycle Facilities (AASHTO, 1997, Draft)	S	n/a			
Guide for the Dev. of Bicycle Facilities (AASHTO, 1991)	B	n/a			
USDA FS Trails Mgt. Handbook (USDA FS, 1985)	E		n/a	n/a	n/a
USDA FS Trails Mgt. Handbook (USDA FS, 1985)	X		n/a	n/a	n/a
USDA FS Trails Mgt. Handbook (USDA FS, 1985)	SM		n/a	n/a	n/a
USDA FS Trails Mgt. Handbook (USDA FS, 1985)	ATV		n/a	n/a	n/a

AR = Accessible Route  
H = Hiking Trail  
MB = Mountain Biking Trail  
SM = Snow Machine Trail  
OHV = Off-Highway Vehicle Trail

ORAR = Outdoor Recreation Access Route  
S = Shared-Use Path  
E = Equestrian Trail  
ATV = All-Terrain Vehicle Trail  
M = Motorcycle Trail

RT = Recreational Trail  
B = Bicycle Path  
X = Cross-Country Ski Trail

**Table 5-7.4:**  
**State, County, and City Guidelines for Minimum Clearance Width**

Source	Path Type	Single Level m	Multiple Levels		
			Easier m	Moderate m	Difficult m
Klamath District's Trail . . . (Beers, 1993, Draft)	ORAR	1.525			
NM Plan for Accessible Fishing (Nordhaus, et al., 1984)	ORAR		0.915	0.915	0.815
Access to Parks Guidelines (CA State Parks, 1997)	RT		0.915	0.915	n/a
Ped. Facilities Guidebook for WA DOT (WA DOT, 1997)	RT		1.2	.9	0.7
Alaska Region Trails Const. (USDA FS, AK Reg. FS, 1991)	H		n/a	n/a	n/a
MO St. Parks Trail Const. Guidelines (MO DNR, 1975)	H	n/a			
PA Plan for Nonmotorized Trails (PA Trails Pgm., 1980b)	H	n/a			
FL Bicycle Facilities Planning . . . (FL DOT. . ., 1997)	S	n/a			
Oregon Bicycle and Ped. Plan (OR DOT, 1995)	S	n/a			
Pitkin City Trails Dgn. and Mgt. . . . (Cimarron Designs, 1994)	S	n/a			
KY Dept. of Parks Trail Construction . . . (KY Dept. of Parks, 1989)	B	n/a			
MO St. Parks Trail Const. Guidelines (MO DNR, 1975)	B	n/a			
PA Plan for Nonmotorized Trails (PA Trails Pgm., 1980b)	B	n/a			
Wisconsin DNR Design Standards (WI DNR, 1994)	B	n/a			
KY Dept. of Parks Trail Construction . . . (KY Dept. of Parks, 1989)	E	n/a			
MO St. Parks Trail Const. Guidelines (MO DNR, 1975)	E	n/a			
PA Plan for Nonmotorized Trails (PA Trails Pgm., 1980b)	E	n/a			
Wisconsin DNR Design Standards (WI DNR, 1994)	E	n/a			
PA Plan for Nonmotorized Trails (PA Trails Pgm., 1980b)	X		n/a	n/a	n/a
PA Plan for Motorized Trails (PA Trails Pgm., 1980a)	SM	n/a			
Wisconsin DNR Design Standards (WI DNR, 1994)	SM	n/a			
PA Plan for Motorized Trails (PA Trails Pgm., 1980a)	ATV	n/a			
Wisconsin DNR Design Standards (WI DNR, 1994)	ATV	n/a			

AR = Accessible Route                      ORAR = Outdoor Recreation Access Route                      RT = Recreational Trail  
H = Hiking Trail                              S = Shared-Use Path                              B = Bicycle Path  
MB = Mountain Biking Trail                      E = Equestrian Trail                              X = Cross-Country Ski Trail  
SM = Snow Machine Trail                      ATV = All-Terrain Vehicle Trail  
OHV = Off-Highway Vehicle Trail                      M = Motorcycle Trail

**Table 5-7.5:**  
**Additional Recommendations for Minimum Clearance Width**

Source	Path Type	Single Level m	Multiple Levels		
			Easier m	Moderate m	Difficult m
ORAR and RT Design Specification (Axelson et al., 1995)	ORAR		0.915	0.815	0.710
Universal Access. to Outdoor Rec. (PLAE, Inc., 1993)	ORAR		1.220 <sup>2</sup>	0.915 <sup>2</sup>	0.915 <sup>2</sup>
ORAR and RT Design Specification (Axelson et al., 1995)	RT		1.220	0.915	0.710
Universal Access. to Outdoor Rec. (PLAE, Inc., 1993)	RT		1.220	0.915	0.710
Recreational Trail Design and Const. (Rathke and Baughman, 1994)	H	n/a			
Trails for the 21st Century (Ryan, 1993)	S	.815 <sup>1</sup>			
Recreational Trail Design and Const. (Rathke and Baughman, 1994)	B	n/a			
Trails for the 21st Century (Ryan, 1993)	B	n/a			
Mountain Bike Trails: Tech for. . . (McCoy and Stoner, 1992)	MB		n/a	n/a	n/a
Recreational Trail Design and Const. (Rathke and Baughman, 1994)	E	n/a			
Trails for the 21st Century (Ryan, 1993)	E	n/a			
Recreational Trail Design and Const. (Rathke and Baughman, 1994)	X	n/a			
Trails for the 21st Century (Ryan, 1993)	X	n/a			
Recreational Trail Design and Const. (Rathke and Baughman, 1994)	SM	n/a			
Trails for the 21st Century (Ryan, 1993)	SM	n/a			
OHM and ATV Trails Guidelines for Dgn. . . . (Wemex, 1994)	ATV		n/a	n/a	n/a

<sup>1</sup> For reasonably short distances, 0.815 m is permitted.

<sup>2</sup> For distances less than 0.610 m, 0.815 m is permitted.

AR = Accessible Route  
H = Hiking Trail  
MB = Mountain Biking Trail  
SM = Snow Machine Trail  
OHV = Off-Highway Vehicle Trail

ORAR = Outdoor Recreation Access Route  
S = Shared-Use Path  
E = Equestrian Trail  
ATV = All-Terrain Vehicle Trail  
M = Motorcycle Trail

RT = Recreational Trail  
B = Bicycle Path  
X = Cross-Country Ski Trail

**Table 5-8.1:**  
**Federal Accessibility Guidelines for Vertical Changes in Level**

Source	Path Type	Single Level mm	Multiple Levels		
			Easier mm	Moderate mm	Difficult mm
ADA Standards for Access. Design (US DOJ, 1991)	AR	6 <sup>1</sup>			
UFAS (US DoD, et al., 1984)	AR	6 <sup>1</sup>			

<sup>1</sup> Changes in level between 6 and 13 mm must be beveled with a maximum slope of 50 percent. Changes in level greater than 13 mm must be treated with a ramp, curb ramp, or elevator.

**Table 5-8.2:**  
**Federal Advisory Committee Recommendations for Vertical Changes in Level**

Source	Path Type	Single Level mm	Multiple Levels		
			Easier mm	Moderate mm	Difficult mm
Recommendations for Accessibility Guidelines: Recreational Facilities. . . (Rec. Access. Adv. Comm., 1994)	ORAR		13	13	25
Recommendations for Accessibility Guidelines: Recreational Facilities. . . (Rec. Access. Adv. Comm., 1994)	RT		13	13	25

**Table 5-8.3:**  
**Federal Guidelines for Vertical Changes in Level**

Source	Path Type	Single Level mm	Multiple Levels		
			Easier mm	Moderate mm	Difficult mm
USDA FS Trails Mgt. Handbook (USDA FS, 1985)	H		n/a	n/a	n/a
Guide for the Dev. of Bicycle Facilities (AASHTO, 1997, Draft)	S	n/a			
Guide for the Dev. of Bicycle Facilities (AASHTO, 1991)	B	n/a			
USDA FS Trails Mgt. Handbook (USDA FS, 1985)	E		n/a	n/a	n/a
USDA FS Trails Mgt. Handbook (USDA FS, 1985)	X		n/a	n/a	n/a
USDA FS Trails Mgt. Handbook (USDA FS, 1985)	SM		n/a	n/a	n/a
USDA FS Trails Mgt. Handbook (USDA FS, 1985)	ATV		n/a	n/a	n/a

AR = Accessible Route	ORAR = Outdoor Recreation Access Route	RT = Recreational Trail
H = Hiking Trail	S = Shared-Use Path	B = Bicycle Path
MB = Mountain Biking Trail	E = Equestrian Trail	X = Cross-Country Ski Trail
SM = Snow Machine Trail	ATV = All-Terrain Vehicle Trail	
OHV = Off-Highway Vehicle Trail	M = Motorcycle Trail	

**Table 5-8.4:**  
**State, County, and City Guidelines for Vertical Changes in Level**

Source	Path Type	Single Level mm	Multiple Levels		
			Easier mm	Moderate mm	Difficult mm
Klamath District's Trail . . . (Beers, 1993, Draft)	ORAR	n/a			
NM Plan for Accessible Fishing (Nordhaus, et al., 1984)	ORAR		6	13	n/a
Access to Parks Guidelines (CA State Parks, 1997)	RT	6			
Ped. Facilities Guidebook for WA DOT (WA DOT, 1997)	RT		13	26	76
Alaska Region Trails Const. (USDA FS, AK Reg. FS, 1991)	H		n/a	n/a	n/a
MO St. Parks Trail Const. Guidelines (MO DNR, 1975)	H	n/a			
PA Plan for Nonmotorized Trails (PA Trails Pgm., 1980b)	H	n/a			
FL Bicycle Facilities Planning. . . (FL DOT. . ., 1997)	S	n/a			
Oregon Bicycle and Ped. Plan (OR DOT, 1995)	S	6			
Pitkin City Trails Dgn. and Mgt. . . . (Cimarron Designs, 1994)	S	n/a			
KY Dept. of Parks Trail Construction. . . (KY Dept. of Parks, 1989)	B	n/a			
MO St. Parks Trail Const. Guidelines (MO DNR, 1975)	B	n/a			
PA Plan for Nonmotorized Trails (PA Trails Pgm., 1980b)	B	n/a			
Wisconsin DNR Design Standards (WI DNR, 1994)	B	n/a			
KY Dept. of Parks Trail Construction. . . (KY Dept. of Parks, 1989)	E	n/a			
MO St. Parks Trail Const. Guidelines (MO DNR, 1975)	E	n/a			
PA Plan for Nonmotorized Trails (PA Trails Pgm., 1980b)	E	n/a			
Wisconsin DNR Design Standards (WI DNR, 1994)	E	n/a			
PA Plan for Nonmotorized Trails (PA Trails Pgm., 1980b)	X		n/a	n/a	n/a
PA Plan for Motorized Trails (PA Trails Pgm., 1980a)	SM	n/a			
Wisconsin DNR Design Standards (WI DNR, 1994)	SM	n/a			
PA Plan for Motorized Trails (PA Trails Pgm., 1980a)	ATV	n/a			
Wisconsin DNR Design Standards (WI DNR, 1994)	ATV	n/a			

AR = Accessible Route  
H = Hiking Trail  
MB = Mountain Biking Trail  
SM = Snow Machine Trail  
OHV = Off-Highway Vehicle Trail

ORAR = Outdoor Recreation Access Route  
S = Shared-Use Path  
E = Equestrian Trail  
ATV = All-Terrain Vehicle Trail  
M = Motorcycle Trail

RT = Recreational Trail  
B = Bicycle Path  
X = Cross-Country Ski Trail

**Table 5-8.5:**  
**Additional Recommendations for Vertical Changes in Level**

Source	Path Type	Single Level mm	Multiple Levels		
			Easier mm	Moderate mm	Difficult mm
ORAR and RT Design Specification (Axelson et al., 1995)	ORAR		13	25	50
Universal Access. to Outdoor Rec. (PLAE, Inc., 1993)	ORAR		13	13	25
ORAR and RT Design Specification (Axelson et al., 1995)	RT		25	50	100
Universal Access. to Outdoor Rec. (PLAE, Inc., 1993)	RT		13 <sup>1</sup>	25 <sup>1</sup>	75 <sup>1</sup>
Recreational Trail Design and Const. (Rathke and Baughman, 1994)	H	n/a			
Trails for the 21st Century (Ryan, 1993)	S	n/a			
Recreational Trail Design and Const. (Rathke and Baughman, 1994)	B	n/a			
Trails for the 21st Century (Ryan, 1993)	B	n/a			
Mountain Bike Trails: Tech for. . . (McCoy and Stoner, 1992)	MB	n/a			
Recreational Trail Design and Const. (Rathke and Baughman, 1994)	E	n/a			
Trails for the 21st Century (Ryan, 1993)	E	n/a			
Recreational Trail Design and Const. (Rathke and Baughman, 1994)	X	n/a			
Trails for the 21st Century (Ryan, 1993)	X	n/a			
Recreational Trail Design and Const. (Rathke and Baughman, 1994)	SM	n/a			
Trails for the 21st Century (Ryan, 1993)	SM	n/a			
OHM and ATV Trails Guidelines for Dgn. . . . (Wemex, 1994)	ATV		n/a	n/a	n/a

<sup>1</sup> Changes in level greater than 6 mm must be beveled with a 1:2 slope.

AR = Accessible Route  
H = Hiking Trail  
MB = Mountain Biking Trail  
SM = Snow Machine Trail  
OHV = Off-Highway Vehicle Trail  
ORAR = Outdoor Recreation Access Route  
S = Shared-Use Path  
E = Equestrian Trail  
ATV = All-Terrain Vehicle Trail  
M = Motorcycle Trail  
RT = Recreational Trail  
B = Bicycle Path  
X = Cross-Country Ski Trail



**Table 5-9.1:**  
**Federal Accessibility Guidelines for Vertical Clearance (Head Room)**

Source	Path Type	Single Level m	Multiple Levels		
			Easier m	Moderate m	Difficult m
ADA Standards for Access. Design (US DOJ, 1991)	AR	2.030			
UFAS (US DoD, et al., 1984)	AR	2.030			

**Table 5-9.2:**  
**Federal Advisory Committee Recommendations for Vertical Clearance**

Source	Path Type	Single Level m	Multiple Levels		
			Easier m	Moderate m	Difficult m
Recommendations for Accessibility Guidelines: Recreational Facilities. . . (Rec. Access. Adv. Comm., 1994)	ORAR		2.030	2.030	2.030
Recommendations for Accessibility Guidelines: Recreational Facilities. . . (Rec. Access. Adv. Comm., 1994)	RT		2.030	2.030	2.030

**Table 5-9.3:**  
**Federal Guidelines for Vertical Clearance**

Source	Path Type	Single Level m	Multiple Levels		
			Easier m	Moderate m	Difficult m
USDA FS Trails Mgt. Handbook (USDA FS, 1985)	H		2.440	2.440	2.440
Guide for the Dev. of Bicycle Facilities (AASHTO, 1997, Draft)	S	2.5			
Guide for the Dev. of Bicycle Facilities (AASHTO, 1991)	B	2.440			
USDA FS Trails Mgt. Handbook (USDA FS, 1985)	E		3.050	2.440	2.440
USDA FS Trails Mgt. Handbook (USDA FS, 1985)	X		1.830	1.830	1.830
USDA FS Trails Mgt. Handbook (USDA FS, 1985)	SM		2.135 <sup>1</sup>	2.135 <sup>1</sup>	2.135 <sup>1</sup>
USDA FS Trails Mgt. Handbook (USDA FS, 1985)	ATV		1.830	1.830	1.525

<sup>1</sup> Above-average snow level.

AR = Accessible Route	ORAR = Outdoor Recreation Access Route	RT = Recreational Trail
H = Hiking Trail	S = Shared-Use Path	B = Bicycle Path
MB = Mountain Biking Trail	E = Equestrian Trail	X = Cross-Country Ski Trail
SM = Snow Machine Trail	ATV = All-Terrain Vehicle Trail	
OHV = Off-Highway Vehicle Trail	M = Motorcycle Trail	

**Table 5-9.4:**  
**State, County, and City Guidelines for Vertical Clearance**

Source	Path Type	Single Level m	Multiple Levels		
			Easier m	Moderate m	Difficult m
Klamath District's Trail . . . (Beers, 1993, Draft)	ORAR	2.440			
NM Plan for Accessible Fishing (Nordhaus, et al., 1984)	ORAR		2.030	2.030	2.030
Access to Parks Guidelines (CA State Parks, 1997)	RT		2.135	2.135	2.135
Ped. Facilities Guidebook for WA DOT (WA DOT, 1997)	RT		n/a	n/a	n/a
Alaska Region Trails Const. (USDA FS, AK Reg. FS, 1991)	H		2.440	2.440	2.440
MO St. Parks Trail Const. Guidelines (MO DNR, 1975)	H	2.135			
PA Plan for Nonmotorized Trails (PA Trails Pgm., 1980b)	H	2.440			
FL Bicycle Facilities Planning. . . (FL DOT. . ., 1997)	S	2.4			
Oregon Bicycle and Ped. Plan (OR DOT, 1995)	S	2.4			
Pitkin City Trails Dgn. and Mgt. . . . (Cimarron Designs, 1994)	S	3.050			
KY Dept. of Parks Trail Construction. . . (KY Dept. of Parks, 1989)	B	3.050			
MO St. Parks Trail Const. Guidelines (MO DNR, 1975)	B	2.440			
PA Plan for Nonmotorized Trails (PA Trails Pgm., 1980b)	B	2.440			
Wisconsin DNR Design Standards (WI DNR, 1994)	B	3.050			
KY Dept. of Parks Trail Construction. . . (KY Dept. of Parks, 1989)	E	3.050			
MO St. Parks Trail Const. Guidelines (MO DNR, 1975)	E	2.440			
PA Plan for Nonmotorized Trails (PA Trails Pgm., 1980b)	E	3.050			
Wisconsin DNR Design Standards (WI DNR, 1994)	E	3.660			
PA Plan for Nonmotorized Trails (PA Trails Pgm., 1980b)	X			2.440 <sup>1</sup>	2.440 <sup>1</sup>
PA Plan for Motorized Trails (PA Trails Pgm., 1980a)	SM	2.440 <sup>1</sup>			
Wisconsin DNR Design Standards (WI DNR, 1994)	SM	3.660 <sup>1</sup>			
PA Plan for Motorized Trails (PA Trails Pgm., 1980a)	ATV	2.440 <sup>2</sup>			
Wisconsin DNR Design Standards (WI DNR, 1994)	ATV	3.660 <sup>2</sup>			

<sup>1</sup> Above-average snow level.

<sup>2</sup> Above trail surface.

AR = Accessible Route	ORAR = Outdoor Recreation Access Route	RT = Recreational Trail
H = Hiking Trail	S = Shared-Use Path	B = Bicycle Path
MB = Mountain Biking Trail	E = Equestrian Trail	X = Cross-Country Ski Trail
SM = Snow Machine Trail	ATV = All-Terrain Vehicle Trail	
OHV = Off-Highway Vehicle Trail	M = Motorcycle Trail	

**Table 5-9.5:**  
**Additional Recommendations for Vertical Clearance**

Source	Path Type	Single Level m	Multiple Levels		
			Easier m	Moderate m	Difficult m
ORAR and RT Design Specification (Axelson et al., 1995)	ORAR		n/a	n/a	n/a
Universal Access. to Outdoor Rec. (PLAE, Inc., 1993)	ORAR		2.030	2.030	2.030
ORAR and RT Design Specification (Axelson et al., 1995)	RT		n/a	n/a	n/a
Universal Access. to Outdoor Rec. (PLAE, Inc., 1993)	RT		2.030	2.030	2.030
Recreational Trail Design and Const. (Rathke and Baughman, 1994)	H	2.440			
Trails for the 21st Century (Ryan, 1993)	S	3.050			
Recreational Trail Design and Const. (Rathke and Baughman, 1994)	B	2.440			
Trails for the 21st Century (Ryan, 1993)	B	2.135			
Mountain Bike Trails: Tech for. . . (McCoy and Stoner, 1992)	MB		2.440	2.440	2.440
Recreational Trail Design and Const. (Rathke and Baughman, 1994)	E	3.050			
Trails for the 21st Century (Ryan, 1993)	E	3.050			
Recreational Trail Design and Const. (Rathke and Baughman, 1994)	X	2.440			
Trails for the 21st Century (Ryan, 1993)	X	2.135 <sup>1</sup>			
Recreational Trail Design and Const. (Rathke and Baughman, 1994)	SM	2.440			
Trails for the 21st Century (Ryan, 1993)	SM	3.050			
OHM and ATV Trails Guidelines for Dgn. . . . (Wemex, 1994)	ATV		2.740	2.440	2.440

<sup>1</sup> Above-average snowfall.

AR = Accessible Route  
H = Hiking Trail  
MB = Mountain Biking Trail  
SM = Snow Machine Trail  
OHV = Off-Highway Vehicle Trail

ORAR = Outdoor Recreation Access Route  
S = Shared-Use Path  
E = Equestrian Trail  
ATV = All-Terrain Vehicle Trail  
M = Motorcycle Trail

RT = Recreational Trail  
B = Bicycle Path  
X = Cross-Country Ski Trail



# Abbreviations and Acronyms

AASHTO	American Association of State Highway and Transportation Officials
ABA	Architectural Barriers Act
ADA	Americans with Disabilities Act
ADAAG	Americans with Disabilities Act Accessibility Guidelines/ADA Standards for Accessible Design
ANSI	American National Standards Institute
ATS	Audible traffic signal
ATV	All-terrain vehicle
CFR	Code of Federal Regulations
BOCA	Building Officials and Code Administrators International
DoD	Department of Defense
DOJ	Department of Justice
DOT	Department of Transportation
EEOC	Equal Employment Opportunity Commission
FCC	Federal Communications Commission
FEMA	Federal Emergency Management Agency
FFE	Finished floor elevation
FHWA	Federal Highway Administration
FTA	Federal Transit Administration
GPS	Global Positioning System
HUD	United States Department of Housing and Urban Development
ICBO	International Conference of Building Officials
ISTEA	Intermodal Surface Transportation Efficiency Act
NAHB	National Association of Home Builders
MPO	Metropolitan Planning Organization
MGRAD	Minimum Guidelines and Requirements for Accessible Design
MUTCD	<i>Manual on Uniform Traffic Control Devices</i>
NWPS	National Wilderness Preservation System
OHV	Off-highway vehicle
ORAR	Outdoor Recreation Access Route
RT	Recreation trail
SBCCI	Southern Building Code Congress International

STIP	Statewide Transportation Improvement Program
STP	Surface Transportation Program
TIP	Transportation Improvement Program
TDD	Telecommunication display device, or text telephone
TTY	Telecommunication display device, or text telephone
TEA-21	Transportation Equity Act for the 21st Century
U.S. Access Board	United States Architectural and Transportation Barriers Compliance Board
U.S. ATBCB	United States Architectural and Transportation Barriers Compliance Board
UFAS	Uniform Federal Accessibility Standards
USDA	United States Department of Agriculture
USDI	United States Department of the Interior
U.S. DoD	United States Department of Defense
U.S. DOJ	United States Department of Justice
U.S. DOT	United States Department of Transportation
UTAP	Universal Trail Assessment Process

# Glossary

**Accessible route** — A continuous, unobstructed path connecting all accessible elements and spaces of a building or facility that meets the requirements of ADAAG.

**Alteration** — Modification made to an existing building or facility that goes beyond normal maintenance activities and affects or could affect usability.

**Americans with Disabilities Act of 1990 (ADA)** — A Federal law prohibiting discrimination against people with disabilities. Requires public entities and public accommodations to provide accessible accommodations for people with disabilities.

**Americans with Disabilities Act Accessibility Guidelines** — Provide scoping and technical specifications for new construction and alterations undertaken by entities covered by the ADA.

**ANSI A117.1, Making Buildings Accessible to and Usable by the Physically Handicapped** — The first American standard developed for accessibility; specifies technical requirements for new construction and alterations.

**Approach** — The section of the accessible route that flanks the landing of a curb ramp. The approach may be slightly graded if the landing level is below the elevation of the adjoining sidewalk.

**Architectural Barriers Act of 1968 (ABA)** — A Federal law stating that buildings and facilities designed, constructed, or altered with Federal funds, or leased by a Federal agency, must comply with standards for physical accessibility.

**Arterial road** — A major through route; arterials often provide direct service between cities and large towns.

**Assistive device** — A device that assists users in accomplishing day-to-day functions. For example, a wheelchair is an assistive device to assist a person who cannot walk.

**Audible warning** — A warning consisting of words or sounds indicating a potentially hazardous situation.

**Barrier curb** — A relatively high and steep-faced curb, designed with the intention of discouraging vehicles from leaving the roadway.

**Barrier removal** — Removal, rearrangement, or modification of objects positioned or structured in a manner that impedes access. Can include rearrangement or removal of furniture or equipment, installation of curb cuts or ramps, or repositioning items such as telephone kiosks or newspaper boxes.

**Bevel** — A surface that meets another surface at any angle other than 90 degrees.

**Bulbout** — Another term for a curb extension, which is a section of sidewalk at an intersection or midblock crossing that reduces the crossing width for pedestrians and can help reduce traffic speeds.

**Caster** — A wheel that can pivot but is not intended to govern the driving direction; typically used for the front wheels of most wheelchairs.

- Changes in level** — Vertical height transitions between adjacent surfaces or along the surface of a path.
- Clear space in crosswalk** — The additional space required to be included in a crosswalk at the corner where the ramp of a diagonal curb ramp meets the street so that those entering or exiting the base of the ramp can remain within the crosswalk.
- Cognitive disability** — Limitation of the ability to perceive, recognize, understand, interpret, and/or respond to information.
- Collector road** — A roadway linking traffic on local roads to the arterial road network.
- Commercial facility** — Facilities that are intended for nonresidential use by private entities and whose operation affects commerce.
- Community impact assessment** — Assessment of the impact of a proposed transportation project on a community; includes informing local residents, businesses, transportation planners, and politicians of the probable positive and negative effects of a project.
- Continuous passage** — An unobstructed way of pedestrian passage or travel that connects pedestrian areas, elements, and facilities to accessible routes on adjacent sites.
- Crosswalk** — Portion of a roadway where pedestrians are permitted to cross the street; can be marked or unmarked.
- Cross-slope** — The slope measured perpendicular to the direction of travel.
- Curb extension** — A section of sidewalk at an intersection or midblock crossing that reduces the crossing width for pedestrians and that can help reduce traffic speeds.
- Curb ramp** — A combined ramp and landing that accomplishes a change in level at a curb. This element provides street and sidewalk access to pedestrians using wheelchairs.
- Design width** — The width specification that a sidewalk or trail was intended to meet, usually set by building codes or agency guidelines.
- Detectable warning** — A standardized surface feature built in or applied to walking surfaces or other elements to warn visually impaired people of upcoming hazards.
- Diagonal curb ramp** — A curb ramp positioned at the corner of an intersection.
- Diagonal technique** — An environmental scanning technique in which a visually disabled person holds a cane in a stationary position diagonally across the body with the cane touching or just above the ground at a point outside one shoulder. This technique is used primarily in familiar, controlled environments.
- Drainage bar** — A bar made of wood, rubber, or stone placed across a trail to divert runoff across rather than down the trail.
- Drainage inlet** — A location where water runoff from the street or sidewalk enters the storm drain system; the openings to drainage inlets are typically covered by a grate or other perforated surface to protect pedestrians.



- Driveway crossing** — A ramp positioned where a driveway and the sidewalk meet; designed to ease the transition between a street and a driveway.
- Existing facility** — A structure such as a building, site, complex, road, walkway, parking lot, or other real or personal property.
- Feasible** — Capable of being accomplished with a reasonable amount of effort, cost, or other hardship. With regard to ADA compliance, feasibility is determined on a case-by-case basis. For example, it might not be feasible to install a ramp that meets ADAAG specifications on a very steep hill, but it would be feasible to install an ADAAG ramp at the entrance of a building.
- Finished-floor elevation** — The elevation at which the building foundation meets the prevailing ground surface.
- Flare** — A sloped surface that flanks a curb ramp and provides a graded transition between the ramp and the sidewalk. Flares bridge differences in elevation and are intended to prevent ambulatory pedestrians from tripping. Flares are not considered part of the accessible route.
- Global Positioning System (GPS)** — A system that identifies position and elevation; a hand console is used to obtain data from an orbiting satellite.
- Grade** — The slope parallel to the direction of travel that is calculated by dividing the vertical change in elevation by the horizontal distance covered.
- Grade-separated crossings** — Facilities such as overpasses, underpasses, skywalks, or tunnels that allow pedestrians and motor vehicles to cross a street at different levels.
- Gutter** — A trough or dip used for drainage purposes that runs along the edge of the street and curb or curb ramp.
- Hearing impairment** — A condition causing partial or total deafness.
- Hot response** — An instant response to a trigger stimulus, such as a signal change caused by pedestrian-actuated traffic controls at many medians.
- Intermodalism** — The use of multiple types of transportation to reach one destination; includes combining the use of trains and buses, automobiles, bicycles, and pedestrian transport on a given trip.
- Intersection** — An area where two or more pathways or roadways join together.
- Island** — A pedestrian refuge within the right-of-way and traffic lanes of a highway or street; also used as loading stops for light rail or buses.
- Intermodal Surface Transportation Efficiency Act of 1991 (ISTEA)** — Federal legislation authorizing highway, highway safety, transit, and other surface transportation programs from 1991 through 1997. It provided new funding opportunities for sidewalks, shared-use paths, and recreational trails. ISTEA was superseded by the Transportation Equity Act for the 21st Century.

**Land management agency** — Includes national entities such as the USDA Forest Service and National Park Service, State and local park systems, and private organizations that manage large tracts of land including primitive or wilderness recreation areas.

**Landing** — A level area of sidewalk at the top of a curb ramp facing the ramp path.

**Local road** — A road that serves individual residences or businesses and/or distributes traffic within a given urban or rural area.

**Long-range transportation plan** — A transportation plan developed by States and MPOs to encapsulate 20 years of transportation planning and policy.

**Maximum cross-slope** — A limited section of a trail or sidewalk that exceeds the typical running cross-slope of the path.

**Maximum grade** — A limited section of path that exceeds the typical running grade.

**Median** — An island in the center of a road that provides pedestrians with a place of refuge and reduces the crossing distance between safety points.

**Midblock crossing** — A crossing point positioned in the center of a block rather than at an intersection.

**Minimum clearance width** — the narrowest point on a sidewalk or trail.

**Mobility impairment** — A condition limiting physical ability; generally considered to include lack of a limb or loss of limb use due to disease, amputation, paralysis, injury, or developmental condition; or limitation of movement due to cardiovascular or other disease. Although visual or hearing impairments and cognitive disabilities can hamper ease of travel, people with sensory or cognitive impairments are not termed people with mobility impairments in this report.

**Metropolitan Planning Organization (MPO)** — A regional transportation planning and policy agency for urban areas with populations larger than 50,000.

**New construction** — A project in which entirely new facility will be built from the ground up.

**Obstacle** — An object that limits the vertical passage space, protrudes into the circulation route, or reduces the clearance width of a sidewalk or trail.

**Parallel curb ramp** — A curb ramp design in which the sidewalk slopes down on either side of a landing; parallel curb ramps require users to turn before entering the street.

**Passing space** — A section of path wide enough to allow two wheelchair users to pass one another or travel abreast.

**Passing space interval** — The distance between passing spaces.

**Path or pathway** — A track or route along which people are intended to travel.

**Pedestrian** — A person who travels on foot or who uses assistive devices, such as a wheelchair, for mobility.

**Pedestrian-actuated traffic control** — A push-button or other control operated by pedestrians that is designed to interrupt the prevailing signal cycle to permit pedestrians to cross an intersection.

**Pedestrian/Bicycle Coordinator** — A position responsible for planning and managing nonmotorized facilities and programs, creating safety and promotional materials encouraging bicycle and pedestrian transportation, and serving as the principal liaison between government transportation entities, the press, citizen organizations, and individuals on bicycling and walking issues.

**Perpendicular curb ramp** — A curb ramp design in which the ramp path is perpendicular to the edge of the curb.

**Places of public accommodation** — Facilities operated by private entities that fall within the following 12 broad categories defined by Congress: places of lodging, food establishments, entertainment houses, public gathering centers, sales establishments, service establishments, transportation stations, places of recreation, museums and zoos, social service establishments, and places of education.

**Private entity** — An individual or organization not employed, owned, or operated by the government.

**Program access** — Access provided to a program, service, or activity conducted or funded by a public entity.

**Prosthesis** — An artificial device that replaces part of the body; includes artificial limbs that serve as assistive devices and enable mobility.

**Public entity** — Any State or local government; department agency, special-purpose district, or other instrumentality of a State or States or local government, and any commuter authority.

**Ramp** — A sloped transition between two elevation levels.

**Rate of cross-slope change** — The change in cross-slope over a given distance.

**Rate of grade change** — The change in grade over a given distance.

**Readily achievable** — Easily accomplished and able to be carried out without much difficulty or expense; refers to the criterion for barrier removal under Title III of the ADA.

**Reasonable accommodation** — Modifications or adjustments to a program, work environment, or job description that make it easier for a person with a disability to participate in the same manner as other employees.

**Recreation Access Advisory Committee** — A committee established in 1993 by the U.S. Access Board to develop recommendations for accessible recreation facilities.

**Rehabilitation Act of 1973** — A Federal law requiring nondiscrimination in the employment practices of Federal agencies of the executive branch and Federal contractors; requires all Federally assisted programs, services, and activities to be available to people with disabilities.

- Rest area** — A level portion of a trail that is wide enough to provide wheelchair users and others a place to rest and gain relief from prevailing grade and cross-slope demands.
- Rest area interval** — The distance between rest areas.
- Right-of-way** — Real property rights (whether by fee-simple ownership, by easement, or by other agreement) acquired across land for a purpose, including pedestrian use.
- Running cross-slope** — The average cross-slope of a contiguous section of a sidewalk or trail.
- Running grade** — The average of many short, contiguous grades.
- Rural** — Areas outside the boundaries of urban areas.
- Scoping specifications** — Describes where accessibility is appropriate, when it is required, and how many aspects of a building, facility, or site must be accessible.
- Section 14 (1994)** — Proposed accessibility guidelines for public rights-of-way (now reserved).
- Section 504** — The section of the Rehabilitation Act that prohibits discrimination by any program or activity conducted by the Federal government.
- Sensory deficit** — Impairment of one of the five senses; includes partial or complete loss of hearing or vision, color blindness, loss of sensation in some part of the body or the loss of the sense of balance.
- Shared-use path** — A trail that permits more than one type of user, such as a trail designated for use by both pedestrians and bicyclists.
- Shy distance** — The area along the sidewalk closest to buildings, retaining walls, curbs, and fences generally avoided by pedestrians.
- Sidewalk** — The portion of a highway, road, or street intended for pedestrians.
- Sight distance** — The length of roadway visible to a driver or pedestrian; the distance a person can see along an unobstructed line of sight.
- Site infeasibility** — Existing site development conditions that prohibit the incorporation of elements, spaces, or features that are in full and strict compliance with the minimum requirements for new construction and that are necessary for pedestrian access, circulation, and use.
- Structural impracticability** — Changes having little likelihood of being accomplished without removing or altering a load-bearing structural member and/or incurring an increased cost of 50 percent or more of the value of the element of the building or facility involved.
- Surface Transportation Program (STP)** — A Federal program that provides grants to States for federally funded roadways and enhancement projects.
- Suburban** — Refers to an area surrounding a city that is closely settled.

**Switchback** — A trail or road that ascends a steep incline by taking a winding course to reduce the grade of the path.

**Tactile warning** — A change in surface condition that provides a tactile cue to alert pedestrians of a hazardous situation.

**Technical specifications** — Design and installation requirements.

**Technically infeasible** — A situation that prevents full compliance with ADAAG because existing structural conditions would require removing or altering a load-bearing member that is an essential part of the structural frame; or because other existing physical or site constraints prohibit modification or addition of elements, spaces, or features that are in full and strict compliance with the minimum requirements for new construction and that are necessary to provide accessibility.

**Title II of the Americans with Disabilities Act of 1990** — The section of the Americans with Disabilities Act of 1990 that prohibits State and local governments from discriminating against people with disabilities in programs, services, and activities.

**Title III of the Americans with Disabilities Act of 1990** — The section of the Americans with Disabilities Act of 1990 that prohibits places of public accommodation and commercial facilities from discriminating on the basis of disability.

**Touch technique** — An environmental scanning method in which a blind person arcs a cane from side to side and touches points outside both shoulders. Used primarily in unfamiliar or changing environments, such as on sidewalks and streets.

**Trail** — A path of travel for recreation and/or transportation within a park, natural environment, or designated corridor that is not classified as a highway, road, or street.

**Transportation agency** — A Federal, State, or local government entity responsible for planning and designing transportation systems and facilities for a particular jurisdiction.

**Transportation Enhancement** — Projects that include providing bicycle and pedestrian facilities; converting abandoned railroad rights-of-way into trails; preserving historic transportation sites; acquiring scenic easements; mitigating the negative impacts of a project on a community by providing additional benefits; and other projects.

**Transportation Enhancement Coordinator** — A position that manages transportation enhancement programs for State departments of transportation.

**Transportation Equity Act for the 21st Century (TEA-21)** — Federal legislation authorizing highway, highway safety, transit, and other surface transportation programs from 1998 through 2003. It provides funding opportunities for pedestrian, bicycling, and public transit facilities and emphasizes intermodalism, multimodalism, and community participation in transportation planning initiated by ISTEA.

**Transportation Improvement Program or Statewide Transportation Improvement Plan (TIP or STIP)** — A transportation plan that encapsulates planning and policy for a minimum of 3 years. Includes a prioritized list of all projects that will be constructed with Federal transportation funding.

**Truncated domes** — Small domes with flattened tops that are used as tactile warnings at transit platforms and curb edges.

**Uniform Federal Accessibility Standards** — Accessibility standards that all Federal agencies are required to meet; includes scoping and technical specifications.

**Urban** — Refers to places within boundaries set by State and local officials that have a population of 50,000 or more. Urban areas are more densely populated and contain a higher density of built structures.

**U.S. Access Board (United States Architectural and Transportation Barriers Compliance Board)** — A Federal agency that is responsible for developing Federal accessibility guidelines under the ADA and other laws.

**Vertical clearance** — The minimum unobstructed vertical passage space required along a sidewalk or trail.

**Visual impairment** — Loss or partial loss of vision.

**Visual warning** — The use of contrasting surface colors to indicate a change in environment, such as at a curb ramp where the sidewalk changes to the street.

**Wilderness Act of 1964** — A Federal law that prohibits the use of motorized vehicles and mechanized construction on certain tracts of federally managed land.

# Bibliography

ADAAG Review Federal Advisory Committee. (1996). *Final report: Recommendations for a new ADAAG*. Washington: U.S. Architectural and Transportation Barriers Compliance Board.

This report provides the final recommendations of the ADAAG Review Advisory Committee to the U.S. Access Board for revisions to the Americans with Disabilities Act Accessibility Guidelines in the form of a new set of guidelines.

The Access Board, 1311 F Street NW, Washington, DC 20004-1111,  
Telephone: (202) 272-5434, TDD (202) 272-5449, Fax: (202) 272-5447.

Adaptive Environments Center, Inc. (1992). *ADA Title II action guide for State and local governments*. Horsham: LRP Publications.

This book is a practical manual and workbook designed to guide State and local governments through the Title II compliance process. It features a planning process that will help ensure that State and local entities provide equal opportunity to people with disabilities.

LRP Publications, 747 Dresher Road, P.O. Box 980, Horsham, PA 19044-0980,  
Telephone: (215) 784-0860.

Albright, D.P. (1995). *Standing in the cold: Mobility and the mentally challenged*. Washington: Surface Transportation Policy Project.

This booklet depicts the access deficiencies of public transportation.

Alliance for Transportation Research, 1001 University Blvd., S.E.,  
Albuquerque, NM 87106, Telephone: (505) 246-6410.

American Association of State Highway and Transportation Officials. (1983). *Transportation glossary*. Washington.

This book contains definitions of 1,500 transportation terms.

AASHTO, 444 North Capitol Street, N.W., Washington, DC 20001,  
Telephone: (202) 624-5800.

American Association of State Highway and Transportation Officials. (1995). *A policy on geometric design of highways and streets: 1994*. Washington.

This book lists AASHTO-recommended policies for roadway design.

AASHTO, 444 North Capitol Street, N.W., Suite 249, Washington, DC 20001,  
Telephone: (202) 624-5800.

American Association of State and Highway Transportation Officials, Task Force on Geometric Design. (1991). *Guide for the development of bicycle facilities*. Washington.

This guide provides information to help accommodate bicycle traffic in all riding environments. Topics covered include a list of definitions, planning considerations, design considerations, operation and maintenance, and a list of references.

AASHTO, 444 North Capitol Street, N.W., Suite 249, Washington, DC 20001,  
Telephone: (202) 624-5800.

American Association of State Highway and Transportation Officials Task Force on Geometric Design. (Draft, 1997). *Guide for the development of bicycle facilities: Pre-final draft*. Washington.

This document contains design guidelines for bicycle facilities. It addresses design concerns that are not discussed in *A Policy on Geometric Design of Highways and Streets*, 1994.

AASHTO, 444 North Capitol Street N.W., Suite 249, Washington, DC 20001, Telephone: (202) 624-5800.

American College of Sports Medicine. (1986). *Guidelines for exercise testing and prescription*. Philadelphia: Lea and Febiger.

Standard reference document for the industry. Identifies standards of practice for fitness appraisal and exercise prescription. Includes information on health conditions that might influence exercise capacity or participation.

Williams 'n Wilkins, Rosetree Corporate Center Building Two, Suite 5025, 1440 North Providence Road, Media, PA 19063-2043, Telephone: (610) 925-9055, Fax: (610) 892-6670.

American College of Sports Medicine. (1997). *ACSM's exercise management for persons with chronic diseases and disabilities*. Champaign: Human Kinetics.

Summary of diseases and disabilities that influence the ability to exercise.

Human Kinetics Publishers, Inc., Fulfillment Department, P.O. Box 5076, Champaign, IL 61825-5076, Telephone: (800) 747-4457, Fax: (217) 351-1549, Web site: [www.humankinetics.com](http://www.humankinetics.com).

American National Standards Institute, Inc. (1980). *Specifications for making buildings and facilities accessible to and usable by physically handicapped people*. New York.

This manual provides recommendations for designing buildings and facilities accessible to and usable by people with disabilities.

American National Standards Institute, 1430 Broadway, New York, NY 10018.

American Society of Civil Engineers, National Association of Home Builders, The Urban Land Institute. (1990). *Residential streets: Second edition*. Washington: Bicycle Federation of America.

This book outlines current practices in residential street design that provide good examples of design criteria. Specifications related to drainage, intersection, and pavement options are also provided.

Bicycle Federation of America, 1506 Twenty-First Street, N.W., Suite 200, Washington, DC 20036, Telephone: (202) 463-6622, Fax: (202) 463-6625, Email: [bfa@igc.org](mailto:bfa@igc.org) or [bikefed@aol.com](mailto:bikefed@aol.com).

American Society for Testing Materials. (1997). *Annual book of ASTM standards: Section 15: General products, chemical specialties, and end-use products*. West Conshohocken.

This book contains updated information standards for products, chemical specialties, and end-use products.

ASTM, 100 Bar Harbor Drive, West Conshohocken, PA 19428, Telephone: (610) 832-9500, Fax: (610) 832-9555.



Americans with Disabilities Act. (1990). *Public Law 226, 101st Congress*. (July 26, 1990).

Civil rights legislation prohibiting discrimination against people with disabilities; written by the 101st Congress of the United States.

U.S. Government Printing Office, Superintendent of Documents, P.O.  
Box 371954, Pittsburgh, PA 15250-7954, Telephone: (202) 512-1800,  
Fax: (202) 512-2233.

Arapahoe County Department of Development Services and Infrastructure Management. (1997). *Arapahoe County 1997 handicap ramp installation program*. Littleton.

This book contains an outline of the steps that should be taken when designing or constructing public ramps.

Arapahoe County Administration Building, 5334 South Prince Street,  
Littleton, CO 80166-0001, Telephone: (303) 795-4640.

Architecture and Engineering for Parks Canada, Public Works and Government Services Canada. (1994). *Design guidelines for accessible outdoor recreation facilities*. Ottawa: Canada Paraplegic Association.

Provides diagrams and design guidelines for developing accessible outdoor recreation facilities.

Canadian Paraplegic Association, National Office, 1101 Prince of Wales Dr., Suite 320, Ottawa, Ontario K2C 3W7, Telephone: (613) 723-1033,  
Fax: (613) 723-1060.

Ashmead, D.H., Hill, E.W., Talor, C.R. (1989). *Obstacle perception by congenitally blind children*. *Perception and Psychophysics*, 46, pp. 425-433.

This study determined whether or not congenitally blind children were able to use nonvisual information to perceive objects.

Daniel H. Ashmead, Department of Psychology, Venderbilt Bill Wilkerson Center for Otolaryngology and Communication Sciences, Vanderbilt University, Nashville, TN 37232-8700, Telephone: (615) 340-8280,  
Fax: (615) 343-7705, Email: ashmead@ctrvax.vanderbilt.edu.

Ashmead, D.H., Wall, R.S., Eaton, S.B., Ebinger, K.A., Snook-Hill, M.M., Yang, X. (1998a). *Echolocation reconsidered: Using spatial variations in the ambient sound field to guide locomotion*. *Journal of Visual Impairment and Blindness*.

This study determined the ability of people with visual disabilities to use ambient, low-frequency sound to guide their locomotion.

Daniel H. Ashmead, Department of Psychology, Vanderbilt Bill Wilkerson Center for Otolaryngology and Communication Sciences, Vanderbilt University, Nashville, TN 37232-8700, Telephone: (615) 340-8280, Fax: (615) 343-7705,  
Email: ashmead@ctrvax.vanderbuilt.edu.

Ashmead, D.H., Wall, R.S., Ebinger, K.A., Eaton, S.B., Snook-Hill, M.M. (1998b). *Spatial hearing in children with visual disabilities*. *Perception*, 27, pp. 105-122.

This study determined whether spatial hearing in children with visual disabilities was equivalent to that of sighted people.

Daniel H. Ashmead, Department of Psychology, Vanderbilt Bill Wilkerson Center for Otolaryngology and Communication Sciences, Vanderbilt University, Nashville, TN 37232-8700, Telephone: (615) 340-8280, Fax: (615) 343-7705, Email: ashmead@ctrvax.vanderbilt.edu.

Axelson, P.W., Chesney, D.A., Faraone, M., Kirschbaum, J.B., Longmuir, P.E., Richter, W.M., Wong, K.M. (1997). *Accessible exterior surfaces: A review of existing test methods for surface firmness and stability: Phase 1 report*. Washington: U.S. Architectural and Transportation Barriers Compliance Board.

This research report evaluates existing test methods to determine the accessibility of surfaces.

Beneficial Designs, Inc., 5858 Empire Grade, Santa Cruz, CA 95060, Telephone: (831) 429-8447, Fax: (831) 423-8450, Email: mail@beneficialdesigns.com.

Axelson, P., Chesney, D., Kelley, B., Longmuir, P., Pasternak, M., Wong, K., Wright, W. (1997). *Universal trail assessment coordinator training guide*. Santa Cruz: Pax Press.

This book is a guide to the Universal Trail Assessment Process, which can be used to objectively assess outdoor recreation routes and recreation trails to collect access, mapping, usage, and maintenance information.

Beneficial Designs, Inc., 5858 Empire Grade, Santa Cruz, CA 95060, Telephone: (831) 429-8447, Fax: (831) 423-8450, Email: mail@beneficialdesigns.com. Web site: www.beneficialdesigns.com

Axelson, P.W., Chesney, D.A., Longmuir, P. (1995). *Outdoor recreation access route (ORAR) and recreation trail design specification research: Final report*. Martinsville: National Center on Accessibility.

This study measures the difficulty experienced by wheelchair users and pedestrians traveling over a variety of different surfaces with different grade and cross-slope characteristics.

Beneficial Designs, Inc., 5858 Empire Grade, Santa Cruz, CA 95060, Telephone: (831) 429-8447, Fax: (831) 423-8450, Email: mail@beneficialdesigns.com. Web site: www.beneficialdesigns.com

Bach, B. Delft University of Technology, Traffic Consultants Diepens and Okkema. (1993). *International handbook for cycle network design: Second edition*. Delft: Diepens en Okkema Traffic Consultants.

This handbook discusses the vulnerability of bicycle users in automobile traffic and provides illustrated solutions to various traffic and bicycle conflicts.

Diepens and Okkema, P.O. Box 2873, 2601 CW DELFT, Telephone: 015 (2) 147899, Fax: 015 (2) 147902.

Barham, P., Oxley, P., Shaw, T. (1994). *Accessible public transport infrastructure: Guidelines for the design of interchanges, terminals, and stops*. Crowthorne: Mobility Unit of the Department of Transport and the Passenger Transport Executive Group.

These design guidelines outline methods that can be used to develop public transport infrastructures that are more accessible for people with disabilities.

Transport Research Laboratory, Old Wokingham Road, Crowthorne Berks  
RG11 6AV.

Bar-Or O. (1983). *Pediatric sports medicine for the practitioner*. New York: Springer Verlag.

This book contains standards of practice relating to exercise and children, including detailed information on the effect of congenital disabilities (such as cerebral palsy and spina bifida), exercise, and physical activity.

Springer Verlag, 175 Fifth Avenue, New York, NY 10010, Telephone: (212) 460-1500, Fax: (212) 473-6272.

Barrier Free Environments, Inc. (1991). *UFAS retrofit manual*. Washington: United States Architectural and Transportation Barriers Compliance Board.

This manual was designed to provide supplemental information regarding the application of the Uniform Federal Accessibility Standards in retrofit situations.

United States Architectural and Transportation Barriers Compliance Board,  
1331 F Street, N.W., Suite 1000, Washington, DC 20004-1111, Telephone: (202) 272-5434.

Barrier Free Environments, Inc. (1996). *Accessibility in Georgia*. Raleigh: Governor's Council on Developmental Disabilities for Georgia.

This is a technical and policy guide to access in Georgia.

Governor's Council on Developmental Disabilities, ADA Program Consultant,  
254 Washington St., S.W., Atlanta, GA 30334, Telephone: (404) 657-7313,  
TDD: (404) 657-9993.

Bearden, D.M. (1998). *Federal highway funding for air quality projects and transportation enhancements: How much, to whom, and for what?* Washington: Congressional Research Service, Library of Congress.

This report examines how Federal highway funding helps States address the environmental impacts of surface transportation. Funding structure, eligible project types, and other major funding situations are discussed.

Congressional Research Service, Library of Congress, Washington,  
DC 20540-7000.

Beers, D. (Draft, 1993). *Klamath district's trail manual: Draft*. Los Altos: California Trails Foundation.

This manual contains equestrian and mountain bike trail information.

Don Beers, North Coast Redwoods Headquarters, 600-A West Clark,  
Eureka, CA 95501, Telephone: (707) 445-6547 ext.18, Fax: (707) 441-5737.

Bentzen, B.L. (1995). *Impact of curb ramps on the safety of persons who are blind*. Journal of Visual Impairment and Blindness, 89, pp. 319-328.

The research presented in this article found that curb ramps do, in fact, affect the safety of individuals with visual impairments.

AFB Press, American Foundation for the Blind, 11 Penn Plaza, New York,  
NY 10001.

Bentzen, B.L. (1997). *Environmental Accessibility*. In Blasch, W. Wiener, R. Welsh (Eds.), *Foundations of orientation and mobility: second edition* (pp. 317–356). New York, NY: AFB Press, American Foundation for the Blind.

This chapter of *Foundations of Orientation and Mobility* contains detailed information pertaining to environmental accessibility.

AFB Press, American Foundation for the Blind, 11 Penn Plaza, Suite 300, New York, NY 10001. Web site: [http://www.afb.org/r\\_dwrep.html](http://www.afb.org/r_dwrep.html).

Bentzen, B.L., Jackson, R.M., Peck, A.F. (1981). *Information about visual impairment for architects and transit planners*. Washington: U.S. Department of Transportation.

This document reports on improving communications with the visually impaired in rail rapid-transit systems.

National Technical Information Service, Springfield, VA 22161, Telephone: (703) 605–6000.

Bentzen, B.L., Nolin, T.L., Easton, R.D. (1994). *Detectable warning surfaces: Color, contrast, and reflectance*. Washington: U.S. Department of Transportation.

This laboratory study was conducted to determine the optimal physical properties of a detectable warning system and to study properties such as contrast, hue, and reflectance.

National Technical Information Service, Springfield, VA 22161, Telephone: (703) 605–6000.

Bentzen, B.L., Nolin, T.L., Easton, R.D., Desmarais, L., Mitchell, P.A. (1994). *Detectable warnings: Detectability by individuals with visual impairments, and safety and negotiability on slopes for persons with physical impairments*. Washington: U.S. Department of Transportation.

The authors of this study tested the configurations of a variety of detectable warnings against a number of surrounding surfaces and determined how well people with visual impairments, as well as people with physical disabilities, were able to detect and negotiate the surfaces. They tested the stopping distance required for different surfaces and analyzed the causes of negotiation difficulties for people with physical disabilities who use mobility aids.

National Technical Information Service, Springfield, VA 22161, Telephone: (703) 605–6000.

Bentzen, B.L., Tabor, L.S. (1998). *Accessible Pedestrian Signals*. Washington: U.S. Access Board.

This report summarizes available types of accessible pedestrian signals. It analyzes when they are needed and what types of information they provide. Audible broadcast, tactile, vibrotactile, and receiver-based systems are discussed.

U.S. Architectural and Transportation Barriers Compliance Board, 1111 18th Street, N.W., Suite 501, Washington, DC 20036, Telephone: (800) 872–2253 or (202) 272–5434, TTY: (800)993–2822 or (202) 272–5449, Fax: (202) 272–5447.

Bhambhani, Y., Clarkson, H. (1989). *Acute physiologic and perceptual responses during three modes of ambulation: Walking, auxiliary crutch walking, and running*. *Archives of Physical Medicine and Rehabilitation*, 70, (June 1989). pp. 445–450.

This research studies the energy cost of walking, running, and crutch use for able-bodied adults.

University of Alberta, Faculty of Rehabilitation Medicine, Dr. Bhambhani,  
Room 308 Corbett Hall, Edmonton, Alberta T6G2G4 Canada.

Bicycle Federation of America. (1992). *Case study no. 21: Integrating bicycle and pedestrian considerations into State and local transportation planning, design, and operations*. Washington: Federal Highway Administration. Report # FHWA-PD-93-021.

This report discusses methods to integrate bicycle and pedestrian considerations into State and local transportation planning, design, and operations.

Federal Highway Administration, U.S. Department of Transportation,  
400 Seventh Street, S.W., Washington, DC 20590. Fax requests to  
FHWA R & T Report Center: (301) 577-1421.

Bicycle Federation of America. (1993a). *Case study no. 5: An analysis of current funding mechanisms for bicycle and pedestrian programs at the Federal, State, and local levels*. Washington: Federal Highway Administration. Report # FHWA-PD-93-008.

This document, published by the Federal Highway Administration, reviews funding sources for bicycle and pedestrian facilities available under ISTEA.

Federal Highway Administration, U.S. Department of Transportation,  
400 Seventh Street, S.W., Washington, DC 20590. Fax requests to  
FHWA R & T Report Center: (301) 577-1421.

Bicycle Federation of America. (1993b). *Case study no. 18: Final report, analyses of successful provincial, State, and local bicycle and pedestrian programs in Canada and the United States*. Washington: Federal Highway Administration.

This document, published by the Federal Highway Administration, reviews several State and local bicycle and pedestrian programs that have been exceptionally effective.

Federal Highway Administration, U.S. Department of Transportation,  
400 Seventh Street, S.W., Washington, DC 20590. Fax requests to  
FHWA R & T Report Center: (301) 577-1421.

Bicycle Federation of America, Pedestrian Federation of America. (1996). *Probike/pro walk '96, The ninth international conference on bicycle and pedestrian programs*. Portland.

This book contains the papers presented at the Ninth International Conference on Bicycle and Pedestrian Programs, 1996. A list of available references, publications, and reports is included.

Bicycle Federation of America, 1506 Twenty-First Street, N.W., Suite 200,  
Washington, DC 20036, Telephone: (202) 463-6622, Fax: (202) 463-6625,  
Email: bfa@igc.org or bikefed@aol.com.

Birchard, W., Jr., Proudman, R.D. (1981). *Trail design, construction, and maintenance*. Harpers Ferry: Appalachian Trail Conference.

Written for trail workers who maintain the Appalachian Trail, this book provides information about designing, constructing, and maintaining outdoor recreation trails.

Appalachian Trail Conference, P.O. Box 236, Harpers Ferry, WV 25425,  
Telephone: (304) 535-6331.

Birkby, R.C. (1996). *Lightly on the land*. Seattle: The Mountaineers.

This book is a guide for building trails written for the Student Conservation Association. It explains techniques for using volunteers to design and maintain outdoor trails.

The Mountaineers, 1001, S.W. Klickitat Way, Seattle, WA 98134.

Blomberg, R.D., Cleven, A.M. (1998). *Development, implementation, and evaluation of a pedestrian safety zone for elderly pedestrians*. Washington: U.S. Department of Transportation.

The objectives of this study were to develop and apply procedures for defining pedestrian safety zones for older (age 65+) adults and to develop, implement, and evaluate a countermeasure program in the defined zones.

U.S. Department of Transportation, National Highway Traffic Safety Administration/Federal Highway Administration, 400 Seventh Street, S.W., Washington, DC 20590, Telephone: (202) 366-4000.

Bowman, B.L., Fruin, J.J., Zegeer, C.V. (1989). *Planning design and maintenance of pedestrian facilities*. McLean: Federal Highway Administration.

This handbook's contents include pedestrian characteristics, results of pedestrian traffic and safety studies, pedestrian traffic control devices and procedures, pedestrian facilities in work zones, facility maintenance, and a summary of pedestrian facility problems.

Research, Development and Technology, Turner-Fairbank Highway Research Center, 6300 Georgetown Pike, McLean, VA 22101-2296. Fax requests to FHWA R & T Report Center: (301) 577-1421.

Brambilla, R., Longo, G. (1976). *A handbook for pedestrian action*. Washington: U.S. Department of Commerce.

This guidebook provides alternates in improving pedestrian accessibility and includes practical techniques a citizen can use to advocate improvement of pedestrian access.

National Technical Information Service, Springfield, VA 22161,  
Telephone: (703) 605-6000.

Brock, W., Cunill, B., Dockter, S., Isom, J., King, G., Lindsey-Forester, J., Sparklin, D., Stevens, B. (1996). *Community impact assessment: A quick reference for transportation*. Washington: Federal Highway Administration.

This guide outlines the community impact assessment process, highlights areas that must be examined, and identifies basic tools and information sources planners can use to assess the impact of transportation projects.

Office of Environment and Planning, Telephone: (202) 366-0106.

Brown, S.A., Stein, S.M., Warner, J.C. (1996). *Urban drainage design manual: Hydraulic engineering circular 22*. Washington: Federal Highway Administration.

This book is a practical guide to designing storm drain systems connected with transportation facilities.

National Technical Information Service, Springfield, VA 22161,  
Telephone: (703) 605-6000.

BT Countryside for All. (1997). *A good practice guide to disabled people's access in the countryside: Standards and guidelines*. Sheffield.

This document is a collection of more than 20 different plans for countryside accessibility.

BT Countryside For All, The Fairfield Trust, 67a The Wicker,  
Sheffield, South Yorkshire S3 8HT, Telephone: 0114-270-1668,  
Minicom: 0114-275-5380, Fax: 0114-276-7900.

Building Standards Branch, Ministry of Municipal Affairs. (1995). *Building access handbook: Building requirements for persons with disabilities*. Victoria: Queens Printer.

This handbook provides guidelines for and the rationale behind building specifications designed to improve access for people with disabilities.

Crown Publications, 521 Fort Street, Victoria, B.C. V8W 1E7,  
Telephone: (607) 386-4636, Fax: (604) 386-0221.

Burden, D. (1994). *Bike lanes: Improving motorist/bicyclist behavior*. Tallahassee: Florida Department of Transportation.

This paper explores the history and benefits of providing bike lines and paved shoulders in urban settings.

Theo Petritsch, State Pedestrian and Bicycle Coordinator, Florida Department of Transportation, 605 Suwannee Street, MS-82, Tallahassee, FL 32399,  
Telephone: (850) 487-1200, Fax: (850) 922-2935, Email:  
theopetritsch@dot.State.fl.us.

Burden, D., Wallwork, M. (1996). *Handbook for walkable communities*. High Springs.

This handbook discusses problems that pedestrians face because of increased auto congestion and introduces planning and engineering principles designed to improve pedestrian safety. Alternatives to private automobile transportation are discussed as well.

Dan Burden, Telephone: (904) 454-3304, Email: dburden@aol.com.

California State Parks. (1997). *Access to parks guidelines: California edition*. Sacramento.

This document contains the accessibility design guidelines for California State Parks.

California State Parks Store, P.O. Box 942896, Sacramento, CA 94296-0001,  
Ray Ann Watson (ADA Coordinator), Telephone: (916) 653-8148.

Campaign To Make America Walkable. (1997). *The pedestrian resource book*. Washington.

This document contains abstracts and meeting agendas from the National Pedestrian Conference held in Washington, DC, on September 6, 1997.

Bicycle Federation of America, 1506 Twenty-First Street, N.W., Suite 200, Washington, DC 20036-1008, Telephone: (202) 463-6622, Fax: (202) 463-6625, Email: bikefed@aol.com or walk@transact.org, Web site: www.bikefed.com or www.prowalk.org.

Chesney, D.A., Axelson, P.W. (1994). *Assessment of outdoor environments for accessibility*. Proceedings of the Rehabilitation Engineering Society of North America: RESNA Press.

The objectives of this research project were to develop a quantitative system for assessing outdoor environments for accessibility and to evaluate the reliability of the methodology.

Beneficial Designs, 5858 Empire Grade, Santa Cruz, CA 95060, Telephone: (831) 429-8447, Fax: (831) 423-8450.

Chilman, K., Vogel, J., Conley, J. (1991). *Turkey Bay off-road vehicle area at Land Between Lakes: Monitoring use and impacts since 1973*. Carbondale: Department of Forestry, Southern Illinois University.

This report describes 17 years of the changes and monitoring systems in Turkey Bay, an area in western Kentucky and Tennessee designated for off-road vehicle use.

TVA's Land Between the Lakes, Golden Pond, KY 42211, Telephone: (502) 924-5602, Fax: (502) 924-2093.

Cimarron Design. (1994). *Trails design and management handbook: Revision 1.1*. Aspen: Pitkin County Open Space and Trails Program.

This handbook contains the trail design standards for Pitkin County, Colorado. Separate standards are provided for hard surfaces and soft surfaces on multiple-use trails.

Pitkin County Open Space and Trails, 530 East Main Street, Suite 301, Aspen, CO 81611, Telephone: (970) 920-5232, Fax: (970) 920-5198.

City of Boulder. (1995). *Transportation master plan update for Boulder Valley*. Boulder: Charlier Associates, Inc.

This document contains transportation planning strategies for the city of Boulder, Colorado.

Mr. Randall Rutsch, Project Manager, Transportation Engineering City of Boulder, Park Central Building, 1739 Broadway, Second Floor, Boulder, CO 80206, Telephone: (303) 441-4413.

City of Memphis. (1994). *City of Memphis construction standards*. Memphis: City of Memphis, Division of Public Works, Department of Engineering.

This document contains design details for transportation facilities.

City of Memphis, Division of Public Works, Department of Engineering, 125 North Main, Suite 677, Memphis, TN 38103, Telephone: (901) 576-6700, Fax: (901) 576-6960.



City of Portland, Oregon, *Bureau of Maintenance, Sidewalk Repair*. (1996). The sidewalk handbook. Portland.

This brochure reviews property owners' responsibilities with regard to maintaining sidewalks and discusses available city support to repair sidewalks.

Bureau of Maintenance, Sidewalk Repair, 2929 N. Kerby Avenue, Portland, OR 97227, Telephone: (503) 823-1711, Fax: (503) 823-4043.

City of Portland, *Bureau of Transportation Engineering and Development, and the Pedestrian Transportation Program*. (1998). Pedestrian master plan. Portland.

This is the pedestrian Master Plan of Portland; it contains construction guidelines and layouts used by the City of Portland to design pedestrian facilities.

Pedestrian Transportation Program, 1120, S.W. Fifth Avenue, Room 802, Portland, OR 97204-1971, Telephone: (503) 823-7211, Email: jean@sysgen.ci.portland.or.us.

City of Portland, Bureau of Transportation Engineering and Development, and the Pedestrian Transportation Program. (Draft, 1997). *Pedestrian design guide*. Portland.

This is the curb ramp section of the draft design guidelines for pedestrian facilities in Portland.

Pedestrian Transportation Program, 1120, S.W. Fifth Avenue, Room 802, Portland, OR 97204-1971, Telephone: (503) 823-7211.

City of Seattle. (1996). *Making streets that work: Neighborhood planning tool*. Seattle.

This workbook is designed to help planners improve the attractiveness and safety of urban neighborhoods.

Office of the Mayor, City of Seattle, 600 Fourth Avenue, 12th Floor, Seattle, WA 98104-1873.

Clark-Carter, D.D., Heyes, A.D., Howarth, I. (1987). *The gait of visually impaired pedestrians*. Human Movement Science 6 (pp. 277-282). North Holland: Elsevier Science Publishers B.V.

This research study documents the gait characteristics (speed, stride length, etc.) of adults with visual impairments.

Elsevier Science, Regional Sales Office, Customer Support Department, P.O. Box 945, New York, NY 10159-0945, Telephone: (212) 633-3680 or (800) 4ES-INFO, Fax: (212) 633-3680, Email: usinfo-f@elsevier.com.

Conley, J., Vogel, J., Chilman, K. (1990). *Open-area management and monitoring programs*. Proceedings of the cooperative off-highway vehicle workshop. (pp. 10-12) Waterville: Motorcycle Industry Council.

This article discusses the open-area management of an outdoor recreation and environmental education demonstration area administered by the Tennessee Valley Authority (TVA) in western Kentucky and Tennessee designated for off-road vehicle (ORV) riding and contrasts that to designating individual trails for ORV use.

TVA's Land Between the Lakes, Golden Pond, KY 42211, Telephone: (502) 924-5602, Fax: (502) 924-2093.

Council of American Building Officials. (1992). *American national standard: Accessible and usable buildings and facilities* (CABO/ANSI A117.1-1992). Falls Church.

This manual provides recommendations for designing buildings and facilities that are accessible to and usable by people with disabilities.

Council of American Building Officials, 5203 Leesburg Pike, #708, Falls Church, VA 22041, Telephone: (703) 931-4533.

Covington, G.A., Hannah, B. (1997). *Access by design*. New York: International Thomson Publishing Inc.

This book promotes the application of universal design principles in the creation of products, spaces, and services.

Van Nostrand Reinhold, 115 Fifth Avenue, New York, NY 10003.

Davies, S.C. (1993). *Designing effective pedestrian improvements in business districts*. New York: Project for Public Spaces.

This report discusses how pedestrian improvements can be designed and managed to meet peoples' needs more effectively.

Project for Public Spaces, Inc., 875 Avenue of the Americas, Room 201, New York, NY 10001.

De Leuw, C., Jr., Danielson, F., Kudlick, W., Swan, S. (1981). *Effective treatments of over- and undercrossings for use by bicyclists, pedestrians, and the handicapped*. Washington: Federal Highway Administration.

This study provides information about improving access to under- and overcrossings for bicyclists, pedestrians, and the handicapped.

National Information Service, Springfield, VA 22161, Telephone: (703) 605-6000, Fax: (703) 321-8547.

Department of Rehabilitation. (1995). *Access guide: Survey checklist*. Sacramento.

This booklet contains a checklist that can be used to determine whether buildings meet accessible accommodation requirements applicable within the State of California.

Department of Rehabilitation, ADA Implementation Section, P.O. Box 944222, Sacramento, CA 94244-2220, Telephone: (916) 322-0251, TTY (916) 322-1096, CALNET 492-0251 (Voice or TTY).

DiStefano, J., Raimi, M. (1996). *Five years of progress: 110 communities making a difference*. Washington: Surface Transportation Policy Project.

This series of case studies highlights successful community ISTEAs projects.

Surface Transportation Policy Project, 1100 Seventeenth Street, N.W., Tenth Floor, Washington, DC 20036, Telephone: (202) 466-2636, Fax: (202) 466-2247, Email: stpp@transact.org.

Division of Engineering, Lexington–Fayette County Urban Government. (1993). *Sidewalks: A home owner's guide*. Lexington.

This booklet provides an outline of the Urban County Government sidewalk inspection program. It is intended to aid property owners in the regular maintenance of right-of-ways adjoining their private property.

Division of Engineering, Lexington–Fayette County Urban Government, Lexington–Fayette Government Building, 200 East Main Street, Lexington, KY 40507, Telephone: (606) 258–3410.

Earnhart, G., Simon, L. (1987). *Accessibility for elderly and handicapped pedestrians: A manual for cities*. McLean: Turner–Fairbank Highway Research Center.

This handbook provides an overview of existing accessibility planning and programming. Each chapter provides definitions, illustrations, and Federal standards, if they exist, and includes a section on problems and recommended solutions.

National Technical Information Service, Springfield, VA 22161, Telephone: (703) 605–6000.

Ellis–Cauthron, S.L., Cauthron, H.E. (1995). *Accessibility survey for identification of structural barriers to programs and services at visitor centers, developed campgrounds, and day-use/picnic areas*. Phoenix.

This is a collection of survey forms that land managers can use to identify structural barriers to programs and services at visitor centers and outdoor facilities.

Sandra LeAnn Ellis–Cauthron, 6702 West Merrell Street, Phoenix, AZ 85033.

Equal Employment Opportunity Commission, U.S. Department of Justice. (1991). *Americans with Disabilities Act handbook*. Washington.

This handbook was written to provide information and assistance on the ADA to people with disabilities, businesses, and the public. This handbook is a particularly valuable tool that contains EEOC Title I regulations and DOJ Title II and III regulations, together with a section-by-section analysis of each regulatory provision.

U.S. Department of Justice, Telephone: (202) 514–0301 or (800) 514–0301, TTY: (800) 514–0383.

Farbman, A., Park, D.C. (1989d). *Philosophical foundations in providing accessible recreation facilities*. Design: Access 4: Philosophical Concepts: Accessible Picnic Areas and Campgrounds. pp. 3–16. (Fall 1989). Washington: Park Practice Program.

This article is the last in a series of four outlining accessibility design requirements as they relate to standards development, access to buildings and structures, and access to outdoor recreation and trails.

National Recreation and Park Association, 22377 Delmont Ridge Road, Ashburn, VA 20148, Telephone: (703) 858–0784, Fax: (703) 858–0794.

Federal Highway Administration. (1994). *Final report: The national bicycling and walking study: Transportation choices for a changing America*. Washington.

This study analyzes the current state of bicycling and walking in the United States.

Federal Highway Administration, U.S. Department of Transportation,  
400 Seventh Street, S.W., Washington, DC 20590. Fax requests to  
FHWA R & T Report Center: (301) 577-1421.

Federal Highway Administration. (1996a). *Chapter 18 facilities for pedestrians and bicyclists*. Washington.

This book discusses taking bicyclists and pedestrians into consideration when proposed facilities are being designed.

U.S. Government Printing Office, Superintendent of Documents, P.O.  
Box 371954, Pittsburgh, PA 15250-7954, Telephone: (202) 512-1800,  
Fax: (202) 512-2233.

Federal Highway Administration, Region 8 Office. (1996b). *Commentary and text: Section 14: ADA accessibility guidelines*. Lakewood.

This booklet is designed to assist designers, builders, architects, and other planners in the interpretation of Section 14 of the ADA Accessibility Guidelines.

Brenda Weltzer, Federal Highway Administration, Region 8 Office,  
555 Zang Street, Suite 400, Lakewood, CO 80228, Telephone: (303) 969-6716.

Federal Highway Administration. (1997a). *Flexibility in highway design*. Washington. Report # FHWA-PD-97-062.

This book identifies and explains the opportunities and constraints facing designers and design teams responsible for the development of transportation facilities. It includes many illustrations and examples of well-designed highways and roadways.

Federal Highway Administration, U.S. Department of Transportation,  
400 Seventh Street, S.W., Washington, DC 20590. Telephone: (202) 366-0106.

Federal Highway Administration. (1997b). *Urban drainage design programs: HY-22 version 2.0 [diskette]*. Washington.

This technical manual provides a comprehensive guide to designing storm drainage systems for transportation facilities.

Federal Highway Administration, U.S. Department of Transportation,  
400 Seventh Street, S.W., Washington, DC 20590.

Federal Highway Administration, Associate Administrator for Program Development, *Designation of Bicycle and Pedestrian Coordinators within State Departments of Transportation*, January 28, 1992.

This letter outlines the responsibilities of bicycle and pedestrian coordinators within State departments of transportation.

Federal Highway Administration, Federal Transit Administration, Acting Associate Administrator for Program Development, *Associate Administrator for Grants Management, Federal Transit Administration*, November 28, 1994.

This unpublished letter discusses the distribution of interim technical guidance for bicycle and pedestrian planning at State and local MPO levels.

Federal Highway Administration, Federal Transit Administration. (1995). *A guide to metropolitan transportation planning under ISTEA: How the pieces fit together*. Washington: Federal Highway Administration. Report # FHWA-PD-95-031.

This guidebook describes how Metropolitan Planning Organizations operate under ISTEA. Long- and short-range plans are discussed in detail.

Federal Highway Administration, U.S. Department of Transportation, 400 Seventh Street, S.W., Washington, DC 20590. Telephone: (202) 366-5003.

Federal Highway Administration, National Highway Traffic Safety Administration. (1996). *Pedestrian and bicyclist safety and accommodation: Participant workbook*. Washington: Federal Highway Administration. Report # FHWA-HI-96-028.

Prepared by Dan Burden and Betty Drake, this book supplements a National Highway Institute course that focused on pedestrian and bicycle safety and design. It outlines how focus groups and charities can be incorporated into a public participation model.

Federal Highway Administration, U.S. Department of Transportation, 400 Seventh Street, S.W., Washington, DC 20590. Fax requests to FHWA R & T Report Center: (301) 577-1421.

Fischer, J.W. (1998a). *ISTEA reauthorization: Highway and transit legislative proposals in the 105th Congress: Second session*. Washington: Congressional Research Service, Library of Congress.

This report discusses the structure of the House and Senate proposals and provides an overview of the issues that might have come to the forefront during conference.

Congressional Research Service, Library of Congress, Washington, DC 20540-7000.

Fischer, J.W. (1998b). *Transportation trust funds: Budgetary treatment*. Washington: Congressional Research Service, Library of Congress.

This report addresses issues associated with the purpose and use of transportation trust funds.

Congressional Research Service, Library of Congress, Washington, DC 20540-7000.

Fisher, S.V., and Gullickson, G. (1978). *Energy cost of ambulation in health and disability: A literature review*. Archives of Physical Medicine and Rehabilitation, 59, pp. 124-133.

A review of literature pertaining to the energy cost of ambulation with various types of disability. It summarizes previously published research on the energy cost of various physical disabilities.

Archives of Physical Medicine and Rehabilitation, W.B. Saunders Company, Periodicals Department, 6277 Sea Harbor Drive, Orlando, FL 32887-4800, Telephone: (407) 345-2500 or (800) 654-2452, Outside USA or Canada: (407) 345-4000, Web site: [www.archives-pmr.org/apmr/about.html](http://www.archives-pmr.org/apmr/about.html).

Fisher, S.V., and Patterson, R.P. (1981). *Energy cost of ambulation with crutches*. Archives of Physical Medicine and Rehabilitation, 62, pp. 125-127.

This study compares the energy cost of ambulation for walking with that of underarm crutches on level terrain, grade, and climbing stairs.

Archives of Physical Medicine and Rehabilitation, W.B. Saunders Company, Periodicals Department, 6277 Sea Harbor Drive, Orlando, FL 32887-4800, Telephone: (407) 345-2500 or (800) 654-2452, Outside USA or Canada: (407) 345-4000, Web site: [www.archives-pmr.org/apmr/about.html](http://www.archives-pmr.org/apmr/about.html).

Flascher, O.M., Kadar, E.E., Garrett, S.R., Meyer, J., Shaw, R.E. (1995). *Perceptual scaling of doorways: An investigation of perception for design principles development*. In J.L. Nasar, P. Grannis, K. Hanyu (Eds.), *Proceedings of the Twenty-Sixth Annual Conference of the Environmental Design Research Association* (pp. 18-23). Boston, MA: Ohio State University.

This study investigates the relationship between a passageway's size and a human's perception of its accessibility. The researchers propose that this measure of clearance can be applied to ensure the design of maximally efficient and safe throughways and access technologies.

Environmental Design Research Association, P.O. Box 7146, Edmond, OK 73083-7146, Telephone: (405) 330-4863, Fax: (406) 330-4150, Email: [edra@telepath.com](mailto:edra@telepath.com).

Flasher, O.M., Kadar, E.E., Shaw, R.E. (1993). *Dimensionless invariance for intentional systems: Measuring the fit of vehicular activities to environmental layout*. In J.M. Flach, P.A. Hancock, J.K. Caird, K.J. Vicente (Eds.), *An ecological approach to human-machine systems I: A global perspective*. (Chapter 11). Hillsdale: Lawrence Erlbaum Associates.

This article considers how wheelchair users are able to select and follow the best route through cluttered and obstacle-laden courses. It discusses using dimensionless invariance to measure the dynamic fit of active wheelchairs through their functional spaces if given a navigational goal.

Lawrence Erlbaum Associates, 10 Industrial Avenue, Mahwah, NJ 07430-2262, Telephone: (201) 236-9500 or (800) 9-BOOKS-9, Fax: (201) 236-0072, Email: [orders@erlbaum.com](mailto:orders@erlbaum.com).

Florida Department of Transportation, State Safety Office, MS 82. (1997). *Bicycle facilities planning and design handbook*. Tallahassee: Bicycle and Pedestrian Program.

This manual provides a practical overview of the concept and need for bicycle roadway planning. It includes defined terms, bicycle planning needs, principles, and issues. It also describes the bicycle planning process in terms of engineers and community collaboration.

Florida Department of Transportation, Bicycle/Pedestrian Program, State Safety Office, 605 Suwannee Street, Mail Station 82, Tallahassee, FL 32399-0450.

Gallon, C. (1992). *Contractor report 317: Tactile surfaces in the pedestrian environment: Experiments in Wolverhampton*. Crowthorne: Transport and Road Research Laboratory.

This report looks at how effective tactile markings would be in a real pedestrian environment and what form the layout of these surfaces should take.

Vehicles and Environment Division, Vehicles Group, Transport and Road Research Laboratory, Old Wokingham Road, Crowthorne, Berkshire RG11 6AU, Telephone: (STD 0344) 773131, Telex: 848272, Fax: 0344 770356.

Gallon, C., Oxley, P., Simms, B. (1991). *Contractor report 257: Tactile footway surfaces for the blind*. Crowthorne: Transport and Road Research Laboratory.

This document summarizes research to determine how well different textured surfaces were distinguished by the visually disabled.

Vehicles and Environment Division, Vehicles Group, Transport and Road Research Laboratory, Old Wokingham Road, Crowthorne, Berkshire RG11 6AU, Telephone: (STD 0344) 773131, Telex: 848272, Fax: 0344 770356.

Geiger, R.A., Jr. (Summer 1989). *National Wildlife Federation's Mountain Laurel Trail*. Design access 3: Access to outdoor recreation: Trails, pp. 12–16.

This document examines accessibility issues in the outdoor recreation environment using the Mountain Laurel Trail as an example.

Park Practice Program, National Park Service, P.O. Box 37127, Washington, DC 20013-7127, Telephone: (202) 343–7067.

Georgia Institute of Technology. (1979). *Provisions for elderly and handicapped pedestrians: Volume 1: Executive summary*. Springfield: U.S. Department of Commerce.

This document is an executive summary of research done regarding older pedestrians and pedestrians with disabilities. It outlines the research methodologies and summarizes the results of the study.

National Technical Information Service, Springfield, VA 22161, Telephone: (703) 605–6000.

Gilbert, T.A., Goltsman, S.M., Wohlford, S.D. (1992). *User's guide: The accessibility checklist: An evaluation system for buildings and outdoor settings*. Berkeley: MIG Communications.

A comprehensive checklist to determine whether buildings and outdoor settings comply with the ADA Guidelines, UFAS, and California's Title 24 building codes.

MIG Communications, 1802 Fifth Street, Berkeley, CA 94710, Telephone: (510) 845–0953.

Gilleran, B.F., Pates, G. (1994). *Bicycling and walking in the nineties and beyond: Applying Scandinavian experience to America's challenges*. Washington: Federal Highway Administration. Report # FHWA-PL-95-005.

This report is a review of Scandinavian techniques, technologies, practices, and policies for promoting bicycling and pedestrian transportation. It includes an examination of their applicability in the United States.

Federal Highway Administration, U.S. Department of Transportation, 400 Seventh Street, S.W., Washington, DC 20590. Fax requests to FHWA R & T Report Center: (301) 577–1421.

Golden, M., Kilb, L., Mayerson, A. (1993). *Americans with Disabilities Act: An implementation guide*. Berkeley: Disability Rights Education and Defense Fund, Inc.

This manual is designed to provide answers to questions businesses, organizations, and individuals might have about the ADA. The explanation of the law integrates the legislative history, the statute, the regulations and analyses, and Section 504 cases. A guide to legal documents, selected cases under Section 504, and a section on tax incentives are also included.

DREDF, 2212 Sixth Street, Berkeley, CA 94710, Telephone: (510) 644-2555 or (800) 466-4232.

Goltsman, S.A., Gilbert, T.A., Wohlford, S.D. (1993a). *Survey forms: The accessibility checklist: An evaluation system for buildings and outdoor settings: Second edition*. Berkeley: MIG Communications.

This book contains forms to use in conducting accessibility evaluations of buildings and outdoor facilities. Instructions for using the Survey Forms are contained in the User's Guide, the companion volume of The Accessibility Checklist.

MIG Communications, 1802 Fifth Street, Berkeley, CA 94710, Telephone: (510) 845-8750, Fax: (510) 845-8750.

Goltsman, S.A., Gilbert, T.A., Wohlford, S.D. (1993b). *User's guide: The accessibility checklist: An evaluation system for buildings and outdoor settings: Second edition*. Berkeley: MIG Communications.

Designed to accompany *Survey Forms*, this checklist translates the codes and standards of the ADA guidelines and the UFAS standards used on the forms.

MIG Communications, 1802 Fifth Street, Berkeley, CA 94710, Telephone: (510) 845-8750, Fax: (510) 845-8750.

Governor's Committee on Concerns of the Handicapped. (1995). *Sidewalk and curb ramp design*. Santa Fe.

This outline contains design regulations and requirements for all situations encountered with ramp design.

Governor's Committee on Concerns of the Handicapped, Lamy Building Room 117, 491 Old Santa Fe Trail, Santa Fe, NM 87503, Telephone: (505) 827-6465, TDD: (505) 827-6329, Fax: (505) 827-6328.

Greenways Incorporated. (1992a). *Case study no. 7: Transportation potential and other benefits of off-road bicycle and pedestrian facilities*. Washington: Federal Highway Administration. Report # FHWA-PD-92-040.

This report is a compendium of the benefits gained by having bicycle and pedestrian trails; it cites examples of highly successful community greenways.

Federal Highway Administration, U.S. Department of Transportation, 400 Seventh Street, S.W., Washington, DC 20590. Fax requests to FHWA R & T Report Center: (301) 577-1421.

Greenways Incorporated. (1992b). *Case study no. 24: Current planning guidelines and design standards being used by State and local agencies for bicycle and pedestrian facilities*. Washington: Federal Highway Administration. Report # FHWA-PD-93-006.



This is a review of some State and local existing bicycle and pedestrian programs to determine the state-of-practice. The report summarizes the best guidelines and standards currently being used. It also names reference materials critical for leading-edge facility design.

Federal Highway Administration, U.S. Department of Transportation,  
400 Seventh Street, S.W., Washington, DC 20590. Fax requests to  
FHWA R & T Report Center: (301) 577-1421.

Greenways Incorporated. (1996). *Birmingham-area bicycle, pedestrian, and greenway plan: Final plan report*. Birmingham: Birmingham Regional Planning Commission.

This document contains the projected transportation needs of the Birmingham area to the year 2015. Detailed maps, charts, and requirements are also included.

Birmingham Regional Planning Commission, Magnolia Office Park Suite 220,  
2112 Eleventh Avenue South, Birmingham, AL 35256-4799, Telephone:  
(205) 251-8139.

Gusey, D.L. (1991). *Trail hardening test: Project # ORV-86-3P: Final report*.  
Washington: State of Washington Interagency Committee for Outdoor Recreation.

This report discusses study results after examining different methods to harden trails to inhibit erosion and better maintain trails.

Daryl L. Gusey, Grand Mesa, Uncompahgre and Gunnison National  
Forests, 2250 Highway Fifty, Delta, CO 81416, Telephone: (303) 874-7691,  
DG: RO2FO4A.

Guth, D.A., Rieser, J.J. (1997). *Perception and the control of locomotion by blind and visually impaired pedestrians*. In B.B. Blasch, W.R. Wiener, R.L. Welsh (Eds.), *Foundations of orientation and mobility: Second edition*. (pp. 9-37). New York: AFB Press.

This chapter from *Foundations of Orientation and Mobility* discusses how pedestrians with visual impairments obtain information about and navigate through the pedestrian environment.

AFB Press, American Foundation for the Blind, 11 Penn Plaza, New York,  
NY 10001, Web site: [http://www.afb.org/r\\_dwrep.html](http://www.afb.org/r_dwrep.html).

Hall, G., Rabelle, A., Zabihaylo, C. (1994). *Audible traffic signals: A new definition*.  
Montreal: Montreal Association for the Blind.

This guidance document provides government agencies with information regarding audible traffic signals.

Montreal Association for the Blind (MAB), 7000 Shebrooke Street West,  
Montreal, Quebec H4B 1R3.

Harkey, D.L., Stewart, J.R., Rodgman, E.A. (1996). *Evaluation of shared-use facilities for bicycles and motor vehicles: Final report*. Tallahassee: Florida Department of Transportation.

Sponsored by the Florida Department of Transportation, this study evaluates the safety and utility of shared-use facilities to provide engineers and planners comprehensive results.

Theo Petritsch, State Pedestrian and Bicycle Coordinator, Florida Department of Transportation, 605 Suwannee Street, MS-82, Tallahassee, FL 32399, Telephone: (850) 487-1200, Fax: (850) 922-2935, Email: theopetritsch@dot.State.fl.us.

Hauger, J.S., Rigby, J.C., Safewright, M., McAuley, W.J. (1996). *Detectable warning surfaces at curb ramps*. *Journal of Visual Impairment and Blindness*, 90, pp. 512-525.

This article includes tests of blind pedestrians' need for detectable warning surfaces at curb ramps.

AFB Press, American Foundation for the Blind, 11 Penn Plaza, New York, NY 10001.

Hesselbarth, W., Vachowski, B. (1996). *Trail construction and maintenance notebook*. Missoula: USDA Forest Service.

Written in a concise, pocket format that can be used on the trail, this guide summarizes basic trail construction and maintenance information relevant to field work.

USDA-FS, Missoula Technology and Development Center, Building One, Fort Missoula, Missoula, MT 59804-7294, Telephone: (406) 329-3900, Fax: (406) 329-3719.

Hooper, L. (1994). *NPS trails management handbook*. Denver: Denver Service Center.

This book contains easily reduced drainage and construction guidelines.

Lennon Hooper Trails Coordinator, National Park Service, P.O. Box 25287, 655 Parfet Street, Denver, CO 80225.

Hopf, P.S., Raeber, J.A. (1984). *Access for the handicapped*. New York: Van Nostrand Reinhold Company Inc.

This book provides information to make facilities suitable for use by the physically handicapped.

Van Nostrand Reinhold Company Inc., 135 West Fiftieth Street, New York, NY 10020.

Hughes, R.G. (1995). *An evaluation of detectable warnings in curb ramps: Mobility considerations for the blind and visually impaired*. Tallahassee: Florida Department of Transportation.

This study tested the optimal configuration for detectable warnings installed on curb ramps. It also analyzed any difficulties subjects had with negotiating the ramp and provided recommendations on ramp design and configuration regarding tactile warnings.

Theo Petritsch, State Pedestrian and Bicycle Coordinator, Florida Department of Transportation, 605 Suwannee Street, MS-82, Tallahassee, FL 32399, Telephone: (850) 487-1200, Fax: (850) 922-2935, Email: theopetritsch@dot.State.fl.us.

Hughes, R.G., and Harkey, D. (1996). *Lane conditions, traffic speed, and traffic volume: Effects on cyclists' perception of risk in a virtual environment*. Tallahassee: Florida Department of Transportation.

This study addresses the extent to which bicyclists' use of roadway facilities is affected by the conditions of the curb lane, traffic speed, and traffic volume. Subjects viewed several virtual environment simulations of a road from different perspectives.

Theo Petritsch, State Pedestrian and Bicycle Coordinator, Florida Department of Transportation, 605 Suwannee Street MS-82, Tallahassee, FL 32399, Telephone: (850) 487-1200, Fax: (850) 922-2935, Email: theopetritsch@dot.State.fl.us.

Institute of Transportation Engineers, Technical Council Committee A-55. (1997a). *Review of planning guidelines and design standards for bicycle facilities*. Washington: Institute of Transportation Engineers.

This report defines planning guidelines and design standards used by States and localities to develop bicycle facilities and identifies practices that can be used as models by other communities.

Institute of Transportation Engineers, 525 School Street, S.W., Suite 410, Washington, DC 20024-2797, Telephone: (202) 554-8050, Fax: (202) 863-5486.

Institute of Transportation Engineers, Technical Council Committee 5A-5. (1998). *Design and safety of pedestrian facilities*. Chapel Hill.

Provides design recommendations for developing safer and more accessible pedestrian facilities.

Institute of Transportation Engineers, 525 School Street, S.W., Suite 410, Washington, DC 20024-2797, Telephone: (202) 554-8050, Fax: (202) 863-5486.

Institute of Transportation Engineers, Transportation Planning Council Committee 5P-8. (1997b). *Traditional neighborhood development: Street design guidelines*. Washington.

This report, a recommended practice published by ITE, discusses traditional neighborhood development, design parameters, and community planning.

Institute of Transportation Engineers, 525 School Street, S.W., Suite 410, Washington, DC 20024-2797, Telephone: (202) 554-8050, Fax: (202) 863-5486, Web site: <http://www.ite.org>.

Intermodal Surface Transportation Efficiency Act. (1991). *Public Law 240, 102nd Congress*. (December 18, 1991).

This law authorizes transportation funds to be spent on improving intermodal surface transportation alternatives for moving goods and people.

U.S. Government Printing Office, Superintendent of Documents, P.O. Box 371954, Pittsburgh, PA 15250-7954, Telephone: (202) 512-1800, Fax: (202) 512-2233.

Jacobson, W.H. (1993). *The art and science of teaching orientation and mobility to persons with visual impairments*. New York: American Foundation for the Blind.

This textbook teaches orientation and mobility professionals to instruct people with visual impairments in wayfinding and navigation techniques.

AFB Press, American Foundation for the Blind, 15 West 16th Street,  
New York, NY 10011.

Jansma, P., French, R. (1994). *Special physical education: Physical activity, sports, and recreation*. Des Moines: Prentice Hall.

Identifies the impact of various disabilities on the participation in physical activity, sports, and recreation programs. Discusses effective strategies for including individuals with disabilities in physical activity.

Prentice Hall, Order Processing Center, P.O. Box 11071, Des Moines,  
IA 50336, Telephone: (800) 947-7700, Fax: (515) 284-6709,  
Email: orders@prenhall.com.

Joffe, E. (1994). *A detectable warnings implementation document*. Washington: Federal Transit Administration.

This report contains technical help and information on the ADA Rule of 1991.

American Foundation for the Blind, Web site: [http://www.afb.org/r\\_dwrep.html](http://www.afb.org/r_dwrep.html).

Kadar, E.E., Flascher, O.M., Shaw, R.E. (1995). *A field theoretic description for navigation through cluttered environments: Consequences for environment design*. In J.L. Nasar, P. Grannis, K. Hanyu (Eds.), *Proceedings of the EDRA* (pp. 13-17). Edmond: Environmental Design Research Association.

This paper proposes the concept of isovists, or the points visible to a vantage point in space taken with respect to the environment, as useful tools in the objective assessment of environment functionality. It also describes a prototype device that can be used in evaluation.

Environmental Design Research Association, P.O. Box 7146, Edmond,  
OK 73083-7146, Telephone: (405) 330-4863, Fax: (406) 330-4150,  
Email: edra@telepath.com.

Kell, J.H., Fullerton, I.J. (1982). *Manual of traffic signal design*. Washington: Institute of Transportation Engineers.

This manual discusses how to design traffic signals that function well in the street environment.

Institute of Transportation Engineers, 525 School Street, S.W.,  
Suite 410, Washington, DC 20024-2797, Telephone: (202) 554-8050,  
Fax: (202) 863-5486, Web site: <http://www.ite.org>.

Kentucky Department of Parks. (1989). *Trail construction and maintenance: Division of recreation and interpretation*. Frankfort.

This book contains guidelines for equestrian, hiking, OHV, and mountain bike trails.

Kentucky Department of Parks, Telephone: (502) 564-2172.

Knoblauch, R.L., Crigler, K.L. (1987a). *Model pedestrian safety program: User's guide*. McLean: Federal Highway Administration.

This guide describes how localities can plan, implement, and evaluate a pedestrian safety program.

National Technical Information Service, Technology Administration,  
U.S. Department of Commerce, Springfield, VA 22161, Telephone:  
(703) 605-6000, Fax: (703) 321-8547.

Knoblauch, R.L., Crigler, K.L. (1987b). *Model pedestrian safety program: User's guide: Supplement*. McLean: Federal Highway Administration.

This supplement provides detailed information on specific pedestrian encounters.

National Technical Information Service, Technology Administration,  
U.S. Department of Commerce, Springfield, VA 22161, Telephone:  
(703) 605-6000, Fax: (703) 321-8547.

Knoblauch, R., Nitzburg, M., Dewar, R., Templer, J., Pietrucha, M. (1995). *Older pedestrian characteristics for use in highway design*. McLean: Federal Highway Administration.

This report conducts a field study on more than 7,000 pedestrians in four cities to determine older-pedestrian data. This was done to develop traffic planning and engineering guidelines with older-pedestrian capabilities in mind.

National Technical Information Service, Springfield, VA 22161,  
Telephone: (703) 605-6000.

Knoblauch, R.L., Tustin, B.H., Smith, S.A., Pietrucha, M.T. (1988). *Investigation of exposure-based pedestrian areas: Crosswalks, sidewalks, local streets, and major arterials*. McLean: Federal Highway Administration.

This study determined how well drivers and pedestrians recognize marked crosswalk designs.

National Technical Information Service, Springfield, VA 22161,  
Telephone: (703) 605-6000.

Lamont, B., et al. (1997). *Encouraging local planning and regional cooperation*. Colorado Commons, pp. 15-17. (Spring 1997).

This article discusses techniques for encouraging local and regional coordination with regard to transportation issues.

Colorado Commons, P.O. Box 417, Longmont, CO 80502-0417,  
Telephone: (303) 530-1925 ext. 114, Fax: (303) 530-2401, Web site:  
[www.cityofdreams.com](http://www.cityofdreams.com).

Lexington-Fayette Urban County Government. (1993). *Sidewalks: A homeowner's guide*. Lexington.

This booklet contains procedures for evaluating sidewalks and an outline of the local sidewalk improvement maintenance program.

Lexington-Fayette Urban County Government, Division of Engineering,  
Lexington-Fayette Government Building, 200 East Main Street, Lexington,  
KY 40507, Telephone: (606) 258-3410.

Long, R.G., Hill, E.W. (1997). *Establishing and maintaining orientation for mobility*. In B.B. Blasch, W.R. Wiener, R.L. Welsh (Eds.), *Foundations of orientation and mobility: Second edition*, (pp. 39–59). New York: AFB Press.

This is a chapter from Foundations of Orientation and Mobility about spatial orientation of individuals who are blind or visually impaired. It focuses on spatial problems they must solve to move efficiently from place to place and the strategies or tools they use to solve them.

AFB Press, American Foundation for the Blind, 11 Penn Plaza, New York, NY 10001. Web site: [http://www.afb.org/r\\_dwrep.html](http://www.afb.org/r_dwrep.html).

Macdonald, S.H. (1988). *Colorado off-highway vehicle recreation plan*. Denver: Colorado Division of Parks and Outdoor Recreation.

This document reviews current needs and problems of OHV use in Colorado. It also analyzes proposed actions and makes recommendations.

Colorado Division of Parks and Outdoor Recreation, 1313 Sherman Street, Room 618, Denver, CO 80203, Telephone: (303) 866–3437.

Mace, R.L., Hardie, G.J., Place, J.P. (1991). *Accessible environments: Toward universal design*. Raleigh: The Center for Universal Design.

This booklet discusses how universal design can benefit all segments of the population and suggests design principles that can be used to improve access to buildings, outdoor facilities, and other spaces. It also discusses the disabled population and provides an overview of the accommodations required by the Americans with Disabilities Act.

The Center for Universal Design, North Carolina State University, P.O. Box 8613, Raleigh, NC 27695-8613, Telephone and TDD: (919) 515–3082, Info. Requests: (800) 647–6777.

Maine Bureau of Parks and Recreation Department of Conservation. (1995). *1994/1995 Bicycling survey of household residents*. Augustus: Maine Department of Transportation.

This report details the results of a statewide survey of Maine residents regarding bicycling habits, attitudes, complaints, and criticisms of existing bicycle transportation conditions.

Maine Department of Transportation, Sixteen State House Station, Augusta, ME 04333-0016, Telephone: (207) 287–3318, Fax: (207) 287–8300, Web site: [www.State.me.us/mdot/opt/opt1.htm](http://www.State.me.us/mdot/opt/opt1.htm).

Maine Department of Transportation. (1995). *You can get there from here: Volume two: The pedestrian plan*. Augusta.

This report provides an overview of State and local bodies involved with implementing the Multimodal Transportation Act of 1991. The report discusses current needs and conditions and proposes engineering and design principles to facilitate the execution of the plan.

Maine Department of Transportation, Sixteen State House Station, Augusta, ME 04333-0016, Telephone: (207) 287–3318, Fax: (207) 287–8300, Web site: [www.State.me.us/mdot/opt/opt1.htm](http://www.State.me.us/mdot/opt/opt1.htm).

Marcil, F. (1995). *Multi-use trails in Canada: An analysis of some successful cases*. Montreal: Velo Quebec.

This book discusses the importance of having multi-use trails in Canada. It pairs problems and situations with proposed ideas and solutions.

Velo Quebec, 1251 Rue Rachel Est, Montreal (Quebec) H2J 2J9 Canada, Telephone: (514) 521-8356, Fax: (514) 521-5711.

Marshall, L. (1993). *Responsible riding: Snowmobilers aim to freeze out unethical behavior*. *Outdoor Ethics*, 12 (1), pp. 1-4.

This article cites various problems associated with snowmobiling.

Joshua Winchell, Outdoor Ethics Program, Izaak Walton League of America, 707 Conservation Lane, Gaithersburg, MD 20878-2983, Telephone: (301) 548-0150, Fax: (301) 548-0146.

Materials Division, Virginia Transportation Research Council. (1996). *Pavement design guide for subdivision and secondary roads in Virginia*. Richmond: Virginia Department of Transportation.

This document is a companion reference to the Subdivision Street Requirements booklet. It also replaces three earlier documents designated VHRC 73-R18, VHRC 73-R21, and the 1993 revision for secondary and subdivision pavement design manuals.

Virginia Department of Transportation, Secondary Roads Division, 1401 East Broad Street, Richmond, VA 23219, Telephone: (804) 786-2576, Fax: (804) 7786-2603.

McAuley, W.J., Hauger, J.S., Safewright, M.P., Rigby, J.C. (1995). *The detectable warnings project*. Washington: U.S. Architectural and Transportation Barriers Compliance Board.

This paper discusses the results of a study to determine the level of detectability of a variety of raised tactile warning surfaces.

U.S. Access Board, Recreation Report, 1331 F Street, N.W., Suite 1000, Washington, DC 20004-1111, Telephone: (202) 272-5434 or (800) 872-2253, TTY (202) 272-5449 or (800) 993-2822, Web site: <http://www.access-board.gov/rules/child.htm>.

McCoy, M., Stoner, M. (1992). *Mountain bike trails: Techniques for design, construction, and maintenance*. Missoula: Bikecentennial.

This publication contains illustrations and tables of mountain-bike-trail design techniques.

Adventure Cycling Association, P.O. Box 8308, Missoula, MT 59807, Telephone: (406) 721-1776, Fax: (406) 721-8754.

McMillan, J. (1982). *Crowded urban pathways create perils for exercisers*. *The Physician and Sportsmedicine*, 10, pp. 179-180. (October 1982).

This article summarizes the types of injury and increased risks that have been observed with the growing use of shared-use paths and highlights injuries resulting from user conflicts, particularly related to differences in user speed (e.g., bike versus pedestrian).

The Physician and Sportsmedicine, 4530 West Seventy-Seventh Street, Minneapolis, MN 55435, Telephone: (612) 835-3222, Fax: (612) 835-3460, Web site: [www.physsportsmed.com](http://www.physsportsmed.com).

Metropolitan Center for Independent Living. (1993). *How to build ramps for home accessibility*. St. Paul.

This manual offers ramp design standards and principles, ramp blueprints, hints for obtaining local building permits and building according to code, and suggestions for ramp maintenance.

Metropolitan Center for Independent Living, 1600 University Avenue, West, Suite Sixteen, St. Paul, MN 55104, Telephone: (612) 646-8342, TDD: (612) 603-2001, Fax: (612) 603-2006.

Mickelson, L. (1985). *Parkland access for the disabled*. Vancouver: Greater Vancouver Regional District Parks Department and Advent Accounting Services Ltd.

This publication is a design manual for planning and constructing accessible features in the outdoors. Text examples are heavily illustrated with diagrams of standard signage and facilities that include dimensions and useful accessories.

Greater Vancouver Regional District Parks, 4330 Kingsway, Burnaby, B.C., Canada V5H 4G8.

Missouri Department of Natural Resources. (1975). *Missouri State Parks: Trail construction guidelines*. Jefferson City.

This booklet contains the Missouri State Trails System guidelines for trail construction, as well as the procedure for signing trails.

Missouri Department of Natural Resources, Telephone: (573) 751-5360.

Moore, R.L. (1994). *Conflicts on multiple-use trails: Synthesis of the literature and state of the practice*. Washington: Federal Highway Administration. Report # FHWA-PD-94-031.

This report provides a synthesis of existing research to explain the underlying causes of trail conflict, identify approaches for promoting trail sharing, and identify gaps in current knowledge. Principles for minimizing conflicts on multiple-use trails are also reviewed.

Federal Highway Administration, 400 Seventh Street, S.W., Washington, DC 20590. Fax requests to FHWA R & T Report Center: (301) 577-1421.

Moore, R., Dattilo, J., Devine, M.A. (1996). *A comparison of rail-trail preferences between adults with and without disabilities*. Adapted Physical Activity Quarterly 13, pp. 27-37.

Survey research of users on three rail-trails to identify trail characteristics that significantly influence their use of the trail.

Human Kinetics Publishers, Inc., Fulfillment Department, P.O. Box 5076, Champaign, IL 61825-5076, Telephone: (800) 747-4457, Fax: (217) 351-1549, Web site: [www.humankinetics.com](http://www.humankinetics.com).



National Bicycle and Pedestrian Clearinghouse. (1996a). *NBPC technical brief*. Washington.

This newsletter contains public statistics information on bicycle transportation.

The National Bicycle and Pedestrian Clearinghouse, 1506 Twenty-First Street, N.W., Suite 200, Washington, DC 20036, Telephone: (800) 760-6272 or (202) 463-8405, Fax: (202) 463-6625, Email: bikefed@aol.com.

National Bicycle and Pedestrian Clearinghouse. (Ninth edition). (1996b). *NBPC technical brief*. Washington.

This newsletter contains design factors that are critical for nonmotorized trail users.

The National Bicycle and Pedestrian Clearinghouse, 1506 Twenty-First Street, N.W., Suite 210, Washington, DC 200036, Telephone: (800) 760-6272 or (202) 463-8405, Fax: (202) 463-6625, Email: bikefed@aol.com.

National Council on Disability. (1996). *Achieving independence: The challenge for the 21st century: A decade of progress in disability policy: Setting an agenda for the future*. Washington.

This book offers an assessment of the nation's progress in achieving equal opportunity and empowerment during the last decade.

National Council on Disability, 1331 F Street, N.W., Suite 1050, Washington, DC 20004-1107, Telephone: (202) 272-2004, Fax: (202)-272-2022, TDD: (202) 272-2074.

National Highway Traffic Safety Administration. (1998). *Zone guide for pedestrian safety*. Washington: U.S. Department of Transportation.

This document details a method to identify target areas for pedestrian improvements that would make the most impact on safety.

U.S. Department of Transportation, National Highway Traffic Safety Administration/Federal Highway Administration, 400 Seventh Street, S.W., Washington, DC 20590.

New Jersey Department of Transportation. (1995). *Statewide bicycle and pedestrian master plan*. Trenton.

This is the Bicycle and Pedestrian Master Plan for New Jersey. It delineates the vision, strategic planning model, current conditions and needs, implementation strategies, and actions and responsibilities of the plan and includes a list of supporting documents.

Bill Feldman, Pedestrian and Bicycle Advocate, New Jersey Department of Transportation, 1035 Parkway Avenue, P.O. Box 600, Trenton, NJ 08625-0600, Telephone: (609) 530-8062, Fax: (609) 530-3723, Email: billatng@aol.com.

New Jersey Department of Transportation. (1996). *Pedestrian-compatible planning and design guidelines*. Trenton: New Jersey Department of Transportation, Bureau of Suburban Mobility.

These guidelines include an overview of pedestrian activities and problems in New Jersey. Guidelines for accommodating pedestrians on roadways and design techniques encouraging pedestrian travel.

Bill Feldman, Pedestrian and Bicycle Advocate, New Jersey Department of Transportation, 1035 Parkway Avenue, P.O. Box 600, Trenton, NJ 08625-0600, Telephone: (609) 530-8062, Fax: (609) 530-3723, Email: billatng@aolcom.

New York State Department of Transportation. (1997). *The next generation: Transportation choices for the 21st century: The New York State bicycle and pedestrian plan*. Albany.

This document consists of planning strategies and design guidelines for bicycle and pedestrian facilities in New York State.

New York State Department of Transportation, Statewide Bicycle and Pedestrian Program, 1120 Washington Avenue, Building Four, Room 206, Albany, NY 12232-0424, Telephone: (518) 457-8307, Fax: (518) 457-1058, Email: mreilly@gw.dot.State.ny.us.

Nordhaus, R.S., Kantrowitz, M., Siembieda, W.J. (1984). *Accessible fishing: A planning handbook*. Santa Fe: New Mexico Natural Resources Department.

This document presents accessibility design guidelines for most fishing situations.

Resource Management and Development Division, New Mexico Natural Resources Department, Villagra Building, 408 Galisteo, Suite 129, Santa Fe, NM 87504-1147.

O'Leary, A.A., Lockwood, P.B., Taylor, R.V., Lavelly, J.L. (1995). *An evaluation of detectable warning surfaces for sidewalk curb ramps*. Richmond: Virginia Department of Transportation.

The authors of this report investigated the usage of raised detectable warnings, such as truncated domes on curb ramps and other sidewalk environments.

National Technical Information Service, Technology Administration, U.S. Department of Commerce, Springfield, VA 22161, Telephone: (703) 605-6000, Fax: (703) 321-8547.

Office of Traffic Operations, Federal Highway Administration. (1982). *Standard alphabets for highway signs and pavement markings*. Washington: U.S. Department of Transportation

This document contains the latest series of standard metric alphabets for highway signs and pavement markings created by the Federal Highway Administration at the request of the National Advisory Committee on Uniform Traffic Control Devices.

U.S. Government Printing Office, Superintendent of Documents, P.O. Box 371954, Pittsburgh, PA 15250, Telephone: (202) 512-1800, Fax: (202) 512-2233.

Ontario Parks. (1996). *Barrier-free guidelines design manual*. Ottawa.

This report presents guidelines for accessible design. Different needs and types of disabilities are also discussed.

Ontario Parks, 300 Water Street, P.O. Box 700, Peterborough, Ontario K9J 8M5, Telephone: (705) 755-PARK, Fax: (705) 755-1701, Email: ontparks@www.mnr.gov.on.ca.

Oregon Department of Transportation. (1995). *Oregon bicycle and pedestrian plan*. Salem.

This book is a guideline for State and local entities in Oregon involved in establishing bicycle and pedestrian facilities on local transportation systems.

Bicycle and Pedestrian Program, Room 210 Transportation Building,  
Salem, OR 97310, Telephone: (503) 986-3555, Fax: (503) 986-3749,  
Email: michael.p.ronkin@odot.State.or.us.

Orwig, M. (1995). *How to avoid trouble on the trail*. IWLA Outdoor Ethics Newsletter, Winter/Spring, pp. 4-5.

This article discusses human conflicts that occur on trails.

Joshua Winchell, Outdoor Ethics Program, Izaak Walton League of America, 707 Conservation Lane, Gaithersburg, MD 20878-2983,  
Telephone: (301) 548-0150, Fax: (301) 548-0146.

Park, D.C. (1989a). *Designing for everyone: Part of the public is disabled*. Design: Access 1: Standards Development: Space Requirements, pp. 3-16. (Winter 1989). Washington: Park Practice Program.

This document is the first in a series of four articles outlining accessibility design requirements as they relate to standards development, access to buildings and structures, and access to outdoor recreation and trails.

National Recreation and Park Association, 22377 Delmont Ridge Road,  
Ashburn, VA 20148, Telephone: (703) 858-0784, Fax: (703) 858-0794.

Park, D.C. (1989b). *What is accessibility?* Design: Access 2: Access to Buildings and Structures, pp. 3-16. (Spring 1989). Washington: Park Practice Program.

This document is the second in a series of four articles outlining accessibility design requirements as they relate to standards development, access to buildings and structures, and access to outdoor recreation and trails.

National Recreation and Park Association, 22377 Delmont Ridge Road,  
Ashburn, VA 20148, Telephone: (703) 858-0784, Fax: (703) 858-0794.

Park, D.C., Farbman, A. (1989c). *Accessible outdoor recreation facilities*. Design Access 3: Access to Outdoor Recreation: Trails, pp. 3-11. (Summer 1989). Washington: Park Practice Program.

This document is the third in a series of four articles outlining accessibility design requirements as they relate to standards development and access to buildings, structures, outdoor recreation, and trails.

National Recreation and Park Association, 22377 Delmont Ridge Road,  
Ashburn, VA 20148, Telephone: (703) 858-0784, Fax: (703) 858-0794.

Pedestrian Federation of America. (1995). *Walk tall: A citizens' guide to walkable communities*. Emmaus: Rodale Press.

This publication contains stories, ideas, suggestions, resources, and various charts for easy use by people of the community.

Rodale Press, Inc., Thirty-Three East Minor Street, Emmaus, PA 18098.

Pein, W.E. (1996). *Trail intersection design guidelines*. Tallahassee: Florida Department of Transportation.

This publication addresses the details associated with trail–roadway intersection design, with views toward minimizing accidents and problems at crossing points.

Theo Petritsch, State Pedestrian and Bicycle Coordinator, Florida Department of Transportation, 605 Suwannee Street MS-82, Tallahassee, FL 32399, Telephone: (850) 487–1200, Fax: (850) 922–2935, Email: theopetritsch@dot.State.fl.us.

Pennsylvania Department of Transportation, Bureau of Highway Safety and Traffic Engineering. (1996). *Statewide bicycle and pedestrian master plan: Bicycling and walking in Pennsylvania: A contract for the 21st century*. Pittsburgh.

This five-part document contains the planning strategies and design guidelines for bicycle and pedestrian facilities in Pennsylvania State.

Appalachian Trail Conference, P.O. Box 326, Harpers Ferry, WV 25425, Telephone: (304) 535–6331.

Pennsylvania Trails Program. (1980a). *Motorized trails: An introduction to planning and development*. Harrisburg: The Pennsylvania Trails Program, Division of Outdoor Recreation, Bureau of State Parks.

This is a guide to designing trails to be used by motorized vehicles.

Pennsylvania State Parks, Telephone: (717) 787–6674.

Pennsylvania Trails Program. (1980b). *Nonmotorized trails: An introduction to planning and development*. Harrisburg: The Pennsylvania Trails Program, Division of Outdoor Recreation, Bureau of State Parks.

This is a guide for developing nonmotorized trails and discusses maximizing public use of existing trails. It also includes a section on improving access for people with disabilities.

Pennsylvania State Parks, Telephone: (717) 787–6674.

Perry, J., Garrett, M., Gronley, J.K., Mulroy, S.J. (June 1995). *Classification of walking handicap in the stroke population*. *Stroke* 26, pp. 982–989.

This research identifies and evaluates the walking efficiency of individuals who have had a stroke.

American Heart Association, Western States Affiliate, 1710 Gilbreth Road, Burlingame, CA 94010-13317, Telephone: (650) 259–6700 or (800) AHA–USA1, Fax: (650) 259–6891.

Petzall, J. (1993). *Design for accessibility: The development of public transport vehicles with regard to mobility-impaired passengers*. Goteborg: Department of Transportation and Logistics, Chalmers University of Technology.

This is a description and analysis of the process of developing accessible public transportation. It also contains a case study showing how to define specifications for buses, based on results of anthropometric studies.

Department of Transportation and Logistics Chalmers University of Technology, S412 96 Goteborg, Sweden, ISBN 91-7032-847-1, ISSN 0283-3611, Bibliotekets Reproservice CTHB Goteborg.

PLAE, Inc. (1993). *A design guide: Universal access to outdoor recreation*. Berkeley.

This book provides a framework for determining the appropriate level of accessibility in a range of outdoor recreational settings and contains detailed guidelines for designing the elements and spaces necessary for ensuring accessible paths, signage, restrooms, and other outdoor facilities.

MIG Communications, 1802 Fifth Street, Berkeley, CA 94710, Telephone: (510) 845-0953, Fax: (510) 845-8750.

Prestipino, S., Keller, S. (Producers). (1996). *ADA training at the National Civil Rights Conference [Slide set]*. Helena: Montana Department of Transportation.

This is a four-box set of slides portraying problems detected by people with disabilities when encountering curb ramps and other such barriers in public rights-of-way. These slides are available for use in training or promotion of Section 14 standards.

Montana Department of Transportation, P.O. Box 201001, Helena, MT 59620-1001, Telephone: (406) 444-6200, Fax: (406) 444-7643.

Project for Public Spaces, Inc. (1993). *Case study no. 20: The effects of environmental design on the amount and type of bicycling and walking*. Washington: Federal Highway Administration. Report # FHWA-PD-93-037.

This study summarizes knowledge on the impact of environmental design on walking and bicycling. It also identifies successes and failures in the downtown design environment and the factors that promote effective bicycle and walking use.

Federal Highway Administration, U.S. Department of Transportation, 400 Seventh Street, S.W., Washington, DC 20590. Fax requests to FHWA R & T Report Center: (301) 577-1421.

Project for Public Spaces, Inc., Konhiem, Ketcham, and Whyte, W.H. (1986). *Improving how a street works for all users: A design and planning manual*. New York: Project for Public Spaces, Inc.

This book provides planning guidelines designed to improve the accessibility of streets for all users; diagrams are included.

Project for Public Spaces, 153 Waverly Place, New York, NY 10014, Telephone: (212) 206-0254.

Peck, A.F., Bentzen, B.L. (1987). *Tactile warnings to promote safety in the vicinity of transit platform edges*. Washington: U.S. Department of Transportation.

This study discusses the effectiveness of tactile warning materials to assist visually disabled travelers in hands-on station environments. It includes a laboratory evaluation of transit service and additional evaluation of two particular warning systems.

National Technical Information Service, Springfield, VA 22161, Telephone: (703) 605-6000.

Province of British Columbia, Ministry of Education. (1990). *The universal playground: A planning guide*. Victoria.

This planning guide was written to assist schools in planning playgrounds for children of all abilities, with limited resources, while achieving educational objectives.

Ministry of Education, Special Programs Branch, P.O. Box 9165,  
Stn Provgovt, Victoria BC Z8W9H4, Telephone: (250) 356-2333,  
Fax: (250) 356-7631, TTY: (250) 356-7632.

Province of British Columbia Ministry of Education, Ministry Responsible for Multiculturalism and Human Rights. (1992). *Access to conferences, institutes, and meetings: A planning guide*. Victoria: Student Support Services.

These design guidelines discuss what spaces and objects need to be made accessible and show how to identify facilities and programs that need to be modified.

Student Support Services, Parliament Buildings, Victoria,  
British Columbia V8V 1X4.

Province of Ontario, Ministry of Housing. (1989). *Main street: Planning and design guidelines*. Ottawa.

This guidebook looks at existing sidewalks and roads that require repair or readaptation. Suggestions for making safer walkways are included.

Housing Development and Buildings Branch, Ontario Ministry of Municipal Affairs and Housing, 777 Bay Street, Toronto, Ontario M6R1L1,  
Telephone: (416) 585-6515, Fax: (416) 585-7531.

Pugh, B. (1989a). *A bikeway design cookbook*. Roseville: BP Engineering.

This manual contains excerpts from the 2010 Sacramento City/County Bikeway Master Plan. It discusses design standards, figures, uniform traffic control devices, and includes a chapter on signage and roadway traffic diagram figures.

BP Engineering, P.O. Box 1385, Roseville, CA 95678-8385, Telephone:  
(916) 771-4563, Fax: (916) 771-4569, Email: BIKEFED@aol.com.

Pugh, B. (1989b). *A bikeway master plan cookbook*. Roseville: BP Engineering.

This manual contains excerpts from the 2010 Sacramento City/County Bikeway Master Plan. It includes chapters on formulating a bikeway master plan, describes general and specific planning criteria, and introduces the concept of a bicycle advisory committee.

BP Engineering, P.O. Box 1385, Roseville, CA 95678-8385, Telephone:  
(916) 771-4563, Fax: (916) 771-4569, Email: BIKEFED@aol.com.

Pugh, B. (1989c). *A bicycle parking cookbook*. Roseville: BP Engineering.

This manual contains excerpts from the 2010 Sacramento City/County Bikeway Master Plan. It contains chapters on bicycle parking and amenities, Classes I-III bicycle parking, Sacramento City and County bicycle parking-zoning ordinance, and the Sacramento County parking reduction ordinance.

BP Engineering, P.O. Box 1385, Roseville, CA 95678-8385, Telephone:  
(916) 771-4563, Fax: (916) 771-4569, Email: BIKEFED@aol.com.

Rails to Trails Conservancy, Association of Pedestrian and Bicycle Professionals. (1998). *Improving conditions for bicycling and walking: A best practice report*. Washington: Federal Highway Administration.

This is a compilation of walking and biking plans from many different cities and states. An abbreviated list of their restrictions and requirements is included.

Rails to Trails Conservancy, 1100 Seventeenth Street, Tenth Floor, Washington, DC 20036, Telephone: (202) 331-9696, Web site: [www.railtrails.org](http://www.railtrails.org).

Rabelle, A., Zabihaylo, C., Gresset, J. (1998). *Detectability of warning tiles by functionally blind persons: Effects of warning tiles' width and adjoining surfaces texture*. In E. Siffermann, M. Williams, B.B. Blasch (Eds.), *Proceedings of the Ninth International Mobility Conference* (pp. 38-41). Decatur, GA: Rehabilitation Research and Development Center.

This study determines the width needed for pedestrians to detect the presence of truncated domes and other detectable warning systems.

Rathke, D.M., Baughman, M.J. (1994). *Recreational trail design and construction*. St. Paul: Educational Development System, Minnesota Extension Service, University of Minnesota.

This publication was designed to be used by small organizations or private individuals to design and construct trails. It contains step-by-step construction methods.

University of Minnesota, Minnesota Extension Service, Distribution Center, 20 Coffey Hall, 1420 Eckles Avenue, St. Paul, MN 55108-6069, Fax: (612) 625-6281.

Recreation Access Advisory Committee. (1994). *Recommendation for accessibility guidelines: Recreational facilities and outdoor developed areas*. Washington: U.S. Architectural and Transportation Barriers Compliance Board.

This report contains the scoping technical requirements and rationale of the Recreation Access Advisory Committee for accessible outdoor recreational facility. It contains both final guidelines and proposed work perimeters.

U.S. Access Board, Recreation Report, 1331 F Street, N.W., Suite 1000, Washington, DC 20004-1111, Telephone: (202) 272-5434 or (800) 872-2253, TTY (202) 272-5449 or (800) 993-2822, Web site: <http://www.access-board.gov/rules/child.htm>.

Rehabilitation Engineering and Assertive Technology Society of North America. (1998). *American national standard for wheelchairs: Volume 1: Requirements and test methods for wheelchairs (including scooters)*. Arlington.

This document contains wheelchair testing specifications.

RESNA, 1700 North Moore Street, Suite 1540, Arlington, VA 22209, Telephone: (703) 524-6686, Fax: (703) 524-6630.

Ryan, K. (1993). *Trails for the twenty-first century*. Covelo: Island Press.

This book introduces the concept of the multi-use trail and promotes bicycle and pedestrian travel.

Island Press, 24850 East Lane, P.O. Box 7, Covello, CA 95428,  
Telephone: (707) 983-6432, Fax: (707) 983-6414, Web site:  
www.islandpress.org, Email: ipwest@igc.apc.org.

Sanford, J.A. (1985). *Designing for orientation and safety*. Proceedings of the International Conference on Building Use and Safety Technology. (pp. 54-59). Atlanta, GA: Georgia Institute of Technology.

This study determines whether different surfaces are detectable by people with visual impairments, and how the properties of different surfaces affect their detectability. It also presents results of tests of the ability of people with visual impairments to stop after detecting a warning.

Sanford, J.A., Steinfeld, E. (1985). Designing for orientation and safety. Proceedings of the International Conference on Building Use and Safety Technology (pp. 54-59). Washington: National Institute of Building Sciences.

This study discusses the properties of different detectable warnings and how well people with visual disabilities are able to detect them. It also discusses the navigational techniques of people with visual impairments and how they interacted with the detectable warning, and the usage and interpretation of architectural space by visually impaired people versus sighted people.

San Francisco Bureau of Engineering. (1996). *Warning strips for the visually disabled and blind pedestrian*. San Francisco Bureau of Engineering internal report, San Francisco.

This study was conducted by the San Francisco Department of Public Works to determine whether guide strips used in crosswalks are durable enough to withstand the impact of heavy traffic use. This study tested a variety of different types of guide strips.

Joe Ovadia, Project Manager, San Francisco Bureau of Engineering,  
Telephone: (415) 558-4004. Richard Skaff, Disability Access Coordinator,  
San Francisco Department of Public Works, 30 Van Ness Avenue, 5th Floor,  
San Francisco, CA 94102, Email: richardskaff@amer.net.

Sawai, H., Takato, J., Tauchi, M. (1998). *Quantitative measurements of tactile contrast between dot and bar tiles used to constitute tactile pathway for the blind and visually impaired independent travelers*. In E. Sifferman, M. Williams, B.B. Blasch (Eds.), *Proceedings of the Ninth International Mobility Conference* (pp. 178-181). Decatur, GA: Rehabilitation Research and Development Center.

This study discusses the ability of people with visual impairments to detect the difference between the two types of detectable warnings — a dot tile served to alert pedestrians, and a bar tile served to guide pedestrians along a given path.

Schmid, J. (1997). *American trails: 1997 trails resource bibliography*. Prescott: American Trails.



A bibliography of 941 publications and videos containing information about trails.

American Trails, P.O. Box 11046, Prescott, AZ 86304-1046, Telephone: (520) 632-1140, Fax: (520) 632-1147, Email: Amtrails@lankcaster.com, Web site: <http://www.outdoorlink.com/amtrails/>.

Seeing Eye, The (Producer). (1996). *Partners in travel [Videotape]*. Morristown, NJ: Independence and Dignity.

This video provides an overview of dog guides and how they can aid people with visual impairments.

Independence and Dignity, P.O. Box 375, Morristown, NJ 07963-0375.

Seiderman, C.B., Russell, R.A. (1997). *How better bicycle facilities can enhance local economies*. In O. Hatch (Ed.), *Velo-City Falco Lecture Prize Winning Papers*. (pp. 3-12). Vriezenveen: Falco bv.

This study examines the connection between the condition of bicycle facilities and local economies by analyzing existing data.

Oliver Hatch, Velo-City Conference Director, Thirty-One Arodene Road, London SW2 2BQ, England, UK, Telephone: +44 (181) 674-5916, Fax: +44 (181) 671-3386, Email: [oh@velo-city.org](mailto:oh@velo-city.org).

Shephard, R.J. (1990). *Fitness in special populations*. Champaign: Human Kinetics.

This document examines fitness status, training programs, personality, behavior, and biomechanical factors that influence fitness assessment and development.

Human Kinetics Publishers, Inc., Fulfillment Department, P.O. Box 5076, Champaign, IL 61825-5076, Telephone: (800) 747-4457, Fax: (217) 351-1549, Web site: [www.humankinetics.com](http://www.humankinetics.com).

Sherrill, C. (Fourth edition). (1993). *Adapted physical activity, recreation, and sport: Cross-disciplinary and lifespan*. Madison: WCB Brown and Benchmark.

Discusses the impact of disability on physical activity participation. Addresses behavioral, emotional, cognitive, and learning disabilities, as well as effective methods for including individuals with these conditions.

McGraw-Hill Companies, P.O. Box 182604, Columbus, OH 43272-3031, Telephone: (800) 262-4729, Fax: (614) 759-3644, Email: [customer.service@mcgraw-hill.com](mailto:customer.service@mcgraw-hill.com), Web site: [mhhe.com](http://mhhe.com).

Siwek, S.J., Associates. (1996). *Statewide transportation planning under ISTEA: A new framework for decision making*. Washington: Federal Highway Administration. Report # FHWA-PD-96-026A.

This guidebook describes how the Intermodal Surface Transportation Equity Act affects State departments of transportation. Long- and short-range plans are discussed in detail.

Federal Highway Administration, U.S. Department of Transportation, 400 Seventh Street, S.W., Washington, DC 20590.

Staplin, L., Lococo, K., Byington, S. (1998). *Older driver highway design handbook*. McLean: Office of Safety and Traffic Operations R&D.

This project included literature reviews and meta-analytic techniques in the areas of age-related functional capabilities, human factors, and highway safety. A User-Requirements Analysis to gauge the needs of highway design is also used in this study.

National Technical Information Service, Technology Administration,  
U.S. Department of Commerce, Springfield, VA 22161, Telephone:  
(703) 605-6000, Fax: (703) 321-8547.

Steinfeld, E., Schroeder, S., Bishop, M. (1979). *Accessible buildings for people with walking and reaching limitations*. Washington: U.S. Department of Housing and Urban Development.

This document presents research regarding the special needs of people with walking and reaching limitations in relation to building design and spatial layout.

HUD User, P.O. Box 6091, Rockville, MD 20849, Telephone:  
(301) 251-5154 or (800) 245-2691.

Templer, J.A. (1980a). *An implementation manual: Provisions for the elderly and handicapped pedestrians*. Washington: Federal Highway Administration.

This book identifies, defines, and gives solutions for the shortcomings of the pedestrian environment.

U.S. Government Printing Office, Superintendent of Documents,  
P.O. Box 371954, Pittsburgh, PA 15250-7954, Telephone: (202) 512-1800,  
Fax: (202) 512-2233.

Templer, J.A. (1980b). *Provisions for elderly and handicapped pedestrians: Volume 3: The development and evaluation of countermeasures*. Springfield: U.S. Department of Commerce.

This report presents the findings of several countermeasures designed to improve access for older pedestrians and people with disabilities in sidewalk environments.

National Technical Information Service, Springfield, VA 22161, Telephone:  
(703) 605-6000, Fax: (703) 321-8547.

Templer, J.A. (1980c). *Provisions for elderly and handicapped pedestrians: Volume 2: Hazards, barriers, problems, and the law*. Washington: Federal Highway Administration.

This survey was conducted to determine problems experienced by the elderly and pedestrians with disabilities.

National Technical Information Service, Technology Administration, U.S.  
Department of Commerce, Springfield, VA 22161, Telephone: (703) 605-6000,  
Fax: (703) 321-8547.

Templer, J.A. (1980d). *The feasibility of accommodating physically handicapped individuals on pedestrian over- and undercrossing structures*. Washington: Federal Highway Administration.

The objective of this study was to determine the problems faced by people with disabilities when they encounter over- and undercrossing structures.

National Technical Information Service, Technology Administration, U.S. Department of Commerce, Springfield VA 22161, Telephone: (703) 605-6000, Fax: (703) 321-8547.

Templer, J.A., Wineman, J., Zimring, C.M. (1982). *Design guidelines to make crossing structures accessible to the physically handicapped*. Washington: Offices of Research and Development, Federal Highway Administration.

Based on various studies, this book contains recommendations for ramp gradients, detectable materials, and techniques for providing nonvisual information.

National Technical Information Service, Technology Administration, U.S. Department of Commerce, Springfield, VA 22161, Telephone: (703) 605-6000, Fax: (703) 321-8547.

Templer, J.A. (1994a). *The staircase: History and times*. Cambridge: The MIT Press.

This book discusses the history of stairs, design ideas that have been used, and their ergonomic ability.

The MIT Press, Massachusetts Institute of Technology, Cambridge, MA 02142, Telephone: (617) 625-8569.

Templer, J.A. (1994b). *The staircase: Studies of hazards, falls, and safer design*. Cambridge: The MIT Press.

This book discusses the need for safer stair designs and focuses on the relationship between the physiological and behavioral usage of stairs by people.

The MIT Press, Massachusetts Institute of Technology, Cambridge, MA 02142, Telephone: (617) 625-8569.

Texas Department of Licensing and Regulation. (1997). *Architectural Barriers Act*. Austin.

The accessibility design guidelines for the State of Texas; covers the construction and reconstruction of public buildings, public accommodations, and commercial facilities.

Department of Licensing and Regulation, P.O. Box 12157, Austin, TX 78711, Telephone: 1-800-252-8026.

The Resources Agency, Department of Parks and Recreation. (1998). *Trails handbook*. Sacramento: California State Parks.

This handbook, which has not been published, provides guidance on designing, constructing, and maintaining outdoor trails.

Don Beers, North Coast Redwoods Headquarters, 600-A West Clark, Eureka, CA 95501, Telephone: (707) 445-6547 ext. 18, Fax: (707) 441-5737.

Transportation Equity Act for the Twenty-First Century. (1998). *Public Law 178, 105th Congress*. (June 6, 1998).

This law authorizes transportation funds to be spent on improving intermodal surface transportation alternatives for moving goods and people.

U.S. Government Printing Office, Superintendent of Documents, P.O. Box 371954, Pittsburgh, PA 15250-7954, Telephone: (202) 512-1800, Fax: (202) 512-2233.

Tranter, R.T., Slater, R., Vaughan, N. (1991). *Barriers to Mobility: Physically disabled and frail elderly people in their local outdoor environment*. International Journal of Rehabilitation Research, 14, pp. 303-312.

This paper reports the results of a 2-year project that investigated problems with the mobility of physically handicapped people in their external physical environment.

Welsh School of Architecture, University of Wales, P.O. Box 25, Cardiff CF1 3XE, Wales.

United Kingdom Department of the Environment, Transport, and the Regions, The Scottish Office. (Notified Draft, 1997). *Guidance on the use of tactile paving surfaces*. London, England.

These design guidelines discuss mobility for people with visual impairments and provide specifications for tactile delineator strips on segregated, shared cycle track/footways.

Sue Sharp, Mobility Policy Branch, Great Minister House Room 1/11, 76 Marsham House, London SW1P 4DR, Telephone: 0171-271-5256, Divisional inquiries: 0171-271-5252, Fax: 0171-271-5253, Email: mu.dot@gtnet.gov.uk.

University of North Carolina Highway Safety Research Center. (1996). *Florida pedestrian planning and design guidelines*. Tallahassee: State of Florida Department of Transportation.

This manual provides guidelines, standards, and criteria for the planning, design, construction, operation, and maintenance of pedestrian facilities.

Theo Petritsch, State Pedestrian and Bicycle Coordinator, Florida Department of Transportation, 605 Suwannee Street MS-82, Tallahassee, FL 32399, Telephone: (850) 487-1200, Fax: (850) 922-2935, Email: theopetritsch@dot.State.fl.us.

U.S. Architectural and Transportation Barriers Compliance Board. (1985). *Detectable tactile surface treatments: Phase 1: Introduction and laboratory testing: Final report*. Washington: U.S. Architectural and Transportation Barriers Compliance Board.

This is a study of the detectability of different types of surface warning systems, and it investigates how the different properties of these surface systems affect perceptions of people with visual disabilities.

U.S. Access Board, Recreation Report, 1331 F Street, N.W., Suite 1000, Washington, DC 20004-1111, Telephone: (202) 272-5434 or (800) 872-2253, TTY (202) 272-5449 or (800) 993-2822, Web site: <http://www.access-board.gov/rules/child.htm>.

U.S. Architectural and Transportation Barriers Compliance Board. (1991). *36 CFR part 1191: Americans with Disabilities Act (ADA): Accessibility guidelines for buildings and facilities: State and local government facilities*. (July 26, 1991). Washington, DC.

This document contains accessibility guidelines that should be used by Federal agencies seeking to comply with the Americans with Disabilities Act.

U.S. Government Printing Office, Superintendent of Documents, P.O. Box 371954, Pittsburgh, PA 15250-7954, Telephone: (202) 512-1800, Fax: (202) 512-2233.

U.S. Architectural and Transportation Barriers Compliance Board. (1994a). *Bulletin #4: Surfaces*. Washington.

This bulletin clarifies the requirements for accessible surfaces. It defines what is considered firm, stable, and slip-resistant; provides methods to assess firmness and slip resistance; and discusses what materials are considered to comply with ADAAG.

U.S. Access Board, Recreation Report, 1331 F Street, N.W., Suite 1000, Washington, DC 20004-1111, Telephone: (202) 272-5434 or (800) 872-2253, TTY (202) 272-5449 or (800) 993-2822, Web site: <http://www.access-board.gov/rules/child.htm>

U.S. Architectural and Transportation Barriers Compliance Board. (1994b). *36 CFR Part 1191: Americans with Disabilities Act (ADA) Accessibility guidelines for buildings and facilities; State and local government facilities: Interim final rule*. Federal Register, vol. 59, no. 117. (June 24, 1994). Washington, DC.

This document is the set of interim final guidelines published by the U.S. Access Board. It provides additional guidance to the existing ADA Accessibility Guidelines (ADAAG). Section 14, which covers accessibility for public rights-of-way, is included in this interim final rule.

U.S. Government Printing Office, Superintendent of Documents, P.O. Box 371954, Pittsburgh, PA 15250-7954, Telephone: (202) 512-1800, Fax: (202) 512-2233.

U.S. Architectural and Transportation Barriers Compliance Board. (1996). *Bulletin 1: Detectable Warnings*. Washington.

This bulletin was written to alert the public to the requirements of installing detectable warnings.

U.S. Access Board, Recreation Report, 1331 F Street, N.W., Suite 1000, Washington, DC 20004-1111, Telephone: (202) 272-5434 or (800) 872-2253, TTY (202) 272-5449 or (800) 993-2822, Web site: <http://www.access-board.gov/rules/child.htm>.

U.S. Architectural and Transportation Barriers Compliance Board. (1997a). *ADAAG manual: A guide to the Americans with Disabilities Act accessibility guidelines*. Washington.

This interpretive manual of the ADA accessibility guidelines (ADAAG) is intended to provide clarification and technical assistance for developing buildings and facilities.

U.S. Access Board, Recreation Report, 1331 F Street, N.W., Suite 1000, Washington, DC 20004-1111, Telephone: (202) 272-5434 or (800) 872-2253, TTY (202) 272-5449 or (800) 993-2822, Web site: <http://www.access-board.gov/rules/child.htm>.

U.S. Architectural and Transportation Barriers Compliance Board (Producer). (1997c). *Accessible sidewalks: Design issues for pedestrians with disabilities [Videotape]*. Washington: U.S. Architectural and Transportation Barriers Compliance Board.

This video presents design recommendations for making sidewalks accessible to pedestrians who use wheelchairs.

U.S. Access Board, Recreation Report, 1331 F Street, N.W., Suite 1000, Washington, DC 20004-1111, Telephone: (202) 272-5434 or (800) 872-2253, TTY (202) 272-5449 or (800) 993-2822, Web site: <http://www.access-board.gov/rules/child.htm>.

U.S. Architectural and Transportation Barriers Compliance Board. (1998a). *36 CFR part 1191: Americans with Disabilities Act (ADA): Accessibility guidelines for buildings and facilities: Building elements designed for children's use; Final rule*. Federal Register vol. 63, no. 8. (January 13, 1998). Washington, DC.

The U.S. Access Board's final guidelines providing additional guidance in establishing alternate specifications for building elements designed for use by children.

U.S. Access Board, Recreation Report, 1331 F Street, N.W., Suite 1000, Washington, DC 20004-1111, Telephone: (202) 272-5434 or (800) 872-2253, TTY (202) 272-5449 or (800) 993-2822, Web site: <http://www.access-board.gov/rules/child.htm>.

U.S. Architectural and Transportation Barriers Compliance Board (1998b). *36 CFR part 1191: Americans with Disabilities Act (ADA): Accessibility guidelines for buildings and facilities: State and local government facilities: Final rule*. Federal Register, vol. 63, no. 8. (January 13, 1998). Washington, DC.

The U.S. Access Board is issuing final guidelines to provide additional guidance with the new construction and alternations of State and local government facilities. This is to help ensure that government facilities are readily accessible to and usable by individuals with disabilities.

U.S. Access Board, Recreation Report, 1331 F Street, N.W., Suite 1000, Washington, DC 20004-1111, Telephone: (202) 272-5434 or (800) 872-2253, TTY (202) 272-5449 or (800) 993-2822, Web site: <http://www.access-board.gov/rules/child.htm>.

U.S. Architectural and Transportation Barriers Compliance Board. (1998c). *Transit facility design for persons with visual impairments*. Gopher://trace.wisc.edu/oo/ftp/pub/text/ATBCB/BLINDTRN.TXT (June 23, 1998).

This informational sheet provides an overview of the recommendations for making transit facilities more accessible for people with visual impairments.

U.S. Architectural and Transportation Barriers Compliance Board, 1111 18th Street, N.W., Suite 501, Washington, DC 20036, Telephone or TDD: (202) 653-7848.

U.S. Department of Agriculture, Alaska Region Forest Service. (1991). *Alaska region trails construction and maintenance guide*. Anchorage.

This document contains trail design and maintenance guidelines for the Forest Service in the Alaskan region.

Alaska Federal Office Building, 709 West Ninth Street, P.O. Box 21628, Juneau, AK 99802-1628, DG: Mailroom: R10A.

U.S. Department of Agriculture, Forest Service. (1984). *Standard specifications for construction of trails*. Washington: U.S. Government Printing Office.

These U.S. Forest Service design guidelines provide specifications for trail construction.

USDA Forest Service, Engineering Staff, Attn: Publications Specialist, P.O. Box 2417, Washington, DC 20013, Telephone: (202) 205-0957.

U.S. Department of Agriculture, Forest Service. (1985). *Trails management handbook*. Washington.

This handbook consists of guidelines used by the U.S. Forest Service to manage trails. Includes sections on trail planning, development, reconstruction and construction, trail operation and maintenance, and construction and maintenance exhibits.

Forest Service USDA, Engineering Staff, Attn: Publications Specialist, P.O. Box 2417, Washington, DC 20013, Telephone: (202) 205-0957.

U.S. Department of Agriculture, Forest Service. (1994). *Special use permits: The ADA and section 504*. Washington.

This document outlines how the ADA and Section 504 of the Rehabilitation Act apply to special use permits for the USDA Forest Service and its contractors.

USDA Forest Service, Engineering Staff, Attn: Publications Specialist, P.O. Box 2417, Washington, DC 20013, Telephone: (202) 205-0957.

U.S. Department of Commerce, Bureau of the Census. (1994). *Americans with disabilities*. [http://www.census.gov/apsd/www/statbrief/sb94\\_1.pdf](http://www.census.gov/apsd/www/statbrief/sb94_1.pdf). (July 9, 1998).

This is a summary of the 1990 U.S. Census data on people with disabilities.

Customer Services: (301) 763-4100, Persons with Disabilities Contact: John McNeil, (301) 763-8300, Statistical Briefs Contact: Robert Bernstein, (301) 763-1584.

U.S. Department of Defense, General Services Administration, Department of Housing and Urban Development, U.S. Postal Service. (1984). *Uniform Federal accessibility standards*. Washington.

This document contains accessibility guidelines that should be used by Federal agencies to comply with the Rehabilitation Act of 1973.

U.S. Access Board, Recreation Report, 1331 F Street, N.W., Suite 1000, Washington, DC 20004-1111, Telephone: (202) 272-5434 or (800) 872-2253, TTY (202) 272-5449 or (800) 993-2822, Web site: <http://www.access-board.gov/rules/child.htm>.

U.S. Department of Justice. (1991). *36 CFR part 1191: Americans with Disabilities Act (ADA): Accessibility guidelines for buildings and facilities: State and local government facilities*. (July 26, 1991). Washington, DC.

This document contains implementation regulations for Title III of the Americans with Disabilities Act. The ADA Standards for Accessible Design are contained within these regulations.

U.S. Government Printing Office, Superintendent of Documents,  
P.O. Box 371954, Pittsburgh, PA 15250-7954, Telephone: (202) 512-1800,  
Fax: (202) 512-2233.

U.S. Department of Justice. (1993a). *The Americans with Disabilities Act, Title III: Readily achievable: Background paper on accessibility of existing ski facilities*. Washington: Department of Justice.

This document outlines how the “readily achievable” standard set forth in Title III of the ADA applies to accessibility at existing ski facilities.

U.S. Department of Justice, Telephone: (202) 514-0301 or  
(800) 514-0301, TTY: (800) 514-0383.

U.S. Department of Justice. (1993b). *The Americans with Disabilities Act, Title II: Technical assistance manual: Covering State and local government programs and services: 1993*. Washington.

This manual presents the ADA’s requirements for State and local governments in a focused, systematic description. Questions, answers, and illustrations are used throughout to convey points.

U.S. Department of Justice, Telephone: (202) 514-0301 or  
(800) 514-0301, TTY: (800) 514-0383.

U.S. Department of Justice. (1993c). *The Americans with Disabilities Act, Title III: Technical assistance manual: Covering public accommodations and commercial facilities*. Washington: Author.

This manual presents the ADA’s requirements for public accommodations, commercial facilities, and private entities offering certain examinations and courses in a focused, systematic description. Questions, answers, and illustrations are used throughout to convey points.

U.S. Department of Justice, Telephone: (202) 514-0301 or  
(800) 514-0301, TTY: (800) 514-0383.

U.S. Department of Justice. (1994a). *The Americans with Disabilities Act, Title II: Technical assistance manual: 1994 supplement*. Washington.

This document contains material to be added to the Americans with Disabilities Act, Title II: Technical Assistance Manual. These supplements are to be inserted, as appropriate, at the end of each chapter of the manual.

U.S. Department of Justice, Telephone: (202) 514-0301 or  
(800) 514-0301, TTY: (800) 514-0383.

U.S. Department of Justice. (1994b). *28 CFR parts 35, 36, 37: Nondiscrimination on the basis of disability in State and local government services: Public accommodations and commercial facilities: Accessibility standards*. Federal Register, vol. 59, no. 117. (June 20, 1994). Washington, DC.



This document contains implementation regulations for Title II, Subpart A and Title III of the Americans with Disabilities Act.

U.S. Government Printing Office, Superintendent of Documents,  
P.O. Box 371954, Pittsburgh, PA 15250-7954, Telephone: (202) 512-1800,  
Fax: (202) 512-2233.

U.S. Department of Justice. (1996a). *A guide to disability rights laws*. Washington.

This bulletin lists settlements, agreements, and cases of ADA litigation; provides resources for entities seeking ADA technical assistance; lists other sources for ADA information; and provides an address to file complaints.

U.S. Department of Justice, Telephone: (202) 514-0301 or (800) 514-0301,  
TTY: (800) 514-0383.

U.S. Department of Justice. (1996b). *Enforcing the ADA: A status report from the Department of Justice: Issue three*. Washington.

This booklet provides a short overview of Federal civil rights laws that ensure equal opportunity for people with disabilities and lists contact agencies and organizations.

U.S. Department of Justice, Telephone: (202) 514-0301 or (800) 514-0301,  
TTY: (800) 514-0383.

U.S. Department of Justice. (1998a). *Proposed Rule, 28 CFR Part 35 — Requirement for Curb Ramps*. [www.usdoj.gov/crt/ada/newregs/curbrule.txt](http://www.usdoj.gov/crt/ada/newregs/curbrule.txt) (March 27, 1998).

This Web site posts the proposed rule to extend curb ramp requirements and provides background information regarding this issue.

U.S. Department of Justice. (1998b). *Final Rule for Extension of Detectable Warning Temporary Suspension until July 26, 1998*. <http://www.usdoj.gov/crt/ada/detwarns.htm> (March 27, 1998).

This Web site posts the final rule to extend the detectable warning suspension and provides background information regarding this issue.

U.S. Department of Justice, Architectural and Transportation Barriers Compliance Board, U.S. Department of Transportation. (1994). *28 CFR part 36, 36 CFR part 1191, 49 CFR part 37: Americans with Disabilities Act accessibility guidelines: Detectable warnings: Joint final rule*. Federal Register, vol. 59, no. 70. (April 12, 1994). Washington, DC.

This document sets forth the Department of Justice implementing regulations for ADAAG regarding detectable warnings.

U.S. Government Printing Office, Superintendent of Documents,  
P.O. Box 371954, Pittsburgh, PA 15250-7954, Telephone:  
(202) 512-1800, Fax: (202) 512-2233.

U.S. Department of Justice, Equal Employment Opportunity Commission. (1994). *28 CFR part 37, 29 CFR part 1640: Procedures for coordinating the investigation of complaints or charges of employment discrimination based on disability subject to the Americans with Disabilities Act and section 504 of the Rehabilitation Act of 1973: Final rule*. Federal Register, vol. 59, no. 149. (August 4, 1994). Washington, DC.

These regulations coordinate the processing of complaints that fall within the overlapping jurisdiction of the ADA and Section 504 and ensure that they are dealt with in a manner that avoids duplication of effort and prevents inconsistent or conflicting standards.

U.S. Government Printing Office, Superintendent of Documents,  
P.O. Box 371954, Pittsburgh, PA 15250-7954, Telephone: (202) 512-1800,  
Fax: (202) 512-2233.

U.S. Department of Transportation. (1988). *Manual on uniform traffic control devices*. Washington: Federal Highway Administration.

This text, including traffic lights and signage, lists National standards for traffic control devices, their colors, markings, dimensions, and placement. These guidelines must be followed by all public authorities having jurisdiction over traffic control. Numerous diagrams and signage examples are included.

U.S. Government Printing Office, Superintendent of Documents,  
P.O. Box 371954, Pittsburgh, PA 15250-7954, Telephone: (202) 512-1800,  
Fax: (202) 512-2233.

U.S. Department of Transportation. (1991). *49 CFR parts 27, 37, 38: Transportation for individuals with disabilities: Final rule*. Federal Register, vol. 56, no. 173. (September 6, 1991). Washington, DC.

This is the final rule implementing the transportation provisions of the ADA. The rule contains provisions on the acquisition of accessible vehicles by private and public entities and contains the amendment to the implementation of Section 504 of the Rehabilitation Act of 1973.

U.S. Government Printing Office, Superintendent of Documents,  
P.O. Box 371954, Pittsburgh, PA 15250-7954, Telephone: (202) 512-1800,  
Fax: (202) 512-2233.

U.S. Department of Transportation. (1994a). *49 CFR parts 27, 37: Transportation for individuals with disabilities: Proposed rule*. Federal Register, vol. 59, no. 117. (June 20, 1994). Washington, DC.

Regulations regarding transportation and transportation facilities imposed by the ADA Accessibility Guidelines for Buildings and Facilities.

U.S. Government Printing Office, Superintendent of Documents,  
P.O. Box 371954, Pittsburgh, PA 15250-7954, Telephone: (202) 512-1800,  
Fax: (202) 512-2233.

U.S. Department of Transportation. (1994b). *Glossary of transportation terms*. Washington: Federal Highway Administration.

This English/Spanish version is a translation of the Urban Public Transportation Glossary that was published by the Transportation Research Board (TRB).

Federal Highway Administration, U.S. Department of Transportation,  
400 Seventh Street, S.W., Washington, DC 20590.

U.S. Department of Transportation. (1994c). *Innovations in public involvement for transportation planning*. Washington: Federal Highway Administration.

This report provides synopses of different methods for involving the public in transportation planning. A description of each technique, the intended audience, the method of participation, how the output might be used, the costs, advantages, drawbacks, references, contacts to obtain more information, and issues of special concern are discussed for each technique.

Federal Highway Administration, U.S. Department of Transportation,  
400 Seventh Street, S.W., Washington, DC 20590.

U.S. Department of Transportation. (1995a). *49 CFR part 27: Nondiscrimination on the basis of handicap in programs and activities receiving or benefiting from Federal financial assistance*. Federal Register. (October 1, 1995). Washington, DC.

This is an excerpt of the Federal law prohibiting discrimination against people with disabilities involved in Federal assistance programs.

U.S. Government Printing Office, Superintendent of Documents,  
P.O. Box 371954, Pittsburgh, PA 15250-7954, Telephone: (202) 512-1800,  
Fax: (202) 512-2233.

U.S. Department of Transportation. (1995b). *49 CFR part 28: Enforcement of nondiscrimination on the basis of handicap in programs or activities conducted by the Department of Transportation*. Federal Register. (October 1, 1995). Washington, DC.

This is an excerpt of Federal law regarding the enforcement of nondiscrimination against people with disabilities in programs or activities conducted by the U.S. Department of Transportation.

U.S. Government Printing Office, Superintendent of Documents,  
P.O. Box 371954, Pittsburgh, PA 15250-7954, Telephone: (202) 512-1800,  
Fax: (202) 512-2233.

U.S. Department of Transportation. (1995c). *Working together on transportation planning: An approach to collaborative decision making*. Washington: Federal Highway Administration.

This report provides guidelines for planning transportation projects within a coalition of government agencies, community groups, special-interest groups, elected officials, minorities, and private-sector interests.

Federal Highway Administration, U.S. Department of Transportation,  
400 Seventh Street, S.W., Washington, DC 20590.

U.S. Department of Transportation. (1996a). *Public involvement techniques for transportation decision making*. Washington: Federal Highway Administration.

This reference lists techniques to involve the public in transportation planning, enumerating the pros and cons. One chapter is devoted to the Americans with Disabilities Act.

Federal Highway Administration, U.S. Department of Transportation,  
400 Seventh Street, S.W., Washington, DC 20590.

U.S. Department of Transportation. (Draft, 1996b). *Title II of the Americans with Disabilities Act (ADA): A draft primer for bicycle and pedestrian professionals adapted from the U.S. Department of Justice, Title II: Technical assistance manual*. Washington.

This document provides an explanation of the portions of Title II of the ADA that pertain to bicycle and pedestrian coordinators and planners.

Federal Highway Administration, U.S. Department of Transportation,  
400 Seventh Street, S.W., Washington, DC 20590.

U.S. District Court, Eastern District of Pennsylvania. (1993). *Civil Action 92-9101 Elizabeth Kinney vs. Howard Yerusolim.*

This is a Federal district appeals court case that determined that resurfacing affects the usability of the street. The court further ruled that because a street and its curbs are interdependent facilities, alteration of a street triggers the installation of a curb ramp.

Vic Roads Principal Traffic Engineer's Department Quality and Technical Resources Division. (1995). *Vic Roads: Providing for people with disabilities: Traffic engineering guidelines.* Kew: Vic Roads.

These guidelines can be used to improve existing road accessibility conditions.

Vic Roads Bookshop, Sixty Denmark Street, KEW Vic 3101,  
Telephone: (03) 854-2782, Fax: (03) 853-0084.

Viola, R. (1997). *Arlington County pedestrian transportation plan.* Arlington: Arlington County Department of Public Works.

This document revises the Arlington County Virginia Pedestrian Transportation Plan. It contains census materials and street diagrams.

Ritch Viola, 2100 Clarendon Boulevard, Suite 717, Arlington, VA 22201,  
Telephone: (703) 228-3699, Fax: (703) 228-3594, Email:  
rviola@co.arlington.va.us.

Virginia Department of Transportation. (1996). *Subdivision street requirements.* Richmond: Commonwealth of Virginia.

This reference establishes the minimum State requirements accepted by the Department of Transportation for all genres of subdivision development.

Virginia Department of Transportation, Secondary Roads Division,  
1401 East Broad Street, Richmond, VA 23219, Telephone: (804) 786-2576,  
Fax: (804) 7786-2603.

Volunteers for Outdoor Colorado. (Fourth edition). (1992). *Crew leader manual.* Denver.

This is a training manual for the Volunteers for Outdoor Colorado. It provides design guidelines and maintenance techniques for recreational trails.

Volunteers for Outdoor Colorado, 1410 Grant Street B105, Denver, CO 80203,  
Telephone: (303) 830-7792.

Walkable Communities, Inc. (1996). *Creating a more walkable Las Vegas.* High Springs.

This report documents a planning charrette that focuses on the pedestrian environment in Las Vegas, Nevada.

Walkable Communities, Inc., 320 South Main Street, High Springs, FL 32643,  
Telephone: (904) 454-3304, Fax: (904) 454-3306, Email: DBurden@aol.com.

Ward, K.H., Meyers, M.C. (April 1995). *Exercise performance of lower-extremity amputees*. *Sports Medicine*, 20, pp. 207-214.

This is a review of published literature relating to walking speed and energy cost during ambulation for individuals with lower-extremity amputation and able-bodied individuals.

Adis International Inc., 860 Town Center Drive, Langhorne, PA 19047,  
Telephone: (215) 741-5200, Fax: (215) 741-5251, Web site: [www.adis.com](http://www.adis.com).

Washington State Department of Transportation. (1989). *Design manual: M22-01*. Olympia.

This manual provides planning and design guidelines for bicycle facilities.

Washington Department of Transportation, Bike and Pedestrian Program,  
P.O. Box 47393, Olympia, WA 98504, Telephone: (360) 705-7505.

Washington State Department of Transportation, Puget Sound Regional Council, OTAK. (1997). *Pedestrian facilities guidebook: Incorporating pedestrians into Washington's transportation system*. Olympia: Washington State Department of Transportation.

This guidebook provides planning and design guidelines for pedestrian facilities used by the Washington State Department of Transportation.

Washington Department of Transportation, Bike and Pedestrian Program,  
P.O. Box 47393, Olympia, WA 98504, Telephone: (360) 705-7505.

Wernex, J. (1994). *Off-highway motorcycle and ATV trails: Guidelines for design, construction, maintenance, and user satisfaction: Second edition*. Westerville: American Motorcyclist Association.

This document outlines design guidelines for off-highway vehicle trails.

American Motorcyclist Association, P.O. Box 6114, Westerville,  
OH 43081-6114.

Whitstock, R.H., Franck, L., Haneline, R. (1997). *Dog Guides*. In B. Blasch, W. Wiener, R. Welsh (Eds.), *Foundations of orientation and mobility: Second edition* (pp. 260-283). New York, NY: AFB Press, American Foundation for the Blind.

This chapter from *Foundations of Orientation and Mobility* contains information pertaining to dog guides. It includes information on training and responsibilities, and a section on the growth of the dog-guide movement.

AFB Press, American Foundation for the Blind, 11 Penn Plaza, New York,  
NY 10001. Web site: [http://www.afb.org/r\\_dwrep.html](http://www.afb.org/r_dwrep.html).

Wilderness Inquiry, Inc. (1992). *Wilderness accessibility for people with disabilities*. Washington: National Council on Disability.

This report contains the findings of a study that examined the policies used by land management agencies to improve accessibility for people with disabilities. The National Council on Disability's recommendations for improving access to wilderness areas are also included in this report.

National Council on Disability, 800 Independence Avenue, S.W., Suite 814, Washington, DC 20591.

Wilderness Inquiry, Inc. (1995). *Wilderness access decision tool*. Washington: USDA Forest Service.

This document was designed to help all managers of Federal wilderness areas improve access to their trails.

Arthur Carhart National Wilderness Training Center, 20325 Remount Road, Huson, MT 59846, Telephone: (406) 626-5208, Fax: (406) 626-5395.

Wilkinson, W.C., III. (1993). *Case study no. 10: Trading off among the needs of motor vehicle users, pedestrians, and bicyclists*. Washington: Federal Highway Administration. Report # FHWA-PD-94-012.

This document is tenth in a series of case study reports published by the Federal Highway Administration reviewing the needs and conflicts of various roadway and sidewalk users.

Federal Highway Administration, U.S. Department of Transportation, 400 Seventh Street, S.W., Washington, DC 20590. Fax requests to FHWA R & T Report Center: (301) 577-1421.

Wisconsin Department of Natural Resources. (1994). *Department design standards handbook*. Madison.

This document outlines design standards for new outdoor recreation facilities.

Wisconsin Department of Natural Resources, Telephone: (608) 266-7356.

Woo, J., Ho, S.C., Lau, J., Chan, S.G., & Yuen, Y.K. (1995). *Age-associated gait changes in the elderly: Pathological or physiological?* *Neuroepidemiology*, 14, pp. 65-71.

In this study, the walking speed and stride length of men and women 70 years of age were evaluated to determine changes in gait associated with aging.

Publisher S. Karger AG, P.O. Box CH-4009, Basel, Switzerland, Web site: [www.karger.com](http://www.karger.com).

World Health Organization. (1980). *International classification of impairment, disability, and handicap*.

This document provides internationally accepted standard definitions to identify and distinguish among impairment, disability, and handicap.

The World Health Organization Headquarters, Avenue Appia 20, 1211 Geneva 27, Switzerland, Telephone: (+41 22) 791-21-11, Fax: (+41 22) 791-0746, Telex: 415-416, Telegraph: UNISANTE GENEVA, Email: [publications@who.ch](mailto:publications@who.ch).

Zimmerman, B. (Producer). (1994). *Home access solutions: Ramps and stairs [videotape]*. St. Paul: Metropolitan Center for Independent Living.

This video explains how to design ramps that meet the needs of people with disabilities.

St. Paul Metropolitan Center for Independent Living, 1600 University Ave., W., Suite 16, St. Paul, MN 55104-3825, Telephone: (612) 646-8342, TTY: (612) 603-2001, Fax: (612) 603-2006, Web site: [www.macil.org](http://www.macil.org).

