

NUREG/CR-6931/V1 SAND2007-600/V1

***CAROLFIRE Test Report Volume 1:***  
**General Test Descriptions and the Analysis of Circuit Response  
Data**

**DRAFT FOR PUBLIC COMMENT**

Manuscript Completed: March 2007

Prepared by:

Steven P. Nowlen and Francis J. Wyant  
Risk and Reliability Analysis Department 6761  
Sandia National Laboratories  
Albuquerque, New Mexico

Prepared for:

Project Manager: Hugh W. Woods  
Fire Research Branch  
Division of Fuels, Engineering, and Radiological Research  
Office of Nuclear Regulatory Research  
U.S. Nuclear Regulatory Commission  
Under JCN N6125



## ABSTRACT

This report documents the electrical performance and fire-induced failure cable test results from the Cable Response to Live Fire Project (CAROLFIRE). CAROLFIRE testing included a series of 78 small-scale tests, and a second series of 18 intermediate-scale open burn tests. The tests were designed to complement previous testing and to address two needs; namely, to provide data supporting (1) resolution of the ‘Bin 2’ items as identified in Regulatory Issue Summary 2004-03 Revision 1 - *Risk-informed Approach for Post-Fire Safe-Shutdown Circuit Inspections*, and (2) improvements to fire modeling in the area of cable response to fires. The small-scale tests involved one to six lengths of cable exposed to grey-body radiant heating in a cylindrical exposure chamber called *Penlight*. The intermediate-scale tests involved exposure of cables in various routing conditions to open fires created by a propene (propylene) gas diffusion burner. In both test series cables were tested as individual lengths of cable, in bundles of from 3 to 12 cables, and in a limited number of tests, fully loaded electrical raceways. Cables were tested in cable trays, in conduits, and in air drop configurations. The intermediate-scale tests included exposure of cables both in the fire plume and under hot gas layer exposure conditions. A broad range of representative cable types were tested including both thermoset and thermoplastic insulated cables that are typical of the cable types and configurations currently used in U.S. nuclear power plants. All tests measured the thermal cable response using thermocouples placed both on the surface and embedded within the target cables, and electrical cable response based on two different electrical monitoring systems. This volume of the two volume project report focuses on the electrical performance measurements and results. The data are interpreted in the context of the ‘Bin 2’ items and findings relevant to the resolution of those items are presented. The companion Volume 2 focuses on the thermal cable response data intended primarily to support the fire model improvement need area and the development of modeling approaches and correlations to reduce the uncertainty associated with predictions of fire-induced cable failure.



## **FORWARD**

The Browns Ferry fire in 1975 demonstrated that instrument, control and power cables are susceptible to fire damage. At Browns Ferry, many cables were damaged by the fire and caused short circuits between energized conductors. These short circuits (i.e., “hot-shorts”) caused certain systems to operate in an unexpected manner. Additionally, recent advances in the use of risk-informed methods indicate that hot-shorts can pose a significant risk, and that plant risk analyses should account for those additional risks.

In order to better understand the issue of cable hot-shorts, the nuclear industry (Nuclear Energy Institute/Electric Power Research Institute) conducted a series of cable fire tests that were witnessed by the NRC staff in 2001. Based on the results of those tests, and data from previous tests available in the literature, the NRC facilitated a workshop on February 19, 2003. The workshop led the NRC to issue Regulatory Issue Summary (RIS) 2004-03, Revision 1, “Risk-Informed Approach for Post-Fire Safe Shutdown Circuit Inspections,” December 29, 2004 (ADAMS Accession No. ML042440791), which describes the guidance NRC inspectors currently follow in deciding which causes of fire-induced hot-shorts are important to safety and should be considered during inspections. The RIS also describes “Bin 2” items, which are scenarios where the importance to safety of cable hot shots was unknown at the time of the workshop.

This report describes the CAROLFIRE (CAble Response tO Live FIRE) testing program. The primary objective of this program was to determine the safety importance of these Bin 2 items. A secondary objective of CAROLFIRE was to foster the development of cable thermal response and electrical failure fire modeling tools. To achieve these objectives, Sandia National Laboratories conducted a variety of fire experiments designed to examine the “Bin 2” items, and designed to capture cable thermal response and failure data. The cable thermal response data has been provided to the National Institute of Standards and Technology and the University of Maryland for use as the basis of development and initial validation of cable target response models.

The results presented in this report were from a series of both small- and intermediate-scale cable fire tests. The combined test matrices comprised 96 individual experiments of varying complexity. The tests involved a variety of common cable constructions and variations in test conditions like thermal exposure, raceway type, and bundling of similar and dissimilar cable types. The results provide the most extensive set of cable thermal response and failure data to date. This research provides valuable information and insights that may be used to evaluate the risk of fire-induced cable hot-shorts.

Brian W. Sheron, Director  
Office of Nuclear Regulatory Research  
U.S. Nuclear Regulatory Commission



## CONTENTS

|  |      |
|--|------|
| Abstract.....  | iii  |
| Forward.....   | v    |
| List of Acronyms .....   | ix   |
| List of Figures.....   | x    |
| List of Tables .....   | xii  |
| Executive Summary .....  | xiii |
| Acknowledgments.....   | xxi  |
| 1 Background.....  | 1    |
| 1.1 Introduction and Purpose.....  | 1    |
| 1.2 Roles and Responsibilities of the Collaborative Partners SNL, NIST and UMd ... | 2    |
| 2 Overview of Testing Need Areas Addressed by CAROLFIRE.....                       | 4    |
| 2.1 Circuit Analysis and the RIS 2004-03 Bin 2 Items .....                         | 4    |
| 2.2 Fire Modeling Improvement Need Area.....                                       | 5    |
| 3 Approach.....  | 6    |
| 3.1 Overview of Experimental Approach.....   | 6    |
| 3.2 Small-Scale Radiant Heating Tests.....   | 9    |
| 3.3 Intermediate-Scale Cable Burn Tests .....                                      | 13   |
| 3.4 Cable Selection Criteria and Results .....                                     | 18   |
| 4 Primary Measurements and Performance Diagnostics .....                           | 28   |
| 4.1 Thermal Exposure Conditions .....  | 28   |
| 4.2 Fire Behavior .....  | 29   |
| 4.3 Cable Thermal Response .....   | 30   |
| 4.4 Cable Electrical Performance – The IRMS .....                                  | 30   |
| 4.5 Cable Electrical Performance – The SCDUs.....                                  | 32   |
| 5 Test Matrices.....   | 36   |
| 5.1 Overview of Test Matrices .....  | 36   |
| 5.2 The <i>Penlight</i> Small-Scale Test Matrix.....                               | 37   |
| 5.3 The Intermediate-Scale Test Matrix .....                                       | 38   |
| 6 Analysis of the <i>Penlight</i> Small-Scale Test Series.....                     | 50   |
| 6.1 <i>Penlight</i> Preliminary Tests and Group 1 Tests .....                      | 51   |
| 6.2 <i>Penlight</i> Group 2 Tests .....  | 51   |
| 6.3 <i>Penlight</i> Group 3 Tests .....  | 55   |
| 6.4 <i>Penlight</i> Group 4 Tests .....  | 55   |
| 6.5 <i>Penlight</i> Group 5 Tests .....  | 66   |
| 6.6 <i>Penlight</i> Group 6 Tests .....  | 66   |
| 6.7 <i>Penlight</i> Group 7 Tests .....  | 70   |
| 6.8 <i>Penlight</i> Group 8 Tests .....  | 70   |
| 6.9 <i>Penlight</i> Group 9 Tests .....  | 71   |
| 6.10 <i>Penlight</i> Special Thermal Test 1.....                                   | 72   |
| 6.11 Summary of <i>Penlight</i> Test Results in the Bin 2 Context.....             | 72   |
| 7 Analysis of the Intermediate-Scale Test Series .....                             | 74   |
| 7.1 Application of the IRMSs .....   | 74   |
| 7.2 The SCDU Test Results.....   | 105  |

8 Analysis of the Bin 2 Items in Light of the Experimental Data ..... 131

    8.1 Bin 2 Item A..... 132

    8.2 Bin 2 Item B..... 136

    8.3 Bin 2 Item C..... 138

    8.4 Bin 2 Item D..... 141

    8.5 Bin 2 Item E..... 146

9 Summary of Findings..... 149

    9.1 Findings with Respect to the Bin 2 Items ..... 149

    9.2 Other Observations and Conclusions..... 151

10 References..... 154

Appendix A: Listing of the Bin 2 items identified in RIS 2004-03 Rev. 1, Attachment page 3, 12/29/2004 ..... 155

Appendix B: The Sandia Insulation Resistance Measuring System..... 156

Appendix C: Surrogate Circuit Diagnostic Units ..... 164

Appendix D: Power Consumption Profiles for MVT-150A and MCT5-005A Transducers..... 173

Appendix E: A Historical Review of Cable Manufacturers and Suppliers to the U.S. Nuclear Power Industry ..... 176

Appendix F: Introduction to Electrical Cable Polymer Chemistry and Molecular Behavior under Flame and High Temperature ..... 183



## LIST OF ACRONYMS

|           |   |        |  |
|-----------|---|--------|--|
| AC        | Alternating Current                               | NIST   | National Institute of Standards and Technology |
| AOV       | Air Operated Valve                                | NPP    | Nuclear Power Plant                            |
| ASTM      | American Society for Testing and Materials        | NRC    | Nuclear Regulatory Commission                  |
| AWG       | American Wire Gauge                               | NRR    | NRC Office of Nuclear Reactor Regulation       |
| BNL       | Brookhaven National Laboratory                    | PE     | Polyethylene                                   |
| CAROLFIRE | Cable Response to Live Fire                       | PLC    | Programmable Logic Controller                  |
| CFAST     | Consolidated Model of Fire and Smoke Transport    | PORV   | Power Operated Relief Valve                    |
| CPT       | Control Power Transformer                         | PVC    | Poly-vinyl Chloride                            |
| CPE       | Chlorinated Polyethylene                          | RES    | NRC Office of Nuclear Regulatory Research      |
| CSPE      | Chloro-Sulfanated Polyethylene                    | RIS    | Regulatory Issue Summary                       |
| DC        | Direct Current                                    | RTI    | Response Time Index                            |
| DOE       | Department of Energy                              | SCDU   | Surrogate Circuit Diagnostic Unit              |
| EPR       | Ethylene-Propylene Rubber                         | SCETCh | Severe Combined Environmental Test Chamber     |
| EPRI      | Electric Power Research Institute                 | SNL    | Sandia National Laboratories                   |
| FPRA      | Fire Probabilistic Risk Assessment                | SOV    | Solenoid Operated Valve                        |
| HRR       | Heat Release Rate                                 | SR     | Silicone-Rubber                                |
| IEEE      | Institute of Electrical and Electronics Engineers | TC     | Thermocouple                                   |
| IR        | Insulation Resistance                             | TP     | Thermoplastic                                  |
| IRMS      | Insulation Resistance Measurement System          | TS     | Thermoset                                      |
| MOV       | Motor Operated Valve                              | UMd    | University of Maryland                         |
| NEI       | Nuclear Energy Institute                          | VA     | Volt-Amperes                                   |
| NFPA      | National Fire Protection Association              | VL     | Vita-Link®                                     |
|           |   | XLPE   | Cross-Linked Polyethylene                      |
|           |   | XLPO   | Cross-Linked Polyolefin                        |

## LIST OF FIGURES

| <u>Figure Title:</u>   | <u>Page</u> |
|--|-------------|
| Figure 3.1: General view of the <i>Penlight</i> Facility with the cable tray in place and a test in progress. Note that this view shows <i>Penlight</i> in an ‘open-ends’ configuration used in many of the <i>Penlight</i> Preliminary Tests.   | 10          |
| Figure 3.2: View of <i>Penlight</i> with a cable tray in place and in the ‘closed-ends’ configuration.   | 10          |
| Figure 3.3: Illustration of <i>Penlight</i> configured for cable tray testing.   | 12          |
| Figure 3.4: Illustration of <i>Penlight</i> configured for Conduit Testing.  | 13          |
| Figure 3.5: Illustration of <i>Penlight</i> configured for Air Drop Testing (no raceway).  | 13          |
| Figure 3.6: Schematic representation of the CAROLFIRE intermediate-scale test structure.   | 16          |
| Figure 3.7: Schematic representation of the CAROLFIRE intermediate test structure located within the outer test facility.  | 17          |
| Figure 3.8: Photograph of the 15 different cable tests in CAROLFIRE.   | 25          |
| Figure 4.1: Example of a typical IRMS data plot taken from <i>Penlight</i> Test 11.  | 31          |
| Figure 4.2: Illustration of the conductor numbering scheme used in all tests involving the 7-conductor control cables.   | 31          |
| Figure 4.3: Illustration of the grouping of the conductors in a single 7-conductor cable with conductors 2, 4 & 6 connected to one IRMS channel and conductors 3, 5 & 7 connected to a second IRMS channel. This configuration was used when testing cable bundles in order to determine the relative timing of intra-cable faults, faults to an external ground, and inter-cable faults in support of efforts to resolve Bin 2 Items A and B. | 32          |
| Figure 4.4: MOV-1 SCUDU circuit configuration with two active targets (paths 5&6) and one passive target (path 4). Paths 1 and 2 are the energized sources, path 7 is grounded, and path 8 monitors a spare conductor. Note that circuit paths 3 and 9 are not used.   | 33          |
| Figure 4.5: Illustration of a typical six-cable bundle arrangement with the cable tray rungs below cables D-E-F.   | 35          |
| Figure 6.1: Illustration of the cable letter identification code used for the three- and six-cable bundle tests. Note that the same letter code was also used in the intermediate-scale tests when testing three- or six-cable bundles.  | 50          |
| Figure 6.2: Shorting results for Cables A&B in Test PT-60  | 69          |
| Figure 7.1: Illustration of the letter code used to identify cables when testing 12-cable bundles. The corresponding letter codes for testing of three- and six-cable bundles are presented in Figure 6.1 above.   | 75          |
| Figure 7.2: Illustration of the Inter-cable shorting behaviors observed by the IRMS in Test IT-1.  | 79          |

| <u>Figure Title:</u>   | <u>Page</u> |
|--|-------------|
| Figure 7.3: Illustration of the Fuse Blow failure on Circuit 2 in Test IT-1.   | 121         |
| Figure 7.4: Results for SCDU-4 in Test IT-9.   | 122         |
| Figure 7.5: Spurious actuation failure on SCDU Circuit 2 in Test IT-7.   | 123         |
| Figure 7.6: Illustration of the inter-cable interactions observed between circuits 1 and 4 in Test IT-1. Note the voltage spike to Target 4 in Circuit 4 after that circuit had experienced a fuse blow. | 128         |
| Figure 7.7: Illustration of the interactions between Circuits 2 and 3 in Test IT-8. Note the current increase on Circuit 2 Path 7 (C2 A7) in the upper plot concurrent with failure of Circuit 3.        | 129         |

## LIST OF TABLES

| <u>Table Title:</u>   | <u>Page</u> |
|---|-------------|
| Table 3.1: Comparison between complementary aspects of the NEI/EPRI test program and CAROLFIRE. | 7-9         |
| Table 3.2: CAROLFIRE test cable list.   | 24-25       |
| Table 3.3: Physical properties of the CAROLFIRE cables.   | 26-27       |
| Table 5.1: Matrix of Preliminary <i>Penlight</i> tests (PP).                                    | 39          |
| Table 5.2: Primary Matrix of <i>Penlight</i> Tests (PT tests).                                  | 40-44       |
| Table 5.3: Matrix of intermediate-scale tests.  | 45-49       |
| Table 7.1: Summary of the IRMS test conditions for the intermediate-scale tests.                | 75-78       |
| Table 7.2: Summary of CAROLFIRE intermediate-scale tests SCDU test configurations and results.  | 106-120     |
| Table 7.3: SCDU Intra-cable shorting results for TP cables only.                                | 125         |
| Table 7.4: SCDU Intra-cable failure mode results for all Thermoset (TS) cable tests.            | 126         |

## EXECUTIVE SUMMARY

This report documents the cable electrical performance and fire-induced failure test results from the Cable Response to Live Fire (CAROLFIRE) project. The cable fire tests conducted were designed to complement previous industry testing by the Nuclear Energy Institute (NEI) and the Electric Power Research Institute (EPRI)<sup>1</sup> in order to address two need areas; namely, to provide data supporting (1) resolution of the ‘Bin 2’ items as identified in Regulatory Issue Summary 2004-03 Revision 1 – *Risk-informed Approach for Post-Fire Safe-Shutdown Circuit Inspections*, and (2) improvements to fire modeling to reduce uncertainty in predictions of cable response to fires. Note that with respect to the Bin 2 items, CAROLFIRE is addressing five of the six identified items. The sixth Bin 2 item (Item F) deals with safe shutdown systems and is not amenable to resolution through testing. Item F therefore lies outside the scope of CAROLFIRE and has not been evaluated in this report.

Volume 1 (this volume) focuses on the first need area; namely, resolution of the Bin 2 items. For a discussion of the second need area, fire modeling improvement, refer to the companion Volume 2 of this report.

CAROLFIRE testing included a series of 78 small-scale radiant heating tests and 18 intermediate-scale open burn tests. The small-scale tests were performed in an SNL facility called *Penlight* and involved exposure of two to seven lengths of cable to grey-body radiant heating. These tests were aimed in large part at the fire model improvement need area, but also provided data pertinent to the resolution of two of the five Bin 2 items being addressed in this project; namely, Bin 2 items A and B which both deal with inter-cable shorting configurations.

The intermediate-scale tests involved exposure of cables, generally in bundles of 6 to 12 cables each, under various routing configurations and at various locations within a relatively open test structure. The fires were initiated by a propene (also known as propylene) gas diffusion burner. The fire typically spread, at a minimum, to those cables located directly above the fire source. The intermediate-scale tests exposure included cables just above the upper extent of the gas burner’s flame zone, in the fire plume above the flame zone, and outside the plume but within a hot gas layer. The intermediate-scale tests contribute to both need areas.

Testing included a broad range of both thermoset (TS) and thermoplastic (TP) insulated cables as well as one mixed TS-insulated and TP-jacketed cable. The tested cables are representative of those currently in use at U.S. commercial nuclear power plants (NPPs). The tested cables also span a range from those cables that are most vulnerable to fire-induced electrical failure to those that are most resistant to fire-induced electrical failure.

Cable electrical functionality (electrical failure) was measured using two different electrical monitoring systems. One system, the Sandia National Laboratories (SNL) Insulation Resistance Measurement System (IRMS), measured the insulation resistance of individual cable conductors (or groups of conductors) providing a direct measure of cable electrical integrity. The IRMS is able to

---

<sup>1</sup> Specific references to the NEI/EPRI tests are provided in the main text.

detect the onset of cable degradation and determine the specific pattern and timing of shorts occurring among the conductors of one or more cables. The second system, the Surrogate Circuit Diagnostic Units (SCDUs), involved control circuit simulators where a hot short (i.e., a short circuit between an energized ‘source’ conductor and a normally non-energized ‘target’ conductor) could lead to spurious actuation of a motor contactor. The SCDUs were typically configured to simulate a common Motor Operated Valve (MOV) control circuit in the exact same manner as was employed in the NEI/EPRI test program.

The exposure conditions used in testing represent a range of credible fire conditions. The exposure heat fluxes used in the small-scale radiant heating tests were set so as to induce cable failure times of on the order of several minutes consistent with cable damage times typically predicted in risk-relevant fire scenarios (e.g., in fire risk analyses). The intermediate-scale tests used gas burner fire intensities between 200 and 350 kW, a range that is representative of the fire intensities expected from many credible fire ignition sources (e.g., moderate size oil spills and electrical control panel fires). The intermediate-scale test structure allowed for the creation of hot gas layer conditions sufficient to induce cable failure. At the same time, the test structure was quite open allowing for open burning conditions (i.e., no oxygen starvation) consistent with expectations for cable fires in the relatively large spaces common in a typical nuclear power plant (NPP). The gas burner fuel, propene (also known as propylene), was chosen because it produces a luminous yellow flame and generates considerable visible smoke, again consistent with the anticipated behavior of actual NPP fires. The test structure was housed in a larger test facility so that the smoke layer development and other general fire conditions are also typical of those expected in actual nuclear power plant applications.

The Bin 2 items being investigated by CAROLFIRE were defined in large part based on the results of a facilitated workshop conducted by the NRC in February 2003. The Bin 2 items were those cable and circuit faulting configurations for which the experimental evidence was inconclusive. The NEI/EPRI tests were the primary source of experimental data considered, although the results of other prior cable research programs were also considered.

The conclusions based on the CAROLFIRE project with respect to the Bin 2 items are summarized immediately below. For each of the five items being addressed by CAROLFIRE, the discussion opens with a statement of the Bin 2 item quoted directly from the RIS. Background information associated with each item is provided focusing on the pre-existing data and discussions that took place during the facilitated workshop. A summary of the test data relevant to each of item is then presented. Finally, the project’s conclusions relative to each item are presented.

**Bin 2 Item A :**       *“Intercable shorting for thermoset cables, since the failure mode is considered to be substantially less likely than intracable shorting.”*

One spurious actuation attributed to inter-cable interactions between two TS-insulated cables was experienced during the NEI/EPRI tests. This failure mode was placed in Bin 2 because the test where this particular fault was observed had used a rather contrived bundling arrangement intended to maximize the potential for inter-cable interactions. Hence, the one observed spurious actuation was taken as weak evidence of potential TS-to-TS hot short interactions. Further, the fact that inter-

cable interactions among the TS cables were not observed more frequently during those tests was taken as evidence of, at most, a low probability of such interactions.

CAROLFIRE sought to explore the plausibility of inter-cable TS-to-TS hot shorts by providing many more opportunities for the detection of inter-cable shorting between TS cables than did the NEI/EPRI tests. CAROLFIRE also used more realistic cable bundling configurations involving co-located multi-conductor control cables in cable trays and conduits.

With respect to the SCDUs, in all of the CAROLFIRE tests, no cases of inter-cable shorts leading to spurious operation were observed. However, cases were observed where inter-cable shorting between TS cables led to momentary hot shorts on co-located SCDUs (e.g., intermediate-scale test IT-1). These results do demonstrate a potential for some level of TS-to-TS interactions.

With respect to the IRMS, evaluation of these results was based on an assessment of if and when (relative to other modes of faulting) inter-cable interactions were detected between co-located TS-insulated cables. For inter-cable interactions to be risk relevant, one cable must remain energized, and the second cable must remain sufficiently intact so that a hot short can actuate the target circuit. As cable failures progress through primary, secondary and tertiary fault modes, the likelihood of meeting these conditions decreases until ultimately spurious actuations are no longer plausible.

There were a number of relevant inter-cable faults observed by the IRMS. The most significant case was observed during test IT-1, the first intermediate-scale test in the primary matrix. In this test, a clear-cut and sustained conductor-to-conductor inter-cable short circuit occurred between two TS-insulated and TS-jacketed 7-conductor control cables. In this case, the inter-cable shorting was the primary failure mode for both cables (i.e., the first detected faults for either cable). The inter-cable short was sustained for over three minutes (194s) before the cables cascaded through secondary and tertiary fault modes.

The second most significant inter-cable faults were observed in Tests PT-60, one of the later *Penlight* tests, and in IT-7, one of the intermediate-scale tests. In both cases, TS-to-TS inter-cable shorting was observed as a secondary fault mode for one cable (i.e., after intra-cable faulting of this first cable had been detected) and as the primary fault mode in the second cable (the first detected fault for the second cable). These faults could have led to a spurious operation in practice if the proper combination of conductors were involved, a matter that appears to be essentially random.

Other potentially relevant inter-cable interactions between TS cables were observed by the IRMS during at least two other tests (IT-6 and IT-7). In these two cases, the interactions were the tertiary fault mode for one of the two involved cables, but the primary fault mode for the second cable. These faults are less likely to lead to spurious actuation, but the potential cannot be entirely dismissed.

Overall, the collective data show that TS-to-TS inter-cable hot shorts are plausible. However, the data also show that risk-relevant interactions between TS cables are generally of low likelihood and, in particular, are substantially less likely to cause spurious operation in comparison to intra-cable hot shorts. In cases where either intra- or inter-cable faults might lead to the same effect on plant

equipment (e.g., spurious actuation of the same component), the intra-cable shorting will be far and away the predominant effect in terms of spurious actuation likelihood.

Based on the available data with respect to Bin 2 Item A the CAROLFIRE project has reached the following conclusions:

*Inter-cable shorting between two TS-insulated cables that could cause hot shorts and the spurious actuation of plant equipment was found to be a plausible failure mode, although the likelihood of this failure mode is low in comparison to intra-cable short circuits leading to spurious operation. While no detailed statistical analysis has been performed, it appears that the conditional probability (give cable failure) of spurious actuations arising from this specific failure mode is small in comparison to that previously estimated for spurious actuations from intra-cable shorting.*

**Bin 2 Item B:** “Intercable shorting between thermoplastic and thermoset cables, since this failure mode is considered less likely than intracable shorting of either cable type or inter-cable shorting of thermoplastic cables.”

In the case of Item B, there was no direct relevant experimental evidence available at the time of the facilitated workshop. Item B was included among the Bin 2 Items based on expert judgment as expressed at the facilitated workshop. The prevailing opinion was that such interactions were unlikely to cause risk-relevant circuit effects because the TP cables will generally fail more quickly in a fire than will TS cables when the cables are exposed to the same fire conditions (e.g., they are co-located in the same electrical raceway). As noted above in the discussion of Item A, for inter-cable interactions to be risk relevant, one cable must remain energized, and the second cable must remain sufficiently intact that a hot short can actuate the target circuit, and this becomes less and less likely as one or both cables cascade through progressively more severe faulting modes. If the TP cables cascade through all relevant fault modes to the point where all of the conductors are shorted both to each other and to ground prior to faulting of the TS cable, then risk-relevant inter-cable interactions would not be at all plausible. The general approach to analysis for Item B parallels that of Item A in all respects.

As with Item A, CAROLFIRE offered many opportunities for inter-cable interactions to occur between TS and TP cables. In all of the tests conducted, there were no spurious actuations observed among the SCDU circuits that can be attributed to inter-cable shorting. However, there were cases where inter-cable shorting was observed between co-located TS and TP cables.

The most notable case occurred during Test IT-8 between a PE (TP) cable and an XLPE (TS) cable. The TP cable failed first causing a fuse blow failure for that SCDU. Subsequent to this, a hot short from the TS cable impacted the TP cable as evidenced by a current increase on one of the TP cable conductors lasting for about 10 seconds. In this case, the hot short impacted the grounded conductor in the TP cable rather than a target conductor. It is not clear whether or not a hot short to a target conductor could have caused a spurious operation in this case because the exact extent of faulting in the TP cable is not known (only that a fuse blow had occurred).



In other tests, inter-cable interactions on the SCDUs were seen, but these were manifested as momentary voltage and/or current spikes on one cable concurrent with the failure of the second cable. As noted, none of these cases actually led to a spurious actuation. Such faults could, however, be relevant to circuits that possess a ‘latching’ feature such that a momentary hot short could lock in a circuit actuation signal.

With respect to the IRMS data, no cases were observed where inter-cable shorting between a TS and a TP cable was the primary fault mode for both cables. However, at least one case (IT-9) was seen where an inter-cable short was the secondary fault mode for one cable and the primary fault mode for the second cable. Somewhat surprisingly, the TS cable had experienced internal faulting first and then shorted to a TP cable as the primary fault mode for the TP cable. The fact that the TS cable experienced failures first was unexpected. During this test, the same TS cable experienced a second inter-cable short to another co-located TP cable. This became the tertiary fault mode for the TS cable, but was again the primary fault mode for the TP cable.

Other interactions were observed by the IRMS. However, in all other cases, the inter-cable faulting occurred only after the TP cable had displayed extensive faulting both internally and to the external ground. These interactions are not considered risk-relevant.

Taken together, the data show that risk-relevant TS-to-TP inter-cable interactions are plausible. However, the data also indicate that such interactions are of low likelihood.

Based on the available data with respect to Bin 2 Item B the CAROLFIRE project has reached the following conclusions:

*Inter-cable shorting between two a TP-insulated cable and a TS-insulated cable that could cause hot shorts and the spurious actuation of plant equipment was found to be a plausible failure mode, although the likelihood of this failure mode is low in comparison to intra-cable short circuits leading to spurious operation. While no detailed statistical analysis has been performed, it appears that the conditional probability (given cable failure) of spurious actuations arising from this specific failure mode is very small in comparison to that previously estimated for spurious actuations from intra-cable shorting.*

**Bin 2 Item C:** “Configurations requiring failures of three or more cables, since the failure time and duration of three or more cables require more research to determine the number of failures that should be assumed to be ‘likely.’”

The consensus opinion cited at the facilitated workshop relative to the number of concurrent spurious operations to be considered was that if inspections began by looking at failures impacting two cables at a time, they would likely capture the risk-dominant scenarios. No particular basis for limiting the consideration to two cables was put forth; rather, the recommendation was simply cited as a reasonable starting point pending a clearer understanding of the issues and relevant behaviors.

Both the NEI/EPRI tests and CAROLFIRE involved the testing of no more than four simulated control circuits per test (four SCDUs in the case of CAROLFIRE). Even with just four circuits present, both programs include tests where spurious operations occurred in all four circuits. Hence,

there is little basis for limiting the number of spurious operations that might ultimately occur based only on the general likelihood of spurious operation given cable failure. In fact, CAROLFIRE has broadly confirmed that given the failure of electrical cables, one or more spurious actuations are a relatively high-likelihood outcome. For the CAROLFIRE results with the SCUDs in an MOV configuration, roughly 70% of the total failures led to a spurious operation of the control circuit.

The key question then becomes one of timing. That is, how likely is it that the *effects* of multiple spurious operations might overlap in time. CAROLFIRE has explored one aspect of this problem that was not explored by the NEI/EPRI tests. In particular, CAROLFIRE confirmed that both cable location relative to the fire and the routing configuration can have a substantive impact on cable failure times. If the failures are separated in time by some substantial margin, then the *effects* of spurious operations will be less likely to overlap.

The question of how long the effects of a spurious actuation might persist is tied strongly to the nature of the circuit. For certain circuits, once the hot short itself is mitigated (i.e., when the cable cascades to higher failure modes and circuit power is ultimately lost) the component will return to its non-energized (often fail-safe) position. This applies to devices such as solenoid operated valves (SOVs).

However, for a range of other typical components, such as MOVs, the device will be left in whatever state it was in when the hot short itself is mitigated. For an MOV this might be closed, open or partially open. Further, the normal control functions for such devices will generally be lost as well given that the control circuit power is also likely to trip. Hence, for many circuits an operator action will be needed to overcome the effects of the spurious actuation. The action may be a remote shutdown action (e.g., manual closure or opening of a valve), or an action taking place within the main control room (e.g., closing or opening other valves to mitigate the effects of a spurious operation), but some action would be needed. Unfortunately, in these cases the only basis for establishing how long the *effects* of any given spurious operation might persist will often be human factors analysis.

Given the available data relevant to Bin 2 Item C, the CAROLFIRE project has reached the following conclusions:

*The currently available data provide no basis for establishing an a-priori limit to the number of spurious operations that might occur during a given fire. We further find that the timing of spurious actuation is a strong function of various case-specific factors including in particular the relative location of various cables relative to the fire source, the routing configuration (e.g., open cable trays or air drops versus conduits), the thermal robustness of the cables insulation material, and the characteristics of the fire source.*

**Bin 2 Item D:**        *“Multiple spurious operations in control circuits with properly sized control power transformers (CPTs) on the source conductors, since CPTs in a circuit can substantially reduce the likelihood of spurious operation. Specifically, where multiple (i.e., two or more)*

*concurrent spurious operations due to control cable damage are postulated, and it can be verified that the power to each impacted control circuit is supplied via a CPT with a power capacity of no more than 150 percent of the power required to supply the control circuit in its normal mode of operation (e.g., required to power one actuating device and any circuit monitoring or indication features)."*

This item derived from one aspect of the NEI/EPRI testing where a substantial reduction in the spurious actuation likelihood was observed given the use of control power transformers (CPTs) compared to the case with effectively unlimited power available to the control circuit. The CPTs used by NEI/EPRI were sized at 150 VA which represented 150% of the nominal power required to actually operate the simulated MOV control circuit in its normal mode of operation.

The CAROLFIRE tests evaluated a range of relatively larger CPTs ranging from 166% to 333% of the nominal design load required to operate the circuit. In these tests, there was no observed effect on spurious actuation likelihood observed at all, and as noted previously, nearly 80% of the cable failures led to spurious actuations signals of at least momentary duration. The CAROLFIRE tests did experience some cases of voltage decay prior to fuse blow, but in most such cases a prior spurious operation had been observed. No cases were explicitly noted where voltage decay appears to have prevented a spurious operation from occurring. The differences between these two programs cannot be fully explained, and this may be an area that is worthy of further investigation.

Given the available data relevant to Bin 2 Item D, the CAROLFIRE project has reached the following conclusions:

*The currently available data provide no basis for establishing an a-priori limit to the number of spurious operations that might occur during a given fire even given that the circuit is powered by a "properly sized" CPT. We further find that, as with non-CPT cases, the timing of spurious actuations is dependent on the timing of cable electrical failure which is in turn a strong function of various case-specific factors including the relative location of different cables relative to the fire source, the routing configuration (e.g., open cable trays or air drops versus conduits), the thermal robustness of the cables insulation material, and the characteristics of the fire source.*

**Bin 2 Item E:** *"Fire-induced hot shorts that must last more than 20 minutes to impair the ability of the plant to achieve hot shutdown, since recent testing strongly suggests that fire-induced hot shorts will likely self-mitigate (e.g., short to ground) in less than 20 minutes. This is of particular importance for devices such as air-operated valves (AOVs) or power-operated relief valves (PORVs) which return to their de-energize position upon abatement of the fire-induced hot short."*

During the original NEI/EPRI tests, the spurious actuation signals observed lasted for a maximum of 11.3 minutes. Hence, 20 minutes was recommended as an upper bound on the duration of a hot short signal. CAROLFIRE has confirmed that hot shorts will generally be of relatively short duration, and in fact, the longest spurious actuation signal observed in the CAROLFIRE tests was 7.6 minutes.

Given the available data relevant to Bin 2 Item E, the CAROLFIRE project has reached the following conclusions:

*While the available data cannot definitively support the conclusion that no hot short would ever persist for greater than 20 minutes, the available data do provide a strong basis for concluding that hot shorts lasting greater than 20 minutes are of at most very low probability. Hence we conclude that with high probability, hot short-induced spurious actuation signals will clear within less than 20 minutes. We further conclude that on clearing of the hot short signal, the effects of the spurious actuation on plant equipment could persist for a longer time depending on the nature of the impacted equipment. For example, a normally closed Motor Operated Valve might well remain open or partially open even after the hot short-induced spurious actuation signal is mitigated whereas a Solenoid Operated Valve would return to its 'fail safe' condition on mitigation of the hot short-initiated spurious operation signal.*

## **ACKNOWLEDGMENTS**

The authors acknowledge and appreciate the many people who contributed to the success of this project. First, we acknowledge the contributions of our collaborative partners at NIST and at UMD. In particular, the assistance of Dr. Kevin McGrattan (NIST) during the planning stages of this project, and throughout the testing process was most helpful. We also acknowledge the contributions of Elie Avidor and Genebelin Valbuena from UMD to planning and execution of the tests. We also acknowledge the contributions of Pat Brady (Technadyne Engineering Consultants) and Bob Nichols (KTech Corporation) who provided technical support during the actual testing efforts. We also offer particular thanks to Mr. Kent Brown of Tennessee Valley Authority for his patience in our many discussions and for the many insights he provided relative to the cable manufacturing industry and the use of cables by the U.S. nuclear industry. Kent's insights were clearly one key to our success. We also acknowledge H.W. 'Roy' Woods and Mark Henry Salley who were the sponsors of this program at the NRC Office of Nuclear Regulatory Research (RES) and who provided valuable guidance throughout the project. Finally, we acknowledge those who supported the NRC's peer review process including Nathan Siu of RES, Anthony Hammons of NIST, Vern Nicolette of SNL, and Mohammed Modares of UMD. We also gratefully acknowledge the peer review contributions made by Dan Funk of Edan Engineering as well as his patience in dealing with our many queries made over the course of the project. We also acknowledge the comments provided throughout the project by the NRR staff including in particular Ray Gallucci. Finally, Appendix F of this document presents an introductory discussion of polymer chemistry that was prepared in its entirety by Felix Gonzalez of the RES Fire Team Staff.



# 1 BACKGROUND

## 1.1 Introduction and Purpose

This report describes a series of cable fire tests performed by Sandia National Laboratories (SNL) under the sponsorship of the U.S. Nuclear Regulatory Commission (NRC) Office of Nuclear Regulatory Research (RES). This program is known as the Cable Response to Live Fire (CAROLFIRE) project and was designed to address two specific need areas; namely, (1) to provide an experimental basis for resolving five of the six items identified as “Bin 2” circuit configurations in *Risk-informed Approach for Post-Fire Safe-Shutdown Circuit Inspections*, Regulatory Issue Summary (RIS) 2004-03, Rev. 1, 12/29/04 (hereafter referred to as the ‘Bin 2 Items’) [1], and (2) to improve fire modeling tools for the prediction of cable damage under fire conditions.

The project plan for CAROLFIRE was developed over the course of several months beginning in August 2005. The test plan was treated as a “living document” and underwent several revisions up to and including the final Revision C.2, August 1, 2006. The project planning efforts were conducted as a collaborative process involving representatives of RES, SNL, the NRC Office of Nuclear Reactor Regulation (NRR), the National Institute for Standards and Technology (NIST), and the University of Maryland (UMd). The project plan was also subject to an extensive peer review both within the NRC and by representatives of NIST and UMd. In addition, peer review of the test plan was provided by Dan Funk of EDAN Engineering, one of the principal authors of the EPRI test report documenting the original NEI/EPRI tests [2].

All testing was performed during the summer and fall of 2006 using SNL fire test facilities in Albuquerque, New Mexico. The program was subject to basic quality assurance provisions, but was not subject to a strict quality assurance program. With the exception of the voltage and current transducers used in the Surrogate Circuit Diagnostic Units (SCDUs, see Section 4), all instrumentation was subject to the SNL calibration process which provides calibration services traceable to NIST standards. The SCUDU data are taken as ‘indication only.’ All tests followed a proscribed test protocol including pre- and post-test check lists. Field notes were maintained by the lead test engineer documenting all variable aspects of the individual tests and recording field observations during test conduct. All data processing was performed using commercial software (Microsoft Excel®) with data imported from the original data files which were preserved for archival purposes.

Included in Volume 1 (this volume) of the CAROLFIRE project report are: (1) a summary description of all tests performed including experimental setups, test matrices, and a description of instrumentation fielded during each experiment focusing primarily on the electrical performance monitoring systems; and (2) an analysis of test data as they apply to the Bin 2 Items. Volume 2 of this report covers those aspects of the CAROLFIRE program related to the fire modeling need area.

## 1.2 Roles and Responsibilities of the Collaborative Partners SNL, NIST and UMd

In addition to the NRC staff, CAROLFIRE has involved a continuing collaboration partnership between SNL, NIST and UMd. The roles and responsibilities of each organization are summarized below. Additional details on the efforts being performed by NIST and UMd will be published separately by those two organizations. The balance of this report focuses exclusively on the tests themselves, and the analysis of test data.

### *Sandia National Laboratories (SNL):*

SNL is the primary test contractor and was responsible for development and maintenance of the Project Test Plan, including the incorporation of comments and suggestions from collaboration partners (NIST and UMd). The NRC Office of Nuclear Reactor Regulation (NRR) also provided comments on the test plan and participated in test planning activities. SNL was also responsible for conduct of the actual experiments, gathering of test data, and communication of test results and data to the collaboration partners including primary responsibility for the preparation of this report (both volumes).

### *National Institute for Standards and Technology:*

The role of NIST is threefold. First, NIST acts as a member of the overall collaborative team. As such they provided comments, suggestions and peer review during development of the program plan. Second, NIST assists in the review and interpretation of test data, particularly the data associated with the fire modeling improvement need area. Finally, NIST intends to develop a two-parameter model of cable failure similar to the response time index (RTI) approach commonly applied to fusible link sprinkler heads and heat detectors. Their intent is to develop a cable response model that might be incorporated into compartment fire models. Their planned approach is to develop a thermal response model with corresponding cable failure criteria that would require, as input, only the basic physical/electrical cable characteristics (e.g., cable diameter and bulk material properties). Various studies on the thermal degradation of cables suggest that this simple approach will work. That is, prior efforts seem to indicate that reasonable results can be obtained by treating a cable as a homogenous cylinder of plastic. This simple cable model will be combined with a heat transfer calculation using the gas phase temperatures predicted by the fire model as the thermal driving force. The experiments will provide a basis for defining a representative temperature condition that coincides with electrical failure. That is, what is the relevant location on or within the cable whose temperature should be used as a predictor of failure behavior (e.g., the cable surface, the cable center, or perhaps the conductor nearest the surface) and what is the appropriate failure threshold for the cables tested. These insights will be factored into the cable response / failure model.

### *University of Maryland:*

Similar to NIST, UMd has a threefold role in the project. The first two roles parallel those of NIST; namely, (1) to act as collaborative partners providing comments, suggestions and peer review during program planning and execution, and (2) to help in the interpretation of test results. UMd's third role



also parallels NIST's model development activities, but UMD is interested in a complementary part of the cable failure problem. UMD intends to extend the cable damage model to more fully explain the phenomena of cable electrical failure by taking into account the detailed physical and thermal properties of the cable's various materials. They intend to develop a model that inputs transient cable temperature versus time data and outputs predictions of failure time. The intent is to treat the failure behavior as a statistical uncertainty problem, so the model's output would not be a single failure time, but rather, a probability distribution of the likelihood of damage versus time. This type of uncertainty treatment will allow for a direct method of incorporating failure time uncertainty into some risk analysis estimates.

## 2 OVERVIEW OF TESTING NEED AREAS ADDRESSED BY CAROLFIRE

As noted above, CAROLFIRE was designed to address two primary need areas; namely, resolution of Bin 2 Items and fire modeling improvement to reduce uncertainty. These areas have distinct but complementary needs. The two subsections which follow discuss each of the need areas and provide a summary of the approach taken under CAROLFIRE to address each need area.

### 2.1 Circuit Analysis and the RIS 2004-03 Bin 2 Items

The first of the two need areas addressed by CAROLFIRE is to provide experimental data to support the resolution of the Bin 2 Items as defined in RIS 2004-03 Revision 1, *Risk-informed Approach for Post-Fire Safe-Shutdown Circuit Inspections* [1] (referred to hereafter as simply ‘the RIS’). The RIS defines two categories<sup>2</sup> of circuit configurations based on the potential to prevent operation or cause mal-operation of equipment necessary to achieve and maintain hot shutdown in the event of a fire. These two categories are:

- Bin 1 - Circuit configurations most likely to cause failure (to be considered during inspections), and
- Bin 2 - Circuit configurations that need more research (to be deferred from inspection pending additional research).

Bin 2 contains six circuit configurations identified as Items A-F. These six items as cited in the RIS are listed in Appendix A for reference, and are discussed in more depth in Chapter 8 of this report. Of the six items, CAROLFIRE is addressing the first five (Items A-E).<sup>3</sup> In short, the five items being addressed by CAROLFIRE are summarized as follows:

- Item A: Inter-cable shorting between thermoset (TS) cables,
- Item B: Inter-cable shorting between TS and thermoplastic (TP) cables,
- Item C: Spurious actuations arising from failures impacting more than two cables at a time,
- Item D: Multiple spurious actuations due to fire-induced cable failures for control circuits powered by a properly sized control power transformer (CPT), and
- Item E: Fire-induced spurious actuation signals lasting greater than 20 minutes.

The primary need area being addressed by CAROLFIRE is to investigate each of these five Bin 2 Items and to provide findings based on the test data to support NRC resolution of each item. Chapter 8 provides an explicit discussion of each of the Bin 2 items, CAROLFIRE’s general

---

<sup>2</sup> Note that the first version of the RIS included a third Category, Bin 3, circuit configurations that are unlikely to cause failure and do not need to be considered during future inspections. This third category was not included in Revision 1 of the RIS.

<sup>3</sup> The sixth item, Item F, is related to the treatment of cold shutdown circuits. It was concluded at the outset of CAROLFIRE that this item was not amenable to resolution through additional circuit fault testing; hence, CAROLFIRE was not designed to assess this issue.

approach to resolution of each item, and the findings developed based on both pre-existing test results and the CAROLFIRE test results. Chapter 9 summarizes these findings.

## **2.2 Fire Modeling Improvement Need Area**

The second objective of the CAROLFIRE project is, to the extent feasible, provide cable thermal response data that can be correlated to the failure modes and effects data in order to support improvements in cable fire response modeling and damage time predictions. The overall goal of the fire modeling improvements is to reduce uncertainties in fire model outputs for nuclear power plant (NPP) applications. A key NPP application is Fire Probabilistic Risk Assessment (FPRA) which often relies on fire models to predict cable failure times for a pre-defined set of fire conditions. These failure times are weighed against the likelihood that fire suppression succeeds within the available time to assess the conditional probability of cable damage given the fire. The ability of current compartment fire models to predict cable damage is limited. For example, in the NIST Consolidated Model of Fire and Smoke Transport (CFAST), a general thermal target response sub-model is available, but this model was not specifically developed for, nor has it been calibrated for, cables as the thermal target.

Hence, one primary need with respect to fire model improvement is the development, calibration and validation of predictive thermal/damage target response models specific to cables as the target. CAROLFIRE was designed to provide data upon which the initial development of the response models might be based (i.e., model calibration data). This model calibration data involves fundamental target exposure and response data under relatively simple and very well characterized exposure conditions. In CAROLFIRE, these data are being generated primarily through the small-scale tests. Data are also needed to support model validation; that is, separate tests under more realistic and representative testing configurations against which model predictions can be compared. CAROLFIRE is also providing data for this purpose through the intermediate-scale tests. The intermediate-scale tests provide cable thermal response and damage data for a range of credible fire exposure conditions (e.g., direct flame impingement, plume exposure, ceiling jet, and hot gas layers).

It should be noted that the actual model development work is not a part of the SNL project efforts. The actual development activities fall under the purview of collaborative partners NIST and UMD. The efforts performed by each of these two organizations will be documented in separate publications. The nature and goals of their planned efforts have been described in general terms in Section 1.2 above.

## 3 APPROACH

### 3.1 Overview of Experimental Approach

An initial planning meeting for CAROLFIRE was conducted at NRC Headquarters in August 2005. It was the consensus of all participants in that kick-off meeting that both the RIS Bin 2 Items and the key fire model improvement need area associated with cable response to fires could be addressed through a single combined fire testing effort. While the specific needs in the two need areas are unique, they are also complementary. Hence the concept of the combined CAROLFIRE test project was found to be viable, and indeed desirable.

As a result, the approach was to define a single series of cable fire tests that would support both need areas. Note that many of the small-scale tests (especially the preliminary tests and the Group 1 tests as described in Chapter 5 below) are aimed almost exclusively at the fire modeling improvement need area, but the bulk of the tests provide data relevant to both need areas.

It was decided that in order to address the two identified need areas, two scales of testing would be pursued. In general, testing followed a progression of increasingly more complex test conditions and configurations. The intent was to take maximum advantage of low-cost, smaller scale and less complex testing configurations and to then move up in complexity and in scale toward fire configurations that are more representative of actual plant conditions. The two test scales pursued are:

- Small-scale radiant heating tests in an existing SNL facility called *Penlight*, and
- Intermediate-scale open burn tests in a larger test facility.

Ultimately, a fairly large number of tests were conducted involving varied arrays of cable types, cable bundling arrangements, heating conditions, and cable routing configurations. Testing included 26 ‘preliminary’ *Penlight* tests designed to explore the general failure behavior for each of the subject test cables under varying heat flux levels. These tests were used to establish reasonable test conditions for use in the tests of the ‘core’ *Penlight* test matrix. This core *Penlight* matrix involved an additional 52 *Penlight* tests. Eighteen intermediate-scale tests were also conducted for a total of 96 individual tests.

Test design intentionally allowed for flexibility as the testing proceeded. In particular, both the small- and intermediate-test facilities were configured such that changes to the cable and instrumentation configurations could be made with little effort and little or no impact on schedule should insights gained as the tests proceed suggest that changes are in order. Certain tests were also repeated with virtually identical test conditions in order to provide some understanding of the inherent (or aleatory) uncertainty, particularly in the context of the fire modeling improvement need area. Additional detail on the test facilities and configurations used for each test scale are provided in Sections 3.2 and 3.3 below. Instrumentation details are provided in Section 4 below. The actual test matrices are presented in Chapter 5.

It should also be noted that these tests were designed to complement rather than repeat the tests previously performed by the Nuclear Energy Institute (NEI) and the Electric Power Research Institute (EPRI) [2]. Complementary aspects of these tests are described and discussed in Table 3.1.

**Table 3.1: Comparison between complementary aspects of the NEI/EPRI test program and CAROLFIRE.**

| Test Feature        | NEI/EPRI Configurations   | CAROLFIRE Configurations  | Discussion  |
|---------------------|---|---|---|
| Raceway loading     | With the cable tray tests, NEI/EPRI focused on trays with a significant and well ordered cable load (at least one full layer of cables and up to four full layers of cables) always packed neatly and tightly in the trays from side rail to side rail. This approach to tray loading is consistent with other types of cable testing such as ampacity testing. | The CAROLFIRE tests focused on less than fully loaded raceways, on smaller bundles of cables. CAROLFIRE also provided thermal response data for two fully loaded random fill raceways (cables laid in the trays in a random fashion rather than neatly packed). | Cable trays, in particular, with less than full cable loads are quite common in actual practice. Even cable trays that have significant fill are often arranged in a looser more random fill than the tightly packed and well-ordered trays tested in the NEI/EPRI tests. Together, the programs now provide data on both configurations.   |
| Exposure conditions | NEI/EPRI included hot gas layer, plume and radiant heating exposures, but in practice had difficulty in creating damaging hot gas layer or radiant heating conditions because heat losses from the metal plate room were very high and many fires burned under oxygen limited conditions.   | The CAROLFIRE tests also explored various exposure conditions including radiant heating, hot gas layer exposures and exposures within the plume but outside the flame zone.   | The NEI/EPRI tests provide many cable electrical failure data points, in particular, for cables located directly above the fire. CAROLFIRE used more realistic conditions relative to room configuration and ventilation effects, and as a result, was more successful in its exploration of cable damage for hot gas layer. <i>Penlight</i> provided representative radiant heating exposure conditions. |
| Cables tested       | The NEI/EPRI tests examined a small number of cable types.  | The CAROLFIRE tests examined a wide range of cable products and configurations.   | The range of cables used in CAROLFIRE is both representative of the range of cables used by industry and of the range of cables in common use in terms of their resistance to fire-induced failure.   |

**Table 3.1: Comparison between complementary aspects of the NEI/EPRI test program and CAROLFIRE.**

| Test Feature           | NEI/EPRI Configurations   | CAROLFIRE Configurations   | Discussion   |
|------------------------|---|--|--|
| Bundling arrangements  | The NEI/EPRI tests used a cable bundle configuration intended to maximize the potential for inter-cable interactions, but the arrangement was not realistic (a multi-conductor cable with three single conductor cables taped to it with fiberglass tape).              | The CAROLFIRE tests examined more realistic groupings of multi-conductor cables while monitoring explicitly for inter-cable interactions.  | The NEI/EPRI cable bundle configuration was intended to maximize the potential for inter-cable interactions, but was not realistic. CAROLFIRE sought to explore more representative bundling arrangements involving multi-conductor cables co-located in a common raceway.   |
| Cable combinations     | The NEI/EPRI tests each involved a single cable type for any given test.  | The CAROLFIRE tests included bundles of both like and unlike cables, including mixed bundles of TS and TP cables and mixed bundles of different types of TS cables.  | Mixed cable types in a given raceway are relatively common in industry. In this sense, CAROLFIRE explored an aspect of common practice not explored by the earlier tests.  |
| Cable thermal response | The NEI/EPRI tests did measure aspects of the thermal environment, but this was not a focus of testing. Limited measurements of cable thermal response were also made using thermocouples (TCs) taped to a cable but with the measurement bead exposed to the open air. | The CAROLFIRE tests made extensive measurements of the exposure environment and the cable thermal response including TCs placed on the cable surface, below the cable jacket, and embedded among the cable conductors. | The NEI/EPRI tests were not explicitly designed to provide detailed cable thermal response data, and given the manner in which cable TCs were installed, the cable thermal and electrical data cannot be directly correlated. CAROLFIRE included thermal response and electrical performance data that can be directly correlated, a key to the fire modeling improvement need area. |

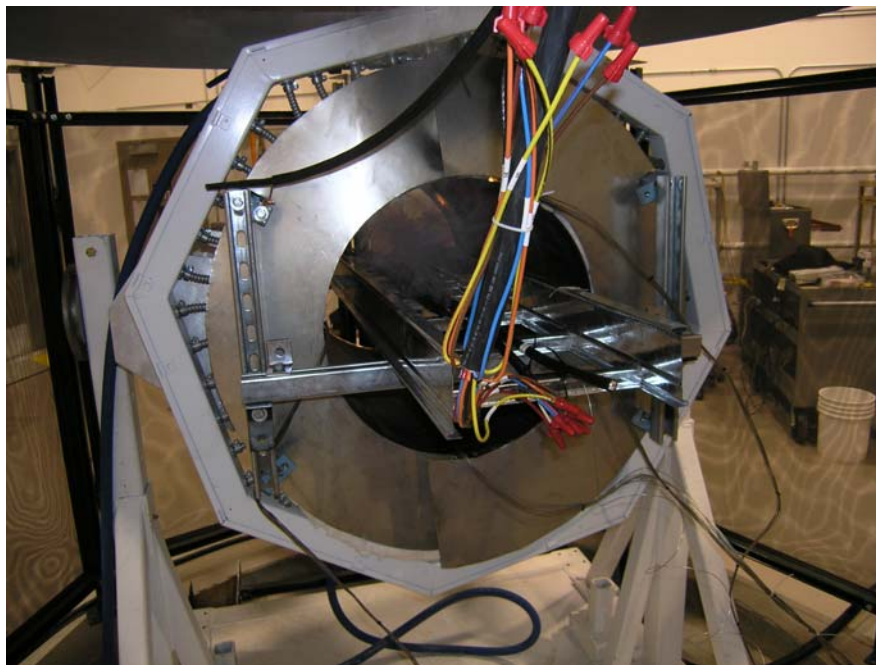
**Table 3.1: Comparison between complementary aspects of the NEI/EPRI test program and CAROLFIRE.**

| Test Feature          | NEI/EPRI Configurations  | CAROLFIRE Configurations   | Discussion  |
|-----------------------|--|--|---|
| CPT size              | The NEI/EPRI tests used one size CPT providing the equivalent of approximately 50% design margin over nominal required circuit power (i.e., the CPT supplies 150% of the nominal circuit demand). The selected CPT size is typical for MOV circuits in particular. | CAROLFIRE tested three sizes of CPTs providing approximately 50-66%, 127-150%, and 200-233% power margins (i.e., providing 150-166%, 227-250%, and 300-333% of required circuit power respectively). | CAROLFIRE tested a broader range of CPT sizes relative to circuit power needs, but in hindsight, tested only CPTs that were in effect larger than those tested by NEI. A range of CPTs are used in practice by industry. The collective data do not cover CPTs with less than 150% of the nominal design power as had been intended with CAROLFIRE. |
| Raceway configuration | Almost all of the NEI/EPRI tests (excepting only the vertical raceway tests) used raceways with a horizontal bend section (e.g., a radial bend) and the tests tended to focus the fire effects on the bend location.   | CAROLFIRE tested conduits and cable trays in straight sections without bends. CAROLFIRE also tested air drop configurations.   | Cable raceways in practice include long sections of straight trays in combination with various bend sections. Bends tend to place additional stress on a cable potentially leading to earlier failures, but the effects of raceway bends on the likelihood of spurious actuation may not follow the same pattern                                    |

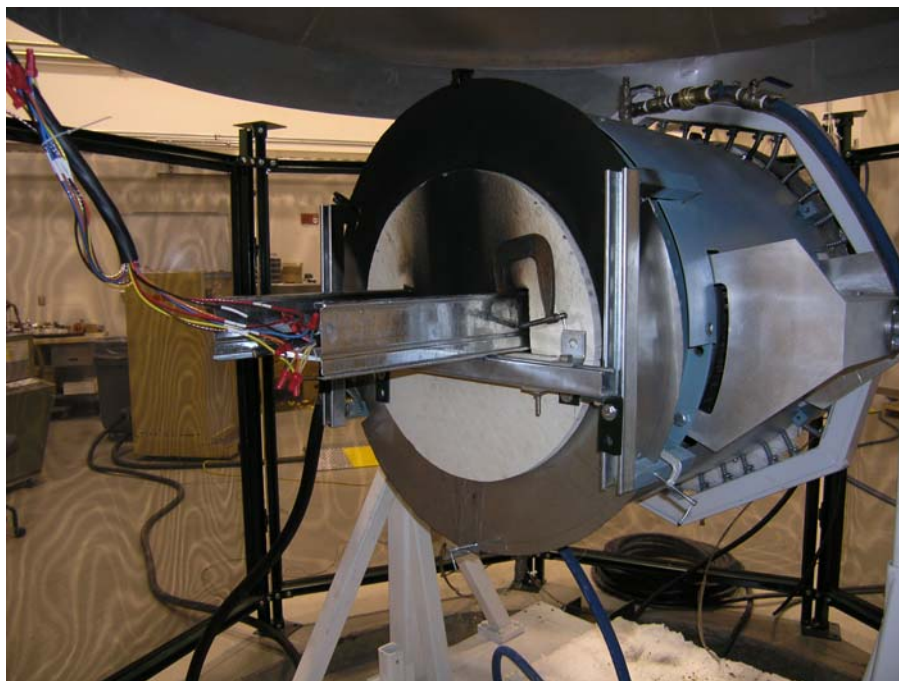
### 3.2 Small-Scale Radiant Heating Tests

The small-scale tests utilized the SNL facility *Penlight*. *Penlight* was originally designed and constructed to support the RES Fire Protection Research Program in the late 1980's and was known at that time as SCETCh (the Severe Combined Environments Test Chamber). The facility was used in a range of component exposure tests including testing of cables, pressure transmitters, and relays [e.g., 3]. After a period of idleness, the facility was turned over to the SNL Fire Safety Science Group who reconfigured the facility and renamed it *Penlight*.

Figure 3.1 provides a general view of the *Penlight* test facility. *Penlight* consists of a cylindrical ring of rod-shaped 0.61 m (24") long quartz heating lamps each held in a water-cooled aluminum fixture with a reflector to direct the heat toward the center of the lamp array. A stainless steel (Inconel) cylindrical shroud (or shell) 0.514 m (20.25") in diameter and 0.813 m (32") long is installed within the array of heating lamps. The shroud is painted with high-temperature flat black paint. The quartz lamps are used to heat the shroud to a desired (and controlled) temperature. The shroud in turn acts as a grey-body radiator heating any target object located within it.



**Figure 3.1: General view of the *Penlight* Facility with the cable tray in place and a test in progress. Note that this view shows *Penlight* in an ‘open-ends’ configuration used in many of the *Penlight* Preliminary Tests.**



**Figure 3.2: View of *Penlight* with a cable tray in place and in the ‘closed-ends’ configuration.**



The exposure environment for *Penlight* is specified based on the temperature of the shroud. However, *Penlight* is not an oven-type exposure facility. *Penlight* is a radiant heating exposure facility. The radiant heat flux leaving the shroud surface can be calculated based on the shroud temperature. The shroud emissivity is approximately 0.81-0.82 given the temperatures used in CAROLFIRE. Volume 2 discusses the exposure conditions in greater detail.

The temperature, and hence heat flux, emitted from the shroud is nominally uniform over the central 0.61 m (24") of the shroud surface. Temperature falls off sharply outside the heated portion of the shroud. The uniformity of the shroud over its heated section has previously been verified and the CAROLFIRE data sets include measurements of the actual shroud inner surface temperature for 28 locations on shroud. These data are also discussed in Volume 2.

Note that the heat flux delivered to the target surface is not necessarily equal to the heat flux leaving the shroud surface. Also, the heat flux *does* vary over the length of the cable based on the geometry of the exposure. The most intense exposure is at the center of the shrouds axial dimension (i.e., half way through the horizontal cylinder). Three factors influence the net heat flux actually delivered to the cable surface.

The first factor is the condition of the shroud ends during testing. As described, the shroud is a cylindrical shell with open ends. For CAROLFIRE, these open ends were generally closed off using a 25 mm (1") thick, low-density, solid refractory insulating board material. Figure 3.2 provides a view of *Penlight* with the tray and end covers in place. Note that the end covers were not heated and were not well sealed. The boards were cut to fit around the raceways, but there were gaps especially for the cable tray tests. The primary purpose of the end covers was simply to minimize air circulation into and out of the exposure chamber. However, in estimating heat flux to the cable surface, note that the unheated end covers are part of the radiant environment that the cables 'see'. This effect can easily be calculated based on the actual test geometry (i.e., with a view factor calculation).

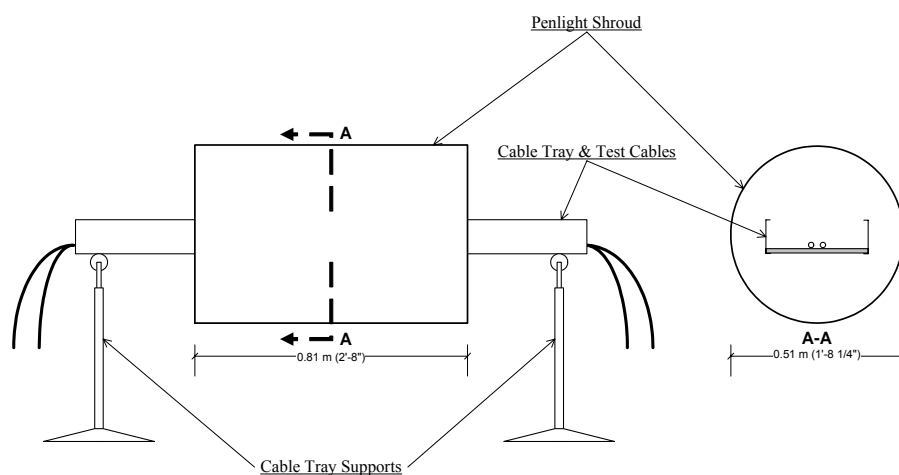
It should also be noted that in several of the later *Penlight* tests, those that involved bundles of six cables per test, the ends of the *Penlight* chamber were actually left open. During the first tests of these larger bundles we observed that the restricted air flow conditions were inhibiting the normal cable burning behavior. It appeared that the burning quickly became oxygen starved. For the subsequent tests with the six-cable bundles the ends of the shroud were left open. Hence, the ambient environment also became part of the radiant environment that the cables could 'see'.

The second factor impacting the heat flux delivered to a target cable is the effect of the raceways used to support the cables during most tests. A small number of tests were conducted with no raceway support (i.e., a simulated air-drop) and these tests are not impacted by this effect. However, most tests involved cables in either a cable tray or a conduit. The cable trays cause a degree of shadowing of the primary target (the cable) mainly due to the cable tray side rails. The raceways used for CAROLFIRE are B-Line® brand Series 286, ladder back, 12" wide, galvanized steel trays. Based on their geometry, this reduces the net heat flux at the cable surface substantially, but again, the effect is easily calculated based on simple geometric view factor calculations. For conduits, the shroud heats the conduit which in turn heats the cables which naturally lay against the inner bottom of the conduit.

The third factor impacts only the cable tray tests, and that is the actual placement of the cables in the cable tray. In general, the tests in *Penlight* would use ‘mirror’ cables in order to gather both thermal response and electrical performance data in a single test. For example, for the tests involving individual lengths of cable there were actually two identical cable samples present. These two lengths of cable would be placed in off-center symmetric locations either side of the cable tray centerline. One length of cable is monitored for thermal response and the second is simultaneously monitored for electrical performance. The use of two separate but identical cables (rather than one cable monitored for both thermal response and electrical performance) ensures that the installed TCs will not bias the electrical performance behavior. This, too, should be considered in estimating heat flux to the cable surface. For the conduits and air drop tests, the cables were located as close to the axial centerline as possible, and the effect of an off-center placement is not applicable.

*Penlight* testing involved the exposure of individual cable lengths, bundles of three cables, and bundles of six cables. The quantity of cables that could be tested in one test was limited because the facility is not designed to endure large-scale burning. For CAROLFIRE, all of the tests were conducted with the cables passing horizontally through the *Penlight* shroud (with or without a supporting raceway). The cables were heated using a predefined shroud temperature (hence, nominal exposure heat flux) and then monitored for temperature response and for electrical failure. Note that no single cable sample is monitored for both temperature and electrical performance because attachment of TCs might impact electrical performance. Rather, two identical samples (individual cables or cable bundles) are run concurrently and in symmetric exposure locations, one with TCs, and one electrically monitored as noted above.

Figures 3.3–3.5 illustrate typical *Penlight* test setups with cable tray, conduit and air drop configurations, respectively. Note that the raceways are supported outside the exposure shroud. The height of these supports was set such that the cables themselves were centered (vertically) within the shroud.



**Figure 3.3: Illustration of *Penlight* configured for cable tray testing.**

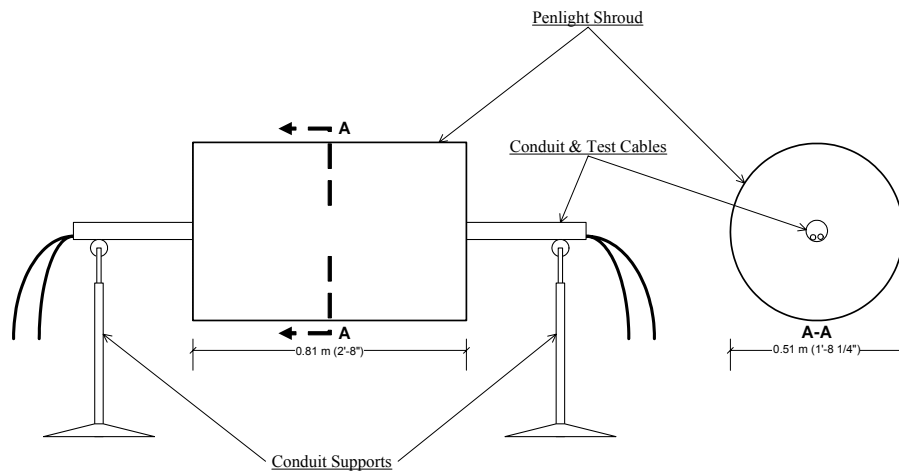


Figure 3.4: Illustration of *Penlight* configured for Conduit Testing.

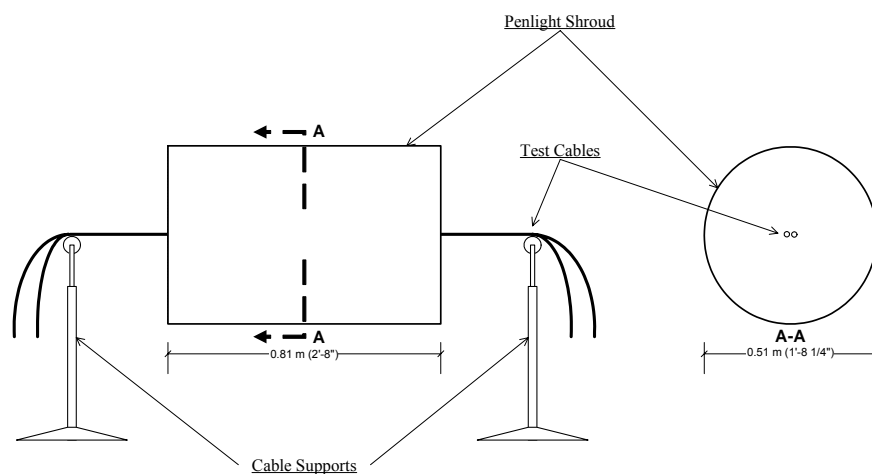


Figure 3.5: Illustration of *Penlight* configured for Air Drop Testing (no raceway).

### 3.3 Intermediate-Scale Cable Burn Tests

The second test set was conducted at a scale that is more representative of in-plant conditions. These tests involved the open burning of larger arrays of cable under more varied and representative exposure conditions. These tests are referred to as the intermediate-scale tests. The overall test scale is quite similar to the scale of testing used by EPRI/NEI in their original tests [2], although the configuration and properties of the CAROLFIRE test structure are quite different.

One key goal of CAROLFIRE was to assess different exposure conditions including cable failures due to a hot gas layer exposure, a mode of exposure that was not successfully explored during the

previous testing.<sup>4</sup> To achieve this, we modified two primary aspects of the test facility in comparison to the NEI/EPRI tests; namely, we chose to use something other than a small metal test room in order to reduce heat losses from the test enclosure to a more representative level, and we chose to allow for more air flow in order to avoid oxygen-limited burning conditions. Given these two changes, CAROLFIRE did observe cable failures due to hot gas layer heating alone.

Another consideration was a strong preference to use, or adapt, a test protocol from a recognized testing standard. In this case, no standard test protocol directly met CAROLFIRE's needs. The standard test method that came closest to meeting our needs was the ASTM E603 room fire facility standard [4]. The CAROLFIRE test structure was, in fact, adapted from the test room specified in this standard.

The decision to modify the ASTM E603 test enclosure was based on several factors. First, CAROLFIRE was not explicitly seeking room response data; hence, use of an enclosed room such as the ASTM E603 test enclosure offered few, if any, technical advantages beyond being tied to the standard test protocol. Second, the ASTM E603 enclosure is considerably smaller than any compartment typically found in a NPP; hence, the exposure conditions would not be representative of in-plant configurations in any case. Third, the ASTM E603 test enclosure has only a single small doorway opening similar to that of the NEI/EPRI test enclosure which led to oxygen-limited combustion conditions during a number of the NEI/EPRI tests. CAROLFIRE sought to create a test structure allowing for more representative open burning conditions which would be more representative of the behavior of fires in actual NPP conditions.

Given these factors, the CAROLFIRE test structure was scaled based on ASTM E603, but was built in a much more open configuration that would not restrict air flow to the fire. The CAROLFIRE test structure (described further below) is arguably a good analog for a very common in-plant configuration; namely, a beam pocket within a larger room (i.e., a typical in-plant situation where the floor above is supported by massive steel and/or concrete beams creating isolated ceiling level beam pockets).

The CAROLFIRE intermediate-scale test structure is illustrated in Figure 3.6. The test structure consists of a steel framework of which only the upper 40% is enclosed. That is, the framework has an overall height of about 3 m (10 ft) but remains open on all sides up to a height of about 1.8 meters (6 ft). Each of the four sides from a height of 1.8 m (6 ft) up and the top of the structure are covered (enclosed) with a non-metallic material. This test structure acts to focus the fire's heat output initially to this confined volume creating the desired hot gas layer exposure conditions. As the fire progresses the hot gas layer depth increases and ultimately smoke and hot gasses spill out naturally

---

<sup>4</sup> The NEI/EPRI tests used a small room enclosure (10'x10'x8'h) made of plate steel. The facility is intended to represent ship-board fire conditions where enclosure walls actually are steel plate. However, heat losses from the room were quite high compared to non-metal construction such as one would find in a NPP. The room also had a single open doorway (30"x7") which restricted air flow and this led to oxygen-limited combustion in several tests (which limits fire intensity). The effect of these two factors meant that NEI/EPRI was unable to create hot gas layer conditions sufficient to induce cable failure. CAROLFIRE's use of non-metallic materials to enclose the upper portion of the intermediate-scale test structure substantially reduced heat losses from the hot gas layer. The open framework allowed for ample air flow to the fire. Both conditions are considered more representative of NPP conditions. The CAROLFIRE tests were readily able to induce cable failures as the result of hot gas layer heating.

from under the sides of the enclosed area. This again would be quite typical of the hot gas layer development behavior for a beam pocket configuration.

Overall, the test structure was similar in size to the recommended dimensions of an ASTM E603 fire test room [4] which is typically 2.4 m x 3.7 m x 2.4 m (8'x12'x 8' - WxLxH). The CAROLFIRE test structure was the same dimension in the horizontal plane, but was slightly taller at 2.4m x 3.7m x 3.0m (8'x12'x10'). This allowed for some additional capacity for the upper region while maintaining accessibility. As an added benefit, the test structure's open configuration allowed for much less restrictive access and thereby optimized test turnaround times.

In the first few tests (tests IP-1 through IP-4 and IT-1 through IT-6) the enclosed sides and top of the test structure were covered with a single layer of standard 13 mm (½") thick gypsum wall board. The intent was to replace this wallboard as needed through the program. However, it was found that the wallboard required replacement more often than desired; hence, in tests IT-7 through IT-14 the surface treatment was revised. An inner layer (i.e., a layer towards the inside of the structure) of 13 mm (½") thick 'fireproof' wall board (trade name Durarock®)<sup>5</sup> plus a second outer layer of the 13 mm (½") standard gypsum wall board was used. This configuration lasted for the remainder of the test series without need for replacement. (Volume 2 of this report provides a more complete description of these materials including the nominal physical properties of each material.)

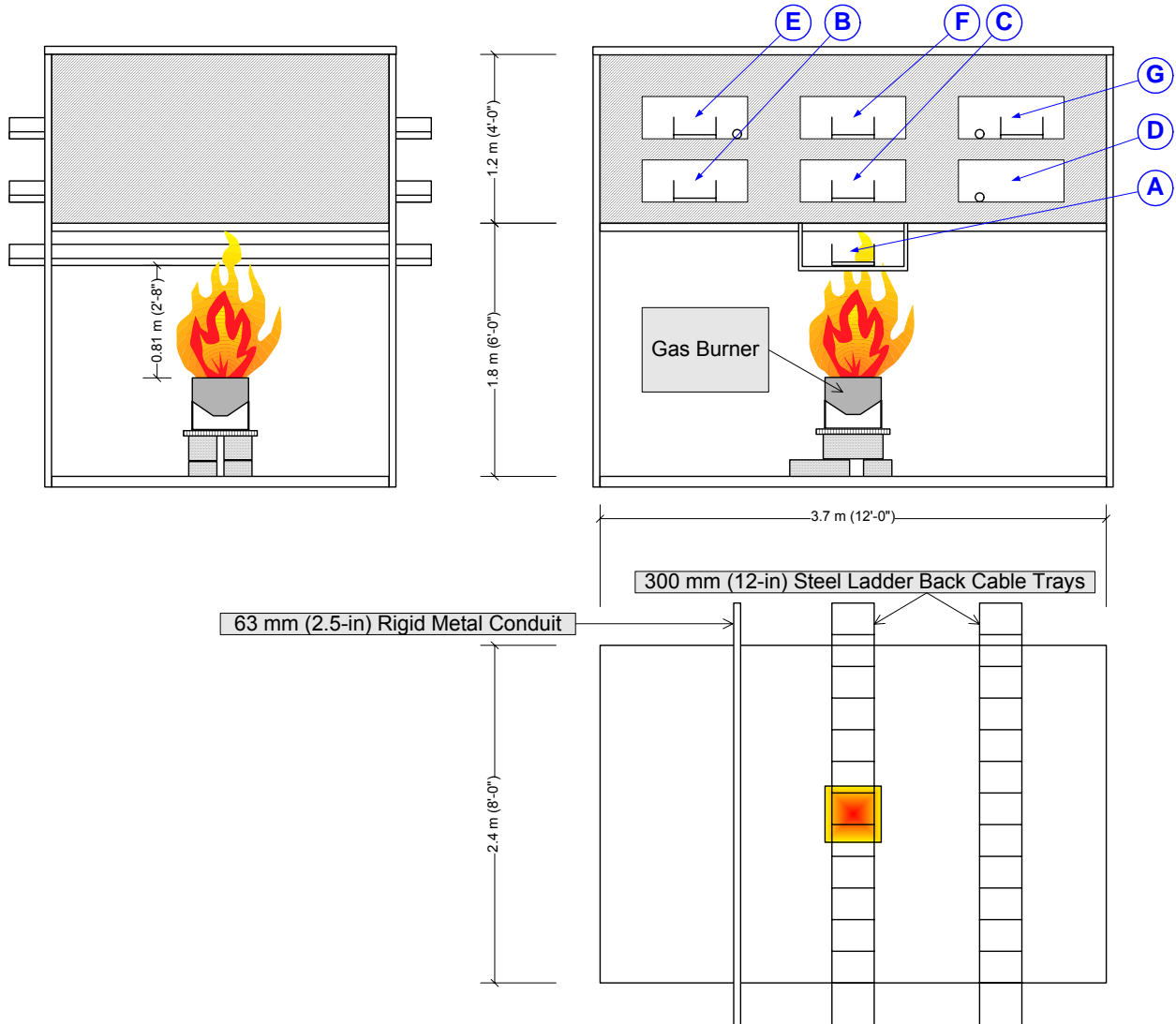
Conduits and trays could be routed in any manner desired. For CAROLFIRE all raceways were routed as a single straight section passing through the full width of the test structure (i.e., across the 2.4 m (8 ft) dimension). Three meter (10 ft) long raceway sections were used, so the raceways extended about 300 mm (12 in) beyond the sides of the test structure. The test matrix included cables located near the fire source (just above the continuous flame zone of the fire), in the upper portion of the fire plume, and in various locations subject to hot gas layer exposure. In practice, cables were placed in seven locations. These locations are illustrated as locations A-G in Figure 3.6. Test descriptions in both volumes of the report identify cables by location consistent with these labels. Through-wall penetration holes were cut in the side panels to accommodate raceway routing.

The CAROLFIRE test structure was positioned within a larger fire test facility. An existing SNL facility (Building 9830) served as the outer test structure. This isolated the test structure from the ambient environment (e.g., wind effects), allowed us to control bulk air flow conditions through the facility to some extent, and made it possible to gather outlet stack data (temperature, velocity, and oxygen concentration). Figure 3.7 illustrates the placement of the Test Structure within the larger facility, and provides overall dimensions for the larger facility.

The fires in all intermediate-scale tests were initiated using a gas burner. The fuel in all cases was propene (also called propylene). The burner used was a square 'sand box' diffusion burner based on the Nordic standard burner [5] but scaled in size to suit the needs of CAROLFIRE.

---

<sup>5</sup> Durarock® is low-density concrete-based material with fiber-mesh reinforcement. The same material in smaller panels is commonly used as a 'backer board' for bathroom tile installations.



**Figure 3.6: Schematic representation of the CAROLFIRE intermediate-scale test structure. Note the illustration of raceway locations A-G in the elevation view figure to the upper right. These are the same letter designations used in the test matrices (Section 5) to identify cable and raceway locations. The lower illustration is a plan view looking down onto the stacked raceways (one conduit and two stacks of cable trays are shown simply to illustrate the general placement).**

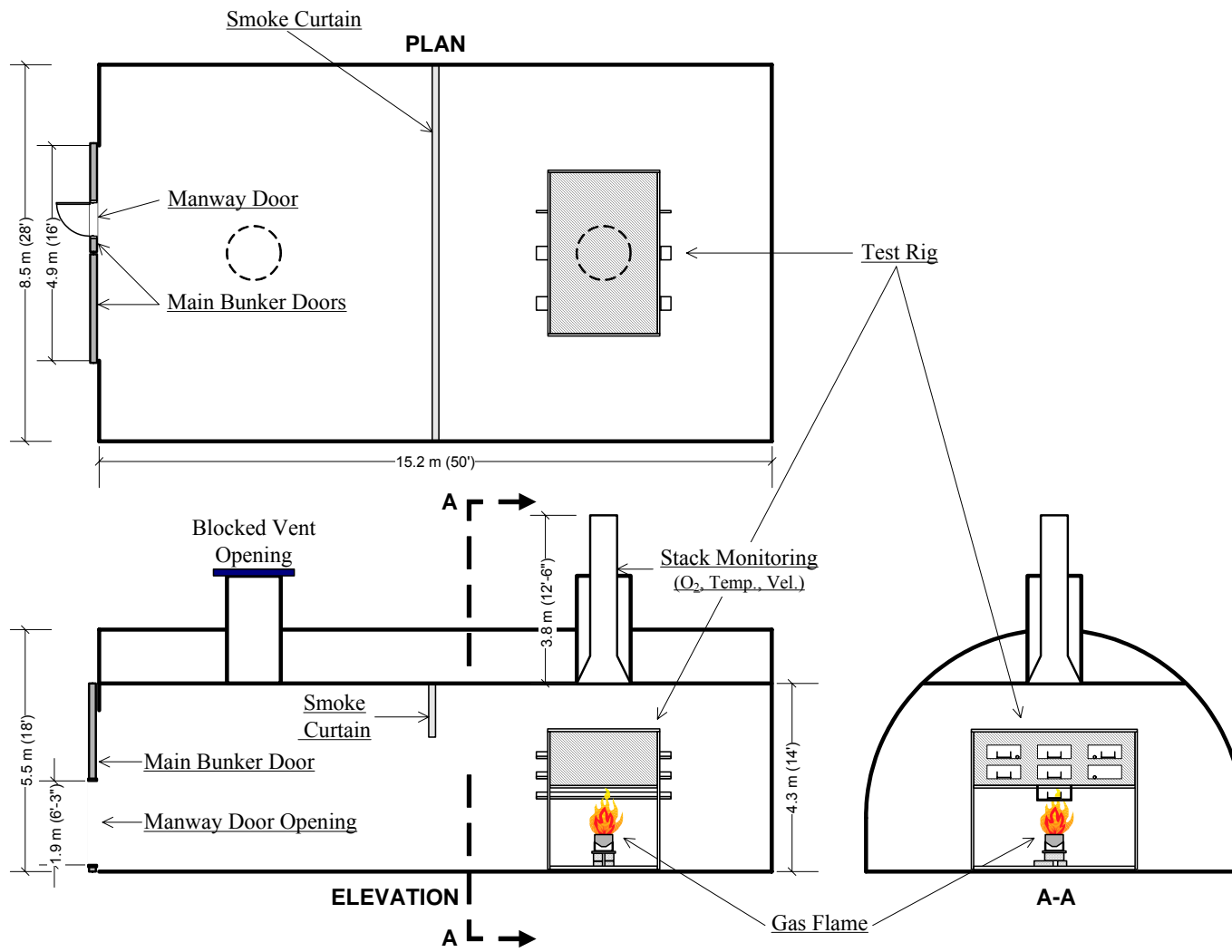


Figure 3.7: Schematic representation of the CAROLFIRE intermediate test structure located within the outer test facility.

The top surface of the burner measured 40 cm (15.75") on a side (outside dimensions). A metal lip around the upper edge of the burner was turned to the inside of the burner on all sides and measured 12 mm (1/2") wide (a piece of standard 1/2"x1/2"x1/8" mild steel angle iron was used to form the top rail of the burner). Volume 2 of this report provides additional detail relative to the construction and operation of the sand burner including a scale drawing.

By itself, the burner stood a total of 40 cm (15.75") high (it's a cube). For testing, the burner was elevated above the floor of the test enclosure. The top surface of the burner was about 0.84 m (33") above the floor of the enclosure. The burner was always placed in the center of the test structure and directly below cable raceway location 'A' (as shown in Figure 3.6). The flow of gas to the burner was measured and controlled using an electronic flow control valve.<sup>6</sup> Real-time gas flow rate data was also recorded.

During the four preliminary tests (IP-1 through IP-4), the gas flow rate was varied in order to assess the relationship between gas flow rate (hence fire intensity or heat release rate (HRR)) and the resulting temperatures within the test structure. For the balance of tests, the nominal starting point for HRR was at roughly 200 kW.<sup>7</sup> For some tests (especially those involving hot gas layer exposures), the fire HRR was increased following failure of those cables directly above the fire in order to create the desired damaging hot gas layer conditions. The maximum HRR used in any test was approximately 350 kW. (For additional details on the specific burner intensity for any given test, refer to Volume 2 of this report.)

As a final aspect of the intermediate-scale tests, a single open head sprinkler was installed near the ceiling of the test structure (on a pendant about 150 mm (6") long). The sprinkler was located directly above the gas burner and in the center of the test cell ceiling. Water flow could be manually initiated using a small electric water pump that drew water from a storage tank on top of the outer test facility. The sprinkler was generally initiated only in those tests where one or more of the cables being monitored for electrical performance had not experienced electrical failures during the fire exposure period of the test. This was, for example, seen in all of the tests that involved either the SR-insulated or the Vita-Link® cables, both of which proved to be resistant to fire-induced damage. As noted below, in most cases these cables did fail once the water spray was initiated.

## **3.4 Cable Selection Criteria and Results**

### **3.4.1 Cable Selection Criteria**

A key expansion of the existing data that resulted from CAROLFIRE was the testing of a much broader range of cables and in more varied configurations. Two of the Bin 2 Items (Items A and B) explicitly required that we test both TS and TP cables<sup>8</sup> and that we test mixed bundles containing

---

<sup>6</sup> The flow controller used was from Omega Controls and is electronic flow controller model FMA5545-Propene.

<sup>7</sup> The nominal fire intensities cited here are based on the mass flow rate and heat of combustion for propene, but do not account for combustion efficiency. Introduction of combustion efficiency would imply slightly lower fire intensity than the nominal HRR values cited here. See Volume 2 of this report for a further discussion of burner and fire characteristics.

<sup>8</sup> Thermoplastic materials will melt on heating and, unless actually burned, will re-solidify if cooled. TS materials will not melt; rather, they will burn and char if heated sufficiently. In general, the melting point of a thermoplastic cable is



both cable types. Beyond this, there was an interest in testing at least one mixed cable construction (i.e., TS insulation with a TP jacket). It was also considered desirable to make the tests as broadly applicable as possible.

These broad objectives, unfortunately, represented a substantially complicating factor for the test program. CAROLFIRE ultimately sought to explore a reasonable range of materials and configurations, and yet also establish reasonable limits on the range of cables to be used in testing. The primary considerations that went into the selection of cable configurations are summarized as follows:

- Each addition cable type tested introduced significant ‘entry level’ material costs. Manufacturers typically require minimum purchase lengths of 300-1500 m (1000'-5000') for any given cable specification, even for stock cables. For non-stock cable configurations, minimums typically increase to 5000 m (15,000') or more. As a result, several of the cable lengths procured far exceeded the nominal needs of the program.
- The cost per 0.3 m of cable (\$/ft) ranged from as little as \$1 to as high as \$12 for the cable products actually procured for CAROLFIRE. For some specialty configurations that were considered (e.g., a fully nuclear qualified Tefzel 280 or silicone insulated cable), costs ranged as high as \$18/ft making them prohibitively expensive so in some cases equivalent industrial grade cables were substituted.
- One of the most important factors considered was the relative popularity of different cable insulation materials. For CAROLFIRE, material selection considered surveys done under various Equipment Qualification Research Programs<sup>9</sup> conducted during the 1980's and 1990's.
- Traceability of the CAROLFIRE cables to materials and products supplied to the U.S. NPP industry during the 1970's and 80's was also considered desirable. While this proved possible for some of the key cable types, it proved to be impossible for most. Appendix E provides detailed discussion relative to each material configuration, but to summarize:
  - The primary success was the continued availability and procurement of Rockbestos Firewall III® cables. This is arguably the single most popular line of cable products used in the U.S. NPP industry.
  - While nuclear grade cable product lines maintain a traceable history for equipment qualification purposes, industrial grade cables generally do not. As a result, industrial grade cable product lines are routinely updated to take advantage of material and manufacturing advances. Industrial grade cables, including TP-insulated cables, are

---

well below the degradation point of a TS cable.

<sup>9</sup> There were a number of USNRC-sponsored cable aging research efforts at SNL in the 1980's, and under RES's Nuclear Plant Aging Research (NPAR) programs through the mid-1990's. EPRI and the U.S. Department of Energy also conducted such investigations under, for example, the Plant Life Extension programs. During the 1990's the USNRC-sponsored efforts shifted to Brookhaven National Laboratory (BNL). The insights cited here are based on information gathered from all of these resources.

used by some plants in locations not subject to equipment qualification requirements (e.g., outside containment).

- Many of the historically popular product lines have simply not survived as viable products in the current marketplace. Appendix E provides information that was gathered as a part of this project relative to the history of some of the more commonly cited cable manufacturers in the U.S. marketplace beginning in the 1960s through the present. Some examples of industry changes include the following:
  - The primary manufacturers of silicone insulated cables that were active in the 1960's and 1970's either no longer exist, or no longer market silicone-insulated cables.
  - Many of the original cable manufacturers have since been bought out or have merged to form larger companies. Hence, many of the product lines originally produced by one company may now be marketed by another.
  - There was an explicit interest in including *Kerite FR*® cross-linked polyolefin (XLPO) insulated cables given evidence that these cables may be more vulnerable to thermal damage than other TS materials. The *Kerite FR*® line of materials is no longer manufactured at all and Kerite no longer manufacturers control cables.
- There was a strong desire to, in some sense, bound the range of materials relative to their robustness (i.e., their resistance to thermal damage). For those Bin 2 Items related to inter-cable interactions (Items A and B), the relative timing of cable failures was expected to influence the likelihood of inter-cable hot-shorts. Failure times are directly correlated to the insulation material's robustness against thermal damage.
- Another consideration was the cable physical configurations; that is, the size and number of conductors in each multi-conductor cable. CAROLFIRE used 7-conductor 12 AWG<sup>10</sup> cables as the primary configuration, this being the most common control cable configuration used by industry. Two secondary configurations, a 3-conductor 8AWG and a 12-conductor 18AWG, were also procured mainly to support the fire modeling improvement need area. These two secondary configurations allowed for the testing of cables with a similar overall diameter, but containing a higher and lower copper-to-plastic relative content, respectively.

Based on these selection criteria, CAROLFIRE procured 15 different cables for testing. These are described in Section 3.4.2 immediately below.

### 3.4.2 Cable Selection Results

The primary factor in cable specification that was considered by CAROLFIRE was the materials that make up the primary insulation (the insulation over each individual conductor) and the cable jacket (a physical protection layer applied over the grouped and individually insulated conductors). In this report, the materials are identified in the format 'insulation/jacket.' CAROLFIRE tested 15 different

---

<sup>10</sup> "AWG" is a standard unit of measure for conductor diameter used in the U.S. and refers to the "American Wire Gage" system.

cable types. This included nine different cable insulation and jacket material configurations as listed below.

- **XLPE/CSPE:** The single most popular insulation material used in the U.S. nuclear power industry is the TS material cross-linked polyethylene (XLPE). Cables with this insulation can be obtained with a variety of jacket materials with the TS material chloro-sulfanated polyethylene (CSPE, also known by the trade name Hypalon) being one of the most popular and common. XLPE is the primary TS insulation material for the CAROLFIRE program. The XLPE-insulated, CSPE-jacketed cables were procured from the Rockbestos Firewall III® line of products, and are fully qualified for NPP applications (e.g., IEEE-383 full qualification).
- **XLPE/PVC:** As noted above, XLPE insulated cables are available with a range of jacket materials. An XLPE insulated polyvinyl chloride (PVC) jacketed cable was considered most representative of a typical “mixed type” cable (TS-insulated, TP-jacketed). The XLPE/PVC cable procured for CAROLFIRE were an industrial grade product procured from the BICC-Brand® line of products (now marketed under the General Cable umbrella).
- **EPR/CPE:** Ethylene propylene rubber (EPR) is the second most popular insulation material (another TS). EPR insulated Chlorinated-Polyethylene (CPE) jacketed cables were procured from the BICC-Brand® line of products (now marketed under the General Cable umbrella). BICC was a long-time supplier to the nuclear industry through the 1970’s and 1980’s, although the cables are not explicitly marketed as nuclear grade cables today.
- **PE/PVC:** Of the TP materials, (non-cross-linked) polyethylene (PE) is one of the two most common for general applications, and is considered the most common TP material in use at U.S. NPPs. PE was nominally the primary TP insulation material for the CAROLFIRE program. The cables procured were industrial grade PE insulated and PVC jacketed cables from General Cable.
- **PVC/PVC:** PVC is a second TP material that is very popular in the U.S. as a general commercial and industrial grade cable. PVC is also widely used in applications outside the U.S. including nuclear applications in Canada and Europe. PVC insulated, PVC jacketed (PVC/PVC) cables played an important role in the CAROLFIRE matrices, especially in the context of the plastic-to-copper relative content issue given their wide availability in a range of conductor configurations. The CAROLFIRE PVC/PVC cables were procured as industrial grade cables from the BICC-Brand® line of products (now marketed under the General Cable umbrella).
- **Silicone-Rubber:** Silicone-Rubber (SR) insulation materials, a TS material, are used by a number of U.S. NPPs, particularly in applications inside containment. Based on input from knowledgeable industry experts, a typical NPP SR cable configuration would involve a SR insulated conductor with a fiberglass braid sheath over each insulated conductor and an overall Amarid braid jacket. An industrial grade Silicone cable of this configuration was procured from First Capitol.

- **Silicone - Vitalink:** Vitalink® is a relatively new trade name product of Rockbestos Corporation. As cited on the corporation web site, Vita-Link® "is a unique silicone rubber insulation material that ceramifies and maintains physical & electrical integrity when exposed to flame conditions."<sup>11</sup> Vita-Link® is marketed as a fire-rated cable, but is not explicitly marketed as a nuclear-grade product.
- **Tefzel:** Tefzel® is a trade name TP material produced by DuPont Chemical. The material is applied directly as supplied by the manufacturer without modification by the cable manufacturer. Two formulations are common; namely, 200 and 280. A cable with a Tefzel 280 insulation and Tefzel 200 jacket is considered most typical of NPP industry use based on input from industry experts. A commercial grade Tefzel cable of this configuration was procured from Cable USA.
- **XLPO/XLPE Low Halogen Zero Smoke:** An XLPO insulated cable was sought primarily on the basis of existing evidence that XLPO may represent the least robust of the TS materials. However, XLPO is a highly generic material classification that has been used to label a wide range of actual material formulations. For example, polyethylene is a specific type of polyolefin; hence, all XLPE materials are also legitimately bounded under the more generic classification XLPO. As noted above, we were unable to find a XLPO cable product that might have been used by industry during original construction. All of the currently available XLPO materials identified during our material search were of a "low halogen zero smoke" type. A decision was made to procure a minimal sample of one of these newer type materials for the program. A Rockbestos XLPO insulated industrial-grade cable was selected and procured. Upon delivery, it was noted that the jacket markings were "XLPE" rather than "XLPO". We contacted Rockbestos and were informed that the material was indeed an XLPE formulation that was being marketed under the more generic XLPO label. The material was tested in a limited number of tests for reference purposes only.

Note that these insulation/jacket configurations represented a rather broad range of materials from essentially those cables that are most vulnerable to fire-induced damage (the PE and PVC insulated cables) to those that are least vulnerable to fire-induced damage (the silicone-rubber insulated cables and the 'fire-rated' Vitalink® cables) available and in use at current U.S. NPPs.

In order to focus the applicability of these tests on generic utilization, the emphasis for testing relative to resolution of the Bin 2 Items was on 7-conductor cables. A limited number of tests on 3-

---

<sup>11</sup> SNL's order for a considerable quantity of Firewall III® cables attracted the attention of the western regional manager for Rockbestos Surrenant Cable Corp., Mr. Mark Valaitis, who contacted SNL. We explained the intent and objectives of the CAROLFIRE project to Mr. Valaitis. Based on these discussions, Mr. Valaitis proposed to include one additional cable product in the test matrix; namely, the Vita-Link® line of fire-rated cables. Mr. Valaitis offered to supply, free of charge, a sufficient length of the Vita-Link® cables in a control cable configuration from off-the-shelf stocks of material to allow for inclusion in the CAROLFIRE test matrix. This offer was discussed with the RES Staff, and Staff determined that inclusion of this new line of cable products offered substantial benefits to the NRC program and that addition of the Vita-Link® cables enhanced CAROLFIRE by incorporating a "look towards the future" and towards the next generation of NPPs. The cable was included in the CAROLFIRE test matrix and tested alongside, and in the same manner as, the other cables.

conductor 8 AWG light power cables, 12-conductor 18 AWG instrument cables, and 2-conductor 16 AWG instrument cables were also performed. These secondary cable configurations were included primarily to support the fire model improvement need area (see discussion in Section 3.4.1 above). However, in those cases where a secondary configuration cable was monitored for electrical performance, the data do provide information on the duration of intra-cable conductor-to-conductor shorting prior to shorts to an external ground.

Table 3.2 lists the specific cables used in the CAROLFIRE project. The Table identifies the insulation and jacket material type (i.e., as insulation/jacket in column 2), the manufacturer, the conductor count, and conductor size. Table 3.3 provides the physical dimensions associated with each cable procured. Included are insulation and jacket thickness, overall cable diameter, and conductor diameter as well as the cable mass in (the nominal pound per foot of cable). Figure 3.8 is a photograph of the 15 different cable items viewed end on. This photograph provides some perspective as to the relative sizes of the different cables tested.

**Table 3.2: Description and identification by item number of the 15 cable products tested in CAROLFIRE.**

| Item # | Short Description*           | Source                | Cable Markings  |
|--------|------------------------------|-----------------------|---|
| 1      | PVC/PVC, 12 AWG, 7/C         | General Cable         | GENERAL CABLE® BICC® BRAND (WC) VN-TC 7/C 12AWG (UL) TYPE TC-ER THHN/THWN CDRS DIR BUR SUN RES 600V 03 FEB 2006   |
| 2      | EPR/CPE, 12 AWG, 7/C         | General Cable         | GENERAL CABLE® BICC® BRAND (WC) FREP 7/C 12AWG EPR/CPE (UL) TYPE TC-ER XHHW-2 CDRS 90C WET OR DRY 600V DIR BUR SUN RES 12 SEP 2005                                      |
| 3      | XLPE/PVC, 12 AWG, 7/C        | General Cable         | GENERAL CABLE® BICC® BRAND (WC) CVTC 7C 12AWG FR-XLP/PVC (UL) TYPE TC-ER XHHW-2 CDRS DIR BUR SUN RES 90C WET OR DRY 600V 08 MAR 2006                                    |
| 4      | PVC/PVC, 16 AWG, 2/C SH      | General Cable         | GENERAL CABLE® BICC® BRAND (WC) VN-TC 1PS 16AWG SHIELDED (UL) TYPE TC TFN CDRS SUN RES DIR BUR 600V 03 NOV 2005   |
| 5      | PVC/PVC, 8 AWG, 3/C          | General Cable         | GENERAL CABLE® BICC® BRAND (WC) VN-TC 3/C 8AWG WITH GRND (UL) TYPE TC-ER THHN/THWN CDRS DIR BUR SUN RES 600V 15 MAR 2006  |
| 6      | PVC/PVC, 18 AWG, 12/C        | General Cable         | GENERAL CABLE® BICC® BRAND (WC) VN-TC 12/C 18AWG (UL) TYPE TC-ER TFN CDRS SUN RES DIR BUR 600V 09 MAR 2006  |
| 7      | XLPE/CSPE, 16 AWG, 2/C (Sh)  | Rockbestos-Surprenant | 2/C 16 AWG COPPER ROCKBESTOS-SURPRENANT (G) 600V 90 DEG C WET OR DRY FIREWALL® III SUN RES DIR BUR OIL RES II NEC TYPE TC (UL) FRXLPE SHIELDED CSPE I46-0021 2006       |
| 8      | XLPO/XLPO, 12 AWG, 7/C       | Rockbestos-Surprenant | 7/C 12 AWG COPPER ROCKBESTOS-SURPRENANT (G) X-LINK® TC 600V 90 DEG C WET OR DRY SUN RES DIR BUR NEC TYPE TC (UL) FMRC GP-1 K2 COLOR CODE FRXLPE LSZH-XLPO C12-0070 2005 |
| 9      | SR/Aramid Braid, 12 AWG, 7/C | First Capitol         | SRGK-12(19)TPC 600V 200DEG.C 7/C  |
| 10     | XLPE/CSPE, 12 AWG, 7/C       | Rockbestos-Surprenant | 7/C 12 AWG COPPER ROCKBESTOS-SURPRENANT (G) 600V 90 DEG C FIREWALL® III XHHW-2 SUN RES DIR BUR OIL RES II NEC TYPE TC (UL) XLPE CSPE FT4 C52-0070 2006                  |
| 11     | VITA-LINK, 14 AWG, 7/C       | Rockbestos-Surprenant | 7/C 14 AWG ROCKBESTOS-SURPRENANT (G) VITALINK® TC NCC 600V 90 DEG C (UL) TYPE TC SUN RES FT-4 FIRE RESISTANT SILICONE LSZH C65-0070 2005                                |
| 12     | TEF/TEF, 12 AWG, 7/C         | Cable USA             | 7/C 12 19/TPC TEF/TEF CONTROL CABLE BLACK (SPEC. NO.: 381207U0)   |

**Table 3.2: Description and identification by item number of the 15 cable products tested in CAROLFIRE.**

| Item # | Short Description*      | Source                | Cable Markings  |
|--------|-------------------------|-----------------------|---|
| 13     | XLPE/CSPE, 18 AWG, 12/C | Rockbestos-Surprenant | 12/C 18 AWG COPPER ROCKBESTOS-SURPRENANT (G) 600V 90 DEG C WET OR DRY FIREWALL® III SUN RES DIR BUR OIL RES II NEC TYPE TC (UL) FRXLPE CSPE I57-0120 2006 |
| 14     | XLPE/CSPE, 8 AWG, 3/C   | Rockbestos-Surprenant | 3/C 8 AWG COPPER ROCKBESTOS-SURPRENANT (G) 600V FIREWALL® III XHHW-2 90 DEG C SUN RES DIR BUR OIL RES II NEC TYPE TC (UL) FRXLPE CSPE FT4 P62-0084 2006   |
| 15     | PE/PVC, 12 AWG, 7/C     | General Cable         | GENERAL CABLE® BICC® SUBSTATION CONTROL CABLE 7/C 12 AWGAWG 600V 30 MAY 2006  |



**Figure 3.8: Photograph of the 15 different cables tested in CAROLFIRE.**

Table 3.3: Physical Properties of the CAROLFIRE Cables

## Control Cables

| Item # | Short Description            | Manufacturer            | Part Number   | No. Cond. | Cond. Size AWG | Cond. Diameter <sup>1</sup><br>mm<br>(in) | Insulation Thickness<br>mm<br>(in) | Jacket Thickness<br>mm<br>(in) | Cable Diameter<br>mm<br>(in) | Net Weight<br>kg/m<br>(lb/ft) |
|--------|------------------------------|-------------------------|---------------|-----------|----------------|---|------------------------------------|--------------------------------|------------------------------|-------------------------------|
| 1      | PVC/PVC, 12 AWG, 7/C         | General Cable           | 234620        | 7         | 12             | 2.3<br>(0.092)                            | 0.51<br>(0.02)                     | 1.14<br>(0.045)                | 12.4<br>(0.49)               | 0.310<br>(0.217)              |
| 2      | EPR/CPE, 12 AWG, 7/C         | General Cable           | 279890        | 7         | 12             | 2.3<br>(0.092)                            | 0.76<br>(0.03)                     | 1.52<br>(0.06)                 | 15.1<br>(0.595)              | 0.383<br>(0.268)              |
| 3      | XLPE/PVC, 12 AWG, 7/C        | General Cable           | 770950        | 7         | 12             | 2.3<br>(0.092)                            | 0.76<br>(0.03)                     | 1.52<br>(0.06)                 | 15.1<br>(0.595)              | 0.372<br>(0.260)              |
| 8      | XLPO/XLPO, 12 AWG, 7/C       | Rockbestos - Surprenant | C12-0070      | 7         | 12             | 2.3<br>(0.092)                            | 0.51<br>(0.02)                     | 0.89<br>(0.035)                | 12.2<br>(0.48)               | 0.307<br>(0.215)              |
| 9      | SR/Aramid Braid, 12 AWG, 7/C | First Capitol           | SRG-K         | 7         | 12             | 2.3<br>(0.092)                            | 1.27<br>(0.05)                     | 1.02<br>(0.04)                 | 14.5<br>(0.57)               | 0.343<br>(0.240)              |
| 10     | XLPE/CSPE, 12 AWG, 7/C       | Rockbestos - Surprenant | C52-0070      | 7         | 12             | 2.3<br>(0.092)                            | 0.76<br>(0.03)                     | 1.52<br>(0.06)                 | 15.0<br>(0.59)               | 0.393<br>(0.275)              |
| 11     | VITA-LINK, 14 AWG, 7/C       | Rockbestos - Surprenant | Special Order | 7         | 14             | 1.85<br>(0.073)                           | 1.54<br>(0.060)                    | 1.91<br>(0.075)                | 19.6<br>(0.77)               | 0.479<br>(0.335)              |
| 12     | TEF/TEF, 12 AWG, 7/C         | Cable USA               | Special Order | 7         | 12             | 2.3<br>(0.092)                            | 0.41<br>(0.016)                    | 0.51<br>(0.020)                | 10.2<br>(0.40)               | 0.279<br>(0.196)              |
| 15     | PE/PVC, 12 AWG, 7/C          | General Cable           | 256750        | 7         | 12             | 2.3<br>(0.092)                            | 0.76<br>(0.03)                     | 1.14<br>(0.045)                | 15.0<br>(0.59)               | 0.522<br>(0.255)              |



**Table 3.3: Physical Properties of the CAROLFIRE Cables (continued)****Power Cables**

| Item # | Short Description     | Manufacturer            | Part Number | No. Cond. | Cond. Size AWG | Cond. Diameter <sup>1</sup> mm (in) | Insulation Thickness mm (in) | Jacket Thickness mm (in) | Cable Diameter mm (in) | Net Weight kg/m (lb/ft) |
|--------|-----------------------|-------------------------|-------------|-----------|----------------|-------------------------------------|------------------------------|--------------------------|------------------------|-------------------------|
| 5      | PVC/PVC, 8 AWG, 3/C   | General Cable           | 236370      | 3         | 8              | 3.71<br>(0.146)                     | 0.91<br>(0.036)              | 1.52<br>(0.06)           | 15.2<br>(0.6)          | 0.440<br>(0.308)        |
| 14     | XLPE/CSPE, 8 AWG, 3/C | Rockbestos - Surprenant | P62-0084    | 3         | 8              | 3.71<br>(0.146)                     | 1.14<br>(0.045)              | 1.52<br>(0.06)           | 16.3<br>(0.64)         | 0.508<br>(0.355)        |

**Instrument Cables**

| Item # | Short Description                      | Manufacturer            | Part Number | No. of Cond. | Cond. Size AWG | Cond. Diameter <sup>1</sup> mm (in) | Insulation Thickness mm (in) | Jacket Thickness mm (in) | Cable Diameter mm (in) | Net Weight kg/m (lb/ft) |
|--------|--|-------------------------|-------------|--------------|----------------|-------------------------------------|------------------------------|--------------------------|------------------------|-------------------------|
| 4      | PVC/PVC, 16 AWG, 2/C SH <sup>4</sup>   | General Cable           | 230830      | 2            | 16             | 1.47<br>(0.058)                     | 0.71<br>(0.028)              | 1.52<br>(0.060)          | 7.62<br>(0.30)         | 0.073<br>(0.051)        |
| 6      | PVC/PVC, 18 AWG, 12/C                  | General Cable           | 236120      | 12           | 18             | 1.17<br>(0.046)                     | 0.51<br>(0.02)               | 1.14<br>(0.045)          | 11.3<br>(0.445)        | 0.187<br>(0.131)        |
| 7      | XLPE/CSPE, 16 AWG, 2/C SH <sup>4</sup> | Rockbestos - Surprenant | I46-0021    | 2            | 16             | 1.47<br>(0.058)                     | 0.635<br>(0.025)             | 1.14<br>(0.045)          | 7.87<br>(0.31)         | 0.093<br>(0.065)        |
| 13     | XLPE/CSPE, 18 AWG, 12/C                | Rockbestos - Surprenant | I57-0120    | 12           | 18             | 1.17<br>(0.046)                     | 0.635<br>(0.025)             | 1.14<br>(0.045)          | 12.7<br>(0.5)          | 0.222<br>(0.155)        |

**Notes:**

- 1 – Values are based on National Fire Protection Association (NFPA) standard 70 National Electric Code 2002, Table 8 Conductor Properties, page 70-625.
- 2 – Values are based on information provided by the manufacturer.
- 3 – Values are based on measured cable samples.
- 4 – Both items #4 and #7 have a foil shield (SH). The drain wire for item #7 is an 18 AWG 16-strand un-insulated wire.

## 4 PRIMARY MEASUREMENTS AND PERFORMANCE DIAGNOSTICS

A number of variables were investigated in this test program. For the purpose of discussion, these variables have been divided into four general categories; namely, characterization of the thermal exposure conditions, general fire behavior, cable thermal response, and cable electrical performance. The following sections provide a discussion of each of these diagnostic groups. Note that the focus here has been placed on the exposure conditions and the cable electrical performance diagnostics. Extensive discussions of the cable thermal response and fire behavior have been deferred to Volume 2 of this report as they are of primary interest to the fire model improvement need area.

### 4.1 Thermal Exposure Conditions

#### 4.1.1 *Penlight* Exposure Conditions

There were two variables that characterized the exposure conditions in any given *Penlight* test; namely, (1) the shroud temperature and (2) the raceway/routing configuration. The shroud temperature can be converted to a nominal radiant heat flux based on the following equation:

$$\dot{q}'' = \sigma \epsilon T^4 \quad (1)$$

where ( $\sigma$ ) is the Stefan-Boltzmann constant ( $5.67\text{E-}8 \text{ W/m}^2\text{K}^4$ ) and ( $\epsilon$ ) is the emissivity of the shroud surface. The shroud emissivity is approximately 0.81-0.82 for the range of temperatures used in the CAROLFIRE tests. Volume 2 of this report provides a more complete discussion of the exposure conditions. The maximum shroud temperature is nominally about 900°C.

Given the nature of typical NPP fires, it was deemed to be desirable to adjust the heat flux to yield cable failure times nominally on the order of 10-30 minutes. This was considered typical of the types of fire scenarios found to be important to fire risk analyses. The heating intensity used in the CAROLFIRE tests was ‘tuned’ to each cable tested because the cables being tests displayed a wide range of thermal ‘robustness’ and resistance to fire-induced electrical failure. The appropriate flux levels were determined during a series of 26 Preliminary tests. The actual values used in each test have been defined in the test matrices which are presented in Chapter 5.

#### 4.1.2 Intermediate-scale Tests

The intermediate-scale tests involved open burning. The initial fire was created by a propylene gas burner running at a nominal HRR of 200-350 kW depending on the specific test conditions. In general, tests were initiated with the gas burner at about 200kW. In some tests, once all of the electrically monitored cables located directly above the fire had failed, the burner intensity was increased to as high as 350 kW. This was done in order to create hot gas layer conditions sufficiently severe so as to induce failure of cables located outside the fire plume within a reasonable time period.

### 4.1.3 Raceway Descriptions

Two types of raceways were employed for CAROLFIRE during both the *Penlight* and intermediate-scale tests. First were 300 mm (12-inch) wide standard ladder-back cable trays and second were 63 mm (2 ½ inches) diameter standard rigid metal conduit.<sup>12</sup> A limited number of tests were also conducted on unsupported cables (i.e., simulated “air drops” where the cable is not supported by a raceway).

For *Penlight*, a single raceway (either a tray or conduit) was routed horizontally through the exposure shroud such that the cables would be located at the centerline of the shroud cylinder. The raceways and cables extended entirely through the shroud and to a length of about 71mm (18 inches) beyond the shroud ends. To simulate an air drop, cables were simply suspended on external supports and run horizontally through the approximate center of the chamber.

For the intermediate-scale tests, the raceways and cables were extended across the entire 2.4 m (8') width of the test structure. Various locations were used for the routing of cables (see Section 3.3 above), and all but one of these was above the lower edge of the enclosed portion of the test structure (i.e., 1.8 m (6') or more above the floor). All electrical connections were made outside the test structure, but within the outer test chamber. Note also that the test structure itself and the installed raceways were grounded.

## 4.2 Fire Behavior

The CAROLFIRE tests were not designed explicitly as fire characterization tests. The focus of this project was not on fire behavior. The intent was, however, to take an “opportunistic” view of fire behavior data gathering. That is, as opportunities and budgets allowed, fire characterization data was gathered, but not as a project priority.

Temperature measurements were gathered for the cables, for the surrounding air in key locations, and the raceways themselves. Measurements of the oxygen concentration, air temperature, and air flow velocity were also made in the stack exiting the outer test facility. This allowed for a nominal calculation of fire HRR based on oxygen consumption calorimetry, although given the ventilation configuration, there was a significant lag between changes in the fire and the detection of those changes at the outlet stack.

This report provides little discussion of the fire environment data. These data are of primary interest to the fire modeling need area and have been deferred to Volume 2 of this report.

---

<sup>12</sup> The cable trays procured for CAROLFIRE are B-Line® Series 2 style steel trays with (per manufacturer specifications) a nominal 3" NEMA VE 1 loading depth, 4" side rail, and 9" rung spacing. The specific part number is 248P09-12-144. Dimensional drawings are available at the manufacturer's website, 'www.b-line.com' and in Volume 2 of this report. The conduits are standard grade rigid metallic conduit procured from a local electrical supply house.

### 4.3 Cable Thermal Response

All the measurements required to satisfy the RIS 2004-03 Bin 2 were electrical in nature. Hence, measurements of the thermal response were primarily of interest to the fire modeling activities. The ability to directly correlate the cable thermal and cable electrical performance (e.g., failure time and mode) was a key element of the fire model improvement need area and this aspect of the data is one of the most unique characteristics of the CAROLFIRE tests. Detailed discussion of thermal response data has been deferred to Volume 2 of this report.

In general, CAROLFIRE committed substantial effort to the gathering of cable thermal response data. This included the monitoring of air temperatures near the cables, raceway surface temperatures, and cable surface temperatures. In addition, considerable effort was spent to gather data on the thermal response within the cables themselves. Cable internal response was generally measured with TCs embedded just below the outer jacket, but in several tests, TCs were also embedded into the center of cables in an attempt to characterize the internal heat transfer response. Monitoring included both individual cables and cable bundles.

As has been noted above, no single cable was monitored for both thermal response and electrical performance. This practice is based on past experience which has established that installation of a TC on, or within, a cable will impact the electrical failure behavior. Instead, for essentially each cable monitored for electrical performance, an identical ‘mirror’ cable (in an adjacent or symmetric location) was monitored for thermal response. None of the cables monitored for electrical performance were instrumented for thermal response.

Finally, in the intermediate-scale tests two slug calorimeters were used to monitor net heat flux to well characterized targets in key locations within the test structure. One calorimeter was located near the ceiling of the test structure directly above the fire and the second at a side location within the enclosed portion of the test structure. The slug calorimeters were made from lengths of solid brass rod with a TC embedded in the center and with the ends insulated. This presented a roughly one-dimensional heating target that was similar in size to the cables themselves.

### 4.4 Cable Electrical Performance – The IRMS

The first of two cable electrical performance monitoring systems used in CAROLFIRE was the SNL Insulation Resistance Measurement System (IRMS). The IRMS can monitor the insulation resistance (IR) between any pair of individual conductors, between any conductor and ground, between groups of conductors (e.g., between two separate cables), and between a group of conductors and ground. For CAROLFIRE all these modes of operation were used. The IRMS is described in detail in Appendix B.

The IRMS provided a continuous stream of cable IR data and thereby measured the progressive degradation of the cables insulating power. The actual IR that might be considered to induce the failure of a circuit depends on the nature and sensitivity of the actual circuit. For CAROLFIRE a general criterion has been applied to reflect a typical 120 VAC control circuit and to reflect the typical faulting behavior observed in previous testing. For purposes of analysis, a control cable was

considered to have failed when any one of the monitored conductors shorts to ground (e.g., the cable tray or conduit) or to another conductor with an IR of less than or equal to 1000 Ω. These particular insulation resistance limits were selected by the CAROLFIRE team as representative of expected failure onset conditions for control and instrument circuits. This value was also chosen because the typical behavior of a cable during fire exposure involved a fairly steady degradation of IR with rising temperature until the IR value reaches about 1000 Ω. At this point, the cable will typically experience rapid degradation to IRs of typically less than 100 Ω. Hence, the use of 1000 Ω as a general failure criteria was representative of this behavior.

A typical cable response plot for the IRMS is illustrated in Figure 4.1. This example was taken from *Penlight* Test 11 which involved the ‘core’ 7-conductor 12 AWG XLPE-insulated cable (item #10). The numbering of the conductors for this test is illustrated in Figure 4.2.

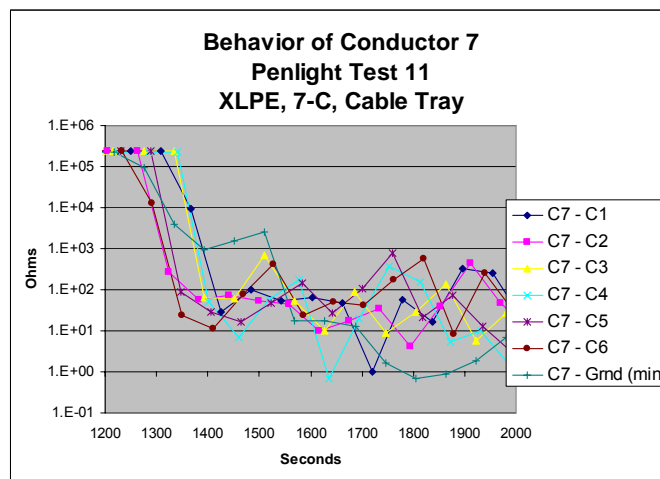


Figure 4.1: Example of a typical IRMS data plot taken from *Penlight* Test 11.

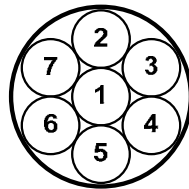
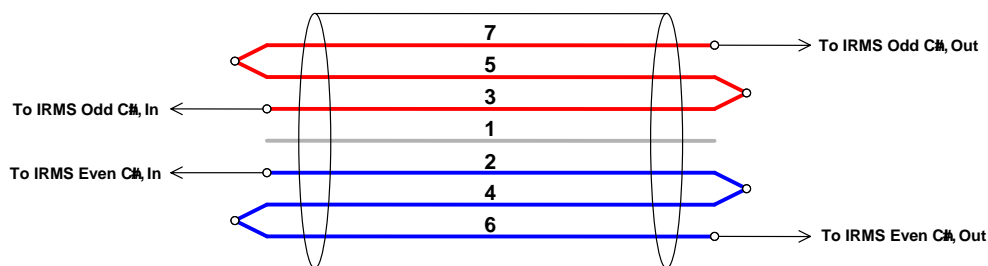


Figure 4.2: Illustration of the conductor numbering scheme used in all tests involving the 7-conductor control cables.

In this case, the shorting behavior of Conductor 7 has been illustrated, one of the three conductors involved in the first failures observed for this test. Note that the data show that the initial faulting was intra-cable shorting between conductors 7 and 2 (C7-C2), and between conductors 7 and 6 (C7-C6). As illustrated above, these were adjacent conductors in the outer ring of conductors for this cable. Complementary plots for each of the other six conductors present were also developed as a part of the data processing, although these plots have not been reproduced here.

When bundles of cables were tested, the IRMS was generally used to monitor for shorting behaviors between different cables in the same bundle (inter-cable shorting). This was an important measurement necessary to address two of the RIS 2004-03 Bin 2 Items under investigation (i.e., Bin 2 items ‘A’ and ‘B’). In these tests, the typical practice was to group the conductors of each of the co-located cables into two groups. For a 7-conductor cable there is one central conductor surrounded by six cables in an outer ring around this central conductor. The six outer conductors were connected into two groups of three conductors each with each group comprised of alternate conductors in the outer ring. In this way, the IRMS is able to determine when each cable shorts internally (intra-cable shorting), when each cable shorts to ground, and when two co-located cables short to each other (inter-cable shorting). The typical grouping of the conductors, using the same conductor numbering scheme as illustrated in Figure 4.2, is shown in Figure 4.3.



**Figure 4.3: Illustration of the grouping of the conductors in a single 7-conductor cable with conductors 2, 4 & 6 connected to one IRMS channel and conductors 3, 5 & 7 connected to a second IRMS channel. This configuration was used when testing cable bundles in order to determine the relative timing of intra-cable faults, faults to an external ground, and inter-cable faults in support of efforts to resolve Bin 2 Items A and B.**

Note that given this arrangement, each cable was associated with two channels of the IRMS. In the discussion in Chapters 6 and 7 these have been designated by ‘conductor’ label that indicates the cable and IRMS channel. For example, Cable A was generally connected to IRMS channels 1 and 2 so the two cable A conductor groups were referred to as ‘conductor A1’ and ‘conductor A2.’ Similarly, cable B was generally connected to IRMS channels 3 and 4 and the two cable B conductor groups were referred to as ‘conductor B3’ and ‘conductor B4.’ This continued for the rest of the cables being monitored.

## 4.5 Cable Electrical Performance – The SCDUs

The second electrical performance monitoring system used in CAROLFIRE was the Surrogate Circuit Diagnostic Unit (SCDU). A total for four SCDUs were used in CAROLFIRE. The general design of the SCDUs is described in detail Appendix C. The subsections which follow describe the specific configurations in which the SCDUs were used during various tests.

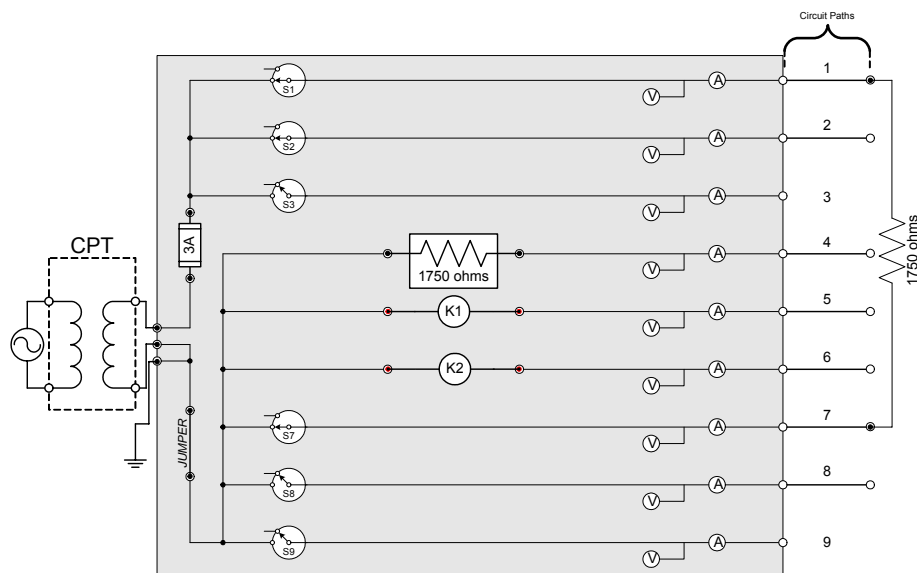
In the majority of tests each SCDU was connected to one cable. In most of these cases each SCDU was configured to simulate a representative MOV control circuit in exactly the same manner as was done for the NEI/EPRI tests. This circuit configuration was referred to as configuration MOV-1 and

is described in Section 4.5.1. Variations on this base MOV-1 configuration are described in Sections 4.5.2 and 4.5.3.

In a small number of tests, the SCDUs were configured explicitly to investigate the potential for inter-cable hot-shorts and spurious actuations with one (or more) cable(s) acting as an energized source and one (or more) separate co-located cable(s) acting as the potential actuation target(s). These configurations are described in Section 4.5.4.

#### 4.5.1 Configuration MOV-1

For most tests, the SCDUs were used to obtain circuit behavior data in a manner essentially identical to the motor operated valve (MOV) surrogate test circuits utilized during the EPRI/NEI tests and the more recent Duke Energy (2006) tests. This is the configuration that is referred to in this report as the ‘MOV-1’ configuration. Figure 4.4 illustrates this configuration.



**Figure 4.4: MOV-1 SCDU circuit configuration with two active targets (paths 5&6) and one passive target (path 4). Paths 1 and 2 are the energized sources, path 7 is grounded, and path 8 monitors a spare conductor. Note that circuit paths 3 and 9 are not used.**

Note that the circuit was configured for the testing of a seven-conductor control cable. The standard configuration used two energized source conductors (Paths 1 and 2), one passive target (a 1750  $\Omega$  resistor on Path 4) and two active motor contactor targets (connected to Paths 5 and 6). Path 7 was connected to one conductor in the cable and grounded. Path 8 was connected to one conductor in the cable, but was not grounded (switch left open) thus simulating a spare conductor in the cable. A 1.75 (or 1.8) k- $\Omega$  resistor connected Circuit Paths 1 (energized source) and 7 (grounded or return conductor) at the far end of the exposed cable simulating the burden imposed by the normally lit indicating lamp.

Note that Path 3 was not connected to any of the cable conductors. Path 3 was monitored routinely during testing, but the data for this path were not relevant to circuit performance in any way. Also

note that in practice, while transducers were provided for circuit path 9, they were not monitored or used in the CAROLFIRE testing. CAROLFIRE actively monitored only Paths 1-8. Path 9 was simply not used and not monitored in any test. (Dropping the ninth circuit path allowed us to use an existing high-speed 64 channel data logging system to monitor all four SCDUs.)

Also note that all of the MOV-1 configuration tests used the so-called ‘source-centered’ wiring scheme. This wiring configuration was found in the original NEI/EPRI tests to be the configuration most likely to lead to spurious actuation. Consistent with the recent Duke Energy (2006) tests, this same wiring configuration was used in CAROLFIRE as well. Using the conductor numbering scheme illustrated in Figure 4.2, the ‘source-centered’ wiring configuration is as follows:

- Conductors 1&2 are the two energized sources (connected to circuit paths 1 and 2 on the SCDU).
- Conductors 3&7 are the two active targets (connected the two motor contactor relay coils on circuit paths 5 and 6 of the SCDU).
- Conductor 4 is connected to the passive target (the 1.75k-ohm resistor on circuit path 4 of the SCDU).
- Conductor 5 is grounded (connected to circuit path 7 on the SCDU).
- Conductor 6 is the spare conductor (connected to circuit path 8 on the SCDU).

#### **4.5.2 Configuration MOV-1a**

In Intermediate-scale Preliminary Test 4 (IP-4) only an error was made in the wiring of the burden resistor to the tested cable. (This wiring error was repeated for all four of the SCDU circuits in this test.) The intent was to conduct this test in the MOV-1 configuration, but the burden resistor was inadvertently connected between Circuit Path 1 and Circuit Path 4 (rather than between Circuit Path 1 and Circuit Path 7). Circuit Path 4 was configured as a passive target (per the normal MOV-1 configuration). The wiring error in effect created a voltage divider circuit on Path 4 and reduced the base current load on Circuit Path 1 by half (by doubling the return path resistance). This error became obvious during data analysis and only impacts test IP-4. All other characteristics of this configuration were the same as configuration MOV-1.

#### **4.5.3 Actuation Circuit 1**

The configuration referred to as Actuation Circuit 1 (shown as ‘AC-1’ in the summary tables) was used in only one test involving a 3-conductor plus drain 8 AWG cable (IT-3 – SCDU Circuit 4). In this configuration, Circuit Path 1 was energized (switch closed) and connected to one insulated conductor. Circuit Paths 5 and 6 were the active motor contactor targets and were connected to the second and third insulated conductors, respectively. The drain wire was connected to Circuit Path 7, whose switch was closed thereby grounding the drain wire (as would be typical in actual practice). This test was run on SCDU-4, so the CPT is also grounded.

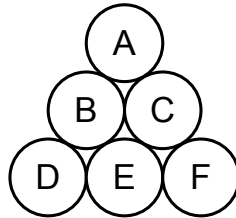


#### 4.5.4 Inter-Cable Configuration

Four of the intermediate-scale tests (IT2-IT5) were conducted using SCDU configurations specifically designed to seek out potential inter-cable interactions either between two TS cables, or between a TS and a TP cable. This configuration is specific to Bin 2 Items A and B, and in particular, Item B relating to TS-to-TP interactions. The details of each test arrangement are provided in Volume 2 of this report and are summarized in Section 7 below as applied for each test.

The typical Inter-Cable configuration (designated as an ‘IC’ configuration in the summary tables presented below) closed the switches energizing SCDU Circuit Paths 1 and 2. Each source path was then connected to all of the conductors in one cable. This created two separate cables either of which could act as the energizing source for an inter-cable hot-short. The three target conductor paths (4, 5, &6) were then connected to the conductors of a third cable. As a result there were two source cables and one target cable.

In the typical arrangement, the three cables connected to the SCDU (two sources and one target) were placed together at the top of a triangular arrangement of six cables. Three additional cables were placed in a row at the bottom of the triangle and were not connected to the SCDUs at all. As a result, the source and target cables were not in direct contact with the raceway. This bundling arrangement is illustrated in Figure 4.5 where cables A&B would typically be the two source cables, and Cable C would be the target cable. Cables D, E&F are the three cables that are not connected to the SCDU.



**Figure 4.5: Illustration of a typical six-cable bundle arrangement with the cable tray rungs below cables D-E-F.**

It should be noted that for the three grounded SCDU circuits (SCDU circuits 2, 3 &4) hot-shorts or spurious actuations impacting the target cable can *only* occur given inter-cable shorting that remains independent of the external ground. Any short between an energized source conductor and the external ground (i.e., the raceway) would cause a fuse blow.

The ungrounded SCDU Circuit 1 is unique in this regard and requires some special consideration. SCDU Circuit 1 is not grounded; hence, a spurious actuation could occur either through inter-cable shorting or via multiple shorts to ground. Also, because the CPT return path is *not present* in the test structure, there was no way to cause a fuse blow failure. For this particular setup, actuation of the active targets on SCDU Circuit 1 was inevitable. The IC configuration tests for SCDU circuit 1 must be, and have been, viewed and interpreted in this context. That is, for SCDU in the IC configuration, spurious actuations are not necessarily attributed to inter-cable hot-shorts.

## 5 TEST MATRICES

### 5.1 Overview of Test Matrices

Tables are presented below for both the *Penlight* and intermediate-scale tests. The tables are deferred to the end of the chapter given their length. A goal of the program was to maintain the option to adjust the test matrices based on insights gained as the program progressed. Adjustments were in fact made at various points in the program, and always in consultation with both the NRC staff and collaborative partners NIST and UMd. The test matrices described here document the tests as performed. Some of the tests originally planned for *Penlight* were ultimately deleted and not performed. In order to maintain continuity relative to the naming of the tests, these deleted tests are still shown in the matrix, although they are indicated as “did not run.” (Note that test numbering is also consistent between the two volumes of this report.)

For each test, a number of relevant factors were defined. At both testing scales a certain number of ‘preliminary’ tests were conducted prior to entering the primary test matrix, and these are numbered separately from the primary tests. Each test has been given a unique test prefix and number. The prefix “PP” indicates Preliminary *Penlight* tests, PT indicates *Penlight* Tests in the primary *Penlight* matrix, IP indicates Intermediate-scale Preliminary tests, and IT indicates Intermediate-scale Tests in the primary matrix. Note that all tests provided some insights relevant to one or both need areas, and have been analyzed and reported accordingly.

For the other cited test parameters, an “X” in any given column indicates the active choice for each experimental variable. In some cases, multiple choices have been indicated (e.g., more than one cable type was often involved and, in the intermediate-scale tests, more than one raceway type was often tested). The primary test variables were:

Cable Insulation and Jacket Material - specifies the cable insulation and jacket materials for the cables being tested, the type of cable,

Number of Conductors - specifies the number of conductors contained within the cable,

Conductor Size - identifies the AWG size of the copper conductors within the cable,

Cable Bundle Size - indicates the number of cables in each bundle of cables to be included in the test (note that some intermediate-scale tests involve more than one cable bundle),

Thermal Exposure - specifies the thermal exposure conditions which vary somewhat depending on the test facility. For *Penlight*, the thermal exposure is defined by the incident heat flux (or equivalently the shroud temperature). For the Intermediate-Scale open burn tests, the thermal exposure is defined by the nominal intensity of the gas burner, and

Raceway Type - indicates how the cable or cable bundles were routed. Raceway types are no raceway (air drop), cable tray, and conduit (for *Penlight*, only one raceway type is indicated but for the intermediate-scale tests multiple raceway types may be indicated).

The intermediate-scale test matrix has one additional column (third from left):

Location - indicates the raceway locations in the Intermediate-Scale Test Structure. Note that these tests all involve cables located in more than one of the available locations. These locations are identified by letter (A-G) and are shown schematically in Figure 3.6.

## 5.2 The *Penlight* Small-Scale Test Matrix

Table 5.1 provides a test matrix for the Preliminary *Penlight* tests (PP-1 through PP-26). These tests were performed primarily in order to assess the general relationship between shroud temperature and the cables' electrical failure times. The PP tests were mainly of interest to the fire model improvement need area. They provided no data relevant to the Bin 2 issues and have not been discussed in this volume of the report (see Volume 2).

Table 5.2 provides the primary matrix of *Penlight* Tests (PT-1 through PT-68 and Special Test S1). These tests have been organized into several groups. Each test group represented a set of tests designed to explore a particular aspect of the overall cable failure behavior. The general nature of each test group is described in the following paragraphs.

The tests identified as Group 1 were primarily fire model calibration tests. That is, these tests were primarily aimed at the fire modeling improvement need area. The primary objective of the Group 1 tests was to provide temperature response data to support the development of the cable thermal response models. The Group 1 tests represented the most simplistic of all possible cable exposure configurations. Each test in Group 1 involved two single lengths of cable either in open air, in a cable tray, or in a conduit. One cable is monitored for thermal response, and the second (in a symmetric location) is monitored for electrical failure using the IRMS. For the tray test, the two lengths of cables were located in symmetric locations to either side of the cable tray's horizontal centerline. For the conduit and air-drop tests, the two cables were routed side-by-side. The main purpose of the Group 1 tests was to correlate the cable's thermal response and electrical performance under simplistic exposure conditions. The Group 1 tests are not relevant to resolution of the Bin 2 items because the Bin 2 Items are not generally associated with the failure of individual cables.

The remaining test groups were designed to progressively address the Bin 2 items with increasing degrees of complexity and through variations in test parameters. In general, Group 2 represented the Bin 2 baseline test runs. These tests represented a core set of failure mode tests providing initial results relevant to the Bin 2 items with small and simple bundles of like cables. The remaining *Penlight* tests represented variations on the Group 2 tests. Each subsequent test varied one or more of the testing parameters (e.g., exposure heat flux, cable type, mixing of cable types, bundle size, etc.). These *Penlight* tests were particularly designed to address Bin 2 Items A and B, those items associated with inter-cable shorting.

Note that some of the tests listed in the matrix include the notation "did not run." These tests were, in fact, not conducted, but were maintained in the test matrix in the interest of continuity of the test numbering scheme used during the test planning process and during initial distributions of preliminary test data to the CAROLFIRE collaborative partners. The reasons why specific tests or groups of tests were not conducted have been explained in Chapter 6 in conjunction with the discussion of test results.

### **5.3 The Intermediate-Scale Test Matrix**

Table 5.3 provides a test matrix for the intermediate-scale tests. There were four Intermediate Preliminary Tests (IP-1 through IP-4) and 14 primary matrix Intermediate Tests (IT-1 through IT-14). All of the intermediate-scale tests provided data directly relevant to resolution of the Bin 2 Items, and, again, involved increasing levels of configuration complexity and the variation of test parameters.

Note that just one IRMS was used in intermediate-scale tests IP-1 through IT-5. Beginning with IT-6, two IRMS units were used in each test. The SCDUs were used starting with Test IP-3 and throughout the remainder of the intermediate-scale test series. Test IP-3 used one SCU and the remaining tests all used all four SCDUs. The exact configurations of these systems are summarized in Chapter 7.

**Table 5.1: Matrix of Preliminary Penlight Tests (PP-1 through PP-26).**

| Test PP-# | Cable Insulation Material |     |    |      |       |           |    |     |        | Cable Item number | Number of Conductors |   |   |    | Conductor Size (AWG) |    |    |    |    | Cable Bundle Size | Thermal Exposure °C | Raceway Type |   |   |      |         |          |
|-----------|---------------------------|-----|----|------|-------|-----------|----|-----|--------|-------------------|----------------------|---|---|----|----------------------|----|----|----|----|-------------------|---------------------|--------------|---|---|------|---------|----------|
|           | TS                        |     |    |      | TS/TP | Vita-Link | TP |     |        |                   | 3                    | 2 | 7 | 12 | 8                    | 12 | 14 | 16 | 18 |                   |                     | 1            | 3 | 6 | Tray | Conduit | Air Drop |
|           | XLPE                      | EPR | SR | XLPO |       |           | PE | PVC | Tefzel |                   |                      |   |   |    |                      |    |    |    |    |                   |                     |              |   |   |      |         |          |
| 1         | X                         |     |    |      |       |           |    |     |        | 10                |                      |   | X |    |                      |    |    |    | X  |                   |                     | 665          | X |   |      |         |          |
| 2         | All data lost             |     |    |      |       |           |    |     |        |                   |                      |   |   |    |                      |    |    |    |    |                   |                     |              |   |   |      |         |          |
| 3         | X                         |     |    |      |       |           |    |     |        | 10                |                      |   | X |    |                      |    |    |    | X  |                   |                     | 600          | X |   |      |         |          |
| 4         |                           |     |    |      |       |           |    |     | X      | 1                 |                      |   | X |    |                      |    |    |    | X  |                   |                     | 450          | X |   |      |         |          |
| 5         |                           |     | X  |      |       |           |    |     |        | 9                 |                      |   | X |    |                      |    |    |    | X  |                   |                     | 665          | X |   |      |         |          |
| 6         | X                         |     |    |      |       |           |    |     |        | 10                |                      |   | X |    |                      |    |    |    | X  |                   |                     | 665          | X |   |      |         |          |
| 7         |                           |     |    |      |       |           |    |     | X      | 1                 |                      |   | X |    |                      |    |    |    | X  |                   |                     | 300          | X |   |      |         |          |
| 8         |                           |     |    |      |       |           |    |     | X      | 1                 |                      |   | X |    |                      |    |    |    | X  |                   |                     | 330          | X |   |      |         |          |
| 9         | X                         |     |    |      |       |           |    |     |        | 10                |                      |   | X |    |                      |    |    |    | X  |                   |                     | 500          | X |   |      |         |          |
| 10        |                           |     | X  |      |       |           |    |     |        | 9                 |                      |   | X |    |                      |    |    |    | X  |                   |                     | 900          | X |   |      |         |          |
| 11        |                           | X   |    |      |       |           |    |     |        | 2                 |                      |   | X |    |                      |    |    |    | X  |                   |                     | 650          | X |   |      |         |          |
| 12        |                           | X   |    |      |       |           |    |     |        | 2                 |                      |   | X |    |                      |    |    |    | X  |                   |                     | 500          | X |   |      |         |          |
| 13        |                           | X   |    |      |       |           |    |     |        | 2                 |                      |   | X |    |                      |    |    |    | X  |                   |                     | 400          | X |   |      |         |          |
| 14        |                           |     |    |      |       |           |    |     | X      | 1                 |                      |   | X |    |                      |    |    |    | X  |                   |                     | 325          | X |   |      |         |          |
| 15        |                           |     |    |      |       |           |    |     | X      | 1                 |                      |   | X |    |                      |    |    |    | X  |                   |                     | 260          | X |   |      |         |          |
| 16        | X                         |     |    |      |       |           |    |     |        | 10                |                      |   | X |    |                      |    |    |    | X  |                   |                     | 475          | X |   |      |         |          |
| 17        |                           | X   |    |      |       |           |    |     |        | 2                 |                      |   | X |    |                      |    |    |    | X  |                   |                     | 460          | X |   |      |         |          |
| 18        |                           |     |    |      |       |           |    |     | X      | 12                |                      |   | X |    |                      |    |    |    | X  |                   |                     | 295          | X |   |      |         |          |
| 19        |                           |     |    |      |       |           |    | X   |        | 15                |                      |   | X |    |                      |    |    |    | X  |                   |                     | 300          | X |   |      |         |          |
| 20        |                           |     |    |      |       |           |    | X   |        | 15                |                      |   | X |    |                      |    |    |    | X  |                   |                     | 325          | X |   |      |         |          |
| 21        |                           |     |    | X    |       |           |    |     |        | 8                 |                      |   | X |    |                      |    |    |    | X  |                   |                     | 475          | X |   |      |         |          |
| 22        |                           |     |    | X    |       |           |    |     |        | 8                 |                      |   | X |    |                      |    |    |    | X  |                   |                     | 470          | X |   |      |         |          |
| 23        |                           |     |    |      |       |           |    |     | X      | 12                |                      |   | X |    |                      |    |    |    | X  |                   |                     | 350          | X |   |      |         |          |
| 24        |                           |     |    |      |       | X         |    |     |        | 11                |                      |   | X |    |                      |    |    |    | X  |                   |                     | 675          | X |   |      |         |          |
| 25        | X                         |     |    |      |       |           |    |     |        | 10                |                      |   | X |    |                      |    |    |    | X  |                   |                     | 665          |   | X |      |         |          |
| 26        | X                         |     |    |      |       |           |    |     |        | 10                |                      |   | X |    |                      |    |    |    | X  |                   |                     | 665          | X |   |      |         |          |

**Table 5.2: Primary Matrix of CAROLFIRE Penlight Tests (PP-1 through PP-68 and Spec. 1)**

| Test PT-# | Primary Application | Cable Insulation and Jacket Material |         |           |      |           |       |          |        | Cable Item numbers | Number of Conductors |   |   |    | Conductor Size (AWG) |    |    |    |    | Cable Bundle Size | Thermal Exposure °C (note 1) | Raceway Type |   |   | Group # |      |         |          |         |
|-----------|---------------------|--------------------------------------|---------|-----------|------|-----------|-------|----------|--------|--------------------|----------------------|---|---|----|----------------------|----|----|----|----|-------------------|------------------------------|--------------|---|---|---------|------|---------|----------|---------|
|           |                     | TS/TS                                |         |           |      |           | TS/TP | TP/TP    |        |                    | 3                    | 2 | 7 | 12 | 8                    | 12 | 14 | 16 | 18 |                   |                              | 1            | 3 | 6 |         | Tray | Conduit | Air Drop |         |
|           |                     | XLPE/CSPE                            | EPR/CPE | SR/Aramid | XLPO | Vita-Link |       | XLPE/PVC | PE/PVC |                    |                      |   |   |    |                      |    |    |    |    |                   |                              |              |   |   |         |      |         |          | PVC/PVC |
| 1         | FMI                 | X                                    |         |           |      |           |       |          | 14     | X                  |                      |   |   | X  |                      |    |    |    | X  |                   |                              | 475          | X |   |         | 1    |         |          |         |
| 2         | FMI                 | X                                    |         |           |      |           |       |          | 14     | X                  |                      |   |   | X  |                      |    |    |    | X  |                   |                              | 470          | X |   |         |      |         |          |         |
| 3         | FMI                 | X                                    |         |           |      |           |       |          | 14     | X                  |                      |   |   | X  |                      |    |    |    | X  |                   |                              | 170          | X |   |         |      |         |          |         |
| 4         | FMI                 |                                      |         |           |      |           |       |          | 5      | X                  |                      |   |   | X  |                      |    |    |    | X  |                   |                              | 300          | X |   |         |      |         |          |         |
| 5         | FMI                 |                                      |         |           |      |           |       |          | 5      | X                  |                      |   |   | X  |                      |    |    |    | X  |                   |                              | 300          | X |   |         |      |         |          |         |
| 6         | FMI                 |                                      |         |           |      |           |       |          | 5      | X                  |                      |   |   | X  |                      |    |    |    | X  |                   |                              | 300          | X |   |         |      |         |          |         |
| 7         | FMI                 | X                                    |         |           |      |           |       |          | 14     | X                  |                      |   |   | X  |                      |    |    |    | X  |                   |                              | 470          |   | X |         |      |         |          |         |
| 8         | FMI                 |                                      |         |           |      |           |       |          | 5      | X                  |                      |   |   | X  |                      |    |    |    | X  |                   |                              | 300          |   | X |         |      |         |          |         |
| 9         | FMI                 | X                                    |         |           |      |           |       |          | 14     | X                  |                      |   |   | X  |                      |    |    |    | X  |                   |                              | 470          |   |   | X       |      |         |          |         |
| 10        | FMI                 |                                      |         |           |      |           |       |          | 5      | X                  |                      |   |   | X  |                      |    |    |    | X  |                   |                              | 300          |   |   | X       |      |         |          |         |
| 11        | FMI                 | X                                    |         |           |      |           |       |          | 10     |                    |                      | X |   |    | X                    |    |    |    | X  |                   |                              | 470          | X |   |         |      |         |          |         |
| 12        | FMI                 | X                                    |         |           |      |           |       |          | 10     |                    |                      | X |   |    | X                    |    |    |    | X  |                   |                              | 470          | X |   |         |      |         |          |         |
| 13        | FMI                 | X                                    |         |           |      |           |       |          | 10     |                    |                      | X |   |    | X                    |    |    |    | X  |                   |                              | 470          | X |   |         |      |         |          |         |
| 14        | FMI                 |                                      |         |           |      |           |       | X        | 15     |                    |                      | X |   |    | X                    |    |    |    | X  |                   |                              | 300          | X |   |         |      |         |          |         |
| 15        | FMI                 |                                      |         |           |      |           |       | X        | 15     |                    |                      | X |   |    | X                    |    |    |    | X  |                   |                              | 325          | X |   |         |      |         |          |         |
| 16        | FMI                 |                                      |         |           |      |           |       | X        | 15     |                    |                      | X |   |    | X                    |    |    |    | X  |                   |                              | 325          | X |   |         |      |         |          |         |
| 17        | FMI                 |                                      | X       |           |      |           |       |          | 2      |                    |                      | X |   |    | X                    |    |    |    | X  |                   |                              | 470          | X |   |         |      |         |          |         |
| 18        | FMI                 |                                      |         | X         |      |           |       |          | 9      |                    |                      | X |   |    | X                    |    |    |    | X  |                   |                              | 700          | X |   |         |      |         |          |         |
| 19        | FMI                 |                                      |         |           | X    |           |       |          | 8      |                    |                      | X |   |    | X                    |    |    |    | X  |                   |                              | 470          | X |   |         |      |         |          |         |
| 20        | FMI                 |                                      |         |           |      | X         |       |          | 3      |                    |                      | X |   |    | X                    |    |    |    | X  |                   |                              | 470          | X |   |         |      |         |          |         |







**Table 5.2: Primary Matrix of CAROLFIRE Penlight Tests (PP-1 through PP-68 and Spec. 1)**

| Test PT-# | Primary Application | Cable Insulation and Jacket Material |         |           |      |           |       |          |        |         | Cable Item numbers | Number of Conductors |   |   |    | Conductor Size (AWG) |    |    |    |    | Cable Bundle Size | Thermal Exposure °C (note 1) | Raceway Type |   |   | Group # |      |         |          |
|-----------|---------------------|--------------------------------------|---------|-----------|------|-----------|-------|----------|--------|---------|--------------------|----------------------|---|---|----|----------------------|----|----|----|----|-------------------|------------------------------|--------------|---|---|---------|------|---------|----------|
|           |                     | TS/TS                                |         |           |      |           | TS/TP | TP/TP    |        |         |                    | 3                    | 2 | 7 | 12 | 8                    | 12 | 14 | 16 | 18 |                   |                              | 1            | 3 | 6 |         | Tray | Conduit | Air Drop |
|           |                     | XLPE/CSPE                            | EPR/CPE | SR/Aramid | XLPO | Vita-Link |       | XLPE/PVC | PE/PVC | PVC/PVC |                    |                      |   |   |    |                      |    |    |    |    |                   |                              |              |   |   |         |      |         |          |
| 58        | Note 3              | X                                    | X       |           |      |           |       | X        |        |         | 10,2&15            |                      |   | X |    |                      |    |    |    | X  |                   |                              | NOT RUN      |   | X |         |      |         |          |
| 59        | Note 3              | X                                    | X       |           |      |           |       | X        |        |         | 10,2&15            |                      |   | X |    |                      |    |    |    | X  |                   |                              | NOT RUN      |   | X |         |      |         |          |
| 60        | 2-A, C              |                                      |         |           |      |           | X     |          |        |         | 3                  |                      |   | X |    |                      |    |    |    |    | X                 |                              | 525          | X |   |         | 6    |         |          |
| 61        | 2-A, C              |                                      |         |           |      |           | X     |          |        |         | 3                  |                      |   | X |    |                      |    |    |    | X  |                   |                              | 525          |   | X |         |      |         |          |
| 62        | 2-A, C              | X                                    |         |           |      |           |       |          |        |         | 13                 |                      |   | X |    |                      |    | X  | X  |    |                   |                              | 470          | X |   |         | 7    |         |          |
| 63        | 2-B, C              |                                      |         |           |      |           |       |          |        |         | 6                  |                      |   | X |    |                      |    | X  | X  |    |                   |                              | 325          | X |   |         |      |         |          |
| 64        | 2-A, C              | X                                    |         |           |      |           |       |          |        |         | 13                 |                      | X |   |    |                      | X  |    | X  |    |                   |                              | 470          | X |   |         | 8    |         |          |
| 65        | 2-B, C              |                                      |         |           |      |           |       |          |        |         | 4                  |                      | X |   |    |                      | X  |    | X  |    |                   |                              | 325          | X |   |         |      |         |          |
| 66        | Note 2              | X                                    |         |           |      | X         |       |          |        |         | 10&11              |                      |   | X | X  |                      |    |    |    | X  |                   |                              | NOT RUN      | X |   |         | 9    |         |          |
| 67        | Note 2              |                                      |         |           |      | X         |       | X        | X      |         | 11,15&1            |                      |   | X | X  |                      |    |    |    | X  |                   |                              | NOT RUN      | X |   |         |      |         |          |
| 68        | 2-A, B, C           | X                                    | X       |           | X    | X         | X     | X        |        |         | 10,2,8,3,11 &15    |                      |   | X |    | X                    | X  |    |    |    | X                 |                              | 525          | X |   |         |      |         |          |
| Spec1     | Note 5              |                                      |         |           |      |           |       | X        |        |         |                    |                      |   | X |    |                      |    |    | X  | X  |                   |                              | Varies       | X |   |         |      |         |          |

---

**Tables 5.1 and 5.2 Notes:**

General notes on field entries:

‘Not Run’ in the exposure conditions column means the test was not conducted. These tests were dropped from testing per the additional notes below (see Notes 2 and 3).

‘FMI’ = Test is primarily aimed the Fire Modeling Improvement need area.

‘2-A, B, C’ = Test is primarily aimed as resolution of Bin 2, Items A, B, and/or C.

1. Thermal Exposure conditions (fifth column from the right for Table 5.2 or forth column from the right for Table 5.1) are shown based on shroud temperature (°C) but actual exposure is radiant heating. These are not oven tests. The conversion from shroud temperature to nominal heat flux is discussed in detail in Volume 2 of this report.
  2. Based on the results of preliminary testing and Test 31, those subsequent tests involving the Vitalink cable in *Penlight* were not conducted. As a result, Tests 32, 33, 66 and 67 were not performed
  3. Initial plans had called for the conduct of testing at two flux levels (one high flux condition and one low flux condition). Based on peer review feedback, it was decided to run all tests at the same heat flux (an intermediate flux value appropriate to each cable configuration). As a result, those tests originally planned as repeated test configurations performed under low flux conditions (Groups 3 and 5, Tests - and 51-59) were not conducted.
  4. At the request of the Fire modeling teams, the tests in groups 7 and 8 were revised to provide additional thermal response data for single cables of varying plastic to copper content.
  5. Special Test 1 (Spec1) was added to the matrix at the request of the fire modeling teams. This was a thermal-monitoring test only involving more extensive temperature response measurements for a cable bundle in conjunction with a single cable. This test involved no electrical functionality monitoring. The exposure conditions for this test were varied. The exposure began at 350°C, was increased to 350°C and then increased again to 375°C. See Volume 2 of this report for additional details.
-

**Table 5.3: Matrix of Intermediate-scale Tests (IP-1 through IT-14).**

| Test # | Location | Cable Insulation Material |     |          |      |       |           |    |     |        | Number of Conductors |   |   |    | Cable Bundle Size |   |   |    |           | Water Spray | Raceway Type |         |          |
|--------|----------|---------------------------|-----|----------|------|-------|-----------|----|-----|--------|----------------------|---|---|----|-------------------|---|---|----|-----------|-------------|--------------|---------|----------|
|        |          | TS                        |     |          |      | TS/TP | Vita-Link | TP |     |        |                      |   |   |    |                   |   |   |    |           |             | Tray         | Conduit | Air Drop |
|        |          | XLPE                      | EPR | Silicone | XLPO |       |           | PE | PVC | Tefzel | 3                    | 2 | 7 | 12 | 1                 | 3 | 6 | 12 | Load Tray |             |              |         |          |
| IP1    | A        | X                         |     |          |      |       |           |    |     |        | X                    |   |   |    | X                 |   |   |    |           | X           |              |         |          |
|        | A        | X                         |     |          |      |       |           |    |     |        |                      | X |   |    | X                 |   |   |    |           | X           |              |         |          |
| IP2    | A        | X                         |     |          |      |       |           |    |     |        | X                    |   |   |    | X                 |   |   |    |           | X           |              |         |          |
|        | A        | X                         |     |          |      |       |           |    |     |        |                      | X |   |    | X                 |   |   |    |           | X           |              |         |          |
| IP3    | A        |                           |     |          |      |       |           |    | X   |        | X                    |   |   |    | X                 |   |   |    |           | X           |              |         |          |
|        | A        |                           |     |          |      |       |           |    | X   |        | X                    |   |   |    | X                 |   |   |    |           | X           |              |         |          |
| IP4    | A        |                           |     |          |      |       |           |    | X   |        | X                    |   |   |    | X                 |   |   |    |           | X           |              |         |          |
|        | A        |                           |     |          |      |       |           |    | X   |        | X                    |   |   |    | X                 |   |   |    |           | X           |              |         |          |
| IT1    | A        | X                         |     |          |      |       |           |    |     |        |                      | X | X | X  |                   |   |   |    | X         |             |              |         |          |
|        | B        | X                         |     |          |      |       |           |    |     |        |                      |   | X |    |                   |   | X |    |           | X           |              |         |          |
|        | D        | X                         |     |          |      |       |           |    |     |        |                      |   | X |    | X                 |   |   |    |           |             | X            |         |          |
|        | E        | X                         |     |          |      |       |           |    |     |        |                      |   | X |    | X                 |   |   |    |           |             | X            |         |          |
|        | G        | X                         |     |          |      |       |           |    |     |        |                      |   | X |    |                   |   | X |    |           |             | X            |         |          |
| IT2    | A        | X                         |     |          |      |       |           |    |     |        |                      |   | X |    |                   |   | X |    |           | X           |              |         |          |
|        | C        | X                         |     |          |      |       |           |    |     |        |                      |   | X |    | X                 |   |   |    |           | X           |              |         |          |
|        | A        | X                         |     |          |      |       |           | X  |     |        |                      |   | X |    |                   |   | X |    |           | X           |              |         |          |
|        | C        | X                         |     |          |      |       |           | X  |     |        |                      |   | X |    |                   | X |   |    |           | X           |              |         |          |
|        | C-A      |                           |     |          |      |       |           |    | X   |        |                      |   | X |    | X                 |   |   |    |           |             |              | X       |          |
|        | E        |                           |     |          |      |       |           |    | X   |        |                      |   | X |    | X                 |   |   |    |           | X           |              |         |          |
|        | G        |                           |     |          |      |       |           |    | X   |        |                      |   | X |    | X                 |   |   |    |           | X           |              |         |          |

**Table 5.3: Matrix of Intermediate-scale Tests (IP-1 through IT-14).**

| Test # | Location | Cable Insulation Material |     |          |      |       |           |    |     |        | Number of Conductors |   |   |    | Cable Bundle Size |   |   |    |           | Water Spray | Raceway Type |         |          |
|--------|----------|---------------------------|-----|----------|------|-------|-----------|----|-----|--------|----------------------|---|---|----|-------------------|---|---|----|-----------|-------------|--------------|---------|----------|
|        |          | TS                        |     |          |      | TS/TP | Vita-Link | TP |     |        | 3                    | 2 | 7 | 12 | 1                 | 3 | 6 | 12 | Load Tray |             | Tray         | Conduit | Air Drop |
|        |          | XLPE                      | EPR | Silicone | XLPO |       |           | PE | PVC | Tefzel |                      |   |   |    |                   |   |   |    |           |             |              |         |          |
| IT3    | A        | X                         | X   |          |      |       |           |    |     |        |                      |   | X |    |                   | X |   |    |           |             | X            |         |          |
|        | C        | X                         | X   |          |      |       |           |    |     |        |                      |   | X |    |                   | X |   |    |           |             | X            |         |          |
|        | A        |                           | X   |          |      |       |           | X  |     |        |                      |   | X |    |                   | X |   |    |           |             | X            |         |          |
|        | C        |                           | X   |          |      |       |           | X  |     |        |                      |   | X |    |                   | X |   |    |           |             | X            |         |          |
|        | E        |                           |     |          |      |       |           |    | X   |        | X                    |   |   |    | X                 |   |   |    |           |             | X            |         |          |
|        | G        |                           |     |          |      |       |           |    | X   |        | X                    |   |   |    | X                 |   |   |    |           |             | X            |         |          |
| IT4    | A        | X                         | X   |          | X    | X     |           | X  |     | X      |                      |   | X |    |                   | X |   |    |           |             | X            |         |          |
|        | C        | X                         | X   |          | X    | X     |           | X  |     | X      |                      |   | X |    |                   | X |   |    |           |             | X            |         |          |
|        | A        | X                         | X   |          |      | X     |           | X  | X   | X      |                      |   | X |    |                   | X |   |    |           |             | X            |         |          |
|        | C        | X                         | X   |          |      | X     |           | X  | X   | X      |                      |   | X |    |                   | X |   |    |           |             | X            |         |          |
|        | C-A      |                           |     |          |      |       |           |    | X   |        |                      |   | X |    | X                 |   |   |    |           |             |              |         | X        |
|        | E        | X                         |     |          |      |       |           |    |     |        | X                    |   |   |    | X                 |   |   |    |           |             | X            |         |          |
| IT5    | A        | X                         | X   | X        | X    |       |           | X  |     | X      |                      |   | X |    |                   |   | X |    | X         | X           |              |         |          |
|        | C        | X                         | X   | X        | X    |       |           | X  |     | X      |                      |   | X |    |                   | X |   |    | X         | X           |              |         |          |
|        | A        | X                         | X   |          | X    |       | X         | X  |     | X      |                      |   | X |    |                   |   | X |    | X         | X           |              |         |          |
|        | C        | X                         | X   |          | X    |       | X         | X  |     | X      |                      |   | X |    |                   | X |   |    | X         | X           |              |         |          |
|        | C-A      | X                         |     |          |      |       |           |    |     |        |                      | X |   | X  |                   |   |   |    |           |             |              |         | X        |
|        | E        |                           | X   |          |      |       |           |    |     |        |                      |   | X |    | X                 |   |   |    |           |             | X            |         |          |
|        | G        |                           | X   |          |      |       |           |    |     |        |                      |   | X |    | X                 |   |   |    |           |             | X            |         |          |

**Table 5.3: Matrix of Intermediate-scale Tests (IP-1 through IT-14).**

| Test # | Location | Cable Insulation Material |     |          |      |       |           |    |     |        | Number of Conductors |   |   |    | Cable Bundle Size |   |   |    | Water Spray | Raceway Type |      |         |          |
|--------|----------|---------------------------|-----|----------|------|-------|-----------|----|-----|--------|----------------------|---|---|----|-------------------|---|---|----|-------------|--------------|------|---------|----------|
|        |          | TS                        |     |          |      | TS/TP | Vita-Link | TP |     |        | 3                    | 2 | 7 | 12 | 1                 | 3 | 6 | 12 |             | Load Tray    | Tray | Conduit | Air Drop |
|        |          | XLPE                      | EPR | Silicone | XLPO |       |           | PE | PVC | Tefzel |                      |   |   |    |                   |   |   |    |             |              |      |         |          |
| IT6    | A        | X                         | X   | X        | X    |       |           | X  |     | X      |                      |   | X |    |                   | X |   |    | X           | X            |      |         |          |
|        | C        | X                         | X   | X        | X    |       |           | X  |     | X      |                      |   | X |    |                   | X |   |    | X           | X            |      |         |          |
|        | E        | X                         |     |          |      |       |           | X  |     | X      |                      |   | X |    | X                 |   |   |    |             |              | X    |         |          |
|        | C-A      | X                         |     |          |      |       |           | X  |     | X      |                      |   | X |    | X                 |   |   |    |             |              |      | X       |          |
|        | A        |                           | X   | X        | X    | X     |           | X  |     | X      |                      |   | X |    |                   | X |   |    | X           | X            |      |         |          |
|        | C        |                           | X   | X        | X    | X     |           | X  |     | X      |                      |   | X |    |                   | X |   |    | X           | X            |      |         |          |
| IT7    | G        |                           |     |          |      | X     |           | X  |     | X      |                      |   | X |    |                   | X |   |    |             |              | X    |         |          |
|        | A        | X                         | X   |          | X    | X     |           | X  | X   |        |                      | X |   |    | X                 |   |   |    | X           | X            |      |         |          |
|        | A        | X                         | X   |          | X    | X     |           |    | X   | X      |                      |   | X |    |                   | X |   |    | X           | X            |      |         |          |
|        | C        |                           | X   |          | X    | X     |           | X  | X   | X      |                      |   | X |    |                   | X |   |    | X           | X            |      |         |          |
|        | E        | X                         |     |          |      |       |           | X  | X   |        |                      |   | X |    | X                 |   |   |    |             |              | X    |         |          |
| IT8    | G        |                           | X   |          | X    | X     |           | X  | X   | X      |                      |   | X |    |                   | X |   |    |             | X            |      |         |          |
|        | A        | X                         |     |          |      |       |           | X  | X   |        |                      | X | X | X  |                   | X |   |    |             | X            |      |         |          |
|        | A        | X                         |     |          |      |       |           | X  | X   |        |                      | X | X | X  |                   | X |   |    |             | X            |      |         |          |
|        | C        | X                         |     |          |      |       |           | X  |     |        |                      | X |   |    |                   | X |   |    |             | X            |      |         |          |
|        | E        | X                         |     |          |      |       |           | X  |     |        |                      | X |   | X  |                   |   |   |    |             |              | X    |         |          |
| IT9    | G        | X                         |     |          |      |       |           | X  |     |        |                      | X |   |    |                   | X |   |    |             | X            |      |         |          |
|        | A        | X                         | X   | X        |      | X     |           | X  |     | X      |                      |   | X |    |                   | X |   |    | X           | X            |      |         |          |
|        | A        | X                         | X   | X        |      | X     |           | X  |     | X      |                      |   | X |    |                   | X |   |    | X           | X            |      |         |          |
|        | C        | X                         | X   | X        |      | X     |           | X  |     | X      |                      |   | X |    |                   | X |   |    | X           | X            |      |         |          |
|        | E        | X                         |     |          |      |       |           | X  |     | X      |                      |   | X |    | X                 |   |   |    |             |              | X    |         |          |

**Table 5.3: Matrix of Intermediate-scale Tests (IP-1 through IT-14).**

| Test # | Location | Cable Insulation Material |     |          |      |       |           |    |     |        | Number of Conductors |   |   |    | Cable Bundle Size |   |   |    |           | Water Spray | Raceway Type |         |          |
|--------|----------|---------------------------|-----|----------|------|-------|-----------|----|-----|--------|----------------------|---|---|----|-------------------|---|---|----|-----------|-------------|--------------|---------|----------|
|        |          | TS                        |     |          |      | TS/TP | Vita-Link | TP |     |        | 3                    | 2 | 7 | 12 | 1                 | 3 | 6 | 12 | Load Tray |             | Tray         | Conduit | Air Drop |
|        |          | XLPE                      | EPR | Silicone | XLPO |       |           | PE | PVC | Tefzel |                      |   |   |    |                   |   |   |    |           |             |              |         |          |
| IT10   | A        | X                         | X   | X        | X    | X     |           |    |     | X      |                      |   | X |    |                   | X |   |    | X         | X           |              |         |          |
|        | A        | X                         | X   | X        | X    | X     |           |    |     | X      |                      |   | X |    |                   | X |   |    | X         | X           |              |         |          |
|        | C        | X                         | X   | X        | X    | X     |           |    | X   |        |                      | X | X |    |                   | X |   |    | X         | X           |              |         |          |
|        | E        |                           |     |          |      | X     |           |    | X   |        |                      | X |   |    | X                 |   |   |    |           |             | X            |         |          |
|        | G        | X                         | X   |          |      | X     |           |    | X   | X      | X                    |   | X | X  |                   |   | X |    |           | X           |              |         |          |
| IT11   | A        | X                         | X   |          | X    | X     |           |    | X   | X      |                      |   | X |    |                   | X |   |    |           | X           |              |         |          |
|        | A        | X                         | X   |          | X    | X     |           |    | X   | X      |                      |   | X |    |                   | X |   |    |           | X           |              |         |          |
|        | C        | X                         | X   |          | X    | X     |           |    | X   | X      |                      |   | X |    |                   | X |   |    |           | X           |              |         |          |
|        | E        |                           |     |          |      | X     |           |    | X   | X      |                      |   | X |    | X                 |   |   |    |           |             |              | X       |          |
|        | G        | X                         | X   |          | X    | X     |           |    | X   | X      |                      |   | X |    |                   | X |   |    |           | X           |              |         |          |
| IT12   | A        | X                         | X   |          | X    | X     |           |    | X   | X      |                      |   | X |    |                   | X |   |    |           | X           |              |         |          |
|        | A        | X                         | X   |          | X    | X     |           |    | X   | X      |                      |   | X |    |                   | X |   |    |           | X           |              |         |          |
|        | C        | X                         | X   |          | X    | X     |           |    | X   | X      |                      |   | X |    |                   | X |   |    |           | X           |              |         |          |
|        | E        |                           |     |          |      | X     |           |    | X   | X      |                      |   | X |    | X                 |   |   |    |           |             |              | X       |          |
|        | G        | X                         | X   |          | X    | X     |           |    | X   | X      |                      |   | X |    |                   | X |   |    |           | X           |              |         |          |
| IT13   | A        | X                         | X   |          | X    | X     | X         | X  |     | X      |                      |   | X |    |                   |   |   | X  | X         | X           |              |         |          |
|        | C        | X                         | X   |          | X    | X     | X         | X  |     | X      |                      |   | X |    |                   |   |   | X  | X         | X           |              |         |          |
|        | E        | X                         | X   |          |      |       |           |    |     |        |                      |   | X |    | X                 |   |   |    |           |             | X            |         |          |
|        | F        | X                         | X   |          | X    |       | X         | X  |     | X      |                      |   | X |    |                   | X |   |    | X         | X           |              |         |          |
|        | F        | X                         | X   |          | X    |       | X         | X  |     | X      |                      |   | X |    |                   | X |   |    | X         | X           |              |         |          |
|        | G        | X                         | X   |          | X    |       | X         | X  |     | X      |                      |   | X |    |                   | X |   |    | X         | X           |              |         |          |
|        | G        | X                         | X   |          | X    |       | X         | X  |     | X      |                      |   | X |    |                   | X |   |    | X         | X           |              |         |          |

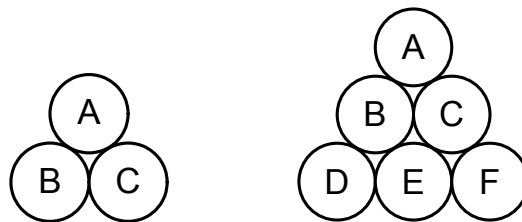
**Table 5.3: Matrix of Intermediate-scale Tests (IP-1 through IT-14).**

| Test # | Location | Cable Insulation Material |     |          |      |       |           |    |     |        | Number of Conductors |   |   |    | Cable Bundle Size |   |   |    |           | Water Spray | Raceway Type |         |          |
|--------|----------|---------------------------|-----|----------|------|-------|-----------|----|-----|--------|----------------------|---|---|----|-------------------|---|---|----|-----------|-------------|--------------|---------|----------|
|        |          | TS                        |     |          |      | TS/TP | Vita-Link | TP |     |        | 3                    | 2 | 7 | 12 | 1                 | 3 | 6 | 12 | Load Tray |             | Tray         | Conduit | Air Drop |
|        |          | XLPE                      | EPR | Silicone | XLPO |       |           | PE | PVC | Tefzel |                      |   |   |    |                   |   |   |    |           |             |              |         |          |
| IT14   | A        | X                         | X   |          | X    | X     |           | X  | X   | X      |                      |   | X |    |                   |   |   | X  |           | X           |              |         |          |
|        | C        | X                         | X   |          | X    | X     |           | X  | X   | X      |                      |   | X |    |                   |   |   | X  |           | X           |              |         |          |
|        | E        |                           |     |          |      | X     |           | X  | X   |        |                      | X |   |    | X                 |   |   |    |           |             | X            |         |          |
|        | F        | X                         | X   |          |      | X     |           | X  | X   | X      |                      |   | X |    |                   | X |   |    |           | X           |              |         |          |
|        | F        | X                         | X   |          |      | X     |           | X  | X   | X      |                      |   | X |    |                   | X |   |    |           | X           |              |         |          |
|        | G        | X                         | X   |          |      | X     |           | X  | X   | X      |                      |   | X |    |                   | X |   |    |           | X           |              |         |          |
|        | G        | X                         | X   |          |      | X     |           | X  | X   | X      |                      |   | X |    |                   | X |   |    |           | X           |              |         |          |

## 6 ANALYSIS OF THE *PENLIGHT* SMALL-SCALE TEST SERIES

This section summarizes the results of the *Penlight* tests as those tests apply to the resolution of the Bin 2 items. The results have been presented in summary form. Due to the extensive nature of the data plots (a minimum of 10 potentially plots were generated for any given test as a part of data processing) they have not been reproduced in full here. Only those plots that illustrate an important point or test result have been reproduced here.

All of the *Penlight* tests were conducted in a very similar manner. The tests involved one of three cable arrangements; namely, (1) two single lengths of cable (one thermal and one electrical as noted above) in trays, conduits or air drops (mainly Groups 1, 7 & 8), (2) bundles of six cables monitored for electrical performance plus a single length of cable for thermal monitoring routed in a cable tray, and (3) bundles of three cables in a conduit. For the six-cable bundle tests in cable trays the cables in the bundle are identified using a consistent lettering scheme with cables A-F. Similarly, the three-cable bundle tests in conduits identify the cables using the letters A-C. These cable identification schemes are illustrated in Figure 6.1.



**Figure 6.1: Illustration of the cable letter identification code used for the three- and six-cable bundle tests. Note that the same letter code was also used in the intermediate-scale tests when testing three- or six-cable bundles.**

Note that for the three-cable bundle conduit tests cables B and C rested on the bottom of the conduit. For the six-cable bundle tests in cable trays the rungs of the tray were below cables D-E-F. For each of the *Penlight* tests involving more than one cable, the test configuration summary presented in the subsections which follow has identified the cables present and their locations relative to other cables present using these lettering schemes.

For the *Penlight* tests all electrical performance monitoring was based on the use of one IRMS. Two general IRMS wiring configurations were used as follows:

- For those tests involving individual lengths of cables (the *Penlight* Preliminary tests and *Penlight* Tests Groups 1, 7 & 8), each of the conductors in the electrical performance cable was monitored on a separate channel of the IRMS.
- For the cable bundle tests (all other *Penlight* Tests), each cable in the outer ring of conductors was monitored using two IRMS channels; one for the odd numbered



conductors, and one for the even numbered conductors (the conductor in the center of the cable was not monitored). This grouping is discussed in detail in Section 4.4 above.

Refer to Section 4.4 for a complete description of how individual channels of the IRMS have been named during the bundle tests. To summarize, each cable had two conductor groups with each conductor group connected to one IRMS channel. Cable A was generally associated with IRMS channels 1 and 2 and the two conductor groups have been referred to here as ‘conductor A1’ and ‘conductor A2’ respectively. Cable B was generally connected to IRMS channels 3 and 4 and the two groups have been referred to as conductor ‘B3’ and ‘B4’, etcetera.

## 6.1 *Penlight* Preliminary Tests and Group 1 Tests

The Preliminary *Penlight* tests and the *Penlight* Tests in Group 1 were all intended for use in the Fire Modeling Improvement need area. The tests did include both thermal response data for the cables and IRMS measurements, but because the tests involved single cable lengths, they were not directly applicable to resolution of the Bin 2 items. For a description of these tests, refer to Volume 2 of this report.

## 6.2 *Penlight* Group 2 Tests

### 6.2.1 Test Conditions

*Penlight* Group 2 included four tests (PT-34 through PT-37). These were the first tests to involve a bundle of cables rather than individual lengths of cables. The test conditions for these four tests are summarized as follows:

| Test # | Cable Types:                     | Cable ID #s | Bundle Size | Routing | Shroud Temp. (C) | Bin 2 Items |
|--------|----------------------------------|-------------|-------------|---------|------------------|-------------|
| PT-34  | XLPE 7/C 12 AWG                  | 10          | 6           | Tray    | 525              | A           |
| PT-35  | XLPE 7/C 12 AWG and PE 7/C 12AWG | 10 & 15     | 6           | Tray    | 525              | B           |
| PT-36  | XLPE 7/C 12 AWG                  | 10          | 3           | Conduit | 525              | A           |
| PT-37  | XLPE 7/C 12 AWG and PE 7/C 12AWG | 10 & 15     | 3           | Conduit | 525              | B           |

### 6.2.2 Results for Test PT-34

Test PT-34 involved a bundle of six XLPE cables (ID #10) identified by the letter code A-F as described above. The results for test PT-34 are summarized as follows:

| Time (s) | Event  | Interpretation            |
|----------|--|---------------------------|
| 175      | Initiated <i>Penlight</i> Heating                                |                           |
| 1479     | Conductors A1 & A2 short together at less than 100 $\Omega$ (23) | Cable A shorts internally |

|           |  |                           |
|-----------|--|---------------------------|
| 1484-1507 | Conductors A1 & A2 short to ground at less than 1000 Ω (303 & 455)                     | Cable A shorted to ground |
| 1750-1759 | Conductors C5 & C6 short to ground at less than 1000 Ω (292 & 309)                     | Cable C shorted to ground |
| 1771      | Conductors C5 & C6 short together at less than 100 Ω (3)                               | Cable C shorts internally |
| 1807      | Conductors D7 & D8 short together at less than 100 Ω (19)                              | Cable D shorts internally |
| 1908      | Conductors B3 & B4 short together at less than 100 Ω (55)                              | Cable B shorts internally |
| 2031      | Conductors F11 & F12 short together at less than 100 Ω (26)                            | Cable F shorts internally |
| 2170-2173 | Conductors E9 & E10 short to ground at less than 1000 Ω (203 & 188)                    | Cable E shorted to ground |
| 2202      | Conductors E9 & E10 short together at less than 100 Ω (7)                              | Cable E shorts internally |
| 2224-2246 | The existing ground faults on conductors A1 & A2 decrease to less than 100 Ω (64 & 61) |                           |
| 2522-2527 | Conductors D7 & D8 short to ground at less than 100 Ω (2 & 5)                          | Cable D shorted to ground |
| 2539-2543 | The existing ground faults on conductors E9 & E10 decrease to less than 100 Ω (<1 & 2) |                           |
| 2561-2563 | Conductors F11 & F12 short to ground at less than 100 Ω (3 & 8)                        | Cable F shorted to ground |

| <b>Additional Observations</b> |  |
|--------------------------------|--|
| Observation 1                  | This test showed some unusual and unexplained behavior. The first cable to fail was Cable A on top of the pyramid bundle. This cable failing first is not unexpected because it is in the most exposed position. However, the cable shorted first internally and then to ground well before other cables shorted to ground. How the cable at the top of the cable bundle found a path to ground before any other cable had failed is unknown. It was well isolated from the tray by the other cables, but none-the-less found a ground path. |
| Observation 2                  | No substantive inter-cable interactions were detected.   |
| Observation 3                  | In all cases except cable C, intra-cable shorting was the first mode of failure followed by shorts to the external ground.   |
| Observation 4                  | The cables did not ignite and burn as expected, but the internal cable temperatures exceeded the shroud temperature and damage to the conductors did occur. This is an indication of smoldering combustion within the bundle.  |

### 6.2.3 Results for Test PT-35

Test PT-35 involved a bundle of six mixed TS and TP cables. The cables present in the bundle were as follows:

- Cables A, D & F (at the corners of the triangle) were XLPE cables (ID #10)
- Cables B, C & E were PE cable (ID #15)

The results for PT-35 are summarized as follows:

| Time (s)  | Event  | Interpretation  |
|-----------|--|---|
| 186       | Initiated <i>Penlight</i> Heating  |   |
| 692-695   | Conductors E9 & E10 both short to ground at less than 100 $\Omega$ (2 & 34)                  | TP Cable E shorts to ground   |
| 1598-1604 | Conductors D7 & D8 both short to ground at less than 1000 $\Omega$ (478 & 651)               | TS Cable D shorts to ground   |
| 1611      | Cable bundle ignites with open burning   | Sparking due to the failure of Cable D was the likely ignition source |
| 1664      | Conductor A1 shorts to A2 at less than 100 $\Omega$ (13)                                     | TS Cable A is shorted internally                                      |
| 1700      | Power to <i>Penlight</i> is shutoff  | Power shut down due to open burning of cables                         |
| 1759-1788 | The existing ground faults on conductors D7 & D8 degrade to less than 100 $\Omega$ (35 & 21) |   |
| 1821-1824 | Conductors F11 & F12 both short to ground at less than 100 $\Omega$ (3 & <1)                 | TS Cable F shorts to ground   |
| 1905-1920 | Conductors B3 & B4 both short to ground at less than 100 $\Omega$ (<1 & 36)                  | TP Cable B shorts to ground   |
| 1911-1914 | Conductor B3 shorts to Conductors C5 & C6 at less than 100 $\Omega$ (5 & <1)                 | Nominal interaction between two TP cables                             |
| 1933-1936 | Conductor B4 shorts to Conductors C5 & C6 (188 & 82)   | Nominal Interaction between two TP cables                             |
| 1935-1943 | Conductors C5 & C6 short to ground at less than 1000 $\Omega$ (663 & 518)                    | TP Cable C shorts to ground   |
| 2039-2062 | Conductors A1 & A2 short to ground at less than 1000 $\Omega$ (782 & 710)                    |   |
| 2224-2246 | The existing ground shorts on Conductors A1 & A2 degrade to less than 100 $\Omega$ (87 & 75) | All conductors have shorted to external ground.                       |

| Additional Observations |   |
|-------------------------|---|
| Observation 1           | The progression of failure modes for the cable bundle was shorting to ground of the three cables on the bottom, followed by shorting of the cables in the middle row and finally the top cable shorted to ground. |
| Observation 2           | The only case of potentially substantive inter-cable interaction was between two TP cables (B and C).   |
| Observation 2           | It took 506 s (8.4 min.) from the start of <i>Penlight</i> heating for the first short to ground to occur, and it took 1425 s (23.8 min.) for the cable bundle to ignite.   |

#### 6.2.4 Results for Test PT-36

PT-36 involved a three-cable bundle of XLPE 7/C 12AWG TS cables (ID #10) in a conduit. The results for Test PT-36 are summarized as follows:

| Time (s) | Event                             | Interpretation |
|----------|-----------------------------------|----------------|
| 118      | Initiated <i>Penlight</i> Heating |                |

|           |  |                               |
|-----------|--|-------------------------------|
| 1622-1624 | Conductors C5 & C6 short to ground at less than 1000 $\Omega$ (587 & 624)                              | Cable C shorts to ground      |
| 1635      | Conductors C5 & C6 short together at less than 1000 $\Omega$ (258)                                     | Cable C is shorted internally |
| 1677      | The existing short between conductors C5 & C6 decreases to less than 100 $\Omega$ (27)                 |                               |
| 1700-1703 | Conductors B3 & B4 short to ground (150 & 19)  | Cable B shorts to ground      |
| 1705      | Conductors B3 & B4 short together at less than 1000 $\Omega$ (231)                                     | Cable B is shorted internally |
| 1706-1708 | The existing shorts between conductors C5 & C6 and ground decrease to less than 100 $\Omega$ (16 & 16) |                               |
| 1848      | Conductors A1 & A2 short together at less than 100 $\Omega$ (9)  | Cable A is shorted internally |
| 1854-1863 | Conductors A1 & A2 both short to ground (110 & 95)   | Cable A shorts to ground      |
| 2228      | Power to <i>Penlight</i> shutoff   |                               |

| Additional Observations |  |
|-------------------------|--|
| Observation 1           | Cable failures progressed as expected during this test: the two lower cables (B & C) shorted to ground well before the top cable (A)   |
| Observation 2           | It took 1504 seconds (25.1 min.) from the start of <i>Penlight</i> heating for the first short to ground failure to occur, and it took 1517 s (25.3 min.) for the first intra-cable short failure. |
| Observation 3           | No substantive inter-cable interactions were detected.   |

### 6.2.5 Results for Test PT-37

Test PT-37 was identical to Test PT-36, except that cables B&C were replaced with PE 7/C cables (ID #15). This created a mixed bundle of TS and TP cables. The results for PT-36 are summarized as follows:

| Time (s)  | Event  | Interpretation                                     |
|-----------|--|--|
| 90        | Initiated <i>Penlight</i> Heating  |  |
| 1491-1662 | Conductors B3 & B4 short to ground (206 & 53)                                  | Cable B (TP) shorts to ground                      |
| 1664-1706 | Conductors B3 & B4 short together at less than 1000 $\Omega$ (100)             | Cable B is shorted internally                      |
| 1765      | Conductors A1 & A2 short together at less than 100 $\Omega$ (46)               | Cable A (TP) is shorted internally                 |
| 1770-1779 | Conductors A1 & A2 both short to ground at less than 1000 $\Omega$ (479 & 722) | Cable A shorts to ground                           |
| 1790      | Conductor C5 shorts to ground at less than 1000 $\Omega$ (207)                 | Cable C (TS) shows high resistance short to ground |
| 1804      | Conductors C5 & C6 short together at less than 1000 $\Omega$ (207)             | Cable C is shorted internally                      |
| 2086      | Conductor C6 shorts to ground at less than 100 $\Omega$ (29)                   | Cable C is shorted to ground                       |
| 2385      | Power to <i>Penlight</i> shutoff   |  |

| <b>Additional Observations</b> |  |
|--------------------------------|--|
| Observation<br>1               | Cable failures did not progress quite as expected during this test: one of the two lower TP cables (B) shorted to ground first, followed by the top TS cable (A) then, finally, the other lower TP cable (C) |
| Observation<br>2               | It took 1401 seconds (23.4 min.) from the start of <i>Penlight</i> heating for the first short to ground failure to occur, and it took 1574 s (26.2 min.) for the first intra-cable short failure.           |
| Observation<br>3               | No substantive inter-cable interactions were detected.   |

### 6.2.6 Summary of Group 2 Test Results

Group 2 was the first test group to explore potential inter-cable interactions between pairs of TS cables and between pairs of TS and TP cables. The observed behavior uniformly involved the shorting of the cables both internally and to the external ground prior to the onset of inter-cable shorts. For all combinations of TS-to-TS or TS-to-TP cables, inter-cable interactions were at most a tertiary failure mode for both cables, and as such would not have caused risk-relevant hot-shorts. In Test PT-35 inter-cable shorting between two TP cables was observed as a secondary failure mode (i.e., after one of the two cables had shorted to ground).

### 6.3 *Penlight* Group 3 Tests

The Group 3 tests were not conducted. Originally, it had been intended that Group 2 would be conducted at a high heat flux, and Group 3 would repeat the Group 2 tests at a lower heat flux. Based on the feedback received during peer review of the test plan, this approach was revised and all tests were performed at an intermediate heat flux. Hence, the Group 2 tests were retained at the intermediate heat flux and Group 3 tests were not performed. The Group 3 tests were retained in the matrix itself in order to preserve the continuity and consistency of the test numbering.

### 6.4 *Penlight* Group 4 Tests

#### 6.4.1 Test Conditions

Group 4 in the *Penlight* Test matrix included nine tests (PT-42 through PT-50). These tests were quite similar to the Group 2 tests, but involved more varied combinations of both TS and TP cables. The test conditions for these nine tests are summarized as follows:

| Test # | Cable Types:                    | Cable ID #s | Bundle Size | Routing | Shroud Temp. (C) | Bin 2 Items |
|--------|---------------------------------|-------------|-------------|---------|------------------|-------------|
| PT-42  | XLPE 7/C 8AWG<br>EPR 7/C 12 AWG | 10<br>2     | 6           | Tray    | 525              | A           |
| PT-43  | EPR 7/C 12 AWG<br>PE 7/C 12 AWG | 2<br>15     | 6           | Tray    | 525              | B           |
| PT-44  | XLPE 7/C 8AWG<br>EPR 7/C 12 AWG | 10<br>2     | 6           | Tray    | 525              | A&B         |

| Test # | Cable Types:  | Cable ID #s                   | Bundle Size | Routing | Shroud Temp. (C) | Bin 2 Items |
|--------|---|-------------------------------|-------------|---------|------------------|-------------|
|        | SR 7/C 12 AWG<br>XLPO 7/C 12 AWG<br>PE 7/C 12 AWG<br>TEF 7/C 12 AWG   | 9<br>8<br>15<br>12            |             |         |                  |             |
| PT-45  | XLPE 7/C 8AWG<br>EPR 7/C 12 AWG<br>SR 7/C 12 AWG<br>XLPO 7/C 12 AWG<br>PE 7/C 12 AWG<br>TEF 7/C 12 AWG      | 10<br>2<br>9<br>8<br>15<br>12 | 6           | Tray    | 525              | A&B         |
| T-46   | XLPE 7/C 8AWG<br>EPR 7/C 12 AWG<br>XLPE/PVC 7/C 12 AWG<br>PE 7/C 12 AWG<br>PVC 7/C 12 AWG<br>TEF 7/C 12 AWG | 10<br>2<br>3<br>15<br>1<br>12 | 6           | Tray    | 525              | A&B         |
| PT-47  | XLPE 7/C 8AWG<br>EPR 7/C 12 AWG   | 10<br>2                       | 3           | Conduit | 525              | A           |
| PT-48  | EPR 7/C 12 AWG<br>PE 7/C 12 AWG   | 2<br>15                       | 3           | Conduit | 525              | B           |
| PT-49  | XLPE 7/C 8AWG<br>EPR 7/C 12 AWG<br>PE 7/C 12 AWG  | 10<br>2<br>15                 | 3           | Conduit | 525              | A           |
| PT-50  | XLPE 7/C 8AWG<br>EPR 7/C 12 AWG<br>PE 7/C 12 AWG  | 10<br>2<br>15                 | 3           | Conduit | 525              | A&B         |

**6.4.3 Results for Test PT-42**

Test PT-42 involved a mixed group of six TS type cables, three XLPE and three EPR, in a cable tray. The cables present were as follows:

- Cables A, D & F (the three corners of the triangle) are XLPE cables (ID #10)
- Cables B, C & E are EPR cables (ID #2)

The results for Test PT-42 are summarized as follows:

| Time (s)  | Event   | Interpretation                                   |
|-----------|---|--|
| 108       | Initiated <i>Penlight</i> Heating                                       |  |
| 1195-1203 | Conductors C5 & C6 both short to ground at less than 1000 Ω (197 & 213) | EPR Cable C shorts to ground                     |
| 1216      | Cable C (C5 & C6) shorts internally at less than 100 Ω (9)              | EPR Cable C shorts internally                    |
| ~1247     | Cables ignite and burn  |  |
| 1267      | Power to <i>Penlight</i> is shutoff                                     | Power shutdown due to open burning of the cables |

| Time (s)  | Event   | Interpretation   |
|-----------|---|--|
| 1294-1353 | Cables A (A1 & A2) and B (B3 & B4) short internally (848 & 15)  | XLPE Cable A and EPR Cable B each short internally   |
| 1413-1434 | Conductors D7, E9 & E10 all short to ground (184, <1 & <1)  | EPR Cable E is shorted to ground   |
| 1437      | Cable D (D7 & D8) shorts internally at less than 100 $\Omega$ (17)  | XLPE Cable D shorts internally   |
| 1451-1454 | Conductors F11 & F12 both short to ground at less than 100 $\Omega$ (1 & <1)  | XLPE Cable F is shorted to ground  |
| 1462-1479 | Cables E (E9 & E10) and F (F11 & F12) short internally at less than 100 $\Omega$ (2 & 8); the existing intra-cable short in cable A (A1 & A2) decreases to 2 $\Omega$ | EPR Cable E and XLPE Cable F each short internally   |
| 1484-1507 | Conductors A1 & A2 both short to ground at less than 1000 $\Omega$ (314 & 338)  | XLPE Cable A shorts to ground  |
| 1515-1518 | Conductor A2 shorts to conductors C5 and C6 at less than 1000 $\Omega$ (380 & 152)  | Interaction between two TS cables but all conductors involved are shorted to ground and shorted internally |
| 1535      | Conductor B3 shorts to ground at less than 1000 $\Omega$ (180)  |  |
| 1546-1549 | Conductor B3 shorts to conductors D7 & D8 at less than 1000 $\Omega$ (270 & 179)  | Interaction between two TS cables but all conductors involved are shorted to ground and shorted internally |
| 1550-1565 | Conductor B4 shorts to ground at less than 1000 $\Omega$ (103); the existing ground fault on conductor C5 decreases to less than 100 $\Omega$ (58)                    | EPR Cable B is shorted to ground   |
| 1569-1571 | Conductor B4 shorts to conductors D7 & D8 at less than 1000 $\Omega$ (151 & 111)  | Interaction between two TS cables but all conductors involved are shorted to ground and shorted internally |
| 1573-1602 | Conductor D8 shorts to ground at less than 1000 $\Omega$ (204); the existing ground faults on conductors C6 and D7 decrease to less than 100 $\Omega$ (53 & 47)       | All conductors have shorted to external ground.  |

| <b>Additional Observations</b> |  |
|--------------------------------|--|
| Observation 1                  | The progression of failure modes for the cable bundle demonstrated a mixture of shorting to ground and intra-cable shorting with no particular bias regarding cable location in the bundle.  |
| Observation 2                  | It took 1087 s (18.1min.) from the start of heating for the initial short to ground, it took 1108 s (18.5 min.) for the first intra-cable short, and it took ~1139 s (19 min.) from the start of <i>Penlight</i> heating for the cable bundle to ignite.   |
| Observation 3                  | Inter-cable interactions were detected, but only as a tertiary failure mode. That is, the inter-cable interactions occurred only after the individual cables had both shorted to ground and shorted internally. These interactions are not considered significant in the context of the Bin 2 items. |

#### 6.4.4 Results for Test PT-43

Test PT-43 involved a bundle of six mixed TS and TP cables. The cables present were as follows:

- Cables A, D & F (the three corners of the triangle) are EPR cables (ID #2)
- Cables B, C & E are PE cables (ID #15)

The results of Test PT-43 are summarized as follows:

| Time (s)  | Event   | Interpretation   |
|-----------|---|--|
| 119       | Initiated <i>Penlight</i> Heating   |  |
| 895       | Cables ignite and burn  |  |
| 917       | Power to <i>Penlight</i> is shutoff   |  |
| 1043-1064 | Conductors D7, E9 & E10 all short to ground (657, <1 & 24)  | PE Cable E is shorted to ground; EPR Cable D shows high resistance short to ground |
| 1068      | Conductors D7 & D8 short together at less than 100 $\Omega$ (24)  | EPR Cable D shorts internally  |
| 1082-1084 | Conductors F11 & F12 both short to ground at much less than 100 $\Omega$ (<1 & <1)  | EPR Cable F is shorted to ground   |
| 1093-1109 | Conductors E9 & E10 short together (3), conductors F11 & F12 short together (2), and conductors A1 & A2 short together (29)                                     | EPR Cables A and F are shorted internally; PE Cable E shorts internally            |
| 1228-1573 | The existing ground fault on conductor D7 decreases to less than 100 $\Omega$ (2); conductors A1, A2, C5, C6 & D8 all short to ground (683, 166, 748, 595 & 6)  | EPR Cables A and D are shorted to ground; PE Cable C shorts to ground              |
| 1585      | Conductors C5 & C6 short together at less than 100 $\Omega$ (5)   | PE Cable C is shorted internally   |
| 1691-1904 | The existing ground fault on conductor A2 decreases to less than 100 $\Omega$ (99); conductors B4 & B3 both short to ground at less than 100 $\Omega$ (54 & 71) | PE Cable B is shorted to ground; all conductors are shorted to ground              |
| 1907      | Conductors B3 & B4 short together at less than 100 $\Omega$ (5)   | PE Cable B is shorts internally  |
| 1934-1942 | The existing ground faults on conductors C5 & C6 decrease to less than 100 $\Omega$ (10 & 13)   |  |

| <b>Additional Observations</b> |  |
|--------------------------------|--|
| Observation 1                  | The progression of failure modes for the cable bundle demonstrated a tendency that the cables on the cable tray rungs short to ground prior to the cables higher in the bundle.                              |
| Observation 2                  | It took 776 s (12.9min.) from the start of <i>Penlight</i> heating for the cable bundle to ignite, 924 s (15.4 min.) for the first short to ground, and 949 s (15.8 min.) for the initial intra-cable short. |
| Observation 3                  | No substantive inter-cable interactions were detected.   |

#### 6.4.6 Results for Test PT-44

Test PT-44 involved a mixed bundle of six TS and TP cables in a cable tray as follows:

- A = PE Cable, ID #15
- B = XLPE Cable, ID #10
- C = XLPO Cable, ID #8
- D = EPR Cable, ID #2



- E = Tefzel Cable, ID #12
- F = Silicone Rubber Cable, ID #9

The results for Test PT-44 are summarized as follows:

| Time (s)  | Event  | Interpretation   |
|-----------|--|--|
| 145       | Initiated <i>Penlight</i> Heating  |  |
| 953       | Cables ignite and burn   |  |
| 981       | Power to <i>Penlight</i> is shutoff  |  |
| 1043-1064 | Conductors D7, D8, E9 & E10 all short to ground (24, 6, 446 & 309)   | EPR Cable D and Tefzel Cable E short to ground                       |
| 1067      | Conductors D7 & D8 short together at less than 100 $\Omega$ (16)   | EPR Cable D shorts internally  |
| 1082-1084 | Conductor D8 shorts to conductors E9 & E10 at less than 100 $\Omega$ (4 & 9)   | Cable to cable short occurs after both cables have faulted to ground |
| 1093-1216 | Conductors E9 & E10 short together (46), conductors C5 & C6 short together (19), and conductors A1 & A2 short together (3) | PE Cable A, XLPO Cable C and Tefzel Cable E are shorted internally   |
| 1246-1249 | The existing ground faults on conductors E9 & E10 decrease to much less than 100 $\Omega$ (<1 & <1)                        |  |
| 1255-1258 | Conductor D7 shorts to conductors E9 & E10 at less than 100 $\Omega$ (27 & 9)  | Cable to cable short occurs after both cables have faulted to ground |
| 1353      | Conductors B3 & B4 short together at less than 1000 $\Omega$ (196)   | XLPE Cable B is shorted internally                                   |
| 1379-1389 | Conductors C5 & C6 both short to ground at less than 100 $\Omega$ (1 & 1)  | XLPO Cable C shorts to ground  |
| 1535      | Conductor B3 shorts to ground at less than 100 $\Omega$ (59)   |  |
| 1537      | The existing short between conductors B3 & B4 decreases to less than 100 $\Omega$ (4)                                      |  |
| 1550      | Conductor B4 shorts to ground at less than 100 $\Omega$ (65)   | XLPE Cable B is shorted to ground                                    |

| <b>Additional Observations</b> |   |
|--------------------------------|---|
| Observation 1                  | The silicone rubber cable (F) did not fail either internally or externally.   |
| Observation 2                  | It took 808 s (13.5min.) from the start of <i>Penlight</i> heating for the cable bundle to ignite, 898 s (15 min.) for the first short to ground, and 922 s (15.4 min.) for the initial intra-cable short.  |
| Observation 3                  | Inter-cable interactions were detected between the EPR (TS) cable and the Tefzel (TP) cable, but only as a tertiary failure mode. That is, the inter-cable interactions occurred only after the individual cables had both shorted to ground and shorted internally. These interactions are not considered significant in the context of the Bin 2 items. |

### 6.4.7 Results for Test PT-45

Test PT-45 was a direct repeat of Test PT-44 in all respects. The results for PT-45 are summarized as follows:

| Time (s)  | Event  | Interpretation  |
|-----------|--|---|
| 135       | Initiated <i>Penlight</i> Heating  |   |
| 1031-1067 | Conductors C5 & C6 short together at less than 100 $\Omega$ (21); conductors D7 & D8 short together at less than 100 $\Omega$ (57) | Tefzel Cable C and EPR Cable D are both shorted internally  |
| 1266      | Cable bundle ignites and burns   |   |
| 1290      | Power to <i>Penlight</i> shutoff   |   |
| 1294-1353 | Conductors A1 & A2 short together at less than 100 $\Omega$ (27); conductors B3 & B4 short together at less than 100 $\Omega$ (11) | XLPE Cable A and PE Cable B are both shorted internally   |
| 1380-1389 | Conductors C5 & C6 both short to ground at much less than 100 $\Omega$ (<1 & <1)   | Tefzel Cable C shorts to ground   |
| 1408-1412 | Conductor C5 shorts to conductors E9 & E10 at less than 100 $\Omega$ (25 & 12)   | Cable to cable interaction between XLPO cable E and Tefzel Cable C occurs, but Cable C had already shorted both internally and to ground (tertiary fault mode for Cable C)                        |
| 1413-1418 | Conductors D7 & D8 both short to ground at less than 100 $\Omega$ (4 & <1)   | EPR Cable D shorts to ground  |
| 1425-1429 | Conductor C6 shorts to conductors E9 & E10 at less than 100 $\Omega$ (2 & 8)   | Additional shorting between XLPO Cable E and PE Cable C (secondary fault mode for E and less than tertiary fault mode for C)  |
| 1430-1434 | Conductors E9 & E10 both short to ground at less than 100 $\Omega$ (30 & 26)   | XLPO Cable E shorts to ground   |
| 1440-1454 | Conductors D7 & D8 short to conductors E9 & E10 at less than 100 $\Omega$ (13, 21, 16 & <1)  | Cable to cable interactions between XLPO Cable E and EPR cable D, but D has already shorted to ground and E has shorted and to grounded cable C (secondary fault for E and tertiary faults for E) |
| 1462      | Conductors E9 & E10 short together at less than 100 $\Omega$ (67)  | XLPO Cable E shorts internally  |
| 1484-1507 | Conductors A1 & A2 both short to ground at less than 1000 $\Omega$ (352 & 425)   | XLPE Cable A shorts to ground   |
| 1510-1513 | Conductor A2 shorts to Conductors B3 & B4 at less than 1000 $\Omega$ (425 & 509)   | Secondary faults for cable B and tertiary faults for Cable A  |
| 1515-1518 | Conductor A2 shorts to Conductors C5 & C6 at less than 1000 $\Omega$ (525 & 543)   | Both cables have already shorted to ground  |
| 1535-1550 | Conductors B3 & B4 both short to ground at less than 1000 $\Omega$ (986 & 546)   | PE Cable B is shorted to ground   |

| Additional Observations |   |
|-------------------------|---|
| Observation 1           | The silicone rubber cable (F) did not fail either internally or externally.   |
| Observation 2           | It took 896 s (14.9 min.) from the start of <i>Penlight</i> heating for the initial intra-cable short to occur, 1131 s (18.9 min.) for the cable bundle to ignite, and 1245 s (20.8 min.) for the first short to ground.  |
| Observation 3           | Various inter-cable interactions were detected, but none as the primary fault mode. Most were combinations of secondary and tertiary faults for both cables. One case involved the XLPO (TS) cable and one Tefzel (TP) cable. This was the primary fault mode for the TS cable, but only as a tertiary failure mode for the TP cable which had already shorted both to ground and internally. |

#### 6.4.8 Results for Test PT-46

Test PT-34 involved a bundle of six mixed TS and TP cables, and included the one mixed type TS-insulated and TP-jacketed XLPE/PVC cable as well. The cables present were as follows:

- A = TS/TP XLPE/PVC Cable, ID #3
- B = PE Cable, ID #15
- C = Tefzel Cable, ID #12
- D = EPR Cable, ID #2
- E = PVC Cable, ID #1
- F = XLPE Cable, ID #10

The results of Test PT-46 are summarized as follows:

| Time (s)  | Event   | Interpretation                                     |
|-----------|---|--|
| 158       | Initiated <i>Penlight</i> Heating   |  |
| 507       | Conductor E9 shorts to ground at less than 100 $\Omega$ (13)                | PVC Cable E shows high resistance shorts to ground |
| 539       | Conductors E9 & E10 short together at less than 100 $\Omega$ (15)           | PVC Cable E shorts internally                      |
| 695       | Conductor E10 shorts to ground at much less than 100 $\Omega$ (<1)          | PVC Cable E shorted to ground                      |
| 994       | Cables ignite and burn  |  |
| 1029      | Power to <i>Penlight</i> shutoff  |  |
| 1043-1049 | Conductors D7 & D8 both short to ground at less than 100 $\Omega$ (32 & <1) | EPR Cable D shorts to ground                       |
| 1068      | Conductors D7 & D8 both short together at less than 100 $\Omega$ (35)       | EPR Cable D shorts internally                      |
| 1267-1269 | Conductors F11 & F12 both short to ground at less than 100 $\Omega$ (1 & 2) | XLPE Cable F shorts to ground                      |
| 1292      | Conductors F11 & F12 both short together at less than 1000 $\Omega$ (474)   | XLPE Cable F shorts internally                     |

| Time (s)  | Event  | Interpretation  |
|-----------|--|---|
| 1332-1350 | Conductor A2 shorts to ground at less than 1000 $\Omega$ (236); conductor B3 shorts to ground at less than 100 $\Omega$ (32) | TS/TP XLPE/PVC Cable A and PE Cable B both show high resistance short to ground |
| 1353      | Conductors B3 & B4 short together at less than 100 $\Omega$ (4)  | PE Cable B shorts internally  |
| 1366      | Conductor B4 shorts to ground at less than 100 $\Omega$ (22)   | PE Cable B shorted to ground  |
| 1476      | The existing intra-cable short between F11 & F12 decreases to less than 100 $\Omega$ (21)                                    | XLPE cable shorts internally at very low resistance                             |
| 1484      | Conductor A1 shorts to ground at less than 1000 $\Omega$ (310)   | One conductor set in TS/TP XLPE/PVC cable shorts to ground                      |
| 1669-1692 | The existing ground faults on Conductors A1 & A2 decrease to less than 100 $\Omega$ (48 & 70)                                | All conductors of the TS/TP Cable A are shorted to ground                       |

| Additional Observations |   |
|-------------------------|---|
| Observation 1           | The Tefzel cable (C) did not short to ground or interact externally.  |
| Observation 2           | It took only 349 s (5.8 min.) from the start of <i>Penlight</i> heating for the PVC cable to short to ground, 381 s (6.4 min.) for the PVC cable to short internally, and 836 s (13.9 min.) for the cable bundle to ignite. |
| Observation 3           | No substantive inter-cable interactions were detected.  |

#### 6.4.9 Results for Test PT-47

Test PT-47 involved a bundle of three TS cables in a conduit, one XLPE and 2 EPR. The cables present were as follows:

- Cable A = XLPE (ID #10)
- Cable B & C = EPR (ID #2)

The results of PT-47 are summarized as follows:

| Time (s)  | Event  | Interpretation                |
|-----------|--|-------------------------------|
| 127       | Initiated <i>Penlight</i> Heating  |                               |
| 1411-1414 | Conductors C5 & C6 short to ground (437 & 60)                                  | Cable C shorts to ground      |
| 1426-1468 | Conductors C5 & C6 short together (436, then decreases to 26)                  | Cable C is shorted internally |
| 1454      | Existing ground fault on conductor C5 decreases to less than 100 $\Omega$ (7)  |                               |
| 1742-1746 | Conductors B3 & B4 both short to ground at less than 1000 $\Omega$ (928 & 407) | Cable B shorts to ground      |
| 1784      | Existing ground fault on conductor B3 decreases to less than 100 $\Omega$ (29) |                               |

| Time (s)  | Event  | Interpretation                          |
|-----------|--|---|
| 1789      | Conductors B3 & B4 short together at less than 100 $\Omega$ (67)       | Cable B is shorted internally           |
| 1890      | Conductors A1 & A2 short together at less than 100 $\Omega$ (8)        | Cable A is shorted internally           |
| 1896-1905 | Conductors A1 & A2 short to ground at less than 100 $\Omega$ (85 & 90) | Cable A shorts to ground intermittently |
| 2778      | Power to <i>Penlight</i> shutoff                                       |   |

| Additional Observations |  |
|-------------------------|--|
| Observation 1           | Cable failures progressed as expected during this test: the two lower cables (B & C) shorted to ground well before cable (A)   |
| Observation 2           | It took 1284 seconds (21.4 min.) from the start of <i>Penlight</i> heating for the first short to ground failure to occur, and it took 1299 s (21.7 min.) for the first intra-cable short failure. |
| Observation 3           | No substantive inter-cable interactions were detected.   |

#### 6.4.10 Results for Test PT-48

Test PT-48 involved a bundle of three TS EPR cables (ID #2) in a conduit. The results for PT-48 are summarized as follows:

| Time (s)  | Event   | Interpretation   |
|-----------|---|--|
| 139       | Initiated <i>Penlight</i> Heating   |  |
| 1596      | Conductors A1 & A2 short together at less than 100 $\Omega$ (6)                               | Cable A is shorted internally  |
| 1653-1728 | Conductors A1 & A2 short to ground at less than 1000 $\Omega$ (880 & 154)                     | Cable A shorts to ground (NOTE: This early ground fault may have been caused by an interaction through the Cable 4 TC sheath.) |
| 2126-2212 | Conductors C5 & C6 both short to ground (28 & 789)  | Cable C shorts to ground   |
| 2207-2708 | Conductors B3 & B4 both short to ground at less than 1000 $\Omega$ (501 & 931)                | Cable B shorts to ground   |
| 2224      | Conductors C5 & C6 short together at less than 100 $\Omega$ (17)                              | Cable C is shorted internally  |
| 2492-2526 | The existing ground faults on conductors A1 & A2 decrease to less than 100 $\Omega$ (24 & 58) |  |
| 2506      | The existing short to ground on conductor C6 decreases to less than 100 $\Omega$ (17)         |  |
| 2543-2876 | The existing ground faults on conductors B3 & B4 decrease to less than 100 $\Omega$ (54 & 33) |  |
| 2839      | Conductors B3 & B4 short together at less than 1000 $\Omega$ (318)                            | Cable B is shorted internally  |
| 2881      | The existing short between conductors B3 & B4 decreases to less than 100 $\Omega$ (60)        |  |

| Time (s) | Event                            | Interpretation |
|----------|----------------------------------|----------------|
| 2914     | Power to <i>Penlight</i> shutoff |                |

| Additional Observations |  |
|-------------------------|--|
| Observation 1           | Cable failures did not progress as expected during this test: the top cable (A) shorted to ground before the two lower cables (B & C). However, this may have been the result of an interaction between Cable A and the Inconel sheath on one of the TCs embedded in the temperature monitoring cable (note the behavior of "Cable 4" in the Temperature Plot).  |
| Observation 2           | It took 1457 seconds (24.3 min.) from the start of <i>Penlight</i> heating for the first intra-cable short to occur, and it took 1514 s (25.2 min.) for the first short to ground failure.   |
| Observation 3           | No substantive inter-cable interactions were detected.   |
| Observation 4           | A post-test operational check of the TCs and temperature data acquisition system showed that all of the TCs behaved normally as long as the IRMS system was turned off. Once the IRMS was turned on, the Cable 4 TC again responded with divergently cyclic readings. Turning the IRMS system off again allowed the Cable 4 TC to respond normally. This is taken as evidence of shorting to one or more of the electrical cables. |
| Observation 5           | After removing the cables from the conduit, a post-test visual inspection of the cable bundle revealed that the "Cable 4" TC sheath <b>could</b> have been touching the conductors on Cable A, but then the sheath on the "Cable 3" TC was also found to be close enough to have touched the Cable A conductors as well.   |

#### 6.4.11 Results for Test PT-49

Test PT-49 involved a mixed bundle of three TS and TP cables in a conduit. The cables present were as follows:

- Cable A = XLPE (ID #10)
- Cable B = EPR (ID #2)
- Cable C = PE (ID #15)

The results of PT-49 are summarized as follows:

| Time (s)  | Event   | Interpretation                                 |
|-----------|---|--|
| 125       | Initiated <i>Penlight</i> Heating   |  |
| 1635      | Conductors C5 & C6 short together at less than 100 $\Omega$ (64)            | Cable C is shorted internally                  |
| 1784-1787 | Conductors B3 & B4 both short to ground at less than 100 $\Omega$ (20 & 75) | Cable B shorts to ground                       |
| 1789      | Conductors B3 & B4 short together at less than 1000 $\Omega$ (289)          | Cable B is shorted internally                  |
| 1790      | Conductor C5 shorts to ground at less than 1000 $\Omega$ (315)              | Cable C shows high resistance shorts to ground |
| 1806      | Conductors A1 & A2 short together at less than 1000 $\Omega$ (906)          | Cable A is shorted internally                  |

|                                |  |                          |
|--------------------------------|--|--------------------------|
| 1831                           | The existing short between conductors B3 & B4 decreases to less than 100 $\Omega$ (43)   |                          |
| 1848                           | The existing short between conductors A1 & A2 decreases to less than 100 $\Omega$ (9)  |                          |
| 1854-1863                      | Conductors A1 & A2 both short to ground at less than 1000 $\Omega$ (255 & 307)   | Cable A shorts to ground |
| 1873-1876                      | The existing ground fault on conductor C5 decreases to less than 100 $\Omega$ (17), and conductor C6 shorts to ground at less than 1000 $\Omega$ (180)                                     | Cable C shorts to ground |
| 2730                           | Power to <i>Penlight</i> shutoff   |                          |
| <b>Additional Observations</b> |  |                          |
| Observation 1                  | Cable failures progressed somewhat as expected during this test: the two lower cables (B & C) shorted to ground (at high resistance) before the top cable (A)                              |                          |
| Observation 2                  | It took 1510 seconds (25.2 min.) from the start of <i>Penlight</i> heating for the first intra-cable short to occur, and it took 1659 s (27.7 min.) for the first short to ground failure. |                          |
| Observation 3                  | No substantive inter-cable interactions were detected.   |                          |
| Observation 4                  | Several shorting failures of various types occurred over a very short time period (1784-1806s)   |                          |

#### 6.4.12 Results for Test PT-50

Test PT-50 involved a bundle similar to that of test PT-49, except that the arrangement of cables was different. The cables present for PT-49 were:

- Cable A = PE (ID #15)
- Cable B = XLPE (ID #10)
- Cable C = EPR (ID #2)

The results of PT-50 are summarized as follows:

| Time (s)  | Event   | Interpretation                               |
|-----------|---|--|
| 140       | Initiated <i>Penlight</i> Heating   |  |
| 1219      | Conductors A1 & A2 short together intermittently at less than 100 $\Omega$ (14)               | Cable A is shorted internally (intermittent) |
| 1476-1485 | Conductors A1 & A2 both short to ground intermittently at less than 1000 $\Omega$ (174 & 190) | Cable A shorts to ground (intermittent)      |
| 1664-1666 | Conductors C5 & C6 both short to ground at less than 100 $\Omega$ (43 & 26)                   | Cable C shorts to ground                     |
| 1720      | Conductors C5 & C6 short together intermittently at less than 100 $\Omega$ (41)               | Cable C shorted internally (intermittent)    |
| 2058      | Conductors A1 & A2 short together at less than 100 $\Omega$ (44)                              | Cable A is shorted internally                |
| 2335      | Conductors B3 & B4 short together at less than 100 $\Omega$ (38)                              | Cable B is shorted internally                |

|           |  |   |
|-----------|--|---|
| 2372      | Conductor B3 shorts to ground intermittently at less than 1000 $\Omega$ (832)  | Cable B shows high resistance shorts to ground (intermittent) |
| 2441-2451 | Conductors A1 & A2 both short to ground at less than 1000 $\Omega$ (487 & 142) | Cable A shorts to ground                                      |
| 2460-2540 | Conductors B3 & B4 short to ground at less than 1000 $\Omega$ (431 & 160)      | Cable B shorts to ground                                      |
| 2686      | Conductors C5 & C6 short together at less than 100 $\Omega$ (12)               | Cable C is shorted internally                                 |
| 3121      | Power to <i>Penlight</i> shutoff   |   |

| Additional Observations |  |
|-------------------------|--|
| Observation 1           | Cable failures were initially intermittent in nature then progressed to "steady state" failure conditions  |
| Observation 2           | It took 1079 seconds (18 min.) from the start of <i>Penlight</i> heating for the first intra-cable short to occur, and it took 1336 s (22.3 min.) for the first short to ground failure. |
| Observation 3           | No substantive inter-cable interactions were detected.   |

### 6.4.13 Summary of Group 4 Test Results

As with Group 2, the Group 4 tests involved various TS cable bundles of both like and un-like cables, and mixed bundles of TS and TP cables of various types. The primary target for these tests was Bin 2 Items A and B. The tests provide only minimal evidence of potentially significant inter-cable shorting either between TS and TP cables or between two TS cables. In one test, PT-45, inter-cable shorting between an XLPO (TS) cable and a Tefzel (TP) cable was detected, but only as a tertiary failure mode for the TP cable which had already experienced intra-cable shorts and shorts to the external ground. However, this was the primary fault mode for the TP cable. As such, this is taken as weak evidence of potentially significant TP-to-TS interactions. Other interactions were detected, but not risk-relevant. For example, in test PT-44 a TS-to-TP interaction was detected, but only as a tertiary fault mode for both cables.

## 6.5 *Penlight* Group 5 Tests

The *Penlight* Group 5 tests were not conducted. The reason is the same as that described above for the Group 3 tests. These tests were originally planned as repeats of the Group 4 tests at a higher heat flux level. The tests were not conducted based on feedback from the peer review process. They were retained in the test matrix only to maintain consistency in the test numbering scheme.

## 6.6 *Penlight* Group 6 Tests

### 6.6.1 Test Conditions

*Penlight* Group 6 included two tests (PT-60 and PT-61). These tests were specifically designed to assess the performance of the one mixed type TS-insulated, TP-jacketed cable (XLPE-insulated, PE-jacketed, cable ID #15) and all of the cables in both tests were of this type. The two tests



involved one tray test and one conduit test. The test conditions for these two tests are summarized as follows:

| Test # | Cable Types:        | Cable ID #s | Bundle Size | Routing | Shroud Temp. (C) | Bin 2 Items |
|--------|---------------------|-------------|-------------|---------|------------------|-------------|
| PT-60  | XLPE/PVC 7/C 12 AWG | 15          | 6           | Tray    | 525              | A/B         |
| PT-61  | XLPE/PVC 7/C 12 AWG | 15          | 3           | Conduit | 525              | A/B         |

### 6.6.2 Results for Test PT-60

Test PT-60 involved a bundle of six TS/TP XLPE/PVC cables in a cable tray. The results of PT-60 are summarized as follows:

| Time (s)  | Event   | Interpretation   |
|-----------|---|--|
| 160       | Initiated <i>Penlight</i> Heating   |  |
| 1082-1084 | Conductors F11 & F12 short to ground at much less than 100 $\Omega$ (<1 & <1)   | TS/TP Cable F shorts to ground   |
| 1105      | Cables ignite and burn  |  |
| 1106-1109 | Conductors F11 & F12 short together at less than 100 $\Omega$ (23); conductors A1 & A2 short together at less than 100 $\Omega$ (8) | TS/TP Cables F & A each short internally   |
| 1118      | Power to <i>Penlight</i> shutoff  |  |
| 1195-1204 | Conductors C5 & C6 short to ground at less than 1000 $\Omega$ (214 & 197)   | TS/TP Cable C shorts to ground for ~369 seconds then recovers to a higher IR level   |
| 1216      | Conductors C5 & C6 short together at less than 100 $\Omega$ (8)   | TS/TP Cable C shorts internally  |
| 1227-1233 | Conductors D7 & D8 both short to ground at much less than 100 $\Omega$ (<1 & <1)  | TS/TP Cable D shorts to ground   |
| 1244-1246 | Conductor C6 shorts to conductors E10 & F12 at less than 1000 $\Omega$ (346 & 196)  | Interaction between cables C, E & F lasts for ~184 s, while conductors C6 and F12 are both grounded (primary for E, secondary for C, tertiary for F) |
| 1245-1249 | Conductors E9 & E10 both short to ground at much less than 100 $\Omega$ (<1 & <1)   | TS/TP Cable E shorts to ground for ~555 seconds then recovers  |
| 1252      | Conductors D7 & D8 short together at less than 100 $\Omega$ (1)   | TS/TP Cable D shorts internally  |
| 1255-1269 | Conductors D7 & D8 both short to conductors E9 & E10 at less than 100 $\Omega$ (<1, 7, <1 & 4)                                      | Interaction between cables D & E lasts for ~383 s, while conductors D7, D8, E9 & E10 are all grounded  |
| 1277      | Conductors E9 & E10 short together at less than 100 $\Omega$ (5)  | TS/TP Cable E shorts internally  |
| 1280-1288 | Conductors E9 & E10 short to conductors F11 & F12 at less than 100 $\Omega$ (14, 31, 15 & 9)  | Interaction between cables E & F lasts for 370 s, while conductors E9, E10, F11 & F12 are all grounded   |

| Time (s)  | Event  | Interpretation   |
|-----------|--|--|
| 1297-1300 | Conductor A1 shorts to conductors B3 & B4 at less than 1000 $\Omega$ (140 & 86)  | Interaction between cables A & B occurs after Cable A is shorted internally, and lasts for ~2 s prior to Cable A shorting to ground                                |
| 1299-1322 | Conductors A1 & A2 both short to ground at less than 1000 $\Omega$ (263 & 284)   | TS/TP Cable A shorts to ground for ~185 seconds then recovers  |
| 1324-1328 | Conductor A2 shorts to conductors B3 & B4 at less than 1000 $\Omega$ (104 & 141) | Interaction between cables A & B occurs after Cable A is shorted to ground, and lasts for ~185 s prior to recovery   |
| 1349      | Conductor B3 shorts to ground at less than 100 $\Omega$ (91)                     | TS/TP Cable B shows high resistance shorts to ground for ~369 seconds then recovers  |
| 1353      | Conductors B3 & B4 short together at less than 1000 $\Omega$ (149)               | TS/TP Cable B shorts internally for ~369 seconds then recovers   |
| 1358      | Conductor B3 shorts to conductor C6 at less than 1000 $\Omega$ (199)             | Interaction between cables B & C occurs after cable B & C are both shorted internally, and while cables B & C are grounded (tertiary failure mode for both cables) |
| 1365      | Conductor B4 shorts to ground at less than 1000 $\Omega$ (353)                   | TS/TP Cable B shorted to ground for ~369 seconds then recovers   |

| <b>Additional Observations</b> |  |
|--------------------------------|--|
| Observation 1                  | The cables on the tray rung tended to short to ground prior to shorting internally. Other cables shorted to ground for relatively short durations then recovered.  |
| Observation 2                  | It took 922 s (15.4 min.) from the start of <i>Penlight</i> heating for a short to ground to occur, 945 s (15.8 min.) for the cable bundle to ignite, and 946 s (15.8 min.) for the initial intra-cable short.   |
| Observation 3                  | Various inter-cable interactions were detected, although most were of limited significance being tertiary faults for at least one of the involved cables. However, it appears that one inter-cable interaction briefly (~2 s duration) took place between cables A & B. This did occur as a secondary failure mode for cable A in that cable A had already experienced intra-cable shorting. The inter-cable short was the primary fault mode for cable B, having occurred prior to any other failures in cable B. The fault also occurred prior to either cable shorting to ground. |

Figure 6.2 shows the faulting behavior for cables A&B relative to Observation 3 immediately above. The plot illustrates intra-cable shorting for each cable, the shorting between each cable and the external ground, and inter-cable shorting between the two cables.

Recall that both cables are of the mixed TS/TP type and therefore have TS-insulated conductors. Prior to the inter-cable interactions intra-cable shorting in Cable A has already occurred. Concurrent with the inter-cable interaction, cable A also shows a marginal insulation resistance to ground as well, although the inter-cable short is of much lower resistance. Hence, the inter-cable short is observed as, at most, a secondary failure mode for cable A. The inter-cable interaction is, however,

the primary failure mode for cable B. This particular case is taken as a possible indication that inter-cable shorting between two TS-insulated cables is plausible.

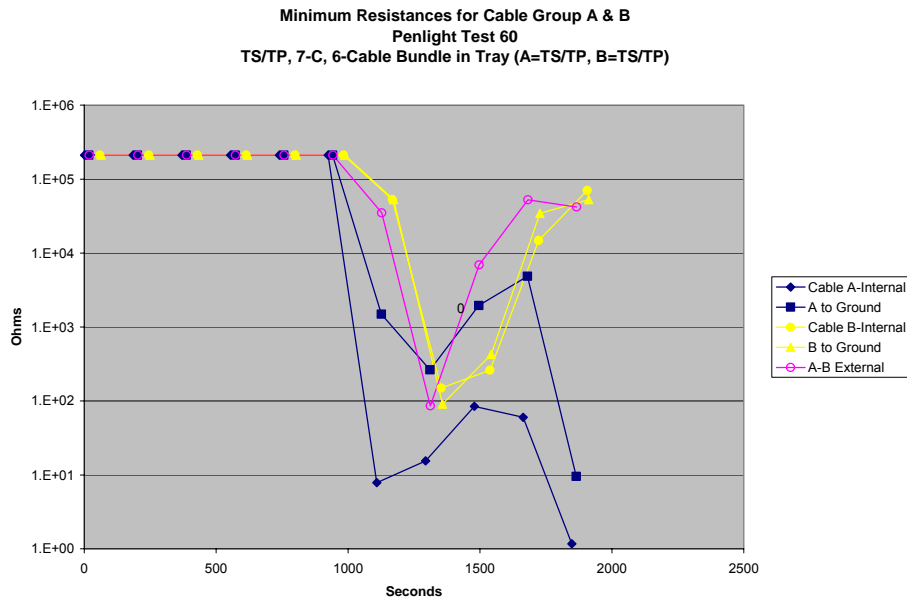


Figure 6.2: Shorting results for Cables A&B in Test PT-60.

### 6.6.3 Results for Test PT-61

Test PT-61 involved a bundle of three of the mixed-type TS/TP cables (XLPE/PVC) in a conduit. The results of PT-61 are summarized as follows:

| Time (s)  | Event  | Interpretation                          |
|-----------|--|---|
| 98        | Initiated <i>Penlight</i> Heating  |   |
| 1639      | Conductors A1 & A2 short together at less than 100 Ω (44)                              | Cable A is shorted internally           |
| 1645-1654 | Conductors A1 & A2 both short to ground intermittently at less than 1000 Ω (490 & 355) | Cable A shorts to ground (intermittent) |
| 1833-1835 | Conductors C5 & C6 both short to ground at less than 100 Ω (23 & 36)                   | Cable C shorts to ground                |
| 1846      | Conductors C5 & C6 short together at less than 100 Ω (27)                              | Cable C is shorted internally           |
| 1995-1998 | Conductors B3 & B4 short to ground intermittently at less than 1000 Ω (195 & 206)      | Cable B shorts to ground (intermittent) |
| 2000      | Conductors B3 & B4 short together at less than 100 Ω (2)                               | Cable B is shorted internally           |
| 2023-2032 | Conductors A1 & A2 both short to ground at less than 100 Ω (6 & 7)                     | Cable A shorts to ground                |

|      |  |  |
|------|--|--|
| 2040 | Conductor B4 shorts to ground at less than 100 $\Omega$ (4)    | Cable B shows high resistance shorts to ground |
| 2415 | Conductor B3 shorts to ground at less than 1000 $\Omega$ (373) | Cable B shorts to ground                       |
| 2844 | Power to <i>Penlight</i> shutoff                               |  |

| Additional Observations |  |
|-------------------------|--|
| Observation 1           | Cable ground failures were initially intermittent in nature then progressed to "steady state" failure conditions   |
| Observation 2           | It took 1541 seconds (25.7 min.) from the start of <i>Penlight</i> heating for the first intra-cable short to occur, and it took 1547 s (25.8 min.) for the first short to ground failure. |
| Observation 3           | No substantive inter-cable interactions were detected.   |

#### 6.6.4 Summary of the Group 6 Results

Test PT-61 did not show any substantive inter-cable interactions. However, test PT-60 did show some interesting results that are potentially relevant to the Bin 2 Item A.

Recall that this group involved a bundle of the one mixed type TS-insulated and TP-jacketed cable. In PT-60 various inter-cable interactions occurred most significantly including between cables A and B. In this case, the inter-cable fault occurred as the secondary fault mode for cable A, but as the primary fault mode for cable B. Hence, an inter-cable hot-short remains plausible for this case. Shortly after the inter-cable fault, several roughly concurrent faults are detected including both cables A and B shorting to ground at a somewhat higher resistance.

Given that the faults all occur over a short time, and that many faults were detected more or less concurrently, the results were taken as a somewhat weak indication that inter-cable interactions between two TS-insulated cables are plausible. Given that the inter-cable interaction was a secondary failure mode for one of the two cables, the interaction has a reduced likelihood of causing a risk-relevant hot-short that might, for example, lead to spurious actuation. However, the possibility does exist and cannot be neglected.

#### 6.7 *Penlight* Group 7 Tests

There are just two tests in Group 7, Tests PT-62 and PT-63. These tests involved testing of single lengths of the 12-conductor 18 AWG cables (one each for thermal response and electrical performance monitoring) and were aimed primarily at the fire model improvement need area. These tests are not relevant to the evaluation of the Bin 2 items. See Volume 2 for a discussion of these tests.

#### 6.8 *Penlight* Group 8 Tests

There are just two tests in Group 8, Tests PT-64 and PT-65. These tests involved testing of single lengths of the 2-conductor 16AWG cables (one each for thermal response and electrical performance

monitoring) and were aimed primarily at the fire model improvement need area. The tests are not relevant to the evaluation of the Bin 2 items. See Volume 2 for a discussion of these tests.

## 6.9 Penlight Group 9 Tests

There are three tests in Group 9, although in practice only one of these tests was conducted. The two tests that were not conducted are PT-66 and PT-67. These tests were to involve testing of the Vita-Link cable in combination with other cables. However, previous testing has shown that the Vita-Link cables were not likely to fail in the *Penlight* test apparatus; hence, the tests were not conducted.

The final test, PT-68, was conducted and involved a mixed bundle of six TS, TS/TP, and TP cables in a cable tray. The cables present in this test are as follows:

- A = PE Cable, ID #15
- B = XLPE Cable, ID #10
- C = XLPO Cable, ID #8
- D = EPR Cable, ID #2
- E = Vita-Link Cable, ID #11
- F = TS/TP XPLE/PVC Cable, ID #3

The results for Test PT-69 are summarized as follows.

| Time (s)  | Event   | Interpretation                                |
|-----------|---|---|
| 162       | Initiated <i>Penlight</i> Heating   |   |
| 1252      | Conductors D7 & D8 short together at less than 100 $\Omega$ (30)  | EPR Cable D shorts internally                 |
| 1267-1269 | Conductors F11 & F12 short to ground at less than 1000 $\Omega$ (730 & 719)   | TS/TP Cable F shorts to ground                |
| 1292-1294 | Conductors F11 & F12 short together at less than 100 $\Omega$ (17); conductors A1 & A2 short together at less than 100 $\Omega$ (1) | PE Cable A and TS/TP Cable F short internally |
| 1300-1322 | Conductors A1 & A2 both short to ground at less than 1000 $\Omega$ (99 & 107)   | PE Cable A shorts to ground intermittently    |
| 1437      | Cables ignite and burn  |   |
| 1452-1454 | The existing ground fault on Conductors F11 & F12 decrease to less than 100 $\Omega$ (4 & 5)  | TS/TP Cable F shorts to ground intermittently |
| 1460      | Power to <i>Penlight</i> is shutoff   |   |
| 1538      | Conductors B3 & B4 short together at less than 100 $\Omega$ (10)  | XLPE Cable B shorts internally                |
| 1586      | Conductors C5 & C6 short together at less than 100 $\Omega$ (25)  | XLPO Cable C shorts internally                |
| 1598-1603 | Conductors D7 & D8 short to ground at much less than 100 $\Omega$ (<1 & <1)   | EPR Cable D shorts to ground                  |
| 1720-1735 | Conductors B3 & B4 short to ground at less than 1000 $\Omega$ (143 & 165)   | XLPE Cable B shorts to ground intermittently  |

| Time (s)  | Event  | Interpretation                 |
|-----------|--|--------------------------------|
| 2304-2313 | Conductors C5 & C6 short to ground at less than 100 $\Omega$ (2 & 2) | XLPO Cable C shorted to ground |

| Additional Observations |   |
|-------------------------|---|
| Observation 1           | The Vita-Link cable (E) did not fail either internally or externally.   |
| Observation 2           | It took 1090 s (18.2 min.) from the start of <i>Penlight</i> heating for the first intra-cable short to occur, 1105 s (18.4 min.) for the first short to ground, and 1275 s (21.3 min.) for the cable bundle to ignite. |
| Observation 3           | No substantive inter-cable interactions were detected.  |

As noted in Observation 3 immediately above, there were no substantive inter-cable interactions detected during test PT-68.

## 6.10 *Penlight* Special Thermal Test 1

There was one final test run in *Penlight* at the request of our collaborative partners working on the fire model improvement need area. This test is referred to in the *Penlight* matrix as “Spec 1” or the Special Thermal Test. This test involved the monitoring of temperature response in a bundle of six PVC cables in a cable tray. The cables present were all being monitored for temperature; hence, there was no monitoring of electrical performance. This test is not relevant to the assessment of the Bin 2 Items. See Volume 2 for a discussion of this test.

## 6.11 Summary of *Penlight* Test Results in the Bin 2 Context

The *Penlight* tests described here were aimed primarily at Bin 2 Items A and B, those items related to the consideration of spurious actuations arising from inter-cable interactions between two or more TS cables, or between a TS cable and a TP cable. The tests offered many opportunities for the formation of short circuits of both types. Note that the NEI/EPRI tests had already demonstrated that TP-to-TP interactions were a plausible mode of cable failure leading to spurious actuations so these types of faults were not examined in CAROLFIRE. The raw data gathered using the IRMS would reveal such faults if they did occur, but the data processing performed to date has not sought these faults out.

Inter-cable interactions of both types were detected, but in all but two cases, these interactions were not considered risk-relevant because for one of the two shorting cables the interactions were tertiary faults only, and for the second cable the inter-cable shorts were either secondary or tertiary faults. In these cases the inter-cable interactions are very unlikely to cause hot-shorts or risk-relevant spurious actuations. The two exceptions involved one case of TS-to-TP shorting and one case of TS-to-TS shorting.

In the specific case of TS to TP interactions, there was one case of potential interest observed. This was test PT-45 where a short occurred between a Tefzel (TP) cable and a XLPO (TS) cable. In this case, the inter-cable fault was the tertiary fault mode for the TP cable, but was the primary fault

mode for the TS cable. In general the CAROLFIRE test results tend to confirm the prior thinking relative to Bin 2 Item B. That is, as expected the TP cables displayed far less resistance to heating than did the TS cables, and given similar conditions, the TP cables would fail earlier than the TS cables.

In the specific case of TS-to-TS shorting, one potentially significant inter-cable interaction was observed; namely, in test PT-60. In this test an inter-cable short between two of the TS-insulated mixed type TS/TP cables did occur. The inter-cable interaction was the secondary failure mode for one cable and the primary failure mode for the second cable. That is, one of the two interacting cables (A) had already experienced intra-cable short circuits prior to any inter-cable interactions while the second (B) had not previously shown failures. The interaction is taken as evidence that risk-relevant TS-to-TS inter-cable interactions are plausible.

## 7 ANALYSIS OF THE INTERMEDIATE-SCALE TEST SERIES

This Section provides a summary description of the results obtained using the IRMSs and the SCDUs during the intermediate-scale tests. In all, there were four intermediate-scale preliminary tests (IP-1 through IP-4), and 14 primary intermediate-scale tests (IT-1 through IT-14). At least one IRMS was fielded in each test, and beginning with test IT-6 two IRMSs were fielded in each test. The SCDUs were fielded beginning with Test IP-3. One SCDU was used in IP-3 and four SCDUs in each of the remaining 15 tests.

The IRMS results for tests IP-1 through IP-4 were of primary interest to the fire model improvement need area and have not been covered in detail here. In addition, Test IT-4 used the IRMS to examine a single cable in depth in conjunction with a thermal response bundle, again in support of the fire modeling need area. The IRMS results for IT-4 have not been discussed here. (See Volume 2 of this report for a discussion of the tests and test results omitted from Volume 1.) The SCDU results for Tests IP-3 and IP-4 are relevant and are discussed as are both the IRMS and SCDU results for all of the remaining intermediate-scale tests.

### 7.1 Application of the IRMSs

#### 7.1.1 Summary of the IRMS-Related Test Conditions

Test IT-1 through IT-5 used a single IRMS. Tests IT-6 through IT-14 used two IRMSs during each test. The results of these tests are presented in summary form given the sheer bulk of the data and the large number of plots generated for each test. The plots presented here are limited to those plots that illustrate a particular behavior or insight.

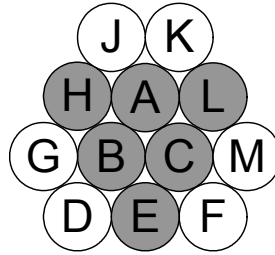
As with the *Penlight* tests, testing involved single lengths of cable, bundles of six cables in a cable tray, and bundles of three cables in a conduit. In addition, three tests were conducted with bundles of twelve cables in a cable tray. Two tests also included random fill loaded raceways, although this was for the purposes of the fire model improvement need area and the electrical performance of the cables in the loaded raceways was not monitored.

The bundles were again configured in a consistent manner, and the individual cables are identified based on a letter code. The letter codes for the three-cable and six-cable bundles are identical to those presented in Section 6 above (see Figure 6.1). The bundling arrangement and letter code for the twelve-cable bundles is illustrated in Figure 7.1. Note that for the 12-cable bundle tests, the IRMS system was configured to focus on the cables in the core of the bundle (cables A, B, C, E, H & L), the shaded cables in Figure 7.1.

In all cases, the electrical connection scheme and the naming scheme for conductor groups within a given cable was as described in Section 4.4 above. To summarize, each cable had two conductor groups with each conductor group connected to one IRMS channel. Cable A was associated with IRMS channels 1 and 2 and the two conductor groups are referred to as ‘conductor A1’ and



‘conductor A2’ respectively. Cable B will be connected to IRMS channels 3 and 4 and the two groups are referred to as conductor ‘B3’ and ‘B4’, etcetera.



**Figure 7.1: Illustration of the letter code used to identify cables when testing 12-cable bundles. Only the shaded cables are monitored for electrical performance. The corresponding letter codes for testing of three- and six-cable bundles are presented in Figure 6.1 above.**

Section 5 provides a comprehensive matrix of the intermediate-scale tests. Table 7.1 presents a complementary test matrix focused on those aspects of each test that are directly relevant to the IRMS measurements and the Bin 2 items.

**Table 7.1: Summary of the IRMS test conditions for the Intermediate-scale tests.**

| Test # | IRMS unit | Cable types  | ID #'s                        | Bundle Size | Raceway | Cable Location | Bin 2 Items |
|--------|-----------|--|-------------------------------|-------------|---------|----------------|-------------|
| IT-1   | 1         | XLPE 7/C 12 AWG  | 10                            | 12          | Tray    | G              | A           |
| IT-2   | 1         | XLPE 7/C 12 AWG  | 10                            | 6           | Tray    | C              | A           |
| IT-3   | 1         | XLPE 7/C 12 AWG<br>EPR 7/C 12 AWG  | 10<br>2                       | 6           | Tray    | C              | A           |
| IT-4   | 1         | EPR 7/C 12 AWG   | 2                             | 1           | Tray    | G              | -           |
| IT-5   | 1         | XLPE 7/C 12 AWG<br>PE 7/C 12 AWG<br>Tefzel 7/C 12 AWG<br>EPR 7/C 12 AWG<br>XLPO 7/C 12 AWG<br>SR 7/C 12 AWG  | 10<br>15<br>12<br>2<br>8<br>9 | 6           | Tray    | C              | A&B         |
| IT-6   | 1         | XLPE 7/C 12 AWG<br>SR 7/C 12 AWG<br>EPR 7/C 12 AWG<br>XLPO 7/C 12 AWG<br>PE 7/C 12 AWG<br>Tefzel 7/C 12 AWG  | 10<br>9<br>2<br>8<br>15<br>12 | 6           | Tray    | A              | A&B         |
|        | 2         | SR 7/C 12 AWG<br>PE 7/C 12 AWG<br>XLPO 7/C 12 AWG<br>Tefzel 7/C 12 AWG<br>TS/TP 7/C 12 AWG<br>EPR 7/C 12 AWG | 9<br>15<br>8<br>12<br>3<br>2  | 6           | Tray    | C              | A&B         |

**Table 7.1: Summary of the IRMS test conditions for the Intermediate-scale tests.**

| Test # | IRMS unit | Cable types   | ID #'s                           | Bundle Size | Raceway | Cable Location | Bin 2 Items |
|--------|-----------|---|----------------------------------|-------------|---------|----------------|-------------|
| IT-7   | 1         | XLPE 7/C 12 AWG<br>PVC 7/C 12 AWG<br>PE 7/C 12 AWG<br>EPR 7/C 12 AWG<br>TS/TP 7/C 12 AWG<br>XLPO 7/C 12 AWG   | 2<br>1<br>15<br>2<br>3<br>8      | 6           | Tray    | A              | A&B         |
|        | 2         | PVC 7/C 12 AWG<br>EPR 7/C 12 AWG<br>XLPO 7/C 12 AWG<br>PE 7/C 12 AWG<br>TS/TP 7/C 12 AWG<br>Tefzel 7/C 12 AWG | 1<br>2<br>8<br>15<br>3<br>12     | 6           | Tray    | C              | A&B         |
| IT-8   | 1         | XLPE 7/C 12 AWG<br>PE 7/C 12 AWG<br>XLPE 12/C 18 AWG<br>XLPE 2/C 16 AWG<br>PVC 12/C 18 AWG<br>PVC 2/C 16 AWG  | 10<br>15<br>13<br>7<br>6<br>4    | 6           | Tray    | A              | A&B         |
|        | 2         | XLPE 7/C 12 AWG<br>PE 7/C 12 AWG<br>PE 7/C 12 AWG<br>XLPE 7/C 12 AWG<br>PE 7/C 12 AWG<br>XLPE 7/C 12 AWG      | 10<br>15<br>15<br>10<br>15<br>10 | 6           | Tray    | C              | A&B         |
| IT-9   | 1         | EPR 7/C 12 AWG<br>PE 7/C 12 AWG<br>Tefzel 7/C 12 AWG<br>SR 7/C 12 AWG<br>TS/TP 7/C 12 AWG<br>XLPE 7/C 12 AWG  | 2<br>15<br>12<br>9<br>3<br>10    | 6           | Tray    | A              | A&B         |
|        | 2         | EPR 7/C 12 AWG<br>PE 7/C 12 AWG<br>Tefzel 7/C 12 AWG<br>SR 7/C 12 AWG<br>TS/TP 7/C 12 AWG<br>XLPE 7/C 12 AWG  | 2<br>15<br>12<br>9<br>3<br>10    | 6           | Tray    | C              | A&B         |

**Table 7.1: Summary of the IRMS test conditions for the Intermediate-scale tests.**

| Test # | IRMS unit | Cable types  | ID #'s                       | Bundle Size | Raceway | Cable Location | Bin 2 Items |
|--------|-----------|--|------------------------------|-------------|---------|----------------|-------------|
| IT-10  | 1         | XLPE 7/C 12 AWG<br>EPR 7/C 12 AWG<br>Tefzel 7/C 12 AWG<br>TS/TP 7/C 12 AWG<br>SR 7/C 12 AWG<br>XLPO 7/C 12 AWG                 | 10<br>2<br>12<br>3<br>9<br>8 | 6           | Tray    | A              | A&B         |
|        | 2         | XLPE 12/C 18 AWG<br>EPR 7/C 12 AWG<br>PVC 12/C 18 AWG<br>TS/TP 7/C 12 AWG<br>SR 7/C 12 AWG<br>XLPO 7/C 12 AWG                  | 13<br>2<br>6<br>3<br>9<br>8  | 6           | Tray    | C              | A&B         |
| IT-11  | 1         | XLPE 7/C 12 AWG<br>EPR 7/C 12 AWG<br>PE 7/C 12 AWG<br>PVC (no connection)<br>TS/TP (no connection)<br>XLPO (no connection)     | 10<br>2<br>15<br>1<br>3<br>8 | 6           | Tray    | A              | A&B         |
|        | 2         | Tefzel 7/C 12 AWG<br>XLPO 7/C 12 AWG<br>EPR 7/C 12 AWG<br>XLPE (no connection)<br>PVC (no connection)<br>TS/TP (no connection) | 12<br>8<br>2<br>10<br>1<br>3 | 6           | Tray    | C              | A&B         |
| IT-12  | 1         | XLPE 7/C 12 AWG<br>EPR 7/C 12 AWG<br>PE 7/C 12 AWG<br>PVC (no connection)<br>TS/TP (no connection)<br>XLPO (no connection)     | 10<br>2<br>15<br>1<br>3<br>8 | 6           | Tray    | A              | A&B         |
|        | 2         | Tefzel 7/C 12 AWG<br>XLPO 7/C 12 AWG<br>EPR 7/C 12 AWG<br>XLPE (no connection)<br>PVC (no connection)<br>TS/TP (no connection) | 12<br>8<br>2<br>10<br>1<br>3 | 6           | Tray    | C              | A&B         |

**Table 7.1: Summary of the IRMS test conditions for the Intermediate-scale tests.**

| Test # | IRMS unit | Cable types   | ID #'s                         | Bundle Size | Raceway | Cable Location | Bin 2 Items |
|--------|-----------|---|--------------------------------|-------------|---------|----------------|-------------|
| IT-13  | 1         | XLPE 7/C 12 AWG<br>EPR 7/C 12 AWG<br>Vita-Link 7/C 12 AWG<br>XLPO (no connection)<br>PE (no connection)<br>Tefzel (no connection) | 10<br>2<br>11<br>8<br>15<br>12 | 6           | Tray    | F              | A&B         |
|        | 2         | XLPE 7/C 12 AWG<br>EPR 7/C 12 AWG<br>Vita-Link 7/C 12 AWG<br>XLPO (no connection)<br>PE (no connection)<br>Tefzel (no connection) | 10<br>2<br>11<br>8<br>15<br>12 | 6           | Tray    | G              | A&B         |
| IT-14  | 1         | XLPE 7/C 12 AWG<br>EPR 7/C 12 AWG<br>PE 7/C 12 AWG<br>PVC (no connection)<br>TS/TP (no connection)<br>Tefzel (no connection)      | 10<br>2<br>15<br>1<br>3<br>12  | 6           | Tray    | F              | A&B         |
|        | 2         | XLPE 7/C 12 AWG<br>EPR 7/C 12 AWG<br>PE 7/C 12 AWG<br>PVC (no connection)<br>TS/TP (no connection)<br>Tefzel (no connection)      | 10<br>2<br>15<br>1<br>3<br>12  | 6           | Tray    | G              | A&B         |

### 7.1.2 IRMS Results for Test IT-1

Test IT-1 involved a 12-cable bundle of XLPE 7-conductor 12 AWG cables (ID #10) in a cable tray at location G (upper side hot gas layer). The results of this test are summarized as follows:

| Time (s)  | Event  | Interpretation   |
|-----------|--|--|
| 632       | Ignited Gas Burner   |  |
| 1180      | Conductors B4 & C5 short together at less than 100 $\Omega$ (76)       | Evidence of inter-cable shorting (B & C) as a primary fault mode |
| 1354      | Conductor E7 shorts to ground at less than 100 $\Omega$ (12)           | Cable E is shows high resistance shorts to ground                |
| 1446-1477 | Conductors A2 & B4 short to ground at less than 100 $\Omega$ (3 & 1)   | Cables A & B are shows high resistance shorts to ground          |
| 1617      | Conductor B3 shorts to ground at less than 100 $\Omega$ (2)            | Cable B shorted to ground  |
| 2190      | Conductors A1 & C5 short together at less than 100 $\Omega$ (84)       | Evidence of inter-cable shorting (A & C)                         |
| 2255-2257 | Conductors H9 & H10 short to ground at less than 100 $\Omega$ (23 & 5) | Cable H shorted to ground  |

| Time (s)  | Event   | Interpretation                      |
|-----------|---|-------------------------------------|
| 2308-2328 | Conductors E7 & E8 short together (6); conductors H9 & H10 short together (22)  | Cables E & H are shorted internally |
| 2336      | Conductors A1 & A2 short together at less than 1000 Ω (315)                     | Cable A shorts internally           |
| 2389      | Conductors B3 & B4 short together at less than 100 Ω (70)                       | Cable B shorts internally           |
| 2408-2414 | Conductors C5, C6 & L11 all short to ground at less than 100 Ω (<1, 5 & 3)      | Cables C & L short to ground        |
| 2431      | Conductors C5 & C6 short together at less than 100 Ω (2)                        | Cable C shorts internally           |
| 2434      | Conductor E8 shorts to ground at less than 100 Ω (4)                            | Cable E is shorted to ground        |
| 2490      | The existing short between conductors A1 & A2 decreases to less than 100 Ω (13) |                                     |
| 2502      | Conductor A1 shorts to ground at less than 100 Ω (10)                           | Cable A shorted to ground           |
| 3307      | Extinguished Gas Burner   |                                     |

This test showed evidence of two cases of inter-cable shorting independent of ground:

- The first short circuits detected were between the conductors of two neighboring cables (B and C). This occurred prior to either intra-cable faulting or faults to ground in either cable.
- In the second case, one of the conductor groups in Cable A shorts to ground, but the other does not. The un-grounded conductor group in A then shorts to a conductor group in Cable C.
- Both of the inter-cable shorts impacted the same conductor group in Cable C (C5).

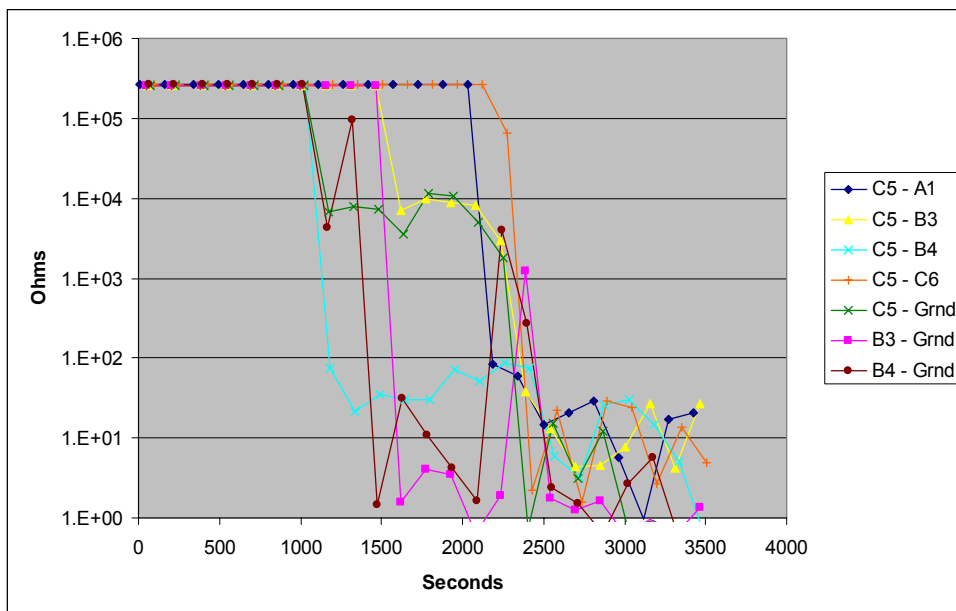


Figure 7.2: Illustration of the Inter-cable shorting behaviors observed by the IRMS in Test IT-1.

These faults are illustrated in Figure 7.2. Note that the light blue line is the insulation resistance (IR) between C5 and B4, and corresponds to the first inter-cable fault. The dark blue line represents the

second inter-cable fault between C5 and A1. The inter-cable fault (‘C5-B4’) persists for about 194 s before B4 shorts to ground (‘B4-Grnd’). (Note that for clarity, not all of the individual channel-to-channel and channel-to-ground failures are not shown.) After this time, various additional faults are detected, and the cables all short to ground within a short time period.

**7.1.3 Results for Test IT-2**

In test IT-2, the IRMS (unit 1) was connected to a bundle of six TS XLPE 7-conductor 12 AWG cables (cable ID #10) in a tray at location C (second tray above the fire). The results of this test are described as follows:

| Time (s)  | Event  | Interpretation  |
|-----------|--|---|
| 221       | Ignited Gas Burner   |   |
| 858-864   | Conductors D7 & D8 both short to ground at less than 100 Ω (26 & 8)                    | Cable D shorts to ground  |
| 883       | Conductors D7 & D8 short together at less than 100 Ω (75)                              | Cable D shorted internally                                      |
| 1246-1249 | Conductors E9 & E10 both short to ground at less than 100 Ω (6 & 8)                    | Cable E shorts to ground  |
| 1267      | Conductor F11 shorts to ground at less than 1000 Ω (608)                               | One conductor group in F shorts to ground at high resistance    |
| 1277      | Conductors E9 & E10 short together at less than 100 Ω (28)                             | Cable E shorted internally                                      |
| 1451      | The existing ground fault on conductor F11 decreases to less than 100 Ω (5)            | Conductor group in F fault to ground degrades to low resistance |
| 1479      | Conductors A1 & A2 short together at less than 100 Ω (14)                              | Cable A shorted internally                                      |
| 1535      | Conductor B3 shorts to ground at less than 100 Ω (51)                                  | One conductor group in B shorts to ground                       |
| 1538      | Conductors B3 & B4 short together at less than 100 Ω (52)                              | Cable B shorted internally                                      |
| 1550      | Conductor B4 shorts to ground at less than 100 Ω (38)                                  | Cable B fully shorts to ground                                  |
| 1585      | Conductors C5 & C6 short together at less than 1000 Ω (235)                            | Cable C shorted internally                                      |
| 1749-1758 | Conductors C5 & C6 both short to ground at less than 100 Ω (33 & 43)                   | Cable C fully shorts to ground                                  |
| 1770      | The existing intra-cable fault on conductors C5 & C6 decreases to less than 100 Ω (10) |   |
| 1854-1876 | Conductors A1 & A2 both short to ground (108 & 68)                                     | Cable A fully shorts to ground                                  |
| 1994      | Gas burner is shut off   |   |
| 2039      | The existing ground fault on conductor A1 decreases to less than 100 Ω (31)            |   |

Observations relative to the IT-2 test results are as follows:

- The progression of cable failure began with the bottom three cables (D, E & F) and moved up the bundle to the top cables.
- No substantive inter-cable interactions were observed.

#### **7.1.4 Results for Test IT-3**

In Test IT-3, the IRMS (unit 1) was connected to the cables of a mixed TS bundle of three XLPE and three EPR cables. All cables are 7/C 12 AWG. The specific cables and arrangement within the six-cable bundle is as follows:

- Cables A, D, F = XLPE (ID #7)
- Cables B, C, E = EPR (ID #2)

The results of test IT-3 are summarized as follows:

| Time (s) | Event   | Interpretation                                  |
|----------|---|---|
| 145      | Ignited Gas Burner  |   |
| 489-494  | Conductors D7 & D8 both short to ground (237 & 36)  | Cable D shorts to ground                        |
| 506-509  | Conductors E9 & E10 both short to ground at less than 100 $\Omega$ (1 & 2)                      | Cable E shorts to ground                        |
| 513      | Conductors D7 & D8 short together at less than 100 $\Omega$ (80)                                | Cable D shorted internally                      |
| 527-530  | Conductors F11 & F12 both short to ground (148 & 37)  | Cable F shorts to ground                        |
| 538      | Conductors E9 & E10 short together at less than 100 $\Omega$ (26)                               | Cable E shorted internally                      |
| 552      | Conductors F11 & F12 short together at less than 1000 $\Omega$ (148)                            | Cable F shorted internally                      |
| 673      | The existing ground fault on conductor D7 decreases to less than 100 $\Omega$ (4)               |   |
| 712      | The existing ground fault on conductor F11 decreases to less than 100 $\Omega$ (1)              |   |
| 737      | The existing intra-cable fault on conductors F11 & F12 decreases to less than 100 $\Omega$ (10) |   |
| 795      | Conductor B3 shorts to ground at less than 100 $\Omega$ (29)                                    | One conductor group in Cable B shorts to ground |
| 798      | Conductors B3 & B4 short together at less than 100 $\Omega$ (82)                                | Cable B shorted internally                      |
| 811      | Conductor B4 shorts to ground at less than 100 $\Omega$ (1)                                     | Cable B fully shorts to ground                  |
| 825-833  | Conductors C5 & C6 both short to ground at less than 100 $\Omega$ (6 & 14)                      | Cable C shorts to ground                        |
| 846      | Conductors C5 & C6 short together at less than 100 $\Omega$ (60)                                | Cable C shorted internally                      |

| Time (s) | Event   | Interpretation             |
|----------|---|----------------------------|
| 924      | Conductors A1 & A2 short together at less than 100 $\Omega$ (65)            | Cable A shorted internally |
| 930-952  | Conductors A1 & A2 both short to ground at less than 100 $\Omega$ (53 & 19) | Cable A shorts to ground   |
| 1072     | Gas burner is shut off  |                            |

Observations relative to the IT-3 test results are as follows:

- The progression of cable failure began with the bottom three cables (D, E & F) and moved up the bundle to the top cables.
- No substantive inter-cable interactions were observed.

### **7.1.5 Results for Test IT-4**

As noted above, the IRMS in Test IT-4 monitored a single cable in detail and was aimed primarily at the fire model improvement need area. The IRMS data for this test is not relevant to the Bin 2 items.

### **7.1.6 Results for Test IT-5**

In Test IT-5, the IRMS (unit 1) was connected to a bundle of six cables of mixed TS and TP types. The specific cables in the bundle are as follows:

- Cable A = XLPE 7/C 12 AWG (ID #10)
- Cable B = PE 7/C 12 AWG (ID #15)
- Cable C = Tefzel 7/C 12 AWG (ID #12)
- Cable D = EPR 7/C 12 AWG (ID #2)
- Cable E = XLPO 7/C 12 AWG (ID #8)
- Cable F = SR 7/C 12 AWG (ID #9)

The results for IT-5 are summarized as follows:

| Time (s) | Event  | Interpretation                                  |
|----------|--|---|
| 163      | Ignited Gas Burner   |   |
| 280      | Conductor C6 shorts to ground at less than 100 $\Omega$ (13)     | One conductor group in Cable C shorts to ground |
| 398      | Conductor A2 shorts to ground at less than 1000 $\Omega$ (193)   | One conductor group in Cable A shorts to ground |
| 442      | Conductor B4 shorts to ground at less than 1000 $\Omega$ (266)   | One conductor group in Cable B shorts to ground |
| 456      | Conductor C5 shorts to ground at less than 100 $\Omega$ (1)      | Cable C fully shorts to ground                  |
| 477      | Conductors C5 & C6 short together at less than 100 $\Omega$ (15) | Cable C shorted internally                      |



| Time (s)  | Event  | Interpretation                 |
|-----------|--|--------------------------------|
| 489-494   | Conductors D7 & D8 both short to ground at less than 100 $\Omega$ (11 & 13)  | Cable D shorts to ground       |
| 507-510   | Conductors E9 & E10 both short to ground at less than 100 $\Omega$ (1 & 2)   | Cable E shorts to ground       |
| 513       | Conductors D7 & D8 short together at much less than 100 $\Omega$ (<1)  | Cable D shorted internally     |
| 538       | Conductors E9 & E10 short together at less than 100 $\Omega$ (11)  | Cable E shorted internally     |
| 555       | Conductors A1 & A2 short together at less than 100 $\Omega$ (29)   | Cable A shorted internally     |
| 560-583   | Conductor A1 shorts to ground at less than 100 $\Omega$ (4); the existing ground fault on conductor A2 decreases to less than 100 $\Omega$ (1)     | Cable A fully shorts to ground |
| 611-626   | Conductor B3 shorts to ground at less than 1000 $\Omega$ (141); the existing ground fault on conductor B4 decreases to less than 100 $\Omega$ (17) | Cable B fully shorts to ground |
| 796       | The existing ground fault on conductor B3 decreases to less than 100 $\Omega$ (11)   |                                |
| 1168      | The existing intra-cable fault between conductors B3 & B4 decreases to less than 100 $\Omega$ (33)   |                                |
| 1708      | Gas burner is shut off   |                                |
| 1739      | Sprinkler is activated   |                                |
| 1821-1823 | Conductors F11 & F12 both short to ground at less than 100 $\Omega$ (10 & 1)   | Cable F shorts to ground       |
| 1846      | Conductors F11 & F12 short together at less than 100 $\Omega$ (29)   | Cable F shorted internally     |
| 1869      | Sprinkler is shut off  |                                |

Observations relative to the IT-5 test results are as follows:

- The reason that the three cables (A, B & C) at the top of the bundle shorted to ground before the bottom three cables is unknown.
- The SR cable (F) showed no signs of failure until the sprinkler was activated. However, the cable did fail about 1-2 minutes after water flow was initiated.
- No substantive inter-cable interactions were observed.

### **7.1.7 Results for Test IT-6**

Recall that test IT-6 was the fire test to use both of the IRMSs. The subsections which follow summarize the results for IRMS Unit 1 and IRMS Unit 2 respectively. (Discussions of the IRMS results for subsequent tests follow this same presentation format.)

#### *7.1.7.1 Results for IRMS Unit 1*

In Test IT-6, IRMS Unit 1 was connected to the same combination of six mixed TS and TP cables as used in Test IT-5, but the arrangement of the cables was slightly different. The cables present were as follows:

- Cable A = XLPE (ID #10)
- Cable B = SR (ID #9)
- Cable C = EPR (ID #2)
- Cable D = XLPO (ID #8)
- Cable E = PE (ID #15)
- Cable F = Tefzel (ID #12)

The results for IRMS 1 in Test IT-6 are summarized as follows:

| Time (s) | Event  | Interpretation   |
|----------|--|--|
| 162      | Ignited Gas Burner   |  |
| 309      | Conductor D8 shorts to ground at less than 100 Ω (1)   | One conductor group in Cable D shorts to ground                    |
| 322      | Conductor E9 shorts to ground at less than 100 Ω (1)   | One conductor group in Cable E shorts to ground                    |
| 342-345  | Conductors F11 & F12 both short to ground at less than 100 Ω (3 & 3)   | Cable F shorts to ground   |
| 367      | Conductors F11 & F12 short together at less than 100 Ω (15)  | Cable F shorted internally   |
| 370      | Conductors A1 & A2 short together at less than 1000 Ω (250)  | Cable A shorted internally   |
| 398      | Conductor A2 shorts to ground at less than 1000 Ω (218)  | One conductor group in Cable A shorts to ground at high resistance |
| 406-409  | Conductor A2 shorts to conductors C5 & C6 at less than 1000 Ω (218 & 239)  | Possible cable to cable short                                      |
| 456-464  | Conductors C5 & C6 both short to ground at less than 100 Ω (11 & 1)  | Cable C shorts to ground   |
| 476      | Conductors C5 & C6 short together at less than 1000 Ω (132)  | Cable C shorted internally   |
| 489      | Conductor D7 shorts to ground at less than 100 Ω (1)   | Cable D shorts to ground   |
| 510      | Conductor E10 shorts to ground at less than 100 Ω (1)  | Cable E shorts to ground   |
| 513      | Conductors D7 & D8 short together at less than 100 Ω (24)  | Cable D shorted internally   |
| 538      | Conductors E9 & E10 short together at less than 100 Ω (5)  | Cable E shorted internally   |
| 560-583  | Conductor A1 shorts to ground at less than 100 Ω (4); the existing ground fault on conductor A2 decreases to less than 100 Ω (1) | Cable A shorts to ground   |
| 661      | The existing intra-cable short between conductors C5 & C6 decreases to less than 100 Ω (5)                                       |  |
| 740      | The existing intra-cable short between conductors A1 & A2 decreases to less than 100 Ω (14)                                      |  |
| 958      | Gas burner is shut off   |  |
| 980-996  | Conductors B3 & B4 both short to ground (454 & 22)   | Cable B shorts to ground   |
| 992      | Sprinkler is activated   |  |
| 1162     | Sprinkler is shut off  |  |
| 1165     | The existing ground fault on conductor B3 decreases to less than 100 Ω (8)   |  |

| Time (s) | Event  | Interpretation             |
|----------|--|----------------------------|
| 1168     | Conductors B3 & B4 short together at less than 100 $\Omega$ (28) | Cable B shorted internally |

Observations relative to these test results are as follows:

- The silicone rubber cable (B) showed no signs of failure until after the sprinkler was activated. The SR cable did fail essentially concurrent with actuation of the sprinklers.
- One inter-cable interaction took place during this test (between cables A & C, both TS type cables). However, this was a tertiary fault mode cable A since the two conductor groups in cable A (A1 and A2) had already shorted to each other, and one of the two conductor groups (A2) had also shorted to ground. Cable C then shorted to A2, the conductor group that was also shorted to ground. The inter-cable short was the primary fault mode for cable C.

#### 7.1.7.2 Results for IRMS Unit 2

In Test IT-6, IRMS Unit 2 was connected to a second mixed bundle of six TS and TP cables. In this test, the bundle also included the one mixed type TS/TP cable (ID #3). The cables present and bundling arrangement was as follows:

- Cable A = SR (ID #9)
- Cable B = PE (ID #15)
- Cable C = XLPO (ID #8)
- Cable D = Tefzel (ID #12)
- Cable E = TS/TP (ID #3)
- Cable F = EPR (ID #2)

The results of for IRMS unit 2 in Test IT-6 are summarized as follows:

| Time (s) | Event   | Interpretation                                  |
|----------|---|---|
| 162      | Ignited Gas Burner  |   |
| 304      | Conductor D7 shorts to ground at less than 100 $\Omega$ (89)                | One conductor group in Cable D shorts to ground |
| 325      | Conductor E10 shorts to ground at less than 100 $\Omega$ (13)               | One conductor group in Cable E shorts to ground |
| 329      | Conductors D7 & D8 short together at less than 100 $\Omega$ (26)            | Cable D shorted internally                      |
| 343-345  | Conductors F11 & F12 both short to ground at less than 100 $\Omega$ (1 & 7) | Cable F shorts to ground                        |
| 368      | Conductors F11 & F12 short together at less than 100 $\Omega$ (94)          | Cable F shorted internally                      |
| 426      | Conductor B3 shorts to ground at less than 100 $\Omega$ (18)                | One conductor group in Cable B shorts to ground |
| 495      | Conductor D8 shorts to ground at less than 100 $\Omega$ (1)                 | Cable D shorts to ground                        |
| 507      | Conductor E9 shorts to ground at less than 100 $\Omega$ (3)                 | Cable E shorts to ground                        |

| Time (s)  | Event  | Interpretation             |
|-----------|--|----------------------------|
| 539       | Conductors E9 & E10 short together at less than 100 $\Omega$ (11)          | Cable E shorted internally |
| 614       | Conductors B3 & B4 short together at less than 100 $\Omega$ (7)            | Cable B shorted internally |
| 627       | Conductor B4 shorts to ground at less than 100 $\Omega$ (1)                | Cable B shorts to ground   |
| 641-650   | Conductors C5 & C6 both short to ground at less than 100 $\Omega$ (14 & 2) | Cable C shorts to ground   |
| 662       | Conductors C5 & C6 short together at less than 100 $\Omega$ (90)           | Cable C shorted internally |
| 958       | Gas burner is shut off   |                            |
| 992       | Sprinkler is activated   |                            |
| 1110      | Conductors A1 & A2 short together at less than 100 $\Omega$ (2)            | Cable A shorted internally |
| 1115-1137 | Conductors A1 & A2 both short to ground at less than 100 $\Omega$ (2 & 1)  | Cable A shorts to ground   |
| 1162      | Sprinkler is shut off  |                            |

Observations relative to these test results are as follows:

- The progression of cable failure generally started with the bottom cables and worked up to the top cable group during the test.
- The silicone rubber cable (A) showed no signs of failure until the sprinkler was activated. The cable then failed within 1-2 minutes of sprinkler activation.
- No substantive inter-cable interactions were observed.

### **7.1.8 Results for Test IT-7**

#### *7.1.8.1 Results for IRMS Unit 1*

In test IT-7 IRMS Unit 1 was connected to a mixed bundle of TS and TP cables including the one mixed TS/TP cable. The specific cables and bundling arrangement is as follows:

- Cable A = XLPE (ID #10)
- Cable B = PVC (ID #1)
- Cable C = PE (ID #15)
- Cable D = EPR (ID #2)
- Cable E = TS/TP (ID #3)
- Cable F = XLPO (ID #8)

The results from IRMS Unit 2 for Test IT-7 are summarized as follows:

| Time (s) | Event  | Interpretation           |
|----------|--|--------------------------|
| 152      | Ignited Gas Burner   |                          |
| 304-309  | Conductors D7 & D8 both short to ground at less than 1000 $\Omega$ (176 & 126) | Cable D shorts to ground |

| Time (s) | Event   | Interpretation                |
|----------|---|-------------------------------|
| 334-345  | Conductors D7 & D8 both short to conductor E10 at less than 1000 $\Omega$ (175 & 125)   | Possible cable to cable short |
| 343-345  | Conductors F11 & F12 both short to ground at less than 100 $\Omega$ (26 & 2)  | Cable F shorts to ground      |
| 367      | Conductors F11 & F12 short together at less than 100 $\Omega$ (25)  | Cable F shorted internally    |
| 429      | Conductors B3 & B4 short together at less than 100 $\Omega$ (25)  | Cable B shorted internally    |
| 456-464  | Conductors C5 & C6 both short to ground at less than 100 $\Omega$ (36 & 32)   | Cable C shorts to ground      |
| 476      | Conductors C5 & C6 short together at less than 1000 $\Omega$ (609)  | Cable C shorted internally    |
| 489-494  | The existing ground faults on conductors D7 & D8 decrease to less than 100 $\Omega$ (5 & 5)   |                               |
| 506-510  | Conductors E9 & E10 both short to ground at less than 100 $\Omega$ (6 & 9)  | Cable E shorts to ground      |
| 513      | Conductors D7 & D8 short together at less than 100 $\Omega$ (12)  | Cable D shorted internally    |
| 538      | Conductors E9 & E10 short together at less than 100 $\Omega$ (4)  | Cable E shorted internally    |
| 555      | Conductors A1 & A2 short together at less than 100 $\Omega$ (21)  | Cable A shorted internally    |
| 583      | Conductor A2 shorts to ground at less than 1000 $\Omega$ (305)  |                               |
| 610-626  | Conductors B3 & B4 both short to ground at less than 100 $\Omega$ (3 & 1)   | Cable B shorts to ground      |
| 661      | The existing intra-cable short between conductors C5 & C6 decreases to less than 100 $\Omega$ (21)  |                               |
| 745-767  | Conductor A1 shorts to ground at less than 100 $\Omega$ (1) and the existing ground fault on conductor A2 decreases to less than 100 $\Omega$ (1) | Cable A shorts to ground      |
| 1551     | Gas burner is shut off  |                               |

Observations relative to these test results are as follows:

- One possible inter-cable interaction took place during this test (between cables D (TS) & E (TS/TP)). However, this was a tertiary fault mode for cable D in that both conductor groups in cable D had already shorted to ground at less than 1000  $\Omega$  resistance. This was, however, the primary fault mode for cable E.

#### 7.1.8.2 Results for IRMS Unit 2

In Test IT-7 IRMS Unit 2 was connected to a similar mixed bundle of TS and TP cables as those connected to Unit 1, but the bundling arrangement is slightly different. The specific cables and bundling arrangement is as follows:

- Cable A = PVC (ID #1)
- Cable B = EPR (ID #2)
- Cable C = XLPO (ID #8)
- Cable D = PE (ID #15)
- Cable E = TS/TP (ID #3)

- Cable F = Tefzel (ID #12)

The results for SCDU Unit 2 in Test IT-7 are summarized as follows:

| Time (s) | Event  | Interpretation                                  |
|----------|--|---|
| 152      | Ignited Gas Burner   |   |
| 490-495  | Conductors D7 & D8 both short to ground at less than 100 Ω (1 & 4)   | Cable D shorts to ground                        |
| 507-510  | Conductors E9 & E10 both short to ground at less than 100 Ω (4 & 1)  | Cable E shorts to ground                        |
| 514      | Conductors D7 & D8 short together at less than 100 Ω (25)  | Cable D shorted internally                      |
| 528-530  | Conductors F11 & F12 both short to ground at less than 100 Ω (1 & 1)   | Cable F shorts to ground                        |
| 539      | Conductors E9 & E10 short together at less than 100 Ω (2)  | Cable E shorted internally                      |
| 553      | Conductors F11 & F12 short together at less than 100 Ω (12)  | Cable F shorted internally                      |
| 556      | Conductors A1 & A2 short together at less than 100 Ω (31)  | Cable A shorted internally                      |
| 561      | Conductor A1 shorts to ground at less than 1000 Ω (363)  | One conductor group in Cable A shorts to ground |
| 612      | Conductor B3 shorts to ground at less than 1000 Ω (119)  | One conductor group in Cable B shorts to ground |
| 617      | Conductor B3 shorts to conductor C5 at less than 1000 Ω (126)  | Possible cable to cable interaction             |
| 627      | Conductor B4 shorts to ground at less than 100 Ω (45)  | Cable B shorts to ground                        |
| 641-650  | Conductors C5 & C6 both short to ground at less than 100 Ω (2 & 3)   | Cable C shorts to ground                        |
| 662      | Conductors C5 & C6 short together at less than 1000 Ω (155)  | Cable C shorted internally                      |
| 746-768  | The existing ground fault on conductor A1 decreases to less than 100 Ω (30) and conductor A2 shorts to ground at less than 100 Ω (8) | Cable A shorts to ground                        |
| 796      | The existing ground fault on conductor B3 decreases to less than 100 Ω (2)   |   |
| 799      | Conductors B3 & B4 short together at less than 100 Ω (23)  | Cable B shorted internally                      |
| 847      | The existing intra-cable fault between conductors C5 & C6 decreases to less than 100 Ω (69)  |   |
| 1551     | Gas burner is shut off   |   |

Observations relative to these test results are as follows:

- The progression of cable failure generally started with the bottom cables and worked up to the top cable group during the test.
- One possible inter-cable interaction occurred during this test (between cables B (TS) & C (TS)). However, the shorting group in Cable B that was involved in this interaction (B3) had already shorted to ground at less than 1000 Ω resistance prior to the inter-cable short

forming. Hence, this was a secondary fault mode for cable B, but a primary fault mode for cable C.

### **7.1.9 Results for Test IT-8**

#### *7.1.9.1 Results for IRMS Unit 1*

In Test IT-8 IRMS Unit 1 was connected to a mixed bundle of TS and TP cables. In this particular test, the cable bundles also included a mixture of 7/C, 12/C and 2/C cables. The specific cables and bundling arrangement is as follows:

- Cable A = XLPE (7/C) (ID #10)
- Cable B = PE (7/C) (ID #15)
- Cable C = XLPE (12/C) (ID #13)
- Cable D = XLPE (2/C) (ID #7)
- Cable E = PVC (12/C) (ID #6)
- Cable F = PVC (2/C) (ID #4)

The results for this case are summarized as follows:

| Time (s) | Event   | Interpretation             |
|----------|---|----------------------------|
| 219      | Ignited Gas Burner  |                            |
| 322-325  | Conductors E9 & E10 both short to ground at less than 100 $\Omega$ (7 & 11)       | Cable E shorts to ground   |
| 343-345  | Conductors F11 & F12 both short to ground at less than 100 $\Omega$ (2 & 4)       | Cable F shorts to ground   |
| 354      | Conductors E9 & E10 short together at less than 100 $\Omega$ (13)                 | Cable E shorted internally |
| 368      | Conductors F11 & F12 short together at less than 100 $\Omega$ (20)                | Cable F shorted internally |
| 456-465  | Conductors C5 & C6 both short to ground at less than 100 $\Omega$ (12 & 6)        | Cable C shorts to ground   |
| 477      | Conductors C5 & C6 short together at less than 100 $\Omega$ (11)                  | Cable C shorted internally |
| 489-495  | Conductors D7 & D8 both short to ground at less than 100 $\Omega$ (6 & 7)         | Cable D shorts to ground   |
| 513      | Conductors D7 & D8 short together at less than 100 $\Omega$ (4)                   | Cable D shorted internally |
| 611-627  | Conductors B3 & B4 both short to ground at less than 1000 $\Omega$ (133 & 166)    | Cable B shorts to ground   |
| 740      | Conductors A1 & A2 short together at less than 100 $\Omega$ (90)                  | Cable A shorted internally |
| 746-768  | Conductors A1 & A2 both short to ground (164 & 32)                                | Cable A shorts to ground   |
| 796      | The existing ground fault on conductor B3 decreases to less than 100 $\Omega$ (7) |                            |
| 799      | Conductors B3 & B4 short together at less than 100 $\Omega$ (63)                  | Cable B shorted internally |
| 811      | The existing ground fault on conductor B4 decreases to less than 100 $\Omega$ (8) |                            |

| Time (s) | Event  | Interpretation |
|----------|--|----------------|
| 930      | The existing ground fault on conductor A1 decreases to less than 100 Ω (3) |                |
| 2257     | Gas burner is shut off   |                |

Observations relative to these test results are as follows:

- No substantive inter-cable interactions were observed.

7.1.9.2 Results for IRMS Unit 2

In Test IT-8 IRMS Unit 2 was connected to a similar mixed bundle of TS (XLPE) and TP (PE) 7/C cables. The specific cables and bundling arrangement is as follows:

- Cable A = XLPE (7/C) (ID #10)
- Cable B = PE (7/C) (ID #15)
- Cable C = PE (7/C) (ID #15)
- Cable D = XLPE (7/C) (ID #10)
- Cable E = PE (7/C) (ID #15)
- Cable F = XLPE (7/C) (ID #10)

The results for this case are summarized as follows:

| Time (s)  | Event   | Interpretation                                  |
|-----------|---|---|
| 219       | Ignited Gas Burner  |   |
| 876       | Conductor E9 shorts to ground at less than 100 Ω (16)   | One conductor group in Cable E shorts to ground |
| 1064      | Conductor E10 shorts to ground at less than 100 Ω (8)   | Cable E shorts to ground                        |
| 1092      | Conductors E9 & E10 short together at less than 100 Ω (1)   | Cable E shorted internally                      |
| 1228      | Conductor D7 shorts to ground at less than 1000 Ω (222)   | One conductor group in Cable D shorts to ground |
| 1252      | Conductors D7 & D8 short together at less than 1000 Ω (279)   | Cable D shorted internally                      |
| 1266-1268 | Conductors F11 & F12 short to ground (85 & 563)   | Cable F shorts to ground                        |
| 1291      | Conductors F11 & F12 short together at less than 1000 Ω (756)   | Cable F shorted internally                      |
| 1412-1418 | The existing ground fault on conductor D7 decreases to less than 100 Ω (1) and conductor D8 shorts to ground at less than 100 Ω (4) | Cable D shorts to ground                        |
| 1453      | The existing ground fault on conductor F12 decreases to less than 100 Ω (2)   |   |
| 1564-1573 | Conductors C5 & C6 both short to ground (31 & 324)  | Cable C shorts to ground                        |



| Time (s)  | Event  | Interpretation             |
|-----------|--|----------------------------|
| 1661      | The existing intra-cable fault between conductors F11 & F12 decreases to less than 100 $\Omega$ (13) |                            |
| 1663      | Conductors A1 & A2 short together at less than 100 $\Omega$ (39)                                     | Cable A shorted internally |
| 1669-1691 | Conductors A1 & A2 both short to ground (114 & 88)   | Cable A shorts to ground   |
| 1719-1735 | Conductors B3 & B4 both short to ground at less than 100 $\Omega$ (29 & 39)                          | Cable B shorts to ground   |
| 1758      | The existing ground fault on conductor C6 decreases to less than 100 $\Omega$ (22)                   |                            |
| 1806      | The existing intra-cable fault between conductors D7 & D8 decreases to less than 100 $\Omega$ (9)    |                            |
| 1854      | The existing ground fault on conductor A1 decreases to less than 100 $\Omega$ (17)                   |                            |
| 1906      | Conductors B3 & B4 short together at less than 1000 $\Omega$ (831)                                   | Cable B shorted internally |
| 1955      | Conductors C5 & C6 short together at less than 100 $\Omega$ (22)                                     | Cable C shorted internally |
| 2092      | The existing intra-cable fault between conductors B3 & B4 decreases to less than 100 $\Omega$ (18)   |                            |
| 2257      | Gas burner is shut off   |                            |

Observations relative to these test results are as follows:

- The progression of cable failure generally started with the bottom cables and worked up to the top cable group during the test.
- No substantive inter-cable interactions were observed.

### **7.1.10 Results for Test IT-9**

#### *7.1.10.1 Results for IRMS Unit 1*

In Test IT-9 IRMS Unit 1 was connected to mixed bundle of TS and TP cables including the one mixed type TS/TP cable. The specific cables and bundling arrangement is as follows:

- Cable A = EPR (ID #2)
- Cable B = PE (ID #15)
- Cable C = Tefzel (ID #12)
- Cable D = SR (ID #9)
- Cable E = TS/TP (ID #3)
- Cable F = XLPE (ID #10)

The results for this case are summarized as follows:

| Time (s) | Event   | Interpretation   |
|----------|---|--|
| 194      | Ignited Gas Burner  |  |
| 322-325  | Conductors E9 & E10 both short to ground at less than 100 $\Omega$ (20 & 33)                | Cable E shorts to ground   |
| 343-345  | Conductors F11 & F12 both short to ground at less than 100 $\Omega$ (18 & 27)               | Cable F shorts to ground   |
| 354      | Conductors E9 & E10 short together at less than 100 $\Omega$ (26)                           | Cable E shorted internally   |
| 368      | Conductors F11 & F12 short together at less than 100 $\Omega$ (18)                          | Cable F shorted internally   |
| 376-398  | Conductors A1 & A2 both short to ground at less than 1000 $\Omega$ (274 & 138)              | Cable A shorts to ground   |
| 382      | Conductor A1 shorts to conductor C6 at less than 1000 $\Omega$ (274)                        | Possible cable to cable interaction                                |
| 404      | Conductor A2 shorts to conductor B4 at less than 1000 $\Omega$ (137)                        | Possible cable to cable interaction                                |
| 426-442  | Conductors B3 & B4 both short to ground at less than 100 $\Omega$ (29 & 23)                 | Cable B shorts to ground   |
| 456-465  | Conductors C5 & C6 both short to ground at less than 100 $\Omega$ (5 & 1)                   | Cable C shorts to ground   |
| 477      | Conductors C5 & C6 short together at less than 100 $\Omega$ (24)                            | Cable C shorted internally   |
| 555      | Conductors A1 & A2 short together at less than 100 $\Omega$ (14)                            | Cable A shorted internally   |
| 560-583  | The existing ground faults on conductors A1 & A2 decrease to less than 100 $\Omega$ (1 & 3) |  |
| 614      | Conductors B3 & B4 short together at less than 100 $\Omega$ (4)                             | Cable B shorted internally   |
| 1228     | Conductor D7 shorts to ground at less than 1000 $\Omega$                                    | One conductor group in Cable D shorts to ground at high resistance |
| 1413     | The existing ground fault on conductor D7 decreases to less than 100 $\Omega$ (37)          |  |
| 1418     | Conductor D8 shorts to ground at less than 1000 $\Omega$ (228)                              | Cable D shorts to ground   |
| 1437     | Conductors D7 & D8 short together at less than 100 $\Omega$ (36)                            | Cable D shorted internally   |
| 2104     | Gas burner is shut off  |  |
| 2144     | Activated sprinkler   |  |
| 2157     | The existing ground fault on conductor D8 decreases to less than 100 $\Omega$ (13)          |  |
| 2314     | Shut off sprinkler  |  |

Observations relative to these test results are as follows:

- Two possible cable to cable interactions were observed during this test (TS Cable A to TP Cable C and TS Cable A to TP Cable B). However, both of the conductor groups in TS Cable A had already shorted to ground at a resistance level less than 1000  $\Omega$  prior to the shorts to either of the two other cables.
- The SR cable did not fail during the fire exposure, but did fail when sprinkler was activated.

## 7.1.10.2 Results for IRMS Unit 2

In Test IT-9 IRMS Unit 2 was connected to mixed bundle of TS and TP cables identical to the bundle connected to unit 1 for this same test. The specific cables and bundling arrangement is as follows:

- Cable A = EPR (ID #2)
- Cable B = PE (ID #15)
- Cable C = Tefzel (ID #12)
- Cable D = SR (ID #9)
- Cable E = TS/TP (ID #3)
- Cable F = XLPE (ID #10)

The results for this case are summarized as follows:

| Time (s)  | Event  | Interpretation             |
|-----------|--|----------------------------|
| 194       | Ignited Gas Burner   |                            |
| 507-510   | Conductors E9 & E10 both short to ground at less than 100 $\Omega$ (6 & 7)                         | Cable E shorts to ground   |
| 527-530   | Conductors F11 & F12 both short to ground at less than 1000 $\Omega$ (456 & 461)                   | Cable F shorts to ground   |
| 552       | Conductors F11 & F12 short together at less than 100 $\Omega$ (77)                                 | Cable F shorted internally |
| 611-627   | Conductors B3 & B4 both short to ground at less than 1000 $\Omega$ (430 & 339)                     | Cable B shorts to ground   |
| 641-650   | Conductors C5 & C6 both short to ground at less than 100 $\Omega$ (10 & 5)                         | Cable C shorts to ground   |
| 662       | Conductors C5 & C6 short together at less than 1000 $\Omega$ (590)                                 | Cable C shorted internally |
| 713-715   | The existing ground faults on conductors F11 & F12 decrease to less than 100 $\Omega$ (1 & 3)      |                            |
| 723       | Conductors E9 & E10 short together at less than 100 $\Omega$ (13)                                  | Cable E shorted internally |
| 740       | Conductors A1 & A2 short together at less than 100 $\Omega$ (29)                                   | Cable A shorted internally |
| 746-768   | Conductors A1 & A2 both short to ground at less than 100 $\Omega$ (29 & 16)                        | Cable A shorts to ground   |
| 796-811   | The existing ground faults on conductors B3 & B4 decrease to less than 100 $\Omega$ (2 & 1)        |                            |
| 799       | Conductors B3 & B4 short together at less than 100 $\Omega$ (21)                                   | Cable B shorted internally |
| 847       | The existing intra-cable fault between conductors C5 & C6 decreases to less than 100 $\Omega$ (29) |                            |
| 2104      | Gas burner is shut off   |                            |
| 2144      | Sprinkler activated  |                            |
| 2152-2158 | Conductors D7 & D8 both short to ground at less than 100 $\Omega$ (13 & 6)                         | Cable D shorts to ground   |
| 2314      | Sprinkler shut off   |                            |
| 2361      | Conductors D7 & D8 short together at less than 100 $\Omega$ (15)                                   | Cable D shorted internally |

Observations relative to these test results are as follows:

- The silicone rubber cable (D) showed did not fail during the fire exposure, but did fail when the sprinkler was activated.
- No substantive inter-cable interactions were observed.

**7.1.11 Results for Test IT-10**

*7.1.11.1 Results for IRMS Unit 1*

In Test IT-10 IRMS Unit 1 was connected to mixed bundle of TS and TP cables. The specific cables and bundling arrangement is as follows:

- Cable A = XLPE (ID #10)
- Cable B = EPR (ID #2)
- Cable C = Tefzel (ID #12)
- Cable D = TS/TP (ID #3)
- Cable E = SR (ID #9)
- Cable F = XLP0 (ID #8)

The results for this case are summarized as follows:

| Time (s) | Event  | Interpretation   |
|----------|--|--|
| 174      | Ignited Gas Burner   |  |
| 304-310  | Conductors D7 & D8 both short to ground at less than 100 Ω (15 & 14)       | Cable D shorts to ground   |
| 328      | Conductors D7 & D8 short together at less than 100 Ω (13)                  | Cable D shorted internally   |
| 343-345  | Conductors F11 & F12 both short to ground at less than 100 Ω (1 & 8)       | Cable F shorts to ground   |
| 368      | Conductors F11 & F12 short together at less than 100 Ω (<1)                | Cable F shorted internally   |
| 398      | Conductor A2 shorts to ground at less than 1000 Ω (329)                    | One conductor group in Cable A shorts to ground at high resistance |
| 426      | Conductor B3 shorts to ground at less than 100 Ω (12)                      | One conductor group in Cable B shorts to ground                    |
| 429      | Conductors B3 & B4 short together at less than 100 Ω (18)                  | Cable B shorted internally   |
| 442      | Conductor B4 shorts to ground at less than 100 Ω (3)                       | Cable B shorts to ground   |
| 456-465  | Conductors C5 & C6 both short to ground at less than 100 Ω (1 & 3)         | Cable C shorts to ground   |
| 477      | Conductors C5 & C6 short together at less than 100 Ω (20)                  | Cable C shorted internally   |
| 555      | Conductors A1 & A2 short together at less than 100 Ω (4)                   | Cable A shorted internally   |
| 560      | Conductor A1 shorts to ground at less than 100 Ω (3)                       | Cable A shorts to ground   |
| 583      | The existing ground fault on conductor A2 decreases to less than 100 Ω (9) | One conductor group in Cable A shorts to ground at low resistance  |
| 1614     | Gas burner is shut off   |  |

| Time (s) | Event  | Interpretation             |
|----------|--|----------------------------|
| 1618     | Conductor E10 shorts to ground at less than 100 $\Omega$ (33)    |                            |
| 1667     | Activated sprinkler  |                            |
| 1763     | Shut off sprinkler   |                            |
| 1800     | Conductor E9 shorts to ground at less than 100 $\Omega$ (4)      | Cable E shorts to ground   |
| 1832     | Conductors E9 & E10 short together at less than 100 $\Omega$ (4) | Cable E shorted internally |

Observations relative to these test results are as follows:

- The silicone rubber cable (E) did not fail during the fire exposure, but did fail when the sprinkler was activated.
- No substantive inter-cable interactions were observed.

#### 7.1.11.2 Results for IRMS Unit 2

In Test IT-10 IRMS Unit 2 was connected to mixed bundle of TS, TS/TP, and TP cables. In this case, the bundle included a combination of 7/C, 12/C and 2/C cables. The specific cables and bundling arrangement is as follows:

- Cable A = XLPE (12/C) (ID #13)
- Cable B = EPR (7/C) (ID #2)
- Cable C = PVC (12/C) (ID #6)
- Cable D = TS/TP (7/C) (ID #3)
- Cable E = SR (7/C) (ID #9)
- Cable F = XLPO (7/C) (ID #8)

The results for this case are summarized as follows:

| Time (s) | Event   | Interpretation   |
|----------|---|--|
| 174      | Ignited Gas Burner  |  |
| 304-309  | Conductors D7 & D8 both short to ground at less than 100 $\Omega$ (20 & 14)   | Cable D shorts to ground   |
| 328      | Conductors D7 & D8 short together at less than 100 $\Omega$ (37)              | Cable D shorted internally   |
| 343-345  | Conductors F11 & F12 both short to ground at less than 100 $\Omega$ (33 & 17) | Cable F shorts to ground   |
| 367      | Conductors F11 & F12 short together at less than 100 $\Omega$ (57)            | Cable F shorted internally   |
| 426-441  | Conductors B3 & B4 both short to ground at less than 100 $\Omega$ (18 & 4)    | Cable B shorts to ground   |
| 464      | Conductor C6 shorts to ground at less than 1000 $\Omega$ (125)                | One conductor group in Cable C shorts to ground at high resistance |
| 477      | Conductors C5 & C6 short together at less than 100 $\Omega$ (72)              | Cable C shorted internally   |
| 555      | Conductors A1 & A2 short together at less than 100 $\Omega$ (34)              | Cable A shorted internally   |

| Time (s)  | Event   | Interpretation             |
|-----------|---|----------------------------|
| 560-583   | Conductors A1 & A2 both short to ground at less than 1000 $\Omega$ (105 & 183)  | Cable A shorts to ground   |
| 614       | Conductors B3 & B4 short together at less than 100 $\Omega$ (1)   | Cable B shorted internally |
| 640-649   | Conductor C5 shorts to ground at less than 100 $\Omega$ (4) and the existing ground fault on conductor C6 decreases to less than 100 $\Omega$ (1) | Cable C shorts to ground   |
| 745-767   | The existing ground faults on conductors A1 & A2 decrease to less than 100 $\Omega$ (2 & 2)   |                            |
| 1614      | Gas burner is shut off  |                            |
| 1615-1618 | Conductors E9 & E10 both short to ground at less than 100 $\Omega$ (18 & 1)   | Cable E shorts to ground   |
| 1667      | Sprinkler activated   |                            |
| 1763      | Sprinkler shut off  |                            |
| 1832      | Conductors E9 & E10 short together at less than 100 $\Omega$ (1)  | Cable E shorted internally |

Observations relative to these test results are as follows:

- No substantive inter-cable interactions were observed.

### **7.1.12 Results for Test IT-11**

#### *7.1.12.1 Results for IRMS Unit 1*

In Test IT-11 IRMS Unit 1 was connected to mixed bundle of 6 TS and TP cables. However, in this case the IRMS was only connected to three of the 6 cables present (cables A, B and C, 2 TS and 1 TP). This allowed for a four-fold increase scan rate for the IRMS. The other three cables were present but simply not connected to the IRMS. The cables that were connected to the IRMS were connected in the same manner as in all other tests (2 channels per cable). The specific cables and bundling arrangement is as follows:

- Cable A = XLPE (ID #10)
- Cable B = EPR (ID #2)
- Cable C = PE (ID #15)
- Cable D = PVC (no connection)
- Cable E = TS/TP (no connection)
- Cable F = XLPO (no connection)

The results for this case are summarized as follows:

| Time (s) | Event  | Interpretation            |
|----------|--|---------------------------|
| 207      | Ignited Gas Burner   |                           |
| 399-402  | Conductors B3 & B4 both short to ground at less than 1000 $\Omega$ (744 & 186)                     | Cable B shorted to ground |
| 404      | Conductors B3 & B4 short together at less than 1000 $\Omega$ (543)                                 | Cable B shorts internally |
| 441-444  | The existing ground faults on conductors B3 & B4 decrease to less than 100 $\Omega$ (83 & 58)      |                           |
| 462      | Conductors A1 & A2 short together at less than 1000 $\Omega$ (674)                                 | Cable A shorts internally |
| 468-477  | Conductors A1 & A2 both short to ground at less than 1000 $\Omega$ (458 & 341)                     | Cable A shorted to ground |
| 488-491  | Conductors C5 & C6 both short to ground at less than 1000 $\Omega$ (119 & 142)                     | Cable C shorted to ground |
| 505      | The existing intra-cable fault between conductors A1 & A2 decreases to less than 100 $\Omega$ (38) |                           |
| 510-519  | The existing ground faults on conductors A1 & A2 decrease to less than 100 $\Omega$ (32 & 27)      |                           |
| 530      | The existing intra-cable fault between conductors B3 & B4 decreases to less than 100 $\Omega$ (3)  |                           |
| 530-533  | The existing ground faults on conductors C5 & C6 decrease to less than 100 $\Omega$ (24 & 67)      |                           |
| 544      | Conductors C5 & C6 short together at less than 100 $\Omega$ (82)                                   | Cable C shorts internally |
| 1148     | Extinguished Gas Burner  |                           |

Observations relative to these test results are as follows:

- No substantive inter-cable interactions were observed.

#### 7.1.12.2 Results for IRMS Unit 2

In Test IT-11 IRMS Unit 2 was connected to mixed bundle of 6 TS and TP cables. However, in this case the IRMS was only connected to three of the 6 cables present (cables A, B and C). This resulted in a four-fold increase in the scan rate for the IRMS. The other three cables were present but simply not connected to the IRMS. The cables that were connected to the IRMS were connected in the same manner as in all other tests (2 channels per cable). The specific cables and bundling arrangement is as follows:

- Cable A = Tefzel (ID #12)
- Cable B = XLPO (ID #8)
- Cable C = EPR (ID #2)
- Cable D = XLPE (no connection)
- Cable E = PVC (no connection)
- Cable F = TS/TP (no connection)

The results for this case are summarized as follows:

| Time (s) | Event   | Interpretation   |
|----------|---|--|
| 207      | Ignited Gas Burner  |  |
| 421      | Conductors A1 & A2 short together at less than 100 $\Omega$ (42)  | Cable A shorts internally  |
| 425      | Conductor A1 shorts to ground at less than 1000 $\Omega$ (683)  | One conductor group in Cable A shorts to ground                    |
| 510-519  | The existing ground fault on conductor A1 decreases to less than 100 $\Omega$ (16); conductor A2 shorts to ground at less than 100 $\Omega$ (4) | Cable A shorted to ground  |
| 528      | Conductor B4 shorts to ground at less than 100 $\Omega$ (6)   | One conductor group in Cable B shorts to ground                    |
| 574      | Conductor C6 shorts to ground at less than 1000 $\Omega$ (117)  | One conductor group in Cable C shorts to ground at high resistance |
| 614-616  | Conductor C5 shorts to ground at less than 100 $\Omega$ (6); the existing ground fault on conductor C6 decreases to less than 100 $\Omega$ (8)  | Cable C shorted to ground  |
| 651      | Conductor B3 shorts to ground at less than 1000 $\Omega$ (164)  | One conductor group in Cable B shorts to ground                    |
| 656      | Conductors B3 & B4 short together at less than 1000 $\Omega$ (163) [erratic shorting behavior noted]  | Cable B shorts internally  |
| 670      | Conductors C5 & C6 short together at less than 1000 $\Omega$ (403)  | Cable C shorts internally  |
| 692      | The existing ground fault on conductor B3 decreases to less than 100 $\Omega$ (8)   |  |
| 754      | The existing intra-cable short between conductors C5 & C6 decreases to less than 100 $\Omega$ (53) but is erratic in nature                     |  |
| 908      | The existing intra-cable short between conductors B3 & B4 decreases to less than 100 $\Omega$ (25)  |  |
| 1148     | Gas burner is shut off  |  |

Observations relative to these test results are as follows:

- No substantive inter-cable interactions were observed.

### **7.1.13 Results for Test IT-12**

#### *7.1.13.1 Results for IRMS Unit 1*

In Test IT-12 IRMS Unit 1 was connected to mixed bundle of 6 TS and TP cables. However, in this case the IRMS was only connected to three of the 6 cables present (cables A, B and C). This resulted in a four-fold increase in the scan rate for the IRMS. The other three cables were present but simply not connected to the IRMS. The cables that were connected to the IRMS were connected in the same manner as in all other tests (2 channels per cable). The specific cables and bundling arrangement is as follows:



- Cable A = XLPE (ID #10)
- Cable B = EPR (ID #2)
- Cable C = PE (ID #15)
- Cable D = PVC (no connection)
- Cable E = TS/TP (no connection)
- Cable F = XLPO (no connection)

The results for this case are summarized as follows:

| Time (s) | Event  | Interpretation   |
|----------|--|--|
| 190      | Ignited Gas Burner   |  |
| 320      | Conductor C5 shorts to ground at less than 1000 $\Omega$ (463)                                     | One conductor group in Cable C shorts to ground with high resistance |
| 362      | The existing ground fault on conductor C5 decreases to less than 100 $\Omega$ (80)                 | One conductor group in Cable C shorts to ground at low resistance    |
| 364      | Conductor C6 shorts to ground at less than 100 $\Omega$ (88)                                       | Cable C shorted to ground  |
| 376      | Conductors C5 & C6 short together at less than 100 $\Omega$ (63)                                   | Cable C shorts internally  |
| 463      | Conductors A1 & A2 short together at less than 1000 $\Omega$ (110)                                 | Cable A shorts internally  |
| 468-477  | Conductors A1 & A2 both short to ground at less than 100 $\Omega$ (79 & 17)                        | Cable A shorted to ground  |
| 483-486  | Conductors B3 & B4 both short to ground (799 & 20)   | Cable B shorted to ground  |
| 488      | Conductors B3 & B4 short together at less than 100 $\Omega$ (76)                                   | Cable B shorts internally  |
| 505      | The existing intra-cable fault between conductors A1 & A2 decreases to less than 100 $\Omega$ (69) |  |
| 524      | The existing ground fault on conductor B3 decreases to less than 100 $\Omega$ (17)                 |  |
| 1323     | Extinguished Gas Burner  |  |

Observations relative to these test results are as follows:

- No substantive inter-cable interactions were observed.

#### 7.1.13.2 Results for IRMS Unit 2

In Test IT-12 IRMS Unit 2 was connected to mixed bundle of 6 TS and TP cables. Again, the IRMS was only connected to three of the 6 cables present (cables A, B and C). The cables that were connected to the IRMS were connected in the same manner as in all other tests (2 channels per cable). The specific cables and bundling arrangement is as follows:

- Cable A = TEFZEL (ID #12)
- Cable B = XLPO (ID #8)
- Cable C = EPR (ID #2)
- Cable D = XLPE (no connection)
- Cable E = PVC (no connection)
- Cable F = TS/TP (no connection)

The results for this case are summarized as follows:

| Time (s) | Event  | Interpretation            |
|----------|--|---------------------------|
| 190      | Ignited Gas Burner   |                           |
| 463      | Conductors A1 & A2 short together at less than 100 $\Omega$ (61) [Erratic shorting behavior noted]   | Cable A shorts internally |
| 510-519  | Conductors A1 & A2 both short to ground (226 & 74)   | Cable A shorted to ground |
| 525-528  | Conductors B3 & B4 both short to ground (167 & 80)   | Cable B shorted to ground |
| 552-567  | The existing ground faults on conductors A1 & B3 decrease to less than 100 $\Omega$ (66 & 67)  |                           |
| 572      | Conductors B3 & B4 short together at less than 1000 $\Omega$ (265) [Erratic shorting behavior noted]   | Cable B shorts internally |
| 572-574  | Conductors C5 & C6 both short to ground (314 & 52)   | Cable C shorted to ground |
| 586      | Conductors C5 & C6 short together at less than 1000 $\Omega$ (313)   | Cable C shorts internally |
| 614      | The existing ground fault on conductor C5 decreases to less than 100 $\Omega$ (32)   |                           |
| 617      | The existing intra-cable short between conductors B3 & B4 decreases to less than 100 $\Omega$ (53) [Erratic shorting behavior still occurring] |                           |
| 628      | The existing intra-cable short between conductors C5 & C6 decreases to less than 100 $\Omega$ (68) but is erratic in nature                    |                           |
| 1323     | Gas burner is shut off   |                           |

Observations relative to these test results are as follows:

- No substantive inter-cable interactions were observed.

### **7.1.14 Results for Test IT-13**

#### *7.1.14.1 Results for IRMS Unit 1*

In Test IT-13 IRMS Unit 1 was connected to a mixed bundle of six TS and TP cables. Again, the IRMS was only connected to three of the 6 cables present (cables A, B and C, all TS). The other three cables were present but simply not connected to the IRMS. The cables that were connected to the IRMS were connected in the same manner as in all other tests (2 channels per cable). The specific cables and bundling arrangement is as follows:

- Cable A = XLPE (ID #10)
- Cable B = EPR (ID #2)
- Cable C = Vita-Link (ID #11)
- Cable D = XLPO (no connection)
- Cable E = PE (no connection)
- Cable F = Tefzel (no connection)

The results for this case are summarized as follows:

| Time (s)  | Event  | Interpretation                                 |
|-----------|--|--|
| 239       | Ignited Gas Burner   |  |
| 1197-1200 | Conductors B3 & B4 both short to ground at less than 100 $\Omega$ (35 & 56)                      | Cable B shorted to ground                      |
| 1244      | Conductors B3 & B4 short together at less than 100 $\Omega$ (16)                                 | Cable B shorts internally                      |
| 1485      | Conductor A2 shorts to ground at less than 100 $\Omega$ (47)                                     | Cable A shows high resistance shorts to ground |
| 1513      | Conductors A1 & A2 short together at less than 100 $\Omega$ (377)                                | Cable A shorts internally                      |
| 1518      | Conductor A1 shorts to ground at less than 100 $\Omega$ (73)                                     | Cable A shorted to ground                      |
| 2280      | Extinguished Gas Burner  |  |
| 2330      | Initiated sprinkler  |  |
| 2465      | Conductor C6 IR value to ground momentarily drops to less than 1000 $\Omega$ (883) then recovers | Momentary high impedance ground fault on C6    |
| 2762      | Sprinkler shut off   |  |

Observations relative to the IT-14 test results are as follows:

- All of the cables in this group tended to short to ground prior to shorting internally.
- Cable C (VL) did not fail during the fire exposure. When the sprinklers were activated, the cables experienced a momentary IR to ground drop below 1000  $\Omega$ . It then recovered to >1000  $\Omega$ . This was somewhat different from prior tests where the VL cable failed when water spray was initiated.
- No substantive inter-cable interactions were observed.

#### 7.1.14.2 Results for IRMS Unit 2

In Test IT-13 IRMS Unit 2 was connected to mixed bundle of 6 TS and TP cables. Again, the IRMS was only connected to three of the 6 cables present (cables A, B and C, all TS). The other three cables were present but simply not connected to the IRMS. The cables that were connected to the IRMS were connected in the same manner as in all other tests (2 channels per cable). The specific cables and bundling arrangement is as follows:

- Cable A = XLPE (ID #10)
- Cable B = EPR (ID #2)
- Cable C = Vita-Link (ID #11)
- Cable D = XLPO (no connection)
- Cable E = PE (no connection)
- Cable F = Tefzel (no connection)

The results for this case are summarized as follows:

| Time (s)  | Event   | Interpretation            |
|-----------|---|---------------------------|
| 236       | Ignited Gas Burner  |                           |
| 1952-1956 | Conductors B3 & B4 both short to ground at less than 100 Ω (5 & 4)  | Cable B shorted to ground |
| 1958      | Conductors B3 & B4 short together at less than 100 Ω (6)            | Cable B shorts internally |
| 2148-2157 | Conductors A1 & A2 both short to ground at less than 100 Ω (11 & 8) | Cable A shorted to ground |
| 2184      | Conductors A1 & A2 short together at less than 1000 Ω (575)         | Cable A shorts internally |
| 2280      | Extinguished Gas Burner   |                           |
| 2330      | Sprinkler initiated   |                           |
| 2762      | Sprinkler shut off  |                           |

Observations relative to these test results are as follows:

- The cables that failed usually shorted to ground prior to shorting internally.
- Cable C (Vita-Link) did not show any sign of failure even after water spray was initiated.
- No substantive inter-cable interactions were observed.

**7.1.15 Results for Test IT-14**

*7.1.15.1 Results for IRMS Unit 1*

In Test IT-14 IRMS Unit 1 was connected to mixed bundle of 6 TS and TP cables. Again, the IRMS was only connected to three of the 6 cables present (cables A, B and C). The other three cables were present but simply not connected to the IRMS. The cables that were connected to the IRMS were connected in the same manner as in all other tests (2 channels per cable). The specific cables and bundling arrangement is as follows:

- Cable A = XLPE (ID #10)
- Cable B = EPR (ID #2)
- Cable C = PE (ID #15)
- Cable D = PVC (no connection)
- Cable E = TS/TP (no connection)
- Cable F = Tefzel (no connection)

The results for this case are summarized as follows:

| Time (s) | Event   | Interpretation                                  |
|----------|---|---|
| 236      | Ignited Gas Burner  |   |
| 615      | Conductor C5 shorts to ground at less than 100 Ω (34)     | One conductor group in Cable C shorts to ground |
| 628      | Conductors C5 & C6 short together at less than 100 Ω (34) | Cable C shorts internally                       |

|         |  |   |
|---------|--|---|
| 659     | Conductor C6 shorts to ground at less than 100 Ω (19)                                  | Cable C shorted to ground                       |
| 693     | Conductor B3 shorts to ground at less than 100 Ω (15)                                  | One conductor group in Cable B shorts to ground |
| 698     | Conductors B3 & B4 short together at less than 100 Ω (80)                              | Cable B shorts internally                       |
| 738     | Conductor B4 shorts to ground at less than 100 Ω (93)                                  | Cable B shorted to ground                       |
| 883     | Conductors A1 & A2 short together at less than 1000 Ω (497)                            | Cable A shorts internally                       |
| 888-897 | Conductors A1 & A2 short to ground at less than 1000 Ω (999 & 435)                     | Cable A shorted to ground                       |
| 925     | The existing short between conductors A1 & A2 decreases to less than 100 Ω (82)        |   |
| 930-940 | The existing ground faults on conductors A1 & A2 decrease to less than 100 Ω (48 & 22) |   |
| 1949    | Extinguished Gas Burner  |   |

Observations relative to these test results are as follows:

- The cables shorted internally prior to shorting to ground.
- The progression of cable failure was that the lower cables failed before the top cable.
- No substantive inter-cable interactions were observed.

7.1.15.2 Results for IRMS Unit 2

In Test IT-14 IRMS Unit 2 was connected to mixed bundle of 6 TS and TP cables. Again, the IRMS was only connected to three of the 6 cables present (cables A, B and C). The other three cables were present but simply not connected to the IRMS. The cables that were connected to the IRMS were connected in the same manner as in all other tests (2 channels per cable). The specific cables and bundling arrangement is as follows:

- Cable A = XLPE (ID #10)
- Cable B = EPR (ID #2)
- Cable C = PE (ID #15)
- Cable D = PVC (no connection)
- Cable E = TS/TP (no connection)
- Cable F = Tefzel (no connection)

The results for this case are summarized as follows:

| Time (s) | Event   | Interpretation                                  |
|----------|---|---|
| 236      | Ignited Gas Burner  |   |
| 871      | Conductor C5 shorts to ground at less than 100 Ω (4)      | One conductor group in Cable C shorts to ground |
| 881      | Conductors C5 & C6 short together at less than 100 Ω (17) | Cable C shorts internally                       |

| Time (s) | Event  | Interpretation   |
|----------|--|--|
| 911      | Conductor C6 shorts to ground at less than 100 $\Omega$ (54)   | Cable C shorted to ground  |
| 1242     | Conductor B4 shorts to ground at less than 1000 $\Omega$ (378)   | One conductor group in Cable B shorts to ground at high resistance |
| 1285     | Conductor B3 shorts to ground at less than 100 $\Omega$ (30) and the existing ground fault on conductor B4 decreases to less than 100 $\Omega$ (4) | Cable B shorted to ground  |
| 1286     | Conductors B3 & B4 short together at less than 100 $\Omega$ (73)   | Cable B shorted internally   |
| 1949     | Extinguished Gas Burner  |  |
| 1990     | Conductor A2 shorts to ground at less than 100 $\Omega$ (37)   | One conductor group in Cable A shorts to ground                    |
| 2017     | Conductors A1 & A2 short together at less than 1000 $\Omega$ (361)   | Cable A shorts internally  |
| 2022     | Conductor A1 shorts to ground at less than 100 $\Omega$ (25)   | Cable A shorted to ground  |

Observations relative to these test results are as follows:

- The cables usually shorted internally prior to shorting to ground.
- The progression of cable failure was that the lower cables failed before the top cable.
- No substantive inter-cable interactions were observed.

#### **7.1.16 Summary of Intermediate-scale IRMS Results**

The IRMSs as fielded in the Intermediate-scale tests were looking primarily for inter-cable interactions relevant to the resolution of Bin 2 Items A and B. A variety of inter-cable interactions were detected that are relevant to both items. With respect to Item A, there was one clear-cut case of an inter-cable conductor-to-conductor short between two TS cables that occurred as the primary failure mode for both of the involved cables (IT-1). In addition, various other TS-to-TS interactions were detected as secondary interactions for one cable and primary for the second (i.e., IT-7), or as a tertiary fault mode for one cable and primary fault mode for the second (i.e. IT-6 and IT-7). These results are discussed further in Chapter 8 in the context of Bin 2 Item A.

In the context of Item B, there were two cases where inter-cable interactions between a TS and a TP cable of potential interest were detected. Unlike the TS-to-TS interactions, there were no cases where the inter-cable shorting was the primary mode for both cables. However, in one test the inter-cable short was the secondary mode for one cable and the primary mode for the second (IT-9). In this same test, there was also a second inter-cable interaction where the fault was a tertiary mode for one cable but a primary mode for the second cable. These results are discussed further in Chapter 8 in the context of Bin 2 Item B.

## **7.2 The SCDU Test Results**

This Section describes the results obtained from the SCDUs as applied in the intermediate-scale tests. An overall summary of the test results is provided in Table 7.2. The SCDUs were used in a total of 16 tests; namely, Intermediate Preliminary Tests IP-3 and IP-4, and in all 14 of the Intermediate Tests (IT-1 through IT-14). Table 7.2 identifies how each SCDU was configured in each test, the cable (or cables) to which it was connected, the fault mode results for intra-cable shorting, and any fault mode results relevant to inter-cable shorting. For any case where a spurious actuation fault was observed, the total duration of the observed spurious actuation signal is also given. Finally, the right-hand column provides a description of the observed faulting behavior.

As noted, the SCDUs were used in a total of 16 tests, for a total of 65 individual trials. The sheer volume of data prevents its full reproduction here. As was the case for Section 7.1 and the presentation of IRMS data, examples are provided to illustrate specific behaviors relevant to the Bin 2 items. In general, in the context of this report, our analyses for the Bin 2 items hinge on an assessment of the plausibility of specific cable failure modes; hence, the illustrative examples are generally taken from cases where the specific failure mode of interest was, in fact, observed if the failure mode was observed at all during testing.

The subsections which follow provide an overview and examples of the test results focusing on various failure modes as follows:

- Section 7.2.1 shows examples of a typical fuse blow failures with some focus on cases where there was some degradation of the source voltage prior to the fuse blow.
- Section 7.2.2 illustrates cases where spurious actuations due to intra-cable shorting were observed.
- Section 7.2.3 focuses on those cases where some level of inter-cable interaction was observed either between TS cables or between TS and TP cables.
- Section 7.2.4 discusses results observed for the Silicone Rubber and Vita-Link cables.

**Table 7.2: Summary of CAROLFIRE Intermediate-scale tests SCDU Test Configurations and Results**

| Test | Circuit Number | Circuit Configuration | CPT Size (VA) | Grounded? (Y/N) | Cable Type | Conductors | Cable ID # | Cable Routing Configuration | Raceway Type | Location | Results   |      |  |                  |      | Discussion   |
|------|----------------|-----------------------|---------------|-----------------|------------|------------|------------|-----------------------------|--------------|----------|---|------|--|------------------|------|--|
|      |                |                       |               |                 |            |            |            |                             |              |          | Intra-cable failure mode and duration (see notes) |      | Were inter-cable interactions detected and if so for how long? |                  |      |  |
|      |                |                       |               |                 |            |            |            |                             |              |          | Mode  | Time | Yes or No  | Target or Source | Time |  |
| IP-3 | 1              | MOV 1                 | 150           | N               | PVC        | 7          | 1          | Single Cable TP             | Tray         | A        | SA  | 35s  | -  | -                | -    | Hot-short spurious actuations were observed and were sustained for a total of approximately 35s. Voltages to the targets do fluctuate, and some chattering and drop out was noted before re-locking. There are only minimal signs of voltage degradation (~10V drop) prior to fuse blow. |



**Table 7.2: Summary of CAROLFIRE Intermediate-scale tests SCDU Test Configurations and Results**

| Test | Circuit Number | Circuit Configuration | CPT Size (VA) | Grounded? (Y/N) | Cable Type | Conductors | Cable ID # | Cable Routing Configuration | Raceway Type | Location | Results   |      |  |                  |      | Discussion   |
|------|----------------|-----------------------|---------------|-----------------|------------|------------|------------|-----------------------------|--------------|----------|---|------|--|------------------|------|--|
|      |                |                       |               |                 |            |            |            |                             |              |          | Intra-cable failure mode and duration (see notes) |      | Were inter-cable interactions detected and if so for how long? |                  |      |  |
|      |                |                       |               |                 |            |            |            |                             |              |          | Mode  | Time | Yes or No  | Target or Source | Time |  |
| IP-4 | 1              | MOV<br>1a             | 150           | N               | PVC        | 7          | 1          | 6-Bundle<br>TP              | Tray         | A        | SA  | <1s  | Yes  | SA<br>Target     | 1s   | Circuit 1 experienced a momentary hot-short to both targets 5 and 6 sustained for less than 0.4s. A fuse blow occurred about 29s later.<br>After loss of circuit power, inter-cable hot-shorts involving essentially all four of the circuits occurred with Circuit 2 as the source. Circuit 1 target conductor Path 6 was hit. The hot-short lasted about 1s.                                   |
|      | 2              | MOV<br>1a             | 150           | Y               | PVC        | 7          | 1          | 6-Bundle<br>TP              | Tray         | A        | SA  | 6s   | Yes  | Source           | <1s  | This circuit did experience spurious actuation of both motor starters. The spurious actuations lasted a total of about 6s.<br>It also appears that this circuit acted as the energizing source for inter-cable hot-shorts to all three of the other circuits present.  |
|      | 3              | MOV<br>1a             | 200           | Y               | PVC        | 7          | 1          | 6-Bundle<br>TP              | Tray         | A        | FB  | -    | Yes  | SA<br>Target     | <1s  | This circuit shorted to ground causing a fuse blow. However, after the fuse blow, the circuit also experienced inter-cable hot-shorts twice. In both cases, the shorts were of momentary duration. In the first case, Circuit 2 acted as the energizing source. In the second case, Circuit 4 acted as the energizing source. Both of the two active target paths were impacted (Paths 5 and 6). |
|      | 4              | MOV<br>1a             | 100           | Y               | PVC        | 7          | 1          | 6-Bundle<br>TP              | Tray         | A        | SA  | 1s   | Yes  | Source           | <1s  | This was the target of two separate inter-cable hot-shorts of momentary duration. It was also the apparent source of momentary inter-cable hot-shorts impacting Circuit #3.<br>Following the inter-cable interactions, the circuit experienced a spurious actuation due to intra-cable shorting on T6 that lasted 1.2 s before fuse blow.  |

**Table 7.2: Summary of CAROLFIRE Intermediate-scale tests SCDU Test Configurations and Results**

| Test | Circuit Number | Circuit Configuration | CPT Size (VA) | Grounded? (Y/N) | Cable Type | Conductors | Cable ID # | Cable Routing Configuration | Raceway Type | Location | Results   |      |  |                  |      | Discussion  |
|------|----------------|-----------------------|---------------|-----------------|------------|------------|------------|-----------------------------|--------------|----------|---|------|--|------------------|------|---|
|      |                |                       |               |                 |            |            |            |                             |              |          | Intra-cable failure mode and duration (see notes) |      | Were inter-cable interactions detected and if so for how long? |                  |      |   |
|      |                |                       |               |                 |            |            |            |                             |              |          | Mode  | Time | Yes or No  | Target or Source | Time |   |
| IT-1 | 1              | MOV-1                 | 150           | N               | XLPE       | 7          | 3          | Bundle 1                    | Tray         | B        | SA  | 106s | Yes  | Source           | <1s  | This circuit saw spurious actuation of the active target 5 that was sustained for a total of 106s. No signs of voltage degradation prior to fuse blow. This circuit also acted as the source of a momentary hot-short to target 4 on Circuit 4 concurrent with time of fuse blow.   |
|      | 2              | MOV-1                 | 150           | Y               | XLPE       | 7          | 3          | Bundle 1                    | Tray         | B        | FB  | -    | No   | -                | -    | This circuit experienced a fuse blow and no spurious actuations. No signs of voltage degradation prior to fuse blow.  |
|      | 3              | MOV-1                 | 200           | Y               | XLPE       | 7          | 3          | Bundle 1                    | Tray         | B        | SA  | 231s | No   | -                | -    | This circuit experienced spurious actuation of active target 5 that was sustained for approximately 231s. Voltage degraded prior to fuse blow, but this was limited to a drop of about 20V.   |
|      | 4              | MOV-1                 | 100           | Y               | XLPE       | 7          | 3          | Bundle 1                    | Tray         | B        | HS & SA   | 98s  | Yes  | Target           | <1s  | This circuit experienced a sustained hot-short to the passive target path 4 that was maintained for 98s. 10 s later, spurious actuation of active target 5 occurred and was sustained for 88s. Minor voltage degradation (about a 10V drop) is observed just prior to fuse blow.<br>After fuse blow, a momentary voltage spike to target 4 is observed concurrent with fuse blow on Circuit 1. This can only be due to inter-cable interactions with Circuit 1. |

**Table 7.2: Summary of CAROLFIRE Intermediate-scale tests SCDU Test Configurations and Results**

| Test | Circuit Number | Circuit Configuration | CPT Size (VA) | Grounded? (Y/N) | Cable Type | Conductors | Cable ID # | Cable Routing Configuration | Raceway Type | Location | Results   |      |  |                  |      | Discussion   |
|------|----------------|-----------------------|---------------|-----------------|------------|------------|------------|-----------------------------|--------------|----------|---|------|--|------------------|------|--|
|      |                |                       |               |                 |            |            |            |                             |              |          | Intra-cable failure mode and duration (see notes) |      | Were inter-cable interactions detected and if so for how long? |                  |      |  |
|      |                |                       |               |                 |            |            |            |                             |              |          | Mode  | Time | Yes or No  | Target or Source | Time |  |
| IT-2 | 1              | IC                    | 150           | N               | XLPE       | 7          | 3          | 12-Bundle TS                | Tray         | A        | -   | -    | Possible   | -                | -    | This circuit was configured for TS-to-TS inter-cable hot-shorts only and is ungrounded. No return path is present so a fuse blow was not possible. The first hot-short likely resulted from direct inter-cable interactions, although this cannot be definitively established. Subsequent faults are likely due to mutual ground faults. |
|      | 2              | IC                    | 150           | Y               | XLPE & PE  | 7          | 3&1<br>5   | 12-Bundle Mixed TS&TP       | Tray         | A        | -   | -    | No   | -                | -    | This circuit was set up to detect inter-cable hot-shorts in a mixed bundle of TS and TP cables. At 286 seconds, one of the source cables (on Path 1) shorts to ground and causes a fuse blow failure. No inter-cable interactions are indicated.   |
|      | 3              | MOV 1                 | 200           | Y               | PVC        | 7          | 1          | Single Cable TP             | Tray         | G        | FB  | -    | -  | -                | -    | The circuit experienced a fuse blow and no spurious actuations.  |
|      | 4              | IC                    | 100           | Y               | XLPE & PE  | 7          | 3&1<br>5   | 6-Bundle Mixed TS&TP        | Tray         | C        | -   | -    | No   | -                | -    | This circuit was set up in an inter-cable configuration in a mixed bundle of TS and TP cables. The circuit experienced a fuse blow and no detected inter-cable hot-shorts. It appears that the energized PE cable shorted to ground causing the fuse blow.   |

**Table 7.2: Summary of CAROLFIRE Intermediate-scale tests SCDU Test Configurations and Results**

| Test | Circuit Number | Circuit Configuration | CPT Size (VA) | Grounded? (Y/N) | Cable Type | Conductors | Cable ID # | Cable Routing Configuration | Raceway Type | Location | Results   |      |  |                  |      | Discussion  |
|------|----------------|-----------------------|---------------|-----------------|------------|------------|------------|-----------------------------|--------------|----------|---|------|--|------------------|------|---|
|      |                |                       |               |                 |            |            |            |                             |              |          | Intra-cable failure mode and duration (see notes) |      | Were inter-cable interactions detected and if so for how long? |                  |      |   |
|      |                |                       |               |                 |            |            |            |                             |              |          | Mode  | Time | Yes or No  | Target or Source | Time |   |
| IT-3 | 1              | IC                    | 150           | N               | XLPE & EPR | 7          | 11&2       | TS&TP                       | Tray         | A        | -   | -    | Possible   | -                | -    | Given the test circuit configuration, this circuit could not experience a fuse blow failure. Prolonged spurious actuations did occur. Given behavior of the shorts, these were most likely caused by multiple ground faults rather than direct conductor-to-conductor interactions. Spurious actuations did drop out after the fire was stopped and prior to de-energizing circuit. |
|      | 2              | IC                    | 150           | Y               | EPR & PE   | 7          | 2&15       | 6-Bundle Mixed TS&TP        | Tray         | A        | -   | -    | Yes  | -                | <1s  | This circuit experienced a momentary HS to target 6, but not sufficient to lock in relay. The circuit then experienced a fuse blow.   |
|      | 3              | IC                    | 200           | Y               | XLPE & PE  | 7          | 11 & 15    | 6-Bundle Mixed TS&TP        | Tray         | C        | -   | -    | Yes  | -                | <1s  | This circuit experienced a momentary voltage spike to passive target path 7. Shortly thereafter a fuse blow occurred. Neither of the active targets spuriously actuated.  |
|      | 4              | AC-1                  | 100           | Y               | PVC        | 3          | 5          | Single Cable TP             | Tray         | G        | FB  | -    | -  | -                | -    | This circuit shorted to ground with no indications of a hot-short. No signs of source voltage degradation prior to fuse blow are observed.  |

**Table 7.2: Summary of CAROLFIRE Intermediate-scale tests SCDU Test Configurations and Results**

| Test | Circuit Number | Circuit Configuration | CPT Size (VA) | Grounded? (Y/N) | Cable Type    | Conductors | Cable ID # | Cable Routing Configuration | Raceway Type | Location | Results   |      |  |                  |      | Discussion   |
|------|----------------|-----------------------|---------------|-----------------|---------------|------------|------------|-----------------------------|--------------|----------|---|------|--|------------------|------|--|
|      |                |                       |               |                 |               |            |            |                             |              |          | Intra-cable failure mode and duration (see notes) |      | Were inter-cable interactions detected and if so for how long? |                  |      |  |
|      |                |                       |               |                 |               |            |            |                             |              |          | Mode  | Time | Yes or No  | Target or Source | Time |  |
| IT-4 | 1              | IC                    | 150           | N               | XLPE EF & PE  | 7          | 3,12 & 15  | 6-Bundle Mixed TS&TP        | Tray         | C        | -   | -    | Possible   | -                | -    | This circuit was set up to look for inter-cable hot-shorts in a mixed bundle of TS and TP cables. The configuration does not allow for a fuse blow failure. Spurious actuations are observed. However, given the behavior (slowly building voltages and never reaching full source potential) these were likely due to multiple ground faults rather than conductor-to-conductor interactions. |
|      | 2              | IC                    | 150           | Y               | XLPE TEF & PE | 7          | 3,12 & 15  | 6-Bundle Mixed TS&TP        | Tray         | C        | -   | -    | No   | -                | -    | The energized PE cable experienced a short to ground causing a circuit fuse blow. No signs of source voltage degradation prior to FB are noted.  |
|      | 3              | IC                    | 200           | Y               | XLPE PE & TEF | 7          | 3,12 & 15  | 6-Bundle Mixed TS&TP        | Tray         | A        | -   | -    | No   | -                | -    | The energized PE cable experienced a short to ground causing a circuit fuse blow. No signs of source voltage degradation prior to FB are noted.  |
|      | 4              | IC                    | 100           | Y               | XLPE PE & TEF | 7          | 3,12 & 15  | 6-Bundle Mixed TS&TP        | Tray         | A        | -   | -    | No   | -                | -    | The energized Tefzel cable experiences short to ground over an extended period that first degrades CPT voltage and eventually leads to a fuse blow failure. No indications of inter-cable interactions. Minimum voltage degradation prior to fuse blow is about 80V  |

**Table 7.2: Summary of CAROLFIRE Intermediate-scale tests SCDU Test Configurations and Results**

| Test | Circuit Number | Circuit Configuration | CPT Size (VA) | Grounded? (Y/N) | Cable Type     | Conductors | Cable ID # | Cable Routing Configuration  | Raceway Type | Location | Results   |      |  |                  |      | Discussion  |
|------|----------------|-----------------------|---------------|-----------------|----------------|------------|------------|------------------------------|--------------|----------|---|------|--|------------------|------|---|
|      |                |                       |               |                 |                |            |            |                              |              |          | Intra-cable failure mode and duration (see notes) |      | Were inter-cable interactions detected and if so for how long? |                  |      |   |
|      |                |                       |               |                 |                |            |            |                              |              |          | Mode  | Time | Yes or No  | Target or Source | Time |   |
| IT-5 | 1              | MOV 1                 | 150           | N               | VL             | 7          | 11         | Mix Bundle, Cable E          | Tray         | A        | SA - 5&6  | 29s  | -  | -                | -    | This circuit did not fail until after the burner was extinguished and water spray initiated. At that point there was a spurious actuation on Target 6 followed by SA on target 5. Spurious actuations persisted for a total of 29 s. The voltage on this circuit degrades progressively until fuse blow when voltage is about 80 V. |
|      | 2              | IC                    | 150           | Y               | XLPE PE & TEF  | 7          | 3,12 &15   | Mix Bundle, Cables A, B, & C | Tray         | C        | -   | -    | No   | -                | -    | The circuit experienced a fuse blow failure. No signs of source voltage degradation prior to fuse blow.   |
|      | 3              | MOV1                  | 200           | Y               | EPR            | 7          | 2          | Single Cable                 | Tray         | G        | DNF   | -    | -  | -                | -    | The cable on Circuit 3 did show signs of degradation, but did not fail.   |
|      | 4              | IC                    | 100           | Y               | XLPE, PE & TEF | 7          | 3,12 &15   | Mix Bundle, Cables A, B, & C | Tray         | A        | -   | -    | No   | -                | -    | This circuit was configured for inter-cable interactions, and in this mode experienced an early fuse blow.  |

**Table 7.2: Summary of CAROLFIRE Intermediate-scale tests SCDU Test Configurations and Results**

| Test | Circuit Number | Circuit Configuration | CPT Size (VA) | Grounded? (Y/N) | Cable Type | Conductors | Cable ID # | Cable Routing Configuration | Raceway Type | Location | Results   |      |  |                  |      | Discussion  |
|------|----------------|-----------------------|---------------|-----------------|------------|------------|------------|-----------------------------|--------------|----------|---|------|--|------------------|------|---|
|      |                |                       |               |                 |            |            |            |                             |              |          | Intra-cable failure mode and duration (see notes) |      | Were inter-cable interactions detected and if so for how long? |                  |      |   |
|      |                |                       |               |                 |            |            |            |                             |              |          | Mode  | Time | Yes or No  | Target or Source | Time |   |
| IT-6 | 1              | MOV 1                 | 150           | N               | SR         | 7          | 9          | 6-Bundle Mixed TS           | Tray         | C        | FB  | -    | No   |                  |      | No circuit failures were observed during the burn portion of the test. After burner was extinguished, water spray was activated, and this did lead to circuit failure. No Spurious actuation occurred, rather, shorts to circuit ground led to a fuse blow. Significant degradation of the CPT voltage level is observed prior to ultimate circuit failure. The supply voltage dropped to a value of 94 volts prior to failure.   |
|      | 2              | MOV 1                 | 150           | Y               | SR         | 7          | 9          | 6-Bundle Mixed TS           | Tray         | A        | FB  | -    | No   |                  |      | The circuit saw no degradation during the burn period. Water spray was started after the burner was shut off. This led to circuit failure and a fuse blow failure. It appears that mechanism of failure was the source conductor on Path 2 shorting to the grounded conductor on Path 7. Some increase in voltage on the target conductors (4,5,6) is seen, although not sufficient to cause relay chatter or actuation (maximum voltage is about 32V). No significant source voltage degradation prior to fuse blow. |
|      | 3              | MOV 1                 | 200           | Y               | EPR        | 7          | 2          | 6-Bundle Mixed TS           | Tray         | C        | FB  |      | No   |                  |      | The circuit experienced a fuse blow failure apparently as a result of a short between one energized source conductor and an external ground source. Only very minor degradation of supply voltage prior to fuse blow is noted.  |
|      | 4              | MOV 1                 | 100           | Y               | XLPO       | 7          | 8          | 6-Bundle Mixed TS           | Tray         | A        | SA  | 16s  | No   | -                | -    | This circuit was configured using the MOV-1 wiring scheme. The circuit experienced one spurious actuation of one relay, and two spurious actuations of the second relay. The total duration of the SA signals was about 16 s. Some degradation of the supply voltage is noted, but at worst, voltage drops by about 20 V.   |

**Table 7.2: Summary of CAROLFIRE Intermediate-scale tests SCDU Test Configurations and Results**

| Test | Circuit Number | Circuit Configuration | CPT Size (VA) | Grounded? (Y/N) | Cable Type | Conductors | Cable ID # | Cable Routing Configuration | Raceway Type | Location | Results   |      |  |                  |             | Discussion   |
|------|----------------|-----------------------|---------------|-----------------|------------|------------|------------|-----------------------------|--------------|----------|---|------|--|------------------|-------------|--|
|      |                |                       |               |                 |            |            |            |                             |              |          | Intra-cable failure mode and duration (see notes) |      | Were inter-cable interactions detected and if so for how long? |                  |             |  |
|      |                |                       |               |                 |            |            |            |                             |              |          | Mode  | Time | Yes or No  | Target or Source | Time        |  |
| IT-7 | 1              | MOV 1                 | 150           | N               | PVC        | 7          | 1          | 6-Bundle Mixed TS&TP        | Tray         | G        | SA  | 15s  | -  | -                | -           | This circuit experienced a spurious actuation of target 6 lasting about 15 s. No voltage degradation prior to fuse blow is noted.  |
|      | 2              | MOV 1                 | 150           | Y               | EPR        | 7          | 2          | 6-Bundle Mixed TS           | Tray         | A        | SA  | 46s  | Yes  | Target           | No HS or SA | This circuit saw spurious actuation of both targets persisting for a total of 47s. The circuit also saw significant voltage degradation prior to fuse blow. Minimum voltage dropped to 80V, but did not cause relay drop-out. After fuse blow, the circuit also sees an increase in current flow on Path 7 (grounded). This occurs concurrent with the degradation and failure of Circuit 3 and is the result of inter-cable interactions. |
|      | 3              | MOV 1                 | 200           | Y               | XLPE       | 7          | 3          | 6-Bundle Mixed TS           | Tray         | A        | SA  | 31s  | Yes  | Source           |             | This circuit saw spurious actuation of both targets persisting for 32 s. This circuit also saw significant degradation of the supply voltage just prior to fuse blow, but not enough to cause relay drop-out. This circuit also acted as a source for inter-cable interactions with the grounded conductor in Circuit 2 which had earlier seen a fuse blow.  |
|      | 4              | MOV 1                 | 100           | Y               | PVC        | 7          | 1          | 3-Bundle Mixed TS&TP        | Conduit      | E        | SA  | 24s  | -  | -                | -           | This circuit saw spurious actuation of target 6 persisting for 24s. No voltage degradation prior to fuse blow is noted.  |



**Table 7.2: Summary of CAROLFIRE Intermediate-scale tests SCDU Test Configurations and Results**

| Test | Circuit Number | Circuit Configuration | CPT Size (VA) | Grounded? (Y/N) | Cable Type | Conductors | Cable ID # | Cable Routing Configuration | Raceway Type | Location | Results   |      |  |                  |      | Discussion   |
|------|----------------|-----------------------|---------------|-----------------|------------|------------|------------|-----------------------------|--------------|----------|---|------|--|------------------|------|--|
|      |                |                       |               |                 |            |            |            |                             |              |          | Intra-cable failure mode and duration (see notes) |      | Were inter-cable interactions detected and if so for how long? |                  |      |  |
|      |                |                       |               |                 |            |            |            |                             |              |          | Mode  | Time | Yes or No  | Target or Source | Time |  |
| IT-8 | 1              | MOV-1                 | 150           | N               | XLPE       | 7          | 3          | 6-Bundle                    | Tray         | G        | DNF   | -    | -  | -                | -    | Circuit 1 did not fail.  |
|      | 2              | MOV-1                 | 150           | Y               | PE         | 7          | 15         | Bundle 2                    | Tray         | A        | SA  | 5s   | Y  | Target           | 13   | This circuit did experience an erratic behavior of with spuratic and short-lived hot-shorts to various target conductors. Repeated cycles of the relays locking and then opening interspersed with chattering of both relays was noted during the test and is reflected in the data. Total duration of this period was about 114 s.<br>Following fuse blow on Circuit 2, this circuit experienced an inter-cable shorting to the cable for circuit 3 acting as the source. No spurious actuations occurred, and it appears that the grounded conductor was the primary target. The inter-cable shorting persisted for about 44 s and did not lead to a spurious actuation. |
|      | 3              | MOV-1                 | 200           | Y               | XLPE       | 7          | 3          | Bundle 2                    | Tray         | A        | SA & HS   | 24s  | Y  | Source           |      | This circuit experienced spurious actuation of both active targets 5&6 and a hot-short to passive target 4. The longest sustained spurious actuation was target 6 which persisted 24s. This circuit also saw significant degradation of the source voltage prior to fuse blow with voltage dropping by about 44V. It also acted as the source for an inter-cable short to the cable on Circuit 2.  |
|      | 4              | MOV-1                 | 100           | Y               | XLPE       | 7          | 3          | 3-Bundle                    | Conduit      | E        | DNF   | -    | -  | -                | -    | Circuit 4 did not fail.  |

**Table 7.2: Summary of CAROLFIRE Intermediate-scale tests SCDU Test Configurations and Results**

| Test | Circuit Number | Circuit Configuration | CPT Size (VA) | Grounded? (Y/N) | Cable Type | Conductors | Cable ID # | Cable Routing Configuration | Raceway Type | Location | Results   |      |  |                  |      | Discussion  |
|------|----------------|-----------------------|---------------|-----------------|------------|------------|------------|-----------------------------|--------------|----------|---|------|--|------------------|------|---|
|      |                |                       |               |                 |            |            |            |                             |              |          | Intra-cable failure mode and duration (see notes) |      | Were inter-cable interactions detected and if so for how long? |                  |      |   |
|      |                |                       |               |                 |            |            |            |                             |              |          | Mode  | Time | Yes or No  | Target or Source | Time |   |
| IT-9 | 1              | MOV-1                 | 150           | N               | EPR        | 7          | 2          | 6-Bundle Mixed TS&TP        | Tray         | G        | SA  | 122s | No   | -                | -    | <p>This circuit saw spurious actuation of both active target paths 5&amp;6. The spurious actuations persist for a total of 122s. No significant degradation of the source voltage is noted prior to fuse blow.</p> <p>Both Circuit 1 and the co-located Circuit 4 experienced repeated spuratic voltage spikes are recorded on various circuit paths for both circuits 1 and 4 which are co-located. The exact source of these spikes is not clear.</p>                                     |
|      | 2              | MOV-1                 | 150           | Y               | EPR        | 7          | 2          | 6-Bundle Mixed TS&TP        | Tray         | A        | SA  | 2s   | No   | -                | -    | <p>This circuit saw spurious actuation on target path 5 persisting for at between 2 and 21 s. The actual duration is not known because the power switch to the SCDU had inadvertently been turned off and when power was restored (19 s later) the fuse blew.</p>   |
|      | 3              | MOV-1                 | 200           | Y               | PE         | 7          | 15         | 6-Bundle Mixed TS&TP        | Tray         | A        | FB  | -    | No   | -                | -    | <p>All targets saw multiple voltage spikes for durations typically lasting a few seconds, but no relay lock-in occurred. Extensive chattering of at least one relay was noted during the test. Only minor degradation of the source voltage is noted prior to fuse blow.</p>  |
|      | 4              | MOV-1                 | 100           | Y               | PE         | 7          | 15         | 6-Bundle Mixed TS&TP        | Tray         | G        | SA & HS   | 457s | No   | -                | -    | <p>This circuit saw spurious actuation on both active Target Paths 5&amp;6. A hot-short to Target 4 also occurs. Total duration of the spurious actuations is 457 s. No significant degradation of the source voltage is noted prior to fuse blow.</p> <p>Both Circuit 1 and the co-located Circuit 4 experienced repeated spuratic voltage spikes are recorded on various circuit paths for both circuits 1 and 4 which are co-located. The exact source of these spikes is not clear.</p> |

**Table 7.2: Summary of CAROLFIRE Intermediate-scale tests SCDU Test Configurations and Results**

| Test  | Circuit Number | Circuit Configuration | CPT Size (VA) | Grounded? (Y/N) | Cable Type | Conductors | Cable ID # | Cable Routing Configuration | Raceway Type | Location | Results   |      |  |                  |      | Discussion  |
|-------|----------------|-----------------------|---------------|-----------------|------------|------------|------------|-----------------------------|--------------|----------|---|------|--|------------------|------|---|
|       |                |                       |               |                 |            |            |            |                             |              |          | Intra-cable failure mode and duration (see notes) |      | Were inter-cable interactions detected and if so for how long? |                  |      |   |
|       |                |                       |               |                 |            |            |            |                             |              |          | Mode  | Time | Yes or No  | Target or Source | Time |   |
| IT-10 | 1              | MOV-1                 | 150           | N               | EPR        | 7          | 2          | 6-Bundle Mixed TS&TP        | Tray         | G        | HS & SA   | 226s | No   | -                | -    | The initial failure involved a hot-short to the passive target conductor on Path 4. Subsequently both Target Paths 5&6 experience spurious operations. The HS on path 4 persists for 226s. The SA on Target 6 lasts approximately 102s total, and that on Target 5 lasts 82s total.   |
|       | 2              | MOV-1                 | 150           | Y               | SR         | 7          | 9          | 6-Bundle Mixed TS&TP        | Tray         | A        | FB  | -    | No   | -                | -    | This circuit failed with a fuse blow at the time that water flow to a sprinkler head was initiated. The circuit fault actually tripped circuit power to the entire circuit monitoring system, hence, data immediately following the fuse blow was lost. Post-test examination of the SCDU did confirm that the CPT output fuse had blown. No degradation of the source voltage prior to fuse blow is noted. |
|       | 3              | MOV-1                 | 200           | Y               | TEF        | 7          | 12         | 6-Bundle Mixed TS&TP        | Tray         | A        | SA & HS   | 11s  | No   | -                | -    | This circuit saw a spurious actuation on Active Target Path 5 that persisted for 11s. A hot-short subsequently impacted Passive Target Path 4 persisting for 8s. No significant source voltage degradation is noted prior to fuse blow.   |
|       | 4              | MOV-1                 | 100           | Y               | PE         | 7          | 15         | 6-Bundle Mixed TS&TP        | Tray         | G        | FB  | -    | No   | -                | -    | This circuit experienced a fuse blow at 1567s. No source voltage degradation prior to fuse blow is noted.   |

**Table 7.2: Summary of CAROLFIRE Intermediate-scale tests SCDU Test Configurations and Results**

| Test  | Circuit Number | Circuit Configuration | CPT Size (VA) | Grounded? (Y/N) | Cable Type | Conductors | Cable ID # | Cable Routing Configuration | Raceway Type | Location | Results   |      |  |                  |      | Discussion  |
|-------|----------------|-----------------------|---------------|-----------------|------------|------------|------------|-----------------------------|--------------|----------|---|------|--|------------------|------|---|
|       |                |                       |               |                 |            |            |            |                             |              |          | Intra-cable failure mode and duration (see notes) |      | Were inter-cable interactions detected and if so for how long? |                  |      |   |
|       |                |                       |               |                 |            |            |            |                             |              |          | Mode  | Time | Yes or No  | Target or Source | Time |   |
| IT-11 | 1              | MOV-1                 | 150           | N               | PVC        | 7          | 1          | 6-Bundle Mixed TS&TP        | Tray         | A        | SA  | 6s   | No   | -                | -    | Spurious actuation to Target 5 persists for 6 s before fuse blow. No indications of source voltage degradation prior to fuse blow.  |
|       | 2              | MOV-1                 | 150           | Y               | PE         | 7          | 15         | 6-Bundle Mixed TS&TP        | Air Drop     | E        | SA  | 229s | No   | -                | -    | No failures on this circuit were observed during burn period. Circuit did fail when water spray initiated. Circuit experienced spurious actuation of both targets 5 and 6. SA on T5 persists for 229s. No indications of source voltage degradation prior to fuse blow. |
|       | 3              | MOV-1                 | 200           | Y               | PVC        | 7          | 1          | 6-Bundle Mixed TS&TP        | Tray         | G        | FB  | -    | No   | -                | -    | This circuit experienced a fuse blow with no spurious actuations and no signs of significant source voltage degradation prior to fuse blow.   |
|       | 4              | MOV-1                 | No CPT        | Y               | XLPE       | 7          | 3          | 6-Bundle Mixed TS&TP        | Tray         | A        | SA  | 33s  | No   | -                | -    | This circuit saw spurious actuation of both targets T5 and T6. A period of chatter is observed, but no signs of voltage degradation prior to fuse blow. Total duration of the spurious actuations is 33 s.  |

**Table 7.2: Summary of CAROLFIRE Intermediate-scale tests SCDU Test Configurations and Results**

| Test  | Circuit Number | Circuit Configuration | CPT Size (VA) | Grounded? (Y/N) | Cable Type | Conductors | Cable ID # | Cable Routing Configuration | Raceway Type | Location | Results   |      |  |                  |      | Discussion  |
|-------|----------------|-----------------------|---------------|-----------------|------------|------------|------------|-----------------------------|--------------|----------|---|------|--|------------------|------|---|
|       |                |                       |               |                 |            |            |            |                             |              |          | Intra-cable failure mode and duration (see notes) |      | Were inter-cable interactions detected and if so for how long? |                  |      |   |
|       |                |                       |               |                 |            |            |            |                             |              |          | Mode  | Time | Yes or No  | Target or Source | Time |   |
| IT-12 | 1              | MOV-1                 | 150           | N               | EPR        | 7          | 2          | 6-Bundle Mixed TS           | Tray         | A        | FB  | -    | -  | -                | -    | This circuit experienced a fuse blow failure. No degradation of the source voltage noted prior to fuse blow   |
|       | 2              | MOV-1                 | 150           | Y               | PE         | 7          | 15         | 6-Bundle Mixed TS&TP        | Air Drop     | E        | SA  | 347s | -  | -                | -    | This circuit experienced spurious actuation of both targets 5 and 6 persisting for about 347 s. No degradation of source voltage prior to fuse blow is noted.   |
|       | 3              | MOV-1                 | 200           | Y               | PVC        | 7          | 1          | 6-Bundle Mixed TS&TP        | Tray         | G        | SA  | 11s  | -  | -                | -    | This circuit saw spurious actuation of both targets. Target 5 held firm but target 6 dropped out and picked up again twice. Total duration of the spurious actuation was 11s. No degradation of source voltage prior to fuse blow is noted. |
|       | 4              | MOV-1                 | No CPT        | Y               | XLPE       | 7          | 3          | 6-Bundle Mixed TS           | Tray         | A        | SA  | 18s  | -  | -                | -    | This circuit saw spurious actuation of Target 5 followed by target 6. Total duration of spurious actuations is 18s. No degradation of source voltage (no CPT).  |
| IT-13 | 1              | MOV-1                 | 150           | N               | XLPE       | 7          | 3          | 6-Bundle Mixed TS           | Tray         | F        | SA  | 63s  | No   | -                | -    | This circuit saw spurious actuation of both Targets 5 and 6 persisting for a total of 63 s. No degradation of source voltage prior to fuse blow.  |
|       | 2              | MOV-1                 | 150           | Y               | VL         | 7          | 11         | 6-Bundle Mixed TS           | Tray         | F        | DNF   | -    | No   | -                | -    | Circuit 2 did not fail.   |
|       | 3              | MOV-1                 | 200           | Y               | XLPE       | 7          | 3          | 6-Bundle Mixed TS           | Tray         | G        | SA  | 42s  | No   | -                | -    | This circuit saw spurious actuation of Target 5. A momentary drop-out and re-lock is noted. Total duration of spurious actuation is 42 s. No degradation of source voltage prior to fuse blow.  |
|       | 4              | MOV-1                 | No CPT        | Y               | VL         | 7          | 11         | 6-Bundle Mixed TS           | Tray         | G        | DNF   | -    | No   | -                | -    | Circuit 4 did not fail  |

**Table 7.2: Summary of CAROLFIRE Intermediate-scale tests SCDU Test Configurations and Results**

| Test  | Circuit Number | Circuit Configuration | CPT Size (VA) | Grounded? (Y/N) | Cable Type | Conductors | Cable ID # | Cable Routing Configuration | Raceway Type | Location | Results   |      |  |                  |      | Discussion  |
|-------|----------------|-----------------------|---------------|-----------------|------------|------------|------------|-----------------------------|--------------|----------|---|------|--|------------------|------|---|
|       |                |                       |               |                 |            |            |            |                             |              |          | Intra-cable failure mode and duration (see notes) |      | Were inter-cable interactions detected and if so for how long? |                  |      |   |
|       |                |                       |               |                 |            |            |            |                             |              |          | Mode  | Time | Yes or No  | Target or Source | Time |   |
| IT-14 | 1              | MOV-1                 | 150           | N               | XLPE       | 7          | 3          | 6-Bundle Mixed TS           | Tray         | F        | SA  | 63 s | No   | -                | -    | This circuit saw spurious actuations on both targets persisting for a total of 63 s. Some minor degradation of the source voltage is noted prior to fuse blow (about 12V drop). |
|       | 2              | MOV-1                 | 150           | Y               | EPR        | 7          | 2          | 6-Bundle Mixed TS           | Tray         | F        | SA  | 19s  | No   | -                | -    | This circuit saw spurious actuation of Target 6 persisting for 19 s. No degradation of source voltage noted prior to fuse blow.   |
|       | 3              | MOV-1                 | 200           | Y               | XLPE       | 7          | 3          | 6-Bundle Mixed TS           | Tray         | G        | SA  | 44s  | No   | -                | -    | This circuit saw spurious actuation of Target 5 persisting for 44 s. No degradation of the source voltage prior to fuse blow.   |
|       | 4              | MOV-1                 | No CPT        | Y               | EPR        | 7          | 2          | 6-Bundle Mixed TS           | Tray         | G        | HS  | 9 s  | No   | -                | -    | This circuit saw a hot-short to passive target path 4 persisting for 9 s. No spurious actuation of the active targets. No degradation of the source voltage prior to fuse blow. |

Notes:

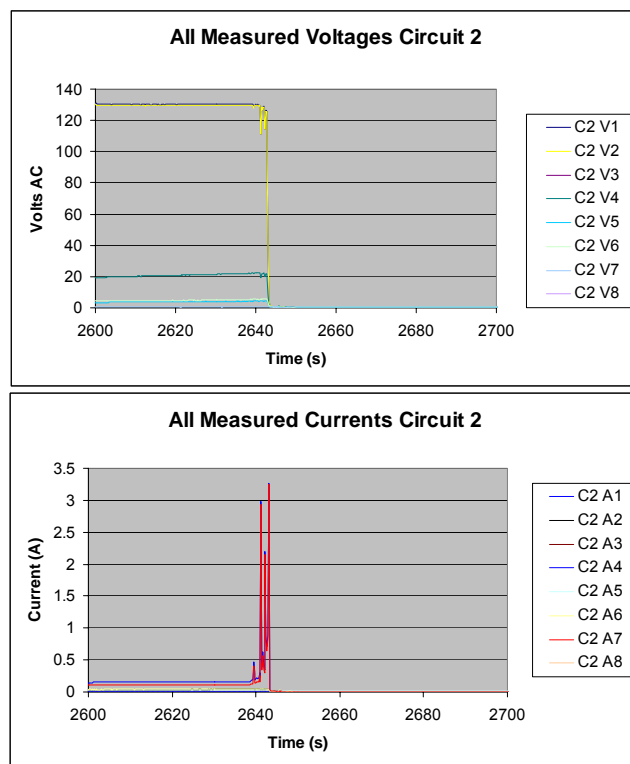
Failure mode abbreviations: SA=Spurious Actuation, HS=Hot-short, FB=Fuse Blow, DNF=Did Not Fail.

A dash (-) in a field indicates that the entry is not applicable to that specific case.

### 7.2.1 Fuse Blow Failures

A fuse blow failure refers to those cases where the first detected cable failures led to an over-current condition and tripping of the circuit's protective fuse. In these cases, the typical behavior shows a very abrupt drop in the voltage of the energized conductors to zero. This drop usually takes place over the course of less than one second.

Fuse blow failures can be caused by a short between one of the energized conductors (Circuit Paths 1 and 2 for the MOV-1 configuration) and the power supply return side conductor (Circuit Path 7 for the MOV-1 configuration). In conjunction with this behavior there will also be a current spike (sharp rise and sharp fall) on one of the two source conductors and on the return path conductor. For the grounded circuits (i.e., for all but SCDU-1) a fuse blow can also result from shorts between an energized conductor (Paths 1 or 2) and the external ground. Note that the mode of ground faulting can be distinguished (at least nominally) because a short to external ground does not cause a current spike on the return path conductor (Path 7) whereas an intra-cable short to the grounded conductor on path 7 does cause a current spike on Path 7.



**Figure 7.3: Illustration of the Fuse Blow failure on Circuit 2 in Test IT-1.**

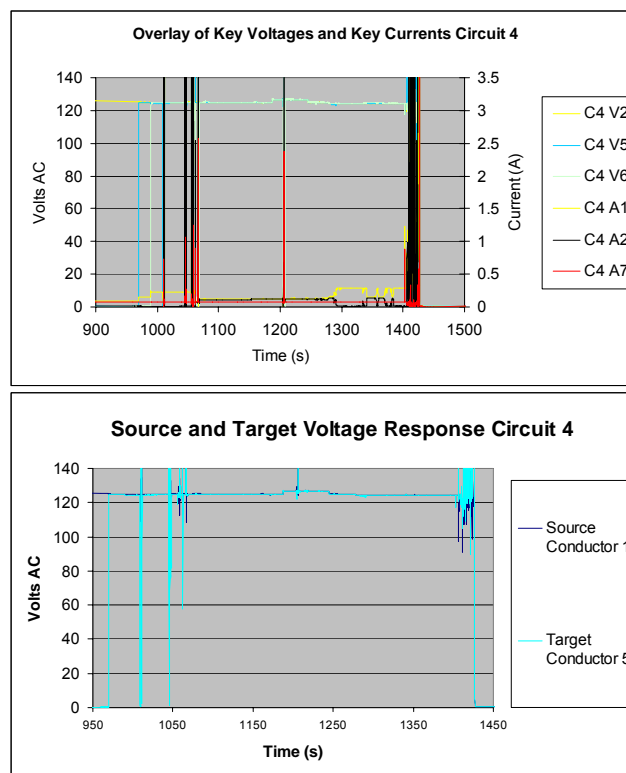
Figure 7.3 shows a typical example of a fuse blow failure with no degradation of the source voltage. This particular figure is for SCDU-2 from Test IT-1. This was a MOV-1 test configuration on a TS (XLPE) cable. The plot shows the data traces for all seven active circuit paths.

Note also that in the upper (voltage) plot, there is an increasing voltage observed on Path 4. This path is the ‘passive target’ in the MOV-1 configuration. The build up of some voltage on either paths 4 or 8 were typically the first signs of cable degradation observed.

Note that this test also saw only very minor degradation of the source voltage prior to the fuse blow failure. For about 5 s just prior to fuse blow, the source voltage falls off by about 10V from the full supply voltage. This is actually typical of the worst-case voltage degradation that was observed for those circuits whose first fault mode was a fuse blow. In other cases, little or no degradation is noted prior to fuse blow.

### 7.2.2 Intra-Cable Spurious Actuations

As indicated in Table 7.2, there were many cases of spurious actuations of the active targets (the motor contactors) for both TP and TS cables. Figure 7.4 illustrates the single longest duration spurious actuation observed; namely, Circuit 4 in Test IT-9, 457s duration. This was, again, a MOV-1 configuration on a 100VA CPT and connected to a TP (PE 7/C 12AWG ID #15) cable.



**Figure 7.4: Results for SCDU-4 in Test IT-9.**

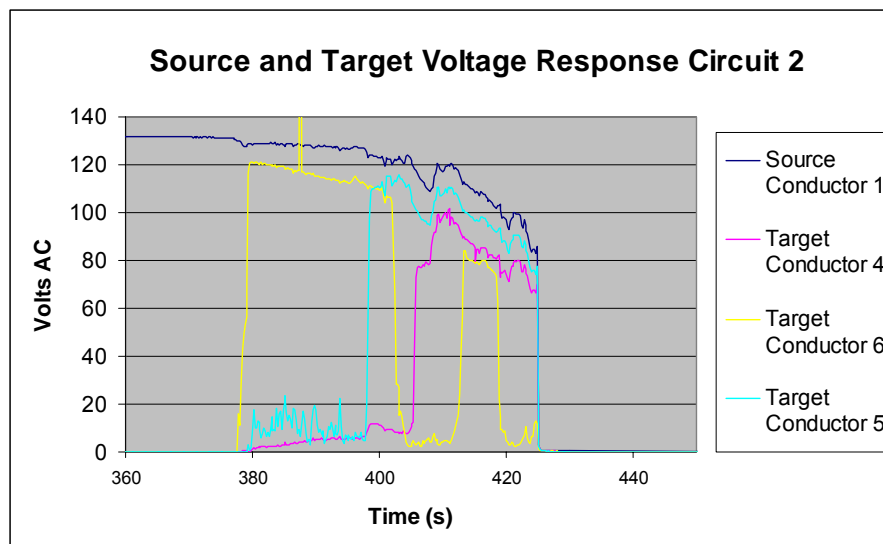
Note that the upper plot overlays the key voltage and current traces on a single plot including the source conductors (A1, V2 & A2), the two active target conductors (V5 and V6, both of which experience a spurious actuation in this test), and the current on the grounded circuit path (A7). The lower plot shows only the two key traces; namely, the source voltage and the voltage for the target that spuriously actuated for the longest time. The spurious actuation is more obvious in the lower



plot which illustrates that the motor contactor relay locked-in, and then went through several momentary cycles of drop-out and re-lock before the circuit finally blew its fuse with a short to ground. Note that the current spike observed on path 7 (the red trace 'C4 A7' in the upper plot) at the time of the fuse blow indicates that the ground fault was caused by an intra-cable short to the grounded conductor on path 7 rather than a short to external ground.

Note that the source voltage holds quite steady up until the last 10 seconds prior to the fuse blow when some fluctuations are apparent. Circuit 4 was the circuit equipped with a 100VA CPT which was providing about 166% of the nominal power required by the circuit for normal operation. The degrading voltage is due to the developing but poor quality fault to the grounded conductor, as can be seen by the erratic current signal on Path 7 in the upper plot. Also note that the energized source conductor on Path 2 was the primary source for the intra-cable hot-short and for the ultimate short to ground on Path 7 (based on A2).

A second example is shown in Figure 7.5. This is taken from SCDU Circuit 2 during Test IT-7. In this case the circuit does experience a spurious actuation and also sees significant degradation of the source circuit voltage prior to a fuse blow.



**Figure 7.5: Spurious actuation failure on SCDU Circuit 2 in Test IT-7.**

Note that in this case, the active target 6 motor contactor sees the initial spurious actuation. Also note that, about 20s later, the motor contactor on Path 5 also activates, and about 8s after this the passive target on Path 4 also experiences a hot-short. A progressive degradation of the source voltage is also observed, but in this case, the minimum voltage just prior to fuse blow is about 80V which is still above the motor contactor pick-up voltage. This is the worst case of source voltage degradation observed in any of the CAROLFIRE tests. This particular test involved the 150VA CPT which is supplying about 250% of the nominal circuit power requirements for normal operation. The degradation appears to have resulted from a developing, but relatively poor quality, short to ground on one of the two source conductors.

Other cases of spurious actuation follow the same patterns as illustrated in these two examples. In many cases, periods of lock-in, drop-out, chatter, and re-lock are observed on one or both active targets. However, the overall pattern of behavior remains the same. While the first example (Figure 7.4) is more typical in terms of the current and voltage behavior, as noted, it is the single longest duration spurious actuation observed in all of the CAROLFIRE tests.

With respect to the intra-cable spurious actuations that were observed, Tables 7.3 and 7.4 provide general summary statistics. These tables summarize the SCDU initial failure mode observed for all trials for TP and for TS cables respectively.

The percentage of spurious actuations was very slightly higher for the TS cables (18 spurious actuations in 25 failures or 72%) than for the TP cables (13 spurious actuations in 19 failures or 68%). Given the total number of trials this difference is not statistically significant.

Overall the number of spurious actuations is roughly consistent with, but somewhat higher than, the likelihoods indicated by the NEI/EPRI tests [2] as evaluated by the EPRI expert panel [9], even for the expert panel's "base case" where there is no CPT in the circuit. The expert panel "best estimate" spurious actuation likelihood for a circuit without CPT was 0.6 (conditional on cable failure). The differences between CAROLFIRE and the expert panel estimates in this regard are not tremendous, but they are large enough that they may not be simple random variability. There are two potential factors that might explain this difference.

First, as noted elsewhere most of the NEI/EPRI failures occurred in trays with a horizontal 90° radial bend, and with the fire placed under the bend section. In contrast, CAROLFIRE tested straight sections of cable. A radial bend places more stress on the cables than does a straight run, and this could influence the failure behavior (see Section 9.2.2 for additional discussion on this point). There is no way to test for this effect given the available data.

Second, CAROLFIRE induced several failure cases involving cable locations away from the fire (e.g., hot gas layer conditions) whereas almost all of the NEI/EPRI test failures occurred with the cables either in or just above the fire source flame zone. The 'intensity' of the heating regime may also influence the failure behavior. Note for the TS cables in CAROLFIRE, all but one of the fuse blow failures occurs in cables in locations A or C, the two cable trays that are directly above the fire source and which are therefore most similar to the NEI/EPRI predominant failure configuration. The same trend is not seen with the TP cables with fuse blow failures occurring in various locations. This may be due to the fact that TP cable insulation simply melts so that the mode of heating may be less important. TS cable char and burn, but do not melt and this may make the mode of heating more important to the mode of failure. If true, the fact that the NEI/EPRI test failures were dominated by this one condition may have biased the results for the TS cables in comparison to a less intense condition (e.g., the hot gas layer case as compared to the fire plume exposures).

**Table 7.3: SCDU Intra-cable shorting results for TP cables only.**

| Test                       | SCDU | Configuration | CPT (VA) | Grounded | Cable type | Conductors | ID # | Routing  | Location | Mode    | Duration |
|----------------------------|------|---------------|----------|----------|------------|------------|------|----------|----------|---------|----------|
| IP-3                       | 1    | MOV 1         | 150      | N        | PVC        | 7          | 1    | Tray     | A        | SA      | 35s      |
| IP-4                       | 1    | MOV 1a        | 150      | N        | PVC        | 7          | 1    | Tray     | A        | SA      | <1s      |
| IP-4                       | 2    | MOV 1a        | 150      | Y        | PVC        | 7          | 1    | Tray     | A        | SA      | 6s       |
| IP-4                       | 3    | MOV 1a        | 200      | Y        | PVC        | 7          | 1    | Tray     | A        | FB      | -        |
| IP-4                       | 4    | MOV 1a        | 100      | Y        | PVC        | 7          | 1    | Tray     | A        | SA      | 1s       |
| IT-2                       | 3    | MOV 1         | 200      | Y        | PVC        | 7          | 1    | Tray     | G        | FB      | -        |
| IT3                        | 4    | AC-1          | 100      | Y        | PVC        | 3          | 5    | Tray     | G        | FB      | -        |
| IT-7                       | 1    | MOV 1         | 150      | N        | PVC        | 7          | 1    | Tray     | G        | SA      | 15s      |
| IT-7                       | 4    | MOV 1         | 100      | Y        | PVC        | 7          | 1    | Conduit  | E        | SA      | 24s      |
| IT-8                       | 2    | MOV-1         | 150      | Y        | PE         | 7          | 15   | Tray     | A        | SA      | 5s       |
| IT-9                       | 3    | MOV-1         | 200      | Y        | PE         | 7          | 15   | Tray     | A        | FB      | -        |
| IT-9                       | 4    | MOV-1         | 100      | Y        | PE         | 7          | 15   | Tray     | G        | SA & HS | 457s     |
| IT-10                      | 3    | MOV-1         | 200      | Y        | TEF        | 7          | 12   | Tray     | A        | SA & HS | 11s      |
| IT-10                      | 4    | MOV-1         | 100      | Y        | PE         | 7          | 15   | Tray     | G        | FB      | -        |
| IT-11                      | 1    | MOV-1         | 150      | N        | PVC        | 7          | 1    | Tray     | A        | SA      | 6s       |
| IT-11                      | 2    | MOV-1         | 150      | Y        | PE         | 7          | 15   | Air Drop | E        | SA      | 229s     |
| IT-11                      | 3    | MOV-1         | 200      | Y        | PVC        | 7          | 1    | Tray     | G        | FB      | -        |
| IT-12                      | 2    | MOV-1         | 150      | Y        | PE         | 7          | 15   | Air Drop | E        | SA      | 347s     |
| IT-12                      | 3    | MOV-1         | 200      | Y        | PVC        | 7          | 1    | Tray     | G        | SA      | 11s      |
| Total failures:            |      |               |          |          |            |            |      |          |          | 19      |          |
| Total Spurious Actuations: |      |               |          |          |            |            |      |          |          | 13      |          |
| Total Hot-shorts (only):   |      |               |          |          |            |            |      |          |          | 0       |          |
| Total Fuse Blows:          |      |               |          |          |            |            |      |          |          | 6       |          |

**Table 7.4: SCDU Intra-cable failure mode results for all Thermoset (TS) cable tests.**

| Test                       | SCDU | Configuration | CPT (VA) | Grounded | Cable type | Conductors | ID # | Routing | Location | Mode | Duration |
|----------------------------|------|---------------|----------|----------|------------|------------|------|---------|----------|------|----------|
| IT-1                       | 4    | MOV-1         | 100      | Y        | XLPE       | 7          | 3    | Tray    | B        | SA   | 98s      |
| IT-6                       | 4    | MOV 1         | 100      | Y        | XLPO       | 7          | 8    | Tray    | A        | SA   | 16s      |
| IT-8                       | 4    | MOV-1         | 100      | Y        | XLPE       | 7          | 3    | Conduit | E        | DNF  | -        |
| IT-1                       | 1    | MOV-1         | 150      | N        | XLPE       | 7          | 3    | Tray    | B        | SA   | 106s     |
| IT-10                      | 1    | MOV-1         | 150      | N        | EPR        | 7          | 2    | Tray    | G        | SA   | 226s     |
| IT-12                      | 1    | MOV-1         | 150      | N        | EPR        | 7          | 2    | Tray    | A        | FB   | -        |
| IT-13                      | 1    | MOV-1         | 150      | N        | XLPE       | 7          | 3    | Tray    | F        | SA   | 63s      |
| IT-14                      | 1    | MOV-1         | 150      | N        | XLPE       | 7          | 3    | Tray    | F        | SA   | 63 s     |
| IT-5                       | 1    | MOV 1         | 150      | N        | VL         | 7          | 11   | Tray    | A        | SA   | 29s      |
| IT-6                       | 1    | MOV 1         | 150      | N        | SR         | 7          | 9    | Tray    | C        | FB   | -        |
| IT-8                       | 1    | MOV-1         | 150      | N        | XLPE       | 7          | 3    | Tray    | G        | DNF  | -        |
| IT-9                       | 1    | MOV-1         | 150      | N        | EPR        | 7          | 2    | Tray    | G        | SA   | 122s     |
| IT-1                       | 2    | MOV-1         | 150      | Y        | XLPE       | 7          | 3    | Tray    | B        | FB   | -        |
| IT-10                      | 2    | MOV-1         | 150      | Y        | SR         | 7          | 9    | Tray    | A        | FB   | -        |
| IT-13                      | 2    | MOV-1         | 150      | Y        | VL         | 7          | 11   | Tray    | F        | DNF  | -        |
| IT-14                      | 2    | MOV-1         | 150      | Y        | EPR        | 7          | 2    | Tray    | F        | SA   | 19s      |
| IT-6                       | 2    | MOV 1         | 150      | Y        | SR         | 7          | 9    | Tray    | A        | FB   | -        |
| IT-7                       | 2    | MOV 1         | 150      | Y        | EPR        | 7          | 2    | Tray    | A        | SA   | 46s      |
| IT-9                       | 2    | MOV-1         | 150      | Y        | EPR        | 7          | 2    | Tray    | A        | SA   | 2s       |
| IT-1                       | 3    | MOV-1         | 200      | Y        | XLPE       | 7          | 3    | Tray    | B        | SA   | 231s     |
| IT-13                      | 3    | MOV-1         | 200      | Y        | XLPE       | 7          | 3    | Tray    | G        | SA   | 42s      |
| IT-14                      | 3    | MOV-1         | 200      | Y        | XLPE       | 7          | 3    | Tray    | G        | SA   | 44s      |
| IT-5                       | 3    | MOV1          | 200      | Y        | EPR        | 7          | 2    | Tray    | G        | DNF  | -        |
| IT-6                       | 3    | MOV 1         | 200      | Y        | EPR        | 7          | 2    | Tray    | C        | FB   |          |
| IT-7                       | 3    | MOV 1         | 200      | Y        | XLPE       | 7          | 3    | Tray    | A        | SA   | 31s      |
| IT-8                       | 3    | MOV-1         | 200      | Y        | XLPE       | 7          | 3    | Tray    | A        | SA   | 24s      |
| IT-11                      | 4    | MOV-1         | None     | Y        | XLPE       | 7          | 3    | Tray    | A        | SA   | 33s      |
| IT-12                      | 4    | MOV-1         | None     | Y        | XLPE       | 7          | 3    | Tray    | A        | SA   | 18s      |
| IT-13                      | 4    | MOV-1         | None     | Y        | VL         | 7          | 11   | Tray    | G        | DNF  | -        |
| IT-14                      | 4    | MOV-1         | None     | Y        | EPR        | 7          | 2    | Tray    | G        | HS   | 9 s      |
| Total failures:            |      |               |          |          |            |            |      |         |          | 25   |          |
| Total Spurious Actuations: |      |               |          |          |            |            |      |         |          | 18   |          |
| Total Hot-shorts (only):   |      |               |          |          |            |            |      |         |          | 1    |          |
| Total Fuse Blows:          |      |               |          |          |            |            |      |         |          | 6    |          |

Another factor to consider is that CAROLFIRE used larger CPTs in relative terms (i.e., relative to the nominal circuit design required power). Looking at the results as shown in Table 7.2, there are no clear signs at all that the size of the CPT made any difference to the likelihood of spurious actuation. In fact, the worst case of voltage degradation that was observed in CAROLFIRE was actually observed with a larger 150VA or 250% CPT. Other cases of voltage degradation are minor, and occur even on the 200VA CPT. There are no indications at all that the smaller CPT was more vulnerable to voltage degradation. Clearly, there are additional unknown factors in play here beyond those that were originally thought to account for the CPT effect on spurious actuation likelihood. Again, the CAROLFIRE results are most comparable to the NEI/EPRI tests with unlimited power (no CPT).

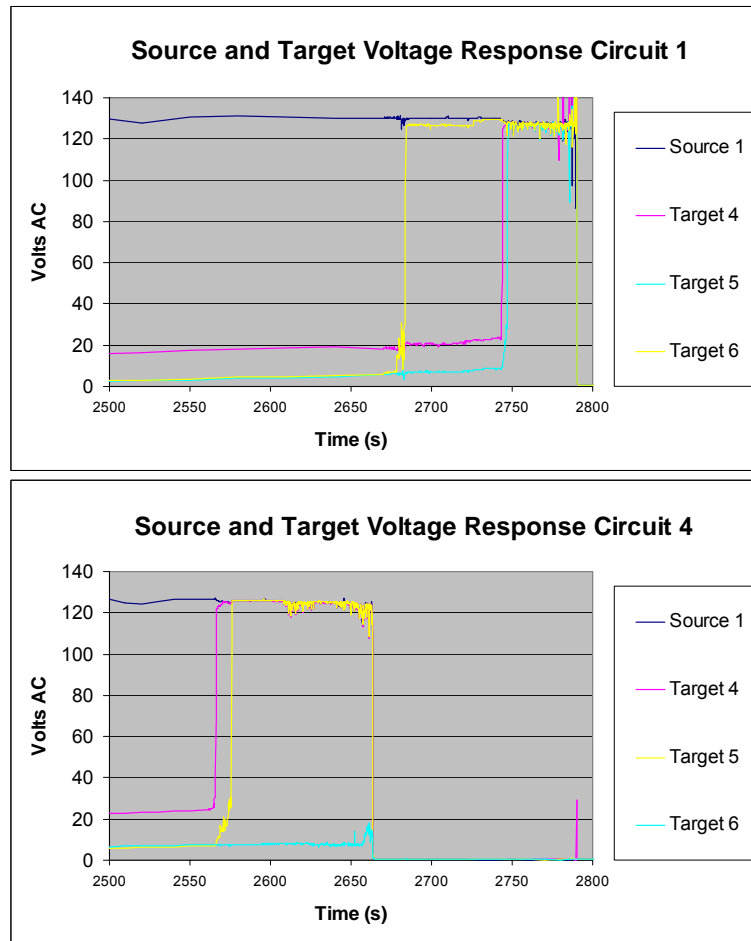
### 7.2.3 Inter-Cable Shorting Behavior

Among all the SCDU tests where fuse blow failures were possible, no spurious actuations due to an inter-cable hot-short were observed. The only cases of inter-cable spurious actuation observed involved the non-grounded SCDU-1 in the inter-cable configuration where, as noted above, a fuse blow failure was not possible given the wiring configuration used (see Section 4.5.4 above). However, there were various cases where inter-cable shorting behavior was observed on the SCDU circuits.

One example of this is SCDU Circuits 1 and 4 in Test IT-1. These were two XLPE-insulated (TS) cables each connected to an SCDU in the MOV-1 configuration, and co-located in a common cable bundle. The results are illustrated in Figure 7.6.

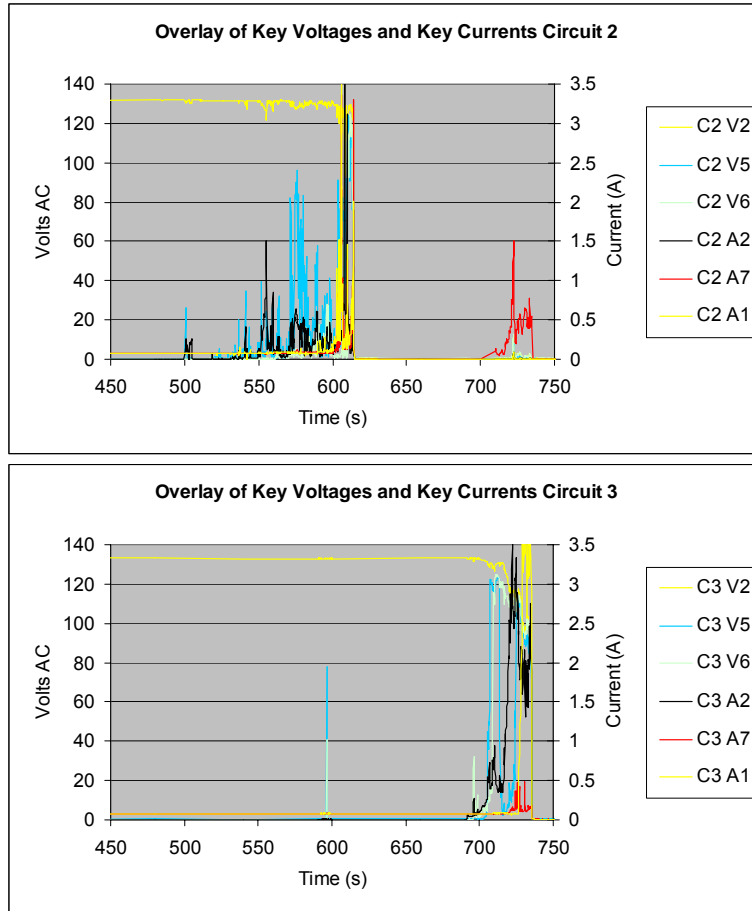
Circuit 4 experienced a spurious actuation followed by fuse blow as the first failures. Shortly thereafter, the cable for Circuit 1 began to fail. Circuit 1 experiences a spurious actuation to one of the target cables, and then follows a typical pattern of progressive failure and ultimately a fuse blow. However, during this same time period, a momentary increase in current flow and voltage is detected on Circuit 4 Path 4, the passive target conductor. This is a clear indication of inter-cable shorting between the two cables. In this case, Circuit 4 had already experienced a fuse blow, and neither the voltage nor the current flow was sufficient to lock in the motor contactors even had one of the active target paths (5 or 6) been the target of this inter-cable short.

This particular case is actually quite typical of the inter-cable interactions that were detected with the SCDU. Similar momentary inter-cable shorts were also observed in Tests IT-3 (with two of the three IC configurations present) and IT-7 (between two MOV-1 configurations). In the case of the IT-3 interactions, it is apparent that one of the cables had shorted to ground and subsequently shorted to an energized conductor in the second circuit creating a momentary voltage/current spike. In Test IT-7, the behavior is essentially identical to that described above for Test IT-1. That is, one circuit had already shorted to ground and experienced a fuse blow. The second circuit then hit the cable for the first circuit with a momentary voltage/current spike as the second circuit was itself cascading to failure. Neither case led to a spurious actuation due to insufficient current/voltage.



**Figure 7.6: Illustration of the inter-cable interactions observed between circuits 1 and 4 in Test IT-1. Note the voltage spike to Target 4 in Circuit 4 after that circuit had experienced a fuse blow.**

There was only one case that did not follow this pattern exactly, but rather, led to more than a momentary inter-cable shorting behavior as shown in Figure 7.7. This was Circuits 2 and 3 in Test IT-8. In this case, a short between two MOV-1 circuits persisted for approximately 13s. In this case the energizing source cable was that connected to Circuit 3 which was a TS cable (XLPE). The target was the cable on Circuit 2 and that was a TP cable (PE). About 100s after the fuse blows on Circuit 2, there is an increase in current to Circuit 2 Path 7, the grounded return conductor, concurrent with the failure of Circuit 4. This current flow can only be explained by inter-cable shorting. The potential for a spurious actuation in the target circuit (Circuit 2) cannot be definitively assessed. If the two target conductors (i.e., those on Circuit 2 Paths 5 and 6) were both shorted to ground, then a spurious actuation was not possible. However, all that can be stated for certain in this case is that at least one of the two energized conductors in Circuit 2 had shorted either to an external ground or to the grounded conductor on Path 7. Hence, there is some potential that this interaction could have led to a spurious actuation in Circuit 2 had the hot-short impacted either of the two target conductors.



**Figure 7.7: Illustration of the interactions between Circuits 2 and 3 in Test IT-8. Note the current increase on Circuit 2 Path 7 (C2 A7) in the upper plot concurrent with failure of Circuit 3.**

#### 7.2.4 Silicone Rubber and Vita-Link Cables

The test results for the Silicone Rubber (SR) and Vita-Link (VL) cables were rather unique in comparison to the other cables. Both cable types were resistant to fire damage in all tests during the fire exposure period. Note that neither of these cables saw failures during any of the *Penlight* tests, except in the case of the SR cable and then only after mechanical impact (striking the cable with a mallet) following a prolonged exposure at high heat flux. During the intermediate scale tests, none of the SR or VL cables experienced significant failures while the gas burner was actually running.

For the SR cable, some failures were observed just after the gas flow to the burner was turned off, but before activation of the sprinkler (e.g., IT-9 and IT-10). No specific explanation for these failures has been developed. With the VL cables, only one case was observed where a momentary drop in insulation resistance below 1000  $\Omega$  occurred prior to activation of the sprinkler. In this case the IR did recover after only a momentary drop. It is not clear what caused the momentary loss of IR, and other factors may have been involved. Both cable types were, however, found to be vulnerable to electrical failure following a fire exposure when the sprinkler was activated. In most tests where the

cables were above the fire and below the sprinkler head, failures were observed once water spray was initiated. These results are discussed further in Volume 2 of this report.

### **7.2.5 Grounded versus Ungrounded CPTs**

As noted elsewhere, based on a review of a proprietary NRC staff report, one of the findings coming out of the recent Duke Energy (2006) tests is that a substantial difference was observed between the spurious actuation likelihood for grounded and ungrounded control circuits. The one unique aspect of the Duke Energy (2006) tests was that the tests all involved spiral-wound armored cables. That is, the cables tests all have a spiral wound metallic armor over the insulated conductors. (The spiral armor is similar in appearance to flexible metal conduit.)

Based on preliminary results, Duke Energy (2006) saw a much lower incidence of spurious actuation failures, and much higher incidence of fuse blow failures, given a grounded circuit. With an ungrounded circuit, the spurious actuation probabilities appear to align, at least nominally, with the results from the NEI/EPRI tests (without CPT).

In the CAROLFIRE tests, two matched 150VA CPTs were used in SCUDU Circuits 1 and 2 and the CPT in Circuit 1 was not grounded whereas that in Circuit 2 was grounded. The results of the testing appear to show no effect whatsoever that is attributable to the grounding configuration. Nominally, the grounded circuit appears to have experienced roughly the same number of spurious actuations as did the ungrounded circuit. The two circuits were run in roughly the same number of trials with the MOV-1 configuration, and the ungrounded circuit experienced 2 fuse blow failures as compared to the grounded circuit with 3 fuse blow failures. Given the total number of trials, this difference is not significant.

It would appear that while grounded versus ungrounded circuits may be a significant factor influencing the likelihood of spurious actuation for armored cables, it does not appear to be a significant factor in the likelihood of spurious actuation for non-armored cables such as those tested by CAROLFIRE.



## 8 ANALYSIS OF THE BIN 2 ITEMS IN LIGHT OF THE EXPERIMENTAL DATA

This section examines each of the five Bin 2 items being addressed by CAROLFIRE (each item is discussed in a separate subsection). In each case, the Bin 2 item is first repeated exactly as stated in RIS 2004-03. Following the item statement is a brief discussion of the issues being raised by the item and a historical discussion relative to how each came to be included in the Bin 2 item list.

The Bin 2 items were defined based primarily on the results of a NRC-organized Facilitated Workshop [6]. This public workshop was widely attended by NRC staff, NRC support contractors (including the authors of this report), industry representatives, industry consultants and members of the general public. A number of circuit and cable faulting configurations were raised, and each was discussed at length with participants presenting arguments for and against inclusion of each configuration in one of three “bins.” Ultimately, the NRC staff consolidated these discussions based on the meeting transcript into two bins as documented in RIS 2004-03 [1].<sup>13</sup> This report includes a brief summary of the discussions that took place relative to each of the Bin 2 items during the workshop.<sup>14</sup> This information established a historical background and context for each item.

The discussions then turn to the general approach to data analysis taken by CAROLFIRE. This includes a description of the types of tests and diagnostics performed relevant to each item, and a general discussion as to how the data would be interpreted. Finally, each subsection closes with a discussion of the test data and findings specific to each Bin 2 item. Section 9 of this report summarizes the findings for each Bin 2 item.

It should also be noted that the findings discussed here are not based solely on the CAROLFIRE test results. All available evidence has been considered. This includes, in particular, the following resources:

- an RES-sponsored study of the cable failure modes and likelihood issues that was completed in 2000 and published in 2003 [7],
- the circuit failure mode results of the NEI/EPRI tests conducted in 2001 [2],
- the companion NRC/RES-sponsored fielding of the SNL IRMS prototype system during the NEI/EPRI tests [8],
- the results of the EPRI expert panel [9], and
- the circuit fault mode tests for armored cables conducted by Duke Energy in 2006 (based on a proprietary NRC staff report).

---

<sup>13</sup> Note that during the workshop a listing of several ‘Bin 3’ items – items that would not be considered in future inspections based on demonstrated evidence of very low likelihood – was also developed, although the listing of Bin 3 items was not included in the final revision to RIS 2004-03.

<sup>14</sup> The summary of workshop discussions is based both on a review of the workshop transcript and the recollections of the authors of this report, both of whom participated in the workshop.

## 8.1 Bin 2 Item A

### 8.1.1 Statement and Summary of the Item

Bin 2 Item A: *Intercable shorting for thermoset cables, since the failure mode is considered to be substantially less likely than intracable shorting.*

This item deals with a straightforward question; namely, can inter-cable interactions between two (or more) TS cables lead to the spurious actuation of equipment? In essence, the key to resolution was an assessment as to whether or not such interactions are at all plausible, and if so, could that potential be tied to specific cases or configurations.

Historically Item A was included in Bin 2 item based primarily on evidence from the previously conducted NEI/EPRI tests [2]. Most of cable bundles in the NEI/EPRI tests were made up of one multi-conductor cable bundled (taped) together with three single conductor cables. There were cases where spurious actuations were attributed to inter-cable hot-shorts (i.e., NEI/EPRI tests 3, 8, 9, 10 and 12). However, in all but one of these cases the hot-shorts occurred between two single conductor cables and did not involve the multi-conductor cable. One case (test 12) did involve a hot-short between an energized source conductor in the multi-conductor cable impacting a single conductor cable target. In this case, the associated motor starter relay chattered, but did not lock in.

The discussion of this configuration at the NRC Facilitated Workshop [6] focused on the fact that the bundling configuration in the NEI/EPRI tests was not typical of installed conditions, and on the fact that only one limited cases showed interactions with the multi-conductor cable despite the somewhat contrived and atypical nature of the cable bundles. As a result, the likelihood of inter-cable interactions given more representative conditions (e.g., between co-located multi-conductor cables) was expect to be rather unlikely. This is also consistent with the finding of the EPRI expert panel [9]. However, given that the NEI/EPRI tests did include cases of inter-cable spurious actuations, the configuration was included in Bin 2.

### 8.1.2 Resolution Approach

Both the small- and intermediate-scale tests included numerous tests where two or more TS cables are bundled together under varying exposure and routing conditions. Hence, the test matrices presented *many* opportunities for inter-cable interactions between TS cables. The matrices included bundles where shorting could occur between TS cables of the same type (e.g., between two XLPE-insulated cables) and between TS cables of different types (e.g., between an XLPE-insulated cable and an EPR-insulated cable).

The SCDUs provided opportunities for inter-cable spurious actuations in two ways. First, in most of the Intermediate-scale tests, at least two of the SCDUs would be co-located in adjacent cables of at least one bundle. When configured as the standard MOV circuit, one grounded SCDU could energize a second SCDU that is also grounded given an inter-cable hot-short between an energized conductor in one cable and a the target conductor in a second cable. The second method was to explicitly configure the SCDUs in an inter-cable configuration as described in Section 4.5 above. As

will be discussed below, in all but one case there were no spurious actuations of the SCDUs attributed to inter-cable interactions. The one case that was observed was the one inter-cable configuration where the electrical setup prevented a fuse blow failure.

As a result, Bin 2 Item A has in practice been evaluated based primarily on the IRMS results. In both the small- and intermediate-scale tests, the IRMSs were used to monitor separate TS cables in a common bundle. The IRMS can detect the onset of inter-cable shorting behavior, can measure the relative timing of inter-cable shorting versus both intra-cable shorting and shorts to the external ground, and can measure the duration of inter-cable shorts (i.e., how long an inter-cable conductor-to-conductor short remains independent of the external ground).

The intent with respect to Bin 2 Item A was that if the testing revealed any reliable evidence of inter-cable conductor-to-conductor hot-shortening behavior between TS cables, this would be interpreted as an indication that inter-cable shorting for TS cables *is* plausible. In this case, the data would be further evaluated to assess factors such as likelihood, timing, and duration of the inter-cable interactions to the extent possible, although providing such statistical results was not a primary goal relative to issue resolution.

One significant factor in the evaluation of Item A was an assessment of when, relative to other modes of faulting, inter-cable interactions were detected between co-located TS-insulated cables. For inter-cable interactions to be risk relevant, one cable must remain energized, and the second cable must remain sufficiently intact so that a hot-short can actuate the target circuit. If prior faults cause a loss of circuit power to a cable, then that cable can no longer act as an energizing source. Further, prior faults that cause intra-cable shorting and/or cause conductors to short to an external ground causes a progressive loss of distinction between conductor (and therefore between circuit traces) making it less likely that subsequent hot-shorts might cause a spurious actuation. Given these observations, the following cases were considered:

- When observed as a primary fault mode for both of the two cables involved in an inter-cable short (i.e., as the first mode of failure impacting the two cables), inter-cable interactions hold a significant potential to cause hot-shorts and/or spurious actuations.
- When occurring as a primary fault mode for one cable and as a secondary fault mode for the second cable (i.e., occurring after either intra-cable shorting or shorts to an external ground were observed in the second cable) inter-cable interactions are less likely to cause risk-relevant circuit effects (e.g., spurious actuation) but hot-shorts or spurious actuation under these conditions are not entirely implausible.
- When occurring as a secondary fault mode for both cables, the potential for a hot-short or spurious actuation still exists, but the likelihood is further reduced.
- When occurring as a tertiary fault mode for either involved cable (i.e., occurring only after both intra-cable faults and shorts to an external ground had occurred), inter-cable interactions are unlikely to cause either a hot-short or spurious actuation. The likelihood is further reduced if the second cable experiences the fault as a secondary fault mode.
- When both cables experience inter-cable interactions as a tertiary fault mode, the interaction is quite unlikely to cause hot-shorts or spurious actuations and such interactions are not considered risk-relevant.

### 8.1.3 Specific Data Relevant to Bin 2 Item A

As noted, the question of TS to TS inter-cable hot-shorts was placed in Bin 2 largely on the basis of the inconclusive evidence from the NEI/EPRI tests, and the use of a rather contrived cable bundling scheme intended to maximize the inter-cable shorting behavior. However, in that program one spurious actuation was observed, and this does indicate that some degree of plausibility does exist. The main goal of CAROLFIRE was to complement the NEI/EPRI tests and to assess more realistic cable bundling arrangements with explicit monitoring for inter-cable interactions. As noted above, CAROLFIRE offered many opportunities for inter-cable interactions and monitored for those interactions using both the SCDUs and the IRMSs.

In the end, no single instance of a spurious actuation on any SCDU configured to simulate an MOV control circuit was attributed to inter-cable interactions during any of the CAROLFIRE tests. Further, when configured in an inter-cable configuration no spurious actuations were observed for any case involving a grounded power source. However, in at least one test, IT-1, there was evidence of some interactions between the cables for two co-located SCDUs. In this case, Circuit 4 had experienced a spurious actuation followed by fuse blow first. Shortly thereafter, Circuit 2 also experienced a spurious actuation. Both spurious actuations were due to intra-cable shorting. Concurrent with the fuse-blow failure on Circuit 1, there were voltage spikes recorded on various conductors for Circuit 4. These can only be explained as inter-cable interactions. No spurious actuations occurred, and the shorts were of just momentary duration. In this particular case the interactions had little potential to cause a spurious actuation given the applied voltage levels for the target cable. However, this has been taken as weak evidence that inter-cable interactions do occur between TS cables.

The only case where an SCDU saw a potential inter-cable short leading to spurious actuation was when using the SCDU with an un-grounded CPT in the Inter-Cable configuration (see Chapter 4). In this case the power supply return path was not accessible to the cables being burned, and a fuse blow failure was simply not possible. A spurious actuation was observed with this set-up. This short did display the characteristics of a conductor-to-conductor short rather than a multiple short to ground fault (conductor-to-ground-to-conductor short), given that the fault formed abruptly (within less than one second) rather than forming progressively (over a period of several seconds). In other tests with the IRMS sharply forming shorts were found to be characteristic of conductor-to-conductor shorting and progressively developing faults among conductors were found to be more typical of multiple shorts to ground. However, the results in this case are inconclusive and given other more directly applicable data (described below), this one instance was discounted as an uncertain case and was essentially not taken into consideration in the final findings.

The most pronounced evidence of the plausibility of TS-to-TS inter-cable hot-shorts was obtained from the IRMS data gathered during test IT-1. In this test, a conductor-to-conductor short between two 7-conductor TS-insulated cables formed. This inter-cable short occurred as the primary fault mode for both cables. That is, the inter-cable short was detected before either cable had shorted either internally or to the external ground. The inter-cable short persisted for a total of 194s before either cable progressed into a secondary fault mode, in this case intra-cable shorting. This case is taken as definitive evidence that TS-to-TS hot-shorts are plausible.

Other cases were also observed where inter-cable shorts formed as a secondary failure mode for one or both cables. In particular, in tests PT-60 and IT-7, an inter-cable short between two TS cables occurred as a secondary fault mode in one of the two cables (i.e., after intra-cable shorting had been detected within this cable), and as the primary fault mode for the second cable. Again, given the manner in which conductor were grouped for these tests, a hot-short leading to spurious actuation was a possible outcome for this case.

In various other *Penlight* and intermediate-scale tests (i.e., PT-42, IT-6, and IT-7), the IRMS detected various other interactions, but in these other cases, the faults occurred as tertiary fault modes for one of the two cables. However, the faults did occur as primary fault modes for the second cable. Given the other interactions as observed above, these interactions were not considered especially significant.

#### **8.1.4 Experimental Findings**

The CAROLFIRE tests did detect some cases of inter-cable shorting between TS cables. However, only one of these cases involved a clear-cut case of a sustained inter-cable short circuit between two TS cables (IRMS in Test IT-1) that could have led to a spurious actuation. In other cases, the interactions were secondary or tertiary failure modes for at least one of the two involved cables. However, the test data clearly showed that TS-to-TS interactions are plausible, albeit the likelihood of risk-relevant interactions appears to be low, especially in comparison to the likelihood of intra-cable interactions leading to spurious actuation.

Based on the available data with respect to Bin 2 Item A the CAROLFIRE project has reached the following conclusions:

*Inter-cable shorting between two TS-insulated cables that could cause hot shorts and the spurious actuation of plant equipment was found to be a plausible failure mode, although the likelihood of this failure mode is low in comparison to intra-cable short circuits leading to spurious operation. While no detailed statistical analysis has been performed, it appears that the conditional probability (give cable failure) of spurious actuations arising from this specific failure mode is small in comparison to that previously estimated for spurious actuations from intra-cable shorting.*

Note that the overall conclusion does find that inter-cable hot-shorts between TS cables are plausible, but of low likelihood. In particular, for cases where and intra-cable short circuit can lead to the same spurious actuation of plant equipment as would an inter-cable short between two TS cables, the data clearly indicate that the overall likelihood of spurious actuation will be dominated by the likelihood of intra-cable shorting leading to spurious actuation.

## 8.2 Bin 2 Item B

### 8.2.1 Statement and Summary of the Item

Bin 2 Item B: *Intercable shorting between thermoplastic and thermoset cables, since this failure mode is considered less likely than intracable shorting of either cable type or intercable shorting of thermoplastic cables.*

Bin 2 Item B is quite similar to Bin 2 Item A, except in that the interactions of potential concern are those that might occur between a TS cable and a TP cable. No evidence for this configuration was gathered during the previous NEI/EPRI tests because all testing involved bundles of similar cable types (i.e., all bundles were either TS or TP and no mixed TS-TP bundles were tested). The discussion of this item at the NRC Facilitated Workshop [6] focused on the fact that the TP cables, being less robust, would generally fail far sooner during a fire exposure than would any co-located TS cables. Hence, it was expected that before the TS cables showed substantive degradation, the TP cables would likely short to ground making it unlikely that inter-cable hot-shorts to a TS cable would lead to spurious actuation. However, given a lack of any experimental evidence to support this presumption, the configuration was included as a Bin 2 item.

### 8.2.2 Resolution Approach

The test matrices (detailed in Section 5) provide numerous opportunities for inter-cable shorting between TP and TS cables. The relevant tests are: tests 32, 34, 36, 38, 40 - 43, 45 - 47, 49 - 52, 54 - 56, 60 and 62 in *Penlight* (see Table 2); tests 28 and 30 - 33 in the Intermediate-Scale Radiant Heating tests (see Table 3); and tests 37 - 39, 41 and 43 - 52 in the Intermediate-Scale Open Burn tests (see Table 4).

The approach to assessment and the data to be applied to the resolution of Item B are essentially identical to those described above for Item A, with the exception that we were specifically looking for TS-to-TP inter-cable interactions.

### 8.2.3 Specific Data Relevant to Bin 2 Item B

In all of the CAROLFIRE tests, there were no actual spurious actuations observed among the SCDU circuits that can be attributed to inter-cable shorting. However, there were cases where inter-cable shorting was observed between co-located TS and TP cables.

The most notable case occurred during Test IT-8. In this case the interactions took place between a PE (TP) cable and an XLPE (TS) cable, both 7-conductor and 12 AWG. The TS cable was connected to SCDU #2, and the TP cable was connected to SCDU #3. Both SCDUs were grounded. The TP cable failed first causing a fuse blow failure for that SCDU and de-energizing the TP cable. Shortly thereafter the TS cable also failed. In this case, a hot-short originating in the TS cable impacted the TP cable as evidenced by a current increase on one of the TP cable conductors lasting for about 10 seconds. In this case, the hot-short impacted the grounded conductor in the TP cable rather than a target conductor. It is not clear whether or not a hot-short to a target conductor could

have caused a spurious actuation in this case because the exact extent of faulting in the TP cable is not known (only that a fuse blow had occurred).

With respect to the IRMS data, no cases were observed where inter-cable shorting between a TS and a TP cable was the primary fault mode for both cables. However, at least one case (IT-9) was seen where an inter-cable short was the secondary fault mode for one cable and the primary fault mode for the second cable. Somewhat surprisingly, the TS cable had experienced internal faulting when it then shorted to a TP cable as the primary fault mode for the TP cable. The fact that the TS cable experienced failures first was unexpected. During this same test, the same TS cable then experienced a second inter-cable short to another co-located TP cable. This became the tertiary fault mode for the TS cable, but was again the primary fault mode for the TP cable.

Other interactions were observed by the IRMS. The most notable case was PT-45 where an inter-cable interaction was a tertiary mode for one TS cable and the primary mode for a TS cable. In all other cases the faults were a tertiary fault mode for one cable and at most a secondary fault mode for the second cable. These interactions are not considered especially important in light of the cases noted above.

#### **8.2.4 Experimental Findings**

Taken together, the data indicated that TS-to-TP inter-cable interactions are plausible. However, the data also indicated that risk-relevant interactions between TS and TP are of very low likelihood, and indeed, of even lower likelihood than are TS-to-TS interactions. While no statistical analysis has been performed, it would appear that the conditional probability of risk-relevant TS-to-TP inter-cable hot-shorts is on the order of 0.001 or less (conditional on cable failure).

Based on the available data with respect to Bin 2 Item B the CAROLFIRE project has reached the following conclusions:

*Inter-cable shorting between two a TP-insulated cable and a TS-insulated cable that could cause hot shorts and the spurious actuation of plant equipment was found to be a plausible failure mode, although the likelihood of this failure mode is low in comparison to intra-cable short circuits leading to spurious operation. While no detailed statistical analysis has been performed, it appears that the conditional probability (give cable failure) of spurious actuations arising from this specific failure mode is very small in comparison to that previously estimated for spurious actuations from intra-cable shorting.*

Note that the overall conclusion does find that inter-cable hot-shorts between TS and TP cables are plausible, but of very low likelihood. In particular, for cases where and intra-cable short circuit in either a TS or TP cable can lead to the same spurious actuation of plant equipment as would an inter-cable short between two TS cables, the data clearly indicate that the overall likelihood of spurious actuation will be dominated by the likelihood of intra-cable shorting leading to spurious actuation.

## 8.3 Bin 2 Item C

### 8.3.1 Statement and Summary of the Item

Bin 2 Item C: *Configurations requiring failures of three or more cables, since the failure time and duration of three or more cables require more research to determine the number of failures that should be assumed to be “likely.”*

Bin 2 Item C is a direct complement to Bin 1 Item A which directed inspectors to consider any combination of spurious actuations that might arise from failures impacting any two cables. Bin 2 Item C essentially asks the question ‘how many spurious actuations might occur during a given fire?’ Bin 2 Item C also raises the issue of concurrency; that is, the potential that multiple spurious actuations might overlap in time.

The tests conducted by NEI/EPRI showed that the number of spurious actuations that might occur was ultimately limited only by the number of cables holding the potential to cause spurious actuation that actually failed in a fire. Generally, the NEI/EPRI tests each involved four MOV circuits; hence, each test presented (nominally) four opportunities for spurious actuation. There was at least one test (test 9) where four out of four circuits spuriously operated and several tests where either two or three out of the four circuits spuriously operated.

The consensus developed during the NRC Facilitated Workshop was that directing inspectors to focus on spurious actuations arising from no more than two impacted cables was a reasonable starting point for the resumption of associated circuit inspections. The evidence available even at that time clearly demonstrated that two concurrent spurious actuations were plausible. Further, the general consensus was that if the inspections looked for the two-cable cases, then they would likely identify the most risk-important cases. The question of higher order spurious actuation combinations (i.e., arising from three or more impacted cables) would be deferred pending more information regarding what types of spurious actuations were being identified as risk-important, and more likelihood information.

It should also be noted that the discussions during the workshop itself focused on two spurious actuations (i.e., rather than spurious actuation arising from two cables). However, during the NRC consolidation of the workshop results, it was realized that this left unaddressed configurations where a single cable might cause multiple spurious actuations. The wording of the Bin 1 Item A in the RIS clarifies that if one cable can cause multiple spurious actuations, then all of those spurious actuations are considered regardless of the number. This is particularly relevant to applications using so-called ‘trunk cables’ where multiple control circuits are routed together in one cable. One relevant case that had been examined by the NRC staff involved the safety relief valves at one licensee’s plant where it was found that hot-shorts in one cable could cause spurious actuation of all seven valves. The wording of Bin 2 Item C clearly states that in such cases, the possibility that seven valves might open concurrently would need to be considered during an inspection.



### 8.3.2 Resolution Approach

In essence, Item C asks the question as to whether an *a-priori* limit can be set on the number of concurrent spurious operations that might occur in a single fire and if so what that limit would be. The approach to data evaluation for Item C was to examine the data from all of the available sources to determine if that data provided a basis for establishing such a limit.

The data analysis relative to Item C rested on the consideration of two issues; namely, the general likelihood of concurrent spurious actuation signals and the timing and duration of hot-short / spurious actuation signals. The collective data from the NEI/EPRI, Duke Energy, and CAROLFIRE testing has provided a very large number of opportunities for hot-shorts and spurious actuations to occur under a broad range of test conditions.

Specific to the CAROLFIRE tests, virtually every test conducted contributed to the resolution of Item C. Even those *Penlight* tests involving individual lengths of cable included an assessment of intra-cable shorting behaviors which contributes to our understanding of the general likelihood of hot-shorts and spurious actuations. That is all of the tests involving the IRMS provided detailed information on the relative timing and mode of failure for single and multiple cables in a common fire environment. By analyzing the timing of cable failures across cables, we gained insights into the nominal likelihood that multiple intra-cable hot-shorts might occur concurrently and how long such faults persist.

Those CAROLFIRE tests considered *most directly* relevant were the intermediate-scale tests which explicitly presented the opportunity for two or more hot-short / spurious actuation failures on the SCUD circuit simulators. These devices (see Appendix C) simulated the actual characteristics of specific control circuits (e.g., motor-operated valves and solenoid-operated valves) and were used to monitor the occurrence of spurious actuations for, primarily, a standard MOV control circuit that was essentially identical to that used both by NEI/EPRI in their 2001 tests [2], and by Duke Energy (2006). Again, data from these devices provided indications of the likelihood of spurious actuation failures, whether or not spurious actuation signals overlapped in time, and how long such signals persisted. Resolution of Item C required that the data from all of the tests, including the NEI/EPRI tests and the Duke Energy (2006) tests, be taken together and analyzed as a set.

### 8.3.3 Specific Data Relevant to Bin 2 Item C

All of the data from the NEI/EPRI tests, CAROLFIRE, and even that from the Duke Energy (2006) tests, point to a relatively high likelihood of spurious actuation given cable failure. The NEI/EPRI test results were evaluated by the expert panel and these probabilities are being used in various contexts today. CAROLFIRE yielded similar, if slightly higher, nominal spurious actuation probabilities, but did not see the effects of CPTs in reducing that probability.

Overall, it appears that the number of spurious actuations that might occur in a fire is ultimately limited only by the number of cable failures involving cables with the potential to cause a spurious actuation. The IRMS data from the CAROLFIRE tests have confirmed one key observation that was made during the NEI/EPRI tests; namely, intra-cable shorting is expected to be the predominant

mode of initial cable failure rather than shorts to an external ground. Intra-cable shorting is also expected to be the predominant cause of spurious actuation signals. CAROLFIRE has also confirmed that the nominal probability of spurious actuation given cable failure is relatively high for at least some cable and circuit configurations. Overall for CAROLFIRE approximately 70% of cable failures led to spurious actuations on the SCDUs. This is actually somewhat higher than the worst-case percentages seen in the NEI/EPRI tests (see further discussion in Section 9.2.2 below).

However, there were distinct trends in the data that should also be considered. This included the following:

- Even for cables that were co-located failures occurred over a distinct period ranging from about 5 minutes to upwards of 20 minutes for a given raceway.
- For cables located in separate raceways, the cable failure times were separated by some minutes.
- Cables in conduits tended to show longer times to failure than did cables in an open cable tray at the same location.

#### 8.3.4 Experimental Findings

The CAROLFIRE data essentially confirmed the findings of the previous testing programs. As noted above, the most directly relevant evidence is that provided by the simulated control circuits, the SCDUs in the case of CAROLFIRE. As in the NEI/EPRI tests, there were four SCDUs available for most tests. The number of spurious actuations observed in any given tests where all four SCDUs were configured as MOV control circuits (MOV1) ranged from one to four, with most tests seeing two or three spurious actuations.

This was, again, quite consistent with both the NEI/EPRI tests and with the Duke Energy (2006) tests. CAROLFIRE was not designed to yield statistical estimates of spurious actuation likelihood; however, based on a nominal review the statistics relative to spurious actuation likelihood are also relatively consistent with the NEI/EPRI tests in particular, with the exception of the issue relating to CPT effects as discussed in Section 8.4 below.

The analysis of Bin 2 Item C was arguably the most complex and difficult of all the Bin 2 items. The accumulated knowledge from all of the available tests provided no basis of support for the current guidance; that is, this project has concluded that limiting consideration to concurrent spurious actuations arising from just two cables is not supported by the existing data. Furthermore, the collective data do not provide a basis for establishing any *a-priori* limit to the number of concurrent spurious actuations signals that should be considered in any given fire. Ultimately, the number of spurious actuations might only be limited by the number of cables damaged in a fire that hold the potential to cause spurious actuations.

The question then becomes one of the relative timing of cable failures, and this question can only be answered on a case-specific basis. Also relevant is the question of how long the effects of a spurious actuation might persist which is tied strongly to the nature of the circuit.

For certain circuits, once the hot-short itself is mitigated (i.e., when the cable cascades to higher failure modes and circuit power is ultimately lost) the component will return to its non-energized (often fail-safe) position. This applies to devices such as solenoid operated valves (SOVs). However, for a range of other typical components, such as MOVs, the device will be left in whatever state it was in when the hot-short itself is mitigated. For an MOV this might be closed, open or partially open. Further, the normal control functions for such devices will generally be lost as well given that the control circuit power is also likely to trip. Hence, for many circuits an operator action will be needed to overcome the effects of the spurious actuation. The action may be a remote shutdown action (e.g., manual closure or opening of a valve), or an action taking place within the main control room (e.g., closing or opening other valves to mitigate the effects of a spurious actuation), but some action would be needed. Unfortunately, in these cases the only basis for establishing how long the *effects* of any given spurious actuation might persist will often be human factors analysis.

Given the test data, and these insights, ultimately, the only reasonable criterion for limiting the scope of a spurious actuation assessment that this project can cite would be the use of risk-importance measures. Given the available data relevant to Bin 2 Item C, the CAROLFIRE project has reached the following conclusions:

*The currently available data provide no basis for establishing an a-priori limit to the number of spurious operations that might occur during a given fire. We further find that the timing of spurious actuation is a strong function of various case-specific factors including in particular the relative location of various cables relative to the fire source, the routing configuration (e.g., open cable trays or air drops versus conduits), the thermal robustness of the cables insulation material, and the characteristics of the fire source.*

## **8.4 Bin 2 Item D**

### **8.4.1 Statement and Summary of the Item**

Bin 2 Item D: *Multiple spurious actuations in control circuits with properly sized control power transformers (CPTs) on the source conductors, since CPTs in a circuit can substantially reduce the likelihood of spurious actuation. Specifically, where multiple (i.e., two or more) concurrent spurious actuations due to control cable damage are postulated, and it can be verified that the power to each impacted control circuit is supplied via a CPT with a power capacity of no more than 150 percent of the power required to supply the control circuit in its normal mode of operation (e.g., required to power one actuating device and any circuit monitoring or indication features).*

This particular item derived directly from the results of the NEI/EPRI tests in 2001. During roughly the first half of the NEI/EPRI test program, their surrogate control circuits were powered directly from service power with effectively unlimited power available to the circuit. During the latter half of the test program, CPTs were added to the circuits so that the power to the circuit was limited to that which could be supplied by the CPT. In practice, CPTs are common in control circuits, especially for devices such as MOVs and SOVs.

A CPT is a small transformer commonly installed in certain types of control circuits (e.g., MOVs) to supply the power to run the control circuit. The CPT taps into the motive power supply source for the device being controlled (e.g., the power supply to the motor of the MOV), steps down the voltage, and thereby feeds power to the device's control circuitry. As an artifact of this design, the total power available to the control circuit is limited to the maximum power output of the CPT. The available power is generally rated as the total volt-amperes (VA) available.

The choice of CPT size for a given circuit is made during circuit design, but in all cases, the CPT must be large enough to supply all of the normally anticipated control power circuit demands. In practice, some margin is provided above the nominal control circuit power demand. Based on industry input, a CPT is typically sized to provide 150% or more of the anticipated normal circuit demand load although higher design margins are also used.

In the case of control circuits based on relay actuations (e.g., MOVs and other types of motor starter circuits), the control power demand is driven mainly by the power required to induce movement and lock-in of the relay coil (the so-called 'pick-up' power demand). A secondary consideration is the power required to illuminate any indication lamps (those lamps that show component or system status on the control board), but these are generally small in comparison to the in-rush power load. For example, the NEI/EPRI tests simulated the normally lit indicator lamp using a 1.75 k $\Omega$  burden resistor. Hence, the total power demand for this part of the circuit was about 7.6 VA ( $(115\text{V})^2/1750\Omega$ ). This is compared to the nominal pick-up demand of the relay of about 89 VA. Taken together, the nominal design power demand for the NEI/EPRI circuits would, nominally, be 100 VA. Given this nominal design load, the 150 VA CPT provides approximately a 50% design margin, or 150% of the power nominally required for normal circuit operation.

If the power demand (e.g., current flow) exceeds the CPT power output limits, then the CPT output voltage will begin to degrade (it drops below the design voltage). For example, with a CPT rated at 150 VA, the maximum current draw available at full voltage is about 1.25A (assuming a 120V supply voltage). If the current draw exceeds this maximum, output voltage degrades. For example, at an output current of 1.5A, voltage would nominally degrade to about 100V.

If the voltage is degraded far enough, then the actuation circuit will not function. For example, the NEI/EPRI motor starters, which are rated for 115 VAC, had measured pick-up voltages<sup>15</sup> of 80-83 V. The motor contactors used in CAROLFIRE are quite similar with pick-up voltages ranging from 72-81 V. If the CPT output voltage drops below the minimum pick-up voltage, the relay cannot fully actuate, and instead will simply chatter or at lower voltages produce a humming noise. In the end, a relay coil will only lock in if the spurious actuation signal exceeds both the pick-up voltage and pick-up current. During the NEI/EPRI tests the introduction of CPTs reduced the likelihood of spurious actuations by approximately one-half (as determined by the EPRI expert panel [9]).

Bin 2 Item D in a sense raises two questions. First is to define what would constitute a "properly sized" CPT in the context of spurious actuation considerations. The sizing of a CPT was considered relative to the nominal design load. Hence, this question can be reduced to the question as to how

---

<sup>15</sup> The pick-up voltage is the minimum voltage required to induce a full lock-in of the device's relay.

large the design margin can grow before the credit for reduction of the spurious actuation likelihood would no longer apply. The second question is to then ask whether or not multiple spurious actuations are plausible given a “properly sized” CPT.

#### 8.4.2 Resolution Approach

In both the original NEI/EPRI and the Duke Energy (2006) tests, only 150 VA CPTs have been tested for a circuit with a nominal power demand of 100 VA under normal operating conditions. This implies a 50% margin, or a CPT that provide 150% of the nominal design power demands. CPTs of this size are commonly used in MOV control circuits in particular, although other sizes are also used.

It was speculated that the observed effect of CPTs on spurious actuation likelihoods was a result of the manner in which cables tend to degrade prior to gross failure. As a multiconductor cable degrades, each energized conductor experiences current leakage. However, this leakage will tend to seek out any circuit return path available. For the NEI/EPRI and Duke Energy (2006) tests, and for most of the CAROLFIRE tests as well, there are five return paths available; namely, the conductor connected to the passive target (the resistor simulating an un-lit indicating lamp), the two conductors connected to the active motor starters/contactors targets, the one grounded/return conductor, and the external ground (e.g., the raceway or cable armor). For ungrounded circuits (which have been tested both by Duke Energy (2006) and CAROLFIRE), the external ground is removed as a return path, but all the other return paths remain active.

In order to initiate a spurious actuation, a source conductor must feed power to a target conductor supplying both voltage and current that exceeds the targets pick-up values. If the source conductor is leaking power to various conductors, the CPT may not be able to maintain the circuit voltage above the pick-up voltage of the relay coil. Hence, while a hot-short may occur, the voltage may not be sufficient to cause relay lock-in.

CAROLFIRE tested three CPT sizes; namely, CPTs with design margins of 66%, 150%, and 233% (i.e., CPTs providing 166%, 250%, and 333% of the nominal required power). A limited number of tests were also conducted with an unlimited power source (direct connection to service power).<sup>16</sup>

To answer the question of what is a “properly sized” CPT in this context, the data from the SCDUs has been carefully examined to look for effects attributable to the CPT size. The effects that were sought were (1) signs that the source voltage was substantially degraded during the exposures, (2) cases where an active target (a motor contactor) had a substantive voltage imposed on it due to a hot-short but did not actuate, (3) cases where a motor contactor chattered but did not lock in, and (4) the general duration of the spurious actuations that were observed. To answer the question of whether or not multiple spurious actuations are plausible given a “properly sized” CPT, considerations have been based on an overall examination of all the available data relative to timing, duration, and likelihood.

---

<sup>16</sup> See the discussion in Appendix C relative to the intended an actual design margins for the CAROLFIRE SCDUs. The values cited here are the actual design margins based on measure coil pick-up currents.

### 8.4.3 Specific Data Relevant to Bin 2 Item D

Three data sources were considered in the assessment of Bin 2 Item D. These are (1) the original NEI/EPRI tests as evaluated by the EPRI expert panel, (2) The CAROLFIRE test results reported here, and (3) the preliminary results of testing on armored cables by Duke Energy (2006) as reported by the NRC staff<sup>17</sup> who observed the tests.

The NEI data were fairly clear-cut and were examined in depth by the EPRI Expert Panel. However, as a part of CAROLFIRE, one aspect of the EPRI/NEI test configurations that had not previously been discussed was brought into question and examined in some depth. For detail on this examination, see Appendix D.

To summarize, the EPRI/NEI test circuits used ‘self-powered’ voltage and current transducers to monitor the voltage and current conditions for each circuit path in the surrogate MOV circuit. The term ‘self-powered’ means that each transducer acted as a parasitic load on the monitored circuit; that is, each transducer drew the power required to operate itself from the monitored circuit. This parasitic load would not be present in an actual circuit. If these parasitic loads were at all significant, the presence of the transducers may have biased the test results inappropriately.

To test this possibility, SNL procured one each of the self-powered voltage and current transducers used by NEI/EPRI. Measurements were then made of the actual power demand required to operate these devices as a function of the magnitude of the input signal (e.g., the power required by a voltage transducer to measure a 1V signal versus that required to monitor a 115V signal). Concern focused mainly on the voltage transducers for two reasons. First, the voltage transducer’s nominal power demand rating is an order of magnitude greater than that of the current transducers. Second, there could be a magnification effect imposed on the CPT when the voltage transducers are monitoring a signal at less than the nominal supply voltage. That is, *if* the power demand was uniform over the transducers’ full range, then monitoring a low voltage signal could place an inordinate power burden on the CPT which has to supply that power at its full output voltage. The following example illustrates this potential effect:

Consider one voltage transducer with a rated burden of 1 VA per the manufacturer specifications. Consider also a case where the transducer is measuring 1V on a conductor within a partially degraded cable. If the transducer burden is constant across the full range of the transducer, then the transducer would need to draw 1A from the monitored circuit in order to supply the required 1 VA burden. However, from the perspective of the CPT, this 1 A power draw would be supplied at the full CPT output voltage. With a 115 V supply voltage, the 1A burden of the transducer would actual represent a burden on the CPT of 115 VA. Note that the balance of the voltage drop from 115 to 1 V occurs across the fault

---

<sup>17</sup> Duke Energy has requested that NRC treat the recent armored cable test results as proprietary information. Hence, the data from those tests cannot be reproduced here, but rather, can only be discussed in general terms. The discussions presented here are based on an internal NRC staff report which describes the test results and on discussions with the staff members who observed the actual testing. The NRC staff report does include presentation of test data, and because the underlying data are proprietary, the NRC staff report is also being treated as proprietary information.

itself. In this example, the bulk of the CPT's available power would be wasted powering the transducer.

The key here was the assumption that the burden imposed by the transducers is constant across the full range of the transducer. Based on our investigation, this proved *not* to be true. In fact, the burden imposed by both types of transducer was found to be a sharp function of the input voltage/current. The power demand of both the voltage and current transducers increased (generally<sup>18</sup>) with increasing input signal. At full scale (150V in the NEI/EPRI case), the voltage transducer's power demand was 1 VA. At a 115 V nominal full circuit voltage, the power demand per voltage transducer would have been about 0.6 VA. At lower voltage levels, the power demand dropped sharply. The burden dropped below 0.1 VA for any voltage below about 60 V.

Overall, the parasitic load imposed on the circuits in the NEI/EPRI tests was likely no more than 5.4 VA, or about 3.6% of the available power at any time. This would not have been a significant factor in the interpretation of the NEI/EPRI tests. Based on our findings (see Appendix D) we concluded that the presence of the self-powered transducers likely had *at most a minor effect on the NEI/EPRI test results*, and likely would not have caused a substantial impact on the findings relative to the CPT effects.

As a matter of good practice, it would be prudent for any subsequent test programs of this type to utilize only externally powered voltage and current transducers or employ some other means of circuit monitoring that does not place a burden on the monitored circuit. (Note that CAROLFIRE used externally powered transducers.)

With respect to the CAROLFIRE tests, recall that the modified design power demand for the actual circuits tested indicate that test data was generated for circuits with a CPT sized with design margins of 67%, 150%, and 233% (i.e., 167%, 250%, and 333% of nominal design load requirements), as well as three tests with unlimited power available. The results showed essentially no effect attributable to the size of the CPT.

The final source of information considered was the tests on armored cable by Duke Energy. Duke Energy (2006) also used essentially the same MOV control circuit test configuration as that used by NEI/EPRI in the original tests. We also noted that the motor starters used by were Joslyn-Clark model T30U031 NEMA-1 reversing motor starters. The EPRI reports states that the original NEI/EPRI tests used A.O. Smith Clark Controls Division model 30U31 motor starters. A.O. Smith now is a manufacturer of electric motors only, and it appears that the Clark Controls division is now operated under the Joslyn-Clark umbrella. Given nearly identical model numbers, it appears that Duke Energy (2006) used a motor starter that was as close to that tested by NEI as would be possible today.

The data for the Duke Energy (2006) tests is proprietary; however, SNL reviewed the test data based on an NRC internal (non-public) report prepared by NRC staff observer. The Duke Energy (2006) tests were quite similar to the CAROLFIRE tests in that there were few signs of significant voltage degradation prior to either spurious actuations or a fuse blow. In a small number of tests, there was

---

<sup>18</sup> The voltage transducers showed a somewhat complex behavior with a very low power demand at about 38 volts, and higher demand at lower and higher voltages. However, even at 60V, the power demand remained below 0.1VA.

evidence that the source voltage degraded to some degree (dropping by on the order of 30 V or less) following lock in of a spurious actuation. However, NRC staff observers reported that there was little sign of relay chatter of the type observed in the NEI/EPRI tests. There were cases where relays would drop out and then re-lock, as there were in CAROLFIRE, but no cases where the relays would chatter substantially but then fail to lock as had been seen in the NEI/EPRI tests.

Overall, the test data showed that the effects of CPTs on circuit response to fire-induced cable failure remains an area of relatively poor understanding. The NEI tests experienced a clear impact given the presence of a CPT in their test circuits as confirmed by the EPRI expert panel. However, neither the more recent Duke Energy (2006) tests nor the CAROLFIRE tests have confirmed the observed behavior. For CAROLFIRE, this was attributed to the relatively large size of the CPTs in light of the power demands of the motor contactors used in the SCDUs. Even so, the Duke Energy (2006) tests do not appear to have seen the same types of effects despite the use of what appears to be a nearly identical circuit set-up and devices as were used by NEI/EPRI.

#### **8.4.4 Experimental Findings**

Bin 2 Item D has proven to be a far more complex issue than had been anticipated. Neither the CAROLFIRE tests nor the Duke Energy (2006) tests were able to confirm the results of the original NEI/EPRI tests with regard to degraded voltage and an impact on spurious actuation likelihood. This was certainly not expected. Nonetheless, no reason to question the original NEI/EPRI results were identified either. Clearly, this particular item deserves some follow-up attention.

Given the available data relevant to Bin 2 Item D, the CAROLFIRE project has reached the following conclusions:

*The currently available data provide no basis for establishing an a-priori limit to the number of spurious operations that might occur during a given fire even given that the circuit is powered by a “properly sized” CPT. We further find that, as with non-CPT cases, the timing of spurious actuations is dependent on the timing of cable electrical failure which is in turn a strong function of various case-specific factors including the relative location of different cables relative to the fire source, the routing configuration (e.g., open cable trays or air drops versus conduits), the thermal robustness of the cables insulation material, and the characteristics of the fire source.*

### **8.5 Bin 2 Item E**

#### **8.5.1 Statement and Summary of the Item**

Item E. *Fire-induced hot shorts that must last more than 20 minutes to impair the ability of the plant to achieve hot shutdown, since recent testing strongly suggests that fire-induced hot shorts will likely self-mitigate (e.g., short to ground) in less than 20 minutes. This is of particular importance for devices such as air-operated valves (AOVs) or power-operated relief valves (PORVs) which return to their de-energize position upon abatement of the fire-induced hot short.*



In the NEI/EPRI tests, the longest duration spurious actuation signal that was observed lasted 11.3 minutes and the average duration observed was 2.3 minutes. Based mainly on this result, the recommendations made at the NRC public workshop [6] were that current inspections should focus on hot-shorts and spurious actuation signals that persist for no more than 20 minutes (roughly speaking, twice the worst case duration observed in the NEI/EPRI tests). The complement, consideration of longer duration spurious actuation signals, was assigned as Bin 2 Item E.

### **8.5.2 Resolution Approach**

One particular factor that led to the conclusion that the NEI/EPRI tests could not be taken as conclusive with respect to hot-short, spurious actuation durations was the fact that most of the failures observed in those tests occurred under rather ‘aggressive’ exposure conditions. In most cases the cables that failed were located directly above the fire source, and in fact, often in the flame zone. While attempts were made by NEI/EPRI to explore other exposure conditions, the cables generally did not fail during these tests. This was due in large part to the nature of the test enclosure being used; namely, a small room constructed from welded steel plates with no insulation on either the inside or outside surfaces. As a result, heat losses from the enclosure surfaces were substantially higher than would be experienced in a more typical room. A second factor was that the room had only a single doorway size opening through which all air flow into and out of the test enclosure had to pass. It is suspected that attempts to increase fire intensity in some tests failed in part because the fire became oxygen starved.

One goal of CAROLFIRE was to induce failure in cables that were not directly above the fire, but rather were subject to damaging hot gas layer conditions. To do this, CAROLFIRE made two critical changes to the test enclosure. First, non-metallic materials, gypsum wall board and/or fire-resistant wallboard (a concrete based panel material), were used to enclose the upper surfaces of the test structure. Second, the test structure was left open around the entire perimeter to a height of 2.8 m (6 ft). These changes substantially reduced heat losses from the hot gas layer while at the same time allowing for a more natural development of the cable fires without inducing an oxygen limited condition. (See Section 3 for a complete description of the intermediate-scale test structure.)

Given the CAROLFIRE test structure, many of the tests were designed to, and did in fact, cause failure of cables in hot gas layer exposure conditions. All of the tests, regardless of location, in which spurious actuations were observed on the SCDUs provide data regarding duration. Finally, the IRMS also provides data on how long both intra- and inter-cable conductor-to-conductor short circuits persist before a short to external ground is observed. Together, these data provide a more varied basis for estimating the potential duration of a hot-short or spurious actuation signal including for less ‘aggressive’ exposure conditions.

### **8.5.3 Specific Data Relevant to Bin 2 Item E**

The results for the NEI/EPRI and CAROLFIRE test programs with respect to hot-short and spurious actuation duration were reasonably consistent. Both programs showed a predominance of shorter duration intra-cable faults cascading to ground faults within no more than 6-12 minutes. The longest

duration spurious actuation signal observed in the original NEI/EPRI tests was 678s (11.3 minutes). A second spurious actuation signal persisted for 618s (10.3 minutes).

Section 7 summarizes the SCDU test results for all of the CAROLFIRE tests including the duration of the spurious actuations observed. In all, CAROLFIRE observed 44 cable failures with the potential for intra-cable spurious actuation. Of these, 31 resulted in a spurious actuation of one or both motor contactors in that circuit. These spurious actuation signals persisted for a maximum of 457s (7.6) minutes. In general, it appeared that the more fully loaded raceways used by NEI/EPRI led to somewhat longer spurious actuation durations than did the lighter loadings used in CAROLFIRE.

Finally, the IRMS system showed very similar behaviors to those displayed by the SCDUs. Generally, once the cables degraded to the point where conductor-to-conductor insulation resistance values drop below about  $1000\Omega$ , the faults progressed to full ground shorts within a few minutes. In no case was a fault persisting for more than a few minutes observed. Note that with the IRMS, the only ground present is the external ground, and generally, there was no ground path available within the cable. Hence, the IRMS results are a bit more conservative in this regard than the SCDU results where a grounded conductor (or a CPT return path conductor for the un-grounded circuits) was also present within each cable.

#### **8.5.4 Experimental Findings**

The CAROLFIRE experiments resulted in no cases where the spurious actuation duration exceeded the maximum duration observed in the original NEI/EPRI tests. In general, the spurious actuation duration results were rather consistent between the two programs and showed that the spurious actuation signals were of relatively short duration. Given these data, it appears that consideration of hot-short spurious actuation signals lasting up to 20 minutes provides a margin of safety over direct application of the experimental results.

Given the available data relevant to Bin 2 Item E, the CAROLFIRE project has reached the following conclusions:

*While the available data cannot definitively support the conclusion that no hot short would ever persist for greater than 20 minutes, the available data do provide a strong basis for concluding that hot shorts lasting greater than 20 minutes are of at most very low probability. Hence we conclude that with high probability, hot short-induced spurious actuation signals will clear within less than 20 minutes. We further conclude that on clearing of the hot short signal, the effects of the spurious actuation on plant equipment could persist for a longer time depending on the nature of the impacted equipment. For example, a normally closed Motor Operated Valve might well remain open or partially open even after the hot short-induced spurious actuation signal is mitigated whereas a Solenoid Operated Valve would return to its 'fail safe' condition on mitigation of the hot short-initiated spurious operation signal.*

## 9 SUMMARY OF FINDINGS

### 9.1 Findings with Respect to the Bin 2 Items

This section summarizes the specific findings based on the test data with respect to each of the five Bin 2 items addressed by CAROLFIRE. Details relative to the data analysis and reasoning with respect to each item have been provided in Section 8.

#### 9.1.1 Bin 2 Item A

The following is Bin 2 Item A as quoted directly from the RIS:

*“Intercable shorting for thermoset cables, since the failure mode is considered to be substantially less likely than intracable shorting.”*

Based on the available data with respect to Bin 2 Item A the CAROLFIRE project has reached the following conclusions:

*Inter-cable shorting between two TS-insulated cables that could cause hot shorts and the spurious actuation of plant equipment was found to be a plausible failure mode, although the likelihood of this failure mode is low in comparison to intra-cable short circuits leading to spurious operation. While no detailed statistical analysis has been performed, it appears that the conditional probability (give cable failure) of spurious actuations arising from this specific failure mode is small in comparison to that previously estimated for spurious actuations from intra-cable shorting.*

#### 9.1.2 Bin 2 Item B

The following is Bin 2 Item B as quoted directly from the RIS:

*“Intercable shorting between thermoplastic and thermoset cables, since this failure mode is considered less likely than intracable shorting of either cable type or intercable shorting of thermoplastic cables.”*

Based on the available data with respect to Bin 2 Item B the CAROLFIRE project has reached the following conclusions:

*Inter-cable shorting between two a TP-insulated cable and a TS-insulated cable that could cause hot shorts and the spurious actuation of plant equipment was found to be a plausible failure mode, although the likelihood of this failure mode is low in comparison to intra-cable short circuits leading to spurious operation. While no detailed statistical analysis has been performed, it appears that the conditional probability (give cable failure) of spurious actuations arising from this specific failure mode is very small in comparison to that previously estimated for spurious actuations from intra-cable shorting.*

### 9.1.3 Bin 2 Item C

The following is Bin 2 Item C as quoted directly from the RIS:

*“Configurations requiring failures of three or more cables, since the failure time and duration of three or more cables require more research to determine the number of failures that should be assumed to be “likely.””*

Given the available data relevant to Bin 2 Item C, the CAROLFIRE project has reached the following conclusions:

*The currently available data provide no basis for establishing an a-priori limit to the number of spurious operations that might occur during a given fire. We further find that the timing of spurious actuation is a strong function of various case-specific factors including in particular the relative location of various cables relative to the fire source, the routing configuration (e.g., open cable trays or air drops versus conduits), the thermal robustness of the cables insulation material, and the characteristics of the fire source.*

### 9.1.4 Bin 2 Item D

The following is Bin 2 Item D as quoted directly from the RIS:

*“Multiple spurious actuations in control circuits with properly sized control power transformers (CPTs) on the source conductors, since CPTs in a circuit can substantially reduce the likelihood of spurious actuation. Specifically, where multiple (i.e., two or more) concurrent spurious actuations due to control cable damage are postulated, and it can be verified that the power to each impacted control circuit is supplied via a CPT with a power capacity of no more than 150 percent of the power required to supply the control circuit in its normal mode of operation (e.g., required to power one actuating device and any circuit monitoring or indication features).”*

Given the available data relevant to Bin 2 Item D, the CAROLFIRE project has reached the following conclusions:

*The currently available data provide no basis for establishing an a-priori limit to the number of spurious operations that might occur during a given fire even given that the circuit is powered by a “properly sized” CPT. We further find that, as with non-CPT cases, the timing of spurious actuations is dependent on the timing of cable electrical failure which is in turn a strong function of various case-specific factors including the relative location of different cables relative to the fire source, the routing configuration (e.g., open cable trays or air drops versus conduits), the thermal robustness of the cables insulation material, and the characteristics of the fire source.*

### 9.1.5 Bin 2 Item E

The following is Bin 2 Item E as quoted directly from the RIS:

*“Fire-induced hot shorts that must last more than 20 minutes to impair the ability of the plant to achieve hot shutdown, since recent testing strongly suggests that fire-induced hot shorts will likely self-mitigate (e.g., short to ground) in less than 20 minutes. This is of particular importance for devices such as air-operated valves (AOVs) or power-operated relief valves (PORVs) which return to their de-energize position upon abatement of the fire-induced hot short.”*

Given the available data relevant to Bin 2 Item E, the CAROLFIRE project has reached the following conclusions:

*While the available data cannot definitively support the conclusion that no hot short would ever persist for greater than 20 minutes, the available data do provide a strong basis for concluding that hot shorts lasting greater than 20 minutes are of at most very low probability. Hence we conclude that with high probability, hot short-induced spurious actuation signals will clear within less than 20 minutes. We further conclude that on clearing of the hot short signal, the effects of the spurious actuation on plant equipment could persist for a longer time depending on the nature of the impacted equipment. For example, a normally closed Motor Operated Valve might well remain open or partially open even after the hot short-induced spurious actuation signal is mitigated whereas a Solenoid Operated Valve would return to its ‘fail safe’ condition on mitigation of the hot short-initiated spurious operation signal.*

## 9.2 Other Observations and Conclusions

Volume 2 of this report reports on the various insights gained relative to the fire model improvement need area. The purpose of this section in this volume is not to repeat these insights, but rather, to offer additional observations and conclusions arising from the CAROLFIRE tests that are related to the circuit analysis issues more generally, but are not explicitly tied to resolution of any one of the Bin 2 items.

### 9.2.1 Relay Specifications

This project had specifically sought motor contactor relays with specific coil power demand requirements in order to properly match the motor contactors to the CPTs used. In particular, the relays procured were advertised as requiring 80-100VA for normal operation. During post-test data analysis the pick-up current for the relays used in testing was measured in an attempt to explain certain aspects of the test data. It was found that in reality, the relays had pick-up power loads closer to 60 VA than to 100VA. This required the re-evaluation of the CPT results using the actual rather than the advertised power demand. As a result, in hindsight, the CPTs tested during CAROLFIRE were effectively sized at 166% or more of the required nominal circuit load requirements.

The lesson to be taken from this experience is that care must be taken in assessing the relative size of a CPT in comparison to the circuit design power loads. It may not be appropriate to directly apply manufacturer specifications of the nominal relay power requirements. The primary specifications associated with devices such as motor contactors are based on the power handling ability; that is, how large of a motor the device can control. The control power requirements are a secondary consideration, and based on our experience, may be conservatively stated. It may be necessary to measure the pick-up power requirements in order to accurately characterize a relay coil when assessing the relative size of a CPT for a given application.

### 9.2.2 General Probability of Spurious Actuation

As noted above, the CAROLFIRE tests experienced a higher incidence of spurious actuations than did the NEI/EPRI tests. For those tests using the SCDUs in the MOV simulation mode, 13-of-19 failures for TP cables (68%) and 18-of-25 failures for TS cables (72%) led to spurious actuation. Both of these are higher than the corresponding probabilities from the NEI/EPRI tests, even considering only those cases from the NEI/EPRI tests where there was no CPT present (i.e., approximately a 0.6 probability of spurious actuation was recommended by the EPRI expert panel for the case with no CPT).

The one difference in the CAROLFIRE test configurations that most likely explains this difference in the results is that CAROLFIRE tested straight length of cable rather than cables with a radial bend section. In all of the NEI/EPRI tests, the cables were installed in a cable tray or conduit with a radial bend section, and the fire was generally placed directly under the bend section. The use of a radial bend is common practice in cable testing where the intent is to explore the limits of electrical performance and failure. Bending creates internal stresses on a cable that are likely to cause electrical failures more quickly than in a comparable cable with no bends. Hence, testing of cables in a bent configuration (e.g., mandrel bend tests) is generally thought of as conservative in the electrical failure context.

However, in the case of the spurious actuations this same general thinking may not apply. That is, a radial bend *is* expected to maximize the likelihood that a cable will fail, but it might also make it more likely that failure will lead to a fuse blow rather than a spurious actuation. For example, if the failure occurs fairly abruptly, the bent section might drive all conductors together more quickly leading to more fuse blow failures and fewer spurious actuation failures. With a straight section, the cable failures would be driven primarily by the internal cable geometry and any residual internal stresses normal within a multi-conductor cable (e.g., due to the fact that the conductors are spiral-wound around a common center along the length of the cable as a part of manufacturing). This could lead to more failures that involve a subset of the cables present and therefore more failures that involve hot shorts and spurious actuation.

It was based in large part on this line of thought that CAROLFIRE chose to test straight sections of cable tray and conduit as a complement to the prior testing of raceways with radial bends. In actual practice plants have a combination of both straight sections and various bend sections, so both configurations are relevant. It would appear that the test results do confirm that straight sections of

raceways may have a greater propensity towards spurious actuations given cable failure than do raceways with bend sections.

### **9.2.3 Grounded Versus Un-grounded Power Supply**

One effect that was noted in the recent Duke Energy (2006) tests was that grounding of the power supply (the CPT) had a pronounced effect and substantially reduced the likelihood of spurious actuation for the tested armored cables. As a result, the CAROLFIRE test plan was revised to include a matched pair of SCUDU circuits, one grounded (Circuit 2) and one un-grounded (Circuit 1).

A review of the CAROLFIRE test data has revealed no significant differences between these two circuits. It appears clear that the effects of power supply grounding will be limited to the armored cable configurations. It appears likely that the presence of the armor itself, which is grounded in typical applications, makes it more likely that a short to ground and fuse blow failure will occur for the grounded power supply cases. In the absence of the armor, the ground plane is available only through either a grounded conductor or the raceway itself.

It would appear that the armor simply makes a much more readily accessible ground plane thereby increasing the likelihood that the energized conductors will short to ground rather than to the potential target conductors. For an un-grounded circuit, a single short to ground will not trip the circuit protection (fuse) and therefore the likelihood of spurious actuation is somewhat higher. Again, it appears that these same effects are not applicable to the non-armored cables.

## 10 REFERENCES

1. NRC: *Risk-informed Approach for Post-Fire Safe-Shutdown Circuit Inspections*, Regulatory Issue Summary (RIS) 2004-03, Rev. 1, U.S. NRC, Washington, DC, Dec. 29, 2004.
2. EPRI: *Characterization of Fire-Induced Circuit Faults – Results of Cable Fire Testing*, TR 1003326, EPRI, Palo Alto, CA, Dec. 2002.
3. NRC: Nowlen, S.P., *An Investigation of the Effects of Thermal Aging on the Fire Damageability of Electric Cables*, NUREG/CR-5546, U.S. NRC, Washington, DC, 1991.
4. ASTM: *Standard Guide for Room Fire Experiments*, Standard E 603-06, ASTM, 100 Barr Harbor Drive, PO Box C700, West Conshohocken, PA 19428-2959, 2006.
5. ISO: *Fire Tests – Full-Scale Room Test for Surface Products*, Standard 9705:1993(E), ISO, Geneva, Switzerland, 1993 (see ‘Annex A’ for cited material).
6. NRC: “Official Transcript of Proceedings of Risk-Informing Post-Fire Shutdown Circuit Analysis Inspection Workshop”, U.S. NRC, held in Rockville, Md., February 19, 2003 (ADAMS Accession Number ML030620006).
7. LaChance, J.L., et.al., *Circuit Analysis – Failure Modes and Likelihood Analysis*, NUREG/CR-6834, SAND2002-1942P, U.S. NRC (2003).
8. NRC: Wyant, F.J., Nowlen, S.P., *Cable Insulation Resistance Measurements Made During Cable Fire Tests*, SNAD2002-0447P, NUREG/CR-6776, U.S. NRC, Washington, DC, June 2002.
9. EPRI: *Spurious Actuation of Electrical Circuits Due to Cable Fires, Results of an Expert Elicitation*, TR 1006961, EPRI, Palo Alto, CA, 2002.



**APPENDIX A: LISTING OF THE BIN 2 ITEMS IDENTIFIED IN  
RIS 2004-03 REV. 1, ATTACHMENT PAGE 3, 12/29/2004**

*(ADAMS ML042440791)*

The following is quoted directly from RIS 2004-03, Revision 1:

“The following items are deferred pending additional research:

- A. Intercable shorting for thermoset cables, since the failure mode is considered to be substantially less likely than intracable shorting.
- B. Intercable shorting between thermoplastic and thermoset cables, since this failure mode is considered less likely than intracable shorting of either cable type or intercable shorting of thermoplastic cables.
- C. Configurations requiring failures of three or more cables, since the failure time and duration of three or more cables require more research to determine the number of failures that should be assumed to be “likely.”
- D. Multiple spurious actuations in control circuits with properly sized control power transformers (CPTs) on the source conductors, since CPTs in a circuit can substantially reduce the likelihood of spurious actuation. Specifically, where multiple (i.e., two or more) concurrent spurious actuations due to control cable damage are postulated, and it can be verified that the power to each impacted control circuit is supplied via a CPT with a power capacity of no more than 150 percent of the power required to supply the control circuit in its normal mode of operation (e.g., required to power one actuating device and any circuit monitoring or indication features).
- E. Fire-induced hot shorts that must last more than 20 minutes to impair the ability of the plant to achieve hot shutdown, since recent testing strongly suggests that fire-induced hot shorts will likely self-mitigate (e.g., short to ground) in less than 20 minutes. This is of particular importance for devices such as air-operated valves (AOVs) or power-operated relief valves (PORVs) which return to their de-energize position upon abatement of the fire-induced hot short.
- F. Consideration of cold shutdown circuits, since hot shutdown can be maintained and the loss of cold shutdown circuits is not generally a significant contributor to risk.”

## **APPENDIX B: THE SANDIA INSULATION RESISTANCE MEASURING SYSTEM**

### **Introduction**

The Sandia National Laboratories (SNL) Insulation Resistance Measurement System (IRMS) enables the real-time monitoring of insulation resistance in a cable or cable bundle by sequentially energizing conductor pairs and observing the voltage states. Through easily developed mathematical relations, one can then calculate the corresponding resistances. The resulting time series of resistances thereby allow identification of adverse developments in the cable bundle at certain instances in time.

### **Theory of Operation**

The concept is based on the assumption that if one were to impress a unique signature voltage on each conductor in a cable (or cable bundle) then by systematically allowing for and monitoring known current leakage paths it should be possible to determine if leakage from one conductor to another, or to ground, is in fact occurring. That is, part of or the entire voltage signature may be detected on any of the other conductors in the cable (or in an adjacent cable) or may leak to ground directly.

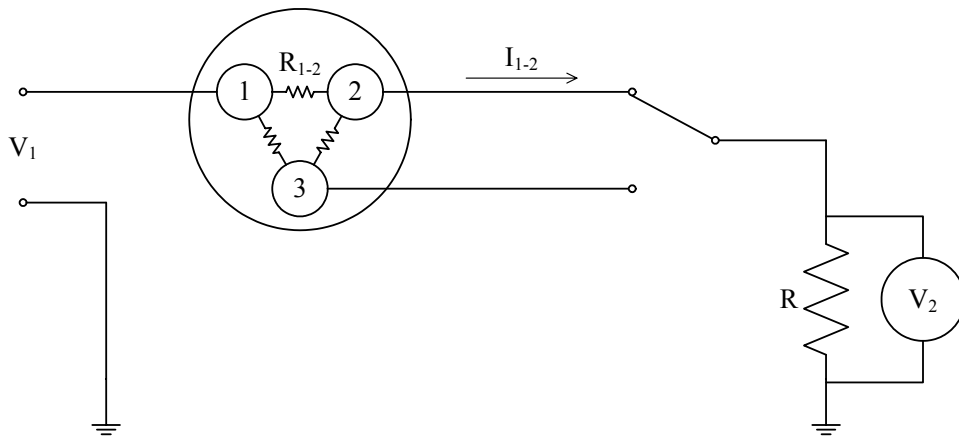
To illustrate, consider a three-conductor (3/C) cable as shown in Figure B.1 (for now we will neglect leakage directly to ground). If a known voltage is applied to conductor 1, then the degree of isolation of conductors 2 and 3 from conductor 1 can be determined by systematically opening a potential conductor-to-conductor current leakage path and then logging the voltages of each conductor in turn while conductor 1 is energized. Determining the insulation resistance between conductors 1 and 2 ( $R_{1-2}$ ) at the time of voltage measurement on conductor 2 ( $V_2$ ) is a simple calculation employing Ohm's law:

$$I_{1-2} = V_2 / R$$

and

$$R_{1-2} = (V_1 / I_{1-2}) - R$$

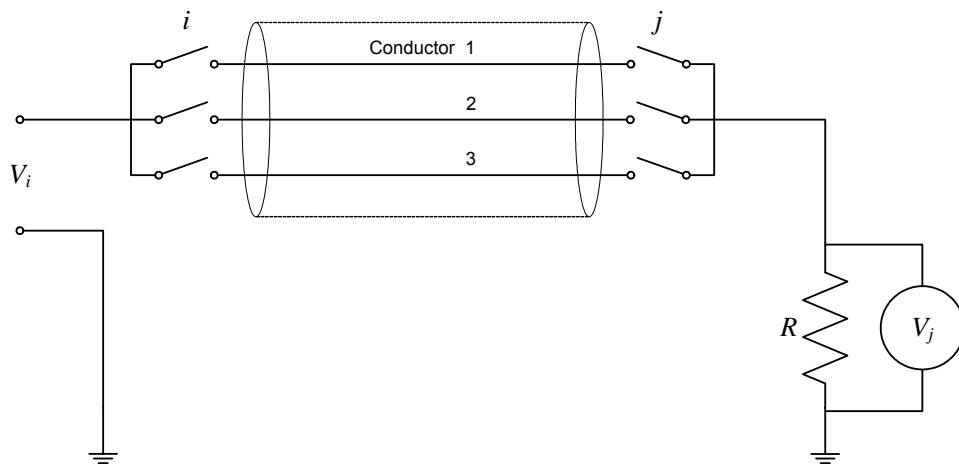
where  $I_{1-2}$  is the measured current flow between the conductors and  $R$  is the known value of the ballast resistors built into the system. In the same way, the insulation resistance existing between conductors 1 and 3 at the time  $V_3$  is measured can be determined. Continuously switching between the two conductors and recording the voltage drop across the ballast resistor  $R$  at each switch position yields a time-dependent history of  $R_{1-2}$  and  $R_{1-3}$ . (Of course an alternate method would be to connect a resistor/voltmeter assembly to both conductors 2 and 3 simultaneously and keep a continuous record of the two voltages. This approach quickly becomes unwieldy as the number of conductors increases.)



**Figure B.1 Simple insulation resistance measuring circuit.**

The above method alone does not describe the isolation existing between conductors 2 and 3 (because conductor 1 is always the energized conductor). However, by sequentially energizing each conductor and reading the impressed voltages on the remaining conductors one can determine the relative resistance existing between any conductor pair (see Figure B.2).

This concept evolved to include the two sets of controlled switches, one set on the input side (i) and one on the output side (j) of the circuit. One switch on the voltage input side is closed (thereby energizing one conductor) followed by the sequential closing-measurement-opening of each measurement side switch. Each sequential switching configuration measures leakage currents between one energized "source" conductor and one non-energized "target" conductor, and the various pairs are systematically evaluated in sequence.



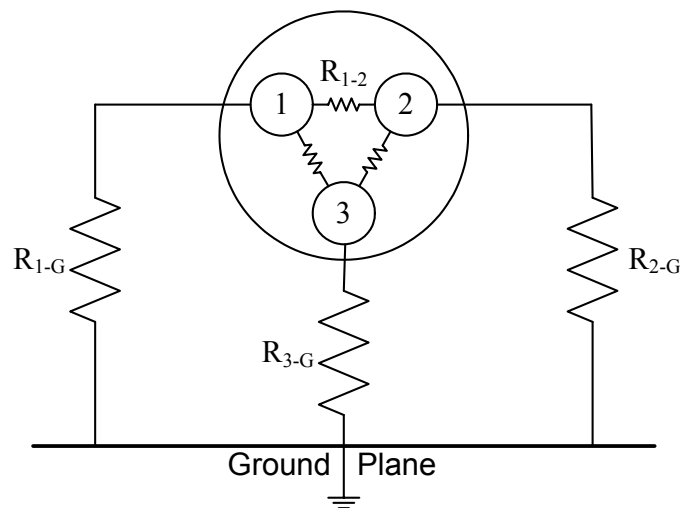
**Figure B.2 Circuit for measuring insulation resistance between any conductor pair in a cable.**

The insulation resistance between pairs of conductors can be determined in the same way as discussed above. Note that when the input and measurement side switches are connected to the same

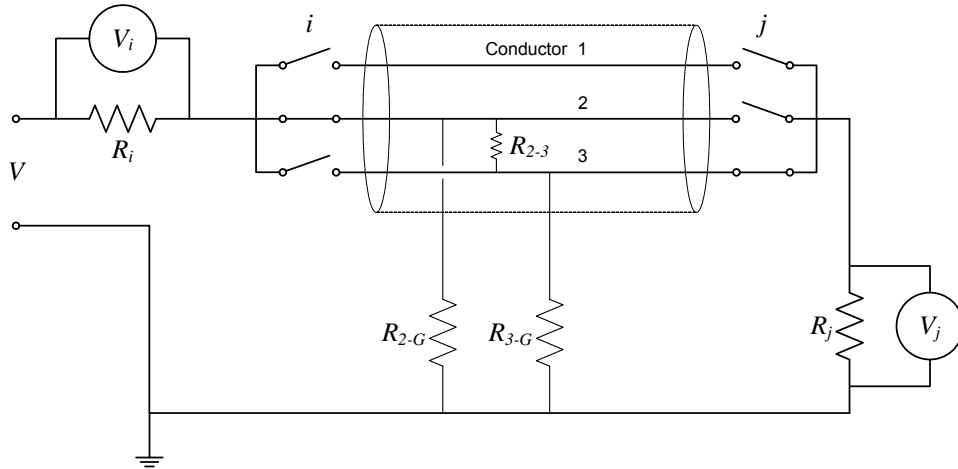
conductor ( $i = j$ ), the full input voltage will be measured across  $R$ . Since this provides no useful information about the isolation existing between any of the conductor pairs, these measurements can be ignored for the purpose of determining IR. (The presence of the full voltage,  $V_j = V_i$ , does however indicate conductor continuity and otherwise could be useful in identifying an open circuit condition.)

This approach is fine as long as the cable can be kept electrically isolated from ground. If that is not possible (or not desirable, e.g., because short to ground failures are of interest) then changes to the design (simple ones) and resistance calculations (significant) are required.

Figure B.3 shows how the number of possible leakage paths for each of the three conductors in the previous example changes when a ground path is considered. By adding a path to ground for each conductor, the complexity of determining the insulation resistance between pairs of conductors has grown from one resistance determination to now having to determine three resistances for each pair of conductors. A circuit change is required to enhance the number of independent measurements so as to retain a solvable problem. The revised circuit is shown in Figure B.4, and includes a ballast/load resistor on the input side in addition to the output side ballast/load resistor.

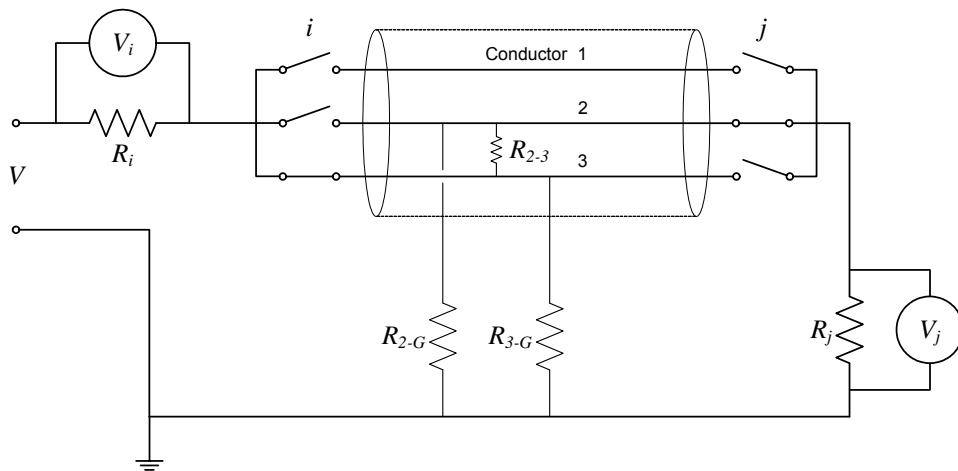


**Figure B.3 Resistive leakage paths for each conductor with a ground present.**



**Figure B.4 Insulation resistance measuring circuit with ground paths.**

The calculation of the three resistances for each conductor pair (one conductor-to-conductor path and each of the two conductor-to-ground paths) requires the measured voltages ( $V_i$  and  $V_j$ ) for two complementary switching configurations. For example, the complement for the case illustrated in Figure B.4 is shown in Figure B.5. As illustrated in Figure B.4, conductor 2 is connected to the input side and conductor 3 is connected to the measurement side. The complementary case shows conductor 3 on the input side and conductor 2 on the measurement side (shown in Figure B.5). This complementary pair provides four separate voltage readings that can be used to determine the three resistance paths affecting these two conductors; namely,  $R_{2-3}$ ,  $R_{2-G}$ , and  $R_{3-G}$ .



**Figure B.5: Complementary IR measuring circuit with respect to the circuit shown in Figure B.4.**

The equations for determining the three resistances for this case are as follows:

$$R_{2-G} = [V_{j2}V_{j3} - (V - V_{i2})(V - V_{i3})] / [(V_{i3} / R_i - V_{j2} / R_j)V_{j3} - (V_{i2} / R_i - V_{j3} / R_j)(V - V_{i3})]$$

$$R_{3-G} = V_{j3} / [(V_{i2} / R_i - V_{j3} / R_j) - (V - V_{i2}) / R_{2-G}]$$

$$R_{2-3} = [(V - V_{i2}) - V_{i3}] / [(V_{j3} / R_{3-G}) + (V_{j3} / R_j)]$$

This concept is scalable for virtually any number of conductors in a cable or bundle of cables. Another advantage is that only the two voltage measurements for each switching configuration need to be recorded in real time; determination of the resistances can be deferred until after the test has been completed. This is the basic concept utilized in the design and application of the IR Measurement System.

### **Design Features**

As configured for CAROLFIRE, each IRMS can monitor the insulation resistance of up to fourteen separate conductors. The limit of fourteen conductors was based on the capacity of the internal memory of the programmable logic control (PLC) units. In practice the system was typically run with fewer active channels. This is because the total cycle time increases exponentially as the number of monitored conductors increases. The goal was to keep cycle times as short a practical.

Figure B.6 provides a photograph of the IRMS unit identifying the principal functional areas of the IRMS. A schematic diagram of the complete system is provided in Figure B.7.

### **Operation**

Operation of the SNL IR Measurement System is a relatively simple matter of connecting the two wiring harnesses to each end of the test cable bundle, turning on power to the main control cabinet, starting up the control software on the computer, and starting the IR measurement program by pushing the "Run" button.

Connection of the wiring harnesses to the test cable during the CAROLFIRE tests was accomplished using commercially available wire nuts. It is important that each end of a specific conductor in the test cable be connected to the corresponding conductors in both wiring harnesses. For example, the conductors marked "1" in each wiring harness needed to be connected to the ends of the same conductor in the test cable. This also applied to the conductors marked "2" through "N" in the harnesses, where N is the total number of conductors being monitored during a give test. Proper connections are checked by performing a continuity check of the pairs of harness conductors at the patch panel ends of the wiring harnesses.

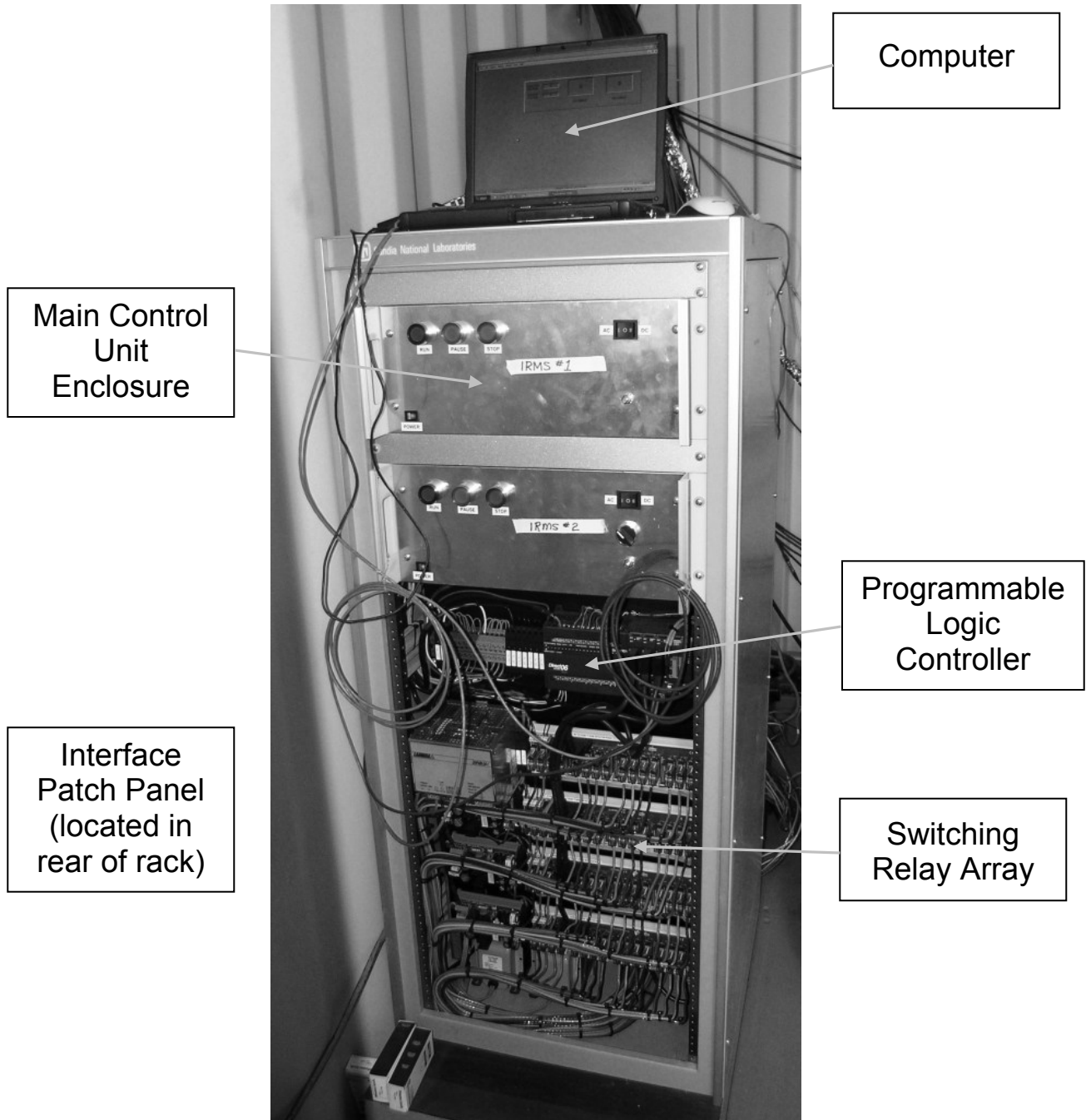
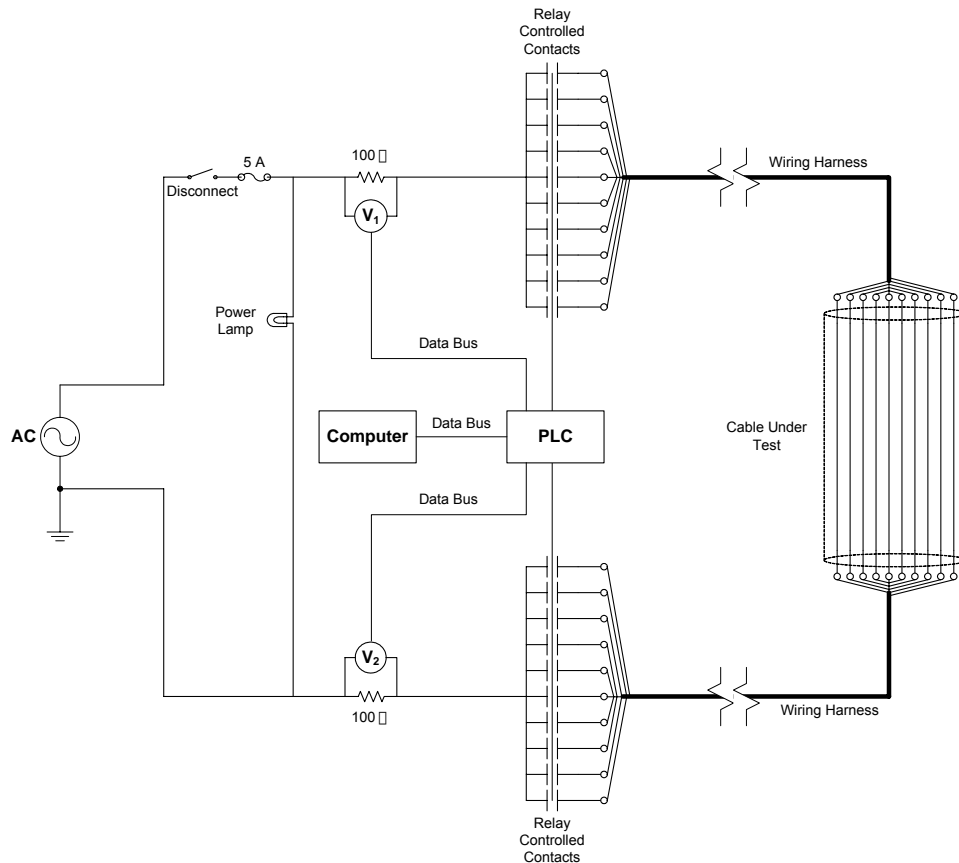


Figure B.6 Photograph of the IRMS with principal functional areas highlighted.



**Figure B.7 Schematic diagram of the IR Measurement System.**

### Data Recording, Analysis and Uncertainty

Raw data is written initially to a simple text file in a specific format and order. The raw data files are preserved for archival purpose. For purposes of analysis, data from the raw files are imported into an Excel™ spreadsheet and the necessary IR calculations are performed to determine the IRs as part of the post-test data analysis. The resulting IR data can then be used to determine the nature (e.g., conductor-to-conductor versus conductor-to-ground) and order (i.e., which conductors shorted and when) of any short-circuit failures observed. The data analysis can also include the generation of IR versus time plots for each conductor in each test.

For CAROLFIRE routine data processing focused on data specifically relevant to the Bin 2 items. For example, for those tests that involved cable bundles with a mixture of TS and TP cables, the analysis focused on interactions between two TS cables or between a TS and a TP cable. Interactions between two TP cables were not pursued in the routine data analysis because TP-to-TP interactions are a Bin 1 item, not a Bin 2 item. The raw data files would contain data on such interactions that could be extracted if desired.



Some notes regarding IRMS sensitivity and uncertainty are also in order. The IRMS as configured for CAROLFIRE was intended to focus on lower IR values at the cost of sensitivity to high IR values. The maximum IR that will be recorded by the IRMS as configured for CAROLFIRE is approximately  $3 \times 10^5 \Omega$  regardless of the actual IR value. In reality, cable IR values for an undamaged cable are typically much higher than this. This should be noted when reviewing the test results as discussed in the body of this report.

In terms of general system accuracy, a comprehensive assessment of the overall uncertainty associated with the new IR system has not been undertaken. The sources of uncertainty would primarily be associated with the voltage monitoring equipment that measures the voltage drop across the two ballast resistors in the system. A general assessment of system accuracy was made as a part of the system “proof of operation” testing. This involved the use of known-value resistors inserted across specific conductor/circuit paths with the IRMS then measuring the resulting ‘IR’ value. The focus of CAROLFIRE testing was on lower IR values (those associated with cable failure); hence, resistors ranging from 10 to 5000  $\Omega$  were used in this assessment. In all cases the IRMS reproduced the known resistance values to within  $\pm 3\%$ .

A second point to note is the fact that IR estimates are based on the manipulation of corresponding data pairs and this introduces an additional source of measurement uncertainty that is particularly relevant to periods of rapid change in the cable IR. That is, for any given pair of conductors (say C1 and C2), the IR for C1-to-ground, C2-to-ground, and C1-to-C2 are estimated based on the analysis of two measured data points – a complimentary pair of data points. The first of this complementary pair monitors current leakage given that C1 is energized and C2 is connected to the system return path. The second of the complimentary pair monitors leakage currents given that C2 is energized and C1 is connected to the system return path. These two data points must be taken at separate points in time because the two conductors must be separately and individually energized to obtain the needed leakage current data. This time separation is the source of the potential added uncertainty.

In practice, the system control software collects the complimentary pair data points in immediate sequence for all conductor pairings. None the less, the two data points will still be separated in time, typically by 3-10 seconds depending on the system cycle time. This separation leads to an added level of measurement uncertainty that is most pronounced in cases where the IR is changing quickly (e.g., as a cable is cascading to failure). The magnitude of the error cannot be estimated generically because it depends entirely on how large of an IR change occurs between the time that the first data point is taken and when the second data point is taken.

Overall, this source of uncertainty is not seen as significant in the context of CAROLFIRE because the focus here is placed on the gross failure behavior and mode of failure. These behaviors would not be masked by the added uncertainty associated with the separation of the complimentary data point pairs in time. However, the exact IR values during times of rapid IR transition do contain an inherently higher level of uncertainty than do those values measured during times of relative IR stability.

## APPENDIX C: SURROGATE CIRCUIT DIAGNOSTIC UNITS

### Introduction

One aspect of CAROLFIRE was the use of surrogate circuit simulation similar to those used by NEI/EPRI in their 2001 tests and more recently by Duke Energy. The CAROLFIRE units are referred to here as the Surrogate Circuit Diagnostic Units or SCDUs and were designed to provide more flexibility than the fixed configuration setups used in previous tests. The SCDUs provide the opportunity to assess how various circuits will respond to cable fire-induced failures. The SCDUs can be configured to simulate a range of circuits, although in practice, most of the CAROLFIRE tests used a standard AC powered MOV control circuit as used in both the NEI/EPRI and Duke Energy (2006) test programs. Some tests varied the number of energized source conductors and/or the number of grounded conductors present in the tested cable. In a small number of tests, the units were configured specifically with inter-cable shorting in mind. Both configurations are described below.

### General Design of the SCDUs

The design approach for the SCDUs was to build in flexibility. Each SCDU can be configured to simulate a range of control circuits including motor operated valve (MOV), solenoid operated valve (SOV) and instrument loop circuits. A number of circuit conditions can be implemented to assess the effects of control power transformers (CPTs), voltage/current form (AC or DC) and circuit grounding (grounded and ungrounded). The SCDUs also allow for variation in the number of energized hot-short source conductors<sup>19</sup>, grounded or return conductors, the number of hot-short target conductors,<sup>20</sup> and the type of targets. The concept was to design a flexible base unit and to then configure circuits for testing by the choice of components and devices connected to the basic unit, and the manner in which connections were made. In all, four of the SCDU units (referred to as Circuits 1-4) were built and used in testing.

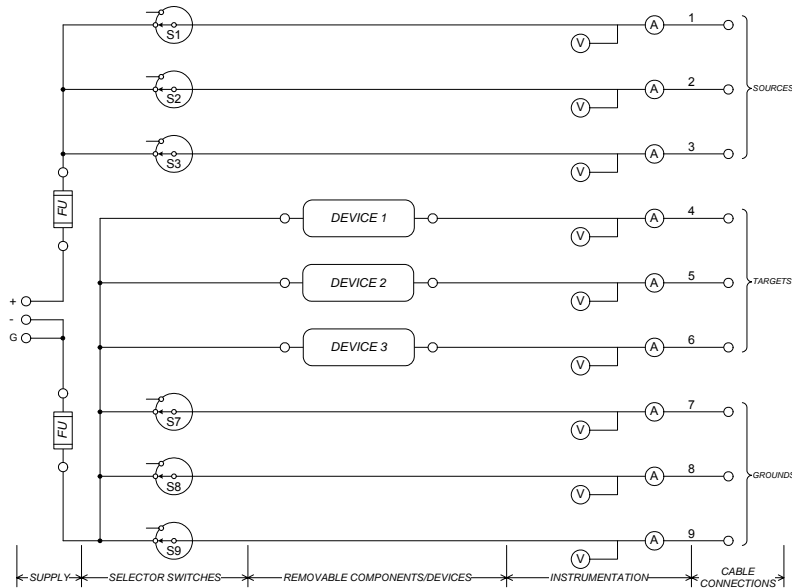
Figure C-1 illustrates the basic SCDU design. A list of the primary components used in each SCDU is provided at the end of this Appendix. Each SCDU has a total of nine circuit paths available. In practice, CAROLFIRE made use of no more than seven of these nine paths because most of the tests involved 7-conductor cables.

---

<sup>19</sup> The term ‘hot-short energized source conductor’ (or more simply ‘energized source’) refers to a conductor that is normally energized with voltage and current potentials so that it may act as the energizing source in a hot-short or spurious actuation failure.

<sup>20</sup> A ‘hot-short target conductor (or more simply ‘target conductor’) is a conductor that is not normally energized that may become energized as a result of a hot-short to an energized source conductor. The nature of the target (i.e., what the target conductor is connected to) will determine the impact on circuit function. Impacts may include no effect (e.g., hot-short to a spare conductor), false indication (e.g., hot-short to a passive target), or spurious actuation (e.g., hot-short to an active target).

All four SCDUs were initially configured with control circuit power supplied through a CPT. The CPTs provide 120V secondary side power and can be configured to accept either a 230 or 460 VAC primary side input. For CAROLFIRE, the CPTs were configured for a 230 V input power. The 230 V input power was in turn supplied by a 115-to-230 V step-up transformer whose primary was connected to line power. (As noted elsewhere, for the final three tests, SCDU Circuit 4 was reconfigured with input power direct from local line power, bypassing the CPT and step-up transformers entirely.)



**Figure C.8: Generic design of the SCDUs.**

The figure shows the SCDUs with a generic indication of the input power source (to the left). The SCDUs were operated in most cases using a Control Power Transformer to provide this input power.

Each SCDU had a slightly different CPT configuration. Two SCDUs (Circuits 1 and 2) used 150 VA CPTs. Of these two, the secondary side of one unit's CPT was grounded (Circuit 2) while the other was not grounded (Circuit 1). One SCDU used a 200 VA CPT in a grounded configuration (Circuit 3). The fourth SCDU used a 100 VA CPT in a grounded configuration (Circuit 4).

All CPTs were equipped with a 600 V, 3 A, fast-acting fuse on one leg of the secondary (output) side consistent with manufacturer recommendations. The CPTs were also equipped with 600 V, 2 A, time-delay fuses on the primary (input) side, again consistent with the manufacturer's recommendations. Fuses were selected based on manufacturer recommendations. Specific fuse types are provided in the hardware list at the end of this Appendix. Fuse holders were built into the CPTs to accommodate both the primary and secondary side fuses.

For the grounded circuits, the non-fused (or return) side of the CPT secondary was connected to a common ground. For the one ungrounded circuit, the CPT secondary was simply not connected to ground at all. (Note that all test instrumentation, the test structure, the CPTs, line power, and all raceways used in testing were grounded to the same common earth ground.)

As shown in Figure C-1, the power source is connected to the supply terminals to the left in the figure. The cables (or conductors) under test are connected to the cable connection terminal blocks to the right in the figure. Up to three conductors can be configured as energized sources based on the position of the switches on Circuit Paths 1-3 (closing a switch energizes the corresponding circuit path). Similarly, up to three conductors can be connected to ground (or to the return side of the CPT for ungrounded circuits) based on the position of the switches on Circuit Paths 7-9 (closing a switch grounds the corresponding circuit path). The number and types of targets connected to the cable depends on the nature of the devices installed. Nominally, there are up to three target paths available using Circuit Paths 4-6.

### **Data Recording and Analysis**

Each Circuit Path (1-9) is equipped with both a voltage and current flow transducer. All transducers are externally powered and impose no burden on the monitored circuit. Voltage measurements are made with reference to ground for grounded circuit configurations, and to the return side (the unfused side) of the CPT secondary for ungrounded circuits. For CAROLFIRE, Circuit Path 9 was not monitored. None of the tests performed required use of all nine circuit paths. Reducing the monitoring to eight circuit paths per SCU (for a total of 32 voltage channels and 32 current channels) also allowed us to use an existing, high-speed, 64 channel data logging system. The original design with nine circuit paths was intended to allow for the monitoring of cables with higher conductor counts (e.g., trunk cables). This option was not pursued in CAROLFIRE.

Each of the voltage and current transducers used in the SCUs generates a 4-20 mA (DC) output signal proportional to the input signal. The output terminals of each transducer were connected through a 470  $\Omega$  precision silicone resistor. This converts the 4-20 mA transducer output to a nominal 2-10 VDC signal that was monitored by the high-speed data logging system.

Data logging used a National Instruments PCI6071E Multi-function data acquisition card installed in a personal computer running the Window XP® operating system. Card control and data recording were performed using National Instruments' Labview® software (Version 7). Data for all 64 channels was recorded at a rate of 5 Hz (one scan of all 64 channels every 0.2 s). Note that this scan rate is much faster than that used in the previous tests. Data were written (as ASCII text) to a data file immediately after each scan. Raw data files were downloaded after each test and preserved for archival purposes. The data were later imported into Microsoft Excel® for analysis.

Conversion of the raw data is based on a simple linear relationship between input value and the measured output voltage. The voltage transducers had a 0-300 V range, and the current transducers had a 0-5 A range. The 4-20 mA signal is linearly proportional to the input signal over this range.

Note that the transducers were not explicitly calibrated beyond the calibration certification provided by the manufacturer. Hence, the recorded and converted data should be viewed as nominal indications of the voltage and current conditions. Further calibration was not pursued given that the circuit diagnostics are based on gross electrical responses (e.g., voltage on a conductor that is normally zero rises to the source voltage indicating a hot-short has occurred).

The nominal voltage output for each transducer at a zero-input condition would be 1.88 V (0.004 A·470 Ω). We did note that given a zero input, most of the transducers gave outputs slightly lower than this nominal value with the measured values ranging between 1.862 and 1.880 V. The differences are likely due to a slight calibration offset. In general, this slight offset is of no consequence to the data given the interest in relatively gross circuit behaviors. No attempts were made to re-zero the transducers given that the offsets were minor and of no real consequence. However, the measured offset was accounted for in the data conversion process. A “zero-point” data run was performed to record the output of each transducer given a zero voltage or zero current input. Data were recorded for a period of about five minutes, and the final ‘zero-point’ values were taken as the simple average of the roughly 1500 measured values. The results are shown in Table C.1.

| Transducer | Circuit 1 | Circuit 2 | Circuit 3 | Circuit 4 |
|------------|-----------|-----------|-----------|-----------|
| V1         | 1.870     | 1.869     | 1.865     | 1.870     |
| A1         | 1.866     | 1.876     | 1.875     | 1.870     |
| V2         | 1.875     | 1.868     | 1.870     | 1.871     |
| A2         | 1.880     | 1.878     | 1.875     | 1.874     |
| V3         | 1.872     | 1.870     | 1.877     | 1.862     |
| A3         | 1.880     | 1.875     | 1.885     | 1.877     |
| V4         | 1.870     | 1.871     | 1.868     | 1.868     |
| A4         | 1.874     | 1.877     | 1.875     | 1.873     |
| V5         | 1.867     | 1.875     | 1.868     | 1.866     |
| A5         | 1.880     | 1.872     | 1.875     | 1.876     |
| V6         | 1.868     | 1.870     | 1.880     | 1.862     |
| A6         | 1.879     | 1.875     | 1.876     | 1.873     |
| V7         | 1.870     | 1.869     | 1.867     | 1.862     |
| A7         | 1.870     | 1.878     | 1.844     | 1.868     |
| V8         | 1.880     | 1.868     | 1.868     | 1.869     |
| A8         | 1.872     | 1.877     | 1.866     | 1.868     |

These ‘zero-point’ values were used in the data processing as a measure of transducer output in lieu of the nominal ‘zero-point’ output of 1.88 V (as described above). This allowed for a more accurate representation of the measurements at values very close to zero. The resulting data conversion formula applied to the voltage transducers is:

$$V_{actual} = \left[ \frac{V_{measured} - V_{zero}}{470} \right] \cdot \left[ \frac{300}{(0.020 - 0.004)} \right]$$

and for the current transducers is:

$$I_{actual} = \left[ \frac{V_{measured} - V_{zero}}{470} \right] \cdot \left[ \frac{5}{(0.020 - 0.004)} \right]$$

where  $V_{zero}$  represents the measured ‘zero-point’ value for each individual transducer. Note that the second grouping on the right hand side of each equation represents the full scale input value divided by the full output range (e.g., for the voltage transducers, 300 V divided by (20 mA - 4 mA)).

Due to the high scan rate and the typical test duration (20-40 minutes), the original data files are quite large (several mega-bytes each) even in simple text format. As noted elsewhere, the original data files have been preserved for archival purposes. However, a more manageable file size was desired for use in routine data processing and analysis. To achieve this, the data were manually filtered as a part of processing.

In all of the tests, the actual cable degradation takes place over a time period generally ranging from a few second to about 20 minutes. For most tests there is an extended period of data recording early in the test where, essentially, nothing happens. Similarly, after a SCUDU experiences a fuse blow all power to that circuit is lost rendering the subsequent data uninteresting unless a subsequent inter-cable hot-short occurs.

Data recorded prior to initial signs of cable degradation were manually filtered retaining, in general, the values recorded at one-minute intervals. Once initial degradation is indicated data scans would be retained at more frequent intervals. The intervals between retained scans varied from 30s, to retention of all data scans depending on the nature and rate of changes being observed. At key times all of the recorded data points were retained. Key times included, in particular, periods when degradation of the CPT source voltage is observed, when a conductors show an increasing voltage signal indicating formation of a hot short, and periods when spurious actuation or fuse blow failures took place.

Following fuse blow on a given circuit the data were again filtered with scans retained generally at 60 s intervals. If any artifacts in the data are noted after fuse-blow (e.g., a voltage or current spike that might indicate a hot-short) the data surrounding this event would be retained at the full scan rate. Note that in filtering the data, a specific scan (e.g., the scan recorded at 0 s, 60 s, 120 s, etc.) would be retained, and intermediate scans deleted from the processed files (i.e., there was no time-averaging).

Note that while voltage and current transducers were provided for circuit path 9 (i.e., the hardware was installed and wired), these two transducers in each circuit were not monitored or used in the CAROLFIRE testing. CAROLFIRE actively monitored only Paths 1-8. Path 9 was simply not used and not monitored in any test. The dropping of the ninth circuit path allowed us to use a faster 64 channel data logging system to monitor all four SCUDUs.

## **Configuring the SCDUs**

The general configurations used in each test are described in detail in Section 4 of the main body of this report. Section 7 in the main body of this report identifies the specific configurations used in each of the tests and the cables to which the SCDUs were connected.

The predominant SCDU used in testing essentially replicates the motor operated valve (MOV) surrogate test circuits utilized during the EPRI/NEI tests and the more recent Duke Energy (2006) tests. This is referred to as the ‘MOV-1’ configuration. Note that MOV-1 is configured for the testing of a seven-conductor control cable. As a result, Path 3 is not connected to any of the cable conductors. The channels for Path 3 were monitored routinely during testing, but they do not represent relevant test data as they were not connected to the tested cables in any way.

The other configurations used in testing represent either variations were either an alternate Actuation Circuit (AC-1) used for testing of a three conductor cable in one test, or Inter-Cable (IC) configurations that monitored explicitly for inter-cable spurious actuations and hot-shorts. These configurations are also described in Section 4.4 of the main body of this report.

## **Nominal Circuit Power Requirements for MOV-1**

The body of this report describes the primary circuit configuration used in the majority of the CAROLFIRE tests. This configuration, referred to as MOV-1, is a direct analog of the circuit used by NEI/EPRI and more recently by Duke Energy. The circuit used for CAROLFIRE uses two motor contactors as the active targets (circuit paths 5 and 6 as described above).

The manufacturer specifications for the motor contactors procured for CAROLFIRE cited that 80-100VA power was required for contactor normal operation. The contactors were selected and procured largely on this basis as this was indeed the target power requirement desired for these tests. Given 80-100VA relay, plus the baseline load of one simulated lit indicator lamp, the implied circuit design power requirement was nominally about 100VA. Given this, the 100, 150, and 200 VA CPTs were expected to be representative of 100%, 150%, and 200% of the nominal circuit design power requirements, respectively.

However, as a part of the post-test data analysis we had reason to examine these contactors more closely. During data analysis we observed that the SCDU results were not showing the same sort of source voltage degradation that the NEI tests had observed. Substantial degradation for the circuit with the 100VA CPT was expected since this was much smaller than the CPT tested by NEI/EPRI. While some cases of minor-to-moderate voltage degradation were observed, the effects were not nearly as pronounced as had been expected. Most cases where any degradation was noted involved source voltage drops of 5-10V and no cases were observed where the drop in source voltage exceeded 30V. We did see cases where the voltage on a target conductor increased but never reached a voltage sufficient to lock in the relays. However, none of these cases were associated with significant source voltage degradation. Hence, the lack of relay lock-in is attributed to poor conductor-to-conductor fault quality, not to degraded voltage.

We pursued two primary lines of inquiry in an attempt to explain this potential discrepancy. One line of inquiry was to investigate the potential effects of the parasitic load imposed on the measured circuit by the voltage and current transducers used by NEI/EPRI. The results of this line of inquiry are discussed in Appendix E.

The second line of inquiry was to re-examine the CAROLFIRE SCDUs. After completion of testing we measured the actual pick-up current for the contactor coils. ‘Pick-up current’ refers to the current required to actually move the relay coil to the closed position. Essentially, this is the current required to overcome static friction and the resisting spring force and to induce movement of the relay. A second parameter is the so-called in-rush current which is a momentary (i.e. less than one milli-second) power rush that occurs as the relay actually locks in. This in-rush current, as noted in the EPRI analysis, is of such short duration that it has no real impact on circuit power demands since even a small CPT can easily sustain such a short burst of power. Hence, the relay pick-up current is the driving factor in the real-life power demands of a motor starter or motor contactor and in the interpretation of spurious actuation likelihood under cable failure conditions.

We evaluated the CAROLFIRE motor contactors using essentially the same method as that documented in Appendix C of the EPRI test report [C.1]. A small variac (variable auto-transformer) was used to progressively increase voltage to the coil while monitoring the current draw. The peak value of this current, which occurs just prior to full lock-in, is taken as the nominal pick-up current. After pick-up, the current will drop substantially to a value referred to as the holding current. The results are illustrated for four of the motor contactors in Figure C.2.

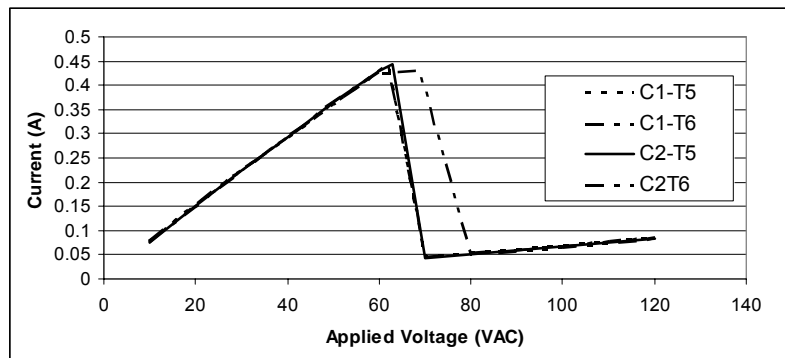


Figure C.9: Current draw of motor contactors versus applied voltage.

The actual pick-up current for the CAROLFIRE relays was measured at only about 0.43-0.44 A. An 80-100 VA contactor would be expected to require a pick-up current of 0.67-0.83 A. Hence, the actual pick-up current was much lower than anticipated. No pre-test measurements were made, but it seems unlikely that the pick-up current would change so dramatically due to the effects of the testing program. Further, while the contactors showed substantial variability regarding the minimum pick-up voltage (ranging from about 66-78 V) the pick-up currents were quite consistent. The measured holding current at 120 V was also measured and ranged from 0.82-0.87 A.

Given the post-test measured pick-up current, a more realistic estimate of nominal design load for the relays is approximately 52-53 VA. Added to this is the power required to operate the normally lit



indicator lamp simulated by the burden resistor between Circuit Paths 1 and 7 (see discussion of the MOV-1 Configuration below), or 8 VA  $((120\text{ V})^2/1800\ \Omega)$ . Hence, the total circuit design load (assuming only one relay would lock in at a time for design purposes) would be about 60 VA. Hence, in effect the 100 VA CPT represents about 167% of the design requirement, the 150 VA CPT represents about 250% of the nominal design requirement, and the 200 VA CPT represents about 333% of the nominal design requirement.

Ultimately this difference does not impact the ability to interpret the test results in the context of the Bin 2 items, and in particular, does not affect our ability to reach conclusions regarding Bin 2 Item D (that item dealing with CPT effect). However, results have been analyzed and interpreted consistent with the measured power requirements, not those of the manufacturer specifications.

This also raises an interesting potential consideration in the analysis of actual circuits. That is, care should be taken to ensure that the nominal base design load is based on a realistic assessment of the actual power requirements of the control circuit. As noted here, one cannot simply assume that the manufacturer specifications reflect actual design loads with high reliability. In our case, the manufacturer may have specified power requirements based on in-rush current which as noted by EPRI would not be an appropriate basis for analysis of actual power requirement. The manufacturer may also have simply been conservative in specifying their devices performance requirements given that allowing for a little extra power to the control circuit is normally not a point of concern. However, in this context (spurious actuation likelihood) a realistic estimate of the circuit power demands appears to be a critical factor. This is discussed further in Chapter 8 of the main body.

### **Circuit Grounding and CPT Sizes**

Note that Figure C-1 shows the control circuit being powered through a control power transformer, and shows the circuit in a grounded configuration. In practice, one circuit was run in an ungrounded configuration (SCDU-1). Also in a small number of tests, SCDU-4 was reconfigured to receive line power directly, bypassing the CPT. The conditions of the four SCDUs are summarized as follows:

#### SCDU general characteristics

| SCDU Designator | CPT Size | Grounded (Yes/No) | Comments          |
|-----------------|----------|-------------------|-------------------|
| Circuit 1       | 150 VA   | No                |                   |
| Circuit 2       | 150 VA   | Yes               | All Tests         |
| Circuit 3       | 200 VA   | Yes               |                   |
| Circuit 4       | 100 VA   | Yes               | Tests IP3 - IT10  |
|                 | No CPT   | Yes               | Tests IT11 – IT14 |

## **SCDU Hardware List**

The following is a list of the primary components of the SCDU systems.

*Voltage Transducers (9 per SCDU):*

Ohio Semitronics, Model MVT-300E, externally powered, 0-300VAC input, 4-20mA DC output, 0.25% accuracy.

*Current Transducers (9 per SCDU):*

Ohio Semitronics, Model MCT5-005E, externally powered, 0-5AAC input, 4-20mA DC output, 0.25% accuracy.

*Active Targets (2 per SCDU):*

Centsable model GH15DN-3-001A, AC motor contactors, 80-100VA coil pickup power requirement, load capacity 10 hp at 480VAC, procured from Automation Direct, measured pick-up voltage 72-81V, and measured drop-out voltage 65-72V.

**Special Note:** These motor contactors were advertised as requiring 80-100VA power for coil pickup. However, the actual current measured for the contactors used in CAROLFIRE at pickup was about 0.46-0.48A. This implies a much lower in-rush power requirement of 55-58 VA. See further discussion above.

*Passive Targets (1 per SCDU):*

1.75k $\Omega$  silicone power resistors.

*Burden Resistors (1 per circuit):*

1.75k $\Omega$  silicone power resistors for Tests IP1-IT5, and

1.80k $\Omega$  ceramic power resistors for Tests IT6-IT14.

*CPTs (1 per SCDU):*

Model numbers CPT115-100-F, CPT115-150-F, and CPT 115-200-F, made in Canada, procured from Automation Direct.

*Step-up transformers (1 per SCDU):*

Stancor Model P8640, 2.17A output, 500 VA capacity, 115 to 230 VAC step-up autotransformers, White-Rogers Division of the Emerson Electric Co., St. Louis, MO.

*CPT primary side fuses (2 per CPT):*

Model HCTR2, 600V, 2A, Class CC, time-delay fuses by Edison Electric Co, Peres, MO.

*CPT secondary side fuses (1 per CPT):*

Model MCL3, 600V 3A midget, fast-acting fuses by Edison Electric Co, Peres, MO.

## **References**

C.1 EPRI: *Characterization of Fire-Induced Circuit Faults – Results of Cable Fire Testing*, TR 1003326, EPRI, Palo Alto, CA, Dec. 2002.

## APPENDIX D: POWER CONSUMPTION PROFILES FOR MVT-150A AND MCT5-005A TRANSDUCERS

### Introduction

The NEI/EPRI circuit tests utilized voltage and current transducers from the same manufacturer (Ohio Semitronics) as those used by SNL in CAROLFIRE. However, there is one key difference between the transducers used in these two programs; namely, SNL procured externally powered transducers (i.e., the transducers have a direct connection to an external power source) whereas NEI/EPRI used self-powered transducers (the transducers draw their power directly from the measured circuit). As a result, the NEI/EPRI surrogate circuits had a parasitic load imposed on them in order to run the transducers whereas the CAROLFIRE circuits did not. Note that in practice, no parasitic load of this type would be present on such a control circuit. This appendix reports on measurements of the magnitude of the burden associated with the NEI/EPRI transducers.

### Approach

In order to understand the potential magnitude of the imposed parasitic load, SNL procured one each of the self-powered voltage and current transducers of the type used by NEI/EPRI. The original MVT-150A voltage transducers as specified in the EPRI test report do remain available from the manufacturer and one of these was procured and tested. However, the original MCT-005A current transducer has been replaced by a corresponding MCT5-005A model transducer. The newer model is identical in appearance and specifications. It is not known what design changes were made between these two models. Hence, the current transducer tested here by SNL is not identical to the NEI/EPRI models, but is as close as can be achieved given currently available models.

For each transducer, SNL conducted a simple bench-top experiment to characterize the power consumption of the transducers as a function of the input signal. For testing, the following set-ups were used:

- MVT-150A: A small variac<sup>21</sup> was used to supply a controlled AC voltage signal to the transducer's input terminals. One leg of the input signal was routed through a multi-meter measuring AC current flow. The input voltage at the transducer terminal was also measured using a second multi-meter set to monitor AC voltage. Power consumed by the transducer is then the simple product of the input voltage signal and the measured current flow.
- MCT5-005A: The same small variac was again used as the power source, but in this case, was routed through a high-power resistor. Changing the variac output voltage caused a change in the current flow through the circuit. The output current output was routed through a multi-meter in order to monitor the actual current flow, and then through the input terminals of the transducer. In addition, a second multi-meter

---

<sup>21</sup> A variac is a variable autotransformer with only one winding providing a true AC variable voltage output ranging from 0 to approximately 110% of the available input line voltage.

configured to measure AC voltage was connected across the input terminals of the transducer. In this case, the power consumption of the transducer is taken as the simple product of input current and voltage drop across the transducer.

In both cases, the transducer output, which by design is a 0-1 mA signal proportional to the input, was shunted through a 470Ω resistor. A third multi-meter was connected across the shunt resistor to ensure that a valid output signal was being generated. (The experiment was also repeated for several measurement points using a 940 Ω shunt resistor with little change in the results.)

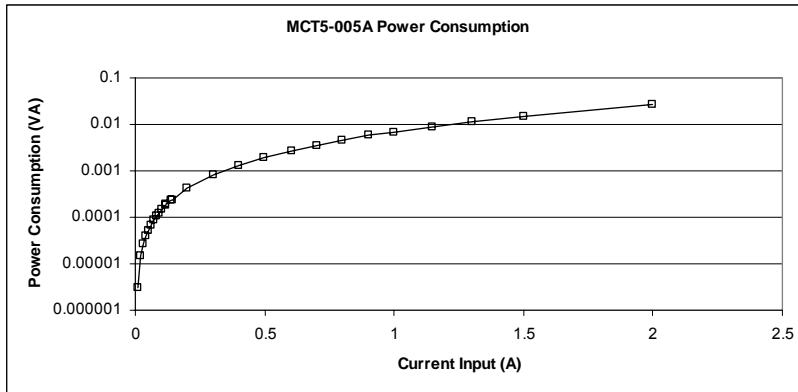


Figure D.10: Power consumption behavior for the NEI/EPRI style current transducers.

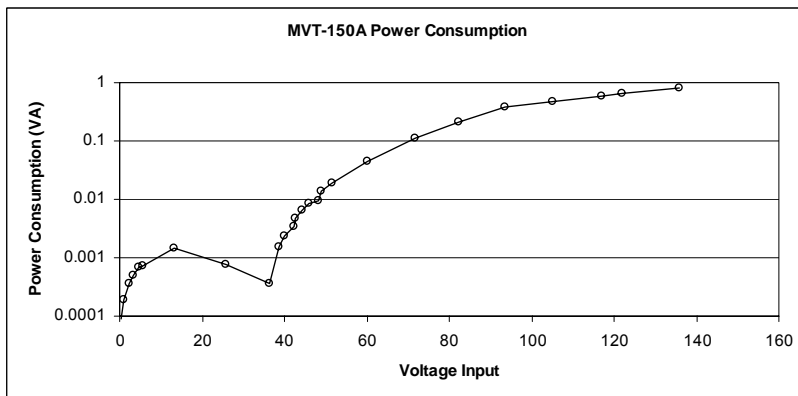


Figure D.11: Power consumption behavior for the NEI/EPRI style voltage transducers.

**Results**

The results of the experiment are illustrated in Figures D.1 and D.2. Note that for both transducers the power consumption generally increases as the input signal increases. The voltage transducer appears to display a “sweet-spot” behavior in the 25-30 V input range where power consumption drops to a minimum. For both transducers, the nominal power consumption does appear to approach the manufacturer’s specified full range values of 1.0 VA for the voltage transducer and 0.1 VA for the current transducer, although SNL did not test the devices to full rated input.

One final factor to be considered is the fact that the NEI/EPRI system actually had to supply current flow to the voltage transducers nominally at the full supply voltage (this effect does not impact the current transducers in the same way). This implies an actual load on the power supply that is somewhat higher than the nominal power required by the transducer. Note that the “extra” power beyond the nominal gets dissipated as waste heat due to resistance heating as the current flows across the fault (the short) between the energizing source and the energized target (i.e., the fault is less than perfect and does retain some residual resistance).

Assuming a nominal 115 VAC supply voltage, the power imposed on the circuit supply transformer (e.g., the CPT) can be recalculated as shown in the final figure below. Note that the percentage differences are most pronounced at the lowest voltage levels where the power consumption is also at its lowest. In this case, the maximum effect in absolute terms is seen at higher voltages. The worst case load increase is in the 80-90 V input range where the supply power required is about 0.09 VA higher than the nominal power requirement of the transducer. The overall effect at all voltage levels is relatively small, but may need to be considered in assessing the effect that up to nine such transducers might have had on a monitored circuit.

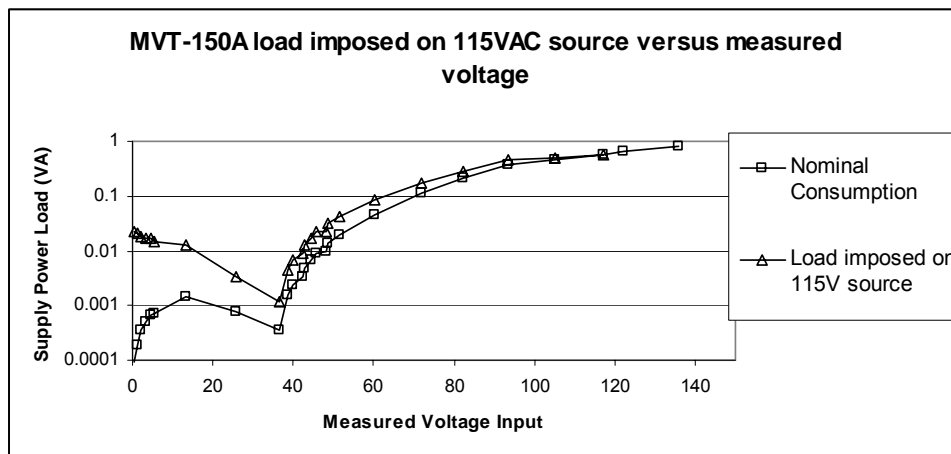


Figure D.12: Power consumption imposed on the CPT by the NEI/EPRI style voltage transducers.

## APPENDIX E: A HISTORICAL REVIEW OF CABLE MANUFACTURERS AND SUPPLIERS TO THE U.S. NUCLEAR POWER INDUSTRY

This appendix provides some general background information related to the cable manufacturing industry in the U.S. and supplying the U.S. commercial nuclear industry. The discussions cover the most common of both past and current suppliers of electrical cable to the U.S. nuclear power industry. These companies have gone through many changes over the past five decades. The information presented here was gathered from various public resources including the manufacturer web sites, news articles, and the Thomas Register®. Information was also gained from discussion with industry cable experts. The information has not been subjected to a rigorous review, but is considered generally accurate.

**Aerospace Wire & Cable:** Established in 1986 as a manufacturer of cables primarily for aerospace applications. A prominent supplier of Tefzel-equivalent cables, although not historically a supplier to the nuclear power industry.

**Alpha Wire:** A manufacture primarily of small data and communication cables. Not historically a supplier of cables to the nuclear industry.

**Anaconda:** Once a stand-alone manufacturer, and more recently a brand name associated with BICC, the Anaconda brand has been owned by General Cable since 1999. New products are produced in the original Anaconda mill in Marion Illinois, but there is no apparent connection between cables produced prior to acquisition by General Cable, and those currently produced. In particular, product lines were switched from historical sources of the base resin to General Cable's in-house formulations. Historically, Anaconda was one of the primary sources of silicone rubber cables used in the nuclear industry, but that product line has been dropped. Anaconda is now primarily a line of cables for mining applications.

**Anixter:** Based on the company web site (Anixter.com) Anixter was established in 1957 as a "reseller of electrical wire and cable." Anixter continues as a major distributor of electrical wire and cable but is not historically a direct manufacturer of cables.

**American Insulated Wire (AIW):** AIW is historically a supplier of cables to a significant share of the U.S. NPP market. For example, AIW was the original manufacturer of the Silicone-insulated cables used at Sequoyah by Tennessee Valley Authority (TVA). (Note: Based on discussion with a TVA cable expert, SR cables were used in a single-conductor configuration inside containment where Equipment Qualification requirements applied. Outside containment TVA used primarily PE/PVC industrial grade cables.) The Silicone-based line of products is no longer listed as a product available from AIW. Primary products currently produced are industrial grade XLPE, PVC, and EPR cables. AIW is also now owned by Leviton Mfg. Co.

**BICC:** BICC or British Insulated Callenders (Submarine) Cables Ltd. was originally formed in 1954 to manufacture and lay a high-voltage power cable between the mainland Canada and Vancouver Island. By the mid 1990's the company had established an international manufacturing presence through the acquisition of a number of other manufacturing companies including Brand Rex and Anaconda. The company was broken up and sold to various companies 1999. It was at this time that General Cable acquired the brand names BICC Energy Cables, Anaconda, and Brand Rex and the associated mill operations in Willimantic CT and Marion IL.

**Boston Insulated Wire (BIW):** BIW was originally established in 1905, and is historically a supplier of primarily EPR insulated cables to the nuclear power industry. The primary product line for this application was the Bostrad brand name. BIW is now owned by Draka, and the Bostrad line of cables is no longer available. According to the Draka web site (drakausa.com), "Since 1905, BIW offered a diverse product selection to the defense, rail, transit, industrial and reservoir management markets."

**Brand Rex:** This brand originally started as Rex Corp, a spin-off from Surprenant in the 1950's. Once a stand-alone manufacturer, and more recently a brand name associated with BICC, the Brand Rex brand has been owned by General Cable since 1999. New products are produced in the original Brand Rex mill in Willimantic Conn. General Cable continues to produce a line of nuclear grade cables under the Brand Rex trade name, and it appears that in order to preserve the historical link to the original qualification basis, the material formulations for Brand Rex cables remains essentially unchanged (i.e., the historical sources for the base resins appears to be unchanged for Brand Rex in contrast to Anaconda whose formulations appear to have been changed to in-house General Cable formulations when Brand Rex acquired BICC), but there is no direct assurance that material formulations have not changed since the company was acquired by General. In particular, some cable product lines were likely switched from historical sources of the base resin to General Cable's in-house formulations.

**Cable USA** This brand was originally established in the 1960's as a spin-off company from a cable manufacturer known as Super Temp. It is now one of several companies operating under the banner of the Marmon Group which also includes Rockbestos and Surprenant. Not historically a supplier to the nuclear power industry, Cable USA manufactures wide range of industrial grade cables including XLPE, PE, PVC, Tefzel, and Silicon-based insulations. (SNL first approached Rockbestos-Surprenant for a bid on SR-insulated cables, but we were referred by Rockbestos to Cable USA. The CAROLFIRE SR cables were procured from Cable USA.)

**Continental:** This was originally a stand-alone manufacturing company that then merged with Anaconda as Anaconda/Continental eventually becoming known again just as Anaconda. Anaconda was then bought out by BICC who was bought in turn by General Cable. It appears that the Continental mill may have once again emerged

from the breakup of BICC as a stand-alone cable manufacturer as the company web site cites that Continental was “re-organized in 1997.” It is not clear how traceable current products are to the old trade name. Research into the history of this company was limited. Continental now sells their products primarily through First Capitol, and are makers of many thermoplastic and thermoset materials, including Silicone.

**Draka Cableteq USA:** According to the company web site (drakausa.com) Draka Cableteq USA was established in 1988, although the company history actually extends to as early as 1906. Draka has since acquired several other companies and brand names including Hitemp-Helix, BIW, and Tamaqua cables. Both BIW and Tamaqua are historical suppliers of cables to the U.S. NPP industry and these product lines remain available.

**First Capitol:** This was a new company formed in 1989. They are currently the primary distributor for the “new” Continental Cable company, but their web site also states that they manufacture a wide range of cable products. Not known historically as a supplier to the U.S. NPP industry.

**GE:** Once a manufacturer of primarily XLPE, PE, and PVC cables for use in GE-designed NPPs, GE no longer manufactures cables. GE XLPE/PVC cables are one of the most common of the “mixed type” cable products (thermoset insulated, thermoplastic jacketed) cables currently installed in U.S. NPPs.

**General Cable:** Originally incorporated in 1927 based on the merger of several manufacturing companies dating back to the 1800’s. Major acquisitions include the Carol Cable Company in 1990, In 1999 General acquired BICC Energy Cables adding Anaconda, BICC and Brand Rex names to it’s product lines.

**Kerite:** Kerite was once a known supplier of cables to the U.S. NPP industry. In particular, they were known for the Kerite FR line of cables. These cables were advertised as an XLPO insulated material. Based on discussion with NPP industry cable experts, the base formulation may, however, have been derived from a vinyl-acetate compound rather than a true polyolephin resin. Kerite still exists as a cable manufacturer under the banner of the Marmon Group. Kerite products are now limited to power cables (no instrumentation or control cable products are listed). The Kerite FR XLPO product line is no longer available.

**Nehring:** Established in 1912, today Nehing primarily offers a line of single-conductor PVC-insulated cables for power applications (e.g., power distribution lines).

**Okonite:** This company is a known name brand supplier of cables to the U.S. nuclear industry. The company still exists and is still manufacturing cable. The trade name Okozel appears to be equivalent to Tefzel. Other possibilities include PE/PVC (7/c control cable) and EPR/Hypalon cable.



**Raychem:** This company was founded in 1958 and is now owned by Tyco Electronics. Raychem currently supplies wire for small appliances (e.g., high temperature wiring for items such as coffee makers). Historical cable product lines used in the nuclear industry do not appear to be in current production. Raychem was also once known for the production of nuclear-qualified cable splicing materials (e.g., shrink wrap and other sealed splicing systems). It is not known if Raychem is still marketing such products.

**Rockbestos:** Rockbestos is now known as Rockbestos-Surprenant, the two companies having been merged under the Marmon Group (also see Cable USA). Rockbestos is still a major supplier of nuclear qualified cables including, in particular, the Firewall III line of XLPE and Silicone insulated cables. Rockbestos also markets a wide range of general cable products and remains a major manufacturer in all senses. The original line of Rockbestos Firewall III XLPE/Hypalon cables is arguably the single most common product line of cables currently installed in U.S. NPPs.

**Samuel Moore:** The Samuel Moore Group dates to at least the 1960's and was the original manufacturer of the Dekoron/Dekorad and Furon brands of cables. Dekoron/Dekorad in particular was a nuclear qualified EPR cable used by the U.S. NPP industry. This research was unable to identify any cable manufacturer still operating under the Samuel Moore name, nor marketing either the Dekoron or Dekorad brand cables.

**Superior Cable:** This company is a manufacturer of general industrial grade cables including XLPE/PVC mixed TS/TP cable, and PVC/PVC cable.

**Surprenant ITT:** Surprenant (founded by Bert Surprenant & George Forsberg) were pioneers in the manufacture of high-performance cables in the late 1940's. In the 1980s the company was renamed FL Surprenant, and in the 1990's, Surprenant was acquired by the Marmon Group which also owned Cable USA, Harbour Cable, and Rockbestos. Surprenant continues to operate under the Marmon banner.

**Tamaqua:** Tamaqua Cable Products is now owned by Draka Cableteq USA. According to the Draka web site ([drakausa.com](http://drakausa.com)) Tamaqua Cable Products is a "manufacturer of power, control and instrumentation cables for standard and specialty applications."

**Reference Resources:**

- [www.drakausa.com](http://www.drakausa.com)
- [www.generalcable.com](http://www.generalcable.com)
- [www.datacable.org](http://www.datacable.org): High Performance Wire & Cable History: The Companies, The Products and The Applications/Markets, Copyright 2004, Society of the Plastics Industry (SPI).

## Appendix F: Introduction to Electrical Cable Polymer Chemistry and Molecular Behavior under Flame and High Temperature

### CONTENTS

|  |     |
|--|-----|
| PUBLICATION NOTE .....   | 181 |
| DEFINITIONS.....   | 181 |
| ABBREVIATIONS .....  | 182 |
| PURPOSE.....   | 182 |
| DISCUSSION: POLYMER STRUCTURE, CHEMISTRY AND PHYSICAL PROPERTIES ..... | 182 |
| 1. <i>Molecules and Structural Units</i> .....                         | 182 |
| 1.1. Monomers .....  | 183 |
| 1.2. Polymers .....  | 183 |
| 1.3. Copolymers.....   | 183 |
| 1.4. Organic and Inorganic polymers.....                               | 184 |
| 1.5. Additives and Plasticizers .....                                  | 185 |
| 1.6. Polymerization .....  | 185 |
| 1.7. Degree of Polymerization .....                                    | 186 |
| 1.8. Polymer Branching and Side Chains .....                           | 186 |
| 1.9. Tacticity .....   | 188 |
| 2. <i>Bonds and Intermolecular Forces</i> .....                        | 189 |
| 2.1. Covalent bonds.....   | 189 |
| 2.2. Intermolecular Forces .....                                       | 189 |
| 3. <i>Chemical and Physical Properties</i> .....                       | 190 |
| 3.1. Glass Transition Temperature (GTT) and Melting Point .....        | 190 |
| 3.2. Crystallization .....   | 191 |
| 3.3. Thermal Effects of Heat on Polymers.....                          | 191 |
| 3.3.1 Thermal Properties .....   | 191 |
| 3.3.2 Thermal Expansion .....  | 192 |
| 3.3.3 Decomposition or Degradation .....                               | 192 |
| 3.3.4 Combustion .....   | 192 |
| 4. <i>Electrical properties and chemistry of Polymers</i> .....        | 192 |
| 4.1. Electrical Conductivity .....                                     | 192 |
| 4.2. Cable failures .....  | 192 |
| 5. <i>Classification of Plastics and Expected Properties</i> .....     | 194 |
| 5.1. Thermoplastic .....   | 194 |
| 5.2. Thermoset .....   | 194 |
| 5.3. CAROLFIRE's Thermoplastic/Thermoset Polymer Properties .....      | 194 |
| 5.3.1 Thermoplastic Polymers:.....                                     | 195 |
| 5.3.2 Thermoset Polymers:.....   | 195 |
| REFERENCES .....   | 196 |

## **Publication Note**

This appendix was prepared by Felix Gonzalez of the NRC/RES staff who is responsible for its content and format. The information has been included as a general background at the request of the NRC project manager.

### **Definitions**

Breakdown voltage: minimum voltage that makes an insulator behave as a conductor.

Free volume: volume (free space) of mass not occupied by atoms or molecules.

Glass Transition Temperature (GTT): Temperature above which the polymer molecules have some movement and the polymer is a malleable and flexible solid.

Gram per Mole (g/gmole): Mass in grams of one mole of molecules.  
(1 gmole =  $6.02 \times 10^{23}$  molecules).

Lewis Diagram: Two dimensional diagrams used to represent chemical bonds in an atom or molecule structure.

Natta Projection: two dimensional diagram used to show the three dimensional structure of a molecule or atom. In a hydrocarbon molecule, the carbon backbone is represented by a zigzag line where each corner and each end represents a carbon atom. A black solid triangle means the molecule is sticking out of the paper and a grey triangle means the molecule is retreating into the paper.

Melt processable: polymer that can be melted, then molded or extruded into a desired shape without altering its chemical properties.

Molecular breakdown: changes at molecular level that will cause the material to behave differently.

Olefin: (Alkenes) Unsaturated chemical compound containing at least one carbon to carbon double bond.

Plastic: Synonym for polymer. Used as a common name for polymers.

Polymer: Synonym for Plastic. Used in chemistry to designate a general class of molecule which has a repeated unit, in this case called monomer.

R: Functional group other than a Hydrogen atom or continuation of the polymer chain.

Ramifications: Synonym for branches. They are short chains of a polymer covalently bonded to the main longest chain of the molecule.

Skeletal formula: Two dimensional diagrams used to draw polymer molecules where a line is used to represent a covalent bond and a corner/junction of two lines is a fully hydrogenated carbon atom.

## Abbreviations

GTT: Glass Transition Temperature

PE: Polyethylene

LDPE: Low density Polyethylene

MDPE: Medium density Polyethylene

HDPE: High density Polyethylene

XLPE: Cross linked Polyethylene

CSPE: Chlorosulfonated Polyethylene

ETFE: Ethylene Tetrafluoroethylene

XLPO: Cross linked Polyolefin

PTFE: Polytetrafluoroethylene or more commonly known as Teflon

PVC: Polyvinyl chloride

## Purpose

The purpose of this Appendix is to provide an introduction to polymer chemistry to readers who have little or no background in the molecular behavior of polymers during thermal changes and flame exposure. This appendix is written for readers who have basic knowledge of general chemistry concepts. This appendix will focus on the physical changes the polymer and its molecules undergo through when heat is added and/or removed. It will also discuss the chemical changes that occur in the polymer structure when combustion occurs. The first three sections of this appendix provide a general discussion on how polymers behave at a molecular level. The fourth and fifth sections discuss the expected properties and behavior of each polymer evaluated in CAROLFIRE.

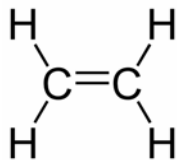
## Discussion: Polymer Structure, Chemistry and Physical Properties

### 1. Molecules and Structural Units

Polymers are composed of repetitive simple units that form extremely long molecules. These molecules vary in length within the same material and the repeating structural unit, called monomer, determines the chemical and physical properties of each polymer. Molecular weights of polymers can vary from approximately 10,000 g/gmole to 1,000,000 g/gmole. Molecules properties, like average length of the molecules, branching and degree of crystallization will have an effect on its molecular behavior. These characteristics affect the solubility, glass transition temperature (GTT), melting temperature, density, strength and other physical properties.

## 1.1. Monomers

A monomer is the simplest repeating unit found in a polymer. It determines the polymer's physical and chemical properties. Monomers have an inner chain of carbon (C), silicone (Si) or alternating silicone-oxygen (Si-O) atoms called the backbone.

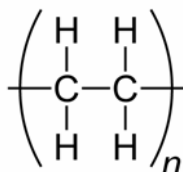


[Fig. 1.1: Monomer example: Ethylene or Ethene (IUPAC name)]

Ethylene is an example of a hydrocarbon monomer composed of C and Hydrogen (H) atoms and commonly used to polymerize PE (see section 1.6).

## 1.2. Polymers

A polymer is a high molecular weight compound that can be either natural or synthetic. It consists of a number of monomers in the same chain. Usually the polymer name is formed by the word “poly” followed by the monomer name. In the case of Polyethylene, the monomer name is ethylene which was mentioned above.



[Fig. 1.2: Polymer structure example: Polyethylene (PE)]

The figure above is a representation of PE repeated unit. The molecule in parenthesis is the monomer, in this case ethylene without the double bonds. The letter “n” is usually a number which will represent the degree of polymerization which designates how many times the monomer repeats itself in the polymer chain. At both ends of the polymer change we will find an H atom. Polymers have a carbon inner chain called a backbone or skeleton which is the largest carbon chain in the molecule. These molecules can have shorter carbon ramifications that are connected to the main molecule carbon chain called branches or side chains (see section 1.8).

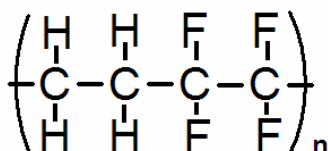
## 1.3. Copolymers

A copolymer is formed of two or more types of monomer molecules. There are several types of chain arrangements of monomers in the copolymer chain including alternating, random, block and grafted, among other copolymers structures. Different ratios of monomer molecules can be combined to give different physical properties. These ratios are usually manufacturer trade secrets.

**Alternating copolymer:** R-A-B-A-B-A-B-A-B-A-B-A-B-A-B-A-B-A-B-R  
**Random copolymer:** R-A-B-B-A-A-A-B-A-B-B-A-B-A-B-A-B-A-A-B-A-R  
**Block copolymer:** R-A-A-A-A-B-B-B-B-B-A-A-A-A-A-B-B-B-B-B-R

[Fig. 1.3: Copolymer's structure arrangements]

The figures above show the alternating, random and block copolymer structures. The A and B represent different monomers in the polymer chain.

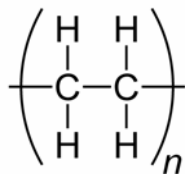


[Fig. 1.4: Copolymer: Ethylene tetrafluoroethylene (ETFE)]

The figure above is a representation of an ETFE repeated unit. At the molecular level, ETFE has similar properties to PE and polytetrafluoroethylene (PTFE or Teflon). ETFE is composed of a combination of PE and PTFE monomers. The high electro-negativity of the fluorine atoms gives ETFE its unique properties for high temperature and chemical resistance. Besides having similar properties to that of fully fluorinated polymers like PTFE, ETFE is also melt processable due to the presence of the PE's monomer.

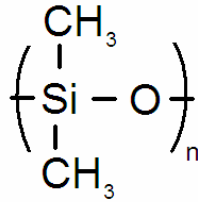
#### 1.4. Organic and Inorganic polymers

Organic based polymers have a molecular backbone based on carbon atoms. Common organic plastics like PE and PVC are polymerized from hydrocarbons like ethylene and vinyl chloride monomers respectively. The simplest of organic polymers is PE.



[Fig. 1.5: Carbon Based Polymer: Polyethylene (PE)]

Inorganic based polymers have a molecular backbone of silicone or silicone-oxygen atoms and can have organic side chains or branches. Silicone rubbers are commonly used in electrical applications. They have excellent thermal resistance and a wide variety of applications. In Si-O inorganic polymers, the presence of the high electronegative oxygen atom in the molecule's main chain can help increase the intermolecular interactions between molecules, improving properties at high temperature applications.



[Fig. 1.6: Silicon Based Polymer: Polydimethylsiloxane]

Polydimethylsiloxane is one of the most widely used silicone based polymer in the industry.

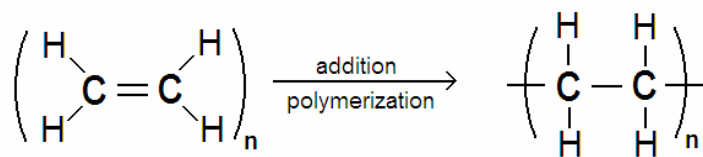
### 1.5. Additives and Plasticizers

Plastics have a wide range of applications and the use of additives and plasticizers further widens their uses. The main use of plasticizers is to soften and increase the material's flexibility. Plasticizers work by lodging their molecules between the polymer molecules increasing the polymer free volume. The distance between the plastic molecules increases, causing the GTT to decrease, making the plastic more flexible. There are a great variety of additives that will increase the material performance in applications for low temperatures, high temperatures, fire retardants, ultraviolet resistance, water resistance, oil resistance, and biodegradables, among many others. Fire retardant additives reduce fire spreading capability through the polymeric material. In many cases an additive with a specific function (like fire retardant) will also act as a plasticizer reducing the polymer GTT.

A good example of the use of additives is PVC. The GTT of PVC is between 350-365°F. This polymer is used in a wide number of applications like electrical cables and water pipes. Water pipes made of PVC tend to be hard, brittle and stiff, since they have a low amount of additives. Conversely, PVC electrical cables are more flexible than PVC water pipes meaning a higher degree of additives and plasticizers. The GTT in PVC electrical cables is lower than the GTT in PVC water pipes; this is why PVC cables are more flexible than PVC water pipes. Usually, specific formulation and quantities of additives and plasticizers used in plastic materials are considered manufacturers' trade secrets. The use of additives and plasticizers by manufacturers can play an important role in the polymer performance during certain conditions. This is why a polymer material manufactured by two different manufacturers could have different properties.

### 1.6. Polymerization

Polymerization is the chemical process of forming a polymer by addition or condensation mechanisms. During polymerization, the monomer molecules are chemically connected to form a long linear chain called the main chain. In some polymers shorter secondary chains connected to the main chain can be formed during the process.



[Fig 1.7: Polymerization Process of Ethylene into Polyethylene (PE)]

Figure 1.7 represents the polymerization of ethylene to PE by addition. The other main polymerization mechanism is condensation polymerization. During a polymerization several parameters can be controlled to give the polymer desired properties such as degree of branching, crystallinity and molecular weight.

### 1.7. Degree of Polymerization

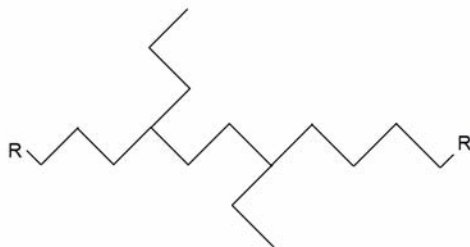
Degree of Polymerization is the number of repeated monomers at a given time during the polymerization process or at its end. It is directly related to the average molecular weight (MW) or average molecular length of the polymer, in other words, the higher the Degree of Polymerization the longer the molecules. Mathematically, the Degree of Polymerization is equal to the Total Molecular Weight of the Polymer divided by the Molecular Weight of the Monomer.

The length of polymer molecules has a great effect on some of the properties of the material. For example, a polymer with a high degree of polymerization will have a higher GTT than that same polymer with a lower degree of polymerization. This result in a polymer with longer molecules has higher intermolecular interactions per molecule. Also, longer molecules have higher capacity to bend and entangle with close molecules showing higher friction, hence increasing the resistance to movement when heat is applied and increasing the GTT.

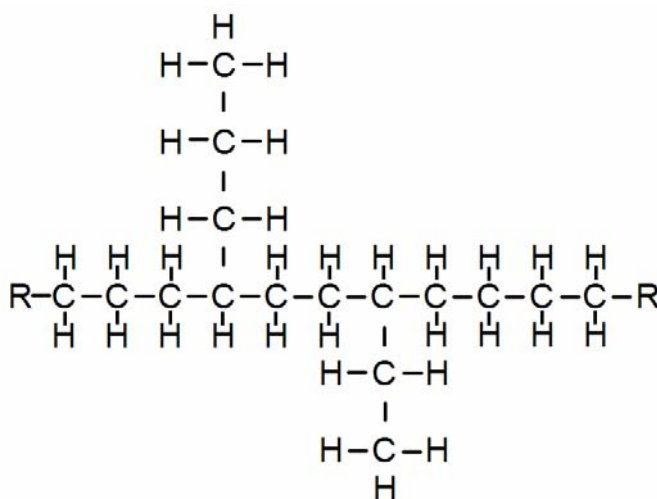
### 1.8. Polymer Branching and Side Chains

When some polymers are formed they may have secondary chains (branches) that connect to the main molecule chain. Usually the main molecule chain is the longest chain in the molecule. The “quantity” or degree of branching will affect the physical properties of the polymer (i.e., higher degree of branching lower GTT). The degree of branching can be controlled in some polymers by controlling some parameters during the polymerization. Most of these processes are considered trade secrets among polymer manufacturers.





[Fig. 1.8: Polymer Branch Example]



[Fig. 1.9: Polymer Branch Example]

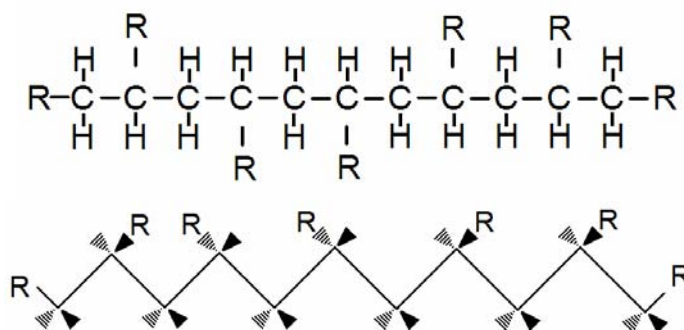
Fig 1.8 and Fig 1.9 show both the same polymer drawn with its skeletal formula (Fig. 1.8) and Lewis diagram (Fig. 1.9). The main chain in this example is the longest chain which is located between the two R's. The secondary chains or branches are ramifications of the main chain. One has a chain composed of 3 saturated carbons and the other of 2 saturated carbons. In actual polymeric molecules, hundreds or thousands of secondary chains may exist.

The difference between the different types of PE, high density PE (HDPE), medium density PE (MDPE), low density PE (LDPE) and linear low density PE (LLDPE) is the degree of branching between polymers. HDPE has the highest density which is mostly due to the low degree of branches which permits molecules to pack closer together and promotes crystallization which increases the GTT. In contrast, LDPE has the lowest density. LDPE has a high degree of branching which separates molecules further apart, increasing the free volume, decreasing density, and providing more flexibility than HDPE.

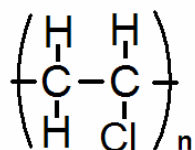
## 1.9. Tacticity

Tacticity is the relative spatial arrangement of an R group relative to another R group in adjacent carbon atoms in a polymer molecule. Tacticity is mostly related to vinyl polymers or any polymers that have a side group monomer. Polymers like PE do not have tacticity since they lack side groups in its monomer. This property of polymers can affect the melting temperature, solubility and crystallinity.

Atactic arrangements have side groups located randomly through the carbon chain. PVC polymerization produces mostly atactic molecules through the carbon chain.

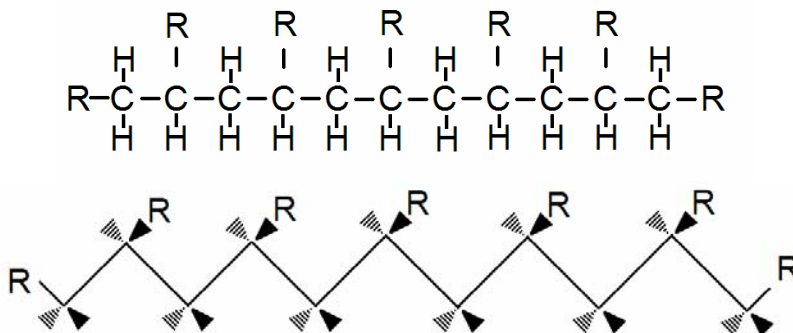


[Fig. 1.10: Atactic chain molecule; Lewis Diagram (above), Natta Projection (below)]



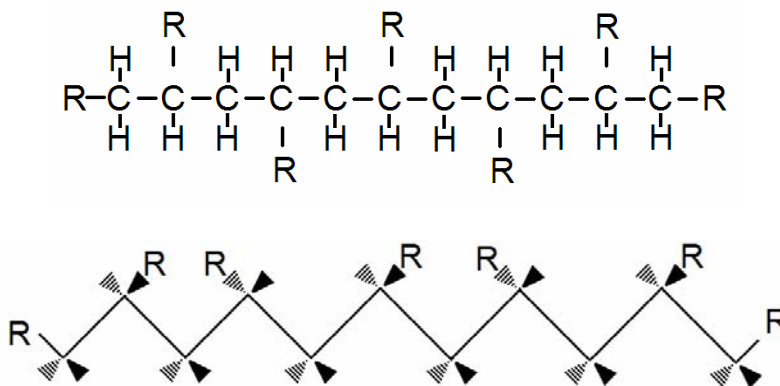
[Fig. 1.11: PVC Molecule]

Isotactic arrangements have side groups on the same side of the molecule. This permits higher packing of the molecules closer together reducing the free volume and increasing the crystallinity, solubility and melting temperature of the material.



[Fig. 1.12: Isotactic chain molecule; Lewis Diagram (above) Natta Projection (below)]

Syndiotactic arrangements have side groups on alternating sides of the molecule. Syndiotactic polymers usually have a higher degree of crystallinity than Isotactic polymers.



[Fig. 1.13: Syndiotactic chain molecule; Lewis Diagram (above), Natta Projection (below)]

## 2. Bonds and Intermolecular Forces

During polymerization chemical bonds are formed to increase the length of the polymer or increase the degree of polymerization. Among the polymer molecules, physical forces or “attractions” called intermolecular forces, keep these molecules together and give the polymer its physical properties.

### 2.1. Covalent bonds

Covalent bonds are characterized as a strong chemical bond where two atoms share a pair or more of electrons resulting in a new molecule with different chemical and physical properties than the original atoms. In polymers, covalent bonds are formed during polymerization in order to increase chain molecule length and the degree of polymerization. If covalent bonds are degraded, the plastic loses its properties. Cross linked polymers are covalently bonded with adjacent molecules. This type of bond gives cross linked polymers their higher stiffness and ability to withstand higher temperatures.

### 2.2. Intermolecular Forces

Intermolecular forces are electromagnetic forces caused by charged particles in a molecule. In polymeric molecules hydrogen bonds, dipole-dipole interactions and Van der Waals forces (London dispersion forces) might exist depending on the polymer and its atomic elements.

Van der Waals forces are instantaneous dipoles that induce a temporary attraction in a non-polar molecule. Highly non-polar polymer molecules like PE rely on this interaction to keep their molecules together. London dispersion forces are the weakest of all intermolecular forces and they exist in all atoms.

Dipole-dipole interactions are of greater magnitude than London dispersion forces but are weaker than hydrogen bonds. These forces occur between two or more molecules with permanent dipoles composed of high and low electronegative atoms. Polymer molecules that could show dipole-dipole interactions are PVC, ETFE and chlorosulfonated PE (CSPE) due to the presence of highly electronegative atoms like chlorine (Cl) and fluorine (F). The presence of these atoms in PVC and ETFE molecules, increase the heat resistance over other similar polymers like PE.

Hydrogen bonds are the strongest of the intermolecular forces. This bond exists between polar molecules where permanent dipoles exist. As with all the other intermolecular forces, there is no chemical connection between molecules, just physical attraction. As the name implies, the hydrogen atom is involved in the interaction with any other electronegative atom like oxygen, fluorine, chlorine and nitrogen. Hydrogen bonds usually exist in polymers with carbonyl or amide groups where partially positive N-H atoms in the chain interact with C=O atoms in another chain or another part of the same chain.

### **3. Chemical and Physical Properties**

The chemical and physical properties in any material are determined by the atomic structure that composes the molecule. Plastic's chemical and physical properties vary within the same polymer depending on the degree of polymerization, branching and additives.

#### **3.1. Glass Transition Temperature (GTT) and Melting Point**

The GTT is the temperature where the polymer molecules have some movement. Above this temperature the polymer is a malleable and flexible solid. Below this point the polymer becomes glassy (rigid and brittle) with properties similar to ceramics. Most plastic applications temperatures are above the GTT and the use of plasticizers helps lower the GTT in order to increase the temperature range where the plastic might be used.

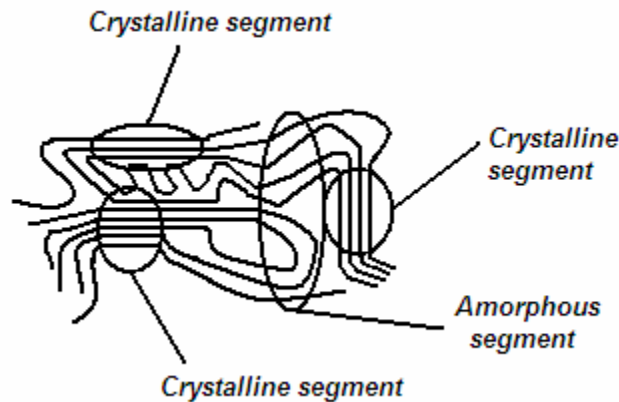
The melting point is the temperature where the rubber or solid phase plastic is converted into the liquid phase. At temperatures above this point, the plastic will flow as a viscous fluid. Usually plastic are used several tenths or hundreds of degrees below the melting temperature.

The temperature range between the glass transition temperature and the melting point (more commonly called rubber plateau) will depend on several characteristics: degree of polymerization, tacticity, crystallization, average molecular weight, additives and plasticizers and molecular branching. This is one of the reasons why specific polymer characteristics can differ from manufacturer to manufacturer. In many polymer applications, the operational temperature is often chosen to be between the glass transition temperature and the melting temperature. Electrical cables, in addition to being good insulators also need a flexible material. The rubber characteristics of plastics give

us this flexibility and hence are excellent materials to be used as insulator or jacket material in electrical cables.

### 3.2. Crystallization

Crystallization can be defined as the slow process of letting a polymer cool down from liquid form and letting the molecules organize to produce minimal molecular stress. A high degree of crystallization will increase the GTT. In theory, a 100% crystallized polymer will have a GTT very close to its melting temperature. In similar form 100% crystallized means 0% amorphous polymer. The process of heating the polymer and letting it cool down will change the degree of crystallization.



[Fig 3.1: Crystalline and Amorphous molecule segments]

In Figure 3.1 we can observe several molecules and segments of these molecules that are crystalline or amorphous. Crystalline segments have minimal molecular stress because neighboring molecules have had time to organize themselves relative to other molecules. Amorphous segments have a higher molecular stress. At crystalline segments, molecules are closer together and will need higher temperatures to break the intermolecular forces than non-crystalline (amorphous) segments.

### 3.3. Thermal Effects of Heat on Polymers

When heat is applied to polymers, they undergo several physical changes on the macro-molecular and micro-molecular level. When heat is applied to a polymer, its molecules separate and the plastic will expand.

#### 3.3.1 Thermal Properties

The thermal conductivity ( $k$ ) is the ability of a material to conduct heat. It is expressed in  $W / (m \cdot K)$  units. Qualitatively, the higher the  $k$  value, the higher the ability of the material to conduct heat. Thermal conductivity will also depend on the state of the material. For solids, thermal conductivity tends to be higher because molecules are closer together permitting the conduction of heat by free movement of valence electrons and/or phonons (molecular vibration). In liquids and gasses, as the distance between particles increases, the movement of free valence electrons becomes more difficult and

the effect of molecule vibration on its neighboring molecules decreases. Plastics usually have low thermal conductivities making them excellent thermal insulators.

### ***3.3.2 Thermal Expansion***

During the addition of heat, polymer molecules start to vibrate. As temperature increases, the intermolecular interactions have less and less effect and the polymer molecules separate. At a macroscopic level the polymer starts to decrease in density and starts to expand. During temperature increase, a plastic can expand around ten times more than a metal. For example, if a jacket material (could be metal in armored cables or a polymer jacket) surrounding a plastic is heated beyond the melting point of the inner plastic, the inner polymer could flow due to expansion and density differences.

### ***3.3.3 Decomposition or Degradation***

In the decomposition stage of a polymer, all the intermolecular interactions have a minimal effect. At this point covalent bonds will start to break causing the long polymer chain to divide into smaller segments. This damage on the polymer structure is irreversible and will cause changes in its molecular behavior and physical and chemical characteristics. The decomposition temperature for thermoplastics is above the melting temperature so the plastic will not undergo much degradation after it has started to melt. In other words, thermoset's decomposition temperature is below its melting temperature so thermoset polymers are expected to degrade before starting to melt.

### ***3.3.4 Combustion***

In a complete ideal combustion of any organic or fossil fuel the products of the reaction are carbon dioxide and water. In polymers, it may include other side products like inorganic gases depending on the molecular elements of the polymer molecules. For example, the combustion of polymers like PVC that contain chlorine atoms may form chloride gas which is toxic. Some plastics like PVC act as fire retardants due to the chlorine atoms in the PVC molecules. Some other methods to suppress combustion are the use of fire retardant additives.

## **4. Electrical properties and chemistry of Polymers**

### **4.1. Electrical Conductivity**

Chemically, for a material to be a good conductor, it needs to have free moving electrons in its last valence orbital. At ambient temperature most common conductor materials have metallic bonds or ionic bonds. Materials with covalent bonds usually do not have free moving electrons and therefore are good electrical insulators. Therefore, polymers are mostly used as electrical insulators in the U.S. cable industry.

### **4.2. Cable failures**

The purpose of cable insulation is to isolate the conducting material (in most cases a metal like copper or aluminum) from other elements that can interact with the cable's electrical energy (i.e., other conductors). If enough heat is added to the cable, the insulation will start to lose its mechanical properties. The polymer will start to burn and

melt and the metal conductor will be able to move through the polymer material. When the metal conductor touches another conductor, a cable failure will occur which may result in unwanted maloperations. These maloperations include shorting to ground or shorting with other conductor(s). Shorting to ground will cause the electrical signal to disappear while short circuits with other conductors will cause unpredictable operation of the equipment. Below is a description on the different failures a polymeric material might go through.

During a fire, cables are exposed to high temperatures and flames. Polymers undergo several physical and chemical changes during a fire. Thermoplastics can combust causing molecules to burn and degrade. The rate at which polymers burn is usually slow due to the long molecules and high quantity of covalent bonds that needs to be broken during combustion. While burning, the temperature of the polymer and air will increase and can cause other sections of the polymer/cable that are not burning to melt. This liquefied part could flow due to gravity and other forces. Thermoset cables will mostly combust and burn while some parts could be able to flow when cross linking bonds between their molecules have been degraded. These changes in the polymer material change it ability to support the conductor allowing it to move and interact with other conductors and/or conductive materials.

Carbonized paths are another possible cause of failure. They can be formed due to high temperatures (arc tracking) or high voltages (dry or wet tracking). Carbonized paths usually occur when the resistance of an insulator is rapidly reduced due to the conditions exposed such that it can conduct current. At high temperatures, the resistance of a polymer can be different than that the polymer's rating, causing molecular breakdown of the polymer and permitting the insulating material to conduct electricity. If a high voltage is applied and the breakdown voltage is reached molecular breakdown will occur also permitting the insulating material to conduct electricity. Once a carbonized path is formed a short circuit can be formed causing sparks or failure of the electrical equipment. Insulator thickness plays an important role, the higher the thickness the less probability for breakdown to occur and carbonized paths to form.

The presence or formation of voids in an insulator is yet another possible cause of failure of a polymer. Voids could be present in the polymer due to manufacturer defects or they can be formed due to excessive loss of additives/plasticizers caused by heat exposure. The excessive loss of additives and plasticizers will cause the polymer to lose the mechanical properties given by these additives (see section 1.5) making the polymer harder and more brittle which could lead to cracking. A good example of this is a car dashboard made of polymers. Over time, a car's dashboard is exposed to sunlight and heat which eventually causes the loss of plasticizers and cracks. At nearly melting temperatures, the loss of additives and plasticizers happen faster increasing possible void formation which can crack the material. Cracks can expose the conductor making it another possible location for electrical failure.

## **5. Classification of Plastics and Expected Properties**

Plastics can be classified in to two major categories: thermoplastics and thermosets. Thermoplastics can be heated, melted and cooled to solid form. Thermosets, if heated will reach decomposition temperature before melting temperature and will degrade irreversibly if exposed to high temperatures.

### **5.1. Thermoplastic**

Thermoplastics are a type of plastic material that can be deformed and/or liquefied by heat addition and can be cooled down to solid form. At the molecular level, the long polymer molecules attract each other by van der Waals forces, dipole-dipole interactions, hydrogen bonding and/or aromatic ring stacking, but there is no direct bonding or linking between molecular chains. These forces and interactions are inversely proportional to the temperature and the distance between the molecules. In the solid form the long polymer molecules are close together and the force between them keeps the material solid. If the thermal energy of the molecules is increased the molecules will separate and expand. If the heat addition is continued, the plastic will become more malleable but will not flow until it reaches its melting point. Once melted, the plastic will flow as a viscous fluid depending on the polymer characteristics and degree of polymerization. If heat is still being added, the plastic will reach its degradation temperature. Once the degradation temperature is reached, the energy added to the molecules is large enough to break the covalent bonds of the molecules causing irreversible change in the properties of the plastic.

### **5.2. Thermoset**

Unlike thermoplastics, thermoset molecules, once cured are covalently bonded between each other. They can not be liquefied by heat addition and cooled down to solid form. If heat is added, the kinetic energy of the molecules will increase and the molecules will start to vibrate, but they will not be able to separate too much. When temperature increases, the plastic might get softer but the degradation temperature will be reached before its glass transition temperature. Once the degradation temperature is reached the plastic molecules will start to lose molecular integrity and the covalent bonds will start to break. Once this happens the process is irreversible and the polymer will loose its chemical and physical properties. In general, thermoset polymers have better mechanical properties, are stiffer and can withstand higher temperatures during longer periods of time than thermoplastic polymers.

### **5.3. CAROLFIRE's Thermoplastic/Thermoset Polymer Properties**

CAROLFIRE evaluated the fire and heat resistance performance of several thermoplastic and thermoset polymers commonly used in the nuclear industry's electrical cables. The thermoplastics evaluated were PE, PVC and ETFE. The thermosets evaluated were EPR, XLPE, XLPO, CSPE and Silicone Rubber. These polymer materials were exposed to fire and high temperature conditions where the electrical failures determined the temperature and time the polymer material would fail. These polymers are used as jacket or insulator materials depending on the manufacturer.



### **5.3.1 Thermoplastic Polymers:**

There is a wide range of different types of PE (LDPE, LLDPE, MDPE and HDPE) which vary in density and degree of branching. In general, as with most polymers, PE is also a good thermal insulator and has excellent electrical insulating properties. LDPE has the lowest density and is the most flexible. HDPE has the highest density, is the least flexible and will perform better than lower density PEs at high temperatures due to close packing of the molecules. If processed adequately HDPE can have a high degree of crystallinity which will improve high temperature performance but increase stiffness. PE performs poorly when exposed to flames and will burn. Fire retardant additives need to be added to the polymer in order to improve fire exposure resistance.

Structurally speaking, PVC is very similar to PE except one chlorine atom replaces one hydrogen atom in the repetitive unit. PVC molecules are highly atactic which will produce highly amorphous polymers. There exist innumerable formulations for PVC but generally speaking it has good heat resistance properties. When exposed to flame, chlorine atoms act as a fire retardant greatly improving flame resistance of the polymer.

ETFE is a copolymer composed of the same monomers as PE and PTFE (Polytetrafluoroethylene or Teflon). ETFE shares the melt processable properties of PE with excellent high temperature resistance, chemical resistance, flame resistance and electrical insulating properties as PTFE and other fluoropolymers.

### **5.3.2 Thermoset Polymers:**

XLPE is a general class of Cross linked Polyolefin (XLPE). XLPE is the most widely used XLPE. Compared with PE, XLPE is expected to have similar properties, but should be stiffer, better resistance against mechanical forces and higher heat resistance properties. If exposed to flame, XLPE will burn the same as PE since its structural formula is the same. As in PE, fire retardant additives are needed in order to improve fire exposure resistance.

EPR (Ethylene Propylene Rubber) is a cross linked synthetic rubber. EPR as the name implies, is composed of Ethylene and Propylene monomers in a cross linked configuration. It has flexibility of rubbers and has similar properties to XLPE but higher heat resistance. It has good electrical properties (insulating properties) and high resistance to heat exposure. If exposed to flame, EPR should burn similarly to XLPE since their structural formulas are very similar. As in PE and XLPE, fire retardant additives are needed in order to improve fire exposure resistance.

CSPE is another type of cross linked synthetic rubber similar in structure with XLPE but also contains chloro-sulfonated molecules in its atomic structure. It has excellent electrical insulating properties, chemical resistance and high temperature performance.

When exposed to flame, CSPE will burn slowly, as chloro-sulfonated molecules in the polymer molecules act as fire retardants, self-extinguishing the combustion.

Silicone Rubber is a silicone based cross linked rubber. It has excellent heat resistance, electrical insulating properties and flame resistance. Silicone rubber's heat resistance should be among the best performing of the thermoset polymer group.

The use of fire retardant and high temperature resistance additives can increase any polymer performance during the conditions such as these to which electrical cables were exposed in the tests. Different formulations and polymerization processes used by polymer and cable manufacturers can also greatly improve their performance.

## References

1. Berins, M.L.; *Plastics Engineering Handbook of the Society of Plastics Industry, Inc;* Fifth Edition; 1991.
2. Babraukas, V.; "Mechanisms and Modes for Ignition of Low Voltage PVC wires, Cables and Cords"; *Fire & Materials* 2005; pp 291-309; Interscience Communications Ltd., London (2005).
3. Cote, A.E.; Hall, J.,R.; Powell, P.,A.; Grant, C.,C.; *Fire Protection Handbook;* Nineteenth Edition; Volume 2; 2003.
4. Hilado, C.J.; *Flammability Handbook for Plastics;* Third Edition; 1982.
5. Hilado, C.J.; *Flammability Handbook for Plastics;* Fourth Edition; 1990.
6. Salley, M.H.; Iqbal, N.; *Fire Dynamics Tools: Quantitative Fire Hazard Analysis Methods for the U.S. Nuclear Regulatory Commission Fire Protection Inspection Program;* 2004.
7. Askeland, D.R.; *The Science and Engineering of Materials;* Brooks/Cole Engineering Division A Division of Wadsworth Inc.; 1984.
8. Wilkens, W.D.; *Anixter Wire & Cable Technical Information Handbook;* Third Edition; Anixter Wire and Cable Group; 1996.