

Stormwater Best Management Practice Design Guide

Volume 3 Basin Best Management Practices

By

Michael L. Clar
Ecosite, Inc.
Ellicott City, MD, 21042

Billy J. Barfield, P.E., Ph.D.
Professor Emeritus
Department of Biosystems and Agricultural Engineering
Oklahoma State University
Stillwater, OK 74074

Thomas P. O'Connor
Urban Watershed Management Branch
Water Supply and Water Resources Division
National Risk Management Research Laboratory
Edison, NJ 08837

Project Officer

Thomas P. O'Connor
Urban Watershed Management Branch
Water Supply and Water Resources Division
National Risk Management Research Laboratory
Edison, NJ 08837

NATIONAL RISK MANAGEMENT RESEARCH LABORATORY
OFFICE OF RESEARCH AND DEVELOPMENT
U.S. ENVIRONMENTAL PROTECTION AGENCY
CINCINNATI, OH 45268

Notice

The U. S. Environmental Protection Agency through its Office of Research and Development funded and managed in the research described here under Order No. 1C-R059-NTSX to Ecosite, Inc. It has been subjected to the Agency's peer and administrative review and has been approved for publication as an EPA document. Mention of trade names or commercial products does not constitute endorsement or recommendation for use.

Foreword

The U.S. Environmental Protection Agency (EPA) is charged by Congress with protecting the Nation's land, air, and water resources. Under a mandate of national environmental laws, the Agency strives to formulate and implement actions leading to a compatible balance between human activities and the ability of natural systems to support and nurture life. To meet this mandate, EPA's research program is providing data and technical support for solving environmental problems today and building a science knowledge base necessary to manage our ecological resources wisely, understand how pollutants affect our health, and prevent or reduce environmental risks in the future.

The National Risk Management Research Laboratory (NRMRL) is the Agency's center for investigation of technological and management approaches for preventing and reducing risks from pollution that threaten human health and the environment. The focus of the Laboratory's research program is on methods and their cost-effectiveness for prevention and control of pollution to air, land, water, and subsurface resources; protection of water quality in public water systems; remediation of contaminated sites, sediments and ground water; prevention and control of indoor air pollution; and restoration of ecosystems. NRMRL collaborates with both public and private sector partners to foster technologies that reduce the cost of compliance and to anticipate emerging problems. NRMRL's research provides solutions to environmental problems by: developing and promoting technologies that protect and improve the environment; advancing scientific and engineering information to support regulatory and policy decisions; and providing the technical support and information transfer to ensure implementation of environmental regulations and strategies at the national, state, and community levels.

This publication has been produced as part of the Laboratory's strategic long-term research plan. It is published and made available by EPA's Office of Research and Development to assist the user community and to link researchers with their clients.

Lawrence W. Reiter, Acting Director.
National Risk Management Research Laboratory

Abstract

This manual provides design guidelines for a group of stormwater management (SWM) best management practices (BMPs) broadly referred to as basin or pond BMPs. Basin BMPs are the mainstay of stormwater management. Water resources engineers have designed small and large ponds for many years for a wide range of applications, including farm ponds, recreational ponds, water supply reservoirs, flood control reservoirs, infiltration basins and multiple use reservoirs. Our collective knowledge of basins or ponds, their design, construction, operation and maintenance is extensive. However, their use for environmental protection purposes including stream channel protection, water quality treatment and protection of receiving waters is a recent development, and in many instances requires reassessing the traditional applications of pond design techniques to meet these new objectives. This volume provides this type of assessment and guidance related to the design of pond BMPs for environmental protection purposes.

Pond BMP types are grouped into three categories: 1) dry detention basins including extended detention basins, 2) wet basins including both retention ponds and wetland ponds, and 3) infiltration basins. This volume provides specific design criteria for stormwater treatment by these types of BMPs along with generalized construction, and operation and maintenance guidance.

Contents

Notice	ii
Foreword	iii
Abstract	iv
Contents	v
List of Figures	viii
List of Tables	ix
Acronyms and Abbreviations	x
Acknowledgments	xii
Executive Summary	1
Section One Introduction to Basin BMP Types and Selection Guidance	1 - 1
Introduction	1 - 1
Background	1 - 2
Detention and Extended Detention Basins	1 - 2
Wet/Retention Ponds	1 - 3
Infiltration Basins	1 - 4
Selection Considerations for Pond BMPs	1 - 7
Impact Area	1 - 7
Watershed Factors	1 - 7
Terrain Factors	1 - 9
Stormwater Treatment Suitability	1 - 9
Physical Feasibility Factors	1 - 11
Community and Environmental Factors	1 - 13
Location and Permitting Factors	1 - 13
Section Two Dry Detention Basins -Design Criteria	2 - 1
Introduction	2 - 1
Analysis Procedures for Dry Detention Basins	2 - 2
Stormwater Routing	2 - 2
Sediment Routing in Extended Detention Ponds	2 - 5
Routing of Chemical Pollutants through Detention Basin	2 - 9
Loading to the Detention Basin	2 - 11
Example Problem for Dry Detention	2 - 12
Outlet Type and Protection	2 - 23
General Considerations	2 - 23
Clogging of Outlets	2 - 24
Trash Rack	2 - 26
Dam Embankment	2 - 26

Vegetation	2 - 26
Maintenance Access	2 - 26
Section Three Retention Ponds – Design Criteria	3 - 1
Introduction	3 - 1
Wet/Retention Ponds	3 - 1
Conditions Where Practice Applies	3 - 2
Analysis Procedures for Wet Retention Basins	3 - 2
Hydraulic Routing	3 - 2
Sediment Routing	3 - 2
Chemical Pollutants Routing	3 - 8
Example Problems for Retention Ponds	3 - 9
Design Criteria	3 - 18
Design Approach	3 - 18
Design Variations	3 - 18
Constructed Wetland Ponds	3 - 25
Feasibility Criteria	3 - 25
Conveyance Criteria	3 - 25
Pretreatment Criteria	3 - 25
Treatment Criteria	3 - 25
Landscaping Criteria	3 - 25
Section Four Infiltration Basins - Design Criteria	4 - 1
Analysis Procedures	4 - 1
Analysis Procedures for Runoff and Loading	4 - 1
Analysis Procedures for Stormwater Routing	4 - 1
Dry Detention	4 - 1
Wet Detention	4 - 2
Analysis Procedures for Sediment Routing	4 - 4
Simple Trapping During Stormflow	4 - 4
Trapping of Sediment for All Storms and in the Intervals between Storms	4 - 5
Analysis Procedures for Chemical Routing	4 - 5
Design Criteria	4 - 7
Feasibility Criteria	4 - 7
Conveyance Criteria	4 - 8
Pretreatment	4 - 8
Landscaping Criteria	4 - 9
Maintenance Criteria	4 - 9
Soil Textures	4 - 9
Procedure for Infiltration Basin Design	4 - 10
Section Five Construction Specifications for Ponds	5 - 1
Introduction	5 - 1
General Considerations	5 - 1
Typical Exemptions Allowed	5 - 2
Site Conditions	5 - 2
Structure Hazard Classification	5 - 2
Peak Breach Discharge Criteria	5 - 3
Embankment Specifications	5 - 3

Earthen Embankment	5 - 3
Seepage Control	5 - 4
Section Six Maintenance and Operation	6 - 1
Introduction	6 - 1
Inspections	6 - 1
Inspection Responsibility	6 - 2
Inspection Reports	6 - 2
Aesthetic Maintenance	6 - 2
Functional Maintenance	6 - 3
Preventive Maintenance	6 - 3
Corrective Maintenance	6 - 4
Maintenance Considerations in Design	6 - 7
Access	6 - 7
Vegetation	6 - 8
Non-clogging Low Flow Orifice	6 - 8
Riser	6 - 8
Pond Drain	6 - 9
Safety Features	6 - 9
Section Seven References	7 - 1
Appendix A Short Cut for Wetland Drawdown Assessment	A - 1
Appendix B Miscellaneous Details for BMP Design	B - 1

List of Figures

Figure 1-1 Typical Dry Basin	1 - 3
Figure 1-2 Extended Detention Basin, Typical Detail	1 - 4
Figure 1-3 Wet Pond	1 - 5
Figure 1-4 Infiltration Basin	1 - 6
Figure 2-1 Typical Dry Pond	2 - 1
Figure 2-2 Illustration of the Triangular Hydrograph Approximation	2 - 4
Figure 2-3 Graphical Presentation of Equation 2-9	2 - 7
Figure 2-4a Typical Outlet Structure: Negatively Sloped Pipe Outlet	2 - 24
Figure 2-4b Typical Outlet Structure: Multiple Orifice Hooded Outlet	2 - 24
Figure 2-5 Example Perforation Patterns	2 - 25
Figure 2-6 Minimum Size of a Trash Rack Versus Outlet Diameter	2 - 27
Figure 3-1 Ratio of Effective Storage Volume to Mean Runoff Volume	3 - 3
Figure 3-2 Fraction of Sediment Removed in Quiescent Conditions Between Storms	3 - 4
Figure 3- 3 Geographically Based Design Curves for Solids Settling Model	3 - 6
Figure 3- 4 Schematic of Proposed Development for Example Problem 3-3	3 - 13
Figure 3- 5 Schematic of Stormwater Retention Pond for Example Problem 3-3	3 - 14
Figure 3-6 IDEAL Input for Area, Land Use and Hydrologic Information for Example Problem 3.3	3 - 15
Figure 3-7 IDEAL Input for Sediment, EMC, and Nutrient Isotherms for Example Problem 3.3	3 - 15
Figure 3-8 IDEAL Input for Stormwater Retention Pond for Example Problem 3.3	3 - 16
Figure 3-9 IDEAL Output for Runoff and Peak Discharges for Example Problem 3.3	3 - 16
Figure 3-10 IDEAL Output for Sediment Loading and Trapping for Example Problem 3.3	3 - 17
Figure 3-11 IDEAL Output for Nutrient Loading and Trapping for Example Problem 3.3	3 - 17
Figure 3-12 Typical Principal Spillway Outlet Structure	3 - 23
Figure 4-1 Average Long Term Performance of Flow Capture Device	4 - 3
Figure 4-2 USDA Soils Textural Classification	4 - 10
Figure 4-3 Truncated Hydrograph Method	4 - 13

List of Tables

Table 1-1 Pond BMP Types vs. Ability to Control Impacts	1 - 8
Table 1-2 Pond BMP's Suitability to Address Watershed Factors	1 - 9
Table 1-3 BMP Selection - Influence of Terrain Factors	1 - 10
Table 1-4 Comparison of Pollutant Removal Percentages by Basin BMP Designed for Water Quality Control	1 - 10
Table 1-5 Comparison of Detention Storage Requirements in Fairfax County, VA: Permanent Pool Retention Pond Versus Extended Detention Basin	1 - 11
Table 1-6 BMP Selection - Physical Suitability Factors	1 - 12
Table 2-1 Spreadsheet Calculations for 10-yr Peak Discharge Post Development for Example Problem 2.1 . . .	2 - 13
Table 2-2 Expected Value of Runoff and Peak Discharge for Post Development for Example Problem 2.1 . . .	2 - 14
Table 2-3 Spreadsheet Calculations for 10-yr Peak Discharge Pre-development for Example Problem 2.1	2 - 15
Table 2-4 Expected Value of Runoff and Peak Discharge for Pre-development Example Problem 2.1	2 - 15
Table 2-5 Fraction of Sediment by Class Based on Soil Matrix Fractions for Example Problem 2.2	2 - 17
Table 2-6 Representative Diameters by Classes Based on Soil Matrix Fractions for Example Problem 2.2	2 - 18
Table 2-7 Fraction of Clay Sized Particles Within Particle Classes for Example Problem 2.2	2 - 18
Table 2-8 Mass of Sediment Trapped and Discharged for Example Problem 2.2	2 - 19
Table 2-9 Mass of Settleable Nutrients for Example Problem 2.2	2 - 20
Table 3-1 Determination of Quiescent Settling for Retention Pond of Example Problem 3.2	3 - 11
Table 3-2 Determination of Dynamic and Combined Trapping Efficiency for Retention Pond of Example Problem 3.2	3 - 11
Table 3-3 Comparison of Trapped and Discharged Sediment and Pollutants for Detention Basin versus Retention Pond	3 - 12
Table 3-4 Example Isotherm Values for Coastal South Carolina	3 - 12
Table 3-5 Hydrologic and Hydraulic Design Criteria for Standard Extended Detention Wet Pond System	3 - 19
Table 3-6 Recommended Criteria for Wet Pond Design for Nutrient Removal	3 - 20
Table 4-1 Hydrologic Soil Properties Classified by Soil Texture	4 - 9
Table 5-1 Hazard Classification Based on Depth of Overtopping of Downstream Roads	5 - 3

Acronyms and Abbreviations

APWA	= American Public Works Association
ASCE	= American Society of Civil Engineers
BMP	= Best Management Practice
BOD	= Biochemical Oxygen Demand
CERCLA	= Comprehensive Environmental Response, Compensation and Liability Act
CZARA	= Coastal Zone Act Reauthorization Amendments
CZMA	= Coastal Zone Management Act
COD	= Chemical Oxygen Demand
CREAMS	= A field scale model for Chemicals, Runoff, and Erosion from Agricultural Management Systems
CUHP	= Colorado Urban Hydrograph Procedure
CWA	= Clean Water Act
CZARA	= Coastal Zone Act Reauthorization Amendments
CZMA	= Coastal Zone Management Act
DCIA	= Directly Connected Impervious Area
EIS	= Environmental Impact Statement
EPA	= Environmental Protection Agency
EPT	= Ephemeroptera (mayflies), Plecoptera (stoneflies) and Trichoptera (caddisflies)
ESA	= Endangered Species Act
EMC	= Event Mean Concentration
FBI	= Family Biotic Index
FEMA	= Federal Emergency Management Agency
FIFRA	= Federal Insecticide, Fungicide and Rodenticide Act
FWPCA	= Federal Water Pollution Control Act
HPA	= Hydraulic Project Approval
HSPF	= Hydrologic Simulation Program Formulation
ILLUDAS	= The Illinois Urban Area Simulator
IPM	= Integrated Pest Management
IDF	= Intensity Duration Frequency
MDE	= Maryland Department of the Environment
MEP	= Maximum Extent Practicable
MS4	= Municipal Separate Storm Sewer System
MTBE	= Methyl Tertiary Butyl Ether
MUSLE	= Modified Universal Soil Loss Equation
NEPA	= National Environmental Policy Act
NGPE	= Native Growth Protection Easement
NMFS	= National Marine Fisheries Service
NOAA	= National Oceanographic and Atmospheric Administration
NPDES	= National Pollution Discharge Elimination Program
NPS	= Non Point Source

NRCS	= Natural Research Council Service
NRDC	= National Resource Defense Council, Inc.
NURP	= Nationwide Urban Runoff Program
OCZM	= Office of Coastal Zone Management
OPA	= Oil Pollution Act
PAH	= Poly Aromatic Hydrocarbons
PSRM	= Penn State Runoff Model
RCRA	= Resource Conservation and Recovery Act
RFS	= Rainfall Frequency Spectrum
RPD	= Rain Point Diagram
RVPD	= Runoff Volume Point Diagram
SBUH	= Santa Barbara Urban Hydrograph
SCS	= Soil Conservation Service
SD	= Settling Depth
SLAMM	= Source Loading and Management Model
SS	= Suspended Solids (also TSS = Total Suspended Solids)
SSP	= Stormwater Site Plan
SUBH	= Santa Barbara Urban Hydrograph
SWM	= Stormwater Management
SWMM	= Stormwater Management Model
SWPPP	= Stormwater Pollution Prevention Plan
TESC	= Temporary Erosion and Sediment Control
TIA	= Total Impervious Area
TMDL	= Total Maximum Daily Loads
TPH	= Total Petroleum Hydrocarbons
TN	= Total Nitrogen
TP	= Total Phosphorus
UDFCD	= Urban Drainage Flood Control District
USDA	= U.S. Department of Agriculture
USFWS	= U.S. Fish and Wildlife Service
USGS	= U.S. Geological Survey
WAC	= Washington Administrative Code
WEF	= Water Environment Federation
WERF	= Water and Environment Research Foundation
WEPP	= Water Erosion Prediction Model
WMS	= Watershed Modeling System
WQS	= Water Quality Standards
WSDOT	= Washington State Department of Transportation
WWF	= Wet Weather Flow

Acknowledgments

These stormwater management control practices, or best management practices (BMPs) design guidelines were prepared by Ecosite, Inc. under a contract with the Urban Watersheds Management Branch, Water Supply and Water Resources Division, National Risk Management Research Laboratory, Edison, New Jersey.

A major undertaking of this type requires the dedication and cooperation of many individuals. The technical direction and coordination for this project was provided by the technical project team of the Urban Watershed Management Branch, under the direction of Mr. Thomas P. O'Connor, the technical project officer. Many members of the branch assisted in making this product available to the public. Special recognition is also extended to the other members of the branch, which included:

- Mr. Daniel Sullivan, P.E., Former Branch Chief (retired)
- Mr. Richard Field, P.E., Senior Advisor
- Dr. Dennis Lai, P.E., Senior Engineer
- Mr. Michael Borst, P.E., Senior Engineer
- Mr. Evan Fan, P.E., Senior Engineer (retired)
- Dr. Ariamalar Selvakumar, P.E., Environmental Engineer

The Ecosite project team included Michael L. Clar, P.E., project manager, and Dr. Bill Barfield, P.E., Professor Emeritus, Oklahoma State University.

Thanks to the external peer reviewers Gene Driscoll, P.E. and Ben Urbonas, P.E. and Office of Water Jesse Pritts, Norbert Huang and King Boynton. Dr. Swarna Muthukrishnan checked example problem calculations. Judy Norinsky and Jatu Bracewell edited the final draft. Carolyn Esposito and Asim Ray performed QA review.

The objective of the project was to identify and build upon existing guidance documents scattered throughout the United States. A number of excellent publications were identified and have been referenced extensively throughout this document. The authors wish to acknowledge the previous work and contributions in the field of stormwater management of the following organizations:

- U.S. Environmental Protection Agency
- Urban Water Resources Research Council, American Society of Civil Engineers
- U.S. Federal Highway Administration
- Water Environment Federation
- Maryland Department for the Environment
- Denver Urban Drainage and Flood Control District.

EXECUTIVE SUMMARY

As this document is being published by U.S. Environmental Protection Agency's Office of Research and Development, its primary focus is not the promulgation of regulation or the enforcement of policy. Instead, this is a forward looking document that tries to develop ways to address water quality issues of best management practices (BMPs) in the absence of a complete regulatory framework. The intended audience for this document are the municipal planners, regulators and watershed managers who will be deciding how BMPs will be applied in their locality.

In the past, BMP models were purely hydrologic; now they require two components: hydrology and quality. The purpose of this document is two-fold:

1. to present the state-of-the-practice for BMP design for water quality control
2. to aid the end user in making better choices.

This document is the third volume of a three-volume series that provides guidance on the selection and design of stormwater management BMPs. The first volume provides general considerations associated with the selection and design of BMPs.

Volume 2 provides specific design guidance for a group of onsite BMP control practices that are referred to as vegetative biofilters and includes the following BMP control practices:

- grass swales
- filter and buffer strips
- bioretention cell.

This volume provides specific guidance for pond type BMPs, which are the most widely used type of BMP. The pond types that are covered include:

- extended detention basins (dry)
- retention ponds (wet)
- constructed wetland ponds
- infiltration basins.

Volume 2 is also the only volume that contains the full storm routing which is applicable to all treatment controls detailed in Volume 2 and 3.

The purpose of this three-volume series is to guide the selection of BMPs that will be effective in preventing or mitigating the adverse impacts of urbanization either through retrofitting of existing BMPs or application of newly constructed BMPs to new development. There is sufficient evidence to indicate that urbanization is causing environmental impacts. Existing BMP technologies can resolve some of the impacts. There are continuing innovative BMP efforts such as bioretention, infiltration basins and low impact development that are being pursued at the research level and in some actual applications, which should improve our ability to reduce or prevent impacts due to urbanization and land-use changes.

The authors have also developed a spreadsheet tool - Integrated Design and Assessment for Environmental Loadings (IDEAL) - which can aid the reader in examining the hydrology, sedimentology and water quality for BMP devices. Aspects of the capabilities of the IDEAL spreadsheet tool are demonstrated through the use of relevant equations for BMP water quality design and several examples as presented in Volume 2 and Volume 3.

Section One Introduction to Basin BMP Types and Selection Guidance

Introduction

This manual is Volume 3 of a three volume document that provides guidance on the design of best management practices (BMPs) for the mitigation of the environmental impacts to receiving waters associated with urban runoff. Volume 1 presents general design considerations associated with the selection and use of BMPs. Volume 2 presents design considerations related to the use of vegetative biofilters. This volume provides design guidelines for a group of stormwater management (SWM) BMPs broadly referred to as basins or ponds. The objectives of these guidance manuals are to provide practical design guides that when followed, result in SWM BMPs facilities that maximize pollutant removal and flood control.

Basin or pond BMPs are the mainstay of SWM. Water resources engineers have designed small and large ponds for many years for a wide range of applications, including farm ponds, recreational ponds, water supply reservoirs, flood control reservoirs and multiple uses reservoirs. Our collective knowledge of ponds, their design, construction, operation and maintenance is extensive. However, their use for environmental protection purposes including stream channel protection, water quality treatment and protection of receiving waters is a recent development, and in many instances requires reassessing the traditional applications of pond design techniques to meet these new objectives. This volume provides this type of assessment and guidance related to the design of pond BMPs for environmental protection purposes.

Section 1 of this volume provides an introduction to various pond BMP types and the selection of the appropriate pond BMP type. Selection guidance is provided with respect to a number of selection factors that include: 1) impact area, 2) watershed factors, 3) terrain factors, 4) stormwater treatment suitability, 5) physical suitability factors and 6) community and environmental factors.

Section 2 provides criteria for designing dry detention BMPs. Criteria are provided for sizing the required pond volume, basin configuration, outlet protection, vegetative cover and other considerations.

Section 3 provides criteria for the design of wet retention ponds. Guidance is provided for the following design parameters: pool volume, pool depth, surface area of permanent pool, minimum drainage area and pond volume, side slopes, pond configuration, outlets, and other considerations. Criteria are also provided for the design of wetland ponds. These criteria include: general feasibility, conveyance, pretreatment, treatment and maintenance.

Section 4 provides criteria for the design of infiltration ponds. Design criteria are provided for the following elements: general feasibility, conveyance, pretreatment, treatment and maintenance. In addition design procedures address the following elements: soil texture, hydrologic design methods and sizing procedures for infiltration pond design.

Section 5 provides construction specifications for pond BMPs. The specifications address the following elements;

embankments, spillways, pipes, valves, plant materials and riprap.

Section 6 provides guidance regarding inspection and maintenance considerations for pond BMPs. The following topics are described: inspection responsibility and contents of inspection reports, aesthetic and functional maintenance requirements, and access requirements. In addition some guidance is provided relating how to design pond BMPs to minimize the maintenance requirements.

Background

For the purposes of this guidance document, pond BMPs are grouped into three types: 1) dry basins, including detention ponds and extended detention basins, 2) wet ponds, including both wet detention basins and retention ponds and 3) infiltration basins.

Detention and Extended Detention Basins

Detention of urban stormwater runoff began appearing as an urban SWM practice in the late 1960s in North America, to control runoff peaks from new land development sites. Figure 1-1 shows a typical detention basin. While many jurisdictions initially applied this approach to control the 10-, 25-, 50-, or 100-yr storm flow rates, a small number of jurisdictions, including Montgomery County and Prince George's County, Maryland, also mandated detention to control the 2-yr peak flow rate for stream bank erosion control purposes (as discussed in Volume 1, this policy has not been able to achieve the objective of stream channel protection). Extended detention for stormwater quality began to be used for new installations of extended detention ponds or as retrofits of old dry ponds. By the late 1980s, sufficient empirical data were available to design extended detention basins for water quality purposes with reasonable confidence in their performance. Extended detention refers to a basin designed to *extend* detention beyond that required for stormwater control to provide some water quality affect.

Extended detention basins are viable and effective treatment facilities. When properly designed, significant reductions are possible in the total suspended sediment load and of constituents associated with these sediments. Typically these basins are less effective in removing soluble solids. Figure 1-2 illustrates the elements of a typical extended detention basin. The amount of reduction depends on a wide variety of factors, including:

- surface area of the basin
- peak outflow rate
- size distribution of the particles
- specific gravity of particles
- fraction of the sediment that is active clay
- type of associated pollutant concentrations
- fraction of influent solids that are colloidal, dissolved and or unsettleable.

The manner in which these characteristics impact performance is described in Section 2.

Extended detention basins will sometimes have a small permanent pool below the invert of the low flow outlet. This is normally so small that it does not materially impact trapping of sediment and chemicals, and is typically included for aesthetics or to cover deposited sediments.



Figure 1-1 Typical Dry Basin

Regional facilities often offer economies of scale and greater reliability in capturing stormwater, while on-site facilities offer institutional and fiscal advantages of implementation as the land is urbanized. Other advantages and disadvantages of regional and on-site facilities are described in Section 5 of Volume 1.

Because of the poorly documented stormwater pollutant control effectiveness of detention basins designed for flood control, these basins cannot themselves be recommended as viable water quality control measures (Moffa et al., 2000). However, detention basins can be effective when used in conjunction with other upstream stormwater control practices such as swales, filter strips and biofiltration BMPs covered in Volume 2.

Wet/Retention Ponds

A retention pond is a small artificial lake with emergent wetland vegetation around the perimeter, designed to remove pollutants from stormwater. This BMP is sometimes referred to as a “wet pond” or a “wet detention basin”. In this manual, it is referred to as a retention pond to distinguish it from the extended detention basin described in the previous section. Removal rates of solids by retention ponds, tend to outperform detention basins. The larger permanent pool of retention basins allows water to reside in the interval between storms, when further treatment occurs. A retention pond can be sized to remove nutrients and dissolved constituents, while any pool that may be associated with an extended detention basin is smaller and is provided for aesthetics, as discussed under the extended detention discussion above. Figure 1-3 illustrates the elements of a wet/retention pond.

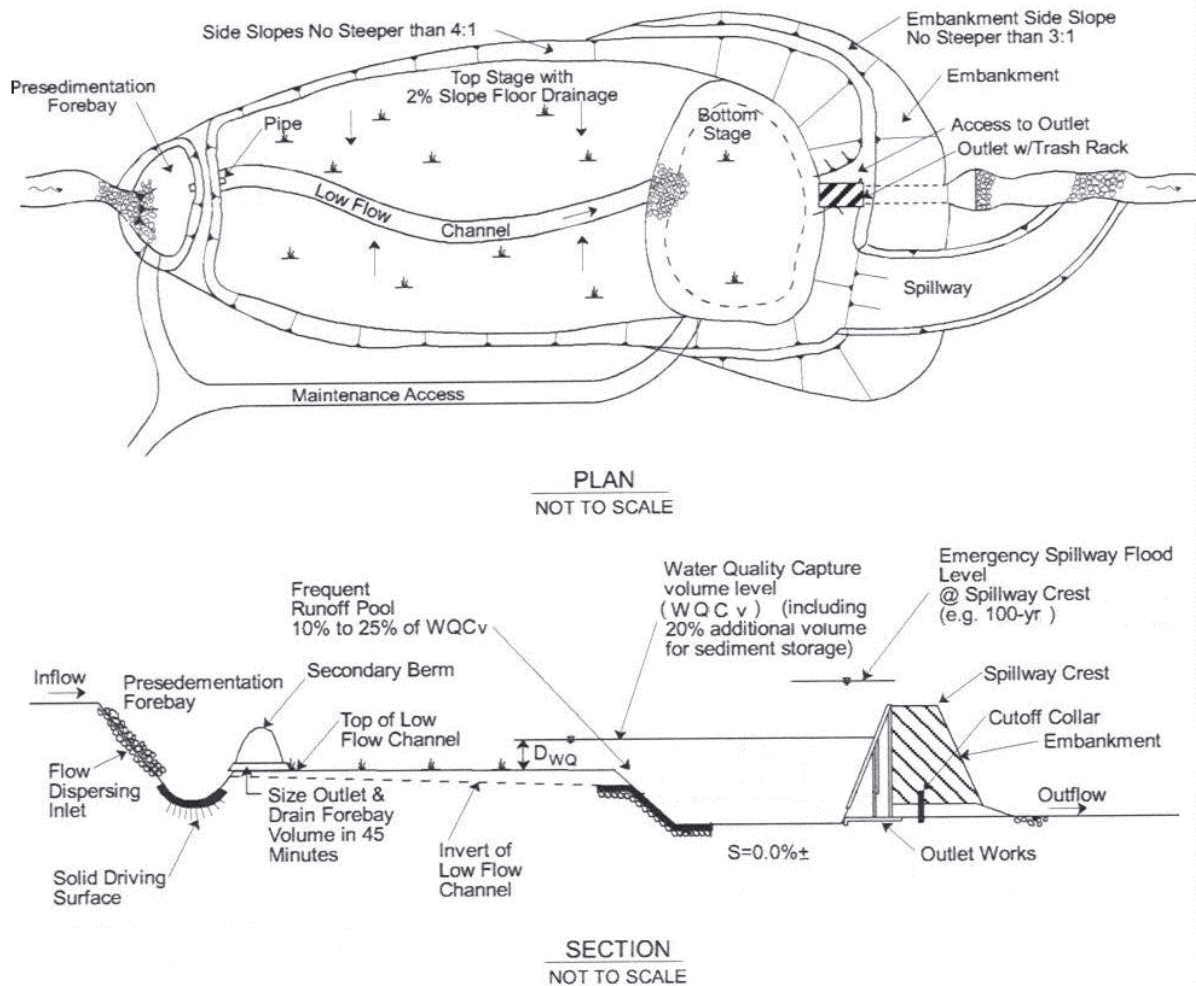

Figure 1-2 Extended Detention Basin, Typical Detail (modified from UDFCD, 1999)

Infiltration Basins

Infiltration basins are detention ponds constructed to allow infiltration to occur simultaneously with other treatment processes. Figure 1-3 provides a typical detail for an infiltration basin. The operating characteristics of infiltration basins are essentially the same as for dry detention, with a few significant exceptions:

- Infiltration basins also remove dissolved solids in the volume of infiltrated water, whereas dry detention basins do not remove dissolved solids.
- The settling velocities of the particles are increased by a value equal to the infiltration rate in the basin. The impact would, of course be more important for the clay-sized particles than for silt, sand, and small or large aggregates.
- Infiltration practices differ from typical dry basins because they have the ability to meet the groundwater recharge requirements (V_R) (described in Appendix C Volume 1), and therefore provide an additional element of control or performance.

- Because they can provide volume control, infiltration basins can effectively address the issues of increased frequency and duration of peak flows that are important in providing downstream channel protection.
- Because they operate by infiltration of runoff into the subsurface soils, infiltration basins are able to prevent the thermal impacts issues associated with extended detention and retention ponds.

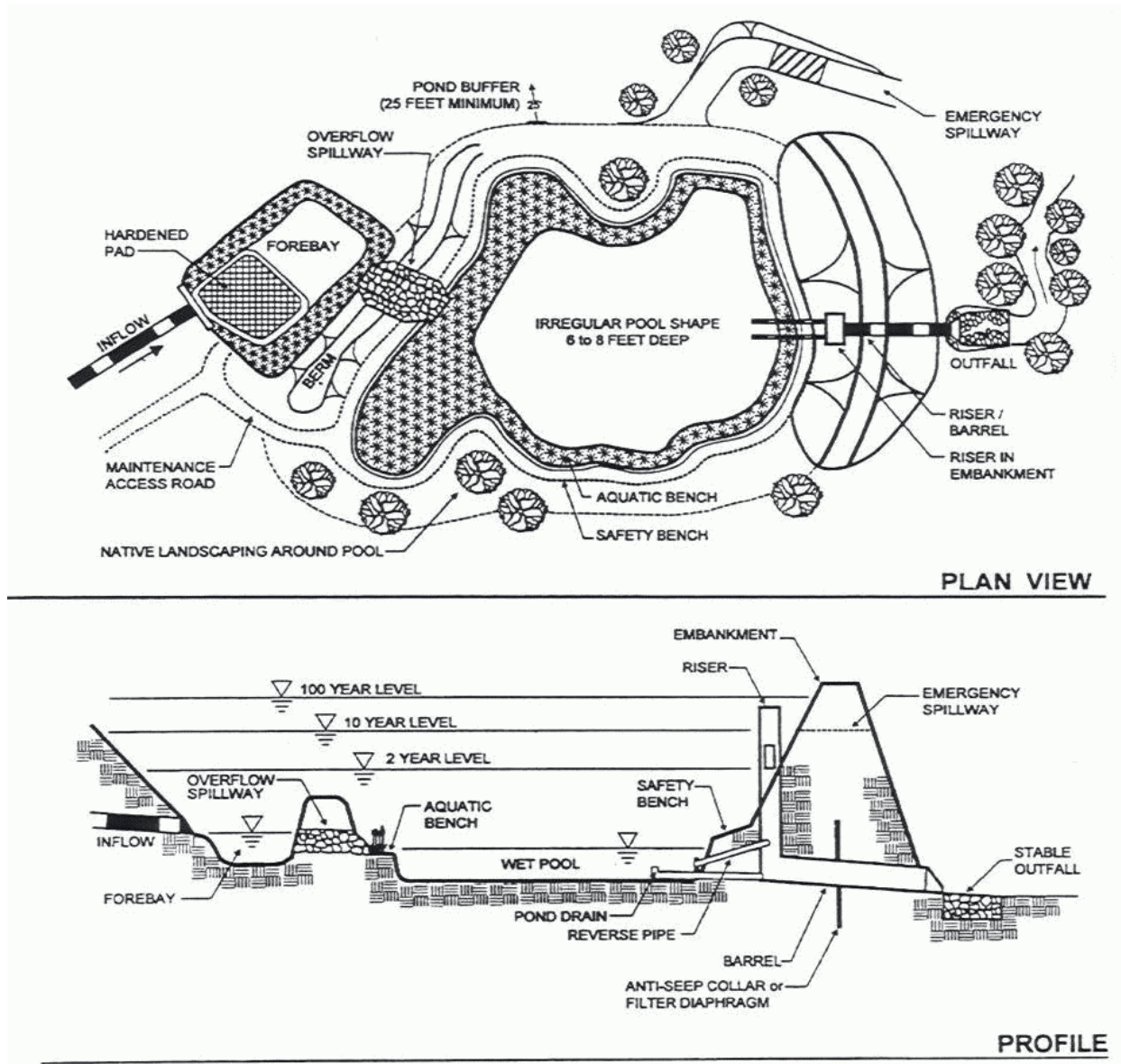
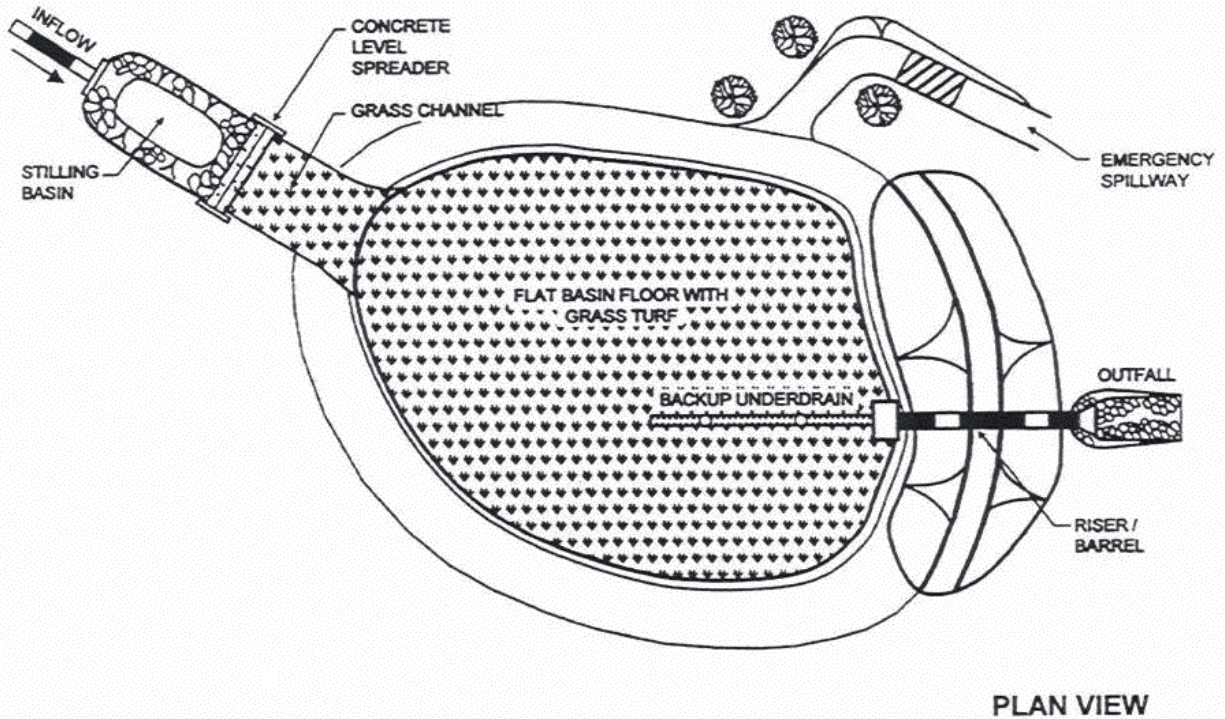
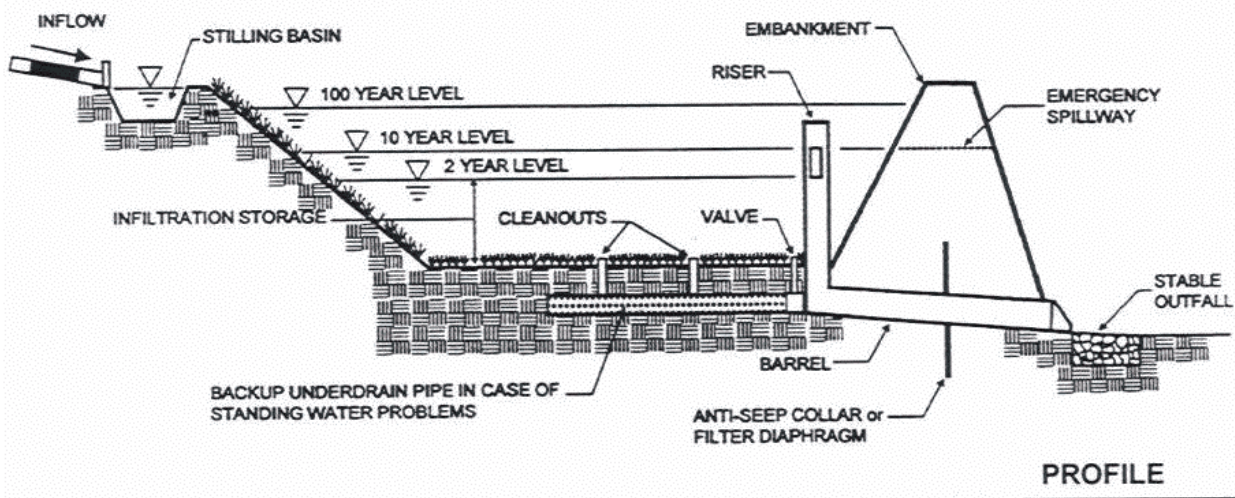

Figure 1-3 Wet Pond (modified from MDE, 2000)



PLAN VIEW



PROFILE

Figure 1-4 Infiltration Basin (MDE, 2000)

Selection Considerations for Pond BMPs

There are a number of factors and considerations that can help to identify the appropriate pond BMP for a given site. These factors can be grouped as listed below:

- impact area
- watershed factors
- terrain factors
- stormwater treatment suitability
- physical feasibility factors
- community and environmental factors
- locational and permitting factors.

Impact Area

Section 2 of Volume 1 identified and grouped the major impact areas associated with urban stormwater runoff. These major areas of impact included:

- physical impacts
 1. flooding
 2. channel erosion
 3. ground water recharge and base flow maintenance
 4. thermal (increase in stream temperatures)
- chemical impacts
- habitat and biological impacts

Table 1-1 provides a relative assessment of the ability of the three pond BMP types to address these impacts.

Watershed Factors

Five watershed factors for BMP suitability were identified and described in Section 5 of Volume 1. These include:

1. coldwater streams
2. sensitive streams
3. wellhead protection
4. reservoir protection
5. shellfish/beach

Table 1-2 provides a summary assessment of the suitability of pond BMPs with respect to the watershed factors discussed above.

Table 1-1 Pond BMP Types vs. Ability to Control Impacts

Impact Area	Dry/Extended Detention Basins	Wet/Retention Pond	Infiltration Basin
Physical Impacts			
<i>Peak Discharge & Flooding</i>	Yes ¹	Yes ¹	Yes ¹
<i>Channel Erosion</i>	Design Dependent ²	Design Dependent ²	Yes ³
<i>Groundwater Recharge/Base Flow</i>	No	No	Yes
<i>Thermal Impacts</i>	No ⁴	No ⁴	Yes
Chemical Impacts	Yes ⁵	Yes ⁶	Yes ⁷
Habitat & Biological Impacts	Design Dependent ²	Design Dependent ²	Yes ⁸

NOTES:

- (1) Pond BMPs use peak discharge control strategies to discharge at pre-development release rate. A downstream analysis should be conducted far enough downstream to ensure that super positioning of peaks will not result in aggravated downstream flooding conditions.
- (2) To date, pond BMPs using peak discharge control of 2-yr storm have been demonstrated to be ineffective in controlling channel erosion. The State of Maryland (MDE, 2000) has now adopted a channel protection control strategy based on providing extended detention control of the 1-yr pre-development storm Policy is currently under evaluation. **In general for erosion and habitat and biological impacts, effectiveness is subject to the design, size of the targeted storm, the holding period for the volumes captured and the nature of the receiving water.** Refer to discussion of peak discharge control strategies and channel protection in Section 4 of Volume 1.
- (3) Infiltration basin may be effective in providing channel erosion protection, depending on the volume of the design storm that is infiltrated.
- (4) Extended detention basins and wet ponds have been documented to increase thermal impacts to receiving streams.
- (5) Dry and extended detention ponds do provide pollutant removal but the removal efficiency performance is highly variable.
- (6) Wet and retention ponds provide much better pollutant removal efficiency than dry ponds.
- (7) The infiltration basins can provide the highest pollutant removal effectiveness of all pond BMPs. While the potential for groundwater contamination from stormwater infiltration facilities is a valid concern, there is limited documentation of groundwater contamination from infiltration facilities. Wilde (1994) showed breakthrough of metals to groundwater from stormwater impoundments. Pitt et al. (1994) discuss the potential for contamination in much further depth.
- (8) Infiltration basins can reduce the level of impact to habitat and biological areas because they address base flow maintenance, thermal impacts, and reduced channel erosion impacts.

Table 1-2 Pond BMP's Suitability to Address Watershed Factors

Watershed Factor	Dry/Extended Detention Pond	Wet/Retention Pond	Infiltration Basin
Cold Water Stream	May be restricted due to thermal impacts Offline design recommended	Restricted due to thermal impacts Offline design recommended Maximize shading of open pool areas	Yes, if site has suitable soils
Sensitive Stream	May be limited due to channel erosion impacts*	May be limited due to channel erosion impacts	Yes, if site has suitable soils
Groundwater Protection	May require liner if A soils are present Pre-treat hot spots	May require liner if A soils are present Pre-treat hot spots	Requires safe distance from wells & water table Pre-treat hot spots
Reservoir Protection	May be limited due to channel erosion May require additional volume control	May be limited due to channel erosion May require additional volume control	Safe distance from bedrock & water table
Shellfish / Beach	May be limited due to low pollutant removal	Moderate bacteria removal design may be required	Requires safe distance to water table

* Longer release times (i.e., smaller discharges) may limit channel erosion but increase potential thermal impacts.

Terrain Factors

Three key factors to consider are low-relief, karst and mountainous terrain. Special geotechnical testing requirements may be needed in karst areas (see Appendix F of Volume 1). Table 1-3 summarizes key issues that need to be considered for each BMP type with respect to the three terrain factors.

The type of structure used can be influenced by terrain factors. For example, in very flat areas, it is difficult to construct a basin with a dam as would be possible in a steeper watershed. In the case of the flatter areas, it may be necessary to construct the basin by excavation. Also, the type of outlet can be controlled by the terrain with drop inlets in steeper slopes but weir and open channel outlets favored for flat terrain.

Stormwater Treatment Suitability

Retention ponds can be superior to extended detention basins for the control of nutrients in urban stormwater. While detention basins rely on solids-settling processes, retention ponds remove dissolved nutrients through several physical, chemical and biological processes in the permanent pool. Table 1-4 shows a comparison of removal efficiencies of properly sized retention ponds and extended detention basins using data from EPA (1983). In addition, petroleum hydrocarbon removals are similar to those of total suspended sediments. Stahre and Urbonas (1990) summarize data from a variety of sources and develop the second data set in Table 1-4. The trapping efficiencies for nitrogen are significantly lower than reported in the EPA study. This data is supplemented by the data provided in the ASCE (2001) publication, "Guide for Best Management Practice (BMP) Selection in Urban Developed Areas." Recent results (Strecker et al., 2002) may indicate that differences in performance between detention and retention may not be statistically significant (refer to Volume 1 Appendix E about further discussion of BMP performance).

Retention ponds are most appropriate where nutrient loadings are of concern, especially in the following situations:

- Watershed tributaries to reservoirs and lakes: retention ponds in the watershed can help achieve eutrophication management goals in downstream reservoirs and lakes.
- Watershed tributaries to tidal embankments and estuaries: nutrient loadings into estuarine systems is a growing concern in coastal areas, including upland areas that drain into tidal waters. Retention ponds can help reduce the nutrient loads.

Table 1-3 BMP Selection - Influence of Terrain Factors

Terrain Factor	Dry/Extended Detention Pond	Wet/Retention Pond	Infiltration Pond
Low Relief	May be limited by depth to water table	May be limited by depth to water table	May be limited by depth to watertable
Karst	Geotechnical testing required May require liner Ponding depth may be limited	Geotechnical testing required May require liner Ponding depth may be limited	May be prohibited Check w/ local authority
Mountainous	Embankment heights restricted	Embankment heights restricted	Max slope 15%

Table 1-4 Comparison of Pollutant Removal Percentages by Basin BMP Designed for Water Quality Control

Type of Pond	TSS	Nitrogen	Phosphorus	Lead	Zinc	BOD
Dry, Extended Detention	50 - 80	0 (Dissolved) 10 - 30 (Total)	0 (Dissolved) 10 - 50 (Total)	35 - 80	35 - 70	20 - 40
Wet / Retention	70 - 85	50 - 70 (Dissolved) 30 - 40 (Total)	50 - 70 (Dissolved) 50 - 65 (Total)	25 - 85	25 - 85	20 - 40
Infiltration	60 - 98	60 - 98 (Total)	60 - 98 (Total)	60 - 98	6 - 98	N/A

Source: [U.S. EPA (1983); Stahre and Urbonas (1990); ASCE (2001)]

Removal of nutrients has a price: the permanent pool of a retention pond requires two to seven times more volume than an extended detention basin, depending on local meteorology. The larger volume requires larger structures and more land than detention basins, resulting in costs of facilities that are 50 to 150% more than for extended detention basins. If, however, the facility requires overlying storage for flood control peak-shaving, cost increases become smaller as the flood control volume and benefits get larger. Table 1-5 summarizes design criteria for a regional SWM master plan for Fairfax County, VA and exemplifies the relative difference in size for retention ponds and extended detention basins for this region of the U.S.

Table 1-5 Comparison of Detention Storage Requirements in Fairfax County, VA: Permanent Pool Retention Pond Versus Extended Detention Basin

Land Use	Imperviousness %	Retention Pond ^a (in.)	Extended Detention ^b (in.)
<i>Low-density single family</i>	20	0.7	0.1
<i>Medium-density single family</i>	35	0.8	0.2
<i>Multi-family residential</i>	50	1.0	0.4
<i>Industrial Office</i>	70	1.2	0.5
<i>Commercial</i>	80-90	1.3	0.8

^a Retention pond pool volume (watershed in.) is based on an average hydraulic retention time of 2 weeks

^b Extended detention volume is based on the capture of first-flush runoff

Physical Feasibility Factors

The physical suitability factors were described in Volume 1. The six primary factors are:

- Soils
- Water Table
- Drainage Area
- Slope Restriction
- Head
- Highly Impervious Urban Sites

Table 1-6 cross-references testing protocols needed to confirm physical conditions at the site.

Soils

The key evaluation factors are based on an initial investigation of the USDA hydrologic soils groups (HSG) at the site. Note that more detailed geotechnical tests are usually required for infiltration feasibility, and during design to confirm permeability and other factors.

Highly permeable soils may not be acceptable for retention ponds because of excessive drawdown during dry periods. Where permeable soils are encountered, exfiltration rates can be minimized by scarifying and compacting a 0.3-m (12-in.) layer of the bottom soil of the pond, incorporating clay to the soil, or providing an artificial liner. Excavating the permanent pool into the groundwater table can also ensure its permanency, but seasonal fluctuations in the groundwater table need to be taken into account.

Infiltration basins must be built in soils with high infiltration rates. Alternately, if impervious layers are present, soils can be removed and replaced with more permeable materials that penetrate to a pervious layer. Under drains beneath the pervious soil are also a possibility.

Measurements of bulk density and infiltration rates were conducted both in situ, and on reconstituted samples prepared by the USDA, NRCS National Soil Mechanics Center for soils in a highly disturbed area, i.e., by heavy equipment, and in pasture, in an area of good hydrologic condition. The results show that as soil bulk density increases to 1.65 g/cm³, infiltration rates of the soil decrease rapidly. When the bulk density increases above 1.65 g/cm³, infiltration rates decline slowly, approaching zero. The measured infiltration rates for disturbed soils with high bulk densities were significantly lower than expected (OCSCD et al., 2001). Ocean County, New Jersey, which is in the coastal plain has adopted the following specifications for detention/infiltration basins: a bulk density in the basin bottom of 1.45 g/cm³ or lower and

a permeability rate of 10 in/hr or higher (Friedman, 2004).

Water Table

This column indicates the minimum depth to the seasonally high water table from the bottom or floor of a BMP.

Drainage Area

This column indicates the recommended minimum or maximum drainage area that is considered suitable for the practice. If the drainage area present at a site is slightly greater than the maximum allowable drainage area for a practice, some leeway is permitted or more than one practice can be installed. The minimum drainage areas indicated for ponds and wetlands are flexible depending on water availability (baseflow or groundwater), or the mechanisms employed to prevent clogging.

Dry detention and extended detention basins can be constructed at most sites. In some cases, they can be designed to serve a dual purpose such as playgrounds or landscape feature. For a wet pond to be a desirable option, a reliable source of runoff or ground water must be available to maintain the volume of the permanent pool. Wet pond basins are most suitable for moderate to large drainage areas, often greater than 20 acres. A wet pond basin is an appropriate water quality practice in residential and commercial areas where nutrient loadings are expected to be high.

Slope Restriction

This column evaluates the effect of slope on the practice. Specifically, the slope restrictions refer to how flat the area where the practice may be.

Head

This column provides an estimate of the elevation difference needed at a site (from the inflow to the outflow) to allow for gravity operation within the practice.

Urban Centers

Few BMPs work well in the urban environment with highly impervious location because space is limited and the original soils have been disturbed.

Table 1-6 BMP Selection - Physical Suitability Factors (Modified from MDE, 2000)

BMP	Soils	Water Table	Drainage Area	Slopes	Head	Highly Impervious Urban Sites
Ponds - Wet - Dry	"A" soils may require liner "B" soils may require testing	4 ft ¹ if Hotspot or Aquifer	25 acre minimum ² for wet pond	None	6 to 8 ft wet ³ 4 ft dry ³	Not practical (Area required)
Infiltration Basin	0.52 in./hr min 1.45 g/cm ³ bulk density maximum	4 ft	5 acre maximum 10 acre maximum	15 % maximum	1 ft 3 ft	Not practical

¹ Separation distance to the seasonally high water table elevation.

² Unless adequate water balance and anti-clogging device installed.

³ See Section 5 about definition of embankment and hazard classification.

Community and Environmental Factors

In configuring an extended detention basin an effort should be made to make these facilities an integral part of the community. Factors that should be considered include multiple uses, aesthetics, safety and the way the facility will fit into the urban landscape. Also, maintainability is an important consideration. Although these basins provide passive

treatment with no operational attention, continued successful performance will depend on good maintenance. Adequate maintenance access should be provided.

Retention ponds offer a number of aesthetic advantages. They typically are more attractive than extended detention basins and are considered property value amenities in many areas since sediment and debris accumulate within the permanent pool and are out of sight. The larger surface pool area can be an aesthetic amenity in itself for many developments.

Wet ponds may be limited as a result of potential heating of permanent pool during summer months and should not be used if the receiving waters are ecologically sensitive to temperature change, i.e. warming.

The channel that receives the discharge from the basin's outlet should be protected from erosive discharge velocities. Options include riprap lining of the channel, the provision of stilling basins, check dams, rock deflectors, or other devices to reduce outfall discharge velocities to non erosive levels.

Location and Permitting Factors

Section 5 of Volume 1 provides a condensed summary of current BMP restrictions as they relate to common site features that may be regulated under local, State or federal law. These restrictions fall into one of three general categories:

- Locating a BMP within an area that is expressly prohibited by law.
- Locating a BMP within an area that is strongly discouraged and is only allowed on a case by case basis. Local, State and/or federal permits shall be obtained and the applicant will need to supply additional documentation to justify locating the BMP within the regulated area.
- BMPs must be setback a fixed distance from the site feature.

One potential constraint on the use of retention ponds as regional BMPs is that federal regulations may restrict the filling of wetland areas, and the Section 404 permit program regulating any wetland or retention pond constructed for stormwater management. Although retention pond BMPs typically are designed to enhance pollutant removal by incorporating wetland areas along the perimeter, regulatory agencies may restrict their use if a significant amount of native wetlands will be submerged within the permanent pool. In addition, restorative maintenance of the created wetland areas, which includes removal of silt, may require a Section 404 permit. It is important to check with the local offices of the federal regulatory agencies, such as the U.S. Army Corps of Engineers and State regulators, about the need for such permits.

Potential wetlands constraints must be addressed on a case-by-case basis during final design of each retention pond facility. If field inspections indicate that a significant wetlands area will be affected at a particular site, the following options can be pursued during final design:

- investigate moving the embankment and permanent pool upstream of the major wetland area
- if the above option is unfeasible, a wetland mitigation plan can be developed as a part of the retention pond design.

If neither of the above options results in an acceptable design, consider using an extended detention basin.

Section Two Dry Detention Basins -Design Criteria

Introduction

Dry detention basins are part of a family of SWM practices known as detention practices that “detain” runoff typically based on a selected design frequency of storm and then discharge the runoff at the pre- development peak discharge rate. Detention practices can be classified as dry detention or extended dry detention. This section addresses dry and extended detention basins or ponds. Figure 2-1 provides a view of a typical dry detention basin.



Figure 2-1 Typical Dry Pond (UDFCD, 1999)

Detention of urban stormwater runoff began to appear as an urban SWM practice in the late 1960s in North America, and was followed a few years later in Europe, and Australia to control runoff peaks from new land development sites. This

was initially applied by most jurisdictions to control the 10-, 25-, 50-, or 100-yr flow rates. A small number of jurisdictions, notably Montgomery and Prince George’s counties in Maryland, also mandated detention to control the 2-yr peak flow rate in an attempt to control accelerated stream bank erosion, which was identified as one of the problems associated with rapidly urbanizing areas. Many jurisdictions have since followed this approach, although very little monitoring and assessment has been conducted to determine the success of the approach. As discussed in further detail in Volume 1, a few technical papers and field studies have indicated that the approach has some technical flaws and has not proven as successful as originally hoped.

There is also some concern regarding the effectiveness of detention practices for providing downstream flood control. The design of detention facilities is often confined to the limits of the property for which the facility is being designed without much regard for potential downstream impacts. The issue of super positioning of hydrograph peaks is often overlooked, and yet can result in simply transferring the flood or channel erosion problem to unsuspecting downstream property owners. This issue is discussed in Section 3 of Volume 1.

The use of detention to control stormwater quality began to be used in the early 1980s. By the late 1980s, sufficient empirical data were available to design extended detention basins for water quality purposes with reasonable confidence in their performance. Extended detention basins are best at removing suspended constituents. They are not particularly effective in removing solubles. Also, removal rates of solids by retention ponds tend to outperform detention basins. A comparison of constituent removal efficiencies of extended detention basins and retention ponds was presented in Table 1-4.

Analysis Procedures for Dry Detention Basins

The analysis procedures detailed here and in Sections 3 and 4 are provided as means to calculate the loads discharging from BMPs based on five classes of sediment and include pollutant sorbing to clay particles. Alternative, simpler methods are available that rely on a general sediment load and simplified volume control, e.g., the ASCE/WEF (1998) manual of practice method described in Volume 1. These other methods can be used if this level of detail is not required for sediment routing or pollutant, i.e. nutrient, calculations are not required.

Stormwater Routing

Stormwater routing can serve several purposes, such as:

1. determining the storage volume to match a post construction peak discharge to a predisturbed peak discharge
2. determine whether or not a given structure provides a peak discharge low enough to meet a pollutant loading criteria.

In both cases, the volume of the storm that flows through the pond and the peak discharge - determined for a given stage-area relationship and outlet structure - are critical information.

Volume Routing

The first computation must be routing of volume. For dry detention basins, volume is assumed to be constant; therefore the inflow volume must be equal to the outflow volume. If infiltration becomes important, procedures considered under Section 4 on infiltration basins should be incorporated.

Routing of Discharge

Routing of discharge in a basin must satisfy the continuity equation, given as:

$$dS / dt = q_{in} - q_{out} \tag{2-1}$$

where: S = the storage volume,
 t = time, and
 q_{in} and q_{out} = inflow and outflow discharge rates, respectively.

Detailed routing is accomplished by specifying the discharge and storage as a function of head in the reservoir and solving equation 2-1 numerically. Development of this information normally requires a computer program such as HEC-HMS, SWMM or SEDIMOT II.

Simple Routing Calculation

A simpler approach to routing, and one that yields a reasonable first estimate, is to assume a simple shape for the inflow and outflow hydrographs, and then solve for peak discharge using algebraic relationships. McCuen (1989) summarizes the various shapes that have been assumed and the resulting equations for storage. The most commonly used shape is that of a triangular hydrograph, as shown in Figure 2-2 along with a routed hydrograph. Using this shape, the maximum storage volume becomes:

$$S_{max} = \frac{q_{p,in} - q_{p,out}}{2AConst_5} t_{b,in} \quad (2-2)$$

where: $q_{p,in}$ = the peak inflow rate to a pond in m³/s (ft³/s),
 $q_{p,out}$ = the peak outflow from the pond in m³/s (ft³/s),
 $t_{b,in}$ = the time base of the inflow hydrograph in hr based on a triangular unit hydrograph,
 S_{max} = the maximum storage volume in the reservoir in watershed cm (in.)
 A = watershed area in ha (acre), and
 $Const_5$ = 2.78x10⁻² for metric (1.008 for English) units (originally defined in Volume 2).

The time base of the inflow hydrograph, $t_{b,in}$, is based on the triangular hydrograph assumption and is given by:

$$t_{b,in} = 2QAConst_5 / q_{p,in} \quad (2-3)$$

where: Q = runoff volume in watershed cm (in.).

This can be further simplified to:

$$S_{max} = Q \left(1 - q_{p,out} / q_{p,in} \right) \quad (2-4)$$

In the case of equation 2-4, the units on S_{max} must be the same as Q . Using the triangular hydrograph approximation, a storm can be routed through a pond with the following equation and the peak discharge and storage volume determined, or:

$$Q - S_{max} - q_{p,out} t_{b,in} Const_5 / 2A = 0 \quad (2-5)$$

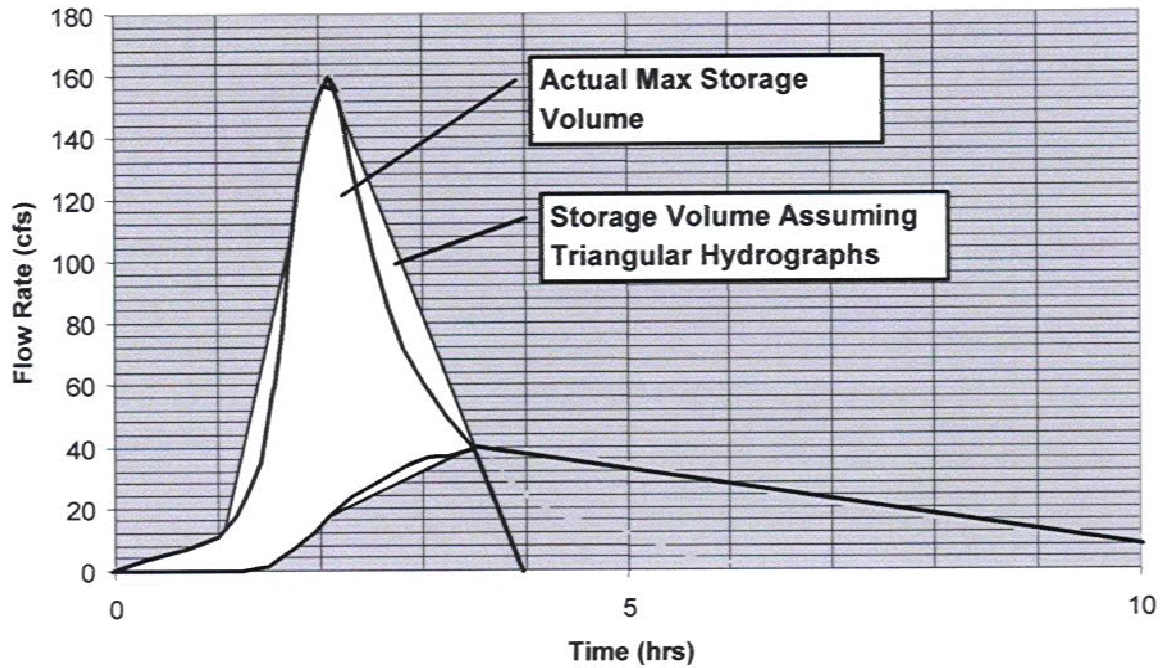

Figure 2-2 Illustration of the Triangular Hydrograph Approximation

Since S_{max} and $q_{p,out}$ are both functions of peak stage during the storm, equation 2-5 can be solved for peak stage and hence S_{max} and $q_{p,out}$. Equations for defining discharge as a function of stage are available in standard hydrology and hydrology references such as Haan et al. (1994) and McCuen (1989). In addition to being used to design the pond for peak discharge control, S_{max} and $q_{p,out}$ are needed for determining sediment and pollutant trapping in the pond.

Simple Detention Time Calculation

Detention time is a representation of the average residence time for a given plug of inflow water and solids. It is necessary to know detention time for bacteria mortality calculations. For steady flow (inflow = outflow) the detention time, T_d , is the time the rate of flow, q , displaces the reservoir volume, V , as represented by:

$$T_d = V / q \quad (2-6a)$$

For variable flow, the flow plugs all have different detention times. Using the triangular hydrograph assumptions and analysis of the centroids of the inflow and outflow hydrographs in Figure 2-3, detention time, T_d , in hr, can be derived as (Haan et al., 1994):

$$T_d = \frac{1}{3} \left[2 \frac{QA_{Const_5}}{q_{p,out}} - t_{r,in} \frac{q_{p,out}}{q_{p,in}} - t_{p,in} \right] \quad (2-6b)$$

where: $t_{r,in}$ = duration of the recession limb of the outflow hydrograph in hr, and

$t_{p,in}$ = is the time to peak of the inflow hydrograph in hr.

Sediment Routing in Extended Detention Ponds

The methods presented below, derived in part for systems that retain a permanent pool of water, are appropriate for retention ponds and for peak discharge of detention basins.

TSS Routing

Routing in a pond can be accomplished with simple procedures or complex computations. Computer models of pond sediment can be obtained that solve the turbulent equations of motion using computational fluid dynamics equations, as can those that use reactor theory to determine trapping (Wilson and Barfield, 1984, 1985; 1986; Ward et al., 1979), and ones that use the simple overflow rate method (Tapp et al., 1986) or the EPA model (Driscoll et al., 1986). Equations that can be used to calculate trapping efficiency typically depend on overflow rate and settling velocity.

For discrete settling, Stoke's Law describes the velocity of an ideal sphere as proportional to the square of the particle diameter. For specific gravity of 2.65 and quiescent settling (low Reynold's number), the settling velocity, V_s , in m/s (ft/s) of small diameter particles, d , in mm, can be described by following simplified equation based on Stokes Law:

$$V_s = \text{Const}_7 d^2 \quad (2-7a)$$

where: $\text{Const}_7 = 0.857$ for metric and 2.81 for English units.

Haan et al. (1994) showed that a good indicator of sediment pond performance could be developed with the overflow rate calculated by using the peak discharge, the pond surface area and the settling velocity corresponding to the d_{15} of eroded sediment.

The discrete settling velocity of large particles can be estimated by a Langrangian polynomial that is fitted through three points of a sedimentation curve in an analysis similar to the approach used to determine Stoke's settling velocity (Wilson et al., 1982). This analysis evaluated the drag coefficient using experimental data for Reynold's number larger than 0.5. The results were:

$$\log_{10} V_s = -0.34246 (\log_{10} d)^2 + 0.98912 (\log_{10} d) + 1.1461 \quad (2-7b)$$

$$\log_{10} V_s = -0.34246 (\log_{10} d)^2 + 0.98912 (\log_{10} d) - 0.33801 \quad (2-7c)$$

where: V_s = cm/s in equation 2-7b and ft/s in equation 2-7c, and
 d = particle diameter mm (for the purposes of example problem > 0.01 mm).

Many factors affect settling velocity, e.g. particle size, aggregation and flocculation. Site specific settling data should be collected if possible. Turbulence, which also alters the settling velocity, is partially addressed by the approach detailed below.

The overflow rate, V_c , which is given by a flowrate through the basin, represented by q_{out} , and the plan area of the basin, A_a :

$$V_c = q_{out} / A_a \quad (2-8a)$$

The overflow rate can also be related to the liquid depth, D , in the basin and T_d , in (s), as follows:

$$V_c = D/T_d \quad (2-8b)$$

This assumes that all sediment with a settling velocity $> V_c$ will be removed with some fraction of all other particles with settling velocities $< V_c$ also being removed.

This approach would be recommended for predicting total sediment trapping, but would not predict the trapping of the varying size fractions as presented in Table 4-8a, Volume 2. Since this information is important for predicting trapping of pollutants other than sediment, it is important to predict the trapping by size classes. An example the simple rate approach is:

$$TE_i = V_{s,i} / (q_{p,out} / A_a) \text{Const}_8 = (V_{s,i} / V_c) \quad (2-9)$$

where: TE_i = the trapping efficiency for particle class i ,
 $q_{p,out}$ = the peak outflow from the pond in m^3/s (ft^3/s),
 A_a = the average surface area of pond in ha (acre) during the storm,
 $V_{s,i}$ = the settling velocity in m/s (ft/s) for particle class i ,
 V_c = the overflow rate in m/s (ft/s), and
 $\text{Const}_8 = 10^{-4}$ for metric and 2.296×10^{-5} for English units.

The impact of dead storage would be including by reducing A_a by a fraction corresponding to the fraction of dead storage. Griffin et al. (1985) showed that the dead storage fraction was 0.18 for ponds with a length to width ratio greater than 2:1 and 0.25 for ponds with a shorter length to width ratio.

An alternative equation was first presented by Hazen in 1904 for describing turbulence in sedimentation tanks (adapted by Driscoll et al., 1986, for retention pond analysis):

$$TE_i = 1 - \left[1 + \frac{1}{n} \frac{V_{s,i} A_a}{q_{p,out} \text{Const}_7} \right]^{-n} \quad n = 1 - \left[1 + \frac{1}{n} \frac{V_{s,i}}{V_c} \right]^{-n} \quad (2-10)$$

where: n = a parameter that indicates the degree of turbulence or short circuiting, which tends to reduce removal efficiency.

The following values are recommended for n :

- 1 - very poor performance,
- 2 - average performance,
- 3 - good performance, and
- 5 - very good performance.

A value of $n = 4$ is ideal performance and the equation reduces to a the familiar solution for a completely mixed tank where efficiency is keyed to detention time, as represented by:

$$TE = 1 - e^{-\left(\frac{V_s A_a}{q_{p,out} \text{Const}_7}\right)} = 1 - e^{-\left(\frac{V_s}{V_c}\right)} \quad (2-11a)$$

A comparison of the predictions is given in Figure 2-3 for various values of n .

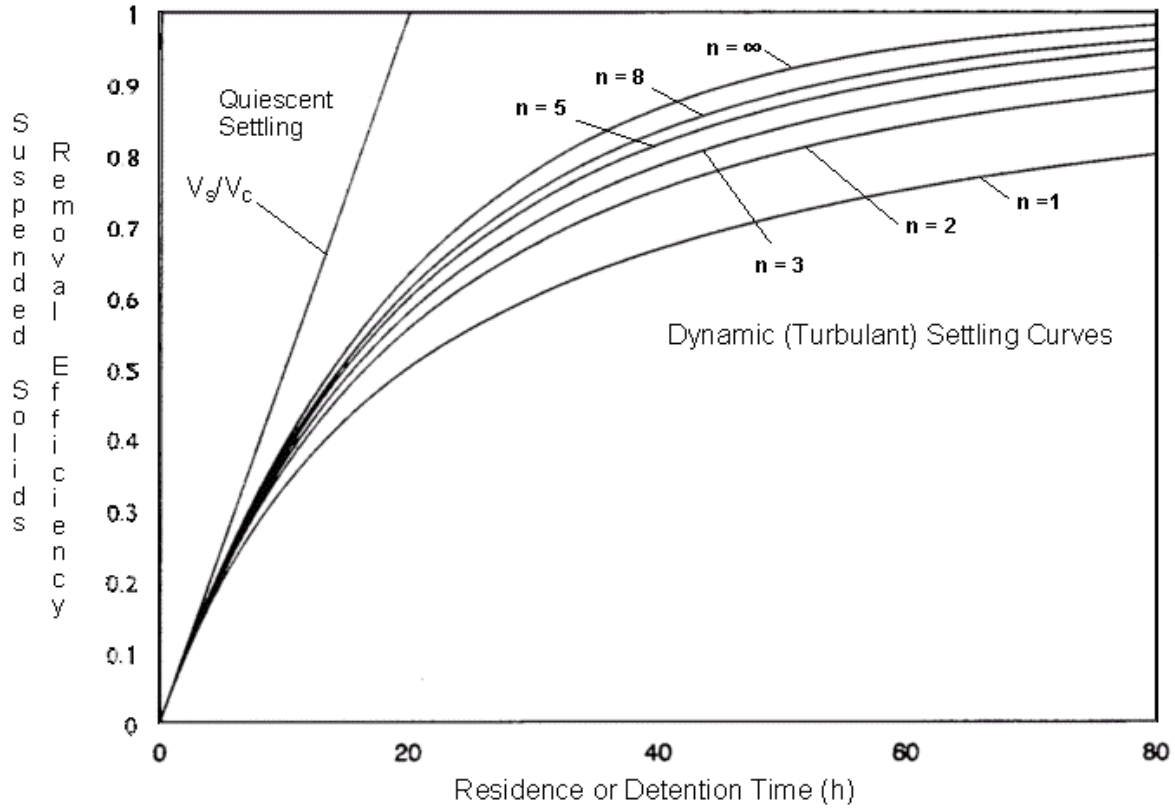

Figure 2-3 Graphical Presentation of Equation 2-9

By substituting v/T_d for $q_{p,out}$, and defining k as a sedimentation rate constant based on settling velocity, V_s , divided by basin depth, h , Equation 2-9a can be rewritten as

$$TE = 1 - e^{-\left(\frac{V_s A_b}{v/T_d}\right)} = 1 - e^{-kT_d} \quad (2-11b)$$

and

$$k = V_s / h \quad (2-11c)$$

Equations 2-11-a and 2-11-b are equivalent and show that trapping efficiency ultimately depends on the settling velocity of the particles present and the detention time. Varying storm flows will have different overflow rates. The IDEAL model incorporated different overflow rates for the calculated peak discharge based on rainfall probability, antecedent moisture conditions and growing season.

Size Distribution Calculations for Discharged and Trapped Sediment

The mass of sediment in any effluent size class i , is given by:

$$M_{D,i} = F_i Y_T (1 - TE_i) \quad (2-12a)$$

$$M_{T,i} = F_i Y_T TE_i \quad (2-12b)$$

where:

$M_{D,i}$ = mass of sediment discharged in kg (lb) for particle size classification i ,

$M_{T,i}$ = mass of sediment trapped in kg (lb) for particle size classification i ,
 Y_T = the total sediment yield from the drainage area in a storm, in kg (lb),
 F_i = the fraction of sediment in a given particle size classification i , and
 TE_i = the trapping efficiency for particle size i .

The yield of sediment and pollutants is discussed briefly at the end of this sub-section. A more complete discussion is available in Section 4 of Volume 2 and the equation presented there should be used for calculation of total yield, Y_T .

The total mass discharged, M_D , and trapped, M_T , for the five size classes (five classes defined in Volume 2, Section 4, Table 4-8) is:

$$M_D = \sum_{i=1}^5 M_{D,i} = Y_T \sum_{i=1}^5 F_i (1 - TE_i) \quad (2-13a)$$

$$M_T = \sum_{i=1}^5 M_{T,i} = Y_T \sum_{i=1}^5 F_i TE_i = Y_T TE \quad (2-13b)$$

where: TE = trapping efficiency for all classes of particles.

The fraction of discharged yield in a given size range, $F_{YD,i}$, is thus:

$$F_{YD,i} = \frac{M_{D,i}}{Y_T} = F_i (1 - TE_i) \quad (2-14a)$$

The fraction of discharged sediment in a given size range, $F_{MD,i}$, is thus:

$$F_{MD,i} = \frac{M_{D,i}}{M_D} = \frac{F_i (1 - TE_i)}{\sum_{i=1}^5 F_i (1 - TE_i)} \quad (2-14b)$$

Similar fractions can be developed for sediment trapped.

Clay Sized Particles and Active Clay Calculations

The mass of trapped and discharged clay sized particles $M_{CP,T}$ and $M_{CP,D}$ in kg (lb) (where the subscript, T , stands for trapped, and D , stands for discharge) are given by:

$$M_{CP,T} = Y_T \sum_{i=1}^5 F_i CF_i TE_i \quad (2-15)$$

and

$$M_{CP,D} = Y_T \sum_{i=1}^5 F_i CF_i (1 - TE_i) \quad (2-16)$$

where: CF_i = the fraction of clay sized particles.

The total yield, fraction in class and clay fraction in the right hand side of the equation are for the inflow to the pond.

Mass of active clay discharged, $M_{AC,D}$ in kg (lb) is given by:

$$M_{AC,D} = M_{CP,D} - \sum_{k=1}^m M_{SD,k} \quad (2-17)$$

where $M_{SD,k}$ is the mass of settleable particulates in nutrient or pollutant k that are discharged and m is the total number of pollutants and nutrients that have settleable particulates. The subscript, **S**, stands for settleable.

The trapping efficiency for active clay, TE_{AC} , is given by:

$$TE_{AC} = \frac{M_{CP,T} - \sum_{k=1}^m M_{ST,k}}{Y_T \sum_{i=1}^5 F_i C F_i - \sum_{k=1}^m M_{S,inf,k}} \quad (2-18)$$

where: $M_{ST,k}$ = the mass of settleable particulates, **S**, in nutrient or pollutant k that are trapped, **T**, and $M_{S,inf,k}$ = the mass of settleable particulates in nutrients and pollutant k in the inflow to the pond, **inf**.

The methods proposed above can be used to predict settleable solids as well as clay size particles that may be either aggregated or primary particles.

Routing of Chemical Pollutants through Detention Basin

Dissolved chemicals are assumed to be conservative. For dry detention reservoirs and the majority of chemicals, this is a reasonable assumption. Therefore, trapping that does occur is a result of settling of the settleable component of the chemicals, referred to as particulate chemicals, and settling of active clay particles with sorbed chemicals.

Settleable Fraction

Trapping of chemicals in the pond can occur as a resulting of particulate settling, that is trapping of the settleable fraction of the chemicals washed or eroded from the watershed. These chemicals, as indicated earlier, can be assumed to be part of the clay sized fraction, and trapping of the particles is assumed to be calculated the same as for clay particles.

If $F_{Pk,i}$ is the fraction of clay sized particles in size class i that are chemical particulates or settleable particles (denoted by the subscript **P**) of a particular pollutant, k , then the total mass of particulates in the inflow to the basin for a given pollutant k , $M_{S,inf,k}$ is given by:

$$M_{S,inf,k} = Y_T \sum_{i=1}^5 F_i C F_i F_{Pk,i} \quad (2-19)$$

Routinely, one would expect $F_{Pk,i}$ to be a known quantity based on empirical data. However, there may be times when $F_{Pk,i}$ is not known, but there is EMC pollutant data available for the fraction class. If the fraction of the EMC for a given pollutant that is particulates is defined as $F_{S,k}$ and $F_{Pk,i}$ is assumed to be constant across all particle classes (that is the clay component of the aggregates as well as the clay sized fraction), then $F_{Pk,i}$ can be calculated by:

$$F_{Pk,i} = \frac{\gamma F_{s,k} EMC_k QAConst_4}{Y_T \sum_{i=1}^5 F_i CF_i} \quad (2-20)$$

where: EMC_k = the EMC of pollutant k ,
 γ = weight density of water in kg/m^3 (lb/ft^3), and
 $Const_4 = 10^{-4}$ for metric (0.00363 for English units) (originally defined in Volume 2).

A value of 0.33 was assumed as default values for both nitrogen and phosphorous for $F_{s,k}$ for the IDEAL model (Hayes et al., 2001) as discussed in Section 4 of Volume 2.

Using equations 2-19 and 2-20 along with trapping efficiency defined by equation 2-9 or 2-10, the settleable mass of a given pollutant trapped and discharged, $M_{ST,k}$ and $M_{SD,k}$ in kg (lb) are given by:

$$M_{ST,k} = Y_T \sum_{i=1}^5 F_i CF_i F_{Pk,i} TE_i \quad (2-21)$$

and

$$M_{SD,k} = Y_T \sum_{i=1}^5 F_i CF_i F_{Pk,i} (1 - TE_i) \quad (2-22)$$

Sorbed and Dissolved Fraction

The mass of sorbed and dissolved pollutant in mg/g, $C_{S,k}$ and $C_{D,k}$, influent to the pond are defined by the isotherm relationship as described in Volume 2, Section 4, equation 4-37 and by the relationship to the concentration of active clay, Volume 2, Section 4, equation 4-40:

$$C_{S,k} = KC_{D,k} \quad C_{S,k} \leq C_{Smax,k} \quad (2-23a)$$

$$C_{DS,k} = C_{S,k} C_{AC} \times 10^{-6} + C_{D,k} \quad (2-23b)$$

where: $C_{S,k}$ = the concentration on the solid phase in : g/g,
 $C_{D,k}$ = concentration in the liquid phase in mg/l,
 C_{AC} = concentration of active clay in mg/l,
 $C_{DS,k}$ = dissolved and sorbed concentration of a pollutant in mg/l.
 K = the phase change constant in : g/g/mg/l, and
 $C_{Smax,k}$ = the maximum value for $C_{S,k}$

The concentration of active clay, C_{AC} , is calculated by using equation 4-41 of Section 4, Volume 2 (see also equation 2-29 below). Values of K and $C_{Smax,k}$ should be based on testing of local soils and be conservative.

The amount of the pollutant mass trapped as a result of being sorbed on the active clay, $M_{DAT,k}$ in kg (lb) can be calculated by multiplying $C_{S,k}$ of the pollutant by the yield of active clay, Y_{AC} , into the pond times the trapping efficiency for the active clay fraction, TE_{AC} , from equation 2-18, or:

$$M_{DAT,k} = C_{S,k} Y_{AC} TE_{AC} \times 10^{-6} \quad (2-24)$$

and the mass of sorbed pollutant discharged on the active clay, $M_{DAD,k}$, in kg (lb) is:

$$M_{DAD,k} = C_{S,k} Y_{AC} (1 - TE_{AC}) \times 10^{-6} \quad (2-25)$$

Loading to the Detention Basin

Section 4 of Volume 2 presents a detailed process for calculating the loadings coming from the watershed, however, the calculations are presented in such a way as to distinguish between impervious and pervious area. The equations below are presented in terms of loading from the total watershed, except where noted.

The yield of clay sized particles, Y_{CP} in kg (lb) is given by:

$$Y_{CP} = \sum_{j=1}^2 Y_j \sum_{i=1}^5 F_{ij} CF_{ij} = Y_T \sum_{j=1}^2 \sum_{i=1}^5 F_{ij} CF_{ij} \quad (2-26)$$

where F_{ij} and CF_{ij} are given in Tables 4-8, 4-9 and 4-10 of Volume 2 for each particle class, i , for each of the two classes of perviousness, j , and Y_j refers to yield from impervious or pervious areas. This distinction in pervious and impervious areas is necessary, as the definitions of clay fractions are not the same for pervious and impervious areas. In the absence of local data collected, the CREAMS model could be used as a default to predict composition of eroded sediment (Foster et al., 1985) for pervious areas. The CREAMS model also contains relationships to predict the fraction of clay on a mass basis for each of the particle classes in Table 4-8b, Volume 2 and the relationships are given in Table 4-10 of Volume 2.

The yield of active clay, Y_{AC} , in kg (lb) is determined by subtracting the settleable solids portion of the nutrients and other chemicals from Y_{CP} , or:

$$Y_{AC} = Y_{CP} - \sum_{k=1}^m M_{S,inf,k} \quad (2-27)$$

where: m = the number of chemical pollutants being considered,

Y_{CP} = yield of clay sized particles in kg (lb), and

Y_{AC} = yield of clay-sized particles with an active charge that provides a surface for sorption of pollutants such as nutrients and other chemicals.

Similarly, the yield of clay sized particles, Y_{CP} , can be derived directly or can be the sum of the mass of clay sized particles, trapped and discharged, as shown:

$$Y_{CP} = Y_T \sum_{i=1}^5 F_i CF_i = M_{CP,T} + M_{CP,D} \quad (2-28)$$

The value of Y_{CP} calculated in equation 2-28 can be used in the denominator of equation 2-18 and as the denominator of 2-20.

For certain pollutants, such as nutrients, there is limited availability of data that distinguishes whether the pollutants comes from pervious areas or impervious areas so the pollutant loading is assumed to derive from the whole watershed (runoff volume would still need to be assessed on an impervious and pervious basis). The total loading of a given pollutant is

given by:

$$Y_k = (C_k)(\gamma QA)Const_4 \quad (2-29)$$

where: Y_k = yield of the pollutant in kg (lb),
 C_k = concentration of pollutant in mg/l, i.e., identified previously as EMC_k
 Q = runoff volume in cm (in.), and
 A = watershed area in ha (acre).

Other chemical pollutants can be calculated in a similar manner, e.g. knowing the Y_{AC} for the entire watershed C_{AC} can be solved for by using equation 2-29.

The yield of total dissolved and sorbed pollutant, $Y_{DS,k}$ can be solved explicitly as in equation 2-29 or can be given by:

$$Y_{DS,k} = Y_k - M_{S,inf,k} \quad (2-30)$$

Sediment from pervious areas is calculated using MUSLE as detailed in Section 4 of Volume 2. Sediment from impervious areas would be calculated using the equation 2-30 but adjusted for the impervious volume and area, as also described in Section 4 Volume 2. The total yield of sediment is the summation from the impervious and pervious areas.

Example Problem for Dry Detention

Example 2.1 Computation of peak discharge, peak flow reduction, storage volume and detention time in a basin.

A detention basin is being designed to provide storage for a 10-yr 24-hr design storm in Beaufort, SC for a twenty acre single family residential development is being proposed with houses on 1/4 acre lots (this is the same watershed previously described in problem 4.1 of Volume 2). The houses occupy 40% of the watershed and drain across the lawns before reaching storm sewer inlets. Streets and sidewalks occupy 10% of the area and drain directly to storm sewer inlets. The time of concentration for the lots draining to the storm sewer inlets is 0.15 hr and for the streets is 0.10 hr. The NRCS HSG is B, a sandy loam soil with a composition of 70% sand, 20% silt and 10% clay. The slope is 2%, the slope lengths 100 ft and the soil erodibility 0.24. The fraction of grass cover in the lawn is 1.0 and the average height of the grass cover 0.1 ft. The assumed area of the basin is 1.2 acres.

Determine:

1. Peak discharge using the probabilities for rainfall, season and associated AMC conditions,
2. Pre-development peak discharge using the same procedure as in (1.) assuming the area were under established vegetation with grass cover greater than 75% prior to land use, and
3. Storage volume required to match a post-construction peak discharge to a pre-disturbed peak discharge and overflow rate.

Solution:

1. Peak discharge using the probabilities for rainfall, season and associated AMC conditions.
Calculations are made separately for the streets and for the lots. The lots are referred to as pervious and unconnected impervious while the streets are impervious areas directly connected to drains.

The peak discharge for 10-yr 24 hr storm is determined following same procedures used in problem 4.2 Volume 2. Details are given in Table 2-1 below. Expected values of runoff and peak discharge in the 10-yr 24 hr storm of 7 in. were calculated and summarized in Table 2-2.

Table 2-1 Spreadsheet Calculations for 10-yr Peak Discharge Post Development for Example Problem 2.1

Conditions and Probabilities for Post Development Runoff Beaufort, South Carolina						
(1) Rainfall Class Number	2	2	2	2	2	2
(2) Precipitation (P) (in.)	7	7	7	7	7	7
(3) Probability of Precipitation ($p_k(P_k)$)	0.0004	0.0004	0.0004	0.0004	0.0004	0.0004
(4) Season	Growing	Growing	Growing	Dormant	Dormant	Dormant
(5) Probability of Season ($p_j(S_{season,i,k})$)	0.6938	0.6938	0.6938	0.3062	0.3062	0.3062
(6) Antecedent Moisture Condition (AMC)	1	2	3	1	2	3
(7) Probability of AMC ($p_i(A_{MC,i,j,k})$)	0.7596	0.0999	0.1405	0.6318	0.1903	0.1779
(8) Joint Probability ($p_T = p_k * p_j * p_i$)	0.00021	0.000028	0.000039	0.000077	0.000023	0.000022
Calculations for Connected Impervious Area						
(9) Curve Number (CN)	95.37	98.00	99.12	95.37	98.00	99.12
(10) S	0.4859	0.2041	0.0887	0.4859	0.2041	0.0887
(11) Q (in.) (P-0.2 S \$0)	6.45	6.76	6.89	6.45	6.76	6.89
(12) A (acre)	2	2	2	2	2	2
(13) Q (ac-ft)	1.075	1.127	1.149	1.075	1.127	1.149
(14) t_c (hr)	0.1	0.1	0.1	0.1	0.1	0.1
(15) Initial Abstraction I_a/P	0.014	0.0058	0.0025	0.014	0.0058	0.0025
(16) Effective Initial Abstraction (0.1 # I_a/P)	0.1	0.1	0.1	0.1	0.1	0.1
(17) $\log q_u$	2.82	2.82	2.82	2.82	2.82	2.82
(18) q_u (cfs/in-mi ²)	660.7	660.7	660.7	660.7	660.7	660.7
(19) q_p (cfs)	0.8035	1.1370	1.3485	0.8035	1.1370	1.3485
Calculations for Pervious and Unconnected Impervious						
(20) Curve Number (CN)	59.05	77.44	88.76	59.05	77.44	88.76
(21) S	6.94	2.91	1.27	6.94	2.91	1.27
(22) Q (in.) (P - 0.2 S \$0)	2.51	4.41	5.68	2.51	4.41	5.68
(23) A (acre)	18	18	18	18	18	18
(24) Q (ac-ft)	3.77	6.62	8.52	3.77	6.62	8.52
(25) t_c (hr)	0.15	0.15	0.15	0.15	0.15	0.15
(26) Initial Abstraction I_a/P	0.2	0.08	0.04	0.2	0.08	0.04
(27) Effective Initial Abstraction (I_a/P #0.5)	0.2	0.1	0.1	0.2	0.1	0.1
(28) q_u (cfs/in-mi ²)	634.7	607.0	607.0	634.7	607.0	607.0
(29) q_p (cfs)	44.81	75.35	96.98	44.81	75.35	96.98
Summary for Total Watershed						
(30) A (acre)	20	20	20	20	20	20
(31) Q (ac-ft)	4.84	7.74	9.67	4.84	7.74	9.67
(32) Q (in.)	2.90	4.65	5.80	2.90	4.65	5.80
(33) q_p (cfs)	58.1	89.3	111.2	58.1	89.3	111.2
Calculations for Pervious and Unconnected Impervious						
(34) $P * p_T$ (in.)	0.0665	0.0087	0.0123	0.0244	0.0074	0.0069
(35) $Q * p_T$ (ac-ft)	0.0055	0.0012	0.0052	0.0020	0.0010	0.0029
(36) $Q * p_T$ (in.)	0.0033	0.0007	0.0031	0.0012	0.0006	0.0018
(37) $q_p * p_T$ (cfs)	0.0713	0.0140	0.0551	0.0262	0.0118	0.0308

Table 2-2 Expected Value of Runoff and Peak Discharge for Post Development for Example Problem 2.1

Precipitation, Runoff and Peak Discharges		Sum Across Rows	Expected Value
	$P \cdot p_T$ (in.)	0.0028	7.00
Total Watershed	Q (ac-ft)	0.00238	5.95
	Q (in.)	0.00143	3.57
	q_p (cfs)	0.0281	70.2
	Q (ac-ft)	0.000437	1.093
Impervious Area	Q (in.)	0.00262	6.556
	q_p (cfs)	0.00541	13.54
	Q (ac-ft)	0.00194	4.85
Pervious Area	Q (in.)	0.00129	3.24
	q_p (cfs)	0.0227	56.6

The expected value of runoff volume from the design storm is 5.945 ac-ft or 3.567 in. The expected value of the peak discharge is 70.17 ft³/s.

2. Determination of pre-development peak discharge.

The curve number for predevelopment condition from is 61 for HSG B (from Table 4-2 Volume 2). This CN value is for antecedent moisture condition II. The CN values for AMC I and AMC III are determined from CN value for AMC II based on Equation 4-8 Volume 2. The pre-development runoff volume and peak discharge for 10-yr 24 hr storm is calculated as shown Table 2-3 below. Expected values of runoff and peak discharge in the 10 year 24 hr storm of 7 in. were calculated and summarized in Table 2-4 of this example problem.

Table 2-3 Spreadsheet Calculations for 10-yr Peak Discharge Pre-development for Example Problem 2.1

Calculations for Pre-development Runoff Beaufort, South Carolina						
(1) Curve Number (CN)	39.65	61	78.25	39.65	61	78.25
(2) S	15.22	6.39	2.78	15.22	6.39	2.78
(3) Q (in.) (P - 0.2 S \$0)	0.82	2.70	4.50	0.82	2.70	4.50
(4) A (acre)	20	20	20	20	20	20
(5) Q (ac-ft)	1.36	4.50	7.50	1.36	4.50	7.50
(6) t_c (hr)	0.15	0.15	0.15	0.15	0.15	0.15
(7) Initial Abstraction I_a/P	0.4349	0.1827	0.0794	0.4349	0.1827	0.0794
(8) Effective Initial Abstraction (I_a/P #0.5)	0.4349	0.1827	0.1	0.4349	0.1827	0.1
(9) q_u (cfs/in-mi²)	359.9	637.2	607.0	359.9	637.2	607.0
(10) q_p (cfs)	9.18	53.8	85.4	9.18	53.8	85.4
(11) P*p_T (in.)	0.0665	0.0087	0.0123	0.0244	0.0074	0.0069
(12) Q*p_T (ac-ft)	0.0055	0.0012	0.0052	0.0020	0.0010	0.0029
(13) Q*p_T (in.)	0.0033	0.0007	0.0031	0.0012	0.0006	0.0018
(14) q_p*p_T (cfs)	0.0713	0.0140	0.0551	0.0262	0.0118	0.0308

Table 2-4 Expected Value of Runoff and Peak Discharge for Pre-development Example Problem 2.1

Precipitation, Runoff and Peak Discharges	Sum Across Rows	Expected Value
P*p_T	0.0028	7.00
Q (ac-ft)	0.00108	2.69
Q (in.)	0.000647	1.62
q_p (cfs)	0.0106	26.5

3. Storage volume required to match a post construction peak discharge to a pre-disturbed peak discharge and overflow rate.

Using the values for peak discharge of the developed and undeveloped site from Tables 2-2 and 2-4, the maximum storage volume required to reduce the peak flow to the level of the pre-development peak can be given by Equation 2-4:

$$S_{max} = Q \left(1 - q_{p,out} / q_{p,in} \right) = 5.95 \left(1 - \frac{70.2}{26.5} \right) = 3.70 \text{ ac - ft}$$

The overflow rate is calculated by dividing the peak outflow from Table 2-2 by the surface area (1.2 acres) (Equation 2-8.a):

$$V_c = q_{out} / A_a = 26.5 / (1.2 \times 45,560) = 0.000506 \text{ ft / s}$$

The liquid depth of the basin can be calculated by dividing the maximum storage by the surface area:

$$D = S_{max} / A_a = (3.70 \text{ ac - ft}) / 1.2 \text{ ac} = 3.09 \text{ ft}$$

Detention time can then be calculated as :

$$T_d = V/q = S_{max}/q_{out} = D/V_c$$

$$= 3.09 / (0.0005 \text{ ft/s} \times 3600) = 1.69 \text{ hr}$$

Example 2.2 Computation of sediment trapping and sediment discharge in a basin, including clay size particles, particulate chemicals and active clay.

For the 10-yr 24-hr design storm and for conditions described in problem statement above, determine: sediment yield, eroded size distribution, the total sediment discharged from and trapped in the pond, the mass of settleable nutrients, discharged and trapped, and the trapping efficiency of active clay and partitioned concentrations and masses of nutrients.

To determine the above both Section 2 of this volume and Section 4 of Volume will be referenced.

Solution:

1. Sediment Yield.

a. Pervious and impervious unconnected to drains:

The MUSLE equation for sediment yield, equation 4-21 Volume 2, requires runoff volume **Q** in ac-ft and peak discharge **q_p** in cfs along with the soil loss equation parameters of **KLSCP**. From Example Problem 2.1 **q_p** is 56.6 cfs and **Q** is 3.24 in. or 4.85 ac-ft. **K** is given as 0.24, **CP** from Table 4-6 Volume 2 is 0.01 for 100% cover and grass height of 0.1 ft, and **LS** is determined from equations 4-24 and 4-25 of Volume 2. Given that the slope is 2%, the slope angle is:

$$\theta = \tan^{-1}(0.02) = 0.01999 \text{ rad or } 1.14 \text{ deg}$$

From equation 4-25 Volume 2, assuming a low tendency to rill, **β** is:

$$\beta = f_r \frac{11.16 \sin \theta}{3.0 \sin \theta^{0.8} + 0.56} = 0.5 \frac{11.16 \sin(0.01999)}{3.0 \sin(0.01999)^{0.8} + 0.56} = 0.161$$

and from equation 4-24 Volume 2 the **LS** factor with **Const₃** = 1 is:

$$LS = \left(\frac{\lambda}{72.6} \right)^{\beta/1+\beta} (10.8 \sin \theta + 0.03)$$

$$= \left(\frac{100}{72.6} \right)^{0.161/1+0.161} (10.8 \sin(0.01999) + 0.03) = 0.257$$

Finally, sediment yield can be calculated from the MUSLE (equation 4-21 Volume 2) as:

$$Y_{Pe} = \text{Const}_2 (Q_{Pe+UCI} q_{p,Pe+UCI})^{0.56} \{K\}_a \{LS\}_a \{CP\}_a$$

$$= 1.9 \times 10^5 [(4.85)(56.6)]^{0.56} (0.24)(0.257)(0.01) = 2723.1 \text{ lb}$$

where the subscript **a** refers to average values over the watershed, here the pervious and unconnected impervious areas (denoted by subscript **Pe** and **UCI**, respectively).

b) Impervious areas directly connected to drains:

Using an event mean concentration of 117 mg/L from Table 4-7 Volume 2 to represent the streets, a runoff volume of 13.5 in., the sediment yield for the impervious (denoted by subscript *im*), directly-connected areas is defined from equation 4-27, Volume 2 (or by modifying equation 2-29) as:

$$Y_{im} = (EMC_{SED})(\gamma Q_{im} A_{im}) const_4$$

$$= (117 \text{ mg/l})(62.4 \text{ lb/ft}^3)(6.556)(2 \text{ ac})(0.00363) = 347.5 \text{ lb}$$

c. Total sediment yield:

The total sediment yield in the watershed is given by equation 4-28, Volume 2 :

$$Y_T = 2723.1 + 347.5 = 3070.6 \text{ lb}$$

2. Eroded Size Distributions.

The CREAMS equations are used to calculate sediment size from the pervious areas, based on the fraction of clay, silt and sand primary particles in the parent material. These fractions were given as 0.1, 0.2 and 0.7 for the sandy loam soil. Table 2-5 can be created, using the equations in Table 4-8 Volume 2. Also shown are the fractions for the impervious areas based on NURP data listed in Table 4-9 Volume 2. The composite, weighted eroded size distribution for the sediment from the pervious and impervious area is calculated using the fraction of sediment in each size class, and the sediment yield from pervious and impervious areas.

Table 2-5 Fraction of Sediment by Class Based on Soil Matrix Fractions for Example Problem 2.2

Class	Equation for Fraction of Sediment in Class – Pervious Area	Fraction Pervious Area	Fraction Impervious Area	Total Fraction Watershed
Primary Clay (cl)	$F_{cl} = 0.26 \quad O_{cl} = 0.26(0.1)$	0.026	0.260	0.05248
Primary Silt (si)	$F_{si} = O_{si} - F_{sg} = 0.2 - 0.18$	0.020	0.550	0.07998
Primary Sand (sa)	$F_{sa} = O_{sa}(1 - O_{cl})^{5.0} = 0.7(1 - 0.1)^{5.0}$	0.413	0.190	0.38807
Small Aggregate (sg)	$F_{sg} = 1.8 \quad O_{cl} = 1.8(0.1)$	0.180	0.000	0.15963
Large Aggregate (lg)	$F_{lg} = 1 - F_{cl} - F_{si} - F_{sa} - F_{sg} = 1 - 0.026 - 0.02 - 0.413 - 0.18$	0.361	0.000	0.31984
	Sum	1.000	1.000	1.000

Representative diameters are calculated using the equations in Table 4-8a Volume 2 along with the specific gravities and summarized below in Table 2-6. Settling velocities are calculated using equations 2-7a and 2-7b.

Table 2-6 Representative Diameters by Classes Based on Soil Matrix Fractions for Example Problem 2.2

Class	Representative Diameter (mm)	Specific Gravity	Settling Velocity (ft/s)
Primary Clay (cl)	$D_{cl} = 0.002$	2.65	1.12×10^{-5}
Primary Silt (si)	$D_{si} = 0.010$	2.65	2.81×10^{-4}
Primary Sand (sa)	$D_{sa} = 0.200$	2.65	6.36×10^{-2}
Small Aggregate (sg) ¹	$D_{sg} = 0.030$	1.80	1.56×10^{-3}
Large Aggregate (lg) ¹	$D_{lg} = 0.30$	1.60	6.79×10^{-2}

¹ Correction for specific gravity was made for values other than 2.65: (settling velocity)(specific gravity)/2.65.

The fraction of clay sized particles in each size class are calculated using equations in Table 4-10 Volume 2 and are summarized below in Table 2-7. A weighted composite value was calculated based on sediment yield from pervious and impervious areas.

Table 2-7 Fraction of Clay Sized Particles Within Particle Classes for Example Problem 2.2

Particle Class	Fraction of TSS is the Particle Class That is Clay Sized Particles – CF		
	Pervious Areas	Impervious Areas	Total Watershed
Clay (CF_{cl})	1.000	1.00	1.000
Silt (CF_{si})	0	0	0
Sand (CF_{sa})	0	0	0
Small Aggregates (CF_{sg})	0.333	0	0.296
Large Aggregates (CF_{lg})	0.014	0	0.12

The mass of clay sized particles can be determined from the results in Table 2-5 and 2-7 above.

3. The Total Sediment Discharged from and Trapped in the Pond.

The trapping efficiency for each sediment class is calculated using equation 2-11 using an n value of 3 and settling velocities as presented in Table 2-6. The total trapping efficiency is the sum of the percentage of particles trapped in each size class.

$$TE_i = 1 - \left[1 + \frac{1 V_{s,i}}{n V_c} \right]^{-n} = 1 - \left[1 + \frac{1 V_{s,i}}{3 \cdot 0.000506} \right]^{-3}$$

The sediment discharged and trapped for each sediment class is given by equation 2-12a and b as a function of the total sediment yield, 3070.6 lb, from the watershed, the trapping efficiency for each class and the fraction of sediment in the

size class. The total sediment discharged and trapped for all size classes is the sum of sediment discharged and trapped from each size class as described in equations 2-13a and b. Results are presented in Table 2-8.

Table 2-8 Mass of Sediment Trapped and Discharged for Example Problem 2.2

Class Sediment	Fraction in Class, F_i	Trapping Efficiency ¹ , TE_i	Mass Trapped, M_T (lb)	Mass Discharged, M_D (lb)	Fraction Clay Sized Particles, CF_i	Mass Clay Sized Particles Trapped, $M_{CP,T}$ (lb)	Mass Clay Sized Particles Discharged, $M_{CP,D}$ (lb)
Clay	0.052	0.022	3.53	158	1	3.53	157.63
Silt	0.080	0.399	98	148	0	0	0
Sand	0.388	1.00	431	0.0	0	0	0
Small Aggregates	0.160	0.88	1192	59	0.296	127.5	17.4
Large Aggregates	0.320	1.00	982	0.0	0.12	12.2	0
Total	1.00	0.88	2707	364		143.3	175.0

¹ Trapping Efficiency for Sand and Large Aggregate rounded to 1, calculated beyond significant digits.

The yield of clay sized particles, Y_{CP} , which is 318.2 lb, is the sum of the trapped and discharged clay sized particles as described in Equation 2-28.

The total trapping efficiency for this 1.2 acre detention basin is 88%. Using this method, the predicted surface area to meet a trapping efficiency of 95% would be 9.5 acres.

4. The mass of Nutrients, Discharged and Trapped.

The EMCs for nutrients contain both dissolved and particulate (settleable) matter that are trapped by different mechanisms, hence partitioning is necessary. The total yield of nutrients is based on EMC. From Table 4-11 Volume 2, the EMC values for nitrogen and phosphorus are 1.88 mg/l and 0.4 mg/l respectively.

The yield of nitrogen is calculated using equation 2-29:

$$Y_N = (EMC_N)(\gamma QA) Const_4 = (1.88)(62.4 \times 3.57 \times 20) \times 0.00363 = 30.38 \text{ lb}$$

Similarly, Y_P is equal to 6.46 lb.

Settleable nutrients will be solved for first. Using a value of 0.33 for both nitrogen and phosphorous for $F_{S,k}$, the fraction of nitrogen from each of the areas can be calculated from equation 2-20 as:

$$F_{PN} = \frac{\gamma F_{S,N} EMC_N QA Const_4}{Y_T \sum_{i=1}^5 F_i C F_i} = F_{S,N} \frac{Y_N}{Y_{CP}} = 0.33 \times \frac{30.38}{318.2} = 0.0315$$

A similar calculation can be done for phosphorous with $F_{PP} = 0.0067$.

Using equations 2-21 and 2-22, the mass of a given settleable nutrient trapped and discharged, $M_{ST,k}$ and $M_{SD,k}$ respectively, and total settleable nutrients, $M_{S,inf,k}$ can be calculated by summation (or explicitly by equation 2-19). Values for nitrogen and phosphorous are presented in Table 2-9.

Table 2-9 Mass of Settleable Nutrients for Example Problem 2.2

Class Sediment (with Clay Fraction)	Settleable Nitrogen Trapped, $M_{ST,N}$ (lb)	Settleable Nitrogen Discharged, $M_{SD,N}$ (lb)	Total Settleable Nitrogen, $M_{S,inf,N}$ (lb)	Settleable Phosphorous Trapped, $M_{ST,P}$ (lb)	Settleable Phosphorous Discharged, $M_{SD,P}$ (lb)	Total Settleable Phosphorous, $M_{S,inf,P}$ (lb)
Clay	0.11	4.97	5.08	0.02	1.06	1.08
Small Aggregates	4.02	0.55	4.56	0.85	0.12	0.97
Large Aggregates	0.38	0.0	0.38	0.08	0.0	0.08
Total	4.51	5.51	10.0	0.96	1.17	2.13

5. The Trapping Efficiency of Active Clay and Partitioned Concentrations and Masses of Nutrients.

Active clay is the clay sized particles that participate in the sorption of nutrients. This is assumed to be all soil particles in the clay fraction. The yield of active clay is calculated from equation 2-27:

$$Y_{AC} = Y_{CP} - \sum_{k=1}^m M_{S,inf,k} = 318.12 - (10.0 + 2.13) = 306.1 \text{ lb}$$

The trapping efficiency of active clay can be calculated by equation 2-18:

$$TE_{AC} = \frac{M_{CP,T} - (M_{ST,N} + M_{ST,P})}{Y_{AC}} = \frac{143.3 - (4.51 + 0.96)}{306.1} = 0.45$$

The concentration of active clay (clay sized particles minus particulate nitrogen and phosphorus) must be calculated. Equation 2-29 can be used:

$$C_{AC} = \left(\frac{Y_{AC}}{\gamma QA Const_4} \right) = \frac{306.1}{62.4 \times 3.57 \times 20 \times 0.00363} = 18.9 \text{ mg / l}$$

The sum of dissolved and sorbed nitrogen, $Y_{DS,N}$ will be the total of mass minus the particulate mass, or from equation 2-30 is:

$$Y_{DS,N} = Y_N - M_{S,inf,N} = 30.4 - 10.0 = 20.4 \text{ lb}$$

The concentration of dissolved and sorbed nitrogen can be calculated by equation 2-39:

$$C_{DS,N} = \left(\frac{Y_{DS,N}}{\gamma QA \text{ const}_4} \right) = \frac{20.4}{62.4 \times 3.57 \times 20 \times 0.00363} = 1.26 \text{ mg / l}$$

Similarly, the yield of dissolved and sorbed phosphorous, $Y_{DS,P}$ will be 4.55 lb and the concentration of dissolved and sorbed phosphorous, $C_{DS,P}$, will be 0.26 mg/l. The concentration values of the dissolved and sorbed nutrients are the same as for the design example problem 4.5 in Volume 2. This is because the Y_k is based on the same EMC values as example problem 4.5; the values of $Y_{DS,k}$, Y_k and $M_{S,inf,k}$ are linear, and proportional to the size of the watershed, runoff volume and flow.

Equations 4-42 to 4-43 of Volume 2 are used to partition the nutrients between the sorbed and dissolved phase. Using partitioning coefficients of $K_N = 500 \mu\text{g/g/mg/l}$ with $C_{S,max,N} = 1000 \mu\text{g/g}$:

$$C_{D,N} = \frac{C_{DS,N}}{K_N C_{AC} 10^{-6} + 1} = \frac{1.26}{500 \times 20.34 \times 10^{-6} + 1} = 1.25 \text{ mg / l}$$

$$C_{S,N} = \frac{C_{DS,N}}{C_{AC} 10^{-6} + 1/K_N} = \frac{1.26}{20.34 \times 10^{-6} + 1/500} = 624 \mu\text{g / g}$$

Likewise for phosphorous, the phase concentration of dissolved, $C_{D,P}$, and sorbed, $C_{S,P}$, can be calculated using values of $K_P = 323 \mu\text{g/g/mg/l}$ with $C_{max,P} = 750 \mu\text{g/g}$ with results of 0.27 mg/l and 86 $\mu\text{g/g}$, respectively. These values are similar to the values calculated in example problem 4.5 of Volume 2 as the large partitioning coefficients predict these nutrients will remain in the dissolved phase.

The amount of nitrogen mass trapped as a result of being sorbed on the active clay, M_{DAT} , can be calculated by multiplying C_S by the yield of active clay, Y_{AC} , into the pond times the trapping efficiency for the active clay fraction, TE_{AC} , from equation 2-18, or:

$$M_{DAT,N} = C_{S,N} Y_{AC} TE_{AC} \times 10^{-6} = 624 \times 20.4 \times 0.45 \times 10^{-6} = 0.086 \text{ lb}$$

The mass of sorbed pollutant discharged on the active clay, M_{DAD} , is:

$$M_{DAD,N} = C_{S,N} Y_{AC} (1 - TE_{AC}) \times 10^{-6} = 624 \times 20.4 \times (1 - 0.45) \times 10^{-6} = 0.105 \text{ lb}$$

For phosphorous, $M_{DAT,P}$ and $M_{DAD,P}$ are 0.0119 and 0.0145 lb, respectively.

Basin Sizing and Design Considerations

Sizing for Peak Flow Reduction

The starting point for sizing a basin is to design for peak flow reduction. This means that the peak flow after urbanization matches the pre-development peak flow. Procedures for making this design are straightforward and equations range from simple relationships to those that require the use of computer models such as HEC-HMS and the NRCS TR20 program. In addition the spreadsheet model IDEAL (Hayes et al., 2001), as previously described in Volume 2 for vegetated biofilters, is capable of making these calculations for basins and ponds. The design can be for an average storm or for 2-, 10-, 25-, 50- and 100-yr storms, depending on the regulatory authority.

Sizing for Water Quality Control

After the basin is sized for peak flow reduction, it should be checked for water quality control, assuming that water quality is a design criteria. If the desired removal percentage or effluent criteria is not met, the design will need to be modified to improve control. This is in an iterative process requiring modifications in design until both criteria of peak flow reduction and water quality control are met.

Basin Configuration

Much of the following has been adopted from the ASCE/WEF (1998) manual of practice.

In configuring an extended detention basin, these facilities should be made an integral part of the community as much as possible. Consideration should be given to multiple uses, aesthetics, safety, and the way the facility will fit into the urban landscape. Also, maintenance is an important consideration and the design layout must provide access for maintenance equipment. Although these basins provide passive treatment with no operational attention, continued successful performance will depend on good maintenance.

Figure 1-2 shows an idealized layout for an extended detention basin. The individuality of each on-site or regional facility, and its place within the urban community make it incumbent on the designer to seek out local input, identify site constraints, identify the community's concerns and consider a wide array of possibilities during design.

Storage Volume

A storage volume, sometimes called capture volume, is needed to detain the flow long enough to capture the desired pollutants and keep the peak discharge less than the pre-developed peak. The amount of the required volume should be determined using the routing methods developed in Volume 2, Chapter 4 along with the discussion of detention time earlier in this section. If significant sedimentation is occurring, an additional volume should be added to account for the deposited solids. For critical areas, a complete sediment yield analysis over a period of years (e.g., 20 yr) would need to be made to determine the probable build-up of deposited sediment. For less critical areas, an addition of 20% to this detention volume to provide for sediment accumulation is a reasonable assumption. Randall et al. (1982) and Whipple and Hunter (1981) suggest that such detention basins be designed to promote sedimentation of small particles, namely smaller than 60 : m in size, which account for approximately 80% of the suspended sediment mass found in stormwater (Urbonas and Stahre, 1993).

It is important in the design to select outlet sizes and pond volumes that retain most of the particles long enough to settle. This includes particles in the first part of the storm, so consideration should be given to providing an outlet that empties less than 50% of the design volume in the first one-third of the design emptying period (that is, 12 to 16 hours). An outlet design that contains drainage elements that are too large to capture smaller storms may result in emptying rates that are sufficiently high and the bulk of the smaller storms will have very short residence times. This would result in limited water quality benefit. Newman et al. (2000) found that optimized designs (based on SWMM) of extended detention ponds provided superior pollutant removals compared to the original designs as detention basins. The optimized designs used smaller outlet orifices to maximize detention times of the smaller storms. The outlet should also ensure that small

runoff events will be detained long enough to remove small SS. A long emptying time—thus the term extended detention—permits smaller particles to attach to the bottom of the basin and become trapped.

Flood Control Storage

Whenever feasible, the functions of the extended detention basin should be incorporated within a larger flood control facility. The designer may want to consider combining water quality and flood control functions in a single detention basin. This typically requires multiple stage outlets, which are discussed below.

Basin Geometry

The basin should gradually expand from the inlet and contract toward the outlet to reduce short circuiting. Griffin et al. (1985) found that an aspect ratio (length to width ratio) of 2:1 or greater reduces short circuiting within the pond.

Basin Side Slopes

Basin side slopes must remain stable under saturated soil conditions. They also need to be sufficiently gentle to limit rill erosion, facilitate maintenance and address the safety issue of individuals falling in when the basin is full of water. Side slopes of four units horizontal to one unit vertical (4:1 H:V) and flatter provide well for these concerns.

Two-Stage Design

A two-stage basin is preferable. The lower stage has a micropool that fills frequently. This reduces the periods of standing water and sediment deposition in the remainder of the basin. The upper stage should be 0.6 to 1.8 m (2 to 6 ft) deep, its bottom sloping at approximately 2% toward a low-flow channel. The bottom pool should be 0.5 to 0.9 m (1.5 to 3 ft) deeper and should be able to store 15 to 25% of the capture volume. These recommendations do not necessarily apply to large, regional extended detention basins. The impact of these considerations varies with climate and soil types. The designs should be checked for performance using the tools presented in Volume 2, Section 4.

Forebay

The basin should be designed to encourage sediment deposition to occur near the point of inflow. A forebay with a volume equal to approximately 10% of the total design volume can help with the maintenance of the basin and the service life of the remainder of the basin can be extended. A stabilized access and a concrete or soil cement lined bottom should be used to prevent mechanical equipment from sinking into the bottom.

Basin Inlet

Most erosion and sediment deposition occurs near the inlet. An ideal inflow structure will convey stormwater to the basin while preventing erosion of the basin's bottom and banks, reducing resuspension of previously deposited sediment and facilitating deposition of the heaviest sediment near the inlet. These design goals are achievable in many cases; some circumstances may require minor trade-offs. Inflow structures can be drop manholes, rundown chutes with an energy dissipater near the bottom, a baffle chute, a pipe with an impact basin, or one of the many other types of diffusing devices.

Low-Flow Channel

A low-flow channel should be provided to convey trickle flows and the last of the captured volume to the outlet. This device prevents water logging and enhances the growth of vegetation.

Outlet Type and Protection

General Considerations

An outlet capable of slowly releasing the design capture volume over the design emptying time should be used. Examples of two typical outlet structures are illustrated in Figures 2-4 a and b. The outlet may include multiple orifices with the dual purpose of controlling and releasing both larger storms and water quality storms, as demonstrated in Figures 2-4a and b. A number of alternative details for outlet structures are provided in Appendix B.

Figure 2-4 below shows outlet structures with multiple stage outlets typically used for extended detention basins. Where one outlet would either release the water quality storm too quickly to or retain large storms for much longer periods (e.g. week or more) to maintain water quality performance, the intent of multiple stage outlets is an attempt to provide adequate storage for both the larger storms and the water quality storms.

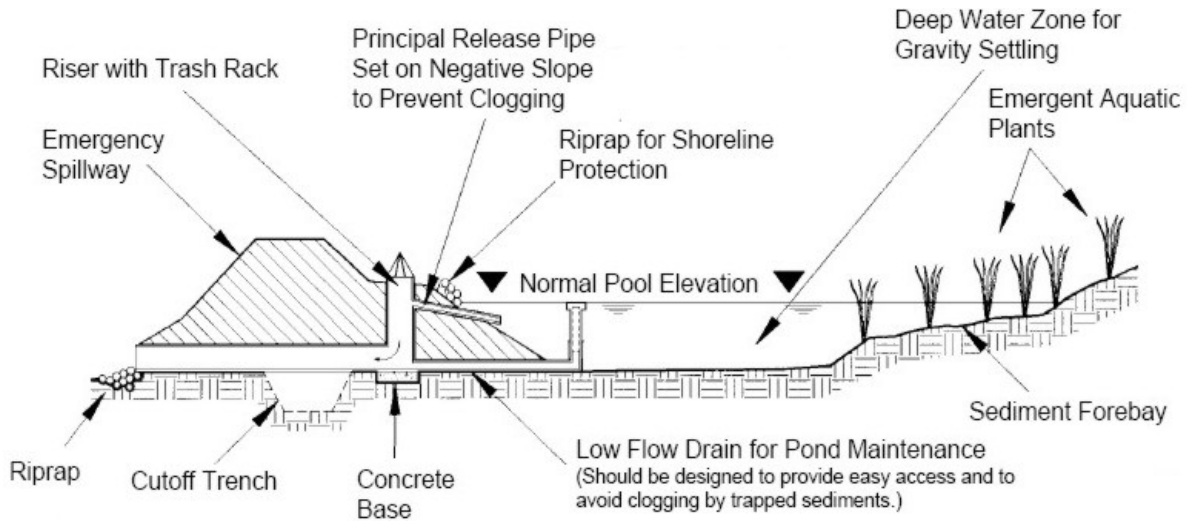

Figure 2-4a Typical Outlet Structure: Negatively Sloped Pipe Outlet (Northern Virginia Planning District Commission (NVPDC) and Engineers and Surveyors Institute (1992).

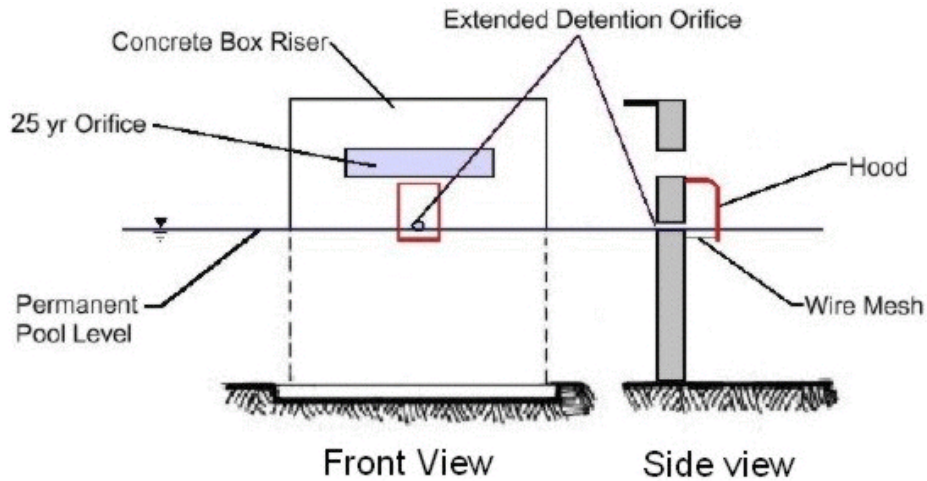

Figure 2-4b Typical Outlet Structure: Multiple Orifice Hooded Outlet (Haubner et al., 2001)

Clogging of Outlets

Because extended detention basins are designed to encourage sediment deposition and urban stormwater has substantial quantities of settleable and floatable solids, basin outlets are prone to being clogged. This can make the design of reliable outlet structures for extended detention basins difficult. A clogged outlet will invalidate the hydraulic function of even the best design, even so, outlet design is such a key element for water quality performance, that water quality performance in outlet design should take precedence over maintenance considerations. Proven design details can be obtained from the Urban Drainage and Flood Control District (UDFCD) (at www.udfcd.org). An example of a perforated pipe detail is provided in Figure 2-5.

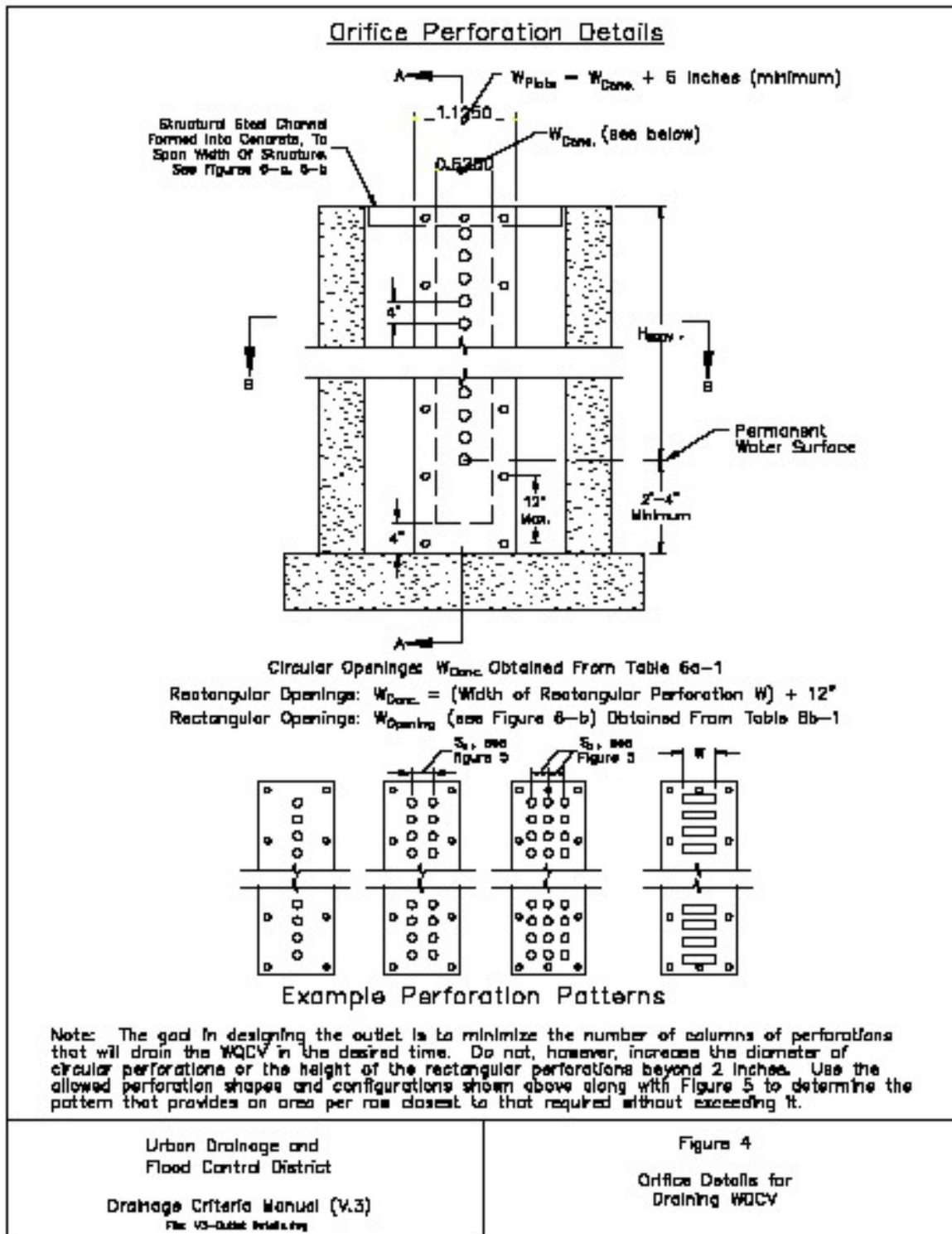

Figure 2-5 Example Perforation Patterns (UDFCD, 1999)

Section 5 provides more guidance on outlet design with maintenance considerations in mind. ASCE (1985), ASCE (1992), DeGroot (1982), Roesner et al. (1989), Schueler (1987), Schueler et al. (1992), Urbonas and Roesner (Eds.) (1986) and Urbonas and Stahre (1993) reported many reasons for outlet problems, which include clogging by trash and debris, silting in of the outlet, damage by vandalism, children plugging an outlet, and other factors, that modify its discharge characteristics. Each outlet has to be designed with clogging, vandalism, maintenance, aesthetics and safety in mind.

Trash Rack

If the outlet is not protected by a gravel pack, as shown in Figure 2-4, some form of a trash rack should be provided. Wrapping a perforated outlet in a geotextile filter cloth that will seal quickly is not a recommended practice. Figure 2-6 is a chart that provides simple, empirically based guidance for minimum sizes of trash racks for detention outlets. Representative details for trash racks are provided in Appendix B; however, more specific design guidance should be sought. For example, Detail 1 of Appendix B requires that the outlet opening behind it be larger than the openings in the “Expanded Steel Grate” and that the net area of the rack is sufficiently large to minimize hydraulic loss during storm events because of potential to clog. In any event, even sufficiently designed trash racks will require routine maintenance to remove debris to keep fully operational.

Dam Embankment

The dam embankment should be designed and built so that it will not fail during storms larger than the design storm for the basin. An emergency spillway should be provided or the embankment should be designed to withstand overtopping commensurate with the size of the embankment, the volume of water that can be stored behind it, and the potential of downstream damages or loss of life if the be compacted to 95% of their maximum density at optimum moisture. Section 5 gives more criteria necessary for dam specifications.

Vegetation

A basin's vegetation provides erosion control and enhances sediment entrapment. The basin can be planted with native grasses or irrigated turf, depending on the local setting, basin design and its intended other uses (such as recreation). Sediment deposition, along with frequent and prolonged periods of inundation, make it difficult to maintain healthy grass cover on the basin's bottom. Options for an alternative bottom liner include a marshy wetland bottom, bog, layer of gravel, riparian shrub, bare soil, low weed species, or other type that can survive the conditions found on the bottom of the basin. Volume 2 provides more information regarding vegetation specifications.

Maintenance Access

Vehicular maintenance access to the forebay should be available along with the outlet areas with grades that do not exceed 8 to 10% and have a stable surface of gravel-stabilized turf, a layer of rock, or concrete pavement. Section 6 provides more information concerning operation and maintenance.

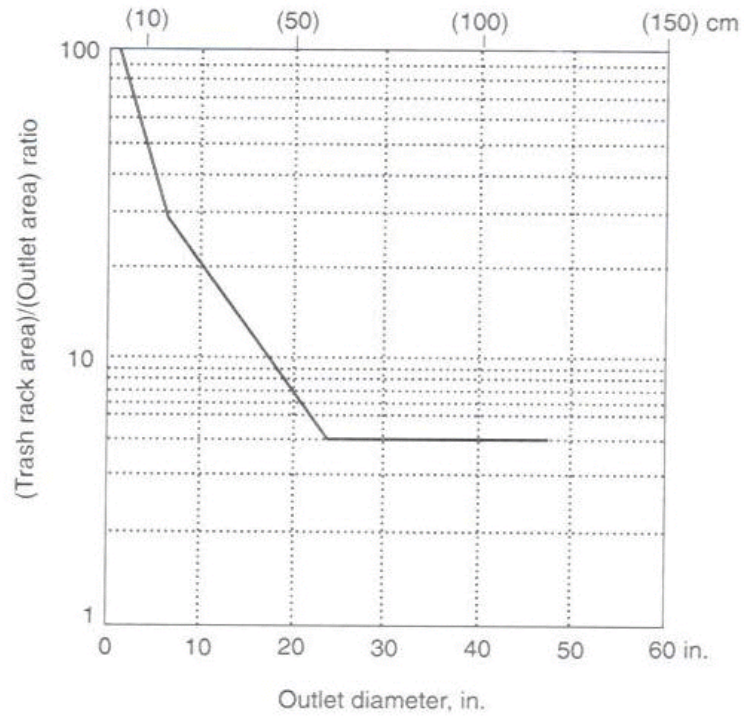

Figure 2-6 Minimum Size of a Trash Rack Versus Outlet Diameter (UDFCD, 1999)

Section Three Retention Ponds – Design Criteria

Introduction

Retention ponds are practices that have a significant permanent pool or a combination of extended detention with a permanent pool equivalent to the entire water quality volume (V_{WQ}). A number of design variations have been developed (MDE, 2000) that include the following variants:

- micropool extended detention pond
- wet pond
- wet extended detention pond
- multiple pond system
- pocket pond.

The term "pocket" refers to a pond or wetland that has such a small contributing drainage area that little or no baseflow is available to sustain water elevations during dry weather. Instead, water elevations are heavily influenced and, in some cases, maintained by a locally high water table.

Wetland ponds are practices that create shallow wetland areas to treat urban stormwater and often incorporate small permanent pools and/or extended detention storage to achieve the full V_{WQ} . A number of design variations have been developed (MDE, 2000) that include the following variants:

- shallow wetland
- extended detention shallow wetland
- pond/wetland system
- pocket wetland.

Stormwater wetlands may also provide storage above the V_{WQ} storage.

Wet/Retention Ponds

A stormwater retention impoundment is created by either constructing an embankment or excavating a pit which retains a permanent pool of water used for water quality improvement. The purpose of the pond is to provide long-term storage of stormwater runoff in order to allow mechanical settling of fine suspended sediments as well as biological processing and removal of nutrients from the stormwater before being discharged by displacement in a subsequent storm event. Permanent pools also protect deposited sediments from resuspension. Wet ponds can provide aesthetic and recreation benefits as well as fire protection and water supply (e.g., irrigation). Wet ponds may also be used for flood and downstream erosion control through the use of multi-stage outlets.

Conditions Where Practice Applies

In order to use a permanent pool structure, a reliable source of runoff or ground water must be available to maintain the volume of the permanent pool. Wet pond basins are usually limited to use with moderate to large drainage areas, often greater than 20 acres. Under these conditions, a wet pond basin is an appropriate water quality practice in residential and commercial areas where nutrient loadings are expected to be high.

Retention pond usage may also be limited by the potential for discharge water to be heated in the permanent pool particularly during summer months, and they should not be used if the receiving waters are ecologically sensitive, i.e. cold water streams.

Other issues to consider when deciding on applicability of a retention pond include:

- whether or not existing wetlands at the site restrict the use of a permanent pool
- whether or not water rights are available for pond evaporation in States with a prior appropriation water law system

Analysis Procedures for Wet Retention Basins

Wet retention basins differ from dry detention basins in that the latter are completely dewatered at the end of stormwater runoff, whereas wet detention basins have a permanent pool of water. This permanent pool may or may not have wetland vegetation, and may or may not have a forebay where sediment is trapped.

In all procedures based on settling, it is assumed that the concentrations of sediment and pollutants in the permanent pool at the end of the storm is that of the average discharge from the pond using the procedures developed in Section 2 for dry detention. The impact of settling between storms is calculated using the average interval between storms and corrected for the variability of the interval using the procedures of Driscoll et al. (1986).

Hydraulic Routing

Hydraulic routing is the same as that of the dry detention. The only difference is that the volume below the riser of the principal spillway or low water dewatering system is assumed to remain in the basin until the next runoff event. During this period, the settleable solids continue to settle out.

Calculation of trapping during the periods between storms could be calculated with continuous simulation models such as the WEPPSIE component of WEPP (Lindley et al., 1998). An alternative and much simpler procedure is to develop empirical procedures that will predict trapping based on an average inter-arrival time as well as the statistics of inter-arrival times between storms (Driscoll et al., 1986). These procedures are discussed under sediment routing.

Sediment Routing

TSS Routing

To predict sediment removal for a single storm, Equation 2-9 or 2-10, which predicts **TE** during the storm (turbulent flow) can be used. Driscoll et al. (1986) developed empirical procedures for sediment routing in a basin with a permanent but variable volume. The analysis is divided into dynamic (stormwater) flows and quiescent flows between storms. A summary of the procedures is presented below. The IDEAL model has incorporated this approach except where noted.

Quiescent Settling

Driscoll et al. (1986) recommended that removal efficiencies for quiescent conditions between stormwater flows be estimated from:

$$R_{Q,i} = 8.64 \times 10^4 V_{s,i} A_Q \quad (3-1)$$

where: $R_{Q,i}$ = quiescent removal rate in m^3/day (ac-ft/day) for particle class i ,
 $V_{s,i}$ = the settling velocity in m/s (ft/sec) for particle class i , and
 A_Q = surface area in m^2 (acre) for the permanent pool.

The removal ratio, RR_i , for average conditions for particle class i is:

$$RR_i = \frac{T_{IA} R_{Q,i}}{V_R} \quad (3-2)$$

where: V_R = mean runoff volume in m^3 (ac-ft),
 T_{IA} = the average time interval between storms in days, and
 RR_i = the removal rate in the interval between storms for the average arrival time between storms.

Values for T_{IA} are tabulated by Driscoll et al. (1986) and are also given in Haan et al. (1994). For much of the country the average interval between storms is between 3 and 4 days with average storm durations of 6 hr.

To convert RR_i to fraction of sediment removed when considering a distribution of arrival times between storms, Driscoll et al. (1986) developed graphs based on statistical analysis and gamma distributions. The storage volume under quiescent conditions is not assumed to be a fixed quantity but varies between storms. Adaptations of the two graphs are shown in Figures 3-1 and 3-2.

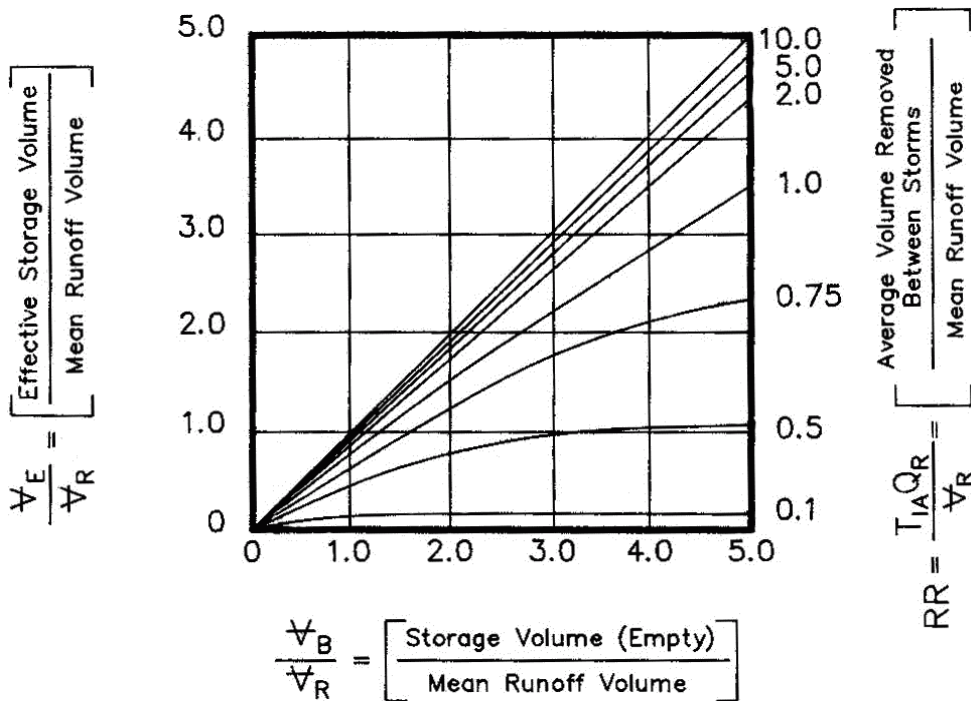

Figure 3-1 Ratio of Effective Storage Volume to Mean Runoff Volume (modified after Driscoll et al., 1986)

The horizontal axis in Figure 3-1 is the ratio of actual permanent pool or storage volume empty to the mean runoff volume. The vertical axis is the ratio of effective permanent pool volume to mean runoff volume. When the average volume removed between storms is equal to 10 times the mean runoff volume, the effective volume is the same as the actual

volume. When less than that amount, the effectiveness of the permanent pool in removing sediment during periods between storms is reduced.

In Figure 3-1 the ratio of effective storage (basin) volume, V_E , to mean runoff volume (runoff volume in an average storm), or V_E / V_R , is given as a function of the storage volume (empty), V_B , to mean runoff volume, or, V_B / V_R . In turn, RR_p , which can be calculated from equation 3-2, is related to the ratios effective storage to storage available (empty or conversely remaining permanent pool volume).

To determine the removal ratio in the permanent pool, averaged over all storms, the variation in runoff volume must be considered. The parameter used for this is the coefficient of variation of runoff volume, CV_R . A reasonable assumption is to assume that variability of runoff parameters are the same as corresponding rainfall parameters (Driscoll et al. 1986). The coefficient of variation of rainfall volumes are found in Driscoll et al. (1986) and Haan et al. (1994) and can be used for CV_R . If available, local rainfall data should be used. The fraction of sediment removed during quiescent settling, E_Q , is determined from Figure 3-2 with the ratio V_E / V_R determined from Figure 3-1. The fraction of sediment removed is determined as the value on the vertical axis. Hayes et al. (2001) developed regression equations for the curves in Figures 3-2 and included them in the IDEAL model.

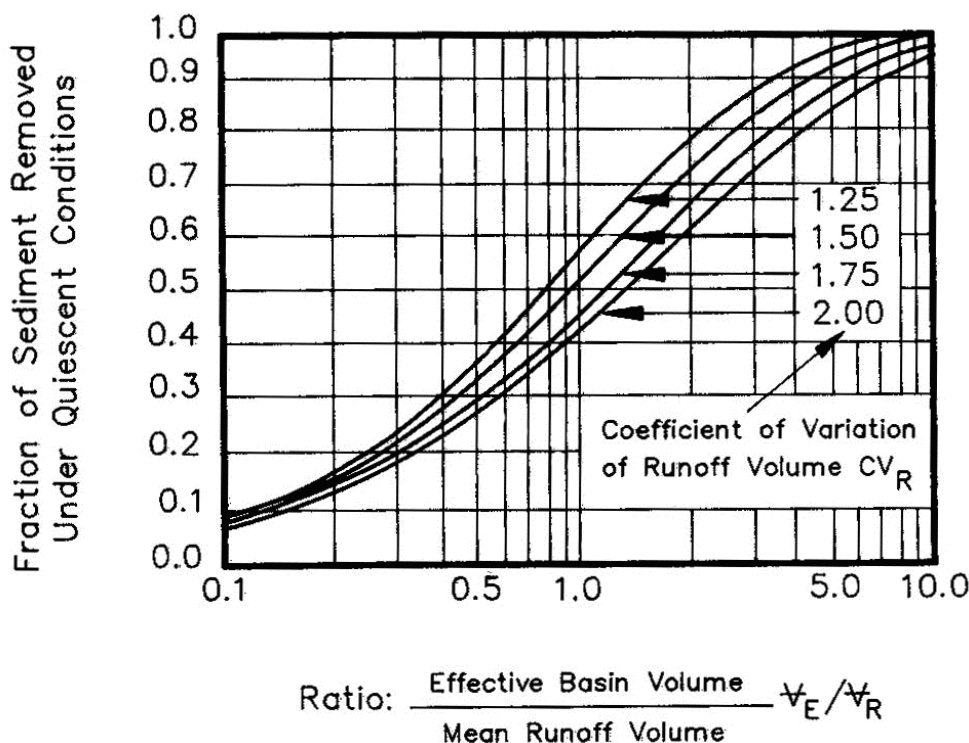

Figure 3-2 Fraction of Sediment Removed in Quiescent Conditions Between Storms (Driscoll et al., 1986)

Dynamic Settling

The trapping efficiency of equation 2-10 for detention removal is only representative of a single storm event. For dynamic settling in a retention pond, with variable stormwater flows, equation 2-10 needs to be statistically averaged over all storms. To predict long-term trapping, the EPA model (Driscoll et al., 1986) combined Equation 2-10 with stochastically generated flows. Dynamic flows were assumed to be gamma distributed and characterized by a mean flow and a coefficient of variation of flow CV_Q . Driscoll et al. (1986) proposed dynamic trapping efficiency could be calculated by:

$$D_{R,i} = \left[\frac{1/CV_Q^2}{1/CV_Q^2 - \ln(TE_{M,i})} \right]^{1/CV_Q+1} \quad (3-3)$$

where: $D_{R,i}$ = dynamic trapping efficiency for particle class i ,
 $TE_{M,i}$ = trapping efficiency for particle class i for mean storm flow

Equation 2-10 for detention basins is typically used to calculate $TE_{M,i}$. The parameter CV_Q can be approximated by using the coefficient of variation of rainfall intensity which is found in Driscoll et al. (1986) and Haan et al. (1994). One limitation of equation 3-3 is that it fails at very low removal rates (values of $TE_{M,i} = 0.065$), and one would expect that $TE_{M,i} \propto D_{R,i}$.

This analysis assumes that the trapping efficiency of the pond is an exponential function of the variable storm flow, or:

$$D_R \approx 1 - e^{f(\text{variable flow})} \quad (3-4)$$

The IDEAL model does not directly use equation 3-3, but does calculate the statistical average of TE over many storms based on rainfall probabilities as described in detail in Section 4, Volume 2 to estimate dynamic trapping efficiency of wet ponds.

Total Removal Efficiency

A relationship for combined conditions, i.e., stormwater trapping plus trapping during quiescent intervals between storms is needed in order to estimate the long-term fraction removed. As stormwater moves through the pond, part of the sediment is retained at the end of the storm as a consequence of settling and part is discharged. Of that remaining, some is in suspension in the permanent pool and some has already settled to the bottom. Of that remaining in suspension, some will continue to settle out during the quiescent period between storms. Any sediment remaining in suspension at the start of a subsequent storm will be discharged. To accurately account for this combinations of dynamic and quiescent settling, a complex computer model would be required. Driscoll et al. (1986) recommended a simple alternative. The combined trapping efficiency, TE_C , for each particle class size, over all storms and the periods between storms, is:

$$TE_{C,i} = 1 - (1 - D_{R,i})(1 - E_{Q,i}) \quad (3-5)$$

where: $TE_{C,i}$ = combined trapping efficiency for particle class i
 $D_{R,i}$ = calculated from equation 3-3, and
 $E_{Q,i}$ = the value determined from Figure 3-2.

Therefore, the trapping efficiency for a retention pond, TE_C , is seen to be the combination of trapping efficiency, TE_M , of the detention storage for mean flow conditions, but expanded for multiple events, as calculated by D_R , and the trapping efficiency for quiescent, or the interval between storms, E_Q .

Discussion of Methods

The original analysis by Driscoll et al. (1986) and the development of the retention pond analysis curves were based on the solids-settling method for low-density, single-family residential development (runoff coefficient $R_V = 0.2$) as shown in Figure 3-3 (Driscoll et al., 1986). Analysis curves were not developed for other land-use patterns. The curves relate average total suspended sediment removal to the size of the permanent pool relative to the watershed area for the situation where the permanent pool has a mean depth of approximately 1 m (3.5 ft). For planning purposes, average removal rates

for other constituents could be estimated by multiplying the total suspended sediment removal rate by the average particulate fraction of the constituent of interest. The method developed by Driscoll et al. (1986) is based on a national average particle size classification and average runoff for a region. No account was taken of variations in particle sizes between areas or variations in volume. For basin surface area to watershed area ratios of 0.01 and 0.5, the impact of changing depth from 3.5 ft to 10 ft can result in a change in trapping efficiency of 10 to 20% while a change in the runoff coefficient, R_v , from 0.1 to 0.4 results in a change of 10 to 40% in trapping efficiency. The procedure gives an rough indicator of trends in performance.

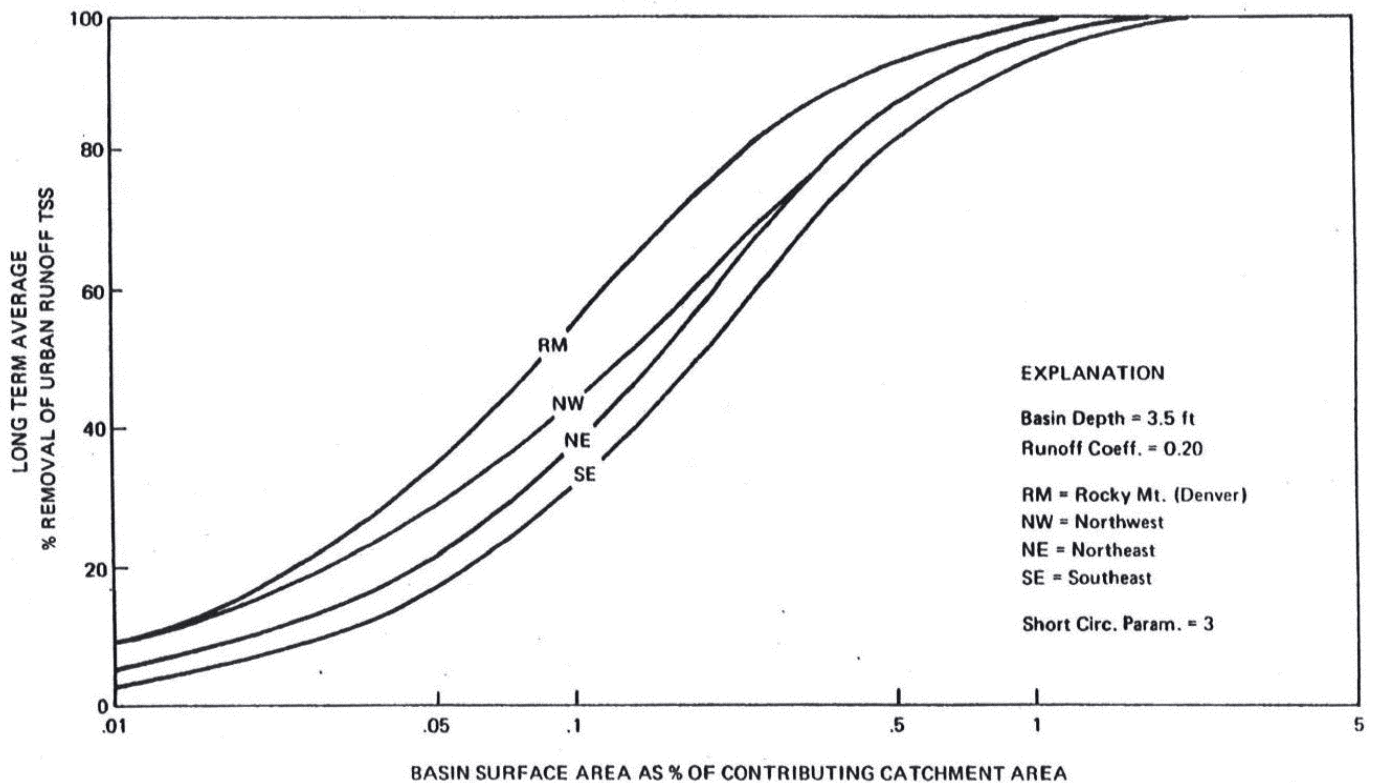

Figure 3-3 Geographically Based Design Curves for Solids Settling Model (ft x .3048 – m) (Driscoll et al., 1986)

Equation 3-3 addresses the performance of a pond under variable influent flows that are gamma distributed when the trapping efficiency for pollutants of differing size class varies with the rate of variable storm flow. The effect of equation 3-3 is to have a more conservative estimate of long term performance of a retention pond by incorporating coefficient of variance of storm flow characteristics rather than relying on average values of volume treated. Equation 3-3 as presented above assumes peak removal rates at low flow for all sediment classes. This assumption was used in the design example provided by Driscoll et al. (1986) which also assumed equal percent sorting of five class sizes of sediment loading. As the watershed loading procedures presented in Section 4, Volume 2 call for the use of the CREAMS model for calculating erodible sediment from pervious areas and the NURP values for impervious sediment, the content of sediment is probably better represented in the procedures outlined in these volumes than for the sediment distribution equation 3-3 was originally proposed. Additionally, the analysis performed by Driscoll et al. (1986) focused on urban runoff but did not segregate between pervious and impervious area.

Size Distribution Calculations

This procedure is similar to the development for detention basins in Section 2 and vegetated biofilters in Volume 2, Sections 4 and 5; essentially, the equations are the same as Section 2 but TE_C is used instead of TE for detention basins. A cursory summary is presented below; other relevant equations can be derived by the user by substituting TE_C for TE .

The fraction of sediment trapped $F_{T,i}$ and discharged $F_{D,i}$ for size class i are given by:

$$F_{T,i} = F_i TE_{C,i} \quad (3-6a)$$

$$F_{D,i} = F_i (1 - TE_{C,i}) \quad (3-6b)$$

where: $TE_{C,i}$ = combined trapping efficiency for a particle class

The fraction of discharged yield in a given size range, $F_{YD,i}$ is thus:

$$F_{YD,i} = F_i (1 - TE_{C,i}) \quad (3-7a)$$

The fraction of discharged sediment in a given size range, $F_{MD,i}$ is thus:

$$F_{MD,i} = \frac{F_i (1 - TE_{C,i})}{\sum_{i=1}^5 F_i (1 - TE_{C,i})} \quad (3-7b)$$

Clay Size Particles and Active Clay Fraction Calculations

The mass of inflow clay size particles is the same for dry detention as for wet detention and is thus described by the relationships in Table 3-10. Following equation 4-13 and 4-14, the mass of clay sized particles trapped and discharged are:

$$M_{CP,T} = Y_T \sum_{i=1}^5 F_i CF_i TE_{C,i} \quad (3-8)$$

and

$$M_{CP,D} = Y_T \sum_{i=1}^5 F_i CF_i (1 - TE_{C,i}) \quad (3-9)$$

The mass of active clay in the effluent is calculated by:

$$M_{AC,D} = M_{CP,D} - \sum_{k=1}^m M_{SD,k} \quad (3-10)$$

where: $M_{SD,k}$ is the mass of particulate or settleable pollutant particles of pollutant k discharged.

Following equation 2-18, the combined trapping efficiency of active clay, TE_{CAC} , can be defined by:

$$TE_{CAC} = \frac{M_{CP,T} - \sum_{k=1}^m M_{ST,k}}{Y_T \sum_{j=1}^5 F_j C F_j - \sum_{k=1}^m M_{S,inf,k}} \quad (3-11)$$

where $M_{ST,k}$ is the mass of settleable particulates in nutrient or pollutant k that are trapped, and $M_{S,inf,k}$ is the mass of settleable particulates in nutrients and pollutant k in the inflow to the pond.

Chemical Pollutants Routing

Settleable Fraction

The fraction of clay sized particles that are particulates or settleable is defined in wet detention the same as dry detention, using equation 2-20. Following equations 2-21 and 2-22 the mass of particulates that are trapped and discharged are given by:

$$M_{ST,k} = Y_T \sum_{i=1}^5 F_i C F_i F_{k,i} TE_{C,i} \quad (3-12)$$

and

$$M_{SD,k} = Y_T \sum_{i=1}^5 F_i C F_i F_{k,i} (1 - TE_{C,i}) \quad (3-13)$$

Sorbed and Dissolved Fraction

Following equations 2-24 and 2-25, by applying equation 2-23, the absorbed fractions of pollutant that are trapped and discharged are given by:

$$M_{DAT} = C_S Y_{AC} TE_{CAC} \times 10^{-6} \quad (3-14)$$

and

$$M_{DAD} = C_S Y_{AC} (1 - TE_{CAC}) \times 10^{-6} \quad (3-15)$$

Example Problems for Retention Ponds

Example Problem 3.1: Calculation of Combined Trapping Efficiency

When averaged over all storms, a pond has a trapping efficiency during storm flow of 20 percent for clay particles with a settling velocity of 3.426×10^{-6} m/s. If the permanent pool volume is 3000 m^3 with a surface area of 2000 m^2 and the drainage area is 20 ha, what is the trapping efficiency for the clay particles including quiescent settling if the pond is in Dallas, TX.

Solution:

In an analysis by Driscoll et al. (1986) (see also Haan et al. Appendix 9B, 1994), Dallas has the following stormwater statistics:

Average runoff volume, V_R :	0.99cm (0.0099 m)
Average interval time between storms, T_{IA} :	100 hr (4.167 days)
Coefficient of variation of rainfall volume, CV_R :	1.64

The removal efficiency for quiescent conditions between storm water flows for the clay size particle can be estimated from equation 3-1 as:

$$R_{Q,i} = 8.64 \times 10^4 (3.426 \times 10^{-6})(2000) = 592 \text{ m}^3 / \text{d}$$

The average runoff would normally be estimated by taking a statistical average over all possible storms, taking into account the actual land use and soil type. For purposes of this example, the average runoff volume will be the value averaged over all watersheds given by Driscoll et al. (1986), or 0.0099 m. Converted to cubic meters by multiplying by the watershed area of 20 ha, the average runoff volume, V_R , is 1980 m^3 . Using this value, the removal ratio, RR_i , from equation (5.2) is:

$$RR_i = \frac{T_{IA} R_{Q,i}}{V_R} = \frac{(4.167)(592)}{1980} = 1.246$$

To convert this value to a removal efficiency for quiescent flow, the ratio of effective permanent pool volume to runoff volume, V_E / V_R , is needed. This is given in Figure 3-1 as a function of RR_i and the ratio of actual permanent pool volume to runoff volume, V_B / V_R . V_B was given as 3000 m^3 and V_R was estimated as 1980 m^3 , hence:

$$V_B / V_R = 3000 / 1980 = 1.515$$

From Figure 3-1, the value of V_B / V_R is 1.3. Using this value and 1.64 for CV_R , the fraction of sediment removed under quiescent conditions, E_Q , can be read from the vertical axis of Figure 3-2 as 0.58. Using the given value of 0.2 for D_{Ri} , the trapping efficiency for clay size particles considering the impact of the permanent pool, TE_{Ci} is:

$$TE_{Ci} = 1 - (1 - D_{Ri})(1 - E_{Q,i}) = 1 - (1 - 0.2)(1 - 0.58) = 0.664$$

Example Problem 3.2 Compare Trapping Efficiency of Retention Pond versus Detention Basin

Assume the retention basin for is being designed to provide storage for the 10-yr 24-hr design storm in Beaufort, SC for a twenty acre site as previously described in problem 2.1 and 2.2. Compare results of detention versus retention.

Solution:

As the watershed characteristics are the same as, all values from problem 2.1 can be used. The calculated yields and concentration from problem 2.2 can also be used. The trapping efficiency for retention basins and all values that depend on the trapping efficiency for retention ponds need to be calculated.

First rainfall statistics for the region of the country being evaluated should be gathered. From Haan et al. (1994), Table 9B.1, general rainfall statistics for South Carolina are:

Average interval time between storms, T_{IA} :	89 hr (days)
Coefficient of variation of runoff (rainfall) volume, CV_R :	1.47
Coefficient of variation of flow (rainfall intensity), CV_Q :	1.28

The fraction of sediment removed during quiescent settling, E_Q needs to be calculated using the procedures detailed above in problem 3.1. Using the post-constriction runoff volume, Q , as calculated in problem 2.1, the ratio of the storage volume to runoff volume, V_B / V_R , is:

$$V_B / V_R = (1.2 \text{ ac} \times 3.09 \text{ ft}) / 5.95 \text{ ac} - \text{ft} = 0.62$$

The settling velocities from Table 2-6 can be used for each particle class to calculate the quiescent removal rate, $R_{Q,p}$, and the removal ratio, RR_p , using equations 3-1 and 3-2 respectively. Then the effective storage volume, V_E / V_R , can be determined from Figure 3-1. Using the value obtained from Figure 3-1 and a of CV_Q equal to 1.47, the fraction of sediment removed for each class of particle by quiescent settling, $E_{Q,p}$, can be determined from Figure 3-2. The Results are presented in Table 3-1.

Next, the dynamic trapping efficiency, D_R for each particle class needs to be calculated using equation 3-3. For this example, the trapping efficiency, TE_p , as calculated by equation 2-10 in example problem 2.2 will be used for comparative purposes (this is a more conservative approach than using $TE_{M,i}$ based on the overflow rate of an average storm). The combined trapping efficiency for each particulate class is then calculated using equation 3-5. Results including summations are presented in Table 3-2.

Table 3-1 Determination of Quiescent Settling for Retention Pond of Example Problem 3.2

Class Sediment	Fraction in Class, F_i	Setting Velocity, $V_{s,i}$ (ft/s)	Sediment Removal Rate, $R_{Q,i}$ (ac-ft/day)	Removal Ratio, RR_i	Ratio of Effective Volume to Runoff Volume (Figure 3-1)	Quiescent Trapping Efficiency, $E_{Q,i}$ (Figure 3-2)
Clay	0.052	1.12×10^{-5}	1.17	0.72	0.39	0.28
Silt	0.080	2.81×10^{-4}	29.1	18.2	0.62	0.39
Sand	0.388	6.36×10^{-2}	162	101	0.62	0.39
Small Agregates	0.160	1.56×10^{-3}	6600	4100	0.62	0.39
Large Agregates	0.320	6.79×10^{-2}	7000	4400	0.62	0.39
Total	1.00					0.38

Table 3-2 Determination of Dynamic and Combined Trapping Efficiency for Retention Pond of Example Problem 3.2

Class Sediment	Fraction in Class, F_i	Setting Velocity, $V_{s,i}$ (ft/s)	Trapping Efficiency, $T_{E,i}$ (Table 2-7)	Dynamic Trapping Efficiency, $D_{R,i}$	Quiescent Trapping Efficiency, $E_{Q,i}$ (Table 3-1)	Combined Trapping Efficiency, $TE_{C,i}$ (Figure 3-2)
Clay	0.052	1.12×10^{-5}	0.022	0.022	0.39	0.30
Silt	0.080	2.81×10^{-4}	0.399	0.228	0.62	0.53
Sand	0.388	6.36×10^{-2}	1.00	1.00	0.62	1.00
Small Agregates	0.160	1.56×10^{-3}	0.880	0.74	0.62	0.84
Large Agregates	0.320	6.79×10^{-2}	1.00	1.00	0.62	1.00
Total	1.00		0.88	0.84	0.38	0.90

Note: calculate $D_R < TE_i$ for clay (< 0.065).

The total trapping efficiency for this 1.2 acre retention basin is 90% in comparison to the same size detention basin with trapping efficiency of 88% (as mentioned in Section 1, whether this difference is statistically significant, is debatable, see: Strecker et al., 2002). The predicted surface area to meet a trapping efficiency of 95% would be 4.75 acres for the retention pond as compared to 9.5 acres for the detention basin.

The sediment and clay fractions trapped and discharged can now be calculated using the equations of this section and Section 2. The comparative results of the detention basins as calculated in Section 2 are presented in Table 3-3 alongside the results of the retention pond based on the TE_C as detailed above.

Table 3-3 Comparison of Trapped and Discharged Sediment and Pollutants for Detention Basin versus Retention Pond

Mass	Detention Basin (lb)	Retention Pond (lb)	Difference (lb)	Percent Difference (%)
Trapped, M_T	2707	2763	56	2
Discharged, M_D	364	308		18
Clay Particles Trapped, $M_{CP, T}$	143	182	39	21
Clay Particles Discharged, $M_{CP, D}$	175	137		28
Settleable Nitrogen Trapped, $M_{ST, N}$	5.72	4.51	1.20	21
Settleable Nitrogen Discharged, $M_{SD, N}$	5.51	4.31		28
Settleable Phosphorous Trapped, $M_{ST, P}$	0.26	1.22	0.26	21
Settleable Phosphorous Discharged, $M_{SD, P}$	4.31	5.51		28
Nitrogen Sorbed to Active Clay, Trapped, $M_{DAT, N}$	0.086	0.109	0.023	21
Nitrogen Sorbed to Active Clay, Discharged, $M_{DAT, N}$	0.105	0.082		28
Phosphorous Sorbed to Active Clay, Trapped, $M_{DAT, P}$	0.0119	0.015	0.032	21
Phosphorous Sorbed to Active Clay, Discharged, $M_{DAT, P}$	0.0145	0.011		28

The trapping efficiency of active clay, TE_{AC} , for the retention pond is 0.57 as compared to 0.45 of the detention basin.

Example Problem 3.3: Analysis of Wet Detention Using IDEAL

A subdivision is being proposed for construction in Beaufort, SC. The subdivision as shown in Figure 3-4, will have 24 lots with an area of 1/3 acre per lot and will drain into the stormwater detention basin shown in Figure 3-5. The slope length for each of the lots is 150 ft with a slope of 4%. Each lot will have 5989 ft² of impervious area, including the house, sidewalks and driveway for a total of 3.30 acre. These impervious areas are not directly connected to the storm drains. Streets are directly connected to the storm drains and occupy 0.04 ac/lot for a total of 0.96 acre. Isotherms have been run for the soil for nitrogen and phosphorus and values for K and $C_{S, max}$ were determined as shown in Table 3-4, along with the fraction of nutrients that are particulates, excluding those sorbed on the clay particles. Using the IDEAL model, calculate the runoff, sediment and nutrients flowing into and out of the stormwater detention basin for an average storm.

Table 3-4 Example Isotherm Values for Coastal South Carolina

Chemical	Particulate Fraction	K (: g/l)	$C_{S, max}$ (μ g/g)
Nitrogen	0.25	32	1050
Phosphorus	0.20	4100	1660

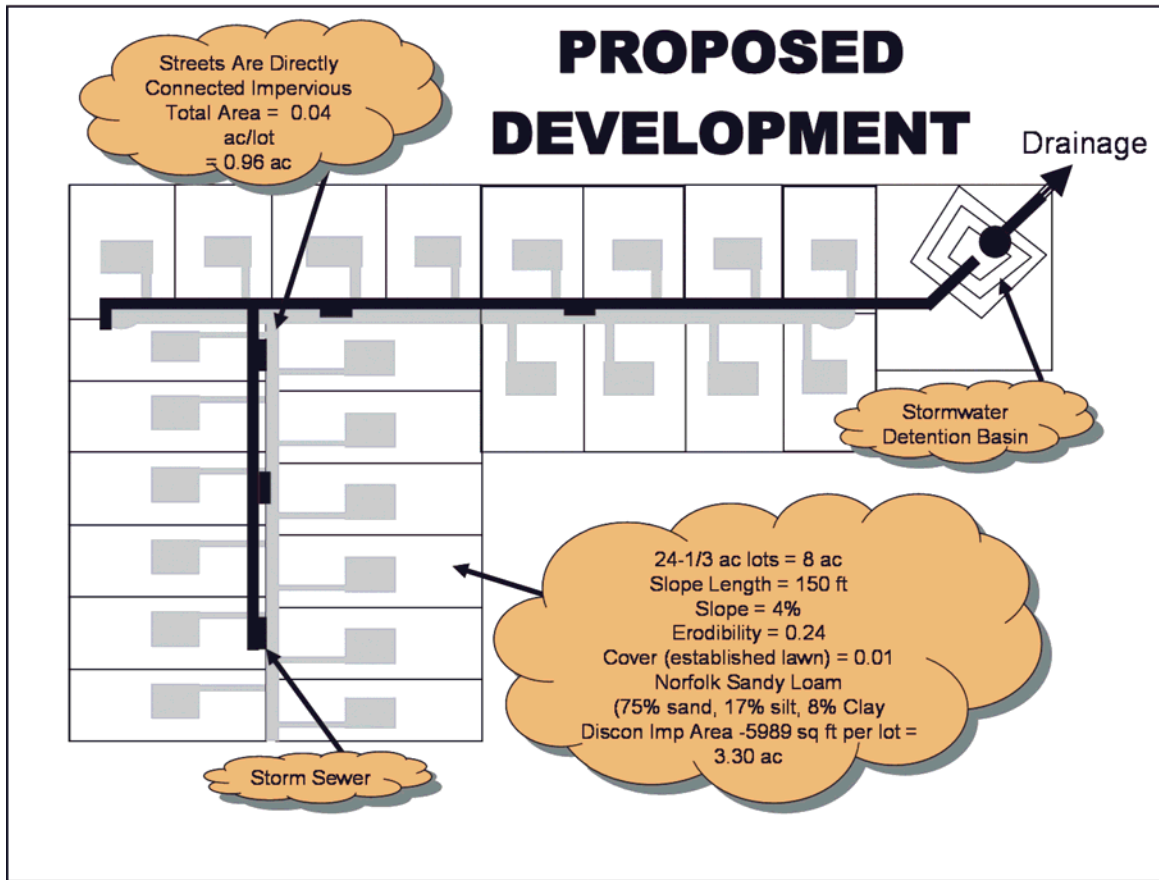

Figure 3- 4 Schematic of Proposed Development for Example Problem 3-3

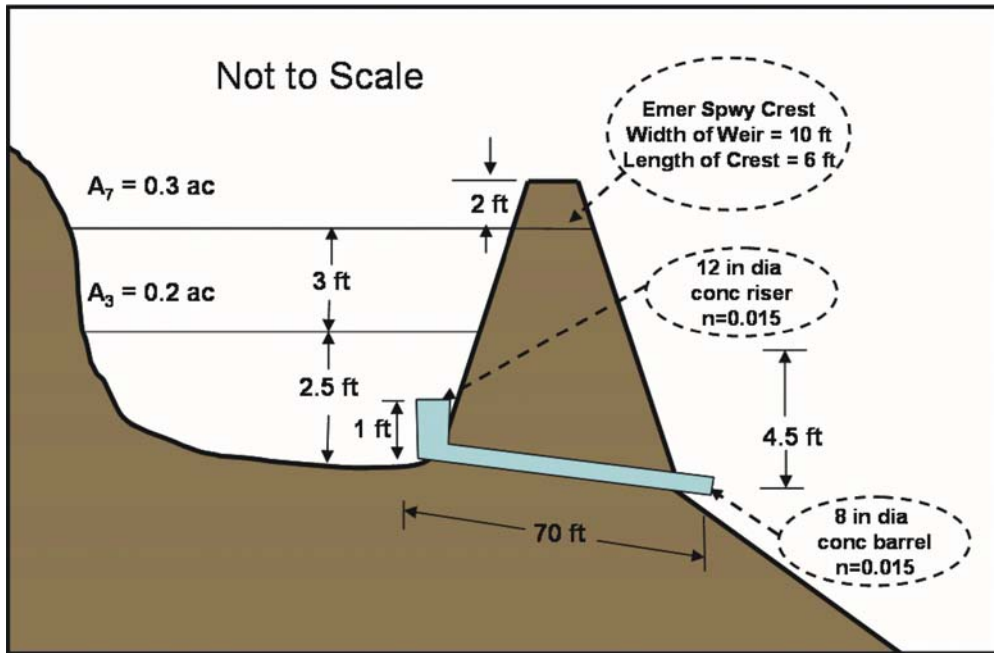

Figure 3- 5 Schematic of Stormwater Retention Pond for Example Problem 3-3

Solution:

Representative diameters and fractions of primary particles for TSS washed from the impervious and pervious areas are given in Volume 2, Table 4.9. As indicated in the discussion of Volume 2, Table 4.9, it is assumed that all sediment in runoff from impervious areas is primary particles. Values for pervious areas are determined in the IDEAL model.

EMC for the all areas have been determined by the local regulatory authority to best be represented by 1.88 for nitrogen and 0.4 mg/l for phosphorous for the entire watershed and 117 mg/l for TSS from directly impervious areas only.

The average interval between storms is 89 hr and with a coefficient of variation of volume of 1.47 (see Haan et al., 1994, Appendix 9). Information for the input worksheet for the IDEAL model is shown in screen captures from the IDEAL model spreadsheet version in Figures 3 - 6 through 3-8. Screen captures of the output values are shown in Figures 3-9 through 3-11 for the average storm.

The spreadsheet version of IDEAL displays output in three columns: average storm, return period storm and total annual. More information is provided in the example of Section 5, Volume 2. A working definition the average storm, which is specified for this problem, given that it rains, is the statistical average value over all precipitation values, seasons and AMC.

Example Problem to Illustrate Use of Model		
Cells with shading and blue font are for user input.		
Item	Values	
Area and Land Use		
Total Area (ac)	8.96	
% Pervious Area (All Three Percentages Must Add to 100)	52.46	
% Impervious Area Not Connected to Drainage Channels (%)	36.83	
% Impervious Area Connected to Drainage Channels (%)	10.71	
Hydrologic Information		
Precipitation Table used (1 if User Defined (See "User Defined Storm Data" for input) or 2 for Example Data Using GSP)		
Airport	1	
Soil Information		
Soil Series (Name)	Horfolk	
Soil Classification (i.e., clay loam, silt loam, etc)	Loam	
Land Use (By listed Categories)		
Pervious Area (By listed Categories)	lawn (good)	
Impervious Area Not Con. To Drainage Ch	Residential Home	
Impervious Area Con. To Drainage Ch	Streets with Gutters	
Hydrologic Soil Groups of Pervious Area (A, B, C, or D)	B	
Curve Numbers CN for AMC II		
Pervious Area	61	
Impervious Area Not Connected To Drainage Channel	98	
Impervious Area Connected to Drainage Channel	98	
Time of Concentrations		
Combined Pervious and Imp. Areas Not Connected to Drain (hr)	0.3	
Impervious Areas Connected to Drainage Channel (hr)	0.1	
Time Between Storms		
Average Interval Between Storms in hrs	89	
Coefficient of Variation of Rainfall Volume, CV _r (in)	1.47	

Figure 3-6 IDEAL Input for Area, Land Use and Hydrologic Information for Example Problem 3.3

MODEL		
Version 2.70 (5-23-04)		
WATERSHED PARAMETERS USED IN MODEL		
Project Title:		
Example Problem to Illustrate Use of Model		
Cells with shading and blue font are for user input.		
Sediment Information	Values	
Erosion Information for Pervious Areas		
Soil Erodibility (from Tables based on soil type)	0.24	
Slope (%) (from topo maps)	4	
Slope Length (ft) (from topo maps)	150	
Cover Factor (0-1.2) (from tables based on land use)	0.01	
Practice factor (0-1) (from tables based on conservation practice, typically 1.0)	1	
Information for Size Distributions		
Percent Sand Sized Particles (%) (from soil survey maps available from NRCS)	75	
Percent Silt Sized Particles (%) (from soil survey maps available from NRCS)	17	
Percent Clay Sized Particles (%) (from soil survey maps available from NRCS, Note: Sand, Silt and Clay must sum to 100)	8	
Event Mean Concentrations		
Impervious Areas Connected to Drains		
TSS (mg/l)	117	
Nitrogen (mg/l)	1.88	0.25
Phosphorus (mg/l)	0.4	0.20
Bacterial Indicators (organisms/100ml) <i>Fecal Coliform</i>	15000	
Pervious Areas and Impervious Areas Not Connected to Drains		
Nitrogen (mg/l)	1.88	0.25
Phosphorus (mg/l)	0.4	0.20
Bacterial Indicators (organisms/100ml)	15000	
Isotherm Values for Chemicals and Bacteria (Conc on Active Phase of Sediment $S = K \leq C_{S \text{ max}}$)		
Nitrogen - values should be based on tests of local soils	K	C _{S max}
Phosphorous - values should be based on local soils	32	1050
Values of K and C _{S max} should be based on testing of local soils and be conservative	4100	1660

Figure 3-7 IDEAL Input for Sediment, EMC, and Nutrient Isotherms for Example Problem 3.3

7 Example Problem to Illustrate Use of Model		
11 <i>Cells with shading and blue font are for user input.</i>		
12	Item	Values
105 Information for Pond		
106	Pond Prescribed (yes=1,no=0)	1
107	Type of Detention (wet=1,dry=0)	1
108	Pond Inefficiency Parameter (accounts for dead storage, short circuiting, etc)	3
109	Stage Information (input stage values for each stage point)	Stage (ft)
110	Stage of pond bottom	0
111	Stage of principle spillway crest above pond bottom (ft)	1
112	Stage of emergency spillway crest (ft)	5.5
113	Stage of top of dam	7.5
114	Area of two significant points along with stage (suggest stage and area of principal spillway and emergency spwy cre	
115	Stage and area 1(ft and ac)	2.5
116	Stage and area of emergency spwy (Stage automatically carried down from above, area is input (ft and ac)	5.5
117	Area of Principal Spillway (ac)	0.124850098
118 Outlet Information		
119	Drop Inlet Spillway (0 = no, 1 = yes)	1
120	Diameter of Barrel (in)	8
121	Length of Barrel (ft)	70
122	Diam of Riser (in)	12
123	Stage of Riser Crest above bottom of pond (ft)	1
124	Distance from invert of outlet to crest of riser (ft)	4.5
125	Entrance Loss Coefficient (Ke)	0.5
126	Bend Loss Coefficient (Kb)	0.5
127	Manning's Roughness	0.015
128	Distance from Crest of EMS to Crest of Principal spillway (ft) (Calculated by Spreadsheet)	4.5
129	Weir Coefficient	3.1
130	Orifice Coefficient	0.64
131	Low Flow Orifice (0 = no, 1 = yes)	0
135	Separate Weir (0 = no, 1 = yes)	0
139	Emergency Spillway (treated as broad crested weir) (0 = no, 1 = yes)	1
140	Width of Weir (Perpendicular to flow path) (ft)	10
141	Length of Spillway Crest (Parallel to flow path) (ft)	6
142	Weir Coefficient	3.087
143	Height of Weir above Reservoir Bottom (ft)	5.5

Figure 3-8 IDEAL Input for Stormwater Retention Pond for Example Problem 3.3

3 Example Problem to Illustrate Use of Model		
38	Runoff and Peak Discharges	Avg Storm
40	Average Annual Single Storm	
41	Rainfall (in)	0.4641
43	Q(ac-ft)	0.0372
44	Q(in)	0.0498
45	q _p (cfs)	0.5634
53	Flow From Pond (If Pond is Specified)	
54	q _p (cfs)	0.2785
55	Peak Stage (ft)	1.1162
56	Fraction of Runoff in Per Pool	1.0000
57	Ratio of Peak Outflow to Inflow q _{po} /q _{pi}	0.4944

Figure 3-9 IDEAL Output for Runoff and Peak Discharges for Example Problem 3.3

3 Example Problem to Illustrate Use of Model		
59	Sediment Loading and Trapping	Avg Storm
61	<i>Watershed Yield</i>	Avg Storm
62	Total TSS Yield From Watershed Into VFS or Drain (lbs)	21.96
63	Average Concentration (mg/l)	217.24
64	Clay Sized Particles (lbs)	2.74
65	Settleable Nitrogen (lbs)	0.05
66	Settleable Phosphorus (lbs)	0.01
67	Active Fraction (clay) (lbs)	2.68
102	<i>Trapping in Pond - Wet Detention</i>	
103	Total Sediment Trapped (lbs)	20.3884
104	Clay Sized Particles (lbs)	1.5415
105	Settleable Nitrogen (lbs)	0.0281
106	Settleable Phosphorus (lbs)	0.0049
107	Active Fraction (clay) (lbs)	1.5578
108	Trapping Efficiency (Total Sed)	0.9286
109	Trapping Efficiency (Active Fraction)	0.5814
110	Total Sediment Discharged (lbs)	1.5678
111	Clay Sized Particles (lbs)	1.1937
112	Settleable Nitrogen (lbs)	0.0194
113	Settleable Phosphorus (lbs)	0.0049
114	Active Fraction (clay) (lbs)	1.1704

Figure 3-10 IDEAL Output for Sediment Loading and Trapping for Example Problem 3.3

3 Example Problem to Illustrate Use of Model		
121	Pollutant Loading and Trapping	Avg Storm
171	<i>Nitrogen</i>	
172	From Watershed (lbs)	0.1900
173	Mass Absorbed on Active Phase (lbs)	0.0001
174	Mass Trapped (lbs)	0.0001
175	Discharged from Pond (lbs)	0.1618
176	Average Concentration in Pond Discharge (mg/l)	1.6010
177	Trapping Efficiency	0.1484
178	<i>Phosphorus</i>	
179	From Watershed (lbs)	0.0404
180	Mass Absorbed on Active Phase (lbs)	0.0032
181	Mass Trapped (lbs)	0.0018
182	Discharged from Pond (lbs)	0.0337
183	Average Concentration in Pond Discharge (mg/l)	0.3333
184	Trapping Efficiency	0.1669

Figure 3-11 IDEAL Output for Nutrient Loading and Trapping for Example Problem 3.3

As shown in Figure 3-9, the average runoff from the development for this simulation is expected to be 0.05 watershed in., the average rainfall is 0.46 in. and peak discharge for the average storm is 0.56 ft³/s. The low runoff and peak discharges for the average storm results from the high infiltration rates (low curve number) for the sandy loam soil. After routing the storms through the wet detention basin, the runoff is unchanged, but the peak discharge is decreased to is 0.28 ft³/s. Thus, the ratio of peak outflow to inflow is 0.49 for the average storm.

TSS yields are quite low for the average storm, as shown in Figure 3-10, averaging 22 lb from the development with only approximately 12% of that, 2.7 lb, in clay sized particles. Due to the coarse particle sizes, the wet detention basin is expected to trap 93% of the sediment load averaged over all storms. The trapping efficiency of the pond is 58% for the clay sized particles. Much of the cause for this high trapping efficiency of clay size particles is due to the permanent pool.

As shown in Figure 3-11, nitrogen and phosphorus loads averaged over all storms are small, and are only reduced by a small amount with trapping percentages of 15 and 17%, respectively. These values are typical of what is observed in stormwater detention ponds.

Design Criteria

Much of this subsection has been adopted from the ASCE /WEF (1998) manual of practice.

Design Approach

Two alternative approaches can be used to establish design criteria for water quality purposes in wet detention ponds. The first approach is based on solids settling and assumes that all pollutant removal within the pond occurs primarily due to sedimentation. The second approach treats the wet pond as a lake with controlled levels of eutrophication to account for the biological and physical/chemical processes that are principal mechanisms for nutrient removal (Hartigan, 1989 and Walker, 1987). Both approaches relate the pollutant removal efficiencies to hydraulic residence time.

The design approach should be selected based upon the target of the control efforts as well as site and economic constraints. The controlled eutrophication approach requires longer residence times and larger storage volumes compared to those of the solids settling approach. However, where the chief concern is to control nutrient levels in waters such as lakes and reservoirs, it is then advantageous to use the controlled eutrophication approach. If the major goal is the removal of a broad spectrum of pollutants, especially those adsorbed onto suspended matter, it may be preferable to base the design criteria on the sedimentation models. Currently, most pond water quality practice designs for runoff pollution control rely heavily on the sedimentation process.

Design Variations

Two basic design variations are available to satisfy particular site-specific conditions or requirements. These are:

- A wet pond with a permanent pool of water with a volume equal to some fraction or multiple of the mean storm runoff volume. The runoff displaces a portion of the pool volume and is treated during the dry period and in turn is displaced by the next storm. A schematic of this wet pond design was illustrated in Figure 1-3.
- A multipurpose multistage wet pond designed to provide stormwater management (peak attenuation, etc.) in addition to water quality enhancement.

Design Parameters

The primary removal mechanism for pollutants in wet ponds is by settling of the solid materials. Thus, wet ponds should be designed to maximize sedimentation within the permanent pool. The permanent pool of water is equal to some fraction or multiple of the runoff volume. The runoff displaces a portion of the pool volume and is treated during the dry period and in turn is displaced by the next storm. A schematic of this wet pond design was illustrated in Figure 1-3. Schueler and Helfrich (1988) summarized some typical design criteria for this approach in Table 3-5. General hydrologic and hydraulic suggestions for on-site (drainage area 20-100 acres) and regional (drainage area 100-300 acres) wet pond water quality practices for treatment of nutrients and a broader spectrum of pollutants are given in Tables 3-6.

Some important design parameters are discussed below. The actual design selected should be based on an analysis of the effective of the design in meeting the performance criteria and modifications made as necessary using analytical procedures as detailed in this manual.

Table 3-5 Hydrologic and Hydraulic Design Criteria for Standard Extended Detention Wet Pond System (Schueler and Helfrich, 1988)

Permanent Pool Storage

Design criteria	Treat first flush of runoff
Storage volume	One-watershed inch * R_v * watershed area
Water surface elevation	Established by invert of extended detention pipe
Pipe sizing (pool drain)	Drain pool volume within 24 hr

Extended Detention Storage

Design criteria	Provide minimum 24 hr of detention for next one-half inch watershed runoff
Storage volume	0.5 in. * watershed area
Water surface elevation	Upper limit set at beginning of 2-yr design storm storage
Pipe sizing - Allowable release rate (Q_R)	$Q_R = [(0.5 \text{ acre} \cdot \text{in})(43560 \text{ cf} / \text{acre}) (\text{ft} / 12 \text{ in.})] / [2(24\text{hrs})]$

Two Year Storm Event Peak Discharge Control Storage

Design criteria	Maintain pre-development peak discharge for 2-yr design storm
Storage volume	Obtained from TR-55, short cut method , TR-20, HEC-HMS or other methods which produce similar results
Water surface elevation	Upper limit: bottom of 100-yr storage Lower limit: top of extended detention storage

Safety Storm / Emergency Spillway

Design criteria	Safety storm: design event depends on hazard class Emergency spillway: must pass safety storm
Storage volume	Safety storm: obtained from TR-20 (NRCS, 1982) Emergency spillway: obtained from NRCS spillway charts (NRCS, 1982)

Pool Volume

The volume of the permanent pool, in relation to the drainage area or runoff volume, is the most critical parameter in the sizing of the wet pond and its ability to remove pollutants. Various design criteria or rules of thumb are expressed in terms of the VB/VR ratio where VB is the volume of the permanent pool and VR is the volume of runoff for an average storm. The impact of an actual design should be calculated by using the relationships given in sub-section “**Analysis Procedures for Wet Retention Basins.**” A starting point for selecting a design would be to size the pool for a hydraulic detention time, which is a simple calculation to make, and then check the pollutant removal with the procedures detailed above. The value of detention time T (in years) is given by dividing the permanent pool volume VB by the product of the total number of runoff events per year, n , namely:

$$T = \frac{VB}{nVR} \tag{3-14}$$

Table 3-6 Recommended Criteria for Wet Pond Design for Nutrient Removal* (Hartigan et al., 1989)

Design Parameter	Recommended Criteria	
	On-Site Wet Pond	Regional
Storage Volume (Permanent Pool)	a. $T = 2$ weeks or more b. $VB/VR > 4$ or more	Same as on-site wet pond
Mean Depth (Permanent Pool)	3 to 6 ft	Same as on-site wet pond
Surface Area (Permanent Pool)	> 0.25 acres	3 to 5 acres or more
Drainage area	Minimum of 20 - 25 acres	100 - 300 acres depending on impervious cover
Side slopes	5:1 to 10:1 (H:V)	
Length/width ratio	2:1 or greater	
Soils at site	Hydrologic Soil Groups B,C and D (Compaction may be required on A and B soils)	

T = average hydraulic residence time

* Projected Nutrient removal (P=65%, Solids 85-90%)

Field studies indicate that an optimum removal of approximately 50% nutrients occurs at T values of 2 to 3 weeks for pools with mean depths of 1.0 to 2.0 m (3 to 6 ft) (Hartigan et al., 1989). In the eastern U.S., this optimum range for T values corresponds to VB/VR ratios of 4 to 6. Ponds with values of T greater than 2 to 3 weeks have a greater risk of thermal stratification and anaerobic bottom waters, resulting in an increased risk of significant export of nutrients from bottom sediments.

State and regional stormwater management regulations and guidelines often address design criteria for the permanent pool storage volume in terms of either average hydraulic retention time, T , the ratio VB/VR , or minimum total suspended sediment removal rate. For example, the State of Florida (Florida DER, 1988) requires an average hydraulic retention time of 14 days, equivalent to VB/VR of 4. The UDFCD’s BMP criteria manual in the Denver, Colorado, area (UDFCD, 1992) specifies that the permanent pool storage volume should be 1.0 to 1.5 times the “water quality capture volume,” which is equivalent to VB/VR on the order of 1.5 to 2.5. A municipal BMP handbook published by the California State Water Resources Control Board (Camp Dresser & McKee et al., 1993) recommends that retention pond permanent pools be sized for a VB/VR of 3.

Some State or local regulations require detention of a specified runoff volume as surcharge above the permanent pool. Storage in the surcharge zone is released during a specified period through an outlet structure. This surcharge detention requirement is intended to reduce short circuiting and enhance settling of total suspended sediments. Settling-solids analysis shows that retention ponds sized for nutrient removal with a minimum detention time, T , of 2 weeks and a minimum VB/VR of 4 achieve total suspended sediment removal rates of 80 to 90%. North Carolina’s stormwater disposal regulations for coastal areas and water supply watersheds specify that the permanent pool should be sized to achieve a total suspended sediment removal rate of 85%, which is equivalent to a VB/VR in the range of 3 to 4 when no surcharge extended detention is provided. With surcharge extended detention, 85% removal of total suspended sediments has been achieved with a VB/VR of 2 or less.

Addition of an extended detention zone above the permanent pool is unlikely to produce measurable increases in the removal of total suspended sediments. Still, a surcharge extended detention volume is recommended whenever the

VB/VR, is less than 2.5. Whenever one is used or required, it is suggested that the maximized event-based volume with a 12-hr drain time be used. Again, the impacts of each of these suggestions should be made by using the analytical methods in Section 3.

In cases where relatively permeable soils (HSG A and B) are encountered, the risk of drawdown may be minimized by installing a six inch clay liner at the bottom of the pond or simply by compacting the pond soils.

Pool Depth

The depth of the permanent pool is an important design parameter since it affects solids settling. Mean depth of the pool is obtained by dividing the storage volume by the pool surface area. The pool should be shallow enough to ensure aerobic conditions and avoid thermal stratification, yet be deep enough to minimize algal blooms or resuspension of previously deposited materials by major storms or wind generated disturbances. Prevention of thermal stratification will minimize short-circuiting and maintain aerobic bottom waters, thus maximizing pollutant uptake and minimizing the potential release of nutrients to the overlying waters. An average depth of 3 to 6 ft is sufficient to maintain the environment within the pool. A 10 ft wide and 1 ft deep bench is needed around the perimeter of the pool to promote aquatic vegetation and to reduce the potential safety hazard to the public. Shallow depth near the inlet structure is desirable to concentrate sediment deposition in a smaller and easily accessible area. The effluent riser should be located in a deeper area to facilitate withdrawal of cooler bottom water for the mitigation of downstream thermal impacts, if any.

The minimum depth of the open water area should be greater than the depth of sunlight penetration to prevent emergent plant growth in this area, namely, on the order of 2 to 2.5 m (6 to 8 ft). A mean depth of approximately 1 to 3 m (3 to 10 ft) should produce a pond with sufficient surface area to promote algae photosynthesis, and should maintain an acceptable environment within the permanent pool for the average hydraulic retention times recommended above, although separate analyses should be performed for each locale. If the pond has more than 0.8 ha (2 acre) of water surface, mean depths of 2 m (6.5 ft) will protect it against wind generated resuspension of sediments. The mean depths of the more effective retention ponds monitored by the NURP study typically fall within this range. A water depth of approximately 1.8 m (6 ft) over the major portion of the pond will also increase winter survival of fish (Schueler, 1987).

A maximum depth of 3 to 4 m (10 to 13 ft) should reduce the risk of thermal stratification (Mills et al., 1982). In the State of Florida, pools up to 9.2 m (30 ft) deep have been successful when excavated in high groundwater areas. This is probably because of improved circulation at the bottom of the pond as a result of groundwater moving through it.

Readily visible SWM facilities receive more and better maintenance than those in less visible, more remote locations. Readily visible facilities can also be inspected faster and more easily by maintenance and mosquito control personnel. If maintained at the recommended 3 to 6 foot depth, the permanent pool can serve as aquatic habitat.

Minimum Surface Area of Permanent Pool

Minimum surface area will be contingent upon local topography, minimum depth and solids settling guidelines. For on-site wet pond water quality basins, the typical minimum pool surface area is 0.25 acres. The impact of surface area on performance should be checked with the procedures earlier in this section.

Minimum Drainage Area and Pond Volume

The minimum drainage area for an on-site wet-pond, water-quality structure should be large enough to sustain the wet pond during the summer periods. The drainage area should permit sufficient base flow to prevent excessive retention times or severe drawdown of the permanent pool during dry seasons. Unless regional experience is available for determining the minimum drainage area required in a particular location, it is recommended that a water balance calculation be performed using local runoff, evapotranspiration, exfiltration and base flow data to ensure that the base flow is adequate to keep the pond full during the dry season. Base flow will, of course, vary considerable from watershed to watershed in a region. However, a regionalized analysis would be helpful. This information is typically available from the USGS offices in a State or possibly the local NRCS office.

The maximum tributary catchment area should be set to reduce the exposure of upstream channels to erosive stormwater flows, reduce effects on perennial streams and wetlands, and reduce public safety hazards associated with dam height. Again, regional experience will be useful in providing guidelines. For example, in the southeastern U.S., some stormwater master plans have restricted the maximum tributary catchments to 40 to 120 ha (100 to 300 acre), depending on the amount of imperviousness in the watershed, with highly impervious catchments restricted to the lower end of this range and vice versa. On the other hand, experience in semiarid areas has shown that even a small area of new land development can cause downstream erosion and that drainage way stabilization is needed between the new development and the pond for relatively small catchments.

As a rule of thumb, a minimum drainage area of 20 acres is required to sustain the desired dry weather inflow. In general, 4 acres of contributing drainage area are needed for each acre-foot of storage. As indicated earlier, however, a local analysis is needed. Appendix A offers a “short-cut” method for determining wetland drawdown, which is similar to the type of analysis needed for a retention pond.

Side-Slopes

Side slopes along the shoreline of the retention pond should be 4:1 (H:V) or flatter to facilitate maintenance (such as mowing) and reduce public risk of slipping and falling into the water. In addition, a littoral zone should be established around the perimeter of the permanent pool to promote the growth of emergent vegetation along the shoreline and deter individuals from wading (see Figure 3-2). The emergent vegetation around the perimeter serves several other functions: it reduces erosion, enhances the removal of dissolved nutrients in urban stormwater discharges, may reduce the formation of floating algal mats, and provides habitat for aquatic life and wetland wildlife. This bench for emergent wetland vegetation should be at least 3 m (10 ft) wide with a water depth of 0.15 to 0.45 m (0.5 to 1.5 ft). The total area of the aquatic bench should be 25 to 50% of the permanent pool's water surface area. Local agricultural agencies or commercial nurseries should be consulted about guidelines for using wetland vegetation within shallow sections of the permanent pool.

Pond Configuration

Length to width ratio of the pond should be as large as possible to simulate conditions found in plug flow reaction kinetics. Under the ideal plug flow conditions, a “plug” or “pulse” of runoff enters the basin and moves as a plug through the pond without mixing. Relatively large length-to-width ratios can help reduce short circuiting, enhance sedimentation and help prevent vertical stratification within the permanent pool. Griffin et al. (1985) showed that the dead storage for length to width ratios less than 2:1 was in the range of 27% and for length to width ratios greater than 2:1 was in the range of 17%. A minimum length-to-width ratio of 2:1 is therefore recommended for the permanent pool. The permanent pool should expand gradually from the basin inlet and contract gradually toward the outlet, maximizing the travel time from the inlet to the outlet. Baffles or islands within the pool can increase the flow path length and reduce short circuiting.

To reduce the frequency of major cleanout activities within the pool area, a sediment forebay with a hardened bottom should be constructed near the inlet to trap coarse sediment particles. As with detention basins, frequently used value for the forebay storage capacity is approximately 10% of the permanent pool storage. Access for mechanized equipment

should be provided to facilitate removal of sediment. The forebay can be separated from the remainder of the permanent pool by one of several means: a lateral sill with wetland vegetation, two ponds in series, differential pool depth, rock-filled gabions, a retaining wall, or a horizontal rock filter placed laterally across the permanent pool.

Outlets

An outlet for a retention pond typically consists of a riser with a hood or trash rack to prevent clogging and an adequate antivortex device for basins serving large drainage areas. A typical principal spillway structure is shown in Figure 3-12. Some typical outlet structures and details are provided in Appendix B. Antiseep collars should be installed along outlet conduits passing through or under the dam embankment (see Section 5). If the pond is a part of a larger peak-shaving extended detention basin, the outlet should be designed for the desired flood control performance. Section 6 provides more guidance on outlet design, especially for low flow. Typically, the riser structure should be sized to drain the permanent pool within 48 hr so that sediments may be removed mechanically when necessary. The drain pipe should be controlled by a locking gate valve at the outlet.



Figure 3-12 Typical Principal Spillway Outlet Structure

An emergency spillway must be provided and designed using accepted engineering practices to protect the basin's embankment. The return period of the design storm for the emergency spillway depends on the hazard classification, which can vary from region to region. The designer should make certain that the pond embankment and spillway are designed in accordance with federal, State and local dam safety criteria. Section 5 gives more criteria necessary for dam specifications.

The inlet design should dissipate flow energy and diffuse the inflow plume where it enters the forebay or permanent pool. Examples of inlet designs include drop manholes, energy dissipaters at the bottom of paved rundown, a lateral bench with wetland vegetation and the placement of large rock deflectors.

Other Considerations

A wet pond basin contains a permanent pool in addition to the flood control storage. To maintain water quality (oxygen levels), control mosquito breeding and prevent stagnation, a sufficient inflow of water (either surface or ground water) is necessary on a regular basis. A fountain or solar powered aerator may be used for oxygenation of water. The potential effects of sediment loading on the permanent pool should be considered when determining if a site is suitable for a wet pond basin. The use of existing lakes and ponds as wet ponds for treatment of stormwater is sometimes prohibited.

A well designed pond will accumulate considerable quantities of sediment. A typical cleanout cycle for a wet pond in a stabilized watershed is anywhere from 10 to 20 yr, with sediment removal at each cycle costing as much as 20 to 40% of the initial construction cost. The ASCE/WEF (1998) manual of practice provides a calculation procedure based on sediment load to anticipate the time to clean out which is included in Section 6. Section 6 also provides more guidance on operation and maintenance.

Thermal effects of the wet pond must be considered since the pool acts as a heat sink during the summer period, between the storm events. When the water is displaced from the pool, it may be as much as 10 ° F warmer than naturally occurring baseflow. Large impervious surfaces can also significantly raise the temperature of runoff in the summer months. The net result of elevated pool temperatures may have an adverse impact on downstream cold water uses such as trout production. Most streams in mature urban areas do not fall into this category. However, in newly urbanizing areas, the pond designer should pay special attention to the potential of thermal effects on downstream water bodies supporting cold water fisheries. Thermal impacts in such areas may be eliminated or mitigated by: (a) prohibiting wet ponds altogether, (b) diverting most of the baseflow and bypassing the wet pond entirely, (c) utilizing a design with a drastically undersized permanent pool, (d) using a design with a deep pool and positioning the inlet of the outlet pipe to withdraw cooler water from near the bottom, (e) planting shade trees on the periphery of the pool (other than the dam) to reduce solar warming in the summer, (f) directing baseflow through the wetland while channeling stormflow to a fringe pool area and (g) employing a series of pools in sequence rather than a single one.

Aquatic Vegetation

Aquatic vegetation plays an important role in the pollutant removal dynamics of the wet pond. Soluble pollutants, especially nutrients, are removed through biological assimilation by both phytoplankton and macrophytes. Wetland plants can help to keep algal proliferation in check by limiting the amount of nutrients available to the phytoplankton. In addition, an organically enriched wetland substrate will provide an ideal environment for bacterial populations to metabolize organic matter and nutrients. Aquatic vegetation may also aid in the regulation of pond water temperature.

Marsh vegetation can also enhance the appearance of the wet pond, stabilize the side-slopes, serve as wildlife habitat, and can temporarily conceal unsightly trash and debris. Water tolerant species of vegetative cover for wet pond surfaces should be used. To promote lasting growth, grasses and other vegetative covers should be compatible with prevailing weather and soil conditions and tolerant of periodic inundation and runoff pollutants. An adequate depth of topsoil should be provided below all vegetative covers in uplands. A minimum thickness of six inches is typically recommended.

The wet pond should, therefore, be designed to promote dense growth of appropriate wetland plant species along the banks from 2 ft below to approximately 1 ft above the surface of the permanent pool. A 10 to 15 ft wide wetland vegetation bench, one foot below the pool surface should be established along the perimeter of the pond.

Constructed Wetland Ponds

These criteria we adopted from the Maryland Stormwater Design Manual (MDE, 2000). As such, regional variations may apply.

Feasibility Criteria

A water balance must be performed to demonstrate that a stormwater wetland can withstand a specific drought period (e.g., 30, 45 or 60 day) at summer evaporation rates without completely drawing down. See Appendix A for a shortcut assessment method for determining the adequacy of water balance. It is important to note that stormwater wetlands may not be located within jurisdictional waters, including wetlands, without obtaining a Section 404 permit and applicable State required permits.

Conveyance Criteria

Flowpaths from inflow points to outflow points within stormwater wetlands should be maximized. Flowpaths of 1.5:1 (length relative to width) and irregular shapes are recommended. These paths may be achieved by constructing internal berms (e.g., high marsh wedges or rock filter cells). Microtopography is encouraged to enhance wetland diversity.

Pretreatment Criteria

Sediment regulation is critical to sustaining stormwater wetlands. Consequently, it is recommended that a forebay be located at the inlet and a micropool be located at the outlet. Forebays are designed in the same manner as ponds. A micropool is a 3 to 6 foot deep pool used to protect the low flow pipe from clogging and prevent sediment resuspension.

Treatment Criteria

The surface area of the entire stormwater wetland is typically at least one percent of the total drainage area to the facility (1.5% for the shallow wetland design). In addition, at least 25% of the total V_{WQ} is normally in deepwater zones with a minimum depth of 4 ft (the forebay and micropool may meet this criteria). This criteria can be reduced if the wetland is located where thermal impacts are a primary concern.

In general, a minimum of 35% of the total surface area should have a depth of six inches or less and at least 65% of the total surface area should be shallower than 18 in.

The bed of the wetland should be graded to create a maximum internal flowpath and microtopography. If extended detention is utilized in a stormwater wetland, the extended detention volume should not comprise more than 50% of the total wetland design, and the maximum water surface elevation shall not extend more than 3 ft above the normal pool.

To promote greater nitrogen removal, rock beds can be used as a medium for the growth of wetland plants. The rock should be 1 to 3 in. in diameter and placed up to the normal pool elevation. Rock beds should also be open to flow-through from either direction.

Landscaping Criteria

Landscaping Plan

A landscaping plan is a useful tool in providing methods for establishing and maintaining wetland coverage. Recommended minimum elements of a plan include: delineation of pondscaping zones, selection of corresponding plant species, planting configuration and sequence for preparing wetland bed (including soil amendments, if needed). Landscaping plans for stormwater wetlands should incorporate features and plant species commonly found in the area. Structures such as fascines, coconut rolls, or straw bales can be used to create shallow marsh cells in high energy areas of the stormwater wetland.

The landscaping plan should provide elements that promote greater wildlife and waterfowl use within the wetland and buffers. A wetland buffer should extend 25 ft outward from the maximum water surface elevation with an additional 15 ft setback to structures.

Wetland Establishment Guidance

The most common and reliable technique for establishing an emergent wetland community in a stormwater wetland is to transplant nursery stock obtained from local aquatic plant nurseries. The following guidance is suggested when transplants are used to establish a wetland. The transplanting window extends from early April to mid-June in most parts of the USA, but local guidance should be sought. Planting after these dates is not recommended, as the wetland plants need a full growing season to build the root reserves needed to get through the winter. If at all possible, the plants should be ordered at least three months in advance to ensure the availability of the desired species.

The optimal depth requirements for several common species of emergent wetland plants are often 6 in. of water or less. To add diversity to the wetland, 5 to 7 species of emergent wetland plants should be used. Of these, at least three species should be selected from the "aggressive colonizer" group (e.g., bulrush, pickerelweed, arrow arum, three square and rice cutgrass) (MDE, 1986). The local cooperative extension will have expertise on which species are most appropriate for the area.

The wetland area should be sub-divided into separate planting zones of more or less constant depth. Approximately half the wetland surface area should be planted. One plant species should be planted within each flagged planting zone, based on their approximate depth requirements. Plants should be installed in clumps with individual plants located an average of 18 in. on center within each clump. Individual plants should be spaced 12 to 24 in. on center.

Post-nursery care of wetland plants is very important in the interval between delivery of the plants and their subsequent installation, as they are prone to desiccation. Stock should be frequently watered and shaded while on-site.

A wet hydroseed mix should be used to establish permanent vegetative cover in the buffer outside of the permanent pool. For rapid germination, scarify of the soil to ½ in. prior to hydroseeding will help. Alternatively, red fescue or annual rye can be used as a temporary cover for the wet species.

Because most stormwater wetlands are excavated to deep sub-soils, they often lack the nutrients and organic matter needed to support vigorous growth of wetland plants. At these sites, 3 to 6 in. of topsoil or wetland mulch should be added to all depth zones in the wetland from one foot below the normal pool to 6 in. above. Wetland mulch is preferable to topsoil if it is available. The mulch is best collected at the end of the growing season.

The stormwater wetland should be staked at the onset of the planting season. Depths in the wetland should be measured to the nearest inch to confirm the original planting zones. At this time, it may be necessary to modify the pondscape plan to reflect altered depths or the availability of wetland plant stock. Surveyed planting zones should be marked on an "as-built" or design plan and located in the field using stakes or flags.

The wetland drain should be fully opened at least three days prior to the planting date (which should coincide with the delivery date for the wetland plant stock). Donor soils for wetland mulch shall not be removed from natural wetlands without proper permits.

Section Four Infiltration Basins - Design Criteria

Analysis Procedures

An infiltration basin is designed to infiltrate a significant fraction of the runoff volume, thereby reducing the runoff volume and rate of discharge into receiving waters. The infiltration basin uses an open area or shallow depression for storage. These basins may or may not have a permanent pool. The success of these basins depends on locating the basins above highly pervious soils and properly constructing the basins to maintain perviousness. Procedures for analyzing infiltration basins are given first, followed by design criteria and procedures. Analysis procedures are very similar to those of dry detention, with the exception of reducing the discharge from the pond during storms by the volume infiltrated. Additionally for wet detention, the infiltration that occurs during the interval between storms needs to be included. Infiltration also removes a fraction of dissolved pollutants.

Analysis Procedures for Runoff and Loading

Analysis procedures for runoff and loading follow the same procedures as discussed in Section 4 of Volume 2, hence the reader is referred to that section for details.

Analysis Procedures for Stormwater Routing

Dry Detention

Analysis procedures for stormwater flow through an infiltration basin are identical to that for dry detention basins, with the addition of discharge due to infiltration. In the absence of models of infiltration into a groundwater reservoir under varying heads, it will be assumed that the infiltration rate is proportional to stage that varies with discharge. Hence, if it is assumed that this forms a triangular infiltration hydrograph, the volume discharged from the pond due to infiltration, Q_{inf} in watershed cm (in.) will be the pond area, times the infiltration rate, times the time base of the outflow hydrograph, or:

$$Q_{inf} = \frac{I_{max} t_{b,out}}{2 A_B Const_5} \quad (4-1)$$

where: A_B = the average area of water in the basin in ha (acre),

$t_{b,out}$ = the time base of the outflow hydrograph in hr,

I_{max} = the maximum infiltration during the peak discharge of the outflow hydrograph in m³/s (ft³/s),

$Const_5$ = 2.78x10⁻² for metric (1.008 for English) units (originally defined in Volume 2).

Using the assumption of a triangular outflow hydrograph (see Figure 2-2), the time base becomes:

$$t_{b,out} = 2QAConst_5 / q_{p,out} \quad (4-2)$$

where: $q_{p,out}$ = the peak discharge in m^3/s (ft^3/s)
 Q = runoff volume in watershed cm (in.), and
 A = watershed area in ha (acre).

Determining the peak discharge (surface discharge) follows the same procedures as the discharge from a dry basin, with the addition of infiltration. This can be accomplished by accounting for the infiltration volume in equation 2-5:

$$Q - S_{max} - (q_{p,out} t_{b,in} / A - I_{max} t_{b,out} / A_B) Const_5 / 2 = 0 \quad (4-3)$$

where: S_{max} = the maximum storage volume in the reservoir in watershed cm (in.)

I_{max} would be a necessary input parameter for this approach. It could be taken as the steady state infiltration rate for the underlying soil beneath the pond.

To get a value for an average storm, the infiltration volume and the peak discharge would be calculated for each of the storm size classes as shown in the previous examples using the IDEAL model and the average calculated by multiplying the values calculated for each precipitation value, season and AMC by the associated probability.

Wet Detention

For infiltration basins that have a dewatering device whose crest is above the bottom, there will be at least some wet pool of water at the end of stormwater discharge. One could analyze the impact by utilizing the average interval between storms. For the period between storms, the infiltration could be assumed to continue at a defined rate for the permanent pool, I_{PP} . The infiltration volume would then be:

$$Q_{inf,PP} = A_Q I_{PP} T_{IA} \leq V_{PP} \quad (4-4)$$

where: A_Q = surface area in m^2 (acre) for the permanent pool
 T_{IA} = the average time interval between storms in days,
 I_{PP} = the infiltration rate for the interval between storms in m/d (ft/d).
 $Q_{inf,PP}$ = the volume infiltrated in m^3 (acre-ft)
 V_{PP} = maximum volume of the permanent pool in m^3 (acre-ft).

Driscoll et al. (1986) also developed procedures where some of the volume is captured and then treated in the basin. In this procedure, it is assumed that all runoff is captured up to the infiltration or treatment rate capacity, Q_T , and everything above that is bypassed untreated (other procedures discussed in Section 2 and 3 detail the treatment of the discharged flow). Further, it is assumed that the infiltrated flow either returns as base flow that has been totally filtered or it disappears. Based on a gamma distribution of rainfall and flows, Figure 4-1 was developed to calculate the percent of stormwater that is removed by infiltration as a function of the ratio of infiltration (treatment flow rate) capacity, Q_T , over the mean runoff flow rate flow, Q_R . This procedure is also dependent on the coefficient of variation of runoff flow, CV_Q .

Figure 4-1 can be used by substituting the infiltration volume $Q_{inf,PP}$ for Q_T and the runoff volume, Q in m^3 (acre-ft), for Q_R . Using Figure 4-1, the effectiveness of an infiltration basin as a treatment device (vertical axis: Percent Removal of Urban Runoff) can be defined as E_r .

If the permanent pool does not empty by infiltration in the interval between storms, there will be a discharge from the basin during the initial storm inflow that will contain some of the retained pollutants from the last storm. As with retention

ponds, the interval between storms is variable and the estimate based on the average interval would not be representative of all storms. A procedure is needed to correct for this variability. As detailed in Section 3, procedures developed by Driscoll et al. (1986) can be used to evaluate the impact of the ponded volume, where the effectiveness of the basin depends on the storage volume provided.

The ratio of effective basin volume to mean runoff volume can be developed from Figure 3-1 based on the ratio of storage volume over mean runoff volume as discussed in Section 3. This procedure would require accounting for the volume infiltrated.

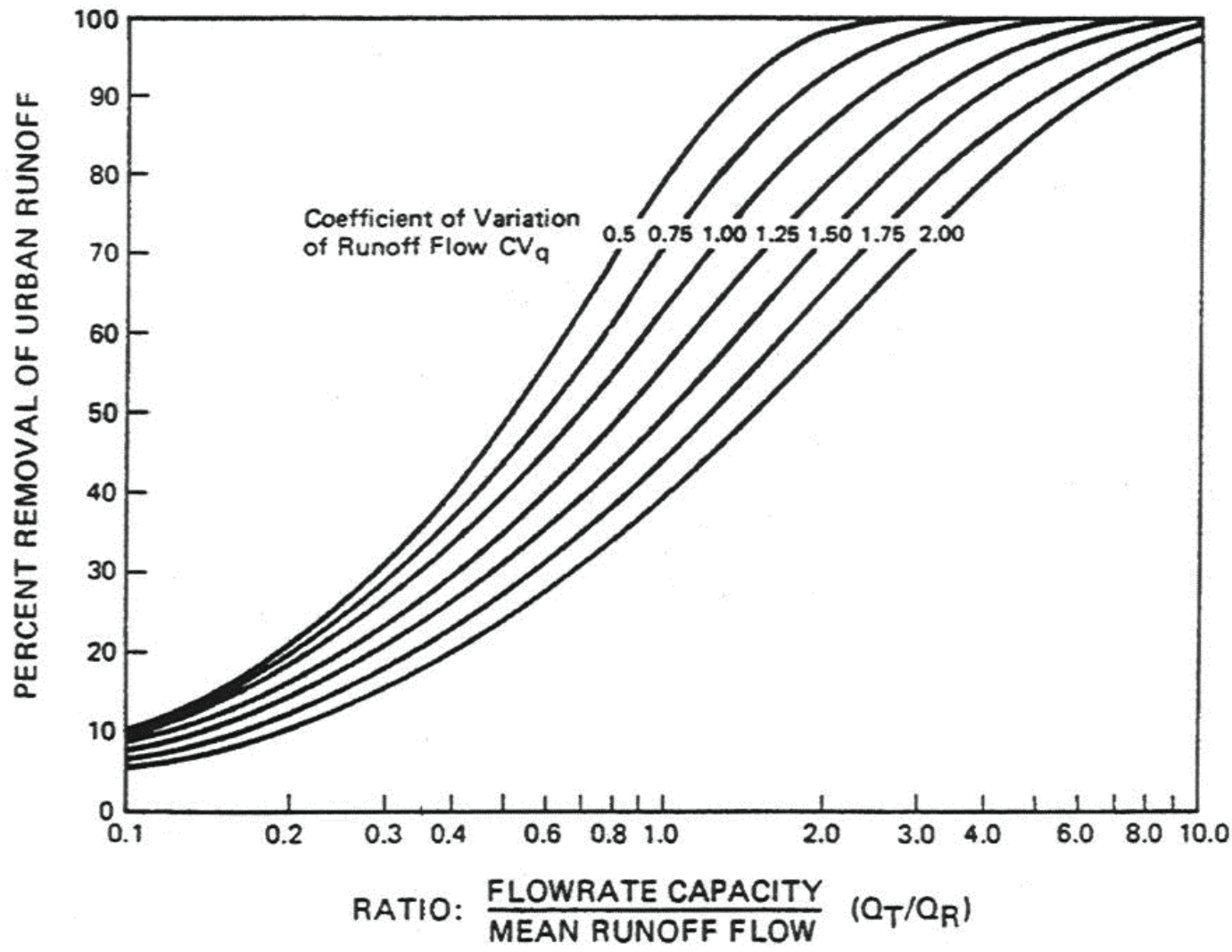

Figure 4-1 Average Long Term Performance of Flow Capture Device (Driscoll et al. 1986)

Analysis Procedures for Sediment Routing

The sediment routing for a basin with significant infiltration was modeled by Lindley et al. (1998) for the WEPP model. The reservoir component was given the acronym WEPPSIE. The model predicts sediment trapping during storm flow by standard settling procedures, and during periods between rainfalls by quiescent settling. Removal rates include infiltration of fine sediments into the soil matrix. The WEPPSIE model is complex and depends on the continuous inputs from the WEPP watershed hydrology model.

The approaches below are derived from the subsection above and those detailed in Section 2 and 3. They are meant to provide an assessment of the sediment and pollutant removal capability for infiltration basins with a significant peak out flow. Infiltration basins that do not discharge (other than to the ground) would not require such analysis.

Simple Trapping During Stormflow

For less complicated single storm procedures as developed in Section 2, a simple approach is needed. The most straightforward approach would be to make use of the peak discharge $q_{p,out}$ as defined by equation 2-3, to determine the trapping efficiency for each of the particle size classes shown in Tables 4-8 and 4-9 in Volume 2.

As in the case of trapping developed for vegetative filter strips (VFS) developed in Section 5 Volume, settling is a combination of the settling rate of the particles as it is transported through VFS and is also a function of the infiltration rate.

For an infiltration basin, the effective settling velocity for particle size class i , $V_{s,inf,i}$ is the sum of the actual particle settling velocity, $V_{s,i}$ and the infiltration rate, I_{inf} all in m/s (in/s). The infiltration rate can be calculated from the maximum infiltration during a storm. The effective removal settling velocity is given by equation 4-5:

$$V_{s,inf,i} = V_{s,i} + I_{inf} = V_{s,i} + I_{max} / A_B \quad (4-5)$$

The increased settling velocity can then be used along with the overflow rate based on the peak discharge to calculate the trapping efficiency for an infiltration basin, $TE_{inf,i}$ as:

$$TE_{inf,i} = V_{s,inf,i} / (q_{p,out} / A_B) \text{Const}_8 = (V_{s,inf,i} / V_c) \quad (4-6)$$

From the trapping efficiency, the effluent sediment discharge for stormwater flow, M_D , in kg (lb) can be calculated as (using the properties calculated from Tables 4-8 and 4-9 in Volume 2):

$$M_D = Y_T \sum_{i=1}^5 F_i (1 - TE_{i,i}) \quad (4-7)$$

where: F_i is the fraction of sediment in particle size class i , and
 Y_T = total yield of sediment from the watershed in kg (lb).

All other relevant sediment equations as detailed in Section 2 can be developed.

Trapping of Sediment for All Storms and in the Intervals between Storms

The following method is proposed but has not been verified.

For infiltration basins that have a dewatering device whose crest is above the bottom, there may be at least some wet pool of water at the end of stormwater discharge. If this pool does not empty by infiltration in the interval between storms, there will be a discharge from the basin during the initial storm inflow that will contain some of the retained pollutants from the last storm. Procedures developed by Driscoll et al. (1986) can be used to evaluate the impact of the ponded volume. As discussed earlier, the basin captures runoff flows until it is filled and then passes all additional stormwater. The effectiveness of this basin in trapping runoff and sediment for all storms and in the interval between storms is defined by Equation 4-7:

$$TE_{IB,i} = 1 - (1 - D_{R,i})(1 - E_{Q,i})(1 - E_{I,i}) \quad (4-8)$$

where: $TE_{IB,i}$ = total trapping efficiency for an infiltration basin, particle class i ,
 $D_{R,i}$ = calculated from equation 3-3,
 $E_{Q,i}$ = the value determined from Figure 3-2, and
 $E_{I,i}$ = the value determined from Figure 4-1.

Therefore, the total trapping efficiency for an infiltration basin with a permanent pool, TE_{IB} , is seen to be the combination of trapping efficiency, TE_M , of the detention storage for mean flow conditions, but expanded for multiple events, as calculated by D_R , the trapping efficiency for quiescent settling, or the interval between storms, E_Q , and the trapping efficiency of the volume infiltrated, E_I . It is important to note that $TE_{inf,i}$ (using the settling velocity for particle size class i as given by equation 4-5) should not be used with E_I , as this would twice attribute the removal by infiltration. The value of E_I is not particle size dependent being the same for all particle sizes. Also, TE_M , D_R and E_Q need to account for the volume removed by infiltration in the analysis by only using the volumes discharged for TE_M and D_R and the average permanent pool volume between storms for E_Q , not V_{PP} .

The method developed by Driscoll et al. (1986) addressed volume capture by a treatment device, i.e. infiltration basin, and treatment by sedimentation of an overflowing retention pond, but treated each of these separately. Equation 4-8 would combine these functions. Currently, there is no other relationship available that could deal with the variability of flow into and out of a BMP as well as the use of the structure as an infiltration device. Equation 4-8 has been included to complete the analysis but has not been verified, other than simple testing of the limits of the equation. From this proposed trapping efficiency, other effluent sediment discharges might be calculated.

Analysis Procedures for Chemical Routing

Trapping of chemicals in an infiltration basin has an additional component, infiltration of the dissolved fraction. For particulate and absorbed chemicals, the procedures are identical to those described for the sediment (depending on trapping analysis chosen), which requires accounting for the reduction in the peak discharge by the volume infiltrated. For dissolved chemicals, the component infiltrated must be accounted for separately.

The procedures for developing yield of sediment and pollutants are detailed in Section 4, Volume 2. including the determining the concentrations for the dissolved phase, C_D , for a pollutant. The dissolved phase concentration can be used to calculate the mass of pollutant removed by infiltration.

For a single trapping analysis, the mass of dissolved chemical infiltrated will be calculated by multiplying the infiltration volume, Q_{inf} , defined by the average concentration of the inflow dissolved component from equation 4-1, or:

$$M_{I,k} = (C_{D,k})(\gamma Q_{inf} A_B Const_4) \quad (4-9)$$

where: $M_{I,k}$ = the mass of pollutant infiltrated in kg (lb) for a storm event, and
 $Const_4 = 10^{-4}$ for metric (0.00363 for English units) (originally defined in Volume 2).

The mass of dissolved chemical infiltrated using analysis for all storms and in the interval between storms, would be described by the following equation:

$$M_{I,k} = (C_{D,k})(\gamma Q_{inf,PP} A_Q Const_4) \quad (4-10)$$

where: $Q_{inf,PP}$ = the volume infiltrated in watershed cm (in.)

The amount of the pollutant sorbed on the active clay, $M_{DA,k}$, in kg (lb) can be calculated by multiplying the sorbed phase, $C_{S,k}$, of the pollutant by the yield of active clay, Y_{AC} , into the pond:

$$M_{DA} = C_{S,k} Y_{AC} \times 10^{-6} \quad (4-11)$$

The total loading of a given pollutant is given by:

$$Y_k = (C_k)(\gamma QA) Const_4 \quad (4-12)$$

where: Y_k = yield of the pollutant in kg (lb),
 C_k = concentration of pollutant in mg/l

The yield of total dissolved and sorbed pollutant, $Y_{DS,k}$, can be solved explicitly as in equation 2-29 or can be given by:

$$Y_{DS,k} = Y_k - M_{S,k} \quad (4-13)$$

where: $M_{S,k}$ = total mass of particulates in the inflow to the infiltration basin for a given pollutant k

The yield of total dissolved pollutant, $Y_{D,k}$, can be solved by:

$$Y_{D,k} = Y_{DS,k} - M_{DA,k} \quad (4-14)$$

The dissolved pollutant discharged, M_{DD} , would then be:

$$M_{DD,k} = Y_{D,k} - M_{I,k} \quad (4-15)$$

With a suitable estimate of the volume discharged, Q_{out} in units of cm-ha (in-acre), this dissolved pollutant discharge could also be solved for directly by solving :

$$M_{DD,k} = (C_{D,k})(\gamma Q_{out} Const_4) \quad (4-16)$$

Design Criteria

There are two general types of situations where infiltration practices may be used: complete and partial treatment. First, one may be interested in the dimensions of an infiltration device that is required to provide storage and treatment of the V_{WQ} or design peak discharge (Q_p). Second, site conditions may dictate the layout and capacity of infiltration measures and one might be interested in determining the level of control provided by such a layout. In the latter case, control may not be sufficient and additional control, possibly using other acceptable BMPs, may be required. However, both cases are suitable to communities considering incorporating groundwater recharge into future development.

The following procedure can be used for designing infiltration basins to meet the V_{WQ} , and the overbank flood protection (Q_p) volume requirements. These methods are based on Appendix D.13 of the Maryland Stormwater Design Manual (2000). The design procedures are based on either intercepting the V_{WQ} from the area contributing runoff or using the truncated hydrograph method for control of the runoff from an area for either V_{CP} or Q_p . The design equations may be defined for either case of stormwater quality or quantity control because the volume of water (V_w) stored in the individual infiltration practice may be determined from the methods described earlier.

An alternative source of information for sizing and function of an infiltration basin can be found in the ASCE/WEF (1998) manual of practice. The required area for an infiltration basin capturing V_{WQ} can also be calculated by equation 7-1 of Volume 2, which was provided for biofiltration design. Local guidance, where available should also be sought and followed.

Feasibility Criteria

The use of infiltration practices depends on careful site investigation. The feasibility conditions listed above and in Volume 1 are to be investigated, and are equally important in ensuring the proper function of an infiltration practice. Should a site investigation reveal that any one of the feasibility tests is inadequate, the implementation of infiltration practices should not be pursued. Alternate feasibility criteria may be permitted only in those conditions where the local jurisdictions can justify and ensure proper application.

To be suitable for infiltration, it is recommended that underlying soils have an infiltration rate (f) of 0.52 in/h or greater, as initially determined from NRCS soil textural classification, and subsequently confirmed by field geotechnical tests. Recommended geotechnical testing procedures for feasibility and design are outlined in Appendix C of Volume 2. The minimum geotechnical testing is one test hole per 5000 ft², with a minimum of two borings per facility (taken within the proposed limits of the facility). More borings (i.e., minimum of three) may be required if determining the direction of ground water flow.

The presence of clay in the soils can greatly reduce the infiltration rate. As a rule of thumb, soils with clay content of 20% or more will not meet the recommended infiltration rate. Also, soils with a combined clay/silt content of 40% or more will not meet the recommended infiltration rates. Steep slopes (i.e., slopes greater than 15%) and fill soils should also be avoided.

To protect groundwater from possible contamination, runoff from designated hotspot land uses or activities cannot be infiltrated without proper pretreatment to remove hydrocarbons, trace metals, or toxicants. A list of designated stormwater hotspots is provided in Appendix F of Volume 1.

Infiltration may be prohibited depending on local geology. For example, if a site overlies karst geology, the local approval authority should be consulted for specific design requirements. Recommended procedures for determining whether a site overlies karst geology are provided in the Appendices of Volume 1.

The bottom of the infiltration facility should be separated by at least 2 to 4 ft vertically from the seasonally high water table or bedrock layer, as documented by on-site soil testing. Infiltration facilities should be located a minimum of 100

ft horizontally from any water supply well, to reduce the potential for contamination of the well. Infiltration practices should not be placed in locations that cause water problems to downgrade properties. Infiltration facilities should be setback 25 ft (10 ft for dry wells) down gradient from structures.

Table 5-11 of Volume 1 recommended a maximum drainage area of 10 acres and recommended a maximum head of 3 ft. Local guidance may reduce this maximum contributing area for an individual infiltration practice to less than 5 acres. Some localities recommend much less head, e.g. 1 ft for the UDFCD of greater Denver, CO. Improperly designed infiltration basin may have a ground water mounding problem or may never properly infiltrate. It is important that soils of an infiltration basin are not compacted during the construction. Specifications for bulk density are provided below.

Conveyance Criteria

A conveyance system should be included in the design of all infiltration practices in order to ensure that excess flow is discharged at non-erosive velocities. The overland flow path of surface runoff exceeding the capacity of the infiltration system shall be evaluated to preclude erosive concentrated flow. If computed flow velocities do not exceed the non-erosive threshold, overflow may be accommodated by natural topography or grass swales as discussed in Volume 2. Adequate stormwater outfalls should be provided for the overflow associated with the 10-yr design storm event (non-erosive velocities on the down-slope).

All infiltration systems should be designed to fully de-water the entire V_{wq} within 48 hr after the storm event. The truncated hydrograph method described later in this section can be used as an alternative analytical procedure if infiltration is used to control peak discharge.

If runoff is delivered by a storm drain pipe or along the main conveyance system, the infiltration practice should be designed as an off-line practice (see Detail No. 5, Appendix B for an example of routing for in-line and off-line infiltration practices).

Pretreatment

A minimum of 25% of the V_{wq} is recommended to be pretreated prior to entry to an infiltration facility (local guidance may vary). If the infiltration rate for the underlying soils is greater than 2.00 in/h, 50% of the V_{wq} shall be pretreated prior to entry into an infiltration facility. Exit velocities from pretreatment should be non-erosive during the 2-yr design storm.

Infiltration systems can be designed using redundant methods (treatment train approach) to protect the long term integrity of the infiltration rate. The following pretreatment techniques can be used to provide protection against premature clogging and failure:

- grass swale or grass filter strip
- sedimentation basin, stilling basin, sump pit or other acceptable measures
- bottom sand layer
- upper sand layer (6 in. minimum) with filter fabric at the sand/gravel interface
- use of washed bank run gravel as aggregate.

Landscaping Criteria

A dense and vigorous vegetative cover shall be established over the contributing pervious drainage areas before runoff can be accepted into the facility. Infiltration practices should not serve as a sediment control device during the site construction phase. In addition, the erosion and sediment control plan for the site must clearly indicate how sediment will be prevented from entering the infiltration site. Do not construct infiltration practices until all of the contributing drainage area has been completely stabilized.

Maintenance Criteria

It is recommended that infiltration designs include dewatering methods in the event of failure. This can be done with underdrain pipe system that accommodates drawdown. Providing direct access to all infiltration practices is recommended for maintenance and rehabilitation. OSHA and local regulatory agency safety standards should be consulted for trench excavation.

Soil Textures

The MDE (2000) hydrologic design methods presented are based on the utilization of two hydrologic soil properties, the effective water capacity (C_w) and the minimum infiltration rate (f) of the specific soil textural groups, as shown in Table 4-1. The effective water capacity of a soil is the fraction of the void spaces available for water storage, measured in inches per inch (in/in). The minimum infiltration rate is the final rate that water passes through the soil profile during saturated conditions, measured in terms of in/h. The hydrologic soil properties are obtained by identifying the soil textures by a gradation test for each change in soil profile. The soil textures presented in Table 4-2 correspond to the soil textures of the U.S. Department of Agriculture (USDA) Textural Triangle presented in Figure 4-2. The data presented in Table 4-1 are based on the analysis of over 5,000 soil samples by the USDA under carefully controlled procedures. The use of the soil properties established in Table 4-2 for design and review procedures will offer two advantages. First, it provides for consistency of results in the design procedures. Second, it eliminates the need for the laborious and costly process of conducting field and laboratory infiltration and permeability tests.

Table 4-1 Hydrologic Soil Properties Classified by Soil Texture (Rawls et al., 1982)

Texture Class	Effective Water Capacity (C_w) (in/ hr)	Minimum Infiltration Rate (f) (in/ hr)	Hydrologic Soil Grouping
Sand	0.35	8.27	A
Loamy Sand	0.31	2.41	A
Sandy Loam	0.25	1.02	A
Loam	0.19	0.52	B
Silt Loam	0.17	0.27	B
Sandy Clay Loam	0.14	0.17	C
Clay Loam	0.14	0.09	D
Silty Clay Loam	0.11	0.06	D
Sandy Clay	0.09	0.05	D
Silty Clay	0.09	0.04	D
Clay	0.08	0.02	D

Based on the soil textural classes and the corresponding minimum infiltration rates, a restriction is established to eliminate unsuitable soil conditions. Soil textures with minimum infiltration rates less than 0.52 in/h are not suitable for usage of infiltration practices. These include soils that have a 30% clay content, which are susceptible to frost heaving and therefore structurally unstable, in addition to having a poor capacity to percolate runoff. Soil textures that are recommended for infiltration systems include those soils with infiltration rates of 0.52 in./hr or greater, which include loam, sandy loam, loamy sand, and sand.

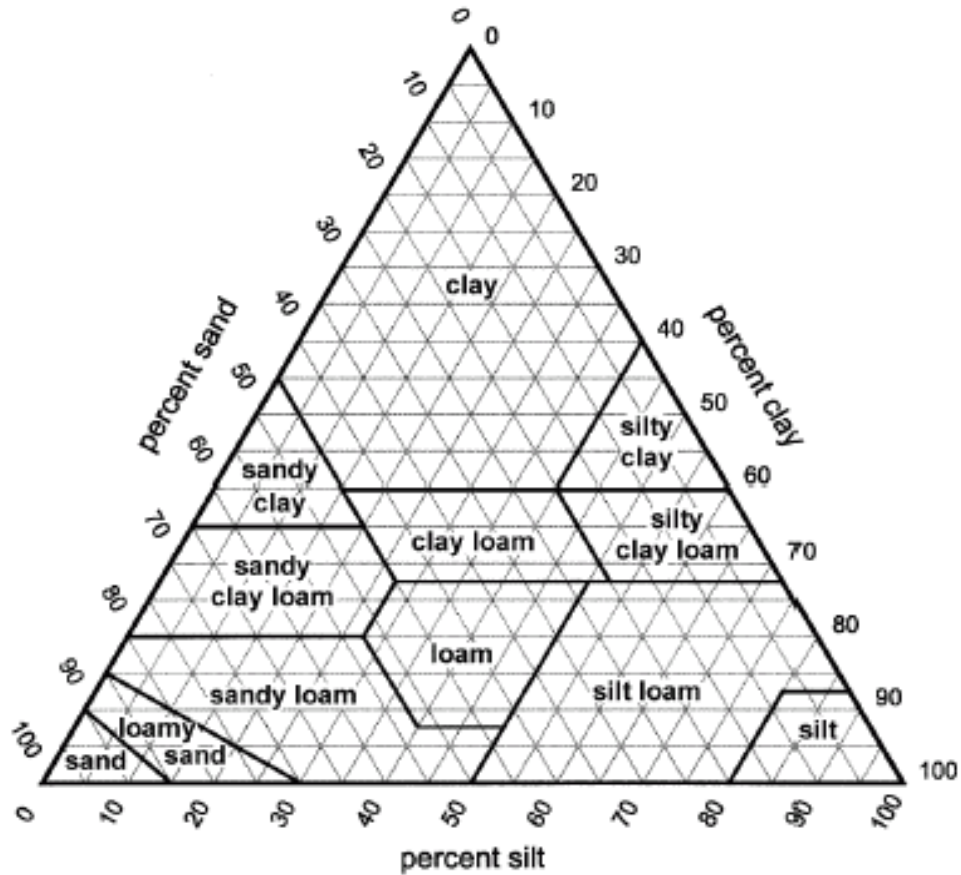

Figure 4-2 USDA Soils Textural Classification (from MDE, 2000)

Procedure for Infiltration Basin Design

The following procedures from the Maryland Stormwater Design Manual (MDE, 2000) for infiltration design can be used.

Sizing of Infiltration Basin

The volume to be treated or captured can be calculated by the procedures detailed earlier in this section. The design of an infiltration basin is based on the soil textural properties and maximum allowable depth. The maximum allowable depth (d_{max}) should meet the following criteria:

$$d_{max} = fT_p \tag{4-18}$$

where: f = the final infiltration rate of the trench area (in/hr) and
 T_p = the maximum allowable ponding time (hr)

An infiltration basin is sized to accept the design volume that enters the basin (V_w) plus the volume of rain that falls on the surface of the basin (PA_b) minus the exfiltration volume (fTA_b) out of the bottom of the basin. Based on the NRCS

hydrograph analysis, the peak flow for most infiltration basins will generally be less than two hours therefore set $T = 2$ hr. The volume of water that must be stored (V) is defined as:

$$V = V_w + PA_b - fTA_b \quad (4-19)$$

where: P = the design rainfall event (ft), and
 A_b = the basin surface area (ft²).

For most design storm events, the volume of water due to rainfall on the surface area of the basin is small when compared to V_w of the basin and may be ignored with little loss in accuracy to the final design.

The volume of rainfall and runoff entering the basin can be defined in terms of basin geometry. The geometry of a basin will generally be in the shape of an excavated trapezoid with specified side slopes. The volume of a trapezoidal shaped basin may be approximated by:

$$V = \frac{(A_t + A_b)d_b}{2} \quad (4-20)$$

where: A_t = the top surface area of the basin (ft²),
 A_b = the bottom surface area of the basin (ft²), and
 d_b = the basin depth (ft).

By setting equations 4-19 and 4-20 equal the following equation may be used to define the bottom area (A_b):

$$A_b = \frac{(2V_w - A_t d_b)}{(d_b - 2P + 2fT)} \quad (4-21)$$

If a rectilinear shape is used, the bottom length and width of the basin may be defined in terms of the top length and width as:

$$\begin{aligned} L_b &= L_t - 2Zd_b \\ W_b &= W_t - 2Zd_b \end{aligned} \quad (4-22)$$

where Z is a specified side slope ratio ($Z:1$). By substituting the above relationships for L_b and W_b , into equation 4.-21, the following equation is derived for the basin top length:

$$L_t = \frac{[V_w + Zd_b(W_t - 2Zd_b)]}{[W_t(d_b - P) - Zd_b^2]} \quad (4-23)$$

If a rectilinear shape is used, the basin top length (L_t) and width (W_t) must be greater than $2Zd_b$ for a feasible solution. If L_t and W_t are not greater than $2Zd_b$ the bottom dimensions would be less than or equal to zero. In this case, the basin depth (d_b) shall be reduced for a feasible solution.

The Truncated Hydrograph Method

Most stormwater polices require that the peak discharge from the post-developed hydrograph for a selected return period(s) not exceed the peak discharge from the pre-developed hydrograph after development for stream channel erosion control and/or flood control purposes. To ensure peak discharge control is provided when considering infiltration practices for peak discharge or stormwater quantity control, the truncated hydrograph method can be used to determine the necessary infiltration storage volumes.

The pre-development and post-development peak discharges can be computed using standard NRCS methodology, TR-55 Tabular (USDA, 1986) or TR-20 (USDA, 1982). The time (T_2) at which the allowable discharge occurs on the receding limb of the post-development hydrograph, as shown in Figure 4-3 is determined from the NRCS methods. The volume of runoff under the post-development hydrograph and to the left of the allowable discharge at T_2 is the design storage volume. The computed infiltration storage volume may be adjusted to account for the volume of water which exfiltrates from the infiltration structure during the period of time required to fill the structure. The exfiltration volume is the product of the minimum soil infiltration rate (ft/hr), the filling time (hrs) and the surface area of the infiltration practice. The filling time (T_f) of the infiltration practice may be determined directly from the post-development hydrograph as shown in Figure 4.5. T_f is the difference between T_2 , where the allowable discharge occurs on the recession limb and the time T_1 where the discharge value on the rising of the hydrograph is equal to the minimum infiltration discharge. The minimum discharge is equal to the minimum soil infiltration rate (ft/sec) times the surface area (ft²) of the infiltration practice.

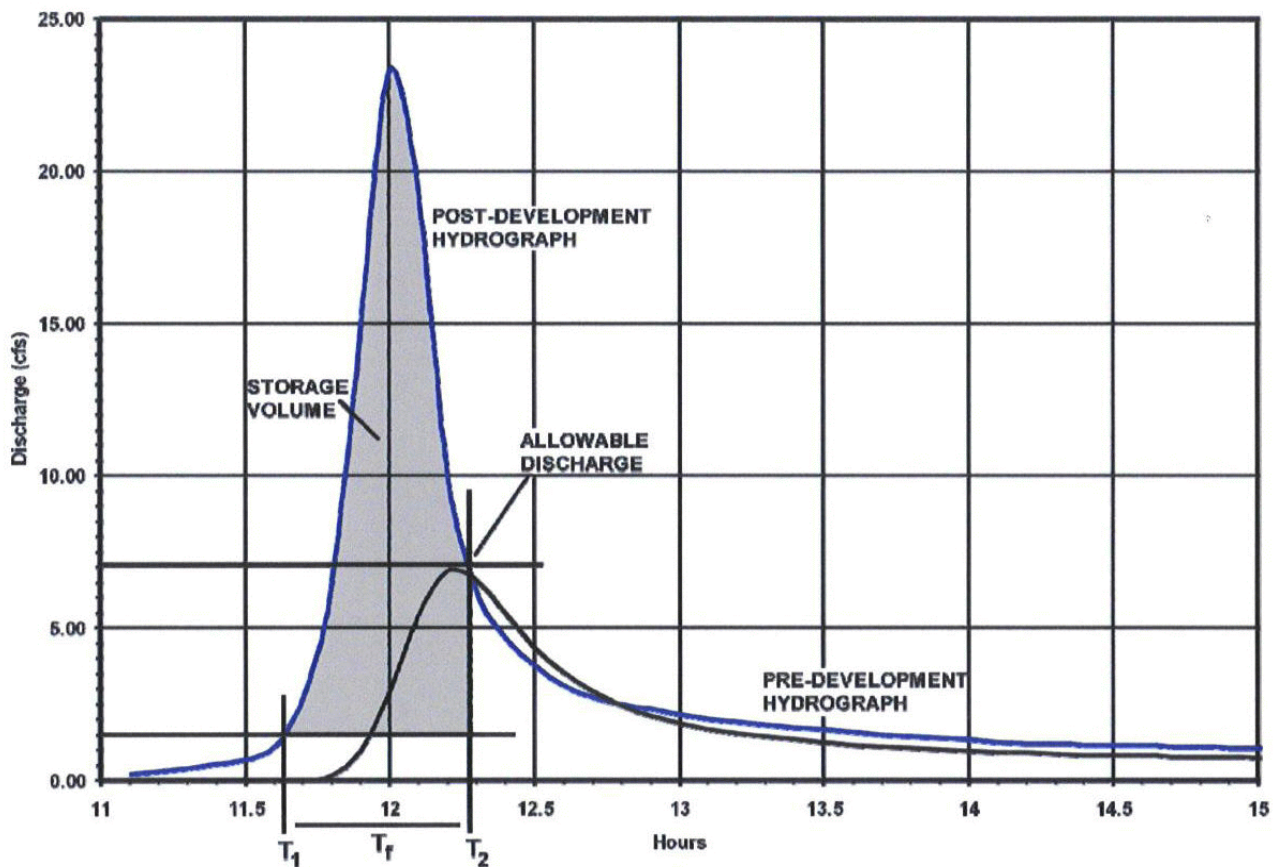

Figure 4-3 Truncated Hydrograph Method (MDE, 2000)

Section Five Construction Specifications for Ponds

Introduction

A pond BMP is a water impoundment made by constructing a dam or an embankment or by excavating a pit or dugout. In this discussion, ponds constructed by a dam or embankment are referred to as embankment ponds, and those constructed by excavation are referred to as excavated ponds. Ponds constructed by both excavation and the embankment methods are classified as embankment ponds if the depth of water impounded against the embankment at the principal spillway storm design high water elevation is 3 ft or more. This 3 ft should be measured from the low point on the upstream toe of the embankment to the design high water.

This brief summary of some of the construction specifications for ponds is provided for completeness; standard text (ASCE/WEF, 1992), and State and federal design guidance should be sought for more detailed procedures, spillway design, and specifications for embankments.

General Considerations

This practice should be applied where it is determined that SWM, water supply, or temporary storage is justified, and it is feasible and practicable to build a pond that will meet local and State law requirements.

This example construction standard establishes a typical minimum acceptable quality for the design and construction of ponds if:

1. Failure of the dam will not result in: loss of life; damage to homes, commercial or industrial buildings, main highways, or railroads; or interruption of the use or service of public utilities.
2. The product of the storage, in acre-feet, times the effective height of the dam, in feet, is less than 3,000. Storage is the volume, in acre-feet, in the reservoir below the elevation of the crest of the emergency spillway. The effective height of the dam is the difference in elevation, in feet, between the emergency spillway crest and the lowest point on a profile taken along the centerline of the dam, excluding the cutoff trench. If there is no emergency spillway, the top of the dam becomes the upper limit for determining the storage and the effective height.
3. For dams in rural areas, the effective height of the dam (as defined above) is 35 ft or less, and the dam is hazard classification of "a" (hazard classification is described below). For dams in urban areas, the effective height of the dam is 20 ft or less, and the dam is hazard class "a".

Ponds exceeding any of the above conditions will typically be designed and constructed according to the requirements of USDA – NRCS Technical Release 60 (1973).

Typical Exemptions Allowed

Small pond approval is typically not required for small class "a" structures where the following exists:

1. Ponds or other structures have less than 4 ft of embankment.
2. The storage at emergency spillway design high water elevation does not exceed 40,000 ft³ and the height of the embankment is 6 ft or less. The height of the embankment should be measured from the top of the dam to the lowest point of excavation, excluding the cutoff trench, along the centerline of the dam.

In addition, an embankment pond that meets the criteria below is normally considered to be an excavated pond, and is also exempt from small pond approval:

- the calculation of $10H+20 = L$, where H = height from the pond bottom to the top of the dam, is provided
- the projection of L horizontally downstream from the pond bottom is below the existing or proposed ground
- the existing or proposed downstream ground slope within the projection of L is less than 10% at any point.

The review and design of such class "a" structures is normally based on sound engineering judgment assuring a stable outfall for the 10-yr, 24-hr storm event. However, designers should review state regulations to see if permits are required.

Site Conditions

Site conditions should be such that runoff from the design storm can be safely passed through (1) a natural or constructed emergency spillway (2) a combination of a principal spillway and an emergency spillway or (3) a principal spillway.

Structure Hazard Classification

Documentation of the classification of dams is normally required for plan approval by the local regulatory agency. Such documentation typically includes, but is not limited to, location and description of dam, configuration of the valley, description of existing development (houses, utilities, highways, railroads, farm or commercial buildings, and other pertinent improvements), potential for future development, and recommended classification. The description also normally includes results obtained from breach routings, if breach routings are used as part of the classification process. The class ("a", "b" and "c") as contained in this manual is related to the potential hazard to life and property that might result from a sudden major breach of the earth embankment.

Structure classification and land use for runoff determination should take into consideration the anticipated changes in land use throughout the expected life of the structure.

The classification of a dam is normally the responsibility of the designer, and is subject to review and concurrence of the approving authority. The classification of a dam is normally determined only by the potential hazard from failure, not by other criteria. Classification factors in the NRCS National Engineering Manual (USDA 1973), as supplemented, are given below as examples:

Class "a" - Structures located in rural, agricultural or urban areas dedicated to remain in flood tolerant usage where failure may damage non-inhabited buildings, agricultural land, floodplains or county roads.

Class "b" - Structures located in rural, agricultural, or urban areas where failure may damage isolated homes, main highways or minor railroads or cause interruption of use or service of relatively important public utilities.

Class "c" - Structures located where failure may cause loss of life or serious damage to homes, industrial and commercial buildings, important public utilities, main highways, or railroads.

“Rural areas” are defined as those areas in which residents live on farms, in unincorporated settlements, or in incorporated villages or small towns. This is where agriculture, including woodland activities, and extractive industries, including seafood harvesting, provides the primary employment base for residents, and where such enterprises are dependent on local residents for labor. Non-rural areas would be classified as urban.

Peak Breach Discharge Criteria

Breach routings are used to help delineate the area potentially affected by inundation should a dam fail. This analysis can be used to aid dam classification. The breach hydrograph is the outflow hydrograph attributed to the sudden release of water in reservoir storage. This can be due to a dam breach during non-storm conditions or storm flow. Stream routings made of the breach hydrograph should be based upon topographic data and hydraulic methodologies mutually consistent in their accuracy and commensurate with the risk being evaluated.

The minimum peak discharge of the breach hydrograph used by NRCS TR-60 (USDA, 1973) regardless of the techniques used to analyze the downstream inundation area, is as follows:

$$q_{max} = 3.2H_w^{2.5} \tag{5.1}$$

where: q_{max} = the peak breach discharge (ft³/s), and
 H_w = the depth of water at the dam at the time of failure (ft).

This is measured to the crest of the emergency spillway or to design high water, if no emergency spillway exists. Non-storm flow conditions downstream of the dam are normally used in the analysis. Where the breach analysis has indicated that only overtopping of downstream roads will occur, the following guidelines in Table 5-1 can be used.

Table 5-1 Hazard Classification Based on Depth of Overtopping of Downstream Roads

Class Structure	Depth of Flow Over Roads
a	<1.5 ft
b&c	>1.5 ft

Frequency of use and importance of the roadway should be considered when making a classification.

Embankment Specifications

Earthen Embankment

The earthen embankment must be properly compacted from appropriate materials. Details are given in appropriate soil mechanics text.

Top Width

The minimum top width of the dam depends on its use. When the embankment top is to be used as a public road, a minimum width of 16 ft is recommended for one-way, and 26 ft for two-way traffic. If the embankment is to be used for infrequent vehicle crossings, the minimum recommended top width is 10 ft. Guardrails or other safety measures are recommended where necessary to meet the requirements of the responsible road authority.

Side Slopes

The combined upstream and downstream side slopes of the settled embankment are not typically recommended to be less than five horizontal to one vertical (5:1) with neither slope steeper than 2:1. If the dam is used as a road crossing with a top width greater than 26 ft, then the combined side slopes of the settled embankment should not be less than 4:1 (H:V) with neither slope steeper than 2:1. Slopes should be designed to be stable in all cases, even if flatter side slopes are required.

Earth Cuts

If cuts in an existing fill or in natural ground are required for the rehabilitation of an existing pond spillway or the construction of a new pond, the slope of the bonding surfaces between the *existing* material in place and the fill to be placed are not recommended to be steeper than a ratio of two horizontal to one vertical (2:1).

Seepage Control

Seepage control should be included: (1) if pervious layers are not intercepted by the cutoff (2) if seepage from the abutments may create a wet embankment (3) if the phreatic line intersects the downstream slope or (4) if special conditions require drainage to insure a stable dam. The phreatic line should be drawn on a 4:1 slope starting on the inside slope at the normal pool elevation. For SWM ponds, normal pool is typically considered as the 10-yr water surface elevation.

Seepage may be controlled by (1) foundation abutment or embankment drains (2) reservoir blanketing or (3) a combination of these measures. Foundation drains may control seepage encountered in the cutoff trench during construction. These drains should be located downstream of the dam centerline and outside the limits of the proposed cutoff trench.

Foundation Cutoff

A cutoff trench of relatively impervious material is recommended under the entire length of the dam and located at or upstream from the centerline of the dam. The cutoff trench should have a bottom width adequate to accommodate the equipment used for excavation, backfill and compaction operations, with a minimum width of 4 ft. Side slopes should be no steeper than one horizontal to one vertical. The minimum recommended depth is 4 ft.

Impervious Core

Any impervious core within the embankment should be located at or upstream from the centerline of the dam, and should extend up the abutments to the 10-yr water surface elevation throughout the embankment.

Section Six Maintenance and Operation

Introduction

Regular inspection and maintenance of BMPs are necessary if these facilities are to consistently perform up to expectations. SWM systems are expected to perform quality and quantity control functions as long as the land use they serve exists. Failure to maintain these systems can create the following adverse impacts:

- increased discharge of pollutants downstream
- increased risk of flooding downstream
- increased downstream channel instability, which increases sediment loadings and reduces habitat for aquatic organisms
- potential loss of life and property, resulting from catastrophic failure of the facility
- aesthetic or nuisance problems, such as mosquitoes or reduced property value, due to a degraded facility appearance.

Most of these impacts can be avoided through proper and timely inspection and maintenance. A major concern associated with these impacts is the general public's expectations related to the quality of life provided, in part, by construction of these systems. Inadequate maintenance means the general public may have a false sense of security. The most common cause of stormwater system failure is the lack of adequate and proper operation, inspection, maintenance, and management. If SWM systems are not going to be adequately maintained, the facilities should not be constructed in the first place.

Good design and construction can reduce subsequent maintenance needs and costs, but they cannot eliminate the need for maintenance altogether. Maintenance requires a long term commitment of time, money, personnel and equipment. Monitoring the overall performance of the SWM system is a major aspect of any maintenance program. Wet retention ponds and wetland systems are especially complex environments that require a healthy aquatic ecosystem to provide maximum benefits, and to minimize needed maintenance.

Inspections

Inspections should be performed at regular intervals to ensure that the BMP is operating as designed. Annual inspection should be considered, with additional inspections following storm events. For the inspection following a major storm, the inspector should visit the site at the end of the specified drawdown period to ensure that any detention or infiltration device is draining properly. Some inspections can be arranged to coincide with scheduled maintenance visits to reduce site visits and ascertain that maintenance activities are performed satisfactorily. Check for accumulations of debris and sediment at the inlets and outlets, and check side slopes for signs of erosion, settlement, slope failure, or vehicular damage. Check emergent vegetation zones to ensure that water levels are appropriate for vegetative growth, that acceptable survival rates are being maintained and that vegetative cover is above acceptable limits.

Inspection Responsibility

Typically there are two levels of inspection responsibility. Increasingly State and local regulatory agencies are requiring the development of a maintenance agreement between the owner of the BMP facility and the responsible local agency, as a condition for approving a BMP design and issuance of a building permit. The maintenance agreement should include the following elements:

- right of entry for inspection and maintenance
- inspection schedule and checklist
- maintenance schedule and checklist.

The local agency generally has the responsibility to inspect and maintain public facilities, and to ensure that inspection and maintenance is provided by the owners of private facilities.

Inspection Reports

Inspection reports for SWM systems should include the following:

- date of inspection
- name of inspector
- condition of:
 - % vegetation or filter media
 - % fences or other safety devices
 - % spillways, valves, or other control structures
 - % embankments, slopes and safety benches
 - % reservoir or treatment areas
 - % inlet and outlet channels or structures
 - % underground drainage
 - % sediment and debris accumulation in storage and forebay areas
 - % any nonstructural practices to the extent practicable
 - % any other item that could affect the proper functioning of the SWM system
- description of needed maintenance.

Inspection reports should be maintained by the owner of the facility for all SWM systems and be available for review by the local agency. Inspection reports help to ensure that the responsible maintenance entity is adequately performing its responsibilities.

Aesthetic Maintenance

Maintenance can be broken down into a number of different categories, but two primary categories are aesthetic/nuisance maintenance and functional maintenance. These two categories overlap at times. They are mutually important to each other and each is equally important. Functional maintenance is important for performance and safety reasons, while aesthetic maintenance is important primarily for public acceptance of SWM facilities, and because it may also reduce needed functional maintenance activities. Both forms of maintenance are needed, and both must be combined into an overall SWM system maintenance program.

Aesthetic maintenance primarily enhances the visual appearance and appeal of a stormwater facility. A stormwater system with a good appearance will allow the facility to more easily become an integral part of a community. Aesthetic maintenance is obviously more important for high profile facilities.

Underground stormwater systems do not have the need for aesthetic maintenance that aboveground, open air systems have. Generally, aesthetic maintenance is more important at ponds and biofiltration facilities, although it may also be important for infiltration facilities with significant landscaping.

Careful, meticulous and frequent attention to performing maintenance tasks such as painting, tree pruning, leaf collection, debris removal and grass cutting (where intended) will allow a SWM system to maintain an attractive appearance and help maintain its functional integrity. The following activities can be included in a preventive maintenance program:

Graffiti Removal

The timely removal of graffiti will improve the appearance of a SWM system. Timely removal may also discourage further graffiti or other acts of vandalism.

Grass Trimming

Trimming grass around fences, outlet structures, hiker/biker paths, and structures will provide a more attractive appearance to the general public. As much as possible, the design of stormwater facilities should incorporate natural landscaping elements that require less cutting and/or trimming.

Control of Weeds

In situations where vegetation has been established, undesirable plants can be expected, and can adversely affect the aesthetics of a stormwater facility. This can also apply to wetland stormwater systems and wet detention littoral zones which may be invaded by undesirable aquatic plant species.

These undesirable plants can be removed through mechanical or chemical means. If chemicals are used, the chemical should be used as directed and leftover chemicals disposed of properly.

Removal of Debris and Litter

Debris and litter accumulate mostly near the inlet and outlet structures of stormwater controls and need to be removed during regular mowing operations. Particular attention should be paid to floatable debris that can eventually clog the outlet control structure or riser. Trash screens or trash racks can be strategically placed near inflow or outflow points to capture debris and assist with maintenance.

Litter and debris from illegal dumping should also be cleaned up on a regular basis. An accurate log of materials removed and improvements made should be maintained. Controlling illegal dumping is difficult, but the posting of "no littering" or "no dumping" signs, with a phone number for reporting a violation in progress, may help. Adoption and enforcement of substantial penalties for illegal dumping and disposal could also serve as a deterrent.

Functional Maintenance

Functional maintenance is necessary to keep a SWM system operational at all times. Functional maintenance has two components: 1) preventive maintenance and 2) corrective maintenance.

Preventive Maintenance

Preventive maintenance refers to procedures that are performed on a regular basis to keep the BMP in proper working order. Preventive maintenance tasks include upkeep of any moving parts, such as outlet drain valves or hinges for grates, or maintenance of locks. Preventive maintenance can also include maintenance of vegetative cover to prevent erosion. Routine maintenance should include debris removal, silt and sediment removal as previously mentioned under **Aesthetic Maintenance**, and clearing of vegetation around flow control devices to prevent clogging. Trees, shrubs and other ground cover require periodic maintenance, including mulching, pruning and pest control.

Grass Maintenance

Mowing requirements at a facility should be tailored to the specific site conditions, grass type and seasonal variation in climate. Grassed areas require limited periodic fertilizing, de-thatching and soil conditioning in order to maintain healthy growth. Provisions may have to be made to reseed and reestablish grass cover in areas damaged by sediment accumulation, stormwater flow, or other causes. Dead turf, will need to be replaced after being discovered. Local soil conservation districts or cooperative extension service offices can provide assistance in determining maintenance requirements for various types of vegetation.

Removal of Trash and Debris

Besides improving the aesthetic appeal of the SWM facility, a regularly scheduled program of debris and trash removal will reduce the potential for outlet structures, trash racks and other facility components from becoming clogged and inoperable during storm events. In addition, removal of trash and debris will prevent possible damage to vegetated areas and eliminate potential mosquito breeding habitats. Sediment, debris and trash that inhibit the ability of the facility to store or convey water should be removed immediately to restore proper functioning of the facility. Temporary arrangements should be made for handling the sediments until a more permanent arrangement is made. Disposal of debris and trash must comply with all local, county, State and federal waste control programs. Only suitable disposal and recycling sites should be used. Sediment disposal is discussed under Corrective Maintenance.

Inlet and outlet flow control structures of the BMP that build up sediment quickly should be cleaned out more frequently. The rate at which the sediment builds up should be something that can be calculated based on the inspection reports. A procedure to calculate this rate is also presented below.

Mechanical Components

Valves, sluice gates, pumps, fence gates, locks and access hatches should remain functional at all times. Regularly scheduled maintenance should be performed in accordance with the manufacturers' recommendations. All mechanical components should be operated during each maintenance inspection to assure continued performance. Fences can be damaged by any number of factors, including vandalism and storm events. Timely repair will maintain the security of the site.

Elimination of Mosquito Breeding Habitats

The most effective mosquito control program is one that eliminates potential breeding habitats, or, in the case of open water ponds or wetlands, ensures that optimal conditions are maintained for the survival of mosquito control organisms.

Any stagnant pool of water can become a mosquito breeding environment after a period of time, depending on climate (e.g., typically six days in the summer). Pondered water in open cans, tires, and areas of sediment accumulations or ground settlement can become mosquito breeding areas. Local mosquito control programs can be contacted for assistance and advice on minimizing mosquito problems.

Corrective Maintenance

Corrective maintenance is required on an emergency or non-routine basis to correct problems and to restore the intended operation and safe function of the SWM system. Corrective maintenance is not done on a scheduled basis but on an as needed basis. Failure to promptly address a problem may jeopardize the performance and integrity of the facility. It may also present a potential safety hazard to those living adjacent to or downstream of the facility.

Sediment Removal and Disposal

There are two types of sediment removal for BMPs that fall under corrective maintenance: clogged control structures and life-cycle maintenance. Each requires proper disposal of sediments.

In the case of a blocked inlet or outlet, stormwater will travel in an area that was not normally designed as a flow path and requires immediate attention. If the inlet is blocked, the stormwater could travel over a curb onto a grassed area and scour

that area. If the outlet is blocked, water will back up in the facility and may travel through the emergency spillway or overflow area. These areas are not designed for frequent flow and may become eroded. If sediments are clogging a facility component, the lack of arrangements for proper disposal should not delay removal of the sediments. In most cases, sediments can be stored on the site until a more permanent disposal site can be determined.

Secondly, the life cycle of most ponds is not infinite. Sediment will need to be removed from the main portion of the pond on a regular schedule, but rarely on an annual basis. Silt removal can be performed anywhere from 5 to 20 years, as needed. Typically, this is a project that requires mechanized equipment, careful survey, transport and disposal of removed materials, and the reestablishment of the original design grades and sections of the BMP. For a retention pond, it will require draining the pond. Certain types of media filters and infiltration systems may require more frequent cleanings. Sediment removal in infiltration systems must also include monitoring the porosity of the subbase, replacing or cleaning the pervious materials as necessary, and reestablishing vegetation. Sediment removal for infiltration systems can be a major operational and maintenance problem unless the facilities are fully exposed to the surface and have good access for appropriate maintenance equipment.

For most treatment systems, the exact schedule will depend on the annual total suspended sediment load being removed by the facility and the size of the area on which it is being deposited. Accumulation rates of 6 to 13 mm/yr (0.15 to 0.25 in/yr) in retention ponds are typical, however, accumulation can be 10 to 100 times greater whenever construction activities take place in the tributary watershed, especially when effective erosion control practices are not used.

Equation 6-1 and 6-2 (ASCE and WEF, 1998) can be used to estimate the average depth of sediment accumulation within almost any facility that removes total suspended sediments from stormwater:

$$V_p = 1.45 \times 10^{-6} (Q_A CTE / R) \tag{6-1}$$

$$Q_A = R_v P_A \tag{6-2}$$

where:

V_p = average annual depth of bottom sediment deposit in mm,

Q_A = average annual runoff depth from the watershed in mm,

R_v = runoff coefficient,

P_A = annual runoff producing-precipitation in mm,

C = average annual concentration of total suspended sediments in runoff in mg/L,

TE = trapping efficiency (fraction of TSS retained in pond), and

R = (pond's surface area)/(tributary watershed area) ratio.

As an example, the annual accumulation rate within a retention pond can be calculated based on the following information: the surface area is 0.53 ha (1.3 acre), the tributary catchment is 223 ha (550 acre) with $C = 0.28$, annual rainfall, P_A , is 352 mm (12.8 in.), and the average concentration of TSS = 400 mg/L in the runoff. The trapping efficiency has been calculated and is 0.80. First, using equation 6-2, the annual runoff depth from the watershed is:

$$Q_A = R_v P_A = 0.28 \times 352 = 99 \text{ mm}$$

Then, using equation 6-1, the average annual accumulation of sediment is:

$$V_p = 1.45 \times 10^{-6} (Q_A CTE / R) = 1.45 \times 10^{-6} (99 \times 400 \times 0.80 / 0.0024) = 19 \text{ mm } (0.75 \text{ in } / \text{ yr})$$

If the pond's original design allowed for a total of 305 mm (12 in.) of sediment accumulation, the pond's bottom will need to be cleaned once every 18 years. This assumes that the bed load fraction is part of the reported TSS concentration and

that there are no other sources of sediment, such as construction activities, being delivered to the ponds. Chances are that the actual accumulation rate will be somewhat higher and that more frequent cleanout will be needed.

Accumulation rates of heavy metals such as lead, zinc, copper, or other constituents may be a concern if such accumulations can create hazardous waste. If so, more frequent removal of sediments and periodic monitoring can be done to avoid these situations. Also, occasional core samples of pond or basin bottom will reveal if buildup of pollutants is occurring. If bottom sediment concentrations approach levels that would restrict disposal on site or in local landfills, site rehabilitation and total cleanout may be required.

Under existing U.S. EPA regulations (40 CFR Part 261), material cleaned from a detention pond should periodically be screened using the toxic characteristics leaching procedure (TCLP). This test should be carried out on accumulated sediment within the pond. If the sediment fails the test, it is subject to Resource Conservation and Recovery Act (RCRA) regulations and must be disposed of in an approved manner at an RCRA-approved facility. If the TCLP test is negative, sediments are subject to State and local solid waste disposal regulations. If the material has been sufficiently dried to be considered a “workable material” and can pass a TCLP test, it can also be disposed of off site. This can be done at a landfill or as unclassified fill. However, sediments from any treatment facility can be nutrient-rich soils and, if other characteristics do not disqualify it, can be used in landscaping or as unclassified fill material. Disposing of accumulated sediment as fill or in landscaping avoids depleting landfill volume.

Structural Repairs

Repairs to any structural component of the facility should be made promptly. Equipment, materials and personnel must be readily available to perform repairs on short notice. The immediate nature of the repairs depends on the type of damage and its effects on the safety and operation of the system. Where structural damage has occurred, the design and conduct of repairs should be undertaken only by qualified personnel.

Dam, Embankment and Slope Repairs

Damage to dams, embankments and slopes must be repaired quickly. Typical problems include: settlement, scouring, cracking, sloughing, seepage and rutting. A concern in an embankment with a barrel assembly or outflow pipe through it is seepage around the outside of the barrel. This can also cause movement of embankment soils, which can weaken the embankment. Repairs need to be made promptly. Crack repair in a concrete structure may necessitate draining the facility and cleaning the area of the crack prior to repair. If the facility is to be dewatered, pumps may be necessary if there is no drain valve.

Elimination of Mosquito Breeding Areas

If neglected, a stormwater system can become a mosquito breeding area, especially facilities that are designed to drain and dry out, but do not. If mosquito control in a facility becomes necessary, the preventive maintenance program for mosquitoes should be reevaluated and more emphasis placed on control of mosquito breeding habitats. Corrective action may be needed if a mosquito problem persists, the stormwater facility is the source of the problem and functional maintenance alone are not adequate.

Erosion Repair

Vegetative cover is necessary to prevent soil loss, maintain the structural integrity of the facility and maintain its pollutant removal benefits. Where a reseeding program has been ineffective, or where other factors have created erosive conditions (i.e., pedestrian traffic, concentrated flow, etc.), corrective steps should be taken to prevent further loss of soil and any subsequent danger to the performance of the facility. There are a number of ways that corrective action can be taken. These include erosion control blankets, riprap, sodding, or reduced flow through the area. Local experts should be consulted to address erosion problems if the solution is not evident.

Elimination of Trees, Woody Vegetation and Animal Burrows

Woody vegetation or animal burrows can present problems for dams or embankments. The root system of woody vegetation can undermine dam or embankment strength. If the vegetation dies and the root system decomposes, voids can be created in the dam or embankment that weaken the structure. Preventive maintenance can avoid this problem. However, when it occurs through lack of a preventive maintenance program, steps must be taken to eliminate the problem. Vegetation, including root systems, must be removed from dams or embankments and the excavated materials replaced with proper material at a specified compaction (normally 95% of the soils maximum density). Animal burrows should be filled and steps taken to remove the animals if burrowing problems continue to occur. In an urban environment, animals of concern are usually groundhogs, muskrats or beavers. If the problem persists, local wildlife officials should be consulted regarding removal steps. Such consultation is necessary as the threat of rabies in some areas may necessitate the animals being destroyed rather than relocated .

Snow and Ice Removal

Accumulations of snow and ice can threaten the functioning of a SWM system, particularly at inlets, outlets and overflow emergency spillways. Providing equipment, materials and personnel to monitor, and remove snow and ice from these critical areas is necessary to assure the continued functioning of the facility during the winter months.

General Facility Maintenance

In addition to the above elements of corrective maintenance, general corrective maintenance should address the overall facility and its associated components. If algae growth becomes a problem for ponds, or if an infiltration facility does not totally drain, steps must be taken to reestablish the original performance of the system. Stormwater facilities often are very complex systems. They will work only as long as each individual element functions correctly. If corrective maintenance is being done to one facility component, other components should be inspected to see if maintenance is needed. There may be a cost savings in conducting numerous maintenance activities if equipment is on-site that could improve a number of needed maintenance items.

A program of monitoring the aquatic environment of a permanent pond should be established. Water quality, aeration, vegetative growth and animal populations should be monitored on a regular basis. The timely correction of an imbalance in the ecosystem can prevent more serious problems from occurring. Problems such as algae growth, excessive siltation and mosquito breeding should be addressed and corrected immediately.

Maintenance Considerations in Design

Access

The BMP facility must be readily accessible from a street or other public right-of-way. Inspection and maintenance easements, connected to the street or right-of-way, should be provided around the entire facility. The exact limits of the easements and right-of-ways should be specified on the project plans and other appropriate documents. Access roads and gates should be wide enough to allow passage of necessary maintenance vehicles and equipment, including trucks, backhoes, grass mowers, and mosquito control equipment. In general, the minimum right-of-way width of 15 ft and a minimum roadway width of 12 ft is recommended. To facilitate entry, a curb cut should be provided where an access road meets a curbed roadway. To allow for safe movement of maintenance vehicles, access ramps should be provided to the

shoreline of all facilities with side slopes greater than 5 ft in height. Access ramps should not exceed 10% in grade and should be suitably stabilized to prevent damage by vehicles and equipment. Turnarounds should be provided where backing-up is difficult or dangerous. To expedite overall maintenance, vehicle and equipment staging areas should be provided at or near each facility site. Design for inlet and outlet structures should provide accessibility for inspection, and preventative sediment and trash removal maintenance.

Vegetation

To minimize maintenance efforts, the use of existing, undisturbed site vegetation is encouraged as long as the existing site topography provides adequate storage volume. Where disturbance of existing vegetation cannot be avoided, replacement with low maintenance vegetation with strong disease resistant and allelopathic (self-weeding) characteristics is encouraged. In general, grass will be easier to establish and will provide better erosion control than other types of ground cover vegetation. The use of grass varieties that are relatively slow growing and tolerant of poor soil conditions will minimize routine maintenance such as mowing and fertilizing. The need for supplemental fertilizing can be substantially reduced when vegetative cover includes a percentage of nitrogen fixing species such as legumes. In addition to minimizing maintenance costs, a reduction in applied fertilizer will also minimize the potential detrimental effects of nitrogen and nitrate runoff.

Non-clogging Low Flow Orifice

The diameter of the low flow orifice is a key element of outlet design and should take precedence over nuisance maintenance considerations. An orifice that is too large may result in high discharge rates for smaller storms. The smaller storms that contain the bulk of the annual pollution load would have short residence times in the BMP and this would result in limited water quality benefit.

The low flow orifice should be adequately protected from clogging by an acceptable external trash rack. Two examples of external trash racks are provided in Detail No. 1 and 2 of Appendix B (MD, 2000). To reduce orifice diameters, an internal orifice can be used, e.g. an over-perforated vertical standpipe that is protected by hardware cloth and a stone filtering jacket. A schematic design of an acceptable internal orifice protection design is provided in Detail No.3 of Appendix B (MDE, 2000) . An adjustable valve should be used, which allows adjustment of the specified drawdown period. Predicted models values may require on-site adjustment, as models may over or under predict actual flow rate and future conditions may change

Vertical pipes may be used as an alternative, especially if a permanent pool is present. The preferred method is an inverted siphon, a submerged reverse-slope pipe that extends downward from the riser to an inflow point 1 ft below the normal pool elevation.

Alternative methods are to employ a broad crested rectangular, V-notch, or proportional weir, protected by a half-round corrugated metal pipe (CMP) or similar device that extends at least 1 ft below the normal pool. (See Detail No. 7 of Appendix B.) A floating riser, which uses a perforated PVC pipe to protect the opening of a flexible tube from floatable material and is attached to floatation device, is another option that prevents most sediment from exiting a detention pond.

The use of horizontal perforated pipe protected by geotextile and gravel is not recommended due to its potential to become clogged, and the higher cost to maintain this configuration.

Riser

The riser should be located within the embankment for maintenance access, safety and aesthetics. Access to the riser should be provided by lockable manhole covers and manhole steps within easy reach of valves and other controls. Riser openings should be fenced with pipe or rebar to prevent trash accumulation. Valve controls should be located inside the riser at a point where they will not normally be inundated and can be operated in a safe manner. To prevent vandalism, the handwheel should be chained to a ring bolt, manhole step or other fixed object.

Pond Drain

Ponds should have a drain pipe that can completely or partially drain the pond over an extended time frame, typically 24 hr. The pond drain should be sized one pipe size greater than the calculated design diameter. A pond drain may not be necessary for low relief areas where positive drainage is difficult to achieve due to very low relief.

The approving jurisdiction should be notified before draining a pond. Care should be exercised during pond drawdowns to prevent downstream discharge of sediments or anoxic water, and slope instability caused by rapid drawdown. Adjustable valves should be used for the pond drain (typically a handwheel activated knife or gate valve). A pond drain is useful for drawing down the water level in the facility to relieve pressure on a dam or embankment, dewatering facilities for repairs and life-cycle sediment removal, and possibly adjusting discharge rates.

Safety Features

Fencing of ponds is not generally desirable but may be required by the local review authority. A preferred method is to manage the contours of the pond to eliminate dropoffs and other safety hazards. In any case, warning signs prohibiting swimming and skating should be posted.

Internal side slopes to the pond should not exceed 3:1 (h:v) and should terminate on a safety bench. Both the safety bench and the aquatic bench may be landscaped to prevent access to the pool. Often, the bench requirement may be waived if slopes are 4:1 or gentler.

Riser openings should not permit unauthorized access. Riser tops shall include railings for safety. Endwalls above pipe outfalls greater than 48 in. in diameter shall be fenced to prevent injury.

Section Seven References

American Society of Civil Engineers (ASCE), 1985. *Final Report of the Task Committee on Stormwater Detention Outlet Structures*, ASCE, New York, NY.

American Society of Civil Engineers (ASCE), 2001. *A Guide for Best Management Practice (BMP) Selection in Urban Developed Areas*, ASCE, Reston , VA.

American Society of Civil Engineers (ASCE) and Water Environment Federation (WEF), 1992. *Design and Construction of Urban Stormwater Management Systems*. ASCE, Manuals and Report of Engineering Practice No. 77, New York. N.Y. WEF, Manual of Practice No. FD-20, Alexandria, VA.

American Society of Civil Engineers (ASCE) and Water Environment Federation (WEF), 1998. *Urban Runoff Quality Management*, ASCE, Manuals and Report of Engineering Practice No. 87, Reston, VA and WEF, Manual of Practice No. 23, Alexandria, VA.

Barfield, B. J., R. Warner and C. T. Haan, 1981. *Applied Hydrology and Sedimentology for Disturbed Lands*. Oklahoma Technical Press, Stillwater, OK.

Barfield, B. J. and J. C. Hayes, 1988. Design of Grass Waterways for Channel Stabilization and Sediment Filtration. In *Handbook of Engineering in Agriculture, Vol. II, Soil and Water Engineering*, CRC Press, Boca Raton, FL.

Barfield, B. J., J. C. Hayes, A. W. Fogle and K. A. Kranzler, 1996. The SEDIMOT III Model of Watershed Hydrology and Sedimentology. *Proceedings of Sixth Federal Interagency Sedimentation Conference*, March 1996.

Chapra, S. C. , 1997. *Surface Water Quality Modeling*. McGraw Hill, New York, NY.

DeGroot, W. G., 1982. *Stormwater Detention Facilities*, ASCE, New York, NY.

Driscoll, E. D., D. DiToro, D. Gaboury and P. Shelly, 1986. Methodology for Analysis of Detention Basins for Control of Urban Runoff Quality. EPA, Washington, DC, Report No. EPA 440/5-87-01 (NTIS No. PB87-116562).

Foster, G. R., R. A. Young and W. H. Neibling, 1985. Sediment Composition for Nonpoint Source Pollution Analyses. *Transactions of American Society of Agricultural Engineering (ASAE)*, 28(1):133-146.

Ferguson, B. and T. N. Debo, 1990. *On-Site Stormwater Management - Applications for Landscape and Engineering*. Van Nodstrandt, Reinhold, NY (ISBN: 0442001169).

-
- Friedman, D. 2004. District Director Ocean County Soil Conservation District, personnel communication and copy of local specifications.
- Haan, C. T. and B. J. Barfield, 1978. Hydrology and Sedimentology of Surface Mined Lands. College of Engineering, University of Kentucky, pp. 296.
- Haan, C. T., B. J. Barfield and J. C. Hayes, 1994. Design Hydrology and Sedimentology for Small Catchments. Academic Press, San Diego, CA.
- Hartigan, J. P., 1988. Basis for Wet Detention Basis BMPs. Proceedings of an Engineering Foundation Conference on Current Practice and Design Criteria for Urban Quality Control, Potosi, MO. L. Roesner, B. Urbonas and M. Sonnen (Ed.), ASCE, New York, NY.
- Haubner, S., A. Reese, T. Brown, R. Claytor and T. Debo (2001). Georgia Stormwater Management Manual, Volume 2: Technical Handbook, First Edition – August 2001.
- Hayes, J. C., B. J. Barfield and R. I. Barnhisel, 1984. Performance of Grass Filters Under Laboratory and Field Conditions. Transactions ASAE, 27(5):1321-1331.
- Hayes, J. C., B. J. Barfield, K. F. Holbrook and B. Bates, 2001. Loading and Best Management Model for South Carolina Office of Coastal Resource Management. Report submitted to SCOCRM by Woolpert, Inc., of Charlotte, NC, December 31, 2001.
- Knisel, W. G., 1980. CREAMS: A Field Scale Model for Chemicals, Runoff, and Erosion from Agricultural Management Systems. Conservation Research Report No. 26, U.S. Department of Agriculture, Washington, DC.
- Knisel, W. G., 1985. Use of Computer Models in Managing Nonpoint Pollution from Agriculture. Proceedings, Nonpoint Pollution Abatement Symposium. V. Novotny (Ed.), Marquette University, Milwaukee, WI.
- Leonard, R. A. and W. G. Knisel, 1986. Selection and Application of Models for Nonpoint Source Pollution and Resource Conservation. Agricultural Source Pollution: Model Selection and Application. A Giorgini and F. Zingales (Ed.), Elsevier, Amsterdam.
- Lindley, M. R., B. J. Barfield, J. C. Ascough II, B. N. Wilson and E. W. Stevens, 1998. The Surface Impoundment Element for WEPP. Transactions ASAE, 14(3):249-256.
- Newman, T. L., T. A. Omer and E. D. Driscoll, 2000. "SWMM Storage-Treatment for Analysis/Design of Extended-Detention Ponds." In: Applied Modeling of Urban Water Systems, Monograph 8 in the Series. William James (Ed.), Proceedings of the Conference on Stormwater and Urban Water Systems, Modeling, Toronto, Ontario, February, 1999.
- Northern Virginia Planning District Commission (NVPDC) and Engineers and Surveyors Institute (1992). Northern Virginia BMP Handbook: A Guide to Planning and Designing Best Management Practices in Northern Virginia, Northern Virginia Planning District Commission.
- Ocean County Soil Conservation District (OCSCD), Schnabel Engineering Associates, Inc. and USDA Natural Resources Conservation Service, 2001. "Impact of Soil Disturbance During Construction on Bulk Density and Infiltration in Ocean County, New Jersey." March 2001 (Rev. 06/01/01), <http://www.ocsd.org/soil.pdf>.

-
- Pitt, R., S. Clark and K. Parmer (1994). Potential for Groundwater Contamination from Intentional and Nonintentional Stormwater Infiltration. EPA, Cincinnati, OH, EPA/600/R-94/051 (NTIS 94-165 354).
- Randall, C. W., et al. 1989. Urban Runoff Pollutant Removal by Sedimentation. In Stormwater Detention Facilities. ASCE, New York, NY.
- Rawls, W. J., D. L. Brakensiek and K. E. Saxton, 1982 Estimation of soil water properties. Transactions ASAE, 25(5)1316-1320, 1328.
- Roesner, L. A., et al., 1989. Design of Urban Runoff Quality Controls. Proceedings of an Engineering Foundation Conference on Current Practice and Design Criteria for Urban Quality Control, Potosi, MO. L. Roesner, B. Urbonas and M. Sonnen (Ed.), ASCE, New York, NY.
- Schueler, T., 1987. Controlling Urban Runoff: A Practical Manual for Planning and Designing Urban BMPs. Metropolitan Washington Council of Governments, Washington, DC.
- Schueler, T. R., and M. Helfrich, 1988. Design of Extended Detention Wet Pond Systems, Proceedings of an Engineering Foundation Conference on Current Practice and Design Criteria for Urban Quality Control, Potosi, MO. L. Roesner, B. Urbonas and M. Sonnen (Ed.), ASCE, New York, NY.
- Schueler, T. R. and J. Lugbill, 1990. Performance of Current Sediment Control Measures at Maryland Construction Sites. Metropolitan Washington Council of Governments, Washington, DC, pp. 90.
- Schueler, T. R., P. Kumble and M. Heraty, 1992. A Current Assessment of Urban Best Management Practices: Techniques for Reducing Nonpoint Source Pollution in the Coastal Zone, Anacostia Research Team, Metropolitan Washington Council of Governments, Washington, DC.
- Schueler, T.R. and H. K. Holland, 2000. The Practice of Watershed Protection – Article 17. Center for Watershed Protection, Ellicott City, MD.
- Stahre, P., and B. Urbonas, 1990. Stormwater Detention for Drainage, Water Quality, and CSO Management. Prentice-Hall, Englewood Cliffs, N.J.
- Strecker, E., B. Urbonas, M. Quigley, J. Howell and T. Hesse, 2002. Urban Stormwater BMP Performance Monitoring A Guidance Manual for Meeting the National Stormwater BMP Database Requirements. EPA, Office of Water, Washington, DC, EPA-821-B-02-001.
- Tapp, J. S., A. D. Ward and B. J. Barfield, 1982. Designing Sediment ponds for Theoretical Detention Time. Proceedings of the ASCE, 108(HY1):17-24.
- U.S. Department of Agriculture (USDA), 1973. Technical Release 60 (TR-60), 210-VI, Revised Oct. 1985. National Resources Conservation Service, Engineering Division.
- U.S. Department of Agriculture (USDA), 1986. Urban Hydrology For Small Watersheds. Soil Conservation Service, Engineering Division. Technical Release 55 (TR-55).
- U.S. Department of Agriculture (USDA), 1982. Project Formulation - Hydrology. Soil Conservation Service, Engineering Division. Technical Release 20 (TR-20).

U.S. Environmental Protection Agency (EPA), 1983. Results of Nationwide Urban Runoff Program (NURP), Final Report, Water Planning Division, Washington, DC.

Urban Drainage and Flood Control District (UDFCD), 1999. Urban Storm Drainage Criteria Manual, Volume 3, Best Management Practices, B. Urbonas (Ed.), Urban Drainage Flood Control District, Denver, CO, 1992, revised and updated 1999.

Urbonas, B. R. and L.A. Roesner (Ed.), 1986. Urban Runoff Quality-Impact and Quality Enhancement Technology, Proceedings of an Engineering Foundation Conference. ASCE, New York, NY.

Urbonas, B. R., J. T. Doerfer, J. Sorenson, J. T. Wulliman and T. Fairley, 1992. Urban Storm Drainage Criteria Manual, Volume 3- Best Management Practices, Stormwater Quality. Urban Drainage and Flood Control District, Denver, CO.

Urbonas, B. R. and P. Stahre, 1993. *Stormwater - Best Management Practices Including Detention*. Prentice Hall, Englewood Cliffs, N.J.

Walker, W. W., 1987. Phosphorus Removal by Urban Stormwater Detention Basins, Lake and Reservoir Management: Volume III. North American Lake Management Society, Washington, DC.

Whipple, W. and J. V. Hunter, 1981. Settleability of Urban Runoff Pollution, Journal of the Water Pollution Control Federation, 53, 1726.

Wilde, F. , 1994. Geochemistry and Factors Affecting Ground-Water Quality at Three Storm-Water- Management Sites in Maryland. Department of Natural Resources, Maryland Geological Survey, Report of Investigations No. 59.

Wilson, B. N., B. J. Barfield and I. D. Moore, 1982. A Hydrology and Sedimentology Watershed Model. Part I. Modeling Technique. Department of Agricultural Engineering, University of Kentucky, Lexington, KY.

Appendix A Short Cut for Wetland Drawdown Assessment

This section presents a simple method for calculating whether a stormwater pond or wetland has an appropriate water balance to maintain a wet pool over a 30-day period without rainfall. This method is reproduced from Appendix D of the Maryland Stormwater Management Design Manual (MDE, 2000).

When conducting this analysis, the following should be considered:

- calculate maximum drawdown during periods of high evaporation and during an extended period of no appreciable rainfall
- the change in storage within a pond (V) = inflows - outflows
- potential inflows: runoff, base flow and rainfall
- potential outflows: infiltration, surface overflow and evaporation (and evapotranspiration)
- assume no inflow from base flow, no losses for infiltration and because only the permanent pool volume is being evaluated, no losses for surface overflows.

Therefore, the change in volume in the pond is:

$$V = \text{runoff} - \text{evaporation.}$$

Using the site conditions in Table A-1 and Table A-2, a wetland drawdown assessment may be determined using the following procedures. A shallow wetland will be designed to treat the water quality volume (V_{WQ}) minus the groundwater recharge volume (V_{Re}). The permanent pool volume is:

$$V_{WQ} - V_{Re} = (1.08 - 0.25) \text{ ac-ft.} = 0.83 \text{ ac-ft.}$$

Use this volume to determine if a sufficient volume will remain during drawdown periods.

Table A-1 Site Data for Sample Water Balance Analysis

Drainage area (acres)	38.0
Post-development CN	78
2-yr design rainfall event (in.)	3.1
2-yr design storm runoff (in.)	1.2
Water quality volume (V_{WQ}) (ac-ft)	1.08
Groundwater recharge volume (V_{Re}) (ac-ft)	0.25
Surface area of wetland (acres) (minimum 1.5% of drainage area to BMP)	0.58

Table A-2 Evaporation Rates for Maryland Ponds (Ferguson and Debo, 1990)

	April	May	June	July	August	September
Precipitation (ft)	0.30	0.35	0.32	0.36	0.38	0.31
Evaporation (ft)	0.36	0.44	0.52	0.54	0.46	0.35

Next, the maximum drawdown during periods of high evaporation needs to be calculated, as follows:

- runoff volume = **$P \times E$**
where: **P** = Precipitation
E = Runoff Efficiency (ratio of NRCS 2-yr storm runoff to rainfall depths)
- for **CN** = 78, runoff volume for 2-yr storm = 1.2 in.
- 2-yr storm rainfall = 3.1 in.
- **$E = 1.2/3.1$ (in/in) = 0.39**
- inflow = runoff volume = **$P \times E$**
= 0.36 ft \times 0.39 = 0.14 ft
= 0.14 ft \times 38 acres = 5.32 ac-ft
- period of greatest evaporation occurs during the month of July at 0.54 ft per month (see Table A-2)
- outflow = surface area \times evaporation losses
= 0.58 ac \times 0.54 ft
= 0.31 ac-ft

The inflow, 5.32 ac-ft, is greater than outflow (0.31 ac-ft) therefore, drainage area is adequate to support wet pond during normal conditions.

Using a 45-day interval as a worst case condition, check for drawdown over an extended period without rainfall:

- highest evaporation occurs during July, 0.54 ft per month (see Table A-2)
- calculate the average evaporation per day, $0.54 \text{ ft}/31 \text{ days} = 0.017 \text{ ft/day}$
- over 45-day interval, evaporation loss = $45 \times 0.017 \text{ ft/day} = 0.78 \text{ ft}$

Assume surface of the permanent pool may drop up to 0.78 ft (9.4 in.) over this 45-day interval. Therefore, to be safe, specify vegetation for the aquatic shelves to 10 in. that can tolerate periods of drawdowns.

Appendix B Miscellaneous Details for BMP Design

The following details for BMP design are reproduced from the Maryland Stormwater Management Design Manual (MDE, 2000):

- Detail 1: Trash Rack for Low Flow Orifice
- Detail 2: Expanded Trash Rack Protection for Low Flow Orifice
- Detail 3: Internal Control for Orifice Protection
- Detail 4: Observation Well for Infiltration Practices
- Detail 5: Off-line Versus On-line Schematic
- Detail 7: Half Round CMP Hood
- Detail 8: Half Round CMP Weir
- Detail 9: Concrete Level Spreader.

These drawings are provided for information purposes only. These details are not engineering drawings and should not be treated as such. Some proven design details can be obtained from the Urban Drainage and Flood Control District (at www.udfcd.org).

Detail 1 Trash Rack Protection for Low Flow Orifice

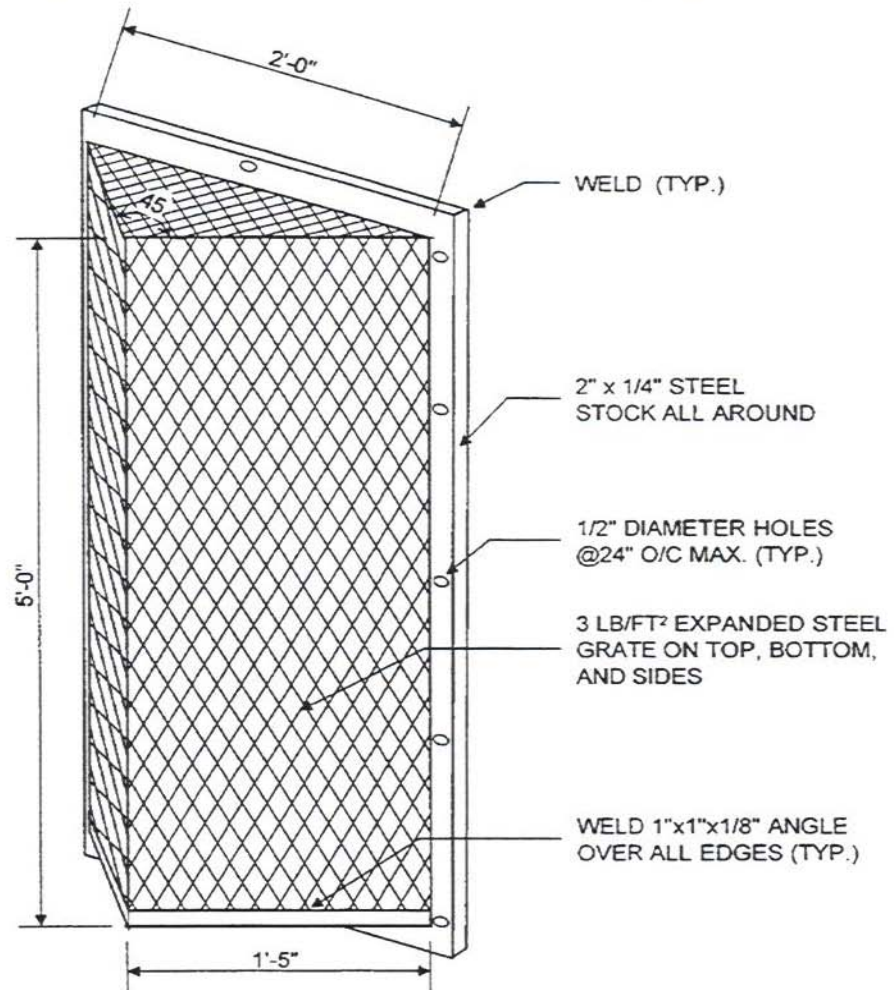

NOTES FOR TRASH RACK

1. TRASH RACK TO BE CENTERED OVER OPENING.
2. STEEL TO CONFORM TO ASTM A-36.
3. ALL SURFACES TO BE COATED WITH ZRC COLD GALVANIZING COMPOUND AFTER WELDING.
4. TRASH RACK TO BE FASTENED TO THE WALL WITH 1/2" MASONRY ANCHORS. TRASH RACK TO BE REMOVABLE.

TRASH RACK DETAIL (NTS)

Detail 2 Expanded Trash Rack Protection for Low Flow Orifice

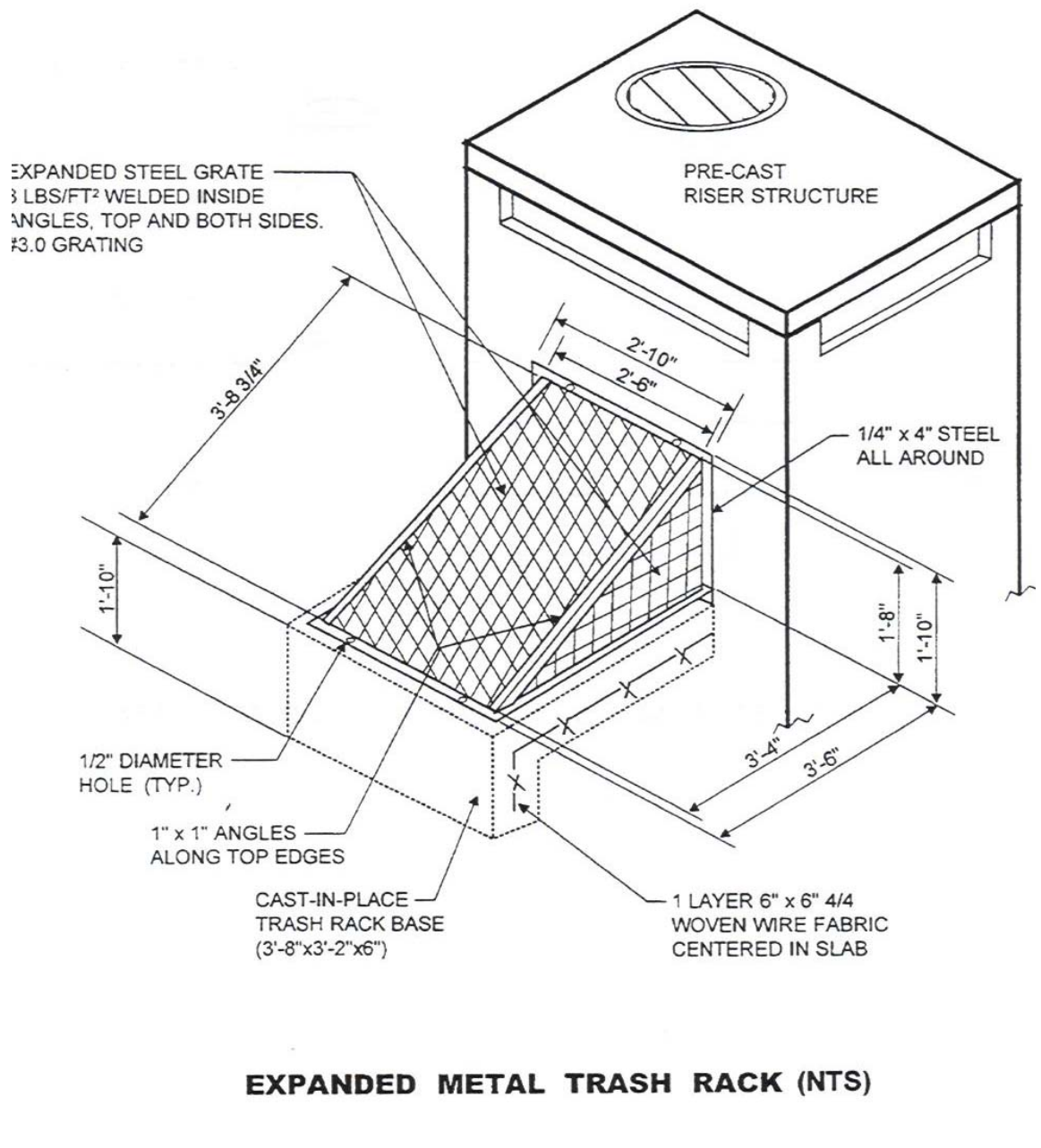

Detail 3 Internal Control for Orifice Protection

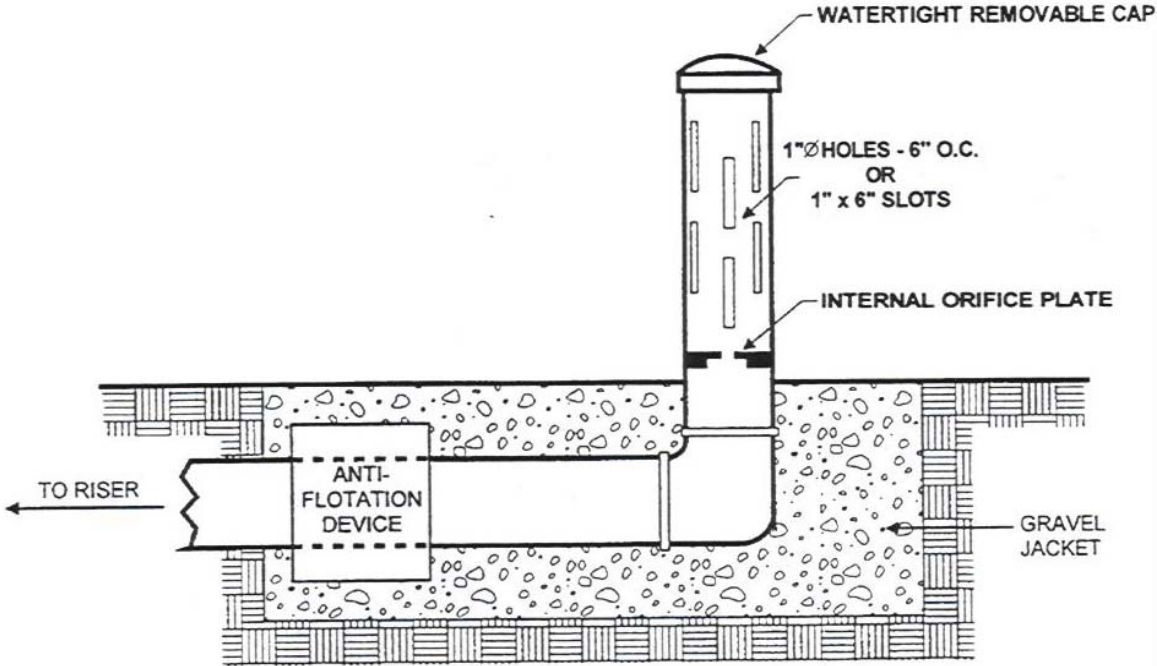

INTERNALLY CONTROLLED ORIFICE (NTS)

Detail 4 Observation Well for Infiltration Practices

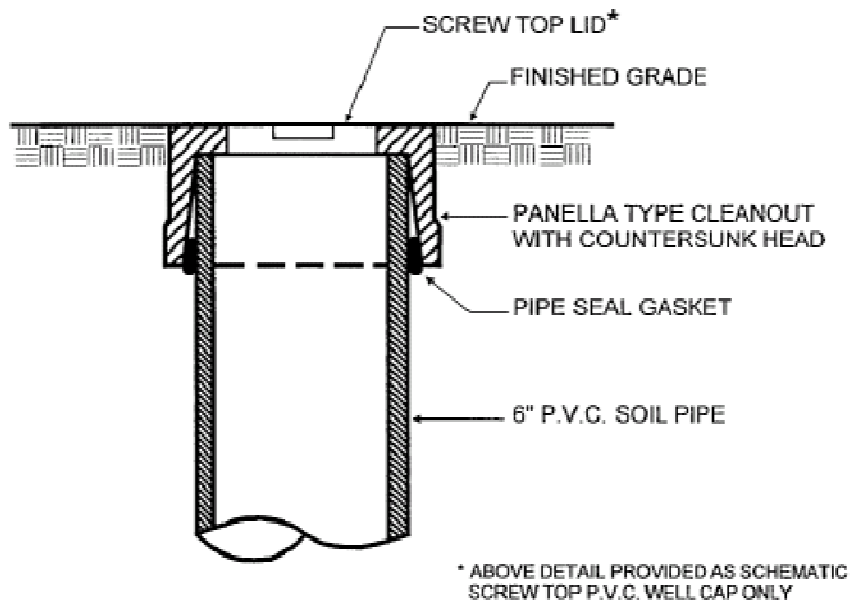

EACH OBSERVATION WELL / CLEANOUT SHALL INCLUDE THE FOLLOWING:

1. FOR AN UNDERGROUND FLUSH MOUNTED OBSERVATION WELL / CLEANOUT, PROVIDE A TUBE MADE OF NON-CORROSIVE MATERIAL, SCHEDULE 40 OR EQUAL, AT LEAST THREE FEET LONG WITH AN INSIDE DIAMETER OF AT LEAST 6 INCHES.
2. THE TUBE SHALL HAVE A FACTORY ATTACHED CAST IRON OR HIGH IMPACT PLASTIC COLLAR WITH RIBS TO PREVENT ROTATION WHEN REMOVING SCREW TOP LID. THE SCREW TOP LID SHALL BE CAST IRON OR HIGH IMPACT PLASTIC THAT WILL WITHSTAND ULTRA-VIOLET RAYS.

Detail 5 Off-Line Versus On-Line Schematic

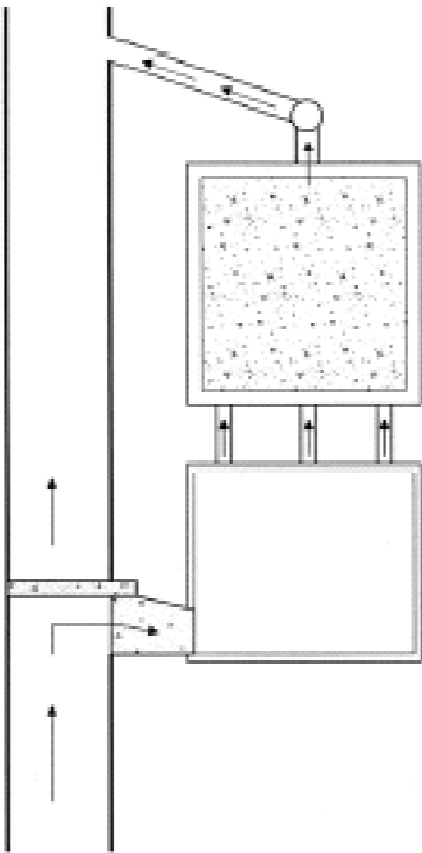

PLAN VIEW

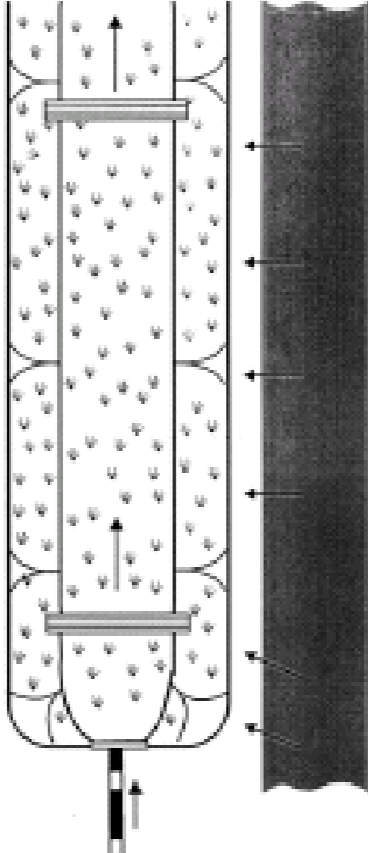

PLAN VIEW

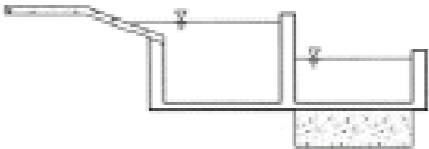

SECTION

**OFF-LINE
FILTERING SYSTEM**

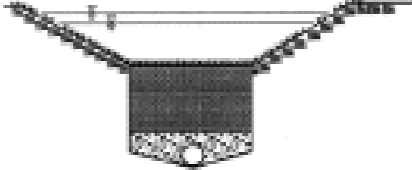

SECTION

**ON-LINE
FILTERING SYSTEM**

SCHEMATIC: ON-LINE vs OFF-LINE

Detail 7 Half Round CMP Hood

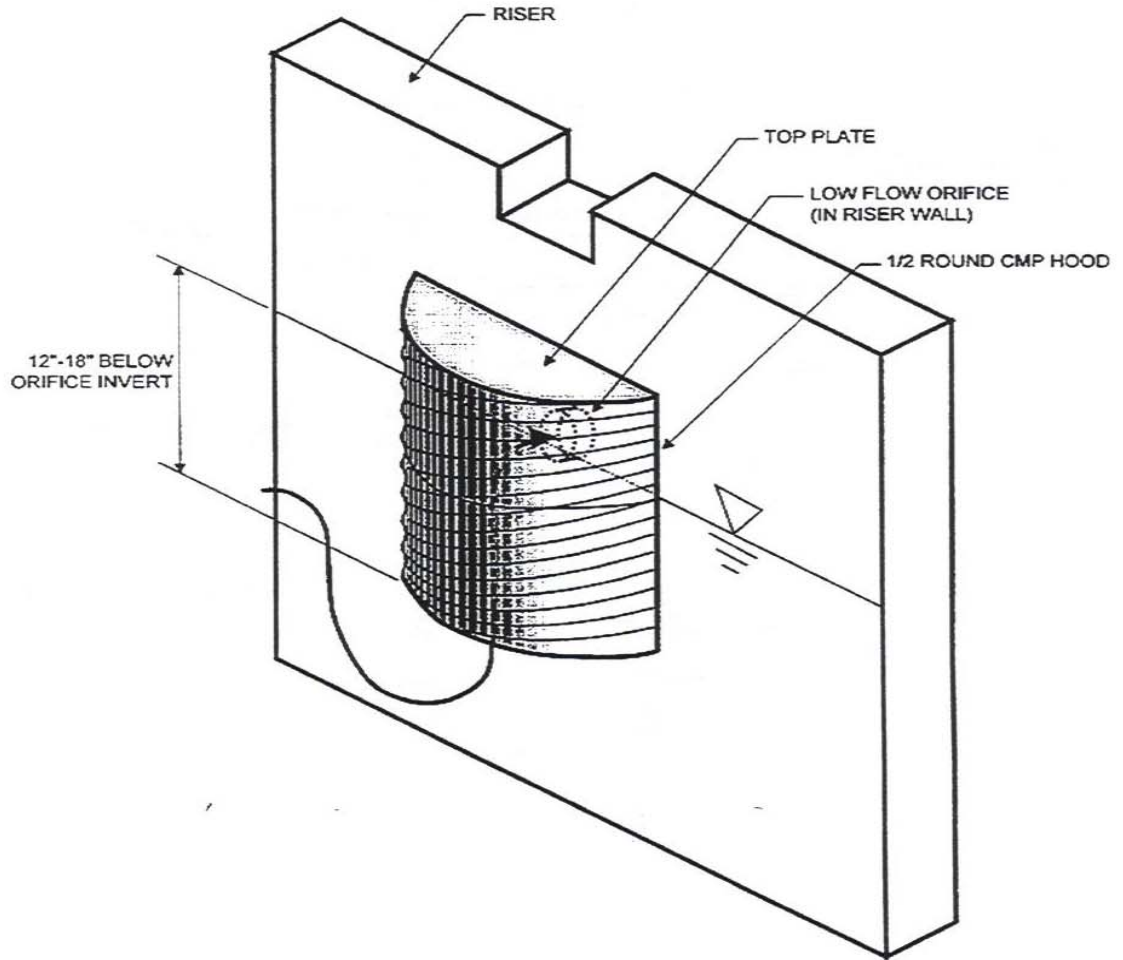

1/2 ROUND CMP PIPE-HOOD
(FOR PROTECTION OF LOW FLOW ORIFICE)

Detail 8 Half Round CMP Weir

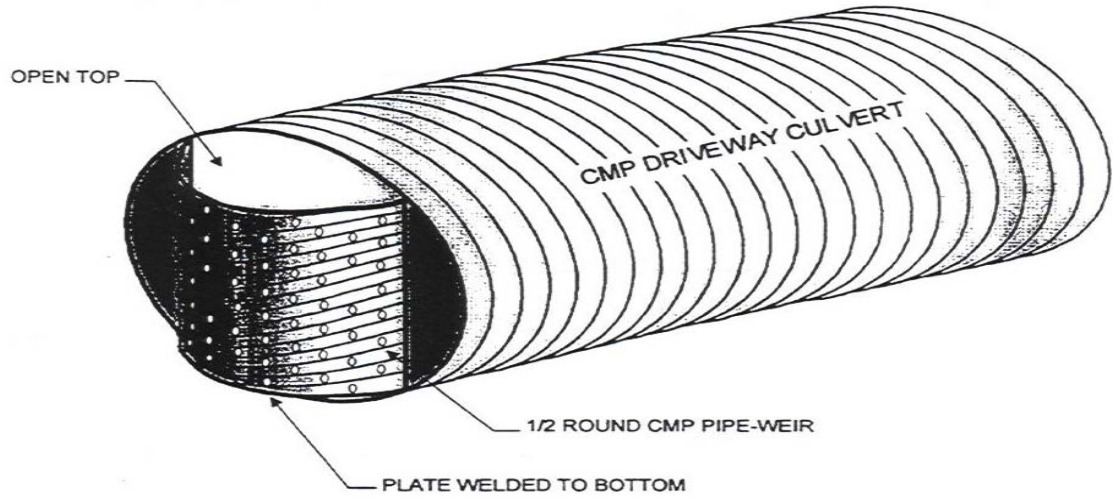

1/2 ROUND CMP PIPE-WEIR
(FOR USE WITH DRY SWALE)

Detail 9 Concrete Level Spreader

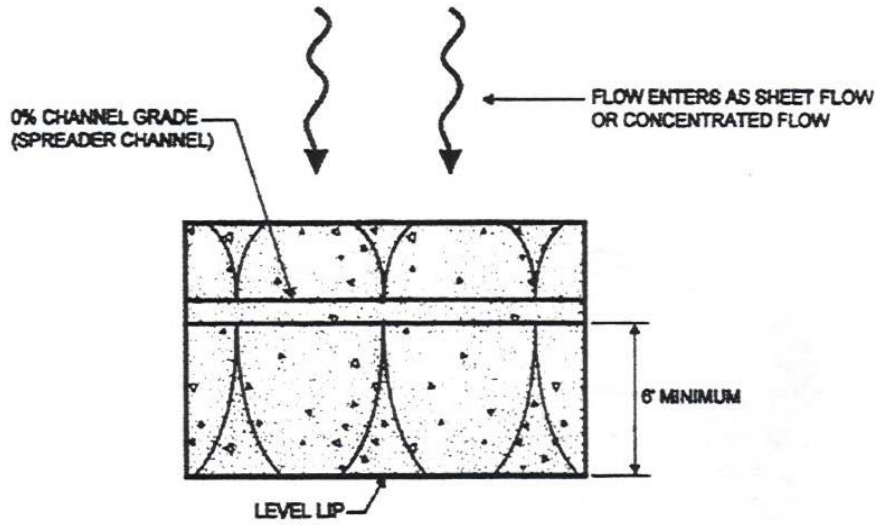

PLAN VIEW

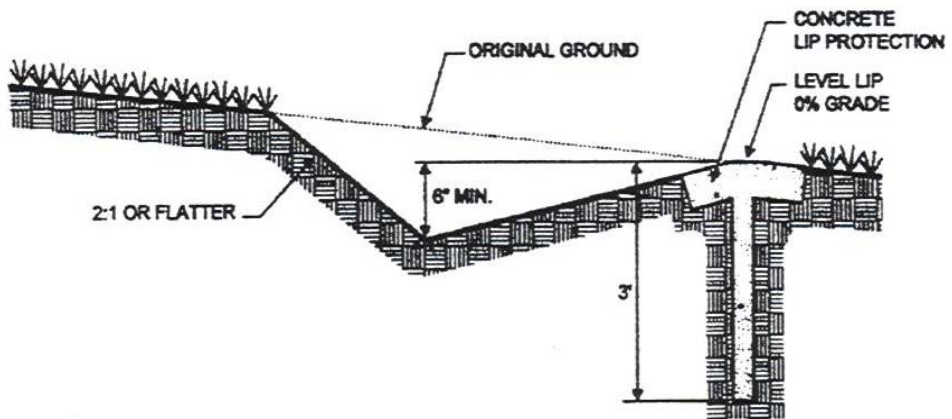

PROFILE

LEVEL SPREADER