



Rockwell International
Rocketdyne Division

7N-38
021631

RSS-8929-8

**System for Anomaly and Failure Detection (SAFD)
System Development**

Final Report
Volume IV of V

22 December 1995

Contract NAS8-40000

Task 233

Appendix C1
Good Test Plots
Rocketdyne Pumps w/ Nominal CCV Schedule

750-168 HPFP bal cav pr.T

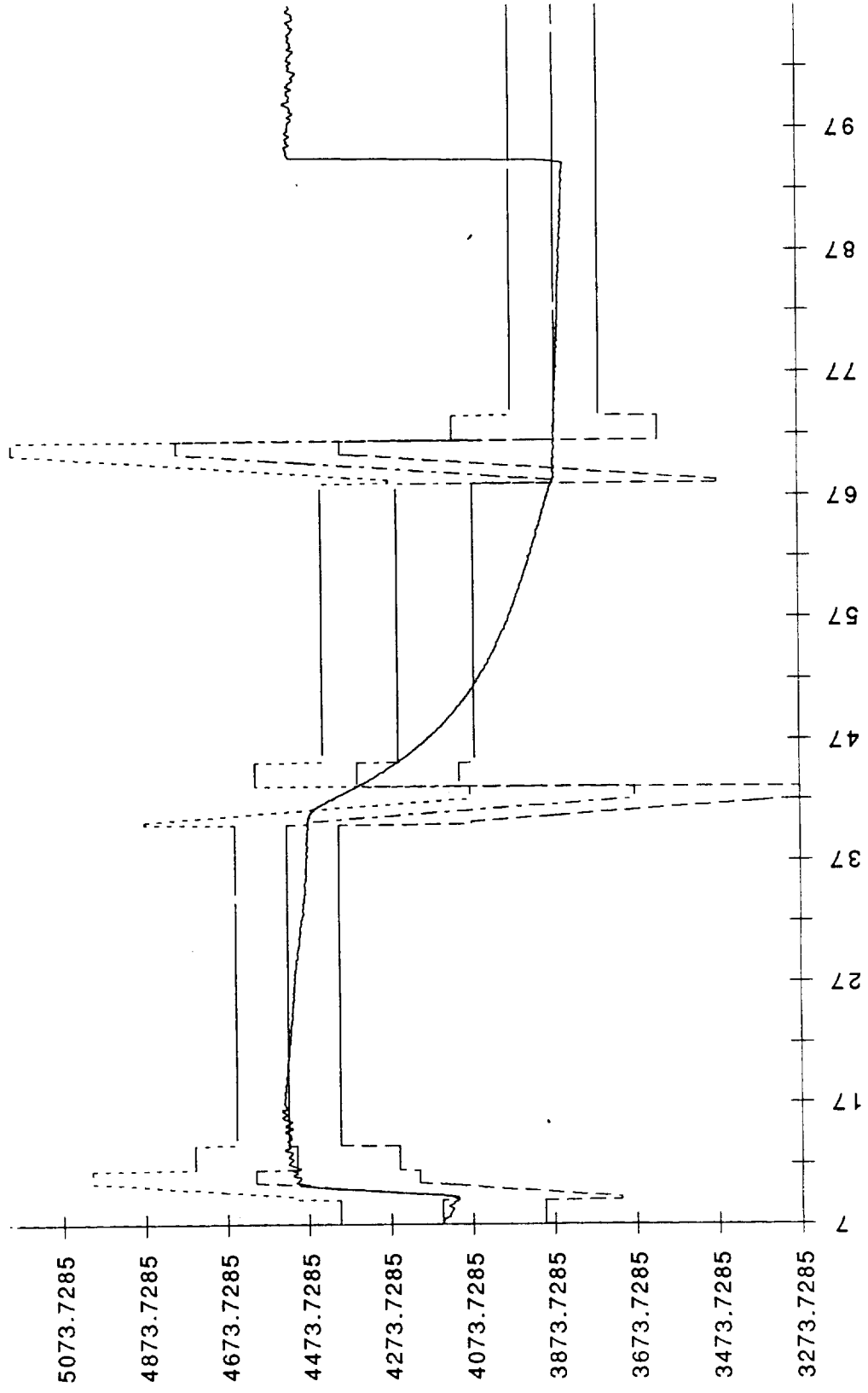

750-168 HPFP bal cav pr.T

750-168 HPFP bal cav pr.T

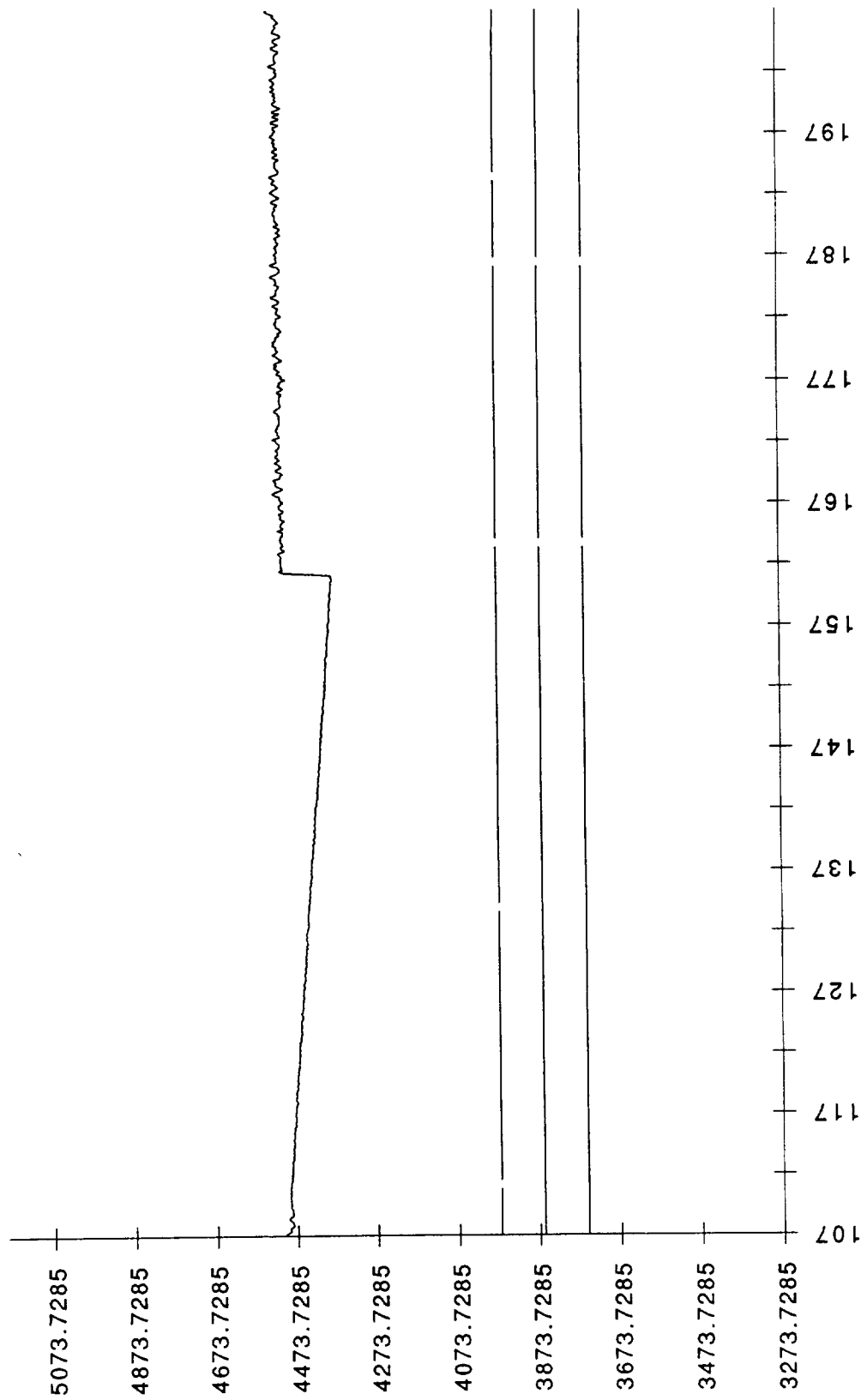

750-168 HPFP bal cav pr.T

750-168 HPFP bal cav pr.T

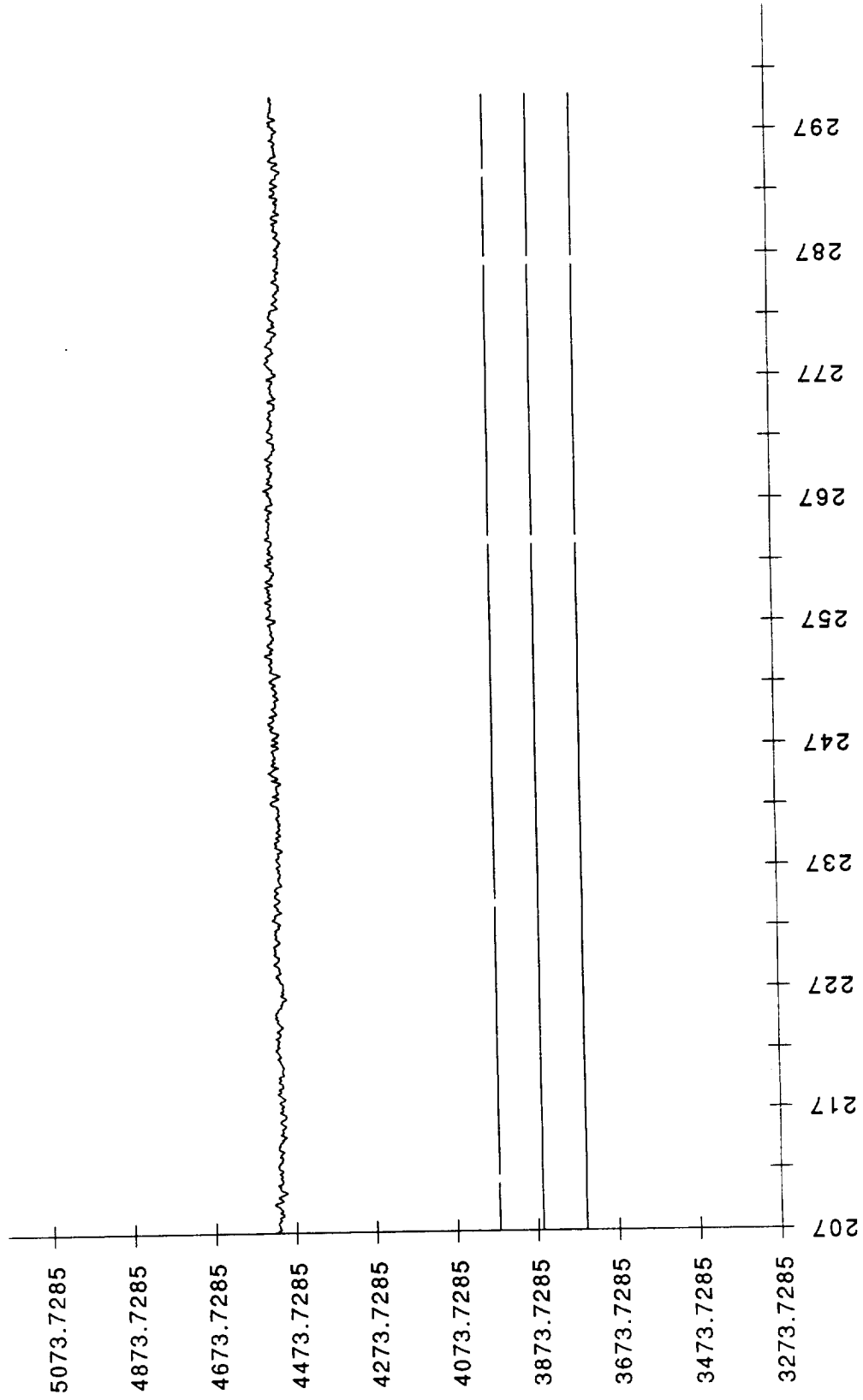

750-168 HPFP bal cav pr.T

750-291 MCC Pc.T

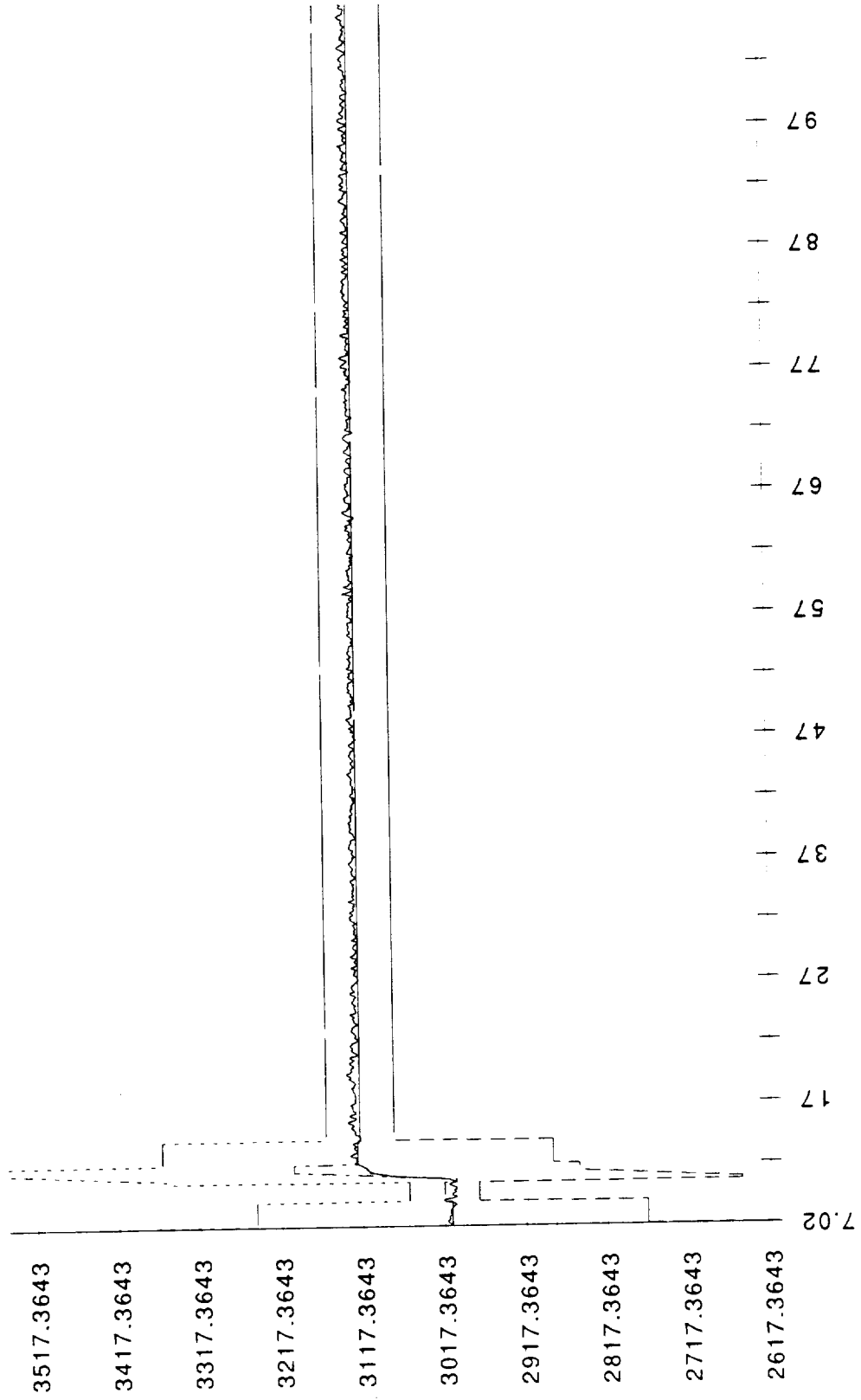

750-291 MCC Pc.T

750-291 MCC Pc.T

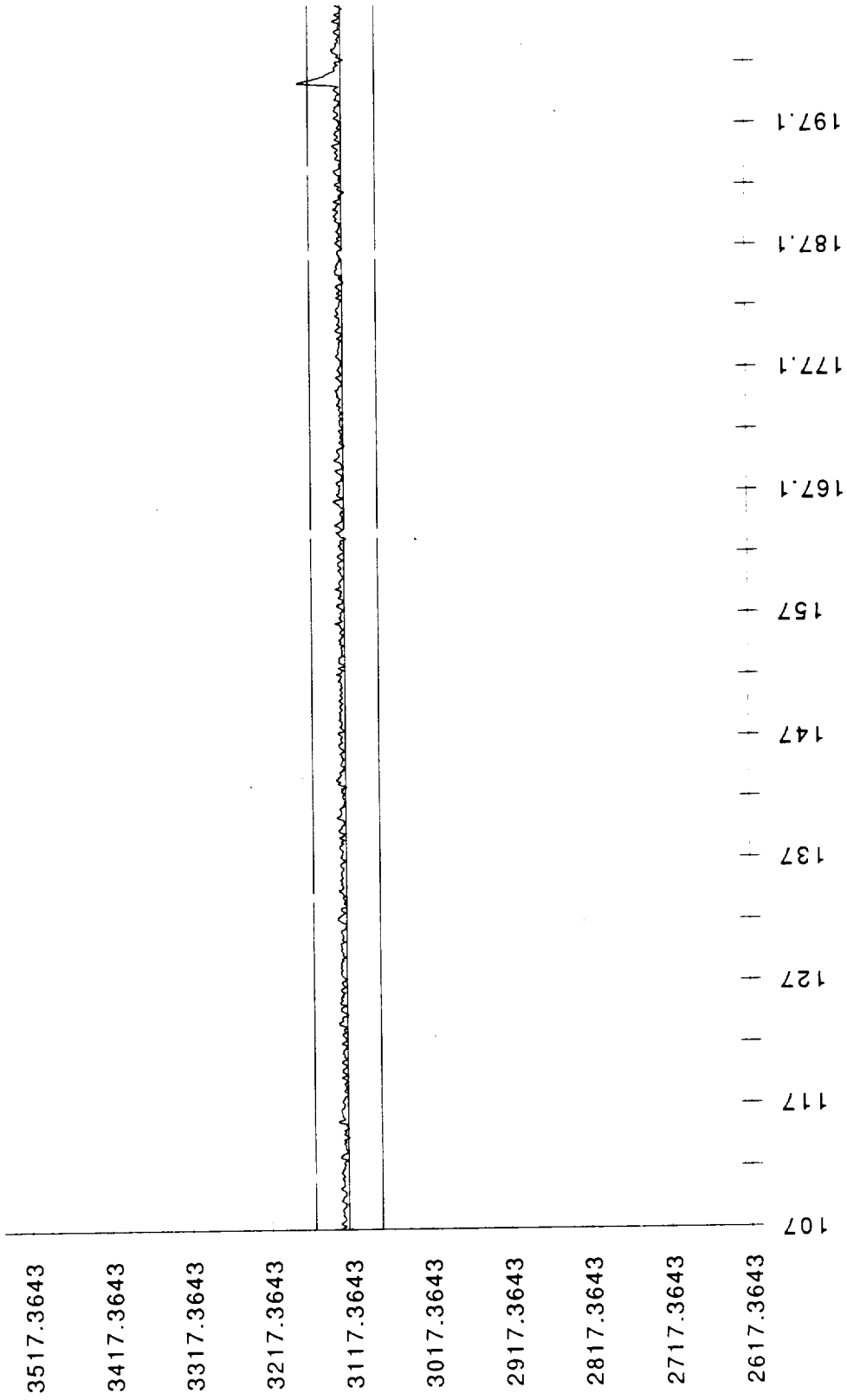

750-291 MCC Pc.T

750-291 MCC Pc.T

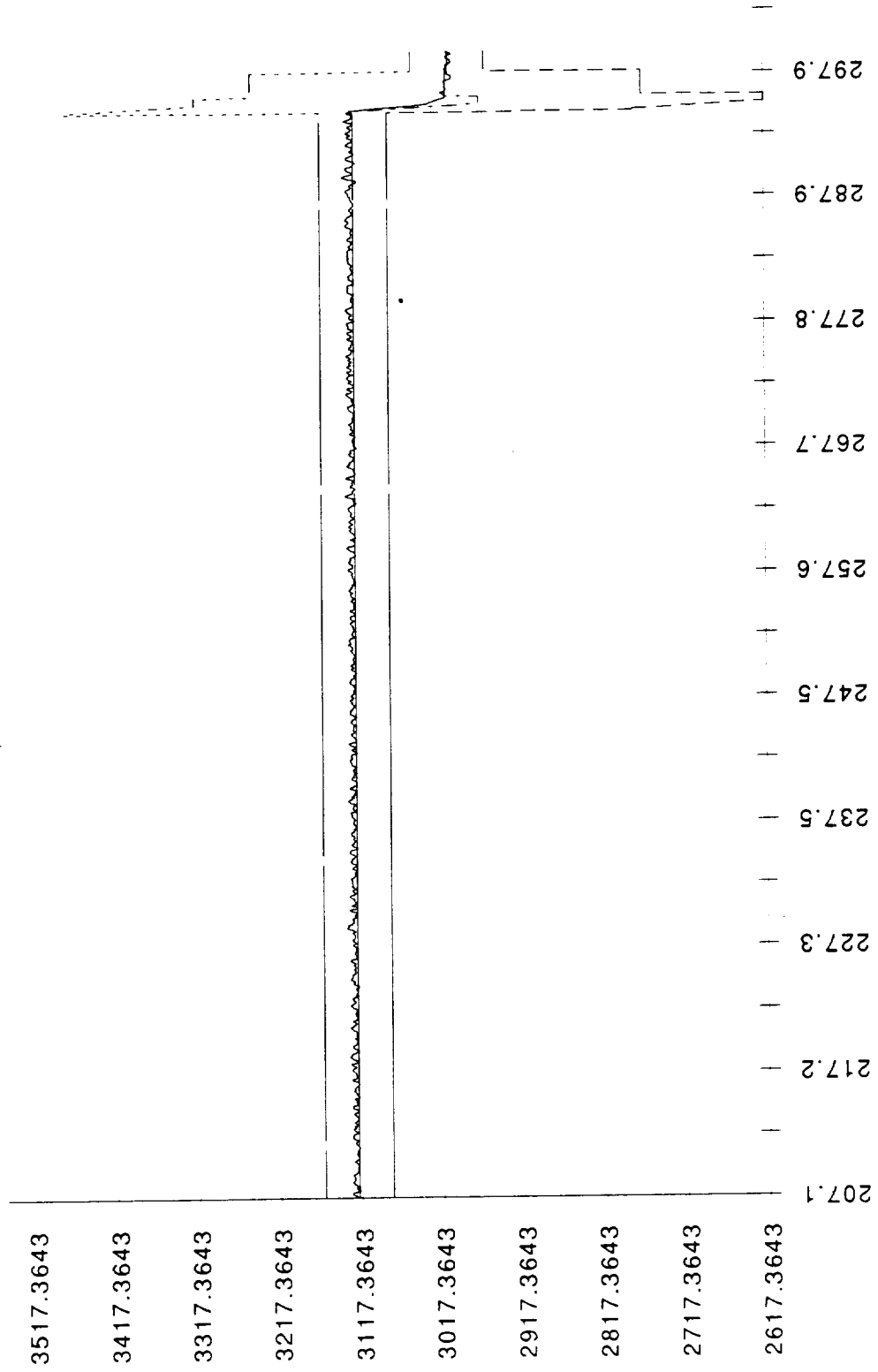

750-291 MCC Pc.T

901-307 HPFP TDT A.T

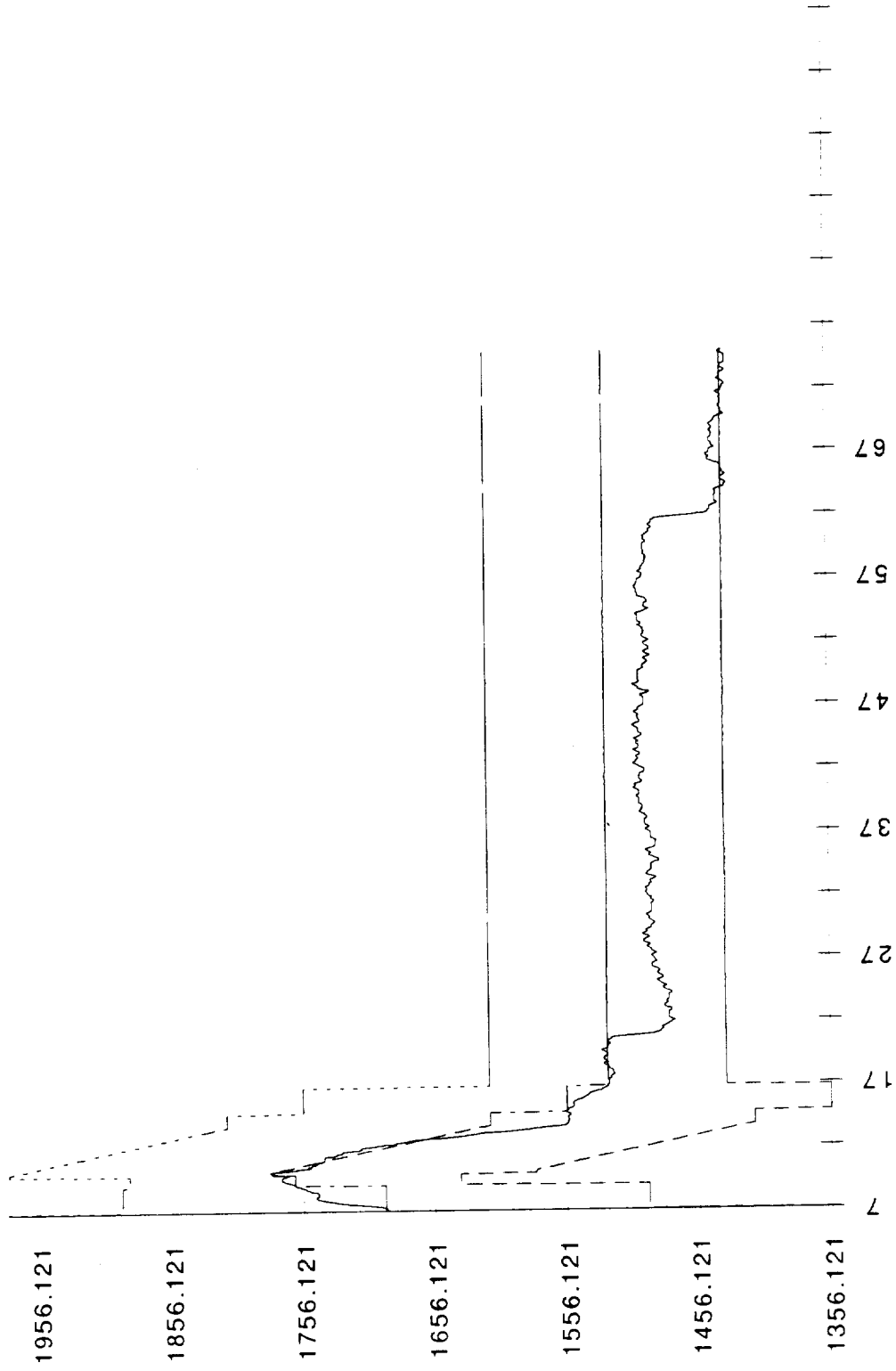

901-307 HPFP TDT A.T

901-307 HPFP TDT B.T

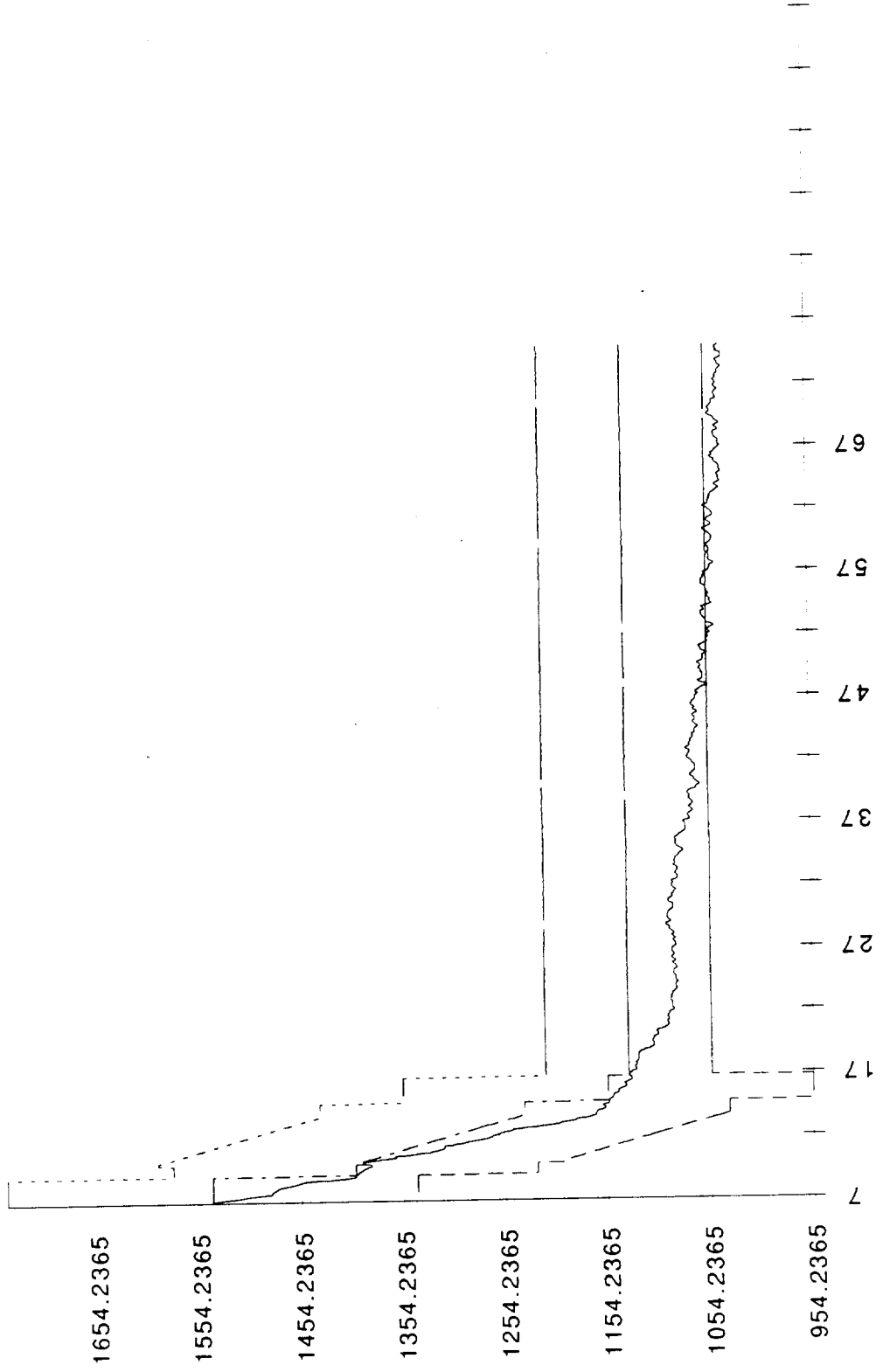

901-307 HPFP TDT B.T

901-307 LPOP dis pr.T

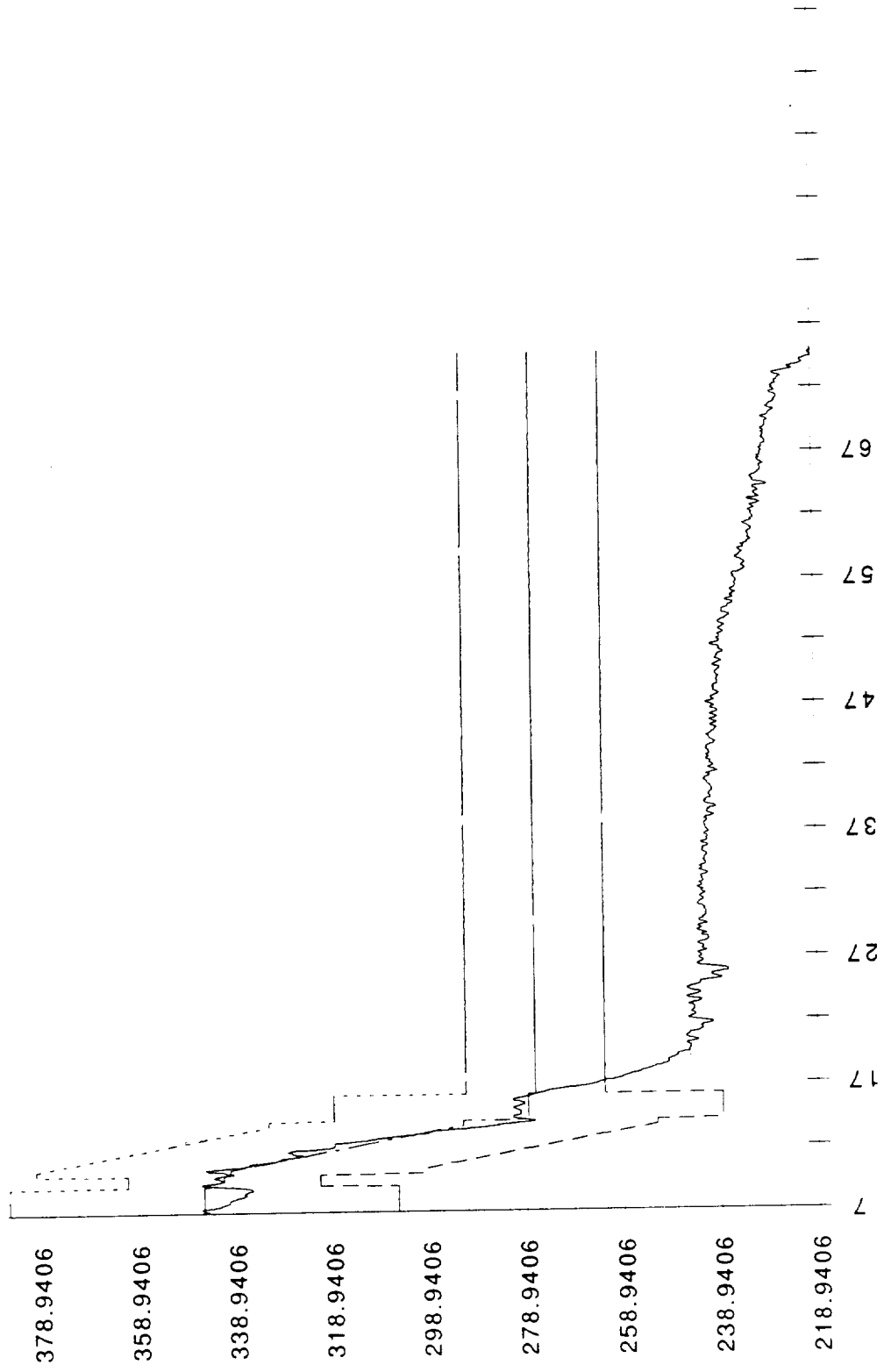

901-307 LPOP dis pr.T

901-346 FPOV pos.T

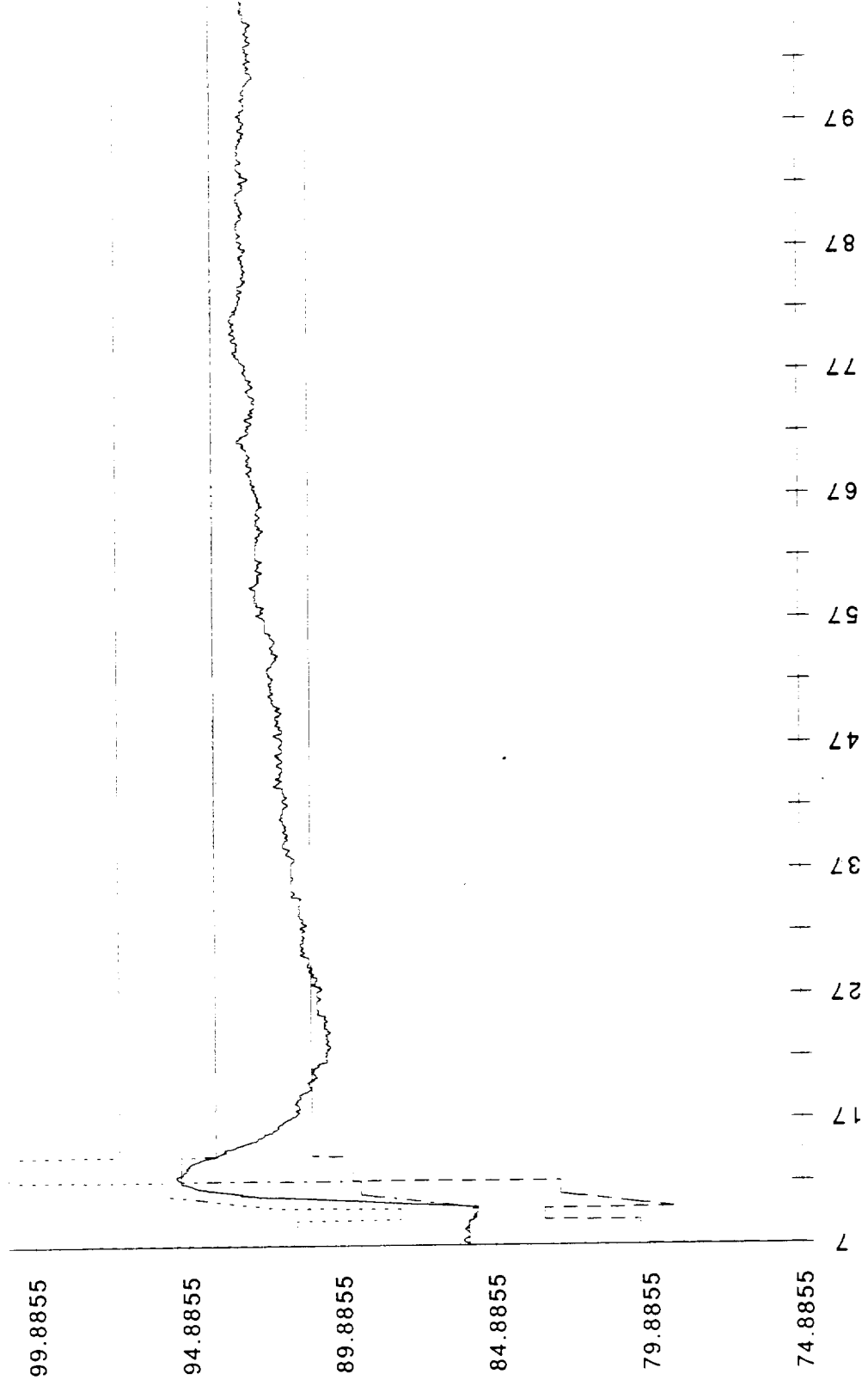

901-346 FPOV pos.T

901-346 FPOV pos.T

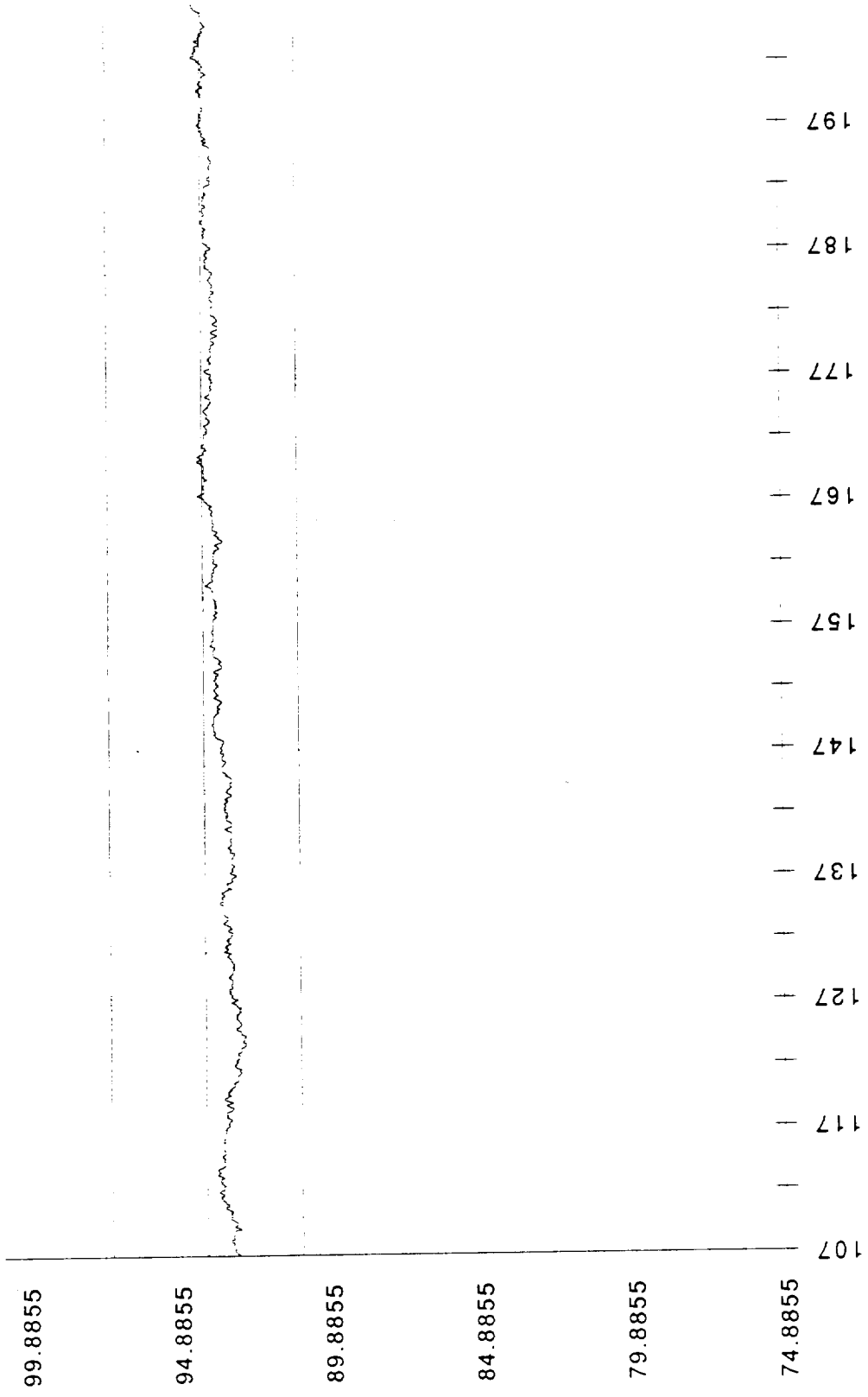

901-346 FPOV pos.T

901-346 FPOV pos.T

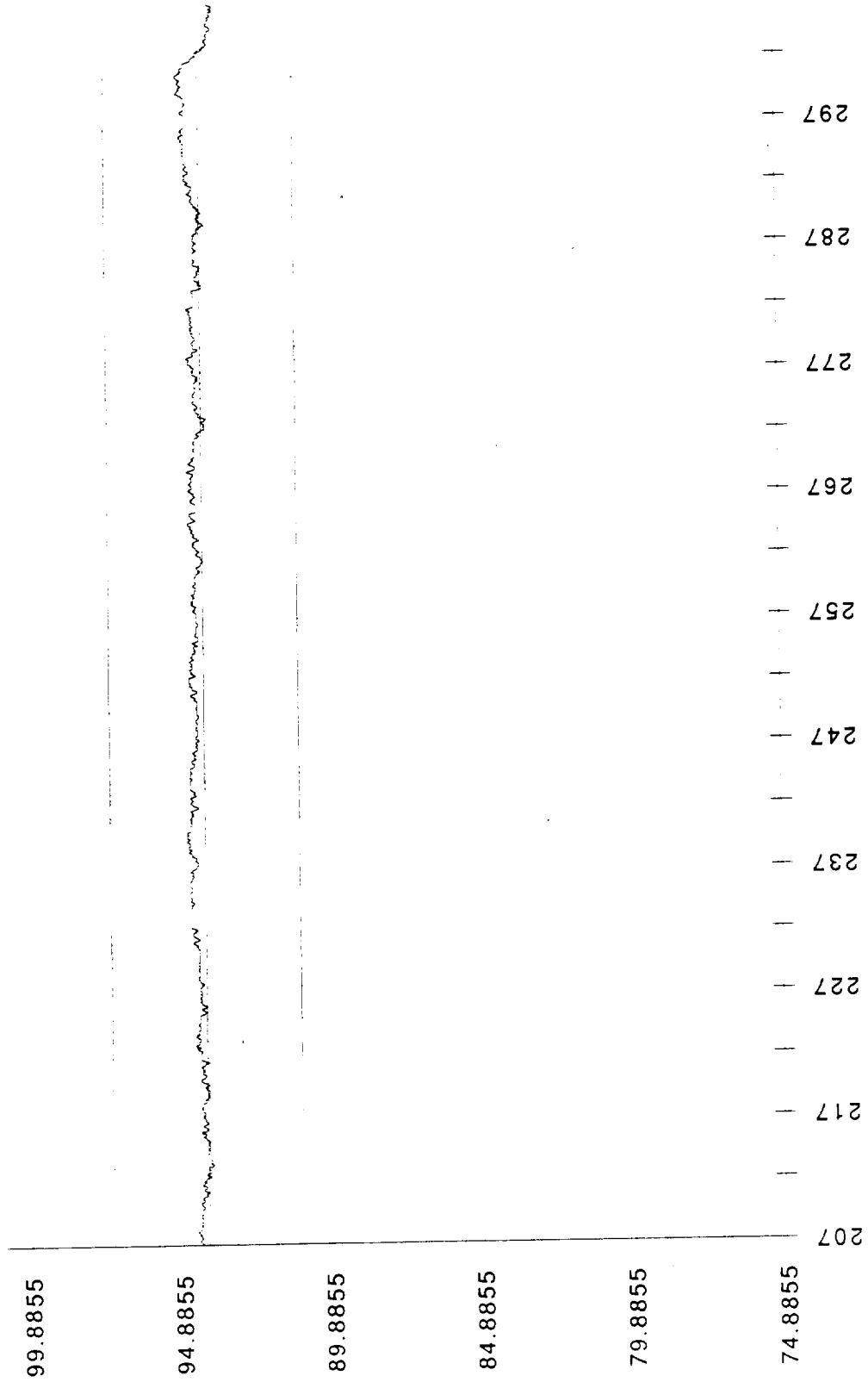

901-346 FPOV pos.T

901-346 FPOV pos.T

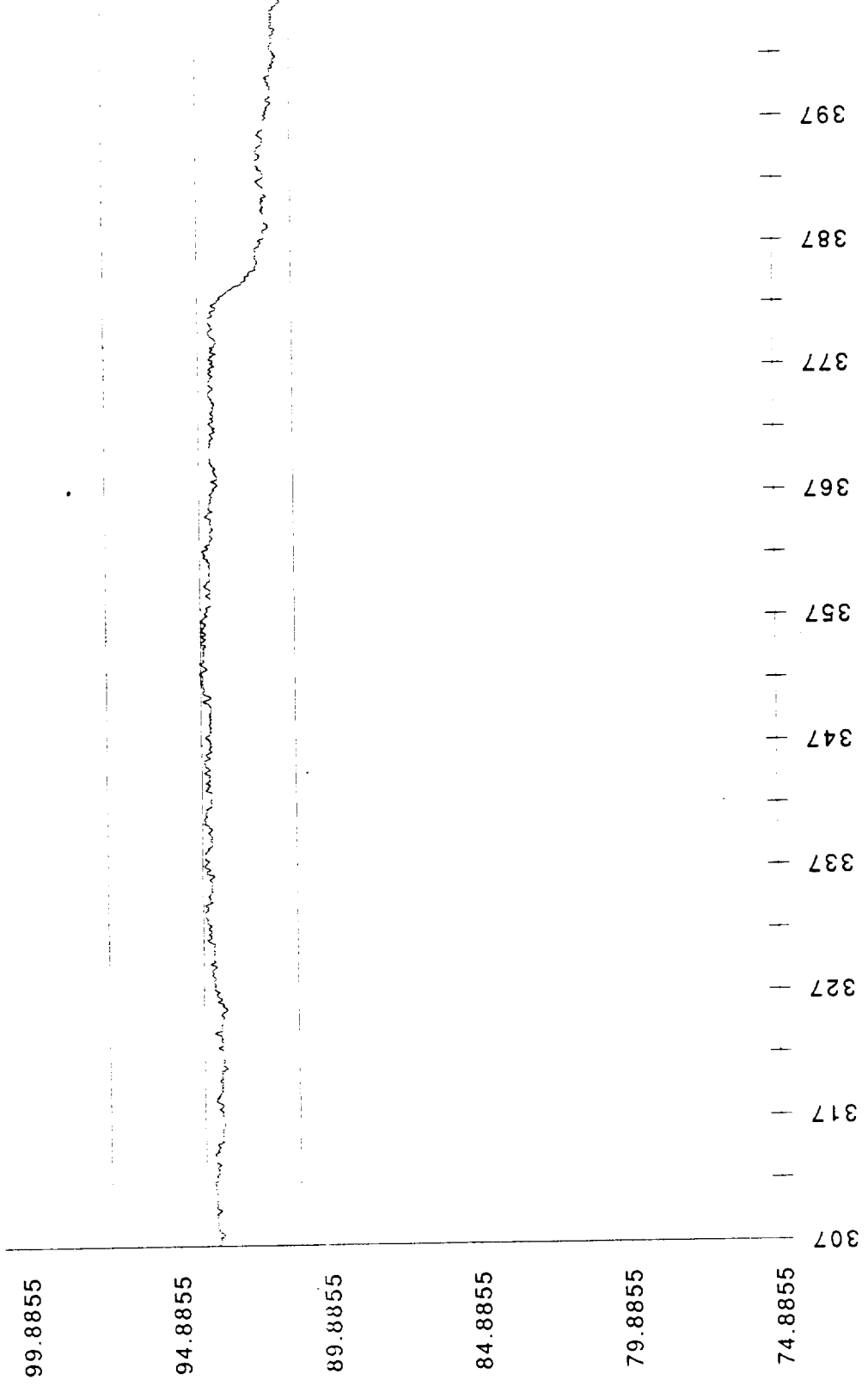

901-346 FPOV pos.T

901-346 FPOV pos.T

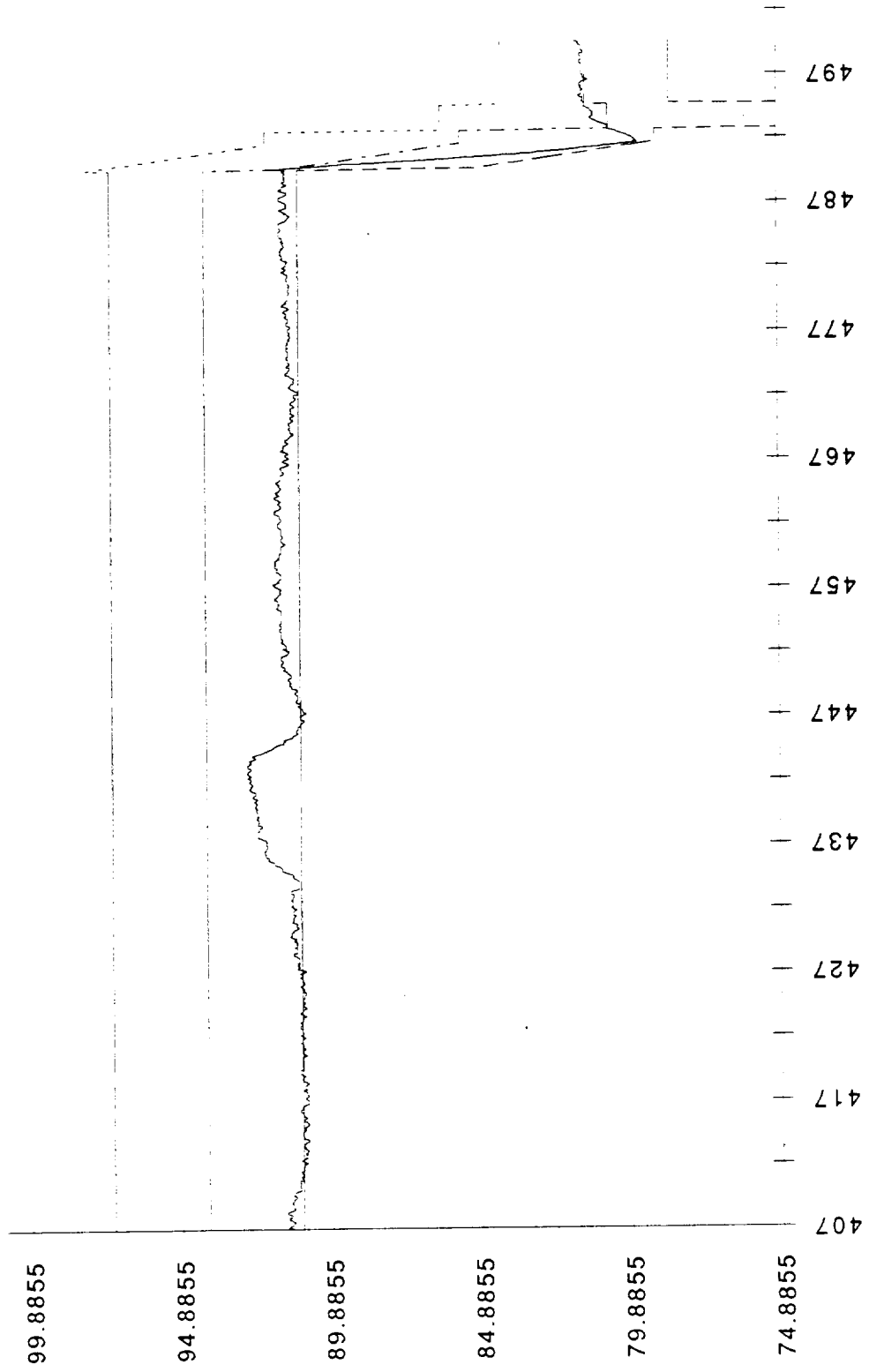

901-346 FPOV pos.T

901-346 LPFP sh sp.T

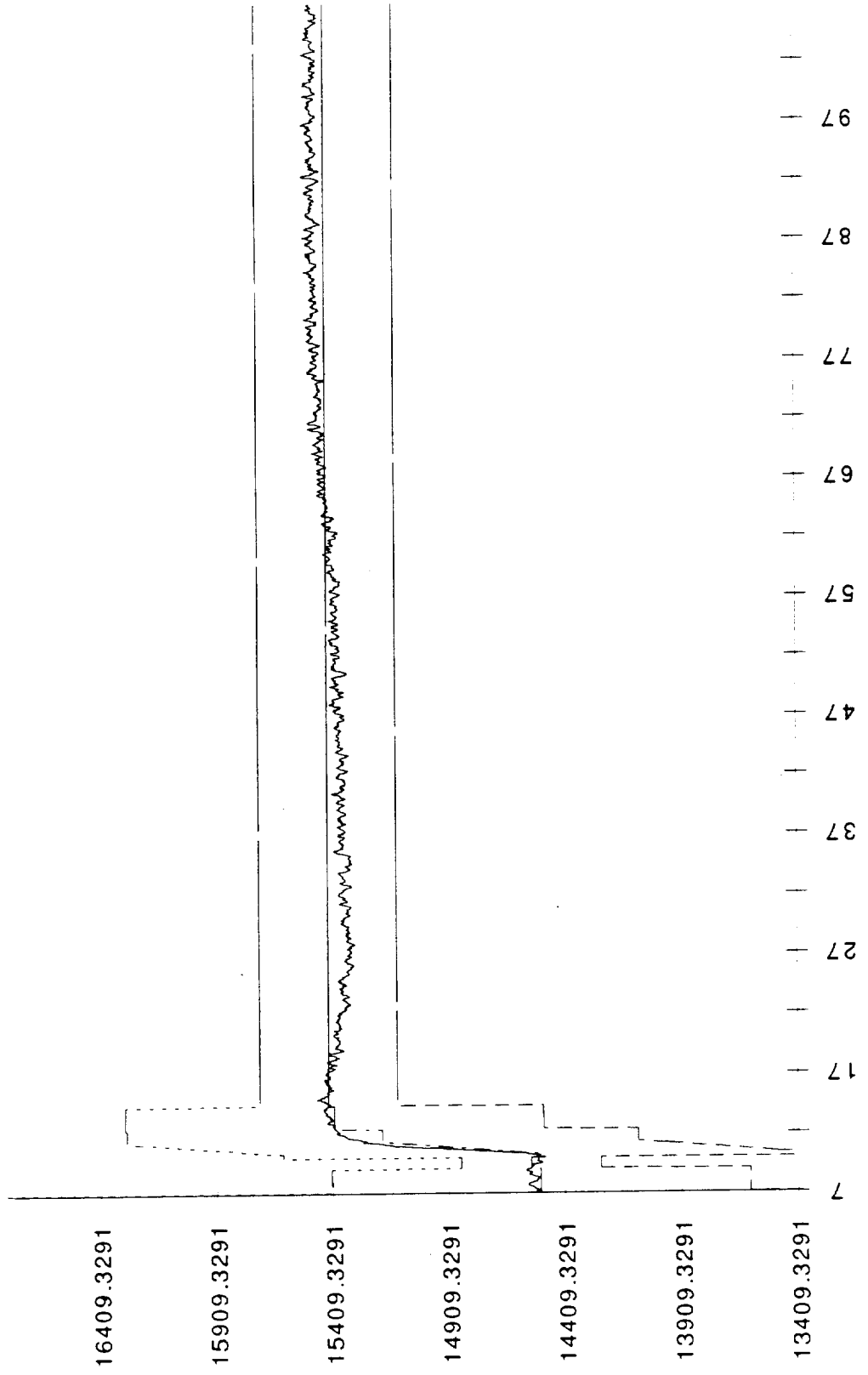

901-346 LPFP sh sp.T

901-346 LPFP sh sp.T

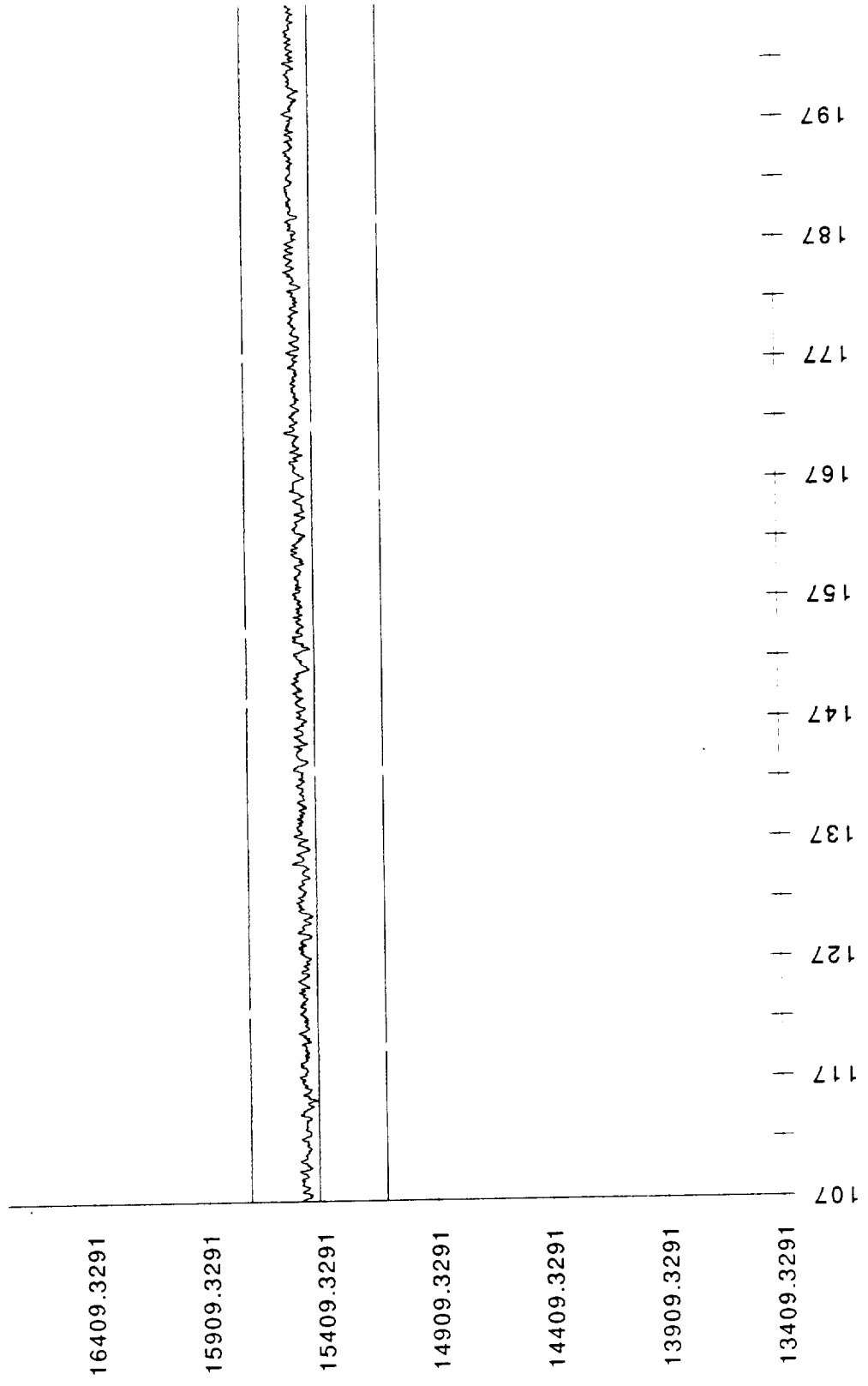

901-346 LPFP sh sp.T

901-346 LFPF sh sp.T

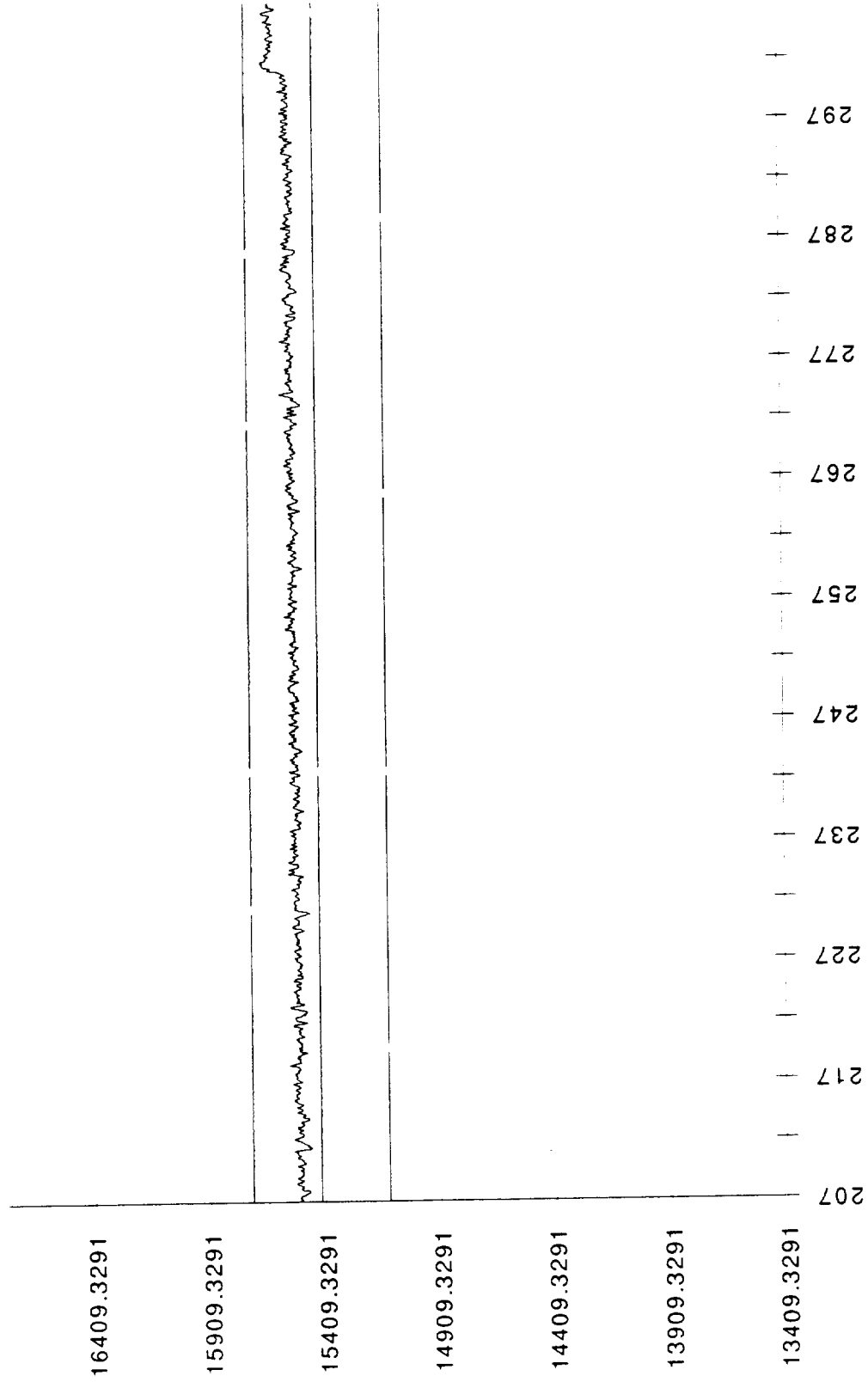

901-346 LFPF sh sp.T

901-346 LPFP sh sp.T

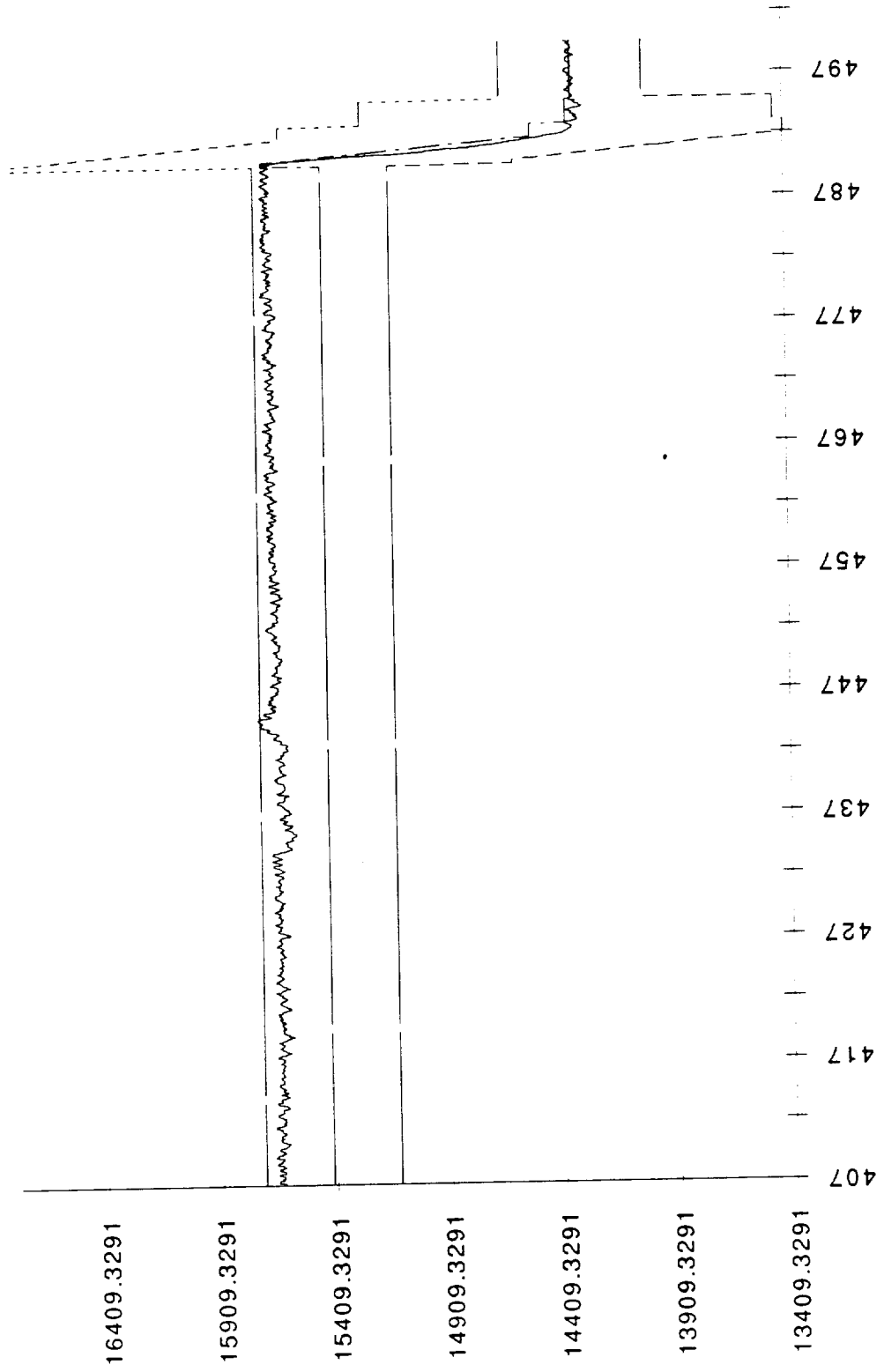

901-346 LPFP sh sp.T

901-346 MCC lin cav pr.T

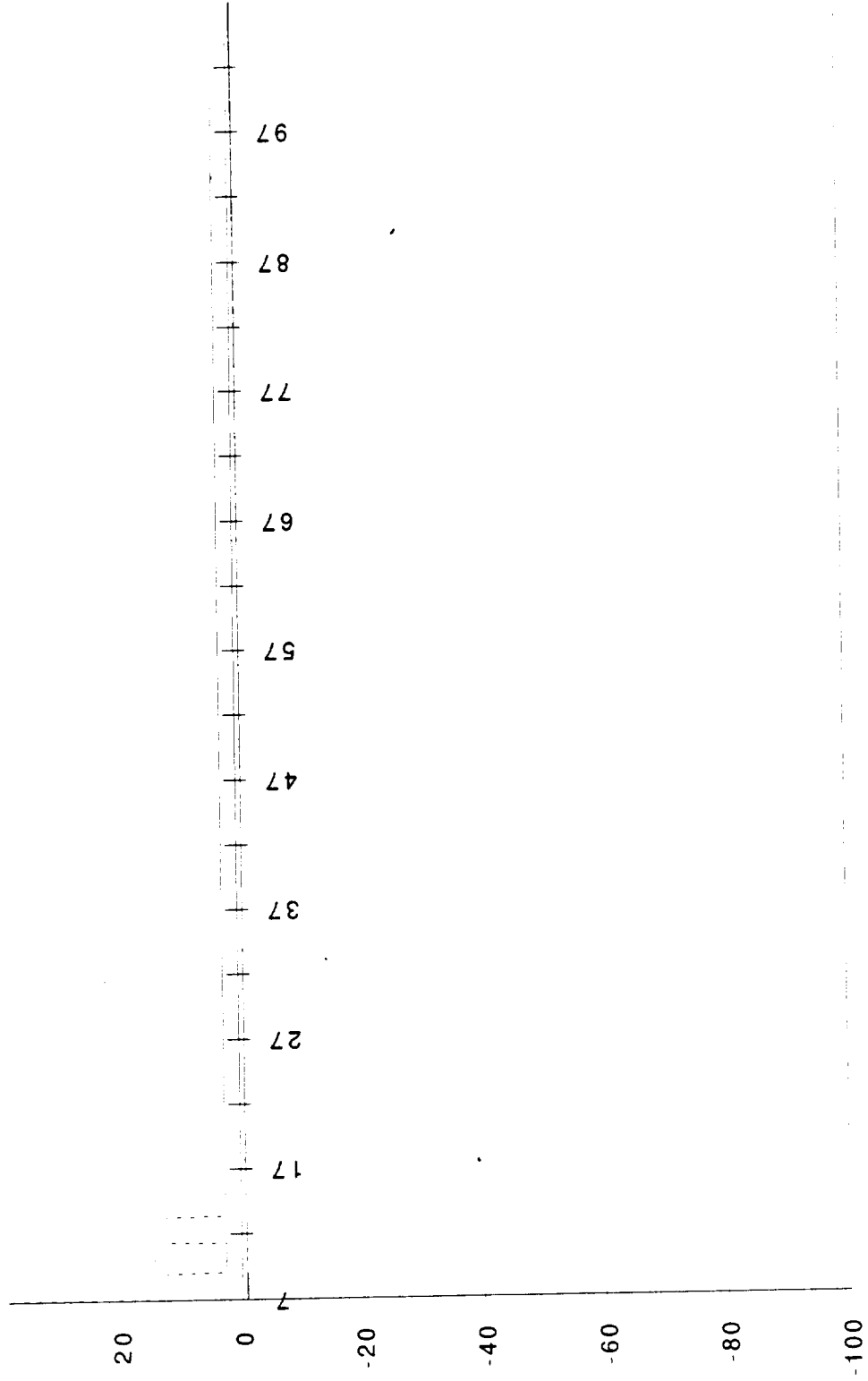

901-346 MCC lin cav pr.T

901-346 MCC lin cav pr.T

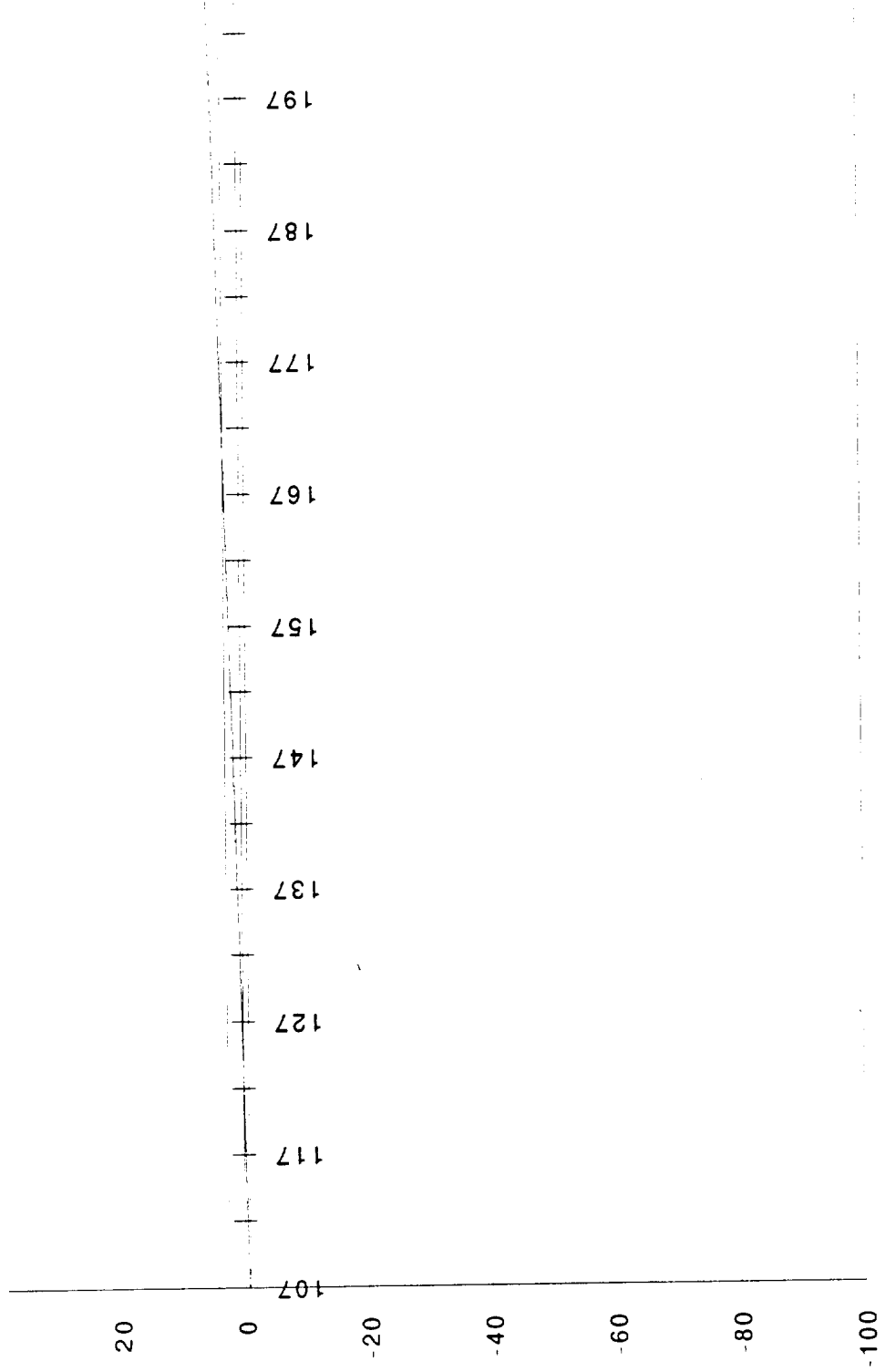

901-346 MCC lin cav pr.T

901-346 MCC lin cav pr.T

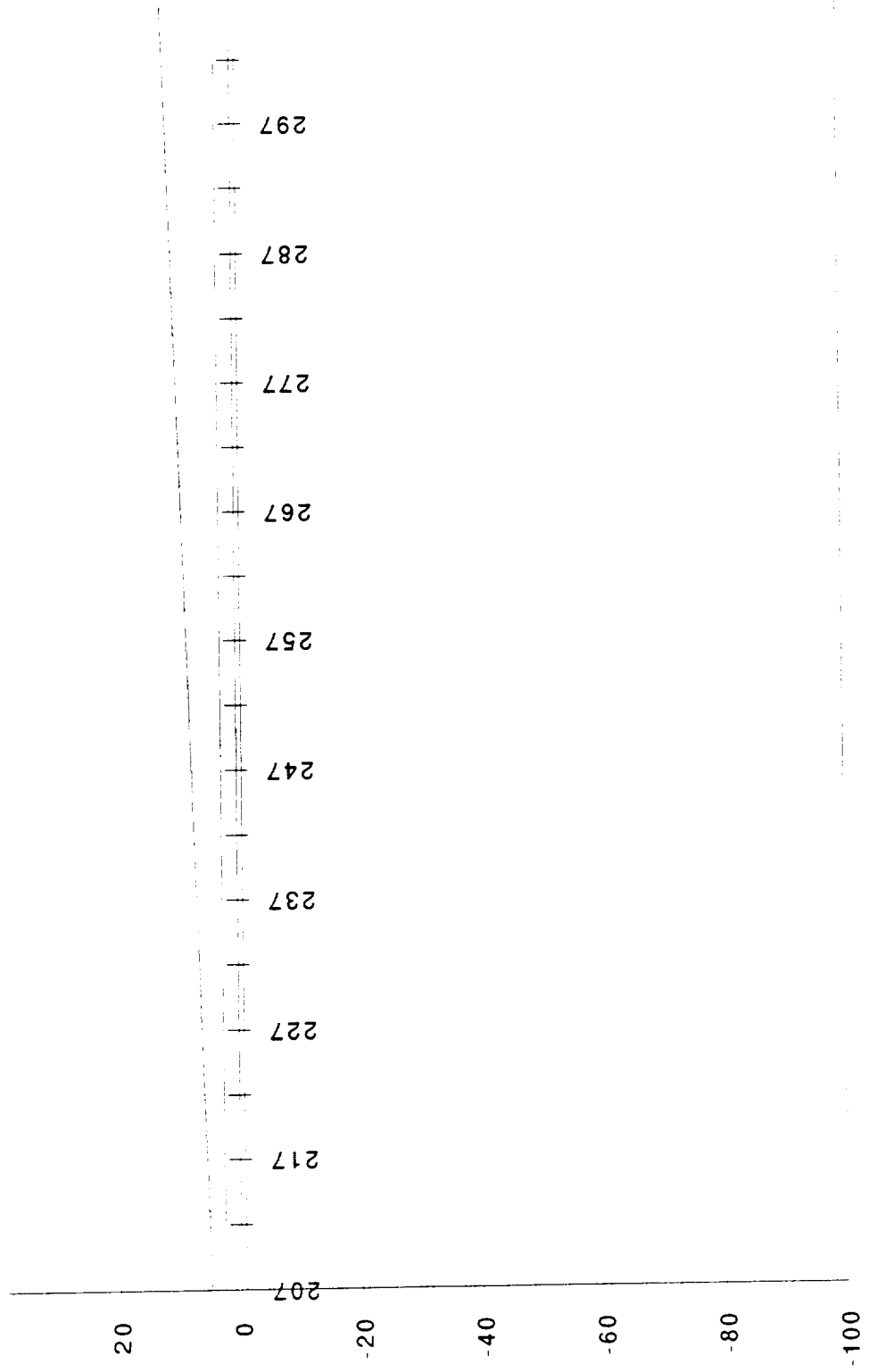

901-346 MCC lin cav pr.T

901-346 MCC lin cav pr.T

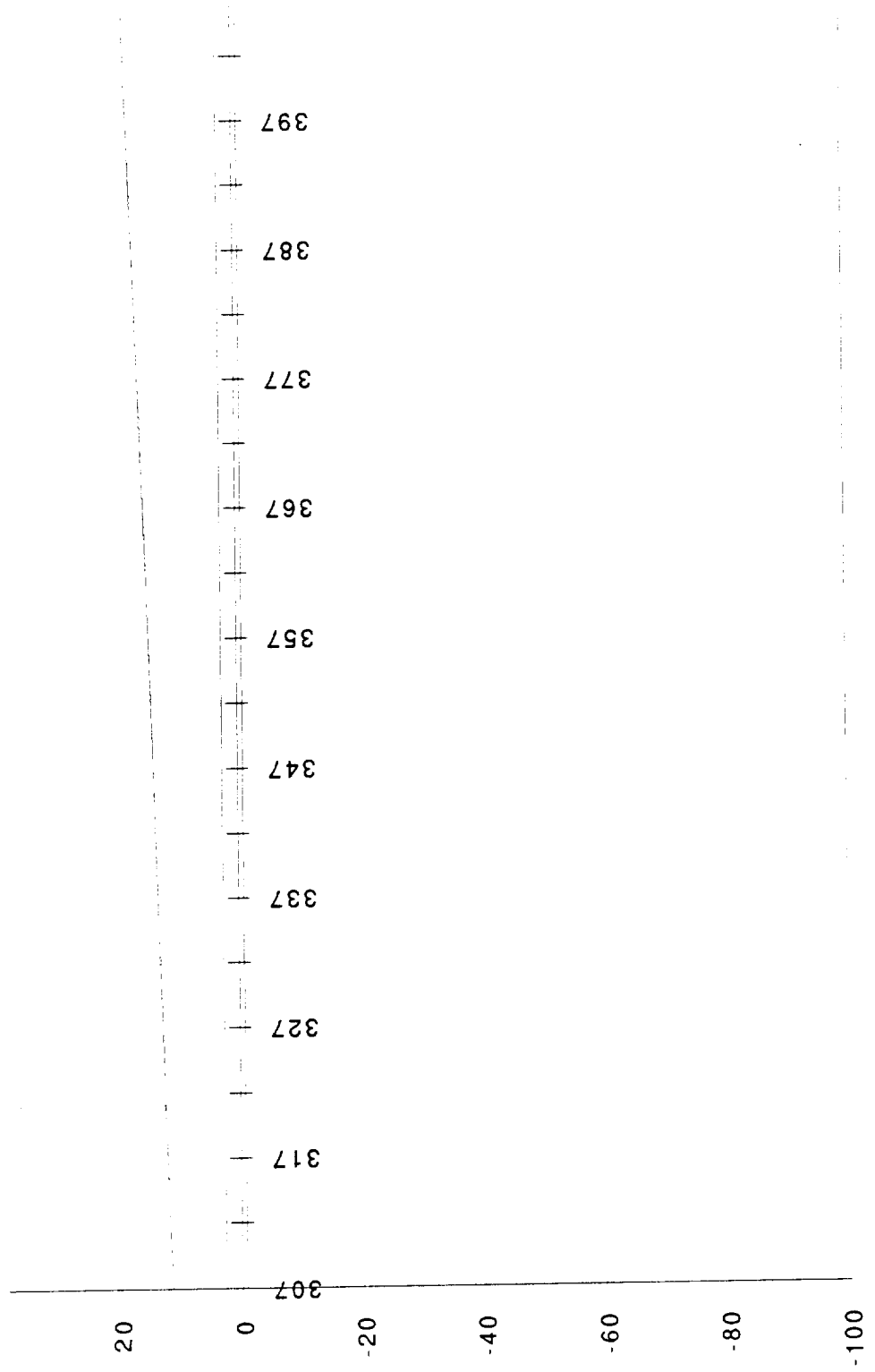

901-346 MCC lin cav pr.T

901-346 MCC lin cav pr.T

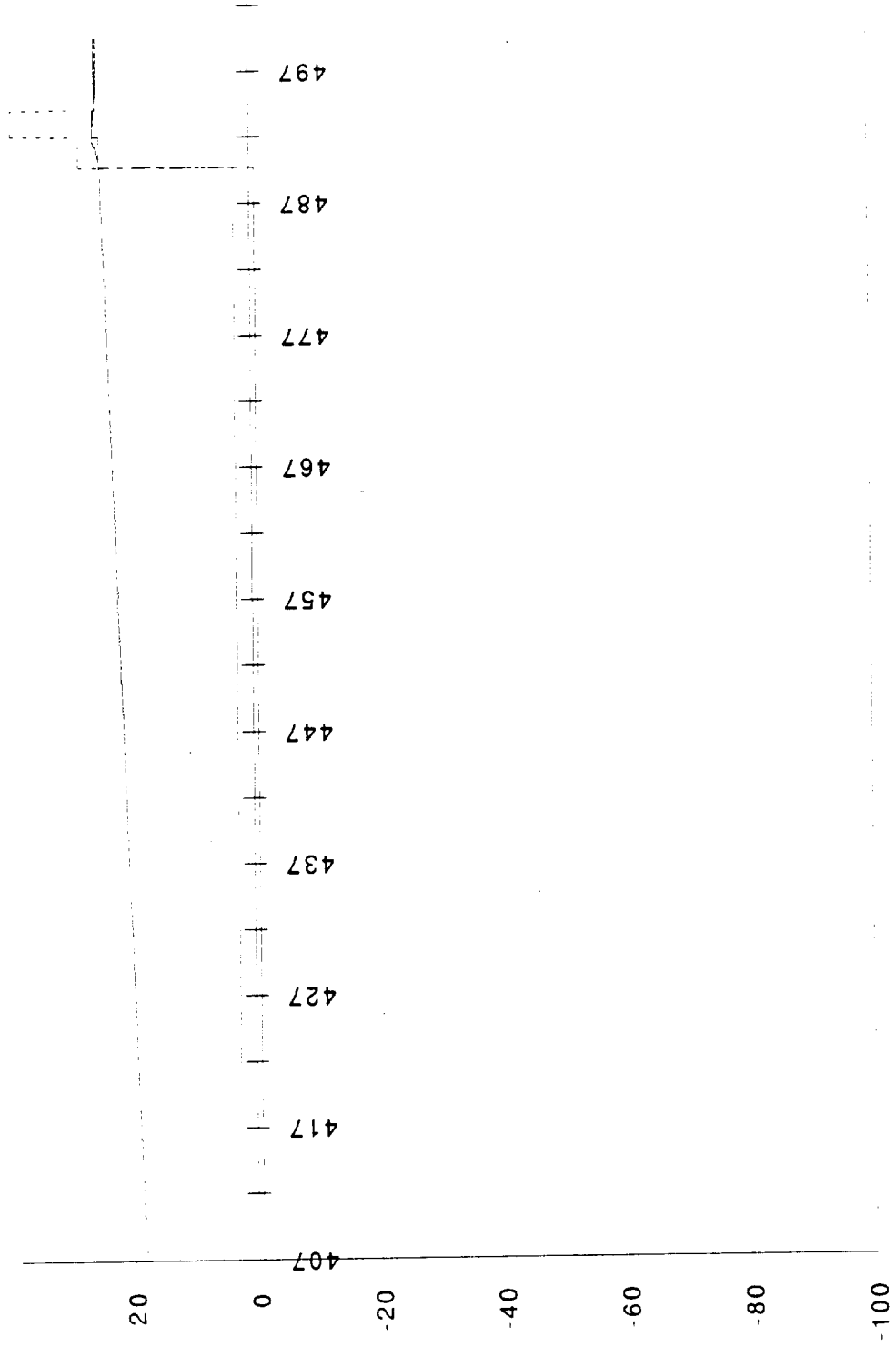

901-346 MCC lin cav pr.T

901-579 Fuel flow.T

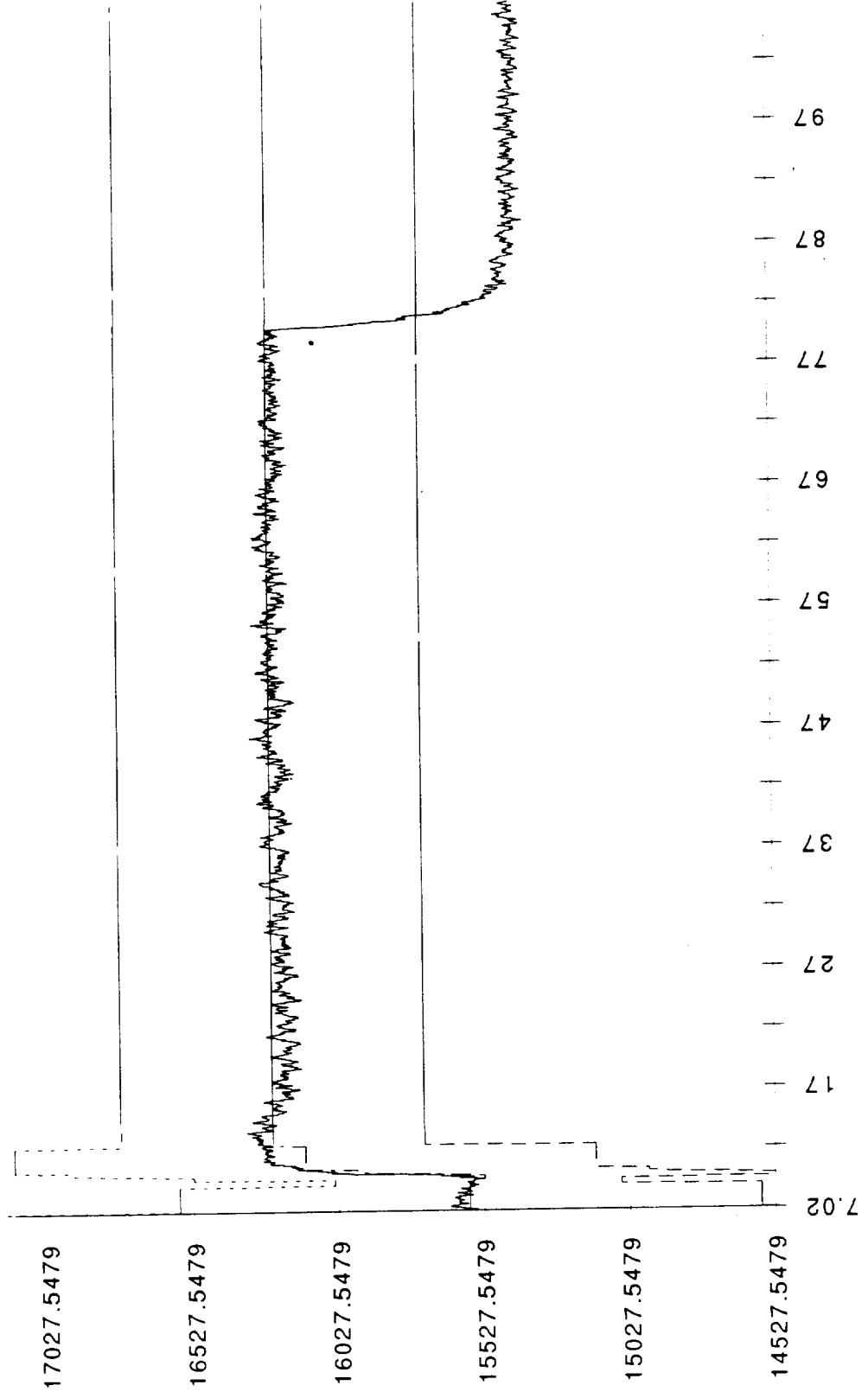

901-579 Fuel flow.T

901-579 Fuel flow.T

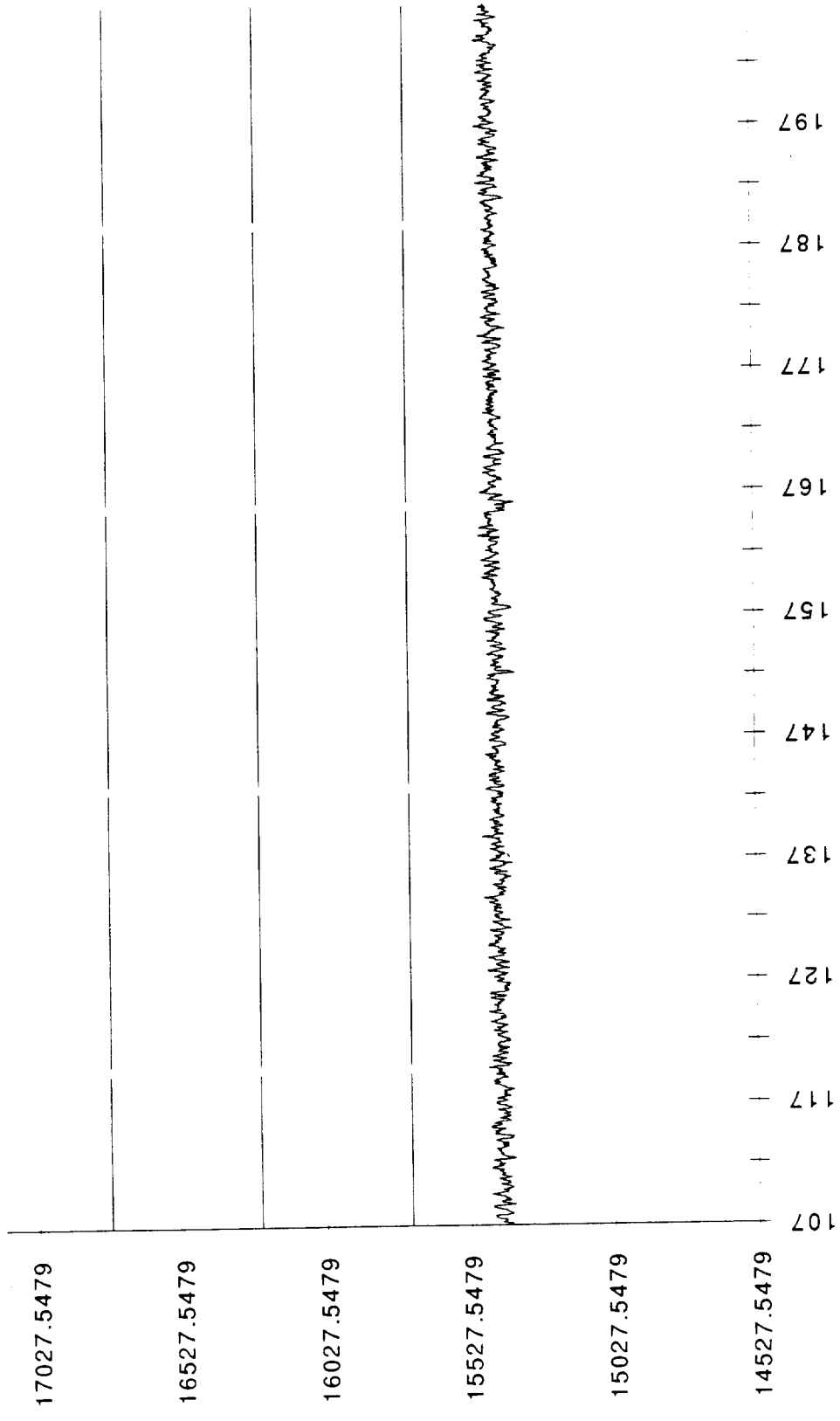

901-579 Fuel flow.T

901-579 Fuel flow.T

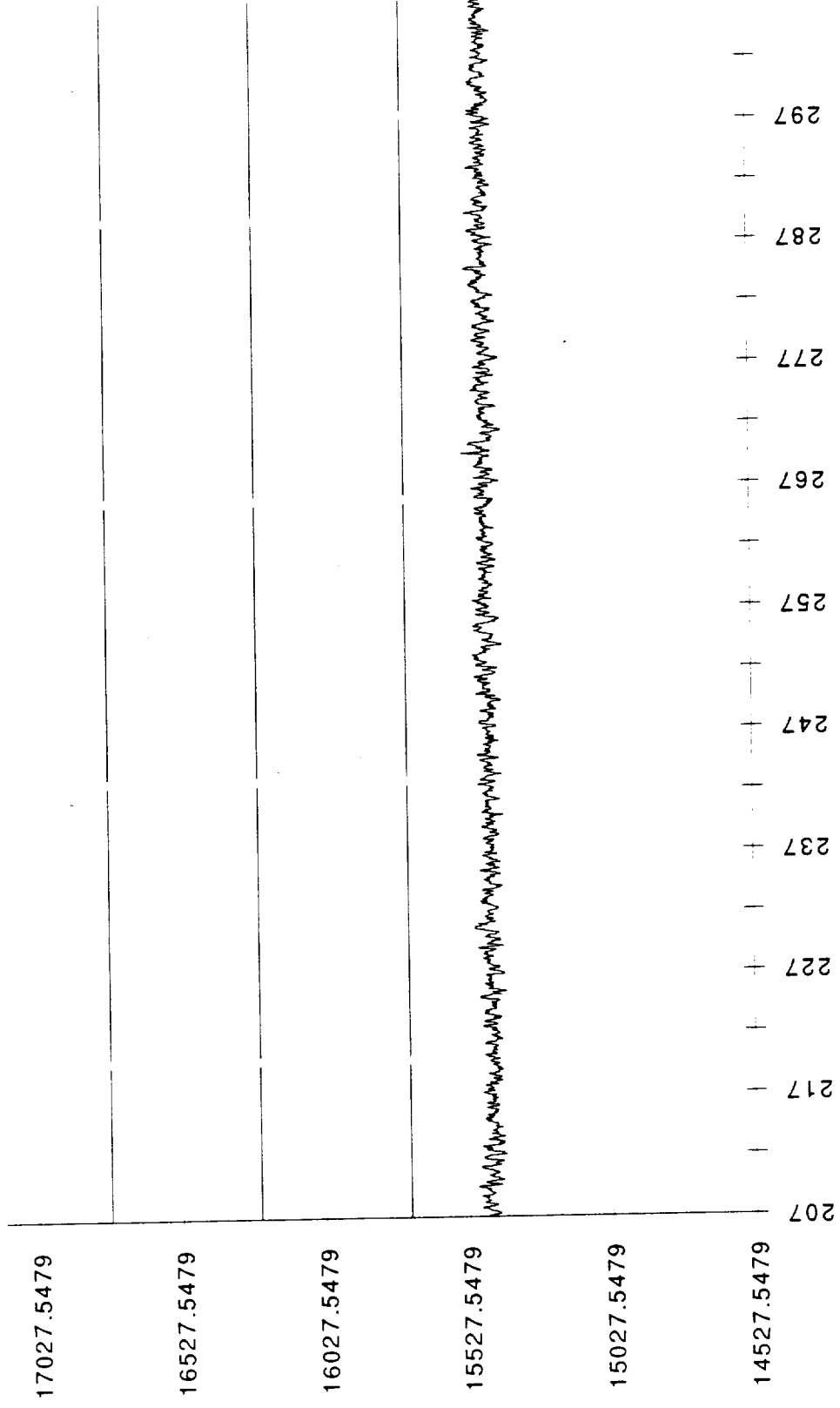

901-579 Fuel flow.T

901-579 Fuel flow.T

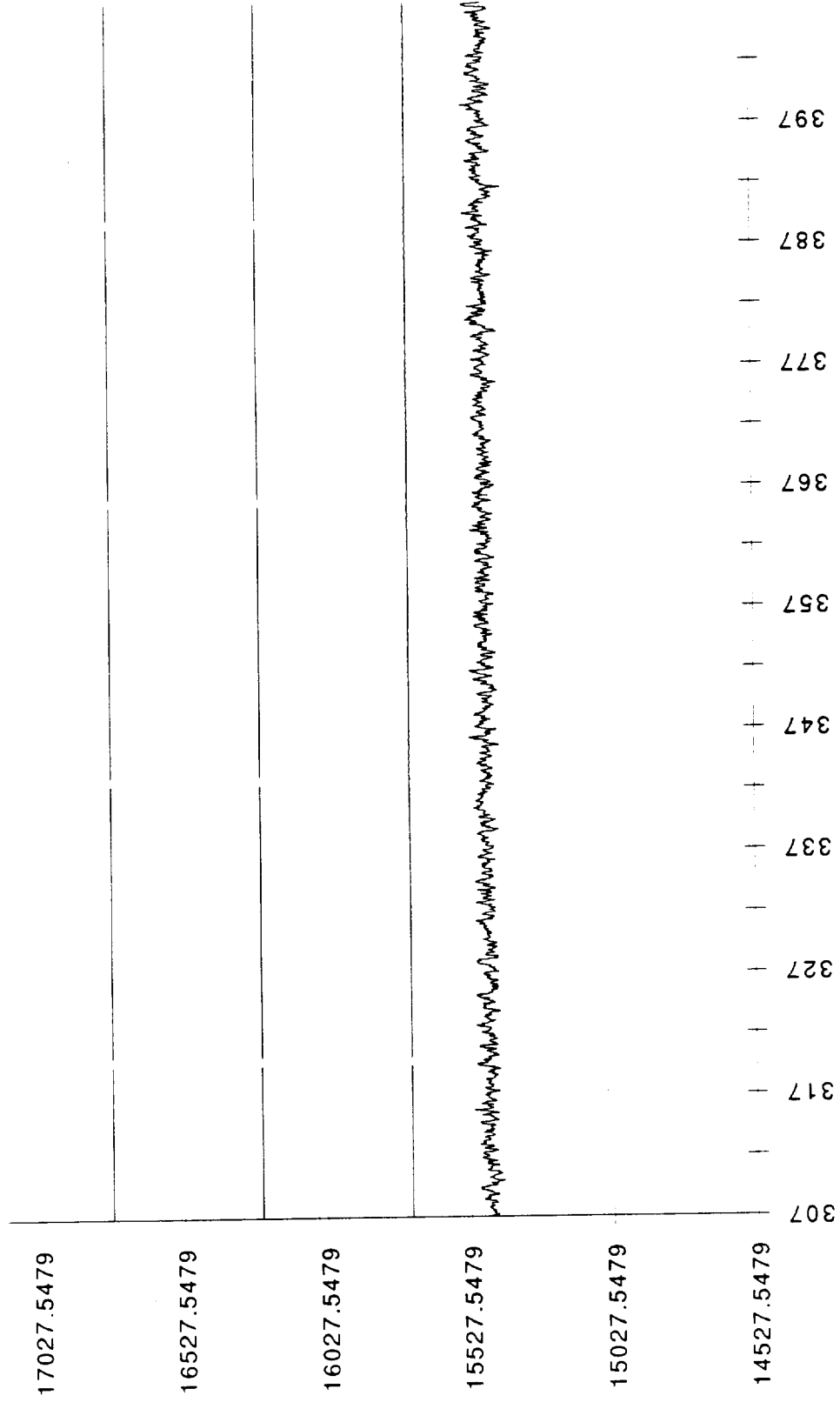

901-579 Fuel flow.T

901-579 Fuel flow.T

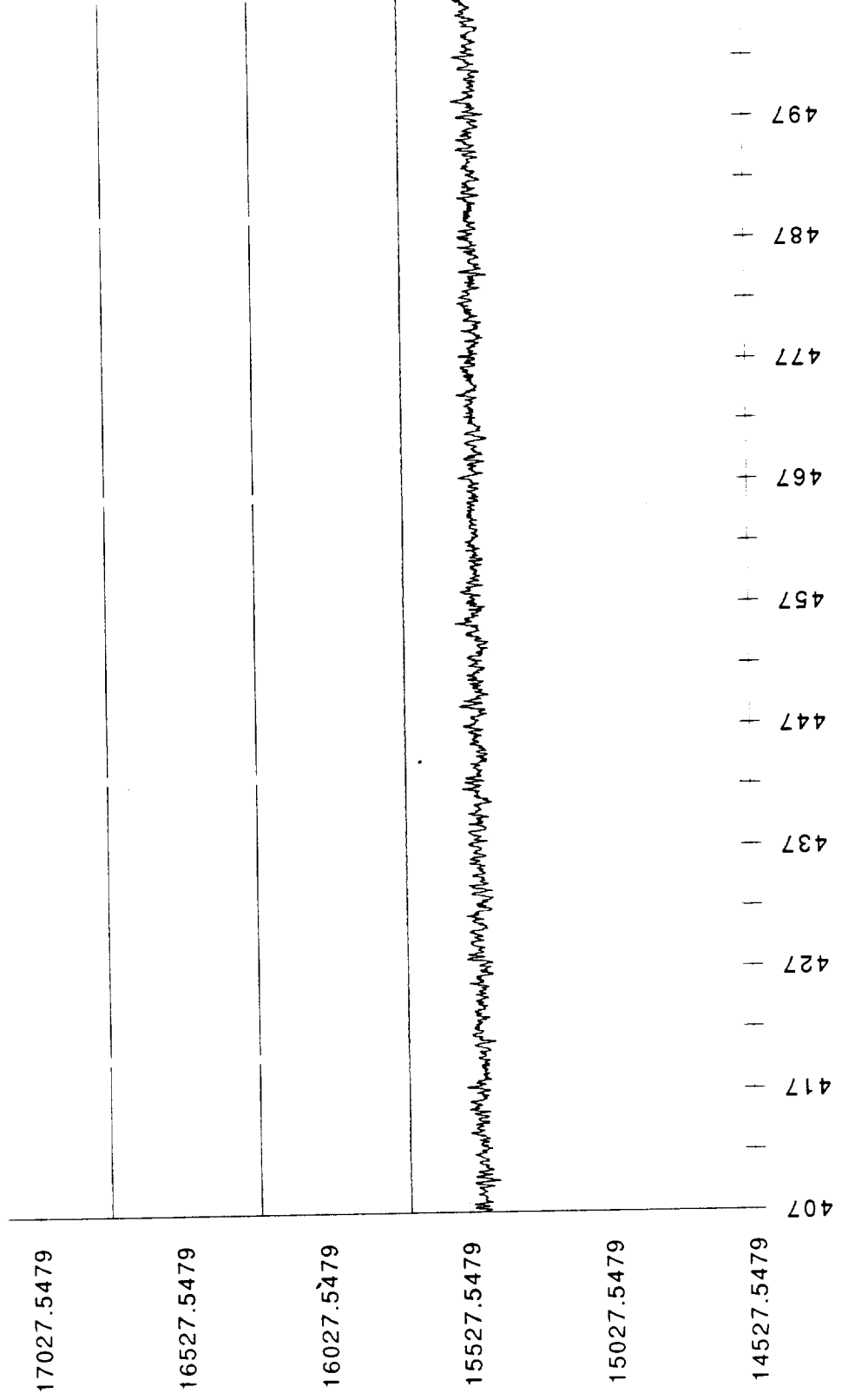

901-579 Fuel flow.T

901-579 Fuel flow.T

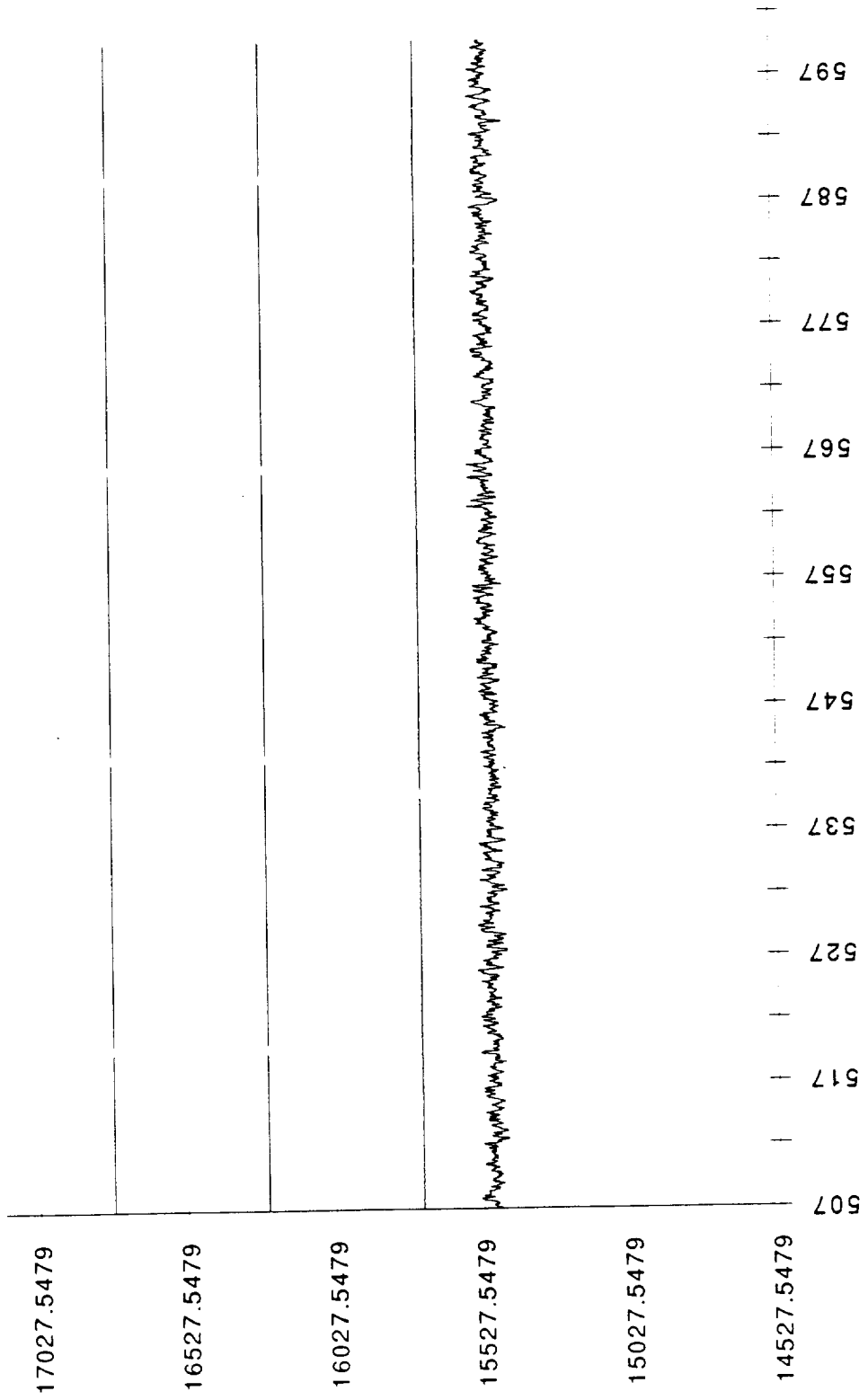

901-579 Fuel flow.T

901-579 HPFP bal cav pr.T

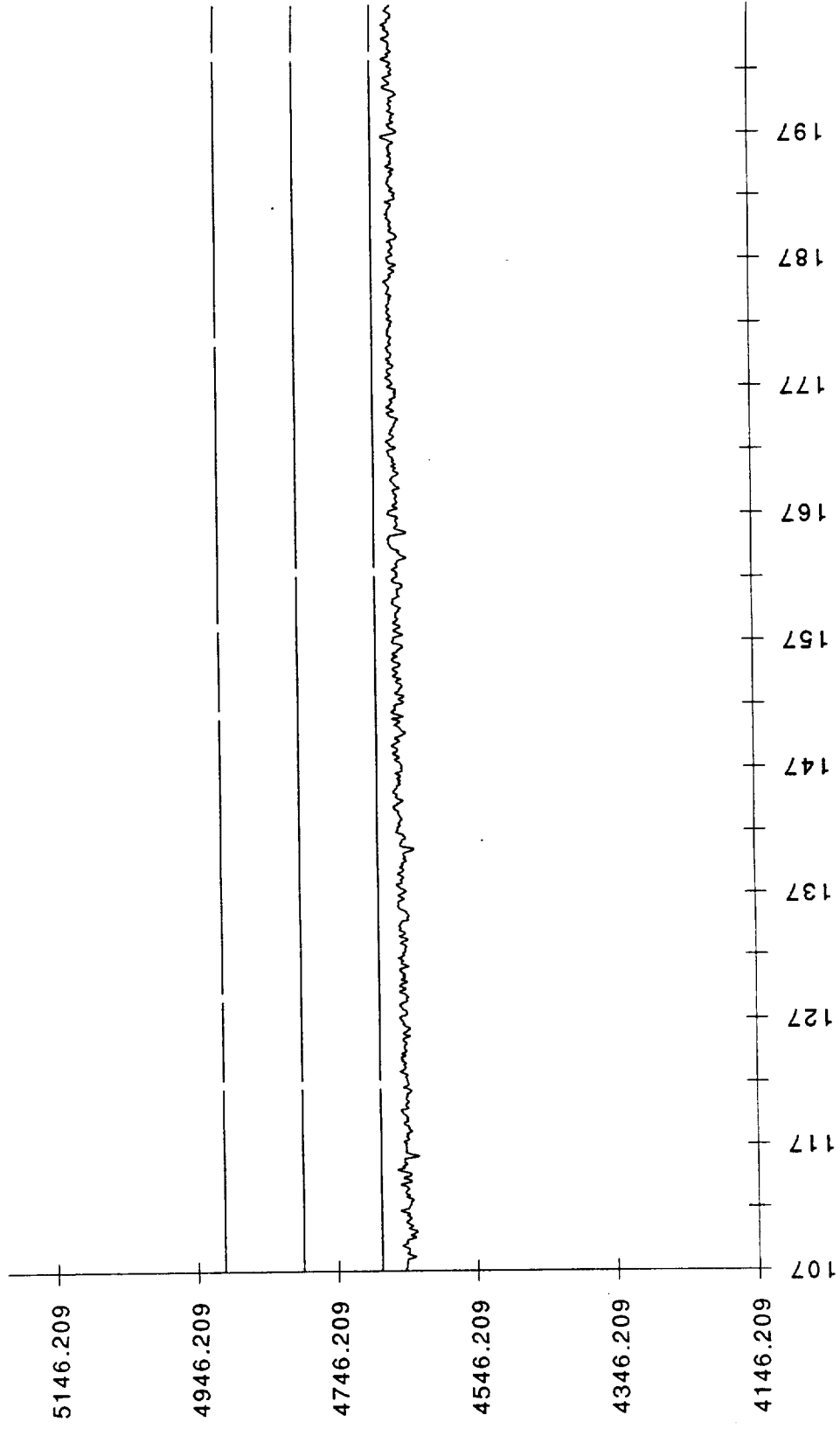

901-579 HPFP bal cav pr.T

901-579 HPFP bal cav pr.T

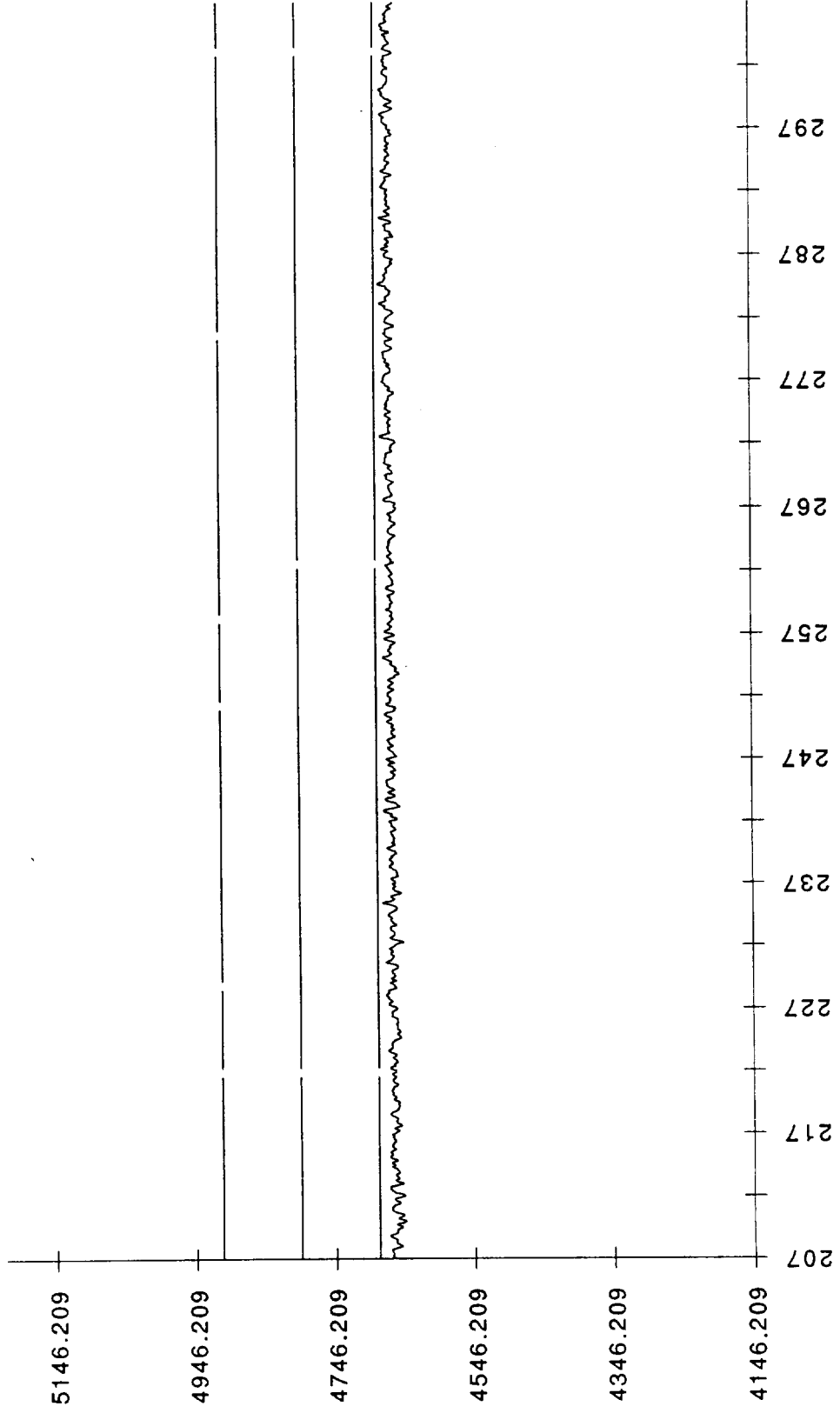

901-579 HPFP bal cav pr.T

901-579 HPFP bal cav pr.T

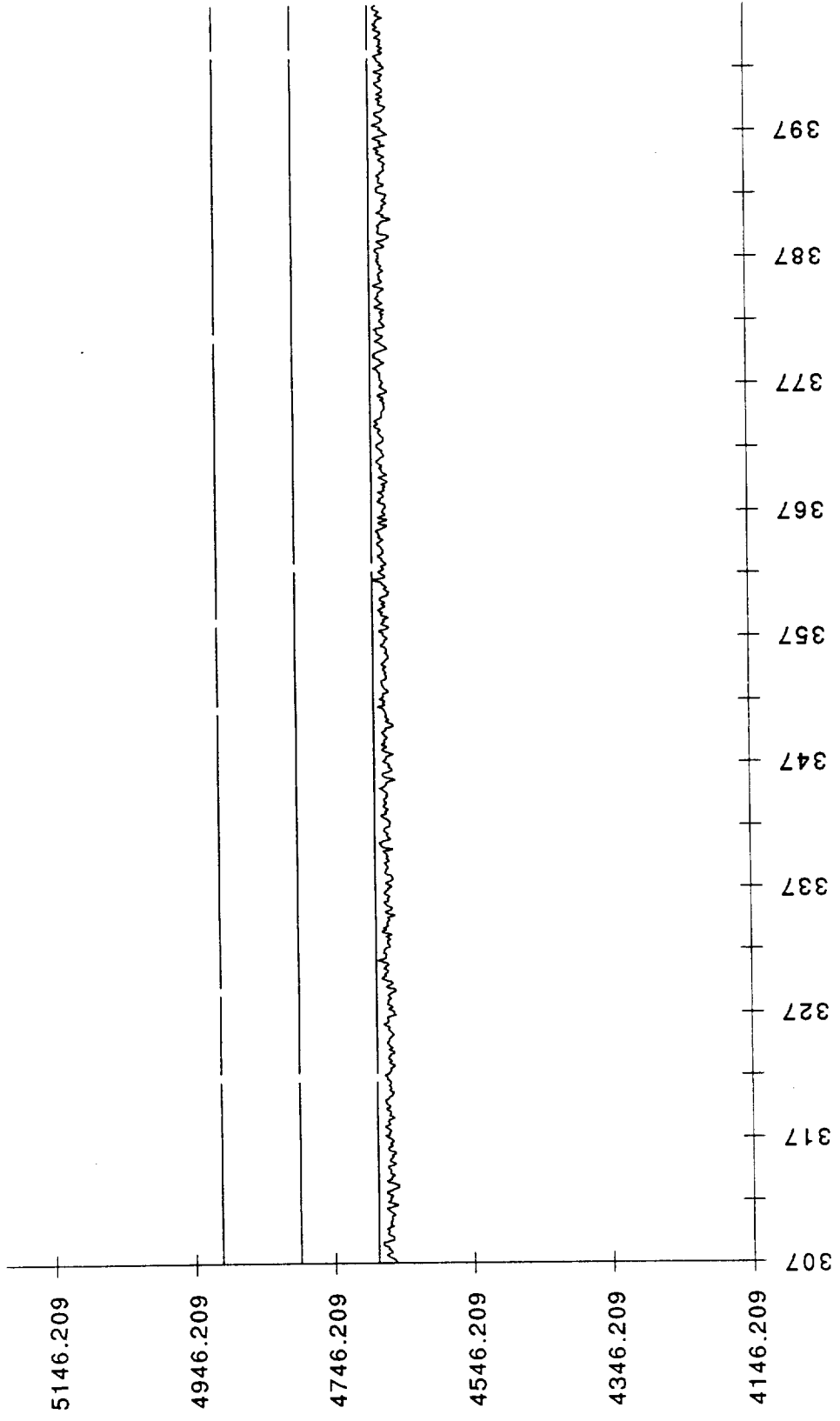

901-579 HPFP bal cav pr.T

901-579 HPFP bal cav pr.T

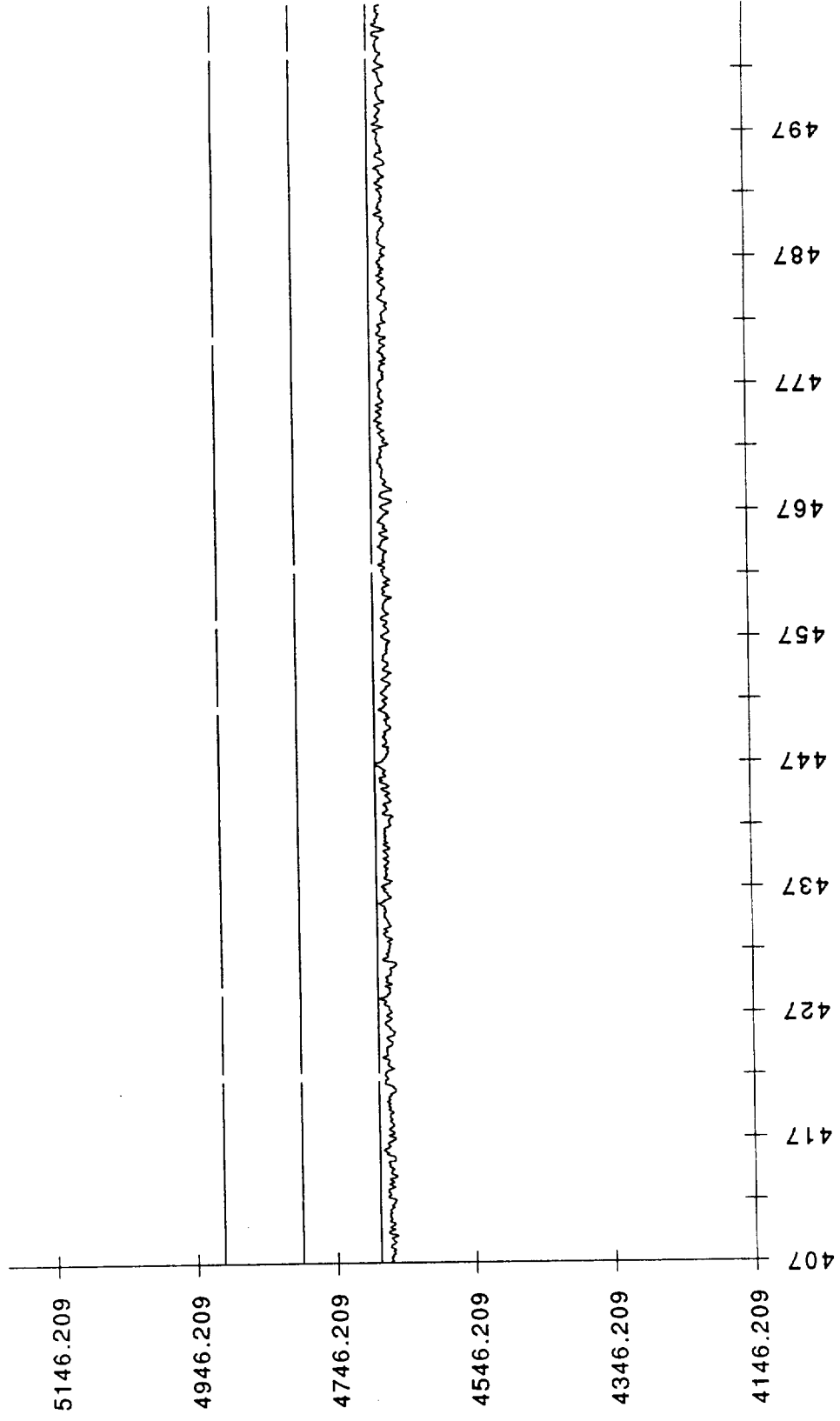

901-579 HPFP bal cav pr.T

901-579 HPFP bal cav pr.T

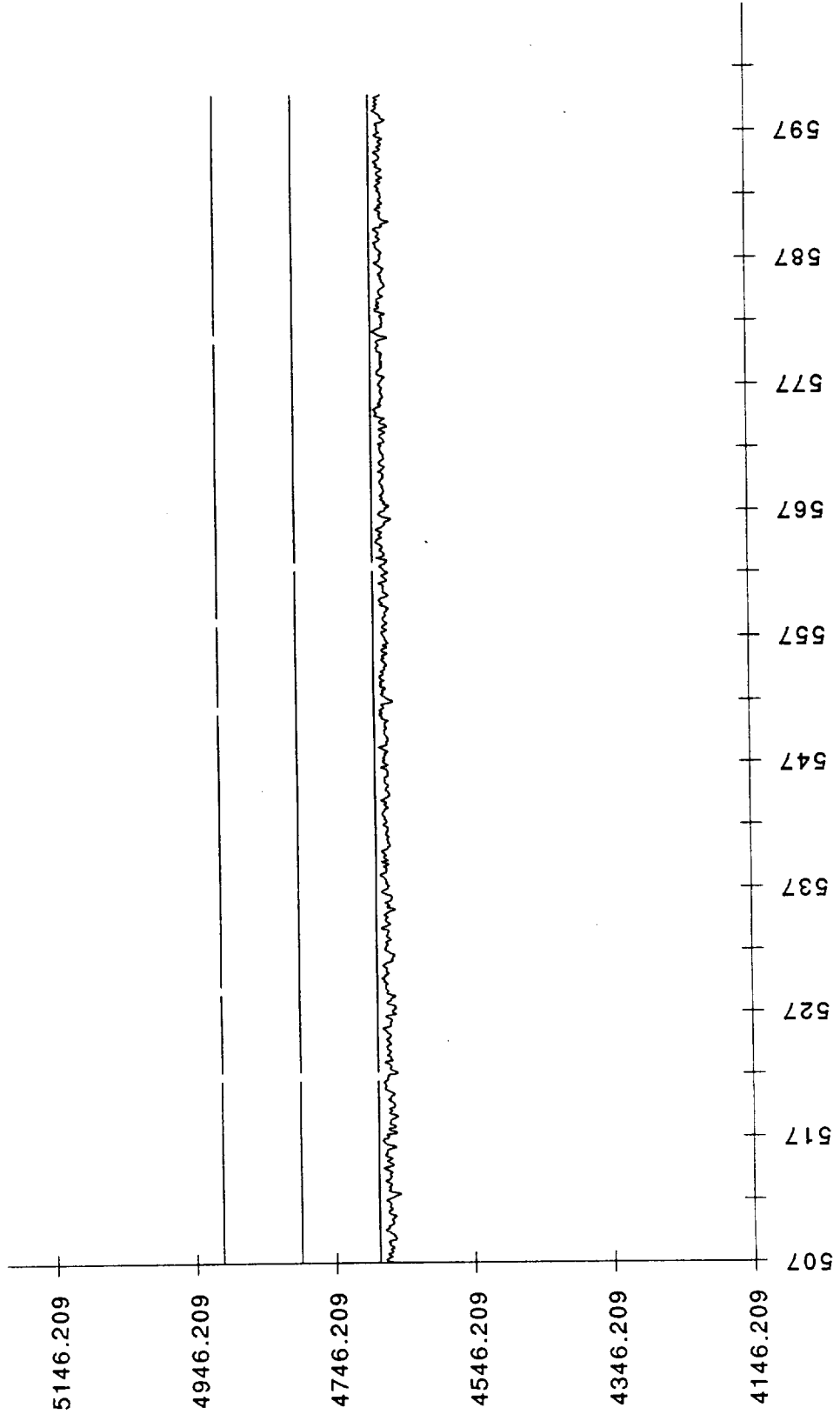

901-579 HPFP bal cav pr.T

901-579 HPFP sh sp.T

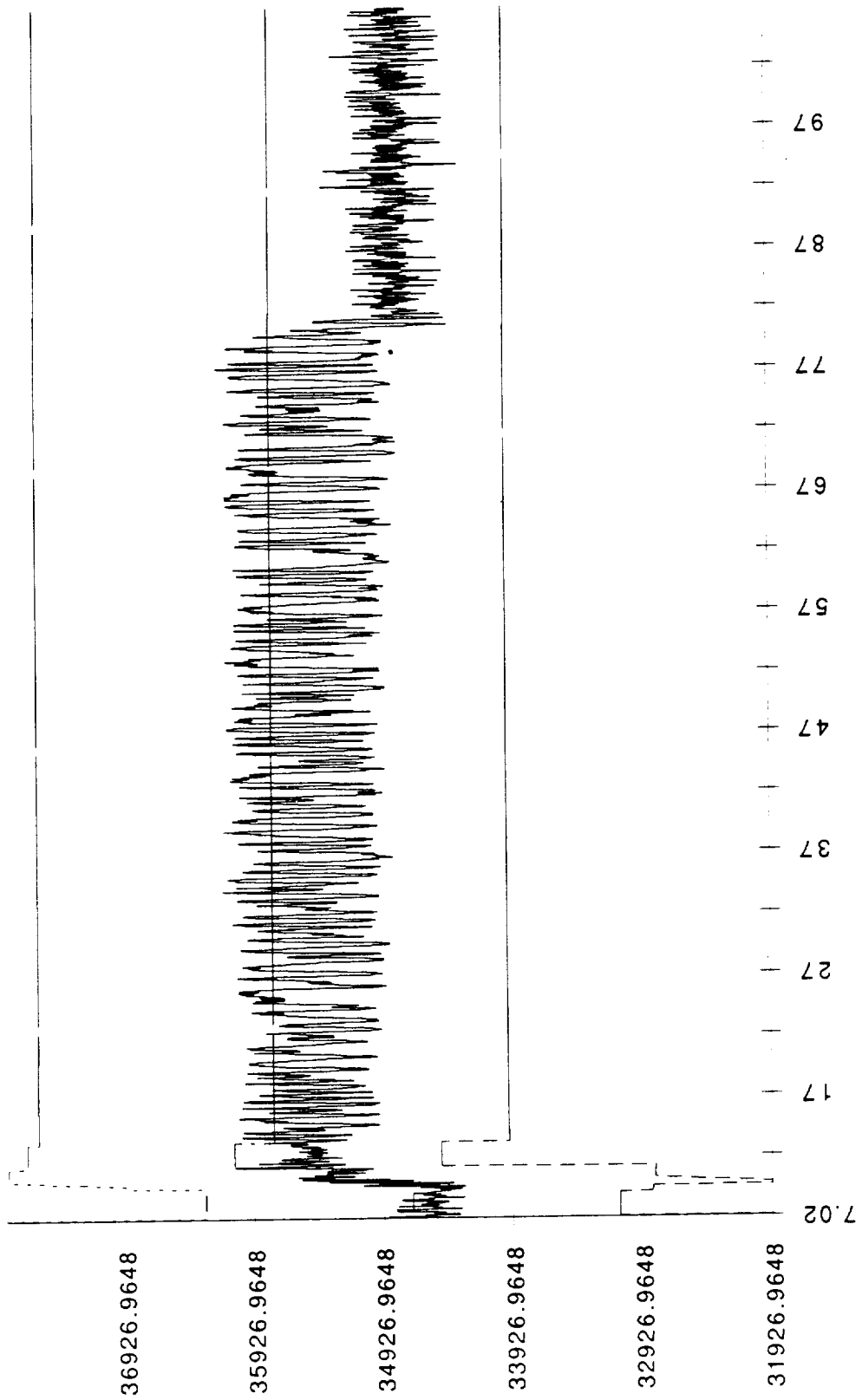

901-579 HPFP sh sp.T

901-579 HPFP sh sp.T

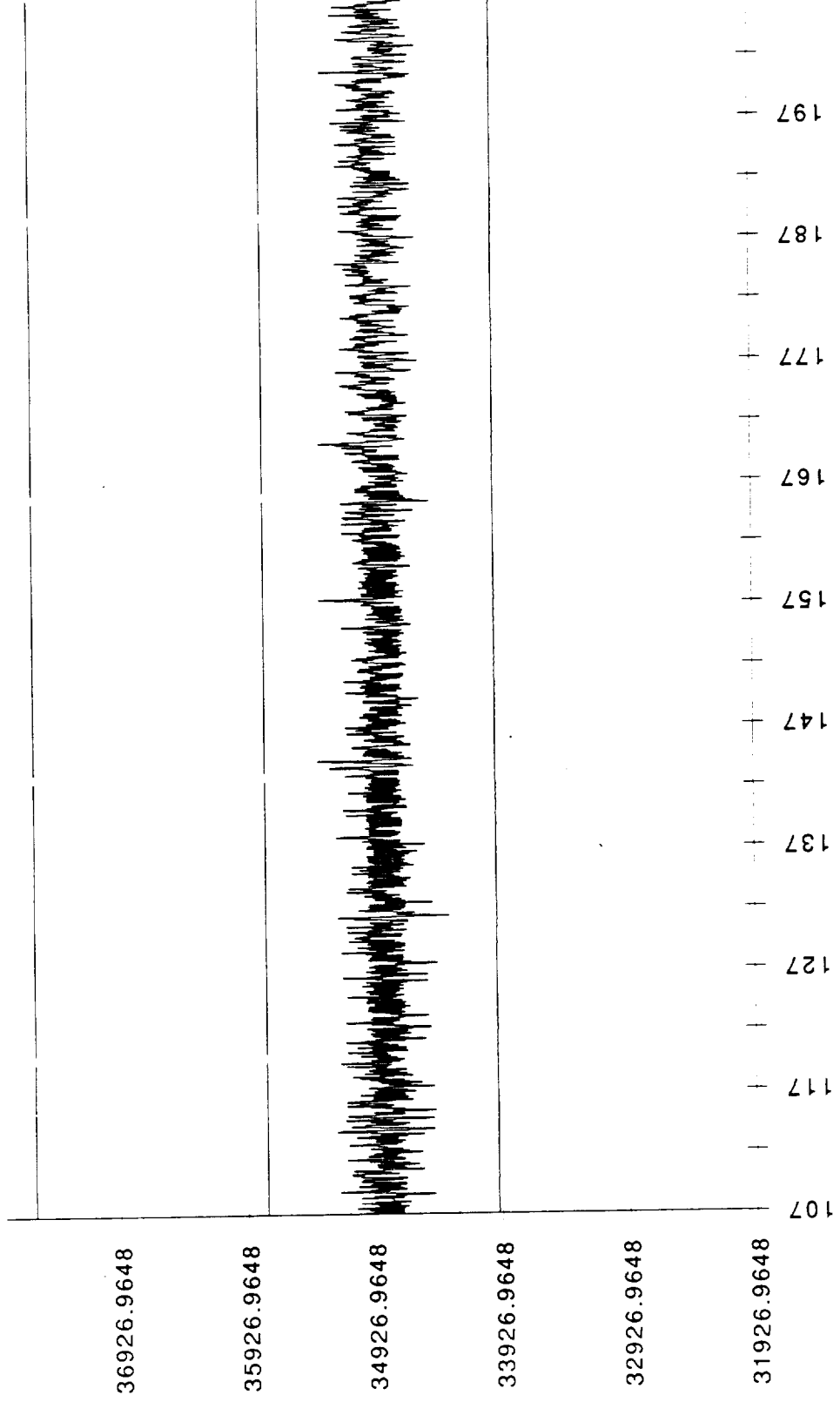

901-579 HPFP sh sp.T

901-579 HPFP sh sp.T

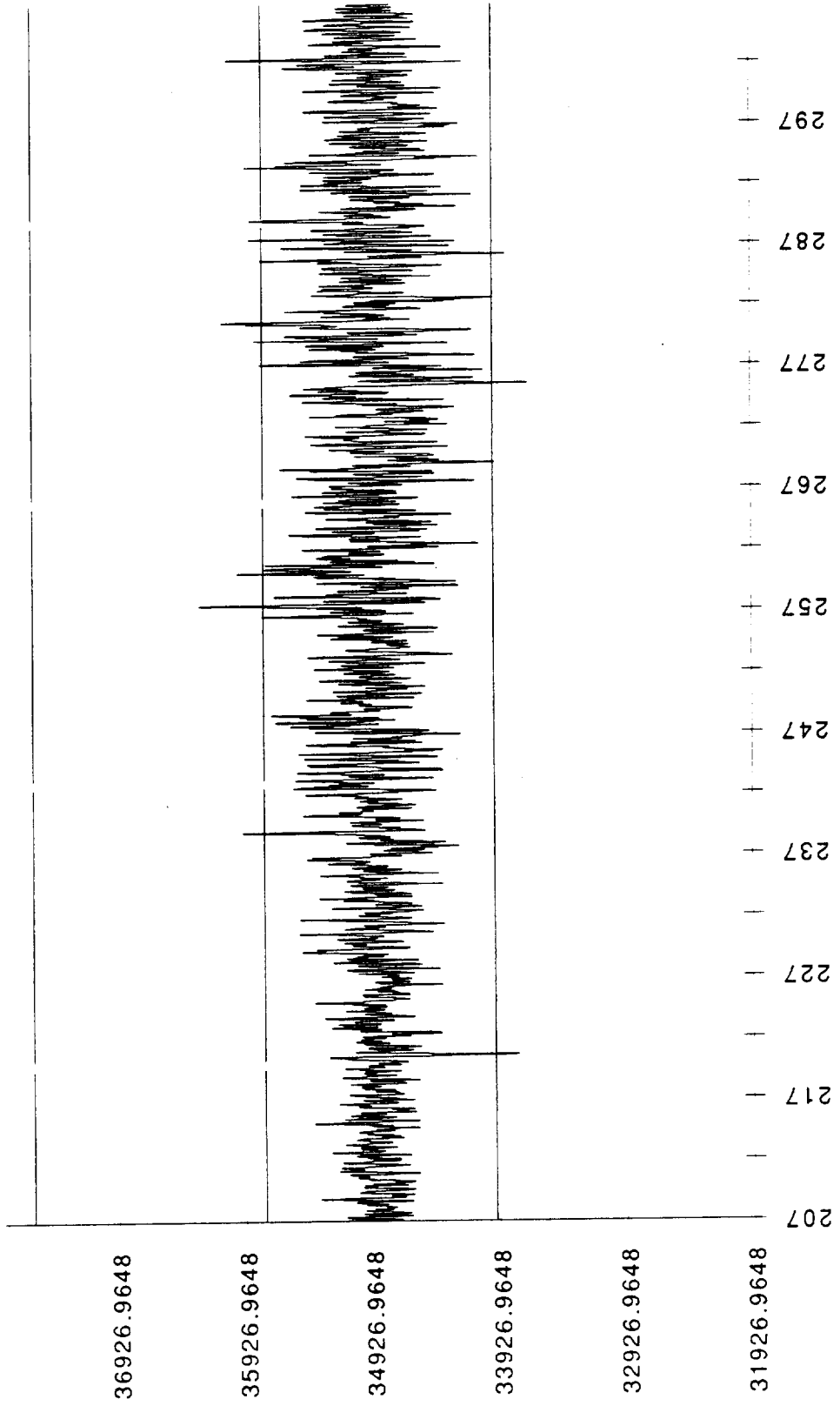

901-579 HPFP sh sp.T

901-579 HPFP sh sp.T

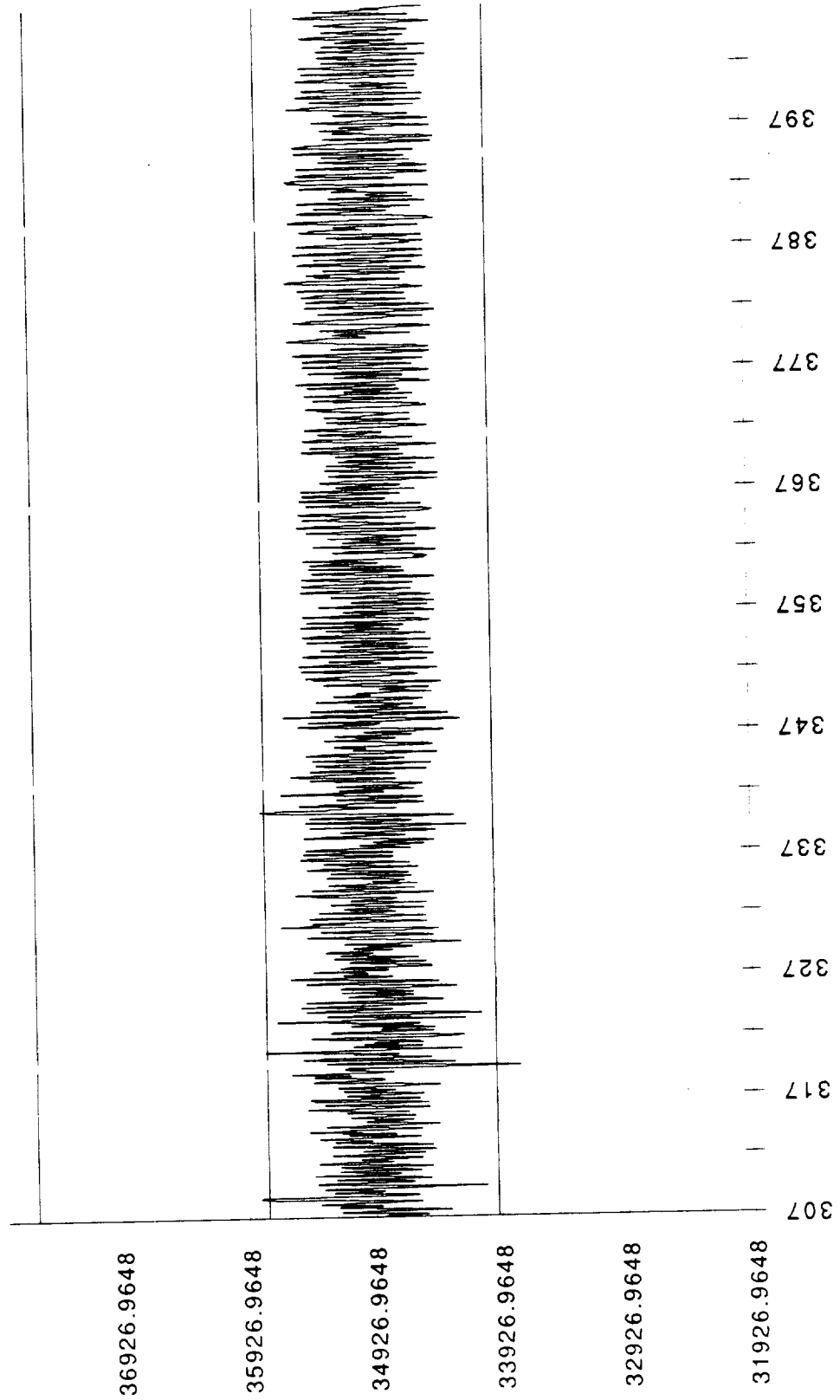

901-579 HPFP sh sp.T

901-579 HPFP sh sp.T

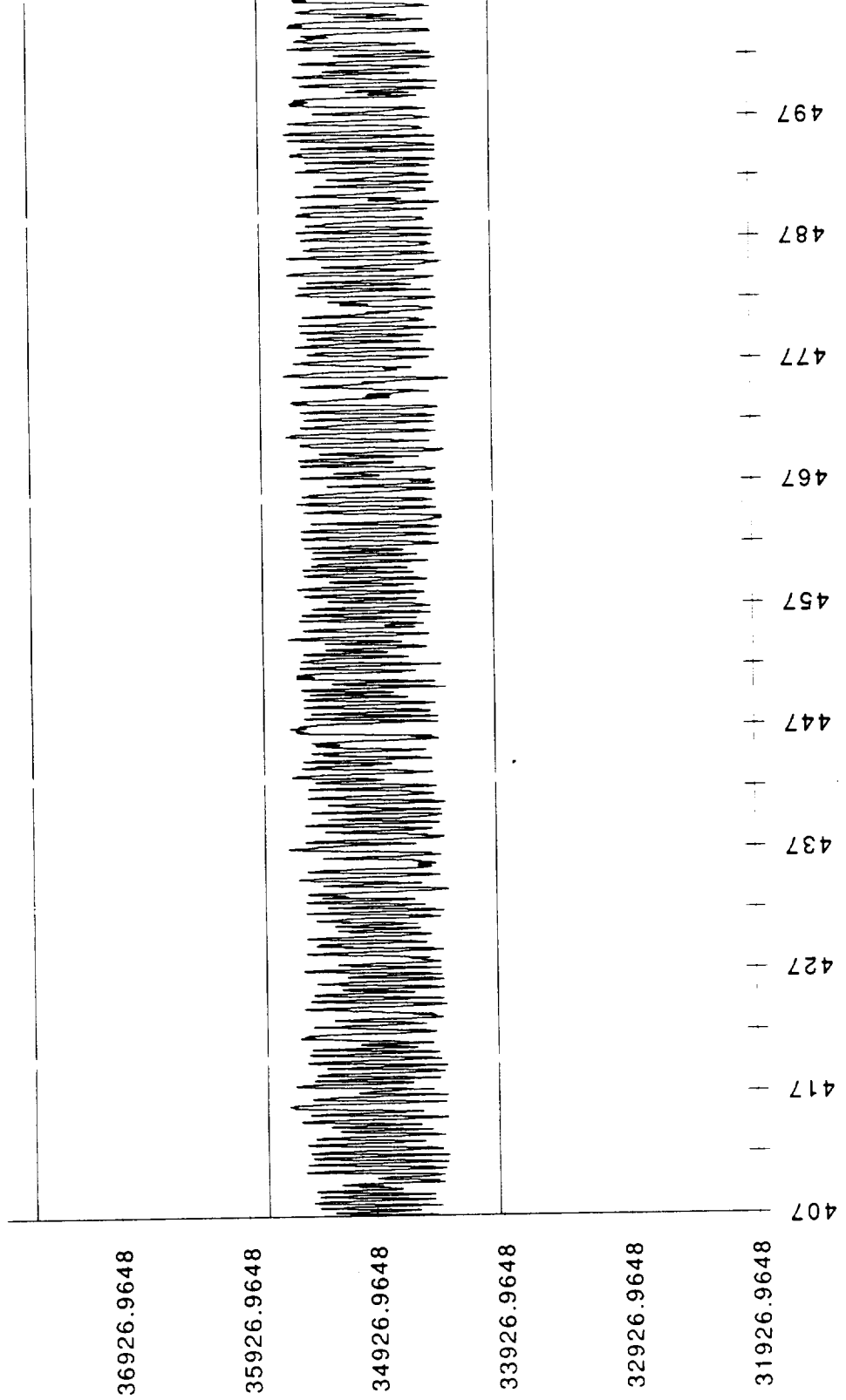

901-579 HPFP sh sp.T

901-579 HPFP sh sp.T

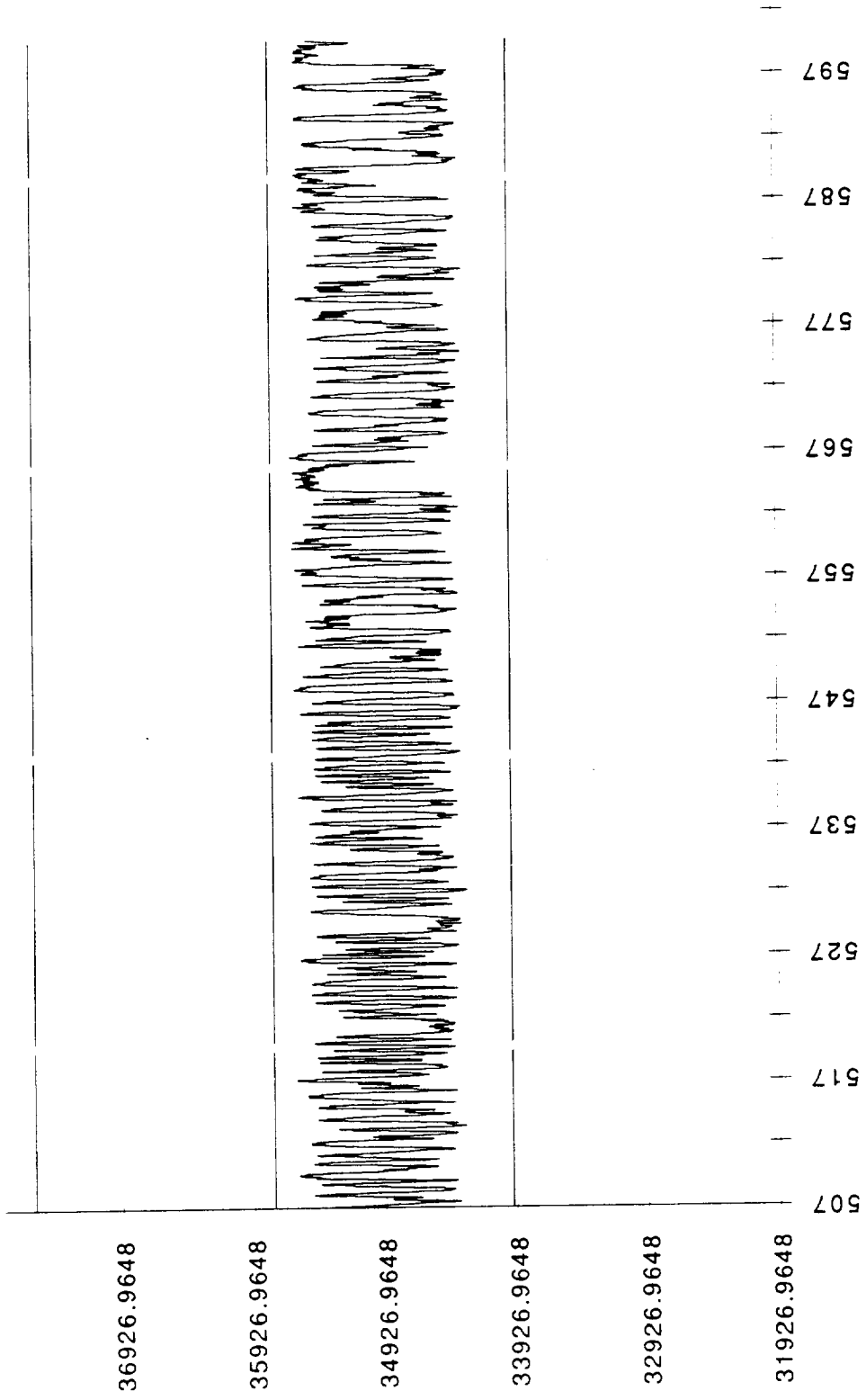

901-579 HPFP sh sp.T

901-579 HPOP dis pr.T

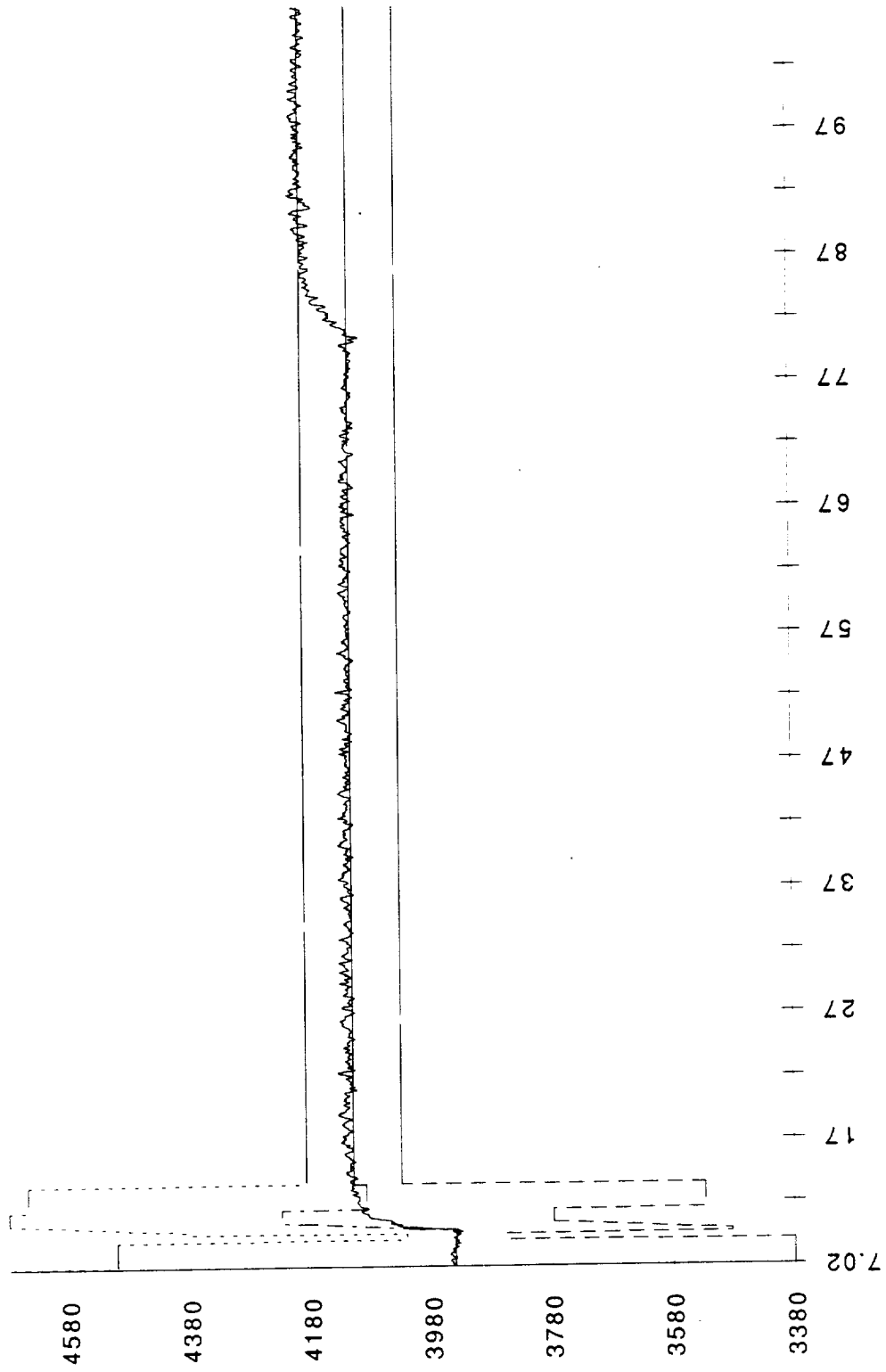

901-579 HPOP dis pr.T

901-579 HPOP dis pr.T

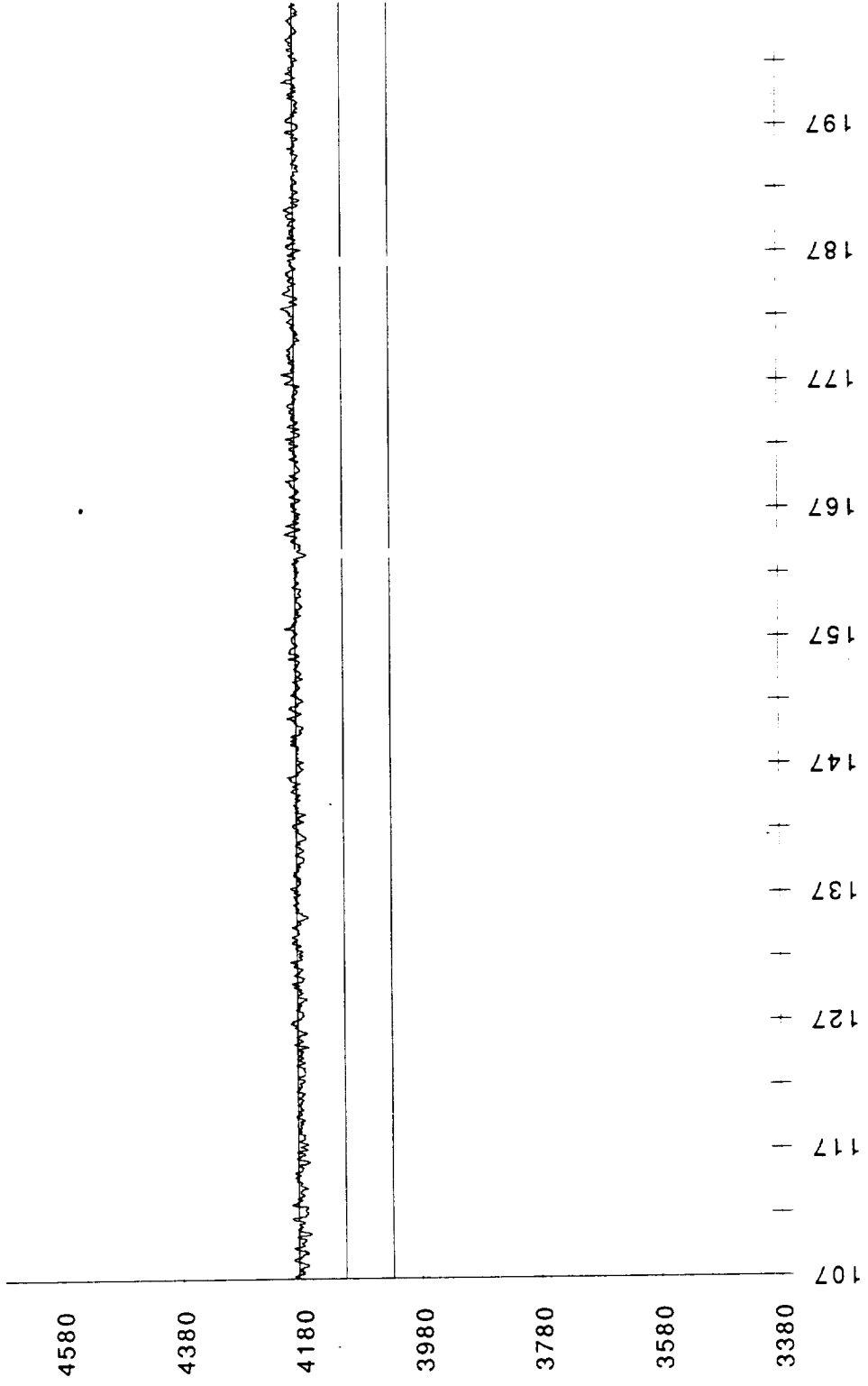

901-579 HPOP dis pr.T

901-579 HPOP dis pr.T

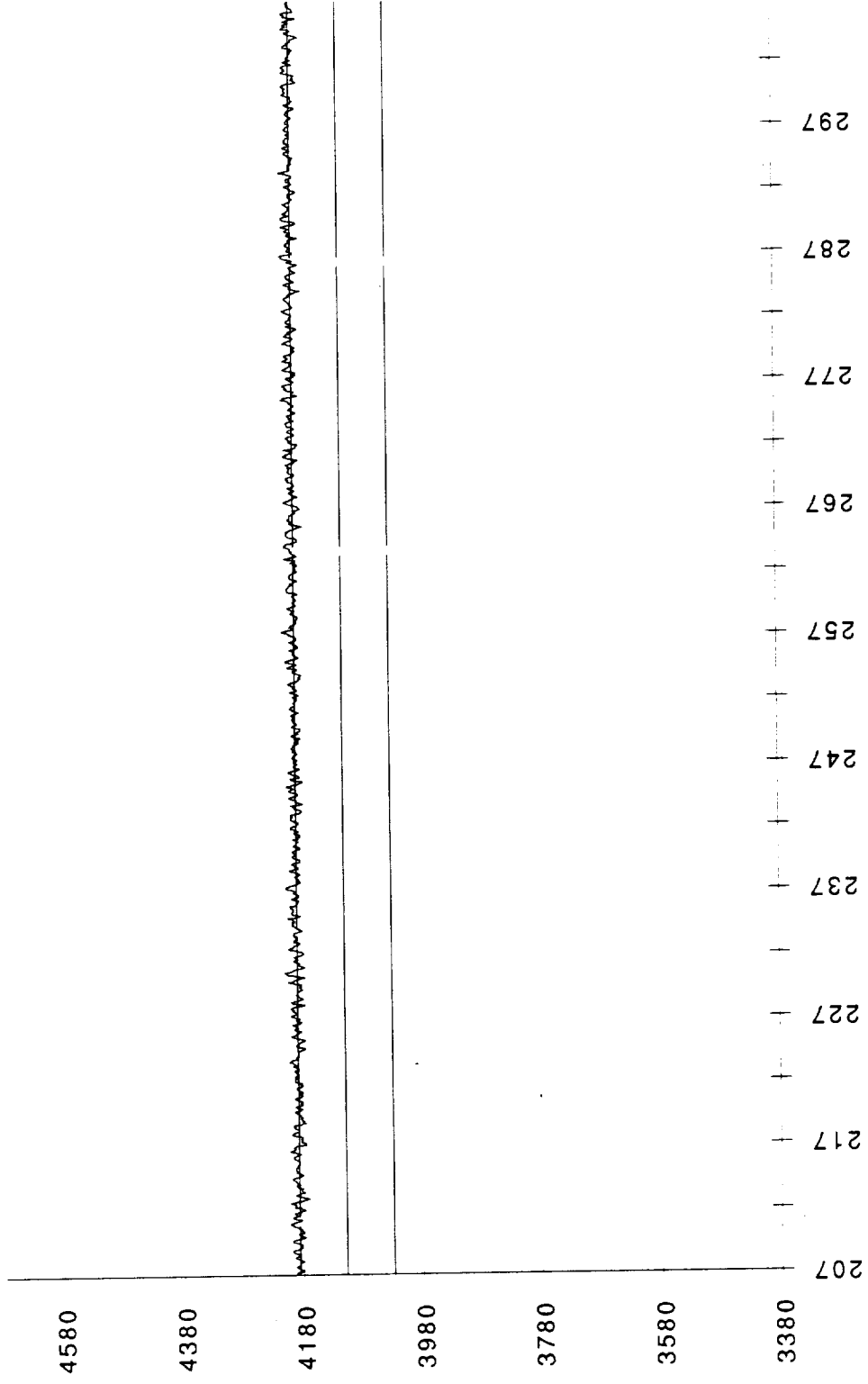

901-579 HPOP dis pr.T

901-579 HPOP dis pr.T

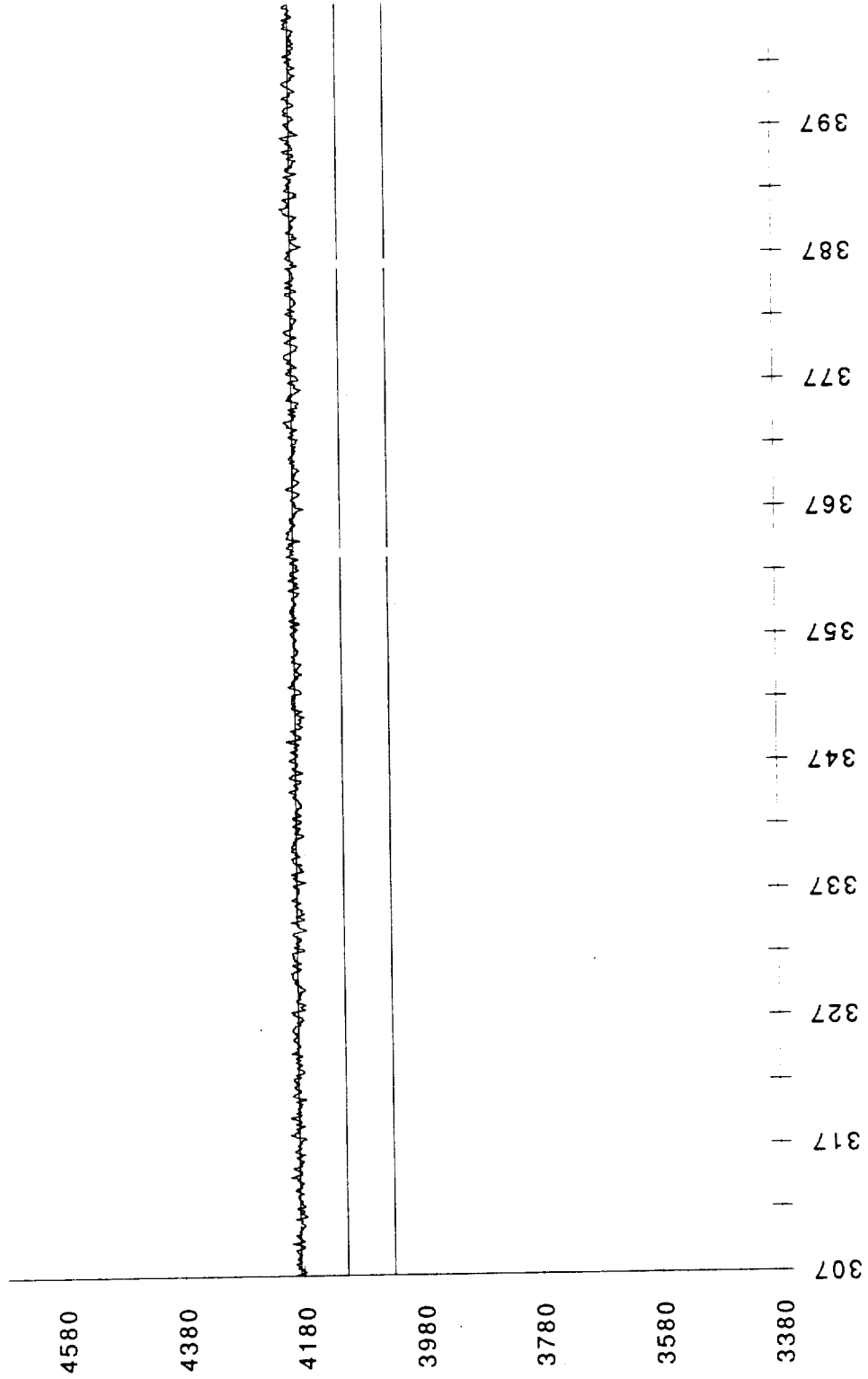

901-579 HPOP dis pr.T

901-579 HPOP dis pr.T

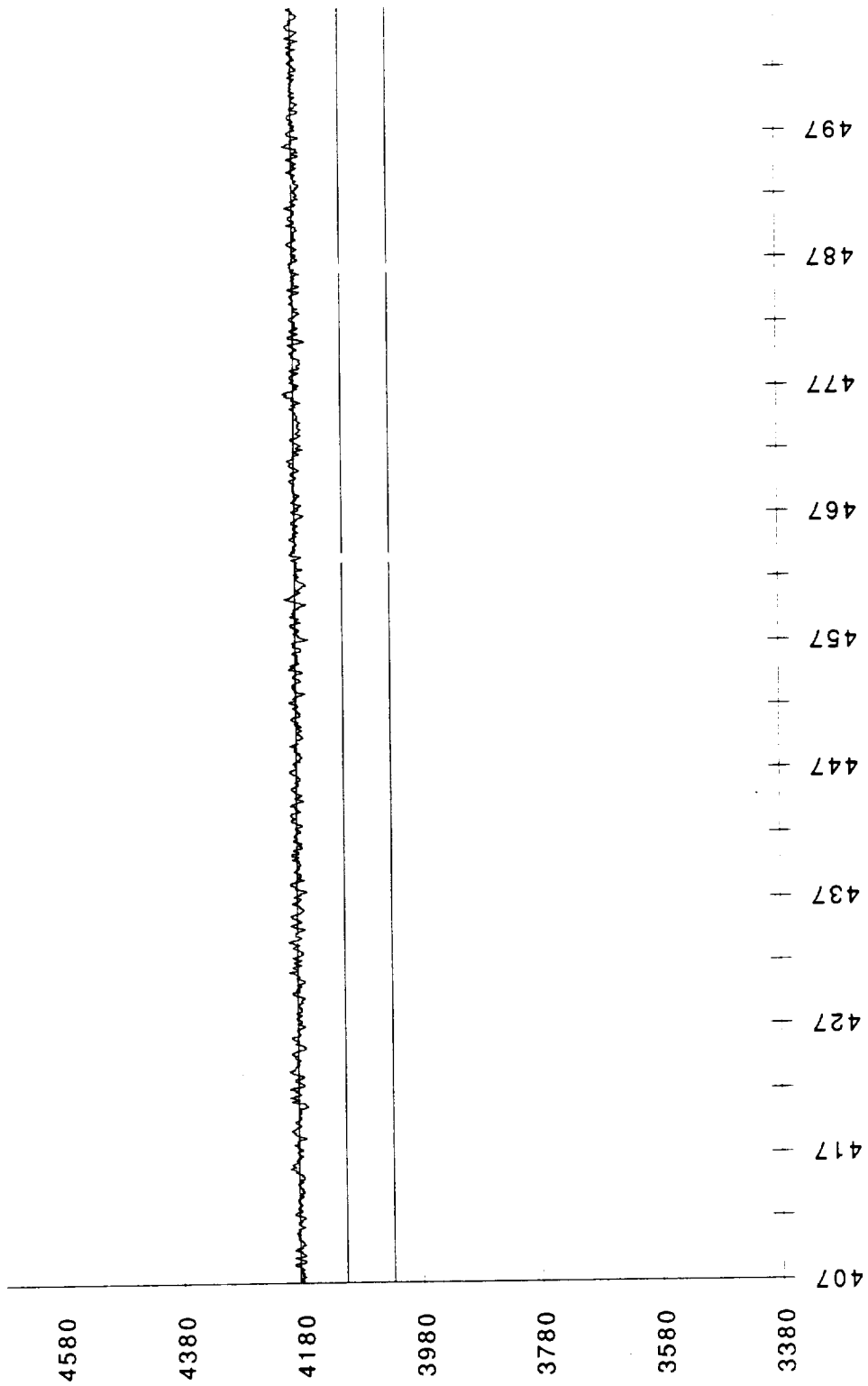

901-579 HPOP dis pr.T

901-579 HPOP dis pr.T

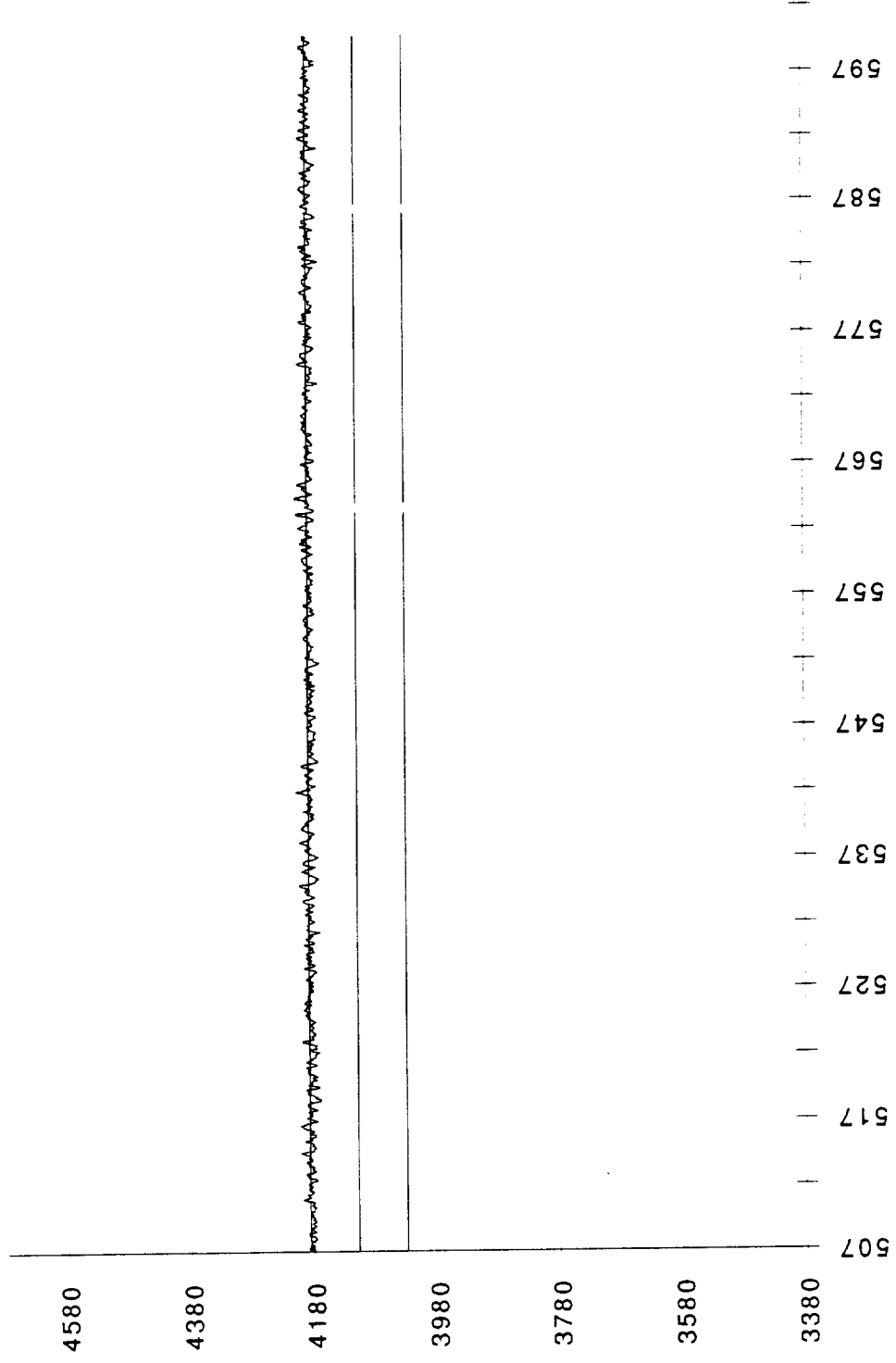

901-579 HPOP dis pr.T

901-655 HPFP accel.T

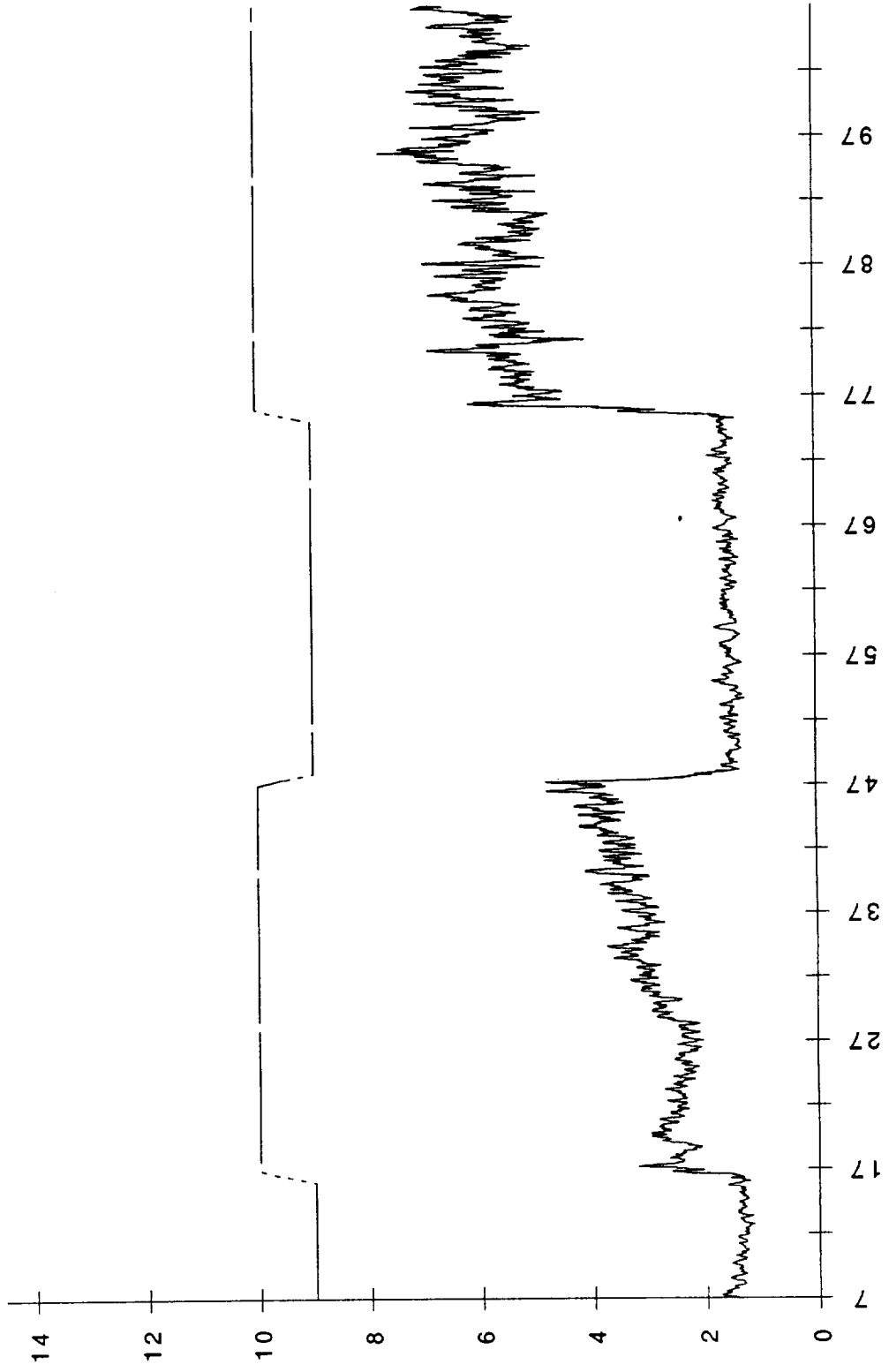

901-655 HPFP accel.T

901-655 HPFP accel.T

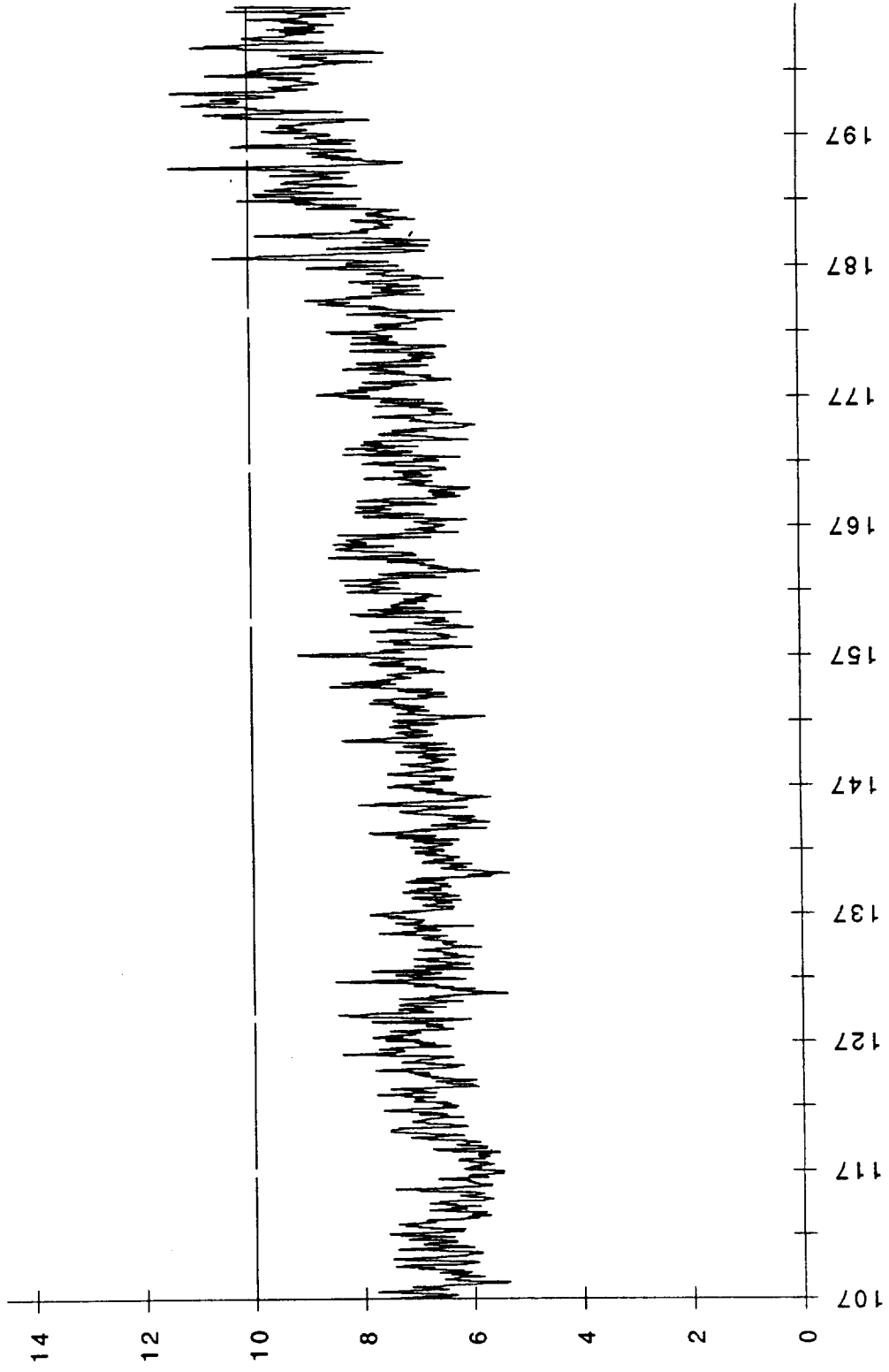

901-655 HPFP accel.T

901-655 HPFP accel.T

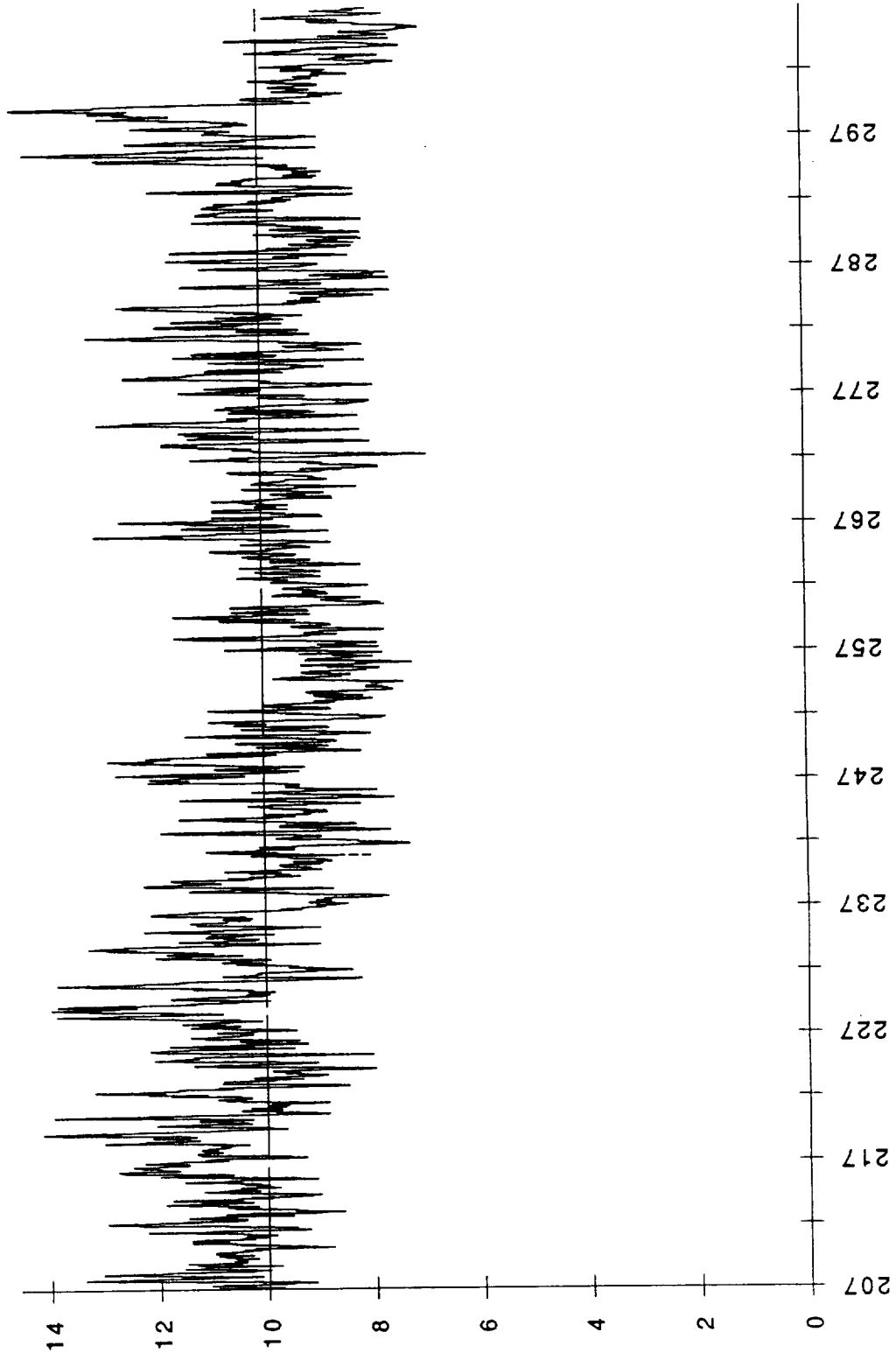

901-655 HPFP accel.T

901-655 HPFP accel.T

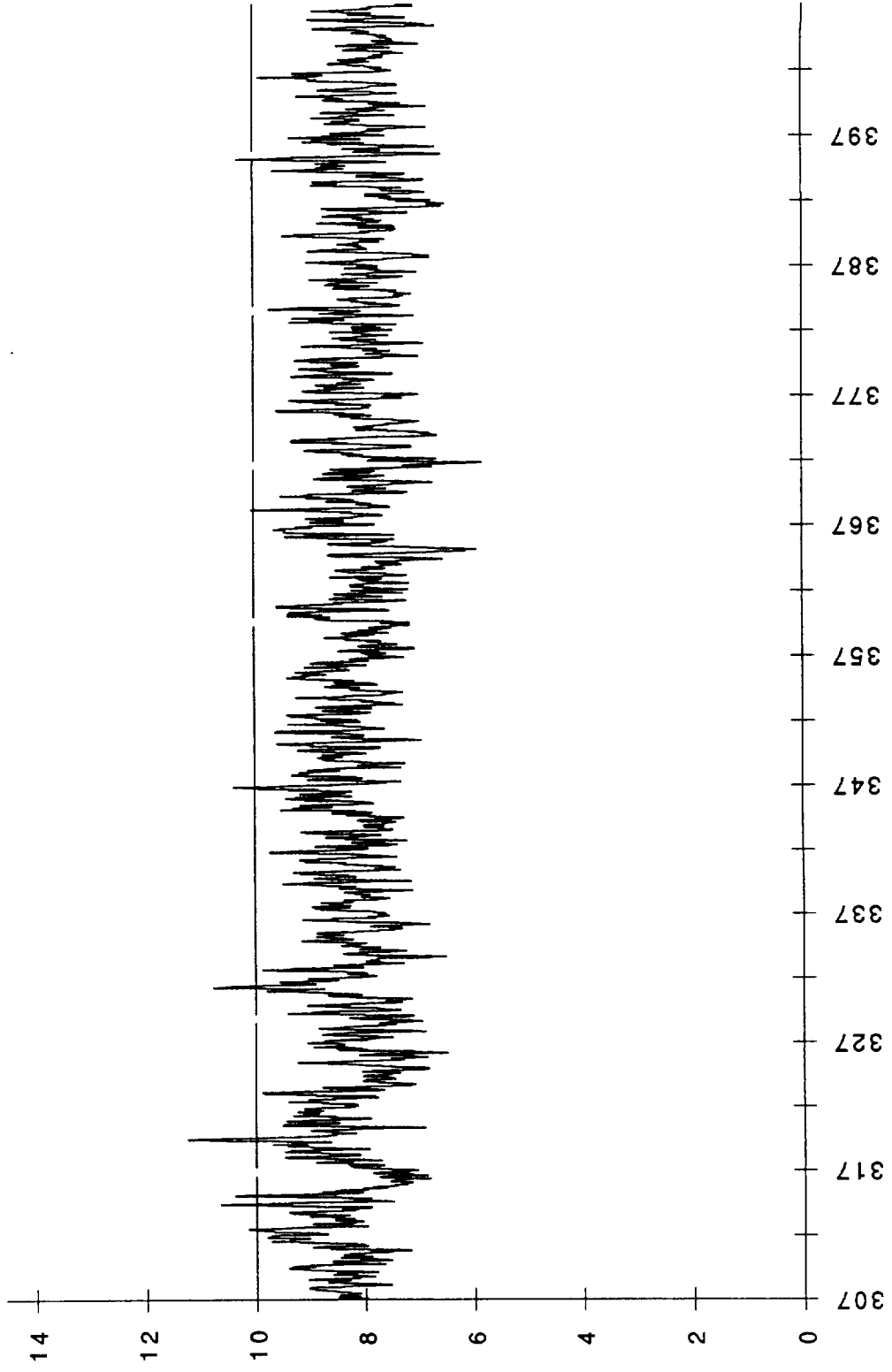

901-655 HPFP accel.T

901-655 HPFP accel.T

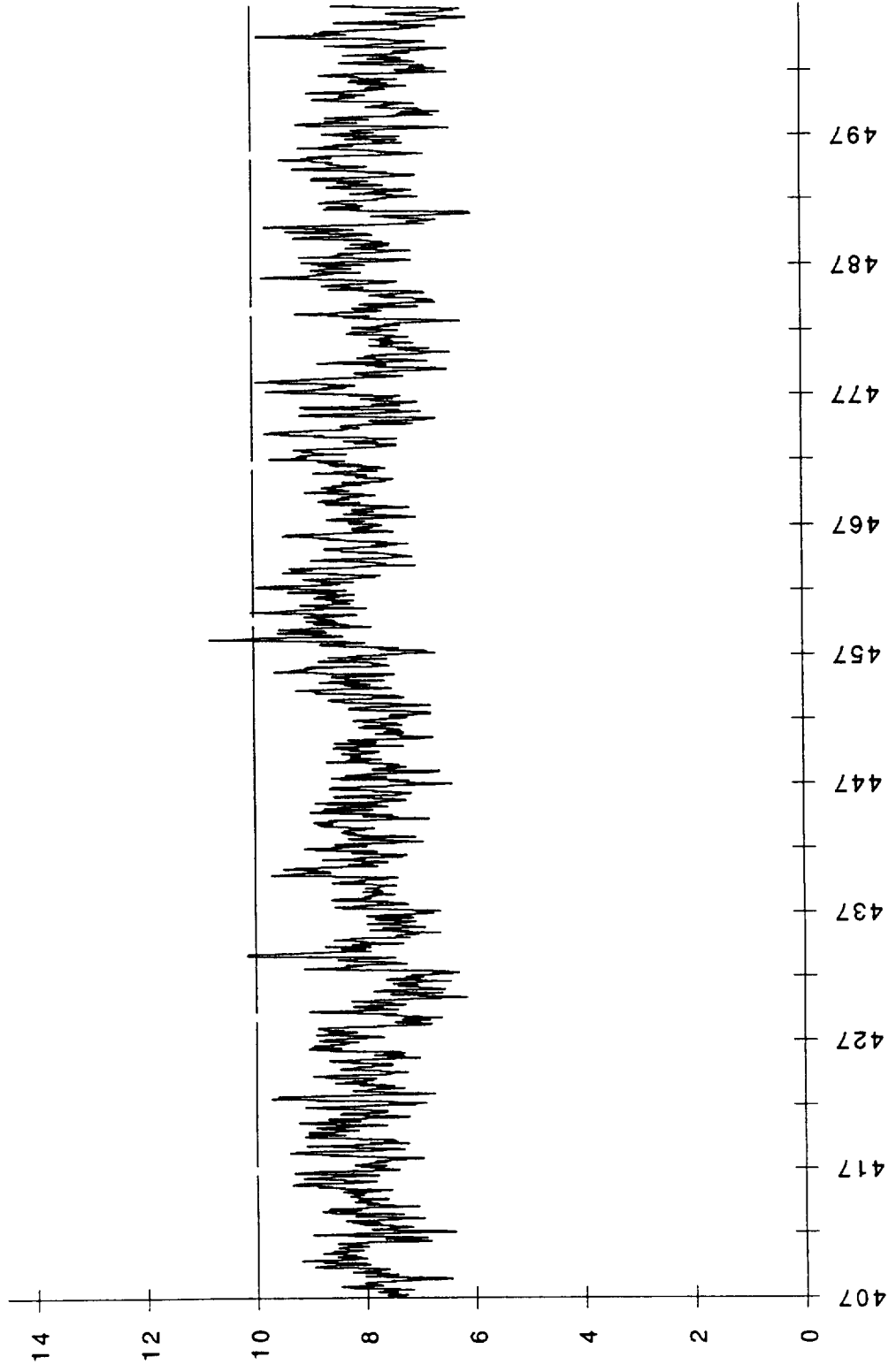

901-655 HPFP accel.T

901-655 HPFP accel.T

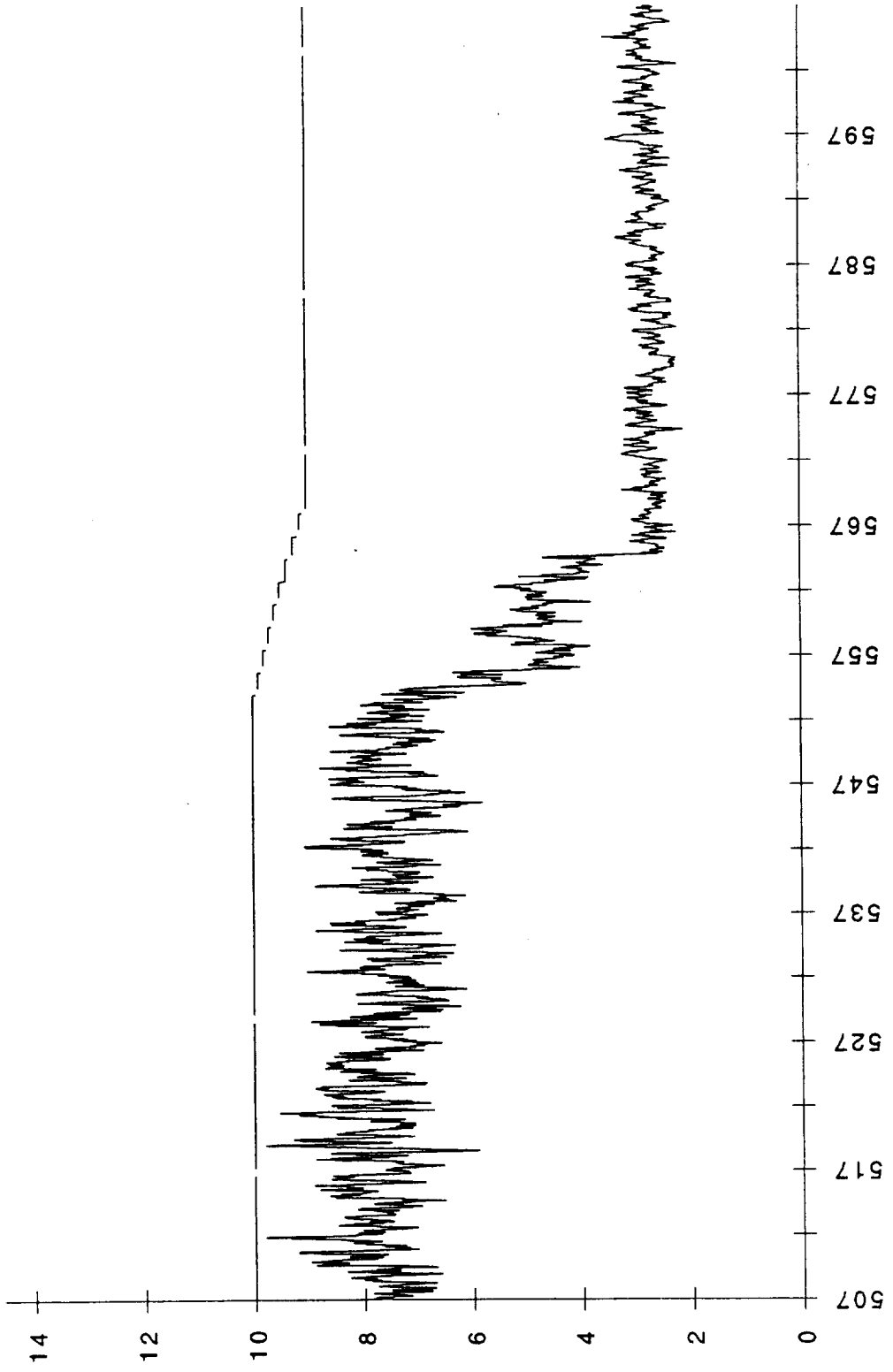

901-655 HPFP accel.T

902-248 HPFP CL pr.T

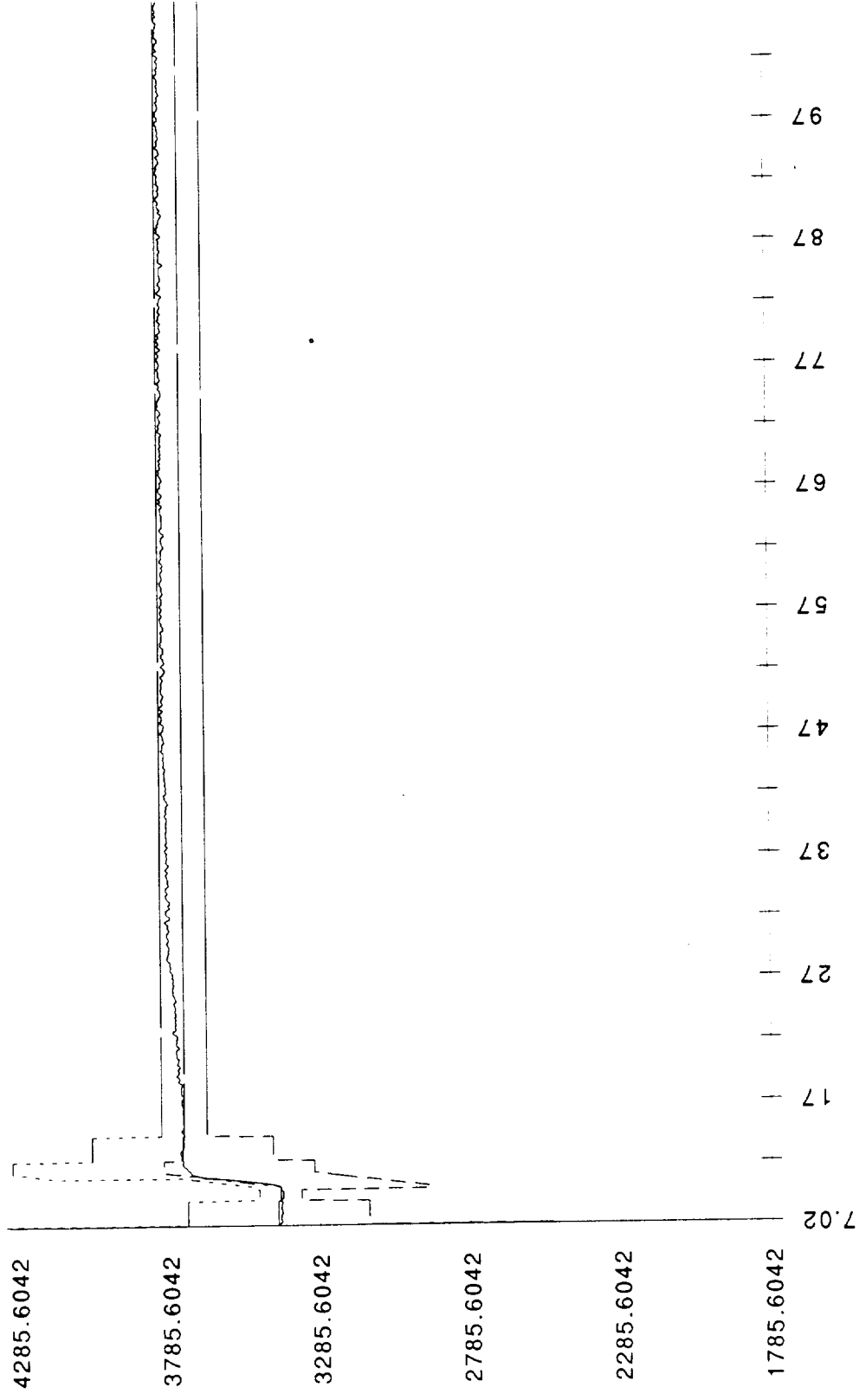

902-248 HPFP CL pr.T

902-248 HPFP CL pr.T

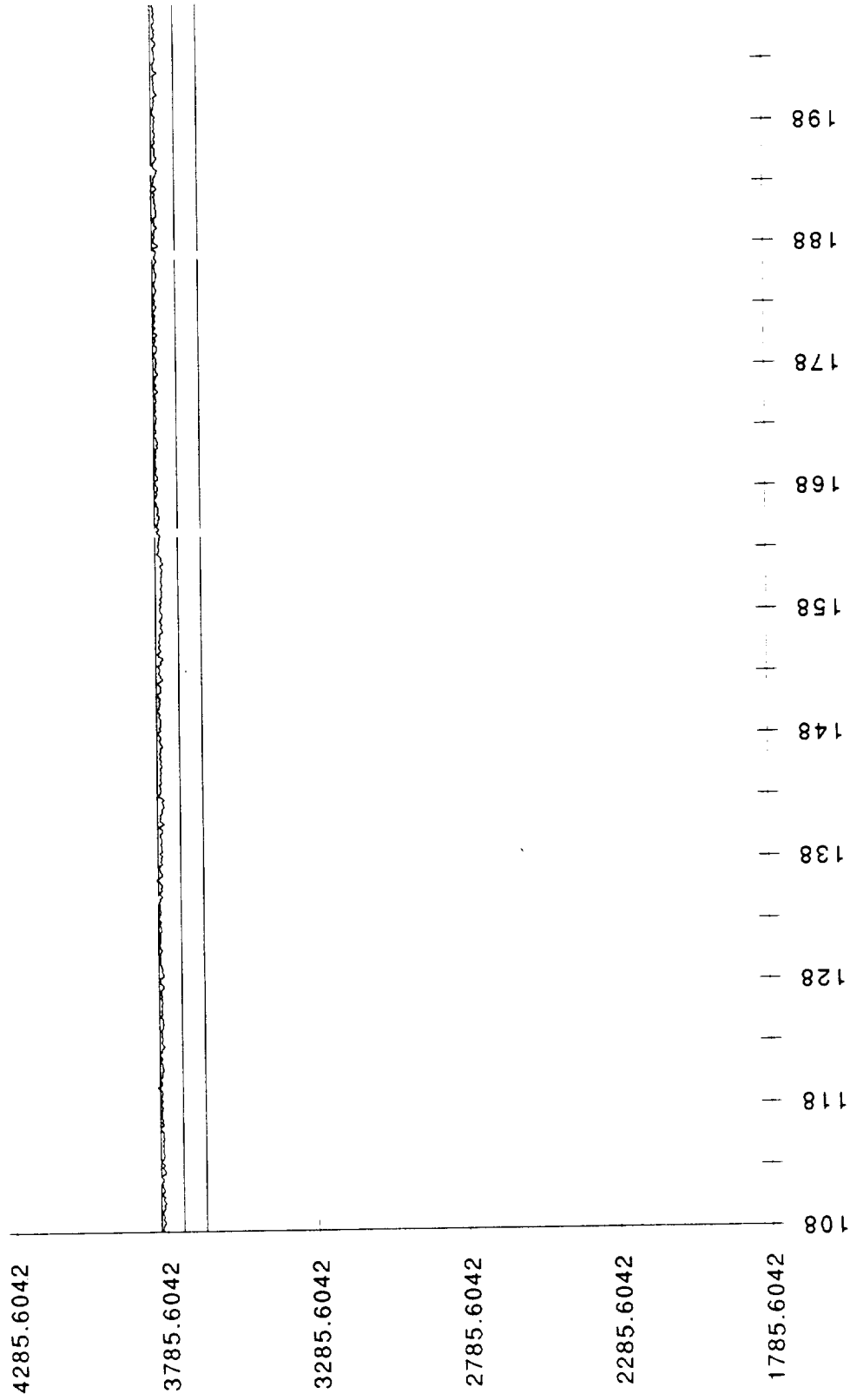

902-248 HPFP CL pr.T

902-248 HPFP CL pr.T

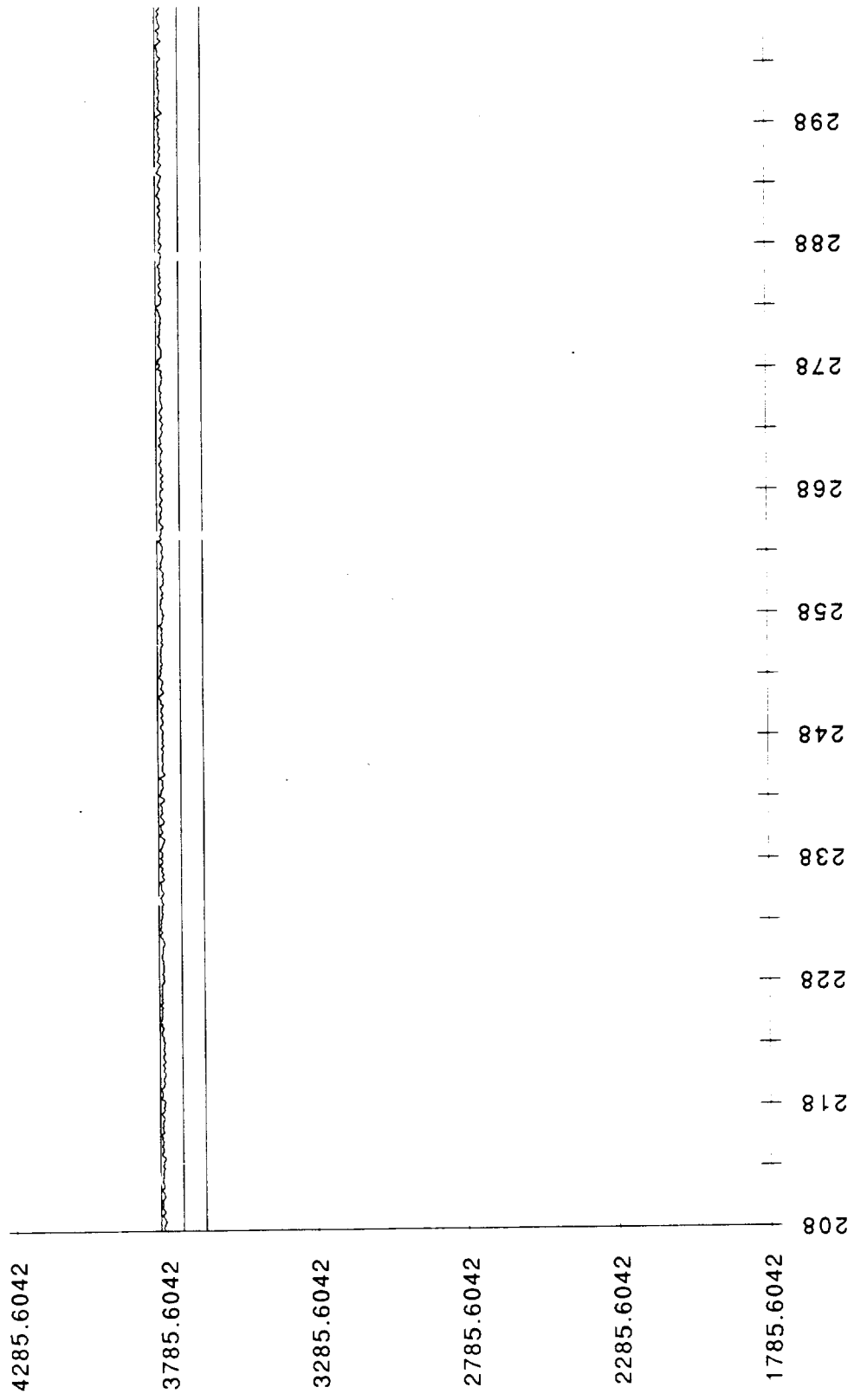

902-248 HPFP CL pr.T

902-248 HPFP CL pr.T

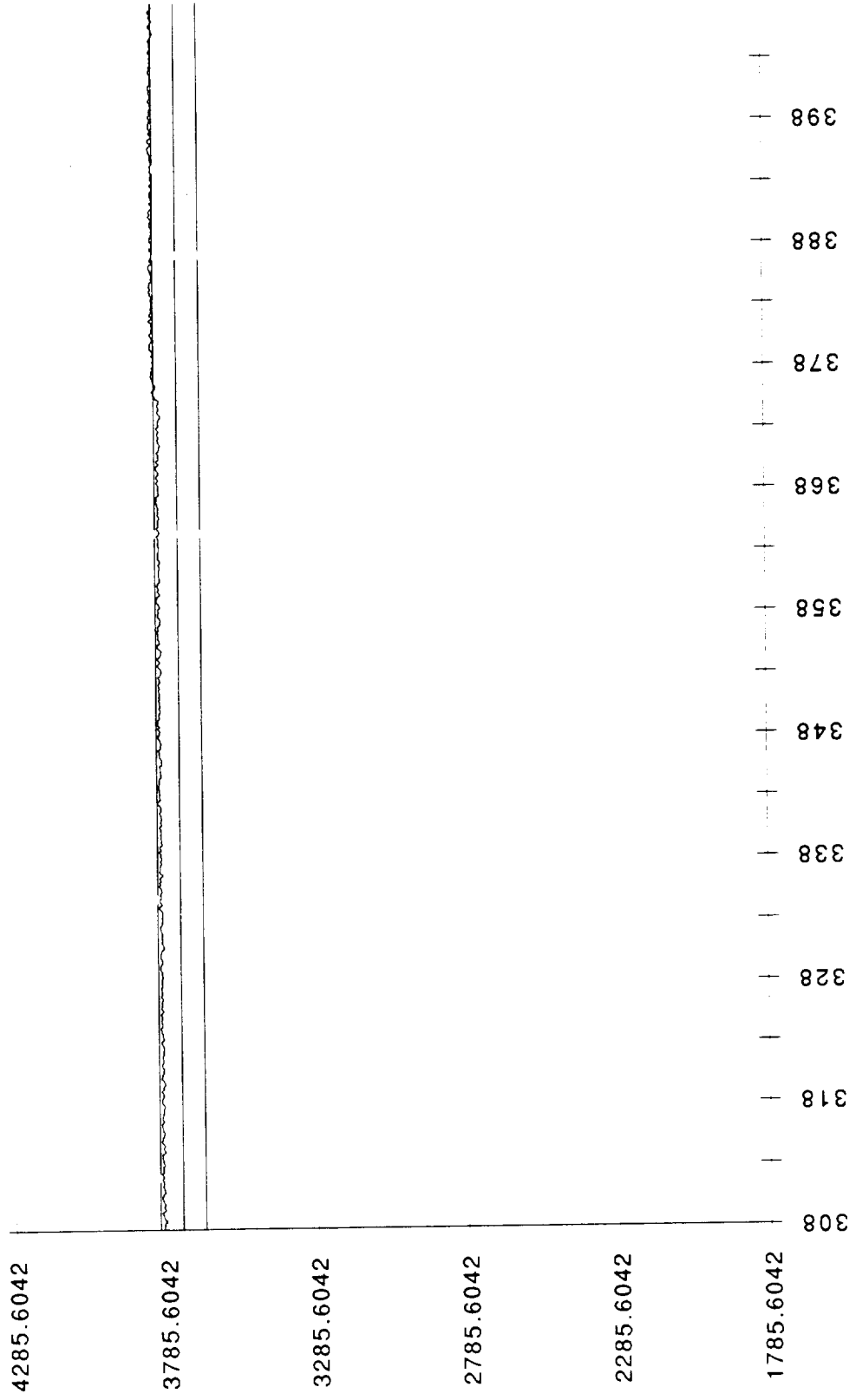

902-248 HPFP CL pr.T

902-248 HPFP CL pr.T

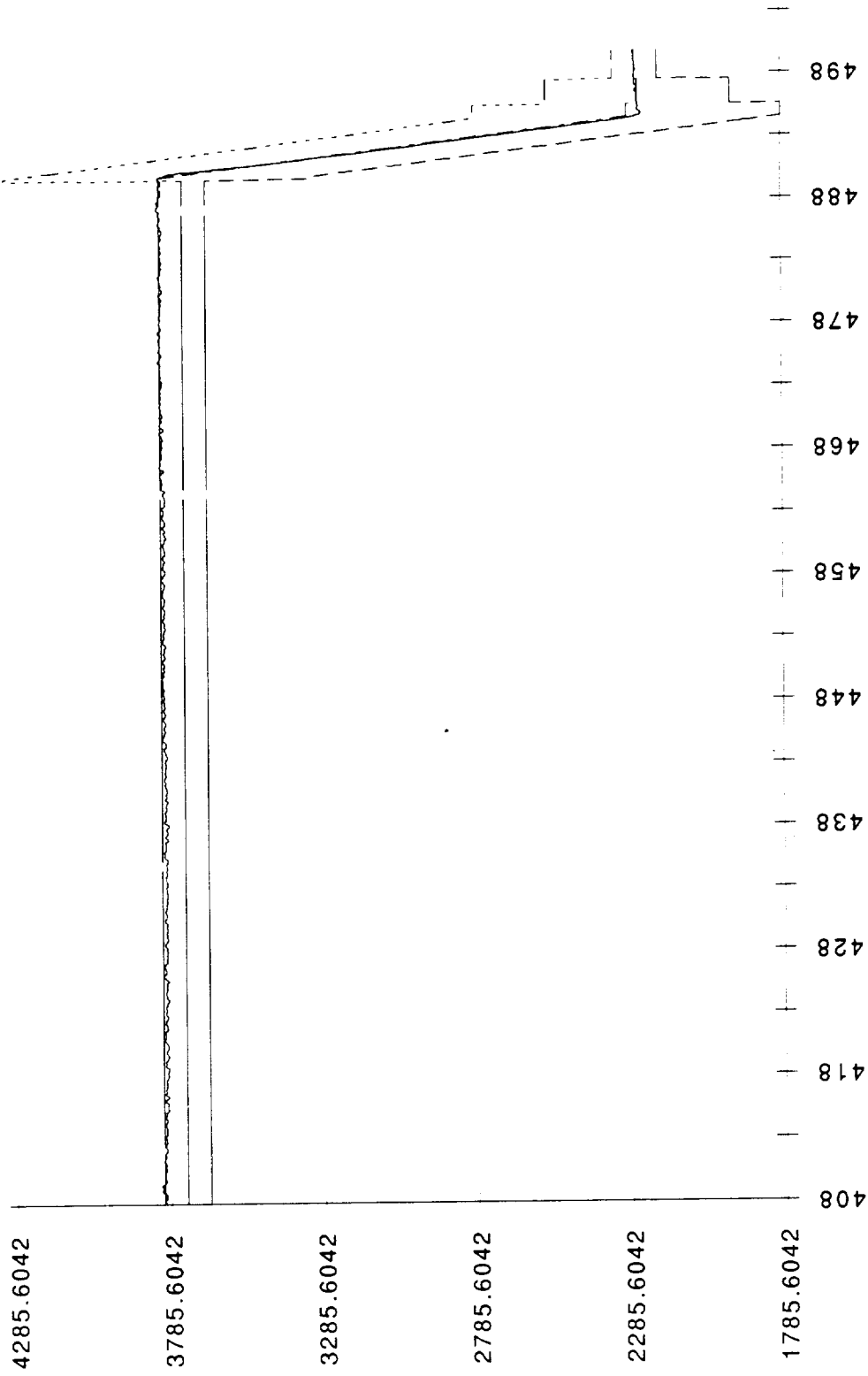

902-248 HPFP CL pr.T

902-248 HPOP IMSL pr.T

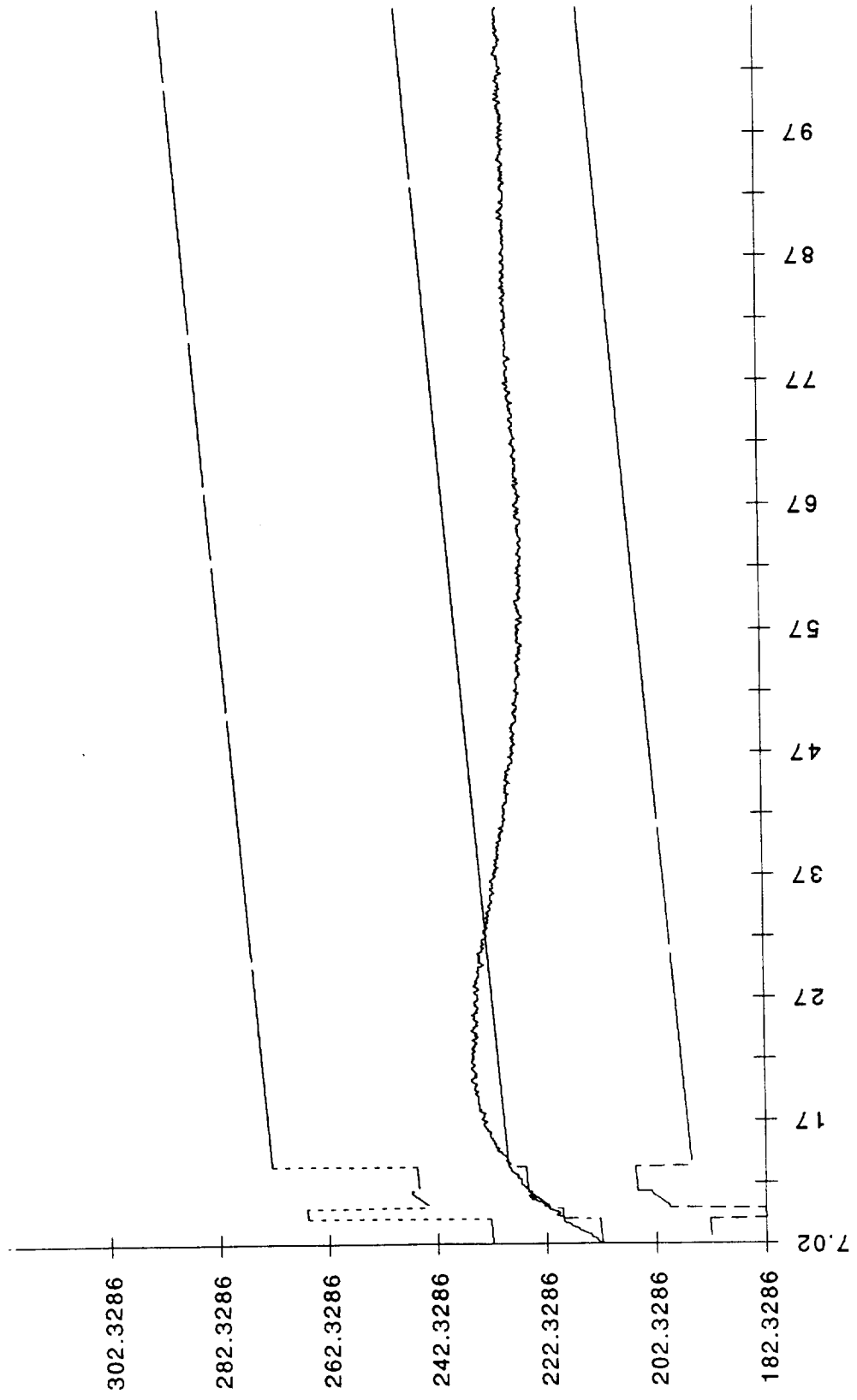

902-248 HPOP IMSL pr.T

902-248 HPOP IMSL pr.T

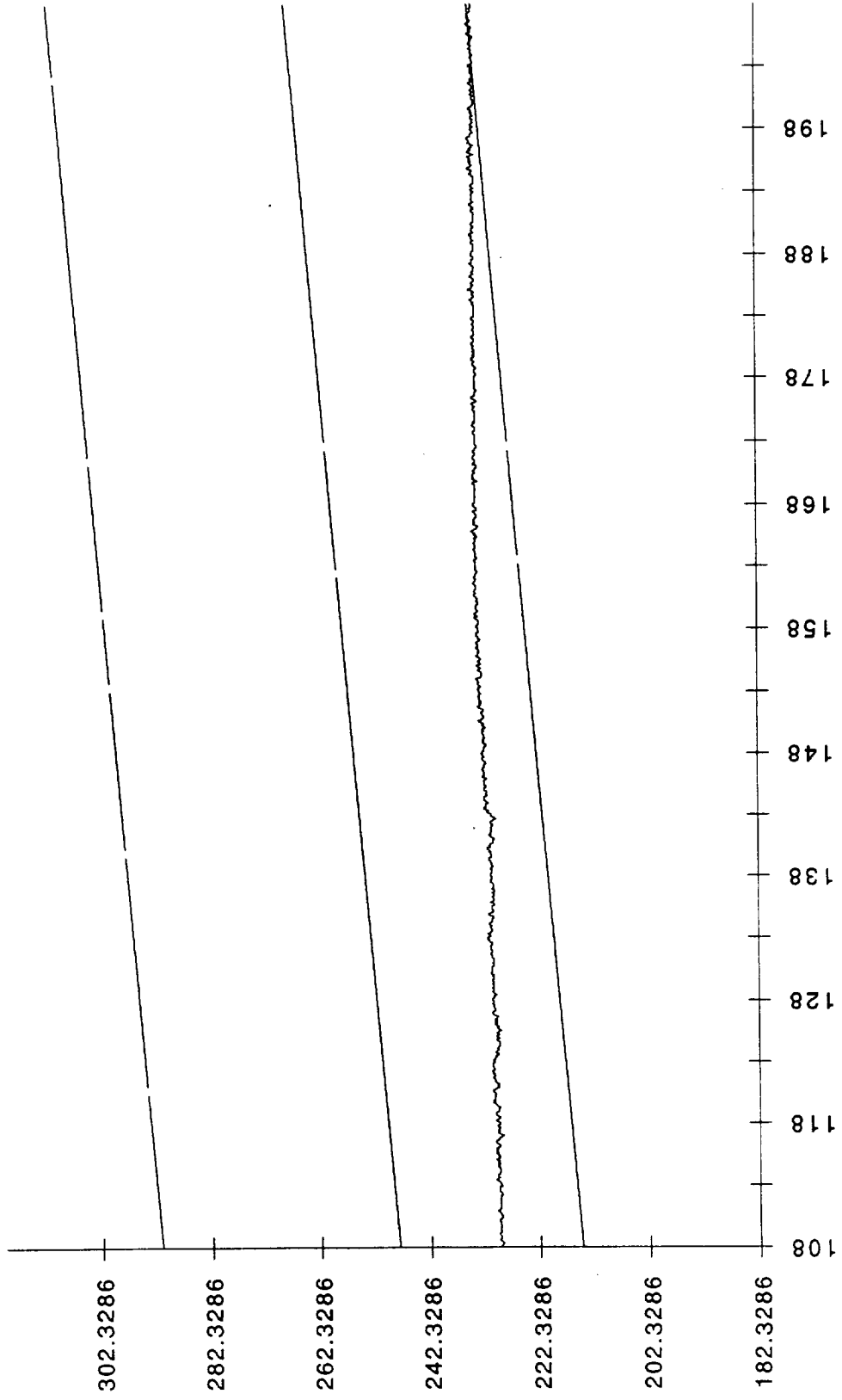

902-248 HPOP IMSL pr.T

902-248 HPOP IMSL pr.T

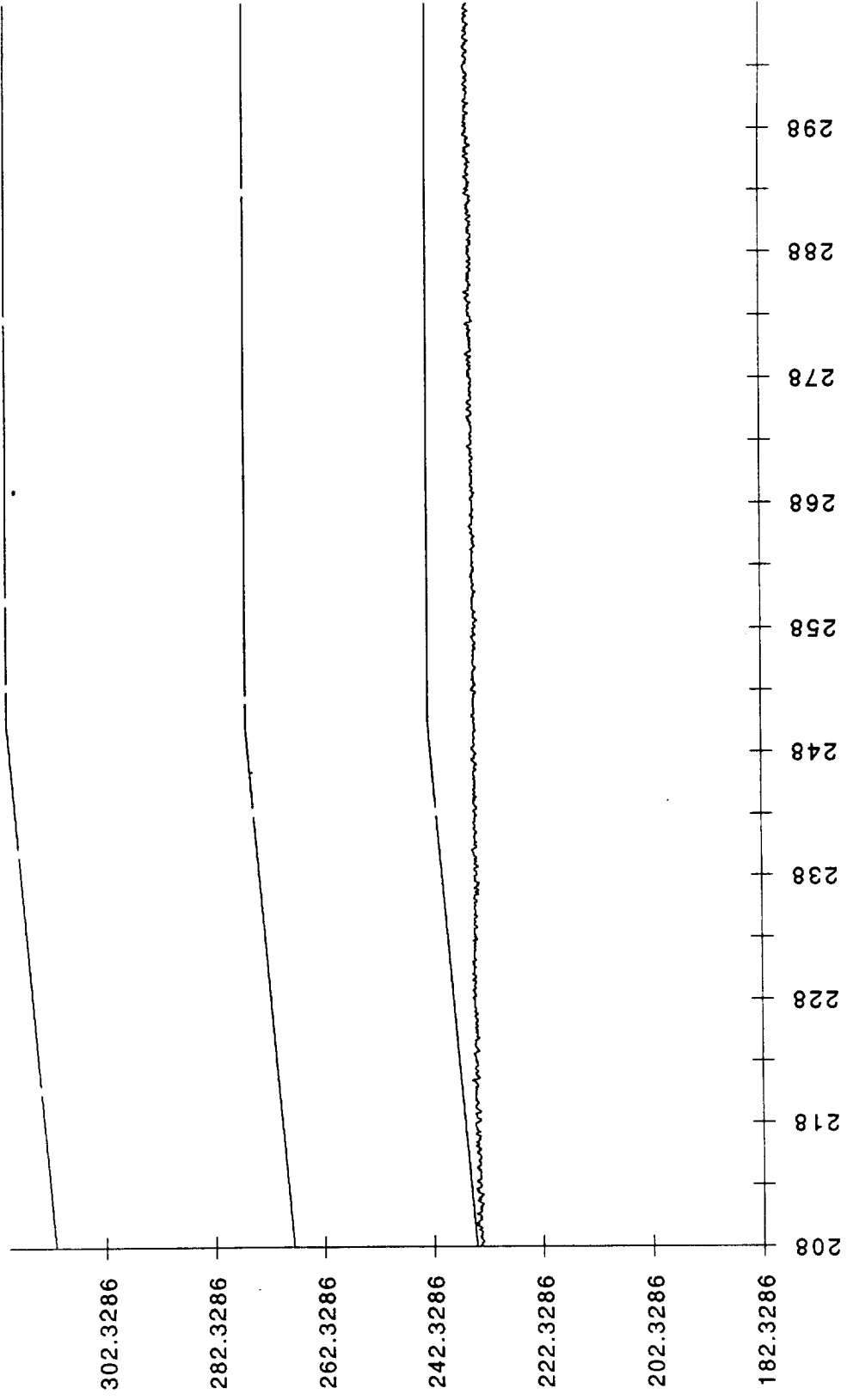

902-248 HPOP IMSL pr.T

902-248 HPOP IMSL pr.T

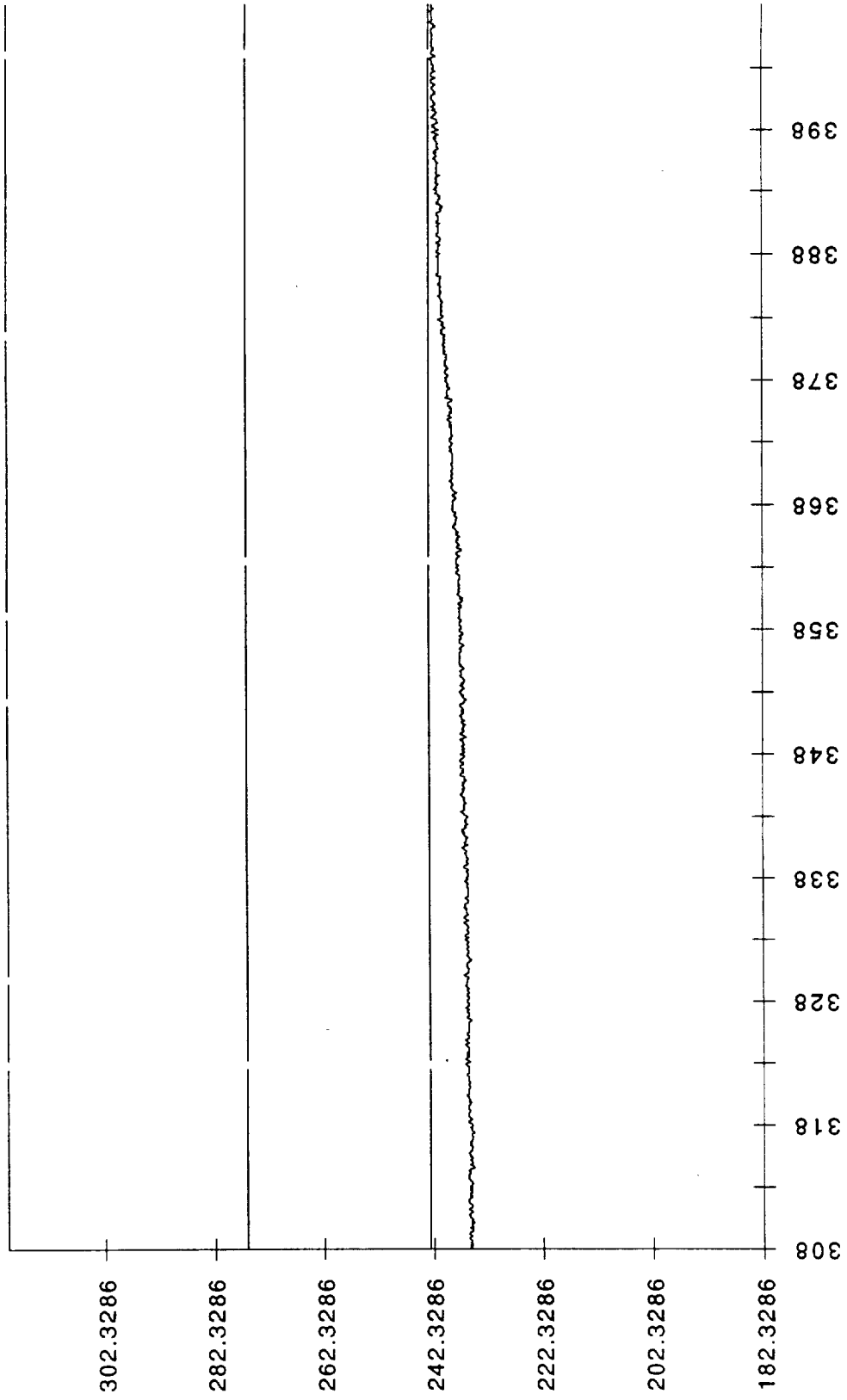

902-248 HPOP IMSL pr.T

902-248 HPOP IMSL pr.T

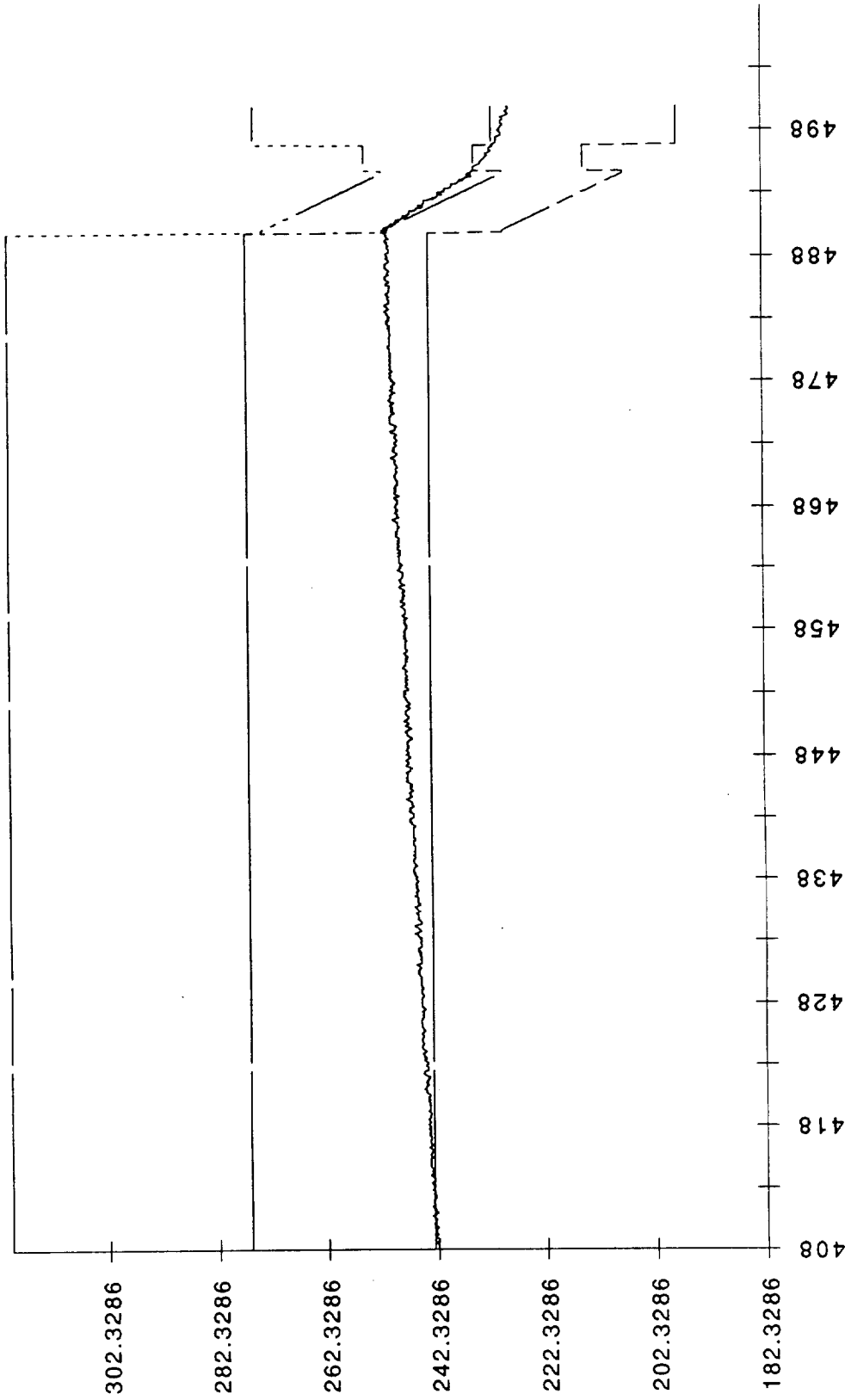

902-248 HPOP IMSL pr.T

902-587 HPFP bal cav pr.T

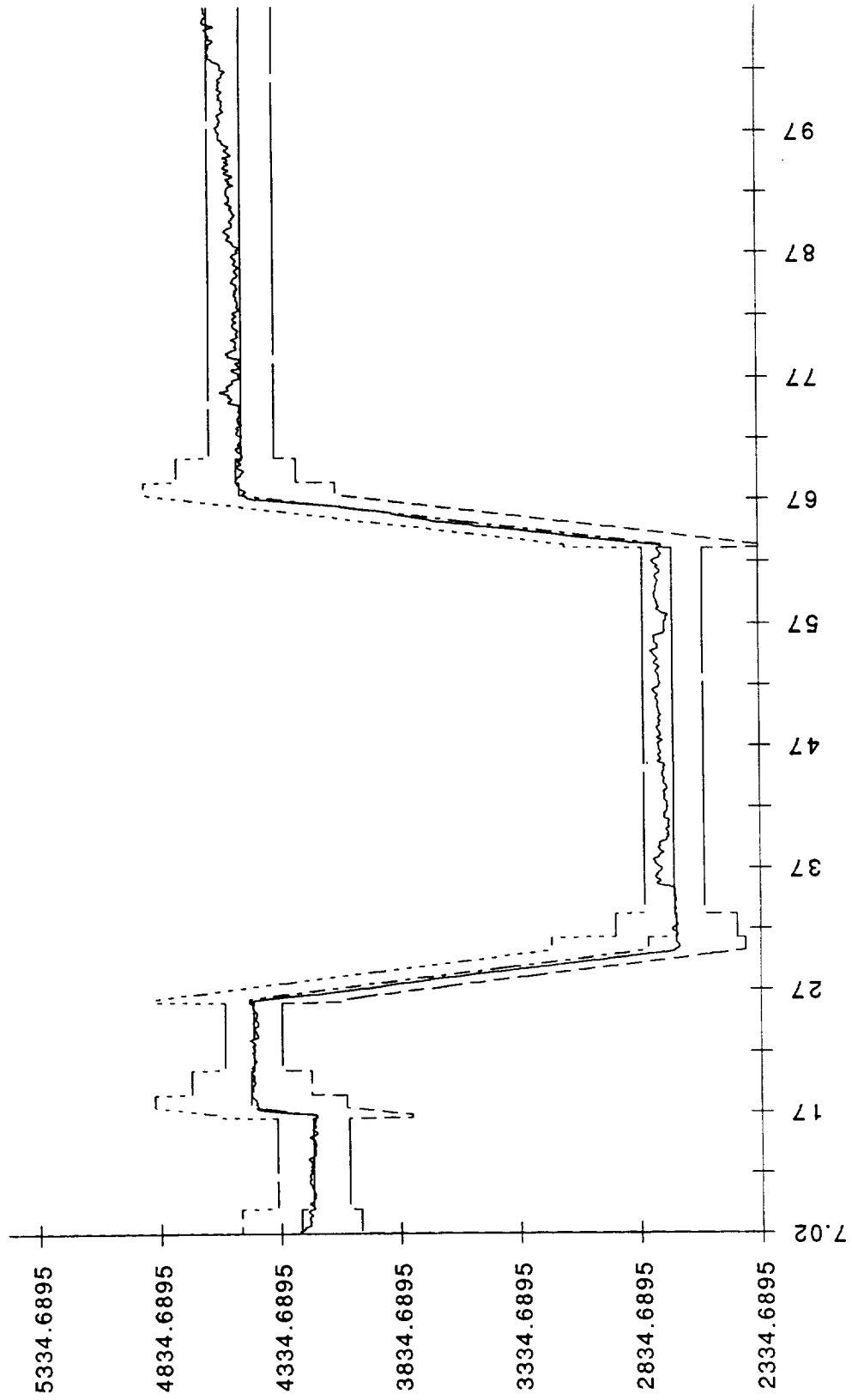

902-587 HPFP bal cav pr.T

902-587 HPFP bal cav pr.T

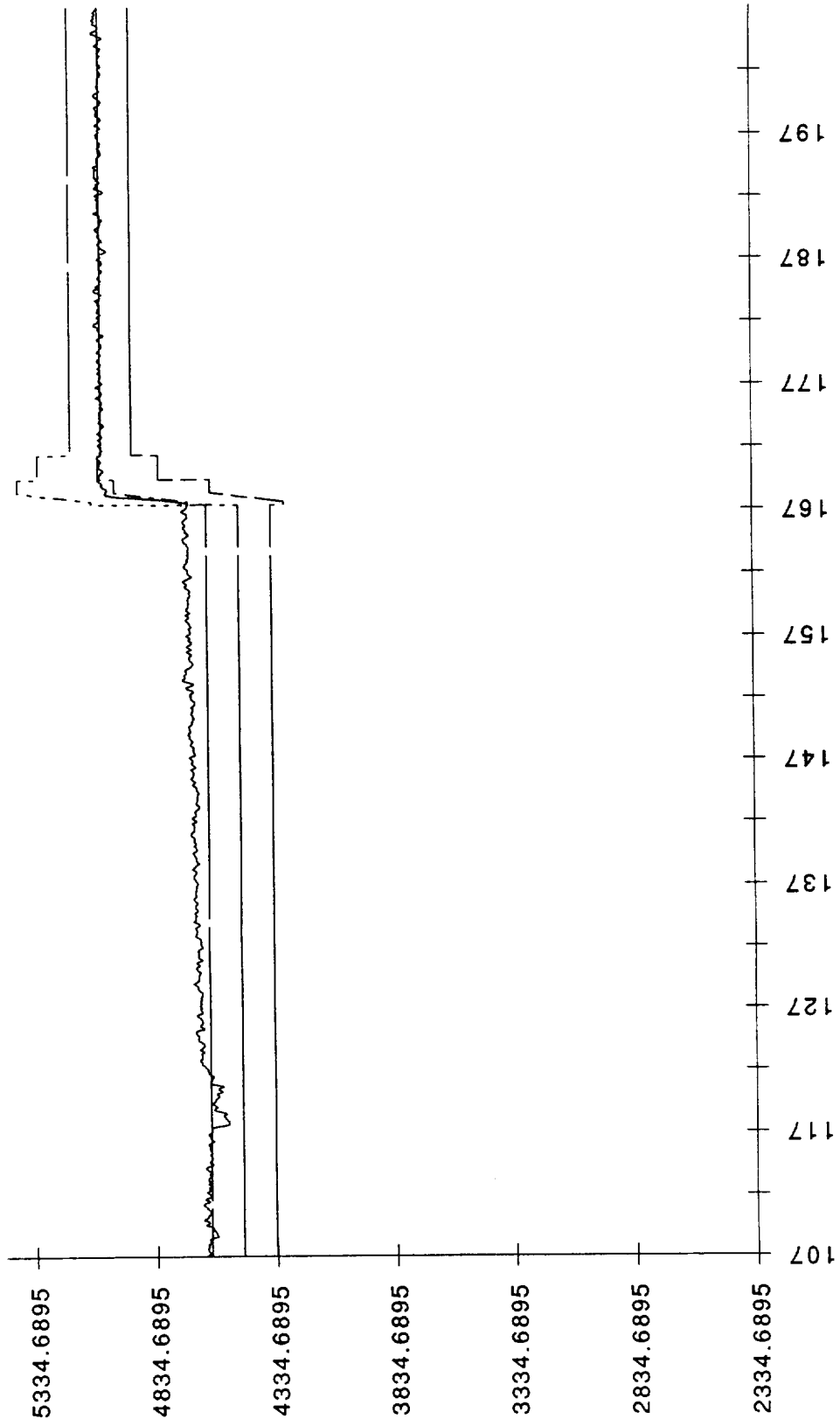

902-587 HPFP bal cav pr.T

902-587 HPFP bal cav pr.T

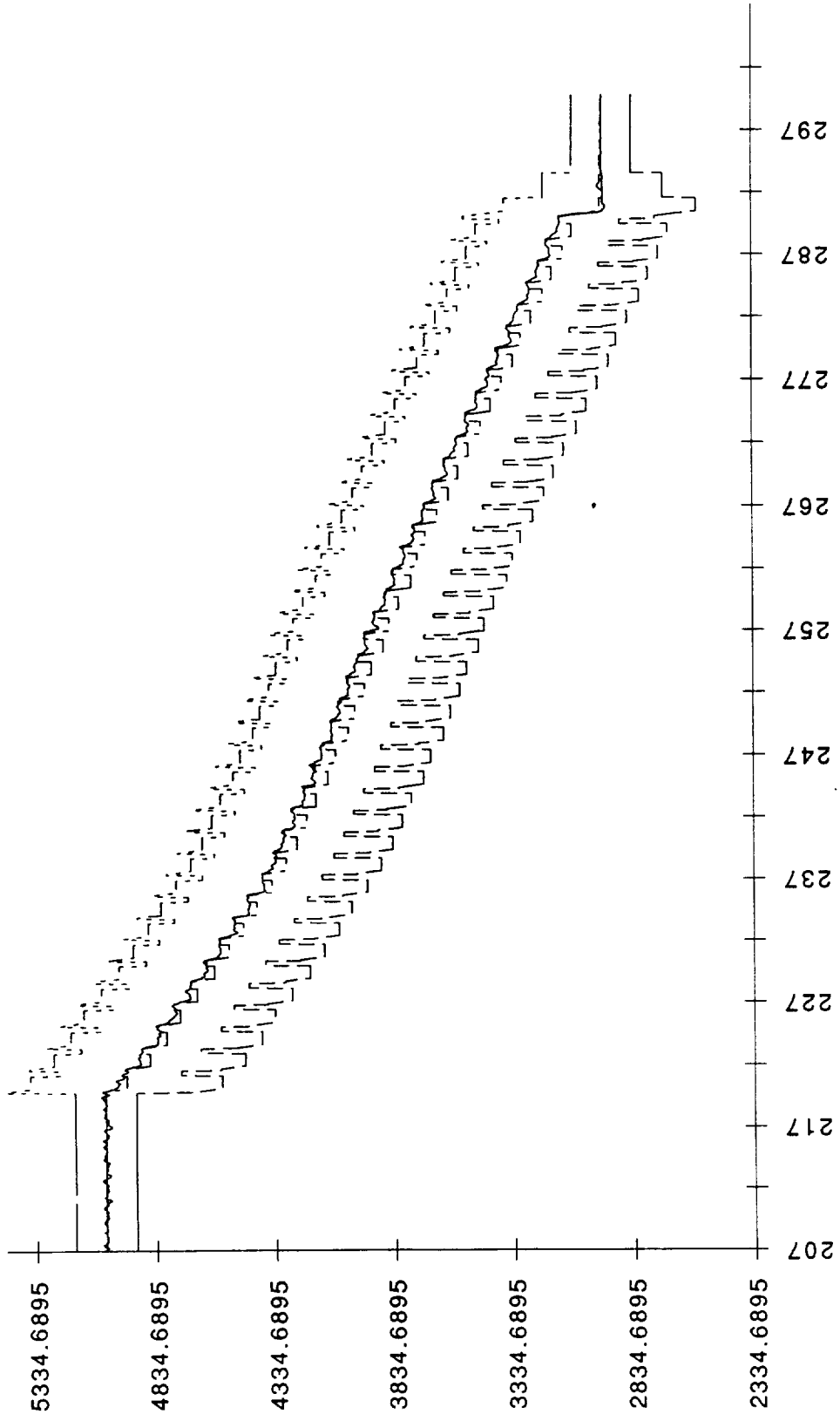

902-587 HPFP bal cav pr.T

902-596 HPOP PBP dis pr.T

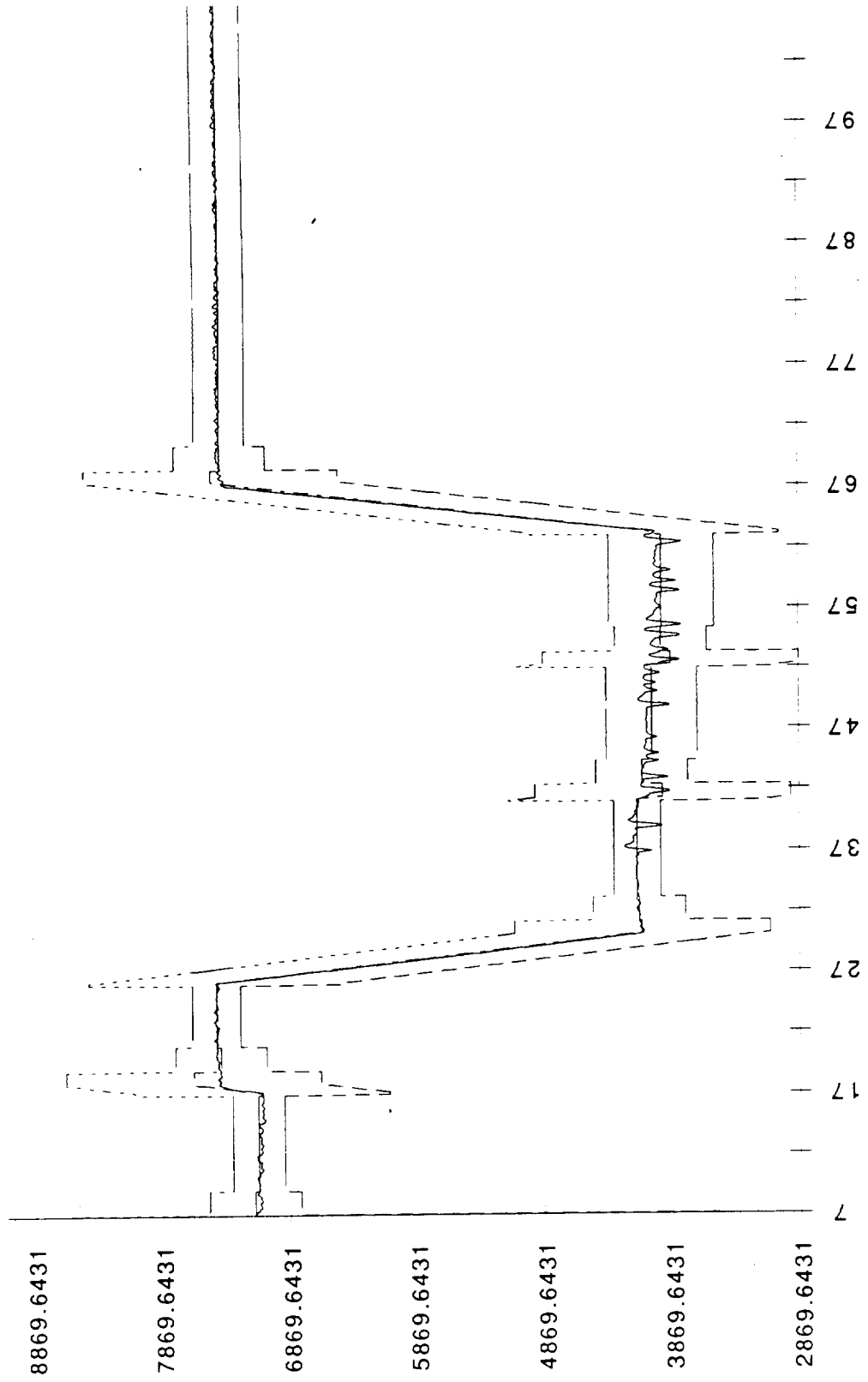

902-596 HPOP PBP dis pr.T

902-596 HPOP PBP dis pr.T

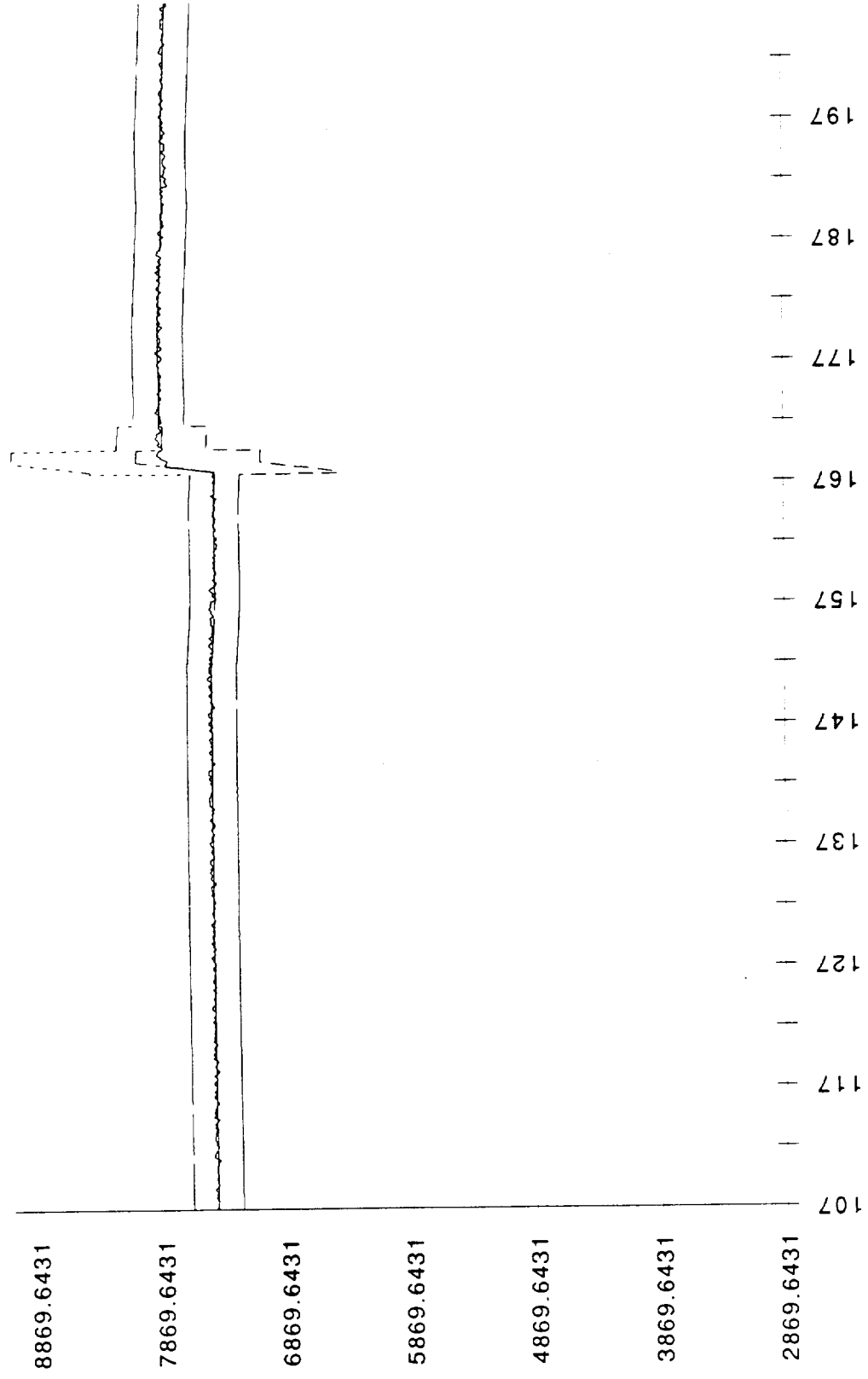

902-596 HPOP PBP dis pr.T

902-596 HPOP PBP dis pr.T

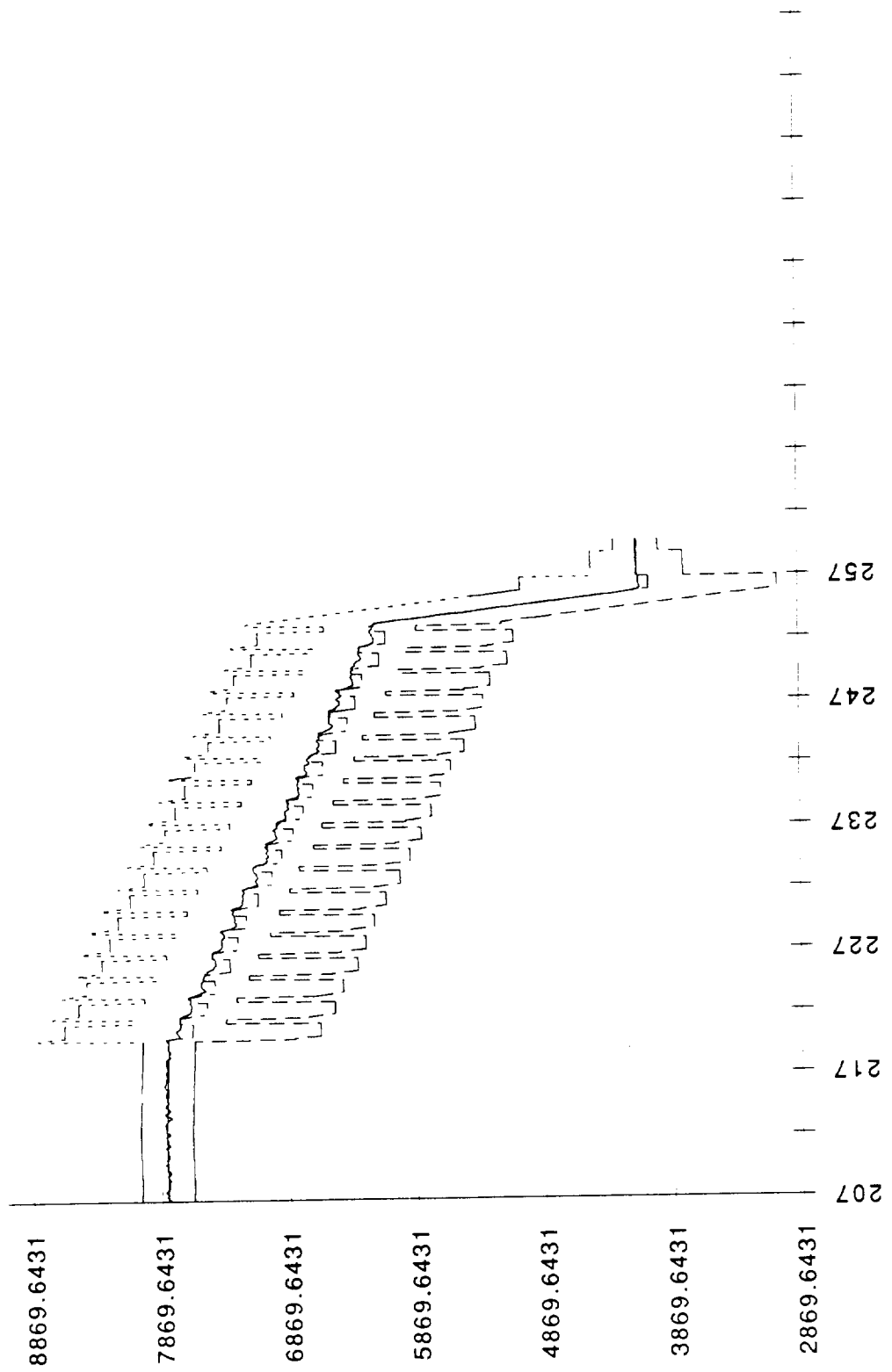

902-596 HPOP PBP dis pr.T

Appendix C2
Good Test Plots
Pratt LOX Pump w/ Nominal CCV Schedule

904-162 HPOP SSC pr.T

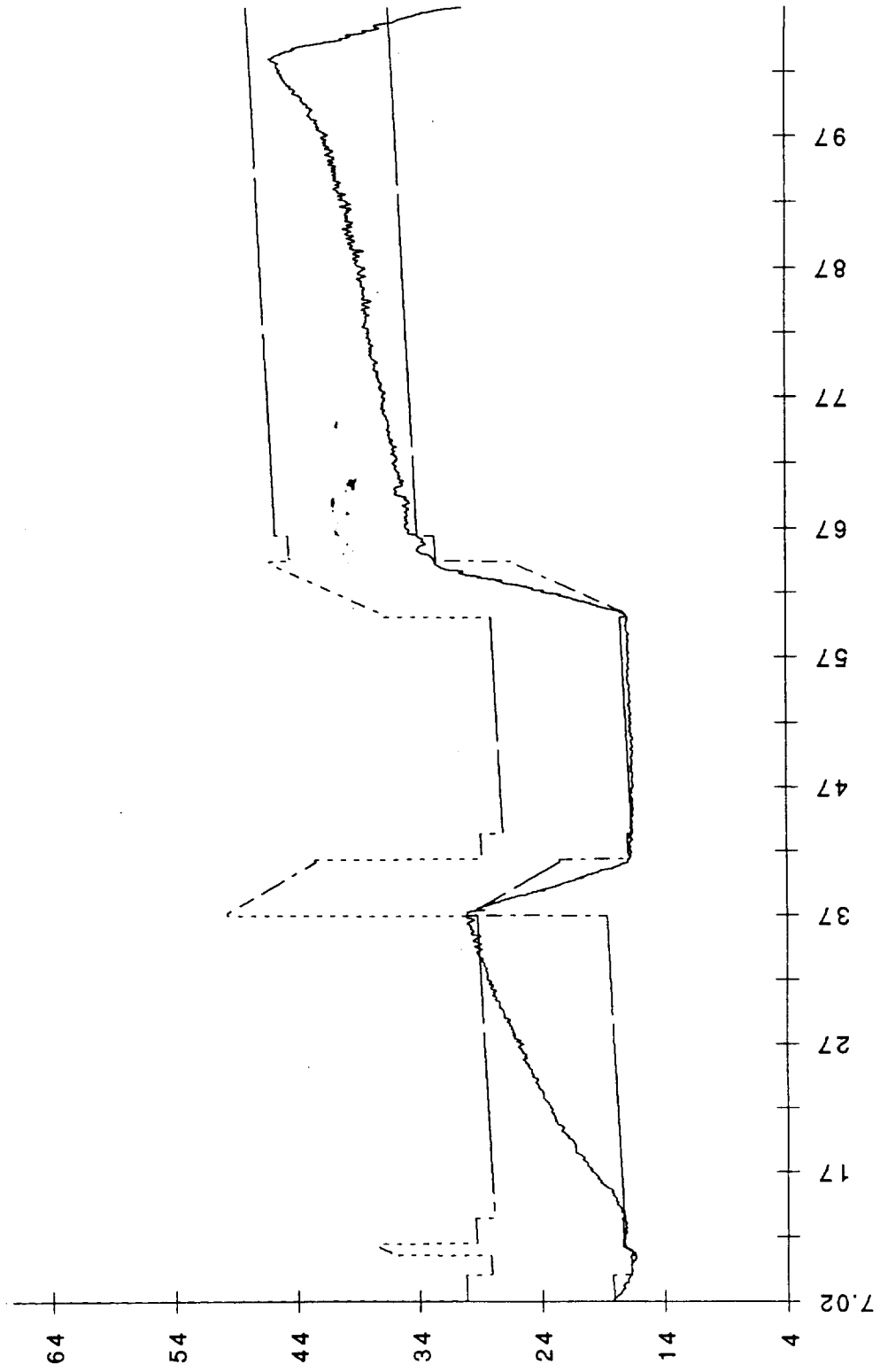

904-162 HPOP SSC pr.T

904-162 HPOP SSC pr.T

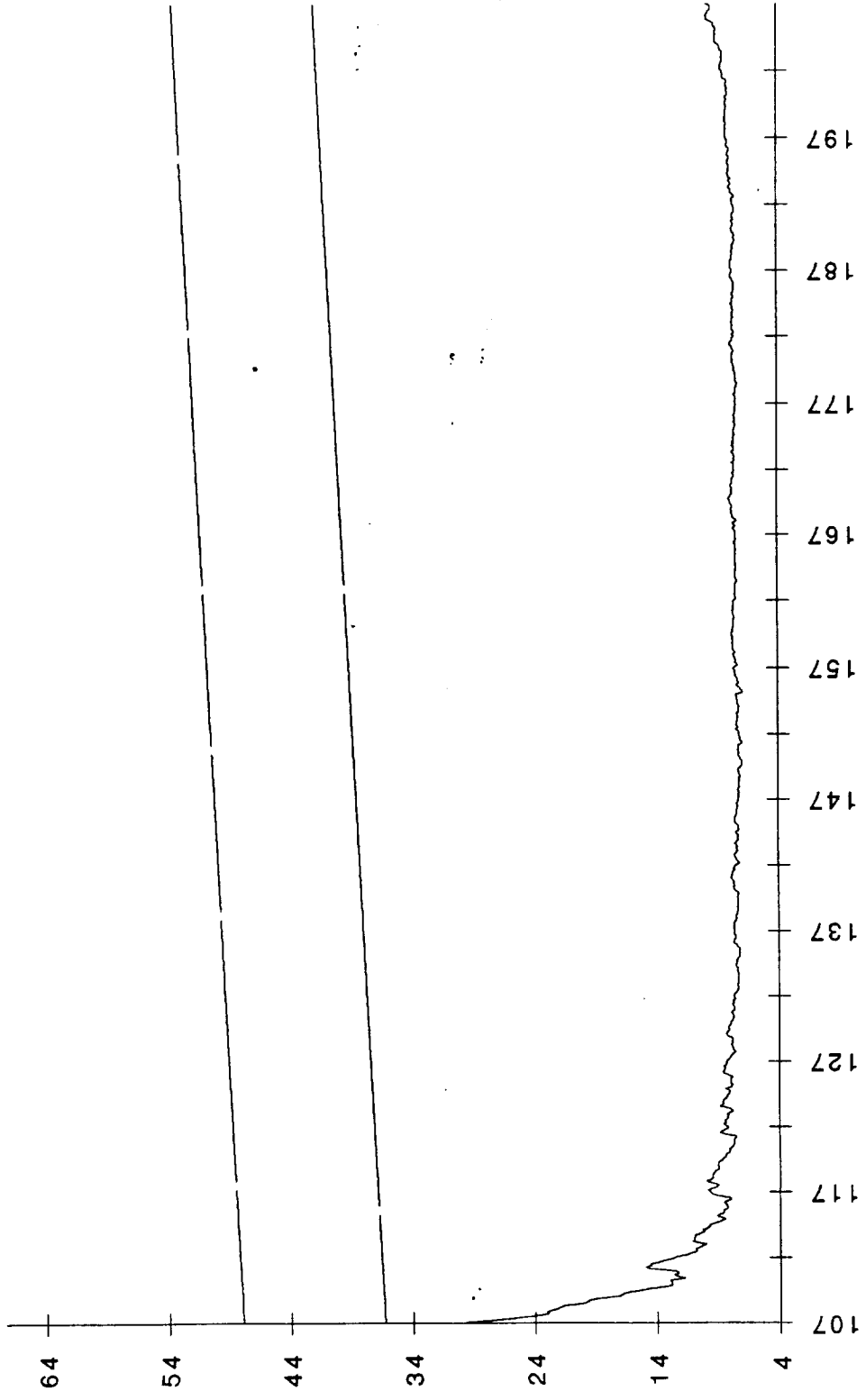

904-162 HPOP SSC pr.T

904-162 HPOP SSC pr.T

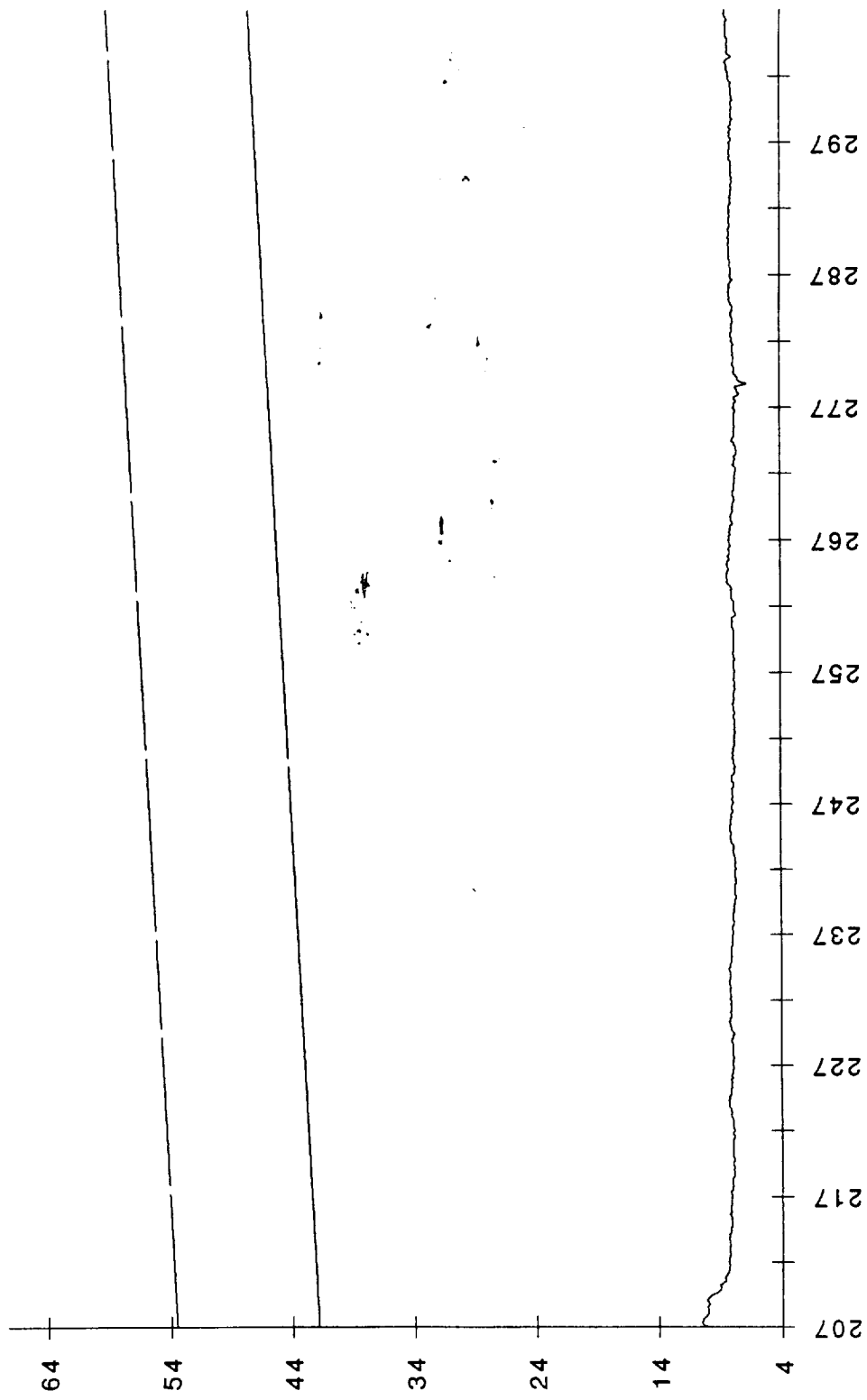

904-162 HPOP SSC pr.T

904-162 HPOP SSC pr.T

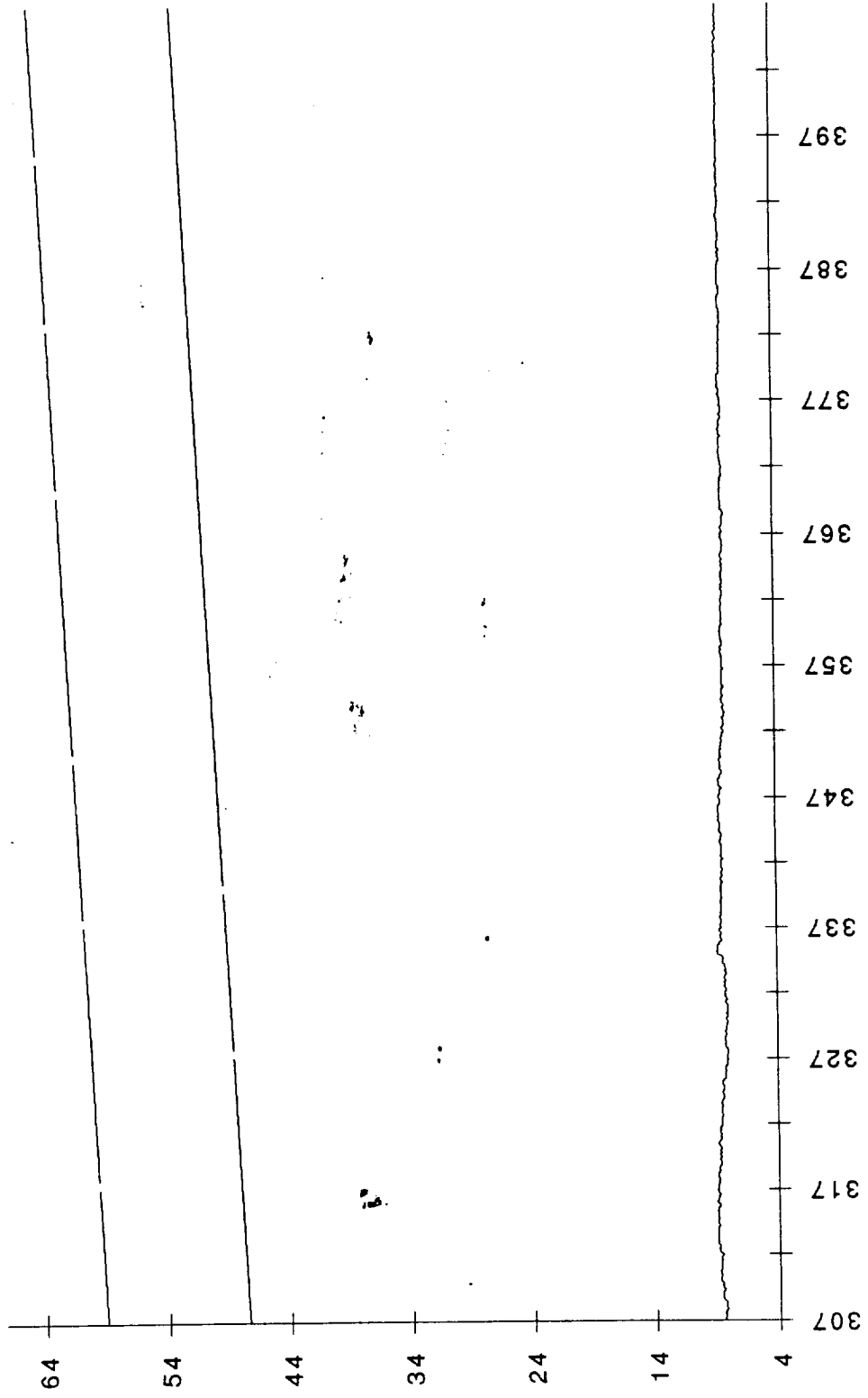

904-162 HPOP SSC pr.T

904-162 HPOP SSC pr.T

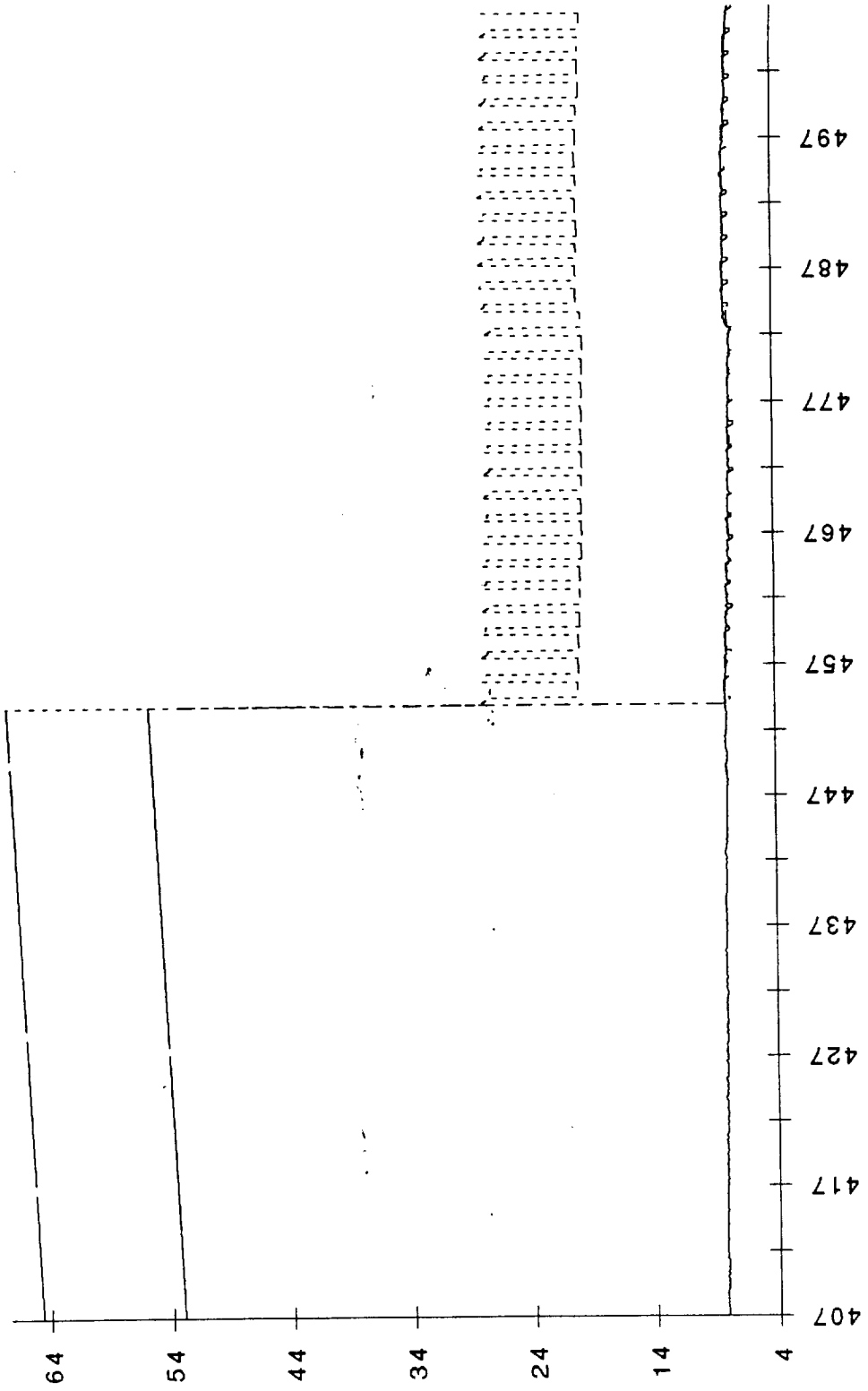

904-162 HPOP SSC pr.T

904-162 HPOP SSC pr.T

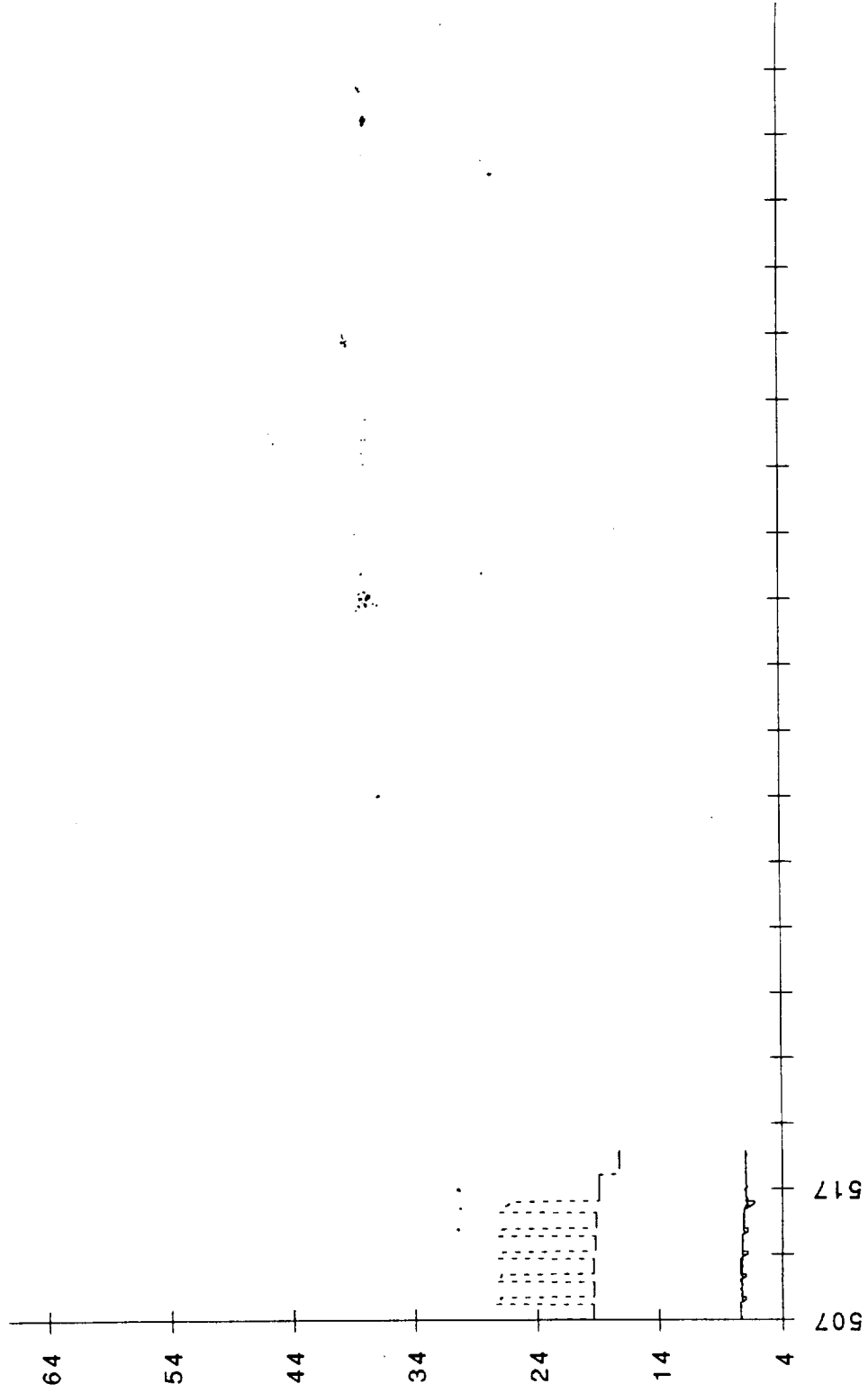

904-162 HPOP SSC pr.T

904-165 HPOP SSC pr.T

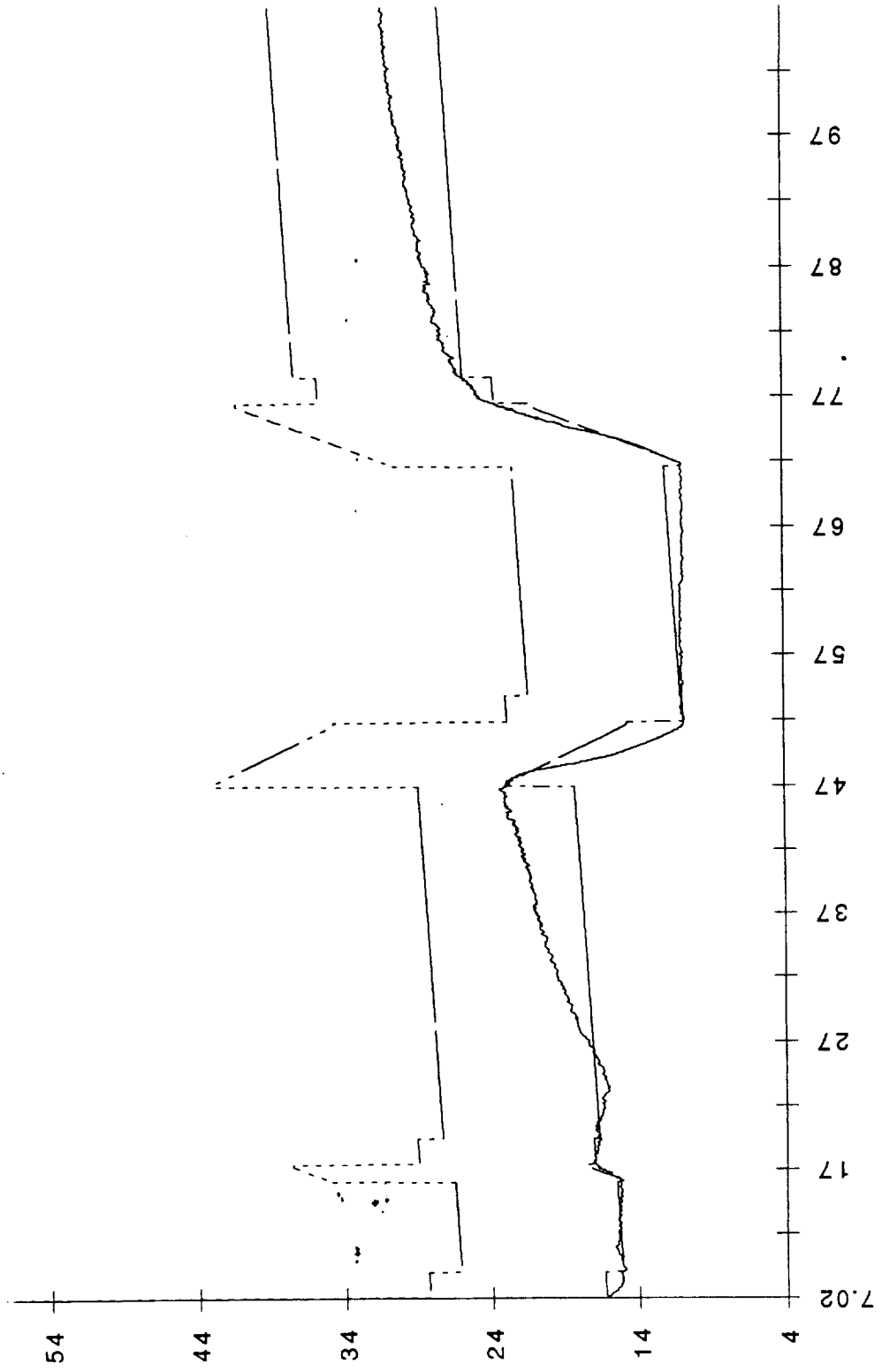

904-165 HPOP SSC pr.T

904-165 HPOP SSC pr.T

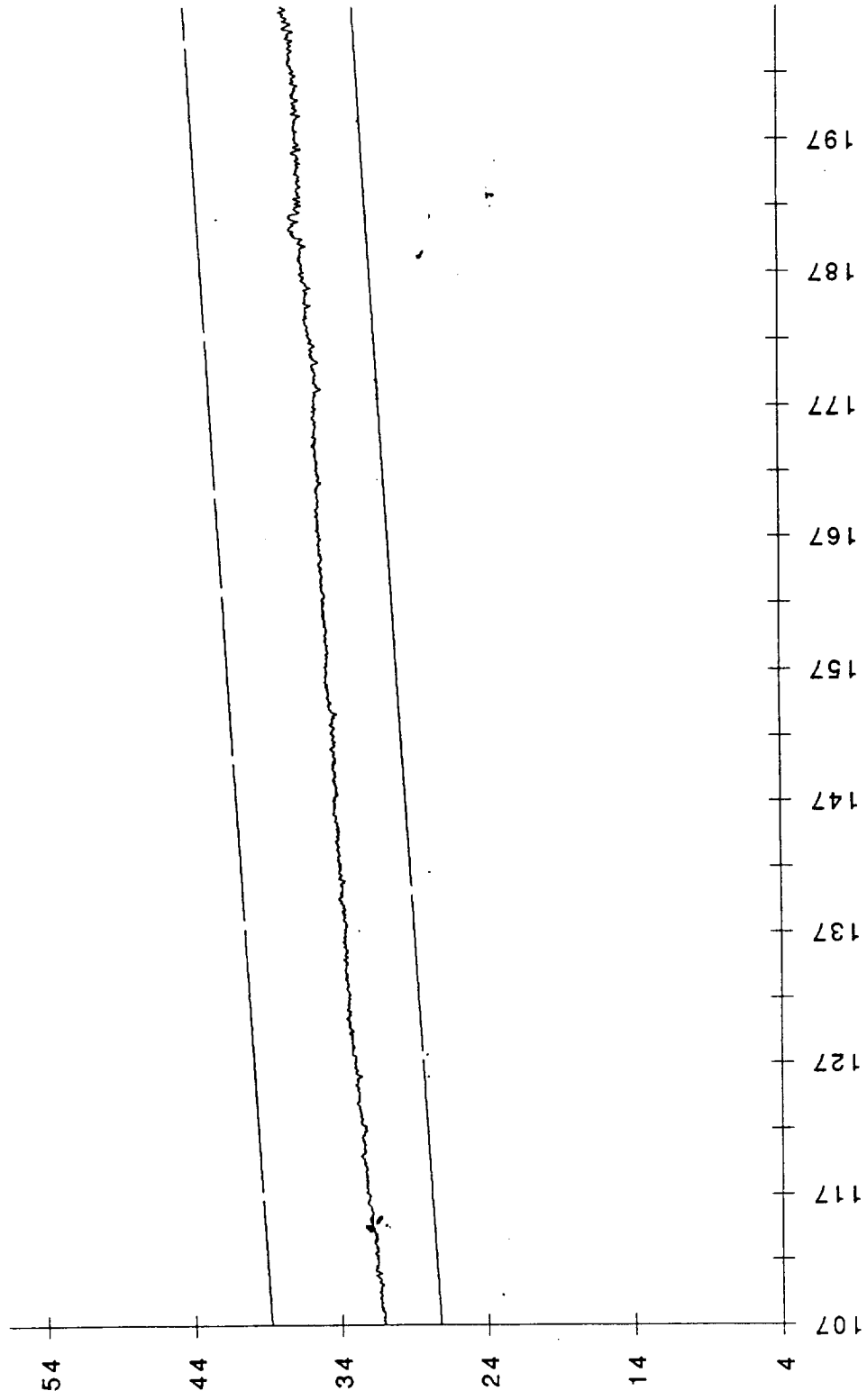

904-165 HPOP SSC pr.T

904-165 HPOP SSC pr.T

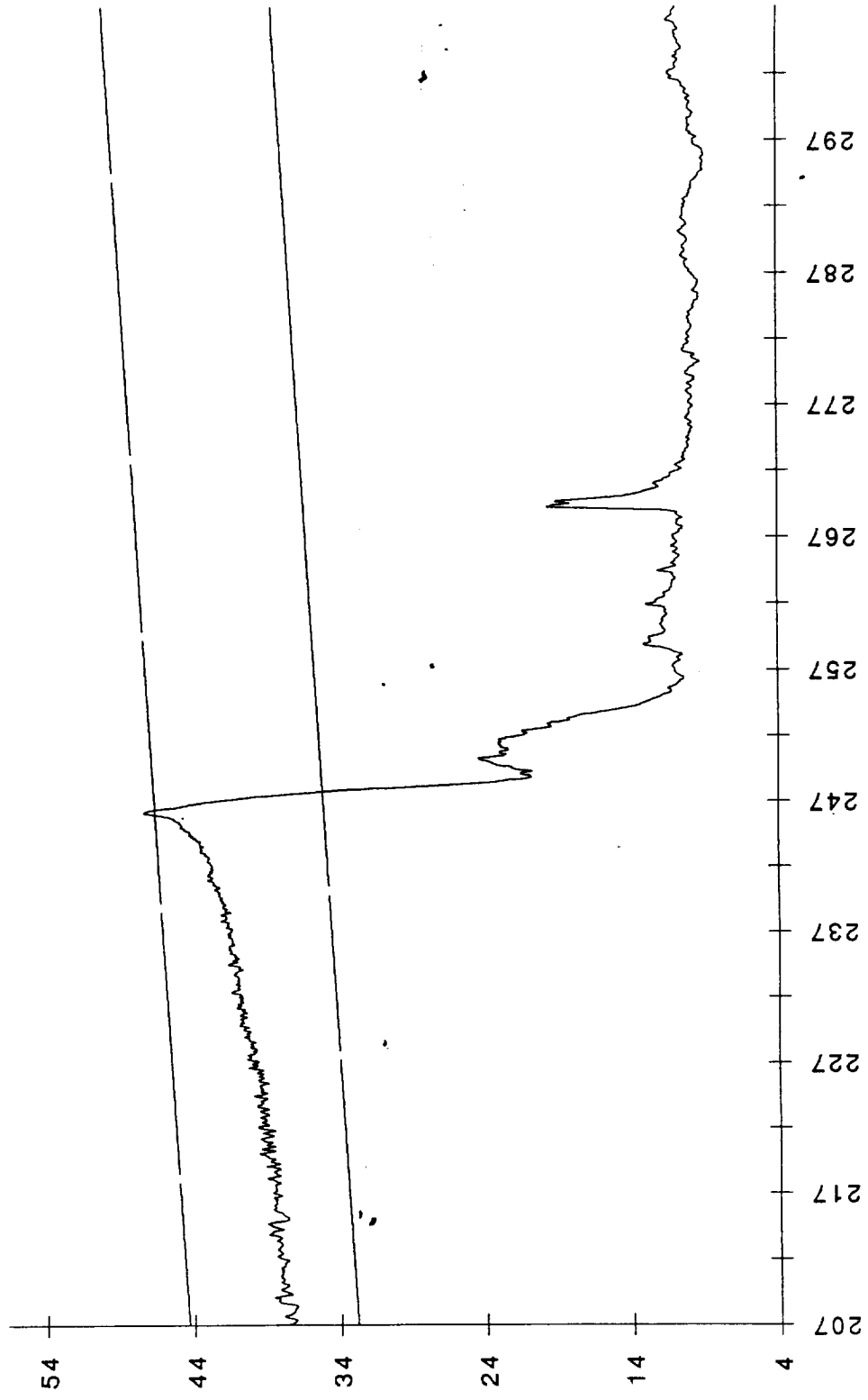

904-165 HPOP SSC pr.T

904-165 HPOP SSC pr.T

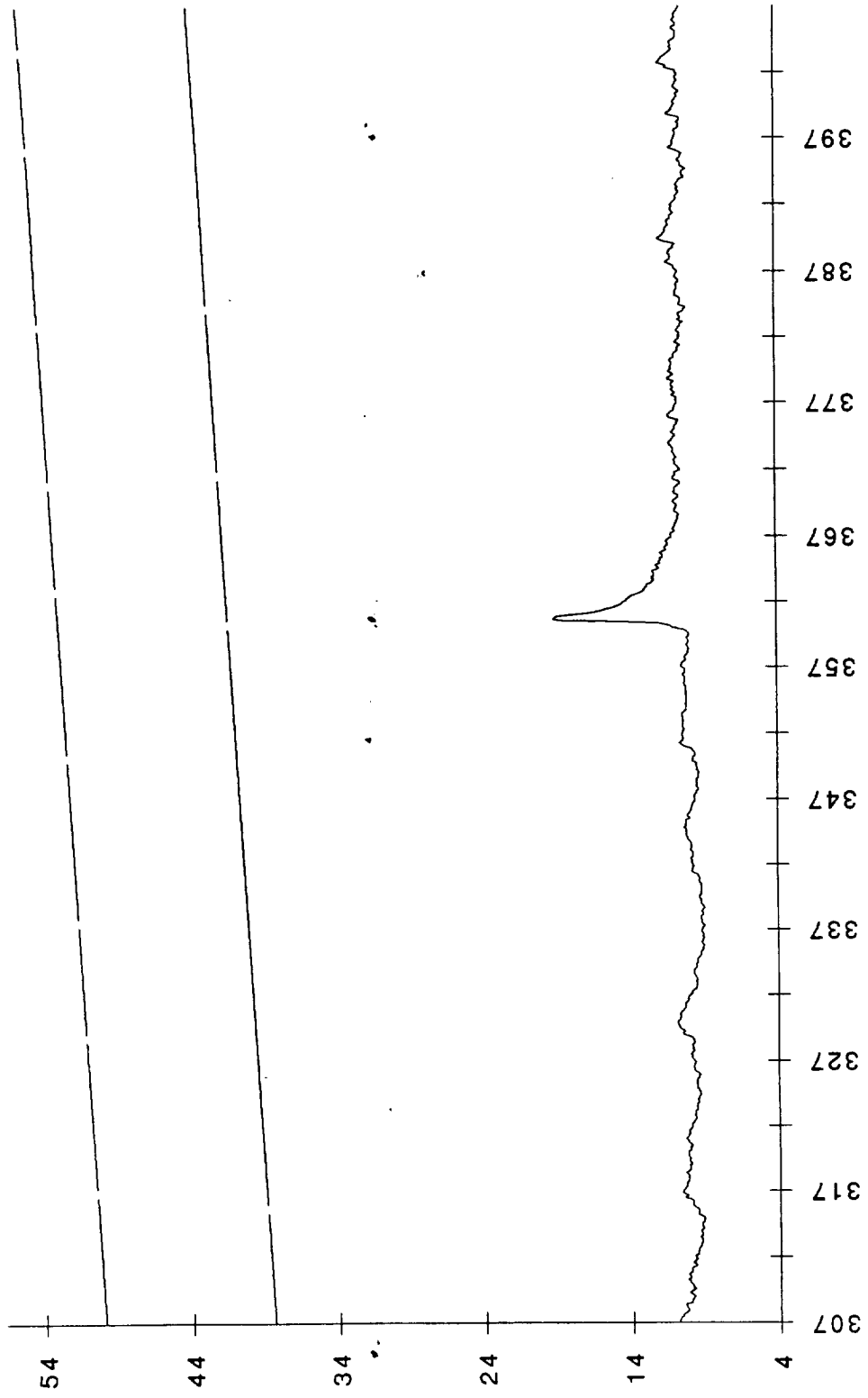

904-165 HPOP SSC pr.T

904-165 HPOP SSC pr.T

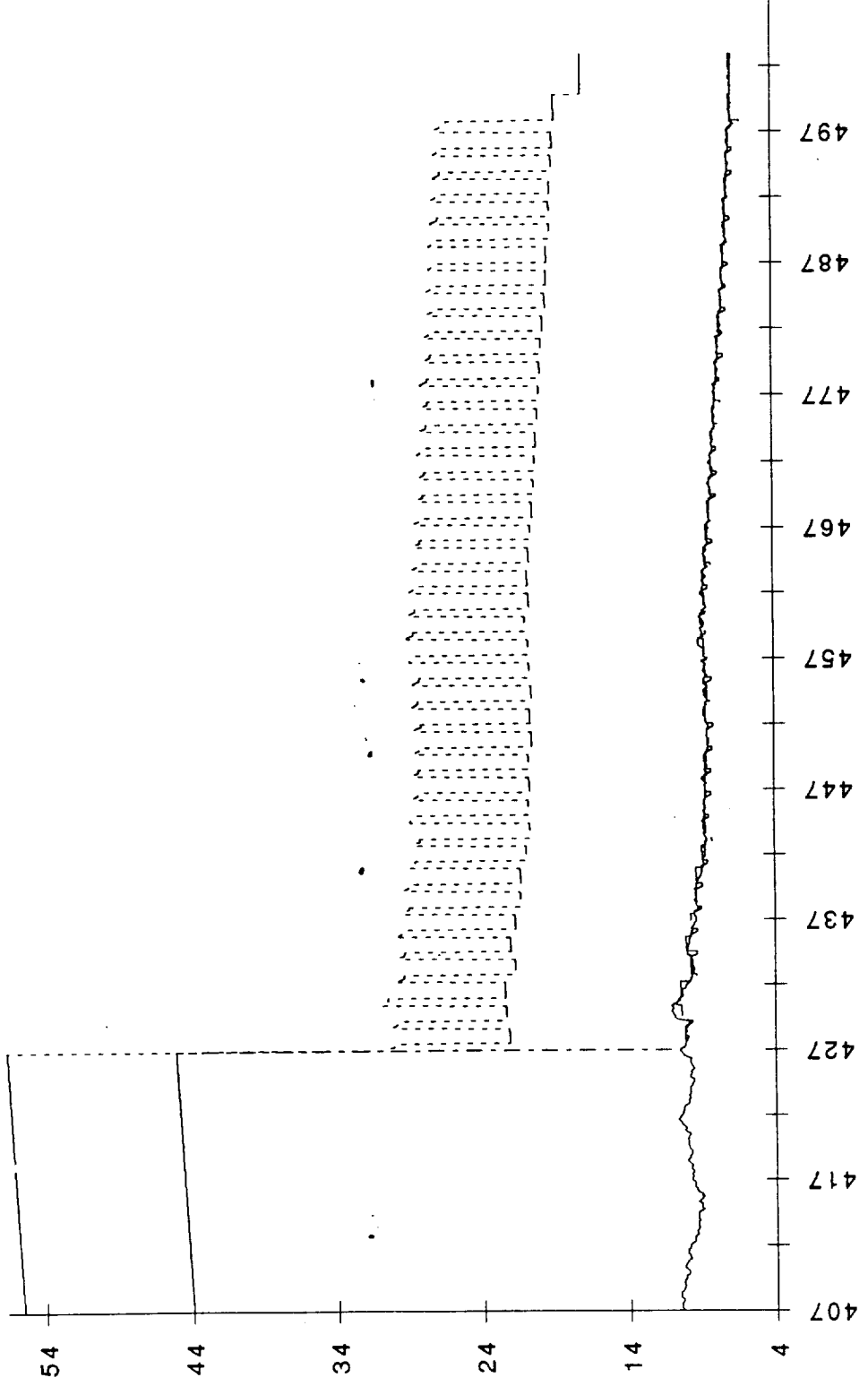

904-165 HPOP SSC pr.T

904-171 FPOV pos.T

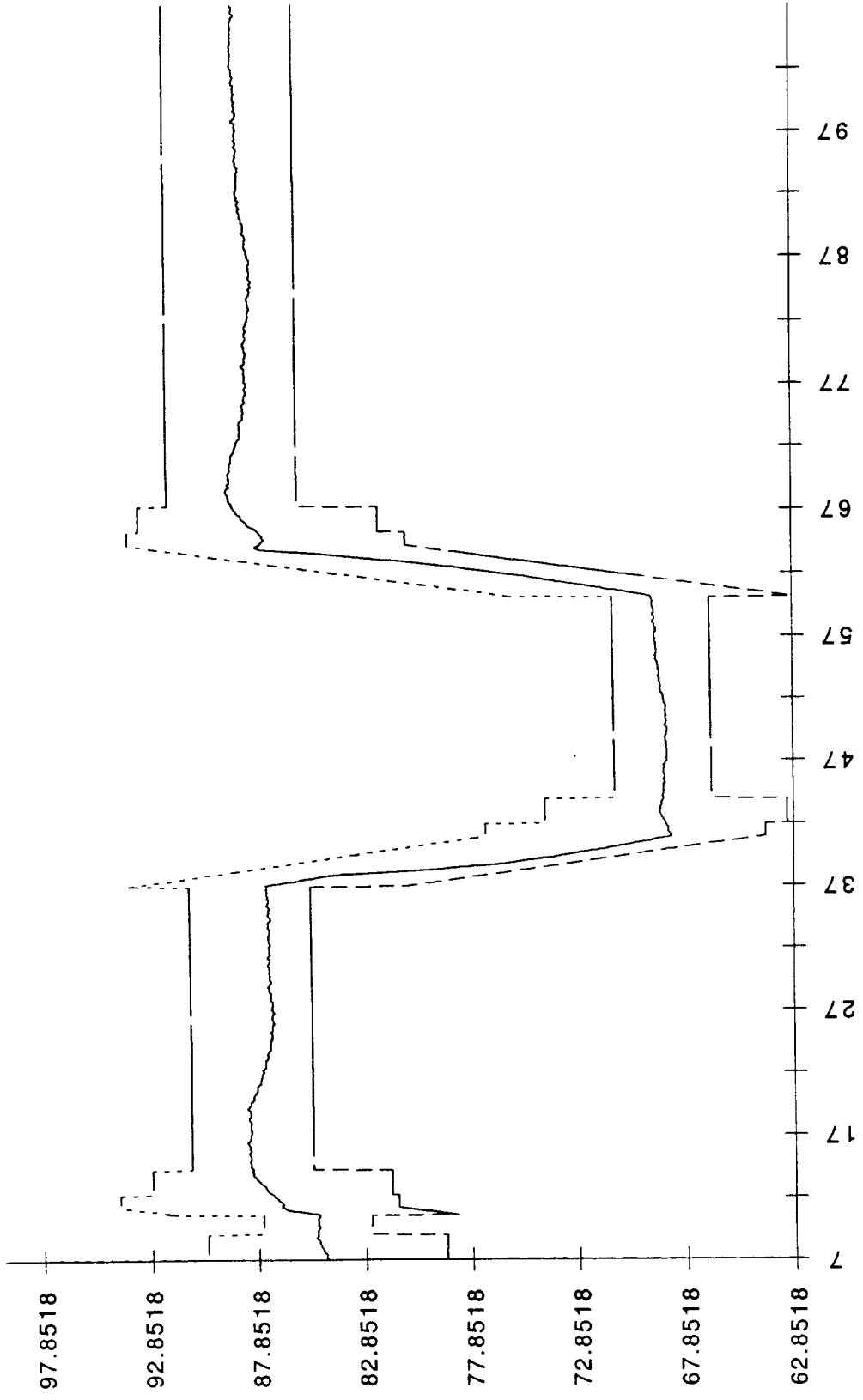

904-171 FPOV pos.T

904-171 FPOV pos.T

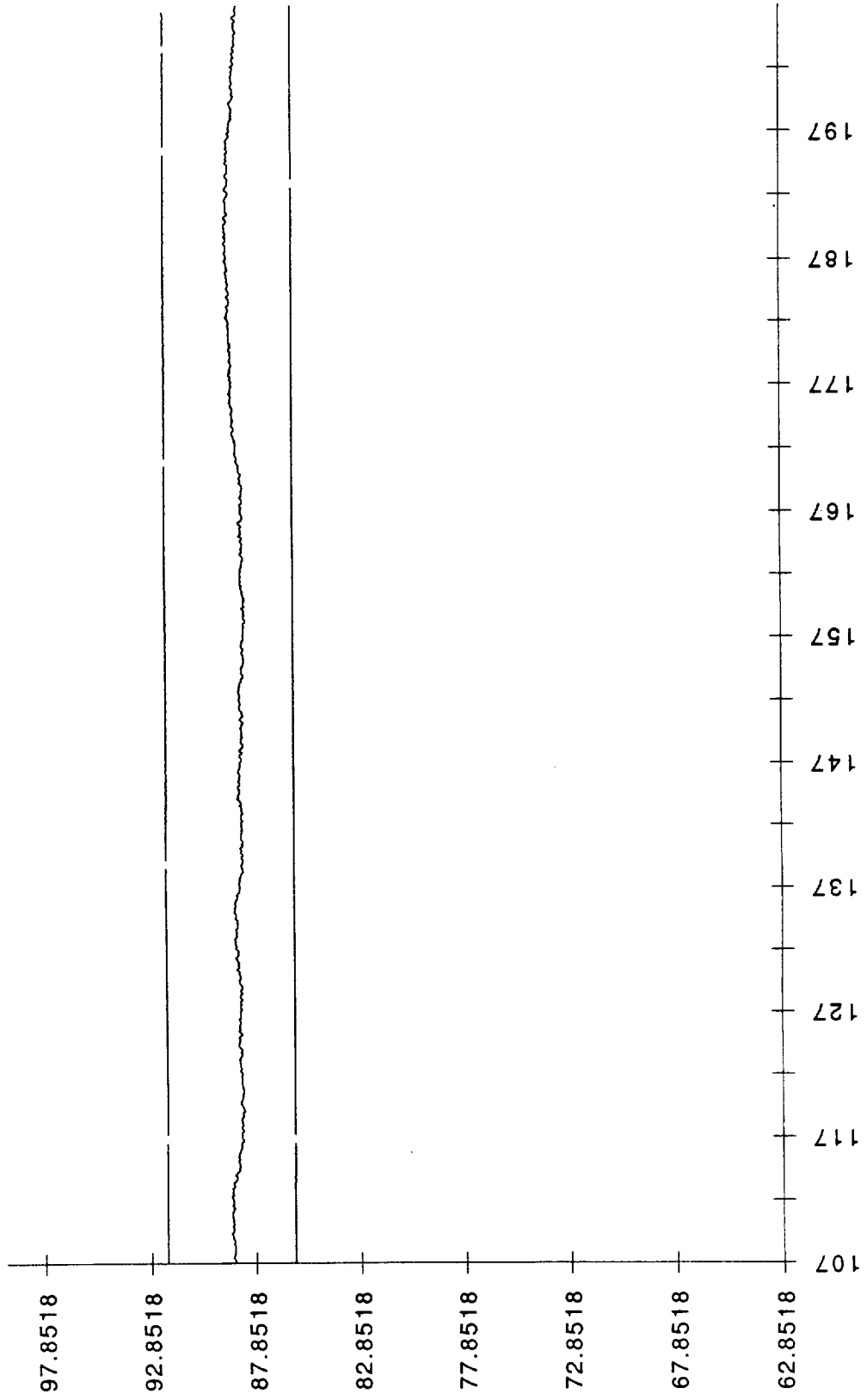

904-171 FPOV pos.T

904-171 FPOV pos.T

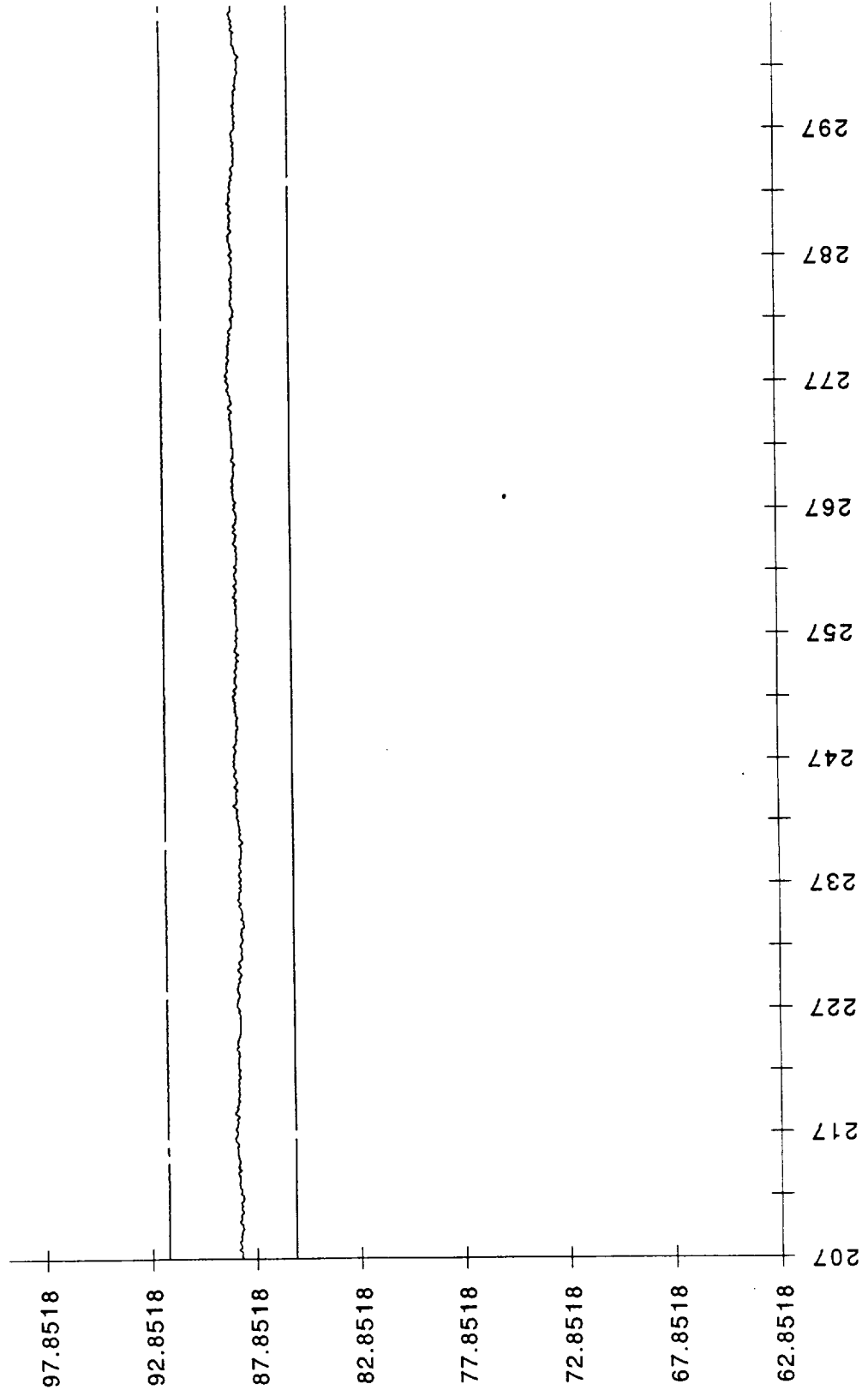

904-171 FPOV pos.T

904-171 FPOV pos.T

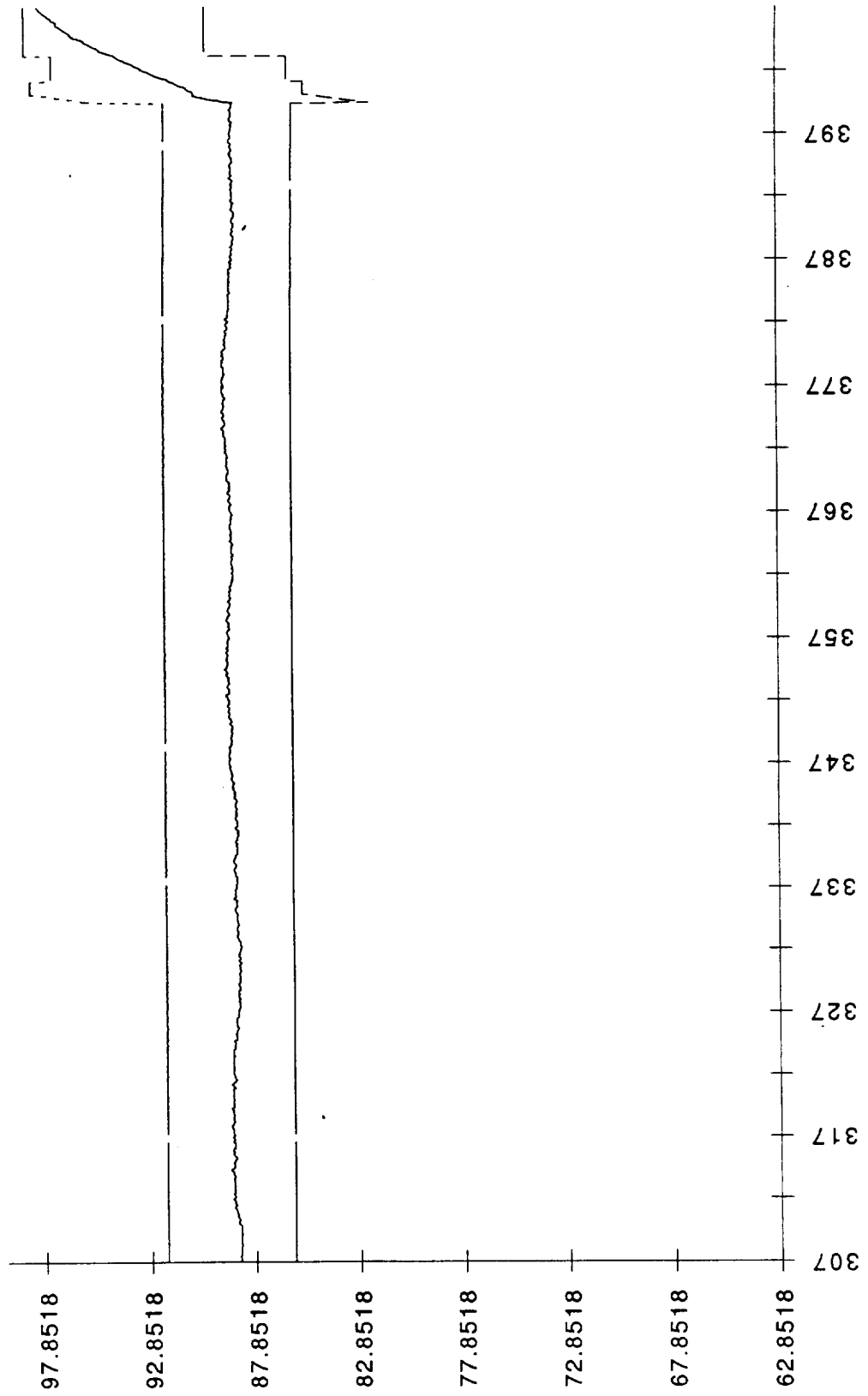

904-171 FPOV pos.T

904-171 FPOV pos.T

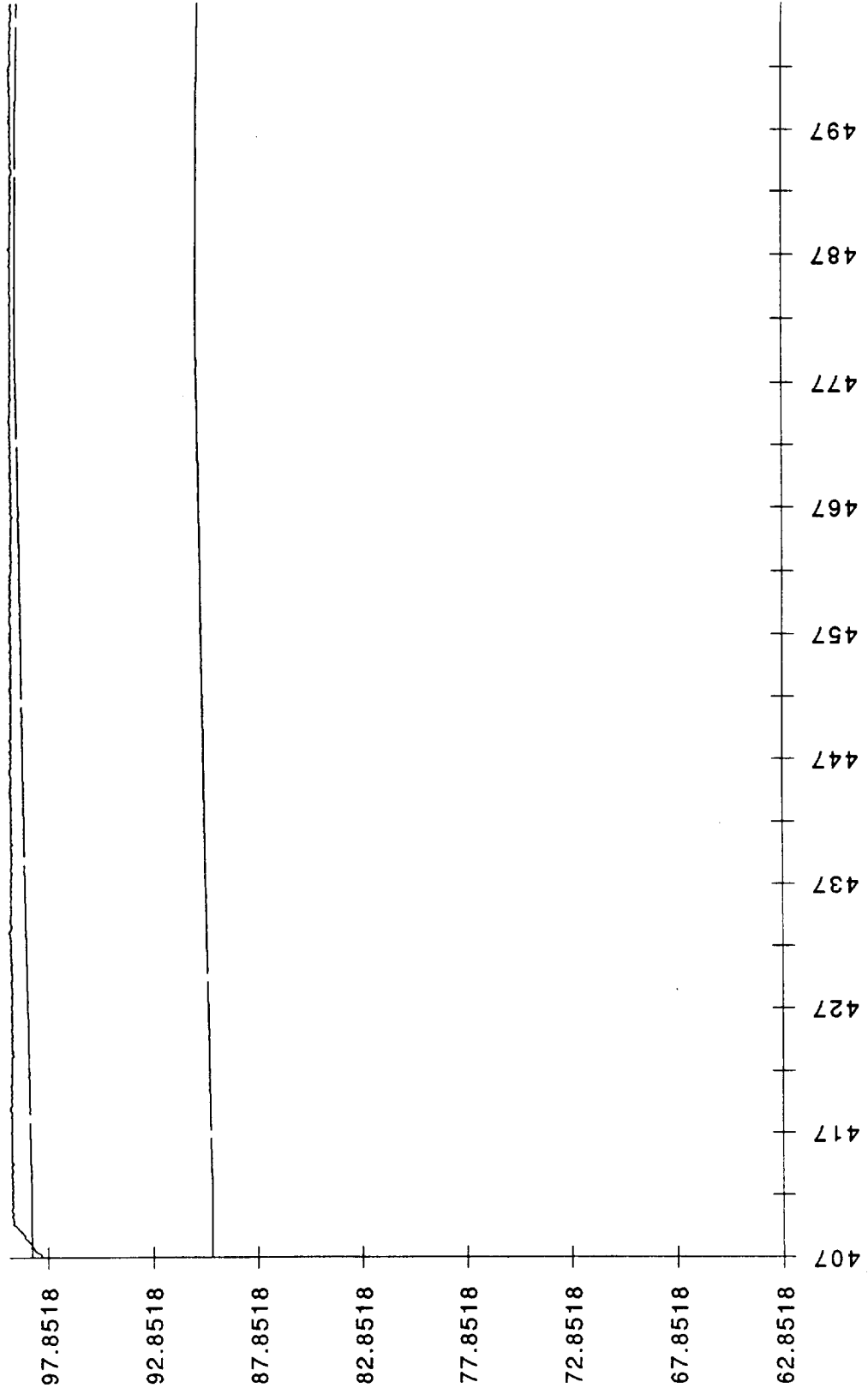

904-171 FPOV pos.T

904-171 FPOV pos.T

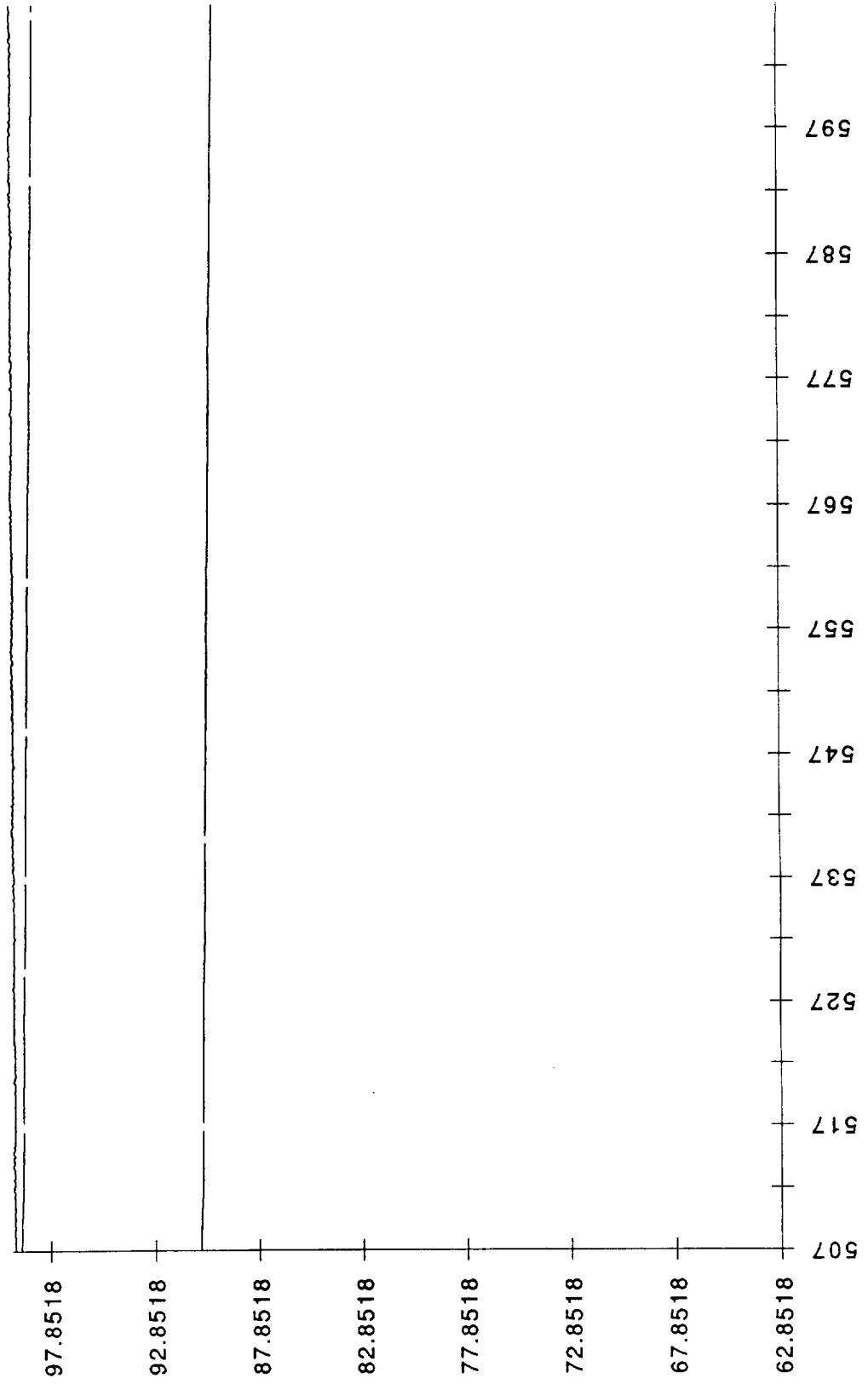

904-171 FPOV pos.T

904-172 FPOV pos.T

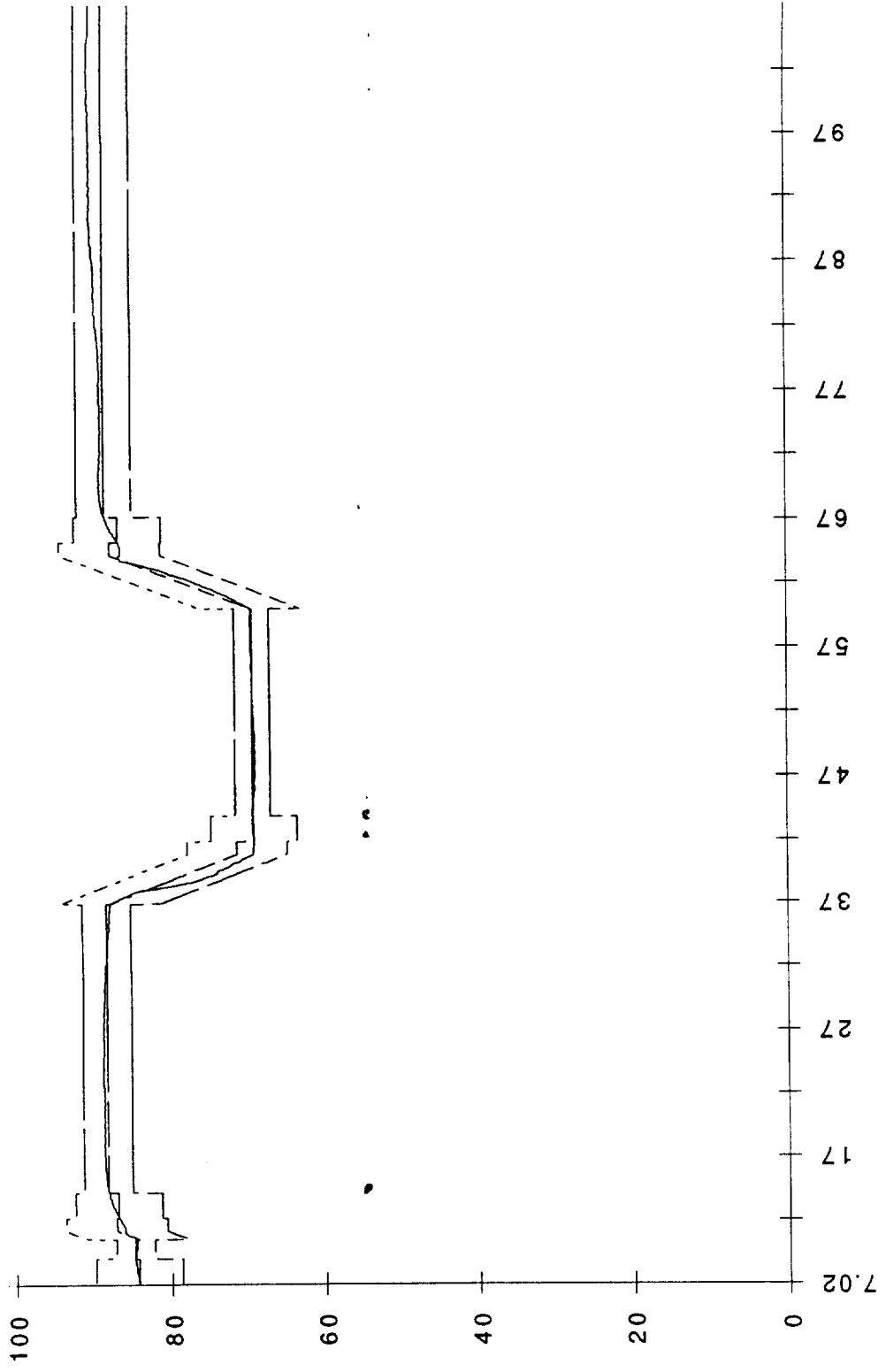

904-172 FPOV pos.T

904-172 FPOV pos.T

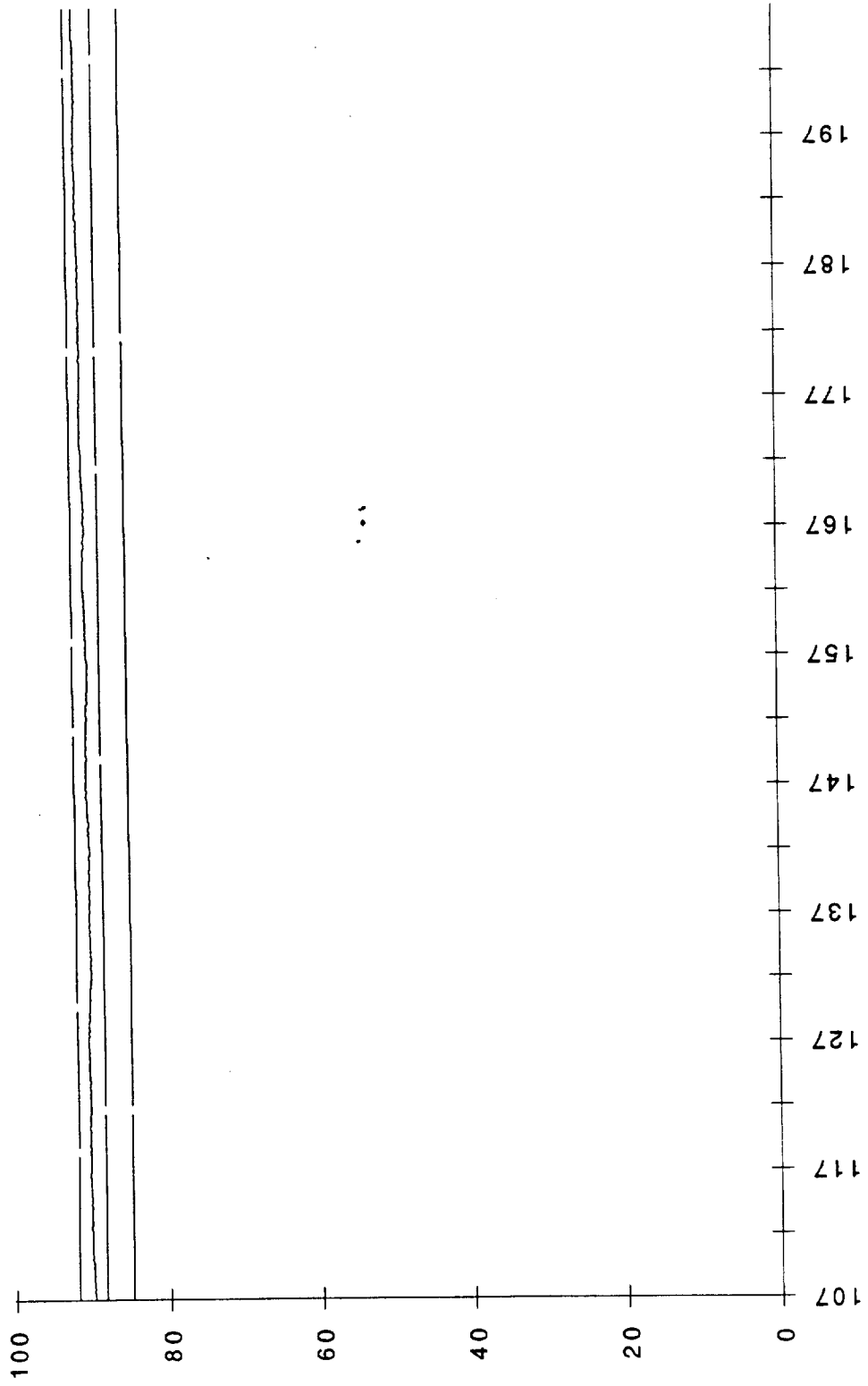

904-172 FPOV pos.T

904-172 FPOV pos.T

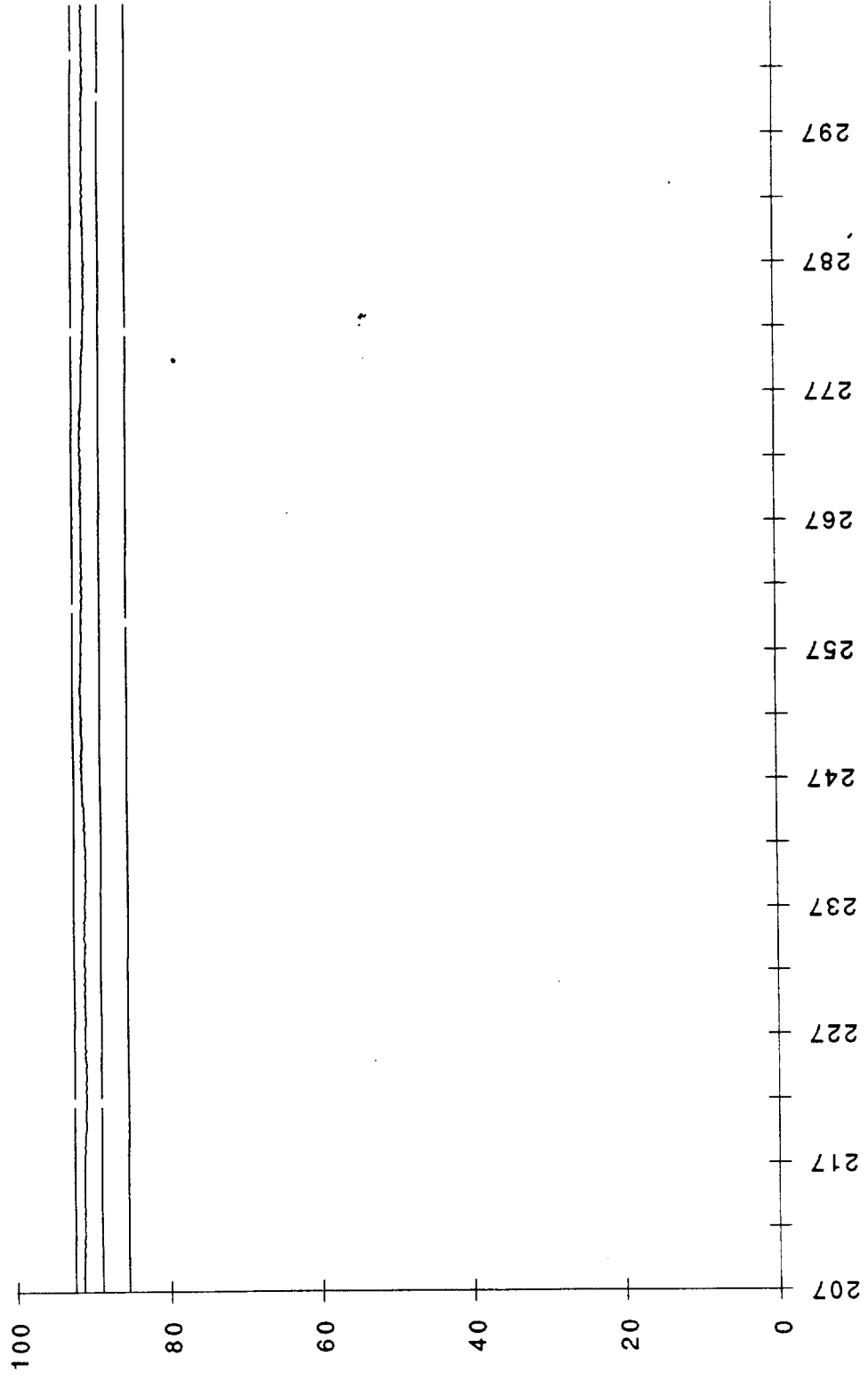

904-172 FPOV pos.T

904-172 FPOV pos.T

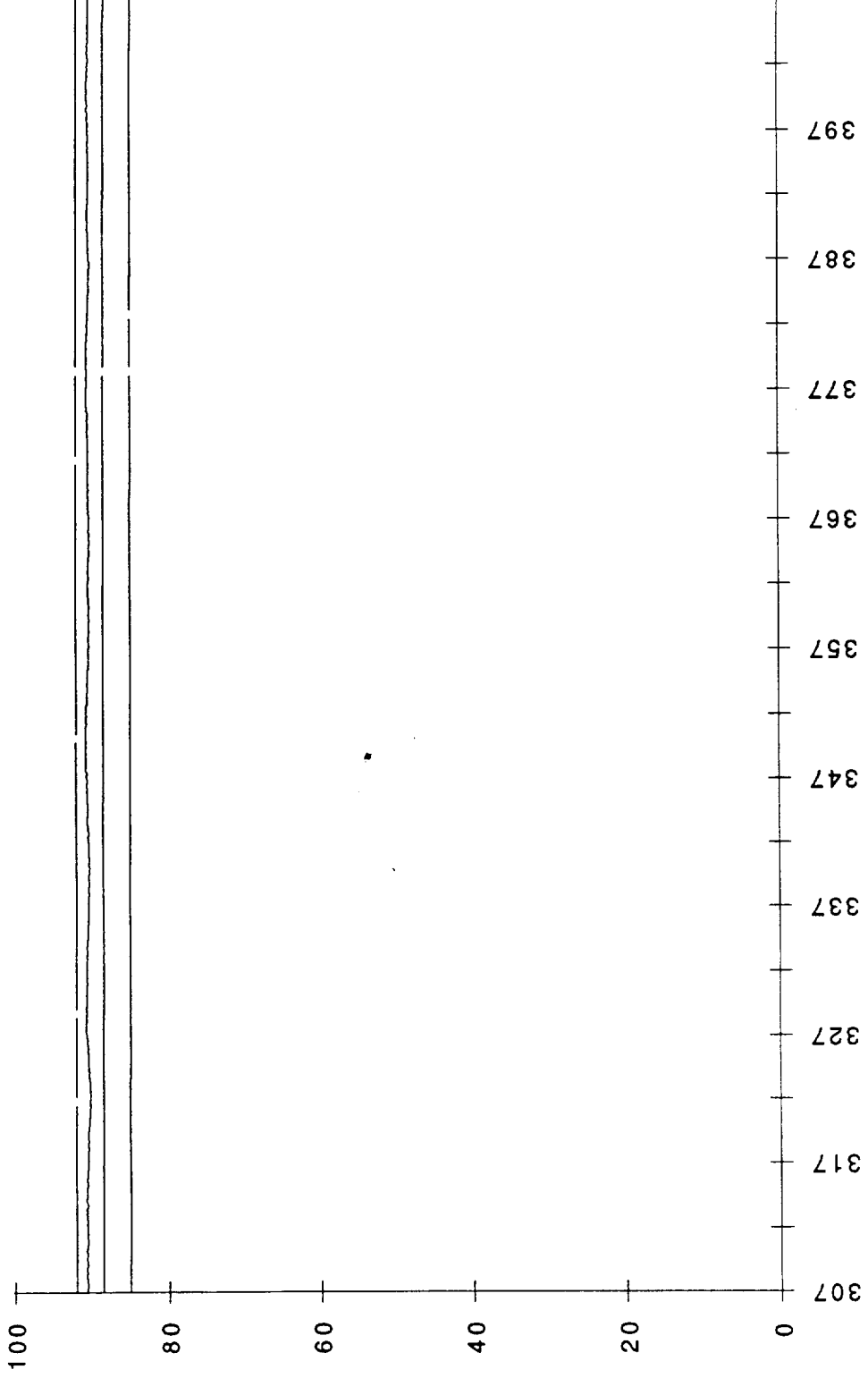

904-172 FPOV pos.T

904-172 FPOV pos.T

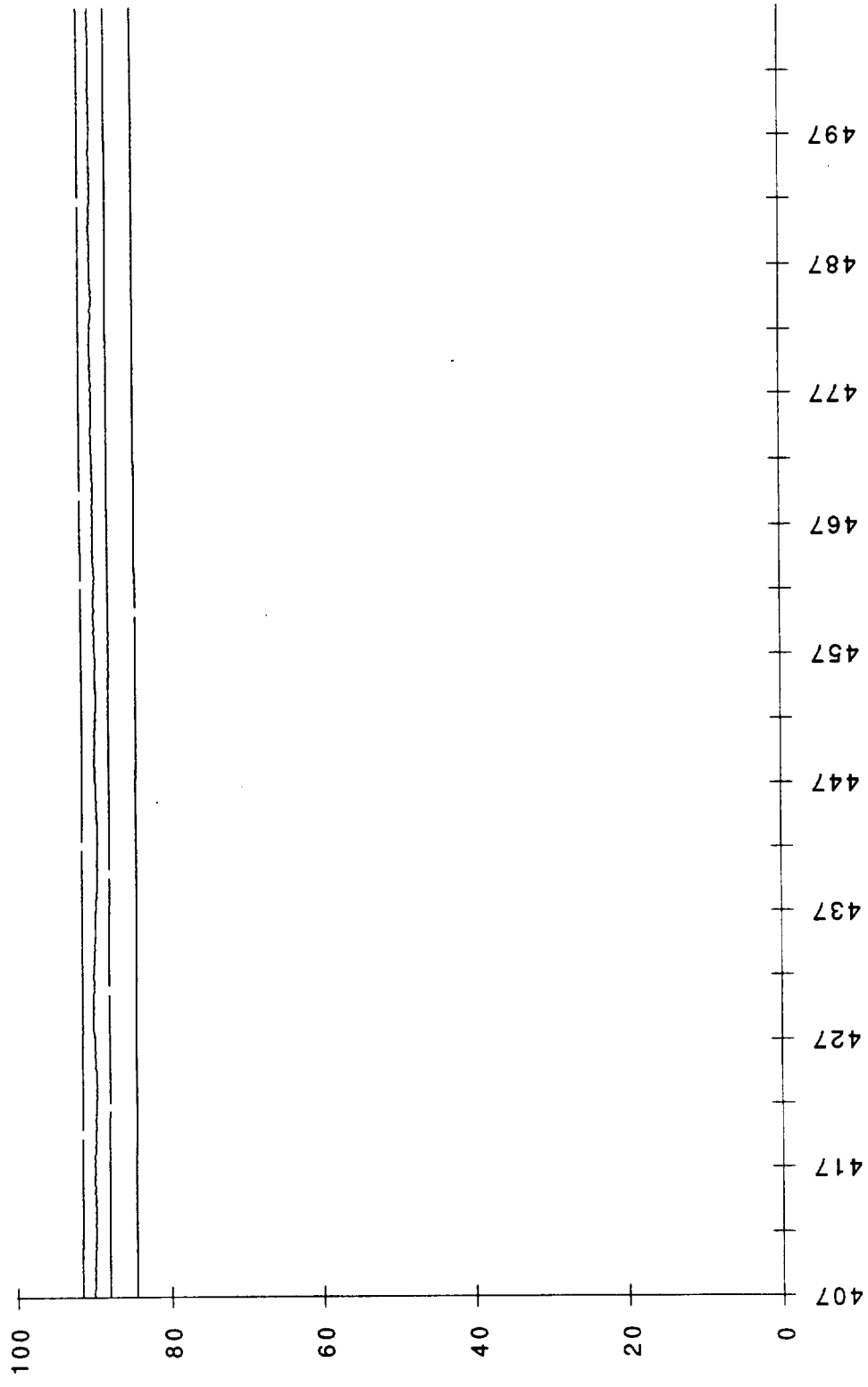

904-172 FPOV pos.T

904-172 FPOV pos.T

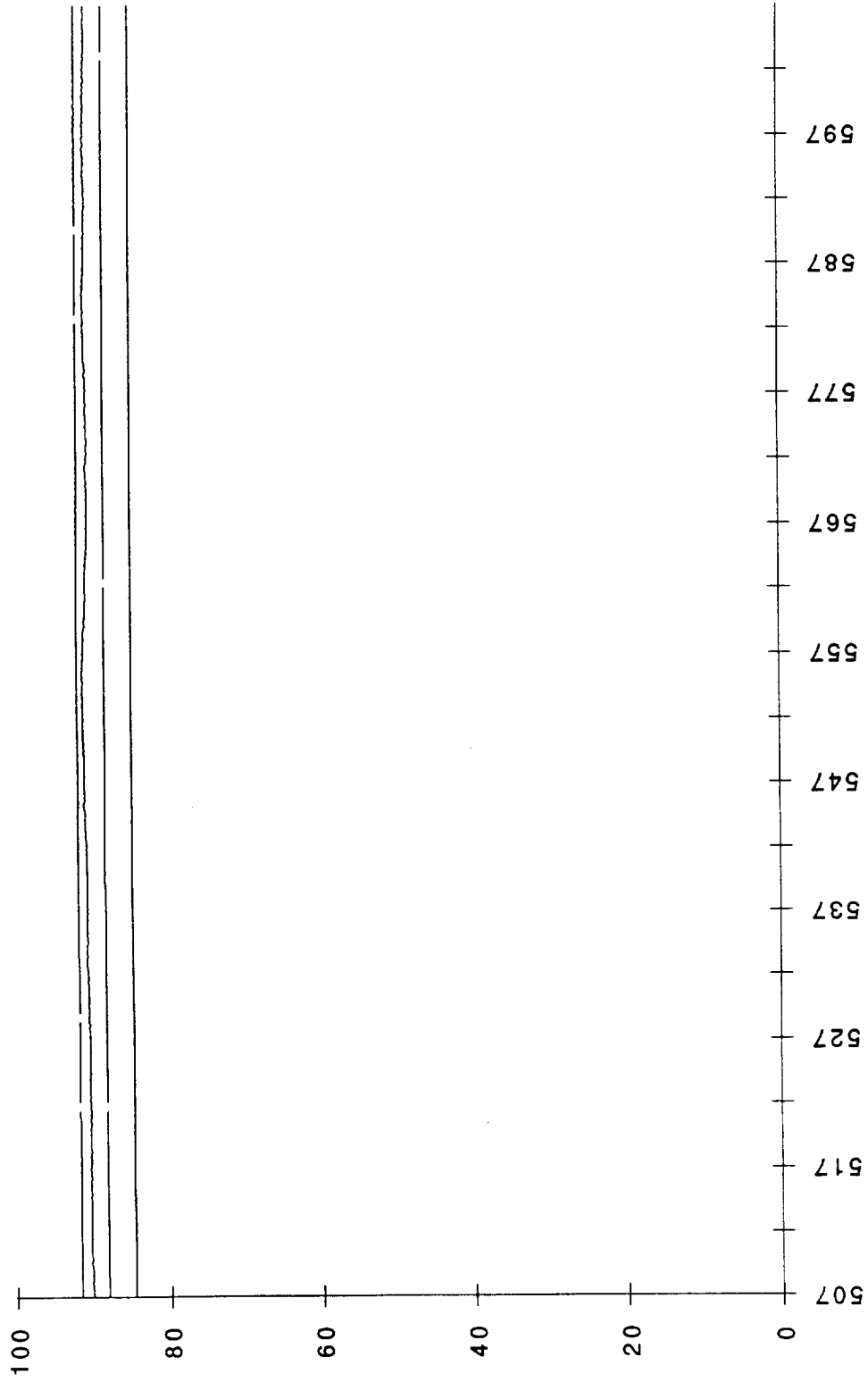

904-172 FPOV pos.T

904-172 FPOV pos .T

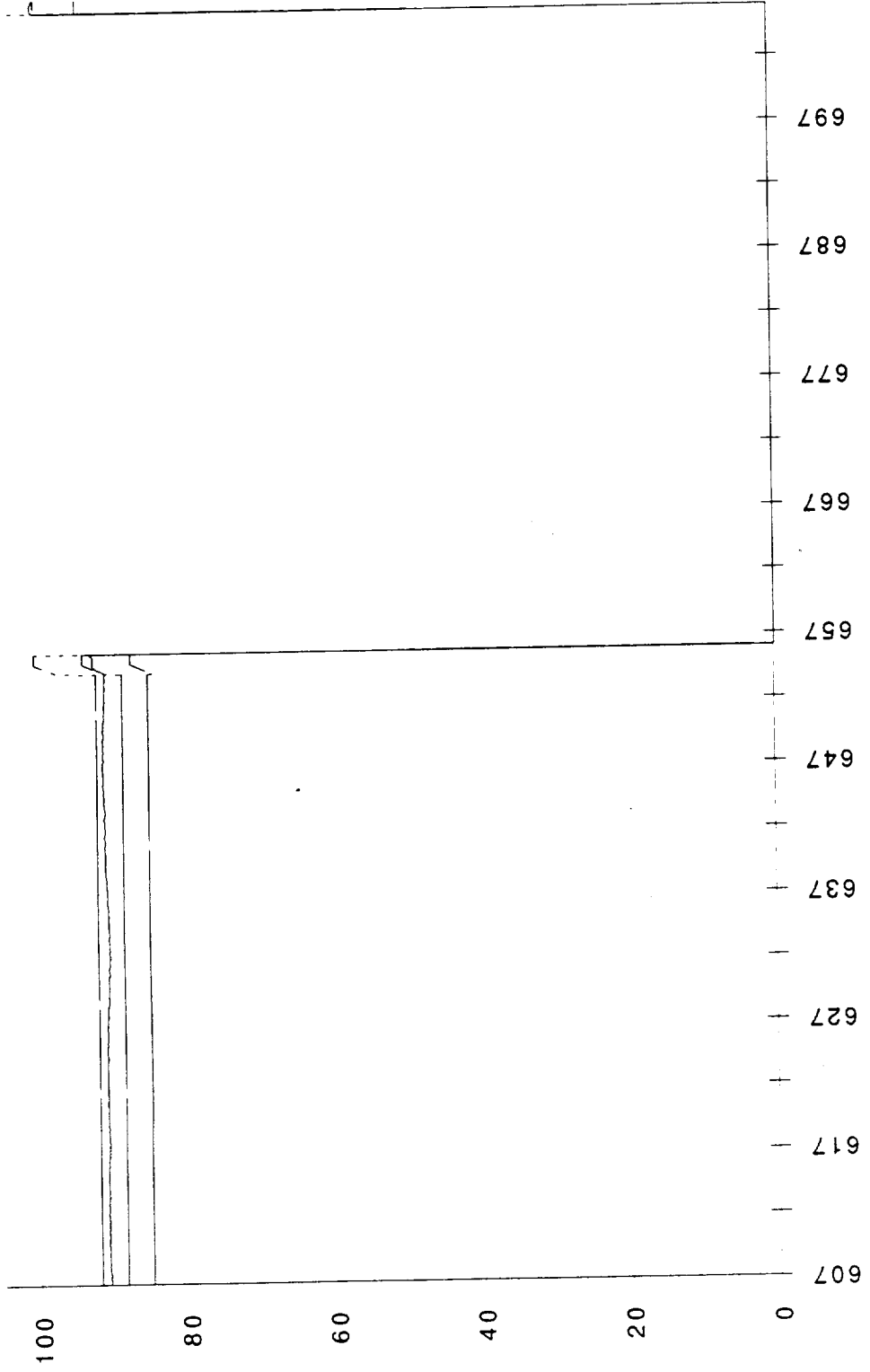

904-172 FPOV pos .T

904-172 FPOV pos .T

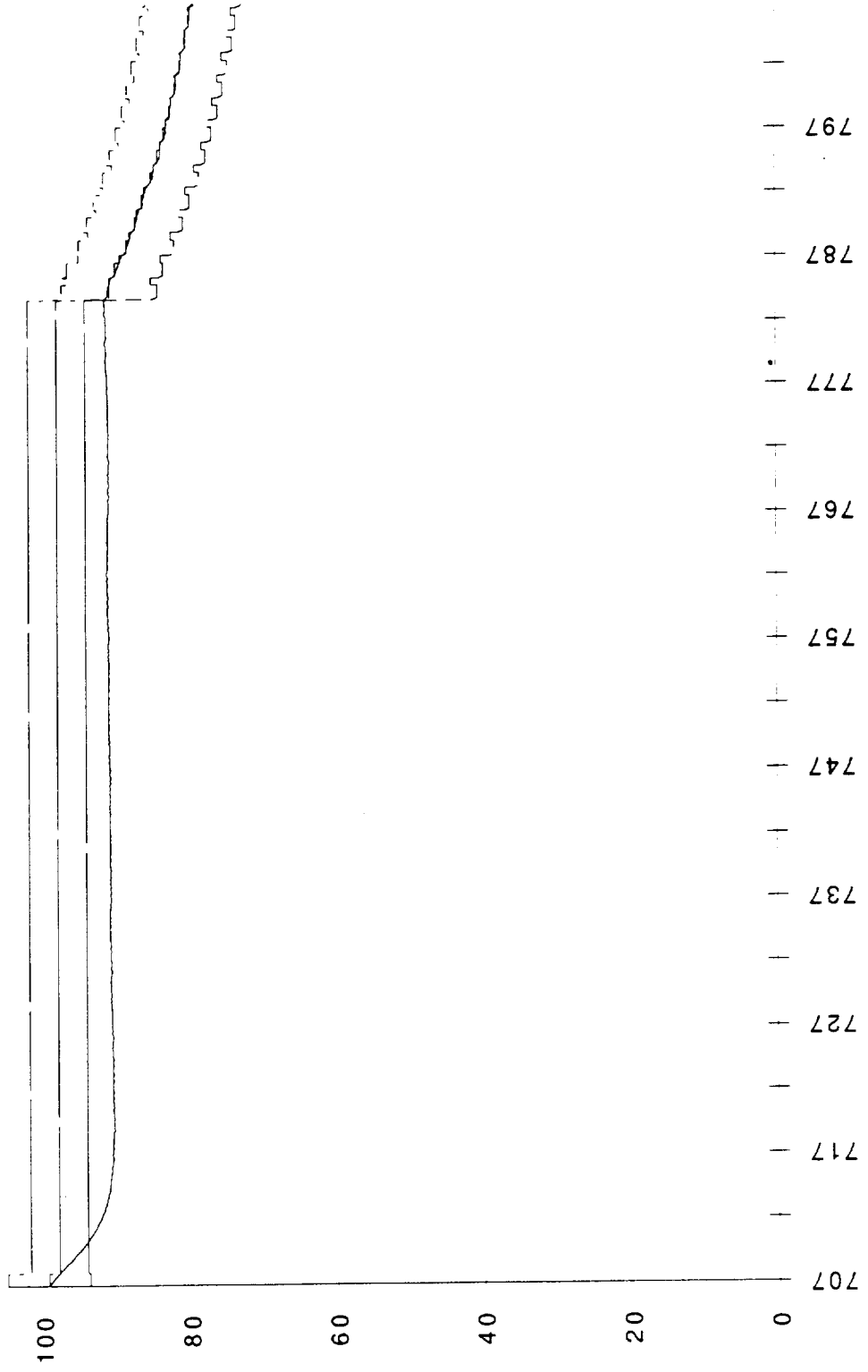

904-172 FPOV pos .T

904-172 FPOV pos .T

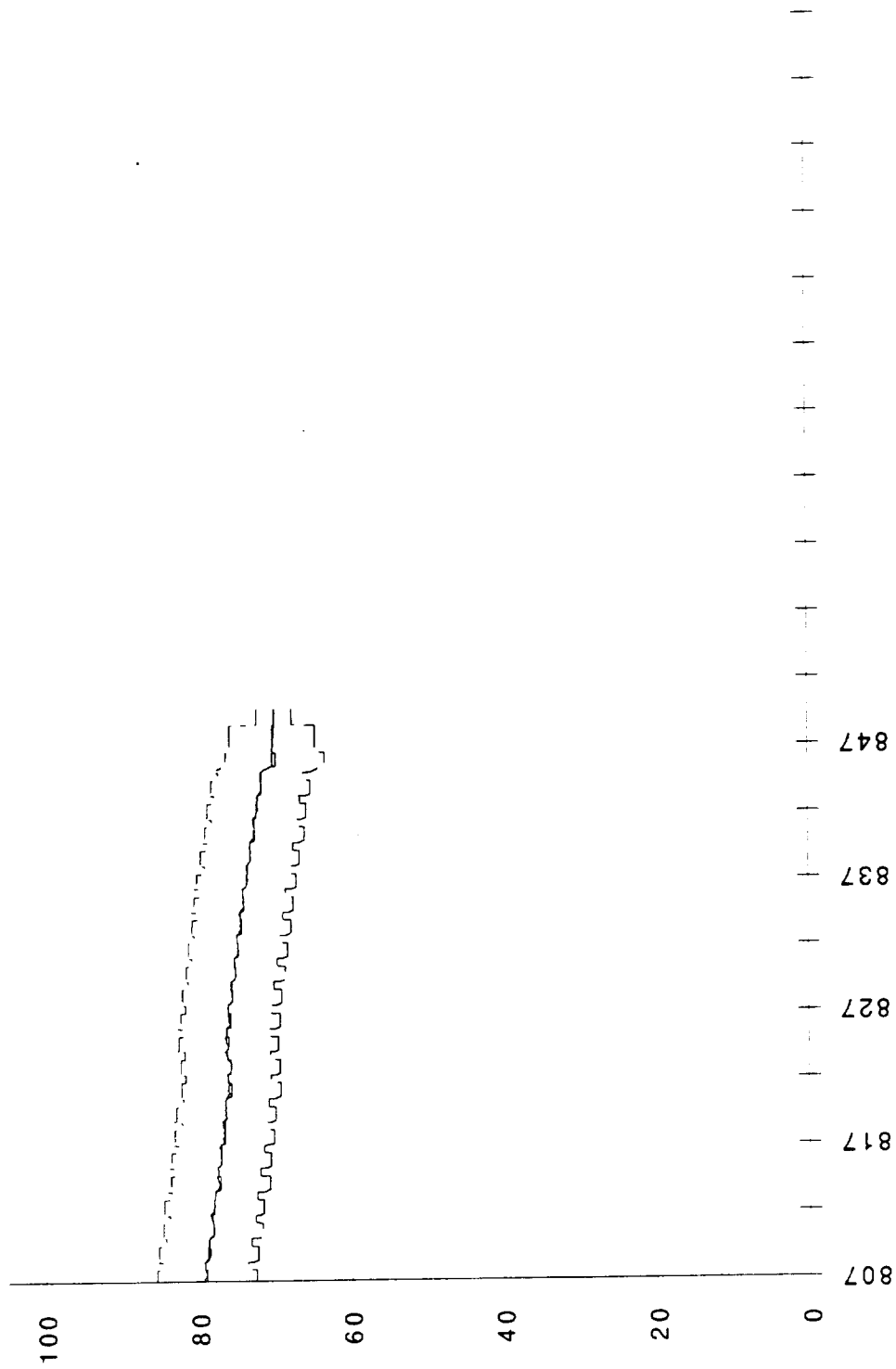

904-172 FPOV pos .T

904-173 FPOV pos.T

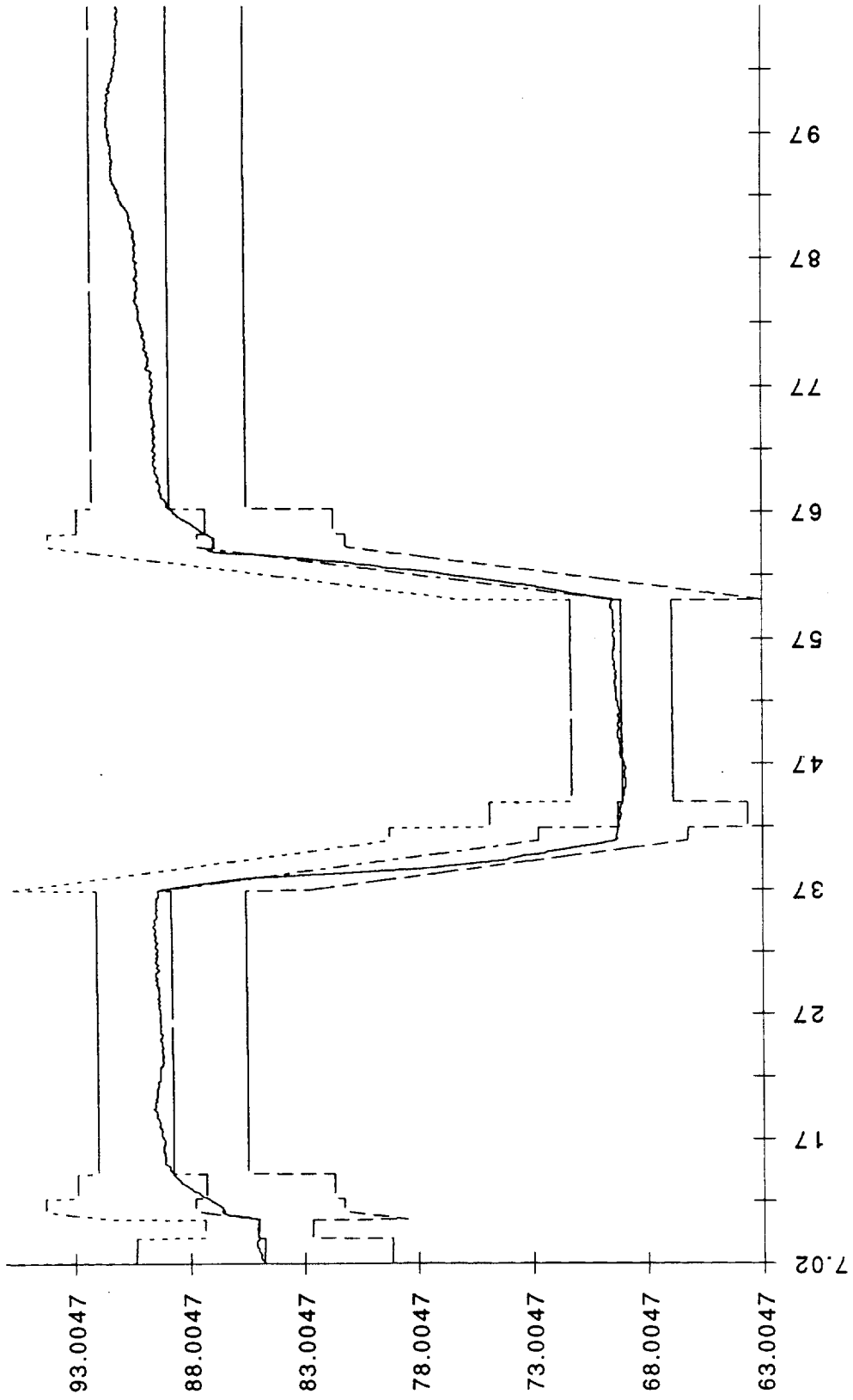

904-173 FPOV pos.T

904-173 FPOV pos.T

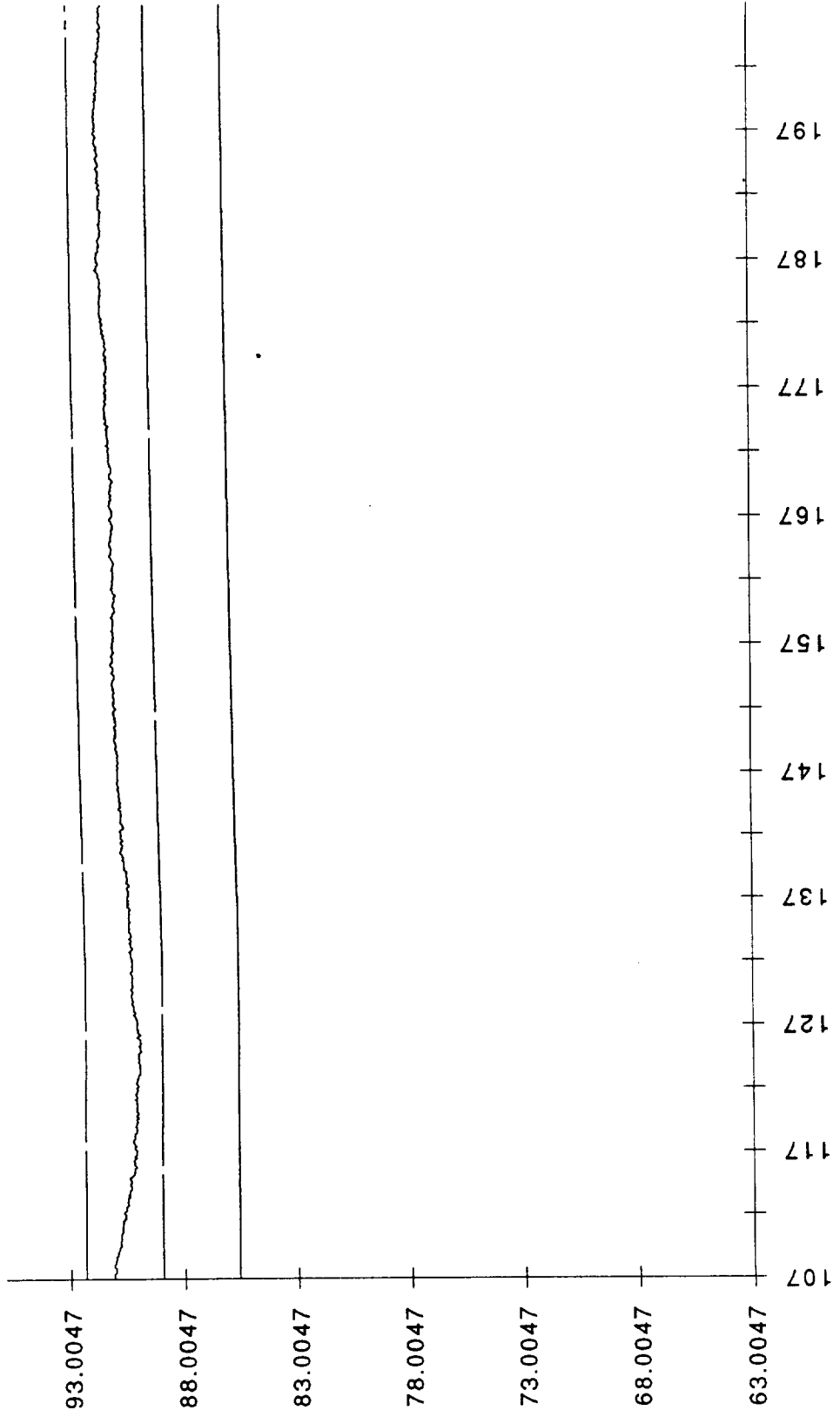

904-173 FPOV pos.T

904-173 FPOV pos.T

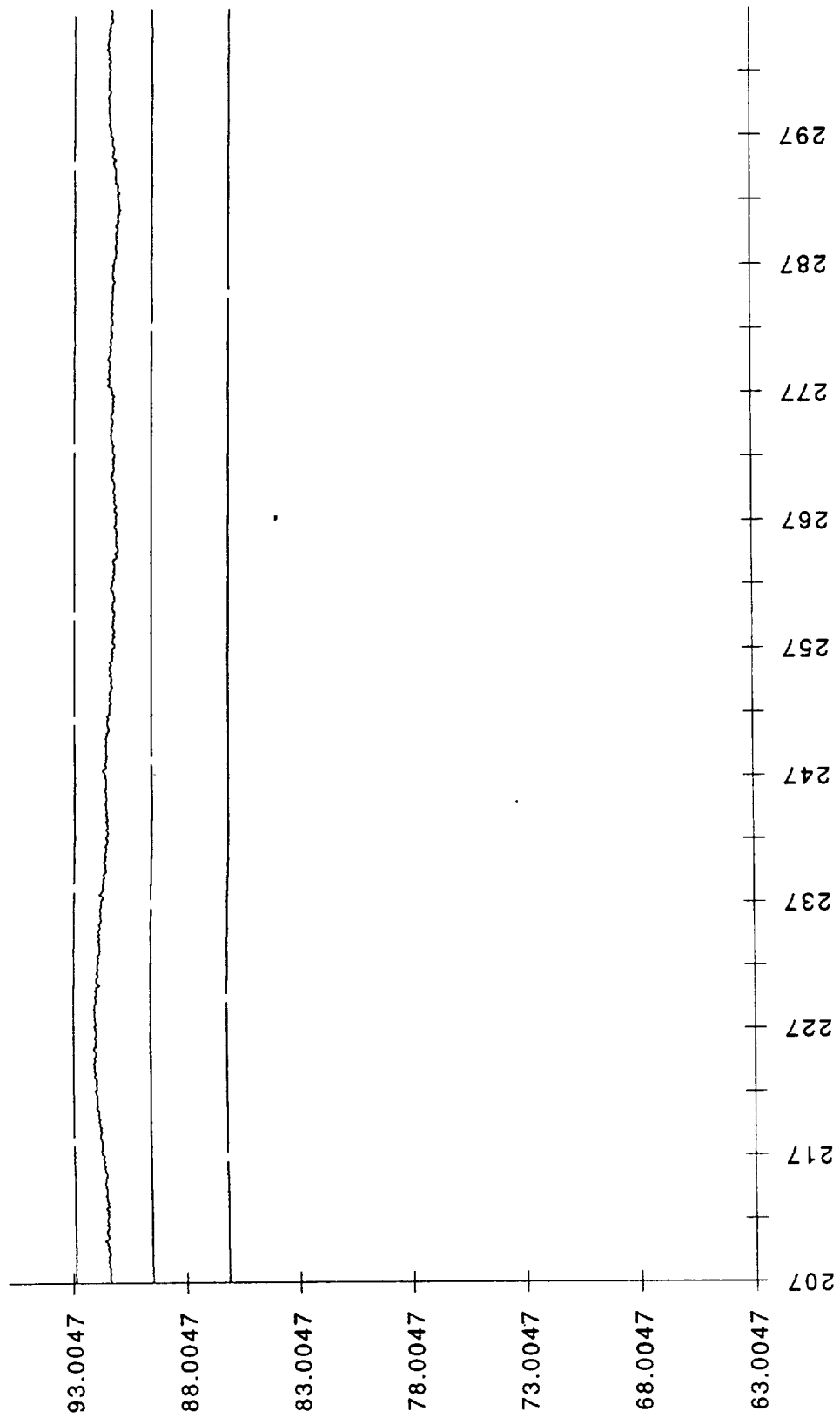

904-173 FPOV pos.T

904-173 FPOV pos.T

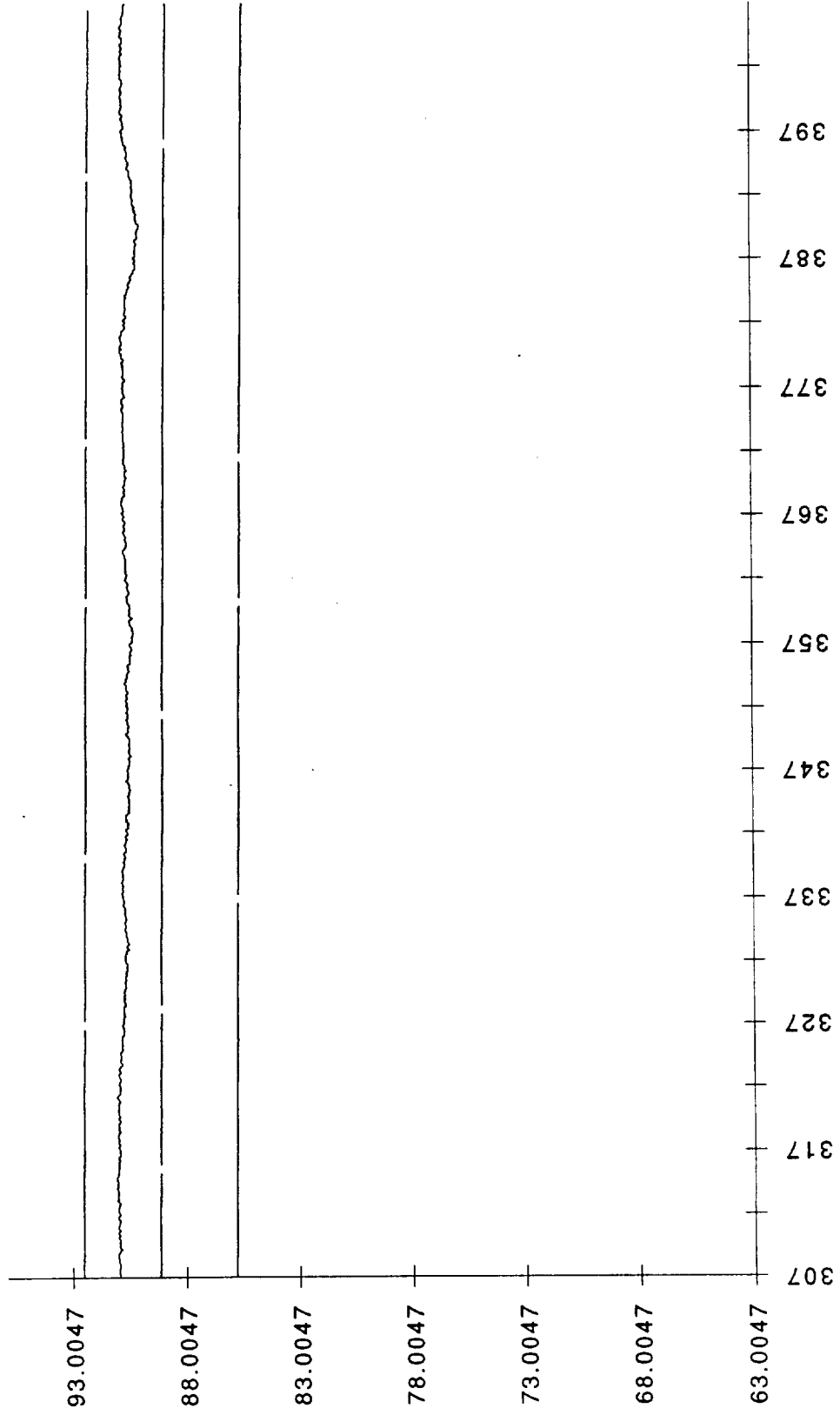

904-173 FPOV pos.T

904-173 FPOV pos.T

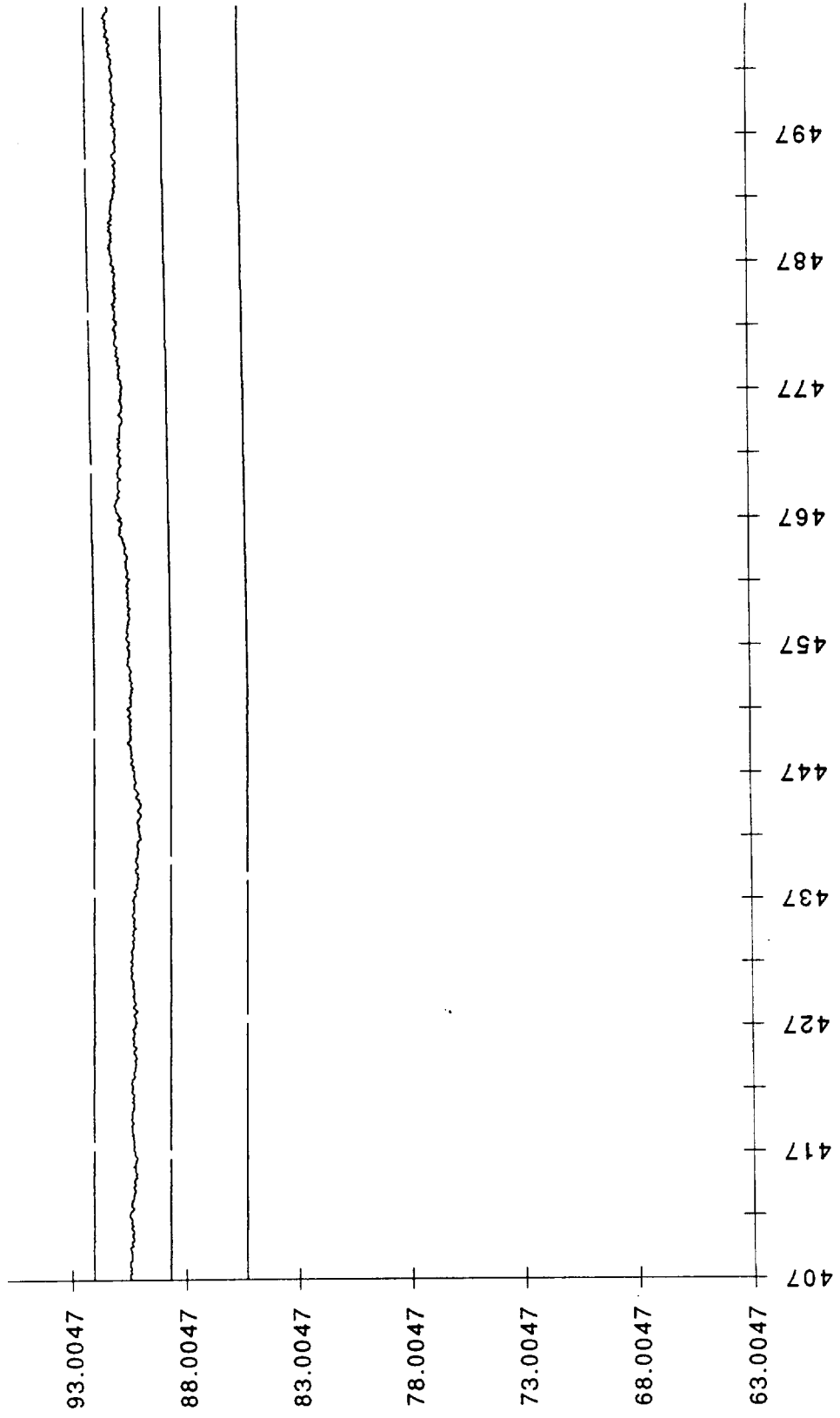

904-173 FPOV pos.T

904-173 FPOV pos.T

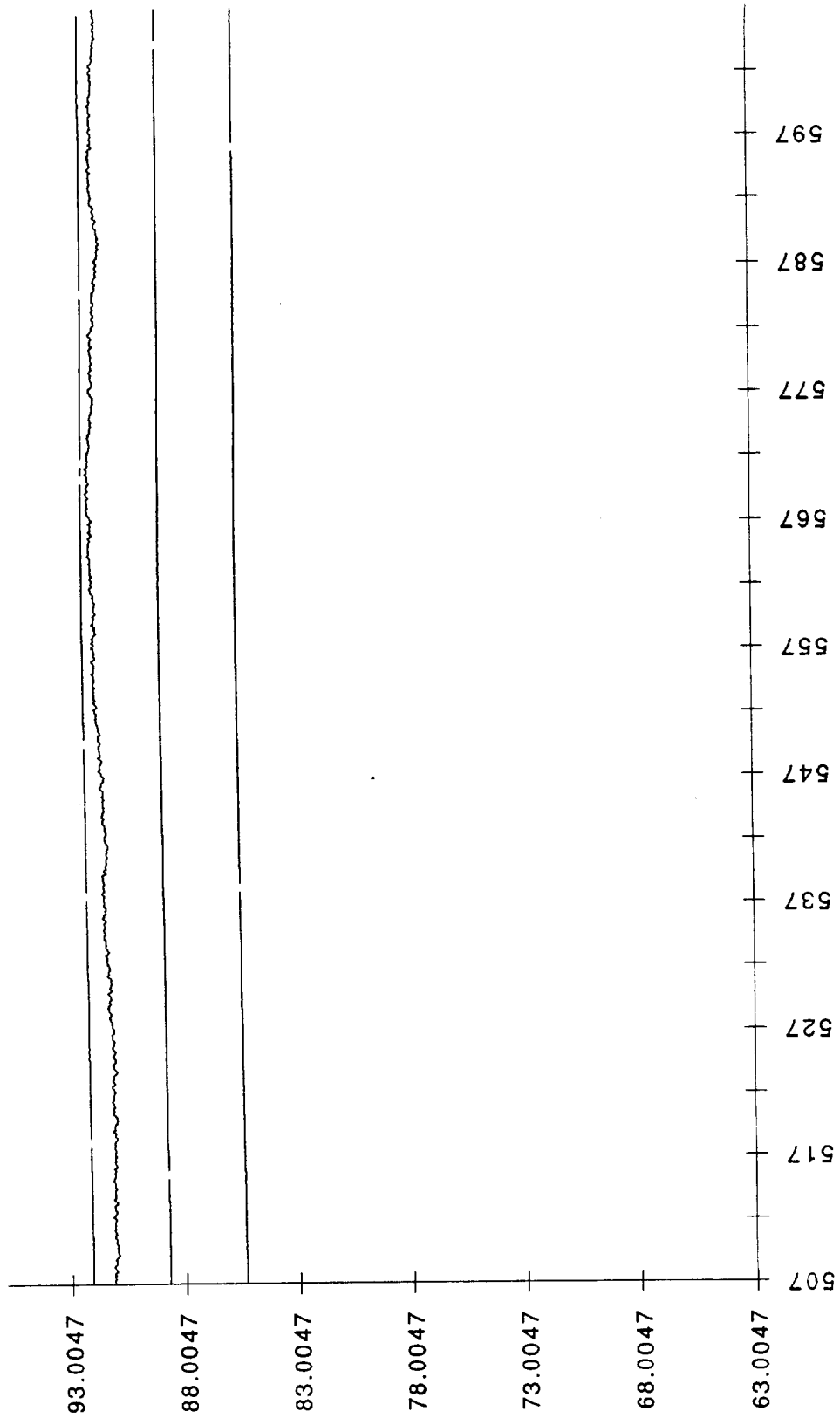

904-173 FPOV pos.T

904-173 FPOV pos .T

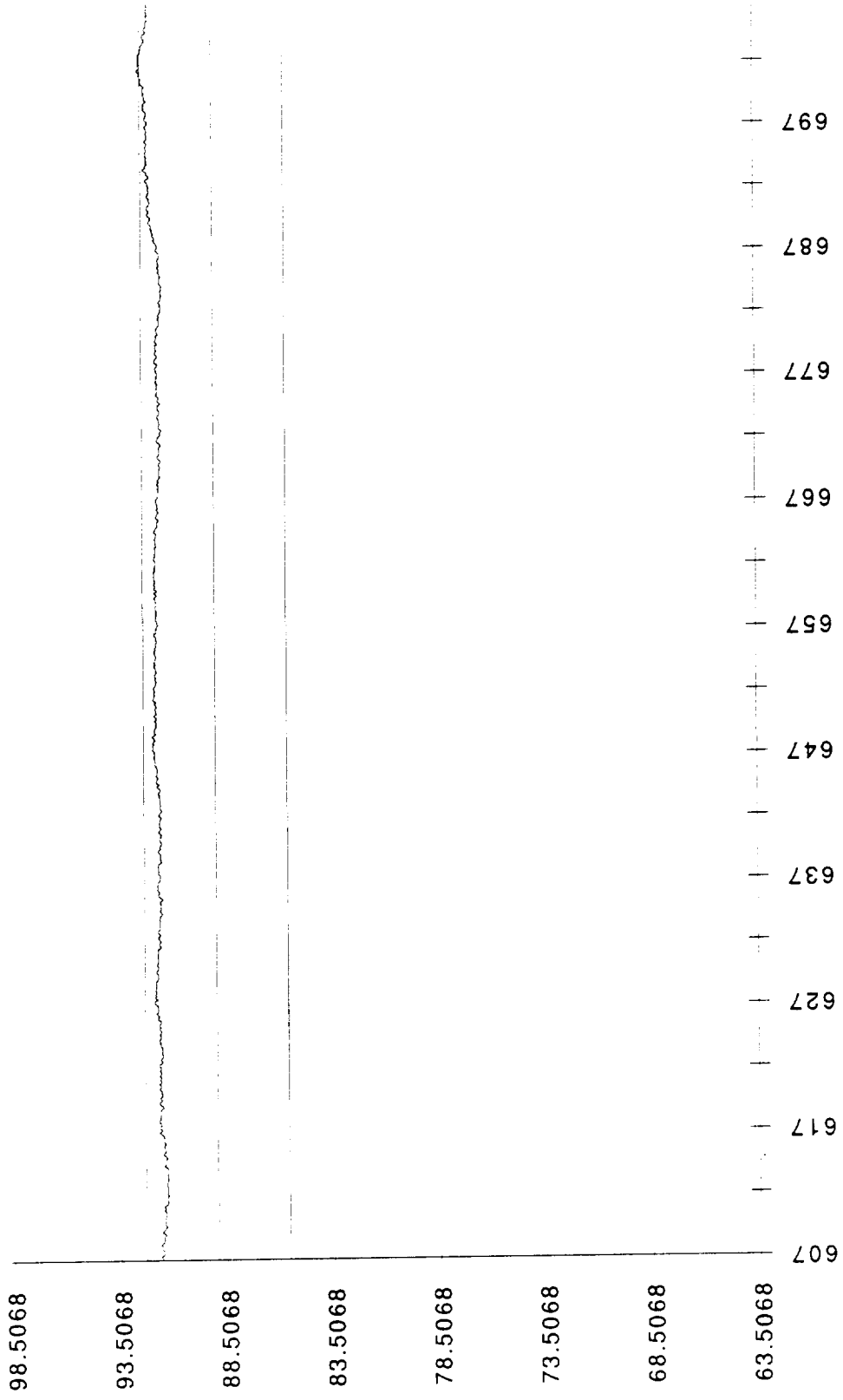

904-173 FPOV pos .T

904-173 FPOV pos .T

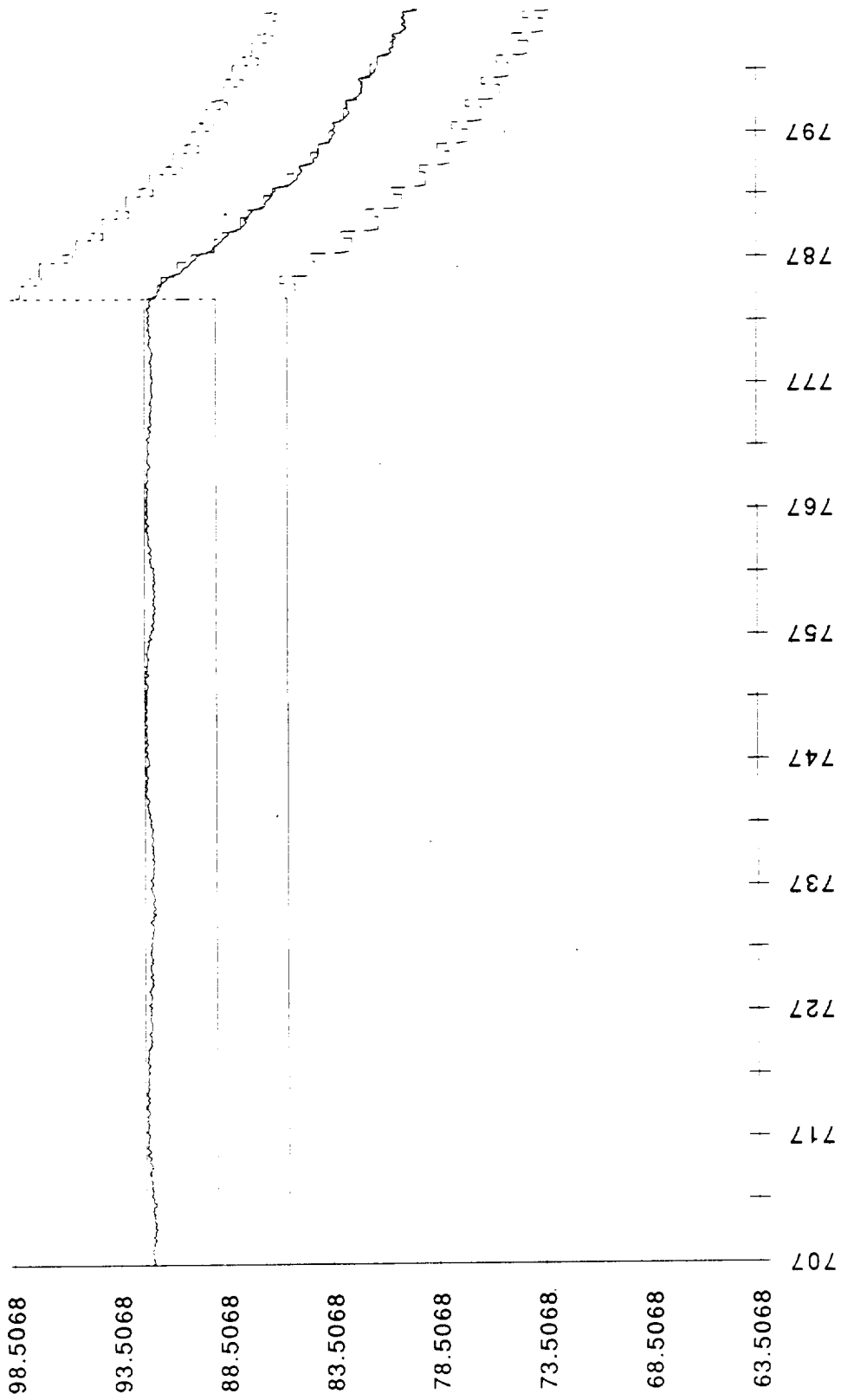

904-173 FPOV pos .T

904-173 FPOV pos .T

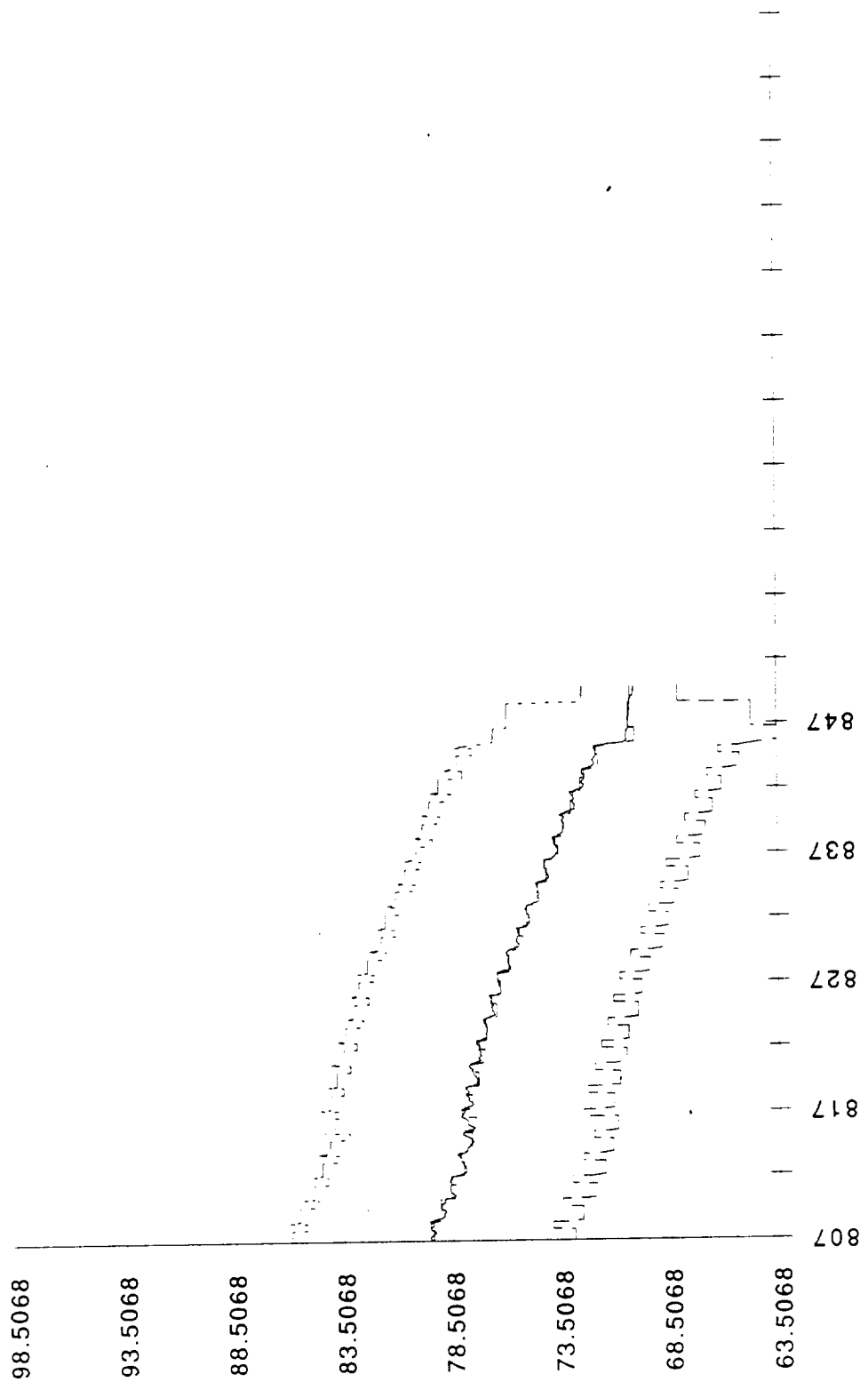

904-173 FPOV pos .T

904-174 HPOP SSC pr.T

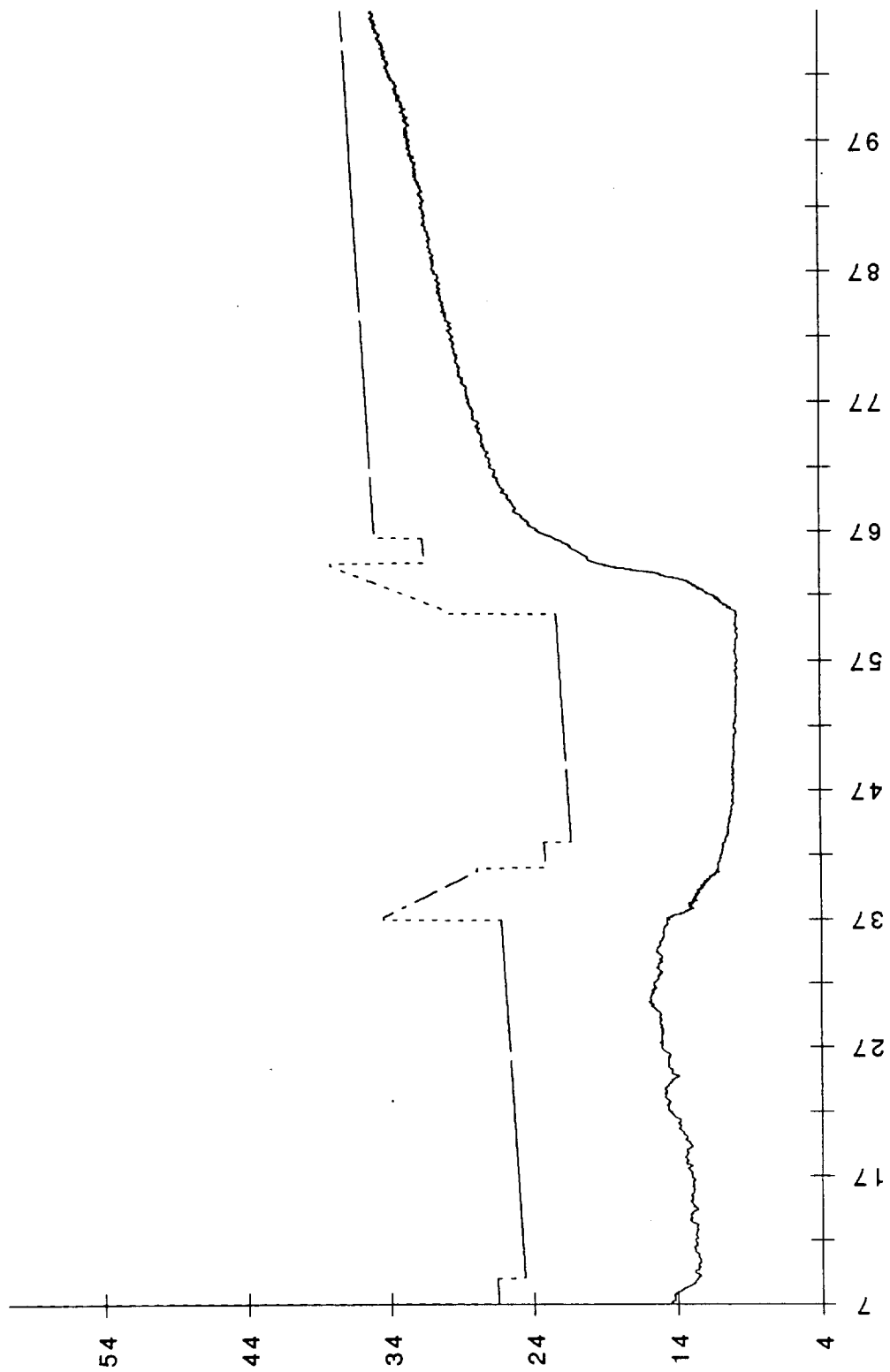

904-174 HPOP SSC pr.T

904-174 HPOP SSC pr.T

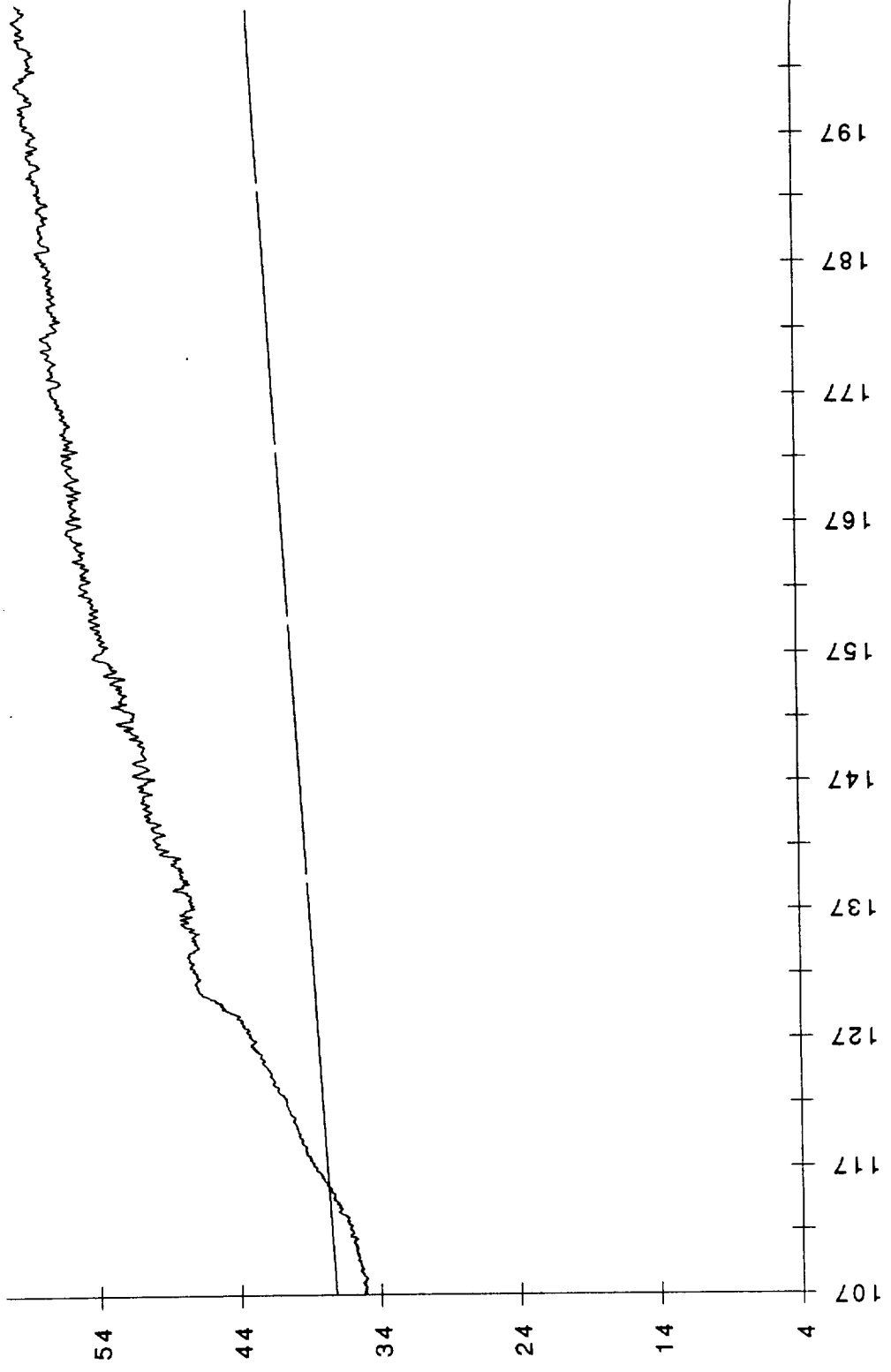

904-174 HPOP SSC pr.T

904-174 HPOP SSC pr.T

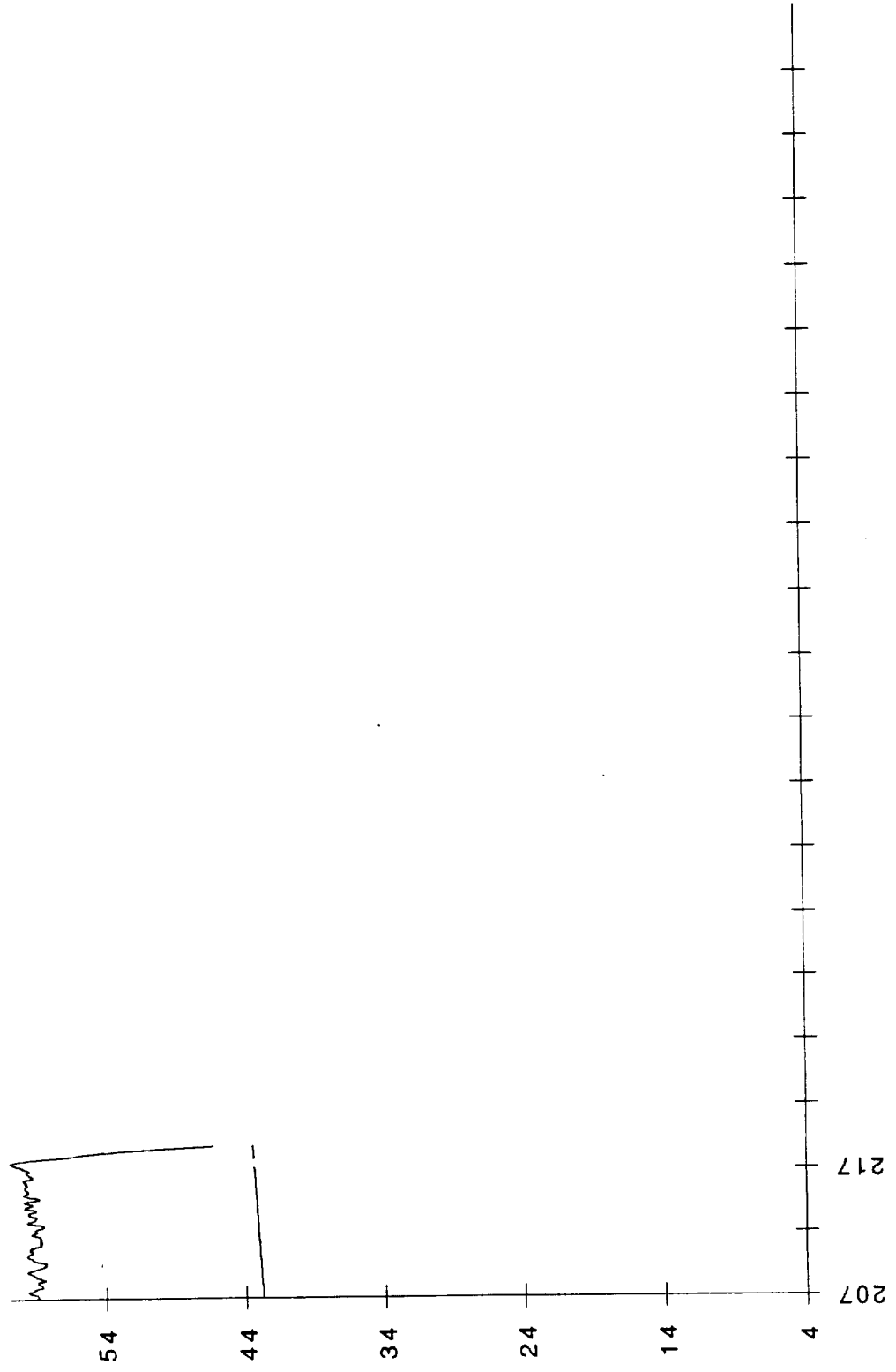

904-174 HPOP SSC pr.T

904-180 HPFP accel.T

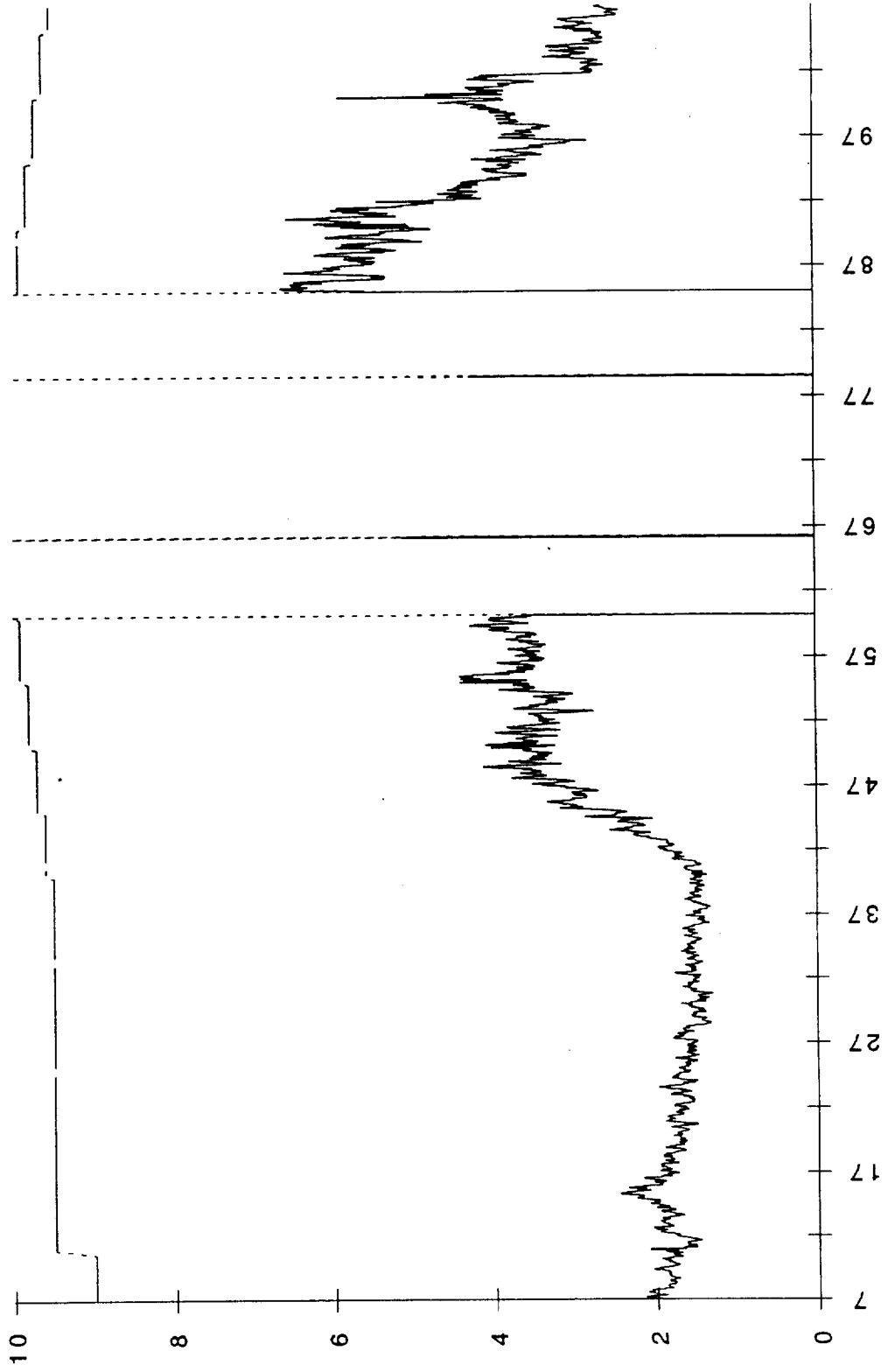

904-180 HPFP accel.T

904-180 HPFP accel.T

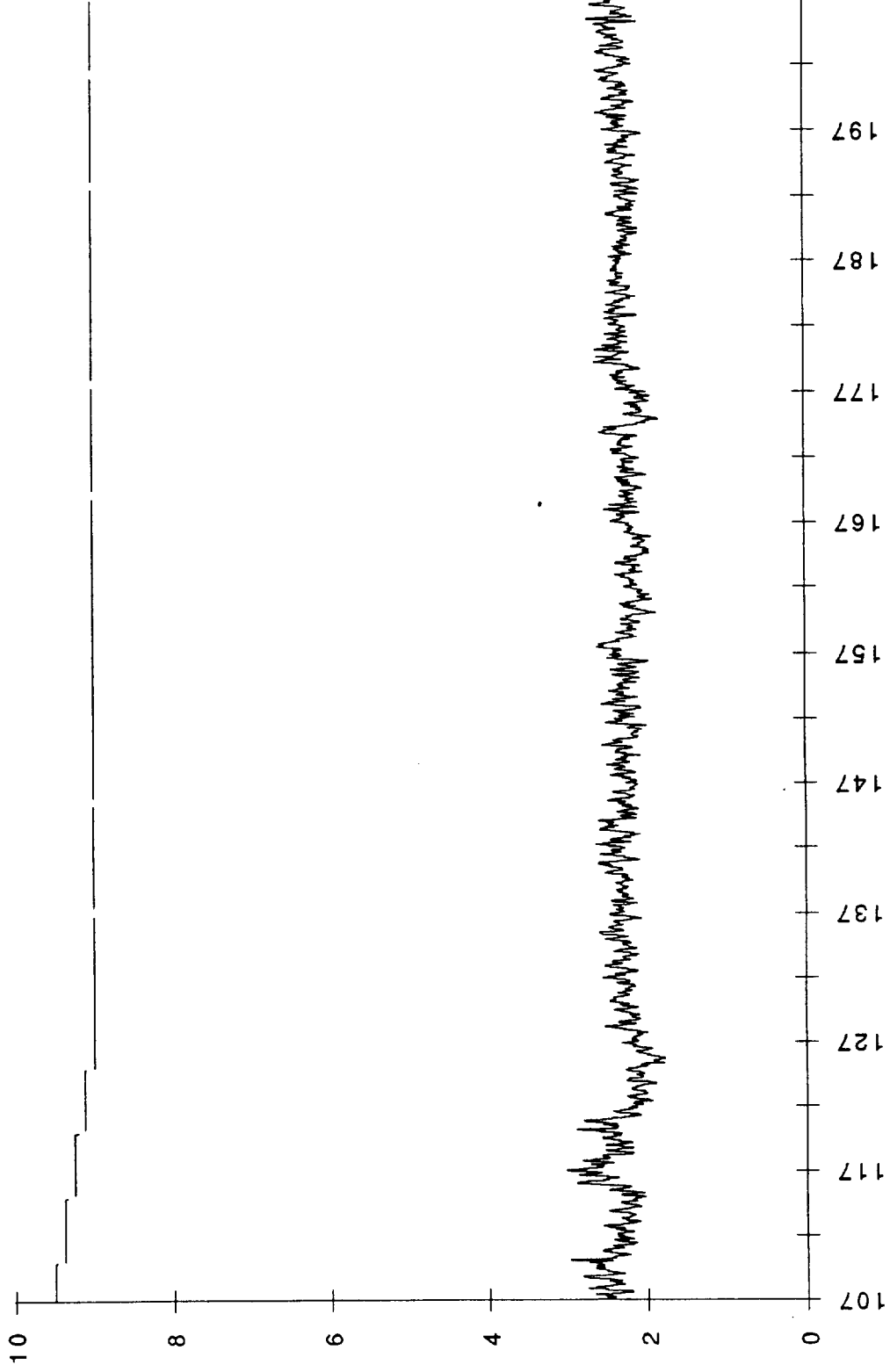

904-180 HPFP accel.T

904-180 HPFP accel.T

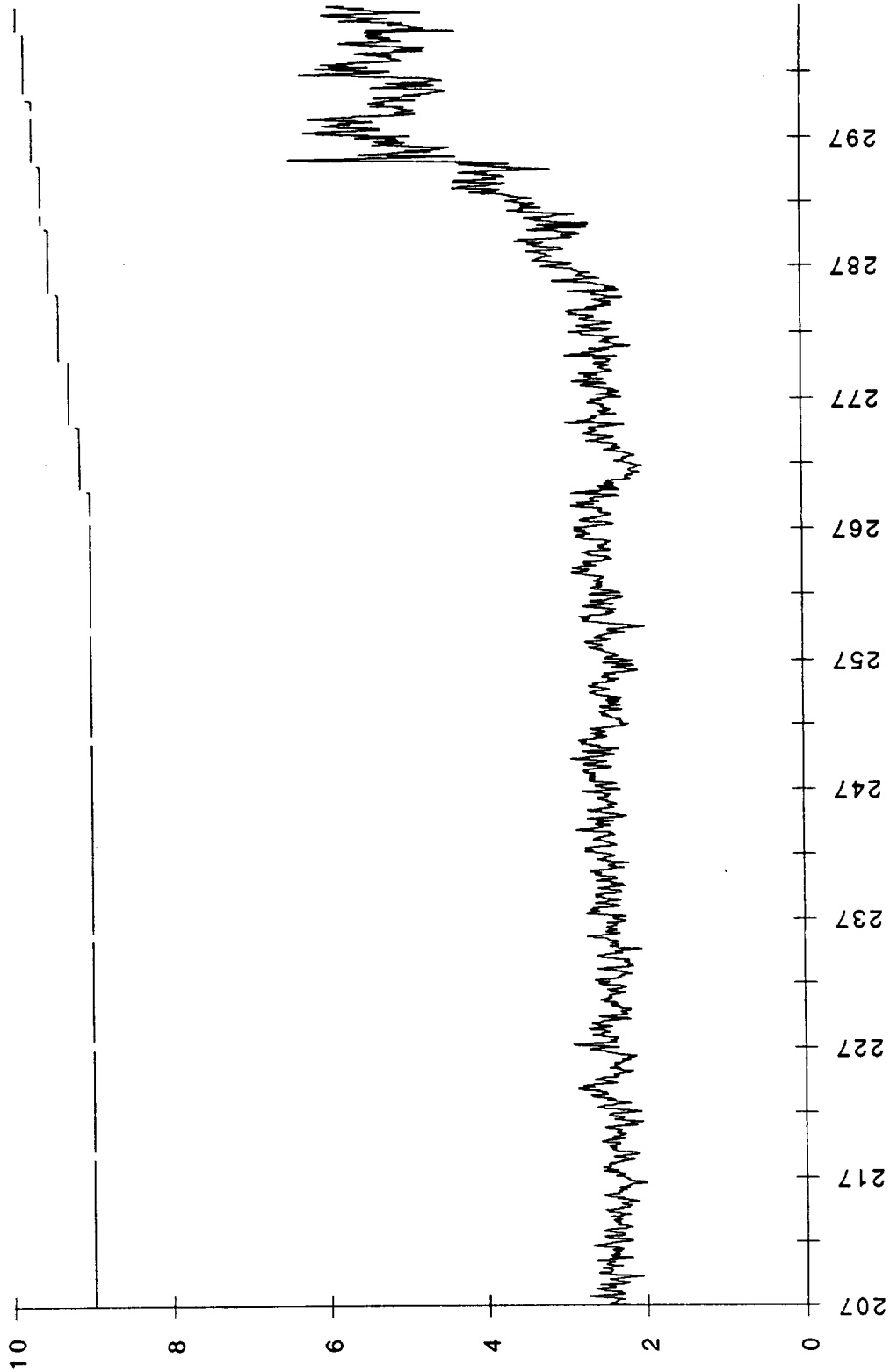

904-180 HPFP accel.T

904-180 HPFP accel.T

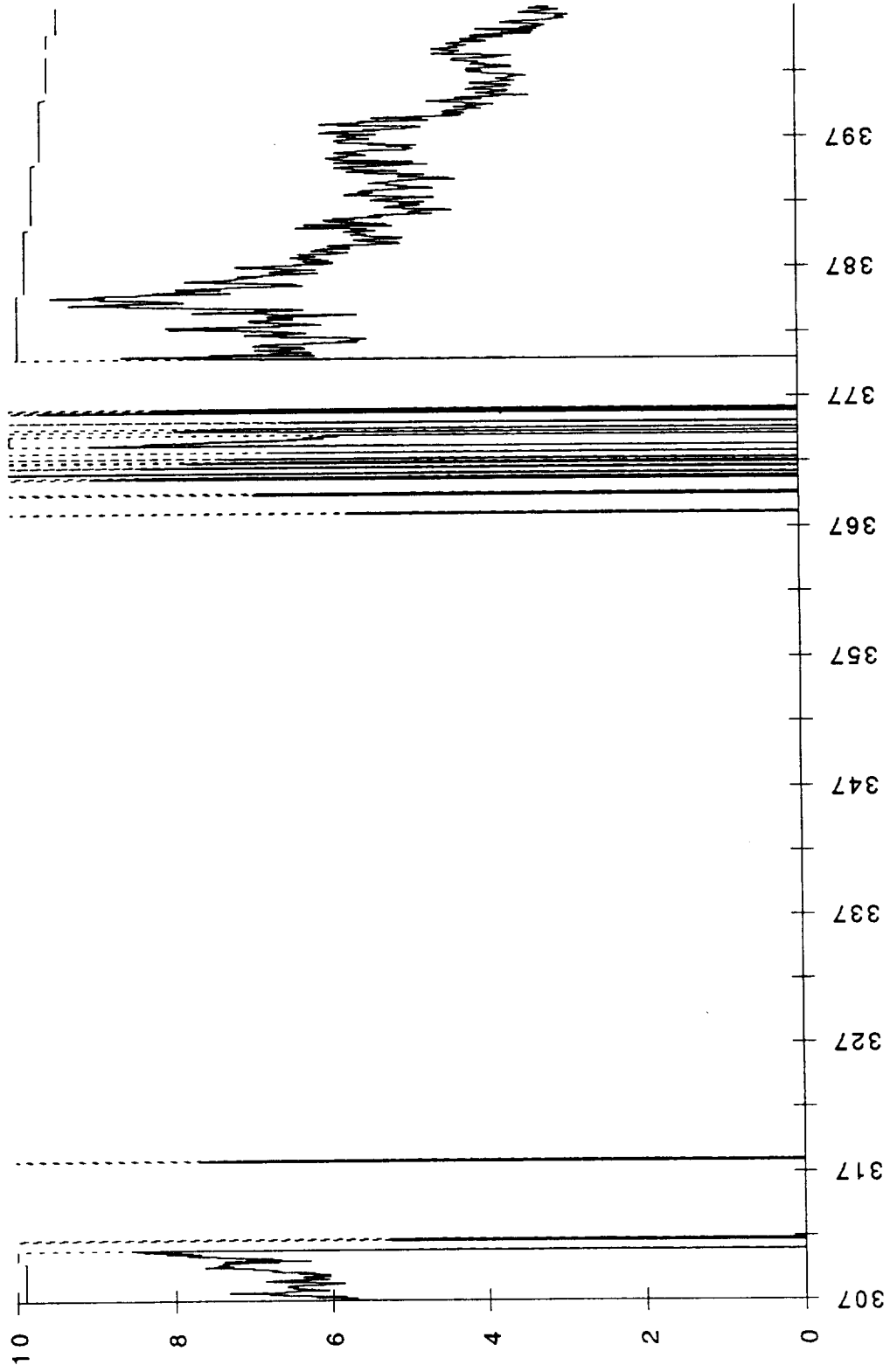

904-180 HPFP accel.T

904-180 HPFP accel.T

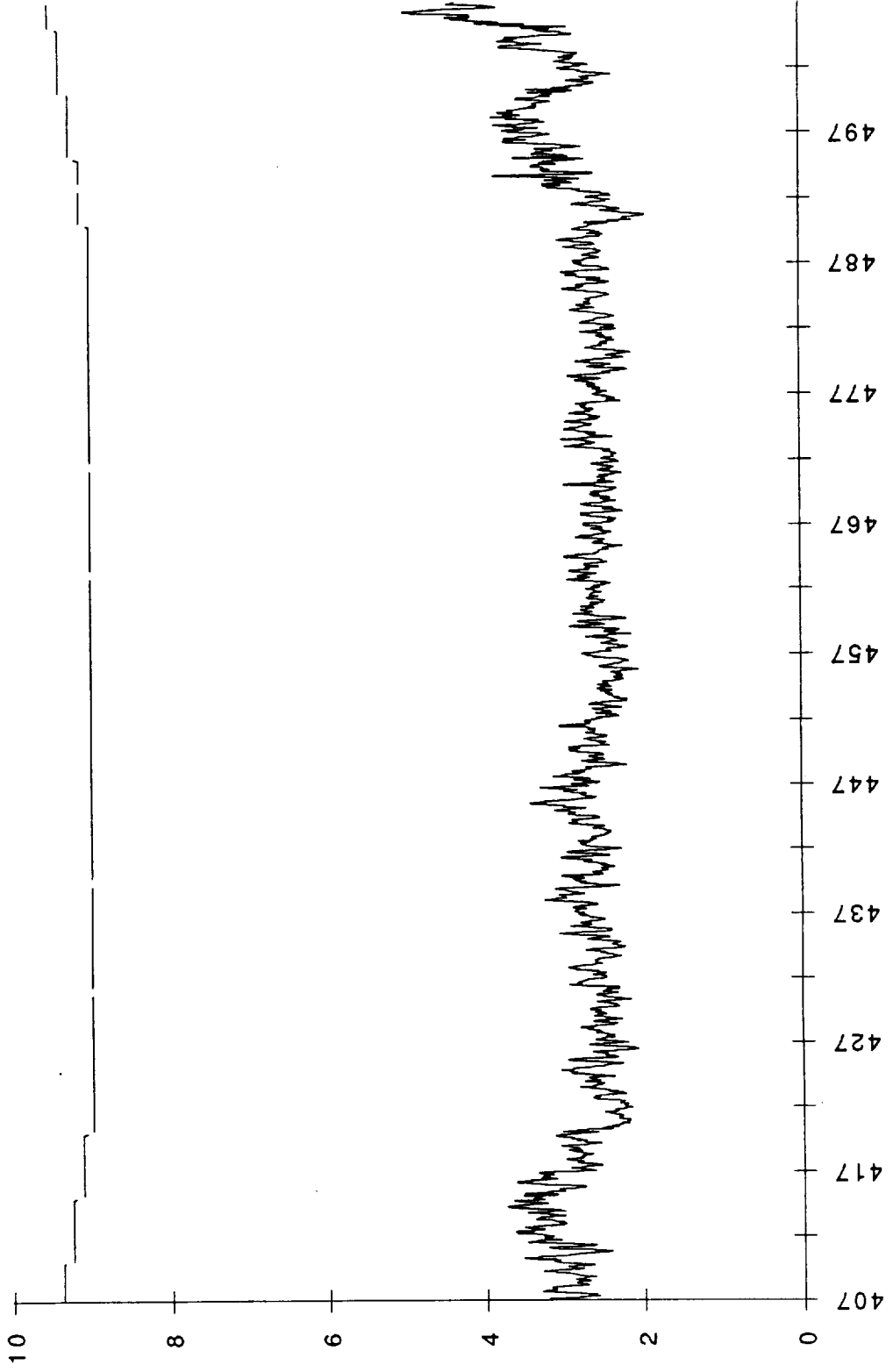

904-180 HPFP accel.T

904-180 HPFP accel.T

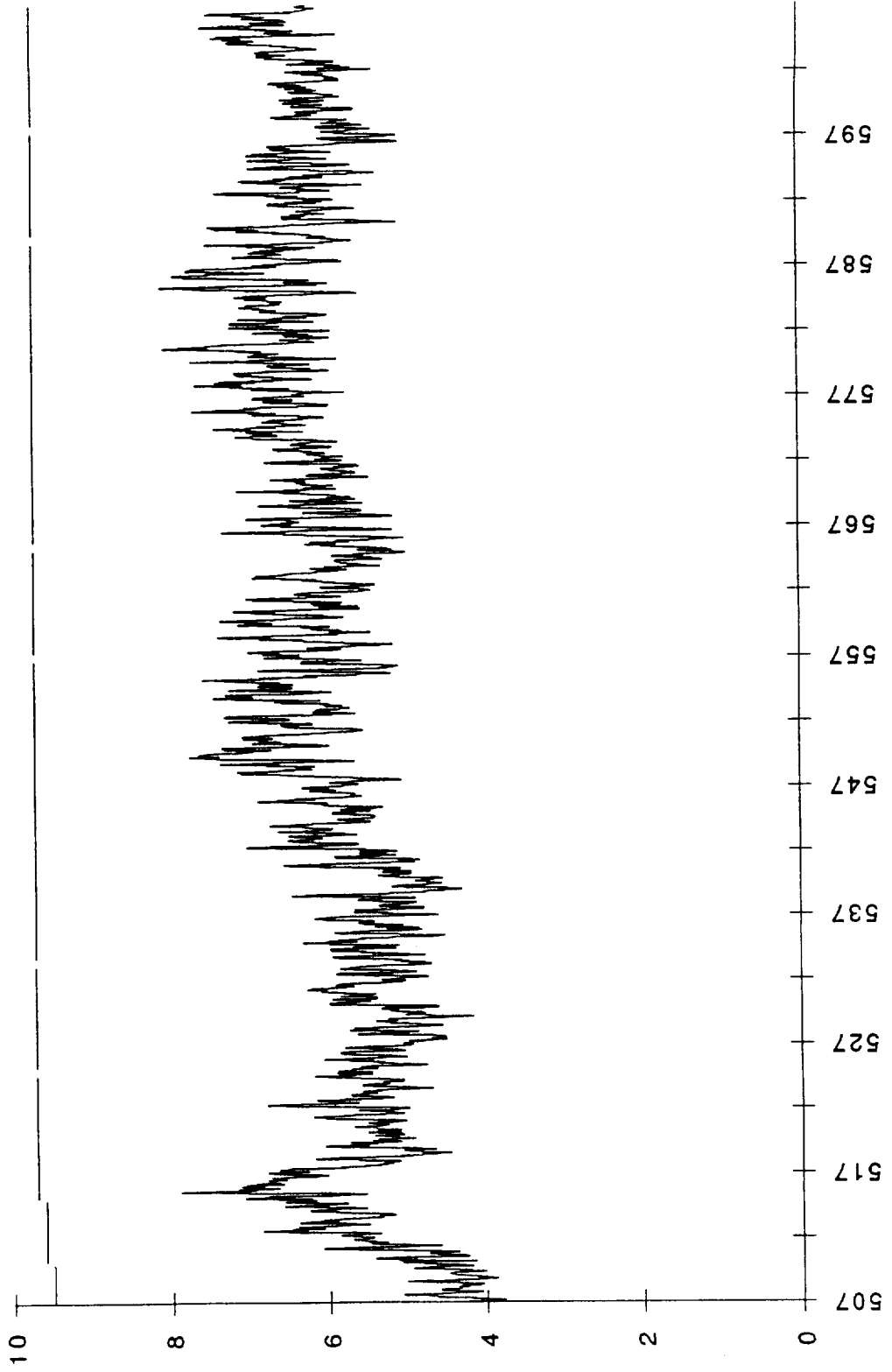

904-180 HPFP accel.T

Appendix C3
Good Test Plot
Pratt LOX Pump w/ Modified CCV Schedule

901-723 HPFP TDT A.T

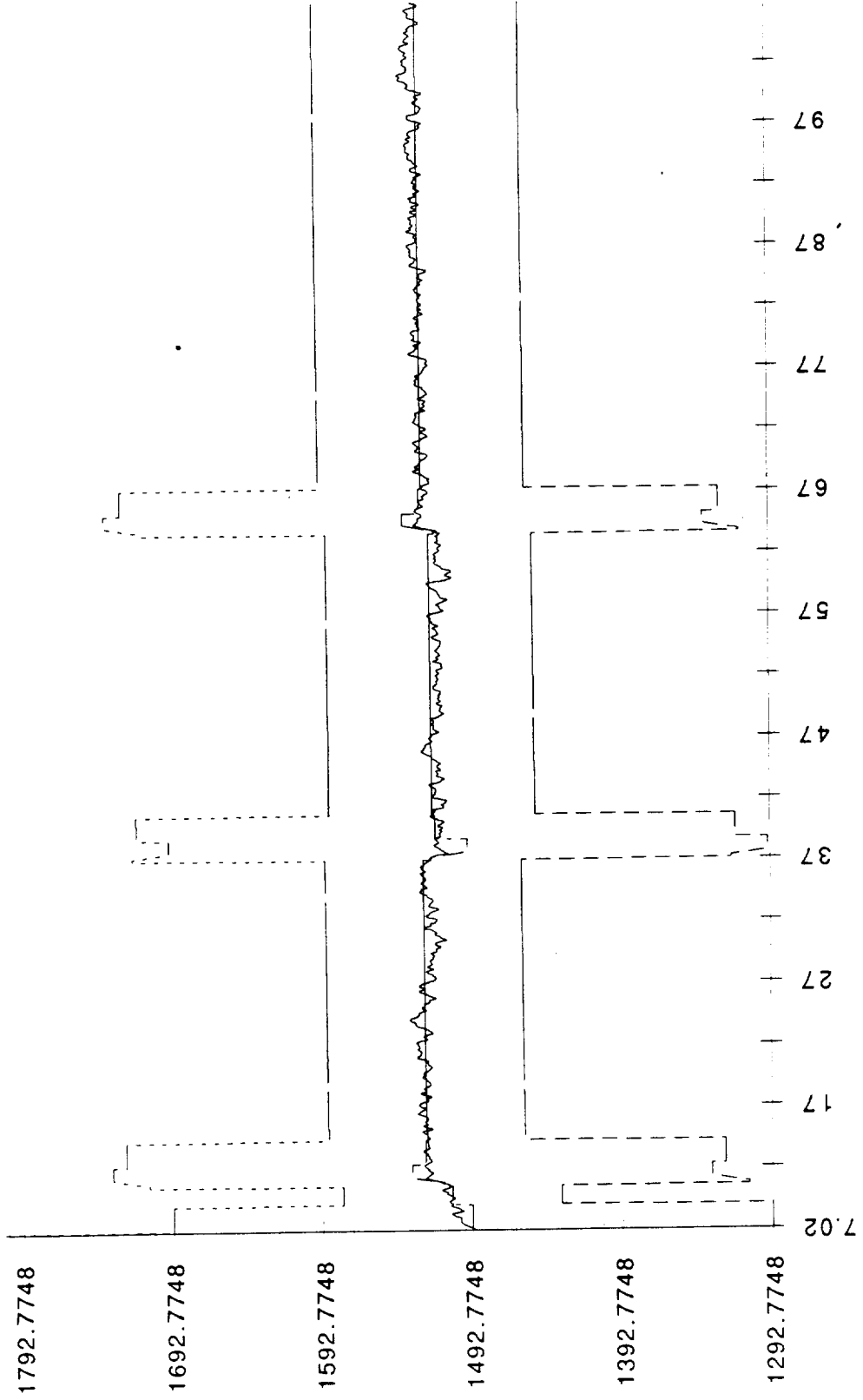

901-723 HPFP TDT A.T

901-723 HPFP TDT A.T

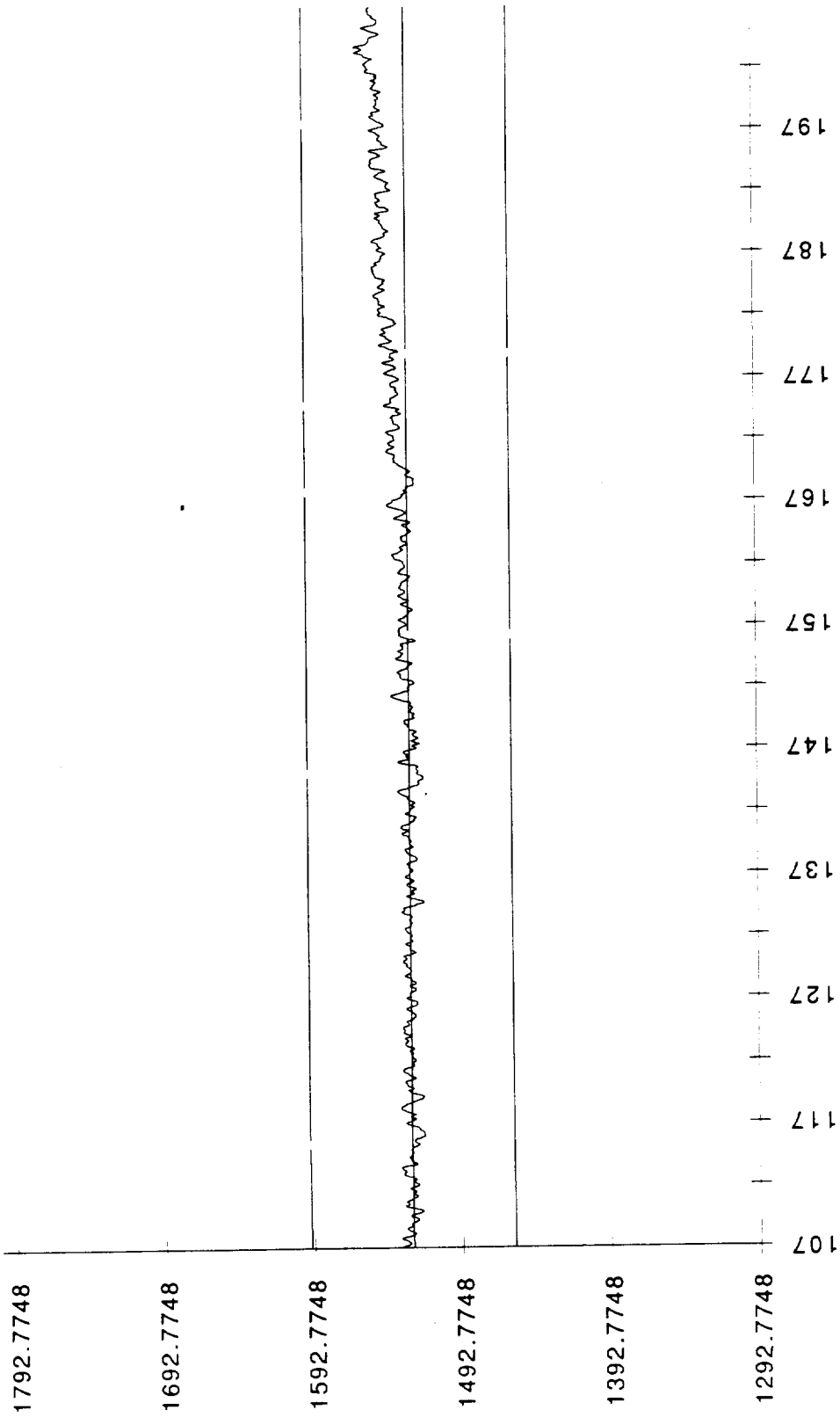

901-723 HPFP TDT A.T

901-723 HPFP TDT A.T

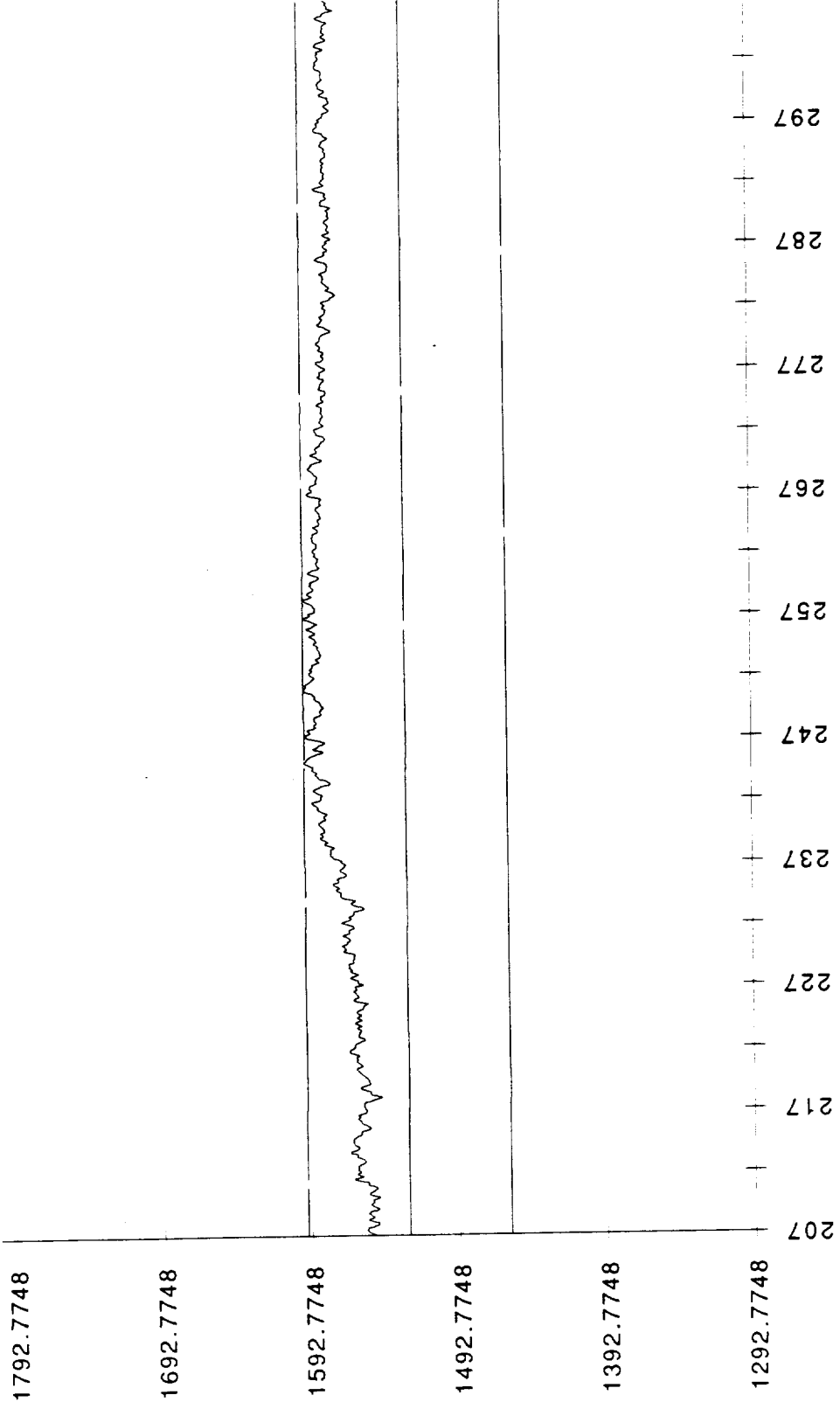

901-723 HPFP TDT A.T

901-723 HPFP TDT A.T

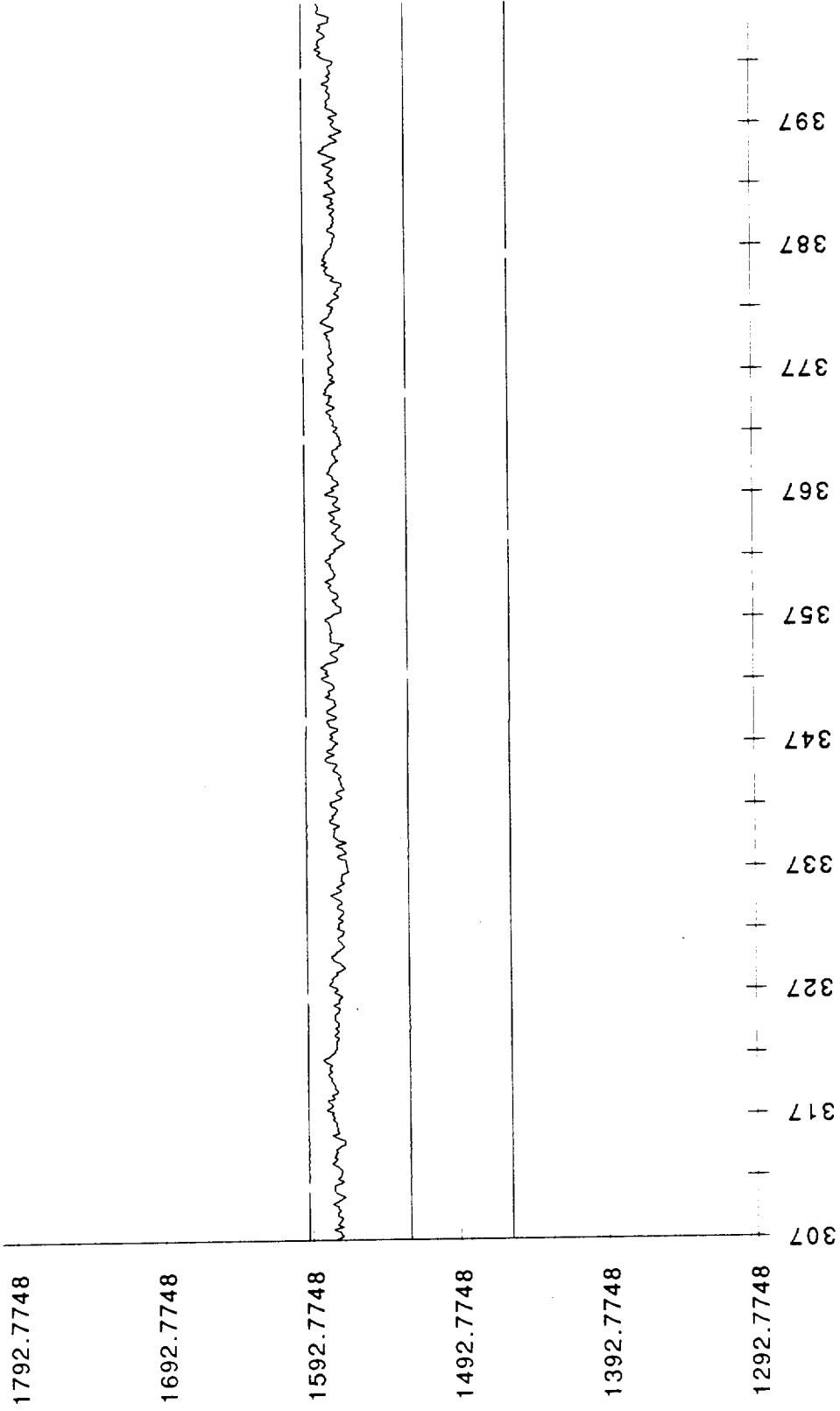

901-723 HPFP TDT A.T

901-723 HPFP TDT A.T

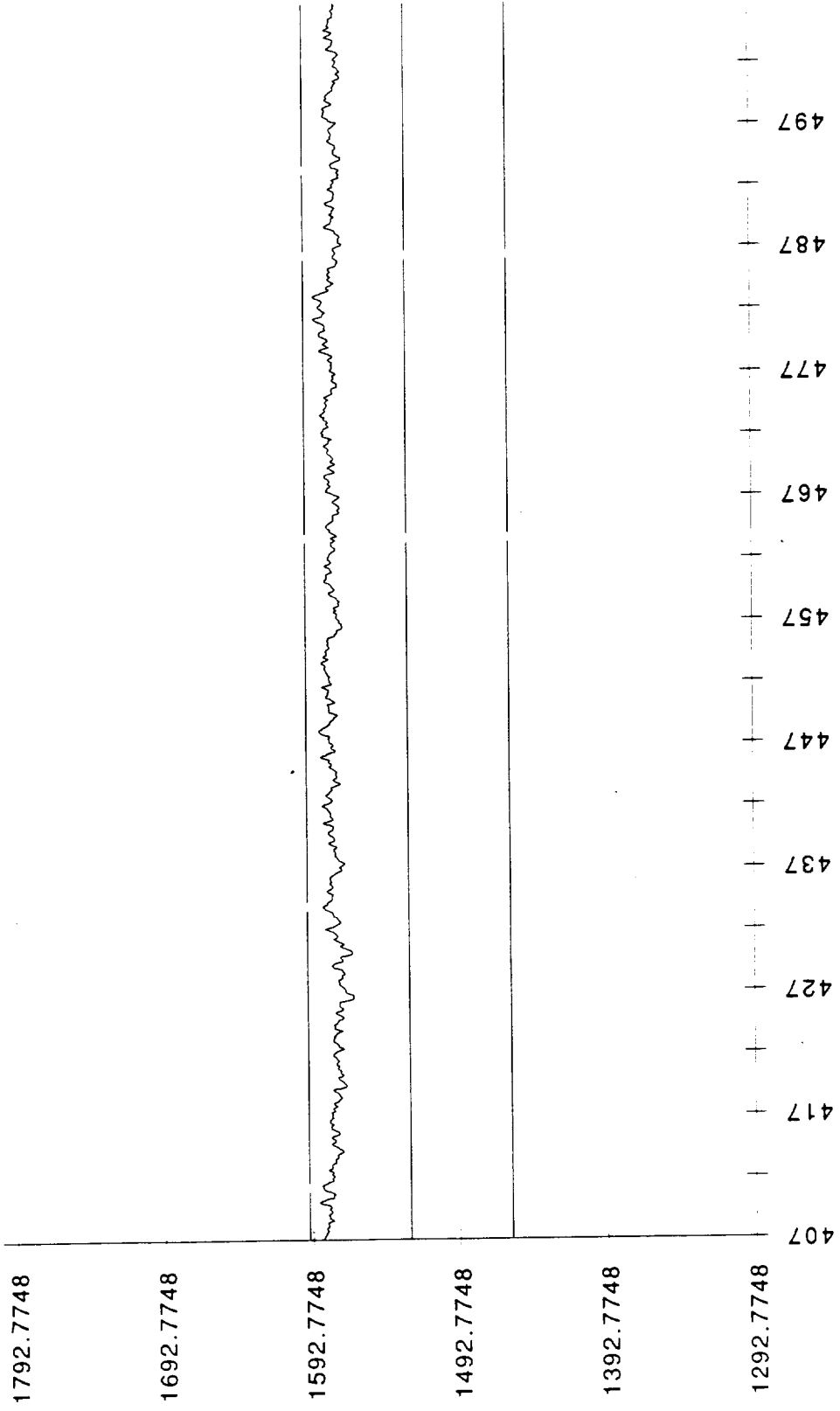

901-723 HPFP TDT A.T

901-723 HPFP TDT A.T

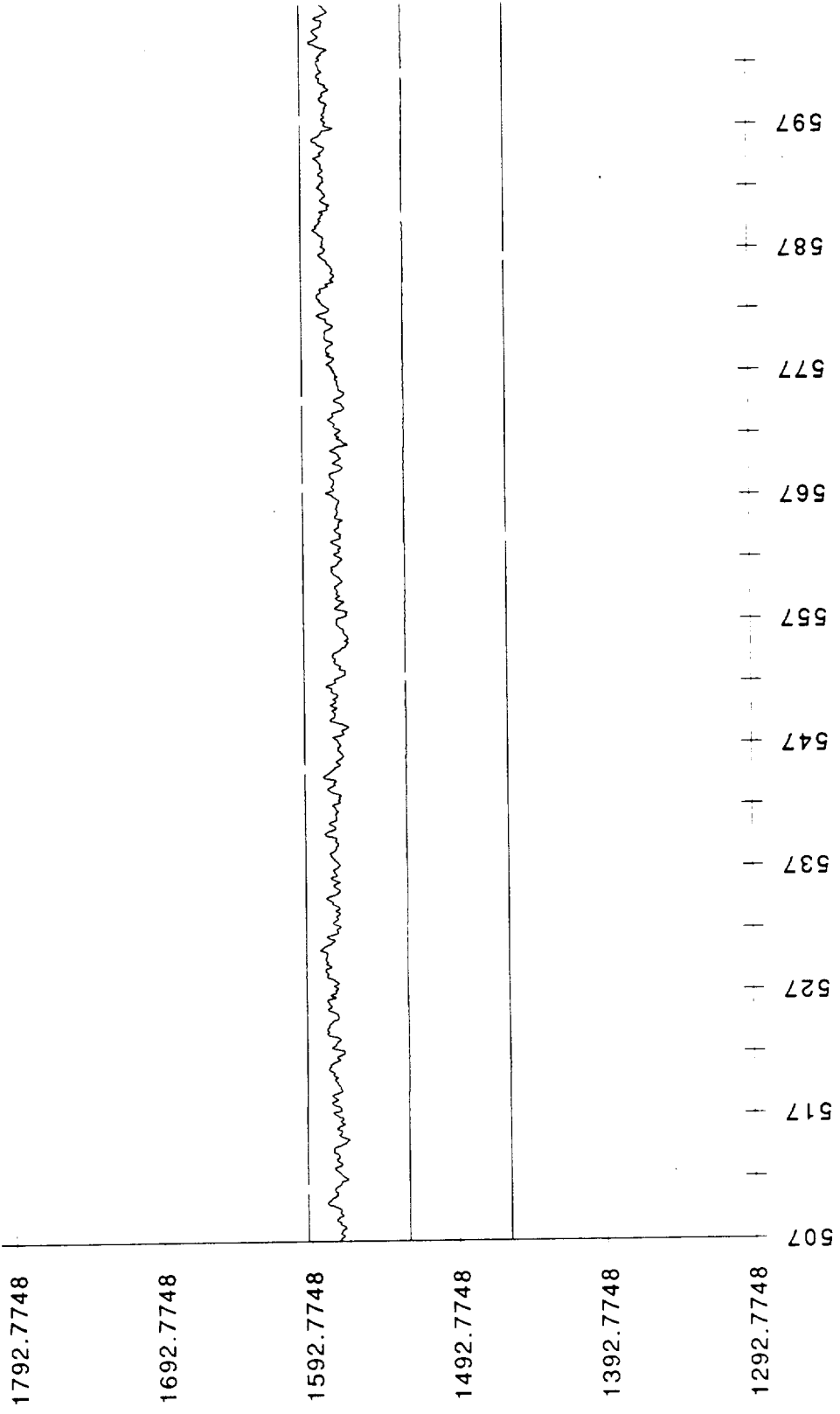

901-723 HPFP TDT A.T

901-723 HPOP IMSL pr.T

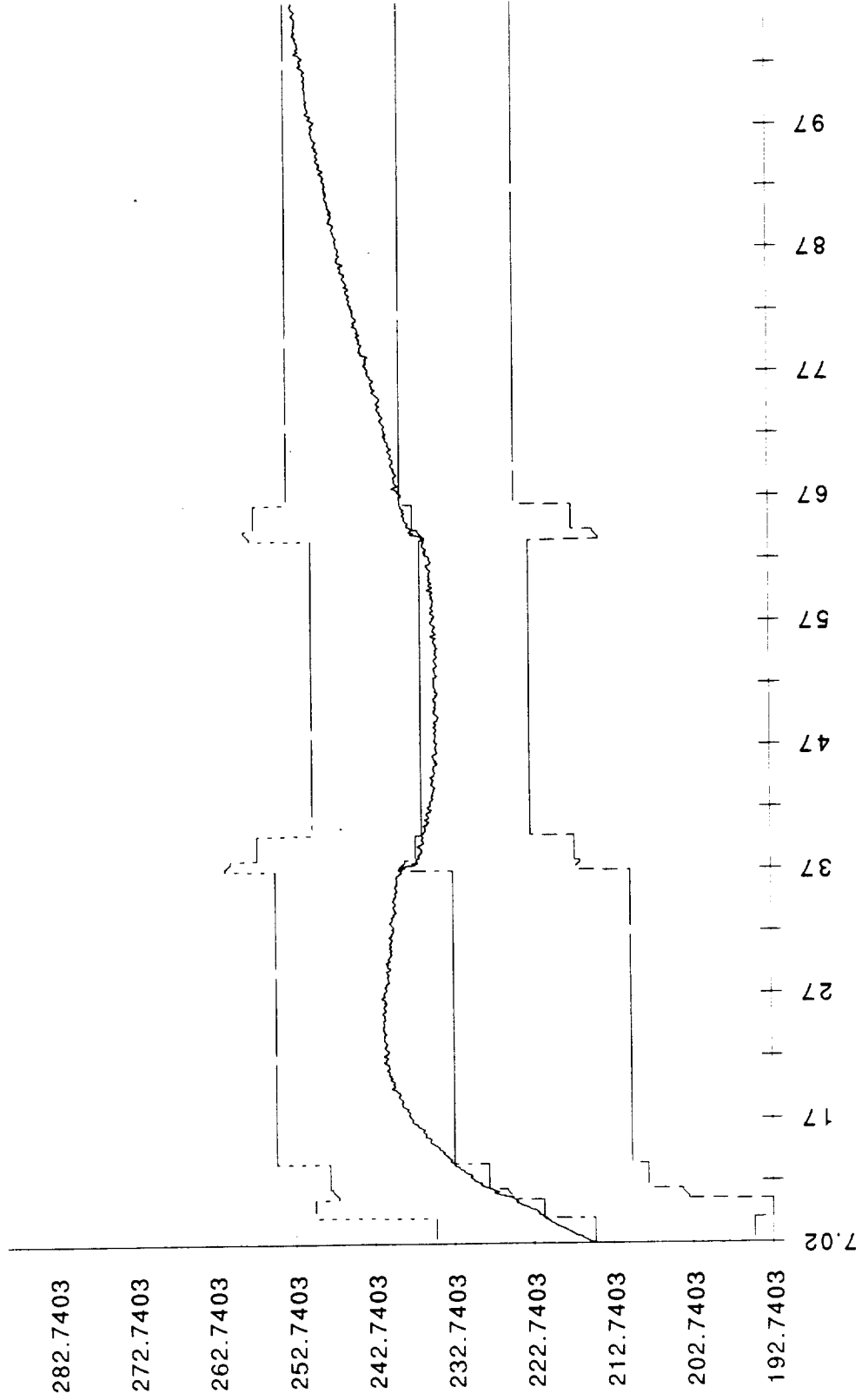

901-723 HPOP IMSL pr.T

901-723 HPOP IMSL pr.T



901-723 HPOP IMSL pr.T

901-723 HPOP IMSL pr.T

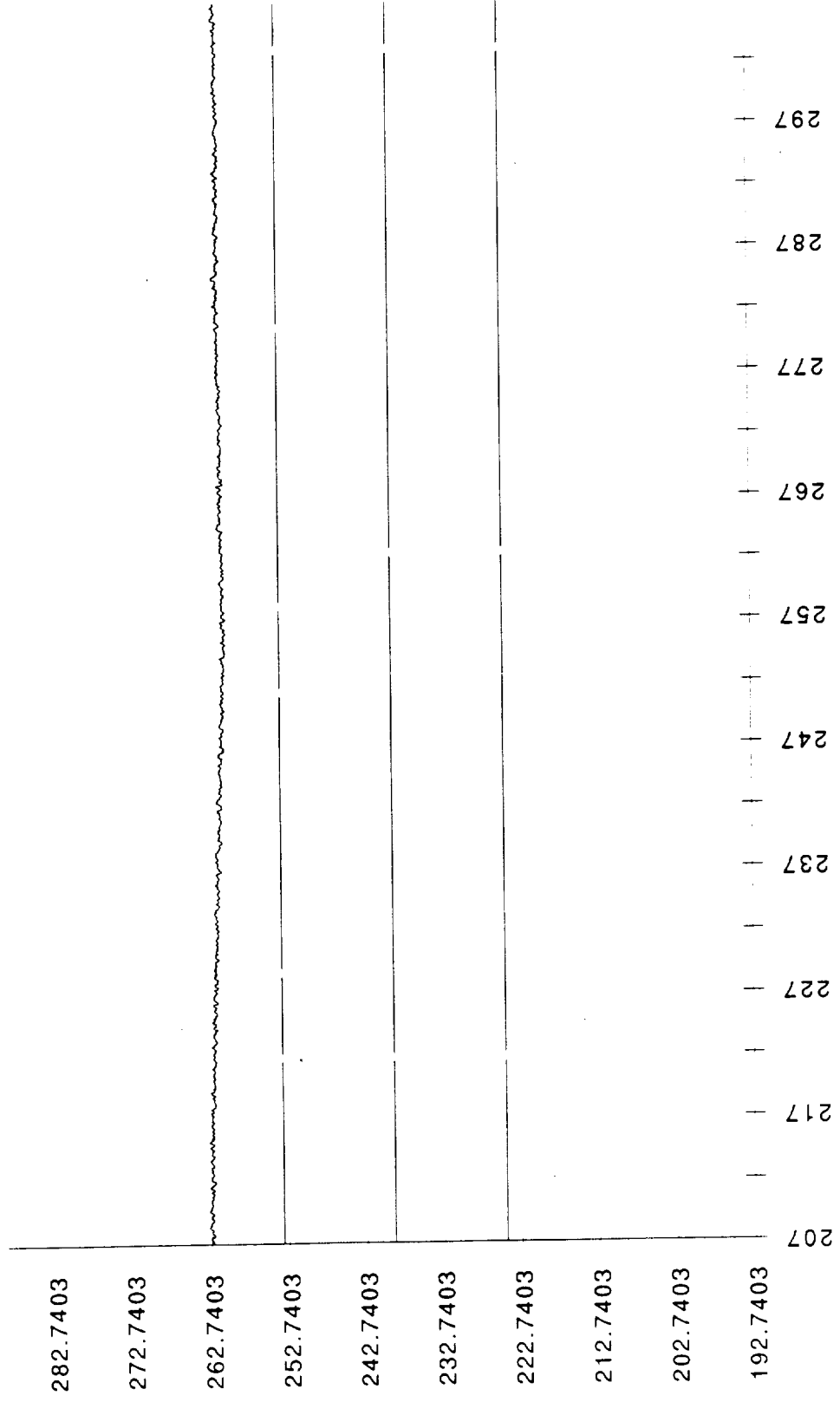

901-723 HPOP IMSL pr.T

901-723 HPOP IMSL pr.T

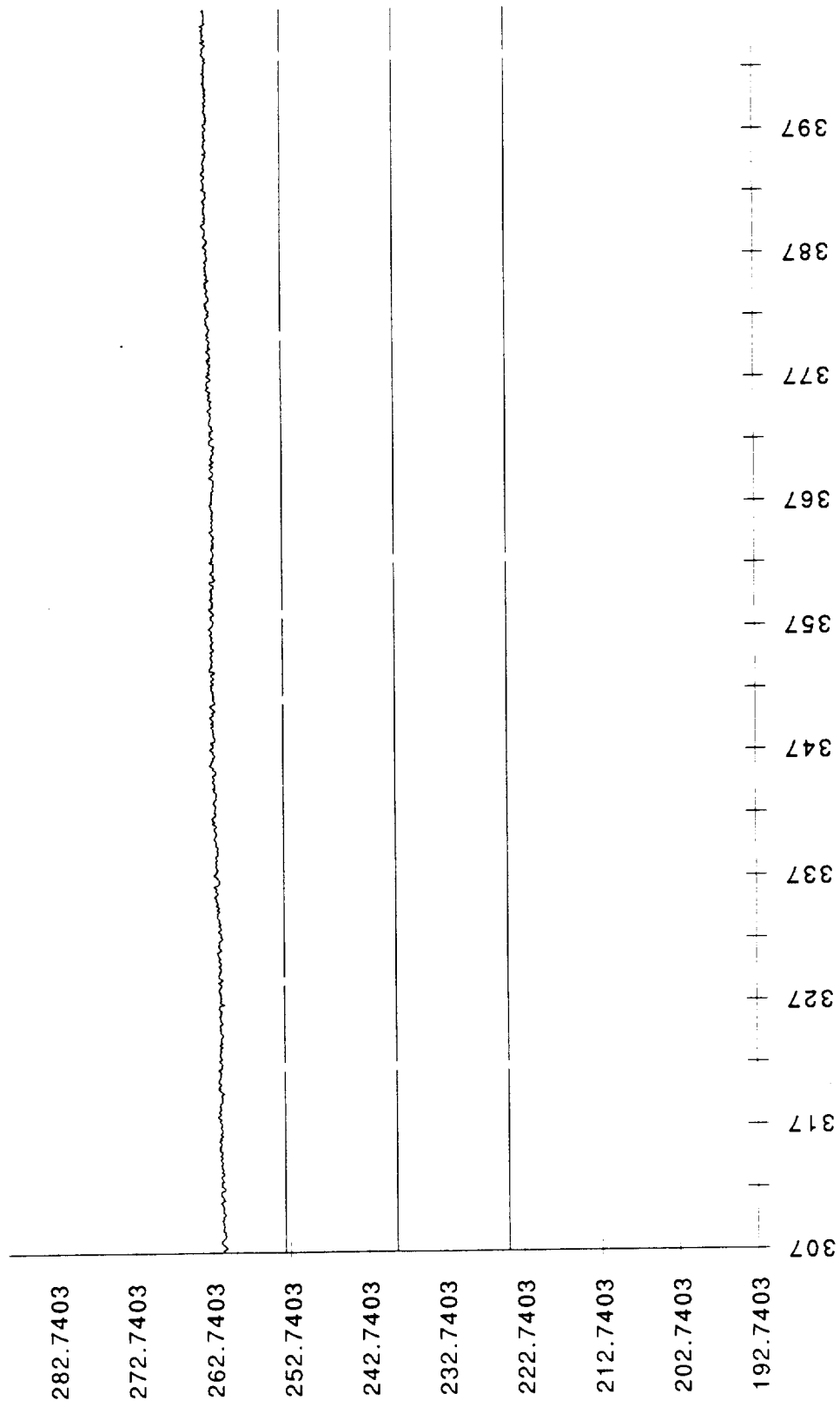

901-723 HPOP IMSL pr.T

901-723 HPOP IMSL pr.T

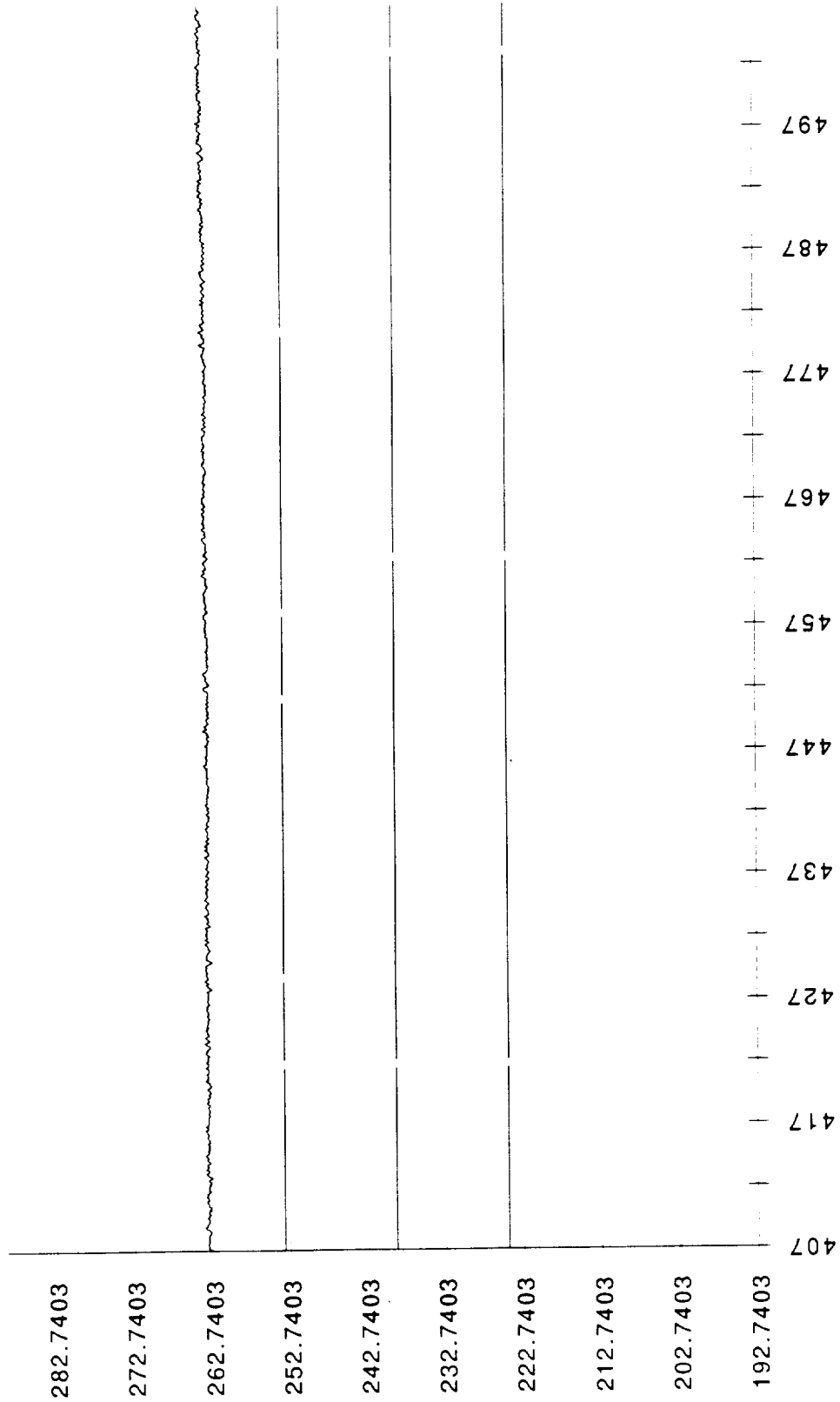

901-723 HPOP IMSL pr.T

901-723 HPOP IMSL pr.T

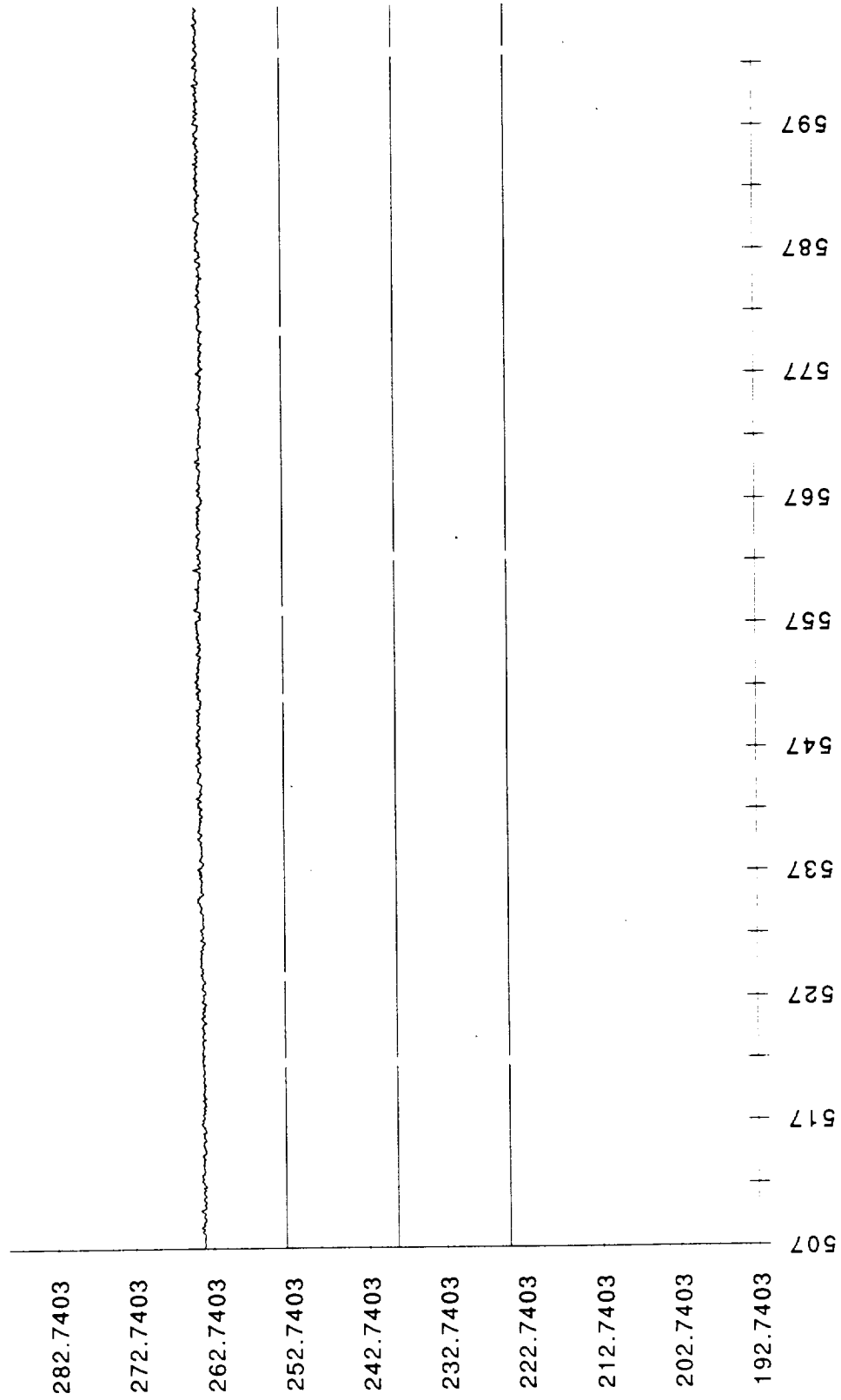

901-723 HPOP IMSL pr.T

901-723 MCC Pc.T

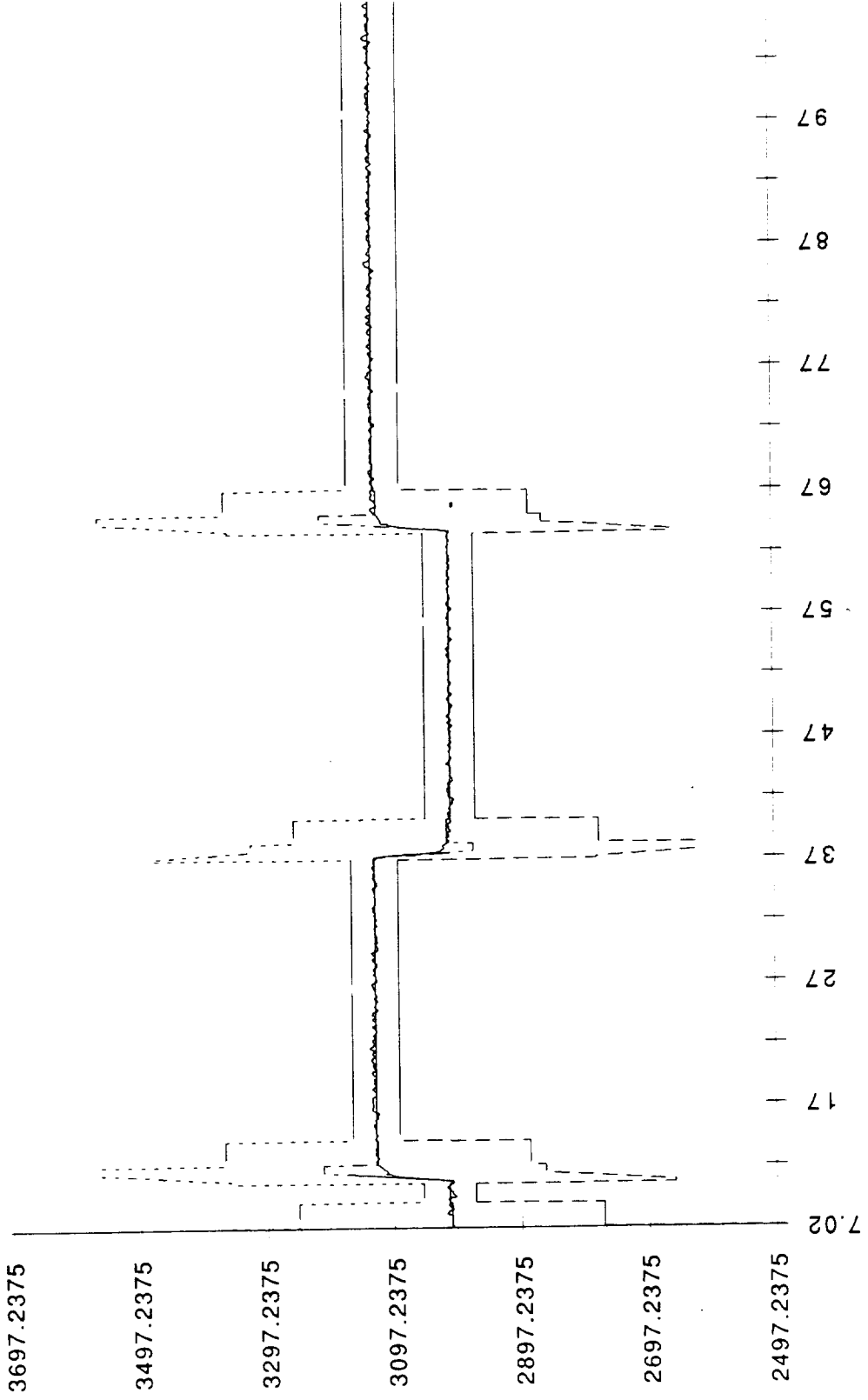

901-723 MCC Pc.T

901-723 MCC Pc.T

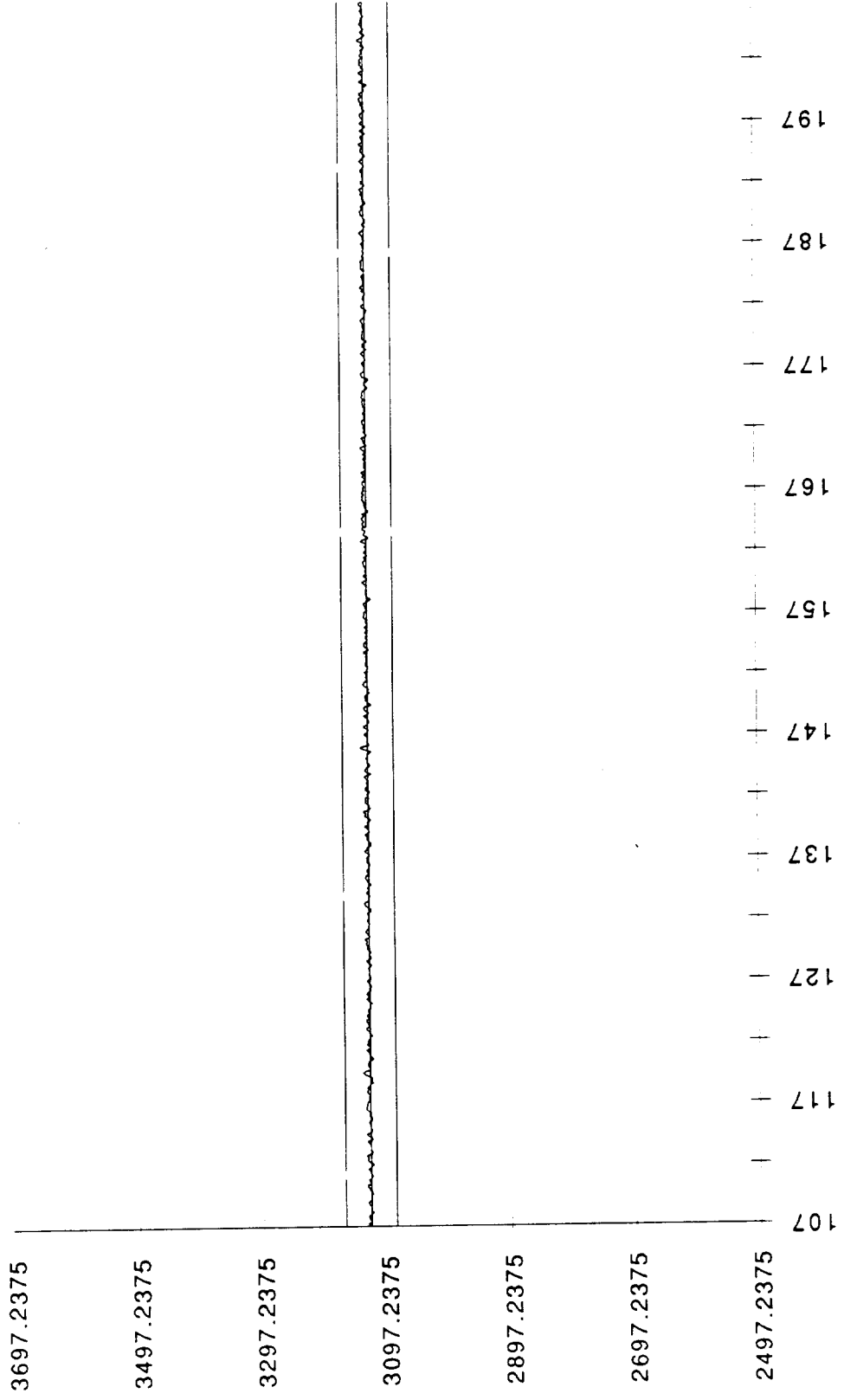

901-723 MCC Pc.T

901-723 MCC Pc.T

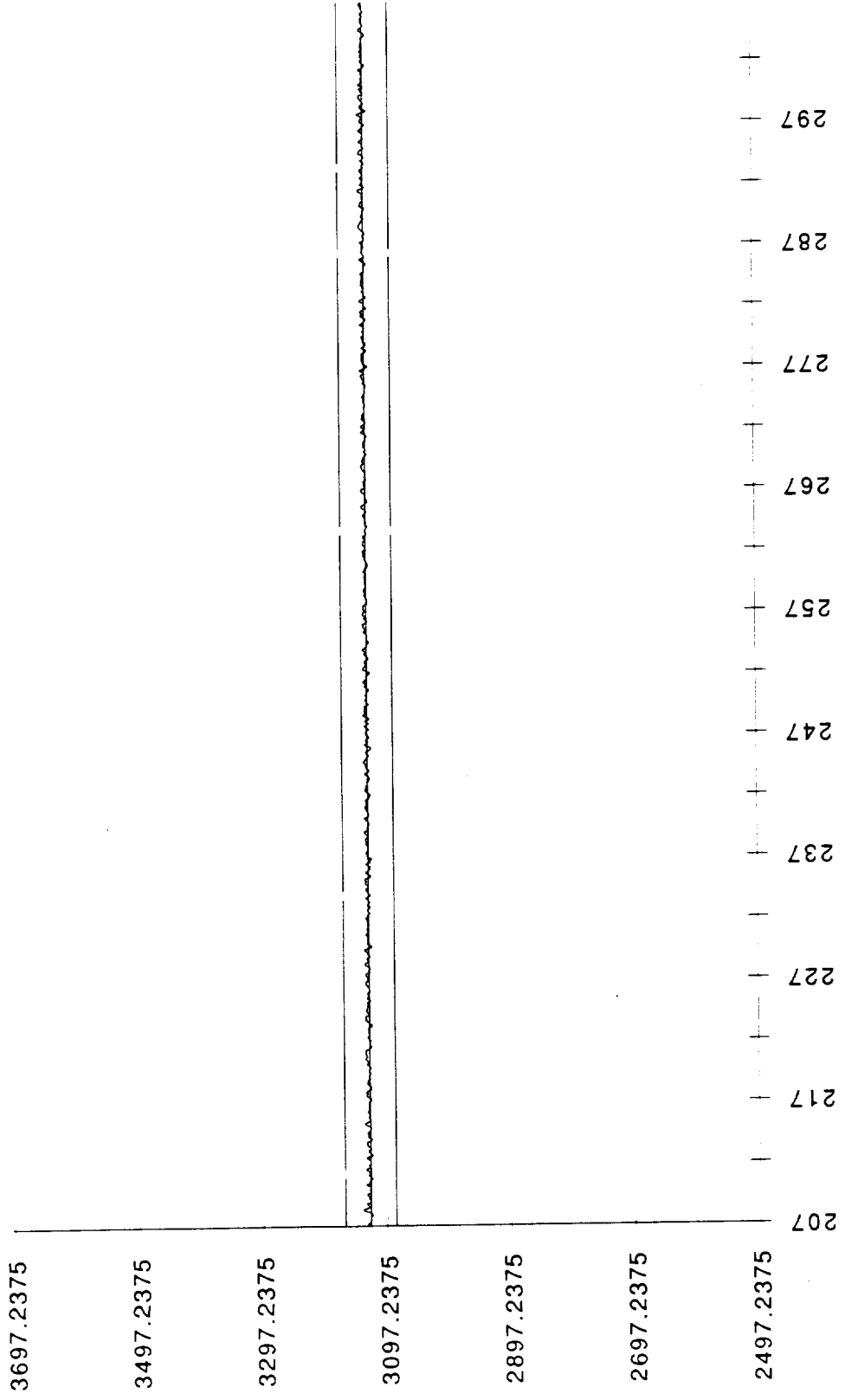

901-723 MCC Pc.T

901-723 MCC Pc.T

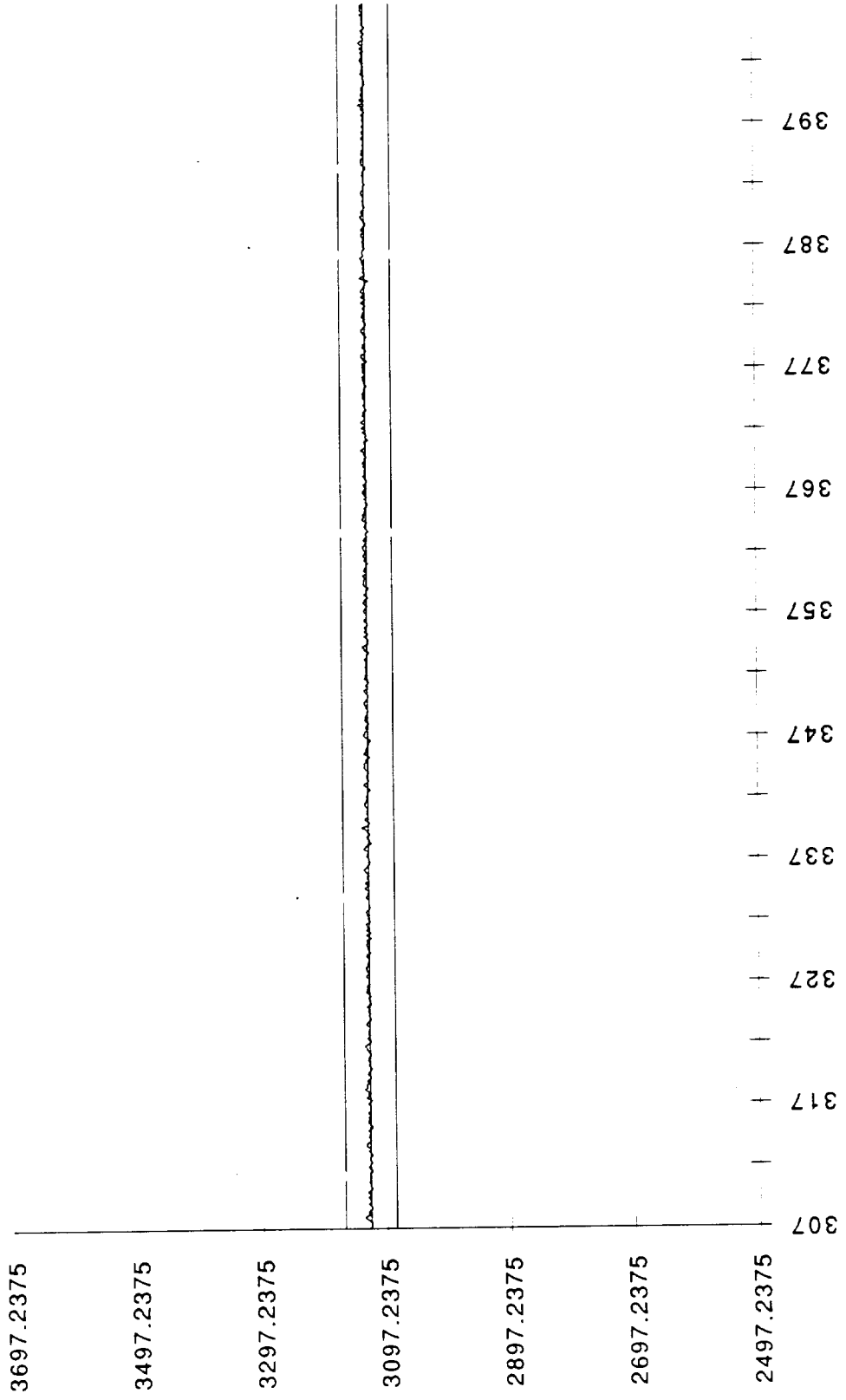

901-723 MCC Pc.T

901-723 MCC Pc.T

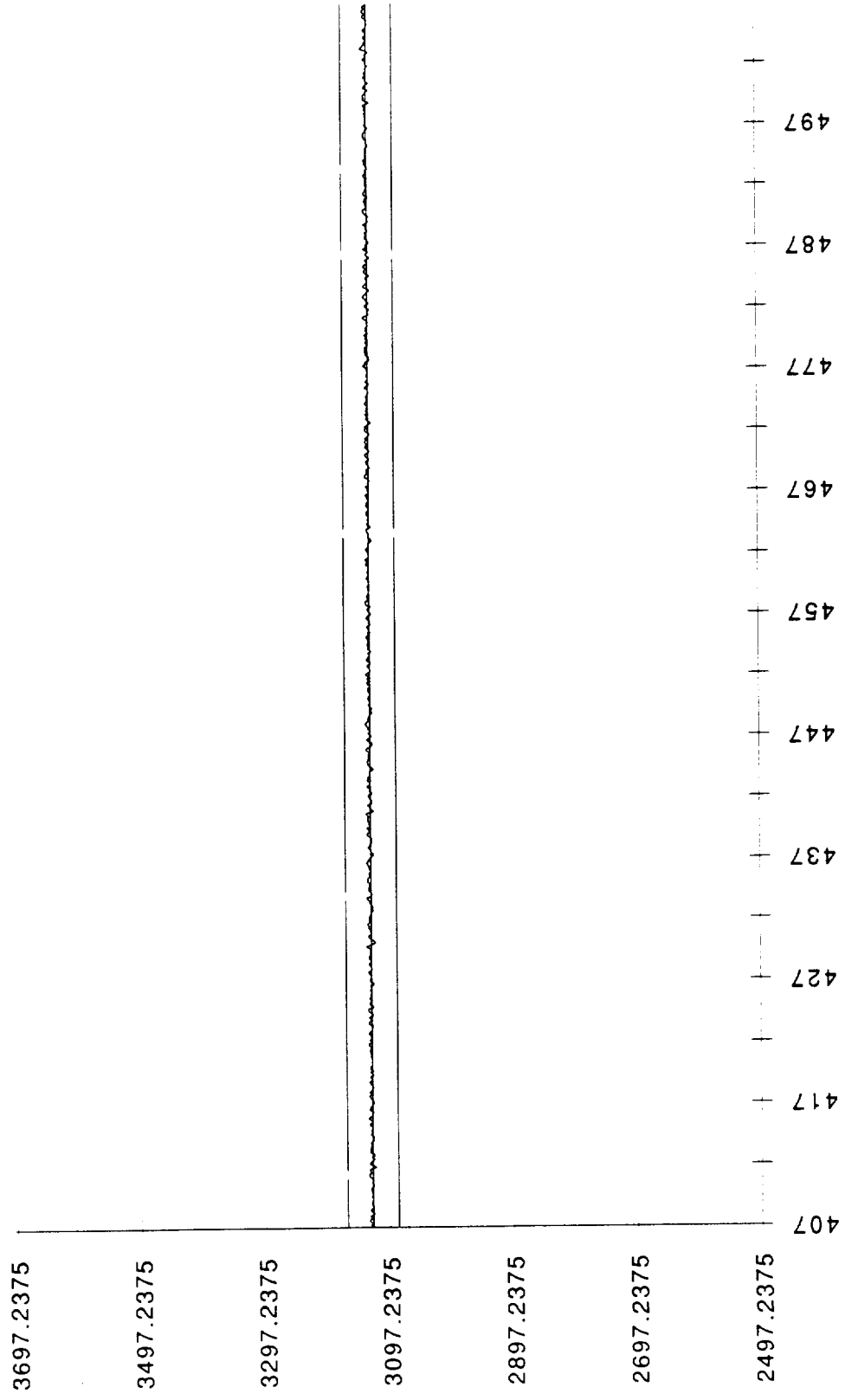

901-723 MCC Pc.T

901-723 MCC Pc.T

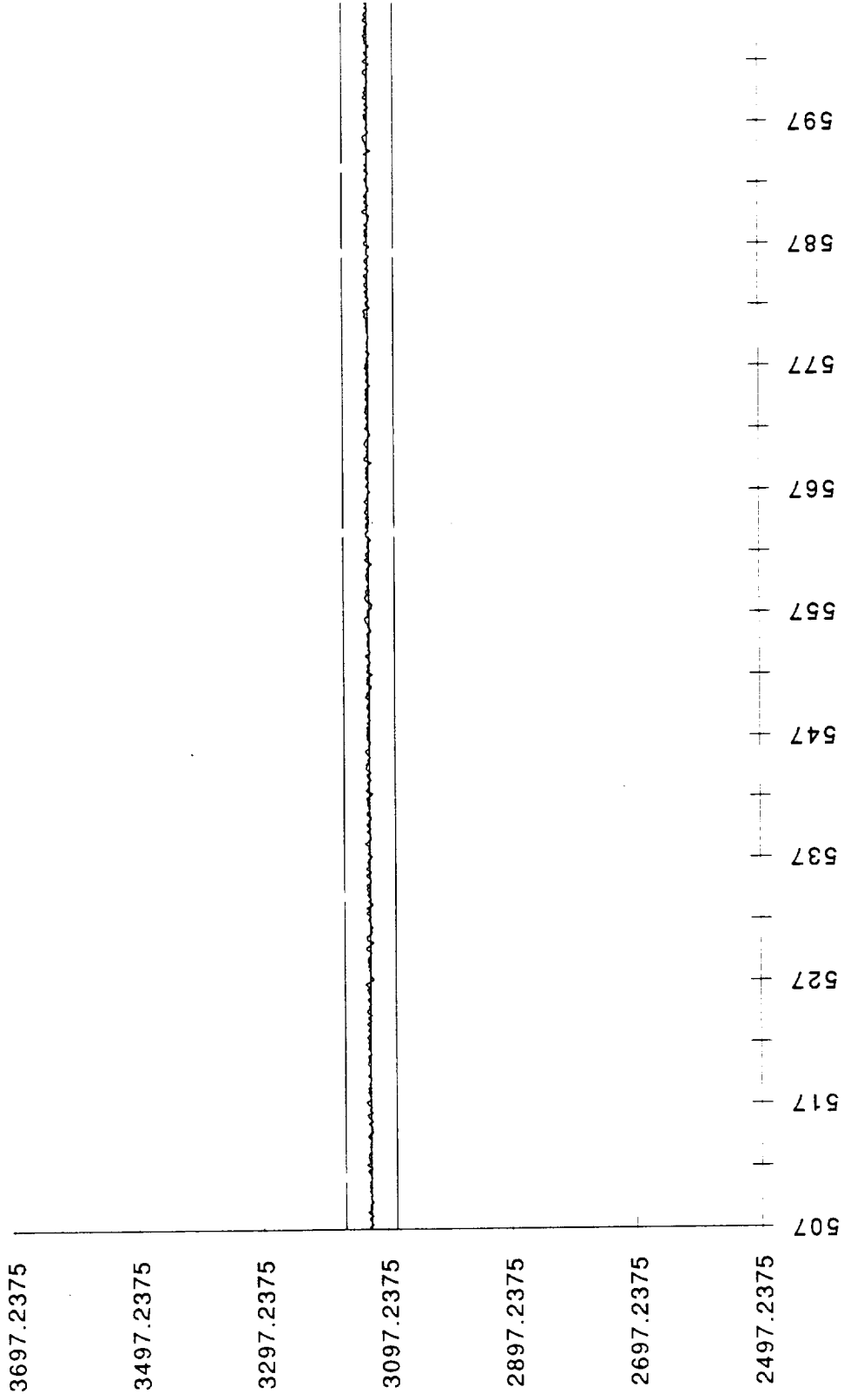

901-723 MCC Pc.T

901-723 MCC Pc.T

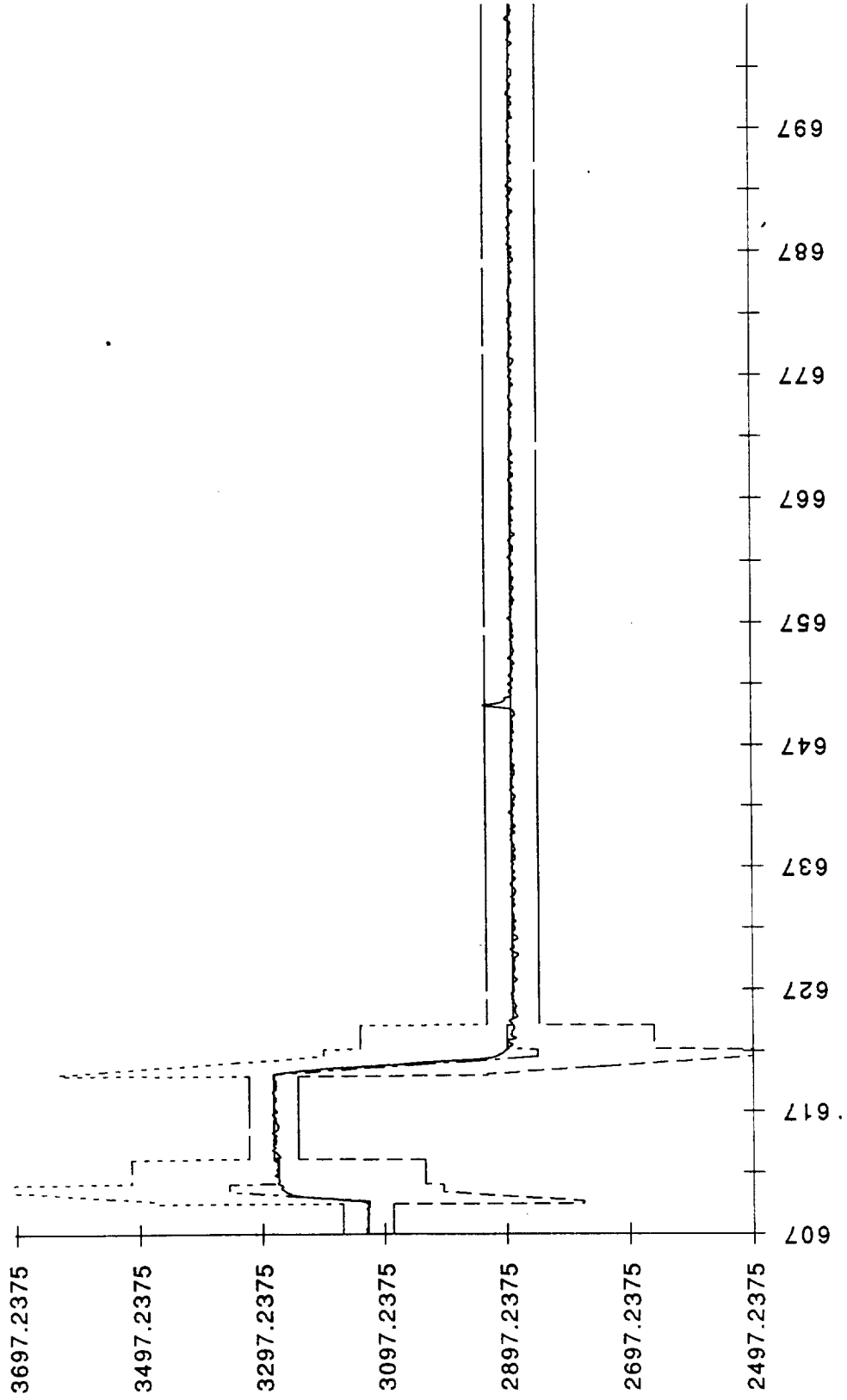

901-723 MCC Pc.T

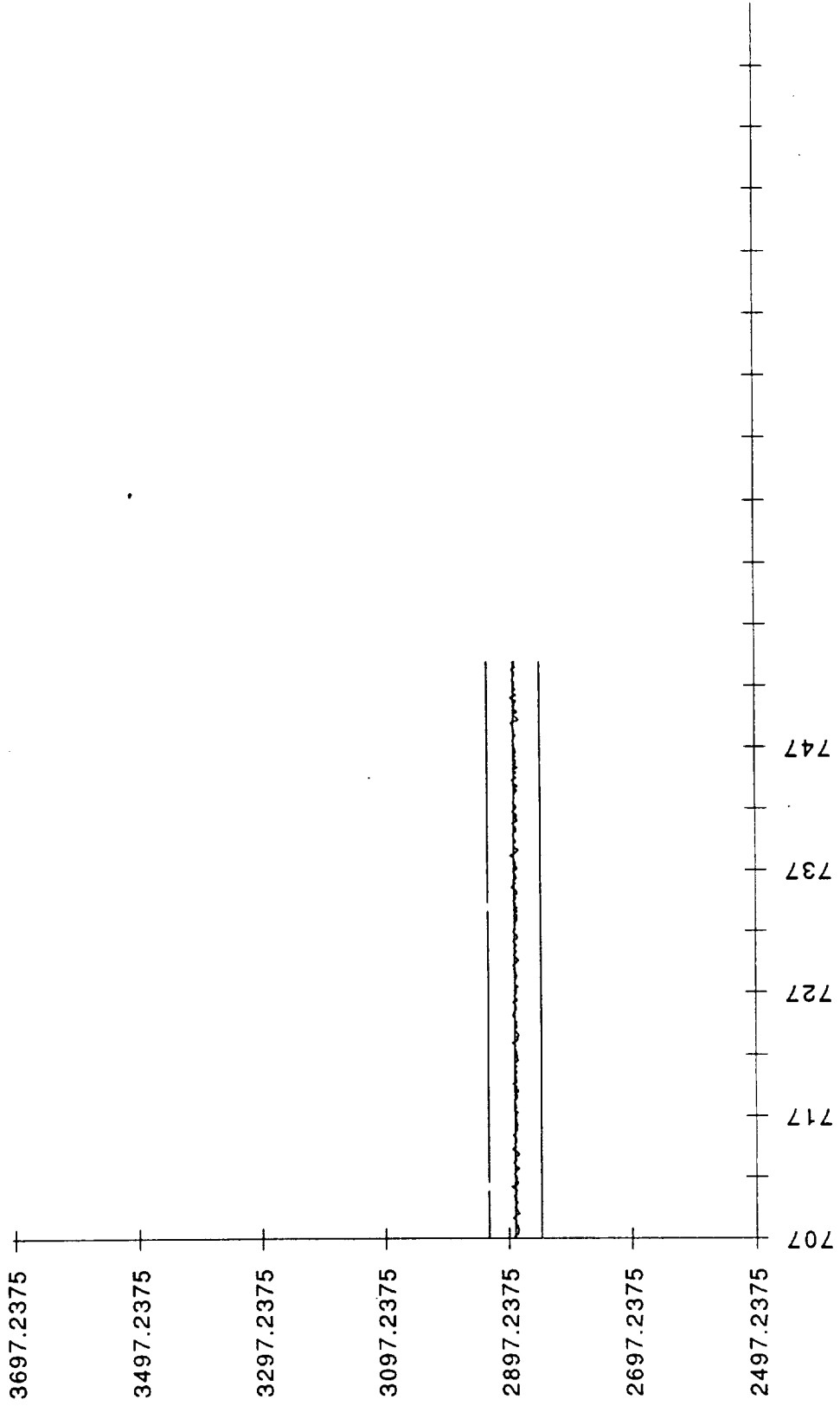

901-772 HPOP IMSL pr.T

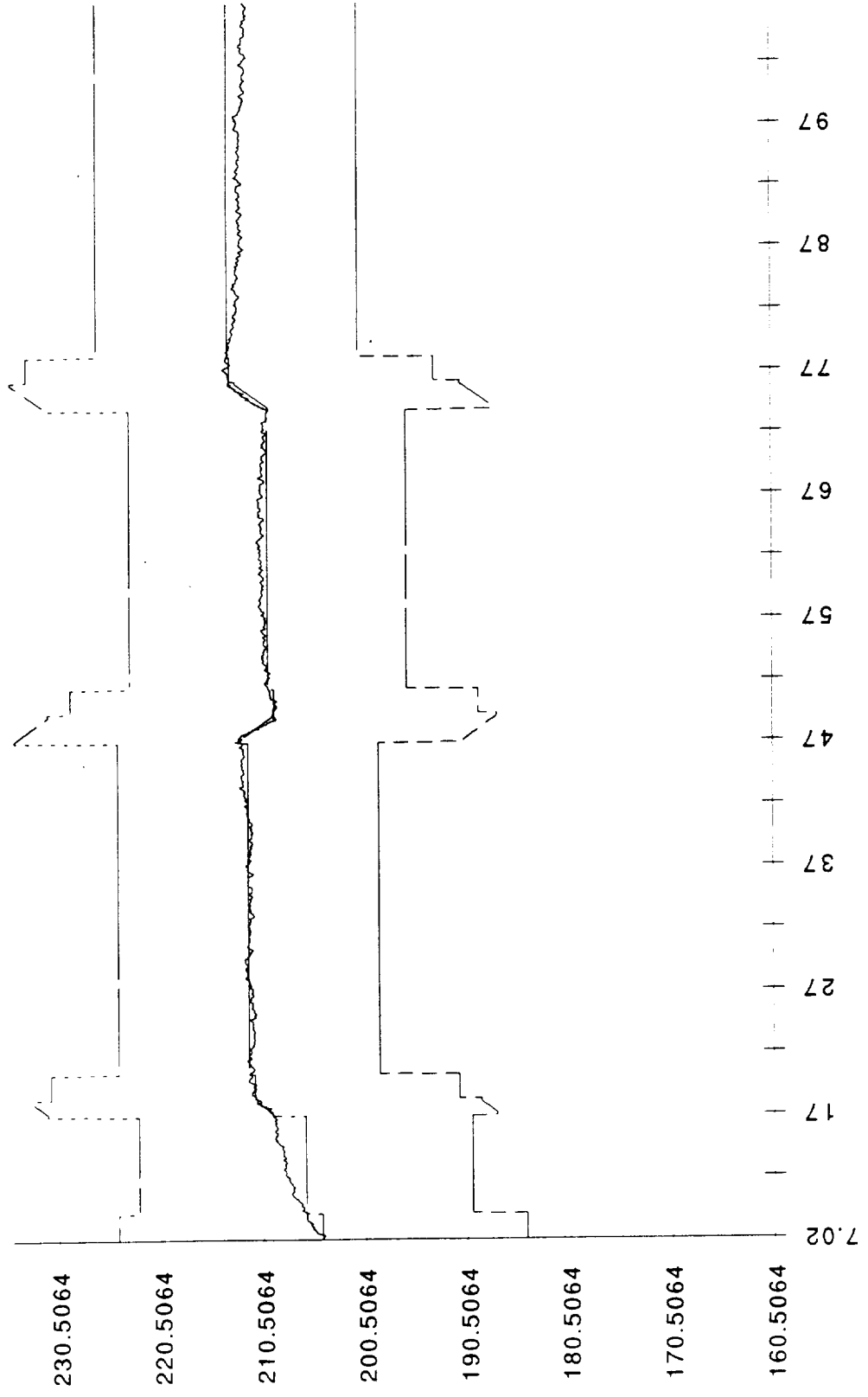

901-772 HPOP IMSL pr.T

901-772 HPOP IMSL pr.T

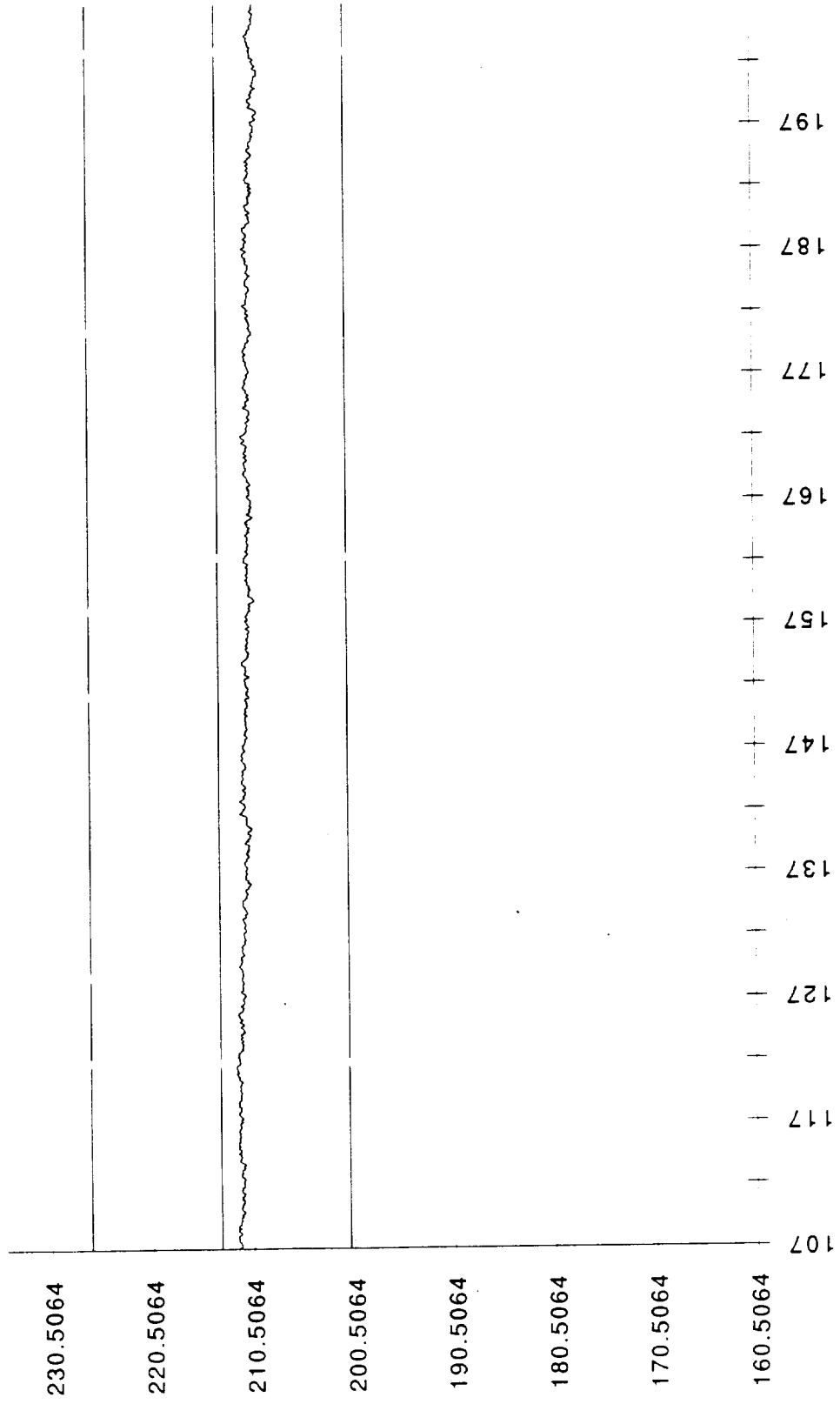

901-772 HPOP IMSL pr.T

901-772 HPOP IMSL pr.T

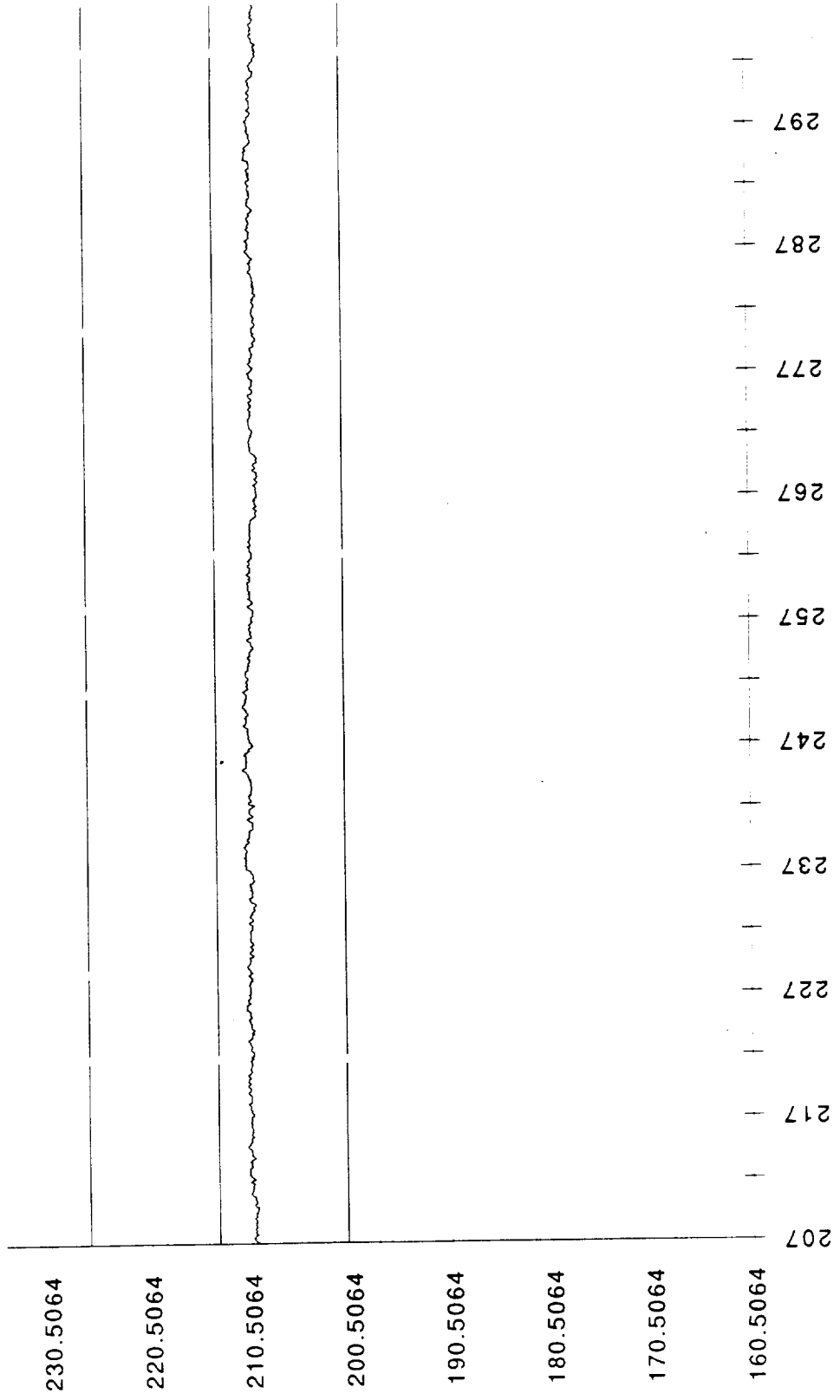

901-772 HPOP IMSL pr.T

901-772 HPOP IMSL pr.T

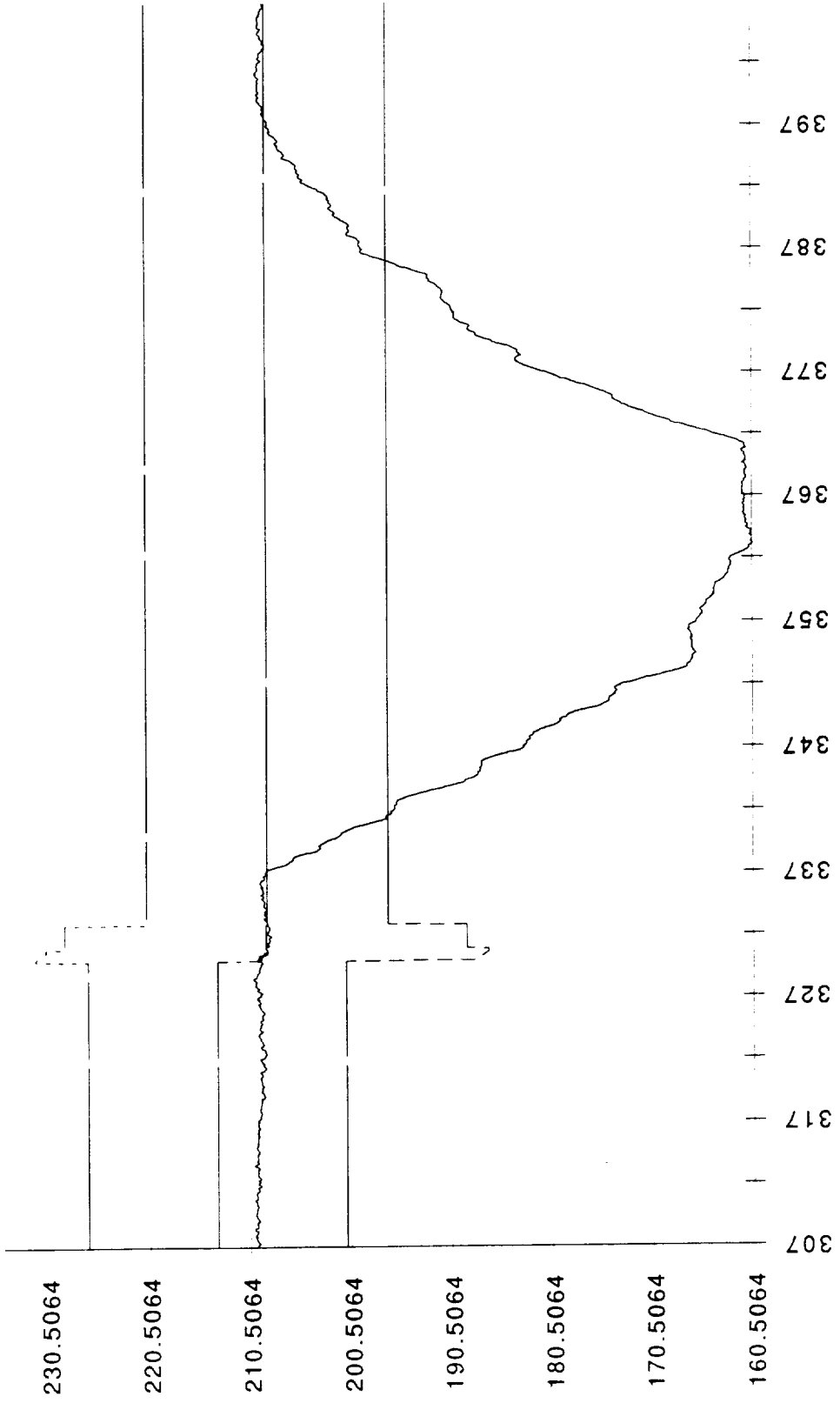

901-772 HPOP IMSL pr.T

901-772 HPOP IMSL pr.T

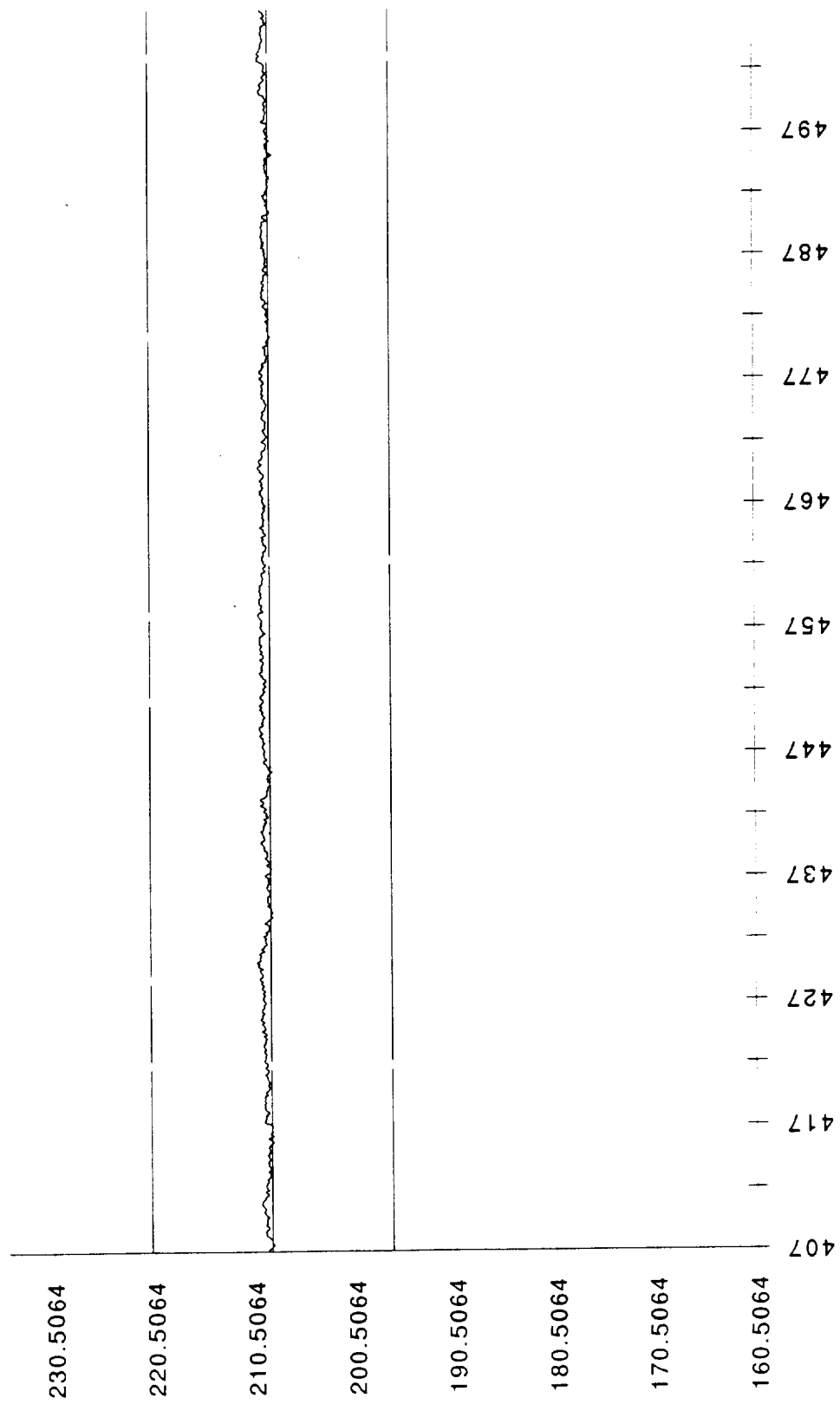

901-772 HPOP IMSL pr.T

901-772 HPOP IMSL pr.T

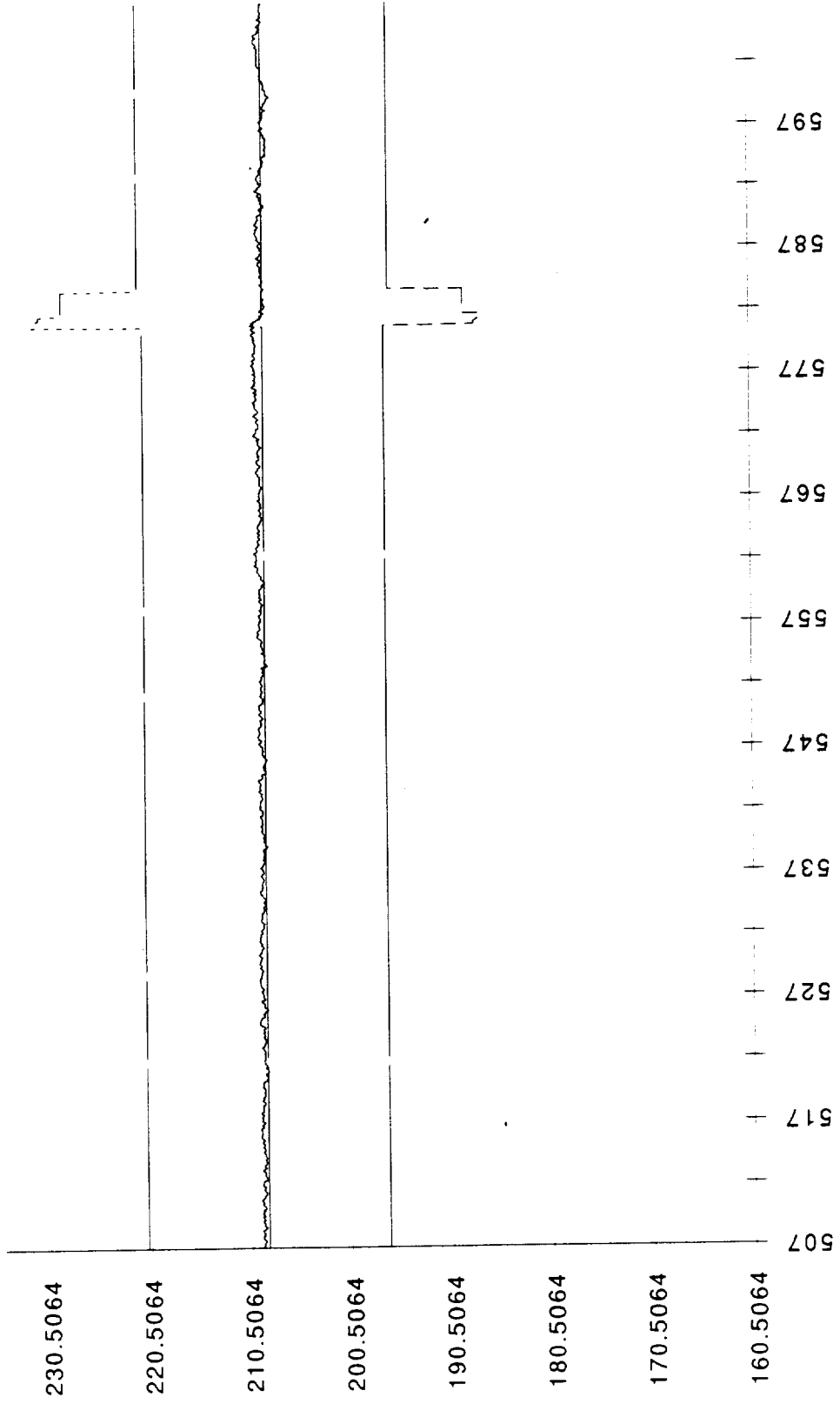

901-772 HPOP IMSL pr.T

901-789 HPFP accel.T

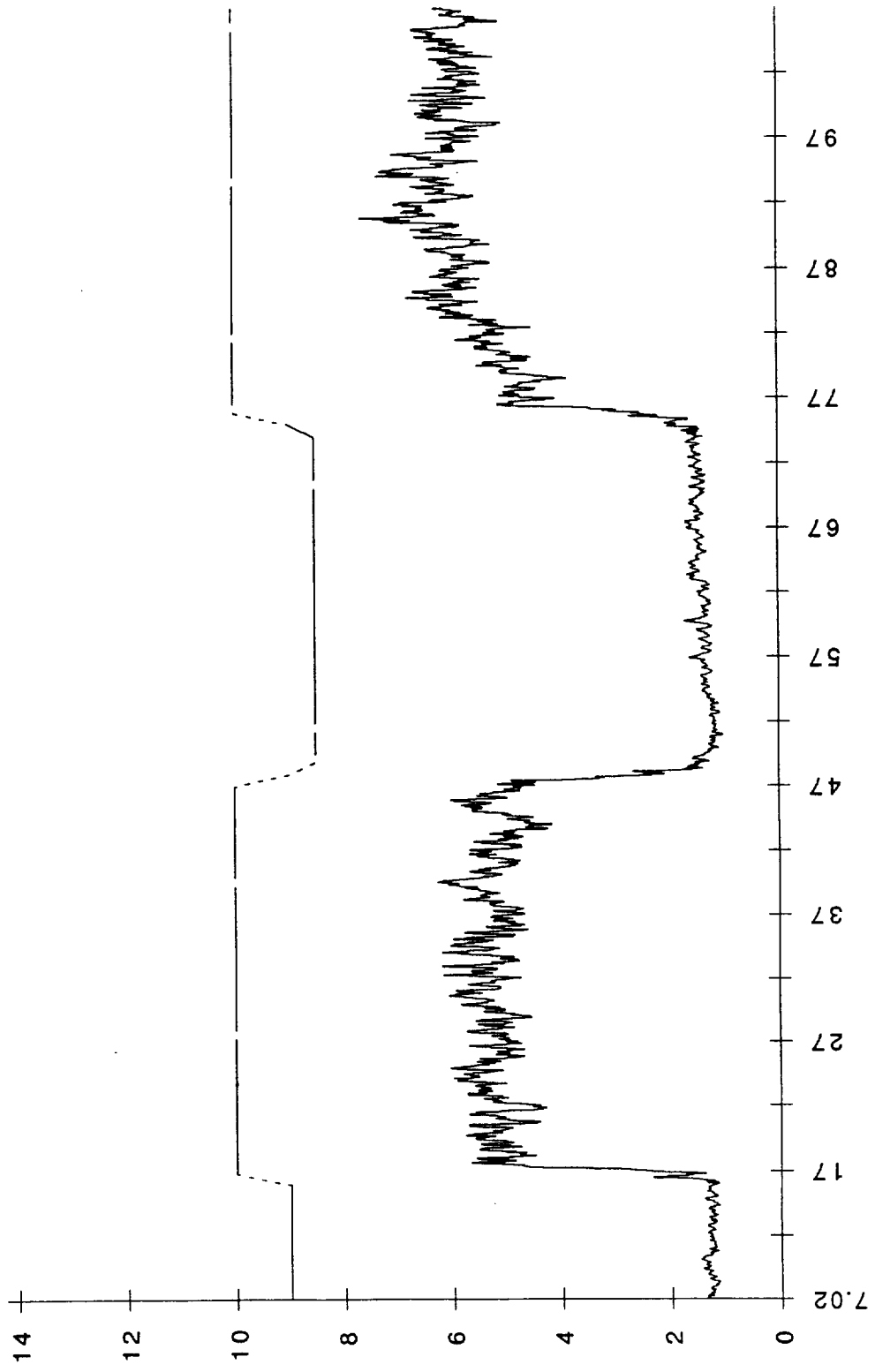

901-789 HPFP accel.T

901-789 HPFP accel.T

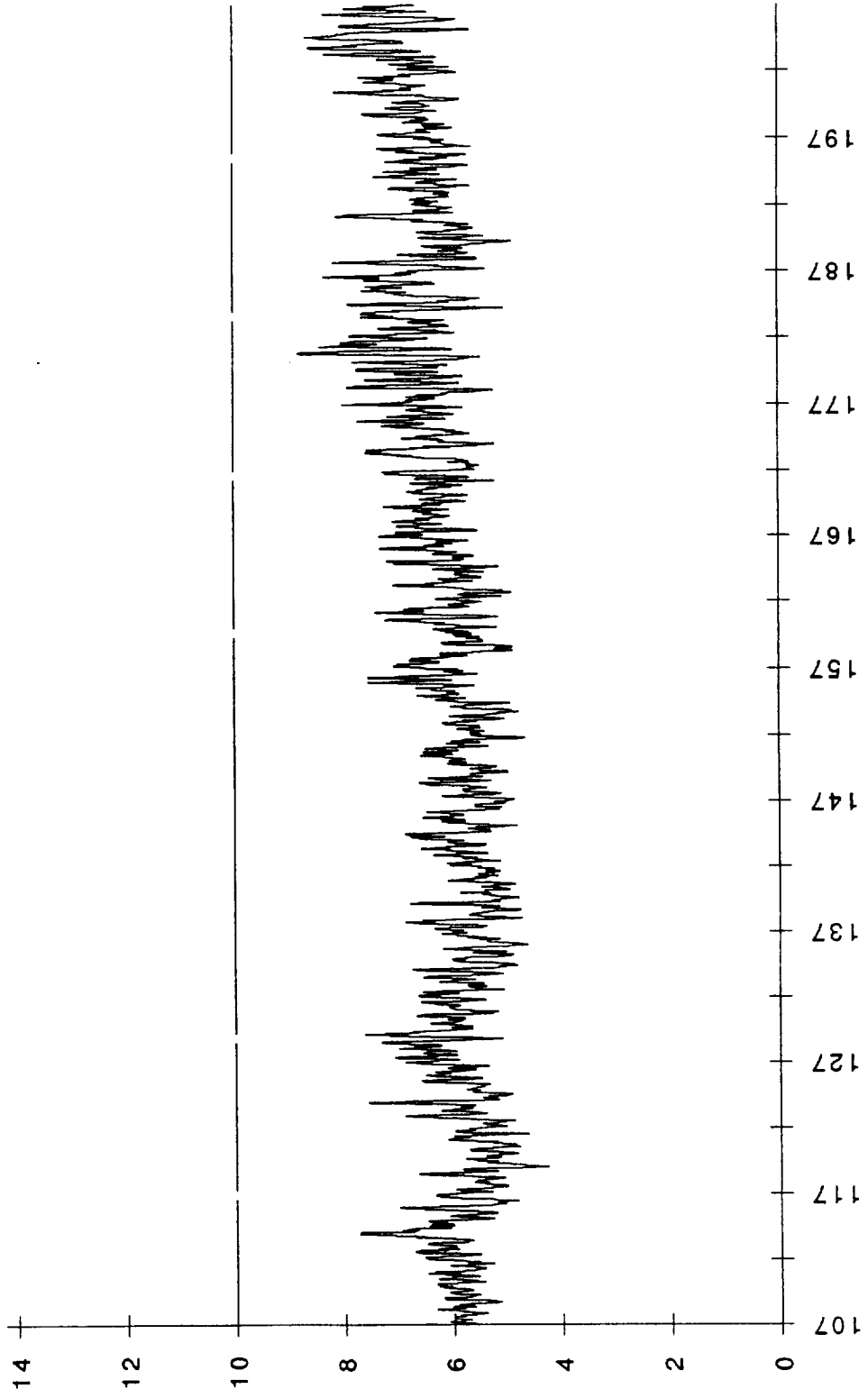

901-789 HPFP accel.T

901-789 HPFP accel.T

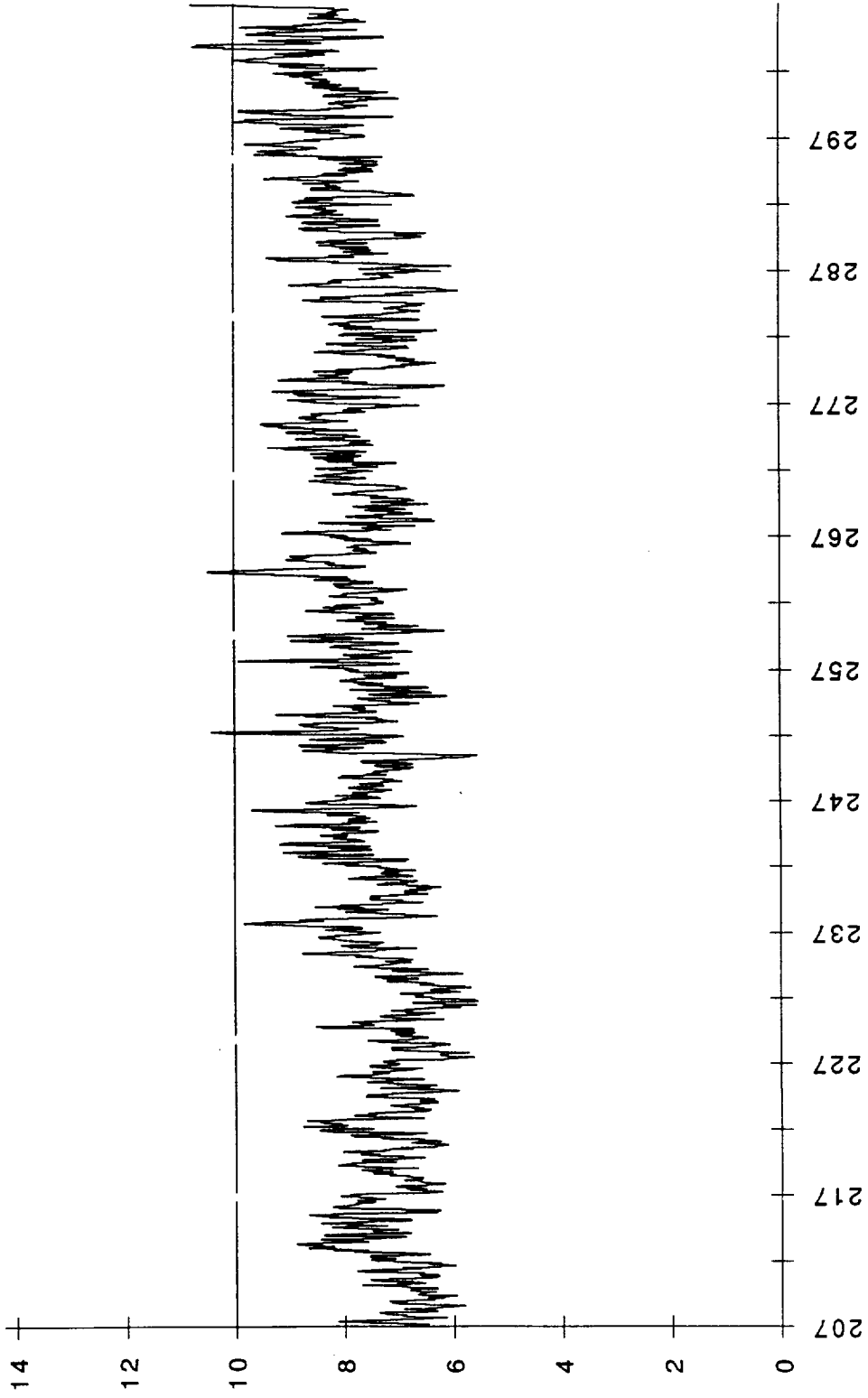

901-789 HPFP accel.T

901-789 HPFP accel.T

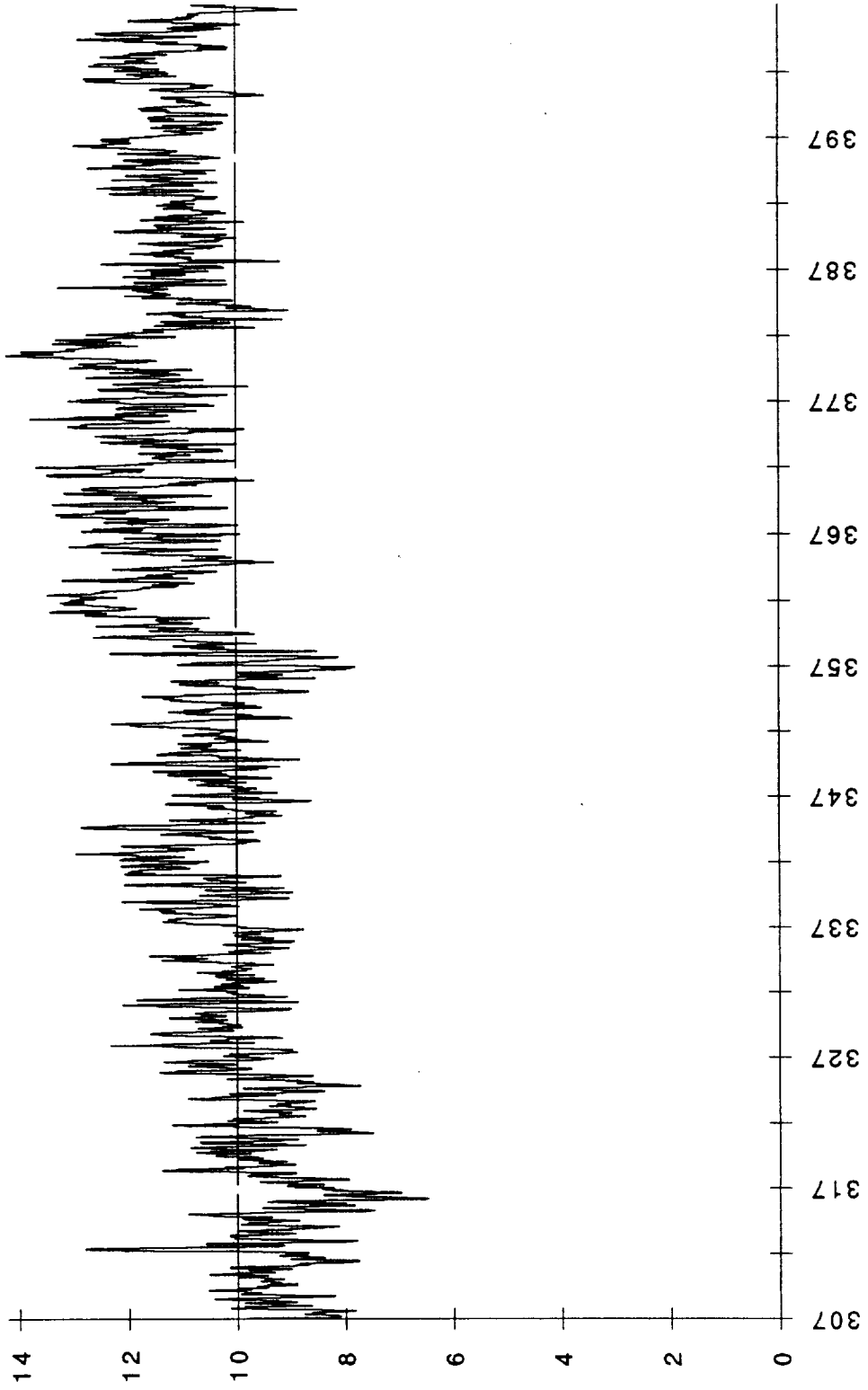

901-789 HPFP accel.T

901-789 HPFP accel.T

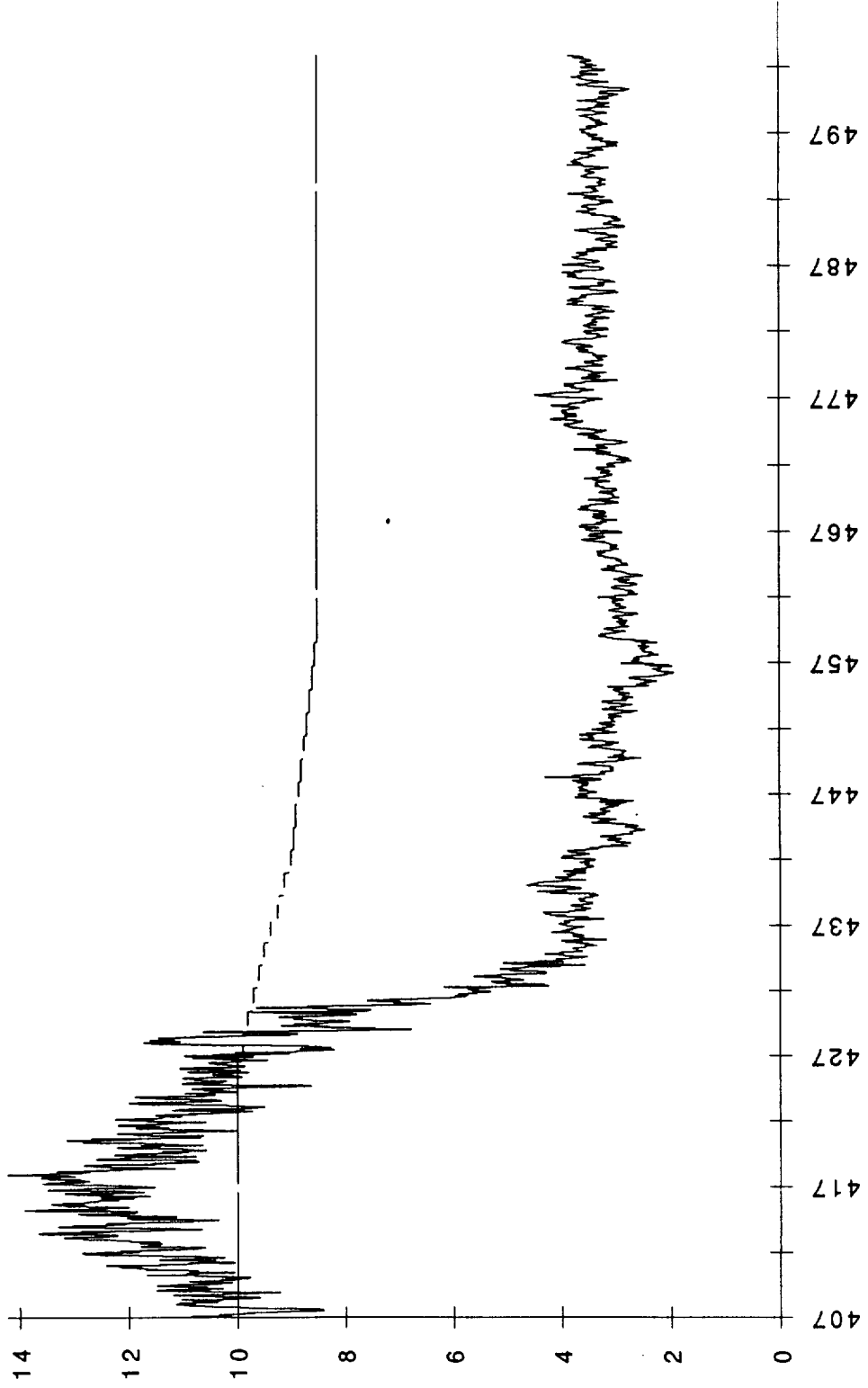

901-789 HPFP accel.T

901-809 HPFP accel.T

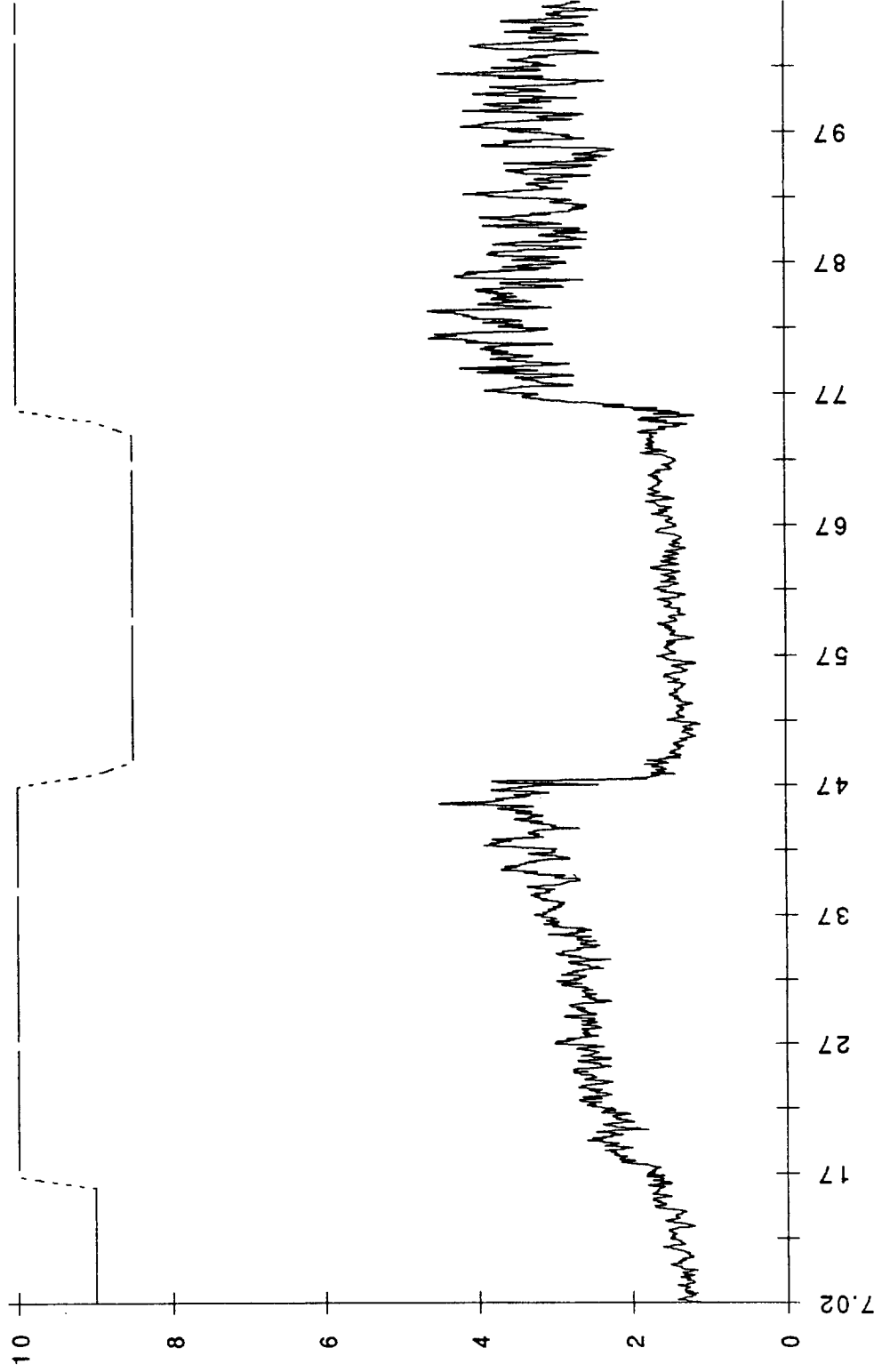

901-809 HPFP accel.T

901-809 HPFP accel.T

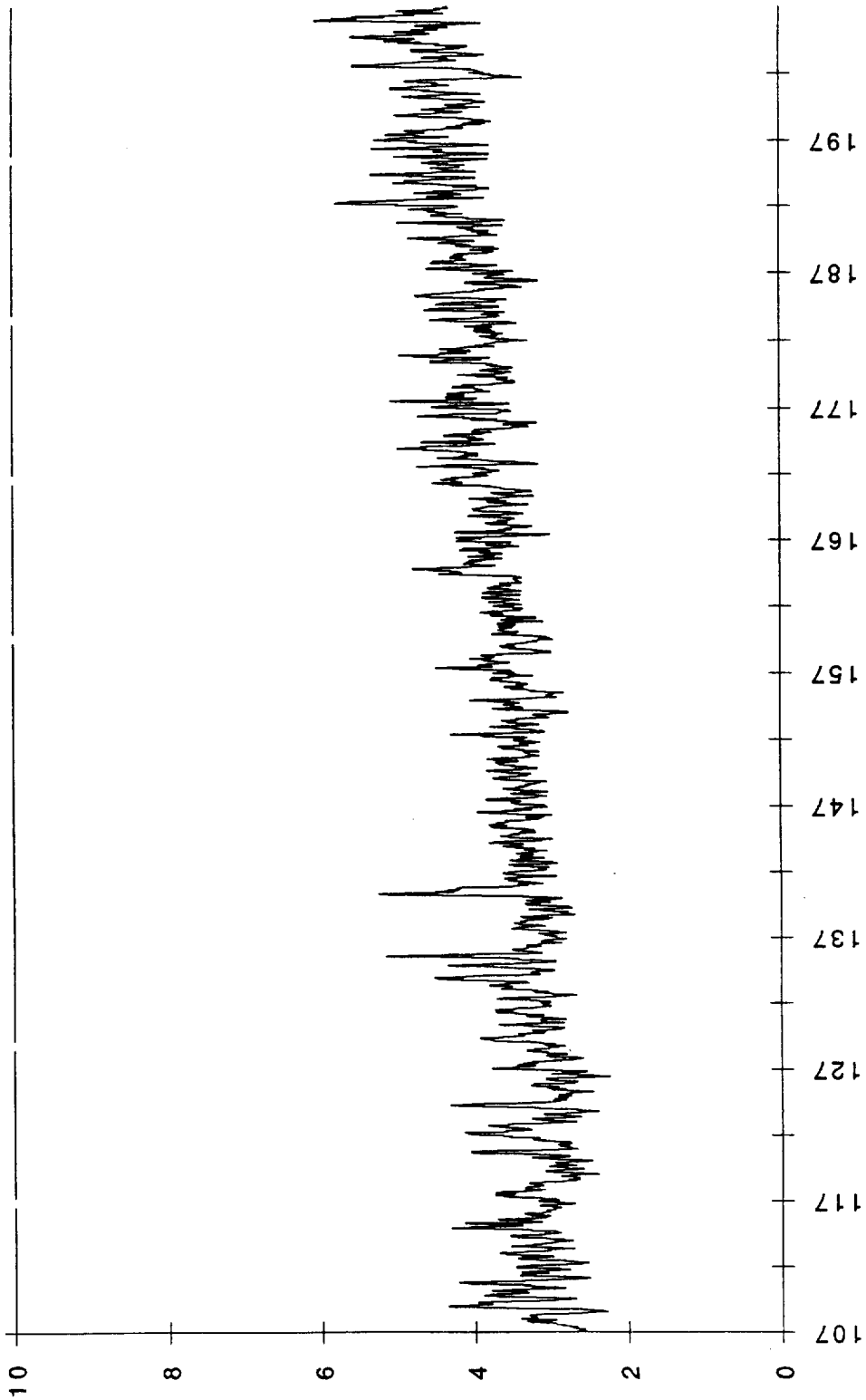

901-809 HPFP accel.T

901-809 HPFP accel.T

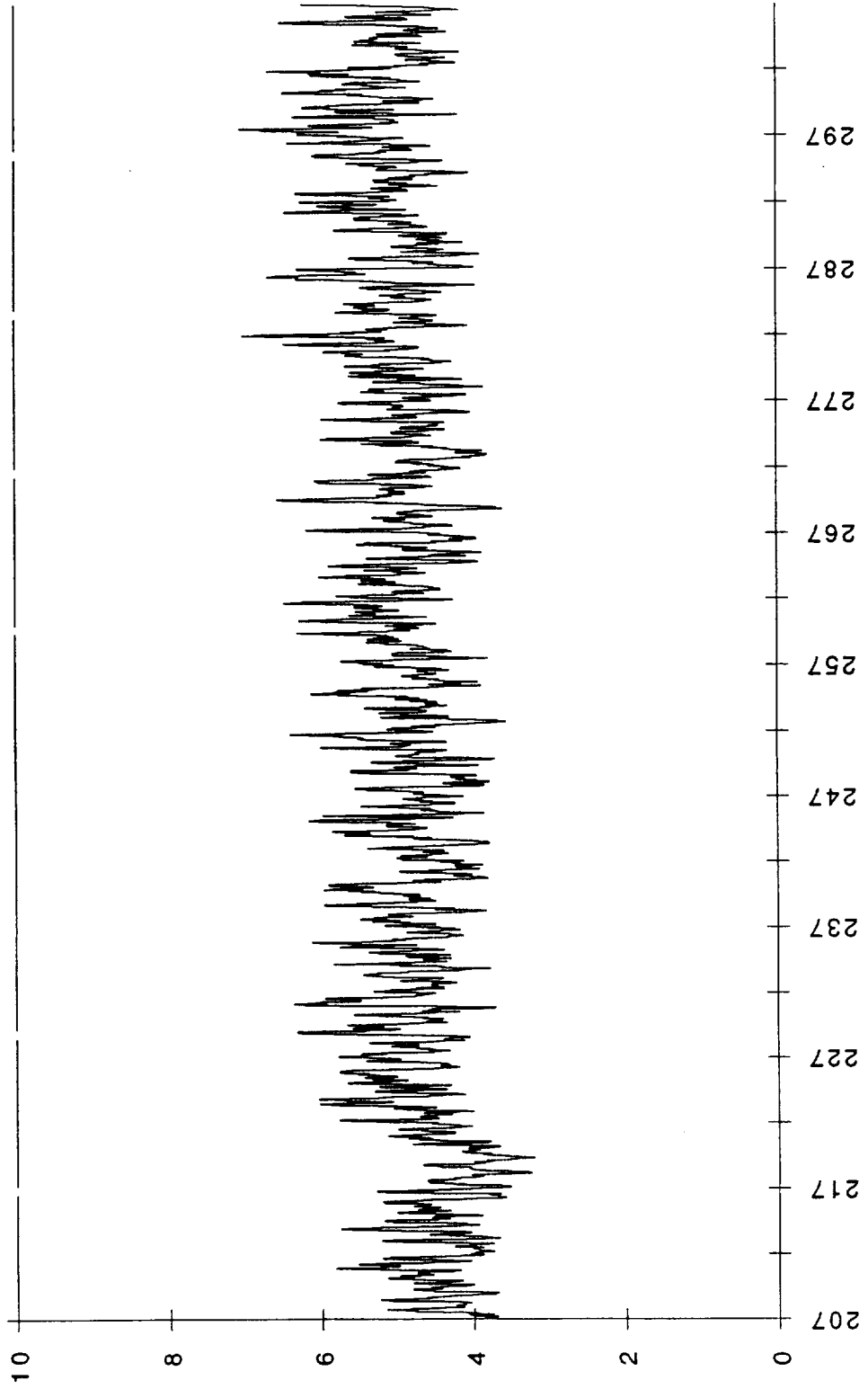

901-809 HPFP accel.T

901-809 HPFP accel.T

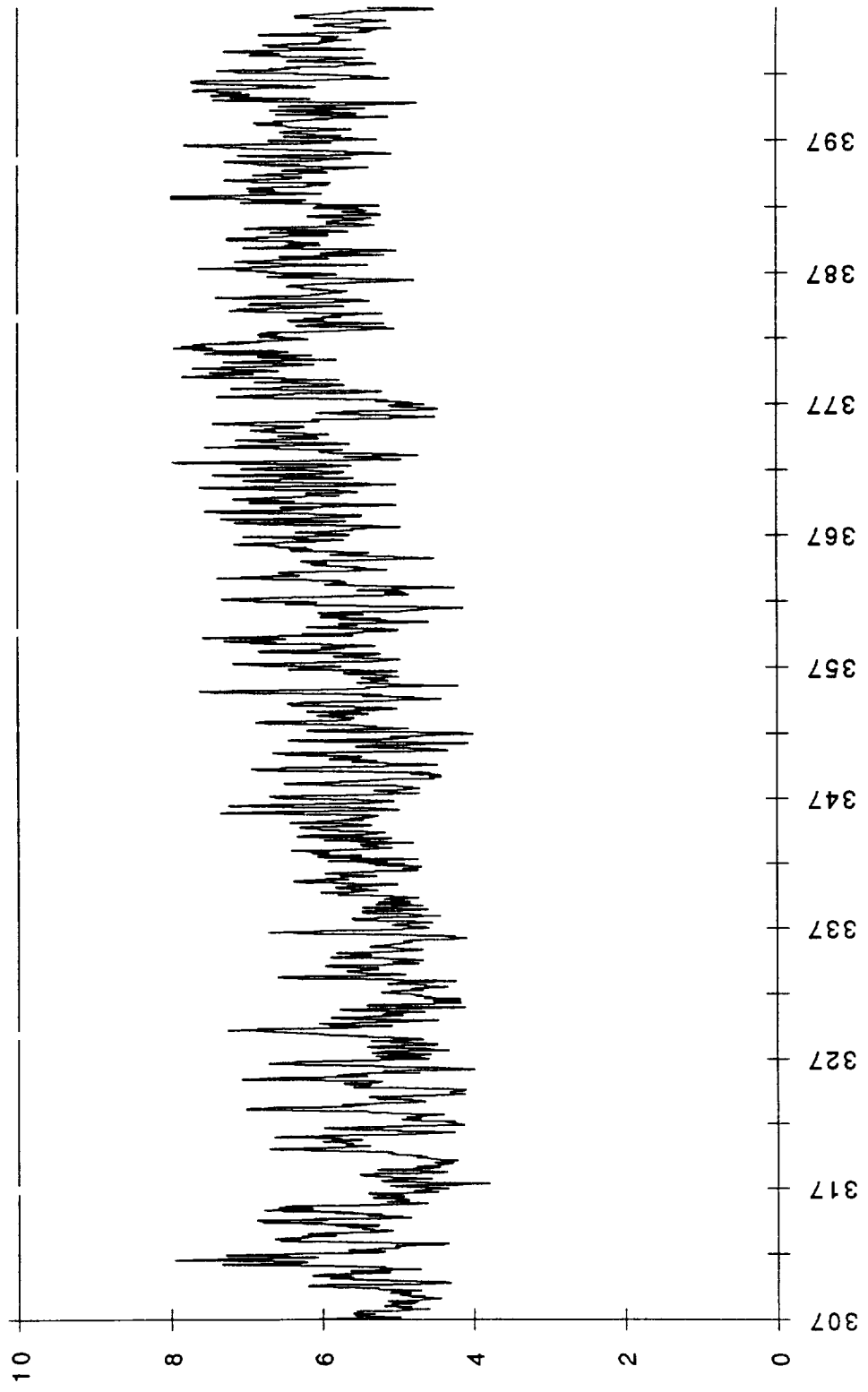

901-809 HPFP accel.T

901-809 HPFP accel.T

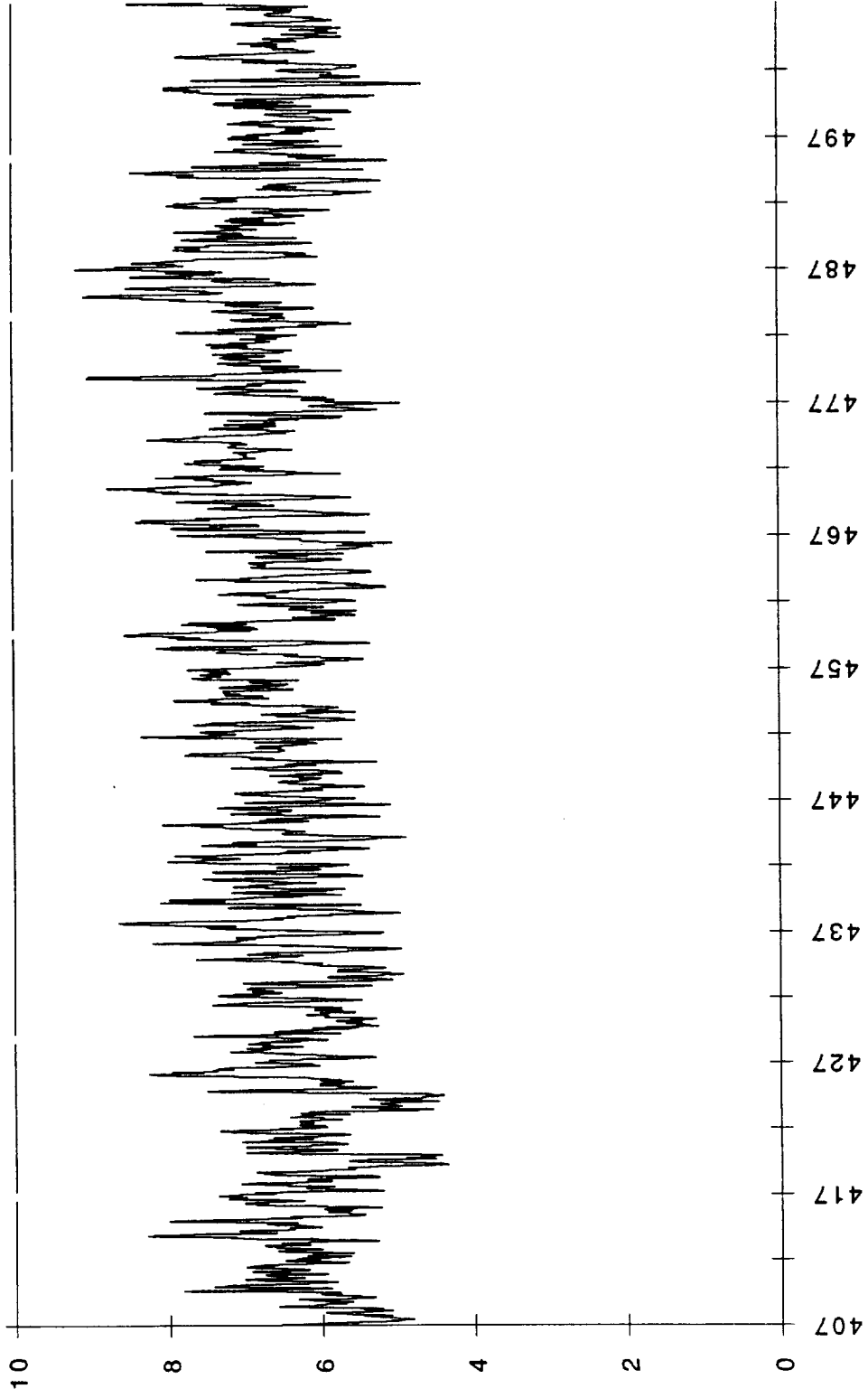

901-809 HPFP accel.T

901-809 HPFP accel.T

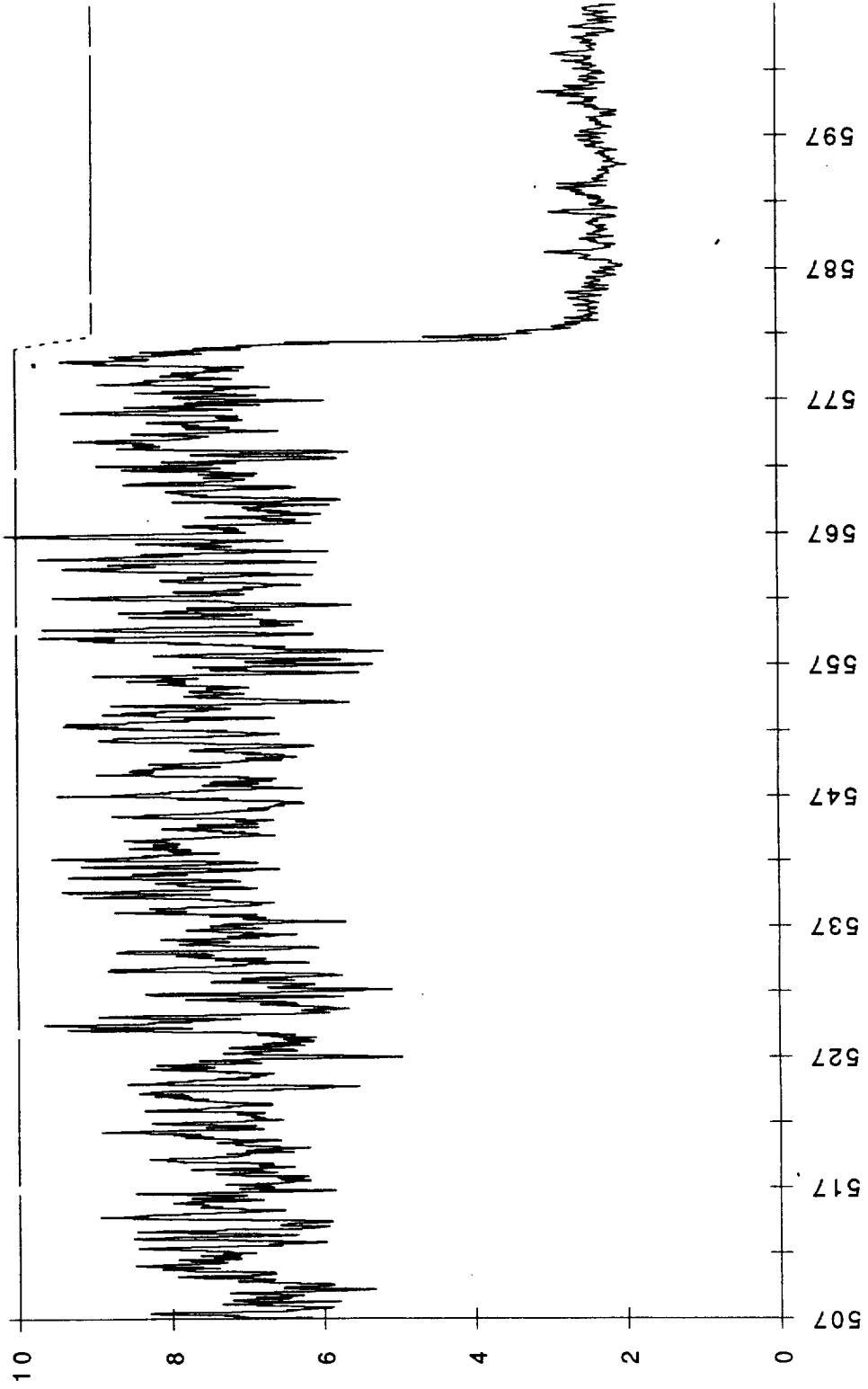

901-809 HPFP accel.T

901-816 HPFP dis pr.T

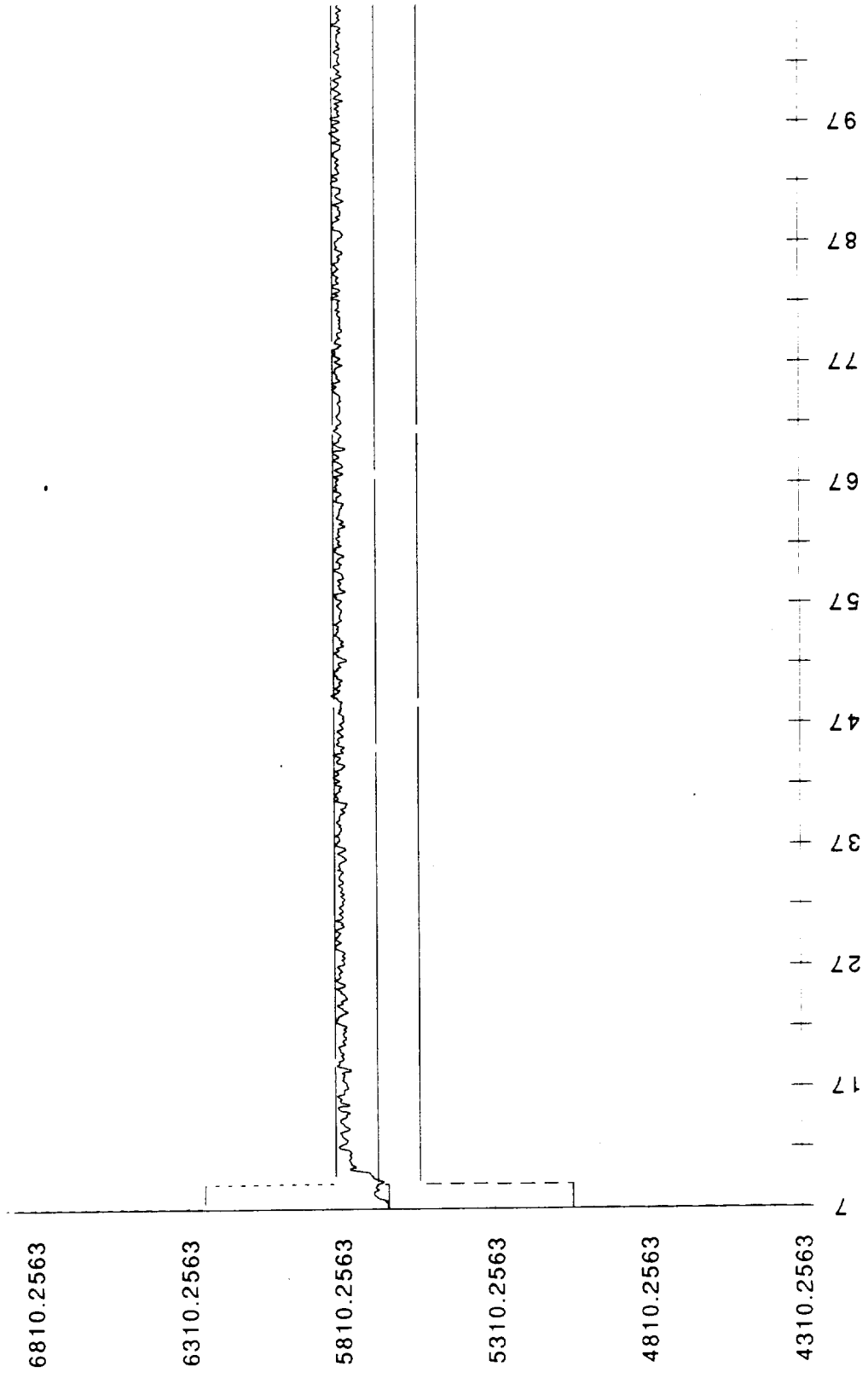

901-816 HPFP dis pr.T

901-816 HPFP dis pr.T

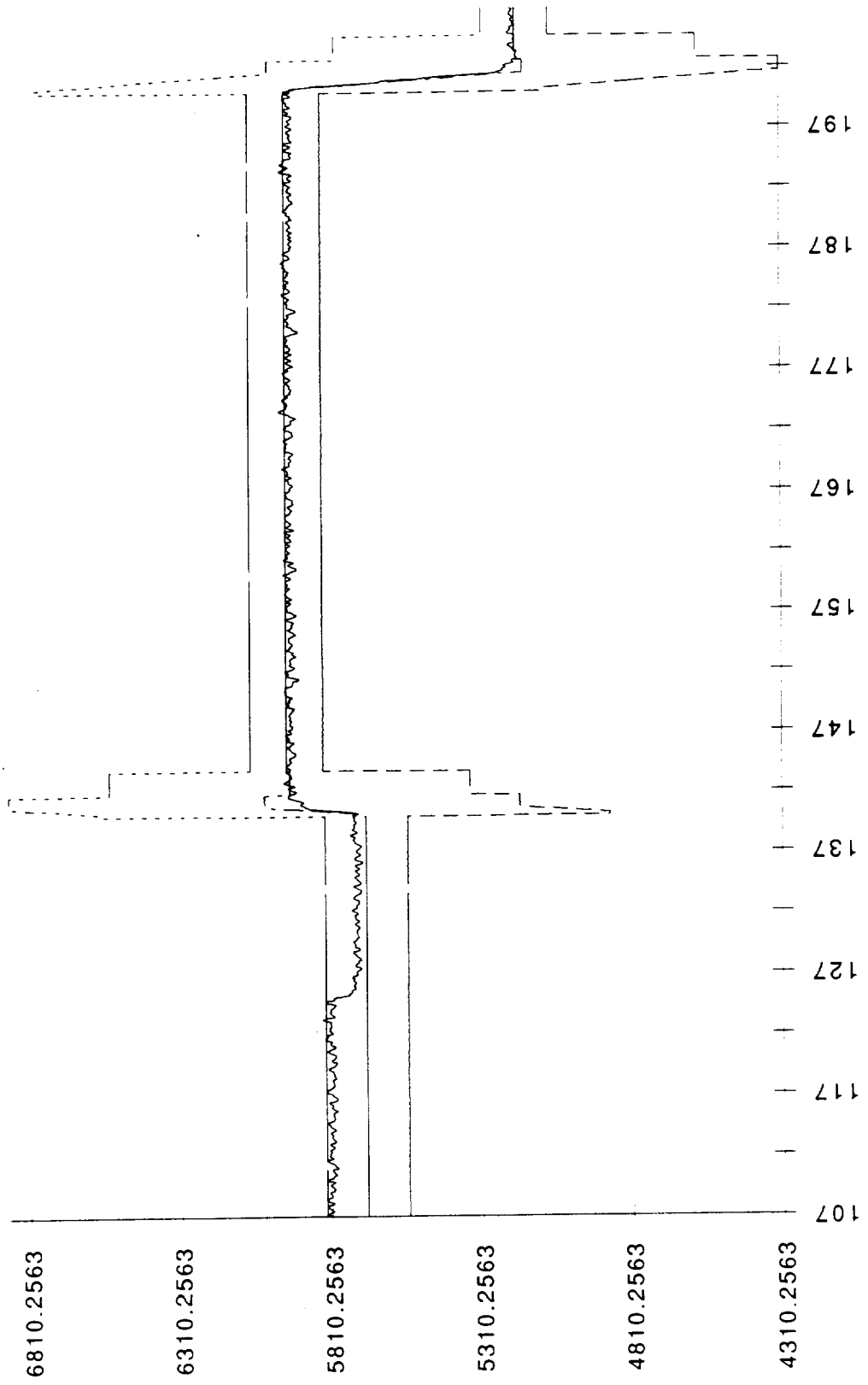

901-816 HPFP dis pr.T

6810.2563

6310.2563

5810.2563

5310.2563

4810.2563

4310.2563

207

901-816 HPOP TDT B.T

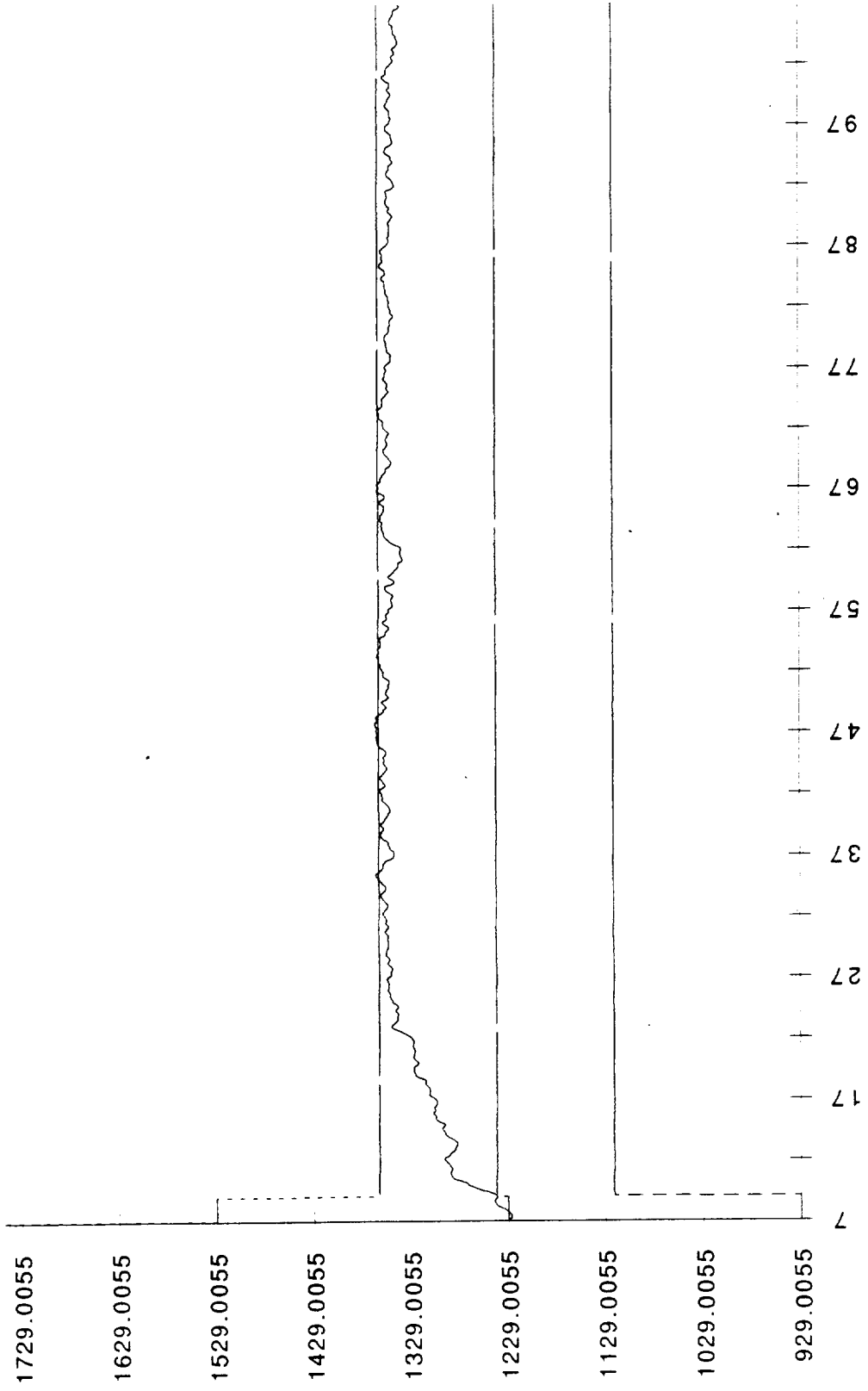

901-816 HPOP TDT B.T

901-816 HPOP TDT B.T

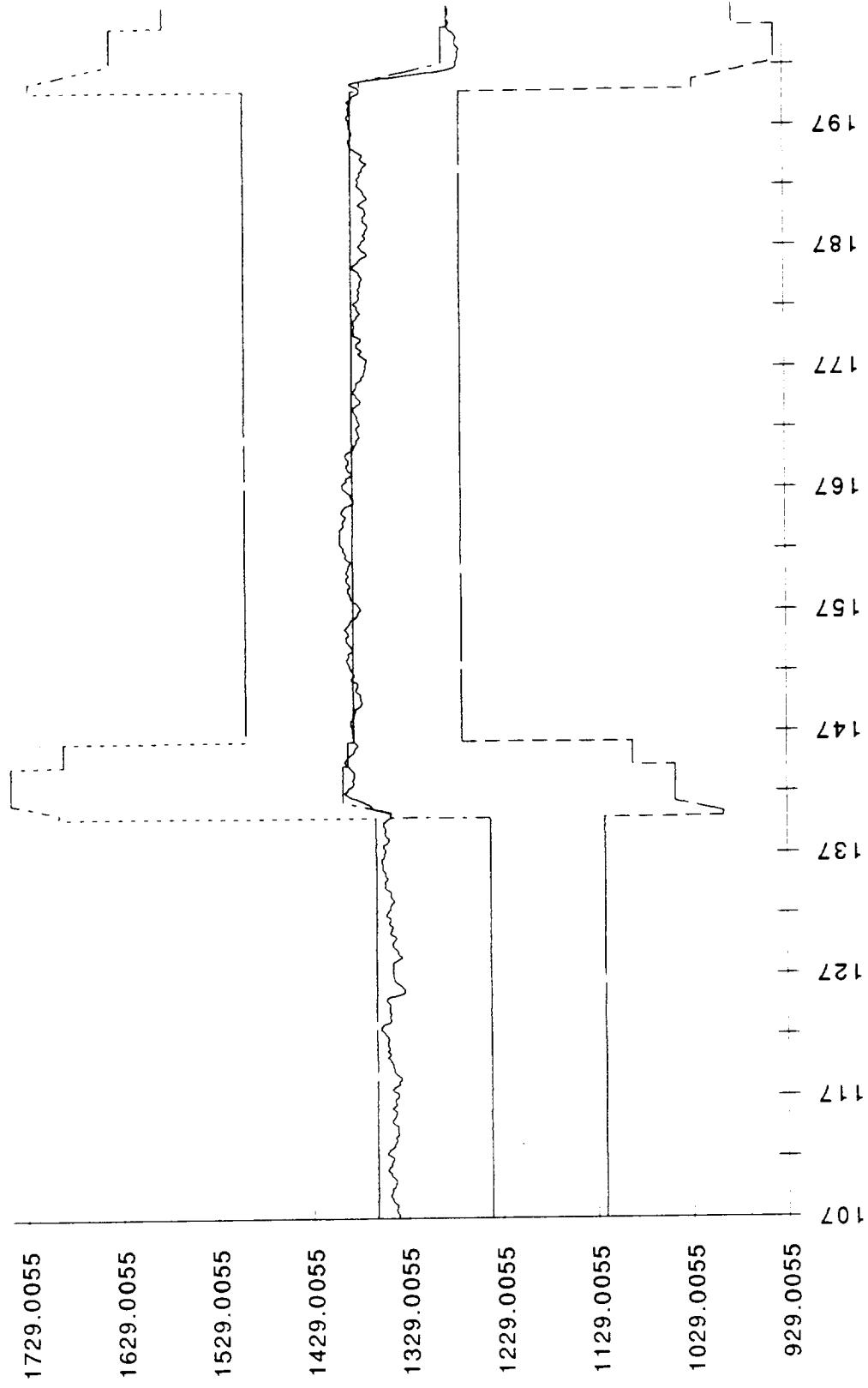

901-816 HPOP TDT B.T

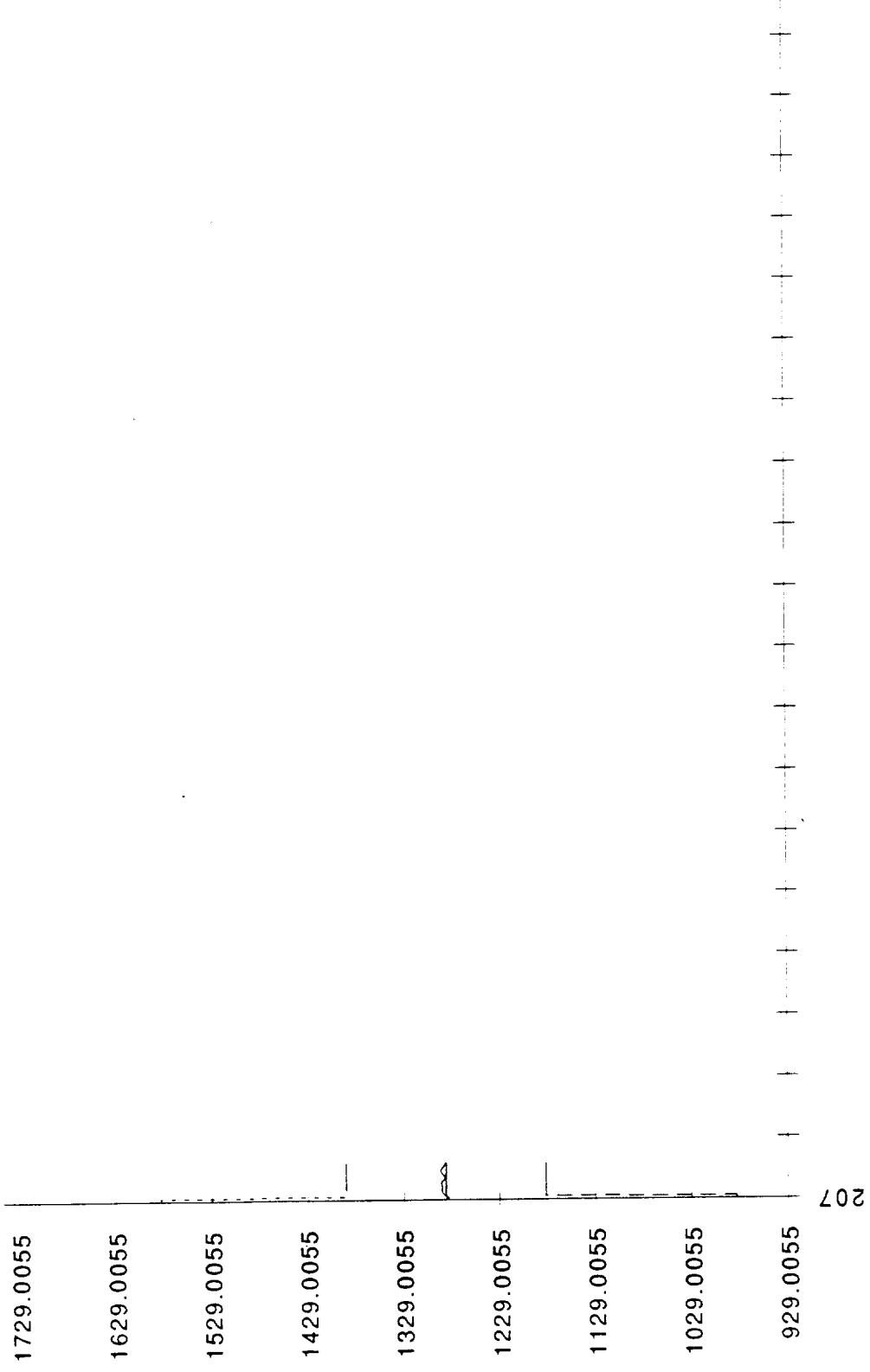

904-196 LPFP sh sp.T

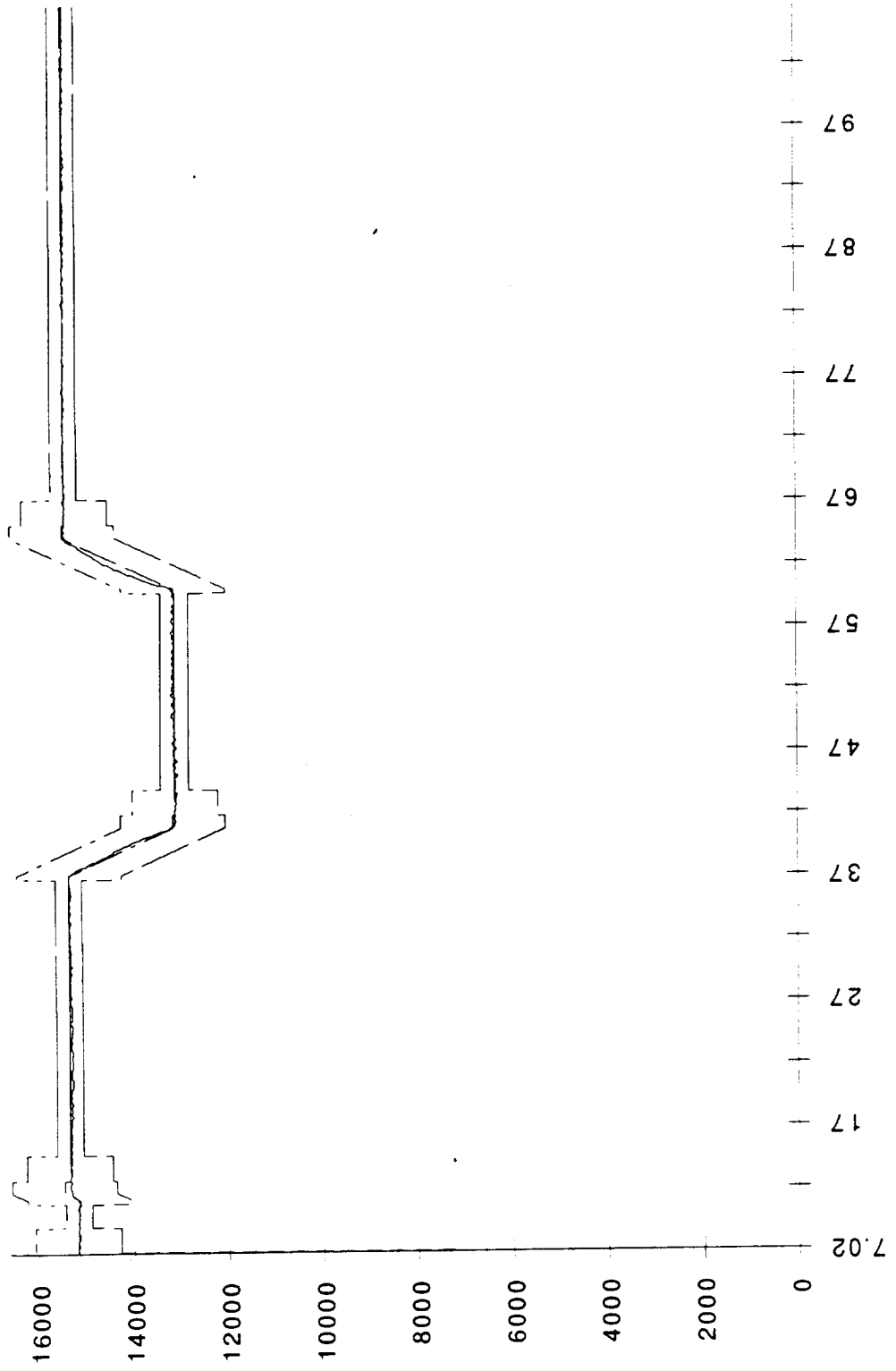

904-196 LPFP sh sp.T

904-196 LPFP sh sp.T

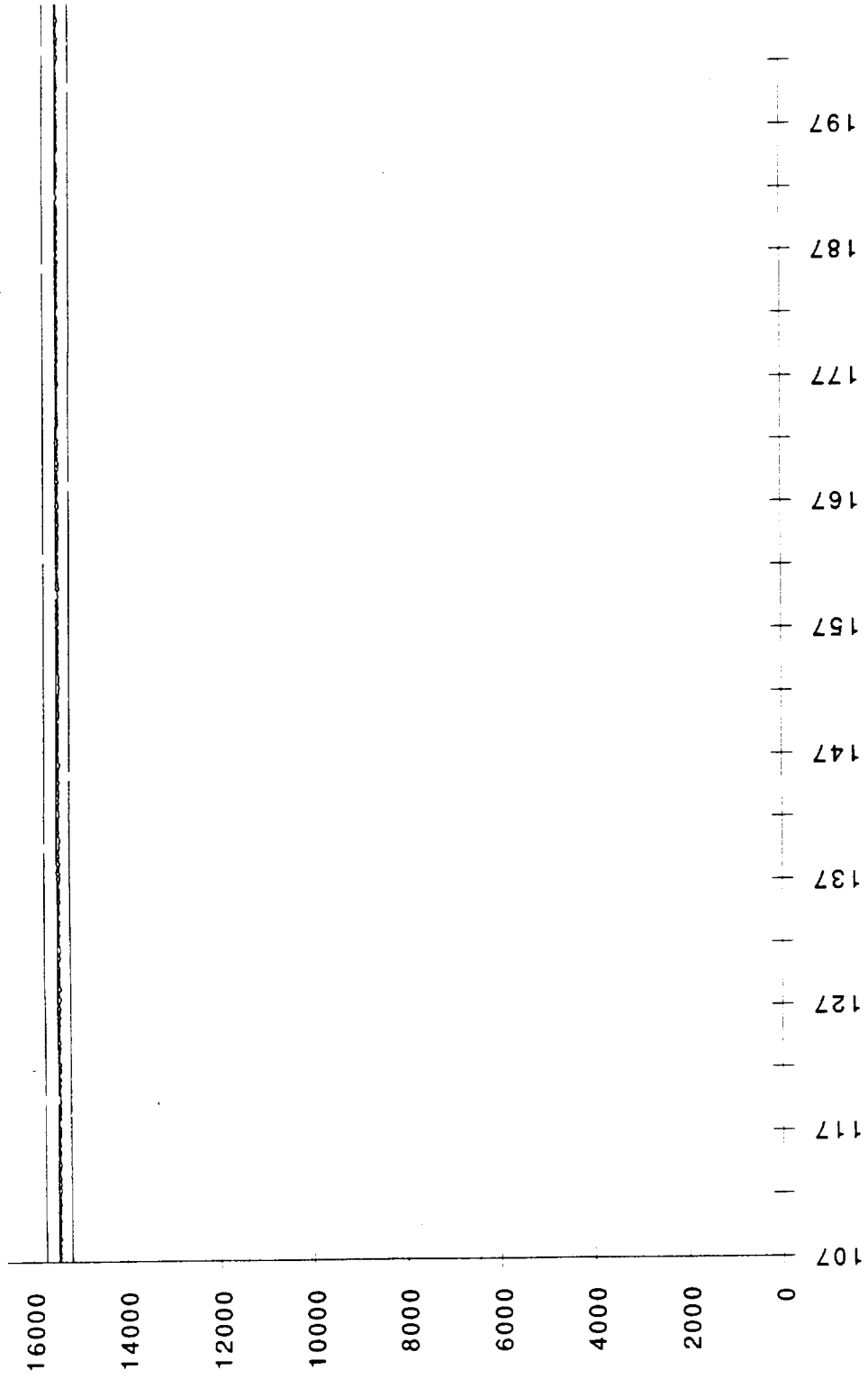

904-196 LPFP sh sp.T

904-196 LPFP sh sp.T

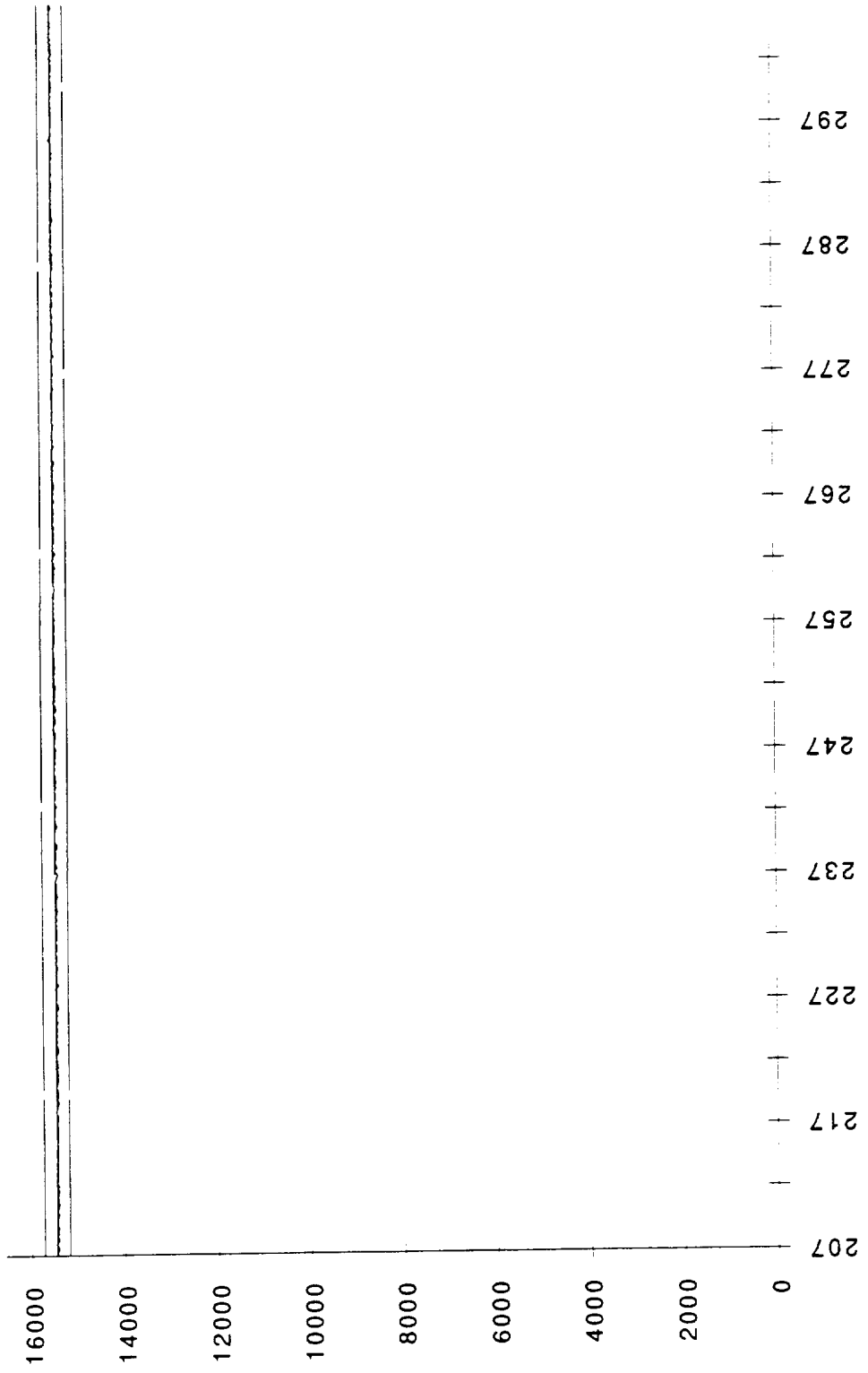

904-196 LPFP sh sp.T

904-196 LPFP sh sp.T

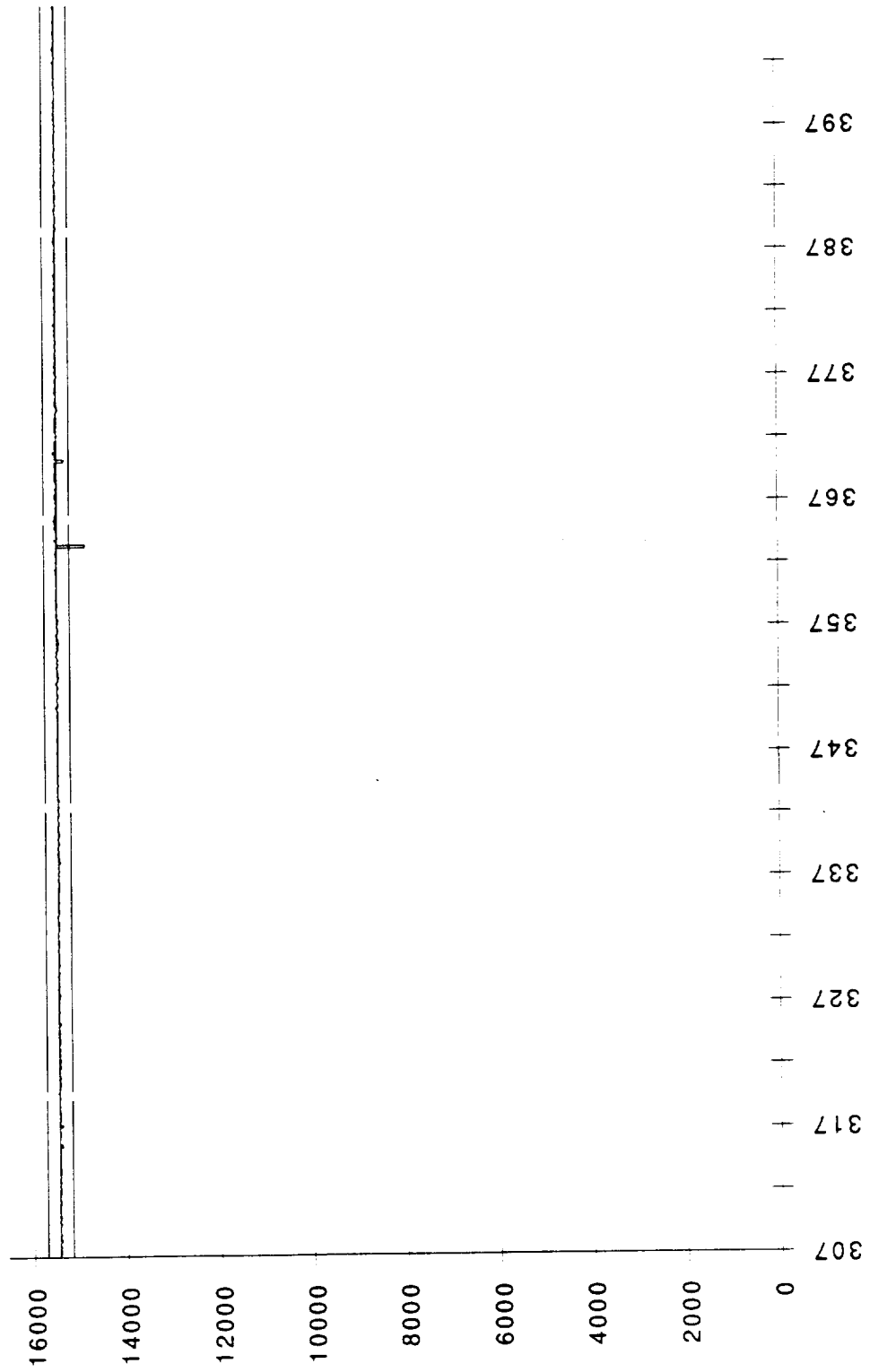

904-196 LPFP sh sp.T

904-196 LPFP sh sp.T

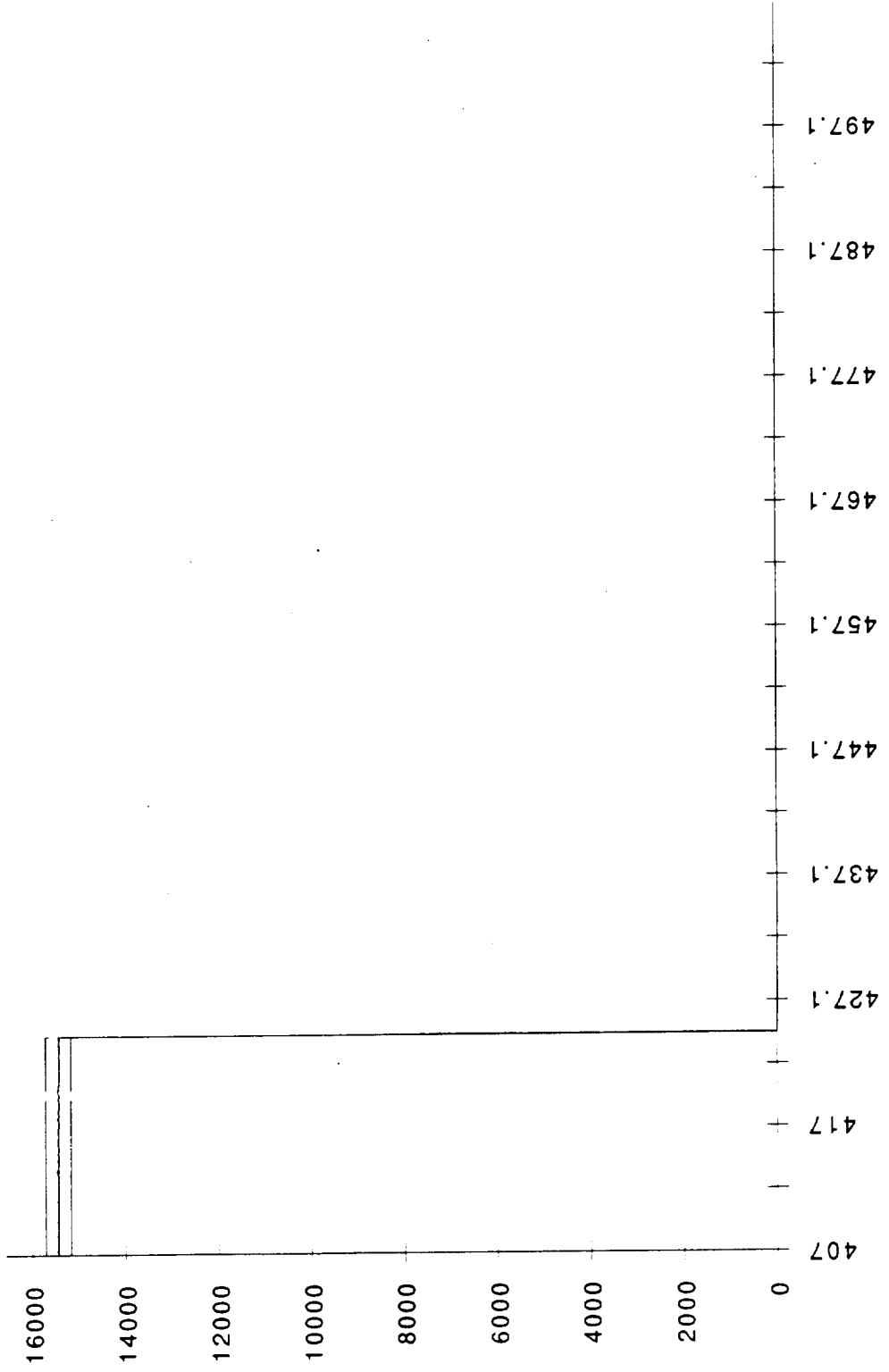

904-196 LPFP sh sp.T

904-196 LPFP sh sp.T

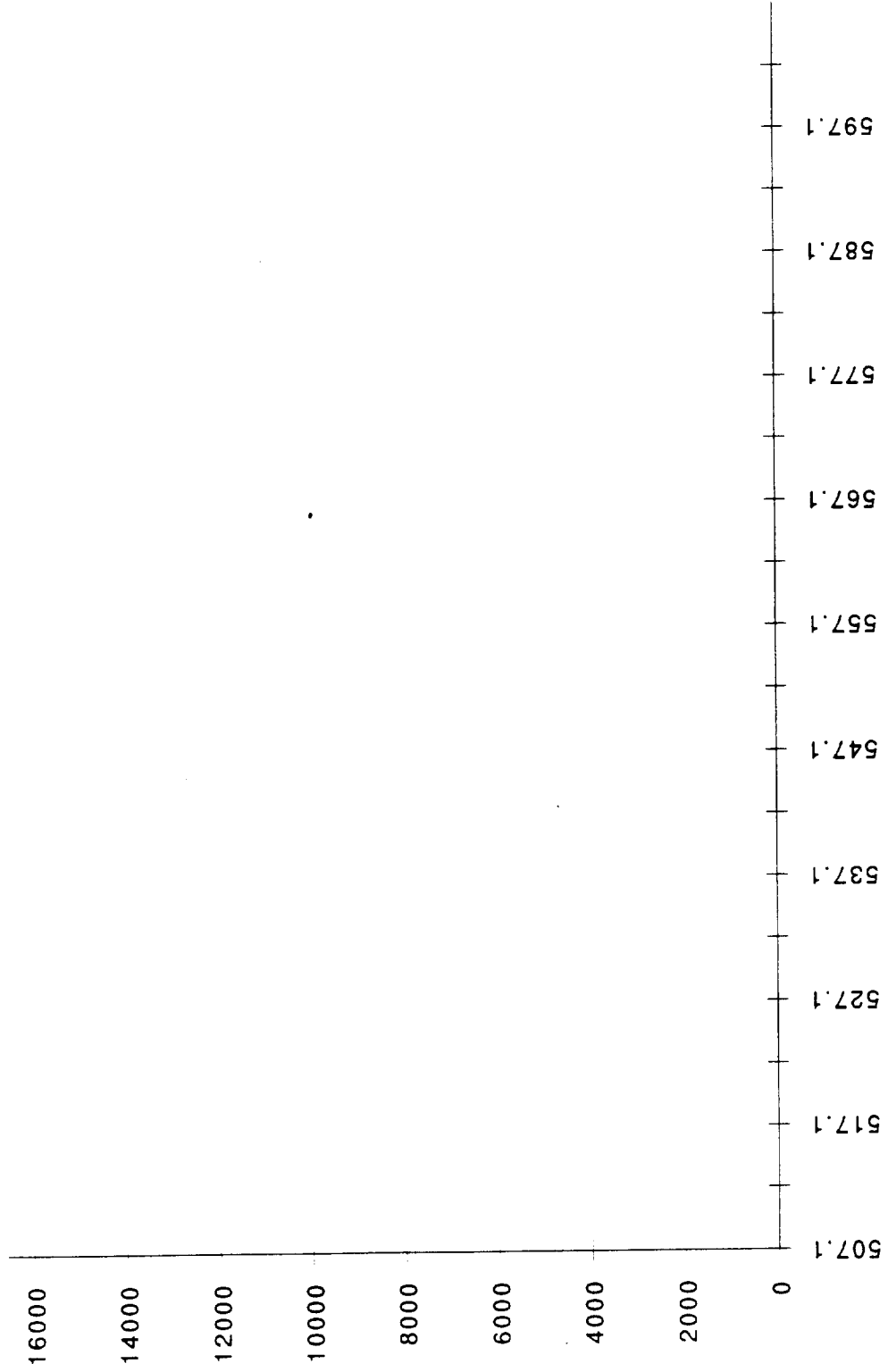

904-196 LPFP sh sp.T

904-201 HPFP TDT A.T

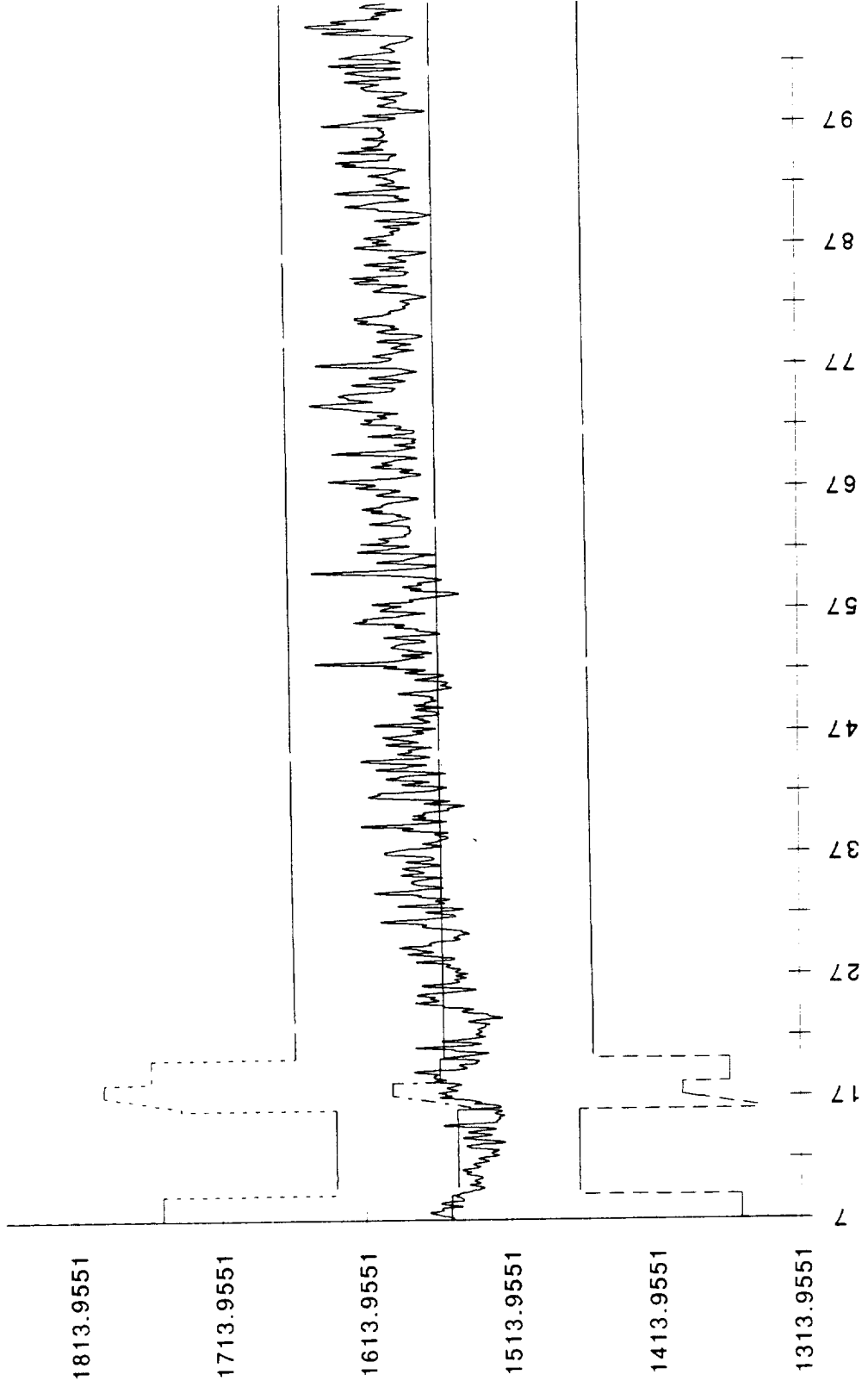

904-201 HPFP TDT A.T

904-201 HPFP TDT A.T

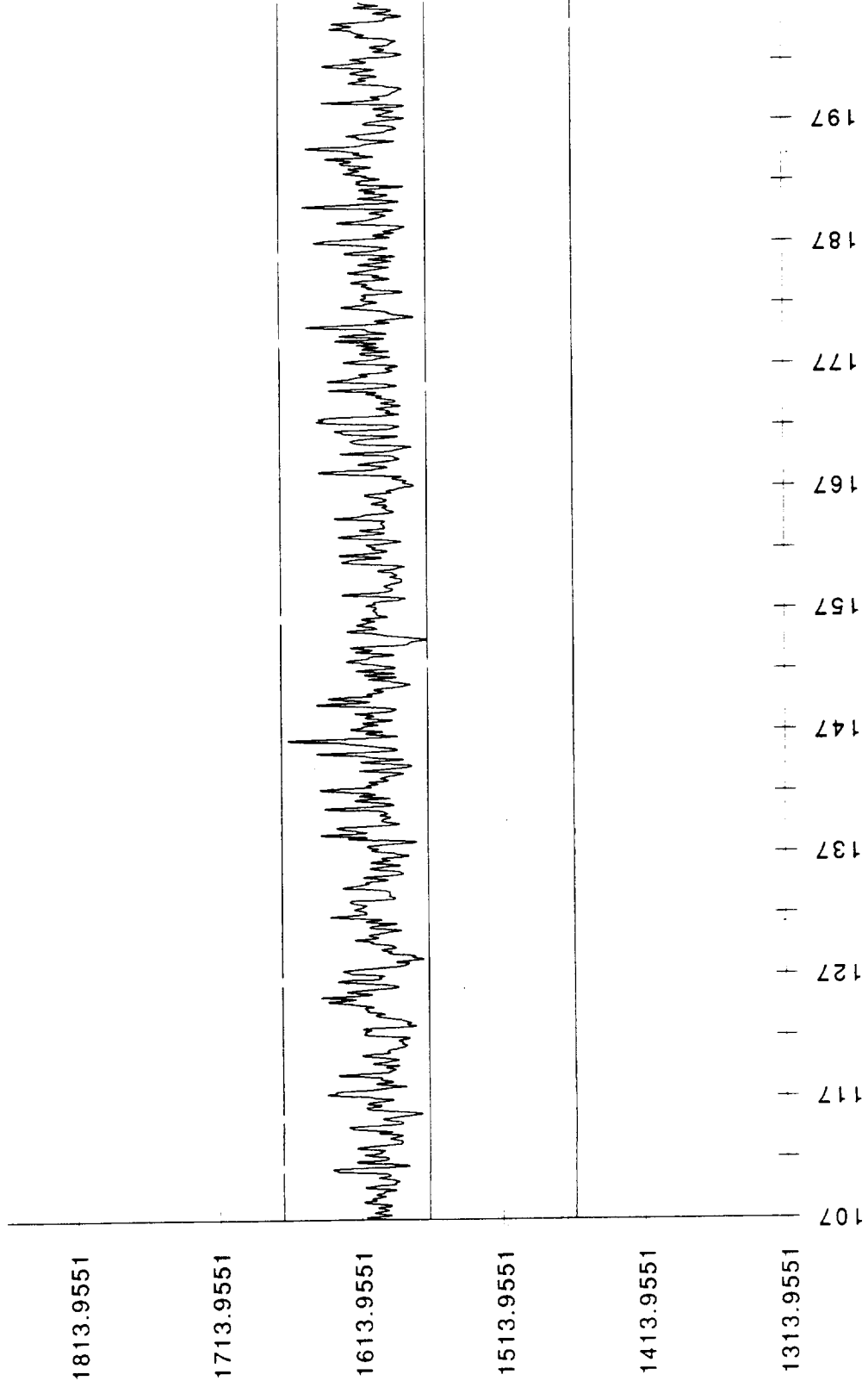

904-201 HPFP TDT A.T

904-201 HPFP TDT A.T

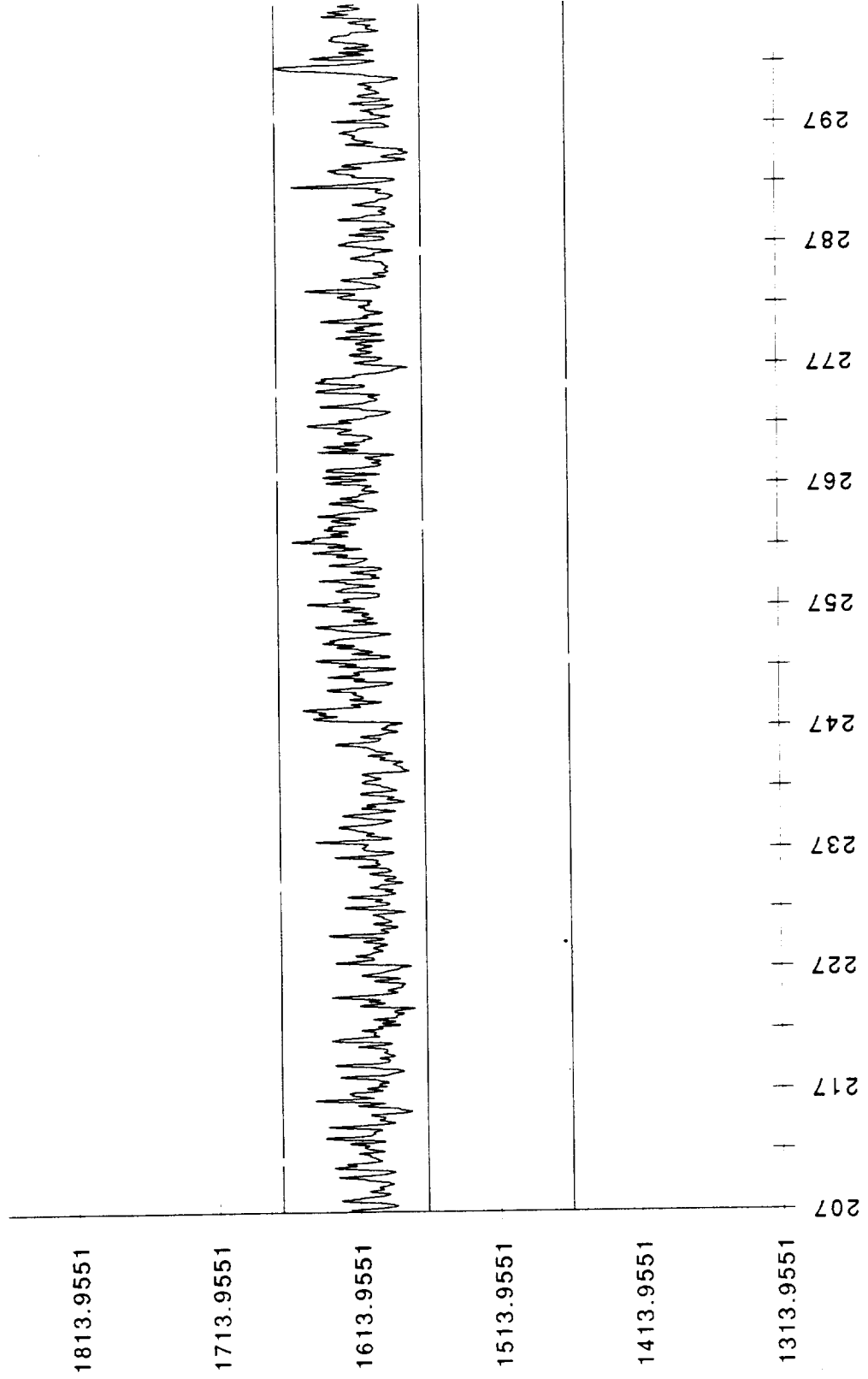

904-201 HPFP TDT A.T

904-201 HPFP TDT A.T

1813.9551

1713.9551

1613.9551

1513.9551

1413.9551

1313.9551

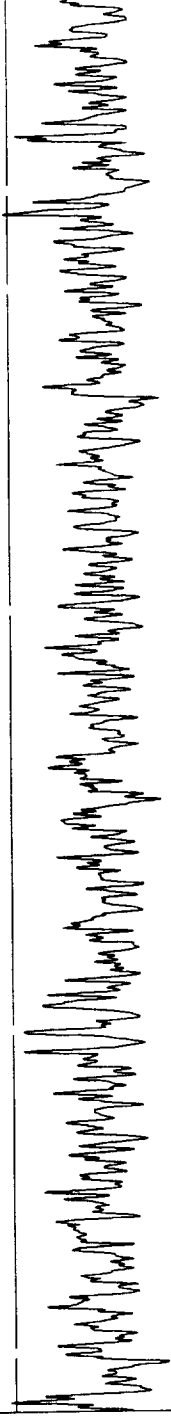

397

387

377

367

357

347

337

327

317

307

904-201 HPFP TDT A.T

904-201 HPFP TDT A.T

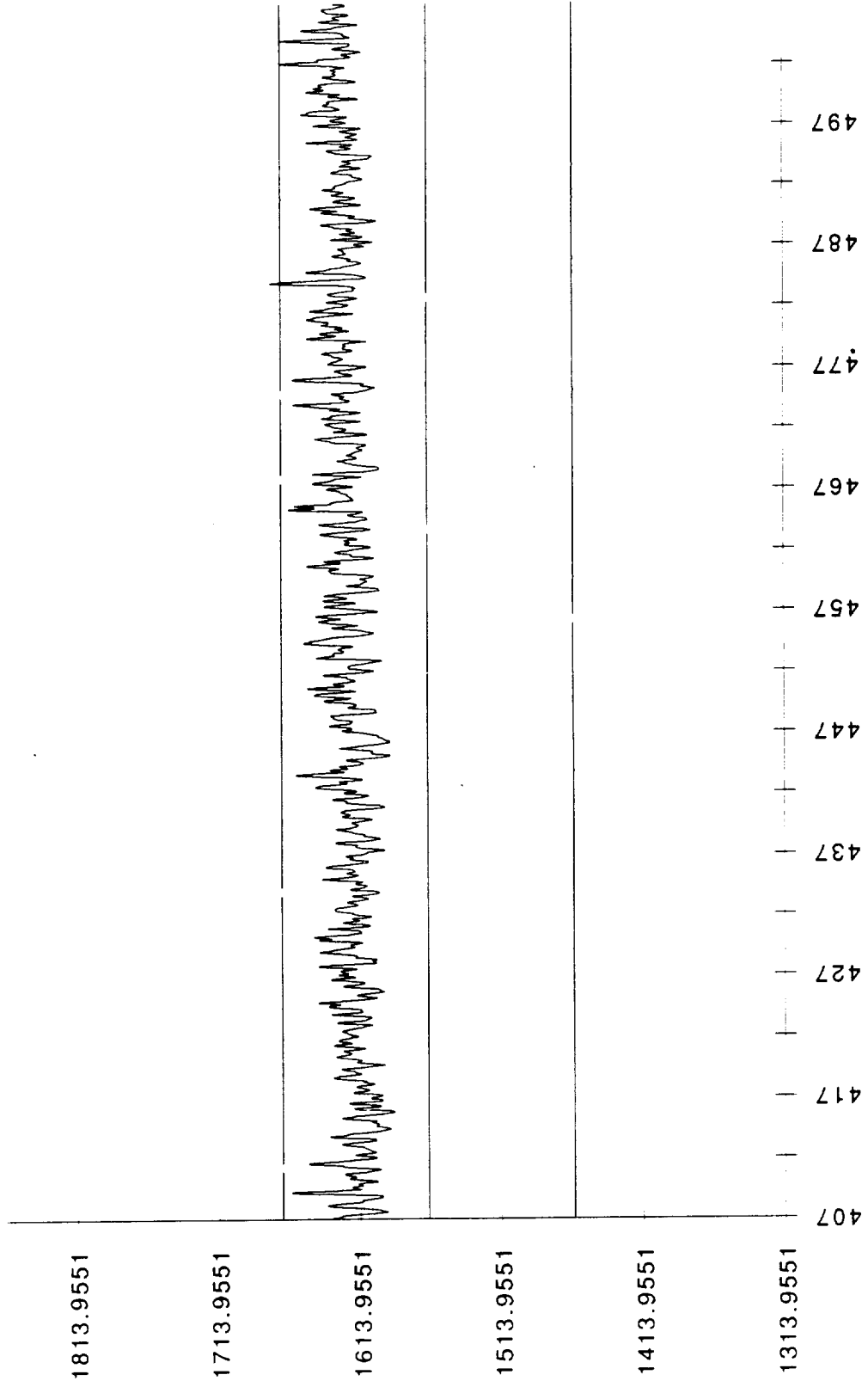

904-201 HPFP TDT A.T

904-201 HPFP TDT A.T

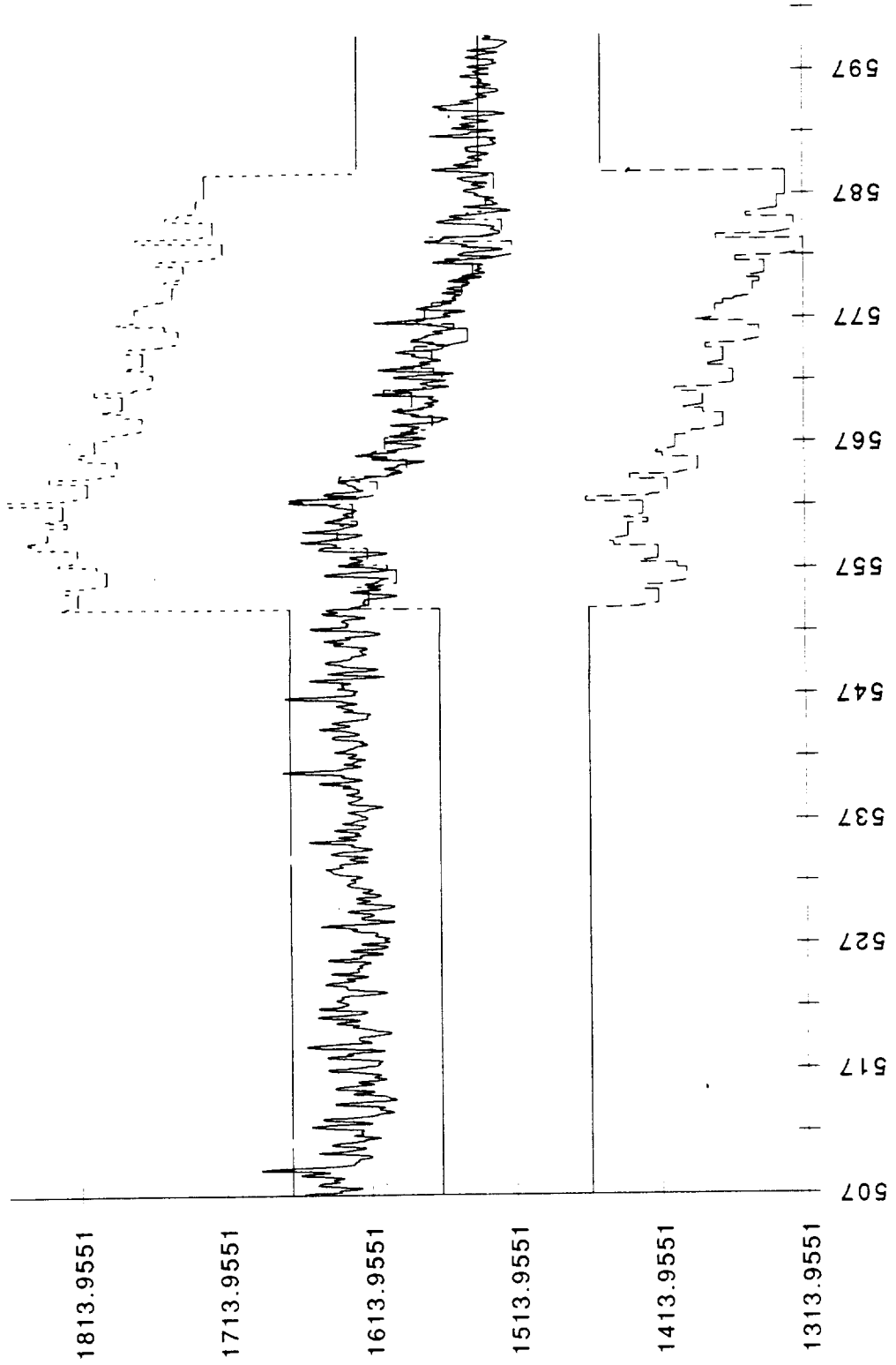

904-201 HPFP TDT A.T

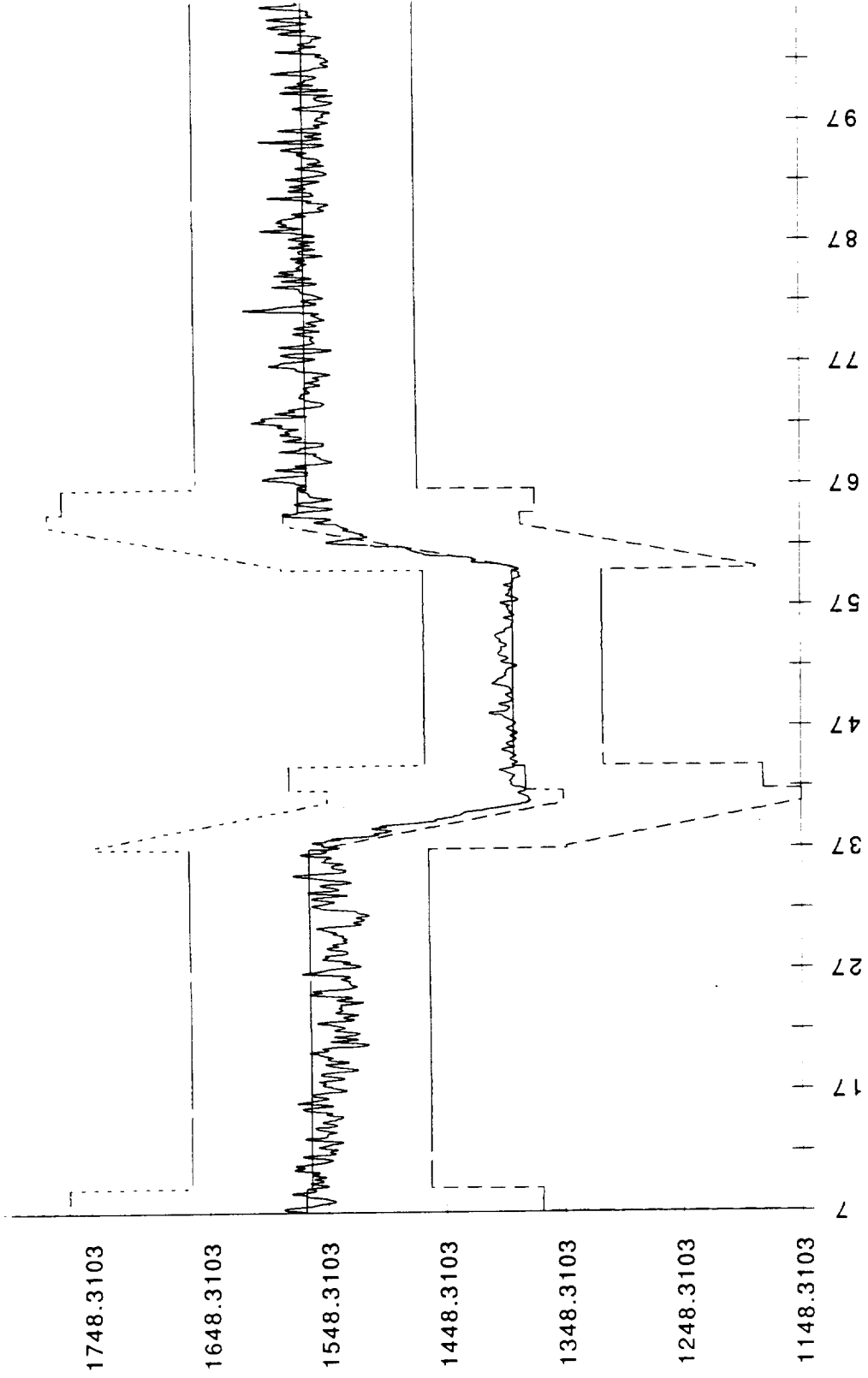

904-205 HPFP TDT A.T

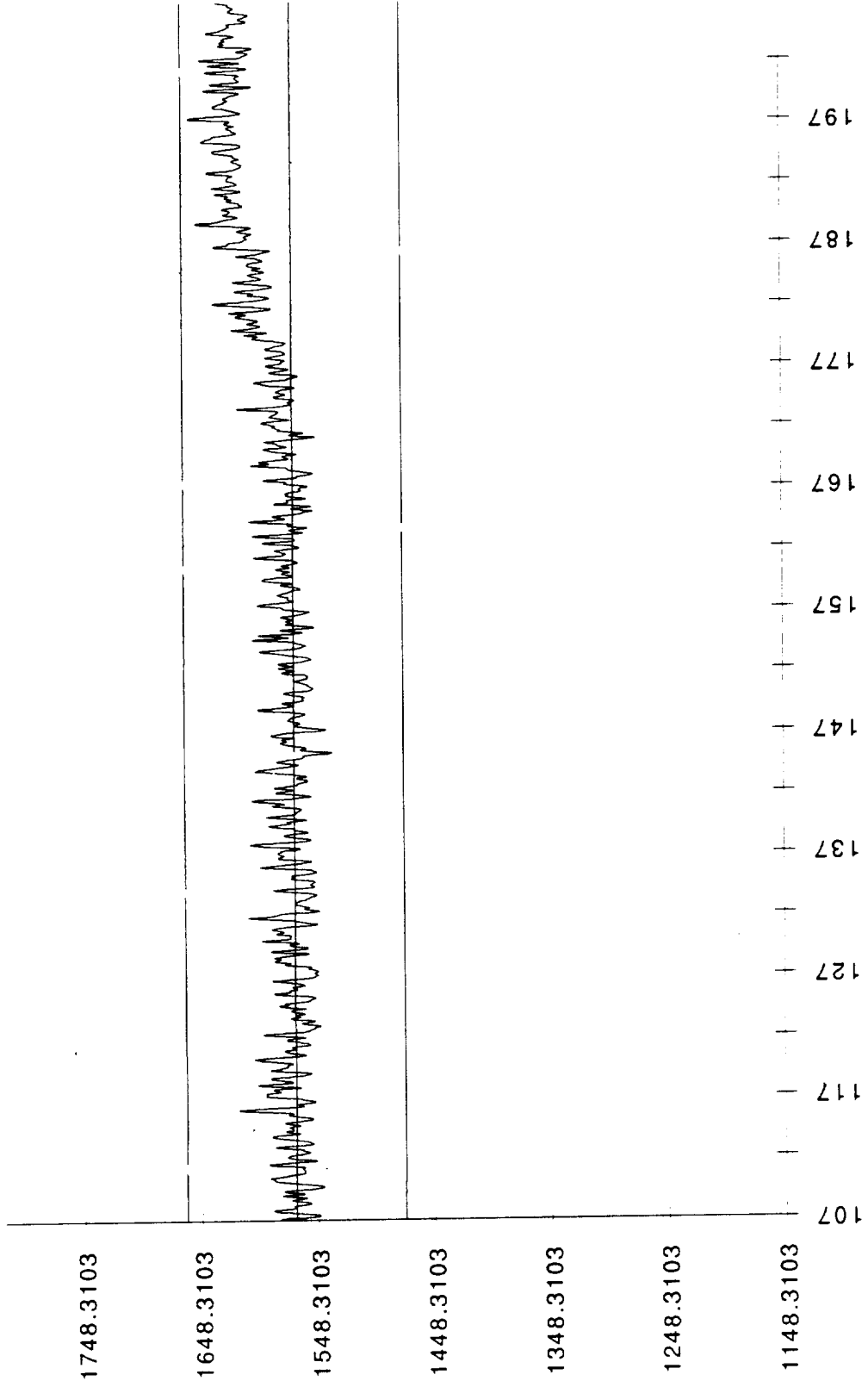

904-205 HPFP TDT A.T

904-205 HPFP TDT A.T

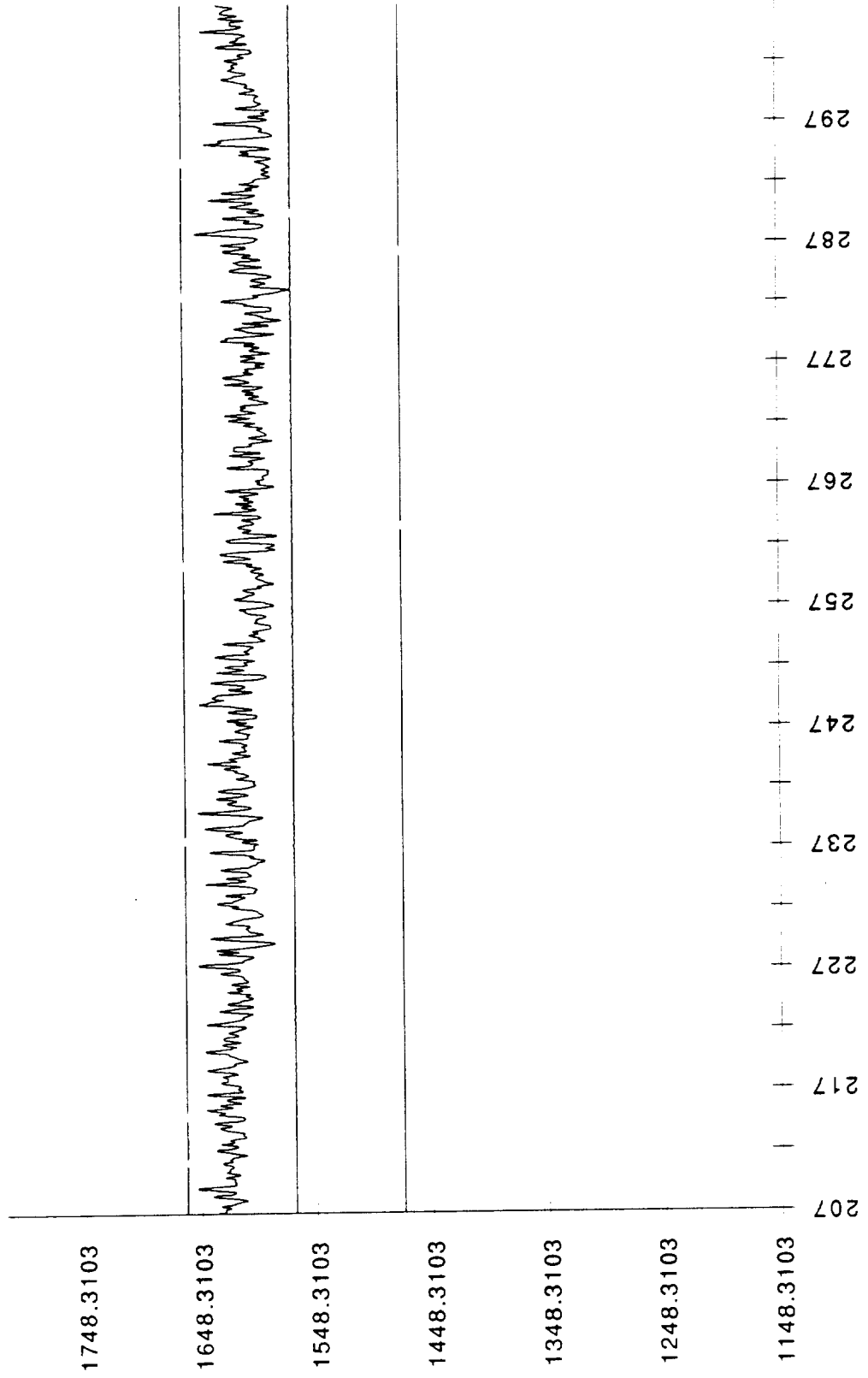

904-205 HPFP TDT A.T

904-205 HPFP TDT A.T

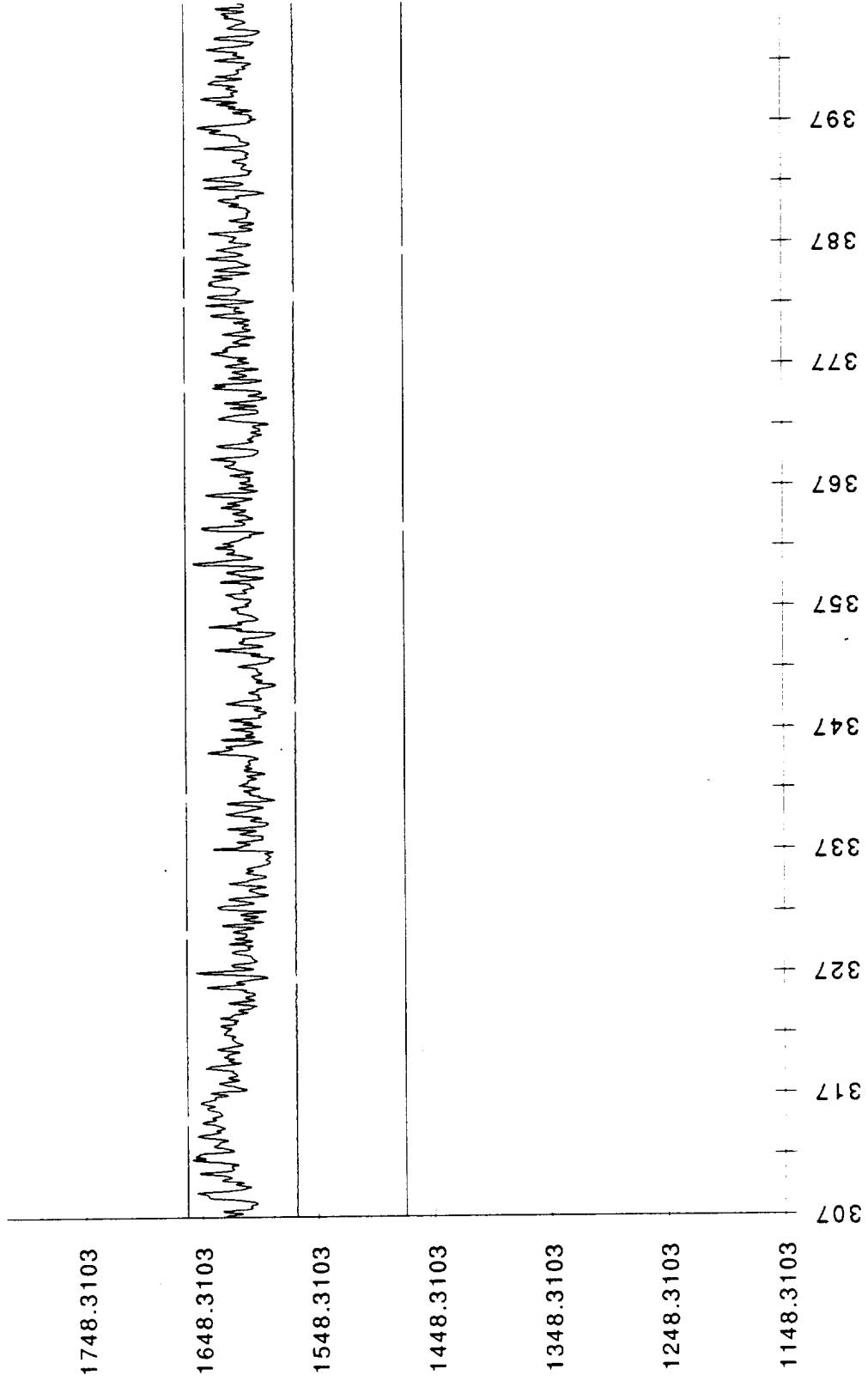

904-205 HPFP TDT A.T

904-205 HPFP TDT A.T

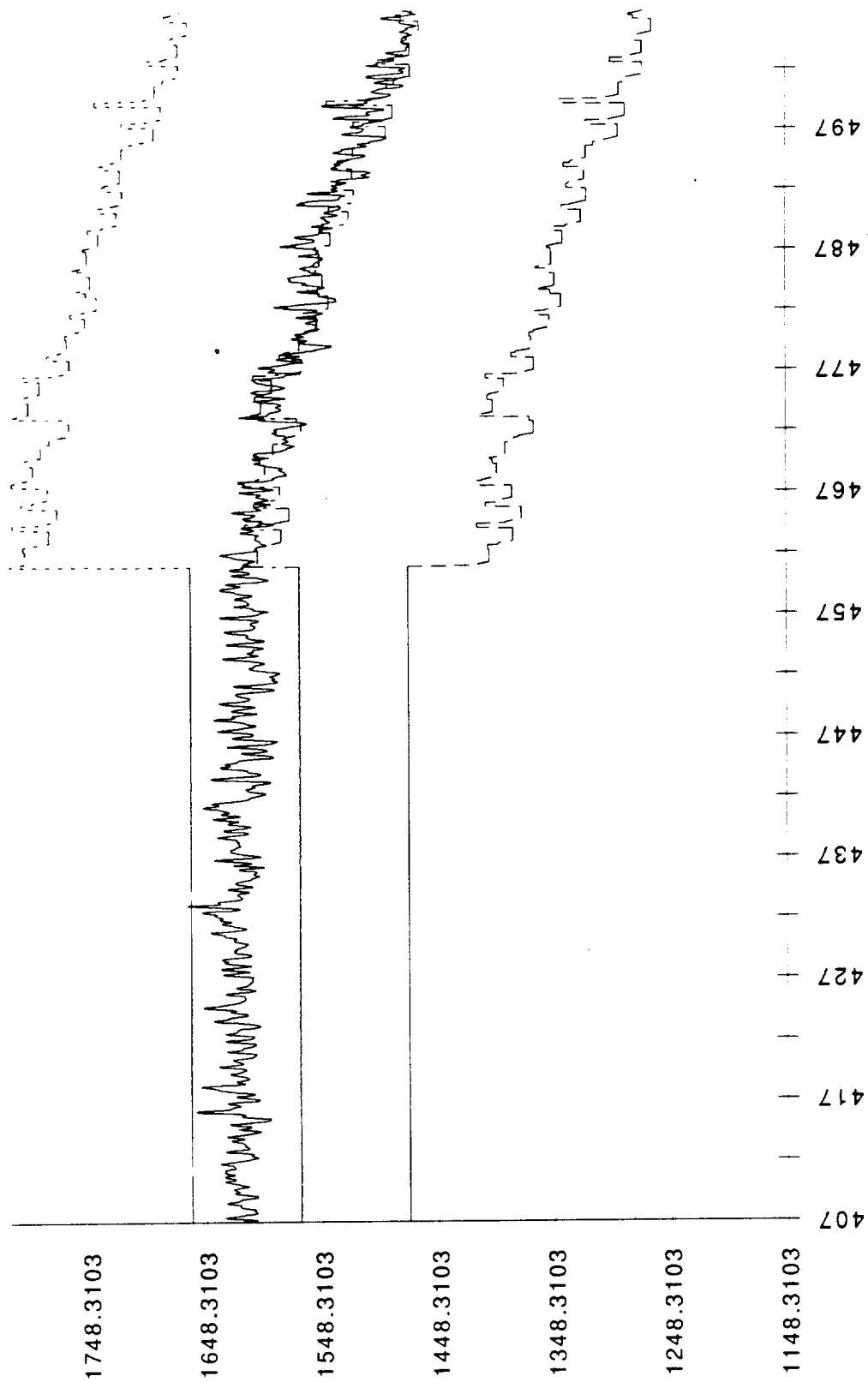

904-205 HPFP TDT A.T

904-205 HPFP TDT A.T

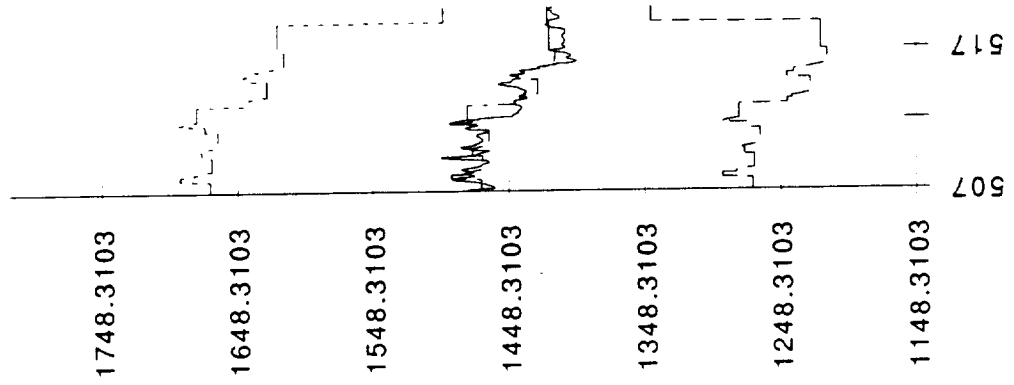

904-205 HPFP TDT A.T

904-207 HPFP TDT A.T

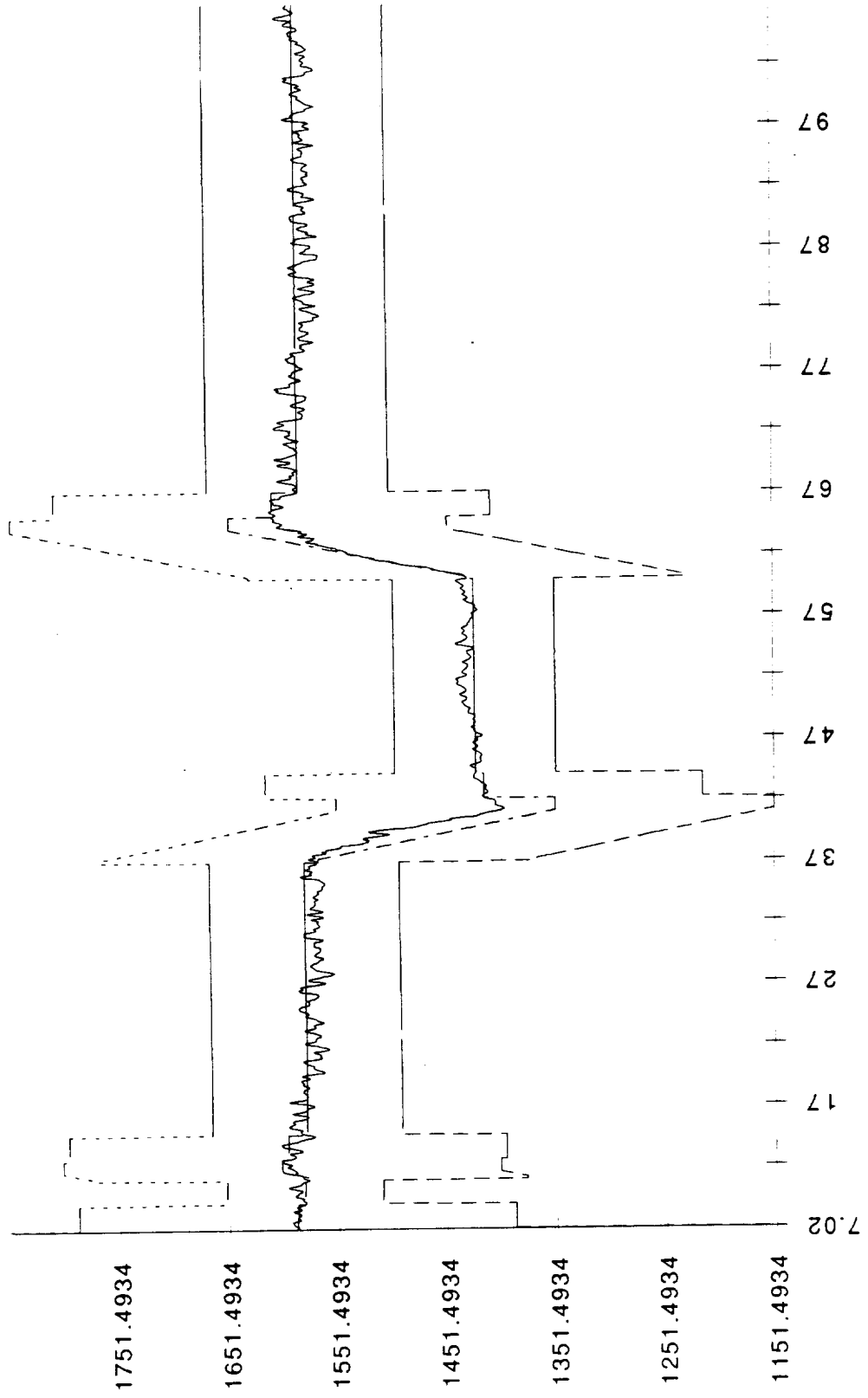

904-207 HPFP TDT A.T

904-207 HPFP TDT A.T

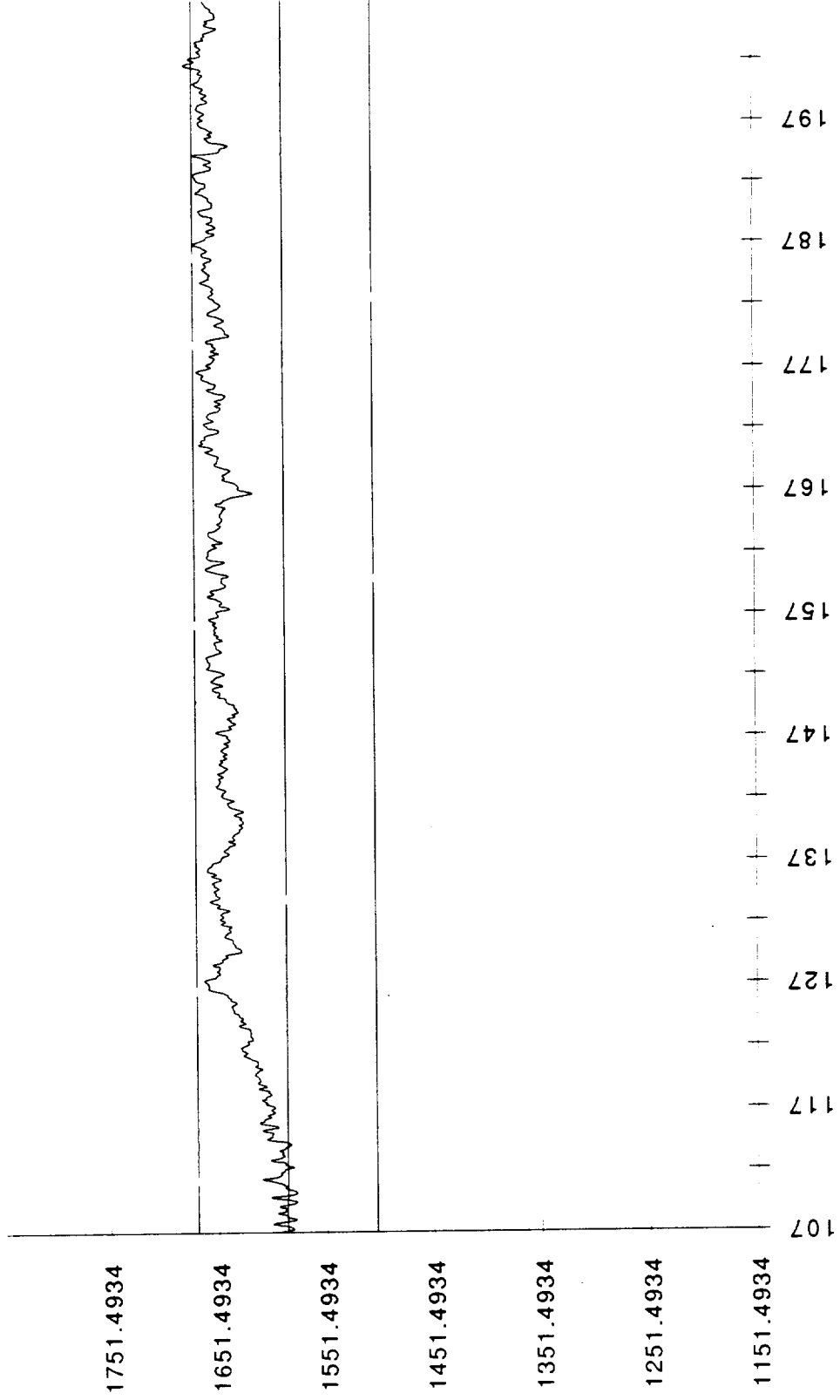

904-207 HPFP TDT A.T

904-207 HPFP TDT A.T

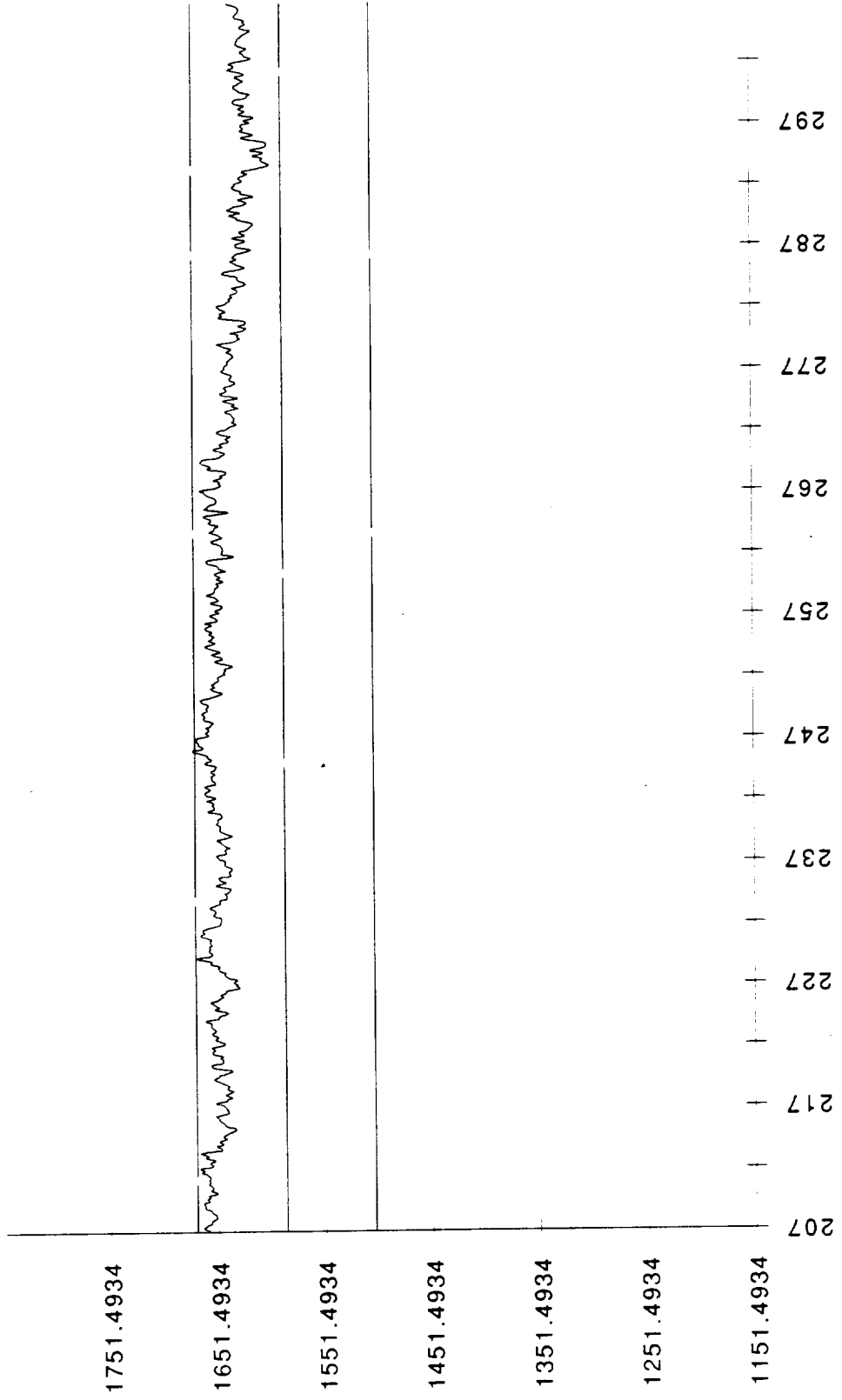

904-207 HPFP TDT A.T

904-207 HPFP TDT A.T

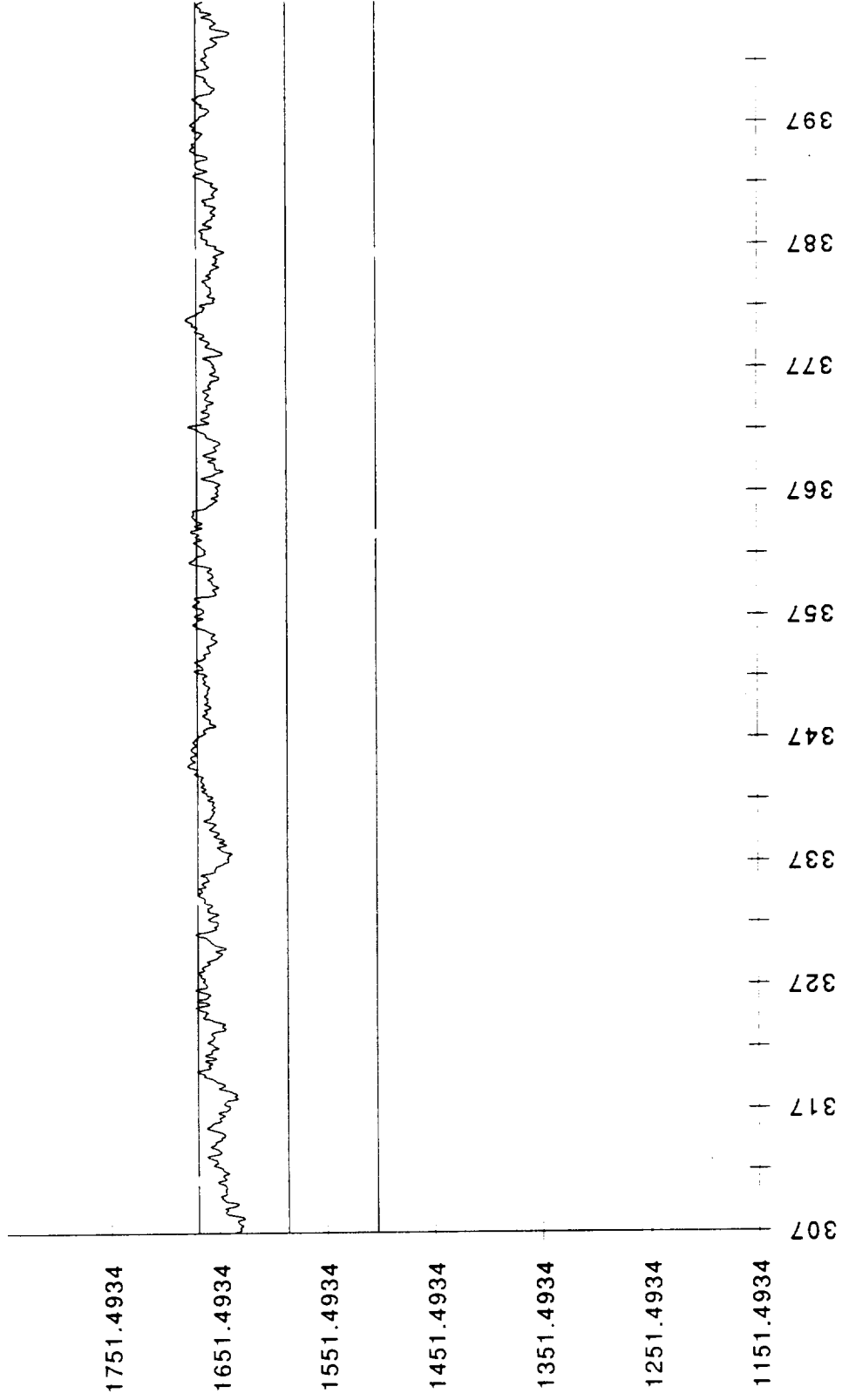

904-207 HPFP TDT A.T

904-207 HPFP TDT A.T

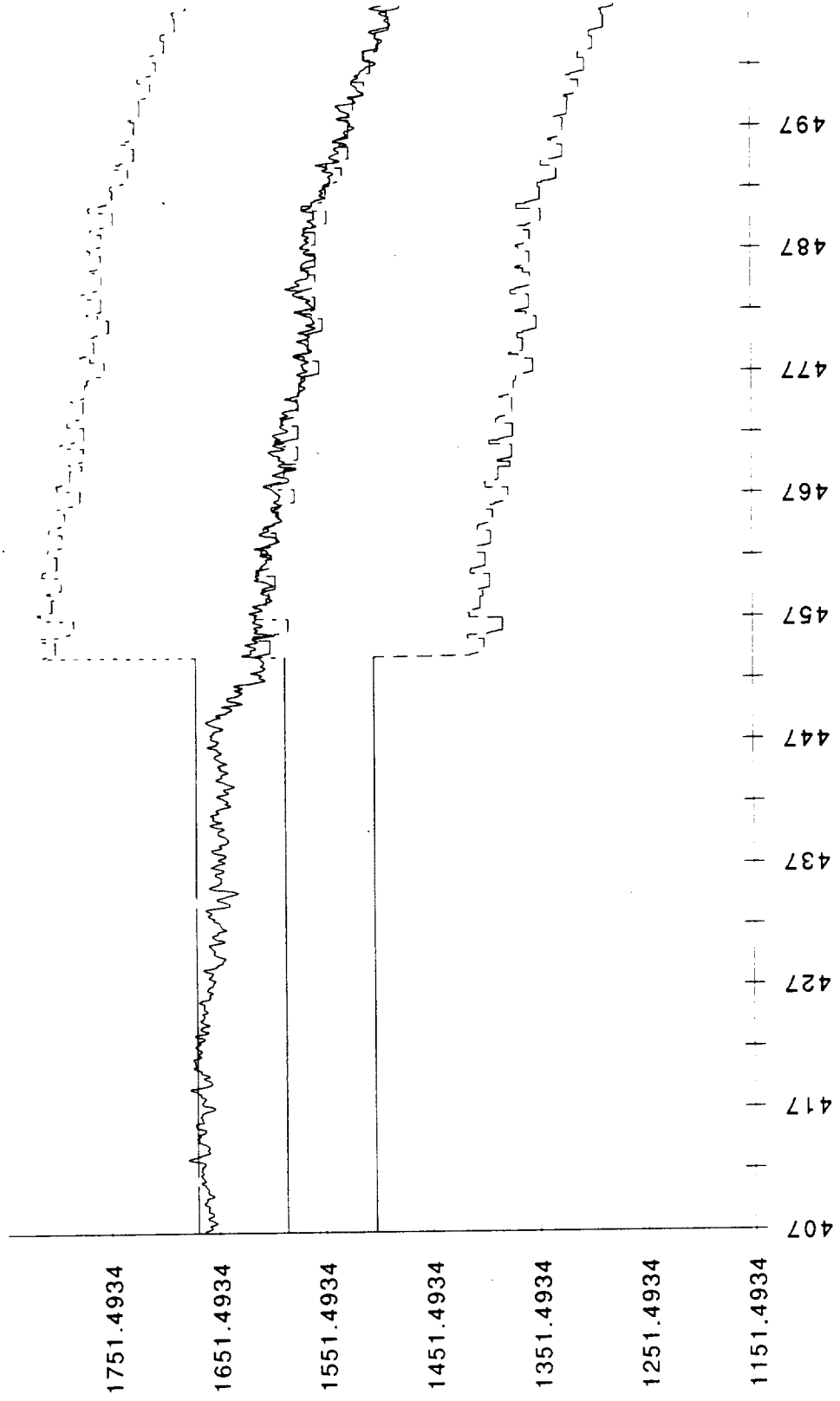

904-207 HPFP TDT A.T

904-207 HPFP TDT A.T

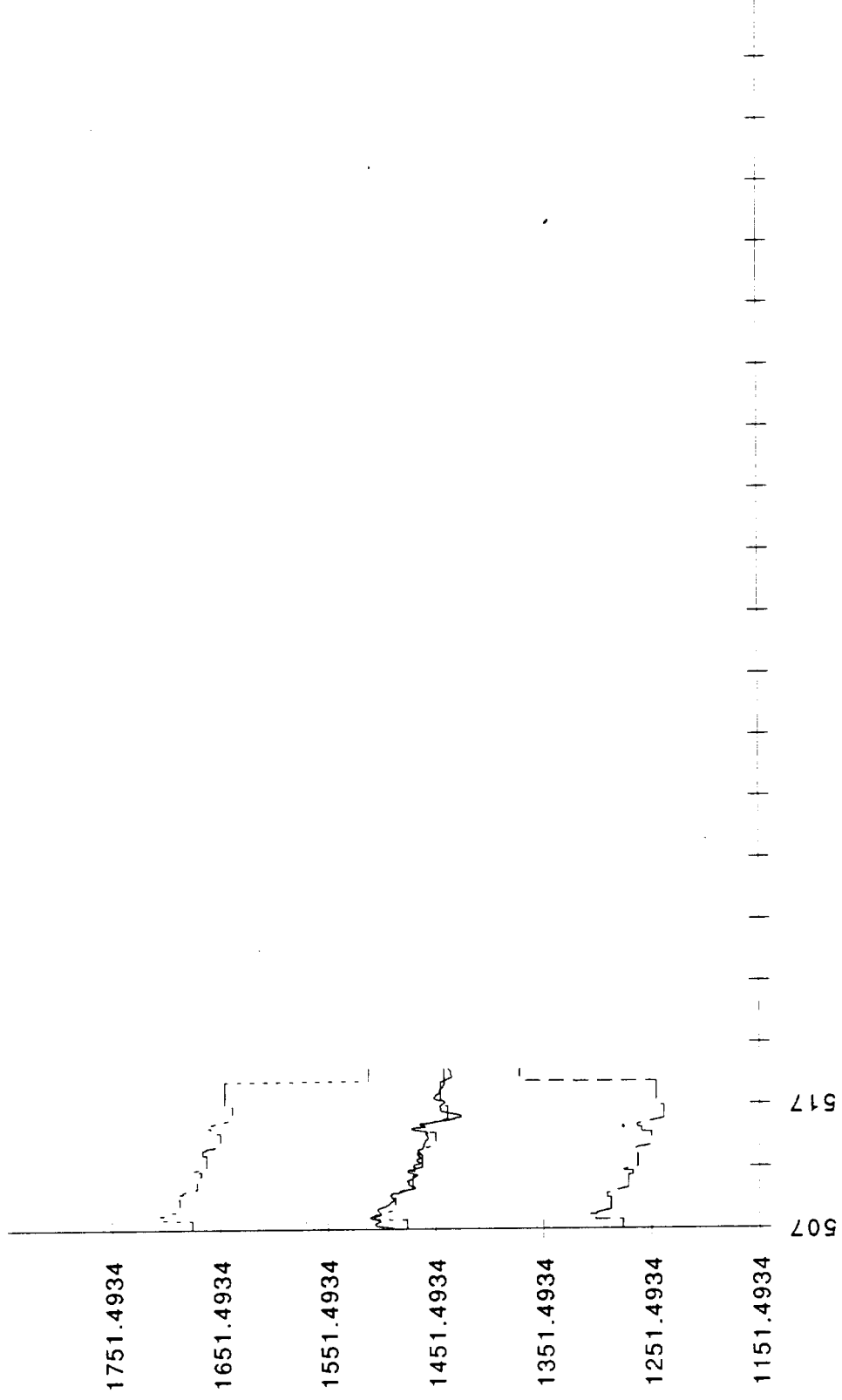

904-207 HPFP TDT A.T

904-207 HPOP SSC pr.T

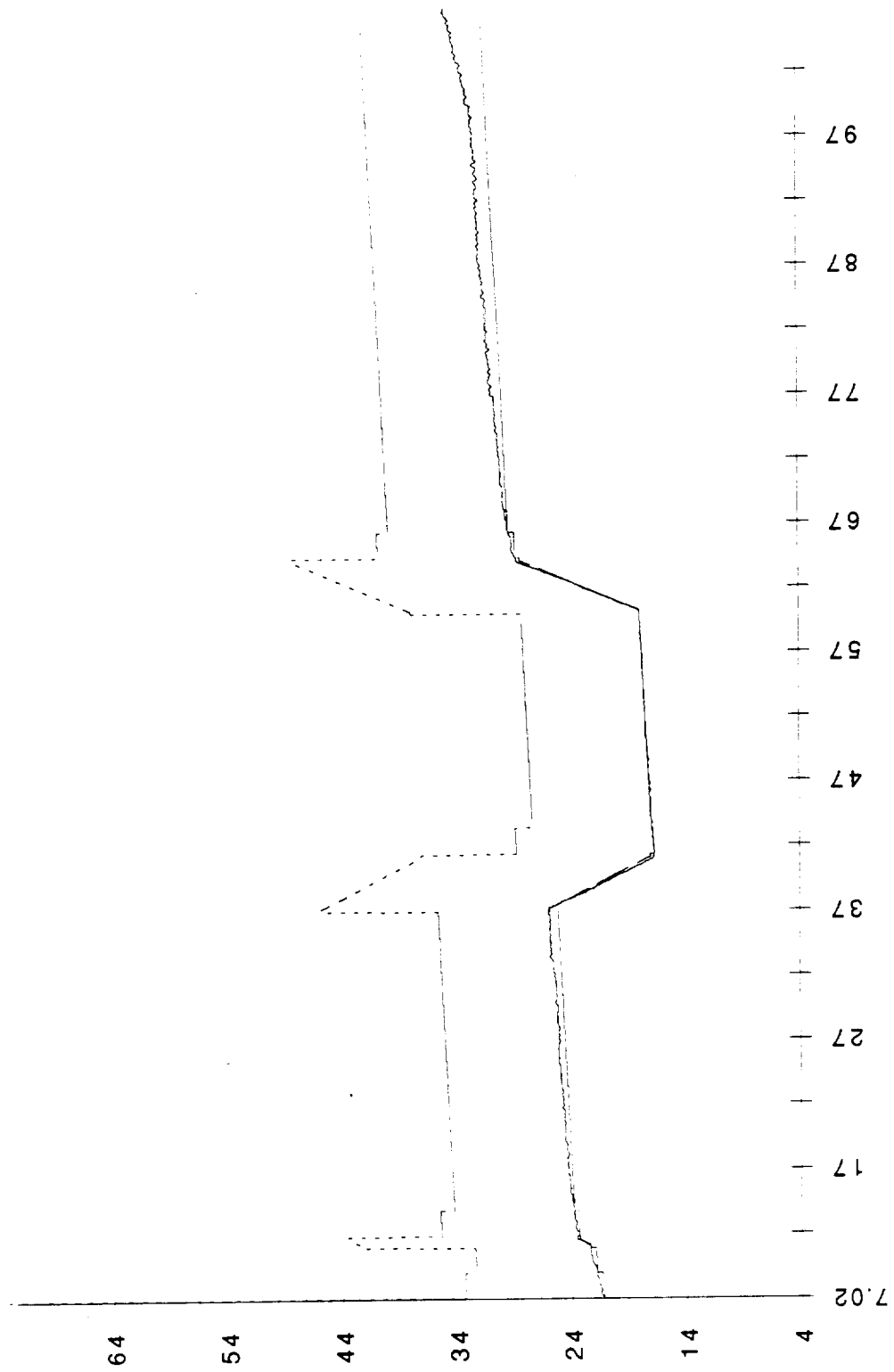

904-207 HPOP SSC pr.T

904-207 HPOP SSC pr.T

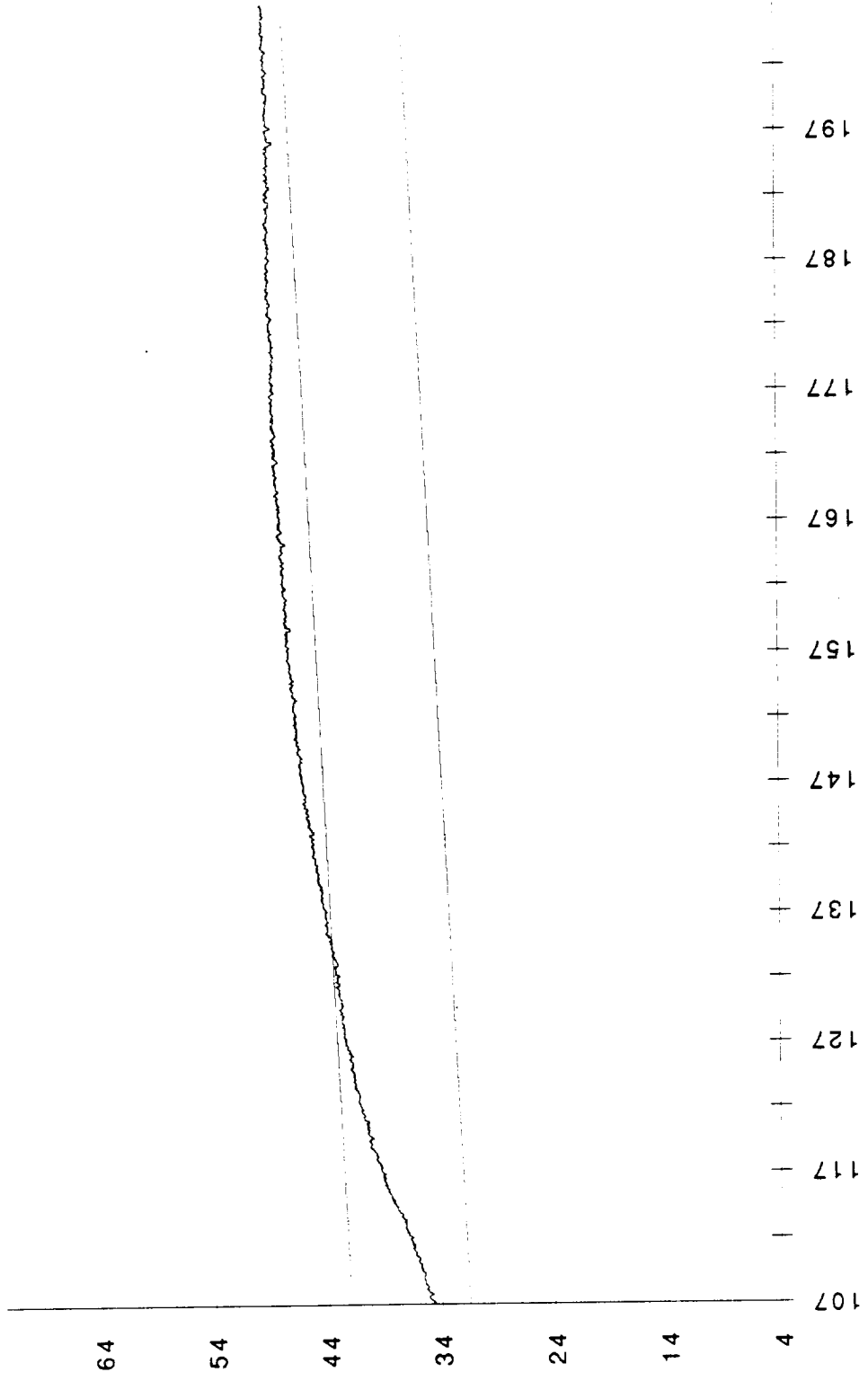

904-207 HPOP SSC pr.T

904-207 HPOP SSC pr.T

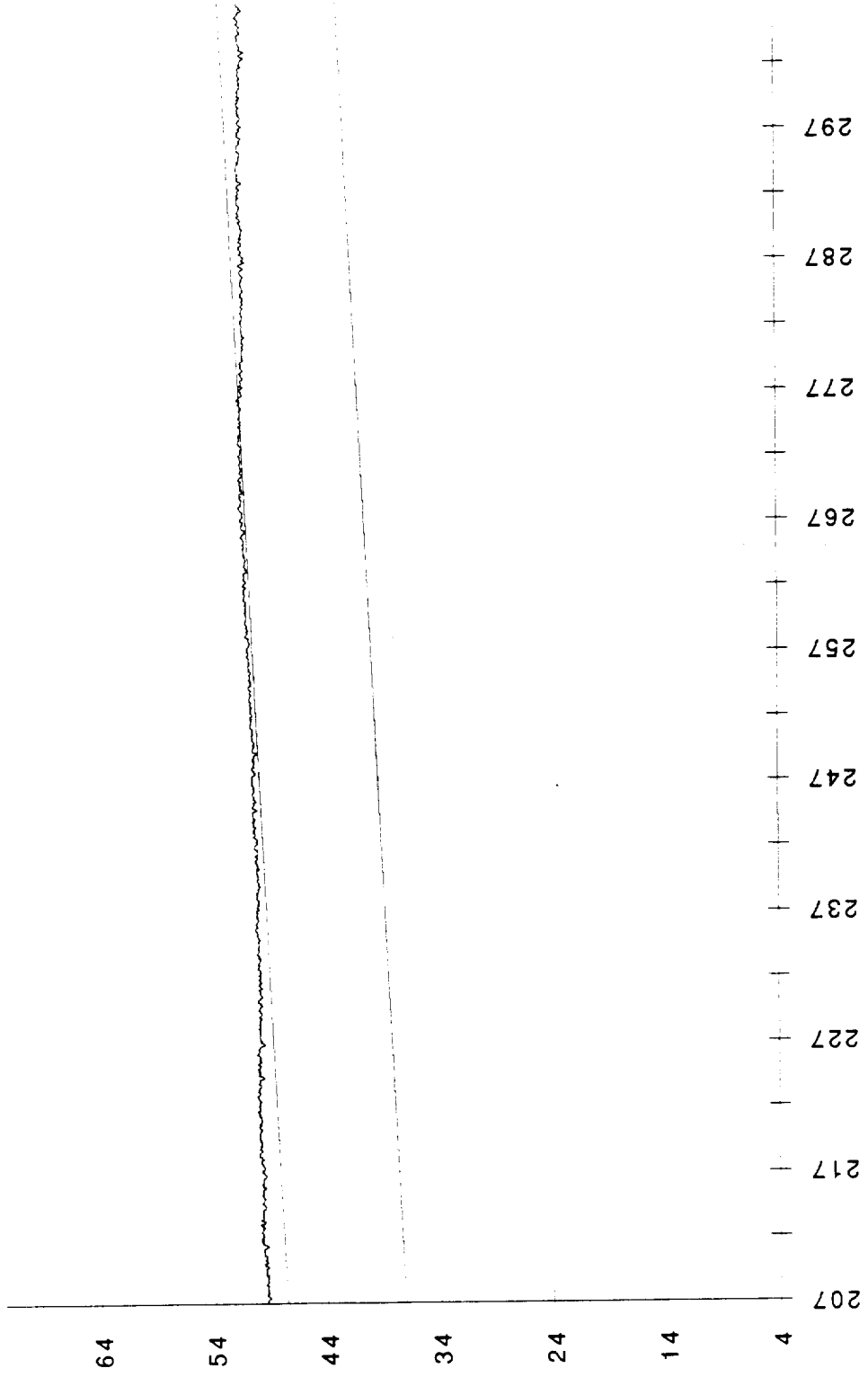

904-207 HPOP SSC pr.T

904-207 HPOP SSC pr.T

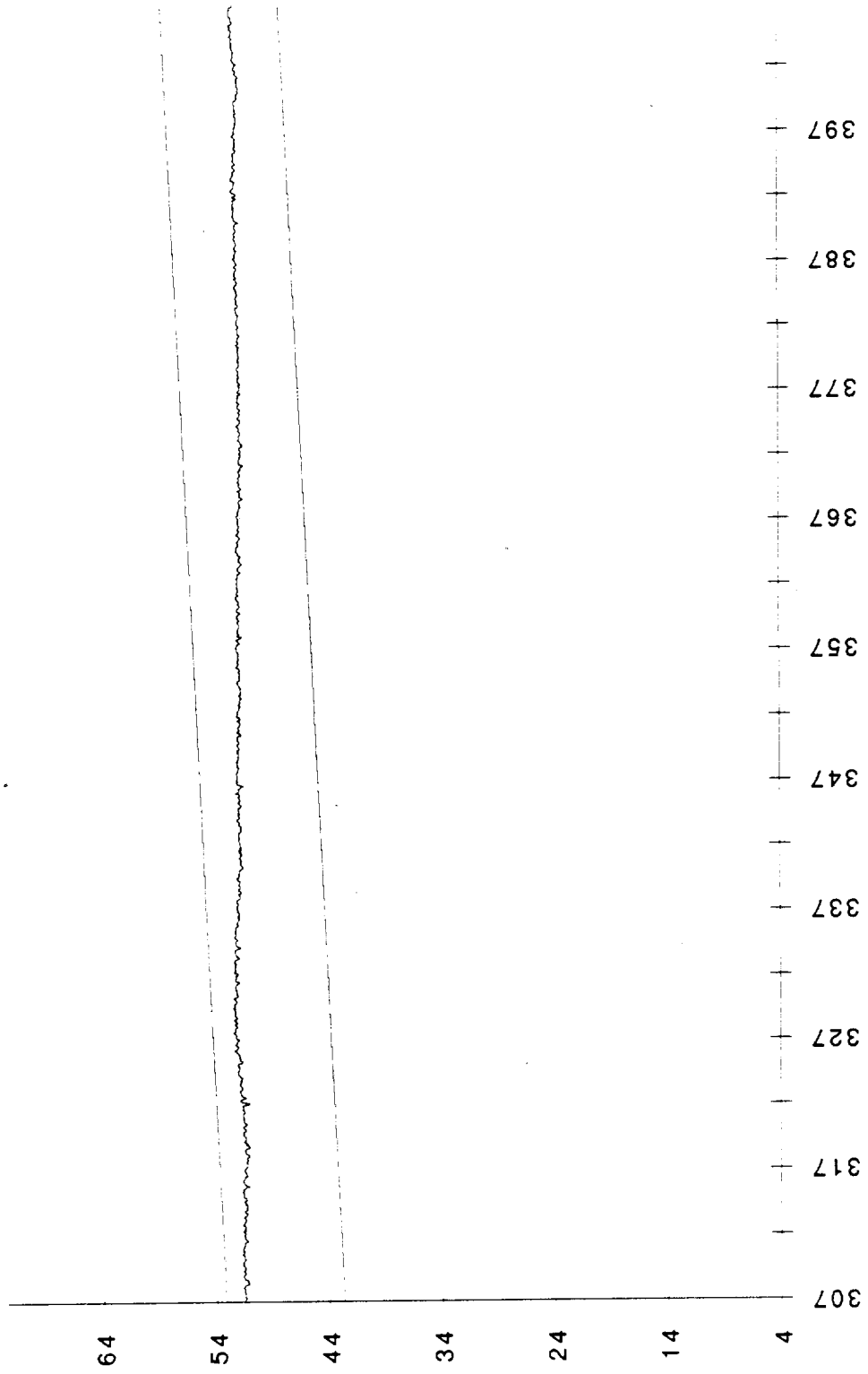

904-207 HPOP SSC pr.T

904-207 HPOP SSC pr.T

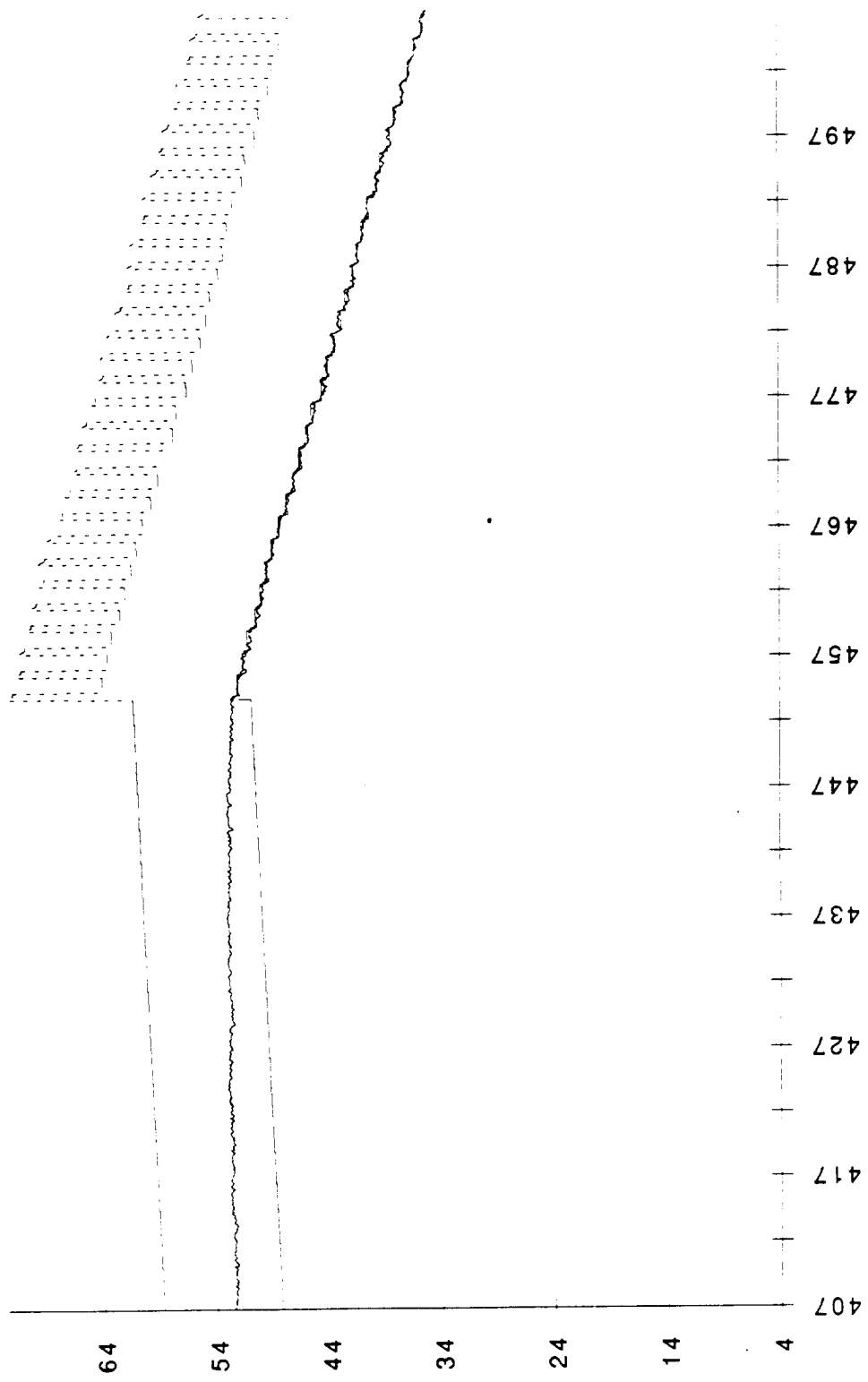

904-207 HPOP SSC pr.T

904-207 HPOP SSC pr.T

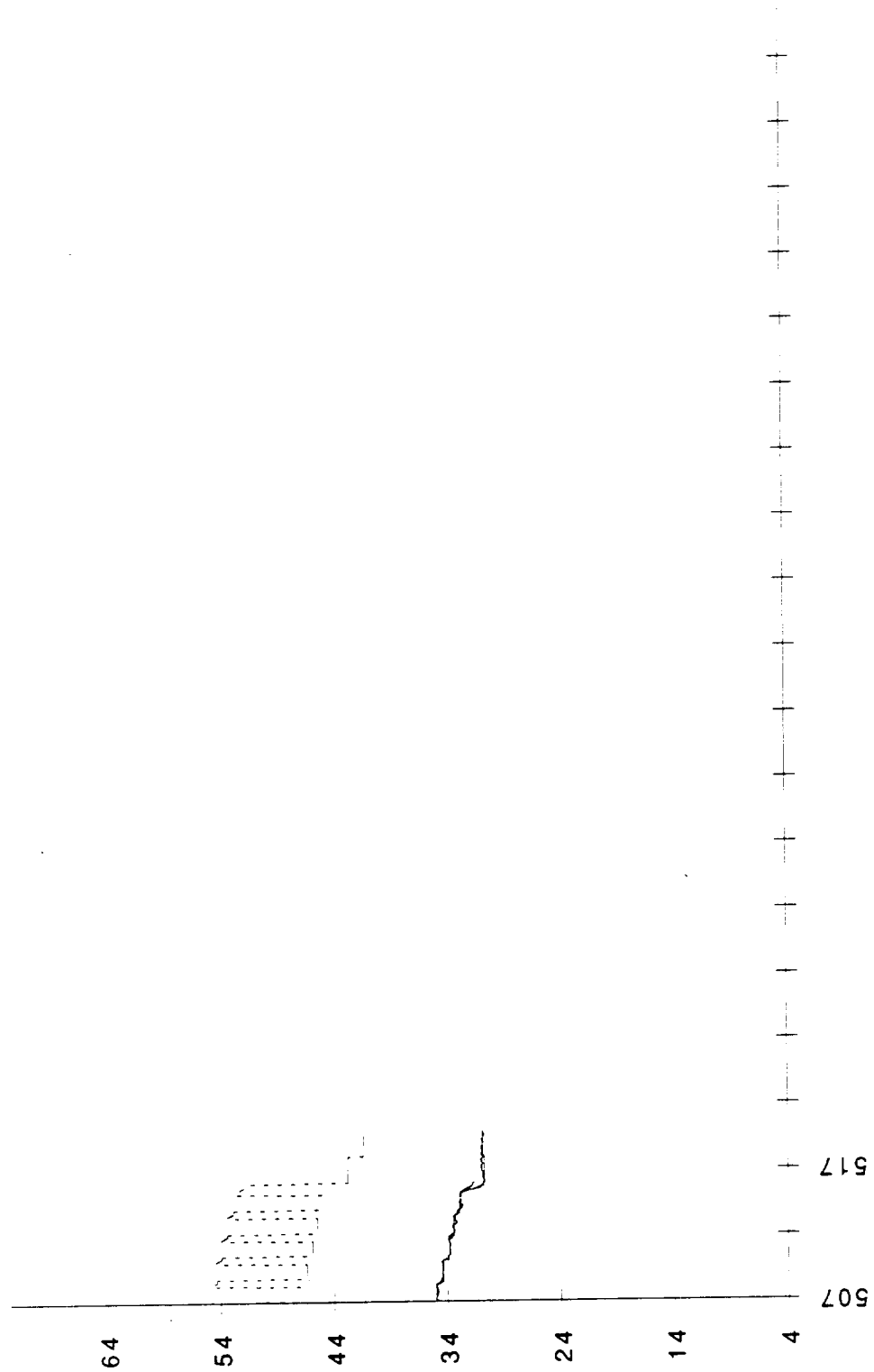

904-207 HPOP SSC pr.T

904-219 HPFP TDT A.T

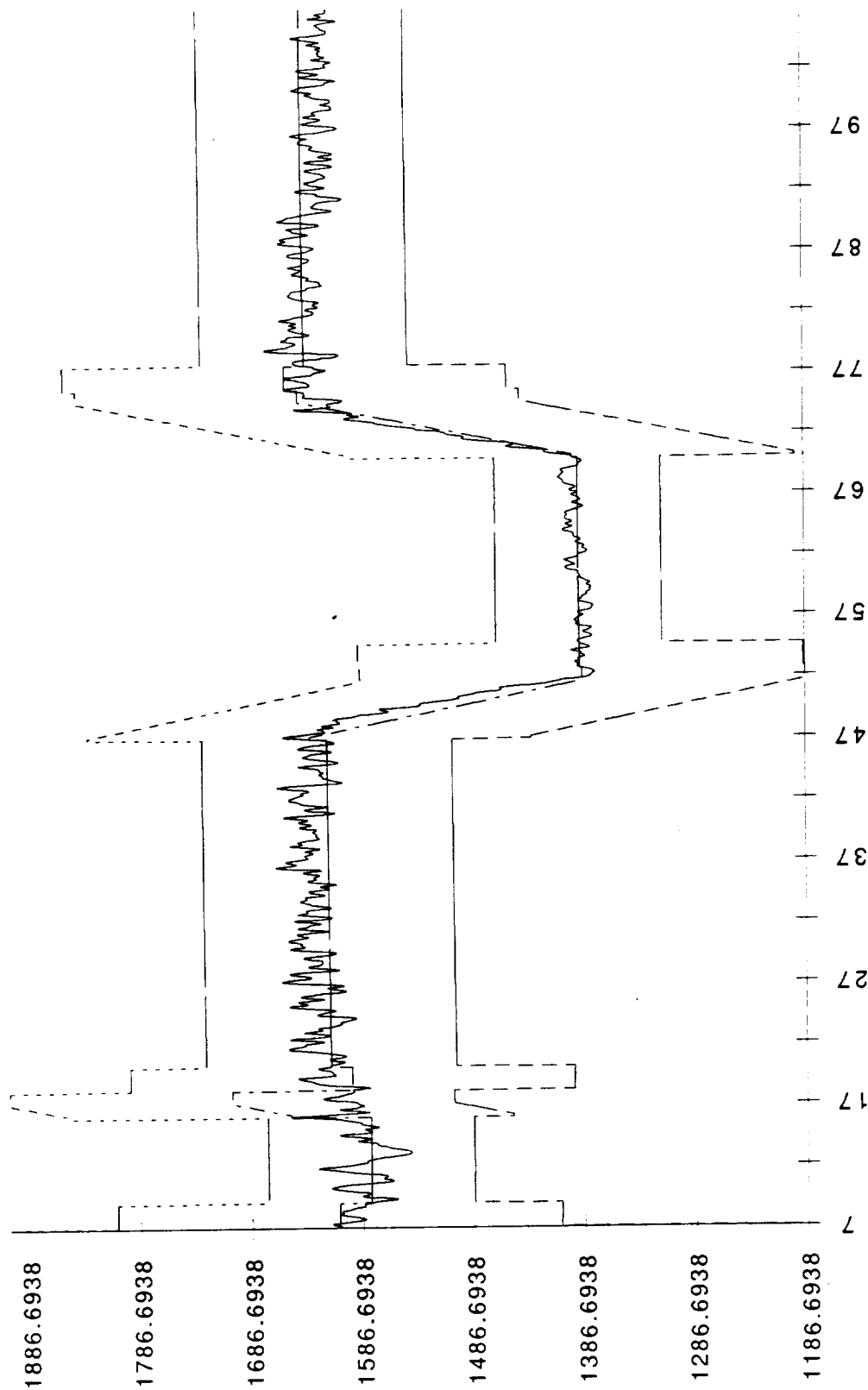

904-219 HPFP TDT A.T

904-219 HPFP TDT A.T

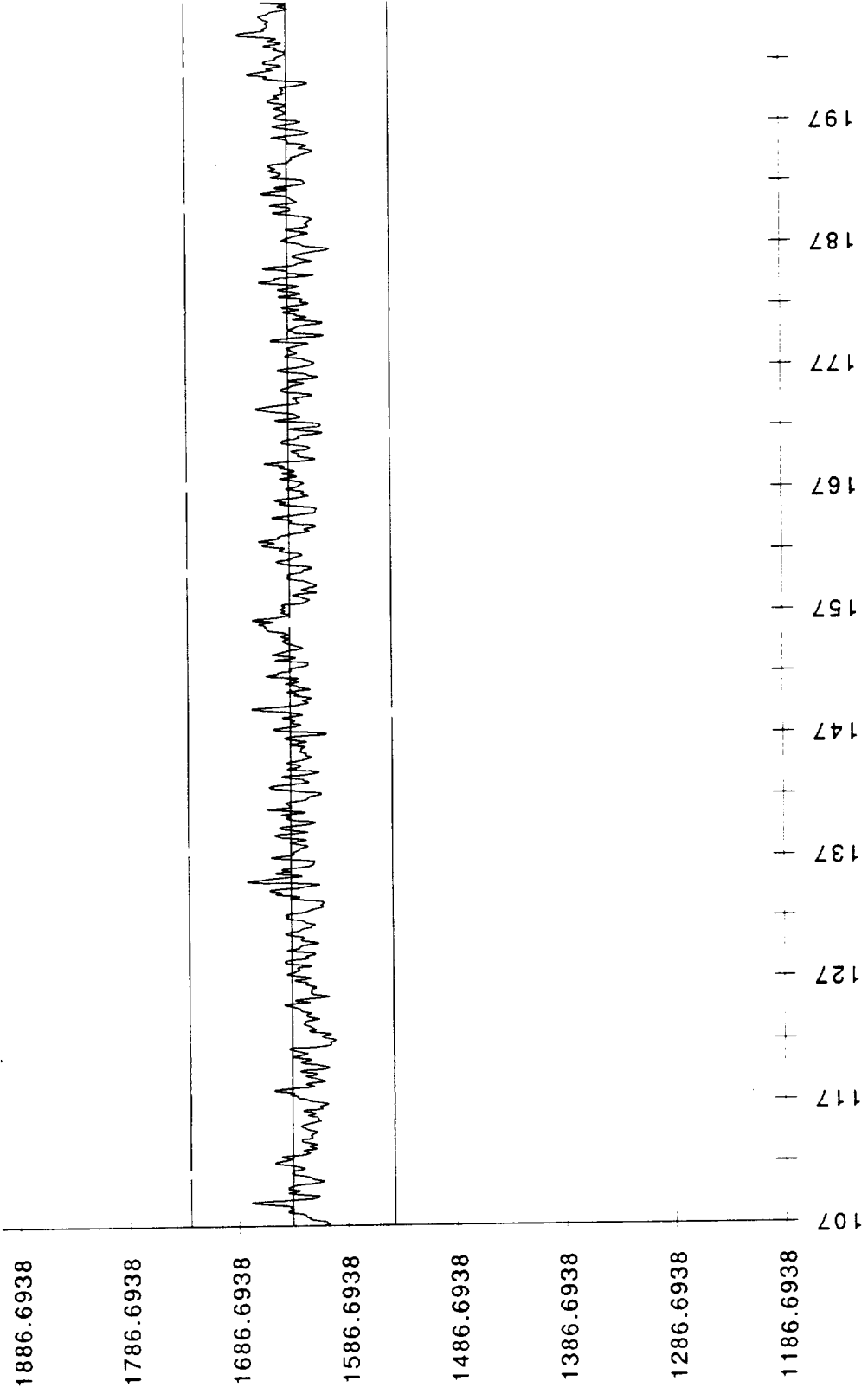

904-219 HPFP TDT A.T

904-219 HPFP TDT A.T

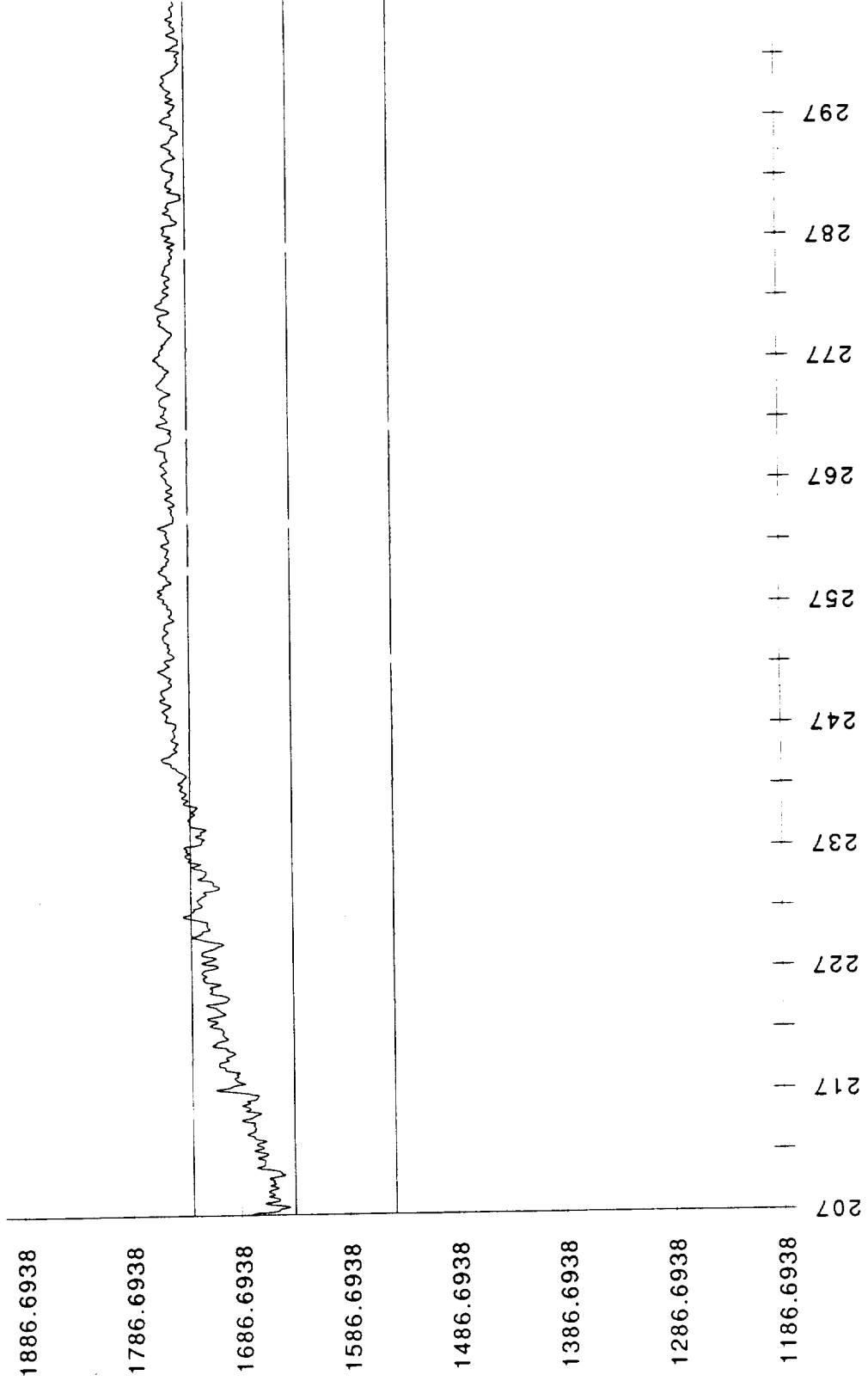

904-219 HPFP TDT A.T

904-219 HPFP TDT A.T

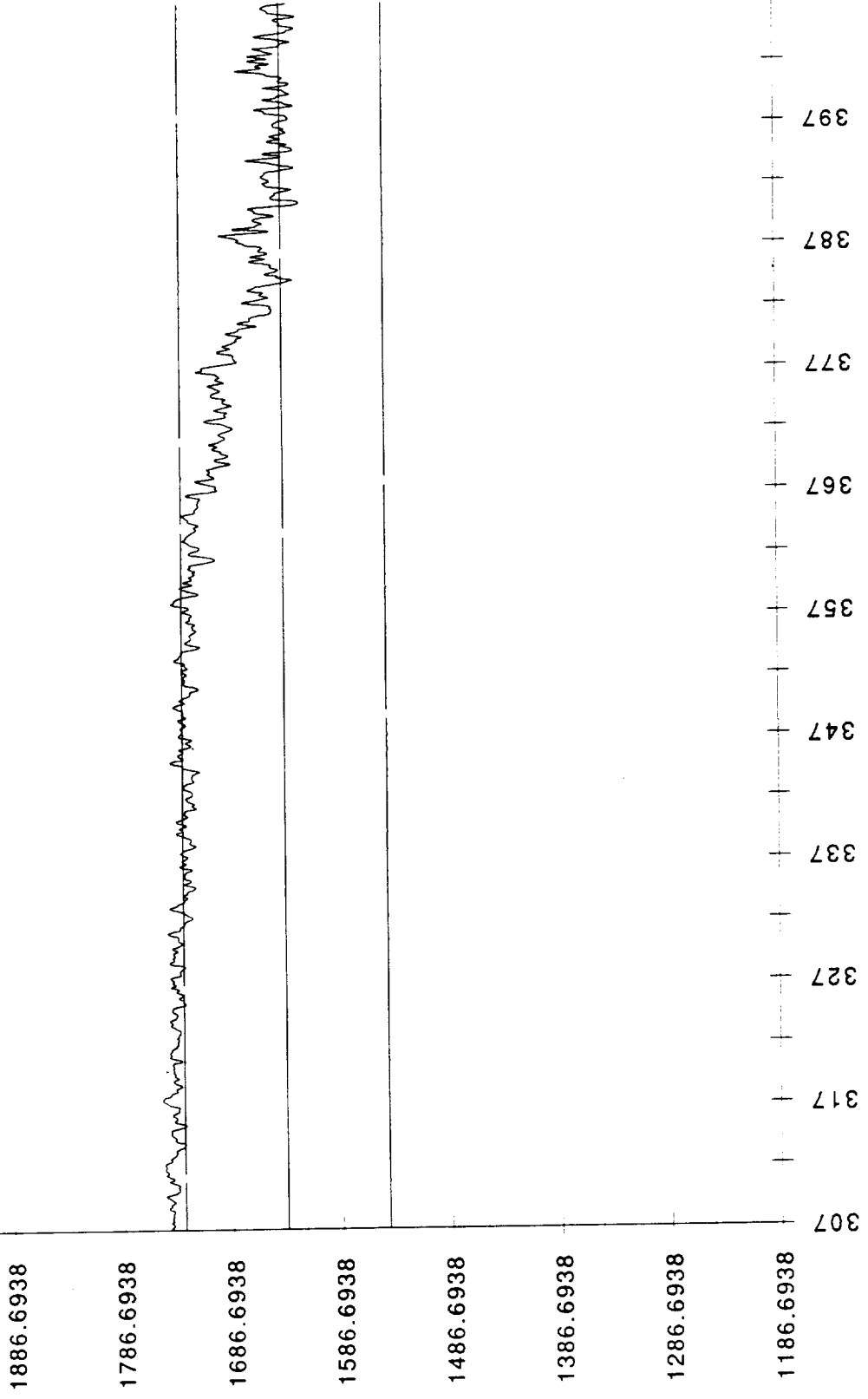

904-219 HPFP TDT A.T

904-219 HPFP TDT A.T

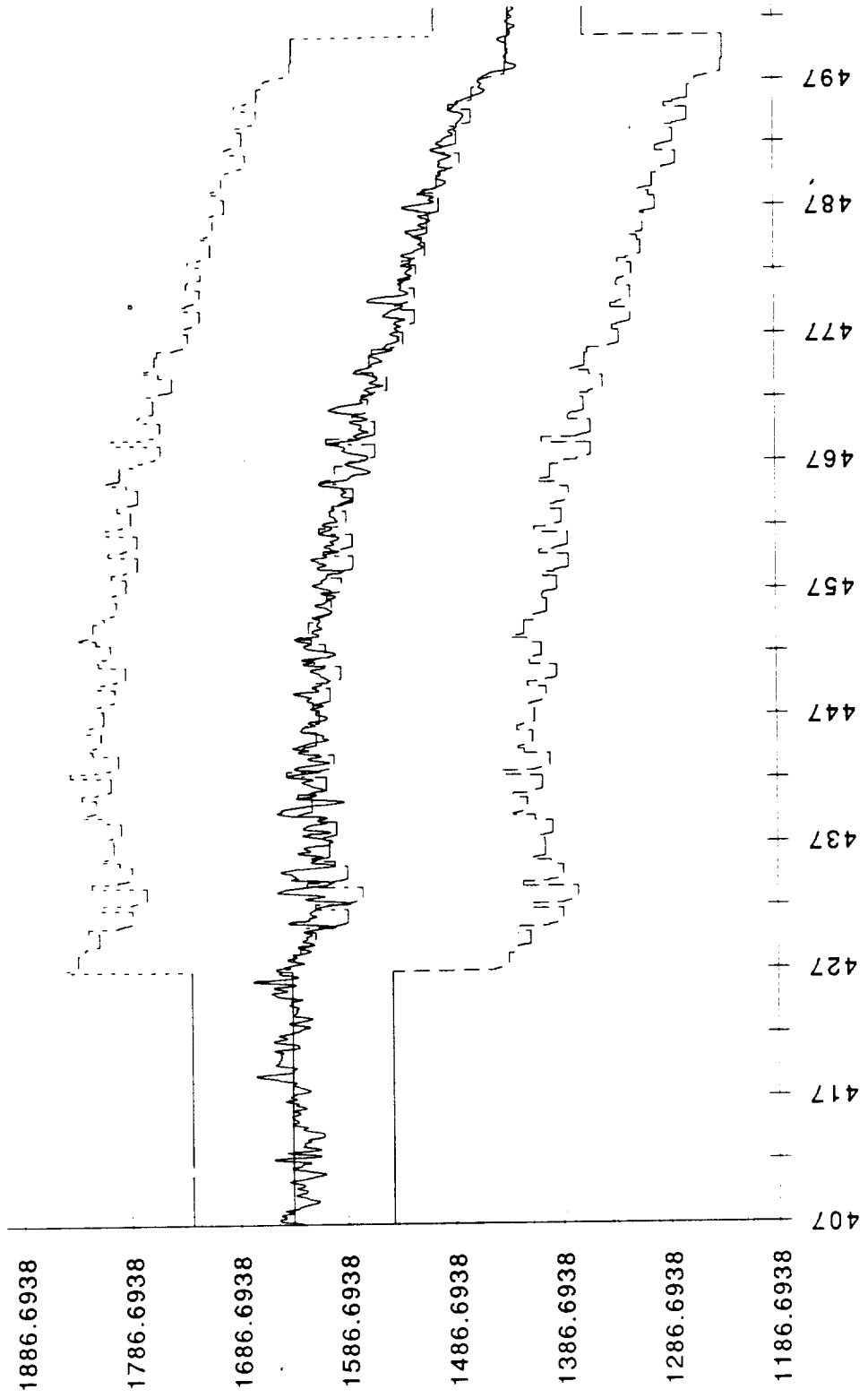

904-219 HPFP TDT A.T

904-220 HPFP TDT A.T

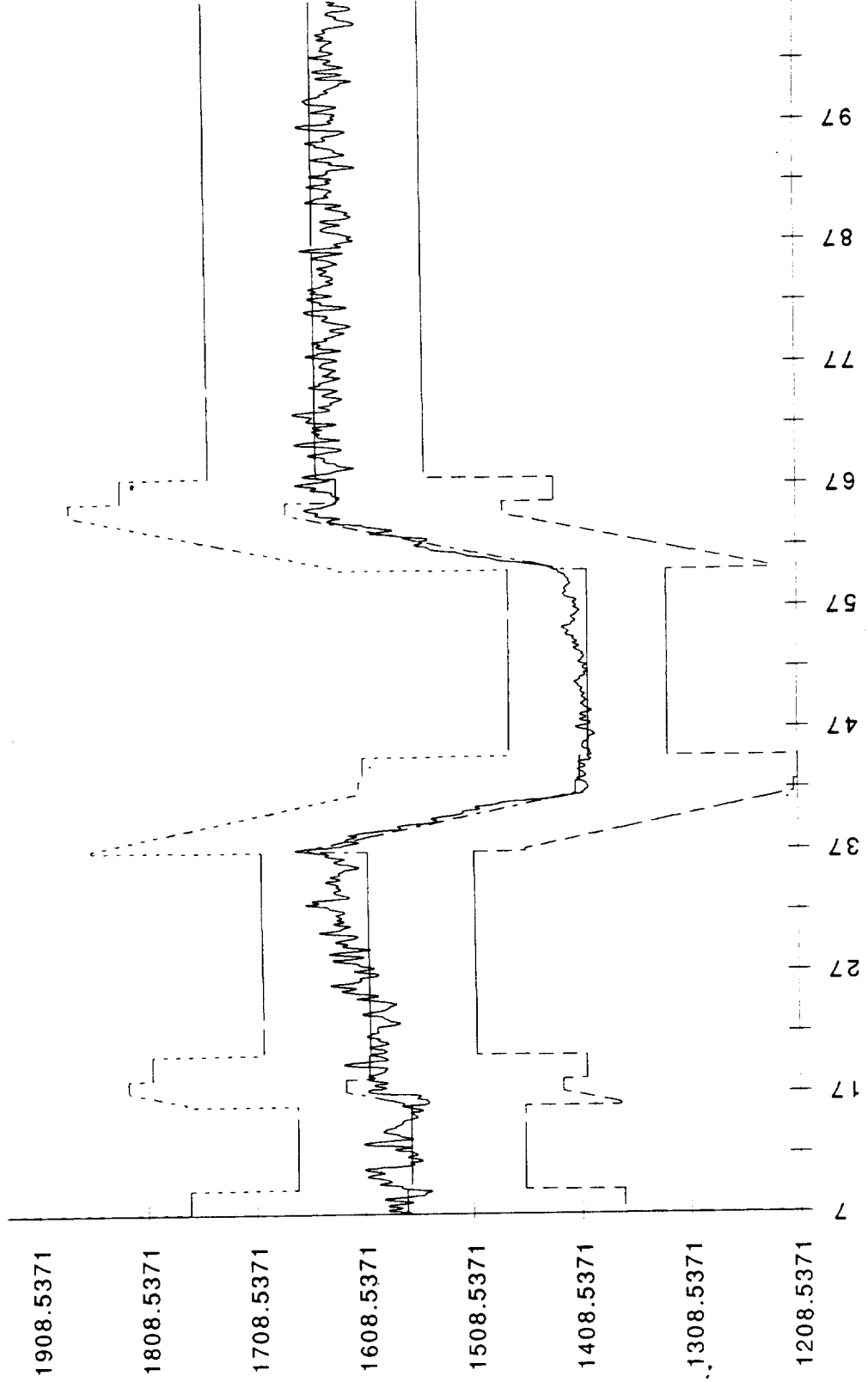

904-220 HPFP TDT A.T

904-220 HPFP TDT A.T

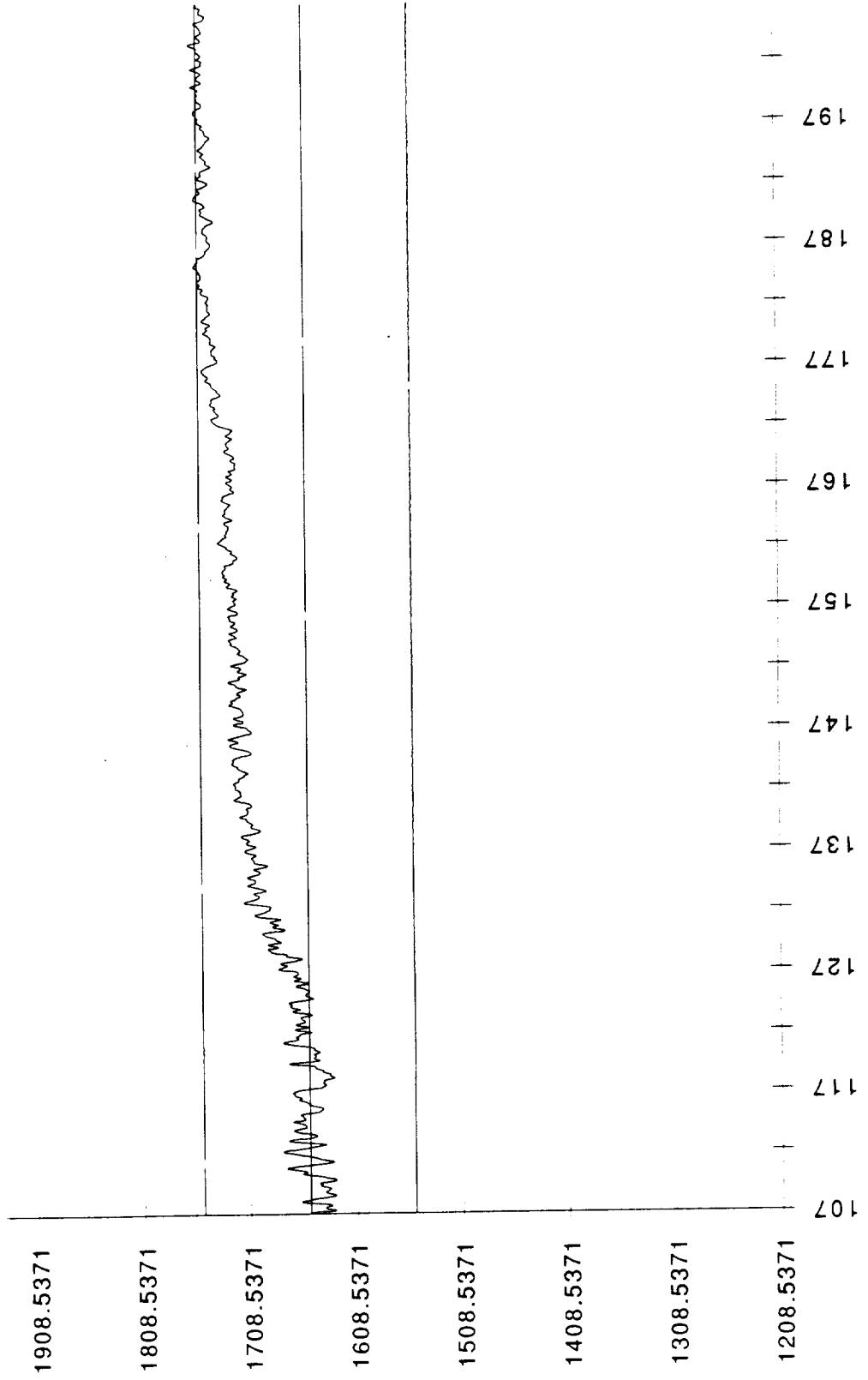

904-220 HPFP TDT A.T

904-220 HPFP TDT A.T

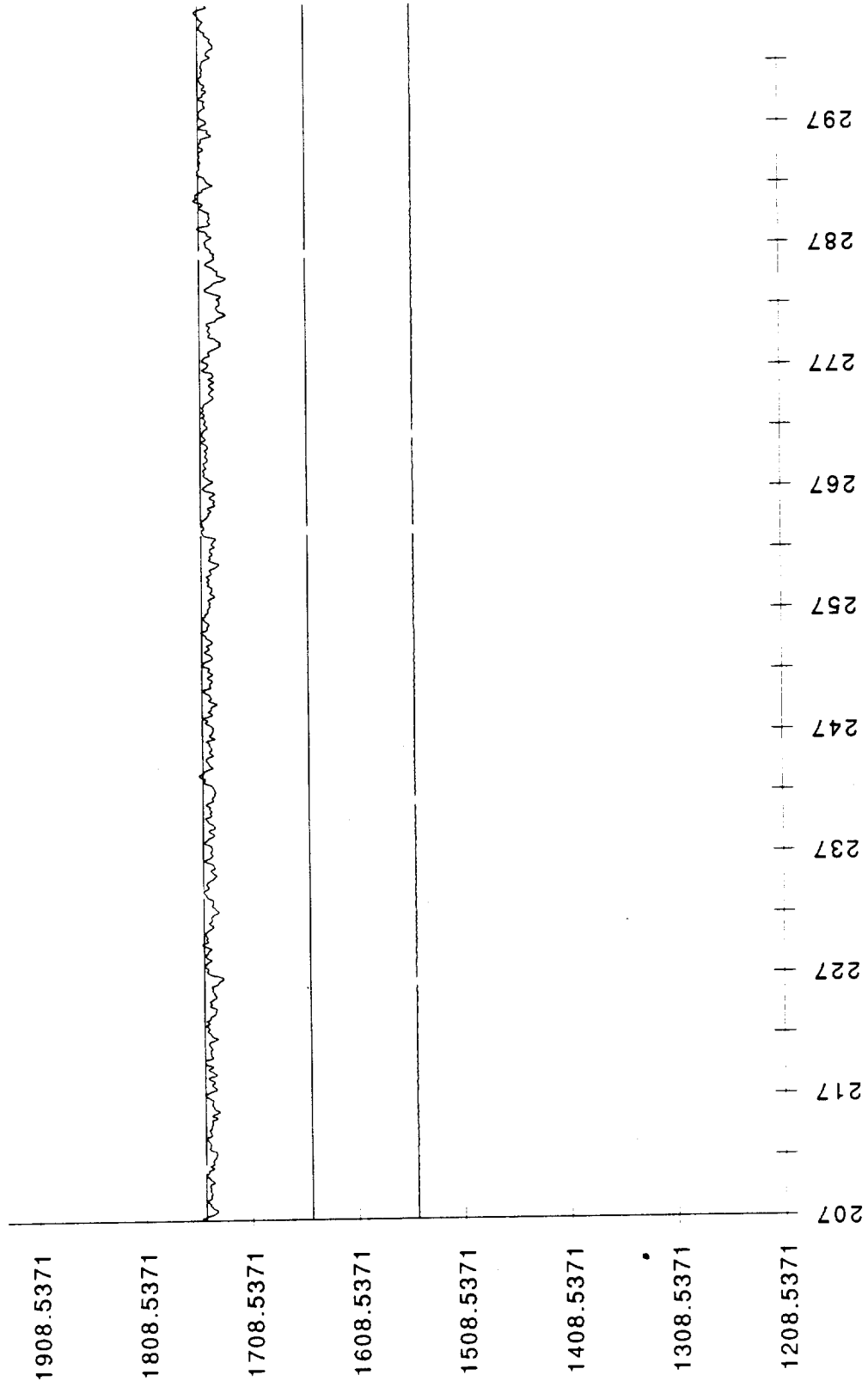

904-220 HPFP TDT A.T

904-220 HPFP TDT A.T

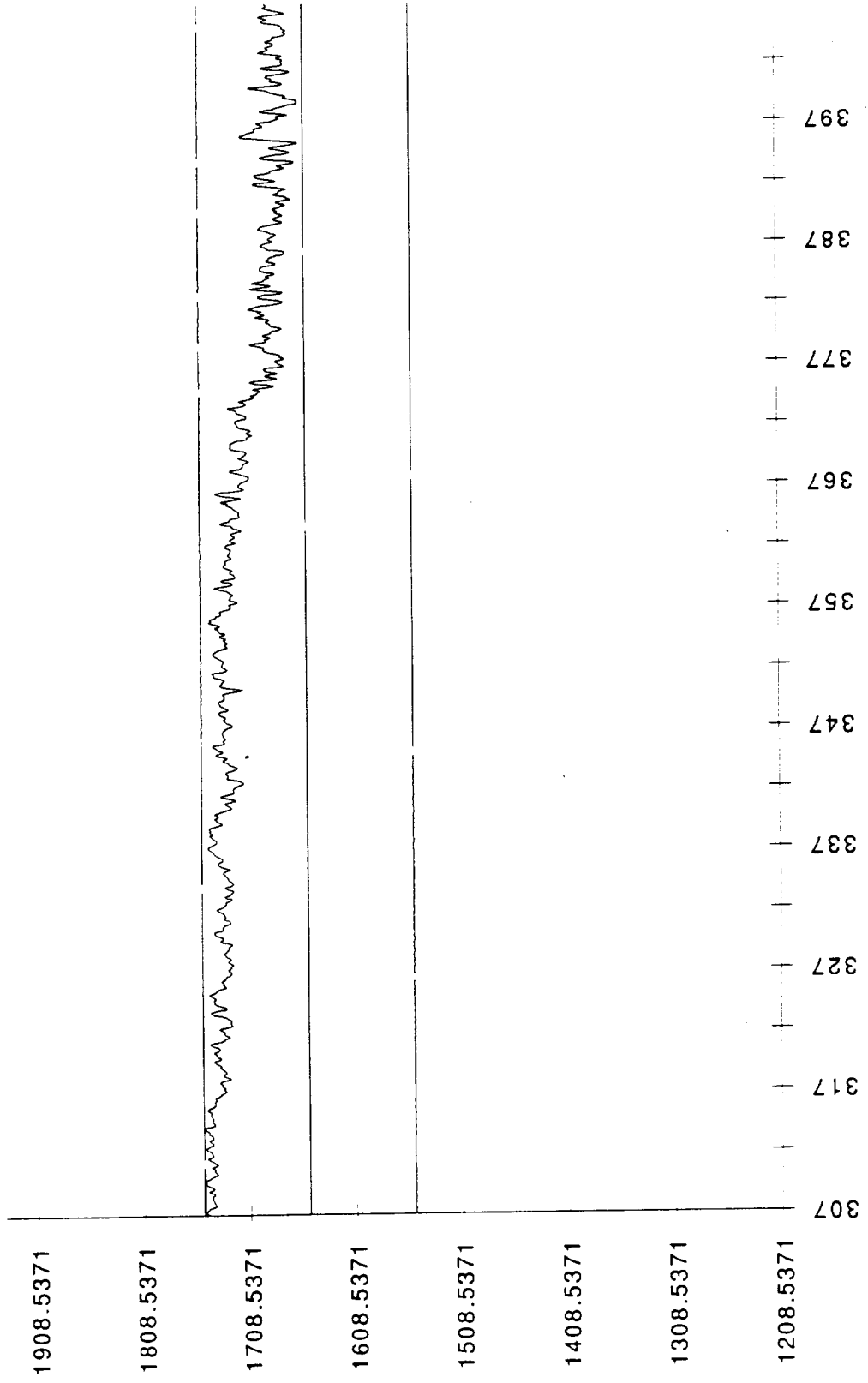

904-220 HPFP TDT A.T

904-220 HPFP TDT A.T

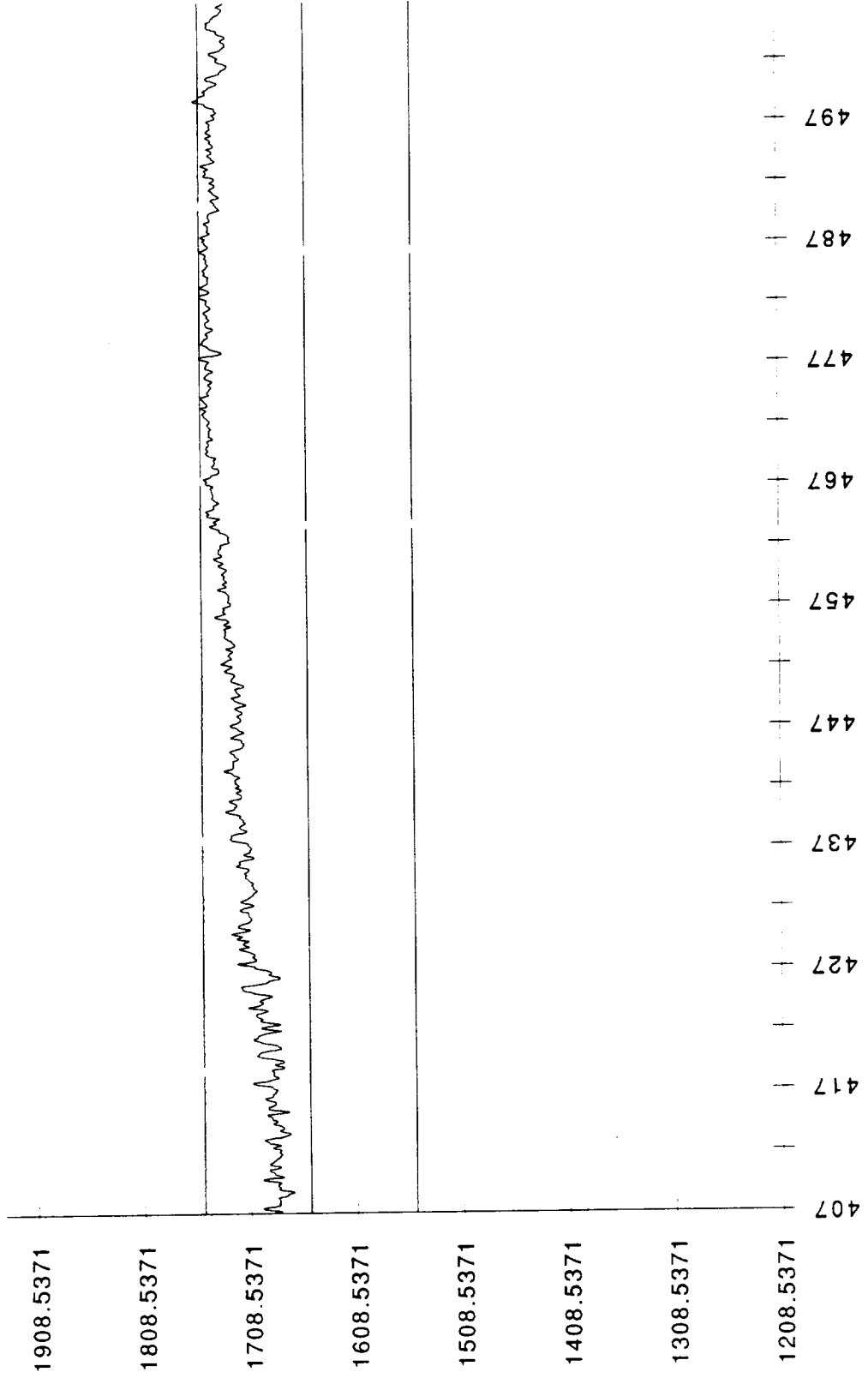

904-220 HPFP TDT A.T

904-220 HPFP TDT A.T

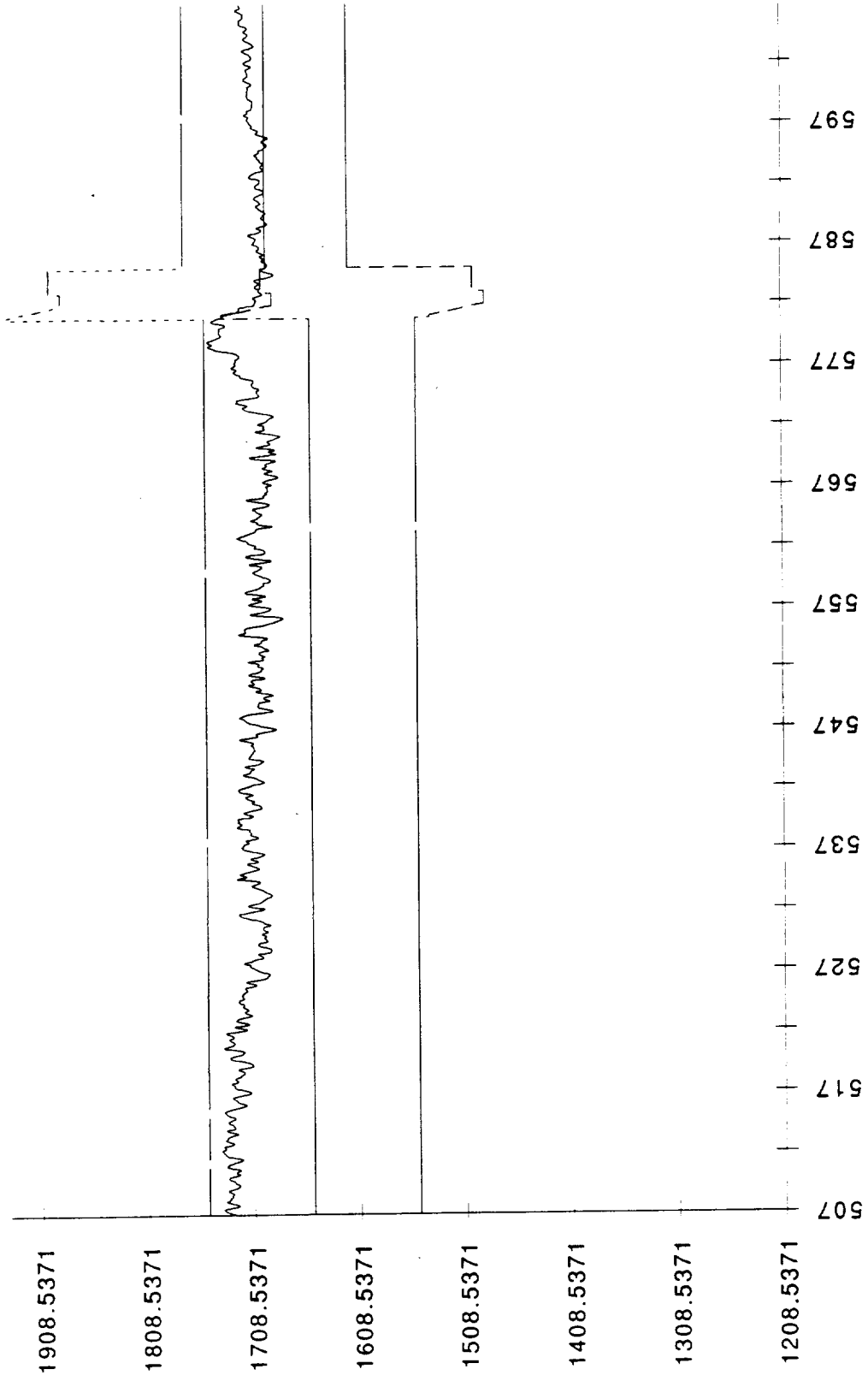

904-220 HPFP TDT A.T

904-227 HPFP CL pr.T

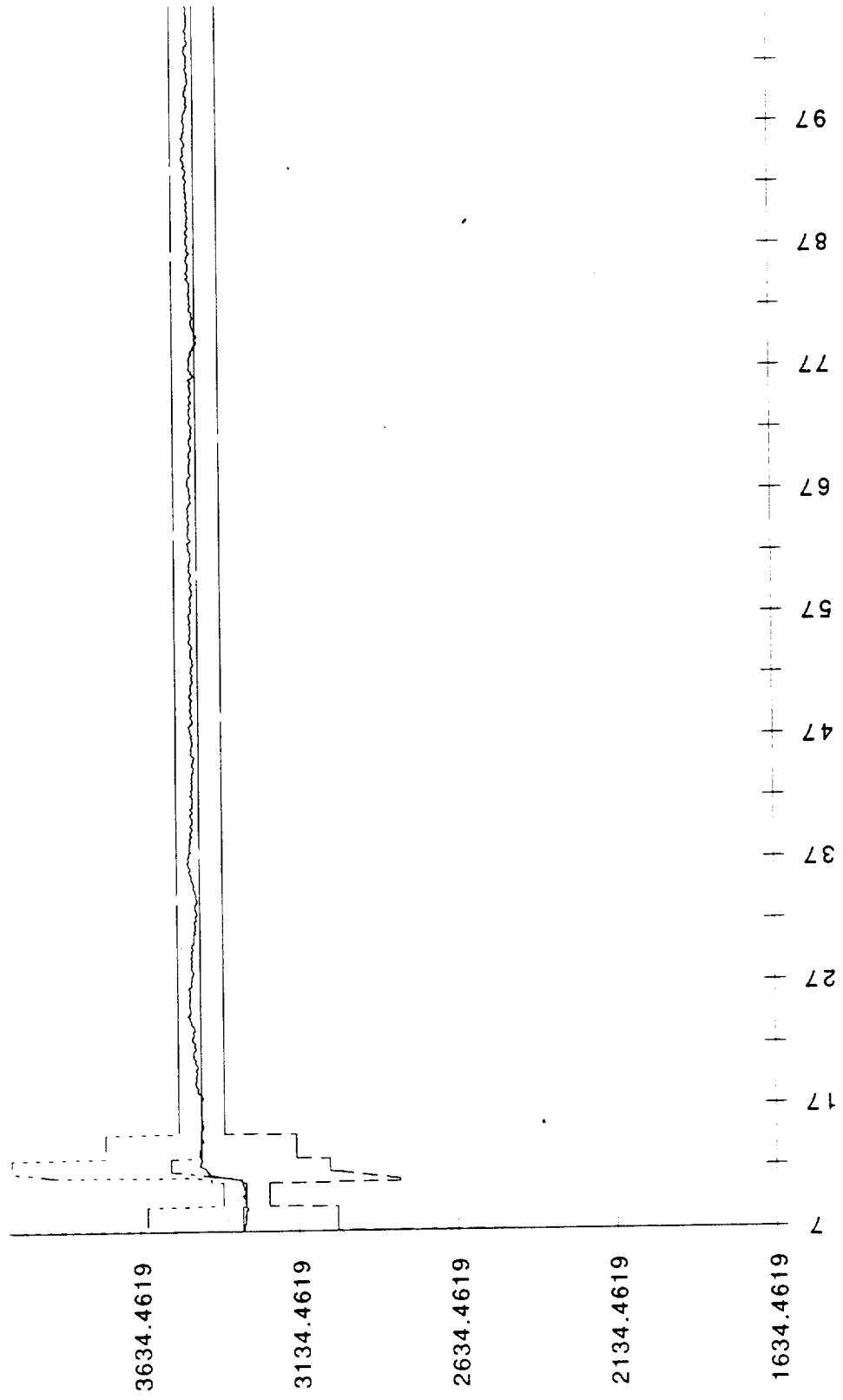

904-227 HPFP CL pr.T

904-227 HPFP CL pr.T

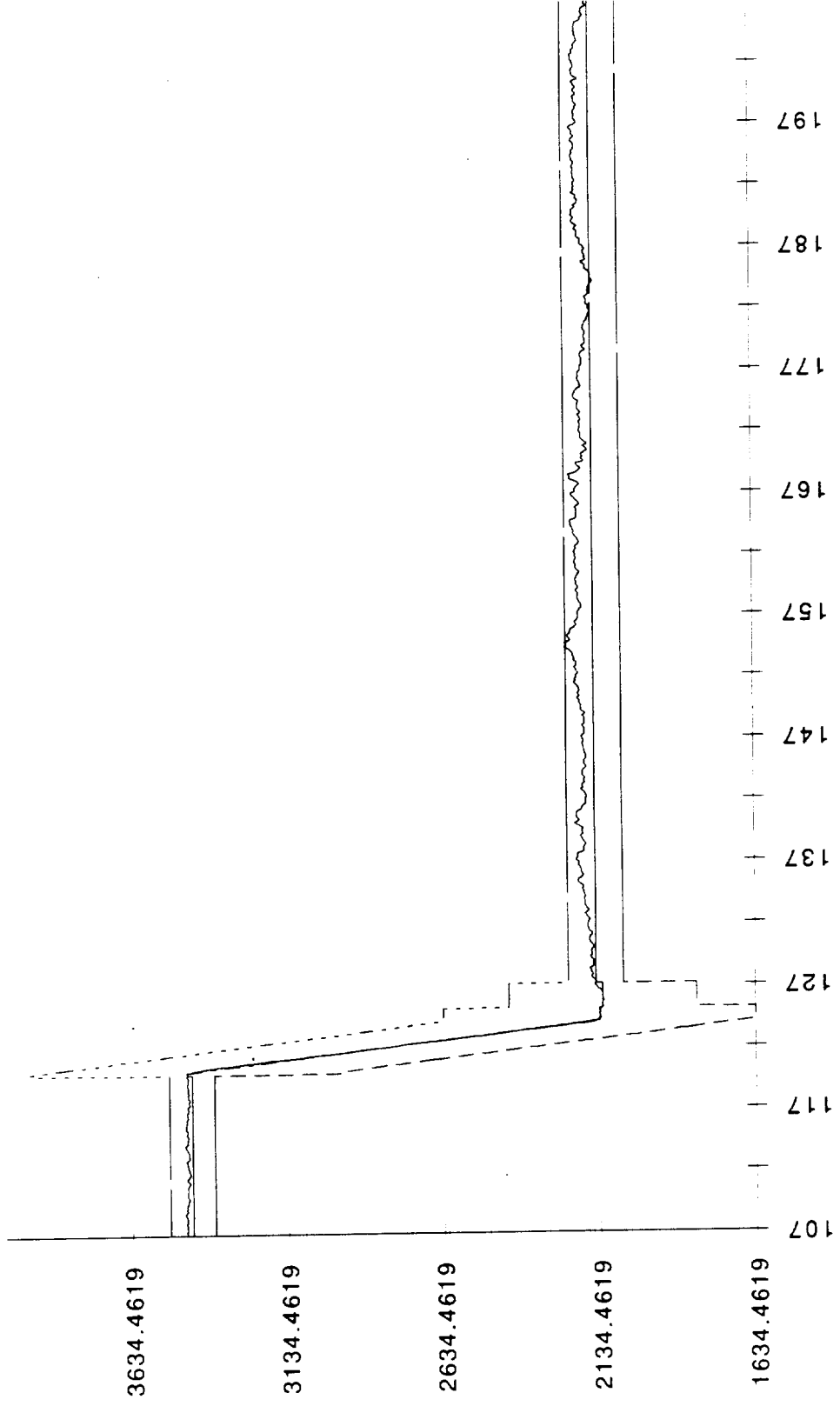

904-227 HPFP CL pr.T

904-227 HPFP CL pr.T

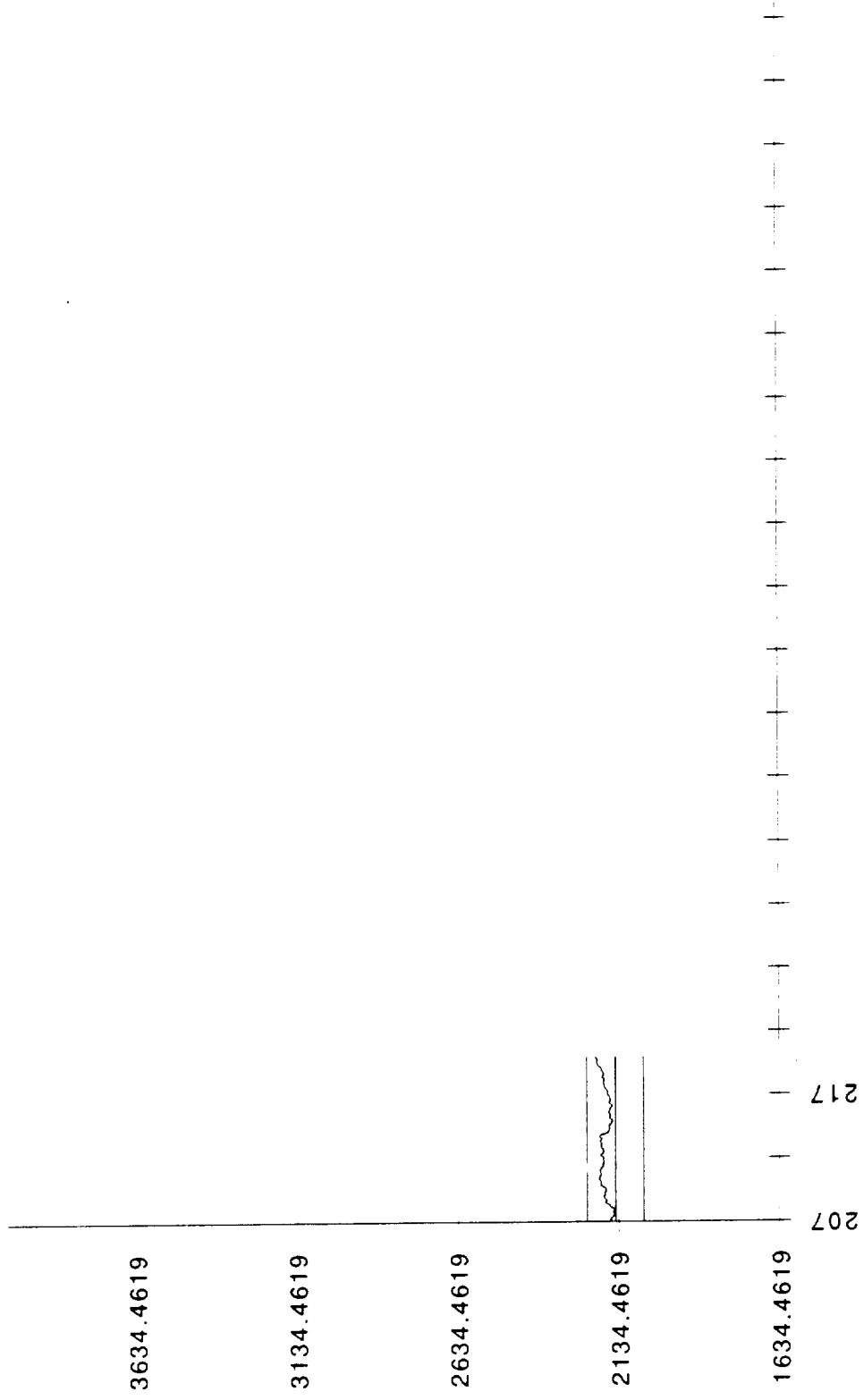

904-227 HPFP CL pr.T

904-234 HPFP TDT A.T

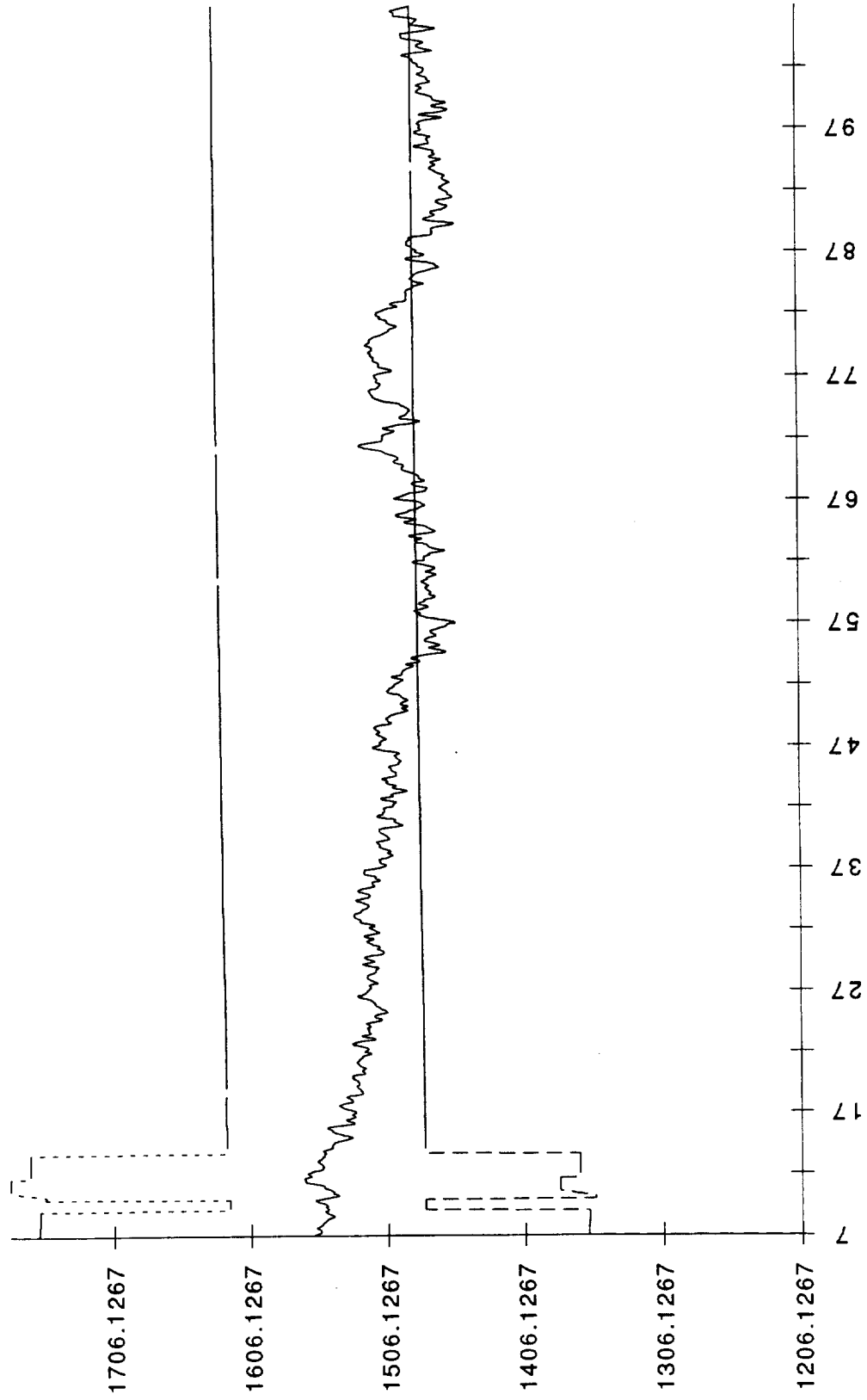

904-234 HPFP TDT A.T

904-234 HPFP TDT A.T

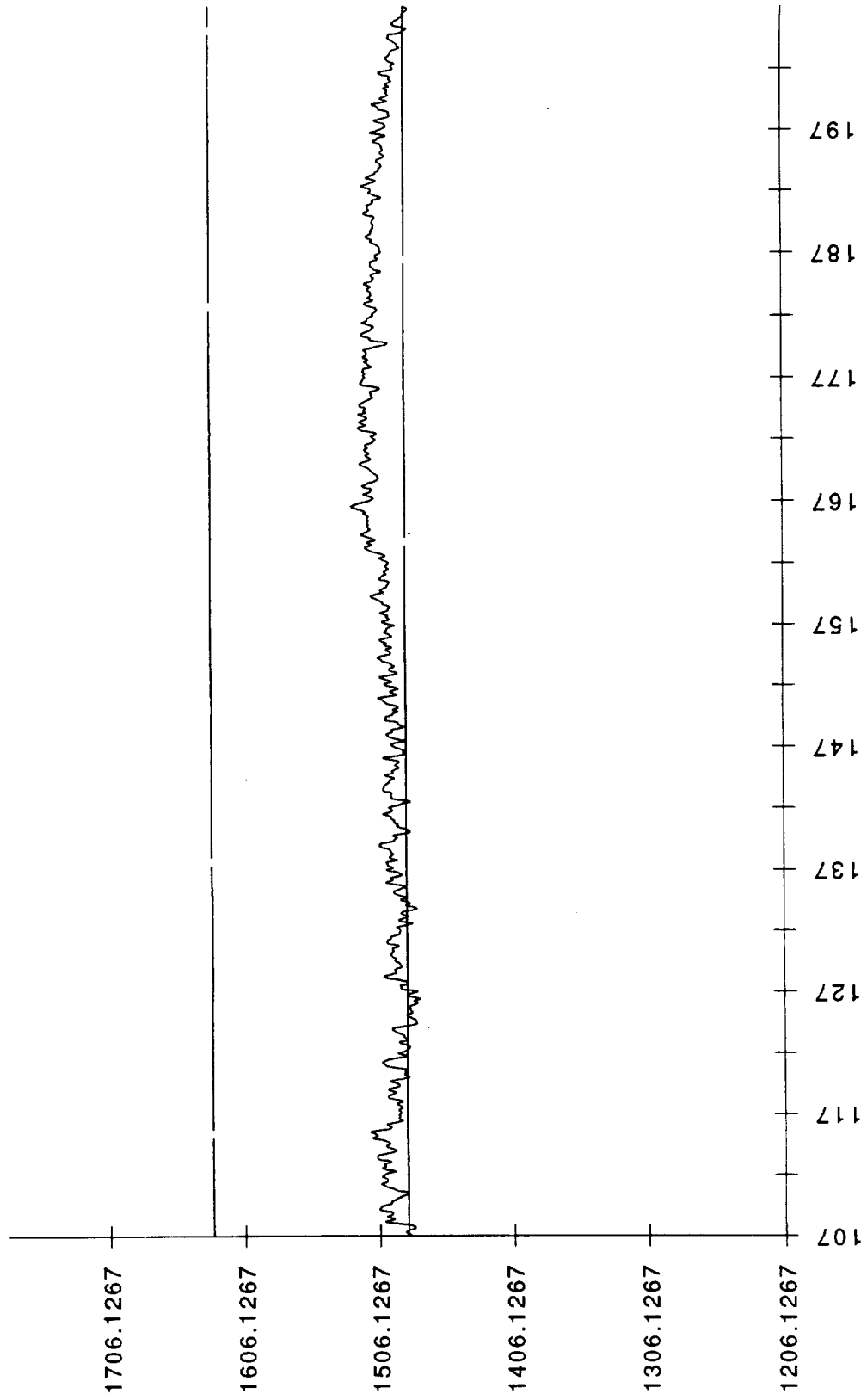

904-234 HPFP TDT A.T

904-234 HPFP TDT A.T

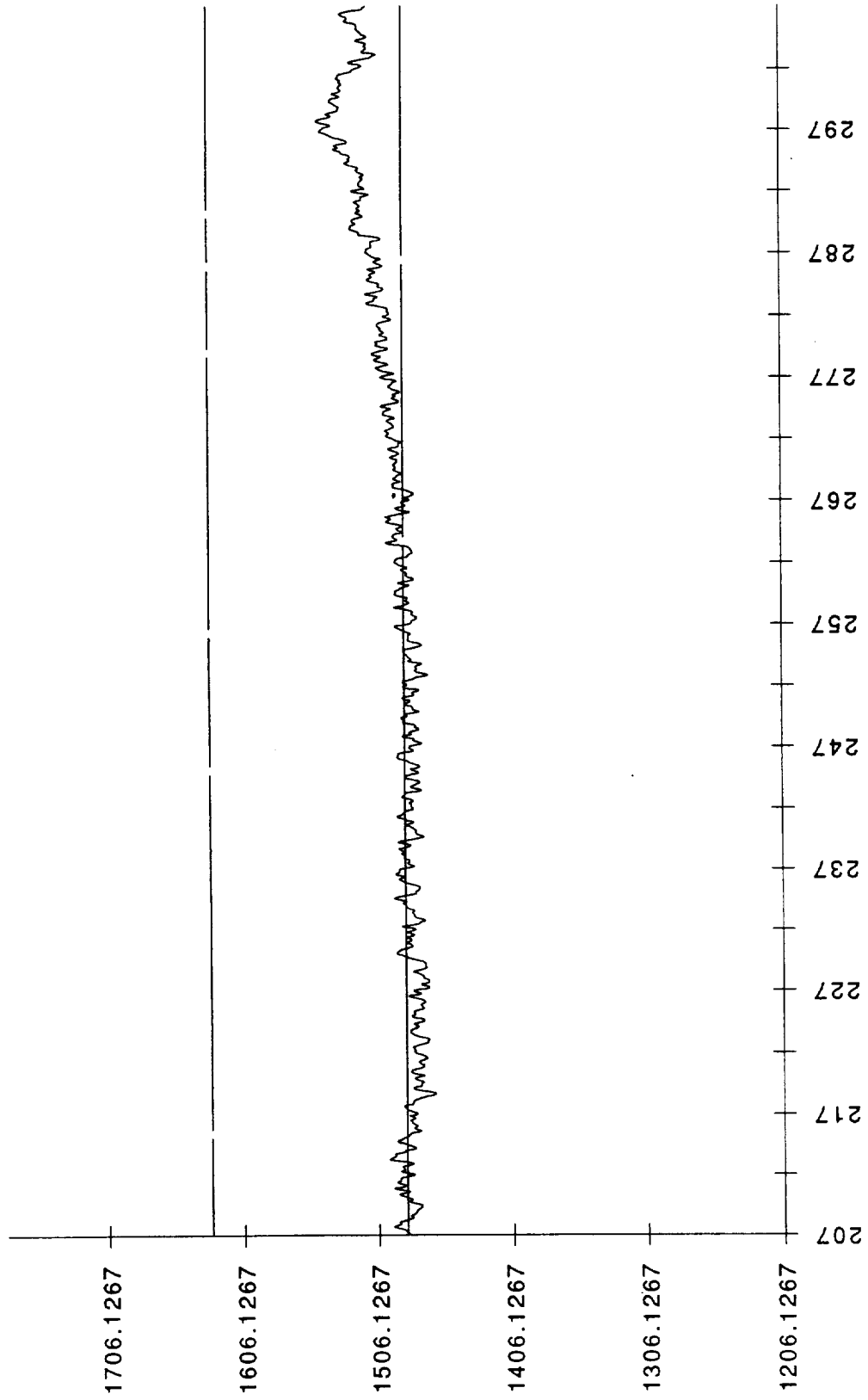

904-234 HPFP TDT A.T

904-234 HPFP TDT A.T

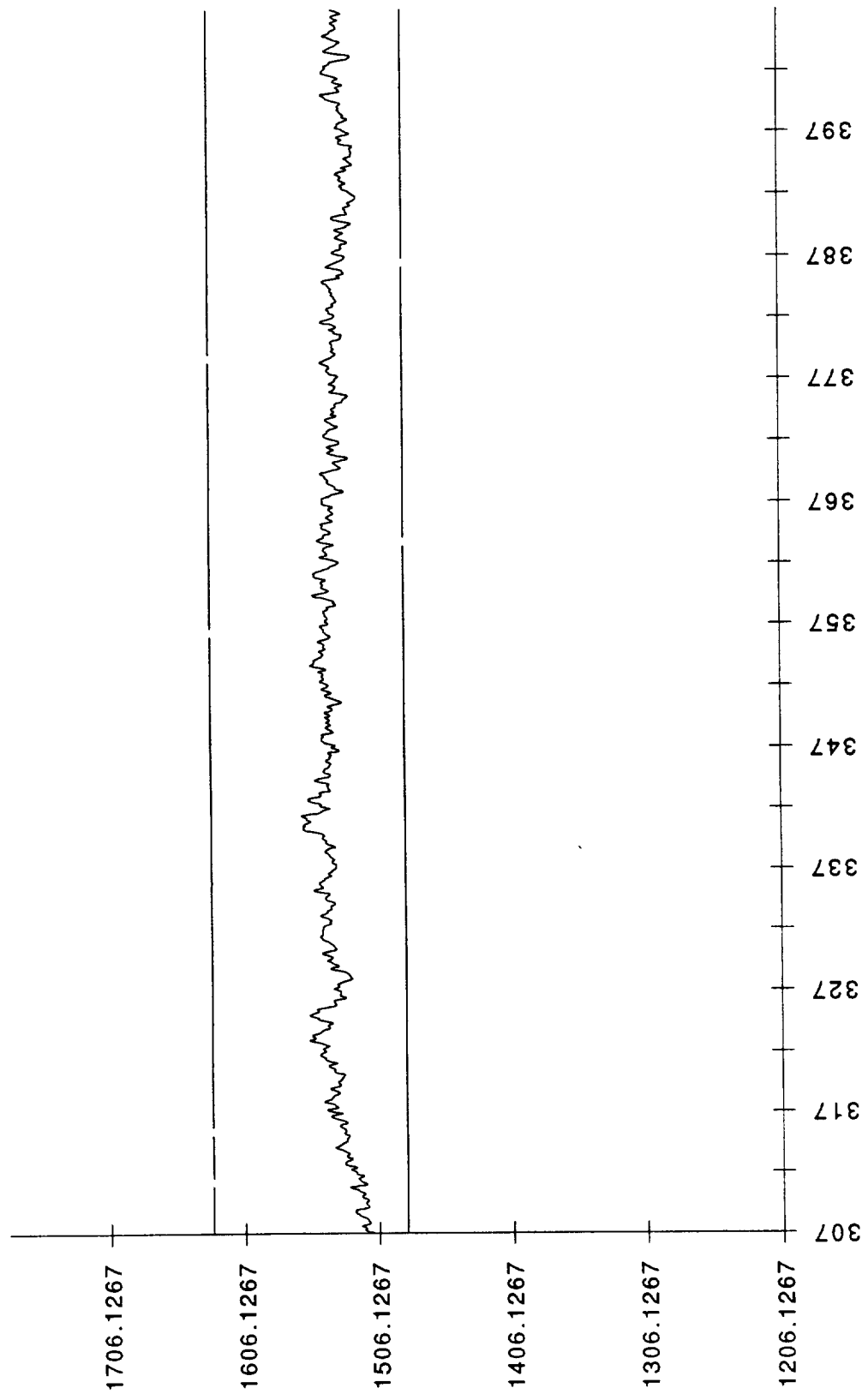

904-234 HPFP TDT A.T

904-234 HPFP TDT A.T

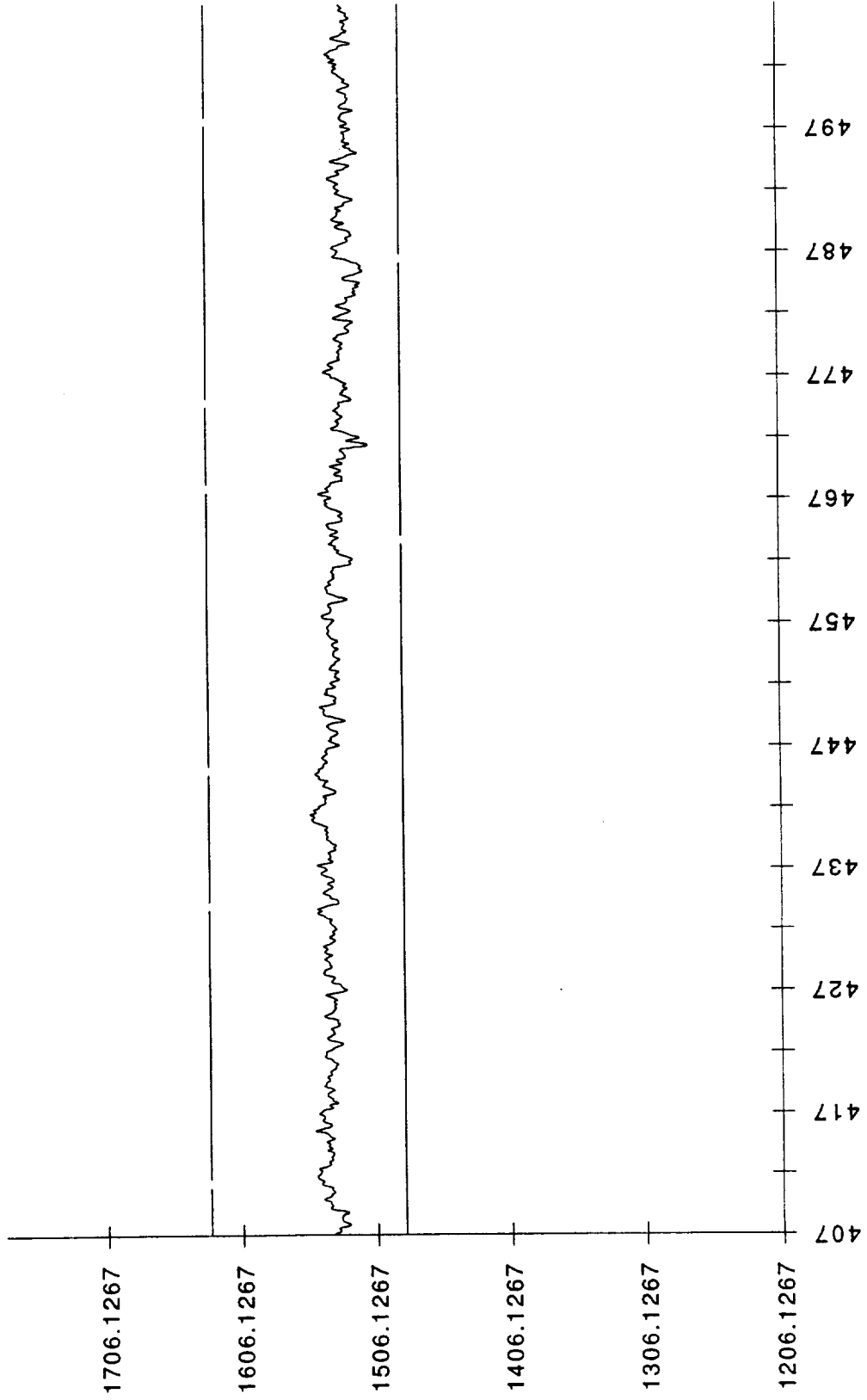

904-234 HPFP TDT A.T

904-234 HPFP TDT A.T

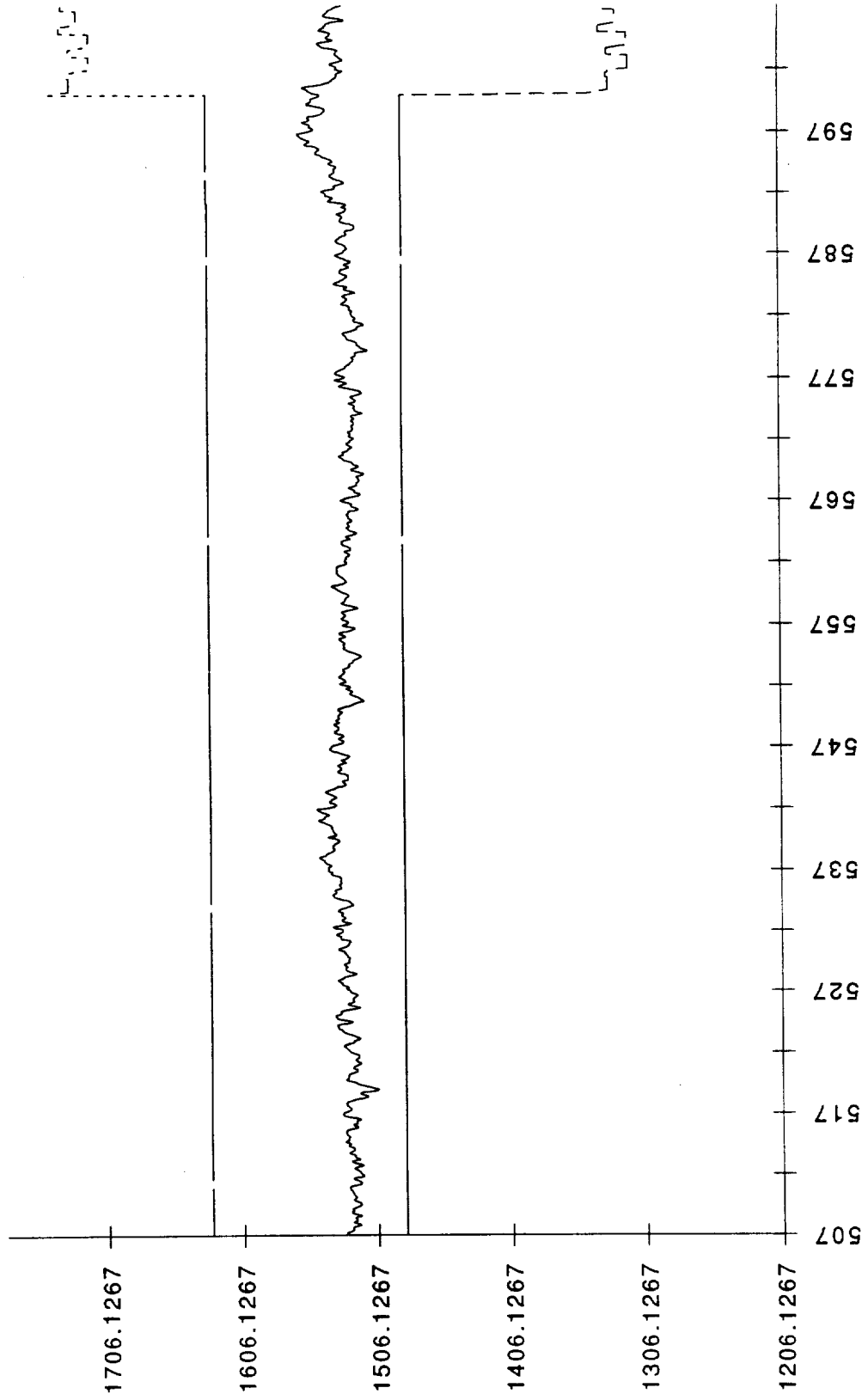

904-234 HPFP TDT A.T

904-235 HPFP TDT A.T

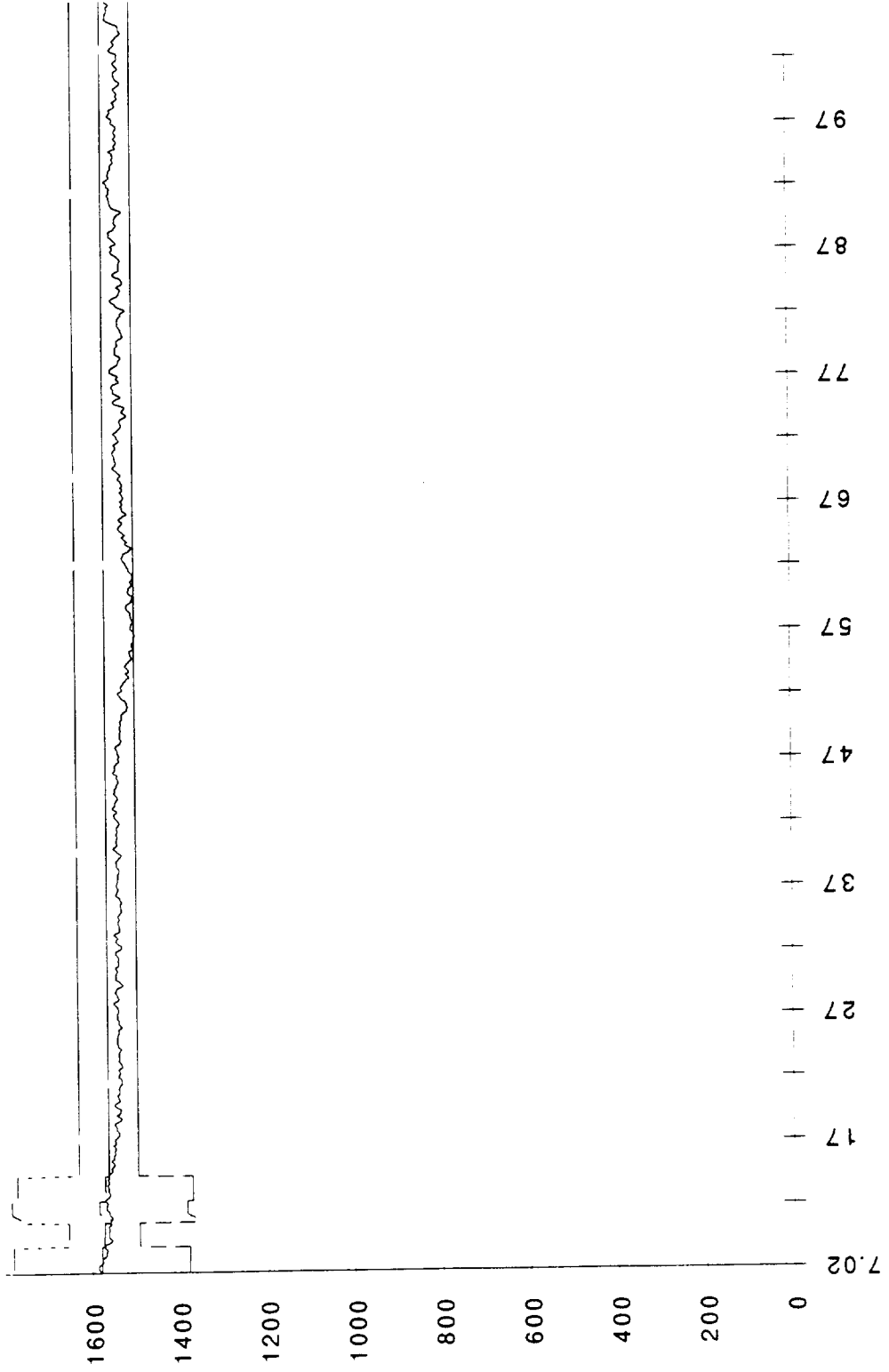

904-235 HPFP TDT A.T

904-235 HPFP TDT A.T

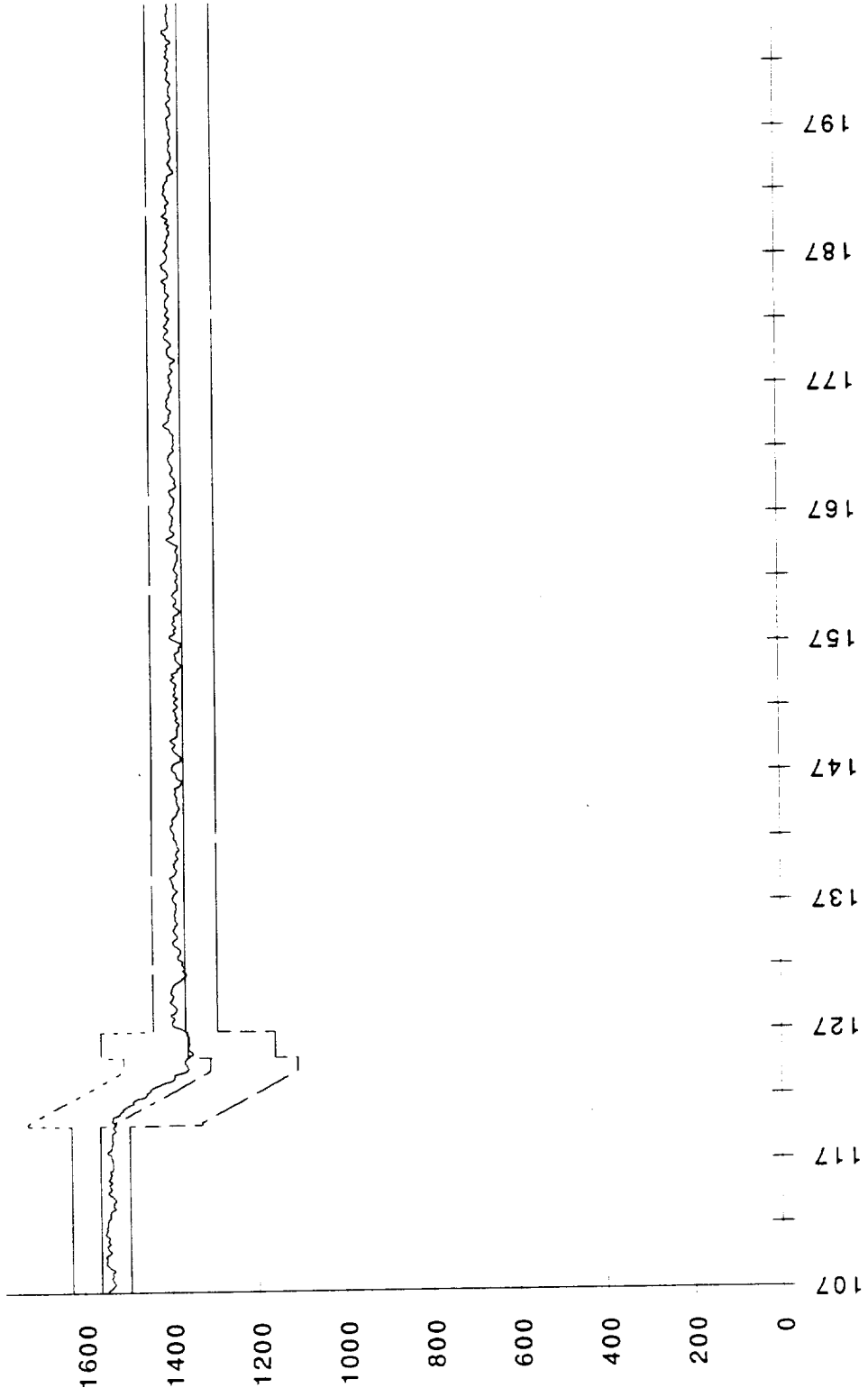

904-235 HPFP TDT A.T

904-235 HPFP TDT A.T

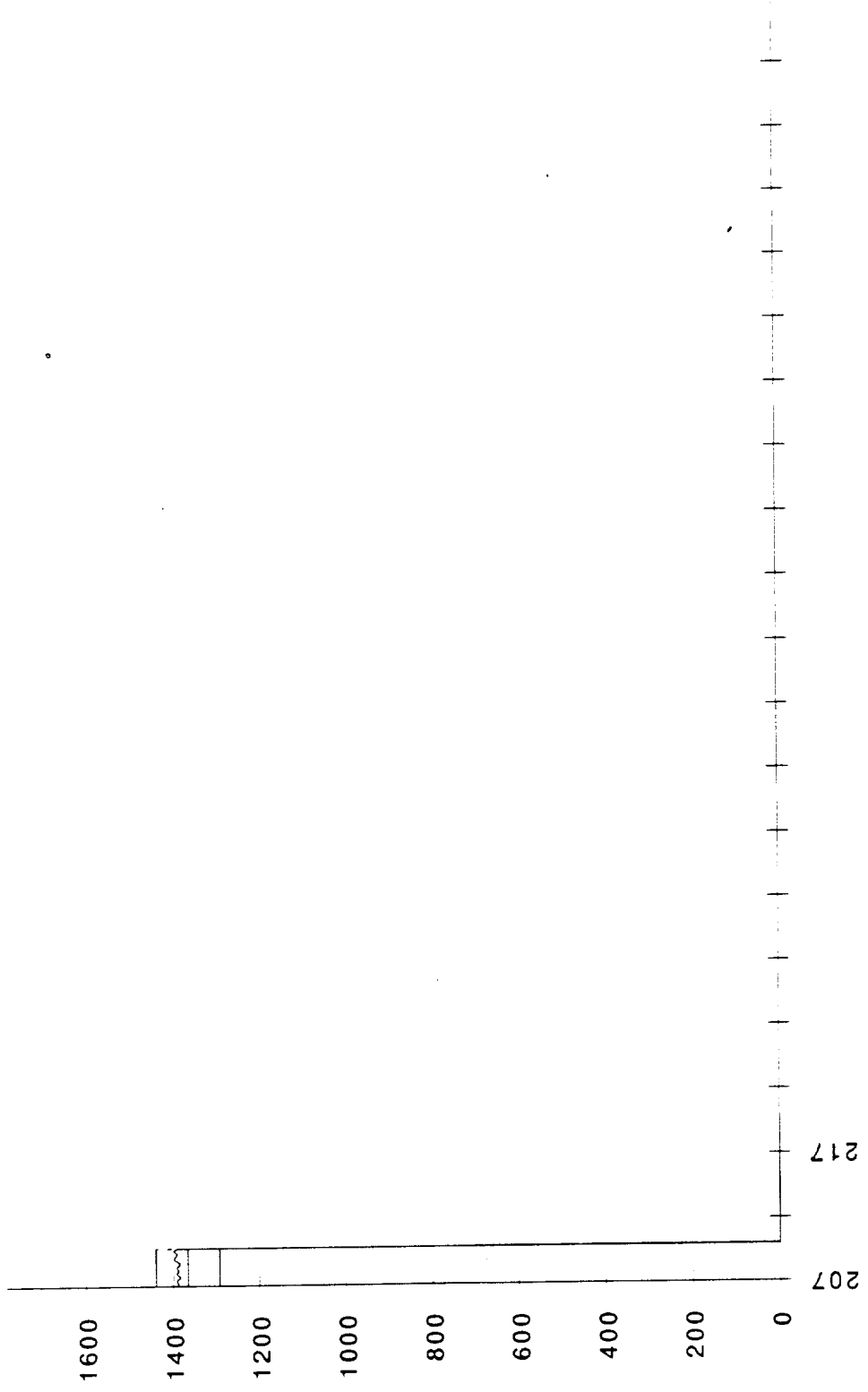

904-235 HPFP TDT A.T

904-236 HPFP TDT B.T

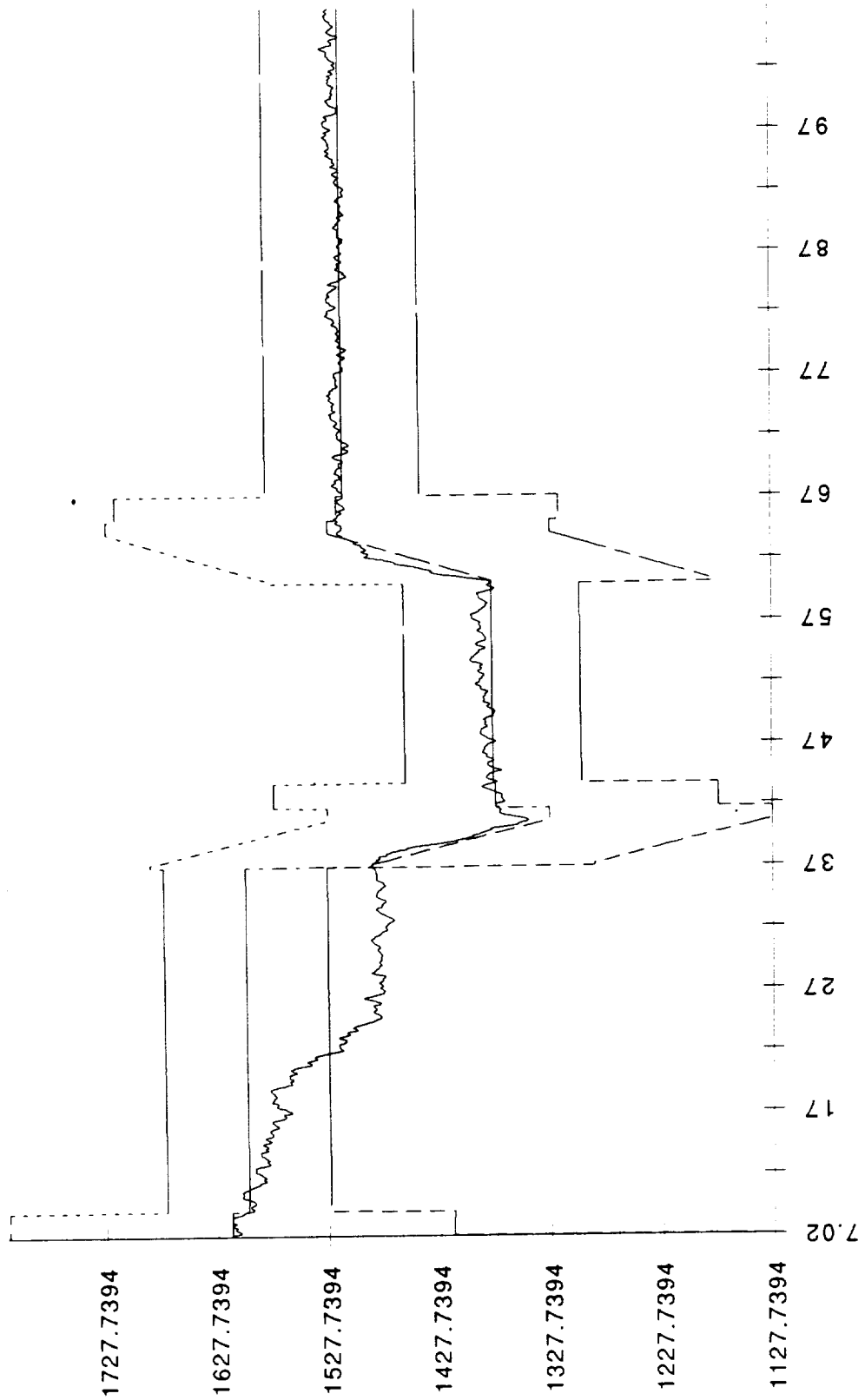

904-236 HPFP TDT B.T

904-236 HPFP TDT B.T

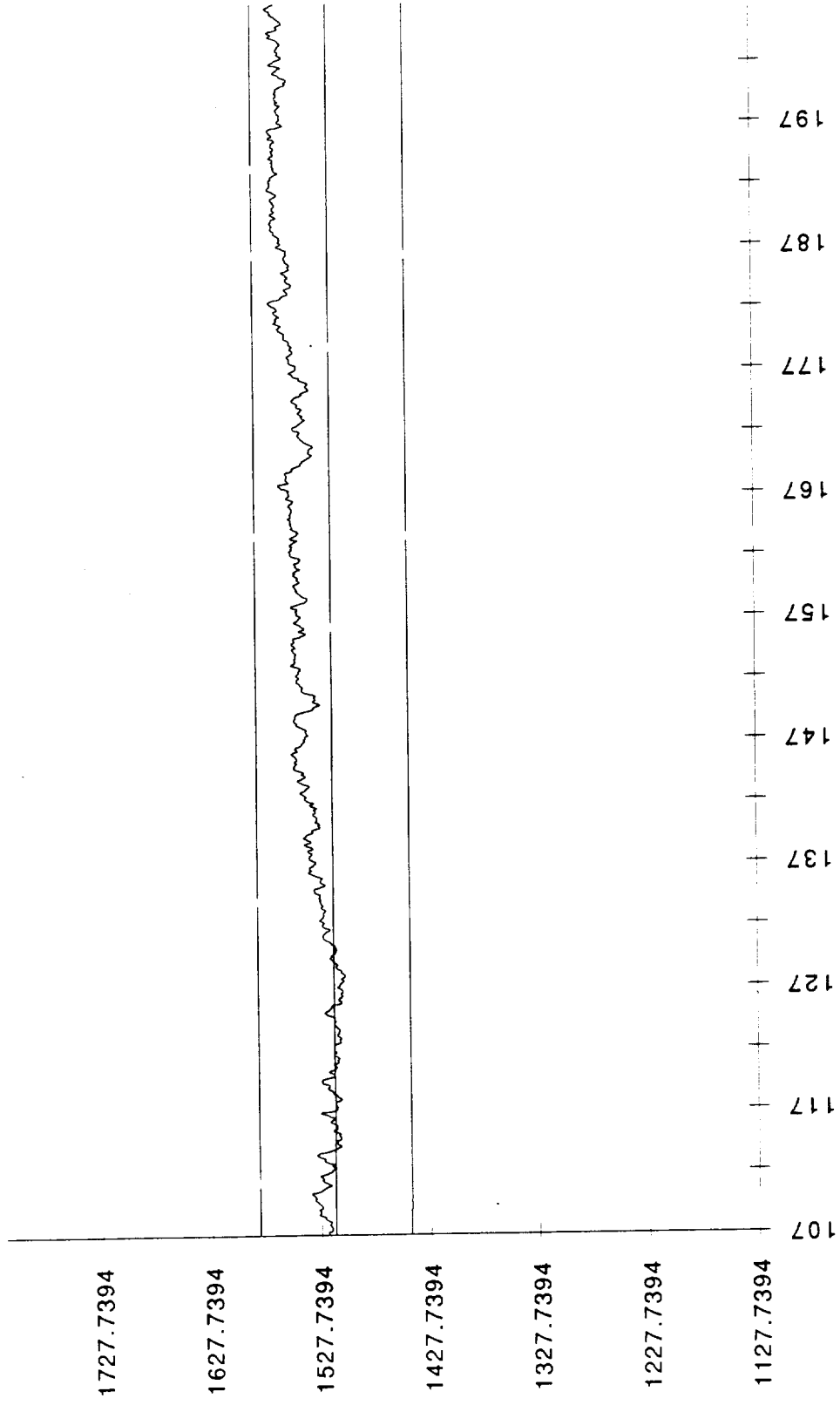

904-236 HPFP TDT B.T

904-236 HPFP TDT B.T

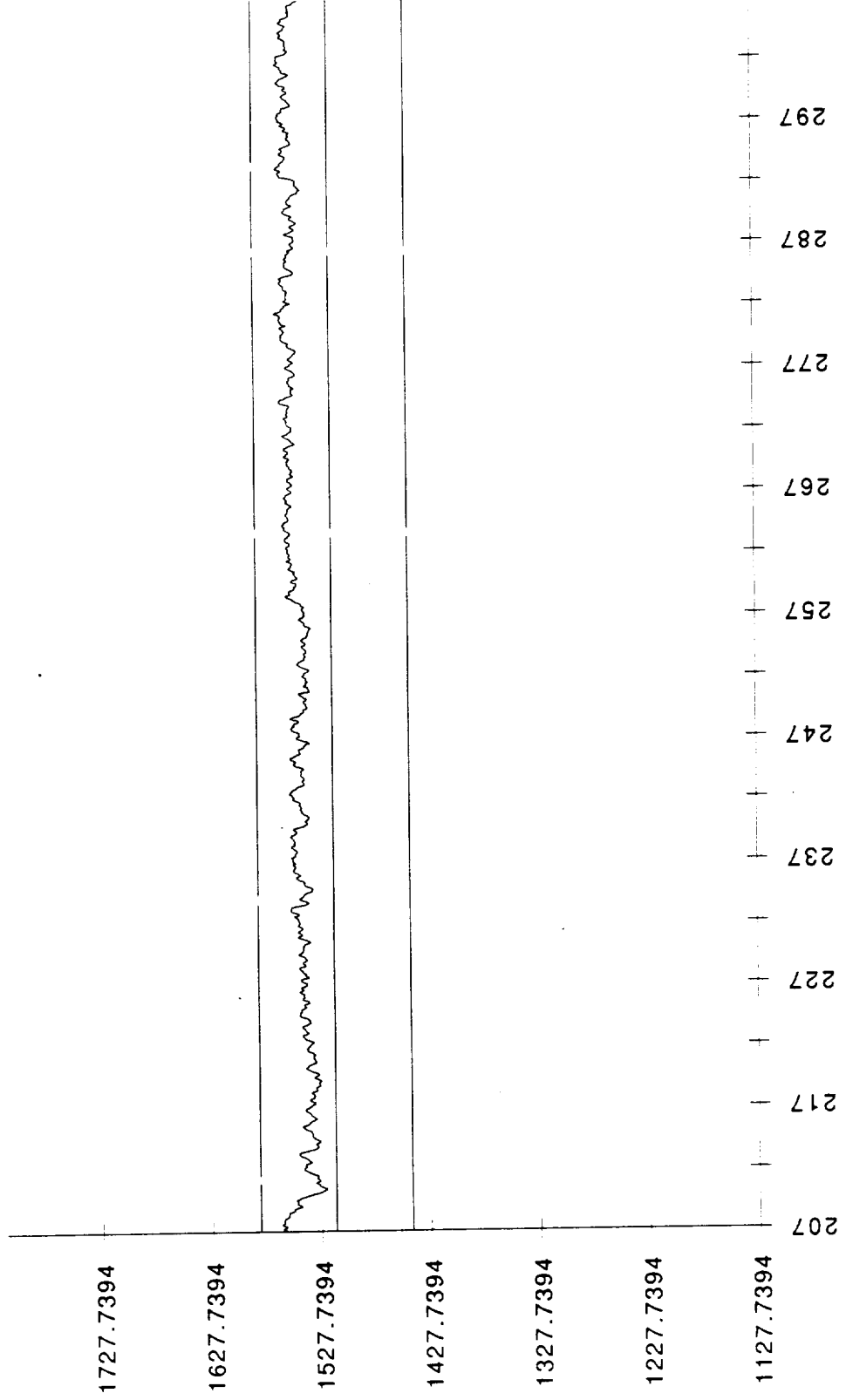

904-236 HPFP TDT B.T

904-236 HPFP TDT B.T

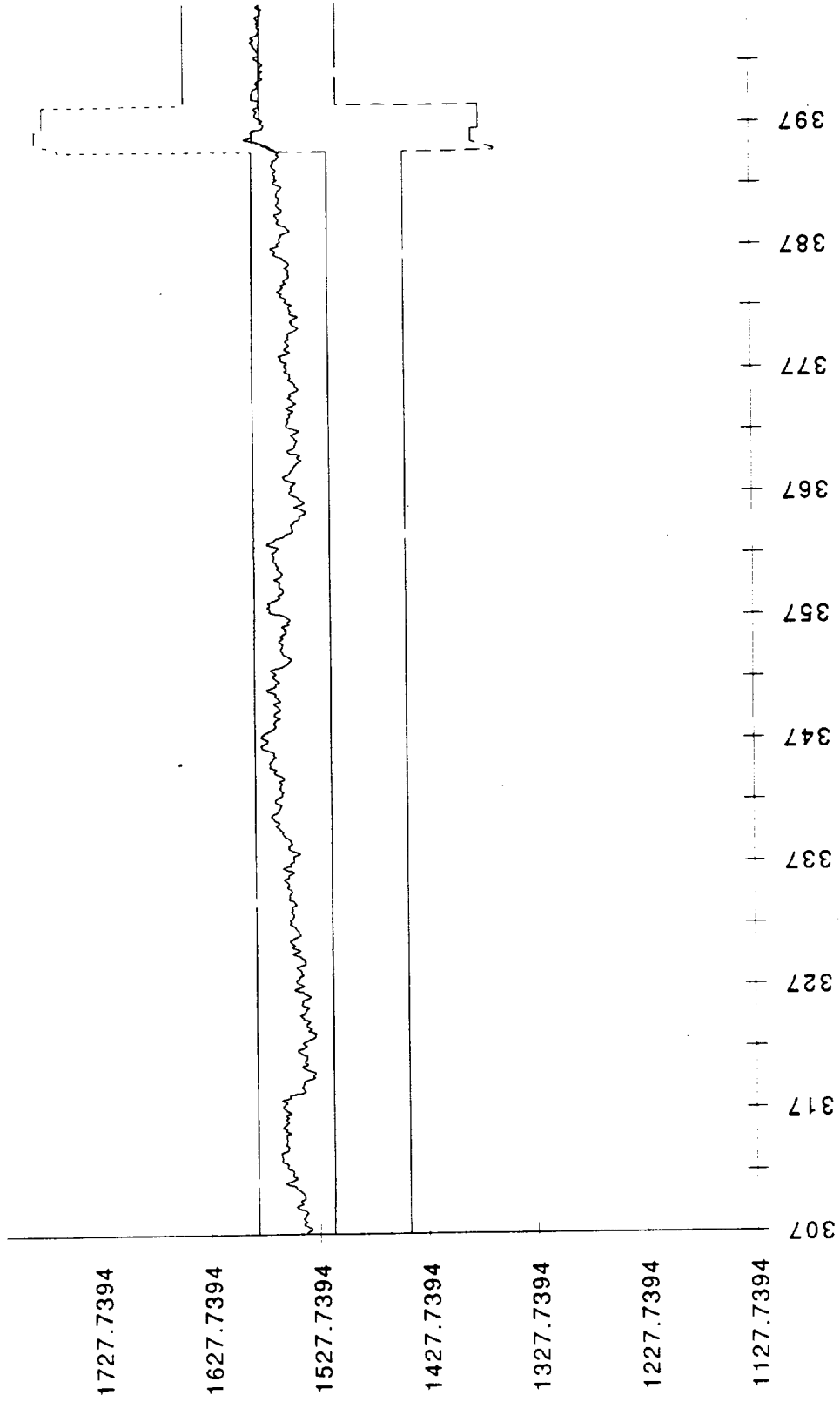

904-236 HPFP TDT B.T

904-236 HPFP TDT B.T

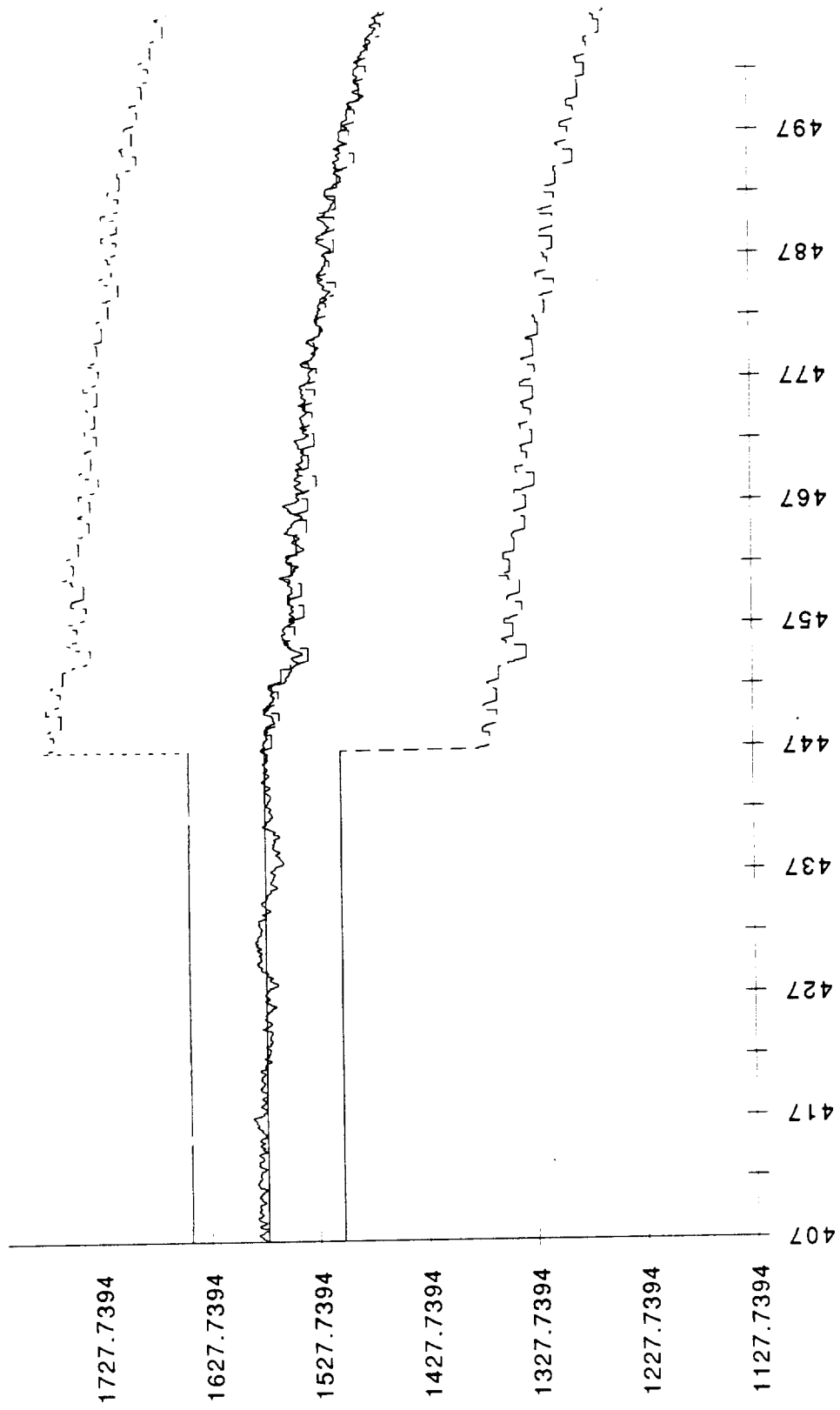

904-236 HPFP TDT B.T

904-236 HPFP TDT B.T

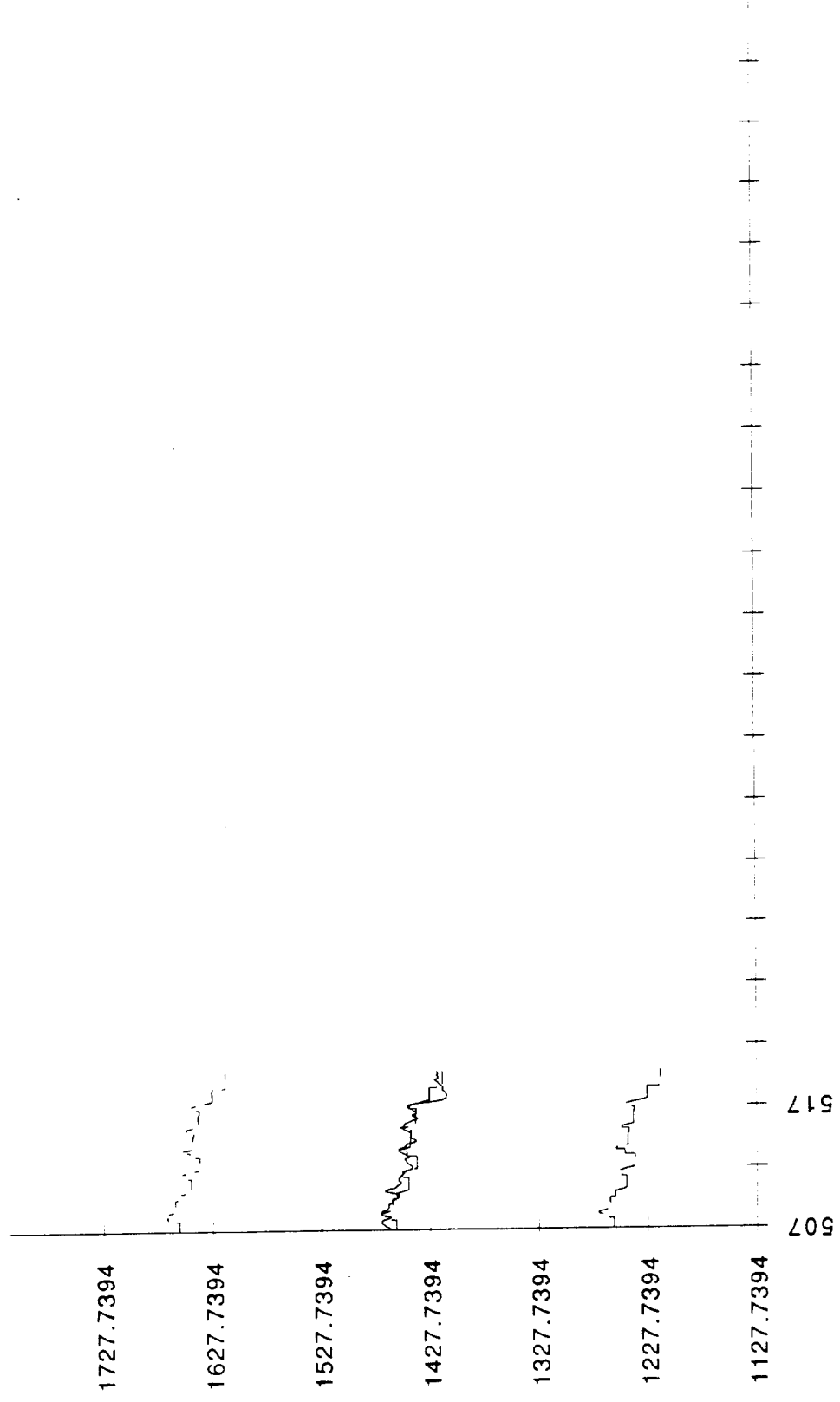

904-236 HPFP TDT B.T

904-242 HPFP TDT B.T

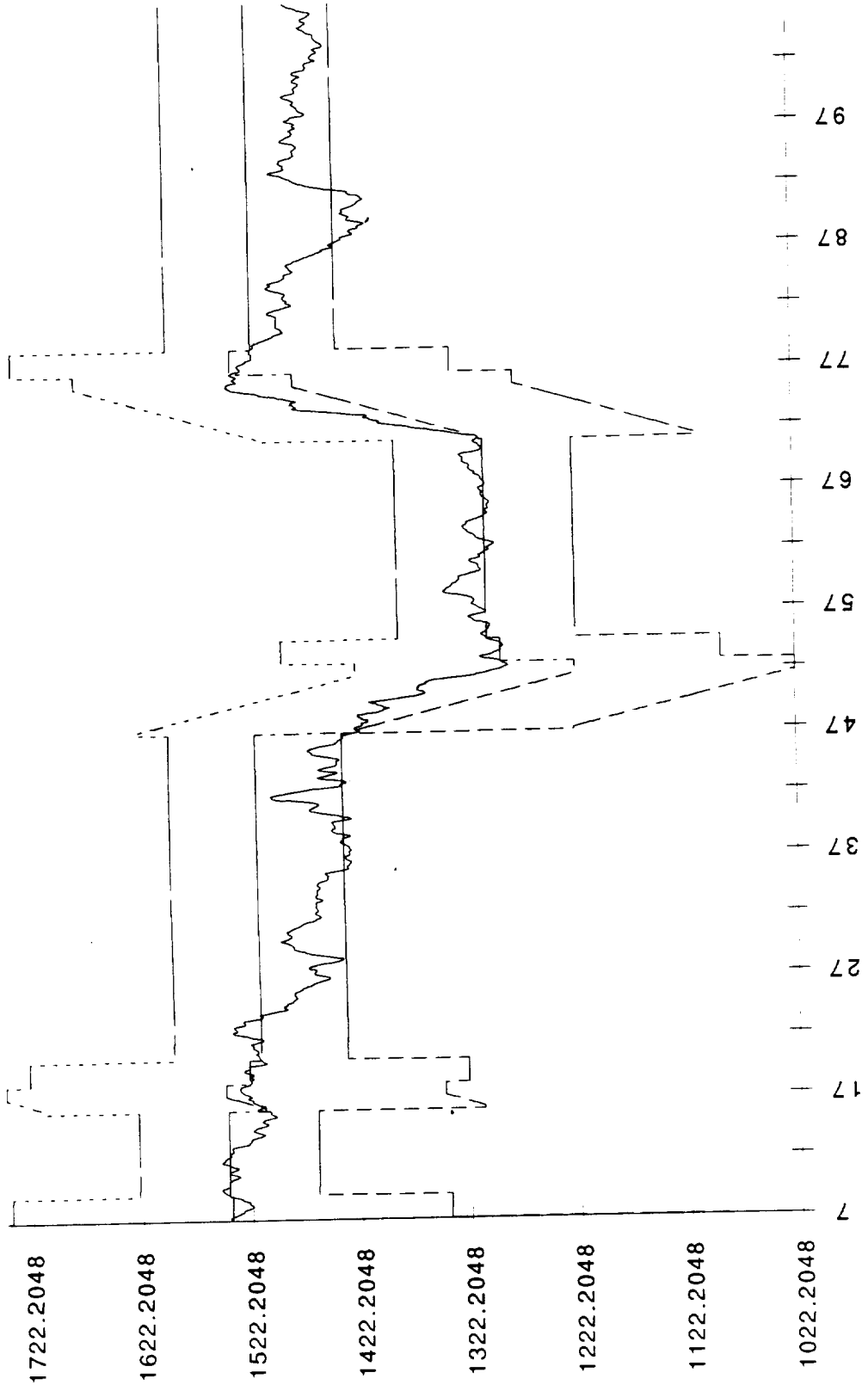

904-242 HPFP TDT B.T

904-242 HPFP TDT B.T

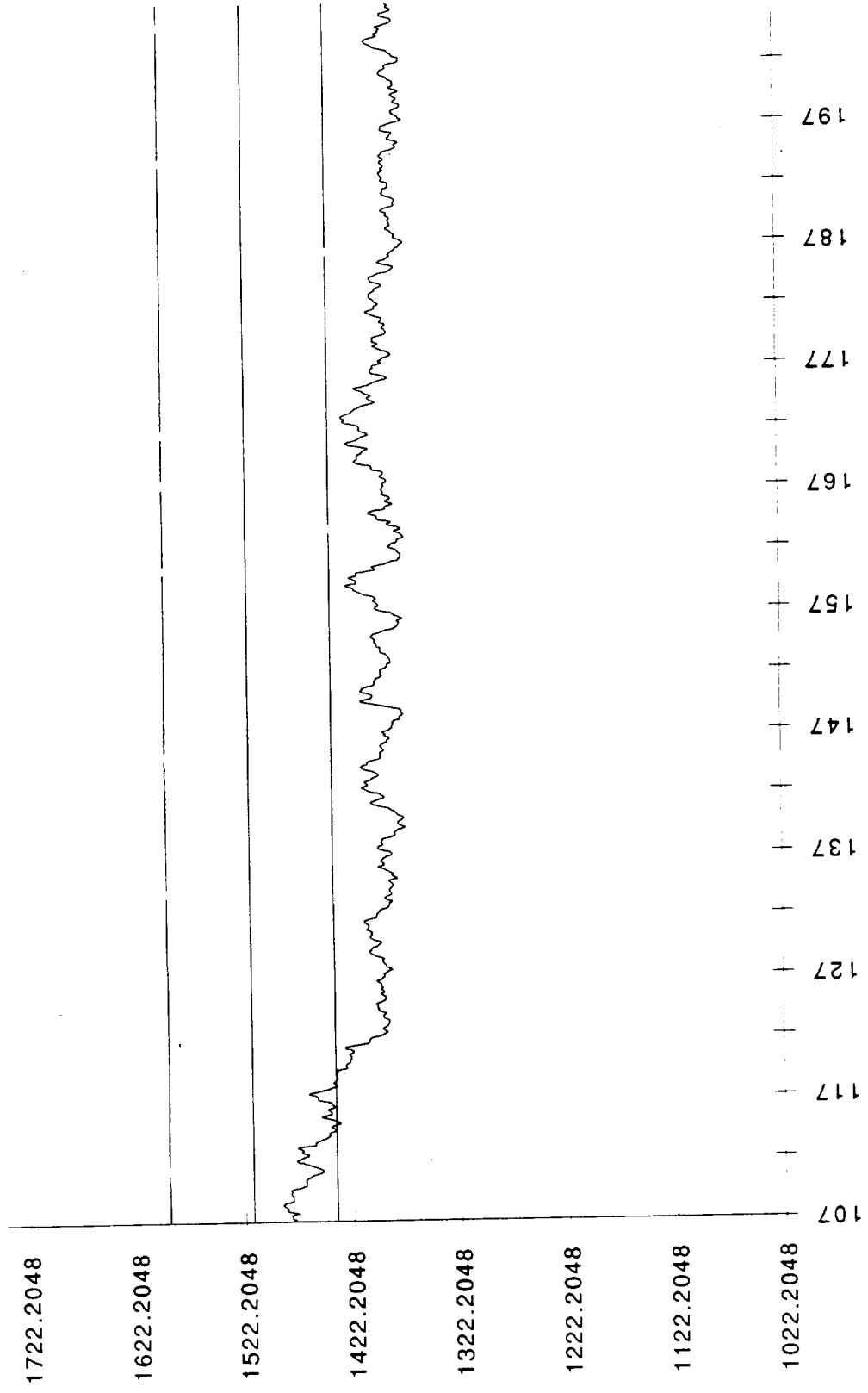

904-242 HPFP TDT B.T

904-242 HPFP TDT B.T

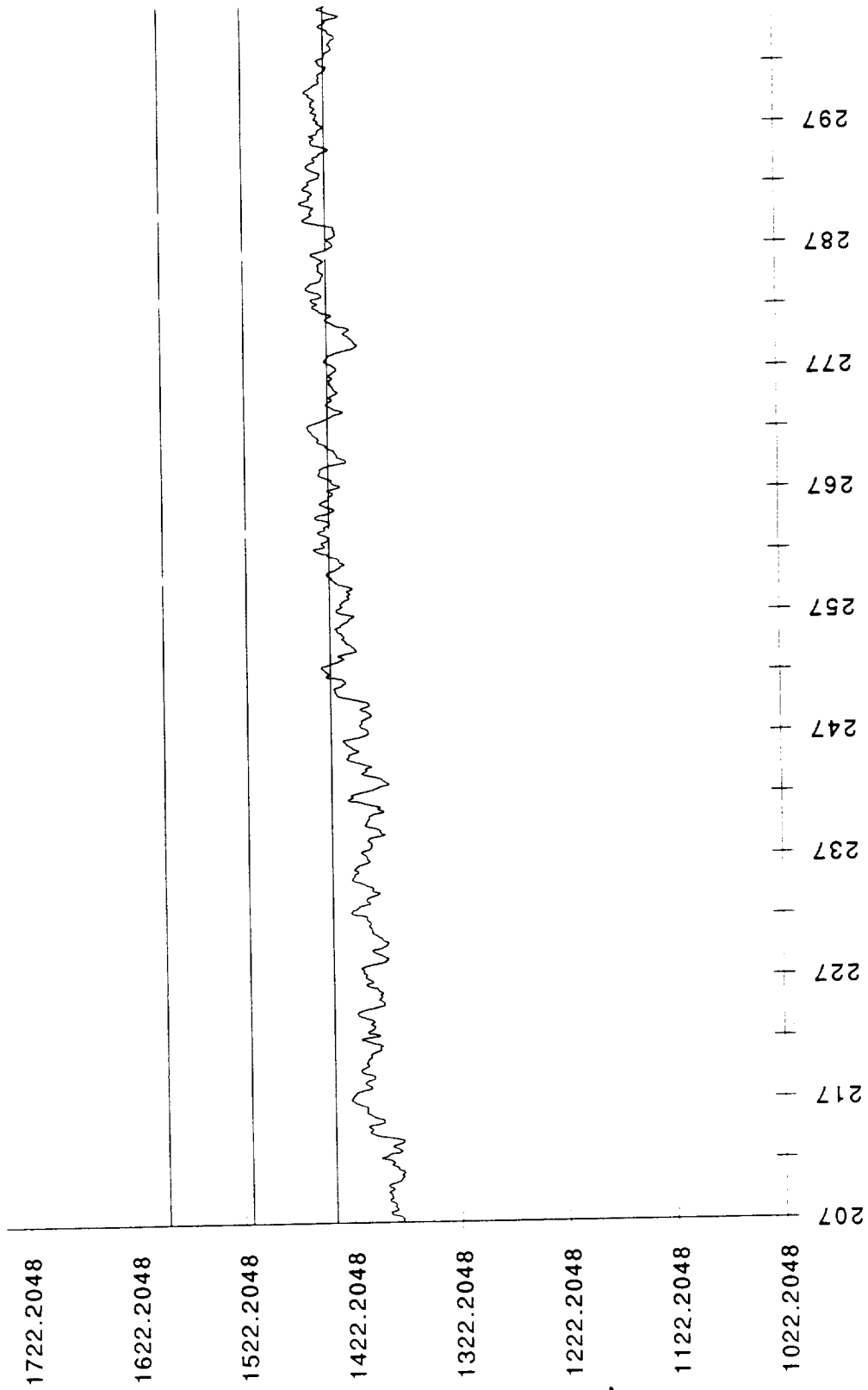

904-242 HPFP TDT B.T

904-242 HPFP TDT B.T

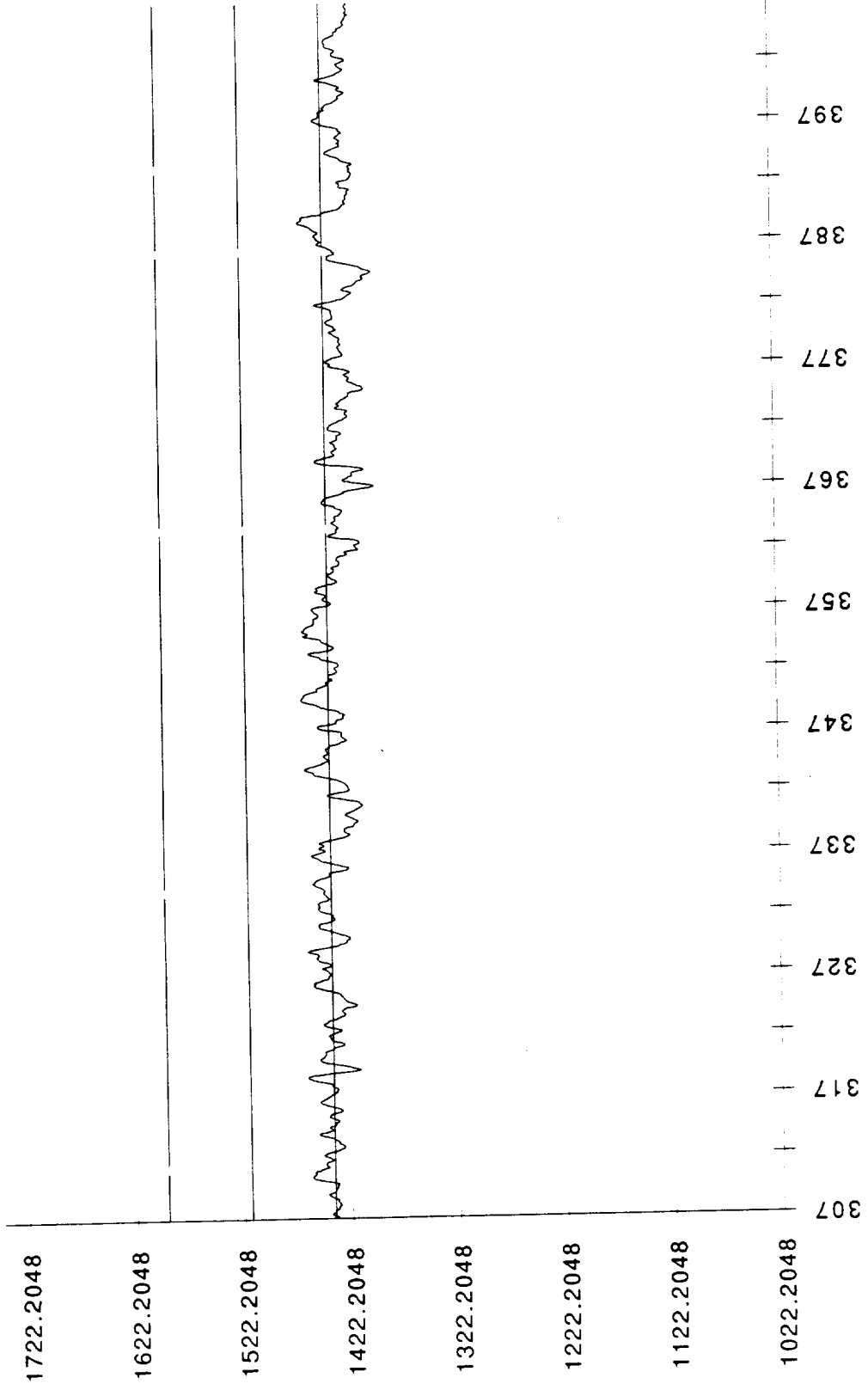

904-242 HPFP TDT B.T

904-242 HPFP TDT B.T

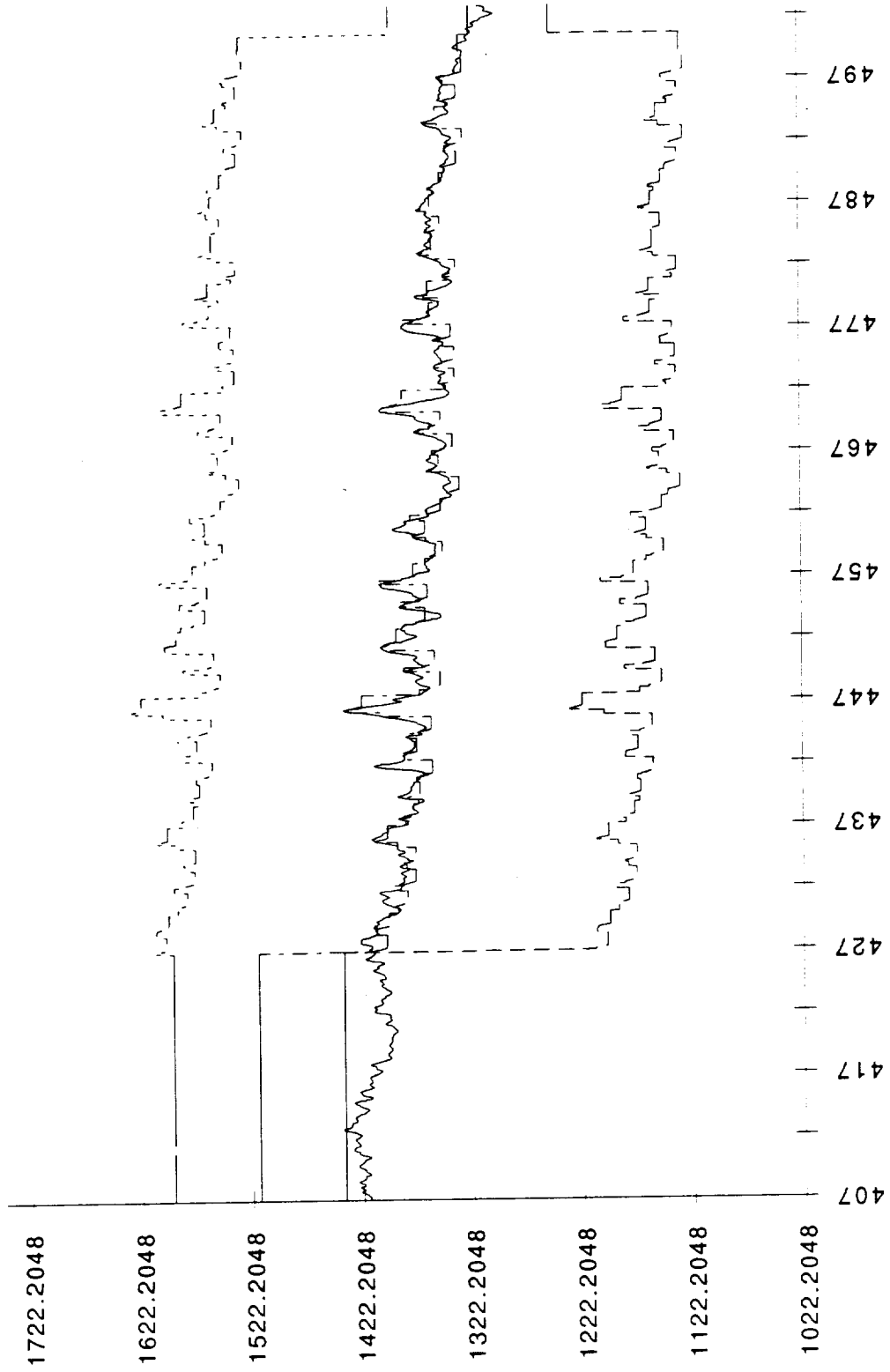

904-242 HPFP TDT B.T

904-243 HPFP TDT B.T

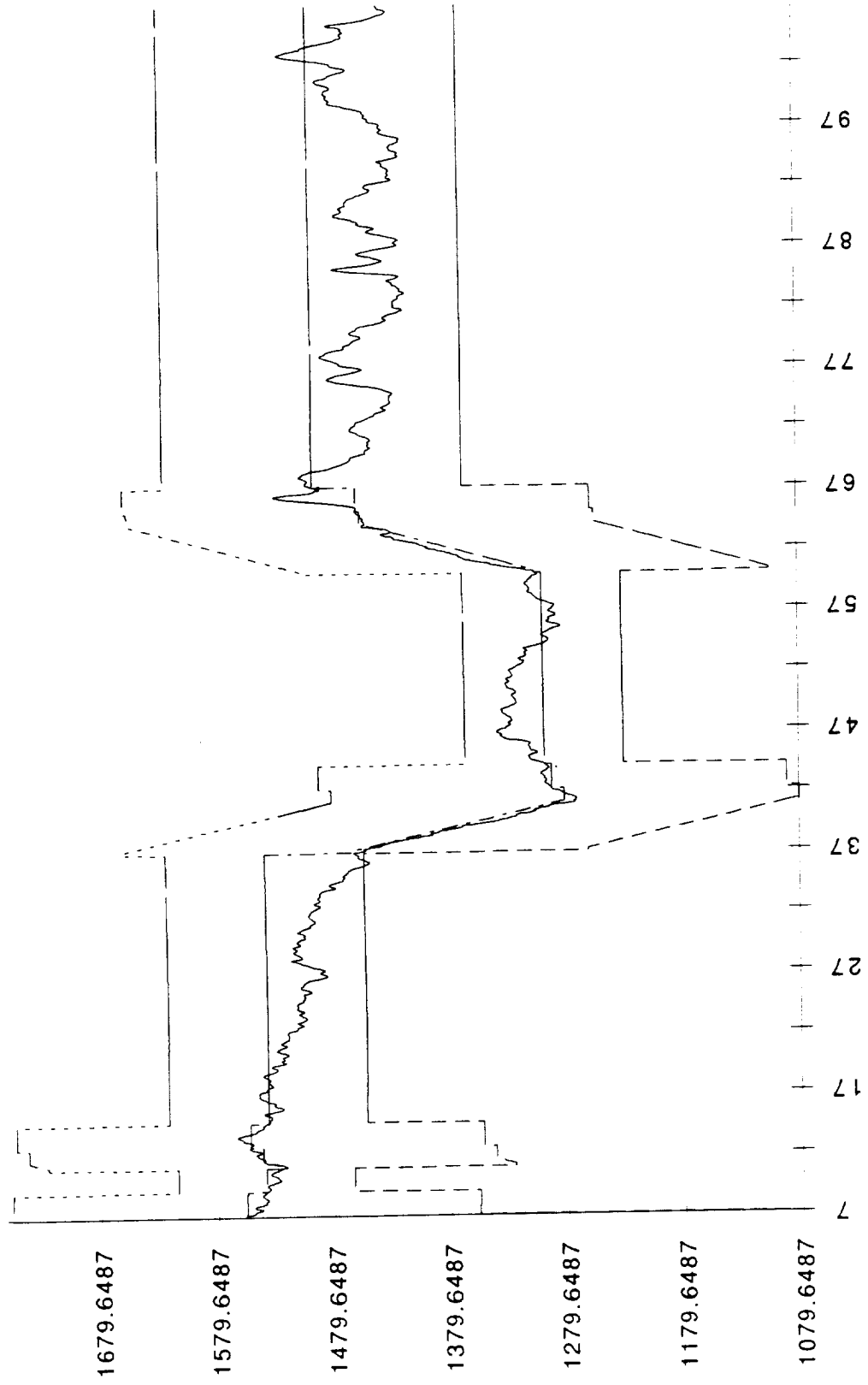

904-243 HPFP TDT B.T

904-243 HPFP TDT B.T

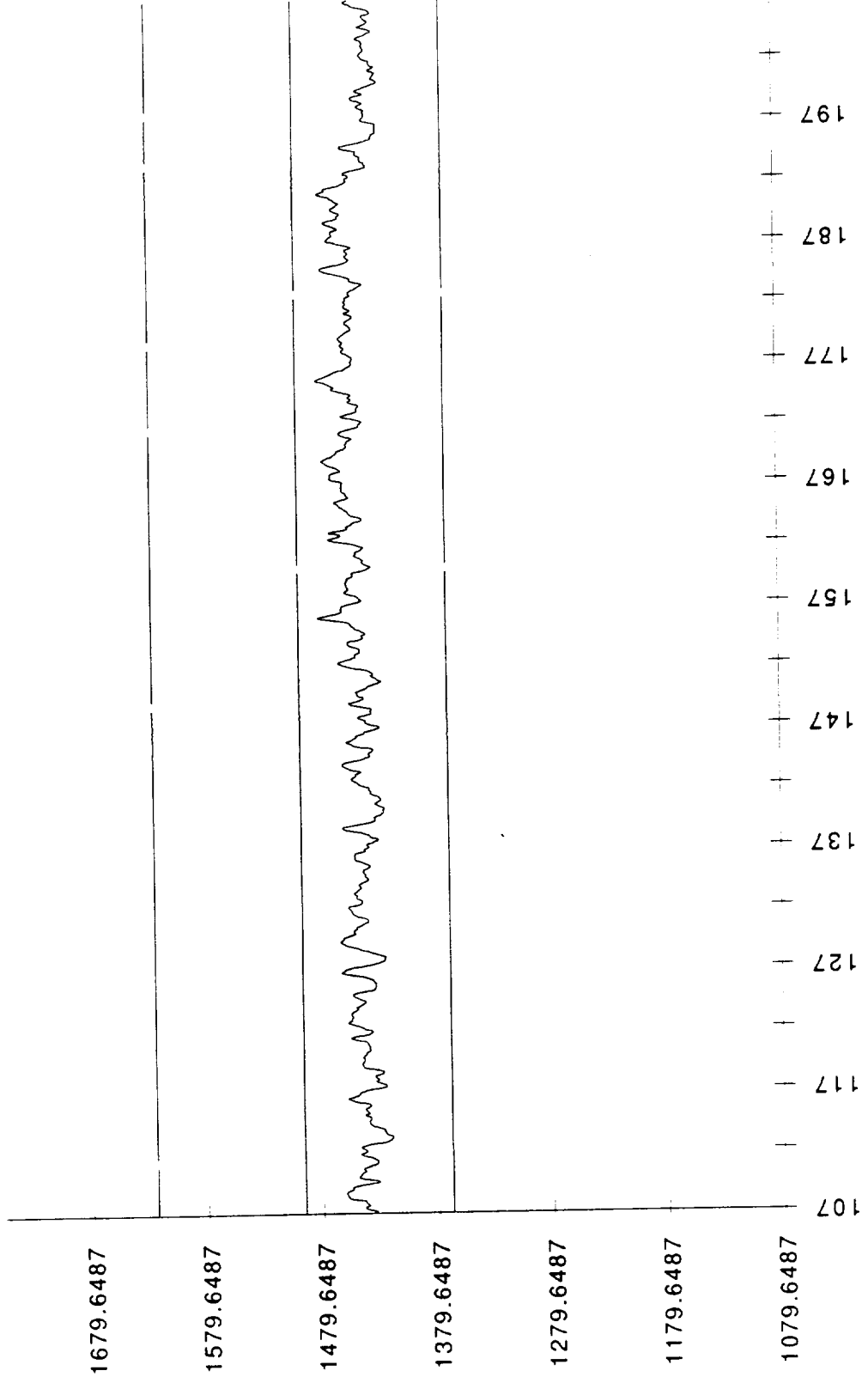

904-243 HPFP TDT B.T

904-243 HPFP TDT B.T

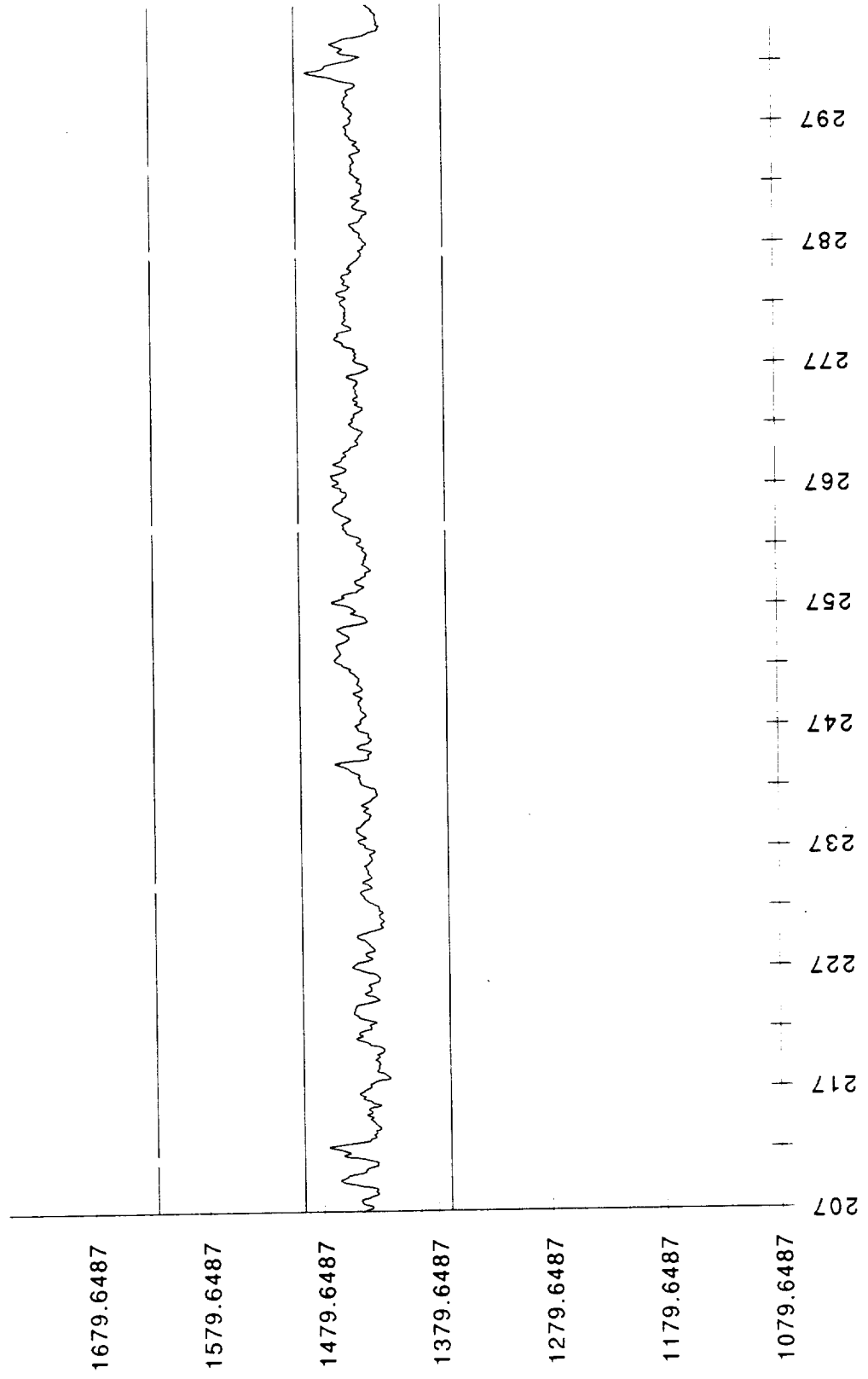

904-243 HPFP TDT B.T

904-243 HPFP TDT B.T

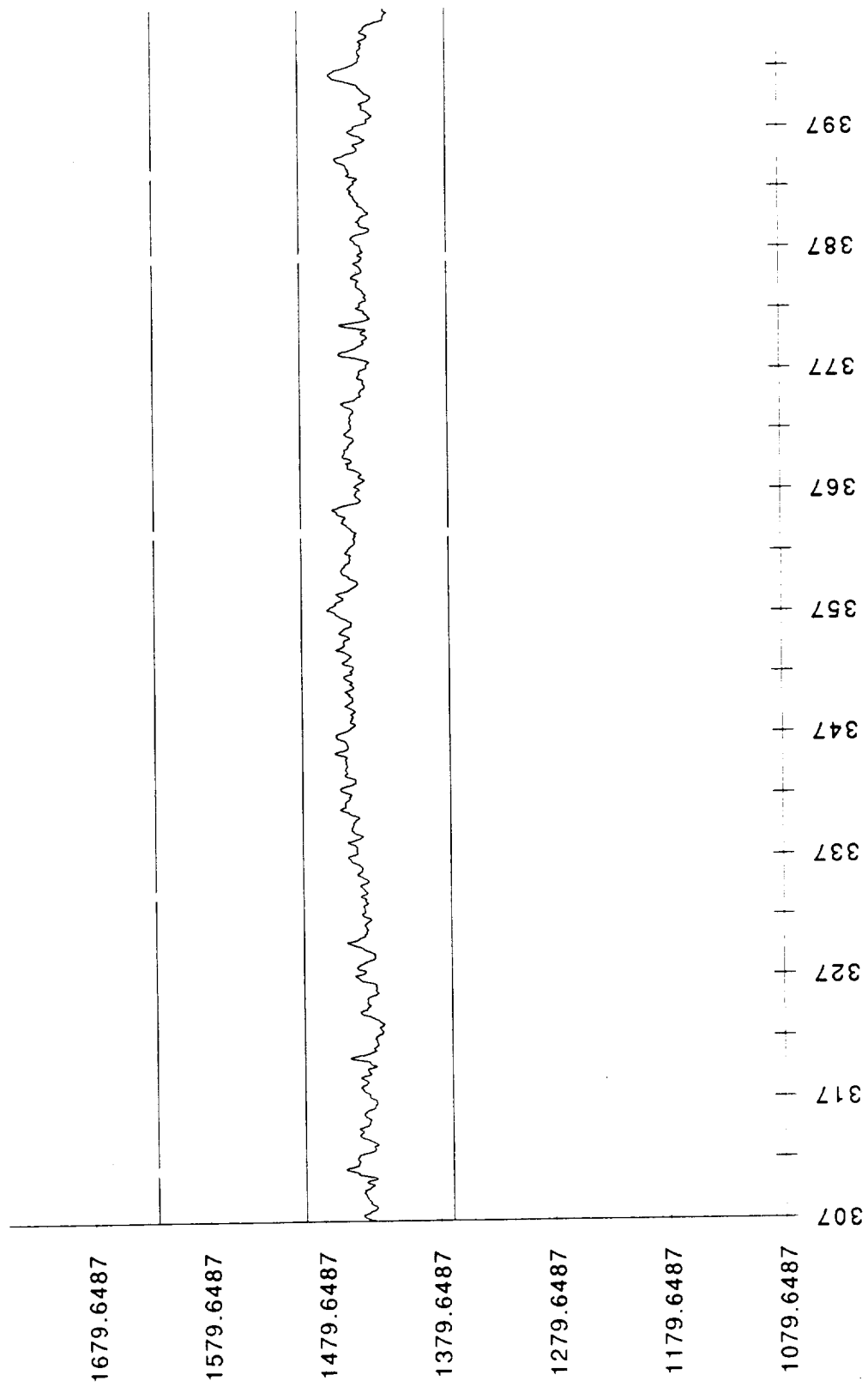

904-243 HPFP TDT B.T

904-243 HPFP TDT B.T

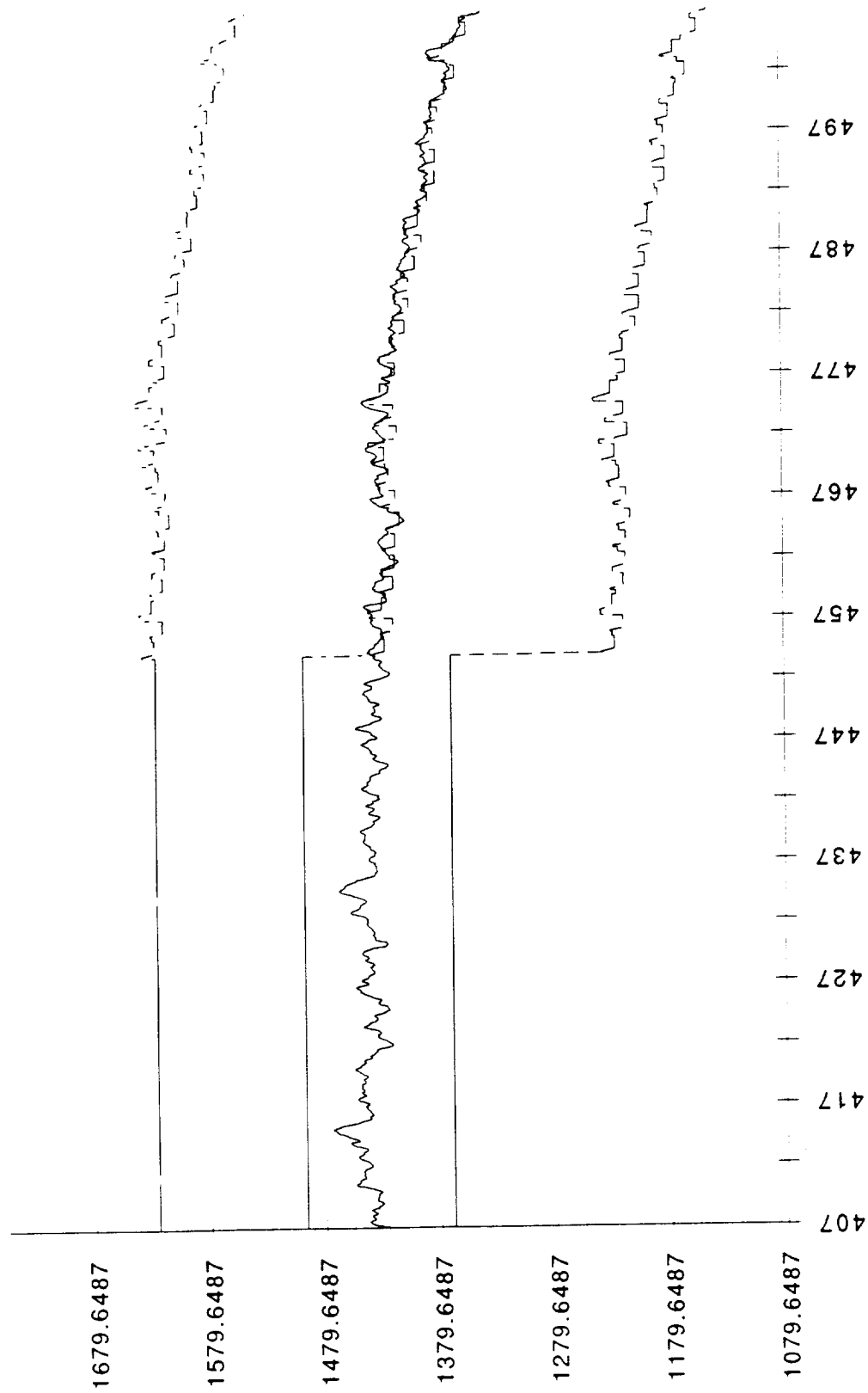

904-243 HPFP TDT B.T

904-243 HPFP TDT B.T

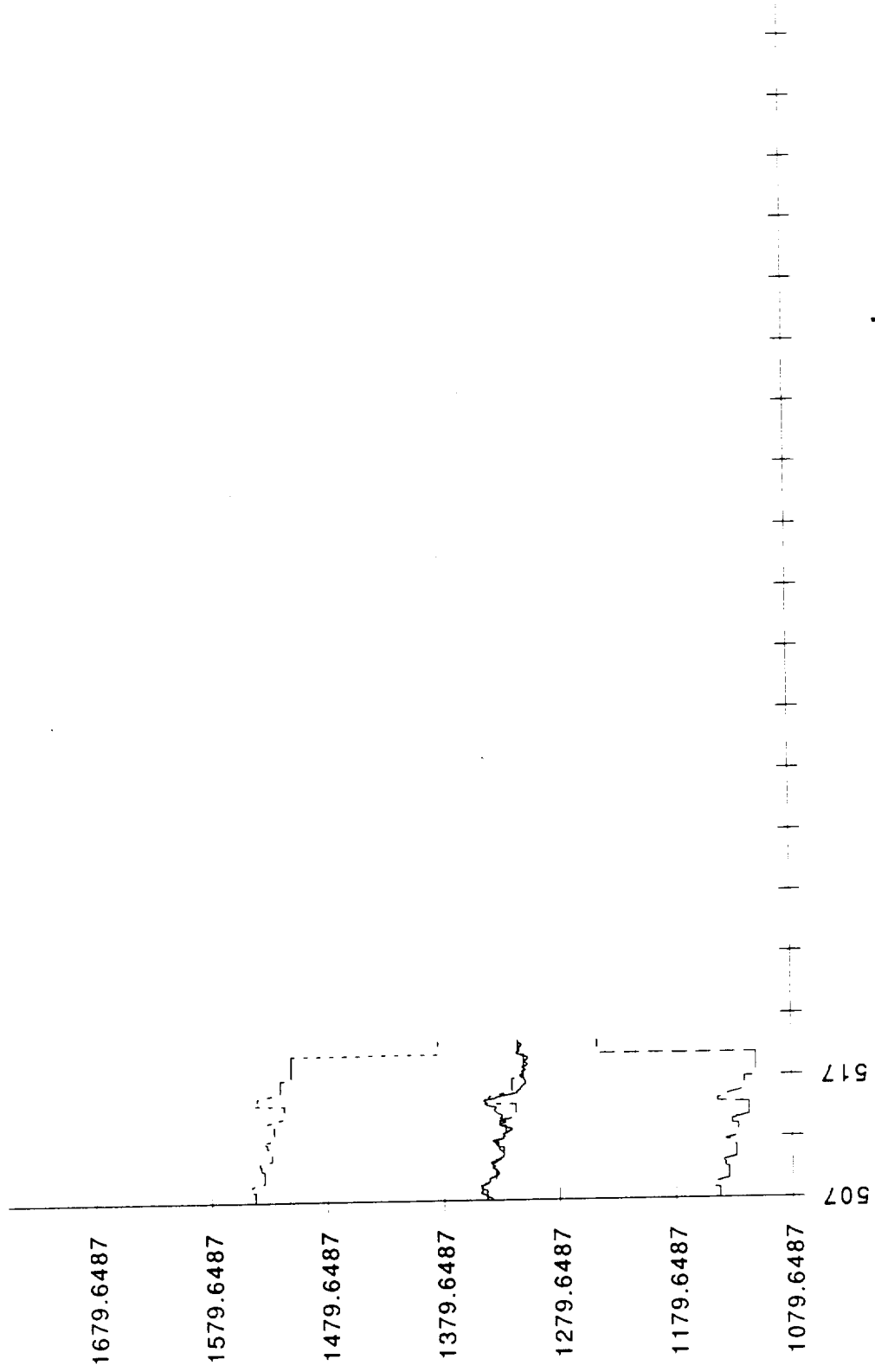

904-243 HPFP TDT B.T

904-244 HPOP PBP dis pr.T

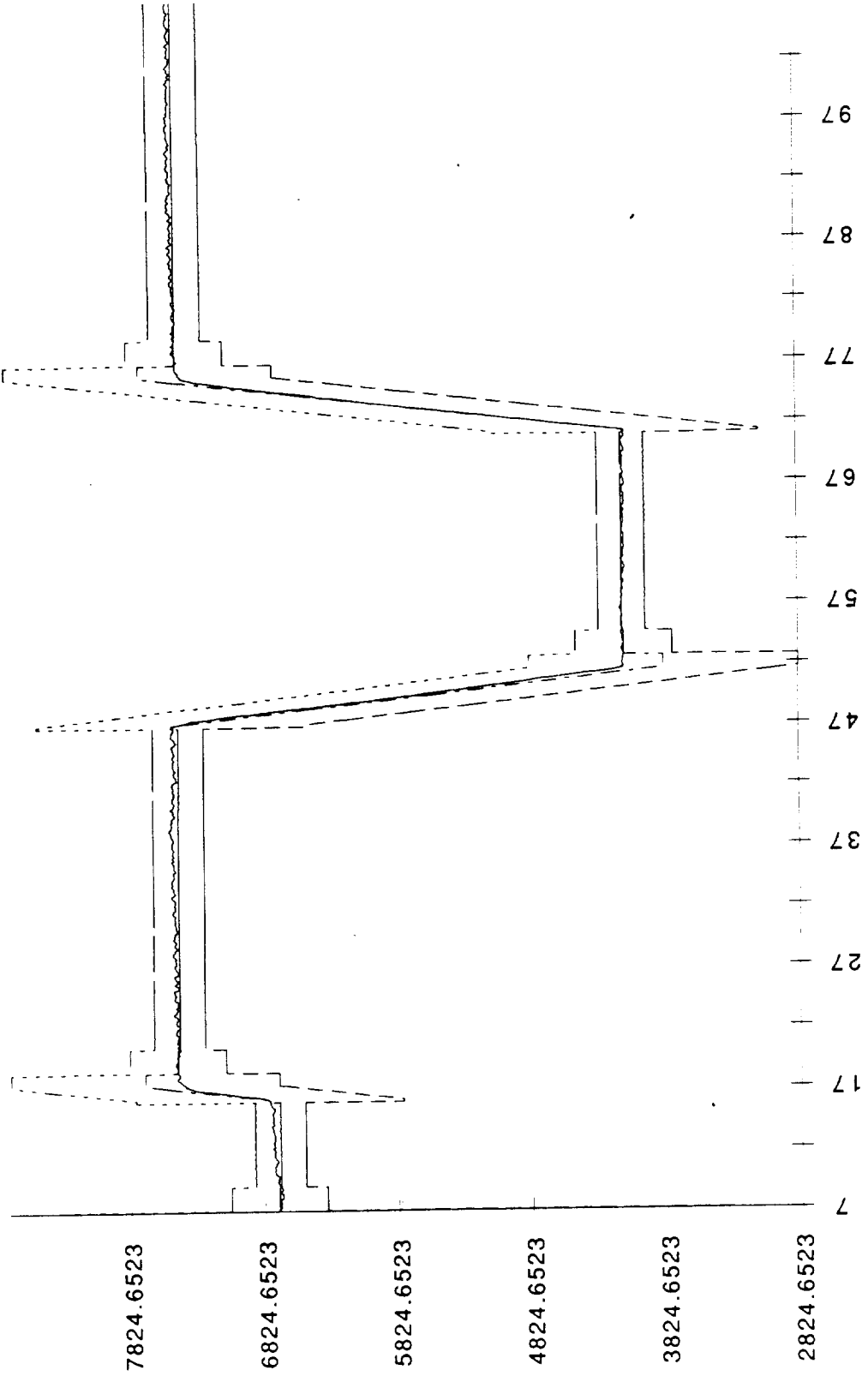

904-244 HPOP PBP dis pr.T

904-244 HPOP PBP dis pr.T

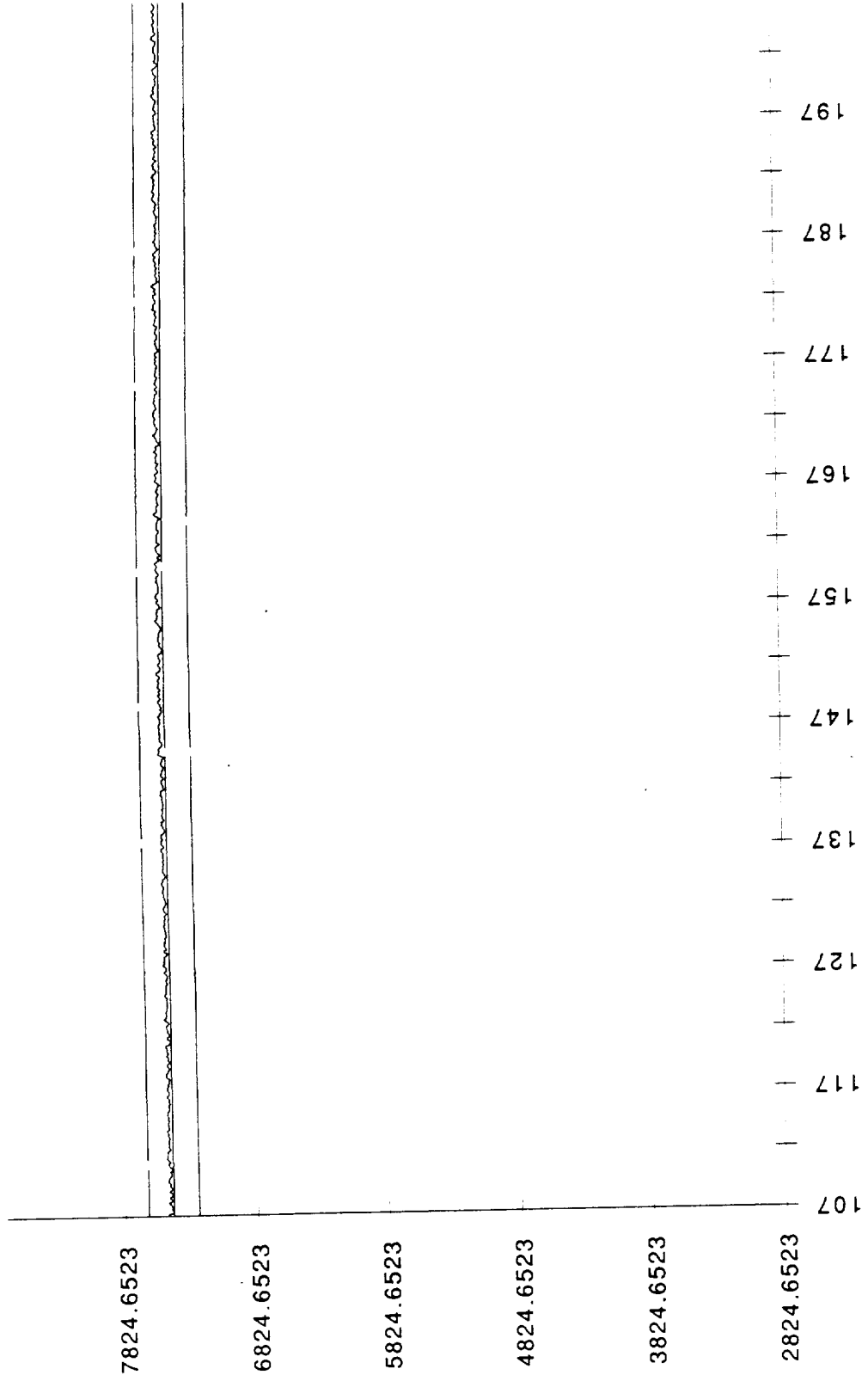

904-244 HPOP PBP dis pr.T

904-244 HPOP PBP dis pr.T

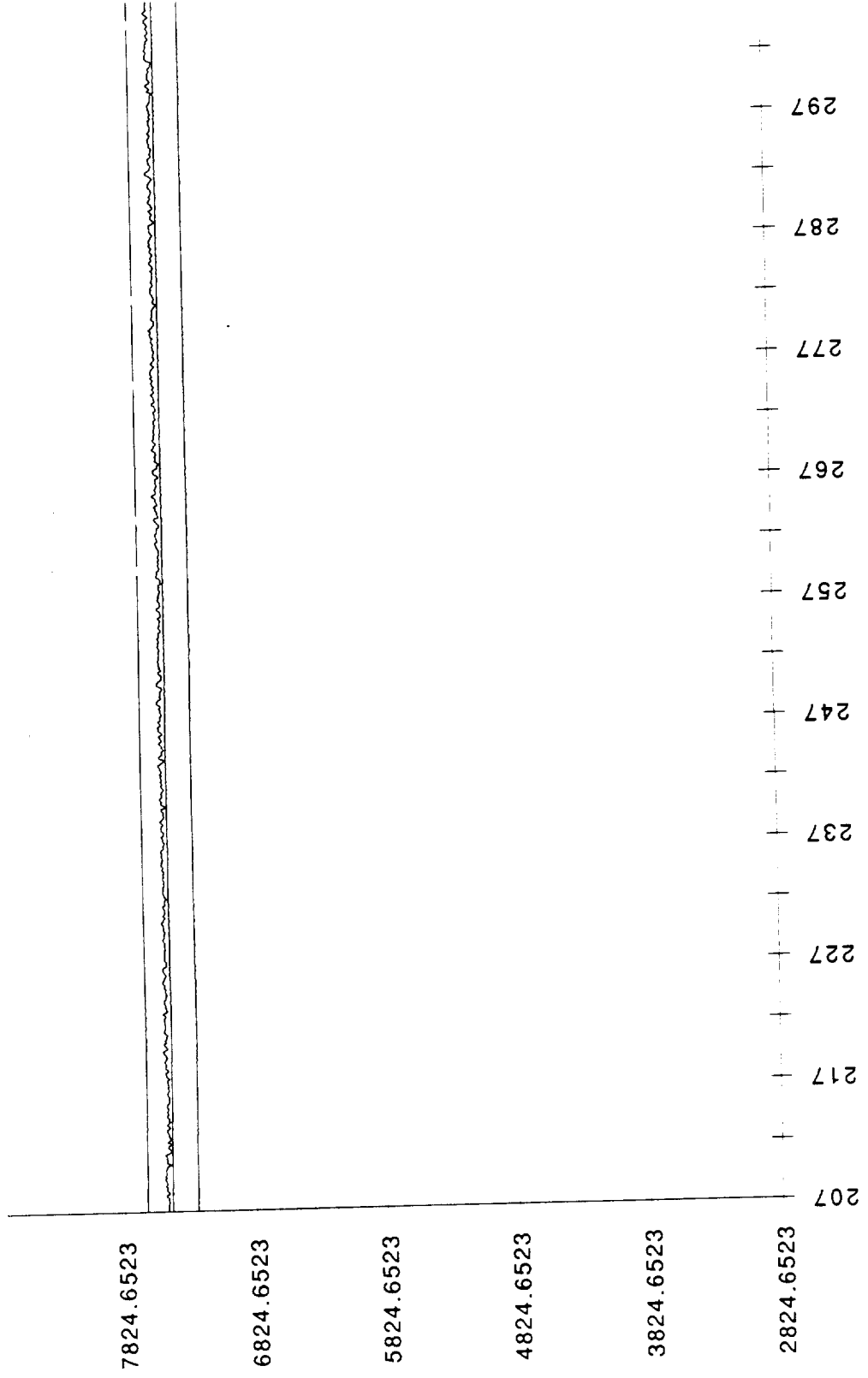

904-244 HPOP PBP dis pr.T

904-244 HPOP PBP dis pr.T

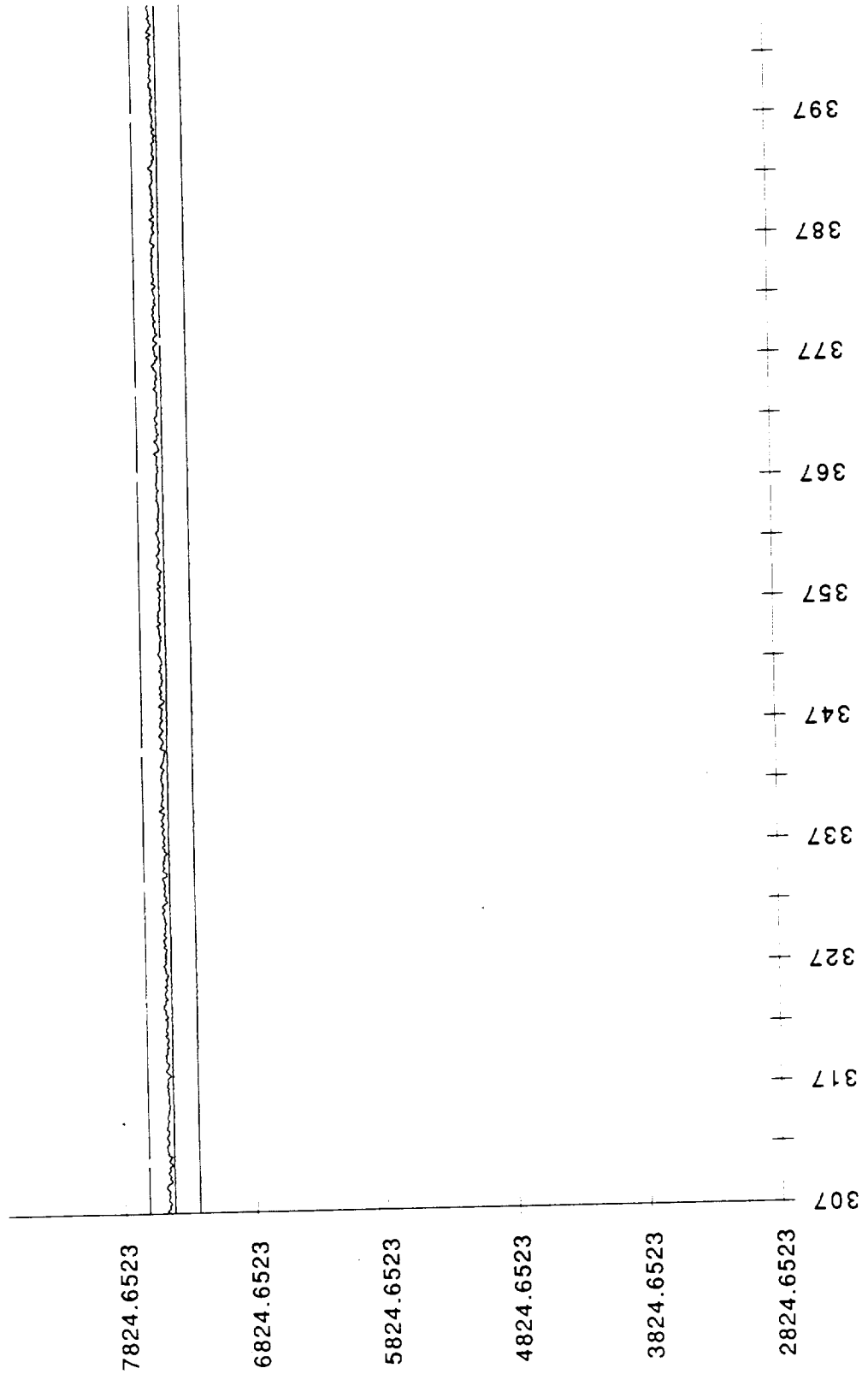

904-244 HPOP PBP dis pr.T

904-244 HPOP PBP dis pr.T

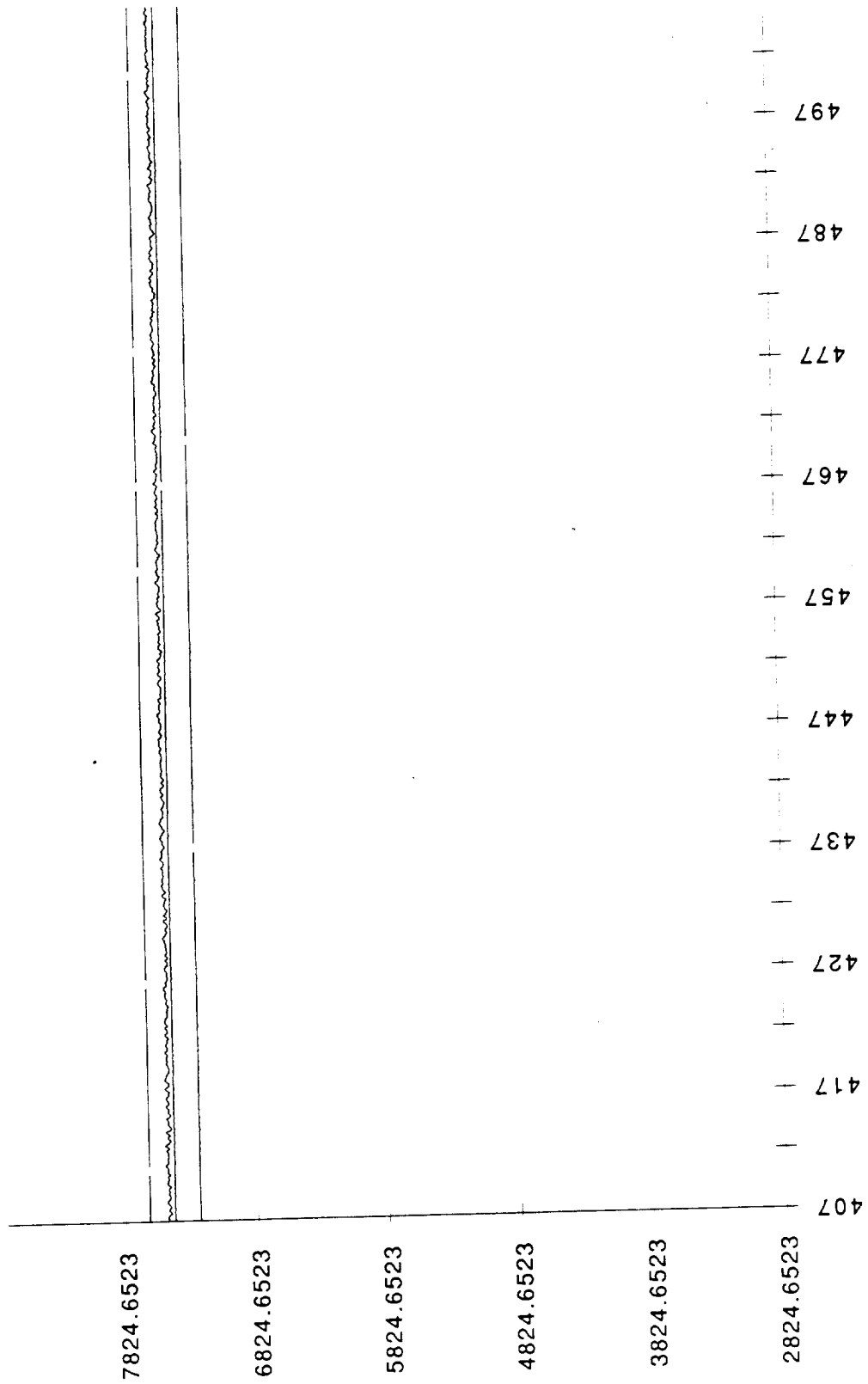

904-244 HPOP PBP dis pr.T

904-244 HPOP PBP dis pr.T

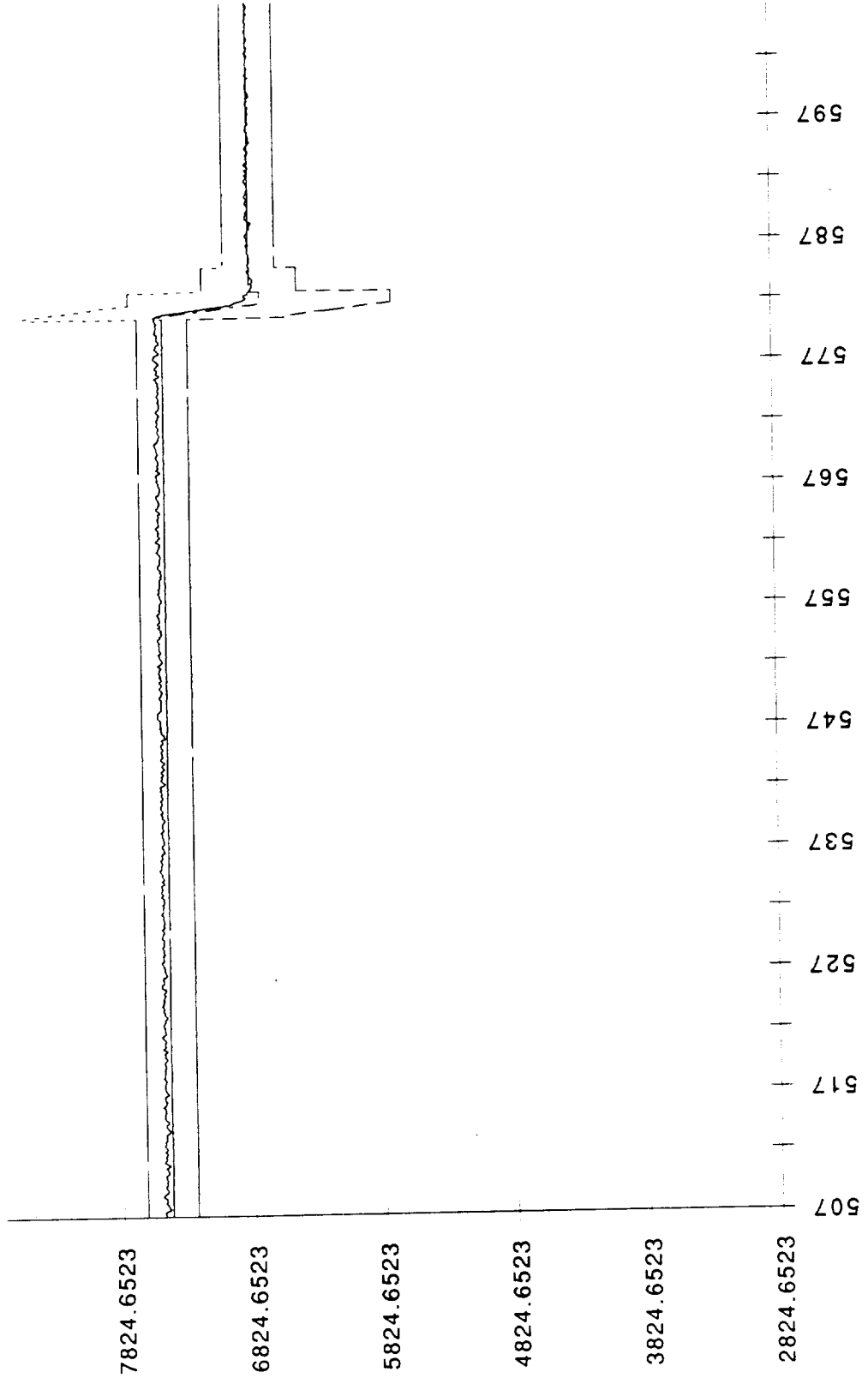

904-244 HPOP PBP dis pr.T

904-244 HPOP PBP dis pr .T

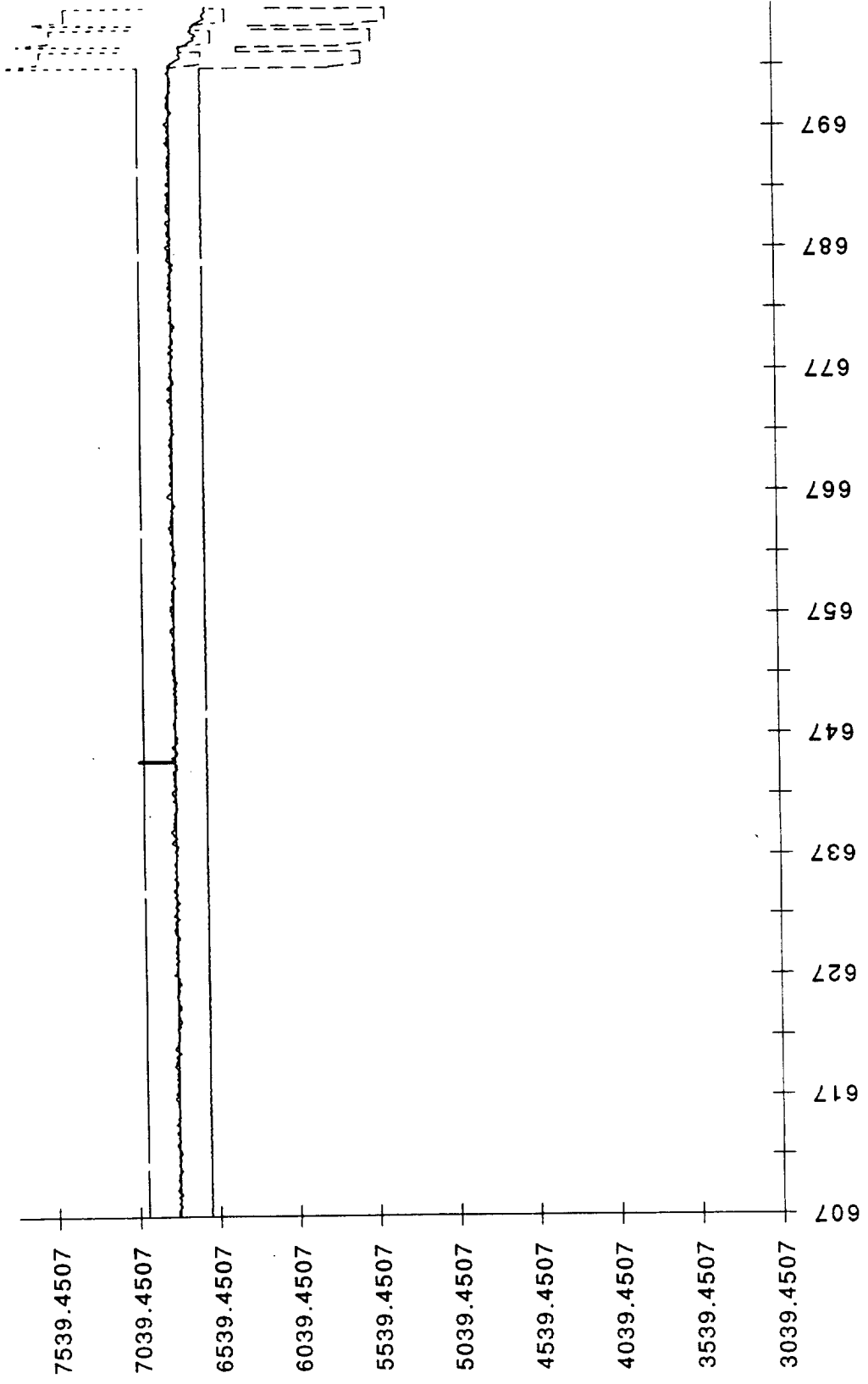

904-244 HPOP PBP dis pr .T

904-244 HPOP PBP dis pr .T

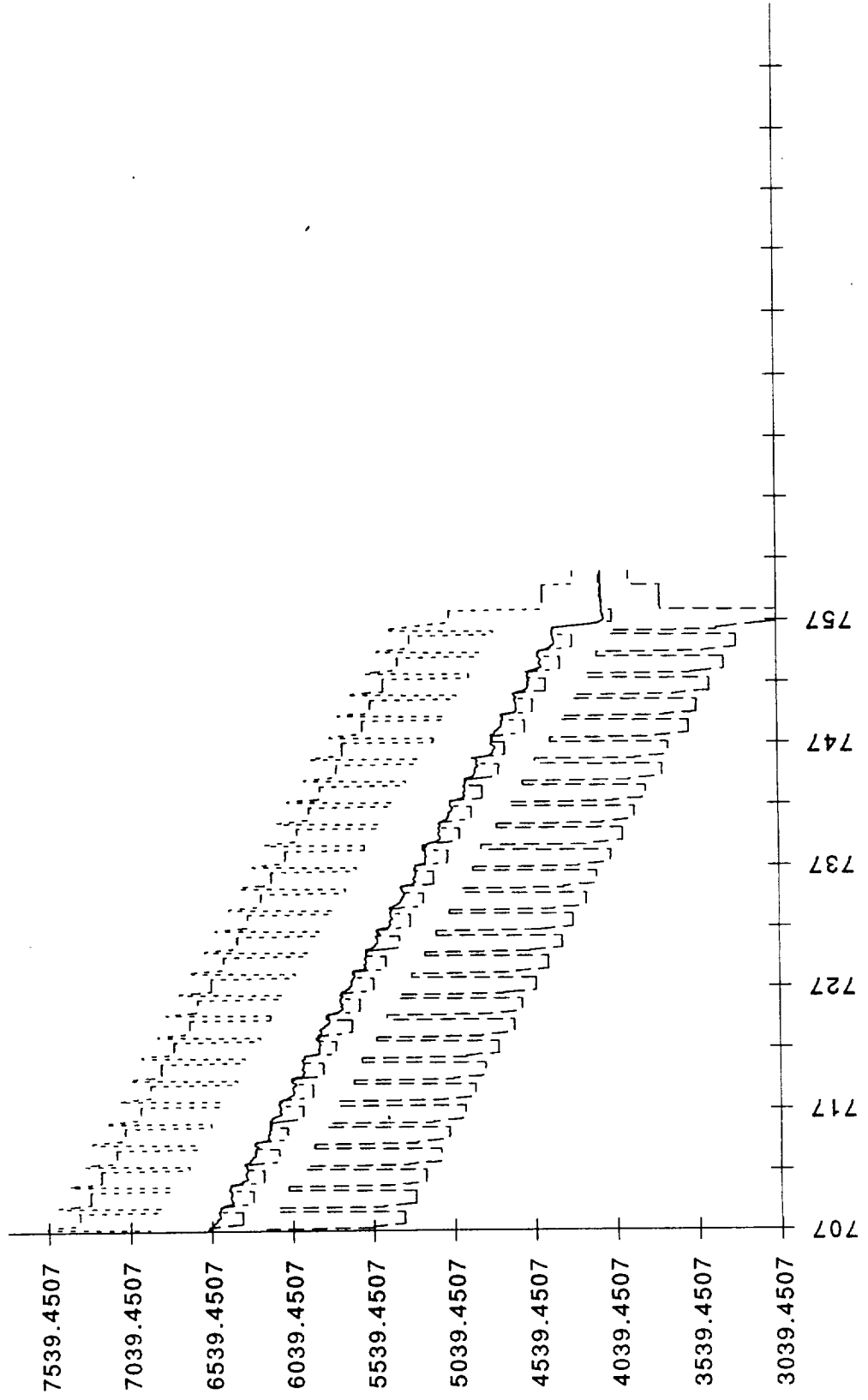

904-244 HPOP PBP dis pr .T

904-246 HPFP TDT B.T

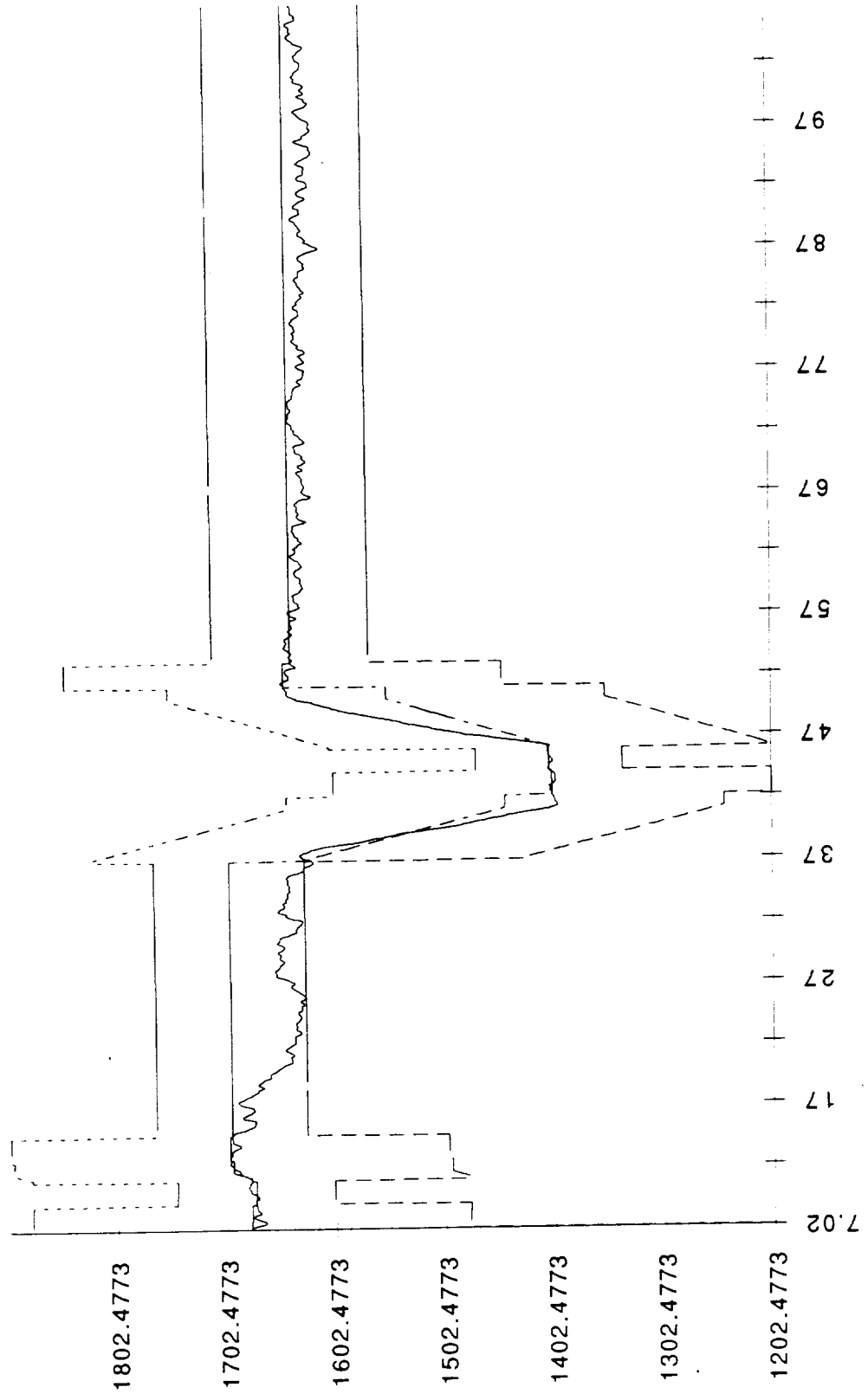

904-246 HPFP TDT B.T

904-246 HPFP TDT B.T

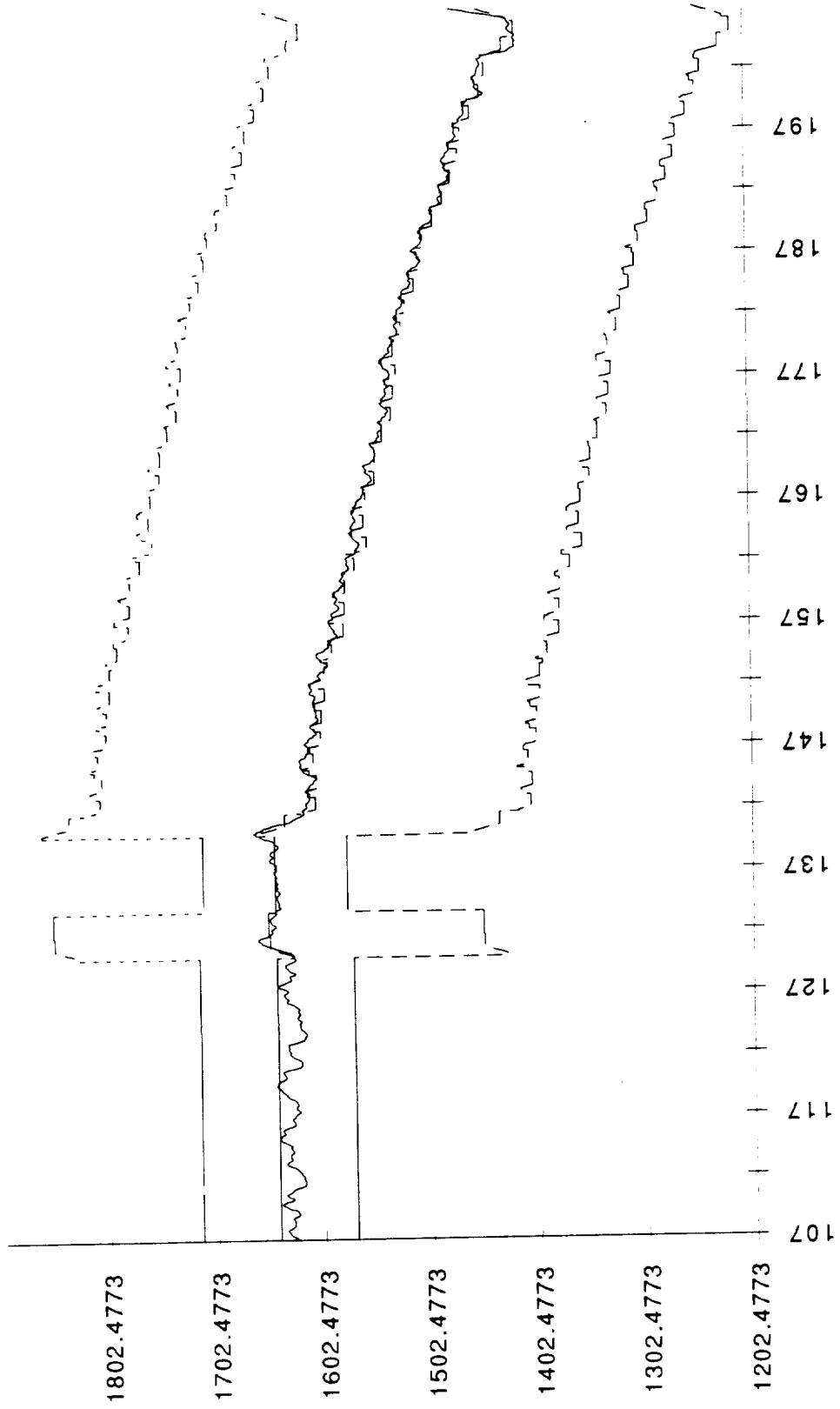

904-246 HPFP TDT B.T

904-246 HPFP TDT B.T

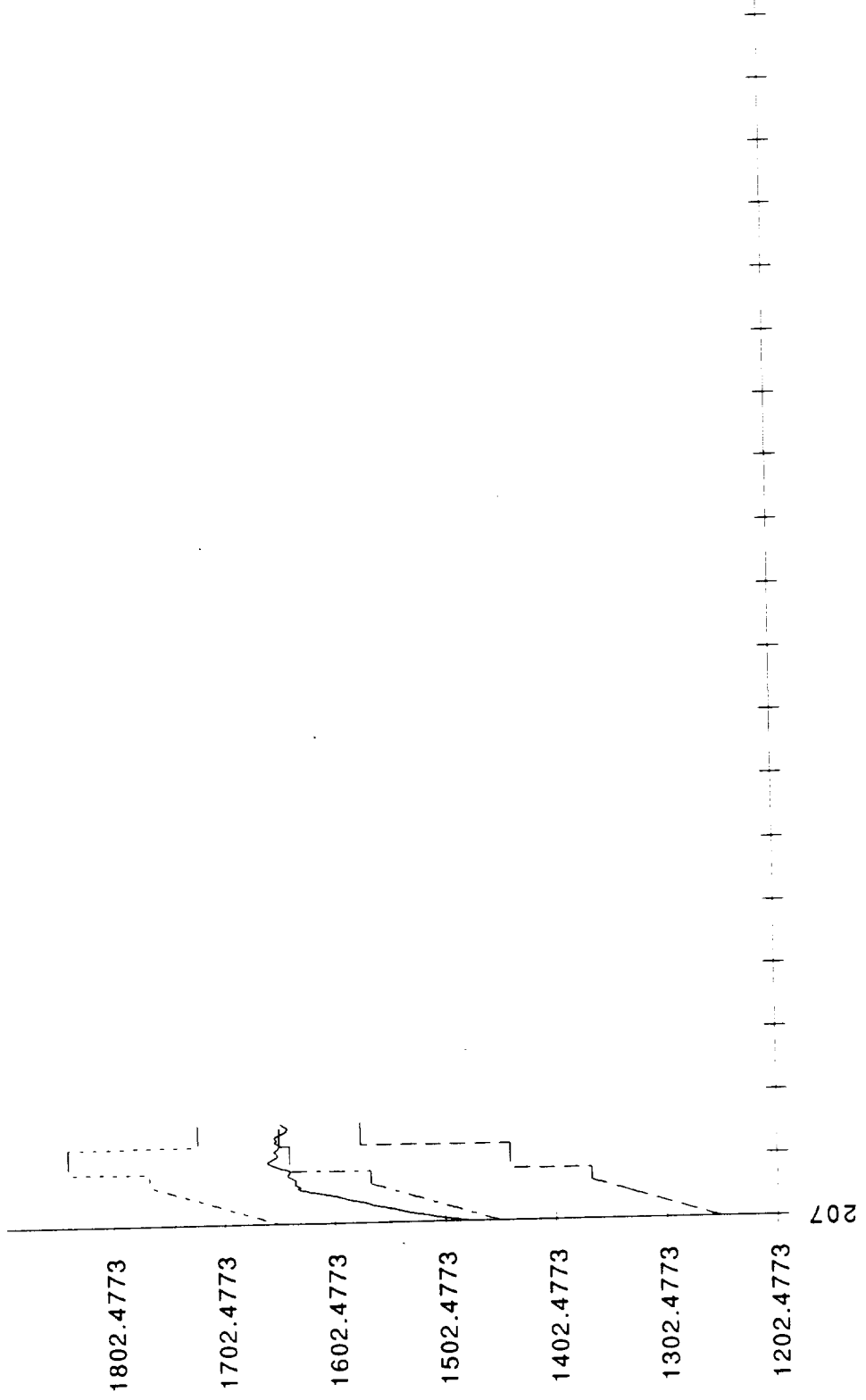

904-246 HPFP TDT B.T