



U.S. Department  
of Transportation  
National Highway  
Traffic Safety  
Administration



---

DOT HS 809 171

September 2000

# **Intersection Collision Avoidance Using ITS Countermeasures**

**Final Report:  
Performance Guidelines**

# **INTERSECTION COLLISION AVOIDANCE USING ITS COUNTERMEASURES**

## **TASK 9: FINAL REPORT**

### **Intersection Collision Avoidance System Performance Guidelines**

Contract No. DTNH22-93-C-07024  
Veridian Engineering Report No. 8149-12  
Veridian Engineering Project No. Y052  
NHTSA Rev 1: September 29, 2000

*Prepared by:*

J. Pierowicz  
E. Jocoy  
M. Lloyd  
A. Bittner  
B. Pirson

Veridian Engineering  
Buffalo, NY 14225

Battelle Human Factors Transportation  
Seattle, WA 98105

*Prepared for:*

U.S. Department of Transportation  
National Highway Traffic Safety Administration  
Office of Advanced Safety Research

Washington, DC 20590

## TABLE OF CONTENTS

<u>Section</u>	<u>Page</u>
1.0 INTRODUCTION .....	1-1
2.0 APPROACH .....	2-1
3.0 THE INTERSECTION COLLISION PROBLEM .....	3-1
3.1 Introduction .....	3-1
3.2 Description of Crash Scenarios .....	3-1
3.2.1 Intersection Crash Scenario No. 1 .....	3-6
3.2.2 Intersection Crash Scenario No. 2 .....	3-8
3.2.3 Intersection Crash Scenario No. 3 .....	3-9
3.2.4 Intersection Crash Scenario No. 4 .....	3-10
4.0 INTERSECTION COLLISION AVOIDANCE SYSTEM (ICAS) TESTBED DESIGN ....	4-1
4.1 Threat Detection System .....	4-4
4.2 GIS/GPS System .....	4-5
4.3 Driver Vehicle Interface .....	4-7
4.4 Vehicle Systems .....	4-7
4.5 ICAS Collision Target Population .....	4-8
4.5.1 Non-Inclusive Intersection Scenarios .....	4-8
4.6 ICAS Algorithm .....	4-10
5.0 ICAS SYSTEM SPECIFICATIONS .....	5-1
5.1 Threat Detection System .....	5-3
5.1.1 Design Overview .....	5-3
5.1.2 Operation Overview .....	5-5
5.1.3 Radar Sensor .....	5-7
5.1.4 Antenna Scanning and Pointing Control .....	5-8
5.1.5 Tracker/Collision Avoidance System .....	5-10
5.1.6 Countermeasure Warning Algorithms .....	5-12
5.1.7 System Evaluations .....	5-16
5.1.7.1 Methods and Performance Measures .....	5-16
5.1.7.2 VERF Tests .....	5-17
5.1.7.3 On-Road Tests .....	5-18
5.1.7.3.1 Intersection of Harris Hill and Wehrle .....	5-19
5.1.7.3.2 Intersection of Stony Road and Genesee Street .....	5-23
5.1.8 Limited Coverage vs. Full Coverage System .....	5-29
5.1.9 Line of Sight Issues .....	5-31
5.1.10 Warning Statistics .....	5-34
5.1.11 Summary, Threat Detection System .....	5-35
5.2 GIS/GPS System .....	5-37
5.2.1 System Design .....	5-37
5.2.1.1 GPS .....	5-38

5.2.1.2	Map Database .....	5-39
5.2.1.3	Computer .....	5-40
5.2.2	Testing .....	5-42
5.2.2.1	DGPS Accuracy .....	5-42
5.2.2.2	Map Database Accuracy .....	5-44
5.2.2.3	Vehicle Speed Measurement .....	5-44
5.2.3	Performance Guidelines .....	5-46
5.3	Driver/Vehicle Interface Performance .....	5-48
5.3.1	Background .....	5-48
5.3.1.1	General ICAS DVI Performance Guidelines .....	5-50
5.3.2	Warning Content .....	5-50
5.3.2.1	Warning Content Guidelines .....	5-50
5.3.2.2	Mode Information Guidelines .....	5-51
5.3.3	Warning Modality .....	5-51
5.3.4	DVI Design Recommendations .....	5-53
5.3.5	ICAS DVI Design Goals .....	5-53
5.3.5.1	Auditory Warning Signal Characteristics .....	5-53
5.3.5.2	Visual Warning Signal Characteristics .....	5-53
5.3.5.3	Haptic Warning Signal Characteristics .....	5-54
5.3.6	Stop Requirement Warnings .....	5-54
5.3.6.1	Timing Stop Requirement Warnings .....	5-54
5.3.6.1.1	Guidelines for Timing Stop Requirement Advisory/Warning .....	5-56
5.3.6.2	Stop Requirement HUD and Tone Warning Evaluation .....	5-56
5.3.6.2.1	Driver Eye Glance Behavior .....	5-60
5.3.6.2.2	Lessons Learned Regarding the Presentation of HUD and Tone Stop Requirement Advisories .....	5-61
5.3.6.3	Stop Requirement Haptic and Tone Warning Evaluation .....	5-61
5.3.6.4	Lessons Learned Regarding the Presentation of Haptic and Tone Stop Requirement Advisories .....	5-70
5.3.7	Inadequate Gap .....	5-70
5.3.7.1	Timing Inadequate Gap Warnings .....	5-70
5.3.7.2	Timing Recommendations for ICAS Inadequate Gap Warnings .....	5-72
5.4	Vehicle Systems .....	5-75
5.4.1	Vehicle Radar Systems .....	5-76
5.4.2	Head-Up Display .....	5-77
5.4.3	Lap Top Computer .....	5-77
5.4.4	Signal Processing/Electrical Systems .....	5-78
5.4.5	Haptic Braking System .....	5-80
5.4.6	Vehicle System .....	5-82
5.5	Performance Guidelines .....	5-83
5.5.1	Threat Detection System .....	5-83
5.5.2	DGPS/GIS .....	5-86
5.5.3	Driver Vehicle Interface .....	5-87

5.5.4	Guidelines Summary .....	5-88
	References .....	5-89
6.0	ICAS SYSTEM ANALYSIS .....	6-1
6.1	Validation of Threat Detection System .....	6-1
6.1.1	Warning On and Off times .....	6-1
6.1.2	Radar Range Errors .....	6-3
6.2	Countermeasure Benefits .....	6-5
6.2.1	System Effectiveness Calculation .....	6-5
6.3	Benefits of Nationally Deployed ICAS .....	6-10
6.3.1	Crashes Avoided .....	6-10
6.4	Technical Feasibility of ICAS Countermeasure .....	6-14
6.4.1	Threat Detection System Feasibility .....	6-14
6.4.2	Geographical Information System/Global Positioning System .....	6-15
6.4.3	Signal Processing Systems Feasibility .....	6-15
6.4.4	Driver-Vehicle Interface Feasibility .....	6-15
6.4.5	Vehicle Configuration Feasibility .....	6-16
6.4.6	Summary .....	6-17
6.5	Practicality and Cost of System Implementation .....	6-18
6.5.1	Practicality of ICAS System Implementation .....	6-18
6.5.2	Cost of ICAS .....	6-18
7.0	SUMMARY AND RECOMMENDATIONS .....	7-1
7.1	Program Summary .....	7-1
7.2	Recommendations .....	7-2

## APPENDICES

<u>Appendix</u>	<u>Page</u>	
A	SUMMARY OF INTERSECTION TESTS, GIS TEST AREA .....	A-1
B	WARNING STATISTICS .....	B-1

## LIST OF FIGURES

<u>Figure</u>		<u>Page</u>
1-1	Driver Advisory System Concept .....	1-2
1-2	Defensive System Concept .....	1-3
1-3	Communication System Concept .....	1-3
3-1	Intersection Collision Scenario No. 1 Left Turn Across Path .....	3-2
3-2	Intersection Crash Scenario No. 2 Perpendicular Paths - No Violation of Traffic Control .....	3-3
3-3	Intersection Crash Scenario No. 3 Perpendicular Paths - Violation of Traffic Control .....	3-4
3-4	Intersection Crash Scenario No. 4 Premature Intersection Entry .....	3-5
3-5	Intersection Dynamic Scenario No. 1 Left Turn Across Path .....	3-7
3-6	Intersection Dynamic Scenario No. 2 Perpendicular Path - No Violation of Traffic Control .....	3-8
3-7	Intersection Dynamic Scenario No. 3 Perpendicular Path - Violation of Traffic Control .....	3-9
3-8	Intersection Dynamic Scenario No. 4 Premature Intersection Entry .....	3-10
4-1	Intersection Collision Avoidance System (ICAS) System Architecture .....	4-2
4-2	The ICAS Testbed .....	4-3
4-3	Illustration of ICAS Equipment .....	4-3
4-4	Drivers Compartment - ICAS Testbed .....	4-4
4-5	Radar Scan Platform Detail .....	4-5
4-6	Illustration of ap Metric .....	4-6
4-7	Illustration of Stop Sign Warning .....	4-7
4-8	Defensive Scenario No. 1 .....	4-9
4-9	Defensive Scenario No. 3 .....	4-10
4-10	Interchange of Data in ICAS Components .....	4-11
4-11	ICAS Algorithm .....	4-12
4-12	Algorithm Implementation - Left Turn Across Path .....	4-16
4-13	Crash Scenario No. 2 - Perpendicular Path - No Violation of Traffic Control .....	4-17
4-14	Crash Scenario No. 3 - Perpendicular Path - Violation of Traffic Control .....	4-20
4-15	Crash Scenario No. 4 - Premature Entry - Violation of Traffic Control .....	4-21
5-1	Scenario 1, 2, and 3 Showing Distances Used to Compute Predicted Times and Warnings .....	5-2
5-2	ICA Threat Detection System Showing Detailed Use of Intersection Information .....	5-4
5-3	Operation Overview - Two Types of Intersections Showing Angular Coverage of Principal Threat Sectors .....	5-6

5-4	Calspan Instrumented Vehicle (CIV) .....	5-7
5-5	Typical Scan Pattern, Left Radar Antenna .....	5-9
5-6	Collision Avoidance System Block Diagram Showing Tracker Logic .....	5-10
5-7	Sketches of Intersections and Traffic Situations Observed by Radars .....	5-14
5-8	Sketch of Intersection Showing Special Logic Boundaries .....	5-16
5-9	Veridian Test Track Facility .....	5-17
5-10	Map of Test Area Digitized Into GIS Database .....	5-19
5-11	Position of C.V. with Time and Video Snapshot of Targets at the Intersection of Harris Hill and Wehrle Drive, Buffalo, NY .....	5-20
5-12	Selected Radar Derived Data for Harris Hill and Wehrle Drive Intersection, Buffalo, NY .....	5-22
5-13	Combined Warnings Left and Right Radars, Harris Hill and Wehrle Intersection .....	5-23
5-14	Position of ICA Vehicle and Video Snapshot of Targets at Intersection of Stony Road and Genesee Street .....	5-24
5-15	Radar Tracks, Warnings, and Warning Logic for Selected Interval at Intersection of Stony Road and Genesee Street .....	5-25
5-16	Line of Sight (LOS) Issue .....	5-31
5-17	Mask Angle and Antenna Pointing Angle .....	5-32
5-18	Driver Stopping Distance .....	5-33
5-19	Computer Controlled Braking Distance .....	5-33
5-20	GIS/GPS Block Diagram .....	5-38
5-21	Map Database Representation of Intersection .....	5-40
5-22	Vehicle Indicated Speed vs. Radar .....	5-45
5-23	Speed vs. Radar Range Rate with Acceleration and Deceleration .....	5-45
5-24	CPS Speed with Lead Filter vs. Radar Range Rate .....	5-46
5-25	Timeline of Control Inputs During Intersection Approach .....	5-55
5-26	Mean Ratings of Advisory Characteristics .....	5-58
5-27	Mean Ratings of Icon Meaningfulness .....	5-59
5-28	Mean Ratings of Advisory Benefits .....	5-59
5-29	Acceleration Profile for Haptic Brake Pulses (100ms duration-50ms separation) at 250 psi .....	5-63
5-30	Acceleration Profile for Haptic Brake Pulses (50ms duration-200ms separation) at 400psi .....	5-63
5-31	Mean Magnitude Ratings of Haptic and Tone Warnings by PSI Condition .....	5-65
5-32	Mean Duration Ratings of Haptic and Tone Warnings by PSI Condition .....	5-65
5-33	Mean Haptic Magnitude Ratings Across Force (PSI) and Pulse Conditions .....	5-66
5-34	Mean Haptic Duration Ratings Across Force (PSI) and Pulse Conditions .....	5-67
5-35	Mean Tone Magnitude Ratings Across Force (PSI) and Pulse Conditions .....	5-68
5-36	Mean Tone Magnitude Ratings Across Force (PSI) and Pulse Conditions .....	5-69
5-37	Scenario 1: Left-Turn Across Path .....	5-72
5-38	Scenario 2: Perpendicular Path - No Traffic Control Violation .....	5-73
5-39	ICAS Testbed Vehicle .....	5-75
5-40	Illustration of Radar Mounting .....	5-76
5-41	HUD System Mounting .....	5-77
5-42	Laptop Computer Mounting .....	5-78



5-43	Equipment Configuration - ICAS Vehicle .....	5-79
5-44	ICAS Electrical Station .....	5-79
5-45	Haptic System Features .....	5-80
5-46	Haptic Braking Caliper Mount .....	5-81
5-47	Haptic Braking Configuration .....	5-81
5-48	Haptic Braking Hydraulic System .....	5-82
6-1	Radar Range Measurements, Warning Activation Errors .....	6-2
6-2	Example of Radar Range Errors for Single Target, Three Runs on Veridian Test Track	6-4

## LIST OF TABLES

<u>Table</u>	<u>Page</u>
3-1	Distribution of Intersection Crash Scenarios ..... 3-6
4-1	Intersection Crash Scenarios Addressed by Modified ICAS ..... 4-8
5-1	Comparison of Expected Performance of Threat Detection Systems for Different Scenarios ..... 5-30
5-2	Summary of False and Missed Warnings ..... 5-35
5-3	GIS/GPS Components ..... 5-38
5-4	Message Format From Central Processing Unit to GIS/GPS System ..... 5-41
5-5	Message Format From GIS/GPS System to Central Processing Unit ..... 5-41
5-6	DGPS Test Results ..... 5-43
5-7	DGPS Test Results ..... 5-43
5-8	Summary of Intersection Crash Causal Factors Analysis ..... 5-49
5-9	Potential Driver Alert/Warning Categories and Functions ..... 5-50
5-10	Modality Characteristic Evaluation Summary ..... 5-52
5-11	Haptic Brake Pulse Parameters Conducted under 250psi and 400psi Conditions ..... 5-62
5-12	Critical Gap by Maneuver Type at Unsignalized Intersections (13) ..... 5-71
5-13	Critical Gap (Median Disposable Gap) by Maneuver Type at Unsignalized Intersections ( <del>61-71</del> )
5-14	Trigger Values for Scenario 1 ..... 5-73
5-15	Trigger Values for Scenario 2 ..... 5-74
5-16	Performance Guidelines Threat Detection System ..... 5-84
5-17	Performance Guidelines - DGPS/GIS System ..... 5-86
5-18	Performance Guidelines Driver Vehicle Interface ..... 5-88
6-1	Activation and Deactivation Measurements ..... 6-3
6-2	Intersection Population by Traffic Control Device ..... 6-6
6-3	Countermeasure System Assignment ..... 6-6
6-4	System Distribution of Intersection Problem ..... 6-7
6-5	ICAS Effectiveness ..... 6-9
6-6	Intersection Crash Population Distribution ..... 6-10
6-7	Severity Distribution of Intersection Crashes ..... 6-11
6-8	Scenario Severity Distribution - Phased Signals ..... 6-11
6-9	Scenario Severity Distribution - Stop Signs ..... 6-12
6-10	Intersection Crash Population Without Countermeasure ..... 6-12
6-11	Intersection Crash Population With Countermeasure ..... 6-13
6-12	Reductions in Intersection Crashes by Severity ..... 6-13
6-13	ICAS System Feasibility ..... 6-17
6-14	ICAS Testbed Cost ..... 6-19
A-1	Intersection Tests, GIS Test Area ..... A-1
B-1	Warning Statistics ..... B-2

## FORWARD

This report documents analyses performed in support of the Intersection Collision Avoidance Using ITS Countermeasures program under NHTSA Contract No. DTNH22-93-C-07024. This work was performed by the Intelligent Transportation Group of Veridian Engineering and the Battelle Memorial Institute during the time frame of March 1, 1998 to August 1, 1999. A list of contributing authors is provided.

The analyses provided in this report utilizes the foundation of knowledge established during Phase I of this program. Phase I illustrated that collisions that occur within the boundaries of intersections are the second most frequently occurring type of crash, (i.e., second only to single vehicle roadway departure crashes). The statistical and clinical analyses performed in Task 1 indicated that while crashes occurred at intersections with varying configurations, the causes and major characteristics of these crashes demonstrated similar features. The results from Task 1 were utilized to develop preliminary functional goals for an intersection collision avoidance countermeasure. Task 3 of this program utilized the functional goals and the crash data from the preceding tasks to derive three countermeasure concepts.

Phase II of this program investigated the technology and research available to construct the countermeasures described in Phase I. Based on the functional descriptions of the countermeasure concept developed during Phase I, Task 4 of Phase II investigated the technologies that could be applied to fulfill the goals of the system. Technology requirements were assessed in key areas, such processors, sensors, actuators, and driver-vehicle interface (DVI) characteristics, to determine the equipment that will facilitate construction of a prototype intersection collision avoidance system.

In Task 5 of the program design studies were performed to enable system definition and component specification for the Testbed system. These studies resulted in the definition of a design for the intersection countermeasure testbed. The design that resulted from the Task 5 effort was subsequently modified due to concerns expressed by NHTSA personnel. The testbed was modified to delete systems that would require the installation of equipment in the infrastructure. The resulting countermeasure, while not having the effectiveness against all potential intersection collision scenarios, is more likely to be fielded at an earlier point.

Phase III of the program was approved to proceed in March of 1997. Phase III developed the Testbed systems, implemented the systems on a vehicle, and performed testing to determine the potential effectiveness of this system in preventing intersection crashes. Those results are contained in this report.

## 1.0 INTRODUCTION

Roadway intersections are areas of potential conflict that increase risk exposure for vehicles attempting to pass through these locations. The varying nature of intersection geometries and the number of vehicles approaching and negotiating through these sites result in a broad range of crash configurations. Preliminary estimates by the National Highway Traffic Safety Administration (NHTSA) indicate that crossing path crashes occurring at intersections represent approximately 26 percent of all police reported crashes each year. This proportion translates into 1.7 million crashes. When non-police reported crashes of this type are also considered, the total number of crossing path crashes increases to approximately 3.7 million each year (Source: RFP No. DTNH22-93-R-07024).

Advances in sensor and data processing technology during the past decade have enabled the collection of large amounts of data from the vehicle environment. Sensor and communication technology permit the detection of vehicle locations and transmission of information between vehicles. An example of this type of technology is the cellular phone, where information from the vehicle (the phone call) is transmitted to a location, then transmitted over a net (phone lines). Technology, such as the Global Positioning System (GPS), allows the position of a vehicle to be determined with an ever-increasing degree of accuracy.

Other systems, such as the VORAD collision avoidance system, and the Mercedes-Benz Stability Enhancement System, illustrate the potential to detect collision situations, and to control the stability of the vehicle during a collision avoidance maneuver. Application of these and other state-of-the-art technologies is part of a program to revolutionize transportation safety. This program, broadly titled Intelligent Transportation Systems (ITS), seeks to integrate sensors and processing equipment into automobiles to increase their safety and utility.

The Intersection Collision Avoidance Using ITS Countermeasures program was developed to address the intersection crash problem and apply technology to prevent or reduce the severity of intersection crashes. The program consists of a sequence of nine related tasks to be completed in three distinct program phases. Phase I, which consisted of three tasks, enumerated the magnitude of the intersection crash problem and defined four distinct configurations, with associated characteristics, for each of these configurations. An output of Phase I was three countermeasure concepts. These countermeasure concepts each offered the potential for prevention of intersection crashes. These countermeasures were the Driver Advisory System, the Defensive System, and the Communication System. The Driver Advisory System, illustrated in Figure 1-1, was equipped with the sensor and vehicle control systems required to identify driver errors, and to act through direct vehicle control to prevent the crash. The Defensive System, illustrated in Figure 1-2, was similar to the Driver Advisory System, but lacked the vehicle control technology to affect vehicle state. This system relied on the driver reacting positively to the warning provided by the countermeasure. The third system, the Communication System, required that all vehicles on the road be equipped with a transponder system communicating with a intersection controller. This system concept is shown in Figure 1-3. Two of these concepts, the Driver Advisory system and the

Defensive systems were developed further in Phase II. The Communication System was dropped from consideration due to the long time frame required to equip all vehicles on the road with the system, along with the fact that no system benefits would be realized until the system attained one hundred percent penetration into the vehicle fleet. The remaining two concepts, and the database of intersection crashes, were built upon in Phase II to determine the technology available to implement and construct the described countermeasures. The efforts in Phase II culminated in the design of an ICA testbed vehicle. While conceptually identical to that system described at the conclusion of Task 3, detailed functionality of the countermeasure components changed.

Phase III of this program saw the construction and testing of the Intersection Testbed System. A re-design of the system was performed to simplify the design of the Threat Detection System. A partial solution to the Threat Detection System was developed that utilized three discrete radar systems to perform the function of the previous design. This approach allowed the program to proceed while dedicating funding to testing of the complete system. An Intersection Collision Avoidance Testbed was constructed that allowed the various system components to be evaluated and tested. Extensive testing of the Threat Detection System, as well as the Geographical Information System (GIS)/Differential Global Position System (DGPS) system was performed to determine system operating characteristics. The results from testing of system components, as well as complete system is documented in this report.

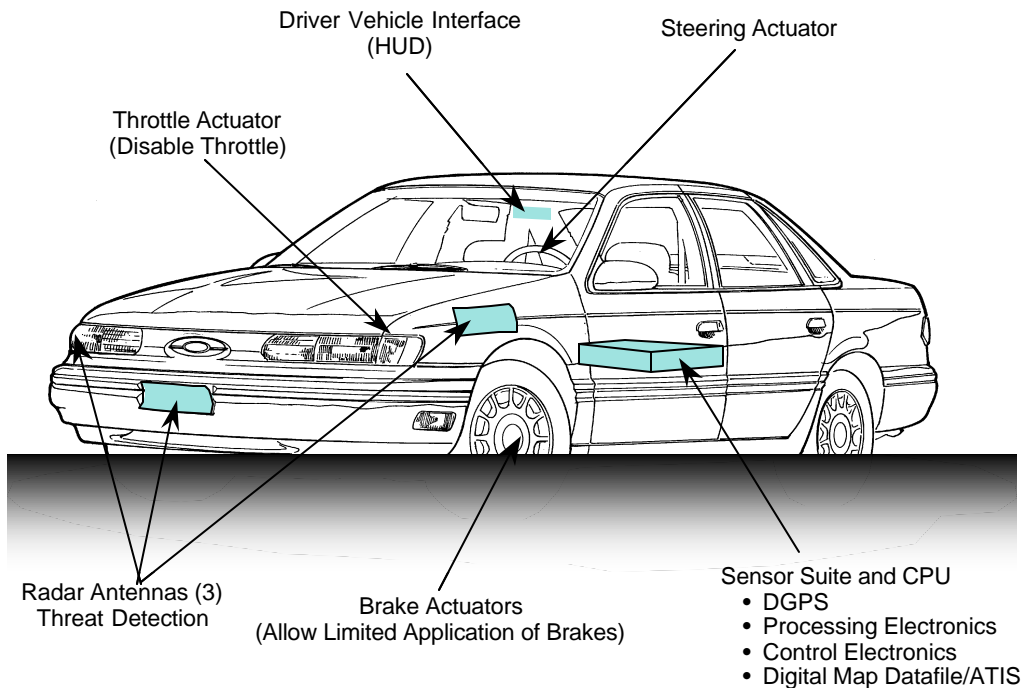
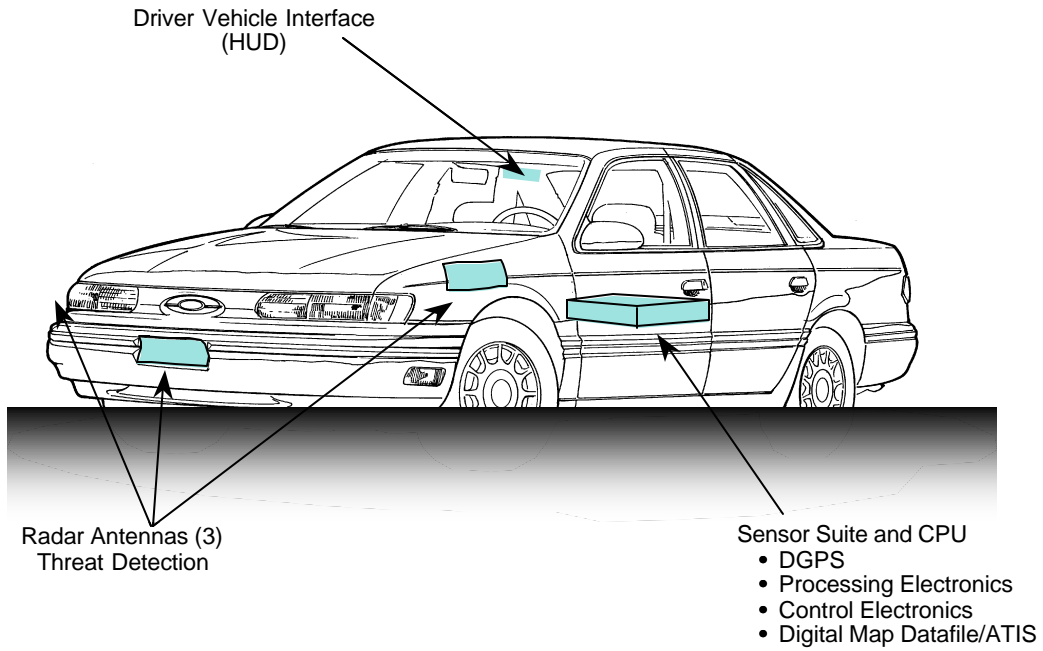
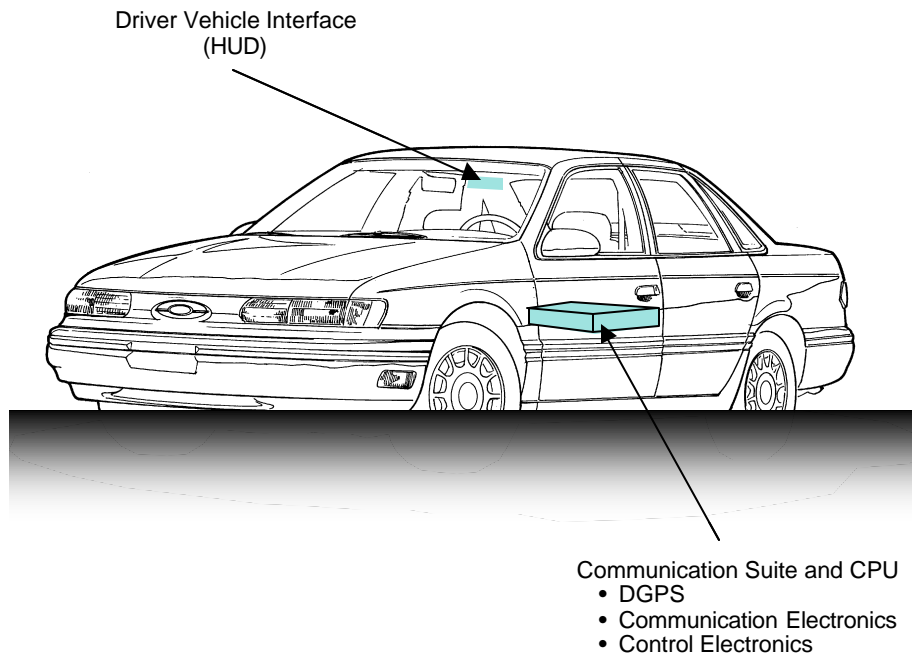


Figure 1-1: Driver Advisory System Concept



**Figure 1-2: Defense System Concept**



**Figure 1-3: Communication System Concept**

## **Section 2.0 APPROACH**

In this section the methodology and sub-tasks included in Task 9 report is described. This section will describe the lay-out of this report.

## **Section 3.0 THE INTERSECTION COLLISION PROBLEM**

This section reviews the intersection collision scenarios for which a countermeasure was developed to prevent. The scenarios were a result of the clinical analysis of NASS CDS data that was accomplished in Task 1 of this program. Four scenarios were identified. Each of the scenarios are described, with the causal factor distribution for each scenario provided. This discussion provides a basis on which to evaluate the Testbed design.

## **Section 4.0 INTERSECTION COUNTERMEASURE DESCRIPTION**

This section reviews the design for the Intersection Collision Avoidance Countermeasure (ICAS). The final countermeasure designed was a development of the system described in the Task 5 report. Changes to the system design were a result of Critical Design Review, held in conjunction with representatives of NHTSA, and engineering development. The result of this was a intersection countermeasure that was not able to deal with all the scenarios described in section 2. This section describes the population of intersection crashes the resulting system was designed to prevent.

## **Section 5.0 ICAS SYSTEM SPECIFICATIONS**

This section provides a detailed description of the countermeasure systems, testing results, and specifications of the Intersection Collision Avoidance System (ICAS). In particular, this section described the engineering development of the three major components of the countermeasure; the Geographical Information System / Global Positioning System (GIS/GPS), Threat Detection System, and the Driver Vehicle Interface. Results from testing of these component systems, as well as the integrated system are provided. Problems and lessons learned during this program are described.

## **Section 6.0 SYSTEM ANALYSIS**

This section addresses countermeasure deployment issues described in the Statement of Work for this program. Examples of these issues include:

- Determine countermeasure benefits
- Technical feasibility of tested system
- Practicality and cost of system implemented

## **Section 7.0 SUMMARY AND CONCLUSIONS**

This section summarizes the work conducted within Phase III of the ICA program, and the resulting countermeasure system developed in this program.



## **3.0 THE INTERSECTION COLLISION PROBLEM**

### **3.1 Introduction**

As an introduction to the work performed during this program, the intersection collision scenarios that occur in routine driving will be reviewed. This work was presented in the Task 2 report of Phase I of this program.

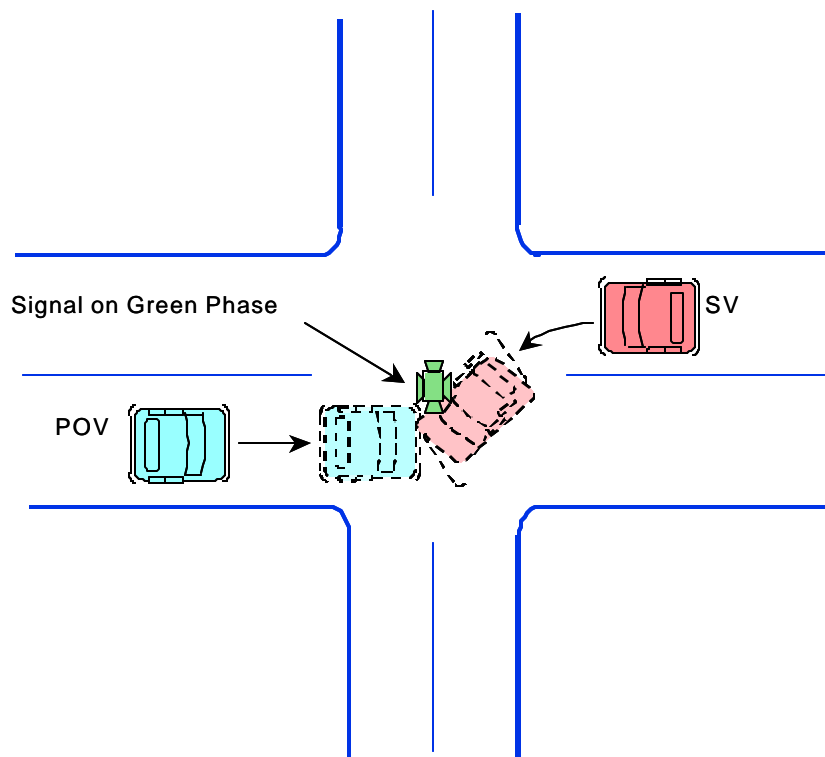
### **3.2 Description of Crash Scenarios**

The crash scenarios presented in this section are extensions of the intersection crash scenarios presented in Section 4.0 of the Task 2 report. The scenarios that were presented in Task 1 were generic scenarios that were applicable to all potential crash configurations within specific geometric alignments. These generic scenarios lead to definition of vehicle dynamic scenarios for each vehicle involved in the crash. The final evolution of the vehicle dynamic crash scenarios was detailed In the Task 2 report. These scenarios utilize vehicle state and maneuver information, as well as clinical analysis results, regarding each involved vehicle. These scenarios promote the listing of countermeasure functional goals. The functional goal assessment for each case leads to compression of crash types into three primary and one secondary crash scenario. Each of these scenarios is detailed below:

*Intersection Crash Scenario No. 1*

Subject Vehicle (SV) not required to stop, no violation of traffic control, SV slowing or stopped in traffic lane.

The SV is required to yield, but not stop for the traffic control and, therefore, no violation of the control device occurs. A large proportion of these cases consist of the SV approaching a traffic signal with a displayed green phase. All other cases in this scenario are cases where the SV is uncontrolled. That is, no traffic control device is present on the roadway segment being traveled by the SV. The SV attempts a left turn across the path of the POV. The SV is either slowing, or at a stop in the traffic lane. This crash scenario is illustrated in Figure 3-1.

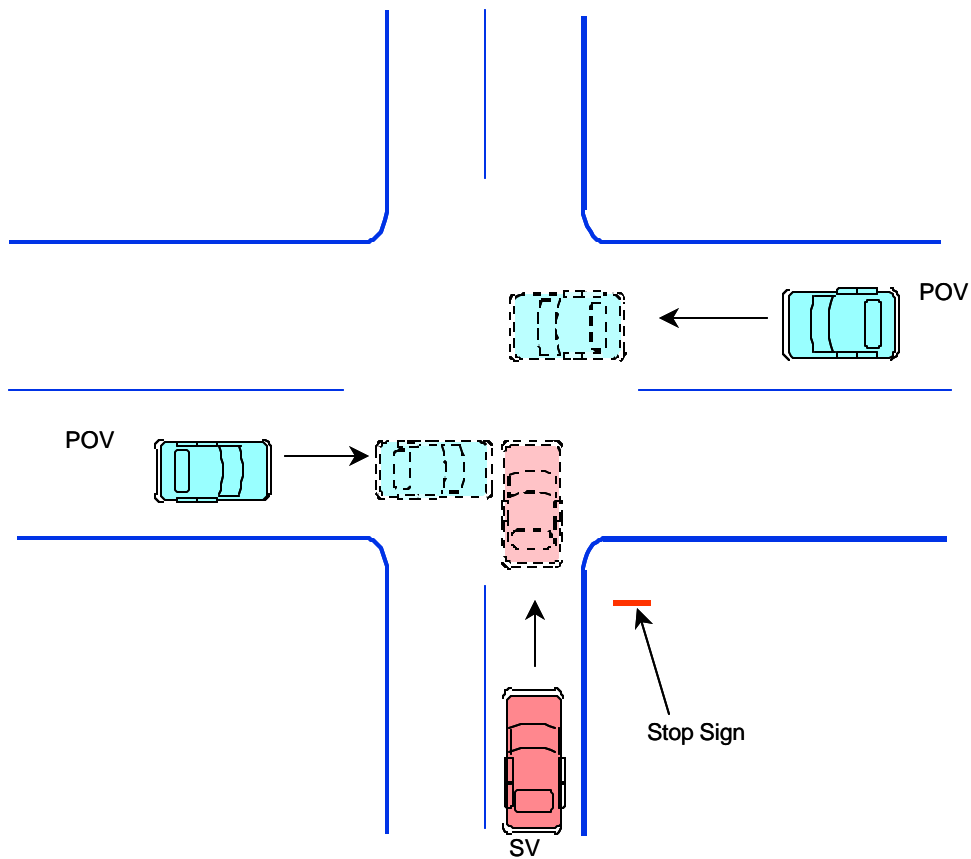


**Figure 3-1**  
**Intersection Collision Scenario No. 1**  
**Left Turn Across Path**

*Intersection Crash Scenario No. 2*

SV required to stop, no violation of traffic control, SV stops and then proceeds into intersection.

The SV is stopped, as required, prior to entering the intersection. Almost all the cases in this category are intersections controlled by stop signs along the roadway being traveled by the SV. No traffic control is present on the roadway being traveled by the POV. The SV attempts to traverse the intersection, or attempts to perform a left turn onto the roadway being traveled by the POV. This intersection crash scenario is illustrated in Figure 3-2.

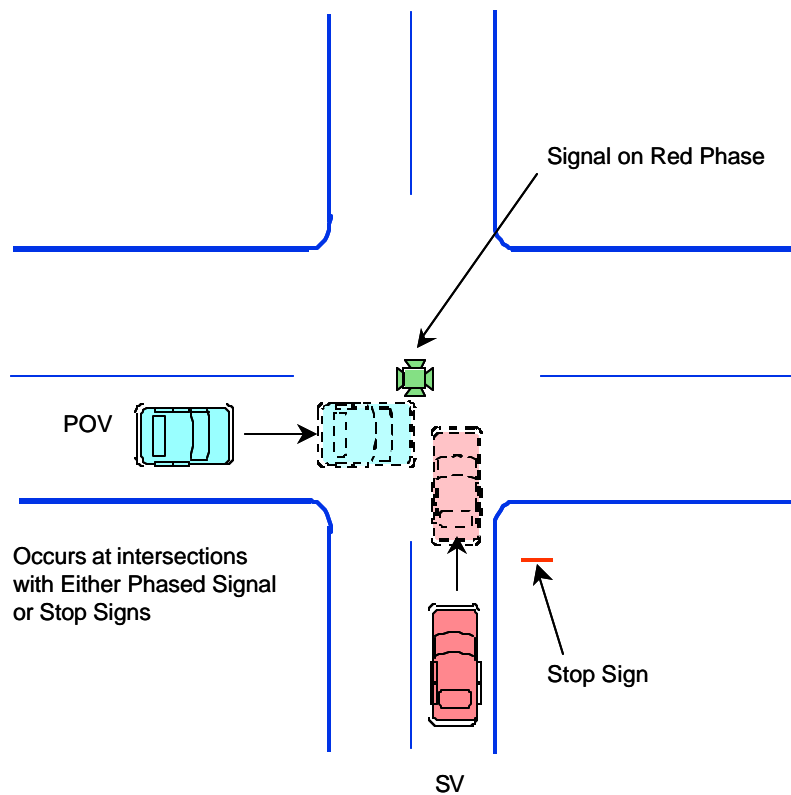


**Figure 3-2**  
**Intersection Crash Scenario No. 2**  
**Perpendicular Paths - No Violation of Traffic Control**

### Intersection Crash Scenario No. 3

The SV is required to stop, a violation of the traffic control occurs, with the SV proceeding into intersection without stopping.

The SV does not stop prior to entering intersection. All of these cases involve violations of the traffic control device. The POV has the right of way and enters the intersection. In a very high proportion of these crashes, the vehicles are performing an intersection traversal on straight paths. This intersection crash scenario is illustrated in Figure 3-3.

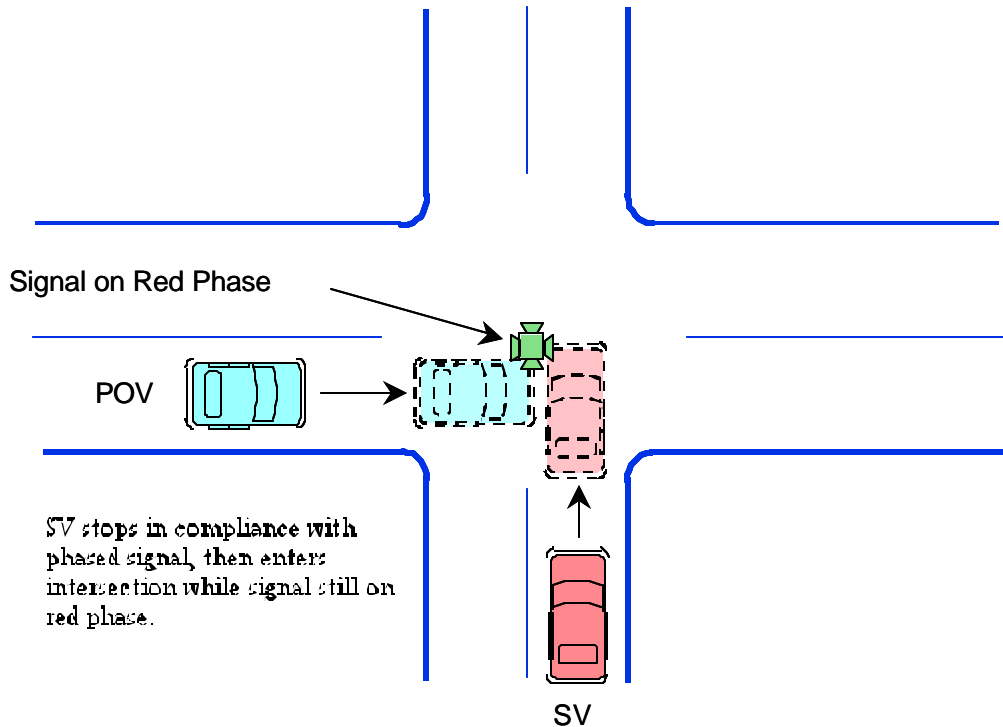


**Figure 3-3**  
**Intersection Crash Scenario No. 3**  
**Perpendicular Paths - Violation of Traffic Control**

### Intersection Crash Scenario No. 4

SV required to stop, violation of traffic control, SV stops, then proceeds into intersection.

This is a distinct, although less frequently observed crash scenario than the first three described above. This scenario occurs when the subject vehicle approaches an intersection controlled by a signal with a displayed red phase. The SV stops, and then proceeds into the intersection prior to the signal phasing to green. This intersection crash scenario is illustrated in Figure 3-4.



**Figure 3-4**  
**Intersection Crash Scenario No. 4**  
**Premature Intersection Entry**

The above listed scenario groups present common factors that allow the crashes to be prevented by application of similar functional goal sets. It is interesting to note the distribution of the clinical sample into these four scenarios. This distribution is shown in Table 3-1. Prior to discussing the countermeasure developed for these scenarios, it is beneficial to review the dynamic situation associated with each of these scenarios. Note that these scenarios focus only the actions of the SV. This is intentional since it is the actions of this vehicle which initiate the crash sequence. The characteristics of each of the above scenarios are provided in the following subsections.

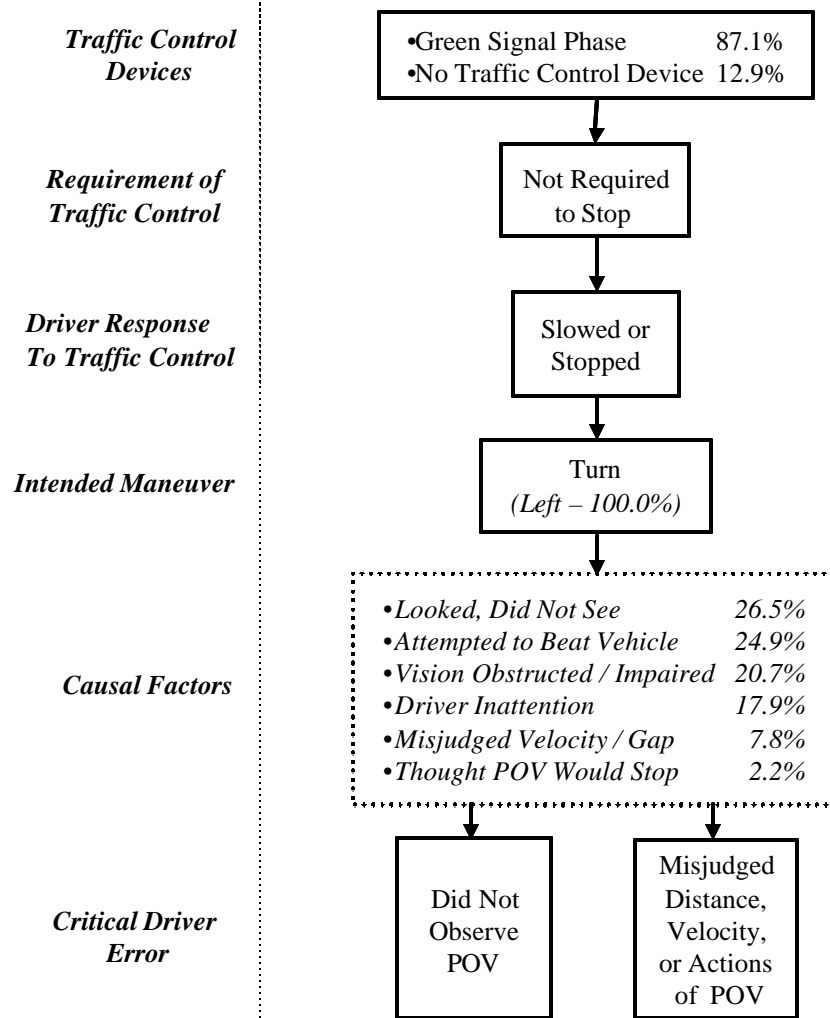
**Table 3-1**  
**Distribution of Intersection Crash Scenarios**

Crash Scenario	Percentage of Sample
No. 1 Left Turn Across Path	23.8
No. 2 Perpendicular Path - Entry with Inadequate gap	30.2
No. 3 Perpendicular Path - Violation of Traffic Control	43.9
No. 4 Premature Intersection Entry - Violation of Traffic Control - Signal	2.1
<b>Total</b>	<b>100.0</b>

### 3.2.1 Intersection Crash Scenario No. 1

Approximately one-quarter (23.8 percent) of the intersection conform to crash Scenario No. 1. This scenario is distinct from other scenarios due to the SV performing a left turn across the path of the POV. A large proportion (87.1 percent) of the cases corresponding to this scenario occur at intersections controlled by phased traffic signals. The remainder of these cases occur at intersections with no traffic controls. Refer to Figure 3-5 for a listing of crash characteristics pertinent to this scenario. In all the cases in this scenario, the SV is either slowing or stopped in the traffic lane while waiting to make a left turn. This scenario has a wide variety of factors that are attributed as causes for the crash. Specifically, four causal factors are associated with over 90 percent of the crashes. The rank order and associated percentages are: Faulty Perception-Looked, Did Not See (26.5 percent), Attempted to Beat Other Vehicle (24.9 percent), Vision Obstructed/Impaired (20.7 percent), and Driver Inattention (18.3 percent).

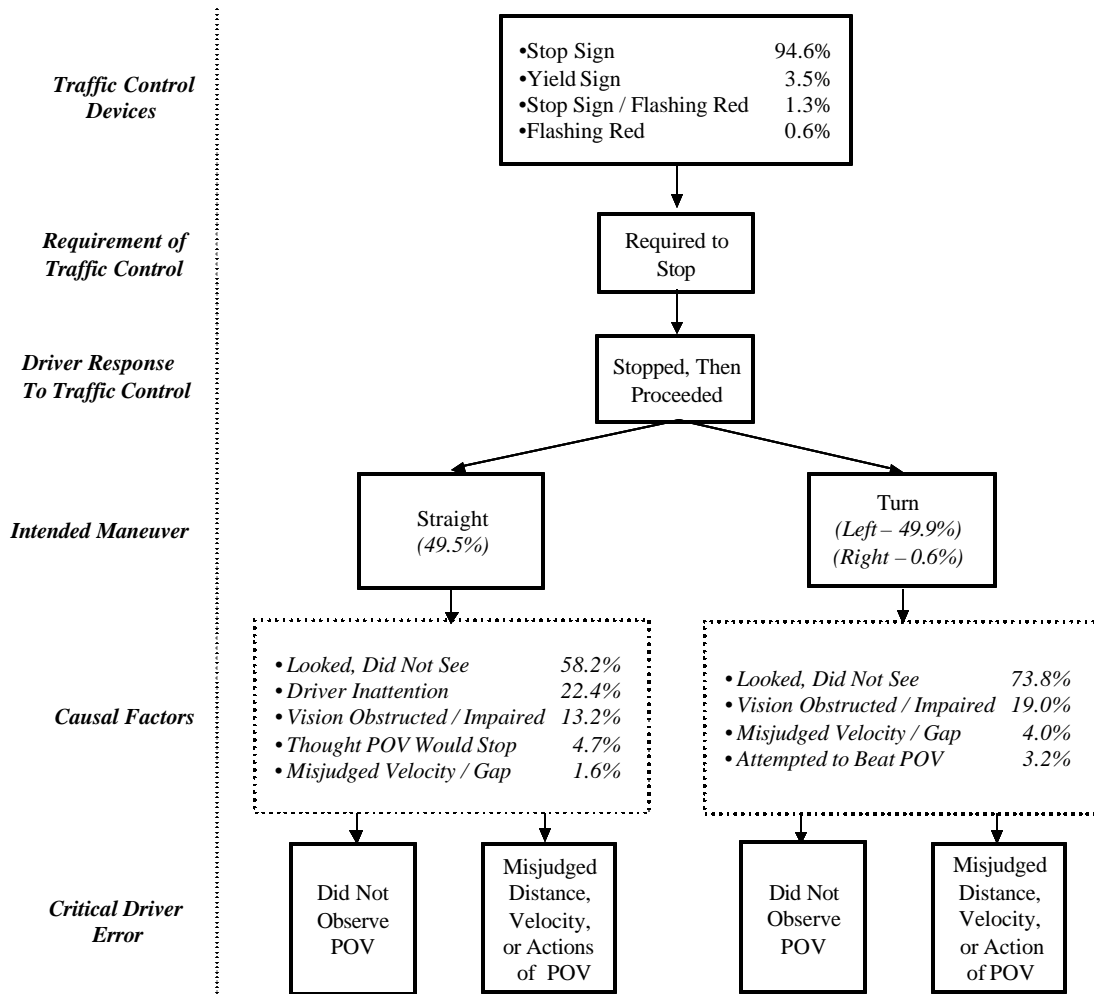
The common linking factor to these causal factors was the SV attempting to perform a left turn across a vehicle path with inadequate vehicle-to-vehicle gap (VTV gap). The countermeasure designed in this program was designed to alleviate this problem by providing the SV driver with a warning of an inadequate gap as they are about to proceed with the turn.



**Figure 3-5**  
**Intersection Dynamic Scenario No. 1**  
**Left Turn Across Path**

### 3.2.2 Intersection Crash Scenario No. 2

Intersection collisions conforming with crash Scenario No. 2 comprise 30.2 percent of the sample. Intersection crash Scenario No. 2 is distinguished by the motion of the SV. In this scenario, the SV stops in compliance with the traffic control device and then proceeds into the intersection. The collision occurs when the SV attempts to make a turn or proceed straight through the intersection. The distribution of characteristics associated with this scenario are illustrated in Figure 3-6. This scenario occurs most frequently at intersections controlled by stop signs. Approximately 95 percent of the cases in this scenario occur in this manner. The remaining cases occur at other types of signs, such as yield or stop signs/flashing lights.



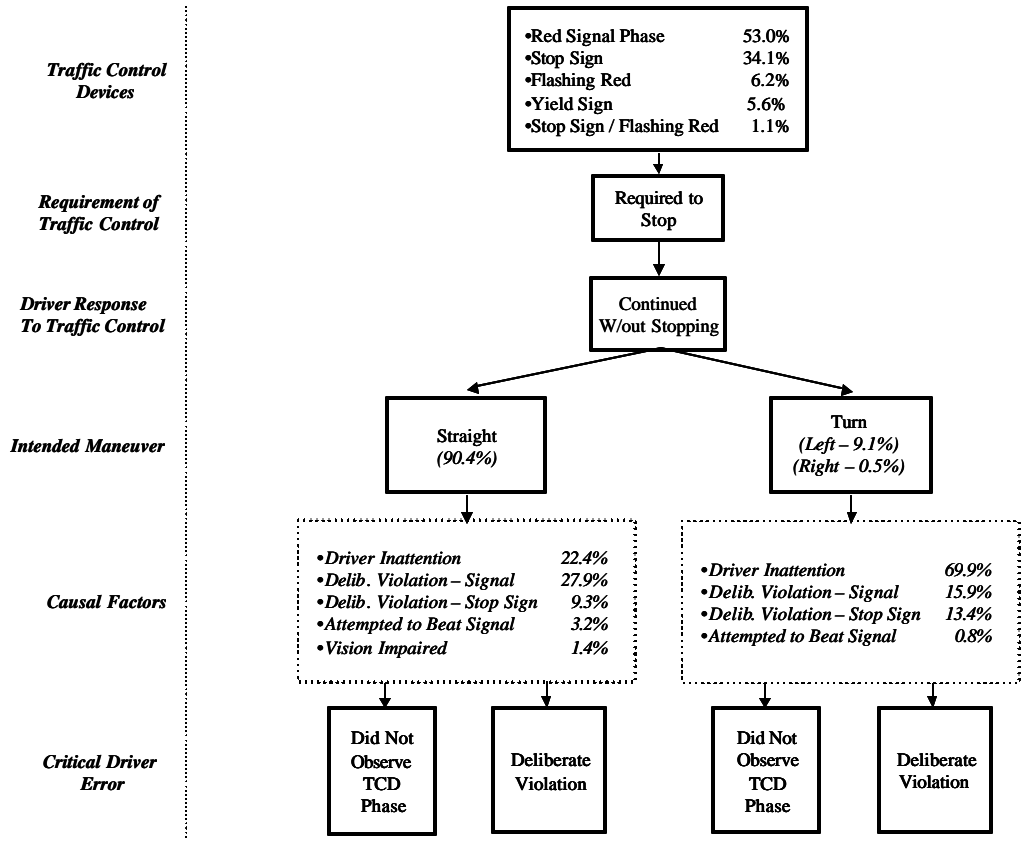
**Figure 3-6**  
**Intersection Dynamic Scenario No. 2**  
**Perpendicular Path - No Violation of Traffic Control**



As in Scenario No. 1 the driver proceeds into the intersection with an inadequate VTV gap. The geometry of the scenario is different due to the perpendicular path of the vehicles in this scenario, but the underlying factor is the same. The Countermeasure system must be able to scan the perpendicular lanes, and provide a warning of the approaching vehicles.

### **3.2.3 Intersection Crash Scenario No. 3**

These crashes are the largest proportion of intersection cases in the sample, comprising 43.9 percent of the sample. In this scenario, the SV is required to stop for a traffic control. The SV violates the traffic control and enters the intersection. The characteristics associated with this scenario are illustrated in Figure 3-7. As evident in the figure, these crashes occur most frequently at intersections controlled by signals, although one-third of the sample occurs at intersections controlled by stop signs. In a large proportion of the sample (90.4 percent), the SV is traversing the intersection on a straight path. This maneuver influences the velocity at which the vehicle approaches the intersection. When the SV is making a turn, the driver usually slows and then proceeds with the turn. An exception to this circumstance is when the SV is traveling at a low velocity and the driver believes that it is safe to proceed with the turn at his/her current velocity.

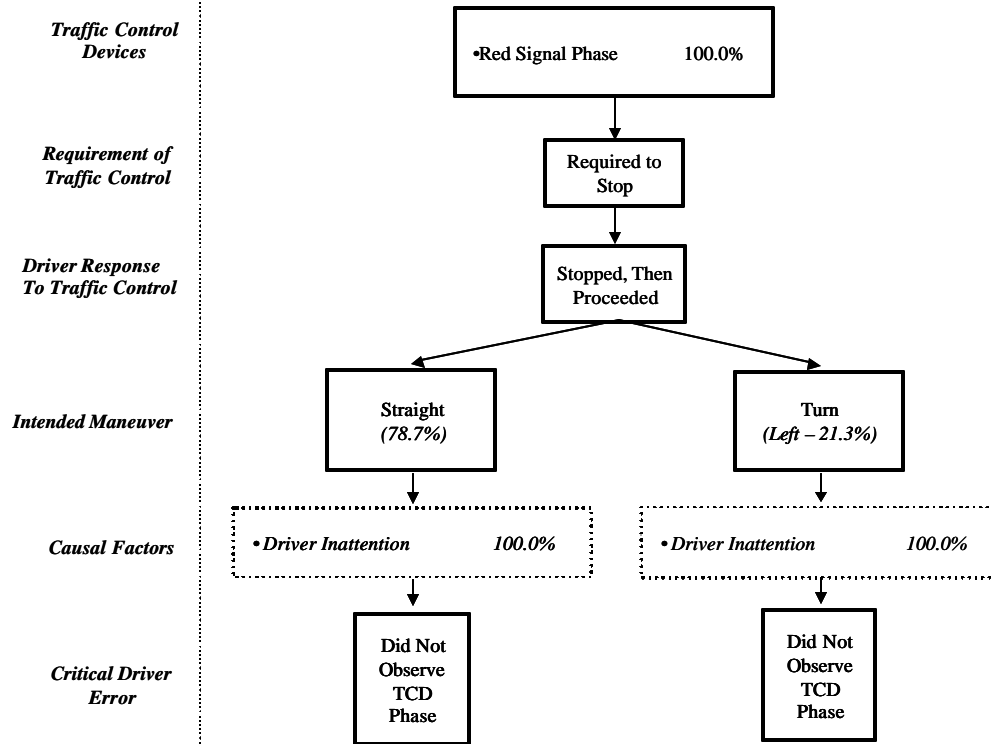


**Figure 3-7**  
**Intersection Dynamic Scenario No. 3**  
**Perpendicular Path - Violation of Traffic Control**

Unlike Scenario Nos. 1 and 2, this crash scenario can be mitigated by providing the driver with a warning of the potential violation of the traffic control. The countermeasure must provide this information to the driver in time for the driver to react to the intersection they are approaching.

#### **3.2.4 Intersection Crash Scenario No. 4**

These types of crashes occur in only a small proportion (2.1 percent) of the sample. This scenario is distinguished by the driver of the SV stopping in response to a traffic signal with a displayed red phase. The driver proceeds into the intersection prior to the light phasing to green. The distribution of crash characteristics is illustrated in Figure 3-8. As evident in this figure, the driver enters the intersection and in a large proportion of the cases proceeds straight across the intersection. In the remainder of the cases the driver performs a left turn. In all cases comprising this scenario, the driver is inattentive to the driving task and does not observe the signal phase.



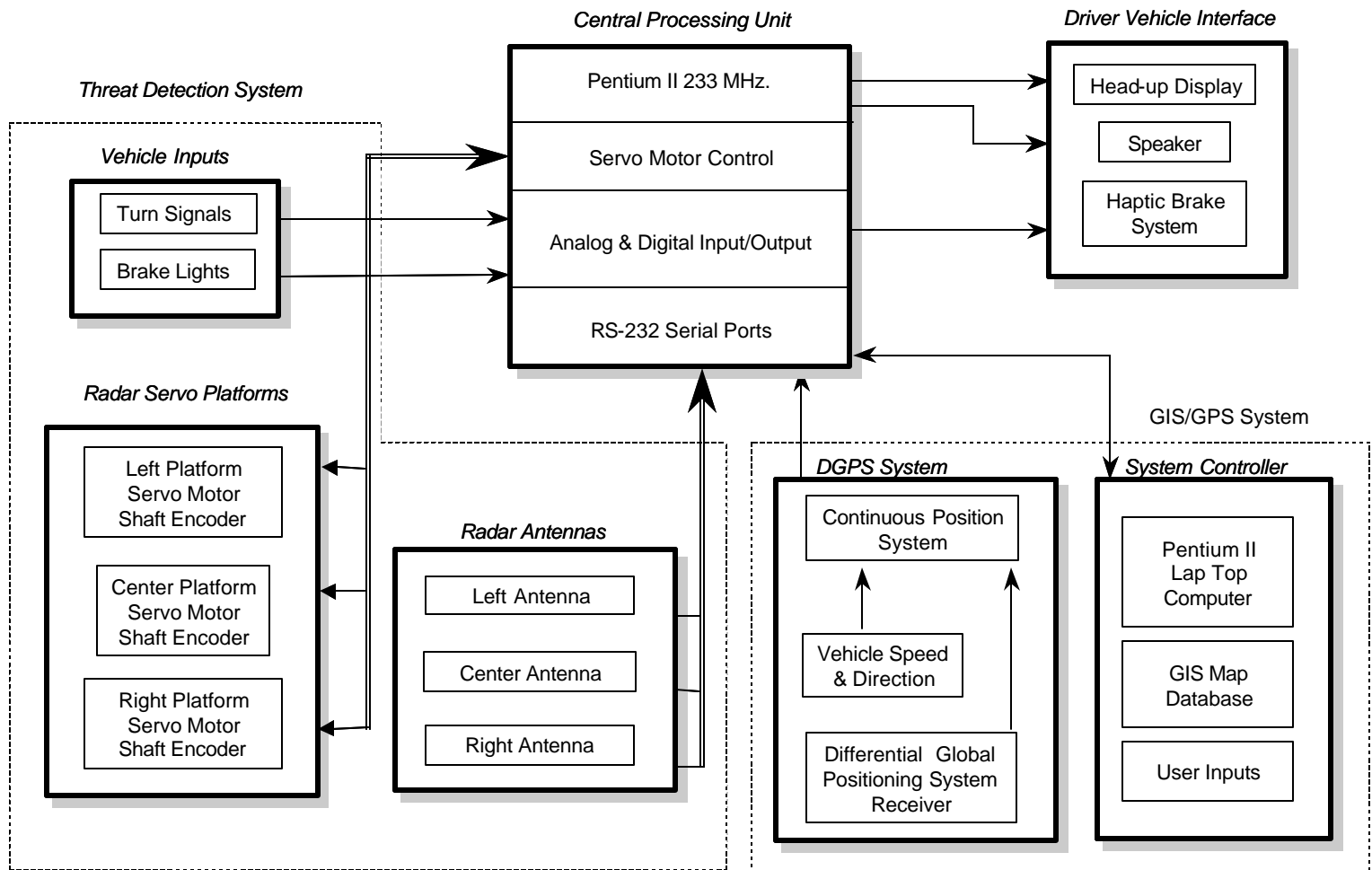
**Figure 3-8**  
**Intersection Dynamic Scenario No. 4**  
**Premature Intersection Entry**

#### **4.0 THE INTERSECTION COLLISION AVOIDANCE SYSTEM (ICAS) TEST BED DESIGN**

The Intersection Collision Avoidance System (ICAS) described in this section is designed to provide a driver with warnings of an impending crash or potential hazards at intersections. The ICAS is a culmination of the work performed in previous phases of this program; the definition of the intersection crash problem, the investigation of the technology to support development of the countermeasure, and the construction of the ICAS test bed vehicle.

The ICAS Test bed design presented in this section, was developed from the design presented in the ICA Task 5 report. The ICAS design presented in Task 5 was capable of addressing the four collision scenarios described in Section 3. During the Critical Design Review, a number of changes were made to the system design at the request of the customer. Primary changes were the elimination of the Signal-to-Vehicle Communication system, and the re-design of the Threat Detection System to implement a “partial solution” design. The elimination of the Communication system prevents the ICAS from being effective against collisions caused by drivers violating signals on red phase. The re-design of the radar in the Threat Detection system was made to ensure that the goals of the program could be met. The original radar system design was complex, with a potential for exceeding the program budget. A compromise radar design was developed that utilized three commercially available radars. This compromise system allowed the development of the countermeasure at a reasonable cost.

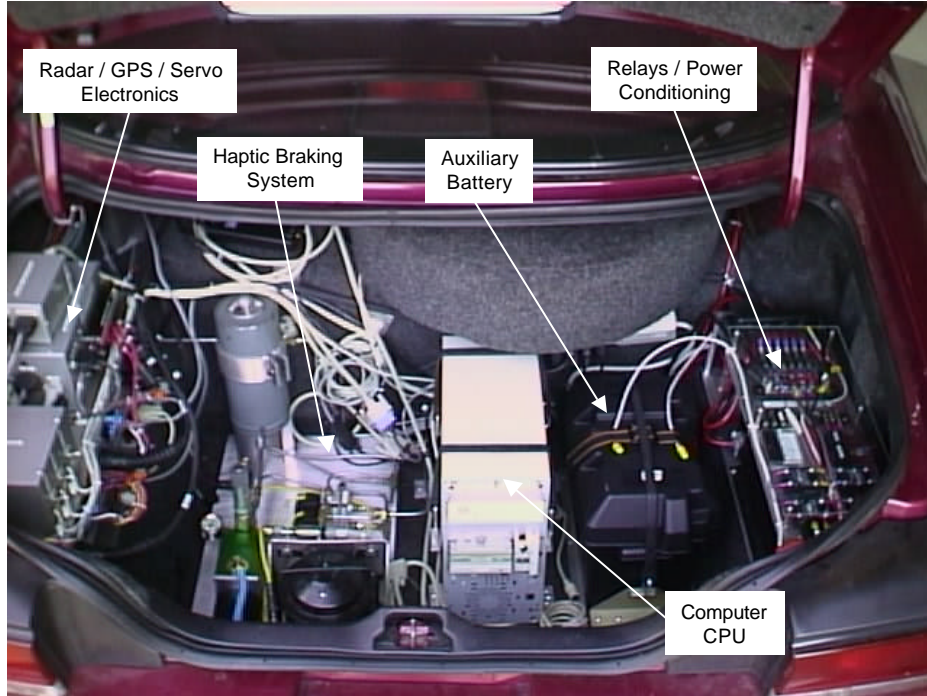
The Intersection Countermeasure is comprised of four sub-systems; the threat detection system, the GIS/GPS system, the driver vehicle interface, and the vehicle support system. The architecture of the countermeasure is illustrated in Figure 4-1. The countermeasure has been designed as an “add-on” to the vehicle platform, where all components are integrated into the vehicle system and structure to the greatest extent possible in this type of application. Due to this constraint it was not possible to integrate the various systems into the vehicle in a transparent manner. For example, it was necessary to place side-looking radars on the vehicle roof in order to acquire data on vehicles approaching the intersection on perpendicular paths. This resulted in the placement of radars in obvious view on the roof of the vehicle. This may be seen in Figure 4-2. This section will provide a description of each of the systems in the countermeasure. The sections that follow shall describe the testing, and performance guidelines that have resulted from these tests. Much of the equipment is installed in the trunk of the test bed, as shown in Figure 4-3. Figure 4-4 shows the driver’s compartment.



**Figure 4-1: Intersection Collision Avoidance System (ICAS) System Architecture**

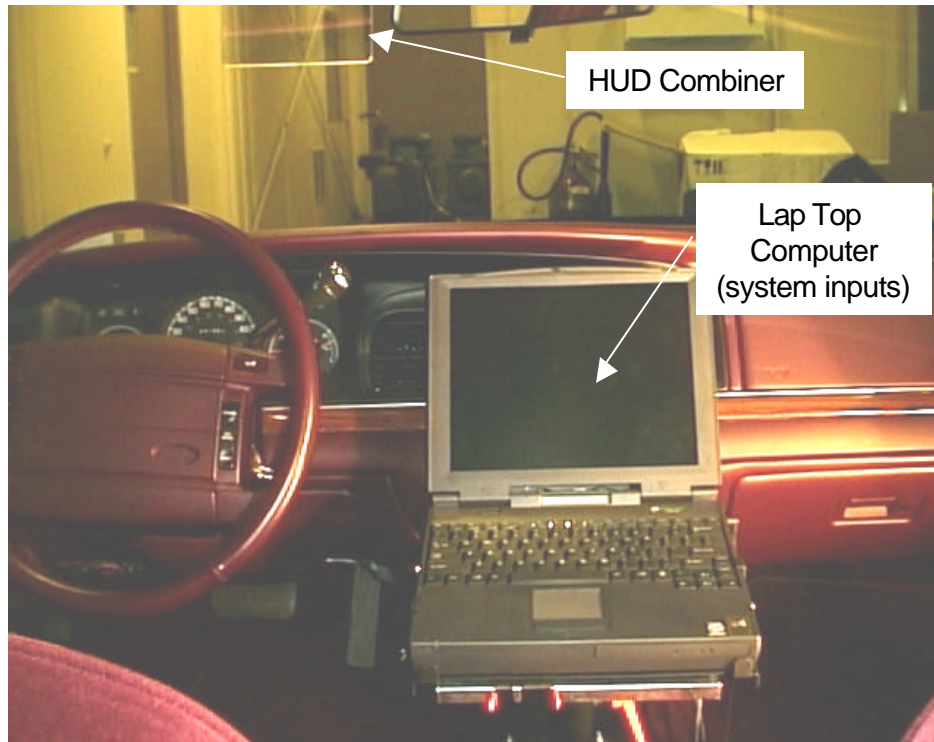


**Figure 4-2**  
**The ICAS Testbed**



**Figure 4-3**  
**Illustration of ICAS Equipment**



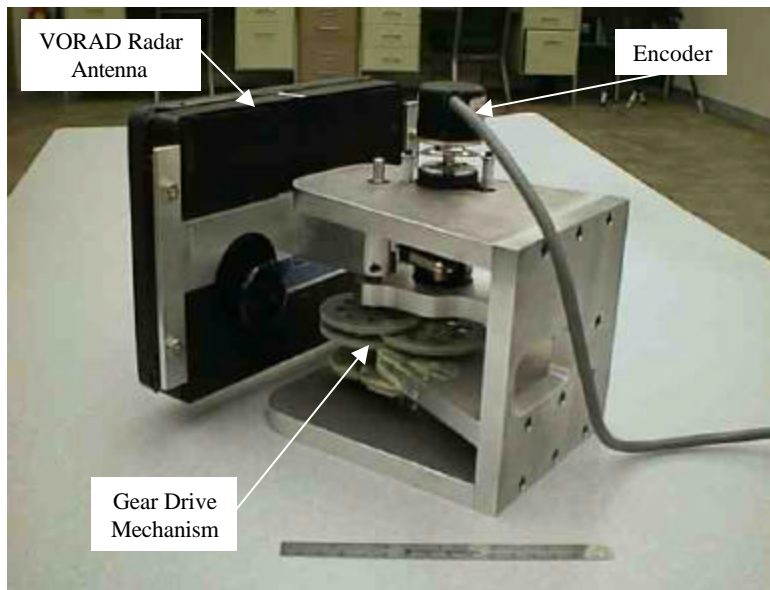


**Figure 4-4**  
**Drivers Compartment - ICAS Testbed**

#### **4.1 Threat Detection System**

The threat detection system utilizes millimeter wave radars to acquire data on vehicles approaching the intersection. The ICAS utilizes three VORAD EVT-200 radar systems. These radars operate at 24 GHz frequency and provide range and range rate data. These units are marketed to the trucking industry as forward collision avoidance systems. The radars are modified at the factory to provide range and range rate data through a RS-232 link.

The radar antennas are mounted to a scan platform designed by Veridian Engineering. The scan platforms are motorized, and gear-driven to allow the radars to be pointed to specific areas of the intersection as the vehicle approaches the intersection. An optical encoder, mounted along the rotational axis of the antenna, provides angular position data. The scan platform is designed to allow the antenna to be positioned, through computer control, to the adjacent roadways of the intersection the vehicle is approaching. Three scan platforms are utilized; two on the vehicle roof to monitor the perpendicular roadways and one forward-looking unit to monitor the parallel roadway. A photograph of the three radars installed on the ICAS Testbed is shown in Figure 4-2. A detailed photograph of the scan platform design is shown in Figure 4-5. This design is utilized in all three installations on the vehicle.



**Figure 4-5: Radar Scan Platform Detail**

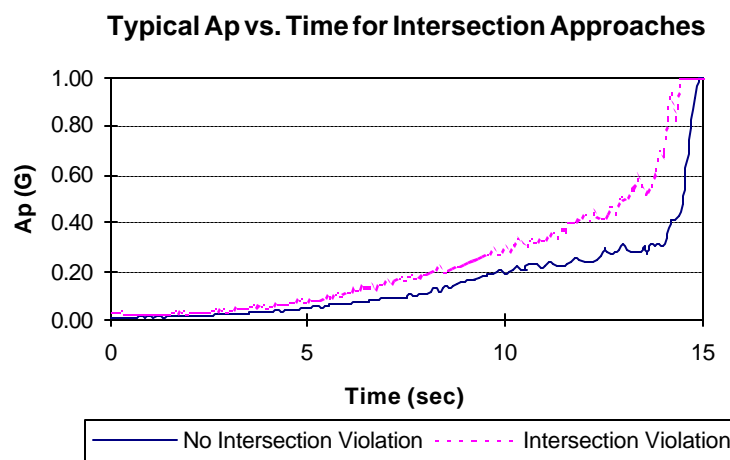
The standard VORAD electronics is used to process the data coming out of the antennas. The resulting range, and range rate data for the closest three targets is provided to Veridian-designed software. The tracker utilizes radar data, in conjunction with information on the intersection provided by an on-board map datafile, to determine if the ICAS Testbed will occupy the intersection at the same time as vehicles on perpendicular, or parallel, but opposite direction paths. The threat detection system is described in full, along with testing performed on the system to derive performance guidelines in Section 5.1 of this report.

## **4.2 GIS/GPS System**

The Geographical Information System/Global Positioning System (GIS/GPS) is a system that includes a Global Positioning System (GPS), a differential correction receiver, and an on-board map database to prevent collisions at unsignalized intersections. The system uses differentially corrected position information provided by the GPS to place the ICAS Testbed on a specific roadway identified in the map database. The map database contains information about the location of intersections, along with roadways. This map datafile is provided by Navigation Technologies, Inc. (NavTech).

The map datafile used in this program is a modification of the standard NavTech product. At the start of this effort NavTech did not include the Buffalo, NY area in their coverage area. When development of the GIS/GPS ramped up, this situation had changed. NavTech was in the final stages of compiling the map datafile for the Buffalo region. Although not released for the public, NavTech agreed to supply Veridian with a subset of the regional map as a test area for the ICAS system. A thirty-three square mile

area was selected in a Buffalo suburb. This area contained a variety of roadway and intersection characteristics. A map of the test area is shown in Figure 5-10, Section 5. The map datafile for the test area was modified by use of higher precision of intersection location, and the inclusion of a data field for traffic controls at intersections. This information is used by the countermeasure to locate the ICAS vehicle on a roadway, and to determine vehicle distance to intersection. With the distance to intersection known the speed of the vehicle can be acquired from vehicle sensors, such as the speedometer, and used to calculate the braking effort required to prevent intersection entry, or “ $a_p$ ”. This metric is used to monitor driver reaction to the intersection prior to entry. Baseline studies of driver behavior performed earlier in this program has indicated that  $a_p$  can be used to identify those drivers who will not comply with the traffic control at the intersection. An illustration of two  $a_p$  curves, with the driver complying, and violating the intersection are shown in Figure 4-6.



**Figure 4-6: Illustration of  $a_p$  Metric**

The upper curve is calculated by the ICAS when the driver leaves the braking for the intersection very late. In the current application, the warning is initiated when  $a_p = 0.35g$ . This 0.35g value was derived through an iterative process of analysis and driving tests. The warning value is a compromise between assuring that the driver has not responded to the stop sign at the intersection they are approaching, and the desire to limit false alarms. Previous baseline studies had determined that drivers brake for stop sign-controlled intersections at a mean level of 0.19g. It was desirable for the  $a_p$  warning value to accommodate driving styles above the mean. A range of  $a_p$  values between 0.25g and 0.45g were tested in the ICAS

Testbed to determine driver acceptability. The lower range of  $a_p$  values produced warnings too early; prior to when drivers would normally initiate braking; the higher values produced warnings at a stage much later than drivers would initiate braking. These tests determined that 0.35g produced a balance of appropriate warning distance and false alarms. Note that although the acceleration to prevent intersection entry is negative, it is illustrated as a positive value in these graphs. As the driver normally approaches the intersection the value of  $a_p$  will exceed the threshold value when distances become very small (generally less than 10 feet.) The algorithm deactivates the warning if vehicle speed is less than 5 mph. In the ICAS application, the calculation of  $a_p$  is limited to those intersections controlled by stop signs. This feature could be expanded to phased signals through the use of a signal to vehicle communication system. If the system detects that the driver is not responding to the intersection, through the exceedance of the  $a_p$  threshold, a warning is provided to the driver through the Driver-Vehicle Interface. An illustration of the warning is provided in Figure 4-7.



**Figure 4-7: Illustration of Stop Sign Warning**

The function of the GIS/GPS system is described fully, along with performance guidelines, in Section 5.2 of this report.

### **4.3 Driver Vehicle Interface**

The Driver-Vehicle-Interface (DVI) is used to transmit warnings to the vehicle driver. The DVI utilizes multiple sensory modes to transmit the warnings. Included within the DVI is a Head-Up Display (HUD), auditory system, and haptic warning system. The HUD and auditory systems are commercially available components that were utilized to support this program. This system utilizes a secondary, computer controlled brake system on the ICAS testbed. The system is triggered when the  $a_p$  threshold is exceeded.

The haptic system provides three deceleration pulses to warn the driver of the intersection they are approaching and to react to it.

#### 4.4 Vehicle Systems

The vehicle systems are those systems that are required to integrate the ICAS equipment into the testbed vehicle. The vehicle chosen for the Testbed was a Ford Crown Victoria. This vehicle was chosen after a requirements study was performed to identify critical features of the host vehicle. The vehicle was desired to be a passenger vehicle, as opposed to a van, or Sport Utility Vehicle. Other features considered were room to install the ICAS equipment and a heavy duty charging system. The Ford Crown Victoria was chosen from a field of vehicles such as the Pontiac Grand Prix, Chevrolet Lumina. The ICAS equipment was successfully integrated into the Vehicle with a minimal amount of modifications. The two areas where changes were made were the vehicle braking system, and installation of a roof mount for the various equipment. The changes made to the vehicle could have been made at the factory if this system were accepted by a vehicle manufacturer. A detailed description of the vehicle changes are presented in Section 5.4 of this report.

#### 4.5 ICAS Collision Target Population

The ICAS system developed in this program is not capable of preventing all the collision scenarios described in Section 3 of this report. The omission of the traffic signal to vehicle communication system, and implementation of a “partial solution” threat detection system capability that was directed in the Critical Design Review in December 1997, resulted in a modified system. The partial solution to the threat detection system changed the design of this subsystem by substituting three independently aimed radar antennas for the one rotating antenna as originally designed. This ICAS system is capable of dealing with intersection collision scenario 1 and 2, and part of scenario three, primarily scenarios for stop sign controlled intersections. Table 4-1 illustrates the portion of the intersection crash population this countermeasure addresses.

**Table 4-1  
Intersection Crash Scenarios Addressed by Modified ICAS**

Crash Scenario	Percentage	% of Sample
No. 1 - Left Turn Across Path	23.8%	23.8%
No. 2 - Perpendicular Path - Entry with Inadequate gap	30.2%	30.2%
No. 3 - Perpendicular Path - Violation of Traffic Control	20.6%	43.9%
No. 4 - Premature Intersection Entry - Violation of Traffic Control	0.0%	2.1%
<b>Total</b>	<b>74.6%</b>	<b>100.0%</b>

The largest impact on the total population of crash scenarios is the inability of the countermeasure to deal with signalized intersections in scenario 3 and 4. These scenarios have a common link in that they require information regarding the signal phase at these intersections. As a result of the omission of the signal-to-vehicle communication system the countermeasure can only address the portion of scenario 3 that occurs

at intersections controlled by stop signs. The lack of the signal to vehicle communication system prevents this countermeasure from addressing scenario 4.

#### 4.5.1 Non-Inclusive Intersection Scenarios

The ICAS was designed to prevent the driver of an equipped vehicle from making a mistake in judgement or perception that results in the four crash scenarios discussed in the preceding sections. There is a set of intersection collisions that the ICAS is not designed to address, although the Threat Detection System will handle them equally well. These collisions are dynamically similar to the four scenarios, except that the action, or lack of action that triggers the crash is initiated by the driver of the Principal Other Vehicle, and not the Subject Vehicle. These crash types have been termed as “defensive modes”, because the countermeasure system must provide the driver with information regarding the actions of the other vehicle(s) approaching the intersection.

There are two primary defensive collision scenarios, that associated with the left turn across path, scenario 1, and violation of traffic control, or scenario 3. These scenarios are illustrated in Figures 4-8 and 4-9. Note that while the dynamics of the scenario do not change, the role each vehicle plays in the scenario is reversed. Since the SV and POV titles of each vehicle are defined by their role in the crash, these scenarios occur in everyday traffic. The Threat Detection System makes no distinction as to which vehicle violates a Traffic Control Device (TCD).

These scenarios were encountered during the testing of the encountermeasures. The countermeasure was found to be able to detect and warn the driver regarding an impending collision.

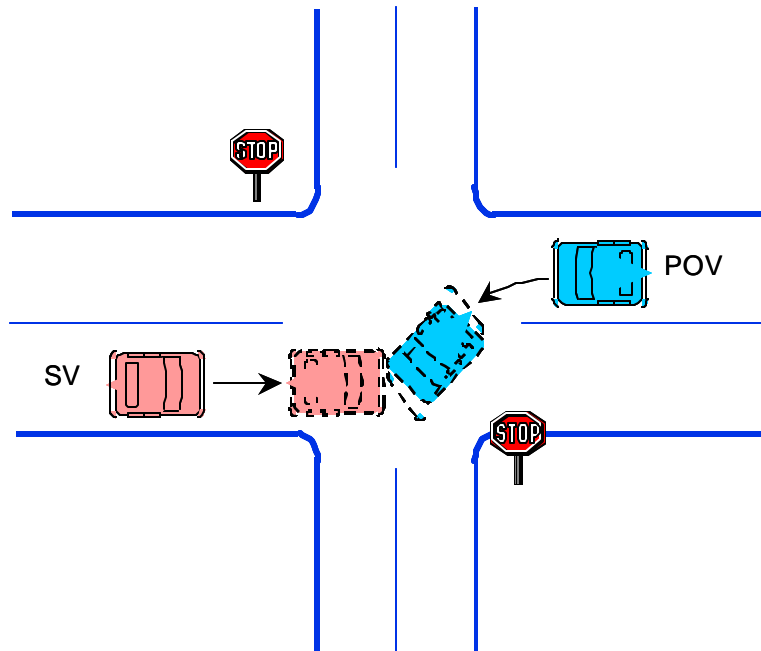
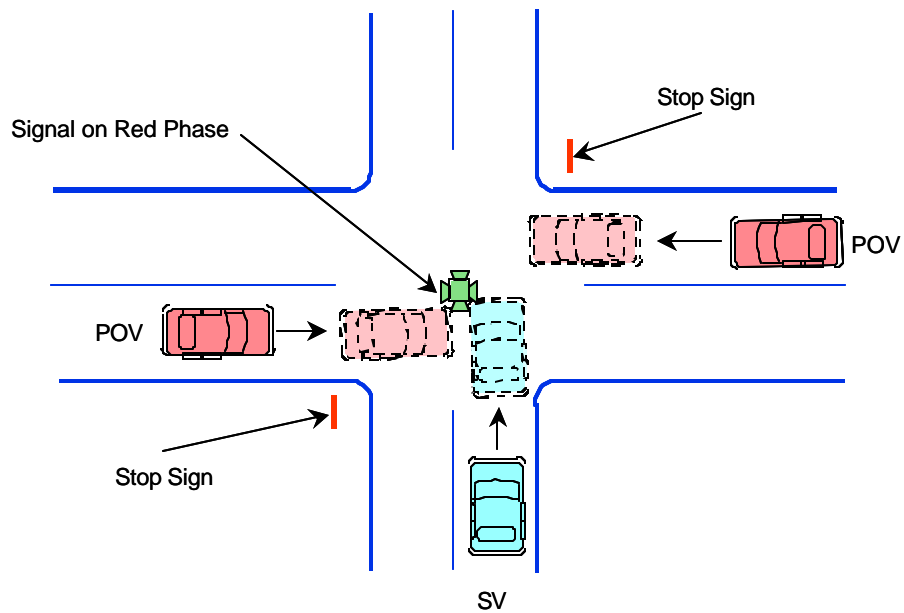


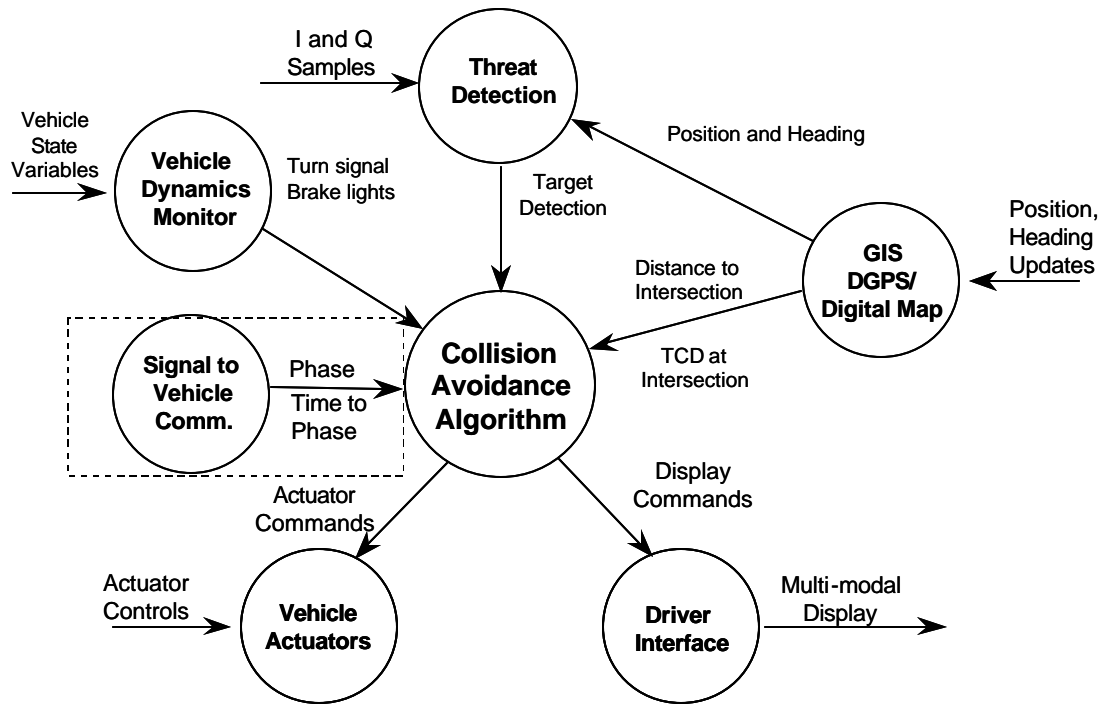
Figure 4-8: Defensive Scenario No. 1



**Figure 4-9**  
**Defensive Scenario No. 3**

#### 4.6 ICAS Algorithm

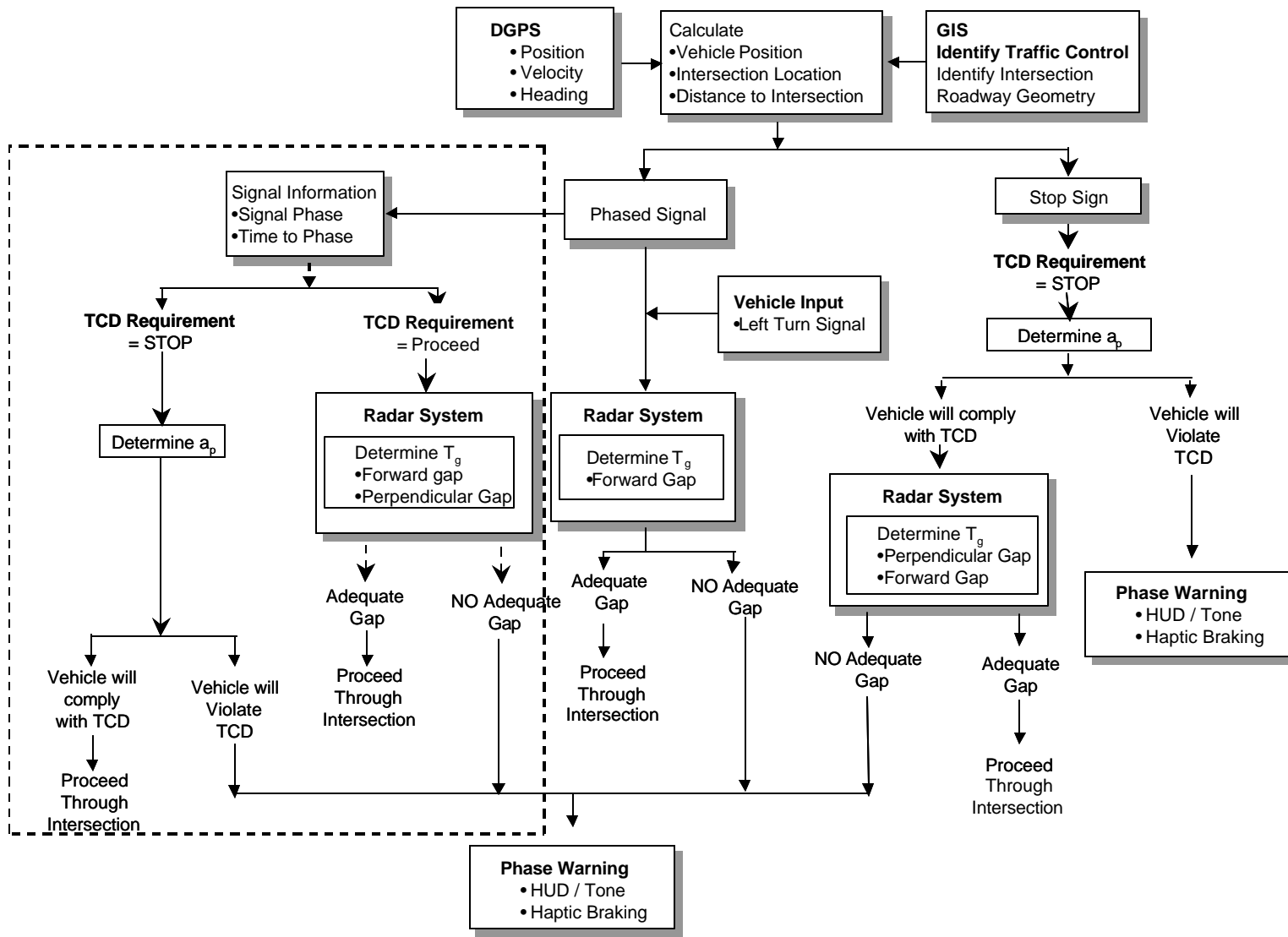
The equipment and systems described in the previous sections provide data to the collision avoidance algorithm. The algorithm is a set of instructions contained within the central processing unit of the system that provides a method of processing the incoming data and providing the driver with warnings when specific thresholds are exceeded. Figure 4-10 illustrates the interchange of information between the components of the countermeasure. Note that the signal to vehicle communication system is included, surrounded by dotted lines, in this diagram. This system was not implemented on the Test bed vehicle.



**Figure 4-10**  
**Interchange of Data in ICAS Components**

All data from the vehicle systems is ported into the Collision Avoidance Algorithm for processing and issuing of warnings. The algorithm monitors the two primary performance metrics,  $a_p$ , or acceleration required to prevent intersection entry, and  $t_g$ , gap time to approaching vehicles. Based on the calculated values for these metrics a warning is provided to the driver of the countermeasure-equipped vehicle. The algorithm for the overall system is illustrated in Figure 4-11. This algorithm shows the system in all potential intersection encounters. Sections that follow describe the countermeasure algorithm for the four intersection crash scenarios.





**Figure 4-11**  
**ICAS Algorithm**

The system algorithm utilizes data from the DGPS system in the vehicle to establish to locate the vehicle's position. This position is correlated with the location of a roadway in the GIS map. If system inaccuracy in either the DGPS or GIS places the vehicle off the roadway, software corrects the location of the vehicle onto the nearest road. Use of DGPS makes this allocation of the vehicle to a specific roadway a much more accurate process than when using GPS only. With the roadway located, the vehicle heading, and vehicle speed, acquired from the DGPS equipment, can be used to determine the intersection the vehicle is approaching. The GIS uses the discrete intersection ID to determine the geometry of the intersection, wither four way, junction right/left, or "T", and the traffic control at the intersection. The on-board processing equipment calculates the distance to the intersection for use by the warning algorithms.

Based on the traffic control at the intersection the actions of the countermeasure can differ. The varying actions of the countermeasure with respect to the traffic control device at the intersection is described below:

Stop Sign:

This portion of the algorithm is illustrated on the right side of Figure 4-11. When the vehicle is approaching an intersection controlled by a stop sign the vehicle must determine the drivers compliance with the traffic control, and then if the driver has an acceptable vehicle to vehicle gap with which to enter the intersection. A driver approaching an intersection controlled by a stop sign is always required to stop, check for a gap to proceed, and then traverse the intersection. The ICAS assures that the driver performs these tasks, and provides warnings when their judgement is faulty. The ICAS determines driver compliance with the stop sign by monitoring the  $a_p$  metric. The  $a_p$  metric monitors the vehicle speed with respect to distance to intersection and calculates the braking effort that is required to prevent the vehicle from entering the intersection. Previous driver behavior studies in this program have indicated that driver's provide cues, such as applying the vehicle brakes, up to nine seconds prior to arriving at the intersection. This behavior can be captured by monitoring the  $a_p$  metric. If the value of  $a_p$  exceeds  $0.35g$ 's a warning is provided to the driver through the DVI.

If the driver is reacting to the intersection by slowing down in order to stop, the vehicle threat detection system initiates a scan of the intersection to determine the presence of threat vehicles. As the vehicle approaches the intersection the system positions the radars to accommodate the geometry of the intersection. This information is provided by the map database within the GIS. The threat detection system will monitor range and range rates to other vehicles approaching the intersection. The tracker in the ICAS will utilize this information to determine if the vehicles shall occupy the intersection at the same time as the ICAS vehicle. Joint co-occupancy of the intersection by the ICAS and any intercepting vehicle will initiate a warning to the driver. This warning logic is modified based upon vehicle distance to intersection and speed. If the vehicle is slowly approaching an intersection, such as when in a line of vehicle, logic within the tracker will disable the alarm. The logic recognizes that the vehicle can stop in a very small distance, and

therefore disables the warning to reduce false alarms. As the vehicle is at the intersection the countermeasure will determine if the ICAS vehicle can safely traverse the intersection. If the driver can safely traverse the intersection no alarm is provided. If conversely, there is no adequate gap, and the driver is not applying the vehicle brake, an alarm is transmitted to the driver through the DVI.

Once the intersection has been safely traversed by the ICAS vehicle, the countermeasure locates the next intersection on the roadway and starts calculating distance to intersection, repeating the process each time.

### Phased Signal:

The processing involved with the ICAS at phased signals is similar to that described regarding stop signs. A critical difference is that the requirement to stop at the intersection cannot be known with the present implementation of the ICAS in the Testbed vehicle. The requirement to stop at the intersection is a function of signal phase. A signal to vehicle communication system was designed to provide the approaching vehicle with information regarding the present signal phase and the time until the signal phases. This system was omitted from the testbed due to difficulty in deployment and testing. The functional aspects of the communication system are illustrated in Figure 4-11 on the left side of the figure, enclosed in dashed lines. Without the signal to vehicle communication system the countermeasure cannot warn the driver of the potential for violating the traffic control. Instead, the system can only warn the driver if they are proceeding into the intersection with an inadequate gap.

If the countermeasure receives input that the driver will perform a left turn, through the activation of the left turn signal, then the system can use the threat detection system to access the gap to vehicle approaching the intersection in a parallel, but opposite direction. The determination by the ICAS that an inadequate gap to approaching vehicles will initiate a warning to the driver through the DVI.

The signal to vehicle communication system can provide information to the countermeasure regarding the present signal phase, and the time to phasing. This information would be broadcast from each signal for each approaching roadway, along with intersection ID information. The details of the message protocol is included in the Task 5 report for this program. With the present signal phase and the time to phasing information acquired from the signal, the requirement to stop for the driver can be determined. If the vehicle, while maintaining current velocity and direction, can traverse the intersection in the time remaining to signal phasing (assuming the signal phase is green), then no warning is provided. If, however, the time is insufficient, a warning is transmitted to the driver. This is equivalent to calculating  $a_p$  for stop sign controlled intersections. Whereas the  $a_p$  for stop signs uses distance to intersection, and then calculates the braking effort required, the  $a_p$  for phased signals substitutes the time to signal phase and calculates the braking effort required to prevent intersection entry. In both cases the same threshold value is used. When the driver stops prior to intersection entry, the threat detection system operates in a like manner as described for stop signs, calculating approaching vehicle paths, and determining those vehicles that will occupy the intersection at the same time as the ICAS vehicle. This also happens when the vehicle enters the intersection with the green signal phase, and there is no requirement to stop.

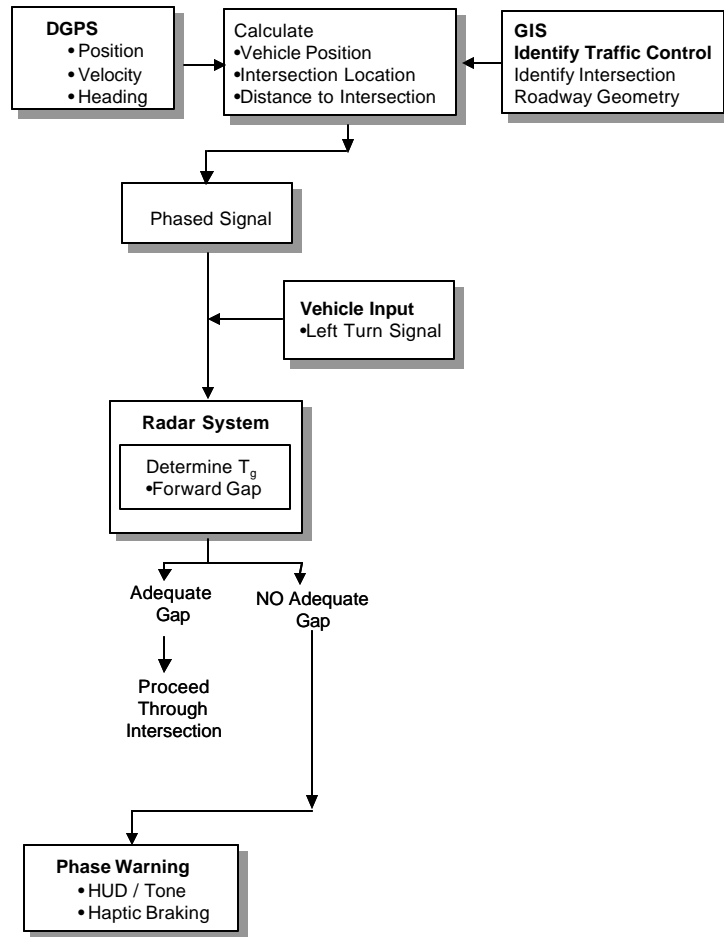
The algorithm that controls the action of the countermeasure in the intersection collision scenarios described in Section 3 of this report will be described in the sections that follow. It should be noted that these specific applications of the algorithm are all contained within the system algorithm described above.

### **Left Turn Across Path - Crash Scenario No. 1**

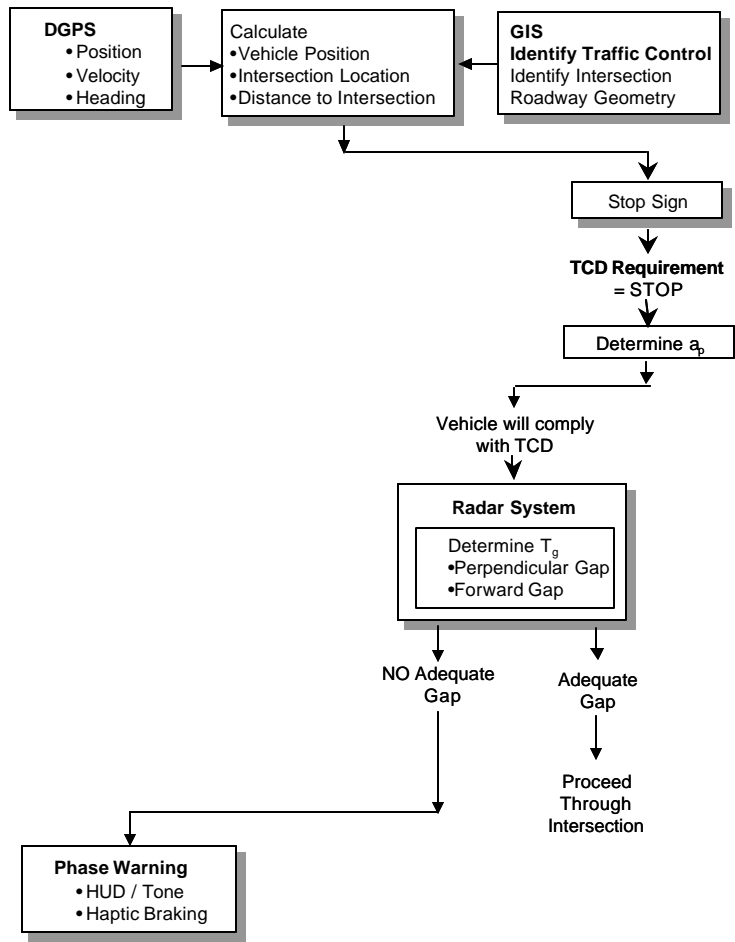
The left turn across path crash occurs primarily at phased signals when the signal is green. This provides the ICAS vehicle with no requirement to stop. The primary task of the driver, and the ICAS is to assure that the driver proceeds with an adequate gap to vehicles approaching on parallel, but opposite paths. The ICAS uses information derived from the DGPS and GIS to provide intersection geometry characteristics. Additional information regarding driver intent, provided by activation of the vehicle turn signal, is used to activate or disable specific warning logic. If the driver does not activate the turn signal the countermeasure is inactive. The algorithm pathway is illustrated in Figure 4-12. The activation of the turn signal allows the warning logic for the forward radar system to be engaged. The radar system is functioning at all times, and only the ability to provide a warning is impeded by the logic. The radar acquires range and range-rate data for the vehicles approaching the intersection on the parallel but opposite direction from the ICAS vehicle. The data is processed by the ICAS tracker, which predicts if the other vehicles will occupy the intersection at the same time as the ICAS vehicle. If the ICAS predicts that the both vehicles will not occupy the intersection at the same time, an acceptable gap is present, and no warning is provided to the driver. If, on the other hand, the tracker indicates that the vehicles will occupy the intersection at the same time, no adequate gap exists, and a warning is issued. The warning would consist of an audio tone, icon presented on the HUD, and, if the vehicle is in motion, pulsing of the brake system.

### **Perpendicular Path - No Violation of Traffic Control Crash Scenario No. 2**

Intersection Crash Scenario No. 2 entails vehicles on perpendicular paths, with no violation of the traffic control. The traffic control in these crashes is always a stop sign. As the vehicle approaches the intersection the driver complies with the traffic control and comes to a stop. The driver checks all directions of traffic and enters the intersection, where they strike, or are struck by vehicles traveling on perpendicular roadways. These crashes are caused primary by faulty perception by the driver; where the driver fails to perceive the approaching vehicle(s) or they misperceive the velocity or gap to the approaching vehicle(s). The ICAS functions to assure that the driver is warned of the lack of a sufficient gap to these approaching vehicles. The ICAS utilizes the Threat Detection System to track these vehicles provide a warning in the case of insufficient gaps. The implementation of the ICAS algorithm is shown in Figure 4-13.



**Figure 4-12**  
**Algorithm Implementation - Left Turn Across Path**



**Figure 4-13**  
**Crash Scenario No. 2 - Perpendicular Path - No Violation of Traffic Control**

### **Perpendicular Paths - Violation of Traffic Control Crash Scenario No. 3**

Intersection crash scenario no. 3 is similar to scenario no. 2 in that the involved vehicles are approaching the intersection on perpendicular roadways. Contrary to scenario 2 however, the subject vehicle in these cases violates the traffic control. The distribution of traffic control devices in this scenario is 53% phased signals and 47% regulatory signs. The action of the countermeasures is different depending upon the traffic control. The primary fault that precipitates the crash in this scenario is violation of the traffic control. The countermeasure is designed to prevent this violation of the traffic control. The manner in which it performs this is illustrated in Figure 4-14 and described for each traffic control below:

#### Stop Sign:

As the ICAS vehicle is approaches an intersection controlled by a stop sign the vehicle must determine the drivers compliance with the traffic control, and then if the driver has an acceptable vehicle to vehicle gap with which to enter the intersection. A driver approaching an intersection controlled by a stop sign is always required to stop, check for a gap to proceed, and then traverse the intersection. The ICAS assures that the driver performs these tasks, and provides warnings when their judgement is faulty. The ICAS determines driver compliance with the stop sign by monitoring the  $a_p$  metric. The  $a_p$  metric monitors the vehicle speed with respect to distance to intersection and calculates the braking effort that is required to prevent the vehicle from entering the intersection. Previous driver behavior studies in this program have indicated that driver's provide cues, such as applying the vehicle brakes, up to nine seconds prior to arriving at the intersection. This behavior can be captured by monitoring the  $a_p$  metric. If the value of  $a_p$  exceeds  $0.35g$ 's a warning is provided to the driver through the DVI.

Once the intersection has been safely traversed by the ICAS vehicle, the countermeasure locates the next intersection on the roadway and starts calculating distance to intersection, repeating the process each time.

#### Phased Signal:

The processing involved with the ICAS at phased signals is similar to that described regarding stop signs. A critical difference is that the requirement to stop at the intersection cannot be known with the present implementation of the ICAS in the Testbed vehicle. The requirement to stop at the intersection is a function of signal phase. A signal to vehicle communication system was designed to provide the approaching vehicle with information regarding the present signal phase and the time until the signal phases. This system was omitted from the testbed due to difficulty in deployment and testing. The functional aspects of the communication system are illustrated in Figure 4-11 on the left side of the figure, enclosed in dashed

lines. Without the signal to vehicle communication system the countermeasure cannot warn the driver of the potential for violating the traffic control. Instead, the system can only warn the driver if they are proceeding into the intersection with an inadequate gap.

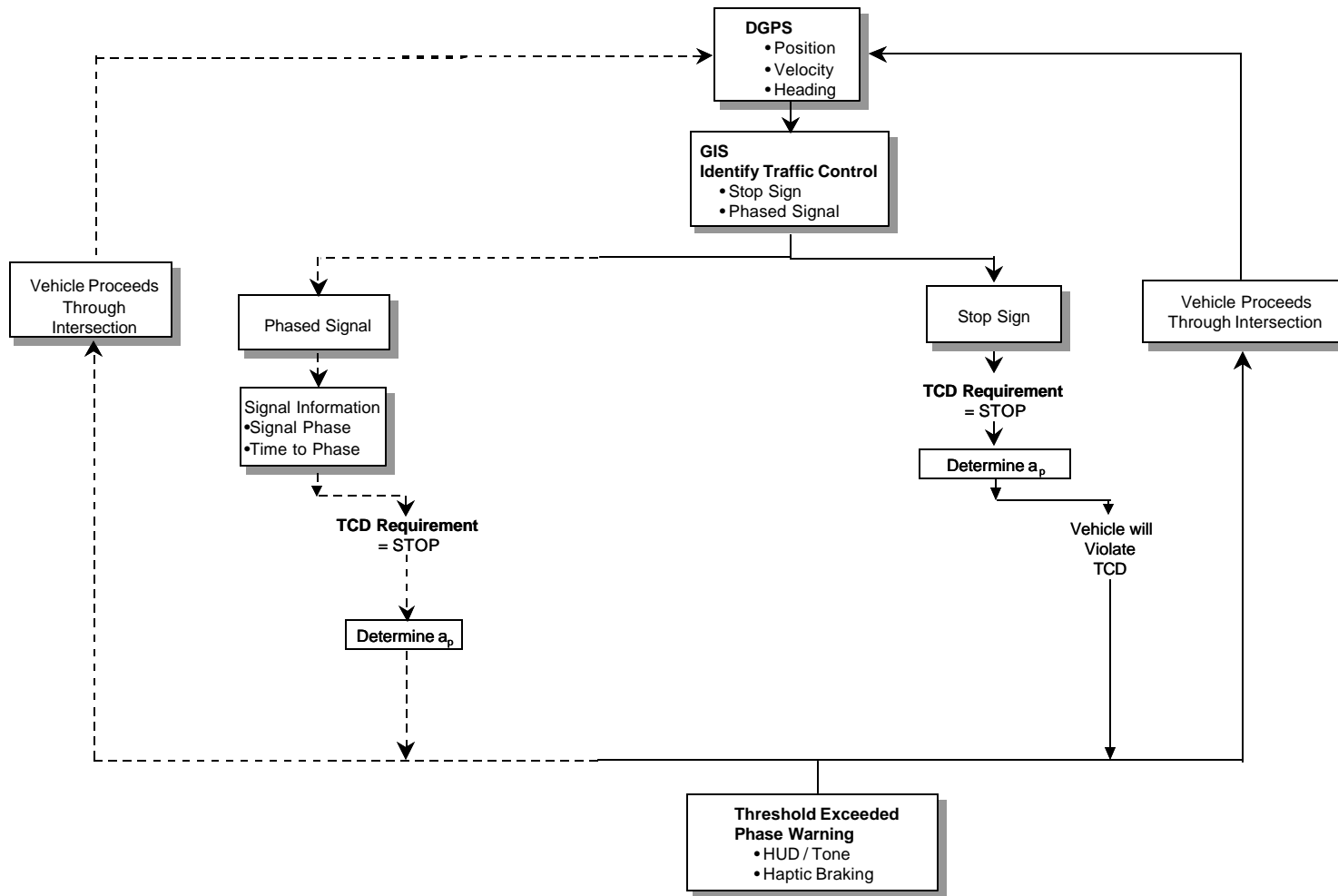
If the countermeasure receives input that the driver will perform a left turn, through the activation of the left turn signal, then the system can use the threat detection system to access the gap to vehicle approaching the intersection in a parallel, but opposite direction. The determination by the ICAS that an inadequate gap to approaching vehicles will initiate a warning to the driver through the DVI.

The signal to vehicle communication system can provide information to the countermeasure regarding the present signal phase, and the time to phasing. This information would be broadcast from each signal for each approaching roadway, along with intersection ID information. The details of the message protocol is included in the Task 5 report for this program. With the present signal phase and the time to phasing information acquired from the signal, the requirement to stop for the driver can be determined. If the vehicle, while maintaining current velocity and direction, can traverse the intersection in the time remaining to signal phasing (assuming the signal phase is green), then no warning is provided. If, however, the time is insufficient, a warning is transmitted to the driver. This is equivalent to calculating  $a_p$  for stop sign controlled intersections. Whereas the  $a_p$  for stop signs uses distance to intersection, and then calculates the braking effort required, the  $a_p$  for phased signals substitutes the time to signal phase and calculates the braking effort required to prevent intersection entry. In both cases the same threshold value is used. When the driver stops prior to intersection entry, the threat detection system operates in a like manner as described for stop signs, calculating approaching vehicle paths, and determining those vehicles that will occupy the intersection at the same time as the ICAS vehicle. This also happens when the vehicle enters the intersection with the green signal phase, and there is no requirement to stop.

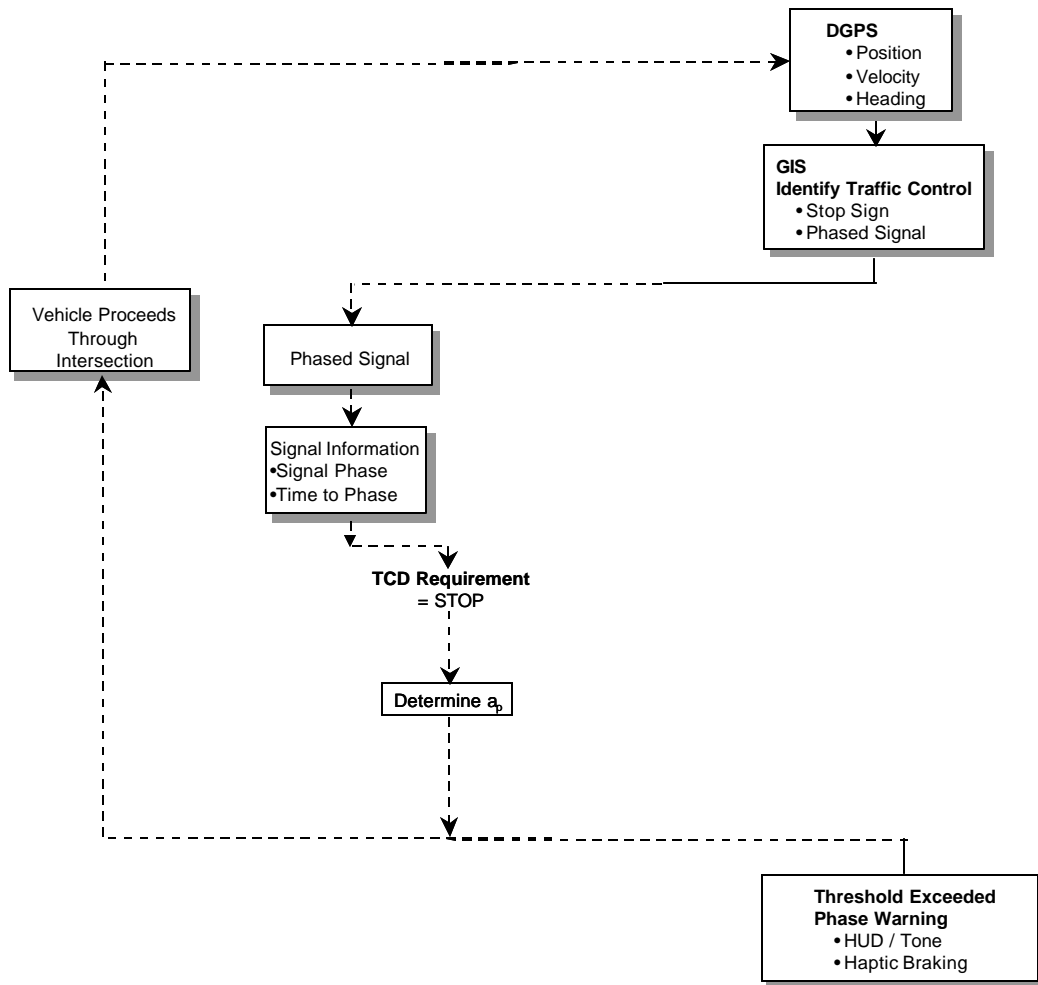
#### **Premature Intersection Entry - Violation of Traffic Control - Crash Scenario No. 4**

Intersection crash scenario no. 4 occurs only at intersections controlled by phased signals with left turn permissive lanes. The accident is precipitated by the entry into the intersection of a driver proceeding straight across the intersection. The driver, through inattention, does not observe that the left turn arrow only has been activated. Thinking that they also are allowed to proceed they enter the intersection, and are struck, or strike the vehicle making a permitted left turn. The function of the ICAS in this case is illustrated in Figure 4-15. The communication system provides the ICAS with signal phase information, indicating driver requirement. In this case, with the signal red, with left turn permitted, the ICAS determines that the driver is not allowed to enter the intersection. This violation of the intersection would initiate a warning to the driver through the DVI. It is important to note that this capability is not implemented within the ICAS test bed.





**Figure 4-14: Crash scenario No. 3- Perpendicular Path - Violation of Traffic Control**



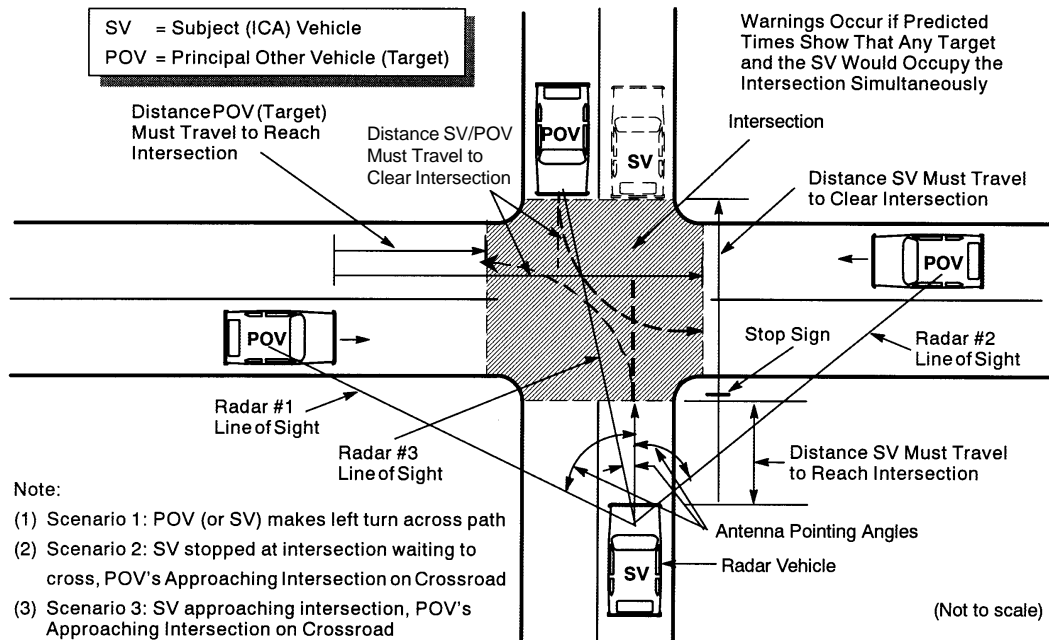
**Figure 4-15**  
**Crash Scenario No. 4 -Premature Entry - Violation of Traffic Control**

## 5.0 ICAS SYSTEM SPECIFICATIONS

This section describes the implementation and testing of a Threat Detection System that includes radar sensors, a global positioning system (GPS), and a geographical information system (GIS). These systems were integrated into a test vehicle, and data acquired and processed by the systems were presented to the driver through audio warnings and a driver vehicle interface (DVI) system that included a heads-up display. On-road tests were performed and the integrated system was evaluated. The Task 5 (1) and 6 (2) reports described the design and development of the elements comprising the integrated system. Section 5.1 describes the radar-based Threat Detection System, Section 5.2 describes the GIS/GPS and Section 5.3 the DVI.

The purpose of the ICAS countermeasure (CM) is to prevent the driver of the equipped vehicle, referred to as the “ICA Vehicle” or “Subject Vehicle” (SV), from causing a collision with another vehicle, referred to as the target or “Principal Other Vehicle” as both vehicles approach and traverse an intersection. The ICAS CM includes three primary systems: the Threat Detection System, the GIS/GPS, and the Driver Vehicle Interface. The Threat Detection System uses three radars deployed on the vehicle to warn of vehicles approaching on intersecting trajectories. The GIS/GPS uses a deceleration function,  $a_p$ , to monitor driver reaction to intersections. Lack of driver reaction on approach to intersection controlled by stop signs will cause a warning to be transmitted to the driver. The above systems utilize data derived from an on-board map database. Information derived from the map includes number and angles of roads converging at the intersection and traffic control at the intersection. A Driver Vehicle Interface, consisting of a Head-Up Display (HUD), audio tone, and haptic brake pulsing is used to transmit warnings to the driver.

Figure 5-1 illustrates an orthogonal intersection of four two-lane roads. The size of the intersection depends on lane width, number of lanes and the curb radius. The location of the intersection is provided by a GIS map prepared by Navigation Technologies for this program. The center of each intersection is identified by a longitude and latitude. The position of the ICA vehicle is determined by a differential GPS receiver on board the vehicle. Target vehicles are located by the sensor(s) (radar in the current system) on board the ICA vehicle. Figure 5-1 indicates the distances to enter and exit the intersection from which, along with target measured speed and acceleration, the intersection entry and exit times are predicted.



**Figure 5-1**

**Scenario 1, 2, and 3 Showing Distances  
Used to Compute Predicted Times and Warnings**

From the overview of the countermeasure systems given above note that

- the “a<sub>p</sub>” and active sensor warning systems are independent of each other;
- the active sensor system is independent of the type of sensor, as long as the sensor’s measurements provide sufficient information to predict intersection entry and exit times;
- the countermeasure system that warns of simultaneous occupancy of an intersection is different than one based on time-to-collision (the latter is not considered herein);
- the intersection collision countermeasure does not cover along-the-route collisions, collisions with cars backing out of driveways and rear-end collisions; and
- the intersection collision countermeasure described above requires on-board GPS, GIS and sensors.

## **5.1 Threat Detection System**

The current system has evolved over the past 4 years. In Task 4, an early intersection dynamics simulation using simulated traffic was developed to aid in determining radar ranges, radar range rates, bearing angles and bearing rates from ICA vehicle to target. In Task 5 a radar system was designed that observed the entire forward threat sector with a single rotating antenna. However, development of the system was estimated to be much too costly. Consequently, a Commercial-Off-the-Shelf (COTS) radar system was investigated that required dividing the forward threat sector into three subsectors covering the principal threat directions (left, right and straight ahead). One of the three radars scans one of the subsectors. One copy of the system was purchased as a first step towards a partial but cost-effective solution. Proof-of-principal tests conducted in Task 5 with the single radar system indicated very satisfactory performance and that the sensor had the potential to be integrated with other major components (GPS, GIS map). Both moving and static on-road tests were conducted with a fixed and scanning antenna. An extensive simulation of targets, tracker and collision warning algorithm was developed in MATLAB® as a design aid.

In Task 6, two additional copies of the COTS radar system were purchased and antenna platforms were designed and developed to point and scan the antennas over the three principal threat subsectors. (Note it is not possible to scan the antenna of a single COTS radar system over the entire threat sector of approximately 180° and maintain a satisfactory update time of 0.1 sec or less). Real-time processing software was developed and the radar sensors, GPS and GIS map were integrated into a vehicle for on-road testing. The simulation was modified to accept target data recorded during on-road tests. This allowed non-real-time tracker and system performance evaluations using actual data. It also allowed the development of special logic to accommodate specific traffic situations (see Section 5.1.6). The real-time processing in “C” code was modeled after the non-real time MATLAB® program.

On-road tests with various components of the integrated system operational began in late February 1999 over the digitized map routes. The first run with the integrated system completely operational occurred on June 2, 1999. These tests continued through late July as parameters were adjusted, errors corrected and system performance evaluated. Some collision warning logic was added/modified in response to specific traffic situations that were encountered. System evaluations are found in Section 5.1.7.

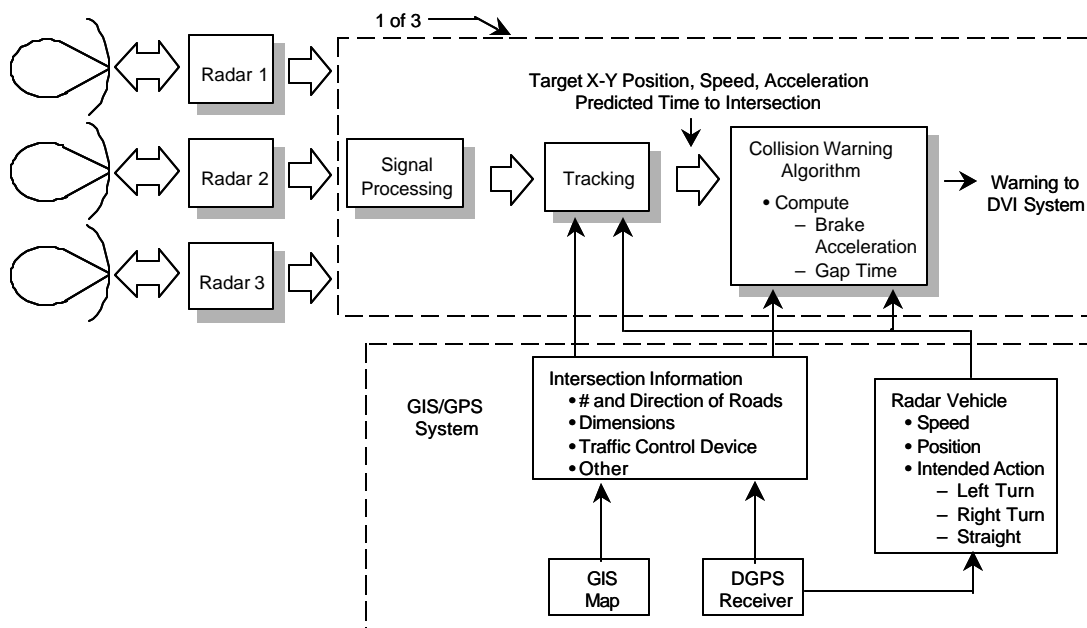
### **5.1.1 Design Overview**

The guidelines that were followed in designing the on-vehicle ICA system were:

- system should not rely on systems on other vehicles ;
- minimum reliance on infrastructure;
- minimize crash severity if crash can't be completely avoided;

- system should operate in all weather; and
- maximize use of intersection parameters derived from on-board GIS map and GPS.

A high level system architecture is shown in Figure 5-2. As indicated, the system uses three radar systems to scan three principal threat sectors: left, center and right. Also indicated in Figure 5-2 is a DGPS receiver. The GPS provides the location of the ICA vehicle at an update rate of about 10 Hz. Other features of the ICA system architecture shown in Figure 5-2, include a Kalman Filter/Tracker which provides a track on each valid target, a GIS Map which identifies an intersection in terms of its latitude and longitude, a warning algorithm which issues warnings to the driver of the ICA vehicle if the time that the ICA vehicle is predicted to occupy the intersection overlaps with the time that any target is predicted to occupy the intersection. In addition, special logic that responds to specific traffic situations, target characteristics and ICA vehicle signals has been added to the basic warning algorithm (see Section 5.1.6).



**Figure 5-2**

**ICA Threat Detection System Showing Detailed Use of Intersection Information**

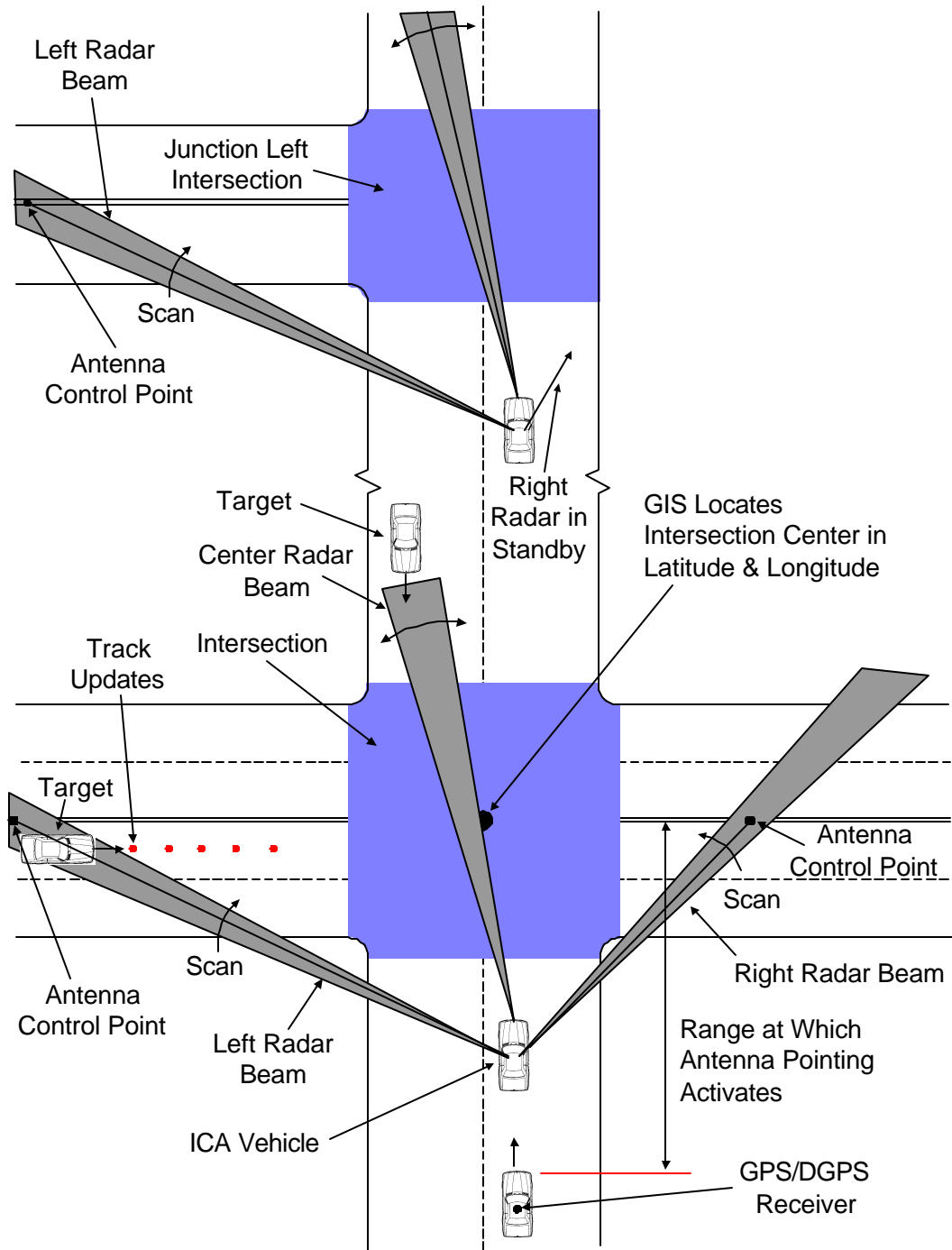
### 5.1.2 Operation Overview

The implementation of the on-board threat detection system utilized three off-the-shelf headway radars. Each antenna is mounted on a computer controlled servo platform. The left and right antennas are pointed along the left and right cross road respectively with a small scan pattern in azimuth superimposed to improve angular coverage. The antenna is pointed to the intersection of the centerline of the cross road and a maximum range radial from the radar. Since the intersection of these lines moves as the ICA vehicle approaches the intersection, the antenna pointing is called “dynamic pointing” (see Section 5.1.4).

Figure 5-3 illustrates a real-time scenario as the ICA vehicle encounters intersections along a route that has been digitized into a GIS. As the ICA vehicle approaches an intersection, the two side-looking antennas rotate from a standby position towards a point (the “control point”) defined by the intersection of a fixed length radial from the appropriate radar with the center of the cross road to the left (for the left radar) or the cross road to the right (for the right radar). The control point slides along the cross road and away from the intersection as the ICA vehicle moves toward the intersection (see Figure 5-3). As previously mentioned, this controlled pointing of the antenna, is called “dynamic pointing”, and directs the antenna toward the cross road traffic threats. Since the radar beamwidth is 4°, the observation of the cross road directions must be supplemented with a small sector about the dynamic pointing angle (the scan angle is typically 0 to 10° or 20° and does not have to be symmetric about the pointing angle). The scan pattern is entirely controlled by the antenna platform motion controller which is described in Section 5.1.4. For static situations with the ICA vehicle at the edge of the intersection (as if waiting for a signal), the antenna pointing angles are in the range of 80°-90° for an orthogonal intersection. Note that, for intersections such as “junction left” (see Figure 5-3), the right radar remains in the standby position since there is no cross road to the right (similarly, for “junction right” intersections, the left radar is in a standby mode). While the scan platform’s motion controller can accommodate any scan pattern, establishing a pointing and scanning pattern that provides good coverage of the observation sector was a non-trivial task.

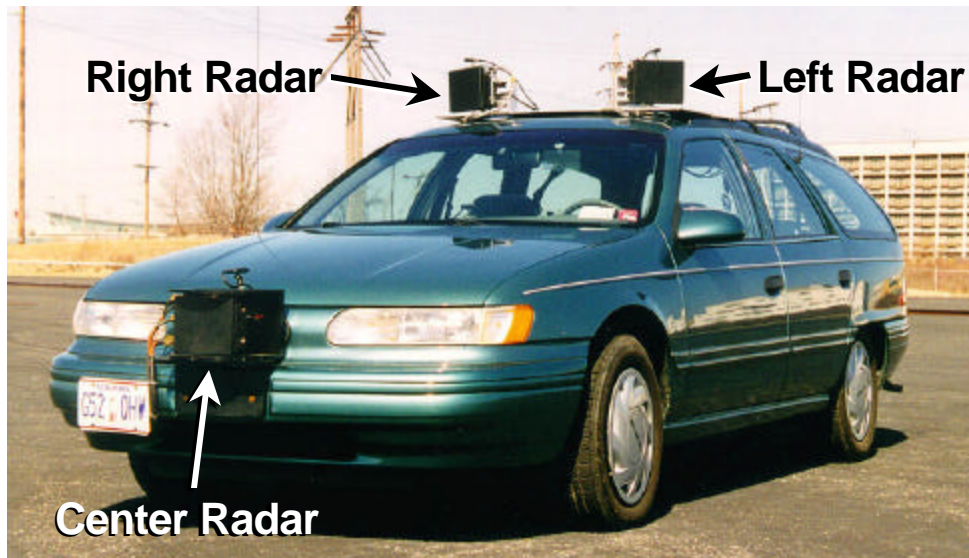
The center radar covers the sector ahead of the ICA vehicle and observes approaching traffic for a left turn either by the target or the ICA vehicle; only a small scan about a pointing angle of a few degrees (see Figure 5-3) is required.

Figure 5-4 shows the radars mounted on a Veridian (previously Calspan) test vehicle configured by Veridian engineers. (Testing with this vehicle, a Taurus, preceded the purchase and implementation of the Crown Victoria test bed.) The radars on the car’s roof observe the cross roads while the bumper-mounted radar observes oncoming traffic.



**Figure 5-3 Operation Overview - Two Types of Intersections Showing Angular Coverage of Principal Threat Sectors**





**Figure 5-4**  
**Calspan Instrumented Vehicle (CIV)**

### **5.1.3 Radar Sensor**

The sensor selected for the ICA application is radar (as opposed to lasers, for example) because of its all-weather capability, and because of the relative availability of systems and components. Three COTS headway radar systems were purchased and adapted it to the ICA task. The system selected was the EATON/VORAD radar, model EVT-200.

The VORAD radar was not designed for this application but has proven to be a reliable, cost-effective sensor that allowed the development of the entire system including the integration of a GPS and a GIS map. The VORAD radar is a “range-on-doppler” type, so called because a range rate, or doppler signal must exist between radar and target before range is calculated. Furthermore, the antenna produces a fixed beam which must be mechanically scanned. The scan platforms are described in Section 5.1.4. Tests to assure that there was no mutual interference between the three radars were performed on the Veridian test track (see Section 5.1.7.2).

Some of the VORAD radar parameters follow:

Type	FMFSK
Frequency (GHz)	24.7
Max Instrumented Range (ft)	395
Range Resolution (ft)	1.6
Velocity Resolution (fps)	0.3
Azimuth/Elevation Beamwidth (deg)	4/5.5
Update Rate (Hz)	10

#### 5.1.4 Antenna Scanning and Pointing Control

The three radar sensors mounted on the ICA vehicle (or SV, subject vehicle) are independently controlled and scanned to maximize the coverage for each radar. The forward-looking radar was scanned from directly forward to 5 degrees left for all tests. This proved adequate for the test area, but a scanning algorithm similar to that used by the side looking radars would need to be developed for intersections where the center road is not an extension of the road the SV is on as it approaches the intersection. The scan for the two side looking radars is computer controlled based on the SV's distance to the intersection and the geometry of the intersection retrieved from the map database.

The side looking radars are scanned based on an algorithm which maintains the radar pointing at a control point on the roadway which is 390 feet from the radar (refer to Figure 5-3). From this control point, the radar is scanned toward the intersection 10 or 15 degrees. The control point is calculated every 100 msec., however the radar is commanded to move only at the end of each scan. The commanded pointing angle is calculated so that at the end of the outward scan, the radar will be pointing at the control point. This angle is calculated using the current vehicle velocity, scan rate (20 deg/sec), and the 390 foot range. Leading the radar angle based on the scan rate and vehicle speed prevents the radar from falling behind in the scan pattern due to the vehicle moving towards the intersection. Similarly, for the inward portion of the scan, the command angle is determined so that the radar is pointing 10 or 15 degrees in from the control point. The command angles are also corrected for changes in the vehicle heading. For example if a driver stops at an intersection with the vehicle heading 10 degrees from the road heading (e.g. preparing to make a right turn) the radar scan angles will be compensated and the scan will still point to the control point.

The side looking radars are only scanned when the SV is within 300 feet of the intersection. At distances greater than 300 feet the radars are positioned at 31 degrees. The VORAD radars have an effective range of 395 feet and do not provide useful information at distances from the intersection greater

than 300 feet. The side looking radar scan platforms are capable of looking from directly ahead to 160 degrees behind the vehicle. The forward looking radar can scan +/- 40 degrees from the vehicle center line.

Figure 5-5 shows a typical scan for the left radar as the vehicle approaches the intersection. The initial position of the radar is at -31 degrees. This angle is a relative angle from the vehicle's heading. Negative angles are to the left and positive angles are to the right when looking forward. When the vehicle is 300 feet from the intersection the radar begins to scan outward. At approximately 421 seconds, the vehicle is stopped at the intersection and the radar maintains a 15 degree scan. The symbols on this plot represent detections from the VORAD radar and indicate that there are about 5 to 15 returns from each target vehicle as it passes through the radar beam. The tracker requires at least two detections to establish a track and several detections may be required to accurately determine the vehicle's acceleration. The fixed sample rate of the VORAD radars (10 Hz) limits the scan rate to about 20 degrees per second. For this scan rate, a scan of 10 to 15 degrees was found to be optimum. A smaller scan did not provide enough coverage, and larger scan results in too long of a time period between scans.

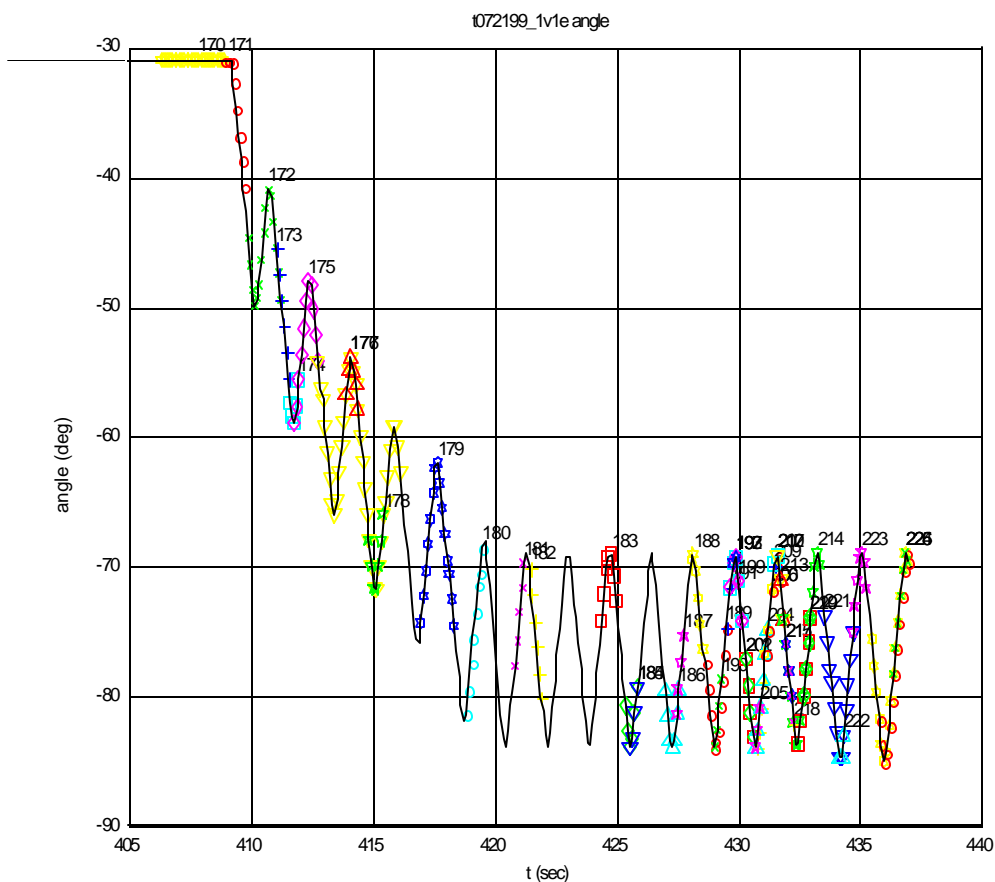
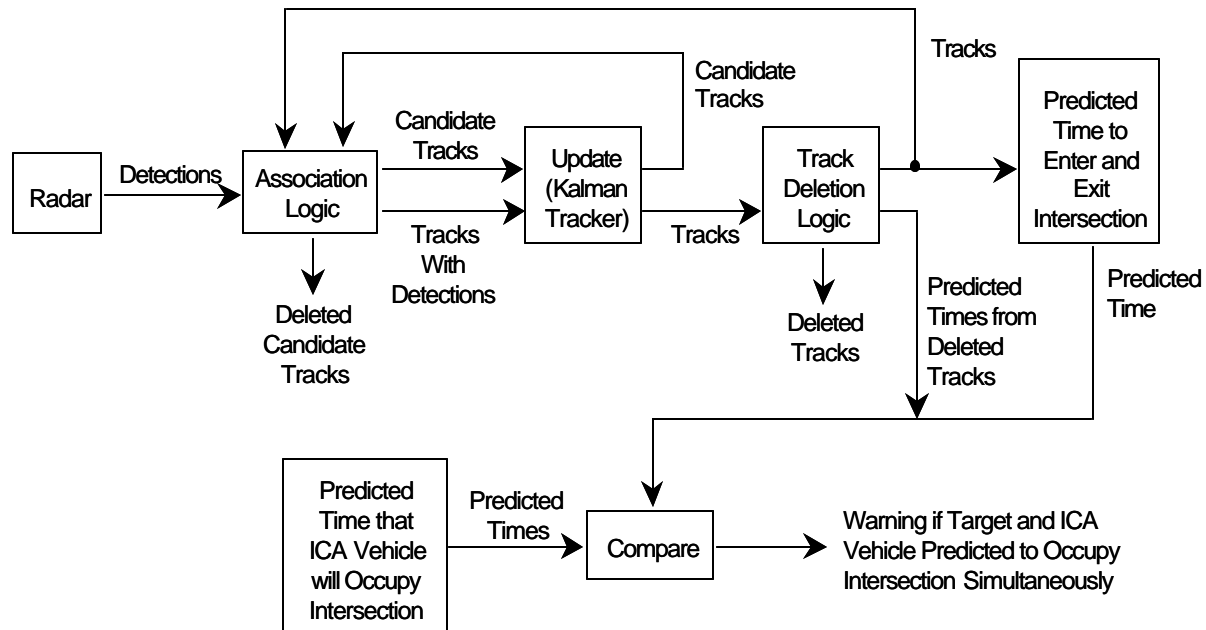


Figure 5-5 Typical Scan Pattern, Left Radar Antenna

### 5.1.5 Tracker/Collision Avoidance System

The block diagram of the ICA system shown in Figure 5-2 indicates a target tracker. (The tracker was designed and developed by Veridian.) A tracker is necessary to obtain a good estimate of the target's current state so that the time that it will occupy in intersection can be predicted. On the other hand, the time that the ICA vehicle will occupy an intersection must also be predicted, but a tracker is not used. Rather, a constant acceleration trajectory from its present position is assumed from which the time to enter and exit an intersection is calculated.

Figure 5-6 is a block diagram of the tracking process and is generally typical of a multitarget tracker (3). In this tracker, detections give birth to a "candidate" track. Each candidate track can be promoted to a track which is maintained until deleted. Detections from the radar are used to update the tracks at the end



**Figure 5-6 Collision Avoidance System Block Diagram Showing Tracker Logic**

of each processing interval. "Association" logic tries to associate the various detections (from multiple targets) with the track representing the appropriate target. The Kalman filter predicts a new state (e.g., position) of each track or candidate track based on previous updates. A "gate" is placed around the predicted positions and logic is used to determine if the detection is within the gate and hence is associated with the track. This process becomes complex when there are multiple closely-spaced tracks, each of which may claim a detection, or when more than one detection falls within a gate, or no detections fall within a gate. Most gates are generalized in the sense they gate in more than one dimension, e.g., position, speed, acceleration, etc. The gate currently used in the ICA tracker is a "maximum likelihood gate".

As implied by Figure 5-6, association logic and principal stages in track life for the ICA tracker are:

- If a detection does not fall within the gate of an existing candidate track or track, a new candidate track is formed.
- If a detection does not associate with any candidate track, the candidate track is deleted.
- If a candidate track does associate with a detection, it is promoted to a track.
- If a track does not associate with any detection for some specified number of updates it is maintained, or “coasted” on its current trajectory for a specified number of updates after which it is deleted. In the coast mode the last update of state variables is retained. The track remains ready for an association.
- If a track is deleted, the predicted times to the intersection can be held resulting in a warning extension for a specified time (typical selections are 0-5 sec). This helps radars with limited angular coverage provide warnings when the target is no longer observed. The feature is similar to coasting except that a track does not have to be maintained. (The feature was not used in the on-road evaluations). The predicted time extension would not be necessary with a full coverage system.
- A track is deleted if it has a speed that is too negative (e.g., less than -10 fps) indicating an “opening” target. (Targets with closing ranges generate “positive” speeds in the tracker.) A track is also deleted if its speed is unreasonably large (for a car) or its (x,y) position unreasonably large with respect to an intersection and its roadways.

The Kalman filter is discussed in many references (4). The state variables selected for the Kalman filter are position (x,y), speed (S), and acceleration ( $\dot{s}$ ). The measurement vector is range (R), range rate ( $\dot{R}$ ) and bearing ( $\Theta$ ). A typical “North and East” coordinate system is centered at the ICA vehicle. A plan view would indicate North as x, East as y and bearing as the pointing angle of the antenna. The Kalman filter implemented is an “extended” Kalman filter<sup>4</sup> which accommodates the non-linear measurement matrix relating target state and radar measurements. The inputs to the Kalman filter are radar updates processed by the association logic. The output is an updated estimate of the target state vector. From this state vector of position (distance to center of intersection) speed and acceleration, the predicted times to enter and exit the intersection are computed.

As mentioned earlier, the time that the ICA vehicle is predicted to occupy the intersection is determined by knowing its present position (from GPS) and assuming a constant acceleration trajectory along the road on which it is approaching the intersection (see next section). The calculations of ICA vehicle predicted times into and out of the intersection are modified in response to certain driver intentions, e.g.

a left turn, right turn or no turn. In addition, special logic is used to inhibit or enable warnings depending on target and ICA vehicle situations. These will be discussed in the next sections.

### **5.1.6 Countermeasure Warning Algorithms**

Warnings for the countermeasure system are based on the predicated times that the ICA vehicle (SV) and target (POV) will occupy the intersection. If both vehicles are predicted to simultaneously occupy the intersection, a warning is provided to the SV's driver through the DVI. Warnings are calculated and updated for every output of the radar, approximately every 100 msec. The DVI is activated if there is a warning on any of the three radar systems. The system has the capability to use different frequency audio warnings during system testing to aid in determining which radar is generating the warning.

The times for the SV to enter and exit the intersection are calculated from the current position and velocity of the vehicle. A nominal velocity and acceleration is assumed for the driver's intentions. If the vehicle is below the nominal velocity, it is assumed to accelerate at the nominal acceleration until it reaches the nominal velocity. Conversely, if the vehicle is above the nominal velocity, the vehicle is assumed to decelerate at the nominal acceleration until it reaches the nominal velocity. This velocity / acceleration profile is easily rationalized for an SV stopped at an intersection and waiting to enter. The driver would accelerate moderately, but not indefinitely and limit the velocity to a moderate speed. If the SV is going to traverse an intersection without stopping, it is assumed the driver would traverse the intersection at moderate speed, accelerating or decelerating to achieve that speed. For all tests, a nominal velocity of 40 feet/sec (27 mph) and a nominal acceleration of 4.83 feet/sec<sup>2</sup> (0.15 g's) was used. These values (user inputs) were not extensively tested, but seem to give acceptable results, and were representative of actual performance over the GIS test area. A more sophisticated algorithm may be useful for future systems to better predict SV motion.

For the POV's, the position, velocity, and acceleration from the tracker are used to calculate the time to and out of the intersection. To determine the times, a simple equation for one-dimensional motion with constant acceleration is solved.

The turn signal indicators on the SV are monitored to determine the intended path of the SV through the intersection. The path through the intersection determines the distance the SV must travel to clear the intersection and therefore determines the time the SV occupies the intersection. A right turn has the shortest distance and a left turn has the longest distance. The turn signals also have additional effects on the warnings as described in the following paragraphs.

The state of the countermeasure system is determined by the range to the intersection, the type of intersection, and the state of the SV turn signals. The range to the intersection is updated every 100 msec and calculated based on the current position of the SV and the location of the intersection. The position of the SV, the location of the intersection, and the type of intersection that the SV is approaching is determined by the GIS/DGPS system and provided to the countermeasure system. The countermeasure

system recognizes four types of intersections: Tee, Quad (4-way), Junction Right, and Junction Left. (A 4-way and a junction left intersection are shown in Figure 5-3.) The countermeasure system remains off until the SV is within 500 feet of the intersection. At this point the system is turned on but the warnings are disabled. This allows time for the trackers to initialize, but no warnings generated would be valid since the intersection is still outside of the radar range. At 350 feet from the intersection the warnings are enabled until the SV passes through the intersection.

The type of intersection determines which radars are active and therefore can generate warnings. For example, at a Tee intersection, there is no road in front of the SV and the center radar countermeasure is turned off. Similarly, the left radar countermeasure is turned off at a junction right intersection. All three radar countermeasures are operational at a quad (4-way) intersection.

Additional logic has been added to reduce false alarms. Under certain combinations of intersection type and SV intended path, the POV may not be a threat. This logic is based on SV turn signals, intersection type, and intended action by the POV as indicated by the deceleration of the POV and is different for each radar as follows (Figure 5-7 illustrates the different situations):

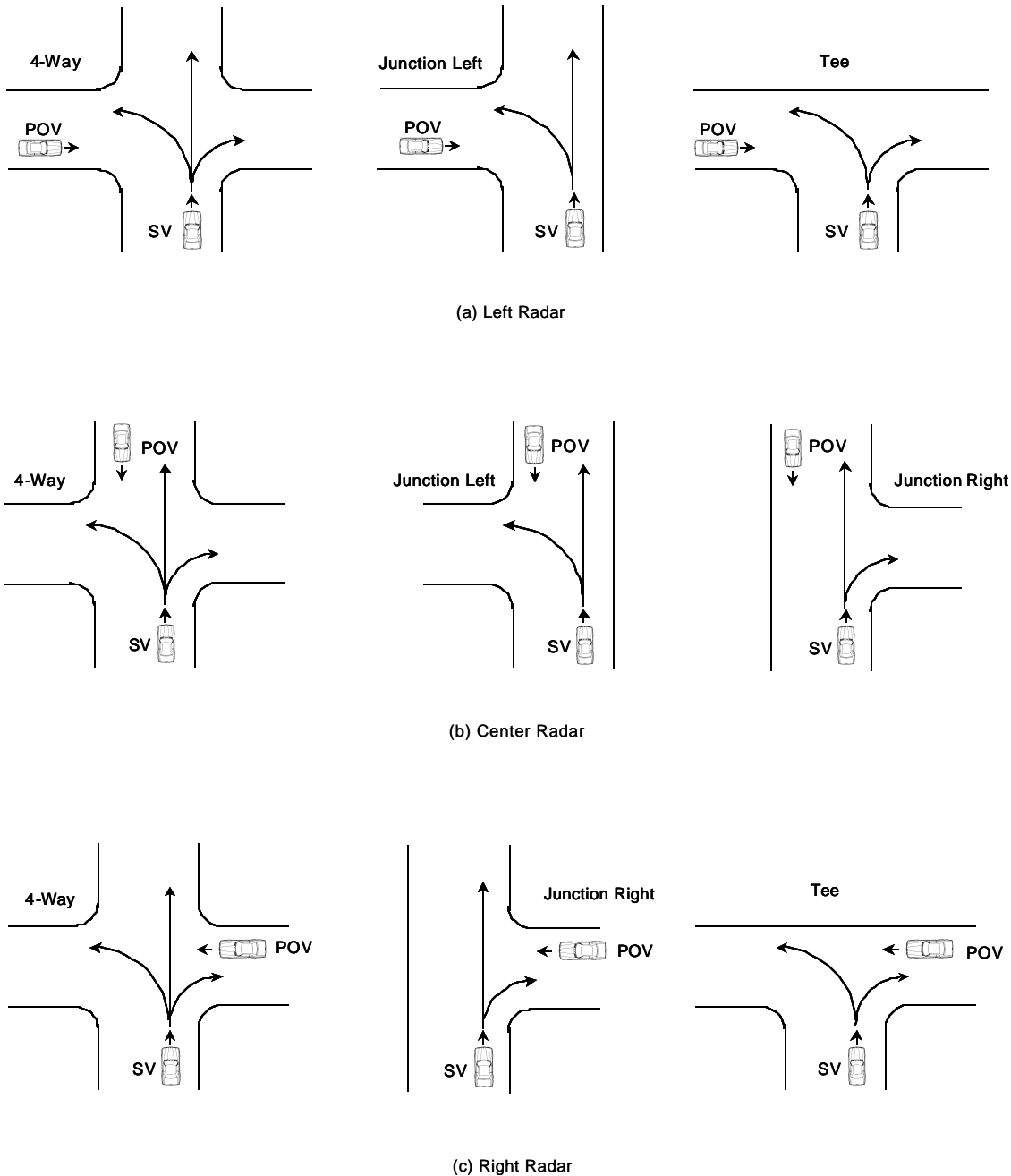
- Left Radar (observes traffic on left cross road, Figure 5-7a)
  - 4-Way Intersection. SV makes:
    - Left Turn, No Turn, Right Turn:

No warning if POV is decelerating more than a prescribed amount. (A deceleration threshold of 3 ft/s/s is a user input) This indicates that the POV is slowing to make a right turn, or stopping and is not a threat.
  - Junction Left Intersection. SV makes:
    - Left Turn, No Turn:

No warning if POV decelerates, otherwise warning.
  - Tee Junction. SV Makes:
    - Left Turn, Right Turn:

No warning if POV is decelerating
- Center Radar (observe oncoming traffic in adjacent lane(s), Figure 5-7b)
  - 4-Way Intersection. SV makes:
    - Left Turn: No warning if POV is decelerating. This indicates that the POV will make a left turn and is not a threat. Otherwise, warning.
    - Right Turn: No warning if POV is not decelerating. This indicates that the POV will not make a left turn and is not a threat. If the POV is decelerating a turn by the POV is indicated and a warning will occur. If the POV turns left the warning is correct; if the POV turns right the target is not a threat and the warning is false. However, the false alarm will not cause a collision.
    - No Turn: No warning if POV is not decelerating This indicates that the POV will not make a turn and is not a threat.

- Junction Left Intersection. SV makes:
  - Left Turn: No warning if POV is decelerating. This indicates that the POV will make a right turn or is stopping and is not a threat.
  - No Turn: Warnings are turned off. POV is not a threat.



**Figure 5-7**  
**Sketches of Intersections and Traffic Situations Observed by Radars**

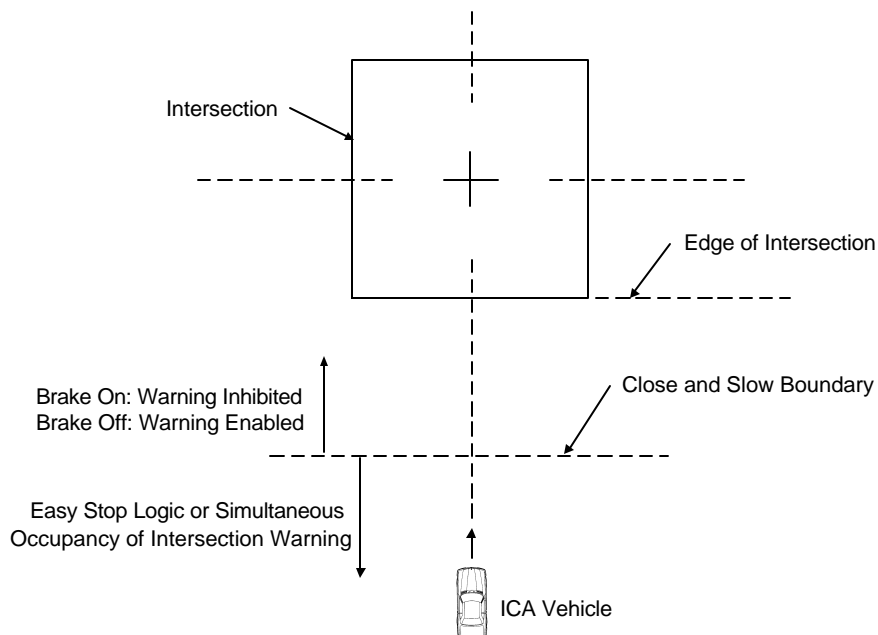


- Junction Right Intersection. SV makes:
  - No Turn: Warning if POV is decelerating. Indicates possible POV left turn across path.
  - Right Turn: No warning.
- Right Radar (observes traffic on right crossroad, Figure 5-7c)
  - 4-Way and Junction Right Intersection. SV makes:
    - No Turn: No warning if POV is decelerating. This indicates that the POV will make a right turn and is not a threat.
    - Right Turn: Warnings are turned off if SV making right turn. No threats from right roadway when SV is making right turn or stopping
  - Tee Intersection. SV Makes
    - Right Turn: Warning off. No threats from right roadway where SV makes a right turn
    - Left Turn: No warning if POV is decelerating.

Using POV deceleration as an indication of the POV's intended path has limitations and may not be a sufficient basis for decisions by the countermeasure system. Empirical testing showed that a car decelerating at greater than 3 ft/s/s is likely to either stop or make a turn. The problem is that the turn could be either a left or right turn. A car approaching from ahead of the SV making no turn is not a threat if it makes a right turn, but is a threat if making a left turn across the SV's path. If the radar had the angular resolution to determine which lane the POV was in, this would indicate which turn it intended to make. This however would only work for multi-lane roadways. Additional study is required using the SV test bed to determine if another metric can be found that predicts POV turning intentions and is reliable enough to base countermeasure warning decisions on.

Further modifications to the basic warning algorithm (warn if target and ICA vehicle are predicted to occupy intersection simultaneously) were found desirable in several traffic situations. Consider the scenario where the ICA vehicle is stopped at an intersection. Cross roads traffic will create warnings based on the assumption that the ICA vehicle might start up and prematurely enter the intersection, even though the driver may be engaging the brake. A more reasonable rationale was adopted which inhibited warnings if the ICA vehicle brake was applied when it is moving slowly and it is close to the intersection. Within the "close and slow" boundary (as an example, one pair of user-defined inputs tested was 20 ft. from the intersection edge and moving less than 5 ft./sec.) applying the brake inhibited the warning derived from the prediction of simultaneous occupancy. Releasing the brake enables the warning. Figure 5-8 illustrates the situation. Outside the "close and slow" boundary, the ICA vehicle may be moving so slowly that even with a driver reaction time delay it can easily stop if threats were visually observed. Consequently, "easy stop"

logic was implemented which, when active, inhibits the warning. This logic specifically counters the annoying warnings that occur when the ICA vehicle which is beyond the “close” boundary is in a queue that is gradually approaching an intersection. Without this logic cross roads traffic observed by the side looking radars would cause warnings even though the targets represent no threat.



**Figure 5-8 Sketch of Intersection Showing Special Logic Boundaries**

## 5.1.7 System Evaluations

### 5.1.7.1 Methods and Performance Measures

Intermediate evaluations of various components of the system, as well as evaluations of the integrated threat detection system were first performed on the Veridian test track (VERF) located behind the main Buffalo facility. Section 5.1.7.2 lists and discusses some of the quantitative evaluations performed on the test track. Following initial evaluations on the VERF, on-road tests were performed. While some quantitative evaluations are possible (and were performed) on the test track by isolating a target or measuring its location by driving over a pressure strip of known location, that is not possible in traffic. The primary evaluation tools used in on-road tests were video cameras which recorded the scene that the radar sensors observed. While warnings can be identified and the target’s position determined by the radar, no

independent measure of the target's position is available. Resources did not permit the use of an instrumented target in traffic. Nevertheless, evaluations using the video data proved very effective.

### 5.1.7.2 *VERF Tests*

Figure 5-9 shows the Veridian Test Track. Tests performed on the Veridian test track (VERF) and some brief results/comments include:



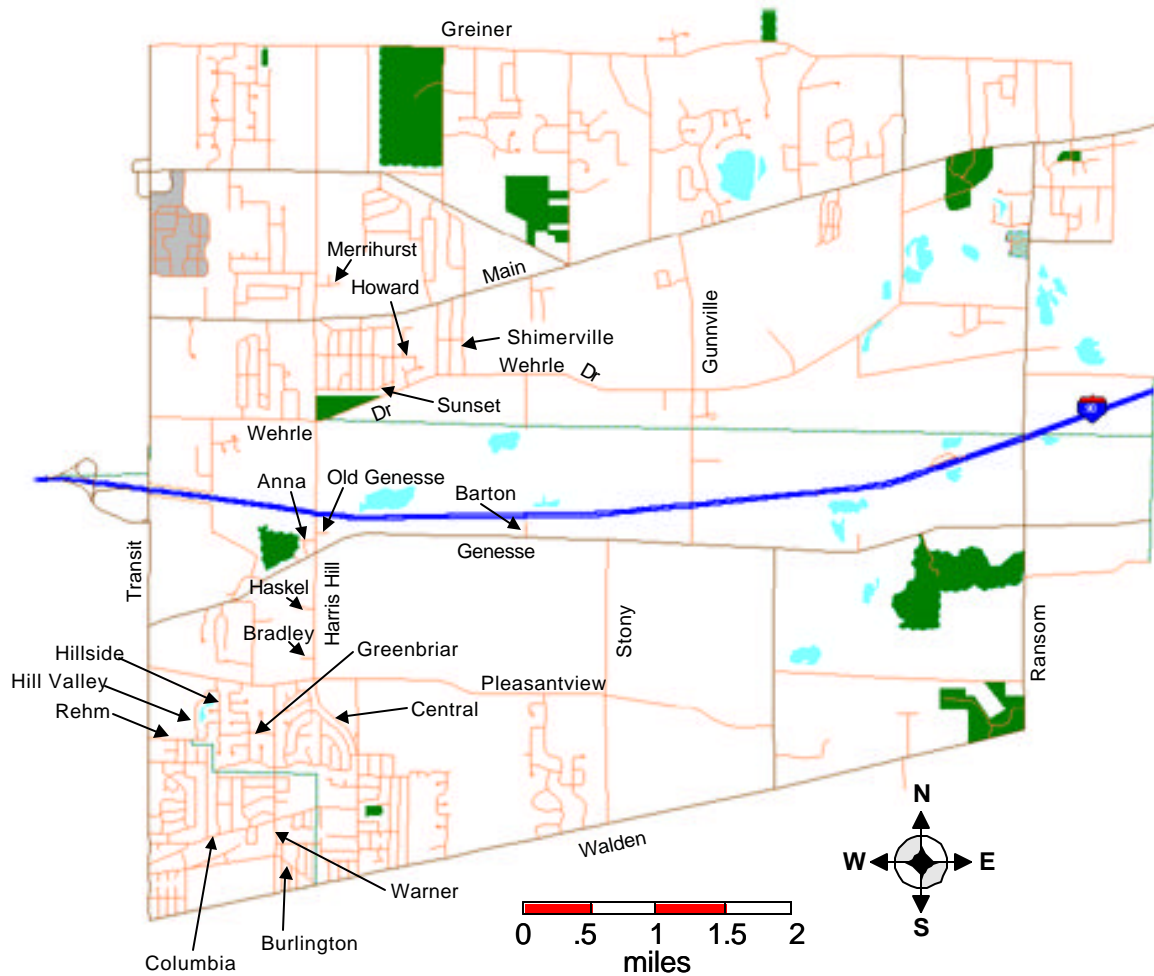
**Figure 5-9**  
**Veridian Test Track Facility**

- initial checkout of all hardware and software;
- test for mutual interference between the three radars (none was found);
- radar evaluations (range and doppler accuracies); and
- tracker performance
  - a single track on a single target was observed to split into two or three tracks at close range (100-150 ft.). This is probably due to the high velocity resolution of the radar (1/3 fps) or doppler scintillation occurring as the target fills more of the beam at close ranges. Logic was used to eliminate spurious tracks if they were close enough in distance and speed to the primary track.

- range and range rate accuracies were checked by driving a single target towards the sensor on the VERT track instrumented with pressure strips. The range rate was also compared to that observed with a police radar speed gun. In both cases the range and range rate were within the specifications of the radar. However, calibration coefficients were developed for range using a least squares fit to the data collected during the tests. The coefficients were not sufficiently stable over all conditions to warrant their use (see Section 6.1).
- warning on and off times
  - with a measured intersection painted on the track and the track instrumented with a series of pressure strips which record the position of the target as it passes over them, warning on and off times were compared to when the warning should actually have turned on and off. A sketch of the test procedure and results are presented in the System Validation section of Section 6.
- testing of special countermeasure logic such as easy stop, brake, turn signal and destination logic (see Section 5.1.6).

### **5.1.7.3 On-Road Tests**

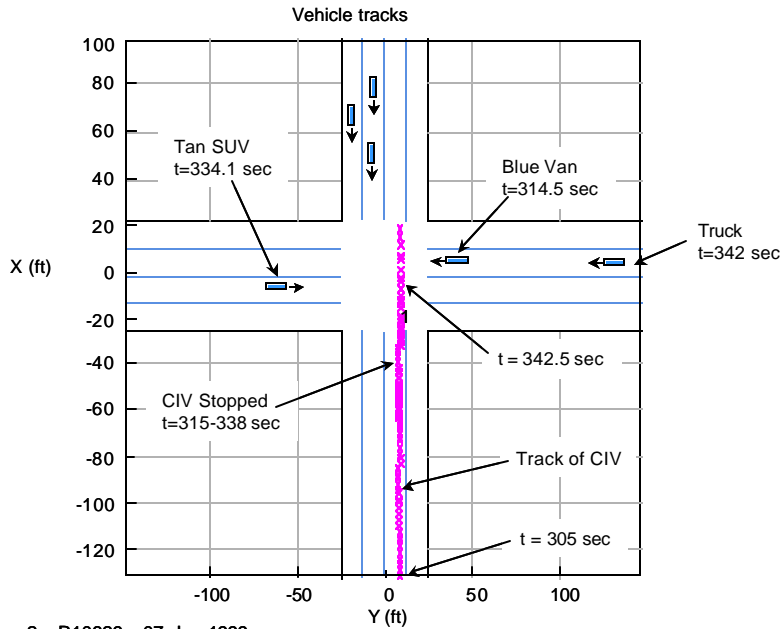
Evaluations of the integrated system were performed in traffic on the road with selected drivers from the project staff. A 30 square mile area of roads and intersections near Buffalo, NY was compiled by Navigation Technologies into a high-resolution GIS database map. The location of intersection centers and road segments are defined by their latitude and longitude. A map of the digitized area is shown in Figure 5-10. The area is bounded on the north by Greiner, east by Ransom, south by Walden and west by Transit. As can be seen, there are a large number of intersections including 4-way intersections, junctions left and right and T's. Not all, however, are heavily traveled. Appendix A contains a table summarizing the tests over the GIS test area. Results from selected intersections are presented in this section. One of the most heavily traveled routes with 4 major intersections and 7 minor intersections is Harris Hill Road from Pleasant View to Main. The next section presents data from the intersection of Harris Hill and Wehrle.



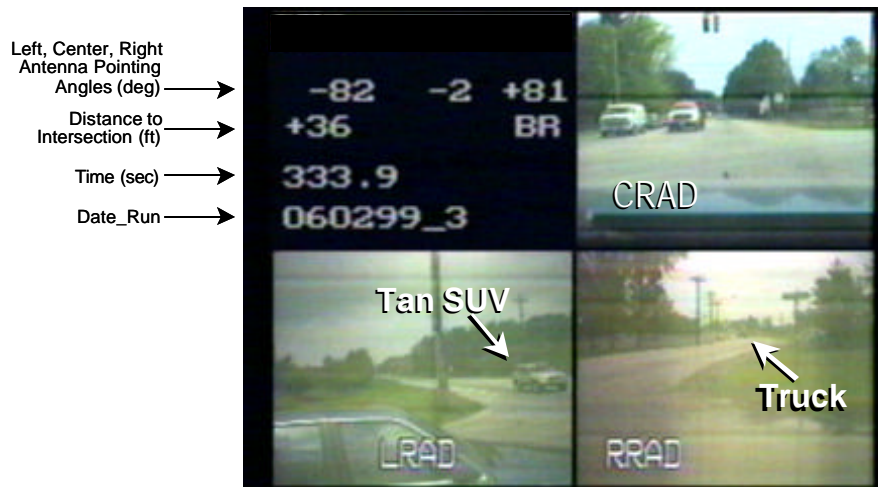
**Figure 5-10 Map of Test Area Digitized Into GIS Database**

### 5.1.7.3.1 Intersection of Harris Hill and Wehrle

This sample result of the system evaluations uses radar and GPS data recorded as the Calspan Instrumented Vehicle (CIV) approaches on Harris Hill and stops at the Wehrle Drive intersection. Figure 5-11a shows the position of the CIV at various times. The position at selected times of three target vehicles that were detected and tracked by the left and right radars are also shown. Figure 5-11b shows the video screen that was recorded simultaneously with the radar and GPS data. As indicated, the radar pointing angles with respect to the CIV's longitudinal axis are shown on the video screen along with time and the CIV's distance to the intersection center. Three video cameras show the intersection as viewed by the three radars. The time stamp allows correlation of the radar and GIS data with the video.



(a) X-Y Plot of Intersection Showing Position of Targets and CIV at Various Times



(b) Video Snapshot of Targets as Observed by Left Radar (LRAD), Center Radar (CRAD), and Right Radar (RRAD)

**Figure 5-11**

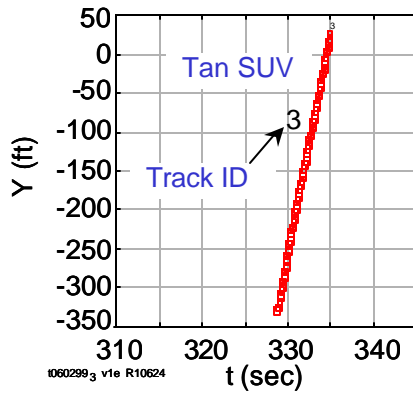
**Position of CIV with Time and Video Snapshot of Targets  
at the Intersection of Harris Hill and Wehrle Drive, Buffalo, NY**

Figures 5-12a through 5-12d show the targets' tracks of distance (y) from target to intersection center and resultant warnings for the left and right radars. For the left radar, the track distance to the intersection decreases from about (-)330 ft. to about (+)25 ft. crossing the intersection center at about 334.7 sec. A warning from the left radar was obtained (see Figure 5-12b) based on an assumption that the CIV might start up, violate the stop light and prematurely enter the intersection; in this case, both the target and CIV would be predicted to occupy the intersection simultaneously. (Note, the warnings are depicted as a bar when on. The vertical scale is track identification.) This warning is disabled in the real-time system because the CIV is stopped with the brake applied, thus eliminating the annoyance of having the audible warning on when the CIV is stopped. (In the example of Section 5.1.7.3.2, warnings with and without brake and other gating are shown.)

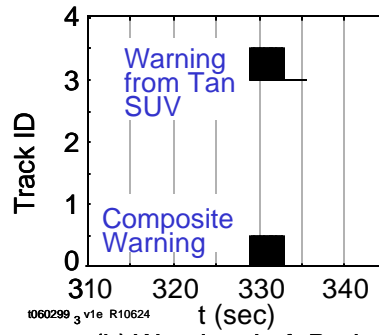
In Figure 5-12c, the cross road tracks of three targets approaching from the right are shown along with the associated warnings (Figure 5-12d). The truck target was shown in the video of Figure 5-11b. Its speed and distance result in a prediction that it will barely enter the intersection before the CIV is estimated to exit the intersection. Hence the warning is very short. Since the CIV is actually stopped at this time, these warnings would be disabled until the brake is released in the real-time system.

In Figure 5-12e and 5-12f the tracks of many targets observed by the center radar are shown as they approach the intersection in the opposing adjacent lane across the intersection and stop in line at the light. (Note that this is the x direction (see Figure 5-11a).) Since the CIV was first in line, the center radar clearly observed and initially tracked the approach of these vehicles. However, the more distant targets quickly became masked by the closer targets as they all approached the intersection. The video snapshot shows only the first cars in line. None of the near targets made any turns, but a number of warnings occurred as the CIV and targets approached the intersection. However, of those in the time segment 310-345 sec., all warnings were suppressed in the real-time system except warning number 19, because the CIV was stopped with the brake applied. Warning number 19 occurred as the CIV and opposing traffic started to move into the intersection following the changing of the signal.

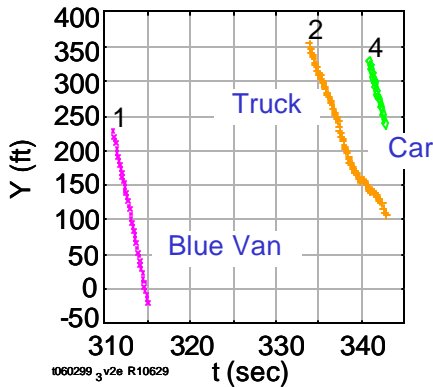
Figure 5-13 shows the combined warnings of the left and right radar. A substantial gap exists between the warning from blue van (right radar) and the tan SUV (left radar). During this gap, the ICA vehicle with nominal acceleration of 0.15 g could safely cross the intersection, if it were to violate the signal. It would exit the intersection before the cross road traffic entered the intersection.



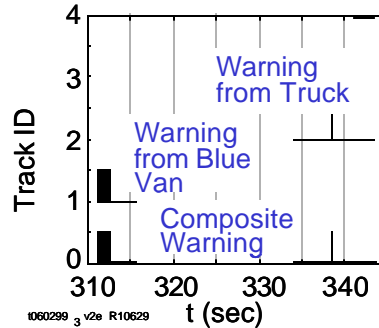
(a) Track, Left Radar



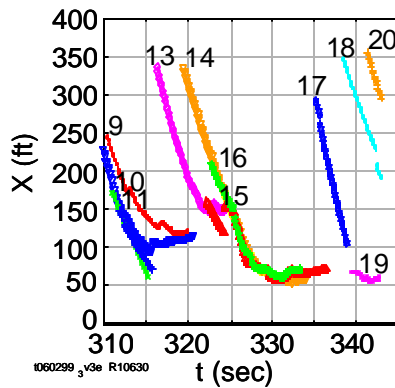
(b) Warning, Left Radar



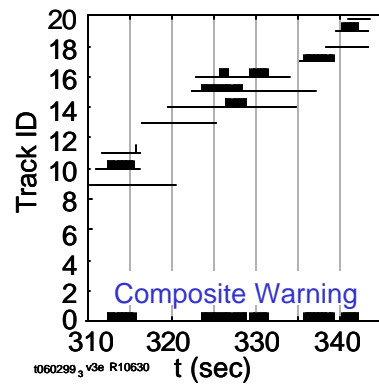
(c) Tracks, Right Radar



(d) Warnings, Right Radar



(e) Tracks, Center Radar

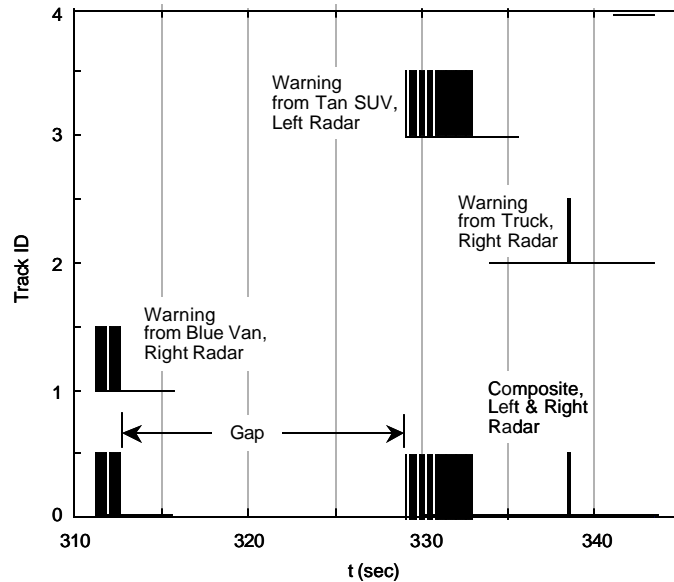


(f) Warnings, Center Radar

Note: X, Y = 0 is intersection center  
Track ID = 0 is composite warning

**Figure 5-12**  
**Selected Radar Derived Data for Harris Hill and Wehrle Drive Intersection, Buffalo, NY**

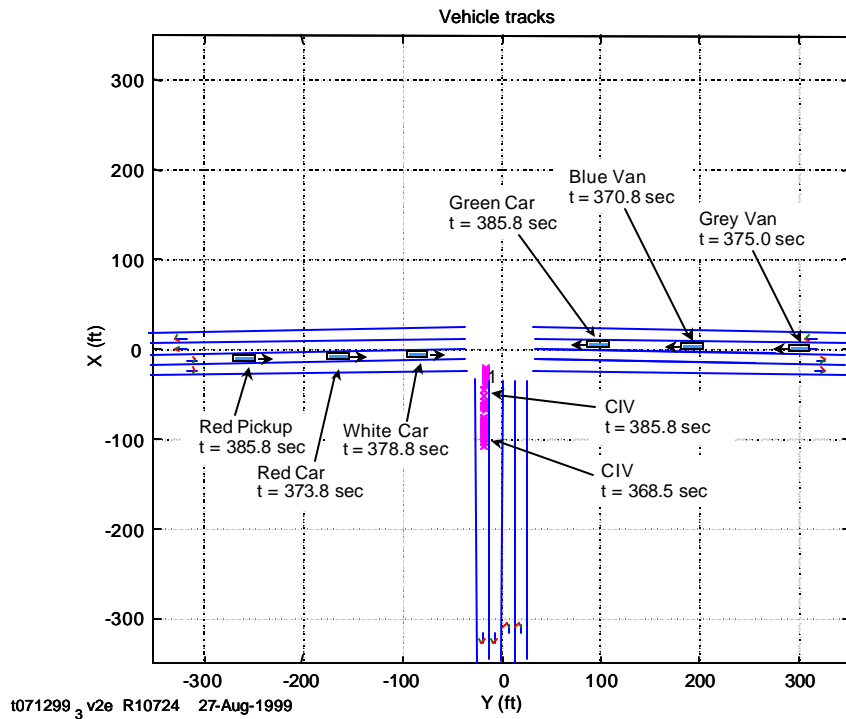




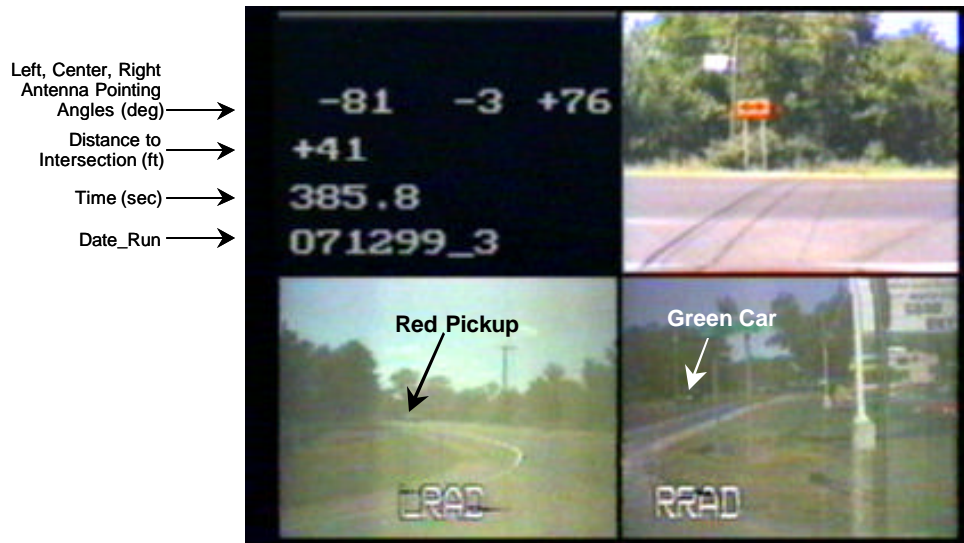
**Figure 5-13**  
**Combined Warnings Left and Right Radars, Harris Hill and Wehrle Intersection**

#### 5.1.7.3.2 Intersection of Stony Road and Genesee Street

As can be seen on the map of Figure 5-10, this intersection is a “T” when approaching Genesee on Stony. Consequently, only the left and right radars are tracking targets. Another difference from the previous example is that all of the special countermeasure logic described in Section 5.1.6 was installed for this run. The cumulative effect of this logic is summarized as a “gate”. Consequently, there will be warning plots with and without the gate, the latter simply being the warnings associated with the basic algorithm of simultaneous occupancy of the intersection by ICA vehicle and target. Figure 5-14a shows the x, y positions of ICA vehicle and several targets at various times. Figure 5-14b is a snapshot of the video showing the targets observed by the left and right radars at a time of 385.8 sec. During the interval 365-400 sec., 13 tracks were obtained from the left radar, 5 of which were of zero velocity, probably from clutter. Figure 5-15a shows the y positions of the tracks while Figures 5-15b and 5-15c show the warnings without and with the logic gate. Most of the target tracks in the time interval 365 to 380 sec. result in very abbreviated warnings as can be seen from Figure 5-15b. There are two reasons for this. First, the ICA vehicle up to that time was sufficiently far from the edge of the intersection that by the time it was predicted to enter the intersection, the target track predicted the target to have exited the intersection. The second reason is that the target was not detected soon enough resulting in the aforementioned target exit time

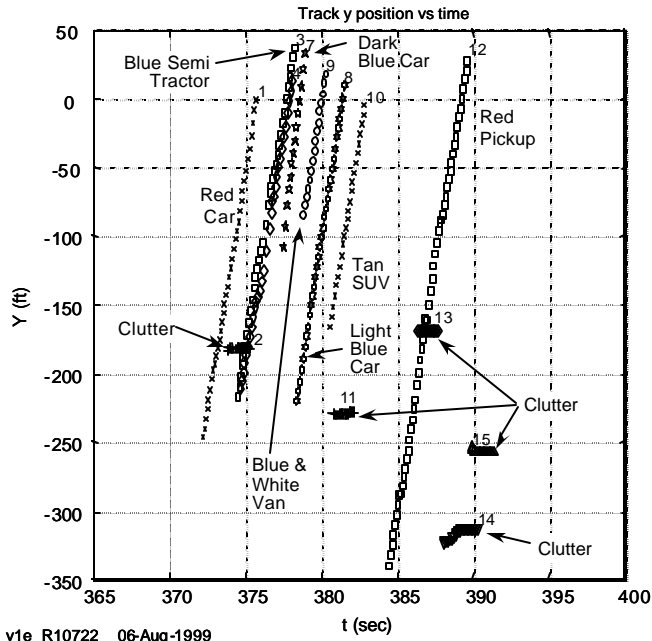


(a) X-Y Plot of Intersection Showing Position of Vehicles at Various Times

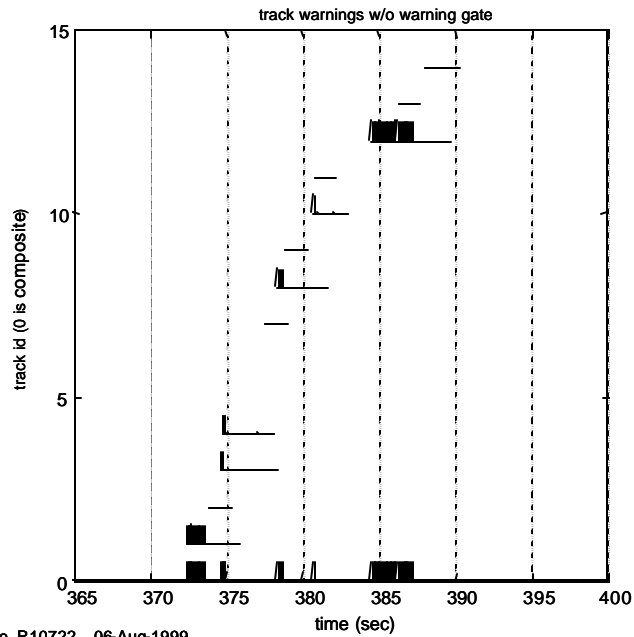


(b) Video Snapshot of Targets as Observed by Left (LRAD) and Right (RRAD) Radars

**Figure 5-14**  
**Position of ICA Vehicle and Video Snapshot of Targets**  
**at Intersection of Stony Road and Genesee Street**

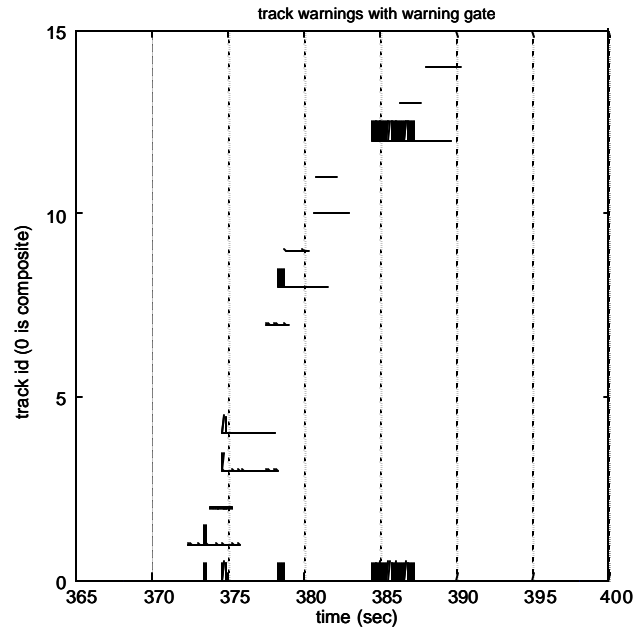


(a) Tracks, Left Radar

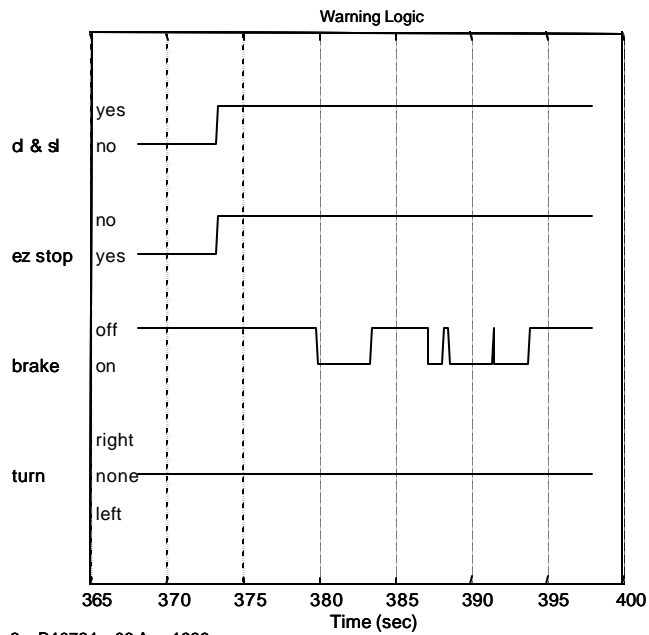


(b) Warnings Without Gate, Left Radar

**Figure 5-15. Radar Tracks, Warnings, and Warning Logic for Selected Interval at Intersection of Stony Road and Genesee Street**

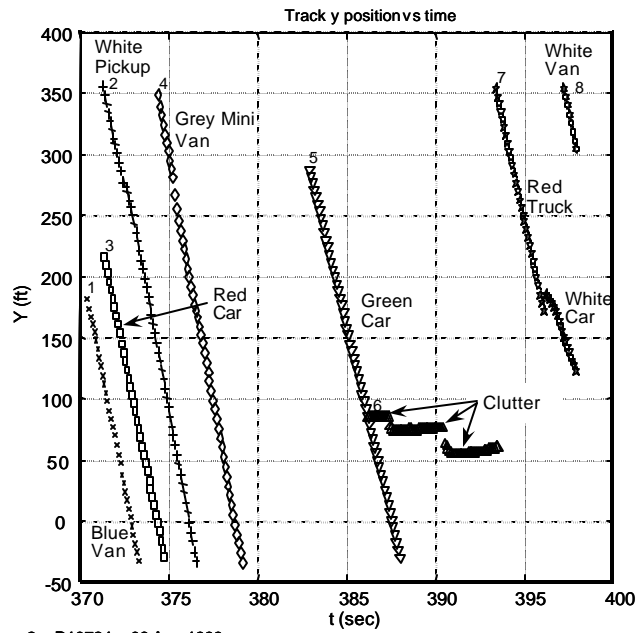


(c) Warnings, With Gate, Left Radar

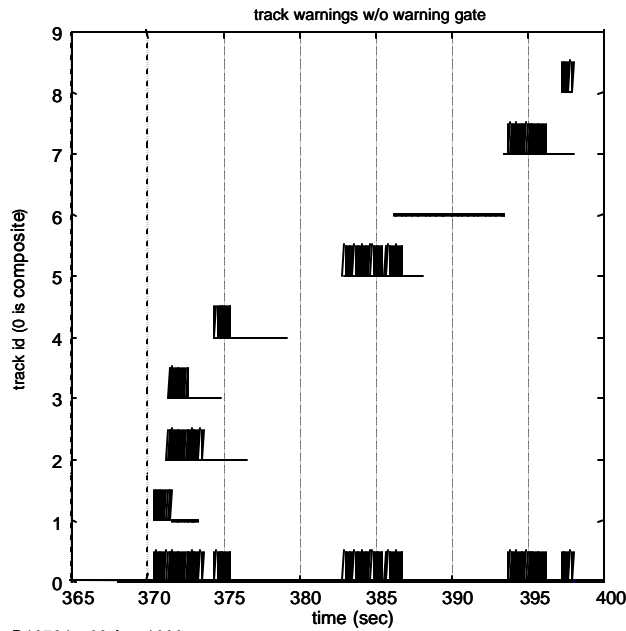


(d) Warning Logic

Figure 5-15. Radar Tracks, Warnings, and Warning Logic for Selected Interval at Intersection of Stony Road and Genesee Street (continued)

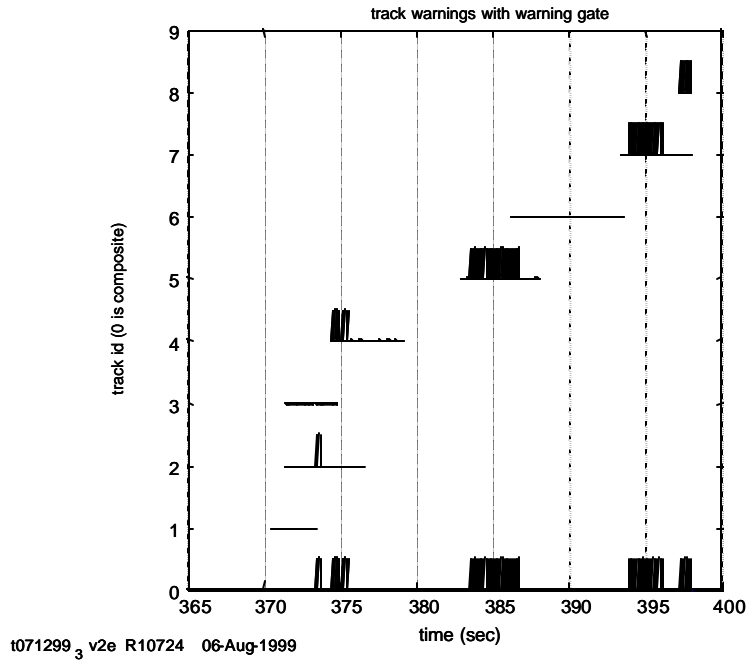


(e) Tracks, Right Radar



(f) Warning, Without Gate, Right Radar

Figure 5-15. Radar Tracks, Warnings, and Warning Logoc for Selected Interval at Intersection of Stony Road and Genesee Street (continued)



(g) Warning, With Gate, Right Radar

**Figure 5-15 Radar Tracks, Warnings, and Warning Logic for Selected Interval at Intersection of Stony Road and Genesee Street (continued)**

prediction. The late detection can be seen on Figure 5-15a where many of the target y positions start between  $y = -250$  to  $y = -150$  ft. (instead of  $-400$  to  $-300$  ft.). The late detection can be caused by the target not being observed because of the limited angular coverage of the antenna scan pattern. (A wider scan angle and faster scan rate would improve the situation. The faster scan rate, however, cannot be tolerated by the VORAD radar system because of its fixed update rate). At about 380 sec., the ICA vehicle moved closer to the intersection and a clear warning was obtained on the red pickup shown in the video of Figure 5-14.

Figure 5-15c shows that the effect of the special gating logic on the basic warnings is minimal, in this case. Only for track one is the onset of the warning significantly delayed. This is because the ICA vehicle is initially far enough from the intersection edge that it is outside the “close and slow” boundary (see Section 5.1.6) and the easy stop logic is in effect and blocks the onset of the warning. Figure 5-15d shows a binary (on/off) time line of the logic. The top trace indicates when the ICA vehicle is within the close and slow boundary (yes). The easy stop logic is indicated in the second trace. When active (yes) it inhibits the warning. The brake inhibits all warnings from 380 to 383 sec. While this eliminates the brief warning on track 10, it has no effect on the warning from the red pickup since that occurs after 383 sec.

For the right radar, 8 non-clutter tracks occurred (Figure 5-15e) which resulted in the warnings shown in Figure 5-15b. The initial detection range was slightly better than for the left radar, perhaps due to a more fortuitous combination of scan angle and target position. Nevertheless, warnings are brief until the ICA vehicle moves closer to the edge of the intersection after about 380 sec. A significant warning is obtained on the green car (track 5) shown in the video of Figure 5-14b. Figure 5-15g shows the effect of the gate logic on the basic warning algorithm. The warnings from tracks 1 and 3 are eliminated while the warning from track 2 is significantly delayed due to the easy stop logic blocking the warning. The same warning logic plots of Figure 5-15d apply to the right radar.

Note that the turn signal function shows no turn signal was on during the time interval shown, even though this intersection is a “T” and a turn must be executed. The turn signal was inadvertently not engaged. This affects the time predicted for the ICA vehicle to occupy the intersection since a turn takes longer than going straight across the intersection. However, the effect was quite likely to be minimal. (It should be noted that for all types of intersections, the collision warning system depends on the driver of the ICA vehicle to engage the correct turn signal.)

### **5.1.8 Limited Coverage vs. Full Coverage System**

It has been well established in this report that a conscious decision was made to develop a partial, cost-effective solution to the ICA problem, rather than a complete solution. The primary benefits of this approach include:

- high probability that integration of the radar sensors with the GIS/GPS and its testing will be realized and evaluated; and

- identification of traffic situations that are difficult regardless of the type of system.

The major difference between the complete and partial solutions is the coverage, in azimuth angle, of the threat sector. The limited coverage system is a 3-radar system. One design of the full coverage system utilizes a radar with a rotating back-to-back antenna. Another might utilize 2 or 3 small phased array antennas with electronically scanned beams. A comparison of the expected performance of the three-radar system that was implemented on this program and an on-board system with full angular coverage is shown in Table 5-1. For Scenario 2, where the SV is stopped at an intersection, the limited coverage system with each side-looking antenna having a small scan superimposed on an appropriate pointing angle should perform very well. (Note: illustrations of the scenarios are given in Section 3.) For Scenario 1, where the SV intends to make a left turn across oncoming traffic, the SV's left turn signal must be on to activate logic which senses that the oncoming traffic is not decelerating and thus represents a threat to executing a left turn. For the case where the SV intends to go through the intersection, the deceleration of any target in the inner lane probably indicates it intends to execute a left turn across the path of the SV. Consequently, the ICA system must sense (1) deceleration of a target and (2) lane occupied by the decelerating target (a decelerating oncoming target in an outer lane is probably making a right turn and is not a threat to the SV). Physical size limitations of the antennas for the limited coverage system and the full coverage system may make lane discrimination difficult because the beamwidth is too large. Beam splitting techniques such as monopulse radar may help. Without lane discrimination, deceleration of any target would cause a warning which may be a false alarm if the target is executing a right turn. (Note the false alarm, while annoying, will not result a collision).



**Table 5-1 Comparison of Expected Performance of  
Threat Detection Systems for Different Scenarios**

Scenario	Situation	Figure	Expected Performance		Comments
			Limited Coverage <sup>(4)</sup> System (3 radars)	Full Coverage <sup>(4)</sup> System	
2	SV <sup>(1)</sup> stops at intersection	3-2	Good	Very good	Limited Coverage <sup>(4)</sup> System will require scanning to accommodate all traffic situations.
1	SV makes LTAP <sup>(2)</sup> of oncoming targets	3-1	Good	Very good	Oncoming targets will produce warning <sup>(3)</sup> even if SV not executing LTAP. Therefore, must enable warning with left turn directional signal.
1	Target makes LTAP of SV	–	Marginal	Good	Must measure deceleration of target to distinguish target's turn intention from straight ahead intention. Better angular accuracy of full coverage system will improve lane identification for discrimination of target's intention to turn left or right.
3	SV and target approach intersection	3-3	Marginal	Very good	Changes in bearing result in minimal observation of target by limited coverage system.
Footnotes: (1) SV = subject vehicle = radar vehicle = ICA vehicle (2) LTAP = left turn across path (3) Warning occurs when target and radar vehicle (SV) are predicted to simultaneously occupy the intersection. (4) Limited coverage system is 3 narrow beam (4°) antennas; one points left, one straight ahead, one points right. Full coverage system observes entire forward threat sector with rotating 1° antenna.					

The most difficult scenario for the limited coverage system is No. 3. The limited coverage system implies that threatening cross road targets may slip through the angular coverage. This has been observed with the limited coverage system implemented on this program.

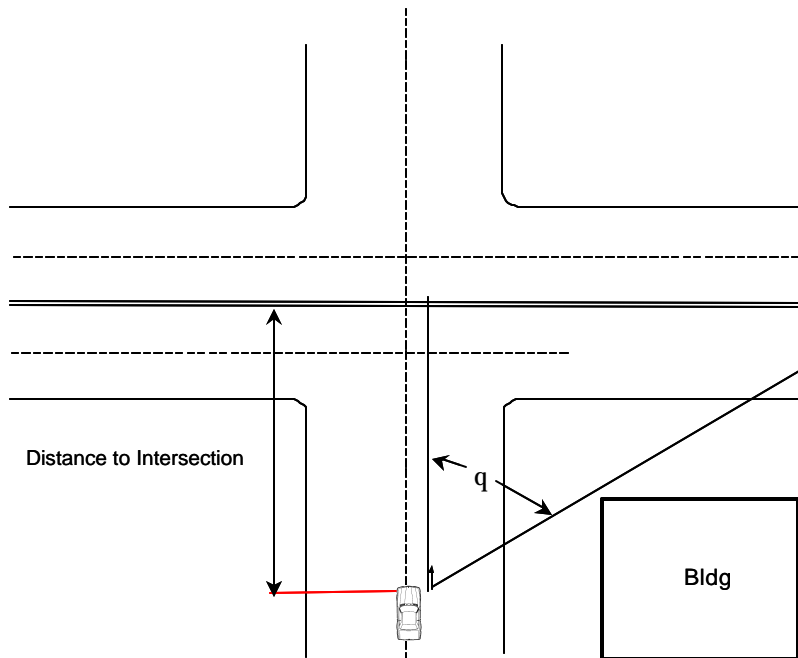
The current 3-radar system more than satisfied the expected performance indicated in Table 5-1 and improvements cited in Section 5.5 would significantly reduce system deficiencies.

### **5.1.9 Line of Sight Issues**

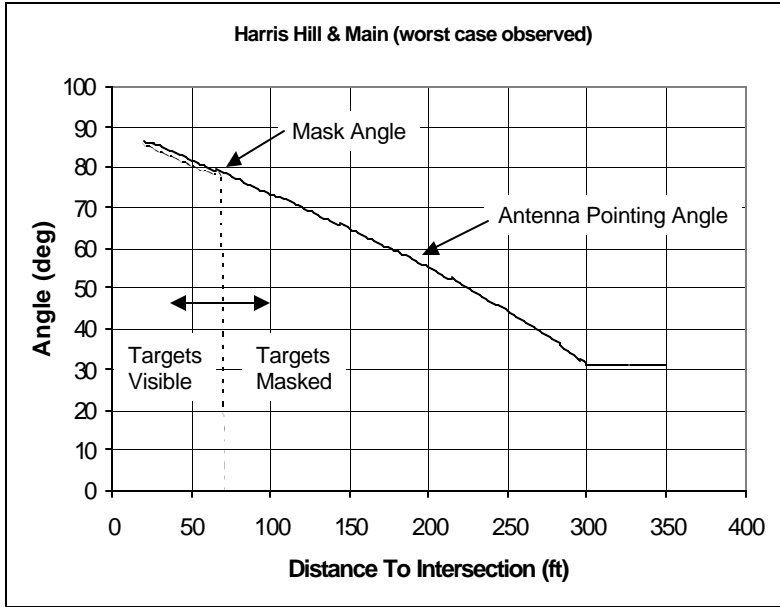
The line of sight (LOS) from the side looking radars to cross roads targets can be limited by buildings or trucks in lanes adjacent to the ICAS vehicle. This is referred to as masking. Of concern is that

a target may not be observed in time to track it and issue a warning to which the driver can react. For the GIS test area the LOS problem for the side looking radars was considerably less than expected. (For the forward looking radar, the critical observation sector is the adjacent oncoming lane which has less chance of masking; however LOS can be limited by a vehicle immediately in front of the ICAS vehicle.)

Figure 5-16 illustrates the problem. The angle  $T$  is called the mask angle. By observing the video from the side looking cameras (which are mounted on the side looking antennas), the angle at which the cross road first becomes visible after being masked can be determined. In addition, the distance from the ICAS vehicle to the center of the intersection can be obtained. Both these parameters are available from the data panel recorded as part of the video (see Figure 5-11). Figure 5-17 shows the antenna pointing as a function of distance to intersection and the distance and angle at which masking first ceased to exist (68 ft. and  $78^\circ$  respectively) as the ICAS vehicle approached the intersection. Figure 5-17 shows the worst case that was observed in the GIS test area. For a sample of other intersections, the ranges (left and right radars) were as large as 280 ft. An average mask distance was 150 ft.



**Figure 5-16**  
**Line of Sight (LOS) Issue**



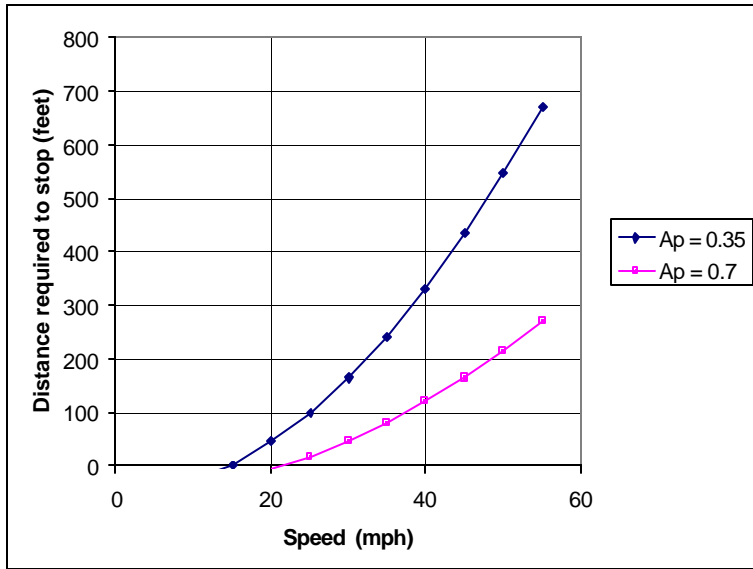
Time Required for ICAS Vehicle to Enter Intersection from Masking Range	
D <sub>mask</sub> = 68 ft	
Speed (mph)	Time to Enter (sec)
45	0.45
30	0.8
15	1.8
7.5	3.7

**Figure 5-17**  
**Mask Angle and Antenna Pointing Angle**

For the worst case that was shown in Figure 5-17, the time required for the ICAS to enter the intersection from the mask distance of 68 ft. (taking into account that the edge of the intersection is some 25 ft. from the center) is tabulated in Figure 5-17 for selected constant speeds. This gives an idea of the time available to the ICAS vehicle driver to take corrective action. At 45 mph, there is essentially no time. At slower speeds there is adequate time to take action.

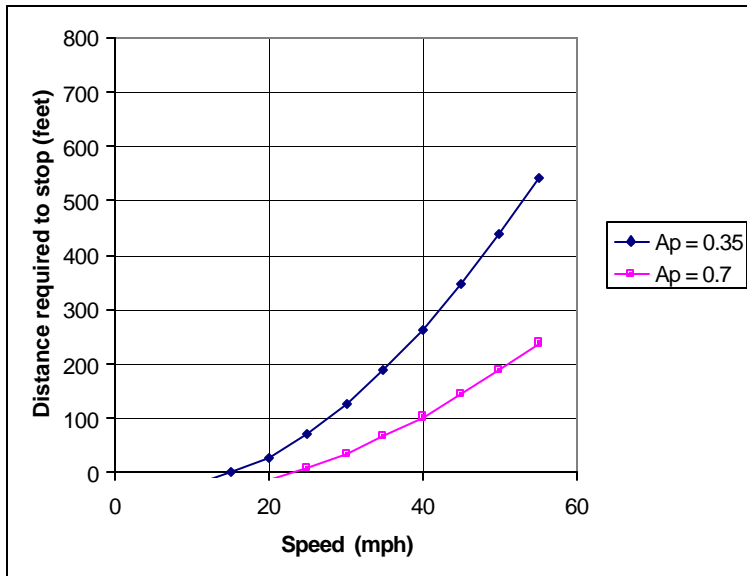
For example, Figure 5-18 shows the distance required for a driver to stop at various speeds assuming a modest driver reaction time and a braking deceleration of approximately 0.35g or 0.7g. To bring the ICAS vehicle to a stop from 68 ft (from intersection center) to the edge of the intersection, the speed would have to be 20 mph or less for braking at 0.35g. However, if “emergency” braking of 0.7g were used, the vehicle speed could be 30 mph.

If the braking were controlled by computer so that driver reaction time were eliminated, the speeds from which the vehicle could be stopped before entering the intersection are about 25 and 35 mph for 0.35 and 0.7g braking, respectively (see Figure 5-19).



Speed Mph	Stopping Distance (ft)	
	Ap = 0.35	Ap=0.70
15	4	0
20	45	0
25	99	16
30	164	45
35	242	80
40	331	119
45	432	164
50	546	215
55	671	270

**Figure 5-18**  
**Driver Stopping Distance**



Speed Mph	Stopping Distance (ft)	
	Ap = 0.35	Ap=0.70
15	0	0
20	28	0
25	72	0
30	126	46
35	189	67
40	262	103
45	345	144
50	438	189
55	540	239

**Figure 5-19**  
**Computer Controlled Braking Distance**

With or without computer controlled braking, the worst case mask range still permits stopping the vehicle if its speed is moderate, as it should be in areas where LOS is obstructed. The on-board threat detection system has at least LOS equivalent to visual LOS and somewhat better than that of the driver for cross roads, since the side looking radars are mounted on the roof of the ICAS vehicle. Consequently, it is highly recommended that tests be conducted in a city GIS test area where “urban canyons” will be encountered.

#### **5.1.10 Warning Statistics**

In a first attempt to evaluate the ICAS as an integrated system, false and missed warnings were tabulated over several routes through the GIS test area. In Appendix B, the results are tabulated for the left, right and center radars for each intersection encountered. Over the routes traveled, 105 intersections were tabulated and the system evaluated by examining the video, listening to the audible warnings and coordinating them with the visual observation of traffic. (Radar data were recorded for almost all of the intersections, but the volume of data precluded reducing and evaluating all of it). The intersections are identified by name in Table B-1 ( the road on which the ICA vehicle is traveling is given first) and can be located on the map in Figure 5-10. All of these tests were conducted in July 1999.

Table 5-2 summarizes the results. Of the 105 intersections, 68 were 4-way (or quad) intersections, 16 were of the junction left type, one was a junction right and 20 were “T” junctions. Note that except for the 4-way, the type depends on which of the intersecting roads the ICA vehicle is traveling. The number of false and missed alarms are actual counts of warnings (or lack thereof) at each intersection. The missed and false alarm probabilities reported are conservative, being based upon the issuance of the warnings by the ICAS and observed vehicles at each intersection.

Missed warnings would appear to be more critical than false alarms. ( The latter are annoying and could affect driver acceptance, but do not result in collisions). Of the 22 missed warnings, 14 were noted to be caused by the target not being observed by the radar. This results from the use of the limited coverage (in angle) system in which the antennas have to be scanned back and forth over the observation sub-sector. A fast cross roads target that was not previously detected can reach the intersection before the scanning antenna catches up with it. See section 5.1.8. An improved scan pattern (faster, wider) would eliminate the missed warnings caused by marginal scanning of the observation sector.

**Table 5-2 Summary of False and Missed Warnings**

<b>Intersection Type</b>	<b>Number of Intersections</b>	<b>Number of Approaching Roadways</b>	<b>False Targets / False Alarm %</b>	<b>Missed Targets / Missed Alarms %</b>	<b>Total</b>
4 way	68	204	21	8	29
Junction Left	16	32	5	1	6
Junction Right	1	2	0	0	0
T	20	40	1	13	14
<b>Total</b>	105	278	27 / 10%	22 / 9%	49

Of the 27 false alarms, 17 occurred with no targets visible and so represent unqualified false warnings. Detailed examination of the radar data is required to determine their cause but poor clutter rejection is a possibility. Some of the remaining 10 include a legitimate prediction of simultaneous occupancy of the intersection by target and ICA vehicle but resulting from system inaccuracies such as GPS positioning of the ICA vehicle or location of the target with respect to the intersection by the radar/GPS system. Other false warnings are for warnings that were extended too long after the target passed out of the threat area. Some of the false warnings recorded for the center radar may be due to cross road traffic.

Considerable reduction in false and missed warnings can be achieved with improvements in the system that are quite realizable, some with the system implemented as is, some with an improved GIS/GPS and some with a better antenna system.

### **5.1.11 Summary, Threat Detection System**

An Intersection Collision Avoidance System (ICAS) was designed and built as described in Sections 4 and 5. Over 60 hours of on-road tests of the ICAS (or elements thereof) were conducted. Half of these were obtained while driving the completely integrated system over the 30-square mile GIS test area which was prepared as part of this program.

The Threat Detection System, which merged a Veridian-developed tracker and collision warning (CW) algorithm with 3 COTS radars, provided the ICAS driver with reliable warnings when targets were present and were predicted to occupy the intersection simultaneously with the ICAS vehicle.

Logic modifications to the basic CW algorithm, developed as a result of the in-traffic tests over the GIS test area, improved system performance by eliminating (valid) warnings in non-threatening situations, thus enhancing driver acceptance of the system. In addition, it was noted that better scan control is needed to improve observation of the threat sector.

In-depth analysis of data and video of the actual target scene recorded during the in-traffic tests over the GIS test area, determined that there were 27 false warnings and 22 missed warnings during observation of more than 100 intersections containing nearly 280 roadways on which potential threats can approach the intersection. Over half of the missed warnings were caused by inadequate observation of the threat sectors. A third of the false warnings were caused by clutter generated tracks and system inaccuracies. Both these causes of warning errors can be reduced with readily achieved improvements to the ICAS as it is currently implemented.

The ICAS in-traffic tests showed the system to be a technically viable collision avoidance system.

## 5.2 GIS/GPS System

The implementation of the ICAS requires that vehicle position be known, and that this position data be related to upcoming intersections. An onboard GPS and a GIS map database are used to provide this information. The application utilizes position data derived from the GPS to locate the vehicle on a specific roadway segment. The map database used in this program was provided by Navigation Technologies Inc. This map database incorporates features not in the standard NavTech product. To support this Intersection Collision Avoidance Program, NavTech provided Veridian a modified map database for an identified test area in suburban Buffalo (Figure 5-10). Map features included higher than standard accuracy for intersection locations and provisions for data fields within the database for traffic control device. The Test Area selected was approximately 33 square miles. This area contained a number of roadway and intersection types and was sufficient to test the effectiveness of the ICAS in the typical collision scenarios. The GIS/GPS System has multiple functions:

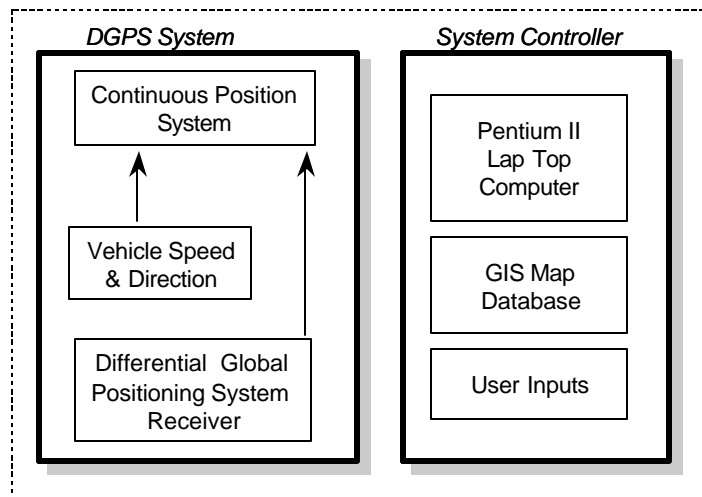
- the system can determine if the driver is reacting to the intersection that they are approaching, and if that intersection is controlled by a stop sign, provide warnings of potential violation of the traffic control, and
- provide attributes, such as type of intersection, “T”, or four leg, incidence angles of other roadways, and traffic control at the intersection.

This information is provided to the Threat Detection System, and allows the system to align the radars to accommodate non-orthogonal intersections.

### 5.2.1 System Design

The GIS/GPS is a standalone system used to determine the vehicles position and to identify attributes of the intersection the vehicle is approaching. A block diagram of the system is shown in Figure 5-20. Note that this figure is a subset of the system diagram presented in Figure 4-1. All system hardware is commercial off the shelf as shown in Table 5-3. In operation, the vehicle’s position, derived from the GPS, is used to search the map database and locate the roadway that the vehicle is currently traveling on. The database is then used to determine the next intersection the vehicle is approaching. The properties of the intersection are utilized to determine the potential for driver violation of the intersection, if controlled by a stop sign, and by the Threat Detection System to align the radars. The position of the vehicle is updated every 100 msec, and intersection data is updated when a new intersection is identified.





**Figure 5-20 GIS/GPS Block Diagram**

**Table 5-3**

**GIS/GPS Components**

<b>System Component</b>	<b>Model</b>
GPS Receiver	KVH Continuous Positioning System
Differential GPS Receiver	Communication Systems International DGPS Beacon Receiver, Model ABX-3
GPS/DGPS Antenna	Communication Systems International GPS/DGPS Antenna, Model MBL-3
Computer	Gateway Solo 2500 SE computer (PII @ 200 MHz.)
Digital Map Database	Navigation Technologies

### 5.2.1.1 GPS

The KVH Continuous Positioning System (CPS) provides vehicle latitude, longitude, heading, and speed using GPS and dead reckoning. The CPS utilizes a Kalman-filtering scheme to blend data from GPS, a fiber optic gyroscope, and the vehicle speed sensor yielding continuous position information regardless of GPS blockage or multipath. The use of dead reckoning improves the GPS accuracy and availability by providing precise location, velocity, direction and heading data, even at slow speeds or when stationary.

To increase the accuracy of the CPS, a Differential GPS (DGPS) Beacon Receiver was added. In the United States, the US Coast Guard and Army Corps of Engineers have constructed a network of Beacon stations that service the majority of the eastern United States, the entire length of both coastlines, and the Great Lakes. Further plans exist to increase the density of this network to provide dual redundant coverage throughout the continental US by the end of the year 2000 for a variety of applications including intelligent transportation system, infrastructure management, and public safety. The Buffalo test area is within the coverage of the USGS Beacon located at Youngstown, NY, approximately 36 km north of the test area.

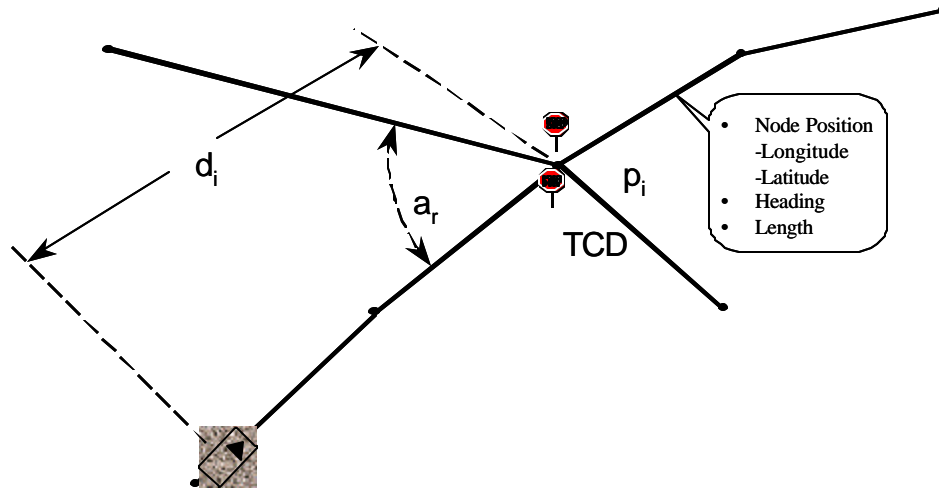
The purpose of DGPS is to eliminate, or dramatically reduce effects of Selective Availability (intentional GPS degraded accuracy), atmospheric, and satellite errors. The reference station calculates the corrections needed for the pseudorange to each satellite and broadcasts this correction to the DGPS receivers. These corrections are then used by the GPS in the CPS to correct the GPS location fix accounting for these errors.

The CPS and DGPS receiver are completely self-contained and do not require user input. Both receivers power up when the ICAS vehicle is started and obtain a stable position within 20 seconds. The accuracy of the position is estimated by the manufacturer to be within 3 meters 95 percent of the time.

#### **5.2.1.2 Map Database**

The map database was developed by Navigation Technologies for this project. The test area (shown in Figure 5-10) comprises 33 square miles east of Buffalo NY in a suburban and rural environment. The area includes single and multilane roadways in commercial, industrial, agricultural, and residential areas. The traffic density varies from low to heavy, with both cars and heavy commercial trucks. The map database utilized in this project was based upon standard NavTech product. At the initiation of this Program NavTech did not offer a map database for the Buffalo area. The area was covered by a database centered around Pittsburgh, PA. This database contained major roadways, and some state and county roads in the Buffalo area. Subsequently, NavTech was in production of a map database for the Buffalo, and Western New York area. Veridian was able to acquire the roadway structure file for this product prior to its release, and worked with NavTech to include the data elements required to support ICAS Testing.

The map database decomposes roadways down to individual segments consisting of nodes and line segments. These nodes and segments are assigned various properties, or attributes. Typical properties of these segments are position, length, ID number, and adjoining roadway segments. The manner in which the map database represents an intersection is illustrated in Figure 5-21. This property, inherent to the NavTech database structure, allows intersections to be readily differentiated from other roadways. To this set of properties, NavTech and Veridian Engineering added a field for traffic control devices at the intersection node.



**Figure 5-21**  
**Map Database Representation of Intersection**

With the vehicle located on a specific roadway segment, vehicle heading data is used to determine the node it is approaching. An association algorithm within the software determines if the node is an intersection. If the node is an intersection, attributes of the intersection are passed to the Intersection Violation Detection and Intersection Collision Avoidance systems.

The database is searched using a library of software function calls provided by NavTech. These functions provide an efficient way to locate the closest roadway to a given latitude and longitude. Addition algorithms are used to track along a roadway to eliminate errors. For example, when the vehicle passes through an intersection, the closest roadway to the GPS position may be the intersecting roadway and not the current vehicle roadway. In this case, the software looks for a change in heading indicating a turn before it switches the track to the intersecting roadway.

### 5.2.1.3 Computer

The GIS/GPS system is hosted on a laptop computer mounted within the vehicle cab (Figure 4-4) in the ICAS Testbed. The computer is connected to the ICAS Central Processing Unit by an RS-232 cable. Messages are sent between the two computers to exchange data. The data elements for the messages to the GIS/GPS computer are shown in Table 5-4. This message is received every 100 msec., and consists of the vehicle position, speed and heading data from the CPS. The CPS is attached to the Central Processing Unit by an RS-232 cable instead of directly to the GIS/GPS computer. This configuration was chosen for two reasons. First, the threat detection software which runs on the Central Processing Unit needs the vehicle data (speed, heading, and position) in real-time and the time delay through the GIS/GPS would be too great to meet this requirement. Second, the GIS/GPS computer only has one serial port which is used to communicate with the Central Processing Unit. The GIS/GPS software

is capable of receiving data directly from the CPS if the threat detection software is not running. This operation mode is useful during unit testing of the GIS/GPS.

**Table 5-4**  
**Message Format From Central Processing Unit to GIS/GPS System**

Message Element
Time tag, GPS time.
Vehicle Latitude (degrees)
Vehicle Longitude (degrees)
Vehicle Speed (feet per second)
Vehicle True Heading (degrees)

When a message is received, the data is used to query the map database to identify the intersection the vehicle is approaching. If the vehicle has passed through an intersection and a new intersection has been identified, a message is sent to the Central Processing Unit providing the threat detection software with the characteristics of the new intersection. The format of this message is shown in Table 5-5.

**Table 5-5**  
**Message Format From GIS/GPS System to Central Processing Unit**

Message Element
Time Tag, GPS time
Intersection Type (quad, tee, junction right or left)
True bearing of road SV is on. (degrees)
True bearing of left intersecting road (degrees)
True bearing of center intersecting road (degrees)
True bearing of right intersecting road (degrees)
Distance to intersection along road.(ft).
Intersection Latitude (degrees)
Intersection Longitude (degrees)
Traffic lights at intersection
Stop signs at intersection

The Central Processing Unit periodically sends a message to the GIS/GPS computer requesting the current approaching intersection. GIS/GPS computer responds with the message in Table 5-5. This ensures that the threat detection system always has the correct intersection information.

The GIS/GPS computer also provides a user interface to the Central Processing Unit, since this system does not have a display or keyboard for user inputs. This interface is used during testing to control

data acquisition for post test processing, changing of tracker or warning algorithm parameters, and the display of error messages.

## **5.2.2 Testing**

### **5.2.2.1 DGPS Accuracy**

The DGPS system positional accuracy performance was tested using two different National Geodetic Survey control points located near the test area. Data was collected three times at each point for approximately 10 to 15 minutes. The data collection occurred on several different days. For this analysis the first and last readings were used. The first reading would more closely approximate the real-time condition of a moving car.

The CPS data is referenced to the WGS84 datum. The benchmark latitude and longitude are referenced to the NAD83 datum. These datums are essentially equivalent. The NavTech map databases are all referenced to the NAD83 datum. All latitudes and longitudes were converted to UTM grid coordinates. UTM is a metric coordinate system which has units in meters North and meters East. Distances between points are more readily calculated, compared to the latitudes and longitude system.

The position errors observed (shown in Tables 5-6 and 5-7) were generally in the 4.0 to 5.6 meter range at “FRANK” and 3.5 to 4.0 meter range at “CHE-VET 1” test points. The CPS antenna could only be located about 1 meter from “FRANK”, which may account for the increased error at this location. The results agree with the expected accuracy of the CPS using DGPS of about 3 meters.

There are numerous factors affecting GPS positioning accuracy, and most are difficult to quantify. One source of error that can be measured is the distance between the DGPS reference station and the GPS receiver. According to the DGPS receiver’s user manual, the error for this offset is on the order of 1 meter for every 100 km separation. The Youngstown Beacon is located about 36 km from the two control points. Therefore, we would expect about 0.3 meter error from this source.

In summary, the data shows that the CPS is working close to its advertised accuracy, and that we can expect a 3.5 to 4.5 meter error within our test area.

**Table 5-6  
DGPS Test Results**

Control Point FRANK (PID NC1191)  
Benchmark Latitude 42°57' 24.86772"  
Benchmark Longitude -78°43' 11.95666"

<b>Time At Benchmark (minutes)</b>	<b>Measured Latitude</b>	<b>Measured Longitude</b>	<b>Error North (meters)</b>	<b>Error East (meters)</b>	<b>Radial Error (meters)</b>
	42° 57.41226'	-78°43.19916'	4.07	0.27	4.08
+10	42° 57.41226'	-78°43.19962'	4.09	-0.35	4.09
	42° 57.41364'	-78°43.19916'	1.52	0.20	1.53
+10	42° 57.41249'	-78° 43.20007'	3.68	-0.98	3.81
	42°57.41158'	-78°43.20053'	5.38	-1.56	5.60
+15	42°57.41089'	-78°43.20053'	6.66	-1.52	6.83

**Table 5-7  
DGPS Test Results**

Survey Station CHE VET 1 (PID NC1409)  
Benchmark Latitude 42°56' 14.16482"  
Benchmark Longitude -78°47' 2.45303"

<b>Time At Benchmark (minutes)</b>	<b>Measured Latitude</b>	<b>Measured Longitude</b>	<b>Error North (meters)</b>	<b>Error East (meters)</b>	<b>Radial Error (meters)</b>
	42°56.23627'	-78°47.03796'	-0.46	3.97	3.99
+9	42°56.23558'	-78°47.03796'	0.82	4.00	4.08
	42°56.23581'	-78°47.03842'	0.41	3.36	3.39
+14	42°56.23558'	-78°47.03842'	0.84	3.38	3.48
	42°56.23558'	-78°47.03842'	0.84	3.38	3.48
+7	42°56.23512'	-78°47.03842'	1.69	3.40	3.79

### **5.2.2.2 Map Database Accuracy**

The accuracy of the digital map database was not quantitatively tested due to a lack of an independent measurement technique with an accuracy as good as the database. During testing of the countermeasures however the GIS/GPS system was qualitatively evaluated with regard to database accuracy and the ability to identify roads. This system proved capable of tracking the ICAS vehicle through the entire test area which includes residential streets which are closely spaced. A few areas with unique conditions were identified where the system briefly lost the correct track resulting in incorrect identification of the approaching intersection. The system always quickly recovered from these situations. The system proved more than adequate for testing of the Threat Detection System in the test area. More refinement of the road tracking algorithms will eliminate these problems.

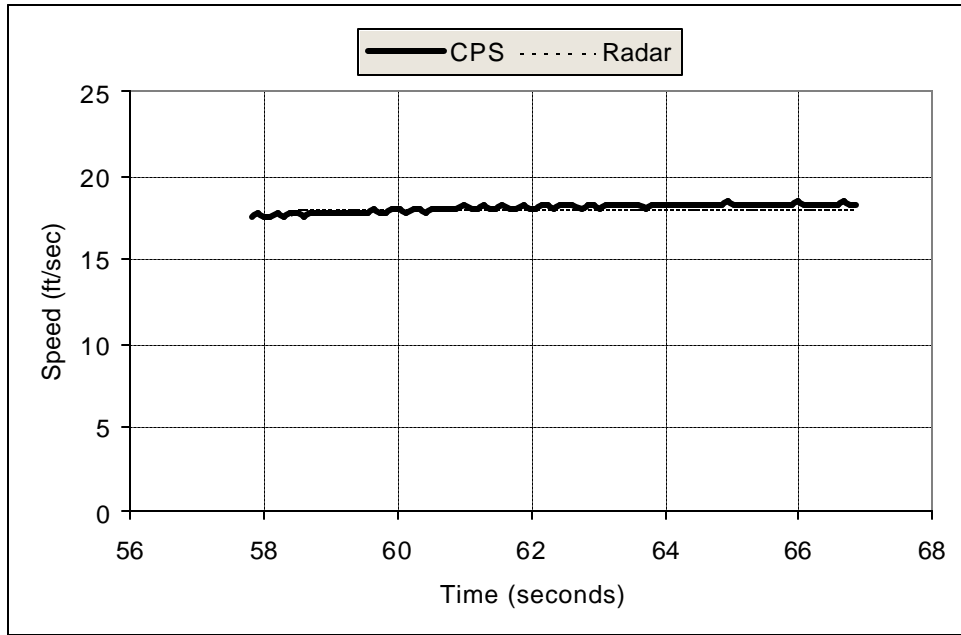
As part of the post test data processing for the Threat Detection System, the track of the vehicle relative to the intersection is plotted. For the majority of intersection processed, the vehicle track was very close to the roadway and intersection locations from the map database. A few intersections consistently showed higher errors in position accuracy. It was not determined whether the problem was with the CPS data or the map database. These few intersections should be resurveyed to ensure that the map database is accurate.

### **5.2.2.3 Vehicle Speed Measurement**

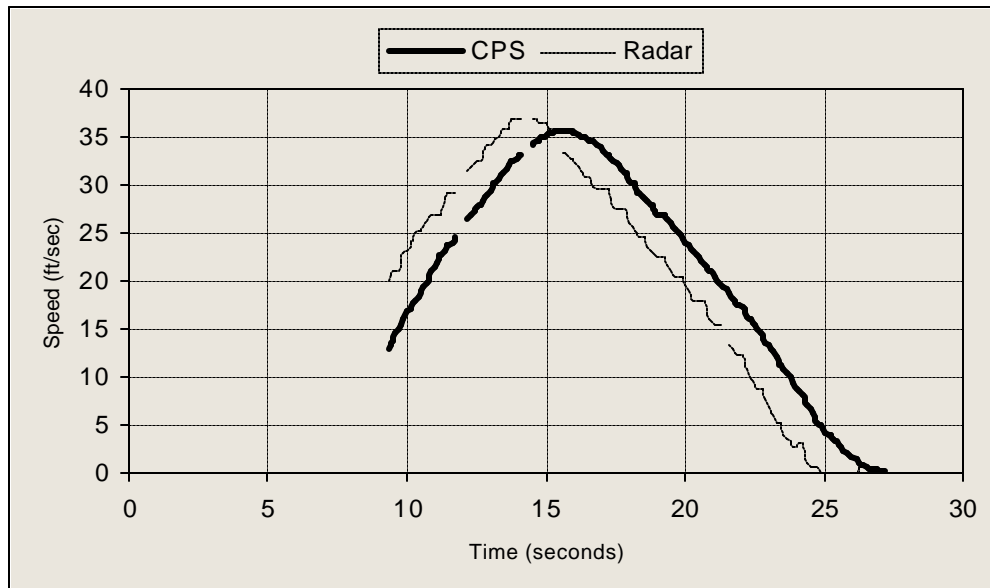
The vehicle speed measurement is critical to the accuracy of the ICAS. The system uses this data to calculate the ICAS vehicle time to the intersection which is critical to the warning algorithms. The vehicle speed is also used with the radar range rate in the calculation of POV speed in the tracker software. Accuracy of the vehicle speed input greatly effects the performance of the Threat Detection System. Clutter targets, which have zero velocity, would appear to have a velocity equal to the error in vehicle speed. This would cause the tracker to establish a track and the warning algorithm to be applied causing possible false alarms. The vehicle speed is measured by the CPS using the vehicles speed sensor.

To test the vehicle speed data accuracy, a test was performed using a parked car on the Veridian Vehicle Experimental Research Facility (VERF). The ICAS vehicle approached this vehicle and data were collected from the CPS and the center radar. The CPS speed data was then compared to the radar range rate data as shown in Figure 5-22. The results for this test showed very good agreement between the two sensors.

During testing of the Threat Detection System, higher than expected errors in the POV velocity were sometimes noted while the ICAS vehicle was approaching the intersection. Upon further review of the data, it appeared that the velocity data from the CPS was delayed more than anticipated. A test was conducted on the VERF similar to the first test except the ICAS vehicle accelerated and decelerated rather than maintaining a constant velocity. The results, shown in Figure 5-23, show that the CPS velocity data significantly lagged behind the radar range rate data by approximately 1.5 seconds.



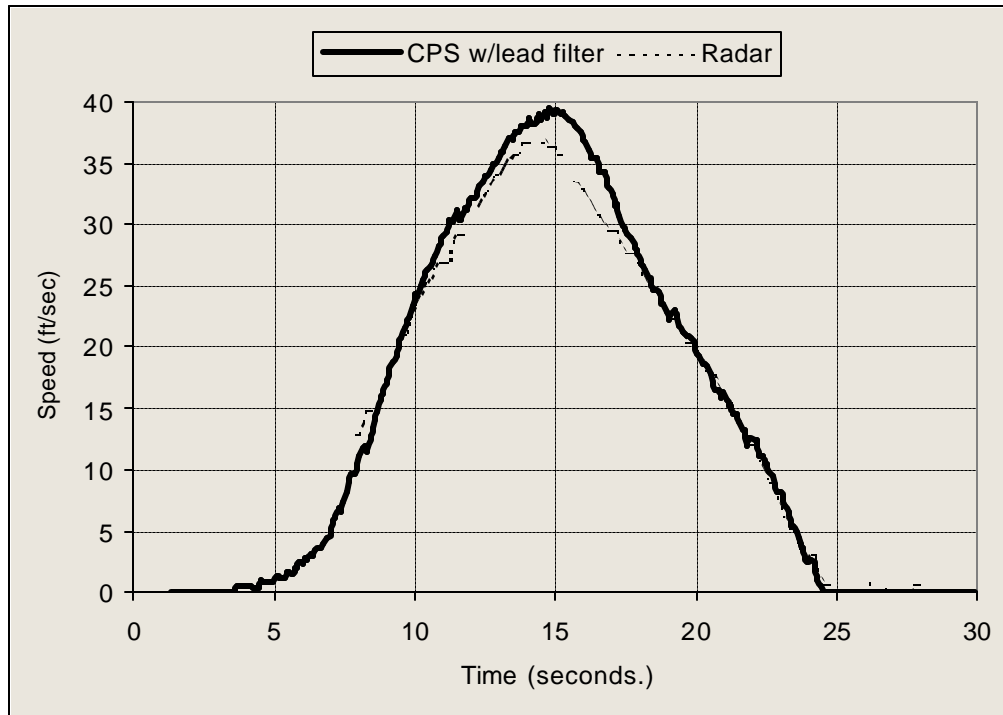
**Figure 5-22**  
**Vehicle Indicated Speed vs. Radar**



**Figure 5-23 Speed vs Radar Range Rate with Acceleration and Deceleration**



There are several ways that the velocity data could be corrected for this time delay. The approach investigated was a lead filter applied to the CPS speed data in Figure 5-23 to compensate for the 1.5 second delay. The results, shown in Figure 5-24, were a significant improvement when compared to the radar range rate data. This filter eliminated the error except during the transition from acceleration to deceleration. In this region the error was limited to about 5 ft/sec. This filter is not computationally intense and could easily be incorporated into the ICAS software.



**Figure 5-24 CPS Speed with Lead Filter vs Radar Range Rate**

### 5.2.3 Performance Guidelines

The development and testing of the GIS / GPS system provided insight as to some performance guidelines that are necessary for the system. The system that was developed for the ICAS program is a straight-forward system that is capable of being deployed with sufficient investment by the government or private industry. Performance guidelines for the system are described and discussed below:

- *Position and roadway information update rate of 10 Hz adequate for ICAS.*  
The ICAS system performed adequately when operating at a system update rate of 10Hz. Investigation of vehicle position update rate of 1 Hz, which is the update rate for standard GPS systems, was found to be inadequate to support the countermeasure function. The inadequate

update rate caused false alarms and inconsistency of the warnings provided by the GIS/GPS unsignalized intersection warning system.

- *The system software was able to access the map database in real time to support transfer of intersection information to the Threat Detection System and unsignalized intersection warning system in a timely manner.*

The system software for the ICAS is adequate to process map information in real-time and to provide roadway and intersection information to the countermeasure. Time delays in the accessing of map data were not sufficient to cause problems with data flow and processing of countermeasure functions

- *Positional accuracy of ~3 meters generally found to be adequate.*

Testing of the GPS / DGPS system against known markers proved that the system provided positional accuracy of approximately 3 meters. This accuracy is within the specifications of most differential - equipped GPS systems. In general, this accuracy specification was found adequate to support the ICAS function. In specific cases, a greater positional accuracy was found to reduce false alarms in the threat detection system.

- *The latency of data is important in the ICAS, and needs careful attention to detail.*

The latency of data being provided by the various sensors in the ICAS is a critical area that must be addressed. Common to many applications where vehicle position and dynamics are being measured, the synchronization of data streams is important. Section 5.2.2.3 described a latency of the vehicle speed data that caused problems with system performance. The vehicle speed data was delayed by 1.5 seconds, and was causing false tracks to be initiated by the threat detection system tracker software. Identifying this problem and rectifying it solved the problem.

### 5.3 Driver/Vehicle Interface Performance

This section addresses human factors issues germane to the presentation of intersection collision avoidance warnings. General issues include: warning content, timing of warnings, and type of warning modality. These issues are discussed in light of preliminary human performance tests conducted to ascertain driver warning effectiveness and driver acceptance of warnings. A brief overview is provided of crash causal analysis research and state-of-the-art technology and literature reviews that served as a basis for ICAS driver/vehicle interface (DVI) design recommendations. Relevant ICA program documents and related publications are referenced that provide additional detail. DVI design criteria and guidelines are included, along with human performance test results and discussions of other DVI performance issues, such as risk compensation, driver controls, and interface standardization.

The ICAS DVI research presented here focuses on the stop-sign controlled intersection. This focus was determined by increased feasibility of near-term deployment of this system, as compared to a system that includes signalized intersections and requires infrastructure integration. Hence, the DVI human performance research reviewed in this section, investigates countermeasure functions for stop-sign controlled intersections—namely, the presentation of *Stop Requirement* and *Inadequate Gap* advisories and warnings.

#### 5.3.1 Background

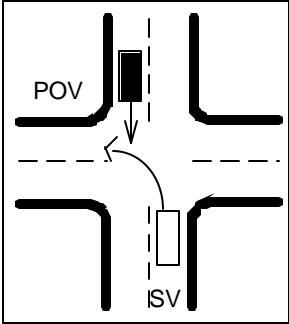
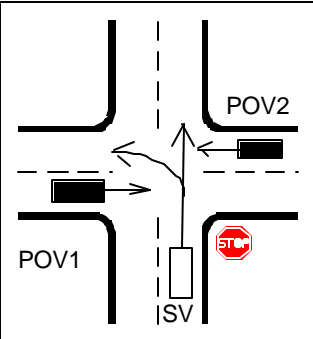
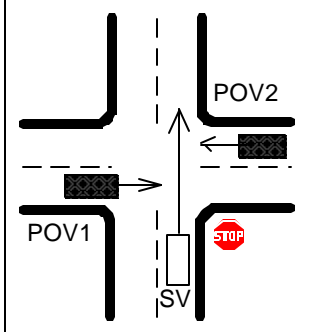
Causal analysis of the crash data sample, conducted during Phase I of the ICA program, concluded that nearly 75 percent of intersection collisions were due to “driver error,” including *Driver Inattention* (28.7 percent), *Faulty Perception* (33.9 percent), and *Vision Impaired/Obstructed* (11.1 percent) (5,6). This indicates that a countermeasure to mitigate or reduce driver errors, such as a driver warning, would significantly reduce the occurrence of collisions at intersections. Causal factors identified for each of the four intersection scenario types are presented in Table 5-8.

The work reported here emphasizes *stop sign-controlled* intersection collision avoidance. In terms of scenario types, depicted in Table 5-8, stop-sign controlled intersections are included in Scenarios 1, 2, and 3. Unlike countermeasures for signalized intersections, where signal phase information is required, collision avoidance countermeasures for stop sign-controlled intersections can be implemented *in-vehicle*—without integration with traffic control infrastructure. In-vehicle countermeasures for stop sign-controlled intersections are significantly less complex and have potential for near-term deployment.

The potential benefits derived from deploying a successful collision avoidance countermeasure for stop sign-controlled intersections are also significant. Though not a solution for the total problem, the solution for stop sign-controlled intersections would have a substantial impact—both in reducing the number and severity of crashes. This is reflected in the fact that 46 percent of intersection crashes reported annually take place at intersections controlled by stop signs (433,810 crashes) and that these crashes *account for 66 percent of intersection fatalities* (7). Though not addressed here, it is noteworthy that such a system could also reduce other classes of crashes as a side benefit (e.g., rear-end collisions). The countermeasure for stop sign-controlled intersection crashes would have a considerable impact on reducing the overall number of crashes occurring annually, particularly those resulting in serious injury of vehicle occupants.

Although stop-sign controlled intersections were the focus of driver performance studies for this effort, the DVI design encompasses issues common to signalized intersections. The ICAS DVI design is capable of accommodating infrastructure information and providing driver warnings for signalized intersections.

**Table 5-8 Summary of Intersection Crash Causal Factors Analysis**

<p><b>Scenario 1 Left Turn Across Path (LTAP)</b></p> 	<p><b>Scenario 2 Perpendicular Path- No TCD Violation</b></p> 	<p><b>Scenario 3 Perpendicular Path- TCD Violation</b></p> 																																
<p><b>Crash Segment:</b> Comprises 23.8% of intersection crash problem</p>	<p><b>Crash Segment:</b> Comprises 30.2% of intersection crash problem</p>	<p><b>Crash Segment:</b> Comprises 43.9% of intersection crash problem</p>																																
<p><b>TCD:</b> Green Signal Phase 87.1 No TCD 12.9</p>	<p><b>TCD:</b> Stop Sign 94.6 Other 5.4 <b>Maneuver:</b> Straight 49.5 Left 49.4 Right 0.6</p>	<p><b>TCD:</b> Red Signal Phase 53.0 Stop Sign 34.1 Other 12.9 <b>Maneuver:</b> Straight 90.4 Left 9.1 Right 0.5</p>																																
<p><b>Causal Factors</b></p> <table border="0"> <tr><td><i>Looked, Did Not See</i></td><td>26.5</td></tr> <tr><td><i>Attempted to Beat Vehicle</i></td><td>24.9</td></tr> <tr><td><i>Vision Obstructed/Impaired</i></td><td>20.7</td></tr> <tr><td><i>Driver Inattention</i></td><td>17.9</td></tr> <tr><td><i>Misjudged Velocity/Gap</i></td><td>7.8</td></tr> <tr><td><i>Thought POV Would Stop</i></td><td>2.2</td></tr> </table>	<i>Looked, Did Not See</i>	26.5	<i>Attempted to Beat Vehicle</i>	24.9	<i>Vision Obstructed/Impaired</i>	20.7	<i>Driver Inattention</i>	17.9	<i>Misjudged Velocity/Gap</i>	7.8	<i>Thought POV Would Stop</i>	2.2	<p><b>Causal Factors</b></p> <table border="0"> <tr><td><i>Looked, Did Not See</i></td><td>58.3 Straight; 73.8 Turn</td></tr> <tr><td><i>Vis. Obstructed/ Impaired</i></td><td>13.2 Straight; 19.0 Turn</td></tr> <tr><td><i>Driver Inattention</i></td><td>22.4 straight; N/A Turn</td></tr> <tr><td><i>Misjudged Velocity/Gap</i></td><td>1.6 Straight; 4.0 Turn</td></tr> <tr><td><i>Thought POV Would Stop</i></td><td>4.7 Straight; 3.2 Turn</td></tr> </table>	<i>Looked, Did Not See</i>	58.3 Straight; 73.8 Turn	<i>Vis. Obstructed/ Impaired</i>	13.2 Straight; 19.0 Turn	<i>Driver Inattention</i>	22.4 straight; N/A Turn	<i>Misjudged Velocity/Gap</i>	1.6 Straight; 4.0 Turn	<i>Thought POV Would Stop</i>	4.7 Straight; 3.2 Turn	<p><b>Causal Factors</b></p> <table border="0"> <tr><td><i>Vis. Obstructed/Impaired</i></td><td>1.4 Straight; N/A Turns</td></tr> <tr><td><i>Driver Inattention</i></td><td>58.2 Straight; 69.9 Turn</td></tr> <tr><td><i>Deliberate Violation-Signal</i></td><td>27.9 Straight; 15.9 Turn</td></tr> <tr><td><i>Deliberate Violation-Stop Sign</i></td><td>9.3 Straight; 13.4 Turns</td></tr> <tr><td><i>Attempted to Beat Signal</i></td><td>3.2 Straight; 0.8 Turns</td></tr> </table>	<i>Vis. Obstructed/Impaired</i>	1.4 Straight; N/A Turns	<i>Driver Inattention</i>	58.2 Straight; 69.9 Turn	<i>Deliberate Violation-Signal</i>	27.9 Straight; 15.9 Turn	<i>Deliberate Violation-Stop Sign</i>	9.3 Straight; 13.4 Turns	<i>Attempted to Beat Signal</i>	3.2 Straight; 0.8 Turns
<i>Looked, Did Not See</i>	26.5																																	
<i>Attempted to Beat Vehicle</i>	24.9																																	
<i>Vision Obstructed/Impaired</i>	20.7																																	
<i>Driver Inattention</i>	17.9																																	
<i>Misjudged Velocity/Gap</i>	7.8																																	
<i>Thought POV Would Stop</i>	2.2																																	
<i>Looked, Did Not See</i>	58.3 Straight; 73.8 Turn																																	
<i>Vis. Obstructed/ Impaired</i>	13.2 Straight; 19.0 Turn																																	
<i>Driver Inattention</i>	22.4 straight; N/A Turn																																	
<i>Misjudged Velocity/Gap</i>	1.6 Straight; 4.0 Turn																																	
<i>Thought POV Would Stop</i>	4.7 Straight; 3.2 Turn																																	
<i>Vis. Obstructed/Impaired</i>	1.4 Straight; N/A Turns																																	
<i>Driver Inattention</i>	58.2 Straight; 69.9 Turn																																	
<i>Deliberate Violation-Signal</i>	27.9 Straight; 15.9 Turn																																	
<i>Deliberate Violation-Stop Sign</i>	9.3 Straight; 13.4 Turns																																	
<i>Attempted to Beat Signal</i>	3.2 Straight; 0.8 Turns																																	
<p><b>Critical Errors:</b> Did not observe POV Misjudged distance, velocity, POV actions</p>	<p><b>Critical Errors:</b> Did not observe POV Misjudged distance, velocity, POV actions</p>	<p><b>Critical Errors:</b> Did not observe TCD Phase Deliberate Violation</p>																																
<p><b>Countermeasure Function:</b> Inadequate gap advisory &amp; warning</p>	<p><b>Countermeasure Function:</b> Inadequate gap advisory &amp; warning</p>	<p><b>Countermeasure Function:</b> Stop requirement advisory &amp; warning</p>																																

### 5.3.1.1 General ICAS DVI Performance Guidelines

Focusing on the stop-sign controlled intersection crash increases the potential for early deployment of an ICAS. This approach enables the ICAS to mitigate 46 percent of intersection crashes reported annually--a crash segment that constitutes 66 percent of intersection fatalities. The ICAS DVI should be designed to:

- c Convey information to the driver regarding stop requirements at upcoming stop-sign controlled intersections,
- C Convey information to the driver regarding inadequate gap to other vehicles approaching the intersection on an intersecting path, and
- C Accommodate future integration of phase information regarding stop requirements at upcoming signalized intersections.

### 5.3.2 Warning Content

The crash causal analysis identified *Inadequate Gap* advisory and warning as countermeasure functions for Scenarios 1 and 2, and *Stop Requirement* advisory and warning for Scenario 3 (see Table 5-8). Table 5-9 summarizes the alerts or warnings that could be provided to the driver regarding potentially hazardous situations at an upcoming intersection. Most critical to intersection crash avoidance, the evaluation of *Stop Requirement* and *Inadequate Gap* advisories/warnings was the focus of this effort. Subjective ratings of *Stop Requirement* and *Inadequate Gap* advisories/warnings obtained during initial in-vehicle human performance tests are provided in Sections 5.3.7 and 5.3.8, respectively.

**Table 5-9 Potential Driver Alert/Warning Categories and Functions**

Alert/Warning Categories	Functions
Intersection Presence	Temporal distance from intersection, intersection type
TCD Presence	Anticipated signal requirements, right-of-way, TCD type
Approaching Vehicle Presence	Threat(s) location and direction, threat intention to turn across path/unacceptable gap
System Status	On/off, malfunction, driver override

#### 5.3.2.1 Warning Content Guidelines

To mitigate crashes occurring at stop-sign controlled intersections, the ICAS DVI should provide:

- C *Stop Requirement* advisories and warnings, and
- C *Inadequate Gap* advisories and warnings.

### 5.3.2.2 *Mode Information Guidelines*

The modes of the automotive Heads-Up Display (HUD) reflect the nature and urgency of information provided as the ICA-equipped vehicle approaches an intersection and threat vehicles. The DVI recommended modes are:

- Advisory/Alert Mode—provides information regarding either the presence of an upcoming intersection TCD or threat-vehicle with potential requirements to stop.
- Warning Mode—provides information regarding the need to stop to avoid violating a TCD and/or a collision.

### 5.3.3 **Warning Modality**

A review of DVI literature and technology focused on the evaluation of the warning modality used to alert the driver (8). The goal of the ICA DVI is to provide an effective information interface with the driver that will increase driving safety. Warnings need to meet several criteria if they are to obtain this goal.

The following criteria were identified for the selection of DVI warning modalities:

- Benefit all drivers;
- Not require specific directional orientation;
- Compatible with driver's response; and
- Viable integration with other crash avoidance systems (CASs) and driver assistance systems (DASs).

Using these criteria, auditory (tone and voice), visual (Head Up Display), and haptic (Brake pulsing) modalities were evaluated. A summary of modality characteristic evaluation is provided in Table 5-10.

**Table 5-10 Modality Characteristic Evaluation Summary**

Advantages	Disadvantages
<b>Warning Tone</b>	
<ul style="list-style-type: none"> <li>• Omni-directional; orienting stimulus</li> <li>• Under normal conditions, demand less attention than voice</li> <li>• Directional cueing</li> <li>• Processed faster than visual stimuli</li> <li>• Language independent</li> <li>• Auditory icons which match a driver’s mental model produce faster, more appropriate responses</li> </ul>	<ul style="list-style-type: none"> <li>• Difficult to accommodate hearing impaired drivers</li> <li>• Unable to convey detailed information</li> <li>• Signal detection problem under high ambient noise conditions</li> <li>• Could cause unwanted “startle” response</li> <li>• Integration with other driver assistance systems could lead to a cacophony of “bells and whistles”</li> <li>• Annoying if unnecessary (intrusive)</li> </ul>
<b>Voice Warning</b>	
<ul style="list-style-type: none"> <li>• Omni-directional; orienting stimulus</li> <li>• Processed faster than visual stimuli</li> <li>• Able to convey detailed information</li> <li>• Speech may be more effective in high stress situations because speech meaning is over-learned</li> <li>• Directional cueing</li> </ul>	<ul style="list-style-type: none"> <li>• Difficult to accommodate hearing impaired drivers</li> <li>• Language dependent</li> <li>• Signal detection problem under high ambient noise conditions</li> <li>• Could cause unwanted “startle” response</li> <li>• Annoying if unnecessary (intrusive)</li> <li>• Integration with other driver assistance systems could distract driver with abundance of verbal messages</li> <li>• Under normal operating conditions, may demand more attention than tone</li> </ul>
<b>Visual Warning (HUD)</b>	
<ul style="list-style-type: none"> <li>• Integration of HUD image with forward view of real world</li> <li>• Less eye accommodation benefits older driver performance</li> <li>• Integration with other DASs &amp; CASs</li> <li>• Directional cueing</li> </ul>	<ul style="list-style-type: none"> <li>• Eye fixation required</li> <li>• Degradation of visual display</li> <li>• Cognitive capture</li> <li>• Masking of forward view</li> </ul>
<b>Haptic Warning (Brake Pulsing)</b>	
<ul style="list-style-type: none"> <li>• Omni-directional; orienting stimulus</li> <li>• Low attention demand; highly detectable by all</li> <li>• Congruent S-R mapping; consistent with driver’s mental model</li> <li>• Reduce rear-end crash potential</li> </ul>	<ul style="list-style-type: none"> <li>• Potential interference with driving maneuvers is unknown but not anticipated</li> <li>• Potential for misperception as a mechanical failure, but this can be avoided (e.g., conceptually similar to speed bumps, which are easily identifiable)</li> <li>• Unable to convey detailed information</li> </ul>

### 5.3.4 DVI Design Recommendations

A multi-modal ICAS DVI is recommended to provide driver warnings: 1) visually, through a head-up display (HUD), 2) aurally, using a pulsed tone, and 3) haptically by pulsing the brakes. No single modality meets all the design criteria. For example, visual warnings via a HUD enables the presentation of more detailed information, required for integration with other CAS and DAS and provision of more detailed information, but requires drivers' attention to be focused on the forward view to perceive the warning. Auditory warnings, while widely used and not orientation specific, exclude hearing impaired drivers and can be masked by ambient noise. Haptic warnings, while meeting most of the criteria, cannot provide detailed information.

### 5.3.5 ICAS DVI Design Goals

Design goals for ICAS DVI are to:

- Minimize the time required by the driver to accurately acquire and utilize salient information from the HWS (direct driver attention to emerging traffic situation);
- Minimize the requirements for learning to interpret the modal information elements as well as achieving a minimization of the time to acquire;
- Provide the potential, where possible, for future expansion of supplementary modal information to accommodate the spectrum of CAS; and
- Maximize user acceptance of the ICAS DVI.

Design guidelines for auditory, visual (HUD), and haptic (brake pulsing) warnings are summarized below.

#### 5.3.5.1 Auditory Warning Signal Characteristics

Guidelines recommend warning should be: a multiple frequency with more than one frequency in range of 250Hz to 4000Hz; intermittent or changing over time; and at least 15db above the amplitude of the masked threshold; and well-separated from existing auditory warnings. Temporarily coupling signals from the haptic warning system and the auditory warning is recommended.

---

*A 1000Hz (1kHz) signal, 20db above the dynamic 1kHz-center frequency filter level, should be temporarily coupled with the pulsed braking signal (i.e., a series of three*

---

#### 5.3.5.2 Visual Warning Signal Characteristics

Guidelines are presented corresponding to content, symbol, image, optical, and user-interface variables for the ICA HUD are provided in the *Driver-Vehicle Interface Guidelines for the Intersection Collision Avoidance System Report* (9). Only the guideline for use of icons is presented here.



---

*Use icons instead of words whenever they have been verified as equally or more recognizable and require less display space.*

*The visual angle subtended by either the vertical or horizontal dimension or icons should be no less than 30 arcminutes.*

---

### **5.3.5.3 Haptic Warning Signal Characteristics**

To maximize general warning signal acquisition (10), warnings should be:

- Intermittent or changing over time, and
- Above the amplitude of the masked threshold.

Informal on-road tests indicate the use of a series of deceleration pulses. Pulses should be in the order of 100ms duration, separated by 100 to 200ms (variable), where each pulse results in -0.6 meter/second (-2 feet/second) velocity change. It is noteworthy that the transition from alert to warning is anticipated to be facilitated by the extension of the signal duration. Paralleling auditory and visual signal requirements, haptic signals should be well-separated from existing haptic warnings that provide alternative information (10,11). Pulsed-braking signals are not always well-separated from roadway edges and some speed-bump signals (speed dependent), but arguably both signal the need to attend to emerging conditions. Driver acceptance research generally indicates that intrusive warning signals are accepted (12,13).

The following guideline recommendation is based on informal road tests:

---

*HWS warning of requirement to stop should be provided by a succession of braking pulses (three) of 100ms with 100 to 200ms separation periods and each braking pulse resulting in a -0.6 meter/second (-2 feet/second) velocity change that continues until an*

---

### **5.3.6 Stop Requirement Warnings**

The following sections describe in-vehicle tests that were conducted to evaluate the presentation of *Stop Requirement* warnings. In the first study, timing of *Stop Requirement* advisories, relative to intersection entry, is evaluated for visual (via HUD) and auditory modalities. Subsequently, a track test is described in which driver acceptance of haptic brake pulse parameter is evaluated.

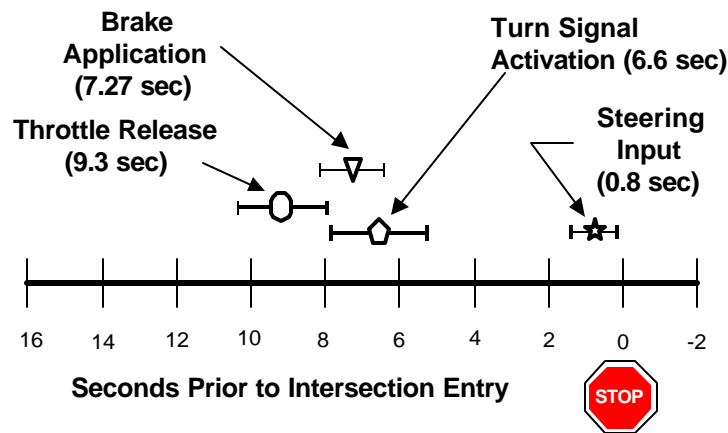
#### **5.3.6.1 Timing Stop Requirement Warnings**

The timing of a driver warning is critical to its usefulness. A warning too late in the intersection approach sequence will not allow adequate time for the driver to respond to a stop requirement. Warnings given too early can violate the expectations of drivers who intend to comply with the stop requirement.

The following delineates an on-road baseline study that was an initial step in determining when driver warnings can be implemented during an intersection approach (14). This on-road baseline study monitored driver input to vehicle controls during the approach to *stop sign-controlled intersections*.

The data showed that, while driver inputs occurred over a relatively wide range of time, the range of standard deviations from the mean values was narrow (e.g., standard deviations for throttle release and brake application were 1.21 and 0.91 seconds, respectively). On the average, drivers released the accelerator approximately nine seconds prior to intersection entry and applied the brakes two seconds later. Steering input occurred significantly later in the approach. This tended to preclude the usefulness of steering input as a predictive cue for determining the timing of warnings to drivers.

A timeline of driver control input was constructed to determine the feasibility of providing warnings to the driver in time for compliance with the intersection traffic control (stop sign). This time line is depicted in Figure 5-19.



**Figure 5-25 Timeline of Control Inputs During Intersection Approach**

Examining the timeline, it may be seen that input to throttle and brakes occur in a relatively narrow time band (i.e., 7 to 9 seconds prior to intersection entry). This implies that a sufficient temporal span is typically available to both alert drivers of a stop requirement and allow drivers to manually react to the warning.

Control input events occur at a considerable distance from intersection entry. Mean throttle release was 68 meters (227 feet) from the intersection and brakes were applied 50 meters (165 feet) prior to entry. Interestingly, turn signals were activated after these events, at 46 meters (154 feet). Maximum longitudinal acceleration applied by the drivers were within a very narrow band. All subjects, with one exception, utilized  $-0.2 \pm 0.05g$  during braking maneuvers. The distances indicated above provide an opportunity to present alerts/warnings to the driver, and potentially prevent traffic control violation under manual braking.

These data suggest that there are distinctive characteristics of control inputs with respect to intended vehicle maneuver at the intersection (15). For example, driver inputs to throttle and brake during straight path maneuver occur consistently earlier in the approach than for turning maneuvers. As might be expected, control input during an approach culminating in a right turn typically occurred latest.

The results also provide insight regarding how driver control inputs can be used to set threshold levels for transmission of warnings to drivers. Thresholds, it is important to note, should be set so as not to violate the expectations of the driver. Specifically, warnings should be presented after drivers would normally make control inputs. Premature presentation of warnings may be viewed as false, or nuisance alarms, hence decreasing the perceived value of the warning and reducing drivers' acceptance of the collision avoidance system (likewise—in keeping with the *psychological refractory period (PRP)* phenomenon—they could serve to delay driver inputs). Examining control input data allows selection of threshold values that are within the range where drivers respond to intersections, and allow sufficient time to prevent violation of the stop sign. Results of an in-vehicle study conducted to examine threshold values is provided below.

#### 5.3.6.1.1 *Guidelines for Timing Stop Requirement Advisory/Warning*

As indicated by a baseline study of driver behavior during the approach to intersections, the provision of driver advisories/warnings regarding a stop requirement at an upcoming stop-sign controlled intersection:

- C Should be determined by driver input to vehicle primary vehicle controls during the intersection approach(7-9 seconds prior to intersection entry), i.e., throttle release and brake application, and
- C Can occur within a time frame that allows the driver to perceive and respond to the stop requirement advisory/warning, without necessitating preemption of vehicle control.

#### 5.3.6.2 **Stop Requirement HUD and Tone Advisory Evaluation**

A driver advisory for stop sign controlled intersections was evaluated during a series of on-road driving studies. The driver advisory of an upcoming stop requirement included a pulsed auditory tone (1000 Hz, 3-100ms pulses) and simultaneous display of a stop sign icon via a Head-Up Display (HUD).

In the study, evaluations were conducted of two of the components (auditory tone and HUD) of the advisory. Test drives were conducted on suburban roadways with posted speed limits of 30 to 35mph. For component evaluation purposes, the ICAS advisory was 7s prior to intersection entry. After the test drive, participants in the study were asked to complete a short questionnaire regarding the driver advisory. Participants' comments were also recorded during the test drive. In general, participants found the duration, and magnitude of the advisory and components to be quite appropriate. They found the timing of the advisory to be somewhat too late, particularly as reflected in their comments. Participants rated the HUD stop sign icon as very meaningful and unambiguous. Finally, participants in the study felt the advisory changed their behavior only slightly but gave high ratings to the overall potential benefits, especially for inattentive or distracted drivers.

## **Method**

Test drives and evaluations were conducted of the auditory tone and HUD components of the advisory. On-road testing used the Veridian Instrumented Vehicle (VIV), equipped with sensors and data acquisition equipment. The test drive was conducted on specifically selected test route on suburban roadways in Buffalo, NY with posted speed limits of 30 to 35mph. Half of the stop sign controlled intersections in the test route were signaled by the advisory, and the other half provided baseline data. To control for potential order effects, this assignment of intersections to conditions was counterbalanced across subjects. In addition, the test route required drivers to perform an equal number of specific maneuvers (8 each of straight path, right turns, and left turns). The drive time of the test route was approximately 40 minutes.

Eighteen drivers (9 males, 9 females) participated in the initial set of evaluations. All participants were Veridian employee volunteers and licensed drivers in NY state. Three age groups were represented in the sample of participants—one third of both males and females were under 35 years of age, one third were between 35 and 50 years old, and one third were 50 or older. Information regarding corrected vision was also collected. On a participant data sheet, participants were also asked to assess their driving on a line scale from *aggressive to conservative*.

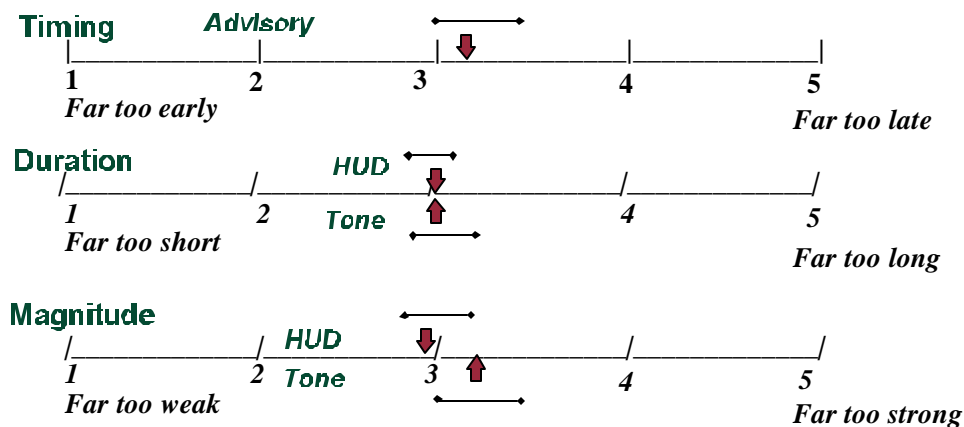
The auditory advisory consisted of three consecutive 1000 Hz tone pulses of 100ms. This will be paired with the haptic advisory in the final system. The haptic advisory will consist of three consecutive - 0.6g break pulses of 100ms, with separation periods of 100ms. The HUD icon – designed to be secondarily attended to with peripheral vision – was presented with the initiation of the auditory tone (or auditory and haptic pulses). Participants were shown three icons during the explanation of the study and system, all of which they were later asked to evaluate, but saw only the stop sign icon (at designated intersections) during the test phase.

The ICAS advisory—when put into operational use—was designed to occur typically about 3s before automated braking would be required to avoid intersection entry. For component evaluation purposes, however, the advisory was 7s prior to intersection entry in an effort to precede driver response. In order to provide estimated time until entry, intersection location was determined via an integrated Geographical Information System (GIS) and Global Position System (GPS). Vehicle dynamics and driver input to vehicle primary controls – throttle, brake, and steering – were monitored during the intersection approach. Video recording equipment also monitored driver response.

Before driving the test route, participants were informed that the purpose of the study was to observe “normal driving behavior.” They were instructed to adhere to traffic regulations and follow general safe driving rules. Participants were also told that they would be asked to evaluate a driver advisory system following the test drive. The advisory system was then described to participants and was demonstrated on the track facility prior to the on-road drive. Participants were also shown a map of the test route and were also prompted regarding the required maneuver prior to each intersection during the test drive. Following the test drive, participants were asked to evaluate components of the advisory and its overall utility.

## Results and Conclusions

The mean age of participants in the study was 43.5 years (SE = 3.13). Data from the aggressive/conservative rating scale were coded into numbers from +5.0 (most aggressive) to -5.0 (most conservative) in .5 point increments, with 0 representing a mark in the middle of the line. Overall, subjects rated their driving as slightly conservative (M = -4.44, SE = 5.54); however, there was a strong correlation between aggressiveness and age ( $r = -.79$ ), with younger drivers more aggressive than older drivers. Very little correlation was found between aggressiveness and gender. The following analyses do not make use of the aggressiveness rating, due to its high correlation with age. No effects of order (of advisory intersections) were found, indicating that order did not affect the results. Figure 5-26 shows participants' ratings of the advisory timing and component qualities. (The arrows represent the mean rating, and the bars above them represent the standard deviation around the mean.)

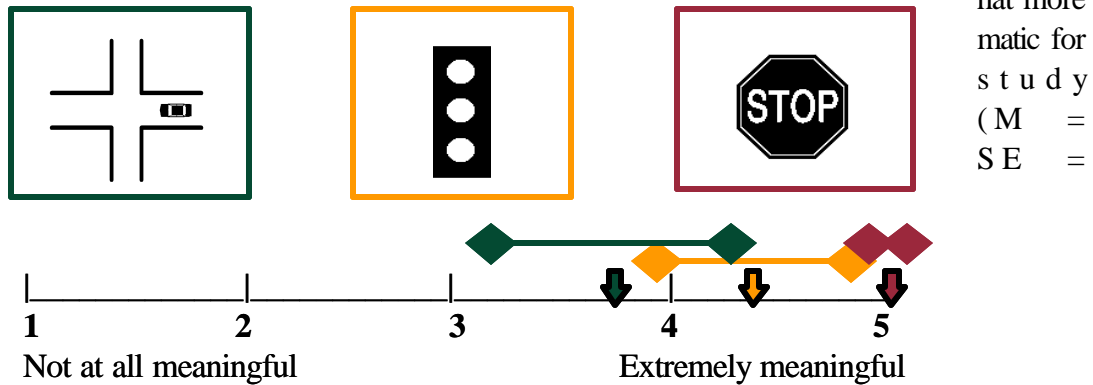


**Figure 5-26 Mean Ratings of Advisory Characteristics**

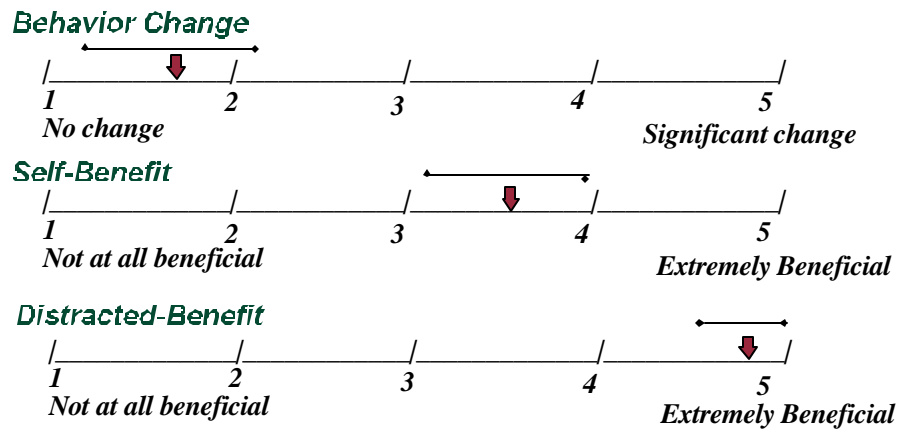
Participants rated the timing of the advisory as a little late (M = 3.24), sometimes directly stating that they had already taken action and begun braking. This effect was pronounced in older adults (50 and over) and males, with both groups finding the advisory to be too late, compared to their counterparts. The duration of both the tone and the HUD were found to be quite appropriate (M for tone = 3.06, M for HUD = 3.06). Overall, participants found the magnitude (i.e., loudness) of the tone to be slightly too strong (M = 3.17) but the magnitude (i.e., brightness) of the HUD to be quite appropriate (M = 2.94). Further examination revealed that younger adults (under 35) rated the tone magnitude as too strong (M = 3.33), while older adults (50 and over) found it to be appropriate (M = 3.00).

Participants were also asked to rate the meaningfulness (on a scale of 1 “Not at all” to 5 “Extremely”) of the particular HUD symbols used in the study (see Figure 5-27). The stop sign symbol—of critical importance in this study and the only symbol that participants saw in the test phase—was rated as extremely meaningful (M = 4.94, SE = .06). The signal light symbol was also found to be quite meaningful

for most participants ( $M = 4.50$ ,  $SE = .19$ ). However, the third symbol—of an intersection—was somewhat more problematic for the drivers in this study ( $M = 3.72$ ,  $SE = .27$ ).



**Figure 5-27 Mean Ratings of Icon Meaningfulness**



**Figure 5-28 Mean Ratings of Advisory Benefits**

An additional four questions were used to assess changes in driver behavior and drivers' perceptions of potential benefits of the advisory. Figure 5-28 shows the results for these questions. As seen in this figure, most drivers believed that the advisory did not change their behavior very much ( $M = 1.83$ ). This finding is consistent with participants rating the advisory as somewhat late and also corresponds

to the conditions of the study—a nearby, relatively straightforward suburban route under normal weather conditions. In fact, most drivers felt that the advisory was *potentially quite beneficial* ( $M = 3.56$ ), *particularly for an inattentive or distracted driver* ( $M = 4.72$ ). This effect was particularly pronounced for the older participant groups. Participants also indicated a relatively high degree of willingness to trust the advisory ( $M = 3.50$ ,  $SE = .22$ ). Older adults and females indicated the greatest willingness to trust the advisory.

Examination of participants' comments helps to illuminate some of these findings. All but one participant (94%) had at least one comment or question. Most comments concerned the potential benefits of the advisory, followed by comments about the timing. Half of the participants made comments specifically regarding whether the driver advisory could be beneficial. Most of these (78%) expressed that it would be particularly beneficial under certain circumstances or situations—e.g., at night or in poor visibility, in a new or unfamiliar area, if distracted, or for an inattentive driver. For the advisory timing, ten participants commented on this aspect (either when specifically rating the timing, or in the general comments at the end of the questionnaire), with 70% of the comments suggesting that the timing was too late.

Most of the comments concerning specific characteristics of the advisory (e.g., tone duration) were positive, particularly regarding the tone and the use of the tone and the HUD together. There was, however, some concern expressed regarding the HUD. In particular, one of the symbols (the intersection symbol) was found to be confusing for some participants. This did not impact the test phase—because that symbol was not displayed on the test drives—but did affect participant evaluations and has resulted in redesign. Reaction to the overall advisory system and potential benefits was quite positive. Five participants specifically expressed an overall positive reaction to the system in general comments, and an additional seven comments offered positive feedback about particular aspects of the advisory.

In summary, the ICAS advisory used in this research was generally evaluated very positively. Participants found it to be potentially quite beneficial, indicating likely acceptance of it in the future. Concern over the advisory timing has been addressed, since the current study, by replication with an earlier advisory. Baseline data revealed that under similar conditions drivers' typically initiate a stop—as indicated by throttle release—at 9.3s (1.2ms SD), on average, prior to intersection entry). This factor also may have affected their responses regarding behavior change. Most subjects in the present study felt the advisory caused little change in their actual behavior—likely because they had already initiated their behavior. The overwhelming majority of participants studied to date have rated the potential usefulness of the ICAS advisory as very high, particularly under circumstances of driver inattention or distraction and novel or difficult driving situations.

#### 5.3.6.2.1 *Driver Eye Glance Behavior*

Driver eye glance data were collected during the on-road *Stop Requirement* advisory study. Results of driver eye glance behavior with respect to advisories presented via the HUD will be included in the final report.

Along with the 18 subjects from the stop requirement advisory study, videotape data from an additional six subjects, recorded during a similar study (i.e., same display and same test route), were

included in eye glance analysis. Of the 24 total subjects, eye glance data could not be obtained for six drivers who wore eye glasses or sunglasses that obscured eye movements. A total of 216 eye glance observations were made from videotapes of 18 subjects.

The results showed that 47 percent of the driver eye glance observations were on average 0.13 seconds in duration ( $SD=0.35s$ ). These very short duration eye glances appear reasonable, given that display changes associated with advisory onset were highly detectable, and display content was visually simple, easy to perceive, and highly familiar. No perceivable eye movements were detected for the remaining 53 percent of the observations. Given the highly perceptible display characteristics, drivers may have obtained the advisory information peripherally, without glancing directly at the HUD display. The display was not visually complex, and the stop sign was a familiar and meaningful icon for drivers. Alternatively, drivers may have simply ignored the HUD display. As discussed earlier, drivers in the stop requirement study were attentive to the driving task and had already started to respond to the stop requirement before they received the HUD advisory. This could have diminished the importance of the information conveyed by the advisory and the perceived need to look at the display. Additionally, even though drivers were led to believe they could receive any of three HUD advisories, they actually were given only the stop requirement advisory during the test drive. Therefore, drivers may have anticipated display content, negating the need to look at the HUD.

In conclusion, the eye glance duration data indicate that a HUD advisory for an upcoming stop requirement can be perceived very quickly—within a short duration glance or possibly with peripheral vision. However, the eye glance behavior observed in this study may differ from patterns observed under conditions of potential violation of traffic control. Eye glance duration should be examined when there is an increased likelihood of stop requirement violation, for instance, when a driver is inattentive or distracted or the driver's line of sight to a TCD is obscured. Future study of eye glance behavior should also assess how conveying various types of driver advisories impacts eye glance duration.

#### 5.3.6.2.2 *Lessons Learned Regarding the Presentation of HUD and Tone Stop Requirement Advisories*

Based on the results of a preliminary on-road evaluation of driver response *Stop Requirement* advisories, the following observations are made:

- C The majority of drivers responded very positively to the *Stop Requirement* advisory and felt the advisory could be very beneficial to a distracted or inattentive driver,
- C Drivers appeared to require only short duration eye glances to observe the HUD advisory or were able to process this information peripherally. It should be noted, however, even though drivers were led to believe any of the icons could be displayed on the HUD, the same information (i.e., *Stop Requirement* advisory) was always presented during the on-road test. This likely decreased the driver's need to look at the HUD. Testing under various driving circumstances, e.g., with additional advisories, under crash imminent situations, and distracted driver circumstances, and with an integrated haptic warning system, is required to validate these results.



### 5.3.6.3 Stop Requirement Haptic and Tone Warning Evaluation

Track tests were conducted to determine the physical properties of haptic warnings—*generated through brake pulsing*—that would be readily recognized and accepted by drivers. Participants were asked to rate the magnitude and duration of the haptic brake pulse and accompanying tone patterns. The haptic countermeasure system was manually triggered to provide a haptic warning and accompanying tone, as participants drove along a leg of the track, maintaining a speed of 35mph.

#### **Method**

Haptic brake pulse parameters identified for testing were based on an initial on-road guidelines development effort and track engineering tests. Prior to the study, over 50 engineering tests of the haptic warning system were conducted. Test drivers' evaluative comments regarding warning characteristics were recorded during these tests and used to identify a set of acceptable haptic brake patterns for study. The system pressures and pulse configurations selected and implemented for the study present are provided in Table 5-11.

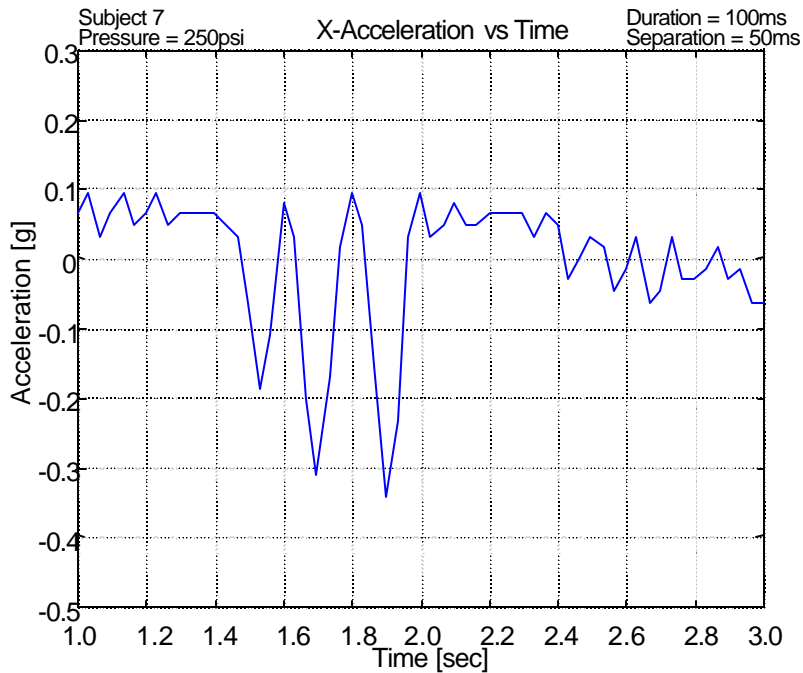
**Table 5-11 Haptic Brake Pulse Parameters  
conducted under 250psi and 400psi Conditions**

Test No.	Pulse Duration (ms)	Pulse Separation (ms)
1	50	50
2	50	100
3	100	50
4	100	100

Each warning consisted of three sequential brake pulses, with a separation period as seen in Table 5-11. The identified brake pulse parameters were tested under 250 and 400psi conditions, resulting in peak accelerations of approximately -0.15 to -0.55gs, for a series of pulse parameters. As shown in Figure 5-29, the 250psi brake pulse condition for a 100ms duration-50ms separation had a -0.3g average acceleration. At 400psi, for a 50ms duration-100ms duration brake pulse, the average acceleration was -0.35g (see Figure 5-30). Effect of velocity on perception of haptic warning was evaluated for ranges of magnitudes and duration of brake pulsing using driver alerting and acceptance ratings. A 1000Hz pulsed tone, presented approximately 10 db above ambient noise conditions, was synchronized with the brake pulse sequence. Participant evaluation of the tone was also conducted. Vehicle brake system modifications required to implement the brake pulsing parameters are later described in Section 5.4. The ICAS Testbed Vehicle was used to acquire and record vehicle dynamics and haptic system activation, with driver performance videotaped.

Six Veridian employees, three male and three female, balanced across three age groups (<35, 35<50, and 50>), participated in the study. They were instructed regarding the nature of the study, signed

consent forms and completed a short questionnaire prior to driving the ICAS testbed vehicle. After becoming acclimated to the vehicle, adjusting mirrors and vehicle seat position, participants drove to the test track area where they were given a demonstration of the haptic warning system. For each system pressure condition (250 and 400 psi), drivers received two repetitions of each pulse configuration. Drivers were first given two trial blocks of four pulses each at 250 psi, followed by two blocks of four pulses each at 400 psi (for a total of 16 trials). In the first blocks, the pulses were presented in the order shown in Table 5-11. Pulse sequence in following blocks were randomized and counterbalanced across subjects.



**Figure 5-29 Acceleration Profile for Haptic Brake Pulses (100ms duration-50ms separation) at 250 psi**

Drivers were instructed not to apply the brakes when they received a warning. This is because the haptic warning system is designed to disengage and terminate the warning signal when the driver applies the brakes, and the purpose of the study was to evaluate warning characteristics. Triggering of the warning occurred after the vehicle reached a travel speed of 35mph, and was initiated at various intervals. Shortly after receipt of a warning, drivers were asked to stop the car and evaluate the magnitude and duration of the haptic brake pulse and the pulsed tone using a rating scale questionnaire described in the next section. Drivers were encouraged to write any additional comments they wanted to make on the questionnaire. Verbal comments were recorded on videotape, with in-vehicle cameras positioned to capture the driver's face and foot position. Following completion of the 16 test trials, drivers were instructed to drive back to the building. While en route to the building, drivers were given an additional "surprise" warning. The

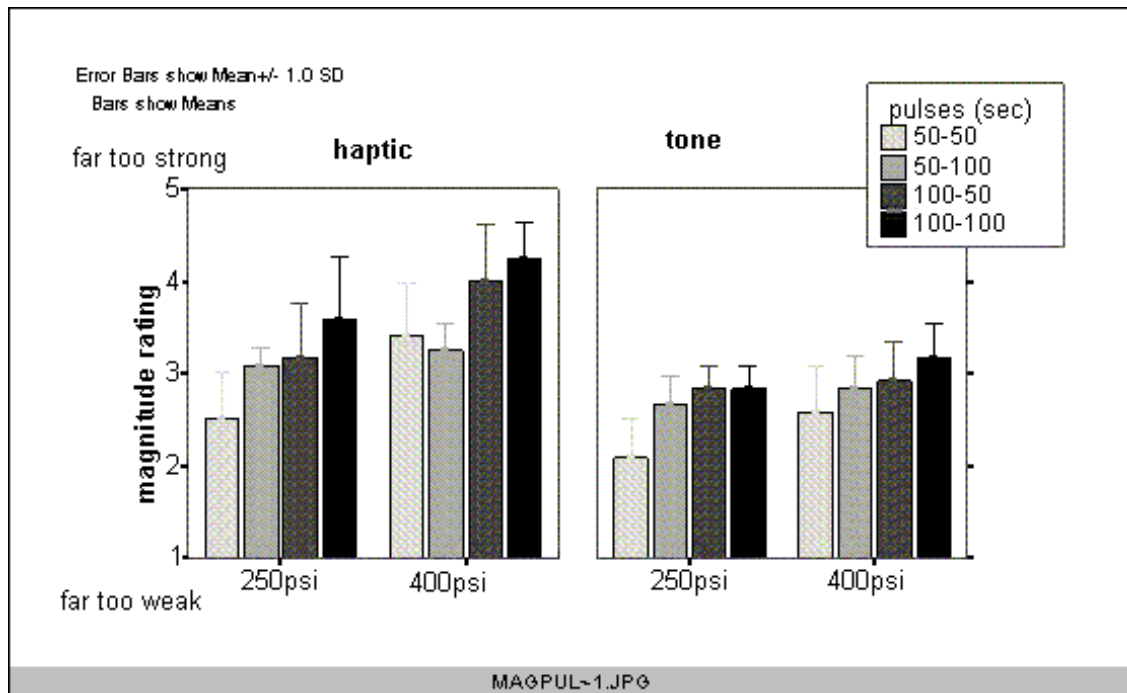
surprise warning was intended to capture drivers' response to an unanticipated warning. Participants rated the surprise warning and completed a post-test questionnaire, upon return to the parking lot.

### Test Results and Conclusions

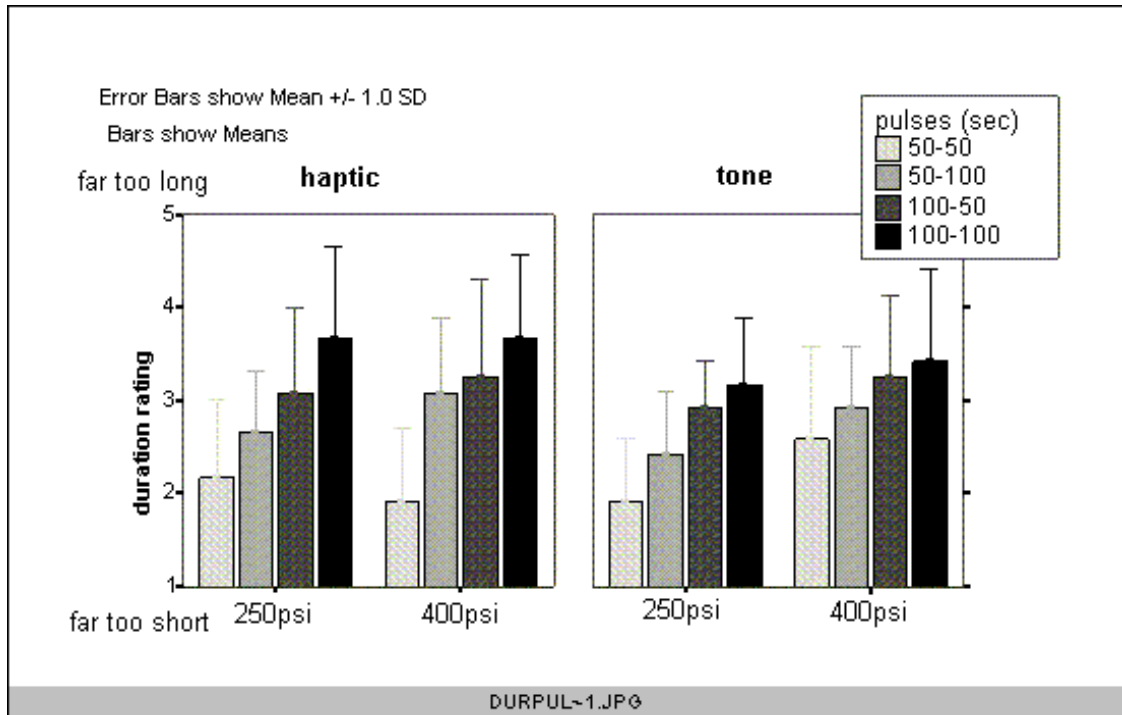
Participants' duration and magnitude ratings of the warning are shown Figures 5-31 and 5-32, respectively, for haptic and tone warning components. As noted earlier, five point rating scales were used to indicate magnitude (1=far too weak, 5=far too strong) and duration (1=far too weak, 5=far too strong). for the haptic and tone components of the warning.

For the haptic component, participants broadly rated the 50-100s pulse configuration as most appropriate. This was true in the 250psi and 400psi conditions for both magnitude (250psi M=3.08, SD=0.29; 400psi M=3.25, SD=0.45 ) and duration (250psi M=2.67, SD=0.65; 400psi M=3.08, SD=0.79). Tone magnitude, which actually did not differ during the test, was also rated favorably for the 50-100s and 100-50s pulse configurations in the 250psi condition (M=2.83, SD=0.39 for both configurations). In the 400psi condition, the tone's magnitude and duration were considered appropriate at 50-100s (M=2.83, SD=0.58; M=2.92, SD=0.67, respectively). The 100-50s pulse was favored in the 250psi condition duration ratings (M=2.92, SD=0.51). Collapsing over mode and psi conditions, the 50-100s pulse was rated more favorably on magnitude (M=2.96, SD=0.50) and duration (M=2.77, SD=0.72) than other pulse configurations.

A series of four analyses of variance (ANOVAs) were conducted separately to evaluate haptic and tone duration and magnitude ratings. These ANOVAs generally supported the observations made above.



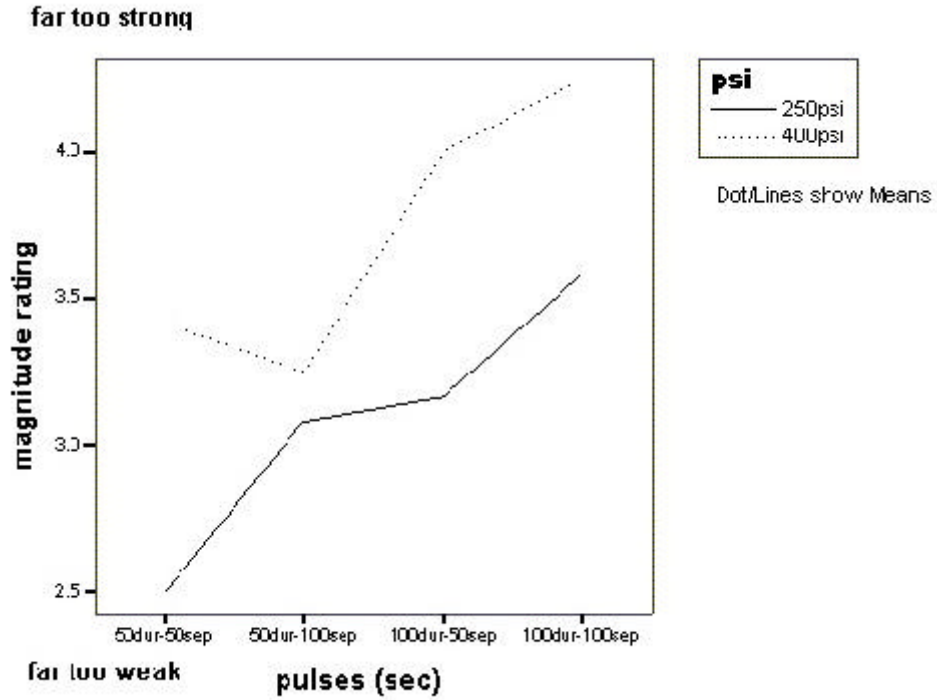
**Figure 5-31 Mean Magnitude Ratings of Haptic and Tone Warnings by PSI Condition**



**Figure 5-32 Mean Duration Ratings of Haptic and Tone Warnings by PSI Condition**

**Haptic Magnitude Rating**

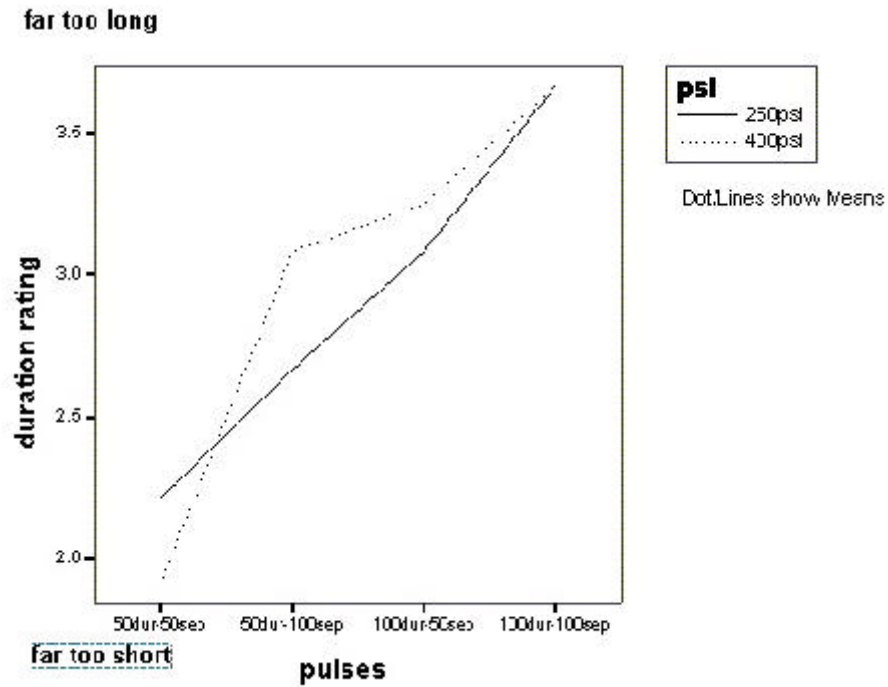
ANOVA haptic magnitude ratings revealed a significant main effect for psi,  $F(1,5)=17.10$ ,  $p<0.01$ , and an interaction of psi and pulse ( $p<0.01$ ). These are illustrated in Figure 5-33. The 250psi 50-100 and 100-50 patterns appear optimal.



**Figure 5-33 Mean Haptic Magnitude Ratings Across Force (PSI) and Pulse Conditions**

## Haptic Duration Rating

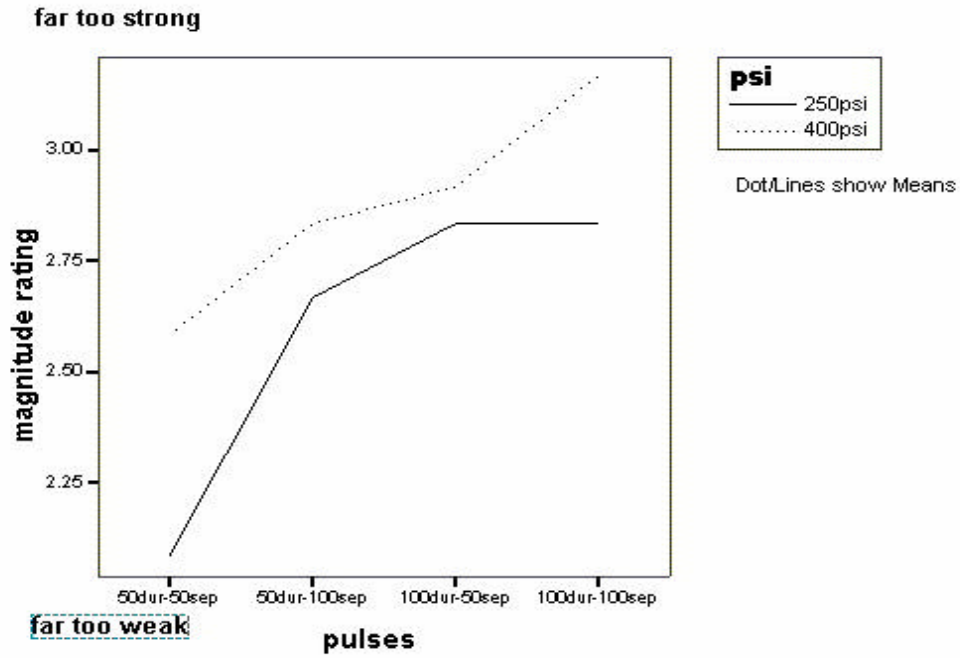
The ANOVA of haptic duration ratings revealed significant main effects ( $p < 0.01$ ), as well as interactions of pulse and psi. Figure 5-34 illustrates these results. Examining this figure, it can be seen that—of the two ideal 250 psi conditions—the 100-50 pulse is judged nearest ideal and the 50-100 is somewhat too soft.



**Figure 5-34 Mean Haptic Duration Ratings Across Force (PSI) and Pulse Conditions**

## Tone Magnitude Rating

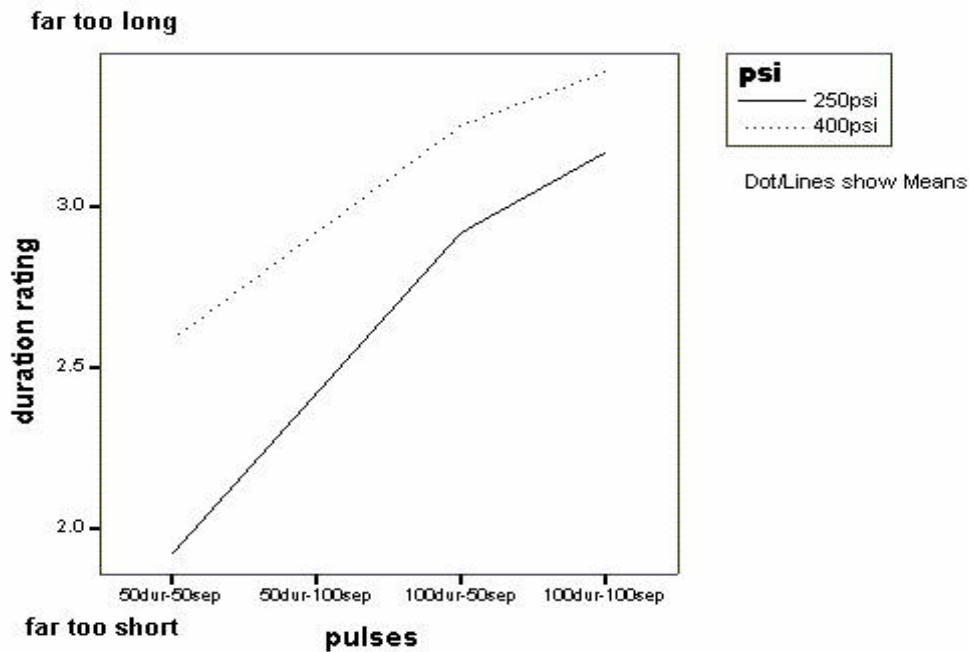
The ANOVA of tone magnitude ratings revealed a significant main effect of pulse ( $p < 0.01$ ). Figure 5-35 illustrates that magnitude was rated as more appropriate for the 50-100 and 100-50 pulse patterns.



**Figure 5-35 Mean Tone Magnitude Ratings  
Across Force (PSI) and Pulse Conditions**

## Tone Duration Rating

The ANOVA of tone duration ratings revealed significant main effects ( $p < 0.01$ ), as well as interactions of pulse and psi. In Figure 5-36, it can be seen that, for the 400 psi condition, 100-50 and 50-100 pulses were considered most appropriate. An upward volume adjustment, controlled by the driver, could serve to increase the acceptability the 50-100 pulse.



**Figure 5-36 Mean Tone Magnitude Ratings Across Force (PSI) and Pulse Conditions**

## Surprise Test Results

Ratings of the 400 psi 50-100 surprise warning mimicked results described earlier. Videotape of driver's foot position was analyzed for the surprise warning event. Five of the six drivers initiated throttle release when they received the surprise warning and two of these drivers also applied the brakes. The remaining driver had already released the throttle prior to receiving the warning and made no further response. Finding that drivers responded to the haptic warning by releasing throttle or applying brakes is noteworthy—particularly since they had just completed 16 trials during which they did not apply the brakes when given a warning. This directly demonstrates that, when unanticipated, the haptic warning stimulus elicited the desired response—to begin to decelerate the vehicle through throttle release and brake application.



## **Post-Test Questionnaire**

Participants were asked to respond to indicate how beneficial they thought the haptic warning would be for their own driving and how beneficial the haptic warning would be for an inattentive or distracted driver using five point rating scales (1=Not at all beneficial, 5= Extremely beneficial). Participant ratings indicated they felt the haptic warning could be quite beneficial to their own driving (M=4.17) and extremely beneficial to inattentive drivers (M=4.83). As shown in Figures 5-32 and 5-34, this effect was somewhat stronger for males than females for both self-benefit ratings (M=4.33 and M=4.00, respectively) and inattentive driver benefit ratings (M=5.00 and M=4.66, respectively). Younger drivers indicated slightly less potential self-benefit (M=3.50, SD=0.71) and inattentive driver benefit (M=4.50) than mid-aged and older drivers (see Figures 5-33 and 5-35).

## **Summary**

Haptic brake pulsing appears a particularly viable and promising means of warning drivers of a stop requirement at an upcoming intersection. Advanced versions of the system may potentially be used to bring a vehicle to a full stop prior to intersection entry. While technically feasible, however, driver acceptance may limit the use of a fully automatic braking system. Haptic brake pulsing, it is noteworthy, provides an omni-directional alert that is consistent with the braking action it is intended to elicit from drivers. Haptic brake pulsing is consequently expected to provide an effective “heads-up” warning for drivers that will enhance the potential for intersection collision avoidance, and provide a key element in a future integrated CAS.

### ***5.3.6.4 Observations Regarding the Presentation of Haptic and Tone Stop Requirement Advisories***

The results indicate that drivers consistently perceived the differences in appropriateness of system pressure and pulse configuration of the haptic warning. The overall results generally support:

- Use of a 50-100 pulse pattern at 250 psi;
- Use of a 1000Hz at 10dB auditory signal that can be upward adjusted for hearing impaired, and
- High driver acceptance of haptic and tone stop requirement advisories.

### **5.3.7 Inadequate Gap**

#### ***5.3.7.1 Timing Inadequate Gap Warnings***

Effective timing of an *Inadequate or Unsafe Gap warning* requires knowledge of typical gap acceptance at intersections. Untimely warnings—those presented too early or too late—could be perceived as false or nuisance alarms, potentially distract drivers, or rendered ineffective if evasive action cannot be taken in time avoid an intersection collision.

For the intersection collision avoidance system (ICAS), *gap* is defined as *the time gap between the Subject Vehicle (SV) attempting to negotiate the intersection, and the Principle Other Vehicle (POV), or threat vehicle, approaching the intersection on an intersecting path*. An Inadequate Gap warning is issued when the ICAS determines the gap between the SV and POV will not allow the

completion of SV’s intersection traversal before the POV enters the intersection. In other words, if the ICAS determines the SV and POV will occupy the same space in the intersection, at the same time, an Inadequate Gap warning is issued.

Since a wealth of traffic engineering research already exists regarding gap acceptance at intersections, a review of these studies was conducted. The objective of the review was to obtain gap acceptance data that could be used as baseline data for timing Inadequate Gap warnings. The majority of the studies reviewed were conducted for traffic engineering purposes, observing traffic flow at intersections to obtain measures of gap acceptance for capacity estimation.

The complexities of gap estimation became readily apparent early in the review. Main road traffic volume and headway distribution, intersection characteristics, vehicle size, and queue wait time, not to mention the procedures used for gap measurement and estimation, all impact critical gap. The definition of gap used in traffic engineering research differs from the gap defined for the ICAS. In traffic engineering research, *critical gap*, a major parameter used in gap acceptance models, is defined as *the minimum time gap between two successive vehicles in the major street traffic stream that is accepted by drivers on a minor street for crossing or merging with the major street flow* (e.g., Brilon et. al, 1999). Although admittedly a different measure, critical gap provides an approximation of the *minimum gap time window* during which drivers determine it is safe to perform intersection maneuvers. Data for left, right, and crossing maneuvers are provided in Table 5-12.

**Table 5-12 Critical Gap by Maneuver Type  
at Unsignalized Intersections (13)**

<b>Intersection Maneuver Type</b>			
	<b>Left</b>	<b>Right</b>	<b>Crossing</b>
Critical Gap (sec)	7.0	6.2	6.5

A variety of methods have been used to measure gap. Recent publications have supported the use of the *maximum likelihood method* and *Hewitt’s method*, as reliable and accurate critical gap estimation procedures (12,13). The critical gap estimations, reported in Table 5-12, were derived with the maximum likelihood method, using field data collected on US roadways.

*Disposable time gap*, a more appropriate gap measure for the ICAS, was reported in a study conducted by Lall and Kostaman (1991). *Disposable time gap* is defined as *the difference between the time stamp when the minor street vehicle leaves the stop line and the time when the next vehicle on major street arrives at the intersection*. In Table 5-13 critical gap is reported as a median value based on the disposable gaps.

**Table 5-13 Critical Gap (Median Disposable Gap) by Maneuver Type  
at Unsignalized Intersections (14)**

<b>Vehicle Maneuver</b>	<b>First</b>	<b>Subsequent</b>
Left-turn from minor road	5.0	3.4

Right-turn from minor road	3.7	3.9
Cross major road	4.0	3.2

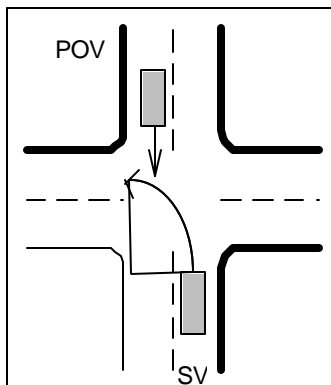
As can be seen in Table 5-13, disposable gaps are somewhat shorter than the critical gaps reported in Table 5-12. Notice also the difference between disposable gap data for first and second or subsequent vehicles. Subsequent vehicles accept shorter gaps than first vehicles. The researchers suggest that subsequent vehicles have shorter critical gaps because the driver of the subsequent vehicle is alerted when the front vehicle leaves the stop line and then evaluates whether the remaining portion of the gap is adequate to negotiate the intersection.

The data discussed thus far were collected at two-way, stop-sign-controlled (unsignalized) intersections. A study of left-turn maneuvers *signalized* intersections (15) demonstrated results consistent with those obtained at unsignalized intersections. When vehicles were standing (stopped) prior to initiating a left-turn, the average left-turn maneuver time was 4.95 seconds. Vehicles that were moving prior to initiating a left-turn, had shorter left-turn maneuver times—3.9 seconds on average.

In the following sections, the data reviewed here are used to support recommendations of trigger values for Inadequate Gap warnings. Trigger values are recommended for two ICA scenarios that use Inadequate Gap warnings as a collision avoidance countermeasure: Scenario 1 Left-Turn across Path; and Scenario 2 Perpendicular Path-No Traffic Control Violation.

### 5.3.7.2 Timing Recommendations for ICAS Inadequate Gap Warnings

#### Scenario 1 Left Turn Across Path (LTAP)



<b>Crash Segment:</b> Comprises 25.2% of intersection crash problem	
<b>TCD:</b> Green Signal Phase	87.1
No TCD	12.9
<b>Causal Factors</b>	
Looked, Did Not See	26.5
Attempted to Beat Vehicle	24.9
Vision Obstructed/Impaired	20.7
Driver Inattention	17.9
Misjudged Velocity/Gap	7.8
Thought POV Would Stop	2.2
<b>Critical Errors:</b>	Did not observe POV Misjudged distance, velocity, POV actions
<b>Countermeasure Function:</b> Inadequate gap advisory and warning	

**Figure 5-37 Scenario 1: Left-Turn Across Path**

The majority of Scenario 1 as shown in Figure 5-37 crashes are due to perceptual errors—e.g., drivers looked, but failed to see approaching vehicle (26.7%), vision obstructed/impaired (20.7%) with

and driver inattention. The Inadequate Gap warning alerts the driver regarding the presence of an approaching vehicle and advises the driver it is unsafe to proceed.

The data suggest that drivers typically accept time gaps of approximately 4-5 seconds when initiating a left-turn across path maneuver at a signalized intersection (15). Therefore, it is recommended that for initial testing, an Inadequate Gap warning under Scenario 1 conditions will trigger when:

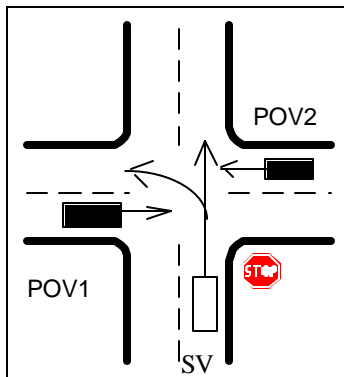
- \$ SV has signaled intention to turn left and is located at the point of intersection entry or in the intersection conflict zone of a signalized intersection; and,
- \$ POV is approaching the intersection on an intersecting path and the gap between SV and POV is inadequate. An inadequate gap warning will trigger when the time gap between SV and POV meets the following criteria:

**Table 5-14 Trigger Values for Scenario 1**

Left-Turn Maneuver	Inadequate Gap (sec)
SV Standing	= 5.0
SV Moving	= 4.0

Provision of an Inadequate Gap warning for signalized intersections requires knowledge of signal phase and left-turn treatment [i.e., protected (separate left-turn lane) or unprotected]. This information could be provided via the roadside infrastructure. This is beyond the scope of the current ICA program.

**Scenario 2 Perpendicular Path-No TCD Violation**



<b>Crash Segment:</b> Comprises 36.1% of intersection crash problem			
<b>TCD:</b> Stop Sign	94.6	<b>Maneuver:</b>	
Stop Sign/Flashing Red	1.3	Straight	49.5
Flashing Red	0.6	Left	49.4
Yield Sign	3.5	Right	0.6
<b>Causal Factors</b>		Straight	Turn
Looked, Did Not See		58.2	73.8
Vision Obstructed/Impaired		13.2	19.0
Driver Inattention		22.4	-
Misjudged Velocity/Gap		1.6	4.0
Thought POV Would Stop		4.7	3.2
<b>Critical Errors:</b>		Did not observe POV	
		Misjudged distance, velocity, POV actions	
<b>Countermeasure Function:</b> Inadequate gap advisory and warning			

**Figure 5-38 Scenario 2: Perpendicular Path - No Traffic Control Violation**

Disposable gaps do not include the time drivers require to perceive the approaching traffic and decide whether or not to proceed into the intersection. Measurement begins when the minor road vehicle (SV) leaves the stop line and ends when the next main road vehicle (POV) arrives at the intersection. This

measures the gap time between SV and POV when SV traverses the intersection. Therefore, disposable gaps appear to represent appropriate trigger values for Inadequate Gap warnings for Scenario 2 Perpendicular Path - No Traffic Control Violation. In Scenario 2, shown in Figure 5-38, the SV complies with the traffic control stop requirement, and the POV is not required to stop. The collision occurs when SV proceeds into the intersection to attempt to turn or continue on a straight path. The majority of Scenario 2 crashes are due to perceptual errors—e.g., drivers looked, but failed to see approaching vehicle, and driver inattention. The Inadequate Gap warning alerts the driver to the presence of an approaching vehicle and advises the driver it is unsafe to proceed.

It is recommended, for preliminary test purposes, that the disposable gap times (accepted by first vehicles) identified by Lall et. al (1991), serve as initial threshold values for triggering an Inadequate Gap warnings for Scenario 2 conditions. This means that Inadequate Gap warnings will be triggered when the following conditions exist:

- \$ SV has signaled intention to turn or is stationary, located at the stop line of an unsignalized intersection (first in the queue), and brake release and/or throttle input occurs; and
- \$ POV is approaching the intersection on an intersecting path, and there is an inadequate gap to POV. An Inadequate Gap warning will trigger when the time gap between SV and POV meets the criteria in Table 5-15.

**Table 5-15 Trigger Values for Scenario 2**

<b>SV Intended Maneuver</b>	<b>Inadequate Gap (sec)</b>
<b>Left-turn</b>	<b>= 5.0</b>
<b>Right-turn</b>	<b>= 3.7</b>
<b>Cross</b>	<b>= 4.0</b>
<b>Default</b>	<b>= 4.0</b>

These trigger values may result in more warnings issued under high traffic volume conditions, when wait times are longer and drivers are more likely to accept smaller gaps. Under these circumstances, warnings could be perceived as nuisance alarms and the perceived benefit of the warning system diminished. Alternatively, it could serve to deter high-risk-taking behavior involved in accepting smaller gaps. Testing of these initial parameters under high volume conditions is required to evaluate their effectiveness.

The Inadequate Gap warning for Scenario 2 will consist the presentation of a pulsed tone and a HUD icon visually depicting the direction of approaching threat. The throttle will be disabled and the brakes applied to prevent the stopped vehicle from entering the intersection under inadequate gap conditions. Override of the warning system will be possible via driver activation of the Vehicle Abort System.

## 5.4 Vehicle Systems

A dedicated ICAS Vehicle Testbed was assembled for this program. The initial system development for ICAS was performed using a Veridian Instrumented Vehicle. This vehicle, a 1993 Ford Taurus equipped with an auxiliary power system and data acquisition equipment allowed the development and initial testing of the threat detection and GIS/GPS systems. When the systems were integrated to function as a full ICAS the components were assembled onto a Ford Crown Victoria. A photo of the Crown Victoria is shown in Figure 5-39. This vehicle was chosen from the automotive fleet due its size, which allowed easy installation of equipment, large engine and electrical system capacity, and it was rear wheel drive. The rear wheel drive provided a large amount of access room in the engine compartment. This became important when installing equipment such as the front radar assembly, and running wiring through the vehicle. It should be noted that this vehicle is equipped with a Ford optional heavy duty electrical system. This included a heavy duty battery, and a large capacity alternator. This system provided adequate electrical power to run all components of the ICAS.



**Figure 5-39**  
**ICAS Testbed Vehicle**

This specific Crown Victoria was selected due to the sunroof that the vehicle was equipped with. The ICAS configuration included mounting of two side-looking radars on the vehicle roof. Previous testing on the Veridian Instrumented Vehicle had indicated that the roof mounting position of the side-looking radars held performance advantages over a bumper mounting system. These advantages were seen in reduced masking by vehicles traveling alongside the testbed. This was especially true when at intersection, and other vehicle are passing to either side of the vehicle.

The ICAS equipment was integrated into the Crown Victoria Platform. A summary of the modifications includes:

- mounting of forward looking radar on front bumper centerline
- mounting of two side-looking radars on roof in replacement of sunroof
- installation of Head-Up Display in vehicle cab
- installation of laptop computer in vehicle cab
- mounting of following component in vehicle trunk:
  - radar processing electronics
  - radar scan platform servo-amplifiers
  - GPS receiver
  - DGPS receiver
  - haptic braking hydraulic system
  - mini-tower computer
  - auxiliary battery
  - DC / AC inverter
  - equipment relays

#### 5.4 1 Vehicle Radar Systems

The installation of the radars on the vehicle may be observed Figure 5-40. Note that while the forward radar installation has an environmental cover, the roof mounted radars do not. This was omitted due to cost considerations associated with fabricating the roof mounted cover. The mounting of the radars on the roof has positive performance benefits when in traffic. Although no direct comparison of roof vs bumper mounted radars were performed the video data taken during on-road tests provided evidence vehicle masking would have occurred in many intersection encounters were the side-looking radar mounted on the bumper.

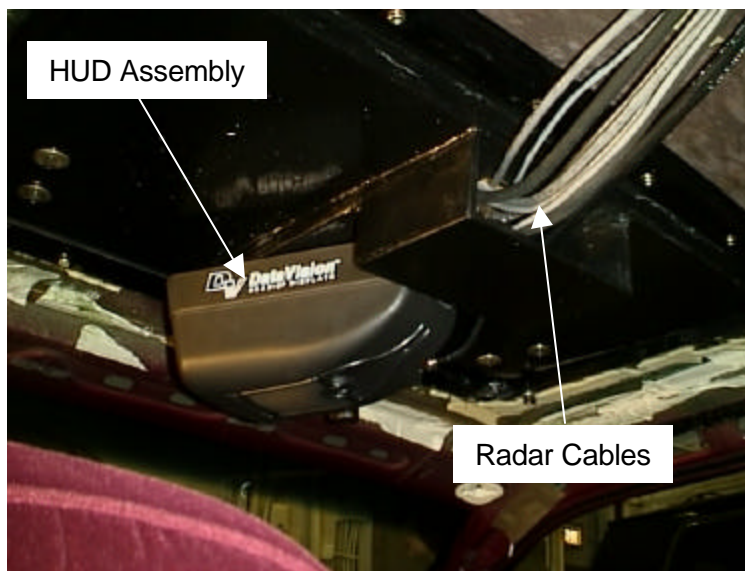


**Figure 5-40**  
**Illustration of Radar Mounting**

Blending the radars into vehicle styling was beyond the scope of this program. An effort was made in siting the components to recognize limitations that a mass deployment of this system would impose on styling and sensor accident survivability. Mounting all three radars into the front bumper, while degrading performance of the side-looking systems, would place these sensors in a vulnerable position, subject to damage by even minor crashes. The roof mounting for the radars puts these sensors in the area of the occupant protection zone. This zone can be defined as the passenger area between the vehicles' "A" and "C" pillars. In frontal, and most side impacts, this area could be given a high probability of surviving undamaged, thereby preventing very expensive sensors from being damaged in any crash. The final siting of the sensor elements is left to the judgement of the vehicle manufacturer.

### 5.4.2 Head-Up Display

The provision of warnings to the driver is a prime performance feature of the ICAS system. The ICAS uses a multi-modal system to display warnings, using visual, audio, and haptic feedback. The visual system is a Head-up Display (HUD) mounted within the cab assembly of the Crown Victoria. Figure 5-41 illustrates the mounting of the HUD within the vehicle. The HUD is mounted on the replacement sunroof that also acts as mounting for the side-looking radars. This mounting system permitted access for the radar cables from the roof mounting location to the processing electronics in the vehicle trunk.



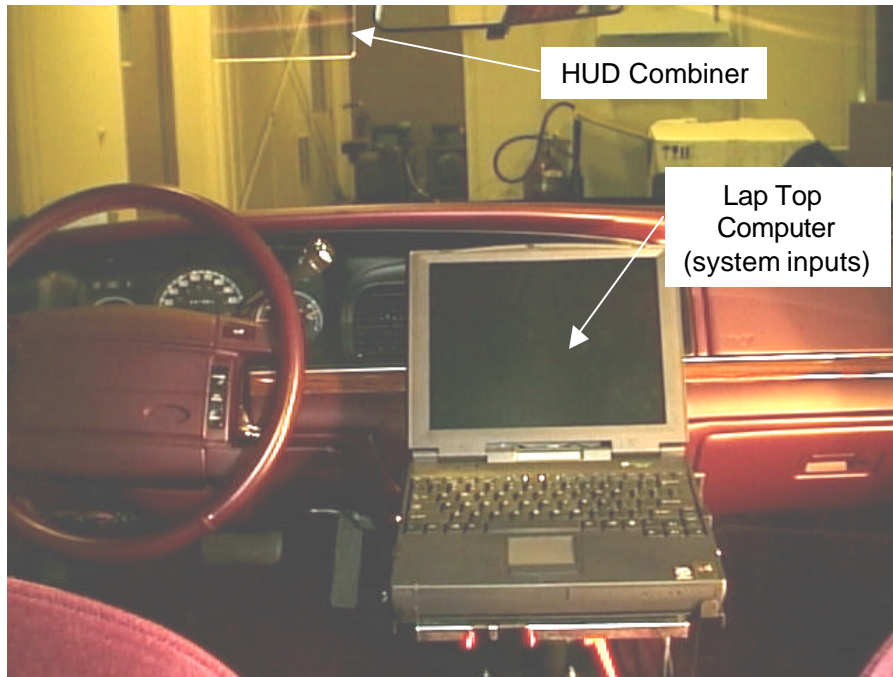
**Figure 5-41**  
**HUD System Mounting**

### 5.4.3 Lap Top Computer

A laptop computer was mounted with the vehicle cab to provide input to the countermeasure software and to allow initiation and completion of data acquisition. The laptop is a commercially available



unit, with no special modifications made for this application. The computer is mounted with a commercially available mount that is marketed to the law enforcement community, made specifically for the Crown Victoria. A photo of the laptop and mount is shown in Figure 5-42.

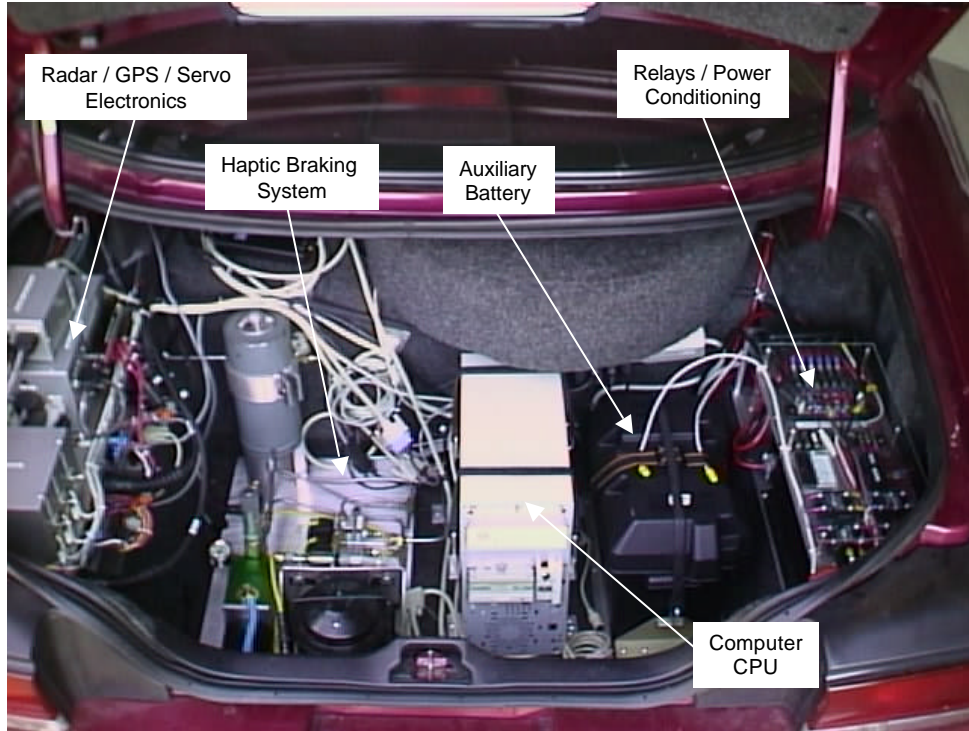


**Figure 5-42**  
**Laptop Computer Mounting**

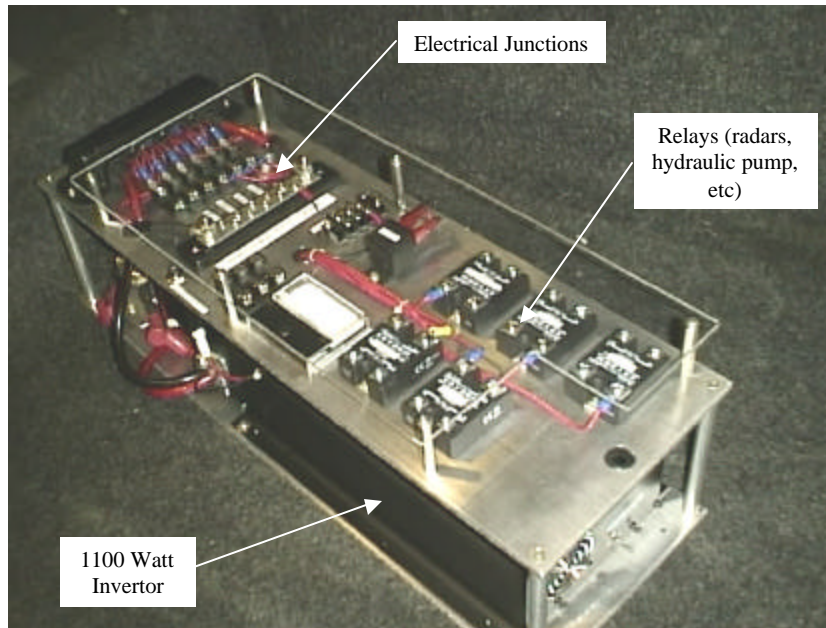
#### **5.4.4 Signal Processing / Electrical Systems**

The ICAS requires the integration of mechanical, electronic, and hydraulic systems. This integration must be made within the physical and electrical limitations of the host vehicle. It is noteworthy that this was accomplished with minimal changes to the vehicle. Apart from the mounting of the radar antennas as previously discussed, the changes to the vehicle were minimal. A secondary battery was installed in the system to prevent excessive draw on the vehicle battery. This battery was charged from the standard vehicle charging system, with no modifications.

All signal processing and electrical processing equipment was placed in the vehicle trunk. A photograph of the vehicle trunk is shown in Figure 5-43. The equipment rack on the left side of the vehicle contained the radar and GPS/DGPS systems. The rack on the right contained the power conditioning and relays to support the system. Figure 5-44 illustrates a close-up of the electrical rack.



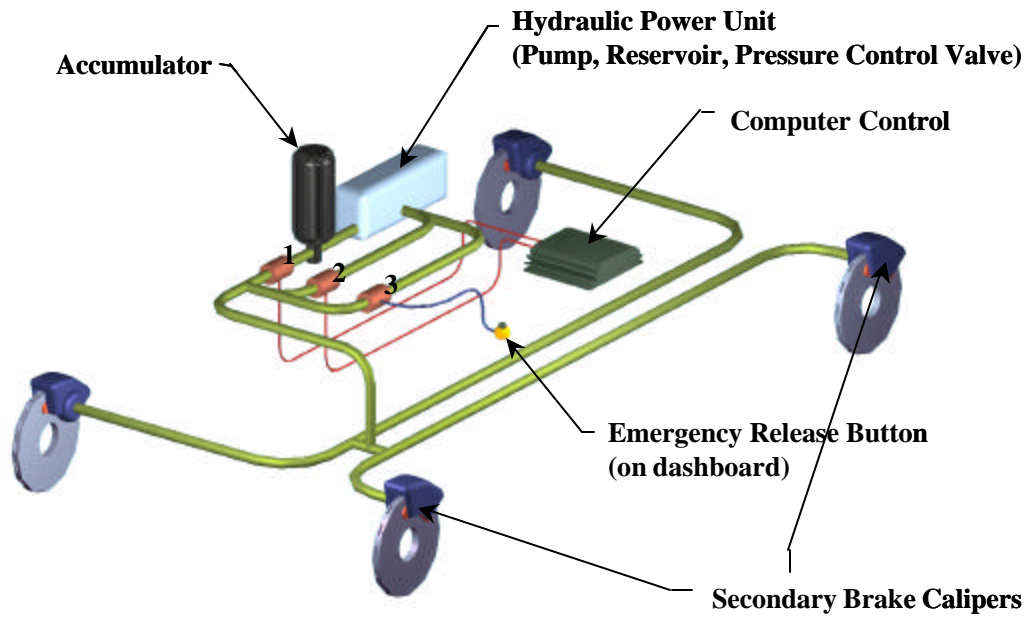
**Figure 5-43**  
**Equipment Configuration - ICAS Vehicle**



**Figure 5-44**  
**ICAS Electrical Station**

### 5.4.5 Haptic Braking System

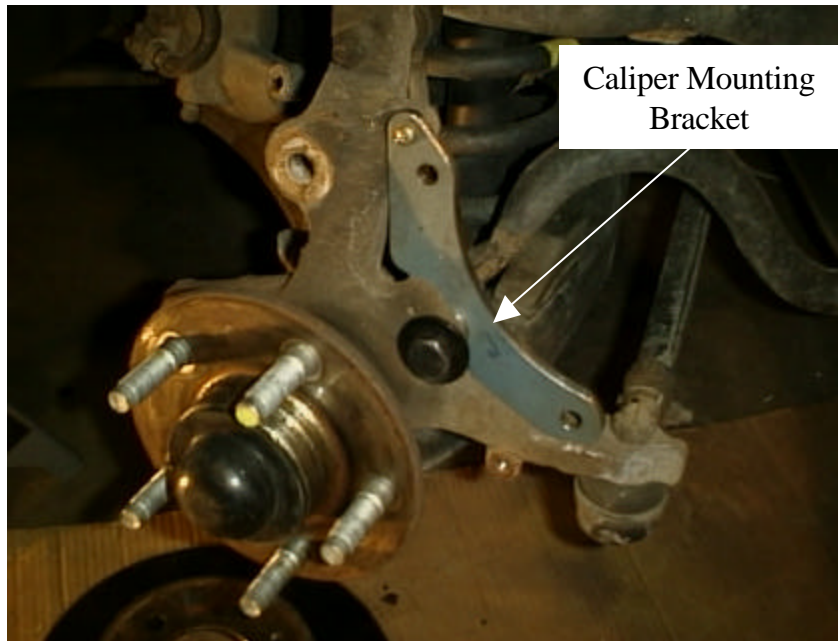
The haptic braking system is part of the driver vehicle interface. This system is a completely self contained secondary hydraulic braking system controlled by the ICAS computer. A system diagram is shown in Figure 5-45



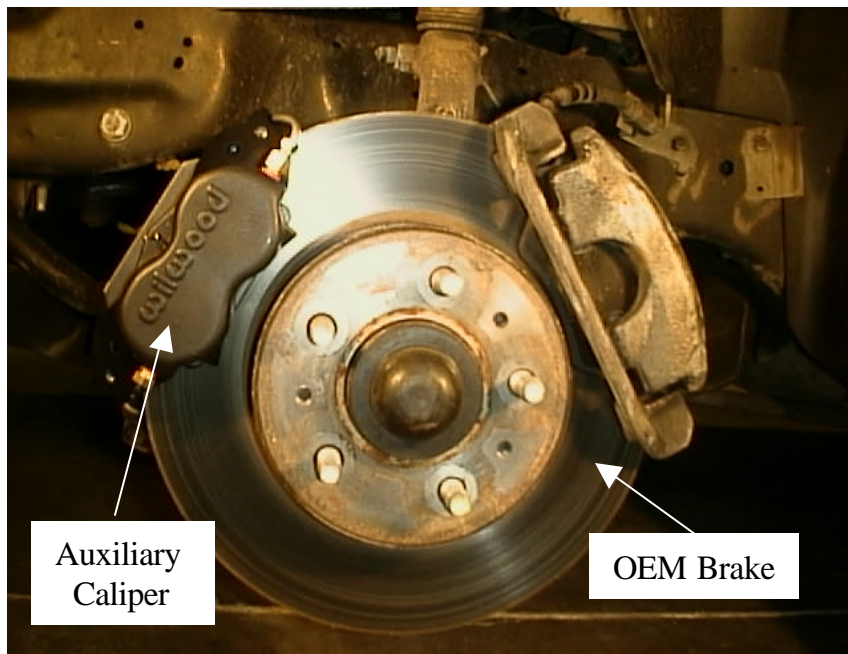
**Figure 5-45**  
**Haptic System Features**

The haptic brake system utilizes after market calipers designed for use in auto racing. These calipers were mounted at all four wheels on brackets designed by Veridian. The secondary calipers and mounting brackets are illustrated in Figures 5-46 and 5-47.

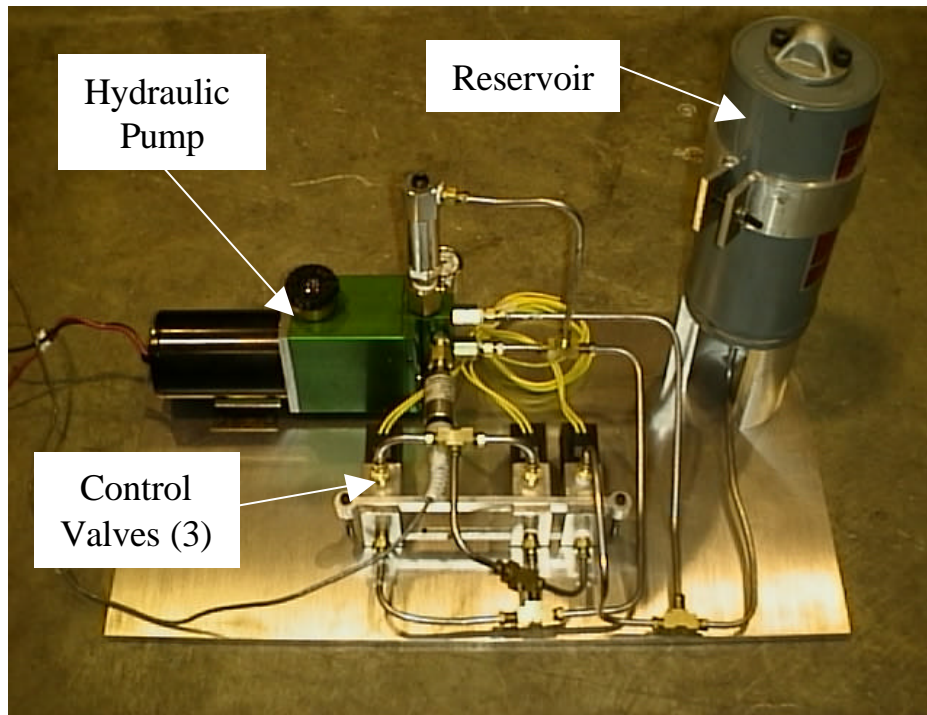
The haptic braking system can be tailored to provide deceleration to the vehicle without the driver providing an input. The system utilizes computer control to open and close solenoid valves. These valves control the flow of hydraulic fluid to the secondary brake calipers. The hydraulic system for the haptic braking system is shown in Figure 5-48. Level and configuration of the deceleration is controlled by the ICAS computer. The system is capable of providing a constant deceleration, or a pulsed deceleration of varying magnitude and duration. The system is designed with a fail-safe mode of system off. That is, the system fails with the secondary brakes in a non-functional mode. A detailed discussion of the haptic braking system is provided along with the discussion of its use as a component in the Driver Vehicle interface.



**Figure 5-46**  
**Haptic Braking Caliper Mount**



**Figure 5-47**  
**Haptic Braking Configuration**



**Figure 5-48**  
**Haptic Braking Hydraulic System**

#### **5.4.6 Vehicle System**

The efforts of this program successfully incorporated the equipment necessary to perform intersection collision avoidance into a passenger vehicle. The systems utilized in this program were for the most part commercial off the shelf. One of the goals of this program to build a prototype ICAS system that could be utilized to determine what functions the system must be able to perform. It was not required that a commercially viable system be available at the completion of the program. The vehicle described here provides a solid performance basis for the development of a commercially viable ICAS, and should not be inferred to be commercially viable in its present form.

## 5.5 Performance Guidelines

The ICAS testbed described within this report is the product of a requirements-driven assessment of the intersection crash problem. Data regarding vehicle dynamic situation and causal factors derived from review of accident data files led to the design and fabrication of an on-board system of sensors and equipment that can be effective in preventing intersection crashes. The data from the accident databases and experience developed in the testing of the system has generated a series of clear requirements that the ICAS must perform in order to prevent crashes. This section describes the system requirements, and recommendations for system improvements that will improve the performance of the ICAS.

In general, the ICAS must perform the following functions in order to prevent intersection collisions:

- C warn driver of proceeding with insufficient gap
- C prevent violation of the traffic control device
- C transmit warnings to drivers in an efficient, effective manner

These functions were described in detail in previous sections of this report. This section will describe the performance guidelines for the ICAS.

### 5.5.1 Threat Detection System

During in-traffic evaluations many situations were encountered that should influence the selection of system parameters and performance specifications for future systems. Some parameters/specifications are associated with the radar sensor and some with the GIS/DGPS. Table 5-16 lists 9 important parameters, the source of the parameter, the current and desired values of the parameter and a comment on how the parameter affects system performance. A brief discussion of Table 5-16 follows.

- *Position errors should be less than 3.05m*

The accuracy with which the ICA vehicle and targets are positioned in a common coordinate system needs to be improved. Significant position errors occurred at a few specific intersections. These errors, which originate primarily in the GIS/GPS were observed to reach 6.10-9.14m during on-road tests. Two consequences of these errors are incorrect application of the special countermeasure logic (which is invoked when the ICA vehicle is within a certain distance of the intersection edge) and incorrect positioning of a target detection and subsequent track, both of which affect the resulting warning times. Position errors should be less than 3.05 m.

**Table 5-16 Performance Guidelines  
Threat Detection System**

Parameter	Source	Current Value	Desired Value	Affects
Target and ICAS vehicle position accuracy	DGPS/GIS	6.1 - 9.1m	≤3 m	Countermeasure logic, warning times
ICAS vehicle speed	CPS (vehicle speed sensor and GPS)	≤1.5 mps (depends on ICAS Decel.)	≤0.15 mps	Target and ICAS speed estimate, clutter cancellation
Max range of threat detection sensor	Radar	120 m	150 m	Early tracking of cross roads targets
Range accuracy	Radar	3% of range	3% of range	Estimated target position, predicted time to intersection
Range rate accuracy	Radar	0.1 mps	0.1 mps	Target speed estimate, predicted time to intersection
Angular accuracy	Radar	~4 deg.	≤1 deg.	Target heading estimate, predicted time to intersection
Scan rate	Scan platform	20 deg/sec.	30-40 deg/sec. for current system	Observation of threat sub-sector, revisit time
Update rate	Radar	0.1 sec.	Commensurate with scan rate	Number of detections/beamwidth
Deceleration estimate	Radar	Simple threshold of 0.9 m/s/s	Better algorithm	Estimate of target's intention to turn

- ICAS vehicle speed should be accurate within 0.15 m/sec*

The ICA vehicle's speed is estimated by the Continuous Positioning System (CPS) which uses the vehicle speed sensor and GPS. The CPS derived speed exhibited a substantial lag estimated at 1.5 sec (see Section 5.2.2.3). Such a lag adversely affects, among other things, the clutter rejection function which rejects zero velocity targets. Consequently, the lag in the CPS's speed estimate can result in the generation of clutter tracks which could result in warnings. (The lag was recently addressed and through filtering has been substantially reduced, but not in time for the evaluations). The estimate of the speed of the ICA vehicle should be accurate to within 0.15 m/sec.
- Final Threat Sensor should have maximum range of 150 m*

On-road evaluations revealed that while some intersections had restricted line of sight (LOS), most of the intersections encountered over the 77 square kilometers of digitized test area had more than adequate LOS. Consequently, it was found that a somewhat longer radar range than the 120 m available with the VORAD system is desirable. A maximum radar range of 150 m is recommended. This would allow a target on a perpendicular cross road to be detected at a distance of nearly 107 m from the intersection while the ICA vehicle is nearly 107 m from the intersection.

- *Radar range accuracy of 2 to 4% of range is acceptable*  
The VORAD radar range accuracy has been quoted at 3% of range. The radars used on this program generally met that criterion with relatively low error standard deviations. More thorough calibration of the radar range measurement and the use of calibration coefficients (developed and tested on the Veridian test track but not incorporated in the real-time software program) should be investigated.
- *Radar range rate of 0.1 mps more than adequate*  
The radar range rate of the VORAD system (about 0.1 mps) is more than adequate.
- *Angular accuracy should be 1 deg or better*  
The angular accuracy of a future system should be considerably better than can be obtained from the 4 deg beam of the EVT-200 VORAD system. This relatively poor angular accuracy resulted in requiring the system to obtain target heading from the direction (heading) of the roadway on which the target was traveling. Roadway heading is obtained from the GIS and is accurate to better than 1.4E. (Targets are “assigned” to a road based on their proximity to the road as determined by the radar.) Angular accuracy of a future threat detection radar should be 1 deg or better and preferably obtained solely from the radar measurement. (Consequences of poor angular accuracy, for example, are errors in the predicted time of a target to enter and exit an intersection since target heading enters into the linear motion dynamics used to determine predicted times).
- *Scan Rate Optimization*  
For an implementation such as the current 3-antenna system, two critical improvements are needed in antenna scan rate and the system update rate. On-road tests clearly showed that the two cross road subsectors observed by the side looking radars could not be adequately observed with a 20 deg/sec scan rate of the 4 deg radar beam (azimuth). Fast cross roads targets that are not detected on a previous scan (perhaps because of masking), could escape detection entirely by reaching the intersection with the antenna beam literally chasing the target as the beam scans inward toward the intersection. With its limited scan rate, the beam never catches up with and observes the target.. Arbitrarily increasing the scan rate results in too few “hits” as the beam scans over the target because of the modest update rate of 0.1 sec. A scan rate of 30 to 40 deg/sec is recommended with a commensurate update rate that results in at least 4 hits per beam for the beamwidth in question. (For example, for a 4 deg antenna scanning back and forth over the subsector at 40 deg/sec, an update time of 0.025 sec would result in 4 “hits” per beam).
- *Deceleration Estimates*  
In scenarios involving left turns across path (LTAP) of the ICA vehicle by the target or a LTAP of the target by the ICA vehicle, a deceleration signature of the oncoming traffic is used (see Section 5.1.6). The system evaluations were performed with a simple threshold applied to the estimated deceleration (or lack thereof). Subsequently, although not in time for system evaluations, an improved deceleration (or “slowing”) algorithm was developed. This algorithm should improve the attempt at determining the intention of oncoming traffic in a LTAP scenario, and needs to be tested. In addition, deceleration profiles of traffic approaching an intersection should be measured to establish parameters in the improved algorithm.



Not listed in Table 5-16 are the phenomena of target scintillation and multipath. Most sensor systems such as radar are subject to angular or doppler scintillation and multipath. Scintillation, where multiple scattering centers on a single target result in a spread in doppler (as well as angle) which in turn results in multiple tracks for a single target. This produces errors in warning times. Scintillation and multipath effects need to be examined and minimized through radar waveform and signal processing techniques. On this program, tracker logic was employed to eliminate the spurious tracks and use only the primary track from a single target. In addition, on-road tests showed the possibility of multipath resulting in the erroneous location of a target which then generated a track and a warning. Techniques and selection of parameters to minimize multipath have yet to be explored.

### 5.5.2 DGPS/GIS

The development and testing of the GIS/GPS system provided insight as to some performance guidelines that are necessary for the system. The system that was developed for the ICAS program is a straight-forward system that is capable of being deployed with sufficient investment by the government or private industry. Performance guidelines for the system are summarized in Table 5-17, and discussed below:

**Table 5-17 Performance Guidelines - DGPS/GIS System**

Parameter	Source	Current Value	Desired Value	Affects
Vehicle position accuracy	DGPS	3 meters	3 meters	consistency of alarms, tracker accuracy
Intersection location accuracy	GIS	3 meters	1 meter	consistency of alarms, tracker accuracy
Vehicle position update rate	DGPS	10 Hz	10 Hz	consistency of a <sub>p</sub> alarms
Accuracy of roadway data elements	GIS	>99.99%	>99.99%	ability of system to function
Accuracy of roadway shape characteristics	GIS	>99.99%	>98%	ability to point radar, vehicle position
Accuracy of Traffic Control Device Inventory	GIS	>99.99%	>99.99%	Provision of a <sub>p</sub> warning, system actions at intersection
Data latency	GIS / GPS	<0.1 sec	0.3 sec	Provision of warnings

- *Position and roadway information update rate of 10 Hz adequate for ICAS.*  
The ICAS system performed adequately when operating at a system update rate of 10Hz.

Investigation of vehicle position update rate of 1 Hz, which is the update rate for standard GPS systems, was found to be inadequate to support the countermeasure function. The inadequate update rate caused false alarms and inconsistency of the warnings provided by the GIS/GPS unsignalized intersection warning system.

- *The system software was able to access the map database in real time to support transfer of intersection information to the Threat Detection System and unsignalized intersection warning system in a timely manner.*

The system software for the ICAS is adequate to process map information in real-time and to provide roadway and intersection information to the countermeasure. Time delays in the accessing of map data were not sufficient to cause problems with data flow and processing of countermeasure functions

- *Positional accuracy of ~3 meters generally found to be adequate.*

Testing of the GPS/DGPS system against known markers proved that the system provided positional accuracy of approximately 3 meters. This accuracy is within the specifications of most differential - equipped GPS systems. In general, this accuracy specification was found adequate to support the ICAS function. In specific cases, a greater positional accuracy was found to reduce false alarms in the threat detection system.

- *The latency of data is important in the ICAS, and needs careful attention to detail.*

The latency of data being provided by the various sensors in the ICAS is a critical area that must be addressed. Common to many applications where vehicle position and dynamics are being measured, the synchronization of data streams is important. Section 5.2.2.3 described a latency of the vehicle speed data that caused problems with system performance. The vehicle speed data was delayed by 1.5 seconds, and was causing false tracks to be initiated by the threat detection system tracker software. Identifying this problem and rectifying it solved the problem.

### **5.5.3 Driver Vehicle Interface**

The Driver Vehicle Interface is the direct connection between the ICAS sensor and processing systems and the driver. This system must provide the driver with a clear indication that a collision is imminent, and provide the information in an unambiguous manner to allow the driver the maximum amount of time to react to the warning. Table 5-18 provides the Performance Guidelines for the Driver Vehicle Interface as applied in the ICAS program.

**Table 5-18 Performance Guidelines  
Driver Vehicle Interface**

<b>Parameter</b>	<b>Source</b>	<b>Current Value</b>	<b>Desired Value</b>	<b>Affects</b>
Provide multiple modes of warning – advisory / alert – warning	DVI	Visual Audio Haptic	Visual Audio Haptic	Driver reaction and reaction time
Use icons to transmit warnings	HUD	Icons	Icons	Driver reaction and reaction time
1kHz audio signal 20db above background	Audio system	1kHz audio signal 20db above background	1kHz audio signal 20db above background	Driver reaction and reaction time
Requirement to stop transmitted by pulsing of brakes	haptic braking system	pulse parameters - three 100msec pulses separated by 100msec	pulse parameters - three 100msec pulses separated by 100msec	Driver reaction and reaction time

#### **5.5.4 Guidelines Summary**

The guidelines provided above were derived from the design and testing of the ICAS testbed constructed in this program. During the development of these guidelines care was taken to provide guidelines independent of specific technologies. In some cases, such as the DVI, this was not feasible. The goal was to provide a description of basic system functions that an ICAS must perform in order to achieve a measure of collision prevention. These guidelines were realized and implemented in the ICAS testbed, thereby providing an example of how intersection crashes may be prevented. Other system designers should benefit from these guidelines.

## REFERENCES

1. Intersection Collision Avoidance Using IVHS Countermeasures, Task 5 Interim Report: Design of Testbed Systems, Vol 1, Calspan Report No. 8169-8 Jan. 29, 1997.
2. Intersection Collision Avoidance Using IVHS Countermeasures Task 6 Interim Report: Development and Refinement of Testbed Systems, Calspan Report No. 8149-11 June 17, 1998.
3. Multitarget Tracking with Radar Applications, Blackman, Samuel, Artech House, 1986.
4. Kalman Filtering Theory and Practice, Grewal, M.S., Andrews, A.P., Prentice Hall, 1993.
5. Pierowicz, J., Bollman, E., Parada, L., Lloyd, M., Weissman, S., Scheiffle, T., and Page, J. (September, 1994). *Intersection Collision Avoidance Using IVHS Countermeasures*, Task 1 Report: Draft Interim Report Volume I: Technical Findings (DTNH22-93-C-07024). Buffalo, NY: Calspan.
6. Pierowicz, J., Bollman, E. and MacDiarmid, P. (January, 1995). *Intersection Collision Avoidance Using IVHS Countermeasures*, Task 2 Report: Draft Interim Report Volume I: Technical Findings (DTNH22-93-C-07024). Buffalo, NY: Calspan.
7. Traffic Safety Facts 1994: A Compilation of Motor Vehicle Crash Data from the Fatal Accident Reporting System and the General Estimates System, U. S. Department of Transportation, National Highway Traffic Safety Administration, 1994, p. 50.
8. Intersection Collision Avoidance Using IVHS Countermeasures, Task 4 Draft Interim Report, State-of-the-Art Technology Review, (DTNH22-93-C-07024). Buffalo, NY: Calspan Corporation.
9. Campbell, J.L., Bittner, A.C. Jr., Lloyd M., Mitchell, E. Everson, J.H. (April 1997). *Driver-Vehicle Interface (DVI) Design Guidelines for the Intersection Collision Avoidance (ICA) System* (Final Report). (DTNH22-93-C-07024). Buffalo, NY: Calspan.
10. Boff, K. R. and Lincoln, J. E. (1988). Guidelines for designing alerting signals. *Engineering Data Compendium* (11.401). Wright Patterson AFB Ohio: AAMRL.
11. COMSIS (1995). *Multiple Attribute Evaluations of Auditory Warning Signals for In-Vehicle Crash Avoidance Warning Systems* (Draft Report). Silver Spring MD: COMSIS Corporation.
12. Jovanis, P. and Campbell, J.L. (1996). *Rapid Prototyping of Collision Warning Alerts* (Final Report). Davis, CA: Institute of Transportation Studies, UC Davis.
13. Campbell, J.L., Hooey, B.H., Carney, C., Hanowski, R. J., Gore, F.R., Kantowitz, B.H., and Mitchell, E. (1996). *Investigation of Alternative Displays for Side Collision Avoidance Systems* (Final Report). Seattle, WA: Battelle Seattle Research Center.
14. Lloyd, M. M., Witherow K., Gawron, V.J. Pierowicz J. A., and Bittner, A. C. (1997). Using driver-vehicle primary control input to determine the timing of alerts and warnings. (*SAE97FTT-12*). Warrendale, PA: Society of Automotive Engineering International.
15. Lloyd, M.M., Pierowicz, J.P., and Bittner, A.C. Jr. (1998). Intersection Driving Maneuver Prediction Using Driver Input to Vehicle Controls. XIIIth Annual International Occupational Ergonomics and Safety Conference.
16. Brilon, W. Koenig, R., Troutbeck, R.J. (1999). Useful estimation procedures for critical gaps. *Transportation Research*, **33**, 161-186.
17. Kyte, M., Tian, Z., Mir, Z., Hameedmansoor, Z., Kettelson, W., Vandehey, M., Robinson, B., Brilon,

- W., Bondzio L., Wu, N., Troutbeck, R., 1996. "Capacity and Level of Service at Unsignalized Intersections, Final Report: Volume 1-Two-Way Stop-Controlled Intersection. National Cooperative Highway Research Program, pp. 3-46.
18. Lall, B. K. and Kostaman Thayib (1991). Critical gap acceptance at two-way stop controlled intersections. *Highway Capacity and Level of Service*, Branolte (ed.): Balkema, Rotterdam (ISBN 90 54100117).
  19. Lu, Y. (October, 1984). A study of left-turn maneuver time for signalized intersections. *ITE Journal*, pp. 42-47.

## **6.0 ICAS SYSTEM ANALYSIS**

The completion of ICAS testing has provided an opportunity to evaluate a number of system features and tools. This section will examine the following issues:

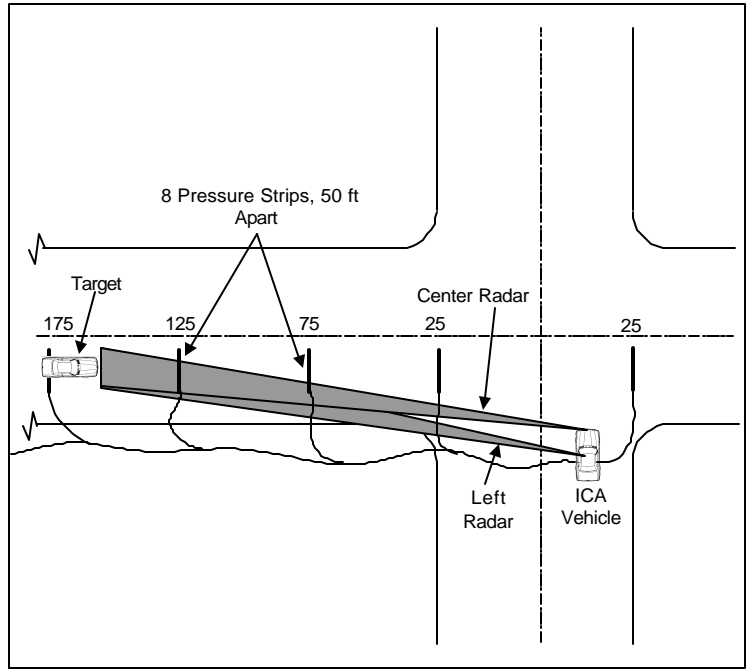
- Validity of the computer model developed in this program
- Countermeasure benefits
- Countermeasure benefit if system applied on a national basis
- Technical feasibility of the ICAS countermeasure
- Practicality and cost of system implementation
- Criteria and procedures to evaluate
  - frequency and effect of false alarms
  - factors that could degrade system effectiveness

These areas will be discussed separately in the sections that follow.

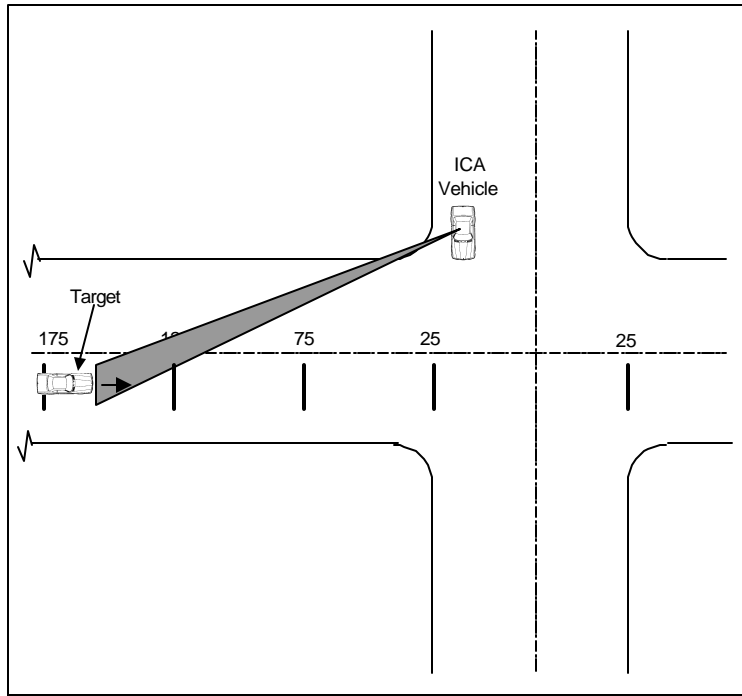
### **6.1 Validation of Threat Detection System**

#### **6.1.1 Warning On and Off Times**

A primary measure of the threat detection system performance is the activation and deactivation warning times of the countermeasure relative to the times that the warning should have activated and deactivated. A quantitative evaluation of warning times was performed on the Veridian test track (VERF) by creating an intersection on the track and instrumenting the roadway through the intersection with pressure strips which, when run over by the vehicle, close a relay which applies a marker to the radar data being recorded. For warning evaluation, the critical pressure strips are the two at the edges of the intersection. Both Scenario 2, with the ICA vehicle waiting on the crossroad as if preparing to cross, and Scenario 1, with the ICA vehicle waiting in the opposing adjacent lane across the intersection, situations were investigated. A single target traveling at constant speed was employed approaching and traversing the intersection from east to west. Figure 5-9 showed the VERF. Figure 6-1 shows the system validation test set-up. Approximately 40 runs (a run is one experiment with target approaching intersection) were made during July and November of 1998 and were distributed over the three radars and three different speeds. Radar data (range and range rate) along with pressure strip markers were applied to the MATLAB® simulation (tracker, collision warning algorithm) and a comparison was made of activation and deactivation times, first by speed and then for all speeds. Some tracker parameters were modified in the simulation as the data were evaluated. Note that the real time system is a “C” code copy of the MATLAB® non-real-time simulation, so that performance evaluated with the non-real-time program applies also to the real-time system. Table 6-1 shows a summary of the results for the center, left and right radars. Turn-on and turn-off errors were averaged over two or three speeds. Although some of the errors were larger than hoped for, the averages and standard deviations of the warning errors were deemed acceptable.



(a) Left and Center Radar Measurements



(b) Right Radar Measurements

**Figure 6-1**  
**Radar Range Measurements, Warning Activation Errors**

Note that this validation approach does not require a target vehicle instrumented with a transponder to determine its exact location and closing rate with respect to the ICA vehicle. While the latter is very desirable, it is also very costly.

**Table 6-1 Activation and Deactivation Measurements**

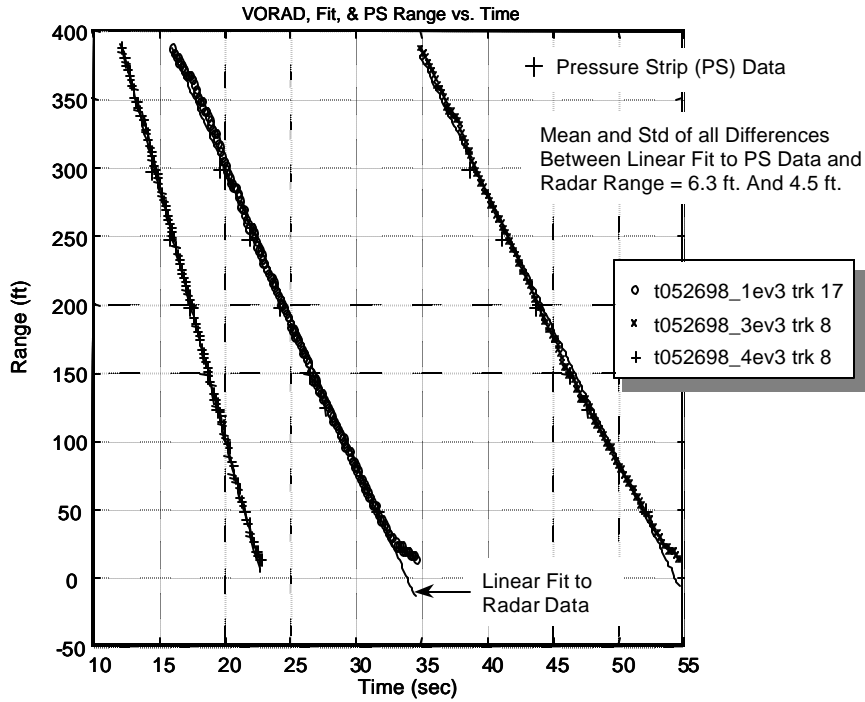
Date	Radars	Speeds (MPH)	Scan	Turn On Error		Turn Off Error	
				AVE.* (sec)	S.D. (sec)	AVE.* (sec)	S.D. (sec)
7/98	Center	15, 30	N	0.04	0.4	-0.6	0.5
11/98	Left	15, 30, 45	Y	0.6	0.5	0.03	0.3
11/98	Right	15, 30, 45	Y	0.8	0.4	0.6	0.8

\* (-) means ON or OFF LATE

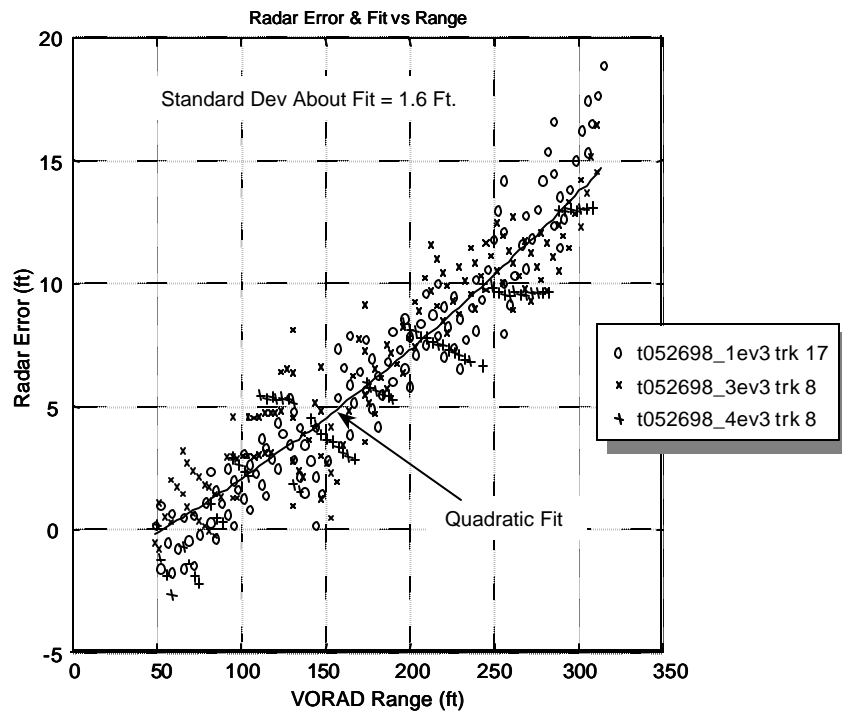
### 6.1.2 Radar Range Errors

Using the same experimental set up shown in Figure 6-1, range errors were determined between radar range measurements on a single target and the target range as determined by the pressure strips. For the range errors, all pressure strips are used. As the target approaches the radar vehicle, the target is tracked and its range is measured. Figure 6-2a shows examples. Three range tracks, from three runs, are shown as a function of time. Also indicated is the pressure strip (PS) data. A linear fit (not shown) is made to the PS data and the error between the radar and PS data is computed. For the 3 runs shown, the mean and standard deviation of all the differences (errors) between the linear fit to the PS data and the radar data was 6.3 ft. and 4.5 ft., respectively. The errors are plotted in Figure 6-2b as a function of range. A quadratic fit to the errors is made and is shown in the figure. The mean error can be corrected by applying calibration coefficients to the data. The mean of the errors about the corrected data is zero. The standard deviation about the quadratic fit is 1.6 ft. The low values of errors (mean and standard deviation) for the uncorrected radar range data (Figure 6-2a) as well as the small spread of error data about the quadratic fit (Figure 6-2b) suggested that correction is not worthwhile. Moreover, over the volume of data collected, the calibration coefficients that were computed seemed to vary substantially. Further investigation may reveal trends that would allow further minimization of errors. For the system evaluations reported herein, no range error correction was used.





(a) Radar Range Measurements and Linear Fit Compared to Pressure Strip Data



(b) Quadratic Fit to Composite of Errors Between Radar Range Measurements And Pressure Strip Data

**Figure 6-2 Example of Radar Range Errors for Single Target, Three Runs on Veridian Test Track**

## 6.2 Countermeasure Benefits

Completion of testing of the ICAS has provided an opportunity to determine the benefits of the system in preventing intersection crashes. Benefits are defined the ability to prevent the types of crashes identified in the intersection crash typology described in section three of this report. Each of the crash scenarios described in section three are composed of specific characteristics and causal factors that the countermeasure is designed to circumvent. The countermeasure designed and built during this program is capable of providing the driver information that will assist them in avoiding the crash.

### 6.2.1 System Effectiveness Calculation

The evaluation of ICAS effectiveness follows the framework established by NHTSA for evaluation of Collision Avoidance System Benefits. The framework compares the number of crashes that occur in the current automotive environment, and then utilizes countermeasure performance data to evaluate the number of collisions that could be avoided by use of the countermeasure. This procedure has been followed in this document.

The effectiveness of the ICAS is defined as the proportion of the intersection crash population that the countermeasure can prevent. To perform this calculation the evaluation utilized the population of intersection crashes described in Section 3 of this report. Each of these crash scenarios were decomposed into specific characteristics and causal factors that were addressed by the countermeasure. These decompositions are illustrated in Figures 3-6 to 3-8. The characteristics, such as the traffic control device present at the intersection, or the causal factor associated with the crash scenario are mapped to specific subsystems within the countermeasure. It should be noted that benefits associated with the Signal-to-Vehicle Communication system are described, even though this system is not implemented in the ICAS Testbed. Table 6-2 illustrates the breakdown of the intersection crash population by the traffic control at the intersection. Note that the percentages shown are cumulative to the entire intersection problem.

**Table 6-2  
Intersection Population by Traffic Control Device**

Scenario	Description	Traffic Control Device		
		Signal	Stop Sign	None
1	Left Turn Across Path	20.7%	0.0%	3.1%
2	Perp. Path - Inadequate Gap	0.0%	30.2%	0.0%
3	Perp. Path - Violation of T.C.D.	23.3%	20.6%	0.0%
4	Premature Intersection Entry	2.1%	0.0%	0.0%
	<b>Total</b>	46.1%	50.8%	3.1%

Each of these scenarios/TCD combinations may be assigned to the countermeasure system that is designed to alleviate this problem. This is shown in Table 6-3 below:

**Table 6-3  
Countermeasure System Assignment**

Scenario	Description	Traffic Control Device		
		Signal	Stop Sign	None
1	Left Turn Across Path	TDS / GIS/GPS	-	TDS / GIS/GPS
2	Perp. Path - Inadequate Gap	-	TDS / GIS/GPS	-
3	Perp. Path - Violation of TCD	Comm.	GIS/GPS	-
4	Premature Intersection Entry	Comm.	-	-

Where:     TDS           = Threat Detection (radar) System  
               GIS/GPS       = Geographic Information System / Global Positioning System  
               Comm.         = Signal-to-Vehicle Communication System

To evaluate the benefits of the ICAS the effectiveness of the system in dealing with each scenario must be determined. The assignment of the subsystems to each scenario provides an avenue to link the performance of each sub-system to effectiveness of the countermeasure to prevent these specific types of crashes. The calculation of system effectiveness for each of the scenarios can be described by the following equation:

$$ICAS\text{Effectiveness} = n_p * (1 - a_f - t_m - p_{cf})$$

where:

- $n_p$  = percentage of population for specific crash scenario
- $a_f$  = percentage of false alarms
- $t_m$  = percentage of missed targets
- $p_{cf}$  = percentage of scenario population with causal factors not addressed by countermeasure

As may be observed, the components in the parentheses make up the effectiveness of the specific ICAS system.

Summing the percentages from Table 6-2 for each of the ICAS sub-systems provides the assignment of crash population by countermeasure system. This is illustrated in Table 6-4.

**Table 6-4**  
**System Distribution of Intersection Problem**

ICAS Component	Percentage of Intersection Crash Population
Threat Detection System (Radar)	54.0%
GIS/GPS	20.6%
Signal-to-Vehicle Communication	25.4%
<b>Total</b>	100.0%

The distribution of the intersection crash population provides an opportunity to examine the effectiveness of the system as a sum of the efficiency of each system to provide the driver the information required to prevent the crash. This approach requires a number of assumptions be made to provide an estimate of system effectiveness. These assumptions are listed below:

*Assumption:*

Driver compliance with DVI-provided warnings is 100%.

*Discussion:*

The rate of driver compliance with a warning provided by the driver-vehicle interface can overwhelm the other effects of system performance. An assumption of 100% compliance, while not realistic from experience, can be used to provide an upper boundary for the system performance. Future research into driver compliance with warnings from ITS equipment will allow a better understanding of this issue and allow a stronger base for system evaluation.

*Assumption:*

Countermeasure System is implemented as per the Testbed Configuration.

*Discussion:*

The ICAS Testbed has a number of features that may be implemented in the driving environment. Primary to this is the improvement, both in cost and capability, of the global positioning system and map databases. The Intersection Testbed utilized a global positioning system with differential

corrections. This configuration is not affordable at this time due to cost of the differential receiver. This is a situation that is rapidly changing however, and should not cause this system from being considered in future equipment.

The map database used in the ICAS program was provided by Navigation Technologies (NavTech) and is complimentary to the map product they produce for many customers in the automotive and navigation industry. This map product differed from the standard NavTech product by having a higher precision as to intersection location, and the inclusion of an additional data field for identification of traffic control device at each intersection. These changes for the standard NavTech product were all implemented by NavTech and represent an additional cost that would be required to be borne prior to deployment of the countermeasure.

Taking these assumptions into consideration, a calculation of system benefits can be made that takes into account the effects of false alarms, missed detections and other factors that would degrade system performance. Note that these degrading factors are detailed in Section 5 of this report in the discussion of each system. Table 6-5 provides the effectiveness of the ICAS in preventing intersection collisions. Note that this table delineates the crash problem by system component, and also illustrates the system configuration as developed in the ICAS Testbed. This configuration does not include the Signal-to-Vehicle Communication System, and therefore, establishes an upper limit on the effectiveness of the entire system. The cumulative effectiveness of the system is a proportion of the crash problem that is handled by each system, and a degradation of this value by the amount of false and missed alarms noted for each system during the testing phase of this program. It should be noted that this value may be conservative, because all false alarms may not cause a crash. Since there is no evidence to quantify this value, a conservative approach is to consider all false and missed alarms to adversely affect the cumulative effectiveness of the system.

*Assumption:*

The ICAS countermeasure is deployed in 100% of the vehicles in the national automotive fleet.

*Discussion:*

Since there is no prior history on the rate of penetration of collision avoidance systems into the national automotive fleet, we are assuming a 100% rate to provide a ceiling rate of system effectiveness and benefits. This assumption may be modified when data is available to support a relevant rate of market penetration.

*Benefit Estimation*

The estimate of benefit that may be realized by implementation of the ICAS, or System Effectiveness, may be calculated by summing the effectiveness values of the ICAS for each of the crash scenarios, or

$$\text{Sys. Eff.} = \sum (\text{eff.}_{(\text{scen no. } 1)} + \text{eff.}_{(\text{scen no. } 2)} + \text{eff.}_{(\text{scen no. } 3)} + \text{eff.}_{(\text{scen no. } 4)})$$

where

eff. = system effectiveness in preventing the specific crash scenario.

The relative proportion of the ICAS to prevent intersection crashes is tabulated in Table 6-5 below.

**Table 6-5  
ICAS Effectiveness**

<b>ICAS Sub-System</b>	<b>Intersection Crash Population</b>	<b>ICAS Testbed</b>	<b>Cumulative Effectiveness</b>
Threat Detection System (radar)	54.0%	54.0%	44.3%
GIS / GPS	20.6%	20.6%	19.6%
Signal-to-Vehicle Communication	25.4%	0.0%	0.0%
	100.0%	74.6%	63.9%

*The ICAS has the capability to prevent  
63.9 percent of intersection collisions*

### 6.3 Benefits of Nationally Deployed ICAS

The benefits of a nationally deployed ICAS can be determined by examining the number of crashes that may be prevented by the deployment of ICAS. The effects of reducing collisions can have wide ranging affects, from reduced traffic congestion, to reduced healthcare costs. The U.S. Department of Transportation has compiled statistics relating economic costs to motor vehicle crashes. This report determines the cost of motor vehicle crashes based on accident severity. This report was used as a reference in the assigning of values to specific injury severities. To utilize this data the intersection crash problem was segregated by crash severity. This task was reported in Task 1 of this program. Further, the intersection accident crash population was segregated by crash scenario and traffic control to allow assignment of each scenario to specific countermeasure sub-systems. With this distribution of the crash population accomplished, the effectiveness of each ICAS system may be applied to determine the number and severity of crashes that may be prevented by the deployment of an ICAS

#### 6.3.1 Crashes Avoided

The number of crashes that a deployed ICAS can prevent may be determined by applying the population distribution provided in Table 6-2 to the total population of crashes. Task 1 of this program identified the total population of intersection crashes from examining the 1993 National Automotive Sampling System statistics database. Using this approach, the total number of intersection crashes was determined to be 962,000 crashes. Applying this total to the population distribution yields the distribution shown in Table 6-6. Please note that rounding errors have occurred in the compiling of this table.

**Table 6-6  
Intersection Crash Population Distribution**

Scenario	Description	Crashes by Traffic Control Device		
		Signal	Stop Sign	None
1	Left Turn Across Path	199,000	0	30,000
2	Perp. Path - Inadequate Gap	0	291,000	0
3	Perp. Path - Violation of T.C.D.	224,000	198,000	0
4	Premature Intersection Entry	20,000	0	0
	<b>Total</b>	443,000	489,000	30,000

The intersection crash population may be applied to the assignment of ICAS equipment shown in table 6-2 to acquire the total number of crashes that the countermeasure may be effective in preventing. To further this, and to determine the severity distribution of the crashes prevented, we will utilize a distribution of crash severity by vehicle maneuver presented in Task 1. This distribution segmented the

intersection crashes by vehicle maneuver, where the possible maneuvers were intersecting paths and vehicle turning. Intersecting paths correspond with perpendicular crash types, i.e., scenario 2 and 3. The Vehicle Turning distribution is applied to scenario 1. Scenario no. 4 is assigned to the perpendicular path distribution. The AIS severity distributions are illustrated in Table 6-7 below. Note that the distribution is a percentage for each maneuver / traffic control configuration. Statistics for AIS category 4 (severe) and 5 (fatal) are combined in this table.

**Table 6-7**  
**Severity Distribution of Intersection Crashes**

Maneuver	Traffic Control	AIS Severity				
		0	1	2	3	4
Turning	Signal	65.1%	17.2%	11.9%	4.9%	0.9%
	Stop Sign	57.4%	23.9%	12.0%	6.1%	0.9%
Perpendicular	Signal	41.5%	32.3%	17.9%	6.7%	1.6%
	Stop Sign	72.1%	13.9%	8.9%	4.8%	0.4%

This severity distribution may be applied to the intersection crash distribution to provide data regarding the severity distribution by scenario and traffic control. Note that two of the scenarios, nos. 2 and 4 have the traffic control as a implied condition of the scenario. This results in zero cell entries in the charts. Tables 6-8 and 6-9 illustrate intersection severity distribution by scenario and traffic control.

**Table 6-8**  
**Scenario Severity Distribution - Phased Signals**

Scenario	Description	AIS Severity				
		0	1	2	3	4
1	Left Turn Across Path	149,079	39,388	27,251	11,221	2,061
2	Perp. Path - Inadequate Gap	0	0	0	0	0
3	Perp. Path - Violation of TCD	92,960	72,352	40,069	15,008	3,584
4	Premature Int. Entry	8,300	6,460	3,580	1,340	320
Total		250,339	118,201	70,929	27,572	5,969



**Table 6-9  
Scenario Severity Distribution - Stop Signs**

Scenario	Description	AIS Severity				
		0	1	2	3	4
1	Left Turn Across Path	0	0	0	0	0
2	Perp. Path - Inadequate Gap	209,811	40,449	25,899	13,968	1,164
3	Perp. Path - Violation of TCD	142,758	27,522	19,622	9,504	792
4	Premature Int. Entry	0	0	0	0	0
Total		352,569	67,971	43,521	23,472	1,956

The above distribution of the intersection crash population may be assigned to the ICAS sub-systems to determine the number of crashes that could be prevented. By applying the effectiveness rates for the sub-systems to the scenarios and traffic controls as shown in Figure 6-2 a number of total crashes may be determined by scenario and severity. Tables 6-10, 6-11, and 6-12 illustrate the intersection crash population by scenario and severity. Table 6-10 provides the intersection crash population without application of the countermeasure, Table 6-11, with the countermeasure, and 6-12 illustrates the change in the intersection crash population brought about by use of the ICAS.

**Table 6-10  
Intersection Crash Population Without Countermeasure**

Scenario	Description	AIS Severity				
		0	1	2	3	4
1	Left Turn Across Path	149,079	39,388	27,251	11,221	2,061
2	Perp. Path - Inadequate Gap	209,811	40,449	25,899	13,968	1,164
3	Perp. Path - Violation of TCD	235,718	99,874	57,718	24,512	4,376
4	Premature Intersection Entry	8,300	6,460	3,580	1,340	320
Total		602,908	186,171	114,448	51,041	7,921

**Figure 6-11  
Intersection Crash Population With Countermeasure**

Scenario	Description	AIS Severity				
		0	1	2	3	4
1	Left Turn Across Path	26,834	7,090	4,905	2,020	371
2	Perp. Path - Inadequate Gap	37,766	7,281	4,662	2,514	210
3	Perp. Path - Violation of TCD	98,670	73,453	40,801	15,388	3,616
4	Premature Int. Entry	8,300	6,460	3,580	1,340	320
Total		171,571	94,284	53,984	21,262	4,516

The values with Table 6-11 provide the distribution of intersection crashes that might be observed after the deployment of the ICAS within the automotive fleet. The savings from the without countermeasure values are tabulated in Table 6-12 below.

**Table 6-12  
Reductions in Intersection Crashes by Severity**

AIS Severity				
0	1	2	3	4
431,337	91,887	60,500	29,779	3,405

The reductions in the number and severity of intersection crashes that may be observed through the deployment of an ICAS shown in Table 6-12 allows an application of the economic impact of intersection crashes to be determined. Values for the economic impact of automotive accidents is provided by NHTSA (Blincoe, 1994). This study found:

Each fatality resulted in lifetime economic costs to society of over \$830,000. Over 85% of this cost is due to lost workplace and household productivity.

Average cost for each critically injured survivor was \$706,000 - nearly as high as for a fatality

Using these values for saving due to reduced fatalities a savings of \$2.8 billion dollars per year. The amount of savings for reduced critical injuries is \$2.1 billion dollars per year.

***The deployment of the ICAS could prevent up to 617,000 intersection crashes as the system enters the vehicle population. This could provide an economic savings of over \$4.9 billion dollars per year***

## **6.4 Technical Feasibility of ICAS Countermeasure**

The technical feasibility of the ICAS is defined as the ability to construct an ICAS that could be implemented into the automotive fleet. It is a function of the technology used and the unique features used in the implementation of the ICAS. During the initial stages of this program no consideration was given as to the technical feasibility of the system. The key to the project was to determine if intersection collision avoidance could be performed. The technical feasibility of the concept developed was to be evaluated at the completion of the program. The Task 3 report of this program detailed the concept of the in-vehicle collision intersection collision avoidance system. Task 4 of the program evaluated whether the technology existed to develop the ICAS. Task 4 determined that the technology existed, and was being rapidly improved, to support the development of the ICAS. The system described in Task 3 has been developed in subsequent Tasks in this program to the prototype vehicle described in previous sections.

The ICAS Countermeasure described within this report has been constructed using commercial off-the-shelf (COTS) equipment modified for use on this system. As such, the components used on the ICAS are readily available. The integration of these components is the driving factor in the feasibility of the system. Factors influencing the technical feasibility shall be addressed in a review of each of the countermeasure systems. This review is included in the sections that follow.

### **6.4.1 Threat Detection System Feasibility**

The threat detection system utilizes a system of three radars to monitor vehicles approaching the ICAS Testbed from +/- 110° from the vehicle's longitudinal axis. The threat detection system utilizes the radar data to construct a situational awareness of vehicle positions and speeds. If another vehicle is on a intercept path, and both vehicles are approaching an intersection, the driver of the ICAS Testbed is provided with a warning through a Head-up Display and audio tone. The major components of the threat detections system are the three radar systems, the antenna pointing control system, signal processing system, and the driver-vehicle interface. Of these systems, only the radar scan platforms were specially constructed for this application.

The radars used are Eaton-VORAD EVT-200' s marketed to the trucking industry as forward collision avoidance systems. These radars are of Frequency Modulated Continuous Wave (FMCW) operating at 24 GHz. The headway-detection capabilities of these systems make them adequate for the ICAS system. The only modification that has been made to these radars is the inclusion of an RS-232 port to allow the range and range rate data to be directly accessed by the computer system. This modification is performed by VORAD at the factory and is available upon request.

Radars are becoming more acceptable to the automobile manufacturers. The advent of Intelligent Cruise Control (ICC) systems on vehicles will allow manufacturers to become familiar and comfortable with this technology. The use of radars in this application has a direct consequence on the feasibility of the ICAS system. The current generation of ICC radars are generally millimeter wave systems operating at

77 GHz. These systems measure range, or headway, and range rate to the vehicle ahead of them in a lane. The ICAS system utilizes this same data, and with additional processing, allows intersection collision avoidance. Advances in the affordability and reliability of these radar systems will have a positive impact on the technical feasibility of an ICAS.

The scan platforms that drive the radar antennas are servomotor operated, and controlled through computer command. The scan platforms are described in Section 5 of this report. These platforms were designed by Veridian for this application. One generic design is utilized for the three antennas. These platforms were designed to support a development program, where operational parameters, such as scan rate and scan azimuth were changed to reflect the changing requirements of the system. The scan platform design used in the present ICAS is optimized for flexibility and to accommodate changing performance characteristics. A scan system optimized for the ICAS could be derived from the current design, and be more efficient and cost effective if required. This was not a primary consideration in the current effort.

#### **6.4.2 Geographical Information System / Global Positioning System**

The Geographical Information System / Global Positioning System (GIS/GPS) provides the vehicle position and roadway configuration data to perform the warnings of stop sign violation, and the dynamic pointing of the vehicle radar system.

#### **6.4.3 Signal Processing Systems Feasibility**

The signal processing system consists of the software and hardware required to receive the data being provided by the radars, the capacity to run the tracking and antenna pointing software, and to operate the antenna pointing hardware and driver-vehicle interface. At this time the ICAS uses an Intel Pentium 233 MHz processor housed within a mini-tower case. All the computer hardware is commercial quality systems, purchased off the shelf. The software to run the ICAS equipment was developed by Veridian Engineering, and is written in "C" language.

Although the computer hardware on-board the ICAS is in excess of what is found on automobiles today, a large portion of the memory and input/output (I/O) devices on the ICAS are required to configure the system, and record test data. A dedicated ICAS processing equipment suite could be simplified greatly. The complexity of the remaining hardware is comparable to an engine management computer.

#### **6.4.4 Driver-Vehicle Interface Feasibility**

The ICAS utilizes a multi-modal Driver-Vehicle Interface (DVI) as detailed in Section 5.3 of this report. The main components of the DVI consist of the Head-up Display, Audio Tone Generator, and Haptic Braking System. These sub-systems utilize a combination of COTS and purpose-designed equipment.

The Head-up Display (HUD) used in the ICAS Testbed is a Delco Electronics DataVision Head-up system. This unit is commercially available and is marketed to Police agencies. Head-Up Displays have been offered on production automobiles in the recent past. The 1989-1995 generation Nissan Maxima, for example, offered a HUD to display vehicle speed and vehicle status information. The 1995-1998 Pontiac Bonneville also offered a HUD system. The technology to implement a HUD to provide warning information is available and could be utilized to provide the driver with warnings of impending collisions.

The audio tone generator was utilized in the ICAS Testbed to provide an audio tone in coordination with the HUD to warn the driver of an impending crash. The system used in the Testbed was a commercially available computer sound card, with two speakers. The sound card was mounted within the mini-tower case of the ICAS computer. Warning tones were generated when the thresholds of the gap time and  $a_p$  metric were exceeded. Any future implementation of audio warnings could be incorporated within the sound system of the host vehicle. The use of the in-vehicle speakers would simplify the countermeasure design, but requires the integration of the system into the vehicle architecture. This was beyond the current program effort, but is performed during the course of equipment selection in the OEM manufacturing process.

The haptic braking system implemented within the ICAS Testbed is designed to support research into the use of haptic feedback to provide warnings to the driver. The system utilizes a secondary hydraulic system actuating a secondary brake calipers mounted on the Testbed's brake rotors. The system utilizes COTS equipment, from brake calipers designed for racing applications, to a hydraulic pump designed for used on towed trailers. This system is designed not to interfere with the operation of the primary braking system. A detailed description of the Haptic braking system is provided in Section 5.4 of this report. It should be noted that non-interference with the vehicle primary braking system was a prime design consideration in the haptic system design effort. This goal was met and has resulted in an excellent tool for research into haptic transmission of collision warnings.

The operation of the haptic braking system can be replicated in current vehicles through the use of brake by wire technology. This technology is becoming more affordable and starting to see its way into production automobiles. Daimler Chrysler, BMW, and Cadillac are utilizing pulsing of the brakes, controlled through an on-board computer, as a means of spin protection. The haptic braking that is being used in the ICAS testbed is an evolution of this technology.

#### **6.4.5 Vehicle Configuration Feasibility**

In the effort to design and fabricate the ICAS Testbed the level of equipment on the vehicle and the components that had to be integrated into the platform had to be considered. The most critical questions of equipment placement entailed the radar systems. Previous testing with the Veridian Instrumented Vehicle had shown that there was a definite advantage to mount the side-looking radars high on the vehicle roof. From this vantage point the radars were able to look over other cars making turns to the right or left of the Testbed. This feature allowed greater time on target for the radar and a greater

accuracy of the warnings. This mounting, while not fitting within the styling criteria of many vehicles, is a potential method of mounting the radars to retain their functionality. Re-siting the radars to another location is also possible. Mounting three radars within the forward bumper structure is possible, although not investigated in this program.

#### 6.4.6 Summary

Table 6-13 illustrates the Technical feasibility of the components utilized in the ICAS testbed.

**Table 6-13  
ICAS System Feasibility**

ICAS System / Component	Status	Comment
Radar Sensor	COTS	present components acceptable, but further development required for deployment
Radar Scan Platforms	Veridian Design	present components acceptable, but further development required for deployment
Signal Processing	COTS	present components acceptable
GIS (map database)	Modified COTS	additional data required, improved accuracy of intersection locations, roadway shape characteristics
GPS / DGPS	COTS	present components acceptable
HUD	COTS	present components acceptable, but further development required for deployment
Audio Tone Generator	COTS	present components acceptable, but further development required for deployment
Haptic Braking System	Veridian Design	Integration with OEM brake system desirable
Software	Veridian Design	Further development required
Vehicle Platform	Modified COTS	Integration effort if deployed by OEM

**The ICAS is technically feasible to deploy as a collision avoidance system. Cost of the main sensor, the radar system, would drive deployment**

## **6.5 Practicality and Cost of System Implementation**

### **6.5.1 Practicality of ICAS System Implementation**

The practicality of deploying the ICAS is a function of the technology used in the system, maturity of the technology, and cost of the technology. This has to be balanced by the perceived benefits of the ICAS. The benefits of the have been discussed in section 6.3 - 6.4 above. It is evident that a fully developed and deployed ICAS can have a significant positive affect in preventing crashes at intersections. In global terms, there is no new technology used within the ICAS that would be incompatible with a system deployment. Many of the systems utilized in ICAS are COTS, with modifications made to suit the intersection environment.

The main components of the ICAS - the radars and GIS / GPS are already seeing limited deployment in the automotive fleet. The VORAD radar system and use of ICC by auto manufacturers can be used as an implied acceptance of this technology by the OEM's. Similarly, navigation systems are becoming common place with the ranks of more expensive vehicles. The applications to which these technologies were used are unique, but not outside of the envelope which they were designed for. The processing electronics uses standard desktop computer components, while not advanced technology, it is not suited for long term usage in a automobile. This area is advancing however, with the advent of the autoPC. This system, while not sufficient to run the ICAS in its present iteration, illustrates the use of more computer power into a vehicle. A more relevant example may be the use of computer systems within a Police vehicle. These systems are generally hardened for their use in the vehicle environment, and are reliable.

**The countermeasure concept developed in this program is a valid approach to performing intersection collision avoidance.**

### **6.5.2 Cost of ICAS**

The ICAS Testbed was constructed from commercially available components, with custom fabricated systems being used only when necessary. Table 6-14 tabulates the costs of the equipment utilized in the ICAS testbed. Certain system costs, such as the radar scan platforms, are only estimated.

**Table 6-14  
ICAS Testbed Cost**

<b>Component</b>	<b>Cost (\$)</b>
Testbed Vehicle	12,000
VORAD radar system (3)	15,000
Main Computer	500
Laptop Computer	2,000
Differential GPS Receiver	900
GPS receiver	2,700
Radar Scan Platforms (3)	1,500
Haptic Braking System	3,000
HUD	2,000
Miscellaneous	1,000
<b>Total</b>	40,600

The question of ICAS cost to the consumer is difficult to answer, because technology is at improving the quality of the sensors used in ICAS while at the same time driving down their cost. Although the sum of the hardware costs may be tabulated for the ICAS Testbed, this value would not take into account any re-design that would make the system more efficient for mass production. The ICAS Testbed is a research system with system capabilities that allow for variation in many system parameters. This additional capability adds cost to the system and would not be required in a production ICAS. Systems such as the haptic braking equipment could be integrated within the vehicles' ABS and stability control system, the equipment infrastructure of a navigation system could be utilized to support the GIS/GPS system. These cost savings are difficult to quantify in a production situation.

The software development accomplished in the course of this program is substantial, overwhelming the cost of the hardware. This amount would be considered a non-recurring cost in a production ICAS, and its cost would be amortized across a number of sold units. The cost of software development is not included in the Testbed vehicle costs.



## **7.0 SUMMARY AND RECOMMENDATIONS**

This section summarizes the accomplishments of the program and provided NHTSA with recommendations as to the development future of the Intersection Collision Avoidance System.

### **7.1 Program Summary**

The Intersection Collision Avoidance Using ITS Countermeasures Program developed a prototype collision avoidance system for use at intersections. This system was derived through the review of national crash databases such as the National Accident Sampling System Crashworthiness Data System (CDS)(now titled National Automotive Sampling System), General Estimates System (GES), and Fatality Analysis Reporting System(FARS). This review of accident data provided a series of accident characteristics and system requirements that the countermeasure had to meet to address the intersection crash problem.

The countermeasure requirements lead to the development of three countermeasure concepts. These three concepts were the Driver Advisory System, the Defensive System, and the Communication System. The first two had similar features, including an on-vehicle radar systems and a means of detecting intersections, such as a map database. The third system, the Communication System, utilized communication between all vehicle approaching the intersection and the intersection itself. The Communication System Countermeasure was discarded because it required that all vehicles be equipped with the countermeasure prior to effective collision avoidance take place. The Driver Advisory and Defensive Systems were similar, varying only in the amount of control the system had over vehicle functions. The Driver Advisory and Defensive Countermeasure Systems were developed into final countermeasure that is documented here.

A detailed system design was completed on the countermeasure. System tests, involving the on-vehicle radar and braking systems were performed to provide design data. The ICAS design was presented to NHTSA in a critical design Review in November 1997. Comments from the Customer resulted in a redesign of the countermeasure. The wide-angle forward looking radar system was re-evaluated to allow a partial solution to be developed using commercially available radar systems. The signal to vehicle communication system was discarded. The redesigned ICAS, while not able to address the entire intersection crash problem, was capable of performing research into system requirements for second generation ICAS.

The redesigned ICAS components were fabricated and developed on a Veridian Instrumented Vehicle. This vehicle, a 1993 Ford Taurus, was equipped with data acquisition and camera equipment sufficient to allow evaluation of each system component. Both the Threat Detection System and GIS/GPS systems were installed and tested on the Veridian Instrumented Vehicle. A number of technical highlights occurred on this vehicle:

- C development and evaluation of real time stop sign violation warning system
- C linkage of map database and radar system
- C development of dynamic pointing feature to control radar beam location
- C development of intersection encounter logic to prevent false and nuisance alarms
- C baseline testing of driver behavior in response to intersections
- C driver testing of Stop Sign Warning System
- C development of automotive tracker system for intersections utilizing map information

These advances were integrated into the ICAS Test bed Vehicle. This vehicle, a Ford Crown Victoria, integrated the separate systems developed on the Veridian Instrumented Vehicle and resulted in a technically viable Intersection Collision Avoidance System.

The ICAS Test bed was utilized in over 150 separate tests, covering over 175 hours of on-road tests of the Intersection Countermeasure. During these tests the ICAS Test bed passed on average 25 intersections per test. This resulted in over 4000 intersection encounters. The lessons learned as to the performance guidelines for an ICAS are detailed within this report with sufficient detail to be of use to future system designers. This program started the design of the ICAS with no preconceived ideas as to what was required to accomplish the task. The design that resulted was a "clean sheet of paper" utilizing techniques and equipment in new ways from which they were originally designed. The ICAS is a solid design that needs no new technology, and minor modifications in existing technology to be realized.

## 7.2 Recommendations

As a result of Veridian's work on the Intersection Collision Avoidance Using ITS Countermeasure Program, a number of recommendations are being made to advance this technology and improve automotive safety. These recommendations, and a discussion of each, follow.

<p style="text-align: center;"><b>Recommendation No. 1</b> <b>Integrate left turn across path sensor algorithms developed on the ICAS into the NHTSA IVI Program</b></p>
--

The ICAS program has developed algorithms and logic for using the range and range-rate data produced by headway detection radars for left turn across path collision avoidance (LTAP CA). Range and range-rate data is typical outputs from the radar systems deployed for Intelligent Cruise Control (ICC) and Rear-end Collision Avoidance (RE CA). The system Veridian used to perform LTAP CA is, in fact, advertized as a rear-end collision avoidance system. With the same data being used in both the rear-end and left turn across path collision avoidance algorithms, an incremental gain in automotive safety can be realized by implementing the LTAP capability into this system. The LTAP configuration of intersection crashes constitutes 23.8% of all intersection crashes. Funding is available for the integration of ICC and

rear-end collision avoidance under the Intelligent Vehicle Initiative. By including LTAP capability within the ICC / RE CA IVI program, a near-term return on the investment made in ICAS may be realized by NHTSA.

**Recommendation No. 2**  
**Continue development of map-based unsignalized intersection system**

The map-based unsignalized intersection collision avoidance system has a high potential for near-term deployment. A number of market factors are making the deployment of this system more realizable. Factors including advances in GPS accuracy, reduction in DGPS cost, growth in navigation system availability, and improvements in map accuracy are all leading toward the feasibility of moving the map-based collision avoidance system to deployment. NHTSA can improve the potential for deployment by continuing the development of this system. By raising the profile of this type of system, through an operational test for example, the practicality, acceptance and usefulness of this system to the driving public may be documented, prompting automobile manufacturer's and first tier suppliers look at using this type of system to differentiate their products.

**Recommendation No. 3**  
**Fund development of forward viewing, wide field sensor**

The most important factor preventing the deployment of an ICAS-type radar system is that any single sensor capable of fulfilling ICAS goals is too costly. In the current program a partial solution to this problem was crafted that used multiple headway detection systems. To move the ICAS toward deployment, a system more along the lines of the radar system designed in Task 5 is necessary. This system used a rotating beam to monitor the entire frontal aspect of the vehicle. This type of sensor has the capability to be used for other applications, as well as ICAS. As an example, a sensor such as this could be used for ICC as well as rear-end collision avoidance. NHTSA can foster this development by funding investigations into fostering advanced manufacturing methods that could reduce the costs of sensors such as this. Another potential means of fostering this technology would be the use of alternative systems such as LIDAR for this application.

**Recommendation No. 4**  
**Investigate use of signal-to-vehicle communication to improve ICAS effectiveness**

The violation of a phased signal at intersections constitutes 23.3% of the entire intersection collision problem. During the present ICAS program a system of traffic signal-to-vehicle communication was

designed that could be used to alleviate the violation of signalized intersections. This design entailed the use of Dedicated Short Range Communication (DSRC), in the form of spread-spectrum transmitter / receiver to transmit the signal phase, and time to phasing, to the approaching vehicle. The approaching vehicle would apply the same  $a_p$  metric to monitor whether the vehicle could pass through the intersection in the time remaining prior to signal phasing. Also designed during the Task 5 effort were the message configuration and operational characteristics of the system.

The Signal-to-Vehicle communication system was dropped from the ICAS at the Critical Design Review because of concerns in developing the system. Advances in technology since the Critical Design Review have lead to the applicability of other forms of DSRC to support the communication link between signal and vehicle. Research and testing of a signal-to-vehicle communication system, based on the work performed in Task 5 of this program, should be initiated to increase the effectiveness of the ICAS design.

**Recommendation No. 5**  
**Continue investigation of Driver-Vehicle Interface effectiveness and driver acceptance**

The issue of a driver's positive reaction to warnings provided by a collision avoidance system is still to be determined. This single factor can overwhelm the calculation of system effectiveness, even beyond the effect of sensor errors. Preliminary work carried out in this program indicates that drivers will notice the warnings, and react in a positive manner. The warnings provided in this program, however, were very limited, requiring the driver to react by applying the vehicles' brakes. This warning was provided through both a HUD and audio tone. A weakness in this data is that we were unable to provide drivers with crash imminent-type warnings in order to determine their positive reaction to the warning.

More research is needed in the area of driver vehicle interfaces for collision avoidance systems, with emphasis placed on the reaction of the driver to time-critical warnings, such as would be seen when a driver proceeds into the intersection with inadequate gap in the intersection crash scenario no. 2.

## APPENDIX A

### SUMMARY OF INTERSECTION TESTS, GIS TEST AREA

There were many ICA system tests performed as the system was developed. Some were performed on the Veridian Test Track, some on the road and in-traffic. Early on-road experiments did not involve the GIS test area and consequently were selected tests for a specific intersection or roadway. In early 1999 the system and GIS test area data were integrated and integrated system tests were initiated. Table A-1 summarizes the integrated system tests performed while driving in the GIS test area. The first column is the date and the second column is a coded date followed by the experiment (run) number and radar identification (v1 = left radar, v2 = right radar and v3 = center radar). The intersections identified in column 3 can be located on the map in Section 5. The observation time is the elapsed time of approach to and exit from the intersection. It does not include the driving time between intersections. The 5<sup>th</sup> column identifies the computer run number(s) associated with the MATLAB® simulation (which used the radar data recorded during the run). The 6<sup>th</sup> column indicates on which 8mm tape the video was recorded. A brief objective or comments are sometimes given in the last column.

**Table A-1 Intersection Tests, GIS Test Area**

Date	Date/Run/ Radar	Intersection	Observ. Times (sec)	Computer Run #	Video	Objectives/Comments
022699		Route: harrishill from pleasantview to main and back			Tape 1	Record identity of intersection, marker when in center of intersection.
	t022699_3v1	harrishill north and main	370-405	r10389	Tape 1	
	t022699_3v2	harrishill north and main	370-405	r10390	Tape 1	
	t022699_5v1	harrishill south and main	228-273	r10391	Tape 1	
031599		Route: Harrishill from Pleasantview to Merrihurst and return				Check real time operation; Record demo tape.
	t031599_0v1	harrishill north and pleasantview	147-181	r10397, r10405, r10421	Tape 2	
	t031599_0v2	harrishill north and pleasantview	147-181	r10406, r10399	Tape 2	
	t031599_0v1	harrishill north and bradley	184-192	r10409	Tape 2	
	t031599_0v1	harrishill north and haskell	215-223	r10410	Tape 2	
	t031599_0v1	harrishill north and main	420-466	r10392	Tape 2	
032499		Route: Harrishill from Pleasantview to Merrihurst and return				Check real time operation; Record demo tape.
	t032499_0v1	harrishill south and main	140-220	r10426	Tape 2	
	t032499_0v2	harrishill south and main	145-213	r10438	Tape 2	
	t032499_0v1	harrishill south and sunset	259-266	r10425	Tape 2	
	t032499_0v1	harrishill south and wehrle	282-300	r10428	Tape 2	

**Table A-1 Intersection Tests, GIS Test Area**

Date	Date/Run/ Radar	Intersection	Observ. Times (sec)	Compute r Run #	Video	Objectives/Comments
041499						Check real time operation; Record demo tape. Observe new scan pattern.
	t041499_1v1	harrishill south and genesee	308-320	r10516	Tape 1	
	t041499_1v1	harrishill south and howard	149-158	r10521	Tape 1	No traffic, no tracks. Good check on small intersection.
	t041499_1v1	harrishill south and main	103-127	r10513, r10510	Tape 1	Increased coast to 4 seconds.
	t041499_1v2	harrishill south and main	80-130	r10534, r10535	Tape1	These 2 runs compared different nominal (IV) accelerations.
	t041499_1v2	harrishill south and main	80-125	r10527	Tape1	Building on right masks view, creates multipath tracks. Tracks occur when LOS clears.
	t041499_1v2	harrishill south and main	103-127	r10509	Tape1	Building on right masks view, creates multipath tracks. Tracks occur when LOS clears.
	t041499_1v2	harrishill south and main	80-130	r10540, r10542	Tape1	Compare different detection threshold distances.
	t041499_1v2	harrishill south and main	80-130	r10531, r10537	Tape1	Compare different detection threshold distances.
	t041499_1v2	merrihurst and harrishill	40-60	r10508, r10505	Tape1	1st left turn analysis.
042899						Warning evaluation; Track evaluation; Eval of new scan positions; Demo tape.
	t042899_1v1	harrishill south and main	70-107	r10553	Tape3	Larger tracking gate, different R and Q values; 2.5 second coast.
	t042899_1v1	harrishill south and main	70-107	r10551, r10552, r10550, r10549	Tape3	Warning modifications, different R and Q values. (R, Q are Kalman filter matrices.)
	t042899_1v1	harrishill south and main	70-107	r10543	Tape3	
	t042899_1v2	harrishill south and main	70-107	r10556. <u>r10557</u>	Tape3	Compare with and w/o logic for crossroad tracks only. Premature warning logic.
	t042899_1v1	harrishill south and wehrle	167-208	r10548	Tape3	This run is consistent with real time system, both gave no warnings.
	t042899_1v2	harrishill south and wehrle	167-208	r10558	Tape3	Inconsistent with real time system.
	t042899_1v1	harrishill south and genesee	280-310	r10547, r10545, r10546	Tape3	Compare crossroad only logic.
	t042899_1v2	harrishill south and genesee	280-310	r10559	Tape3	Premature warning logic included.
051199		Route: Harrishill from Pleasantview to Merrihurst and return				Test new logic, compare simulation to real time

**Table A-1 Intersection Tests, GIS Test Area**

Date	Date/Run/ Radar	Intersection	Observ. Times (sec)	Compute r Run #	Video	Objectives/Comments
	t051199_0v1	harrishill and pleasantview	105-115	r10560, r10561, r10582, r10586, r10583, r10584, r10585, r10587	Tape3	Compare acceleration time constant changes; gate changes; coast time changes; R3 and Q3 changes; and percent of track acceleration used in prediction.
	t051199_0v1	harrishill and bradley	123-131	none	Tape 3	
	t051199_0v1	harrishill and haskell	157-162	none	Tape 3	No targets, no warnings
	t051199_0v1	harrishill and genesee	195-211	r10575	Tape 3	
	t051199_0v1	harrishill and anna	217-223	none	Tape 3	
	t051199_0v1	harrishill and wehrle	291-324		Tape 3	
	t051199_0v1	harrishill and main	399-429		Tape 3	
	t051199_1v1	harrishill south and main	74-90	r10576, r10578, r10579	Tape 3	Compare different tracker gate sizes.
	t051199_1v1	harrishill south and wehrle	208-223	r10580	Tape 3	
	t051199_1v1	harrishill south and wehrle	227-250	r10568	Tape 3	Stopped at the intersection, premature logic enabled (sim only). 1 truck, 3 tracks
	t051199_1v1	harrishill south and genesee	342-354	r10569, r10570, r10571, r10572, r10573, r10574	Tape 3	Compare different gate sizes and different R3 and Q3 measurements. Also, the distvorad variable is changed from 25 to 30.
060299	Run 3 and 4	Route: Harrishill from Pleasantview to Merrihurst and return				
	t060299_3v1	harrishill and pleasantview	120-145	r10618	Tape 3	
	t060299_3v2	harrishill and pleasantview	120-145	r10619	Tape 3	
	t060299_3v3	harrishill and pleasantview	120-145	r10620	Tape 3	
	t060299_3v2	harrishill and genesee	220-227	r10622, r10627	Tape 3	
	t060299_3v3	harrishill and genesee	220-227	r10623, r10628	Tape 3	
	t060299_3v1	harrishill and wehrle	305-343	r10624	Tape 3	
	t060299_3v1	harrishill and wehrle	305-343	r10642	Tape 3	Changed curb radius from 1ft. to 10 ft.
	t060299_3v1	harrishill and wehrle	305-343	r10644	Tape 3	Brake logic test. Dist = 20, Speed = 5
	t060299_3v1	harrishill and wehrle	305-343	r10645	Tape 3	Brake logic test. Dist = 5, Speed = 5
	t060299_3v2	harrishill and wehrle	305-343	r10629	Tape 3	
	t060299_3v2	harrishill and wehrle	305-343	r10643	Tape 3	Changed curb radius from 1ft. to 10 ft.
	t060299_3v3	harrishill and wehrle	305-343	r10630	Tape 3	

**Table A-1 Intersection Tests, GIS Test Area**

Date	Date/Run/ Radar	Intersection	Observ. Times (sec)	Compute r Run #	Video	Objectives/Comments
	t060299_3v1	harrishill and main	406-442	r10631	Tape 3	
	t060299_3v2	harrishill and main	406-442	r10632	Tape 3	
	t060299_3v3	harrishill and main	406-442	r10633	Tape 3	
	t060299_4v1	harrishill south and main	50-70	r10649	Tape 3	
	t060299_4v2	harrishill south and main	50-70	r10650	Tape 3	
	t060299_4v3	harrishill south and main	50-70	r10652	Tape 3	
	t060299_4v1	harrishill south and wehrle	135-143	r10653, r10661, r10664	Tape 3	
	t060299_4v2	harrishill south and wehrle	135-143	r10654, r10665	Tape 3	
	t060299_4v3	harrishill south and wehrle	135-143	r10640, r10641, r10663, r10666	Tape 3	
	t060299_4v1	harrishill south and genesee	220-236	r10657	Tape 3	
	t060299_4v2	harrishill south and genesee	220-236	r10658	Tape 3	
	t060299_4v3	harrishill south and genesee	220-236	r10660	Tape 3	
	t060299_4v1	harrishill south and pleasantview	309-349	r10646	Tape 3	
	t060299_4v2	harrishill south and pleasantview	309-349	r10647	Tape 3	
	t060299_4v3	harrishill south and pleasantview	309-349	r10648, r10651	Tape 3	
070899	Run 6 and 7	Started using 10 ft curb radius...				Run 6: Harris Hill Route North Run 7: Harris Hill Route South Note: Right radar not working correctly
	t070899_6v1	harrishill and pleasantview	90-115	r10693	Tape 3	Warnings due to easy stop logic. 2 cars approach.
	t070899_6v3	harrishill and pleasantview	90-115	r10694	Tape 3	No warnings: decel not below - 3ft/s <sup>2</sup> ; easy stop logic used.
	t070899_6v1	harrishill and genesee	184-194	r10696	Tape 3	Some clutter, one track with warning: easy stop logic.
	t070899_6v3	harrishill and genesee	184-194	r10695	Tape 3	No warnings: decel not below - 3ft/s <sup>2</sup> ; easy stop logic used.
	t070899_7v1	harrishill south and main	54-77	r10692	Tape 3	Easy stop logic, no warnings.
	t070899_7v3	harrishill south and main	54-77	r10691	Tape 3	No tracks, no targets.
	t070899_7v1	harrishill south and wehrle	137-145	r10688	Tape 3	
	t070899_7v3	harrishill south and wehrle	137-145	??	Tape 3	
	t070899_7v1	harrishill south and genesee	229-279	r10683	Tape 3	
	t070899_7v2	harrishill south and genesee	229-279	r10686	Tape3	Radar 2 is not working.
	t070899_7v3	harrishill south and genesee	229-279	r10685	Tape3	Warnings due to decel logic of center radar.
	t070899_7v1	harrishill south and pleasantview	358-368	r10689	Tape3	
	t070899_7v3	harrishill south and pleasantview	358-368	r10690	Tape3	Easy stop logic, no warnings.



**Table A-1 Intersection Tests, GIS Test Area**

<b>Date</b>	<b>Date/Run/ Radar</b>	<b>Intersection</b>	<b>Observ. Times (sec)</b>	<b>Compute r Run #</b>	<b>Video</b>	<b>Objectives/Comments</b>
071299	Run 0, Run 1, Run 3.	New route (Yellow route). See map.				Testing out all types of intersections. Testing complete system.
	t071299_1v1	greenbriar east and warner	330-345	r10699	Tape2	
	t071299_3v1	stony and genesee	368-398 Part 1 of 2	r10700	Tape2	
	t071299_3v1	stony and genesee	398-434 Part 2 of 2	r10701	Tape2	
	t071299_3v2	stony and genesee	368-402 Part 1 of 2	r10702	Tape2	Brake logic enabled after 380 sec.
	t071299_3v2	stony and genesee	402-434 Part 2 of 2	r10703	Tape2	
	t071299_3v3	harrishill south and genesee	1400- 1408.8	r10705	Tape2	
071499	Run 0	New route (Green route); see map.			Tape 1	Testing all logic, different map routes.
	t071499_0v1	warner south and columbia	273-284	r10715	Tape 1	
071599	No data	New route (Blue route); see map			Tape 1	
071699	No data	Random route, see log book.			Tape 3	
071999	No data	Random route, see log book.			Tape 2	Random route, testing all intersections.
072199	Run 0 No Data	Random route, see log book.			Tape 4	Random route, testing all intersections.
072199	Run 1 With Data	Random route, see log book.			Tape 4	Random route, testing all intersections.
	t072199_1v1	transit south and pleasant view	16-26	r10706	Tape 4	
	t072199_1v3	warner south and columbia	345-358	r10714	Tape 4	

## **APPENDIX B**

### **WARNING STATISTICS**

Table B-1 lists the false alarms and missed warnings recorded for 105 intersections encountered by the ICA vehicle as it was driven over the GIS test area. The file number indicates the date and the run number. Generally several runs (drives through the area) were made on any given day. The runs are independent and not necessarily contiguous. The table is based on an examination of the video recordings only. While radar data was almost always recorded, the volume of data precluded an in-depth analysis of each intersection. Furthermore, it was of interest to evaluate the system as the driver observes it.

The intersections are listed with the road that the ICA vehicle is on first and can be found on the map in Section 5. Where there are no entries (no false or missed warnings) the system performed without any warning errors.

A summary of the table is discussed in Section 5.1.10.

**Table B-1 Warning Statistics**

File Number	Intersections with Traffic	Type of Intersection	Warnings: False or Missed		
			Left Radar	Right Radar	Center Radar
070899_6	Harris Hill and Pleasant View	4 way	1 False		
	Harris Hill and Genesee	4 way			
	Harris Hill and Wehrle	4 way	1 False		
	Harris Hill and Main	4 way	1 False		
070899_7	Merrihust and Harris Hill	T			
	Harris Hill south and Main	4 way			
	Harris Hill south and Wehrle	4 way			
	Harris Hill south and Genesee	4 way	1 Missed		
	Harris Hill south and Pleasant View	4 way			
071299_0	Warner south and Columbia	4 way			
	Warner south and Burlington	4 way			1 False
	Walden east and Stony	Junction Left			
	Stony and Pleasant View	4 way			
	Stony and Genesee	T			
	Genesee west and Harris Hill	4 way			
	Harris Hill and Wehrle	4 way			
071299_1	Greenbriar east and Warner	T			
	Warner and Columbia	4 way			
071299_3	Walden and Stony	Junction Left			
	Stony and Genesee	T		5 Missed	
	Genesee west and Harris Hill	4 way			
	Harris Hill and Wehrle	4 way	2 False		
	Wehrle and Shimerville	4 way			
	Shimerville and Main	4 way		1 False	
	Main and Harris Hill	4 way		1 False	
	Harris Hill and Main	4 way			
	Harris Hill and Wehrle	4 way			
	Harris Hill and Genesee	4 way			
	Harris Hill and Pleasant View	4 way			
071499_0	Rehm east and Hill Valley	Junction Left			
	Greenbriar east and Warner	T			
	Warner south and Columbia	4 way			
	Columbia east and Central	T			
	Pleasant View east and Stony	4 way			
	Stony and Genesee	T			
	Genesee west and Harris Hill	4 way			
	Harris Hill and Wehrle	4 way			

**Table B-1 Warning Statistics**

File Number	Intersections with Traffic	Type of Intersection	Warnings: False or Missed		
			Left Radar	Right Radar	Center Radar
	Wehrle east and Shimerville	Junction Left			
	Shimerville and Main	4 way			4 False
	Main and Harris Hill	4 way			
	Harris Hill south and Wehrle	4 way			
	Harris Hill south and Genesee	4 way			
	Harris Hill south and Pleasant View	4 way			
071599_0	Pleasant View east and Harris Hill	4 way			
	Pleasant View east and Stony	4 way			
	Stony and Genesee	T		1 False	
	Genesee west and Barton	Junction Right			
	Barton south and Genesee	T			
	Genesee west and Harris Hill	4 way			
	Harris Hill and Wehrle	4 way			
	Shimerville and Main	4 way		1 False	
	Main west and Harris Hill	4 way			
	Harris Hill south and Wehrle	4 way			
	Harris Hill south and Genesee	4 way		1 False	
	Harris Hill south and Pleasant View	4 way			
071699 temp	Transit and Pleasant View	Junction Left			
	Greenbriar east and Warner	T			
	Warner and Pleasant View	T			
	Pleasant View and Harris Hill	4 way			
	Harris Hill and Genesee	4 way	1 False		
	Harris Hill and Wehrle	4 way			
	Howard and Cameron	4 way	1 False		
	Cameron and Wehrle	T			
	Wehrle and Shimerville	Junction Left			
	Shimerville and Main	4 way	1 False		
	Main and Roxbury	Junction Left			
	Roxbury and Wehrle	T			
	Wehrle and Harris Hill	4 way	1 False		
	Harris Hill and Genesee	4 way			
071999_0	Hill Valley and Rehm	T	1 Missed		
	Hillside and Greenbriar	Junction Left			1 False
	Warner and Columbia	4 way			1 Missed
	Columbia and Central	T			
	Harris Hill and Pleasant View	4 way			

**Table B-1 Warning Statistics**

File Number	Intersections with Traffic	Type of Intersection	Warnings: False or Missed		
			Left Radar	Right Radar	Center Radar
	Harris Hill and Genesee	4 way			
	Harris Hill and Wehrle	4 way	1 Missed		
	Shimerville and Main	4 way			1 False 1 Missed
	Wehrle and Harris Hill	4 way	2 Missed	1 False	
	Harris Hill and Genesee	4 way			
	Genesee and Transit	4 way			
072199_0	Transit and Pleasant View	Junction Left			1 Missed
	Hillside and Greenbriar	Junction Left	1 False		
	Greenbriar and Rose Hill Circle	Junction Left	1 False		
	Greenbriar and Warner	T			
	Warner and Pleasant View	T			
	Pleasant View and Harris Hill	4 way			1 False 1 Missed
	Harris Hill and Genesee	4 way			
	Harris Hill and Wehrle	4 way			
	Wehrle and Cameron	Junction Left			
	Shimerville and Main	T		5 Missed	
	Main and Cameron	Junction Left			
	Main and Roxbury	Junction Left			1 False
	Roxbury and Wehrle	T	2 Missed		
	Wehrle and Harris Hill	4 way			
072199_1	Transit and Rehm	Junction Left	1 False		
	Warner and Columbia	4 way			
	Columbia and Central	T			
	Harris Hill and Pleasant View	4 way			
	Harris Hill and Genesee	4 way			
	Harris Hill and Wehrle	4 way	1 Missed		
	Wehrle and Shimerville	Junction Left			
	Shimerville and Main	4 way			
	Main and Harris Hill	4 way			
	Harris Hill and Wehrle	4 way			
	Harris Hill and Genesee	4 way			
Totals	105 Intersections		12 False	6 False	9 False
	p:\ica\molly's documents\warning stats.xls		8 Missed	10 Missed	4 Missed