

Basics of Space Flight Learners' Workbook



Thanks to the *Planetary Report*, published by The Planetary Society, for the use of the cover painting by David Hardy.

Advanced Mission Operations Section

Multi-team Training Module

Basics of Space Flight Learners' Workbook

By
David Doody
George Stephan

December 1995

Document Log
Basics of Space Flight: Learners' Workbook

Document Identifier	Date	Description
M6 MOPS0513-00-01 JPL D-9774	6/15/92	Draft release. Several sections TBD.
M6 MOPS0513-01-00 JPL D-9774	8/25/93	Extensively revised from draft.
MOPS0513-02-00 JPL D-9774, Rev. A	12/15/95	Minor updates.

CONTENTS

INTRODUCTION	1
Acknowledgements	1
Learning Strategy	1
Online Availability	2
Printed Copies for the General Public	2
Feedback or Questions	2
A Note on Abbreviations	3
Metric to English Conversion	3
 SECTION I.	
THE ENVIRONMENT OF SPACE	
 1. The Solar System	5
Distances Within the Solar System	6
The Sun	6
Interplanetary Space	7
The Terrestrial Planets	8
The Jovian Planets	10
Inferior and Superior Planets	12
Asteroids	13
Comets	13
Meteoroids	16
 2. Earth and its Reference Systems	17
Terrestrial Coordinates	17
Rotation of Earth	18
Precession of the Earth Axis	18
Revolution of Earth	19
The Celestial Sphere	20
Right Ascension, Declination, and Related Terms	21
Time Conventions	23
 3. Gravitation and Mechanics	27
Ellipses	27
Newton's Principles of Mechanics	28
Acceleration in Orbit	30
Kepler's Laws	30
Gravity Gradients and Tidal Forces	31
How Orbits Work	32
 4. Interplanetary Trajectories	35
Hohmann Transfer Orbits	35
Gravity Assist Trajectories	35
 5. Planetary Orbits	39
Orbital Parameters and Elements	39
Types of Orbits	40

6.	Electromagnetic Phenomena	43
	Electromagnetic Radiation	43
	Electromagnetic Spectrum	43
	Natural and Artificial Emitters	46
	Radio Frequencies	46
	Spectroscopy	47
	Atmospheric Transparency	48
	Radio Frequency Interference	50
	Doppler Effect	50
	Differenced Doppler	50
	Reflection	52
	Refraction	54
	Phase	55

**SECTION II.
SPACE FLIGHT PROJECTS**

7.	Overview of Mission Inception	57
	Conceptual Study	57
	Phase A: Preliminary Analysis (Proof of Concept)	58
	Phase B: Definition	59
	Phase C/D: Design and Development	60
	Operations Phase	60
	Design Considerations	60
8.	Experiments	63
	The Scientific Community	63
	Gathering Scientific Data	63
	Science and Engineering Data	64
	The Science Data Pipeline	64
	Radio Science	65
	Gravity Field Surveys	66
	Dissemination of Results	66
9.	Spacecraft Classification	69
	Flyby Spacecraft	69
	Orbiter Spacecraft	69
	Atmospheric Probe Spacecraft	69
	Atmospheric Balloon Packages	70
	Lander Spacecraft	70
	Surface Penetrator Spacecraft	70
	Surface Rover Spacecraft	71
	Current Flight Projects at JPL	72
	Projects Currently Being Studied at JPL	72
	Mission Summaries:	
	Voyagers 1 & 2	73
	Magellan	74
	Ulysses	75
	TOPEX/Poseidon	76
	Pioneers 10 & 11	77
	Viking Lander	78
	Mars Observer	79
	Mars Global Surveyor	80
	Galileo Orbiter	81
	Galileo Atmospheric Probe	82

	Cassini	83
	Huygens Probe	84
	Mars Pathfinder	85
	Mars Pathfinder Lander	86
	Mars Balloon	87
	Pluto Spacecraft	88
10.	Telecommunications	91
	Signal Power	91
	Uplink and Downlink	91
	Modulation and Demodulation	91
	Multiplexing	92
	Coherence	92
11.	Typical Onboard Subsystems	95
	Subsystems and Systems	95
	Structural Subsystems	95
	Data Handling Subsystems	95
	Attitude and Articulation Control Subsystems	98
	Telecommunications Subsystems	99
	Electrical Power Supply and Distribution Subsystems	102
	Environmental Subsystems	104
	Propulsion Subsystems	105
	Pyrotechnic Subsystems	106
	Block Diagram Illustration	106
	Redundancy and Flexibility	107
	Advanced Technologies	107
12.	Typical Science Instruments	113
	Science Payload	113
	Direct and Remote Sensing	113
	Direct-Sensing Science Instruments	113
	Remote-Sensing Science Instruments	114
	Active Sensing Science Instruments	117
	Altimeters	118
13.	Spacecraft Navigation	121
	Data Types	121
	Spacecraft Velocity Measurement	121
	Spacecraft Distance Measurement	121
	Spacecraft Angular Measurement	122
	Optical Navigation	122
	Orbit Determination	122
	Trajectory Correction Maneuvers	123
	Orbit Trim Maneuvers	123

SECTION III. SPACE FLIGHT OPERATIONS

14.	Launch Phase	125
	Launch Vehicles	125
	Launch Sites	127
	Launch Windows	128
	Preparations For Launch	129

15. Cruise Phase	131
Spacecraft Checkout and Characterization	131
Real-time Commanding	131
Typical Daily Operations	132
Preparation for Encounter	133
16. Encounter Phase	135
Flyby Operations	135
Planetary Orbit Insertion	136
System Exploration and Planetary Mapping	137
Occultations	138
Gravity Field Surveying	138
Atmospheric Entry and Aerobraking	139
Landing	139
Balloon Tracking	140
Sampling	140
17. Extended Operations Phase	143
Completion Of Primary Objectives	143
Additional Science Data	143
End of Mission	143
CERTIFICATE OF ACHIEVEMENT	148
GLOSSARY	149
INDEX	161

INTRODUCTION

Since Caltech's Jet Propulsion Laboratory (JPL) manages NASA projects that probe the deep space (translunar) environment of our solar system, operations people need to have an understanding of the basics of space flight in order to perform effectively at JPL. This training module introduces concepts associated with these basics to employees new to the space flight operations environment.

This module is the first in a sequence of training modules that pertain to space flight operations activities. (See diagram below). There is no prerequisite. This module is a prerequisite for the next in the sequence, "End-to-End Information System."

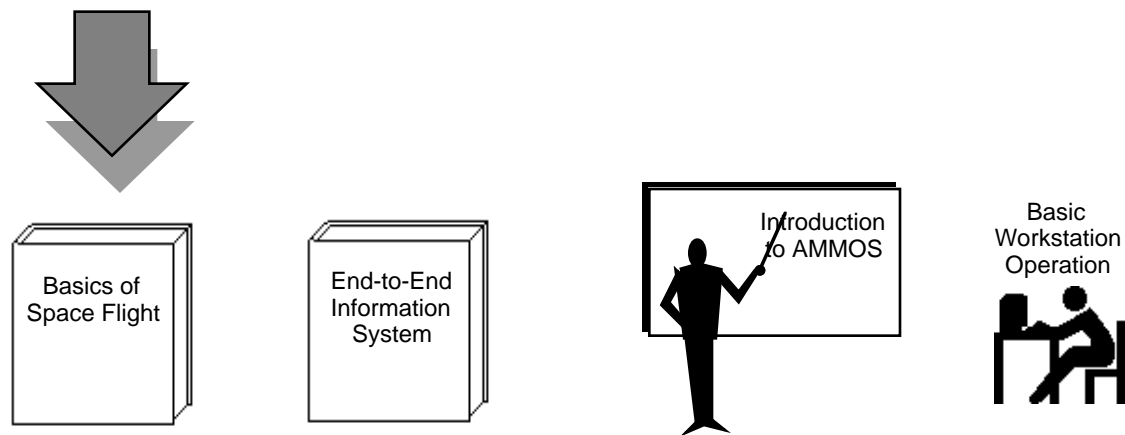

The goal of this training module is to provide an aid for identifying and understanding the general concepts associated with space flight in general and deep space missions in particular. It offers a broad scope of limited depth, presented in 17 chapters. Specific learning objectives are listed at the beginning of each chapter in terms of what you are expected to be able to do upon finishing the chapter.

Acknowledgements

It was prepared by the Advanced Mission Operations Section (391) Training Group, including George Stephan and Dave Doody. Diane F. Miller has done the technical editing, maintained the text and illustrations, and created the online version. Cozette Parker assisted with the initial hardcopy publication. Special thanks to reviewers Ben Toyoshima, Larry Palkovic, Carol Scott, Rob Smith, Dan Lyons, and Bob Molloy, and to field testers Kathy Golden, Steve Annan, Linda Lee, and Paul Porter for their valuable comments. Thanks to Roy Bishop (Physics Department, Acadia University, and the Royal Astronomical Society of Canada) for his independent review.

Learning Strategy

As a participant, you receive your own copy of this self-administered workbook. It includes both learning materials and evaluation tools. The chapters are designed to be used in the order presented, since some concepts developed in later chapters depend on concepts introduced in earlier ones. It doesn't matter how long it takes you to complete it. What is important is that you accomplish all the learning objectives.

You evaluate your own progress in this training module. You are probably eager to learn about the subject and so will want to evaluate your progress as you go. Accomplishing the objectives will be especially important if you plan to participate in the next training module in the sequence, "End-to-End Information System." (Note: The End-to-End Information System module is intended for JPL internal use only.)

The frequent "Recap" (short for recapitulation) sections throughout this workbook will help you reinforce key points and help you evaluate your progress. They require you to fill in blanks. Please do so either mentally or in writing. Answers from the text are shown along the bottom of each Recap.

On page 144 of this book you will find a blank certificate of completion. When you have finished this training module, and you are satisfied that you have met the learning objectives stated in each chapter, please fill in the certificate, sign it, and give it, or a copy of it, to your supervisor for inclusion in your personal file.

Online Availability

This training module is also available on the World Wide Web at

<http://www.jpl.nasa.gov/basics>

In addition, this site has a link to a .pdf (for portable document format) file, readable and printable using Adobe™ Acrobat™ Reader. Acrobat Reader is available free from Adobe's Web site, to which there is also a link.

Printed Copies for the General Public

Printed copies are available for purchase by the general public from JPL's Library, Archives, and Records Section. Contact elizabeth.a.moorthy@jpl.nasa.gov or phone (818) 397-7952.

Feedback or Questions

Feedback from participants is especially valuable to improving any self-administered training. To contribute your ideas to the next edition of this module or to ask a question about any of the material in this workbook, please contact the primary author at david.f.doody@jpl.nasa.gov.

A Note on Abbreviations

Except for units of measure, all terms are spelled out completely the first time they are used, with abbreviations following in parentheses, when applicable. Thereafter, the abbreviations are generally used alone. Units of measure, used without such introduction, are listed below. Refer to the Glossary in the back of the workbook for further help. As with any study endeavor, the participant should also have a good English dictionary at hand.

bps	bits per second
G	Giga (billion, i.e., 10^9). Note that in the U.S., a billion is 10^9 , while in other countries using the metric system a billion is 10^{12} . However, “Giga” means 10^9 everywhere.
g	Gram
Hz	Hertz
k	kilo (thousand)
m	meter (USA spelling; elsewhere, metre)
M	mega (million)
N	Newton
W	Watt

Metric to English Conversion

Throughout this module, measurements are expressed in metric units. If you have a need to convert them into English units, use the following equivalents:

Millimeters to inches:	mm	x	0.04	=	in
Centimeters to inches:	cm	x	0.4	=	in
Meters to feet:	m	x	3.3	=	ft
Meters to yards:	m	x	1.1	=	yds
Kilometers to miles:	km	x	0.6	=	mi
Grams to ounces:	g	x	0.035	=	oz
Kilograms to pounds:	kg	x	2.2	=	lbs

SECTION I.

THE ENVIRONMENT OF SPACE

Chapter 1. The Solar System

Objectives: Upon completion of this chapter you will be able to state distances of objects within the solar system in terms of light-time, describe the sun as a typical star, relate its share of the mass within the solar system, and compare the terrestrial and jovian planets. You will be able to distinguish between inferior and superior planets, describe asteroids, comets, and the Oort cloud. You will be able to describe magnetic fields, particle and radiation environments in planetary vicinities and interplanetary space.

The solar system has been a topic of study from the beginning of history. For nearly all that time, people have had to rely on long-range and indirect measurements of its objects. At first, almost all observations were based on visible light and, later, on radio waves received here on Earth from the objects under investigation. However, with the emergence of space flight, instruments can be sent to many solar system objects to measure their physical properties and dynamics directly and at close range. With the data collected from these measurements, knowledge of the solar system is advancing at an unprecedented rate.

The solar system consists of an average star we call the sun, the planets Mercury, Venus, Earth, Mars, Jupiter, Saturn, Uranus, Neptune, and Pluto. It includes the satellites of the planets, numerous comets, asteroids, meteoroids, and the interplanetary medium. The sun is the richest source of electromagnetic energy in the solar system. The sun's nearest known stellar neighbor is a red dwarf star called Proxima Centauri, at a distance of 4.3 light years away (a light year is the distance light travels in a year, at the rate of 299,792 km per second). The whole solar system, together with the local stars visible on a clear night, orbits the center of our home galaxy, a spiral disk of 200 billion stars we call the Milky Way. The Milky Way has two small galaxies orbiting it nearby, which are visible from the southern hemisphere. They are called the Large Magellanic Cloud and the Small Magellanic Cloud. Our galaxy, one of billions of galaxies known, is traveling through intergalactic space. On a cosmic scale, all galaxies are receding from each other. Galaxies relatively close together may exhibit motion toward or away from each other on a local scale.

The planets, most of the satellites of the planets, and the asteroids revolve around the sun in the same direction, in nearly circular orbits. The sun and planets rotate on their axes. The planets orbit the sun in or near the same plane, called the ecliptic. Pluto is a special case in that its orbit is the most highly inclined (17 degrees) and the most highly elliptical of all the planets. Because of this, for part of its orbit, Pluto is closer to the sun than is Neptune.

Distances Within the Solar System

The most common unit of measurement for distances within the solar system is the astronomical unit (AU). One AU equals the mean distance from the sun to Earth, about 150,000,000 km. JPL refined the precise value of the AU in the 1960s using radar echoes from Venus, since spacecraft navigation depended on its accuracy. Another way to indicate distances within the solar system is terms of light time, which is the distance light travels in a unit of time at the rate of 299,792 km per second. Distances within the solar system, while vast compared to our travels on Earth’s surface, are comparatively small-scale in astronomical terms. For reference, Proxima Centauri, the nearest star at 4 light years away, is about 250,000 AU distant from the sun.

Light Time	Approximate Distance	Example
1 second	299,792 km	~ 0.75 Earth-Moon dist.
1 minute	18,000,000 km	0.125 AU
8.3 minutes	150,000,000 km	Earth-Sun dist. (1 AU)
1 hour	1,000,000,000 km	~ 1.5 x Sun-Jupiter dist.
4 years	(Included for reference)	Distance to nearest star

The Sun

The sun is best characterized as a typical star. The sun dominates the gravitational field of the solar system; it contains 99.85% of the solar system’s mass. The planets, which condensed out of the same disk of material that formed the sun, contain only 0.135% of the mass of the solar system. Satellites of the planets, comets, asteroids, meteoroids, and the interplanetary medium constitute the remaining fraction. Even though the planets make up a small portion of the solar system’s mass, they retain the vast majority of the solar system’s angular momentum. This storehouse of momentum can be utilized by interplanetary spacecraft on so-called “gravity-assist” trajectories.

Mass Distribution Within the Solar System

99.85%	Sun
0.135%	Planets
Remainder	Comets
	Satellites
	Minor Planets
	Meteoroids
	Interplanetary Medium

The gravity of the sun creates extreme pressures and temperatures within itself, sustaining a thermonuclear reaction fusing hydrogen nuclei and producing helium nuclei. This reaction yields tremendous amounts of energy, causing the material of the sun to be plasma and gas. These thermonuclear reactions began about 5×10^9 years ago in the sun, and will probably continue for another 5×10^9 years. The sun has no distinct surface. The apparent surface of the sun is optical only and has no discrete physical boundary.

The sun rotates once on its axis within a period of approximately 28 days at its equator. Because the sun is a gaseous body, rotation speed varies with latitude, being slower at higher latitudes.

The sun has strong magnetic fields that are associated with sunspots. The solar magnetic field is not uniform and is very dynamic. Solar magnetic field variations and dynamics are targets of major interest in the exploration of the solar system.

Interplanetary Space

Nearly all the solar system by volume appears to be an empty void. Far from being nothingness, this vacuum of “space” comprises the interplanetary medium. It includes various forms of electromagnetic radiation and at least two material components: interplanetary dust and interplanetary gas. Interplanetary dust consists of microscopic solid particles. Interplanetary gas is a tenuous flow of gas and charged particles, mostly protons and electrons—plasma—which stream from the sun, called the solar wind.

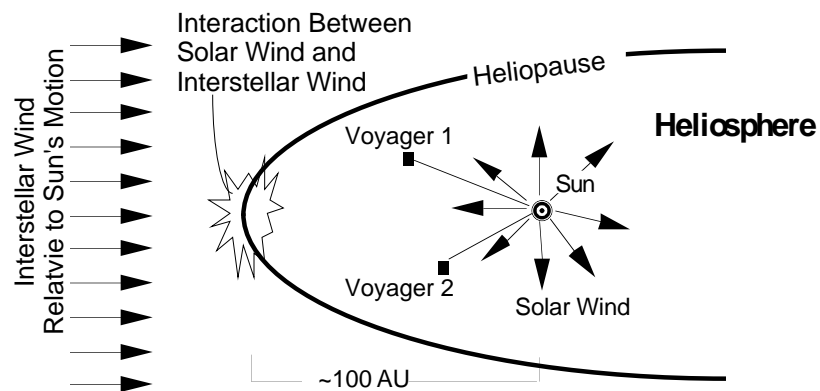

The solar wind can be measured by spacecraft, and it has a large effect on comet tails. It also has a measurable effect on the motion of spacecraft. The speed of the solar wind is about 400 km per second in the vicinity of Earth's orbit. The speed approximately doubles at high solar latitudes. The point at which the solar wind meets the interstellar medium, which is the “solar” wind from other stars, is called the heliopause. It is a boundary theorized to be roughly circular or teardrop-shaped, marking the edge of the sun's influence perhaps 100 AU from the sun. The space within the boundary of the heliopause, containing the sun and solar system, is referred to as the heliosphere.

The solar magnetic field extends outward into interplanetary space; it can be measured on Earth and by spacecraft. The solar magnetic field is the dominating magnetic field throughout the interplanetary regions of the solar system, except in the immediate environment of planets which have their own magnetic fields.

Recap

1. The whole solar system, together with the local stars visible on a clear night, orbits the center of our home _____ .
2. The planets, most of the satellites of the planets, and asteroids revolve around the sun in the same direction and nearly in the same _____ .
3. One AU equals the mean distance from the _____ to the _____ .
4. The sun is best characterized as a _____ .
5. The gravity of the sun creates extreme pressures and temperatures within itself, sustaining a _____ reaction .
6. The Astronomical Unit is abbreviated _____ .
7. Even though the planets make up a small portion of the solar system's mass, they retain the vast majority of the solar system's _____ .

1. galaxy 2. plane 3. sun...Earth 4. typical star 5. thermonuclear 6. AU 7. angular momentum

The Terrestrial Planets

The terrestrial planets are Mercury, Venus, Earth, and Mars, and are called terrestrial because they have a compact, rocky surface like Earth's terra firma. The terrestrial planets are the four innermost planets in the solar system.

Light minutes are often used to express distances within the region of the terrestrial planets, useful because they indicate the time required for radio communication with spacecraft at their distances.

Of the terrestrial planets, Venus, Earth, and Mars have significant atmospheres. The gases present in a planetary atmosphere are related to a planet's size, mass, temperature, how the planet was formed, and whether life is present. The temperature of gases may cause their molecules or atoms to achieve velocities that escape the planet's gravitational field.

Earth is the most massive of the terrestrial planets. The ratios of mass for the terrestrial planets with respect to Earth (100%) is: Venus, 82%; Mars, 11%; and Mercury, 5%. In terms of Earth's radius, Venus is only slightly smaller, Mars is about 50% of Earth's, and Mercury's radius is only 40% of Earth's. In terms of Earth's 24-hour days, Mercury rotates on its axis in 59 days, Venus in 243 days, and Mars every 1.03 days. The slow rotation of Venus is retrograde, opposite the normal rotation of the planets.

Mean Distances Of The Terrestrial Planets From The Sun
 (Orbits drawn approximately to scale)

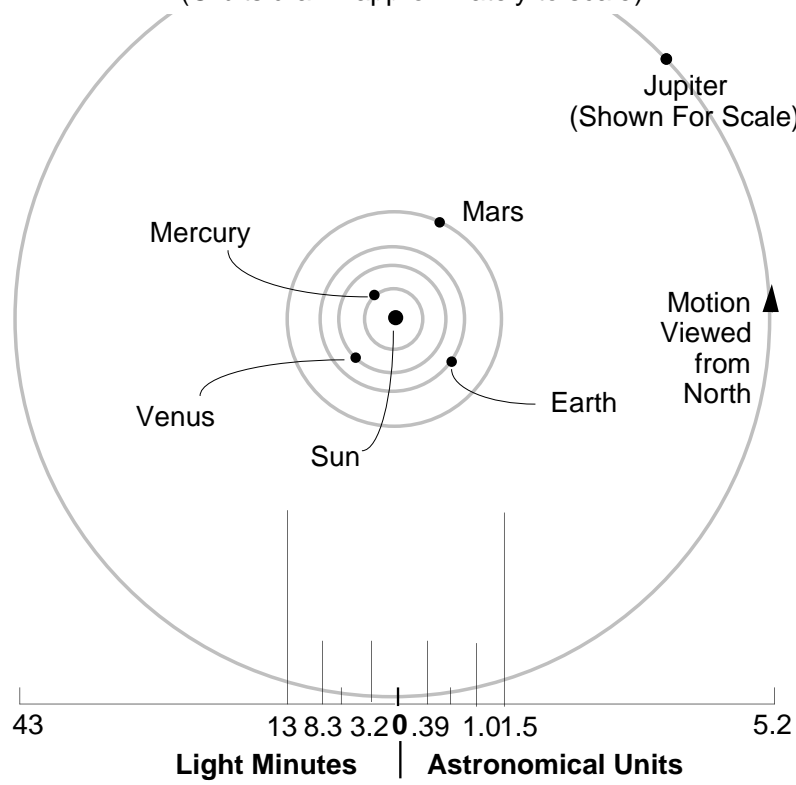

Terrestrial Planetary Data (Approximate)

	Mercury	Venus	Earth	Mars
Mean distance from sun	0.39 AU	0.72 AU	1.0 AU	1.5 AU
Light minutes from sun	3.2	6.0	8.3	12.7
Mass in terms of Earth's	0.05	0.82	1.00	0.11
Radius in terms of Earth's	0.38	0.95	1.00	0.53
Rotation period Earth days	59	243 (retrograde)	1.00	1.03
Natural satellites	0	0	1	2

None of the terrestrial planets have rings. Earth does have a layer of rapidly moving charged particles known as the Van Allen belt, which is trapped by Earth's magnetic field in a doughnut-shaped region surrounding the equator. Of the terrestrial planets, Earth and Mars have natural satellites, Mercury and Venus do not.

The Jovian Planets

Jupiter, Saturn, Uranus, and Neptune are known as the jovian (Jupiter-like) planets, because they are all gigantic compared with Earth, and they have a gaseous nature like Jupiter's. The jovian planets are also referred to as the "gas giants," although some or all of them may have small solid cores.

Jupiter is about 43 light minutes from the sun (add or subtract up to 8.3 minutes to determine light time to Earth); Saturn about 1 hour 20 minutes, Uranus about 2 hours 40 minutes, and Neptune about 4 hours 10 minutes from the sun. By comparison, Pluto, when at its farthest point in orbit, is 5 hours 31 minutes light time from the sun.

Jupiter is 318 times more massive than Earth. Its radius is 11 times Earth's. Jupiter emits electromagnetic energy from a vast number of charged atomic particles spiraling through the planet's magnetic field—its magnetosphere. Jupiter's magnetic field is 20 to 30 times stronger than Earth's. Jupiter has a single equatorial ring made up of particles probably less than 10 microns in diameter—about the size of cigarette smoke particles.

Jupiter has many satellites. Each of the four Galilean satellites, so named because Galileo Galilei (1564-1642) discovered them when he turned his telescope toward Jupiter, exhibits great diversity from the other. Io, the closest Galilean satellite to Jupiter, has active volcanoes, driven by the heat resulting from tidal forces (discussed further in Chapter 3) which flex its crust. Volcanoes are resurfacing the body continuously in the present time. They can now be monitored by Earth-based telescopes. Ganymede has mountains, valleys, craters, and lava flows. Its ancient surface resembles Earth's moon. Callisto is pocked all over with impact craters, revealing the fact that its surface has not changed since the early days of its formation. Europa is covered with an extremely smooth shell of water ice. There may be an ocean of liquid water below the shell, warmed by the same forces that heat Io's volcanoes! (Could life exist there?) Saturn's largest moon, Titan, has a hazy nitrogen atmosphere about as dense as Earth's. All of Uranus's 5 largest moons have extremely different characteristics. The surface of Miranda, the smallest, shows evidence of extensive geologic activity. Umbriel's surface is dark, Titania and Umbriel have trenches and faults, and Oberon's impact craters show bright rays similar to those on Callisto. Neptune's moon Triton is partly covered with nitrogen ice and snow, with active geysers.

Saturn, Uranus, and Neptune all have rings made up of myriad particles of ice, ranging in size from sand to boulders. Jupiter has a thick ring of fine dust, which can be detected at close range in visible light, and from Earth in the infrared. Each particle within a ring is an individual satellite in its own right. When two satellites occupy orbits very close to each other within a ring system, one orbiting farther from the planet than a ring, and the other one orbiting closer to the planet than that ring, they perform like sheep dogs and "flock" the particles between their orbits into a narrow ring, by gravitationally interacting with the ring particles. Thus these satellites are called shepherd moons.

Mean Distances Of The Jovian Planets From The Sun

(Orbits drawn approximately to scale.
Pluto omitted to accommodate scale)

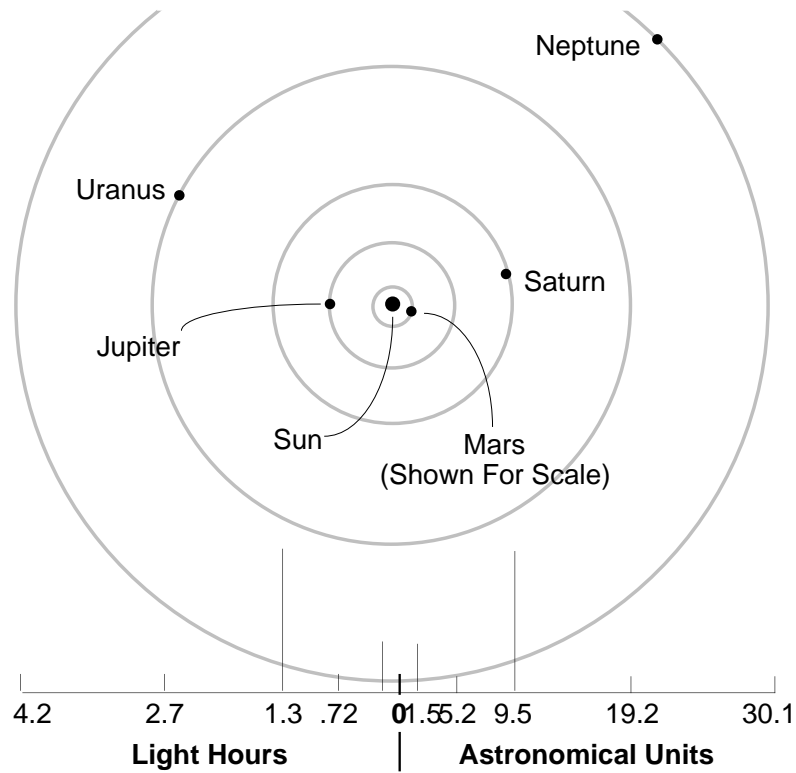

Jovian Planetary Data (Approximate)

	Jupiter	Saturn	Uranus	Neptune
Mean distance from sun	5.2 AU	9.5 AU	19.2 AU	30.1 AU
Light hours from sun	0.72	1.3	2.7	4.2
Mass in terms of Earth's	318	95	15	17
Radius in terms of Earth's	11	9	4	4
Rotation period in hours	9.8	10.7	17.2	16.1
Known natural satellites (1995)	16	18	15	8
Rings	Dust	Extensive system	Thin, dark	Broken ring arcs

Inferior and Superior Planets

Mercury and Venus are referred to as inferior planets because their orbits are closer to the sun than is Earth's orbit. Likewise, Mars, Jupiter, Saturn, Uranus, Neptune, and Pluto are known as superior planets because their orbits are farther from the sun than is Earth's. Viewed from Earth,

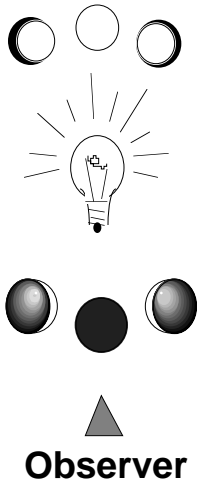

Venus and Mercury go through phases of illumination like Earth's moon does. To visualize phases, in a dark room hold a tennis ball up in front of a light bulb, blocking out the bulb from your view (the tennis ball is now in inferior conjunction with the bulb, and occulting it). The unlighted side of the ball that you see is in the new phase, like a new moon. Move the ball slightly off to one side. Watch a bright crescent appear on the ball. Since the ball can be located between you and the bulb, it can be called an inferior ball. You can see that if the ball were directly across on the other side of the light bulb from you (at superior conjunction), one whole side would be fully illuminated: the full phase. Now swivel around 180° placing your back to the light. Hold the ball out in front of you (it is now a superior ball). Notice its full or near-full phase. Since the superior planets never come between Earth and the sun, they always show a nearly full phase when viewed from Earth. Viewed from superior planets, Earth goes through phases. Superior planets can be seen as crescents only from the vantage point of a spacecraft that is beyond them.

Recap

1. The terrestrial planets are... called terrestrial because they have a compact, _____ surface like Earth's...
2. ...a layer of rapidly moving charged particles known as the _____ belt is trapped by Earth's magnetic field.
3. Jupiter, Saturn, Uranus, and Neptune are known as the jovian planets because they are all gigantic... and have a _____ nature like Jupiter's.
4. Jupiter emits electromagnetic energy from a vast number of charged atomic particles spiraling through the _____ associated with the planet...
5. Jupiter has satellites ... of great diversity. Io, the closest Galilean satellite to Jupiter, has active _____.
6. Mars, Jupiter, Saturn, Uranus, and Neptune, and Pluto are known as _____ planets because their orbits are further from the sun than is Earth's.

1. rocky 2. Van Allen 3. gaseous 4. magnetic field 5. volcanoes 6. superior

Asteroids

Asteroids, also called minor planets, are rocky objects in orbit around the sun. Most asteroids orbit the sun between Mars and Jupiter, moving in the same direction as the planets. Asteroids range in size from Ceres, which has a diameter of about 1000 km, down to the size of pebbles. Sixteen asteroids have a diameter of 240 km or greater. Some asteroids, called Apollo Asteroids, cross the orbit of Earth. It has been estimated that there are around 1000 Earth-crossing asteroids with a diameter of a kilometer or more.

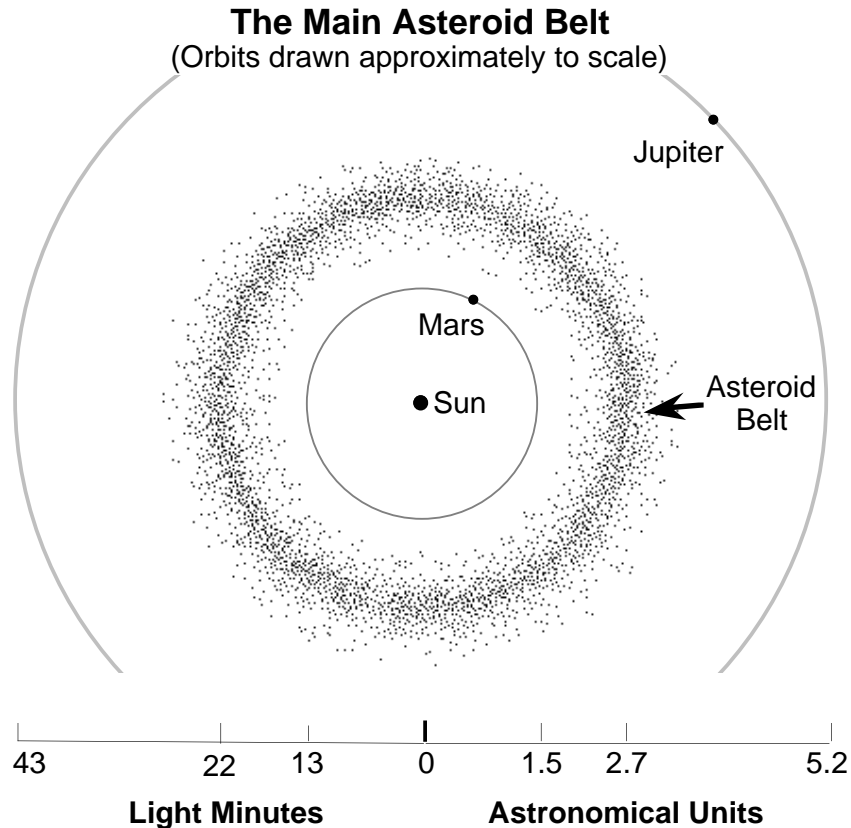

Comets

Most comets are believed to be composed of rocky material and water ice. A few have highly elliptical orbits that bring them very close to the sun and swing them deeply into space, often beyond the orbit of Pluto.

The most widely accepted theory of the origin of comets is that there is a huge cloud of comets called the Oort Cloud (after the Dutch Astronomer Jan H. Oort who proposed the theory), of perhaps 10^{11} comets orbiting the sun at a distance of about 50,000 AU (just under a light year). These comets are near the boundary between the gravitational forces of the sun and the gravitational forces of other stars with which the sun comes into interstellar proximity every several thousand years. According to the theory, these stellar passings perturb the orbits of the comets within the Oort cloud. As a result, some comets may be captured by the visiting star, some may

be lost to interstellar space, and some may begin to “fall” toward the sun. Actually, the comet is still in orbit around the sun as it “falls.” However, the orbit has been modified from a relatively circular orbit to an extremely elliptical one. These are the comets we observe.

A comet entering our planetary system may come under the gravitational influence of the planets as it comes within about 30 AU, especially Jupiter which is at about 5 AU, and its path may be perturbed again. A comet may be accelerated onto a hyperbolic (open) curve, which will cause it to leave the solar system. Unlike the planets that have orbits in nearly the same plane, comet orbits are oriented randomly in space. Comets have been known to break up on closest approach to the sun. Discovered early in 1993, comet Shoemaker-Levy 9 had broken up apparently because of its close passage to Jupiter. It had been captured into orbit about Jupiter and would collide with the planet in July of 1994. The spectacular collision was widely observed.

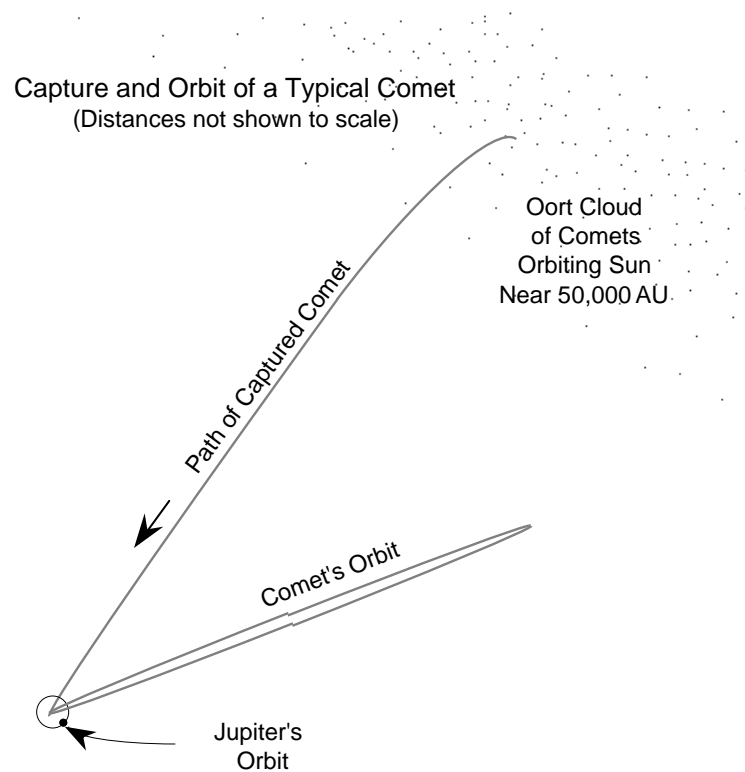

Comet structures are diverse and very dynamic, but they all develop a surrounding cloud of diffuse material, called a coma, that usually grows in size and brightness as the comet approaches the sun. The dense, inner coma often appears pointlike, but the actual nucleus is rarely seen from Earth because it is too small and dim. The coma and the nucleus together constitute the head of the comet.

Components of Comet

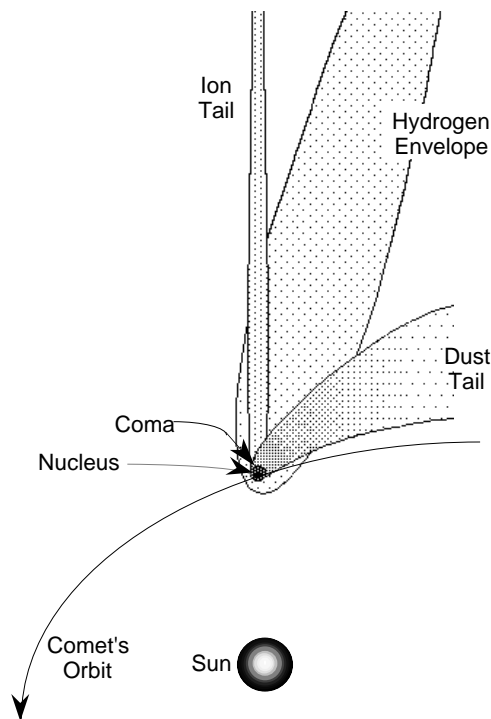

As many comets approach the sun they develop enormous tails of luminous material that extend for millions of kilometers from the head, away from the sun. When far from the sun, the nucleus is very cold and its material is frozen solid within the nucleus. In this state comets are sometimes referred to as a “dirty iceberg” or “dirty snowball,” since over half of their material is ice. When a comet approaches within a few AU of the sun, the surface of the nucleus begins to warm, and volatiles evaporate. The evaporated molecules boil off and carry small solid particles with them, forming the comet’s coma of gas and dust.

When the nucleus is frozen, it can be seen only by reflected sunlight. However, when a coma develops, dust reflects still more sunlight, and gas in the coma absorbs ultraviolet radiation and begins to fluoresce. At about 5 AU from the sun, fluorescence usually becomes more intense than reflected light.

As the comet absorbs ultraviolet light, chemical processes release hydrogen, which escapes the comet’s gravity, and forms a hydrogen envelope. This envelope cannot be seen from Earth because its light is absorbed by our atmosphere, but it has been detected by spacecraft.

The sun’s radiation pressure and solar wind accelerate materials away from the comet’s head at differing velocities according to the size and mass of the materials. Thus, relatively massive dust tails are accelerated slowly and tend to be curved. The ion tail is much less massive, and is accelerated so greatly that it appears as a nearly straight line extending away from the comet opposite the sun.

Each time a comet visits the sun, it loses some of its volatiles. Eventually, it becomes just another rocky mass in the solar system. For this reason, comets are said to be short-lived, on a cosmological time scale. Many scientists believe that some asteroids are extinct comet nuclei, comets that have lost all of their volatiles.

Meteoroids

Meteoroids are small, often microscopic, solid particles that are in orbit around the sun. We see meteoroids as bright meteors when they enter Earth's atmosphere at high speed as they burn up from frictional heat. Any part of a meteor that reaches the ground is called a meteorite. As volatiles boil off from comets they carry small solid particles with them. Particles released from comets in this way become a source for meteoroids, causing meteor showers as Earth passes through them. Meteoroids also come from the asteroid belt.

Recap

1. Asteroids, also called minor planets, are _____ objects in orbit around the sun.
2. Most asteroids orbit the sun between _____ and _____ .
3. ...stellar passings perturb the orbits of the comets within the _____ cloud.
4. Unlike the planets that have orbits in nearly the same plane, comets are oriented _____ in space.
5. ...when a coma develops, dust reflects still more sunlight, and gas in the coma absorbs ultraviolet radiation and begins to _____ .
6. Meteoroids are small (often microscopic) solid particles that are in orbit around the _____ .

1. rocky 2. Mars and Jupiter 3. Oort 4. randomly 5. fluoresce 6. sun

Chapter 2. Earth and its Reference Systems

Objectives: Upon completion of this chapter you will be able to describe the system of terrestrial coordinates, the rotation of Earth, precession, and the revolution of Earth about the sun. You will be able to describe how the locations of celestial objects are stated in the coordinate systems of the celestial sphere. You will be able to describe various conventions of timekeeping.

In order to explore the solar system, coordinates must be developed to consistently identify the locations of the observer, of the natural objects in the solar system, and of any spacecraft traversing interplanetary space or orbiting a planet.

Because space is observed from Earth, Earth's coordinate system must be established before space can be mapped. Earth rotates on its axis daily and revolves around the sun annually. These two facts greatly complicated the history of observing space. However, once known, accurate maps of Earth could be made using stars as reference points, since most of the stars' angular movements in relationship to each other are not readily noticeable during a human lifetime. Although the stars do move with respect to each other, this movement is observable for only a few close stars, using instruments and techniques of great precision and sensitivity (historically, the starry sky has been called "the firmament").

Terrestrial Coordinates

A great circle is an imaginary circle on the surface of a sphere whose center is at the center of the sphere. The equator is a great circle. Great circles that pass through both the north and south poles are called meridians, or lines of longitude. For any point on the surface of Earth a meridian can be defined. The prime meridian, the starting point measuring the east-west locations of other meridians, marks the site of the old Royal Observatory in Greenwich, England. Longitude is expressed in degrees, minutes, and seconds of arc from 0 to 180 degrees eastward or westward from the prime meridian. For example, downtown Pasadena is located at 118 degrees, 8 minutes, 41 seconds of arc westward of the prime meridian: $118^{\circ} 8' 41''$ W.

The starting point for measuring north-south locations on Earth is the equator (the equator is the imaginary circle around Earth which is everywhere equidistant from the poles). Circles in parallel planes to that of the equator define north-south measurements called parallels, or lines of latitude. Latitude is also expressed in degrees, minutes, and seconds of the arc subtended from the center of Earth. Downtown Pasadena is located at 34 degrees, 08 minutes, 44 seconds of arc north of the equator: $34^{\circ} 08' 44''$ N.

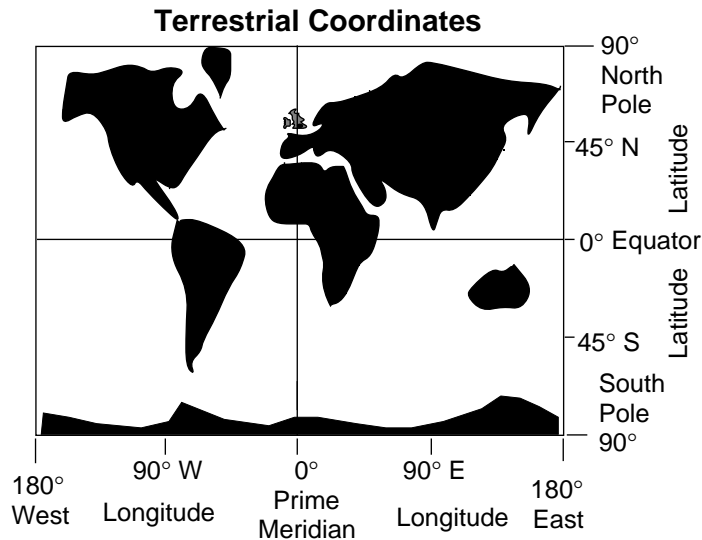

Rotation of Earth

Earth rotates on its axis relative to the sun every 24.0 hours mean solar time, with an inclination of 23.5 degrees from the plane of its orbit around the sun. Mean solar time represents an average of the variations caused by Earth's non-circular orbit. Its rotation relative to the other stars (sidereal time) is 3 minutes 56.55 seconds shorter than the mean solar day, the equivalent of one solar day per year. Forces associated with the rotation of Earth cause it to be slightly oblate, displaying a bulge (oblateness) at the equator.

Precession of the Earth Axis

The moon's gravity, primarily, and to a lesser degree the sun's gravity, acting on Earth's oblateness tries to move Earth's axis perpendicular to the plane of Earth's orbit. However, due to gyroscopic action, Earth's poles do not "right themselves" to a position perpendicular to the orbital plane. Instead, they precess at 90 degrees to the force applied. This precession causes the axis of Earth to describe a circle having a 23.5 degree radius relative to a fixed point in space over about 26,000 years, a slow wobble reminiscent of the axis of a spinning top swinging around.

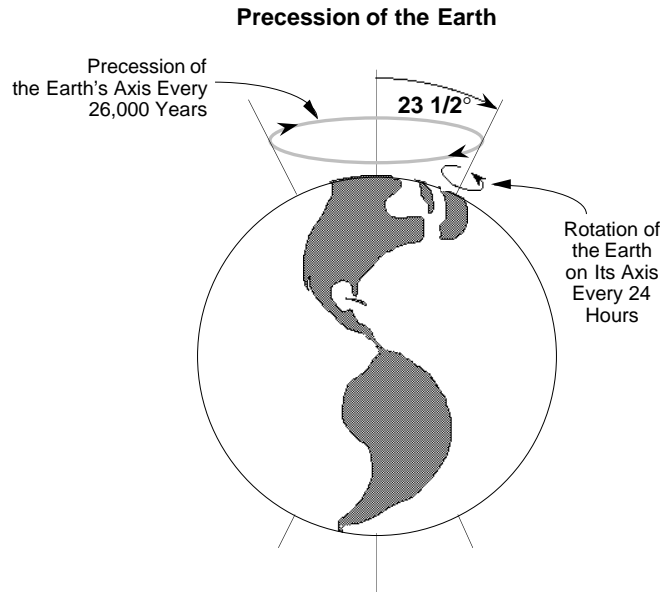

Revolution of Earth

Earth revolves around the sun in 365 days, 6 hours, 9 minutes with reference to the stars. Its mean orbital speed is about 100,000 km per hour. The 6 hours, 9 minutes add up to about an extra day every fourth year, which is designated a leap year, with the extra day added as February 29th. Earth's orbit is elliptical and reaches its closest approach to the sun (perihelion) on about January fourth of each year.

Recap

1. Most of the stars' movements in relationship to each other are not readily noticeable during a _____ .
2. Longitude is expressed in degrees, minutes, and seconds of arc from 0 to 180 degrees eastward or westward from the _____ .
3. North-south measurements on the surface of Earth are called _____ , or lines of _____ .
4. Forces associated with the _____ of Earth cause it to be slightly oblate.
5. Precession causes the axis of Earth to describe a circle having a _____ - degree radius over a period of about _____ years.
6. Earth's orbit is _____ (in shape).

1. human lifetime 2. prime meridian 3. parallels...latitude 4. rotation 5. 23.5 ... 26,000 6. elliptical

The Celestial Sphere

To establish a consistent coordinate system for the sky, a celestial sphere has been conceived. The center of the celestial sphere is the center of Earth. The celestial sphere has an imaginary radius larger than the distance to the farthest observable object in the sky. The extended rotational axis of Earth intersects the north and south poles of the celestial sphere.

The direction to any star or other object can be plotted in two dimensions on the inside of this sphere. The apparent constancy of observed stellar positions allows the preparation of long-lived sky almanacs that identify the direction on the celestial sphere to the observable stars. The apparent direction to the sun, moon, planets, spacecraft, or any object in our solar system can also be plotted on the inside of the celestial sphere. However, these objects all move fairly rapidly in apparent angular distance with respect to the “stationary” stars plotted on the celestial sphere, causing their plots to need regular updating.

A coordinate system analogous to Earth’s latitude and longitude has been devised for the celestial sphere to designate positions on the sphere.

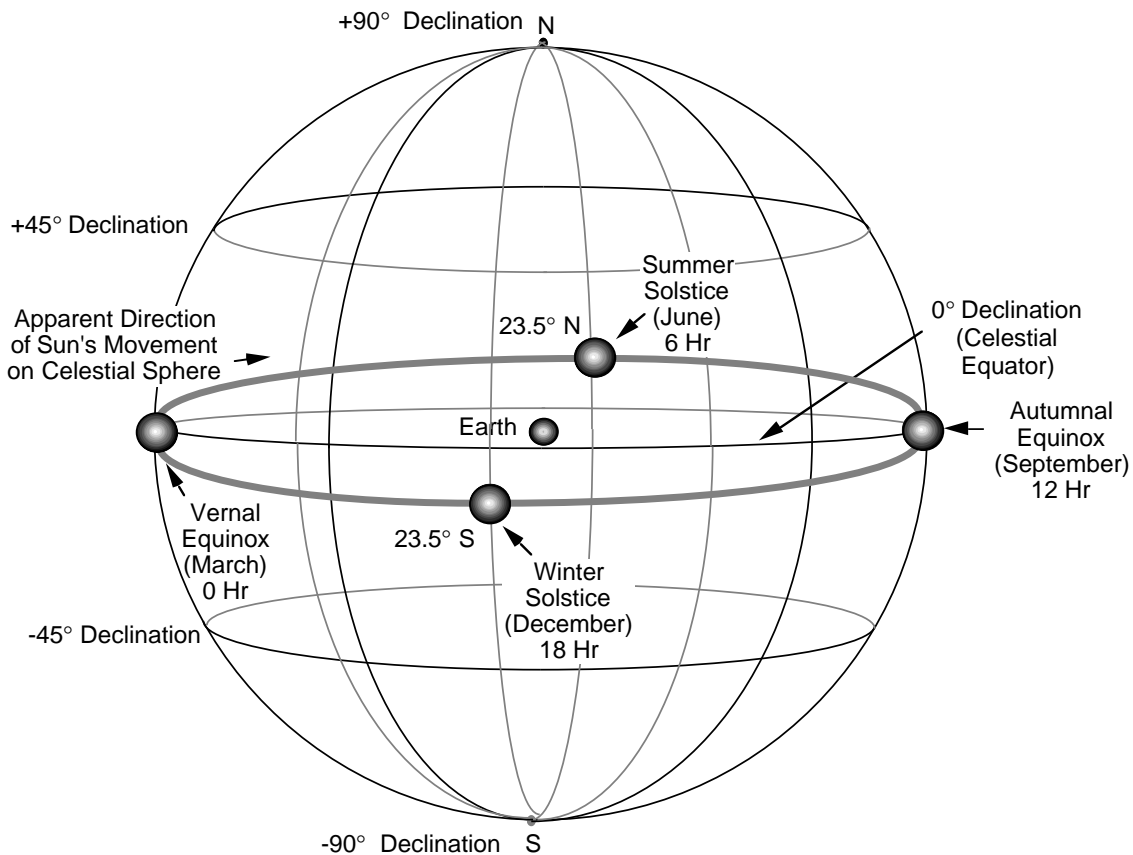

Right Ascension, Declination, and Related Terms

Right ascension (RA) is angular distance measured in hours, minutes, and seconds of the 24-hour circle along the celestial equator eastward from the vernal equinox. The vernal equinox is that point of the celestial sphere where the sun's path crosses the celestial equator going from south to north each year. Declination (DEC) is angular distance measured in degrees north or south of the celestial equator (+90 to -90 degrees). Zenith is imagined as a point straight up from any point on the surface of Earth. Observer's Meridian is an arc on the celestial sphere extending from the north to the south celestial poles that passes through the observer's zenith. The Nadir is the direction opposite the zenith: for example, straight down from a spacecraft to the center of the planet.

Hour angle (HA) is the angular distance measured westward along the celestial equator from the zenith crossing. In effect, HA represents the RA for a particular location and time of day.

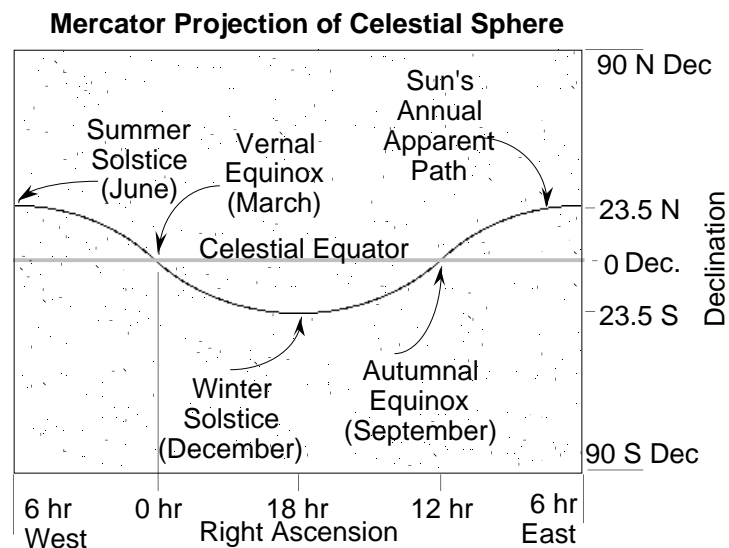

RA, HA and DEC are references within a system based on Earth's equator and poles. There is a simpler system, which uses the local horizon as its reference. Its measurements are elevation (or altitude), EL (or ALT), in degrees above the horizontal, and azimuth (AZ), in degrees clockwise around the horizon from true north. In such a system East is 90° AZ, and halfway up in EL or ALT would be 45° . AZ-EL and ALT-AZ are simply different names within the same reference system.

Telescopes, radio telescopes, and JPL's Deep Space Station antennas are designed with mountings that are engineered to take best advantage of either the HA-DEC coordinate system or the AZ-EL (ALT-AZ) system.

In a HA-DEC system, the HA axis is parallel to Earth's rotational axis. Thus the mounting built for a telescope near the equator would appear different from one built for use in high latitudes. ALT-AZ or AZ-EL systems would appear the same no matter where on Earth they are being used.

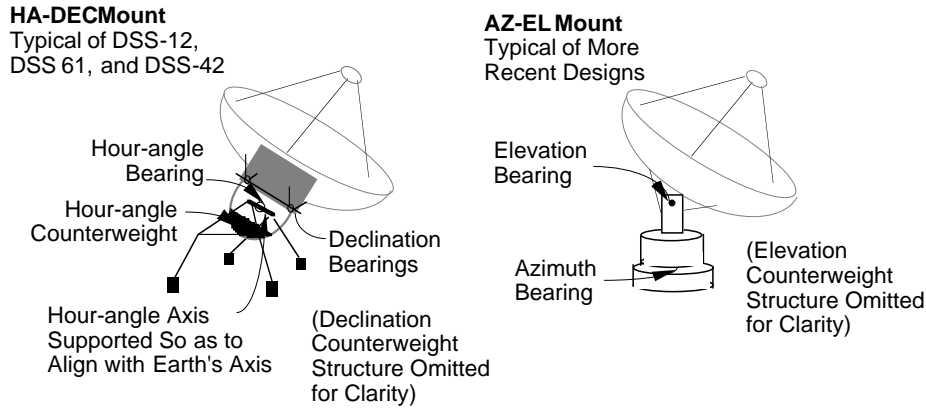

HA-DEC antenna mounting systems require an asymmetrical structural design unsuited to the support of very heavy structures. Their advantage is that motion is required mostly in only one axis to track an object as Earth rotates, although this advantage has largely been obviated by the use of digital computers that can drive both axes of AZ-EL systems properly while they track.

Because of the precession of the poles over 26,000 years, all the stars appear to shift over time, and sky almanacs must be occasionally updated. Precession causes the stars to appear to shift west to east at the rate of .01 degree (360 degrees/ 26,000 years) with respect to the vernal equinox each year. Sky almanacs identify the date and time of the instant used as the date of reference, or epoch, when preparing the almanac, and provide equations for updating data based on the almanac to the current date.

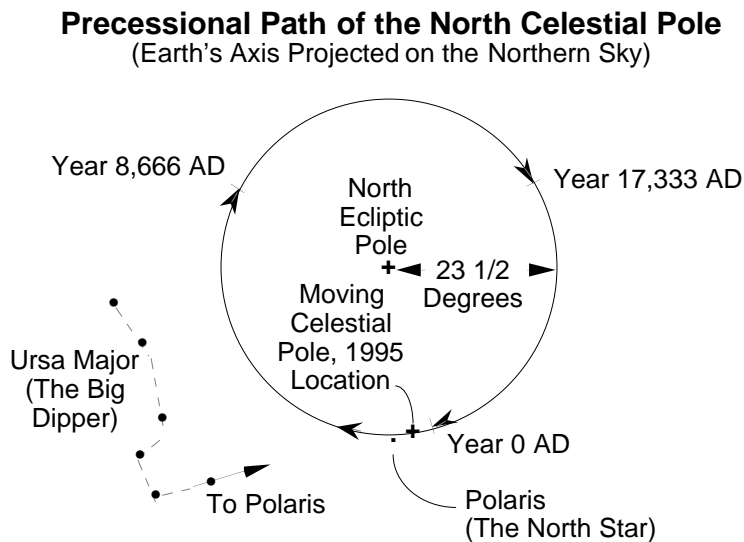

At the present time in Earth's 26,000 year precession cycle, a bright star coincidentally happens to be very close (less than a degree) from the north celestial pole. This star is called Polaris, or the North Star.

Recap

1. The center of the celestial sphere is the center of the _____ .
2. The _____ is the point of the celestial sphere where the sun's path crosses the celestial equator going from south to north...
3. A coordinate system analogous to Earth's longitude and latitude ... to designate positions on the celestial sphere (uses) measurements called _____ and _____ .
4. _____ is the angular distance measured north or south of the celestial equator (+90 to -90°).
5. Because the precession of ... the poles ... over a period of 26,000 years, all the stars appear to move very slowly, and sky almanacs must be occasionally _____ .

1. Earth 2. vernal equinox 3. RA ... DEC 4. DEC 5. updated

Time Conventions

Various measurements of time are used in interplanetary space flight:

Universal Time Coordinated (UTC) is the world-wide scientific standard of timekeeping. It is based upon carefully maintained atomic clocks and is kept accurate to within microseconds. The addition or subtraction of leap seconds, as necessary at two opportunities every year, keeps UTC in step with Earth's rotation. Being the most precise worldwide time system, it is used by astronomers, navigators, the Deep Space Network (DSN), and other scientific disciplines. Its reference point is Greenwich, England: when it is midnight there on Earth's prime meridian, it is midnight (00:00:00.000000) — “all balls”—UTC.

UT1, or simply UT, Universal Time, was previously called Greenwich Mean Time, GMT. It is based on the imaginary “mean sun” which averages out the effects on the length of the solar day caused by Earth's slightly non-circular orbit about the sun. UT is not updated with leap seconds as is UTC. Its reference point is also Greenwich, England: when it is noon on the prime meridian, it is noon (12:00:00) UT.

Local time is adjusted for location around Earth or other planets in time zones. On Earth, many countries adjust for standard time or daylight-savings time. Its reference point is one's immediate locality: when it is 12:00:00 noon Pacific Daylight Time (PDT) at JPL, it is 19:00:00 UTC, and 13:00:00 in Denver. Local time on another planet is conceived as the equivalent time for the height of the sun above the horizon, corresponding to the same local time on Earth. It has no bearing to the planet's rotation rate. Thus around 11:30 am or 12:30 pm at a particular location on Venus, the sun would be nearly overhead. At 5:00 pm at a particular location on Mars, the sun would be low in the west.

Earth-received time (ERT) is the UTC of an event received at a DSN station. One-way light time (OWLT) is the elapsed time it takes for light, or a radio signal, to reach a spacecraft or other body

from Earth (or vice versa). Knowledge of OWLT is maintained to an accuracy of milliseconds. OWLT varies continuously as the spacecraft's distance from Earth changes. Its reference points are the center of Earth and the immediate position of a spacecraft or the center of a celestial body. Transmission time (TRM) is the UTC time of uplink from Earth.

Round-trip light time (RTL) is the elapsed time it takes for a signal to travel from Earth, be received and immediately transmitted or reflected by a spacecraft or other body, and return to the starting point. It is roughly equal to 2 x OWLT, but not exactly, because of the different amount of distance the signal must travel on each leg due to the constant motions of both Earth and spacecraft. RTL from here to Earth's moon is around 3 seconds, to the sun, about 17 minutes. Voyager 1's RTL at this writing in December 1995 is over 17 hours.

Spacecraft event time (SCET) is the UTC time onboard the spacecraft. It is equal to TRM + OWLT. ERT is equal to SCET + OWLT. Spacecraft clock time (SCLK), is the value of a counter onboard a spacecraft as described in Chapter 11. SCET has a nearly-direct relationship with SCLK, although the units of measurement are different, and SCLK is not as constant and stable as the UTC-derived SCET. Tracking the exact relationship between SCLK and SCET is accomplished by analyzing telemetered SCLK values and trends with respect to UTC-derived SCET, and producing a SCLK/SCET coefficients file which tracks the gradual drift of SCLK versus SCET.

Terrestrial Time (TT) was previously called Terrestrial Dynamical Time (TDT), which replaced Ephemeris Time (ET). TT is a measurement of time defined by Earth's orbital motion. It equates to Mean Solar Time corrected for the irregularities in Earth's motions.

This excerpt from a flight project's Integrated Sequence of Events (ISOE) illustrates use of UTC, ERT, TRM, RTL, SCET, and SCLK.

(ISOE is discussed further in Chapter 15.)

ID: 93-24 F SOF YEAR-DAY: 93-171 PRINTED ON DAY 93-168 PAGE 142
 MAGELLAN MISSION OPERATIONS WEEK: 24 DOY: 169-175 RTL = 12:56.354
 SEQUENCE OF EVENTS

ITEM NO.	END TIME DOY/HH:MM:SS	T B	EVENT - DESCRIPTION	COMMAND	DSM	SCET TIME DOY/HH:MM:SS	S/C CLOCK
02518	171/01:28:56	E	<< STAR SCANNER PULSE TST >>	7PULS		171/01:22:28	2159880:90:0
02519	171/01:28:58	E	<< STAR SCANNER PULSE TST >>	7PULS		171/01:22:30	2159881:02:0
02520	171/01:28:58	E	<< NO OPERATION >>	6NOP		171/01:22:30	2159881:02:0
02521	171/01:32:37	E	MISC NOTE 391AG99A, 93-171/01:26:09.134, APOAPS, GOTHER, A7931			171/01:26:09	2159884:58:0
02522	171/01:33:59	T	ACQ U/L - D55 42 5 BAND		42	171/01:40:27	
02523	171/01:34:21	E	END OF MEMORY READOUT	6MROH			
02524	171/01:34:57	E	MISSION PHASE DRB OPS S/W MODE*ATT REF HOLD	AACS		171/01:28:29	2159886:96:0
02525	171/01:35:01	E	STAR SSTAR: << MANEUVER SPECIFICATION >>	7MNVR		171/01:28:33	2159887:00:0
02526	171/01:35:01	E	MISSION PHASE DRB OPS S/W MODE*SLEW TO ATT	AACS		171/01:28:33	2159887:00:0

Recap

1. Universal Time (UT) is the mean or average value of UTC: It is not updated with _____ seconds as is UTC.
2. When it is 12:00:00. noon Pacific Daylight Time (PDT) at JPL, it is _____ UTC.
3. (The abbreviation) _____ is the UTC time on board the spacecraft. It is equal to UTC + OWLT.
4. Spacecraft Clock time (SCLK) is the value of a _____ on board a spacecraft

1. leap 2. 1900 3. SCET 4. counter

Chapter 3. Gravitation and Mechanics

Objectives: Upon completion of this chapter you will be able to describe the force of gravity, characteristics of ellipses, and the concepts of Newton's principles of mechanics. You will be able to recognize acceleration in orbit and explain Kepler's laws in general terms. You will be able to describe tidal effect and how it is important in planetary systems.

Gravitation is the mutual attraction of all masses in the universe. The concepts associated with planetary motions developed by Johannes Kepler (1571-1630) describe the positions and motions of objects in our solar system. Isaac Newton (1643-1727) explained why Kepler's laws worked, in terms of gravitation. Since planetary motions are orbits, and all orbits are ellipses, a review of ellipses follows.

Ellipses

An ellipse is a closed plane curve generated in such a way that the sums of its distances from two fixed points (called the foci) is constant. In the illustration below, Distance A + B is constant for any point on the curve.

Ellipse Foci

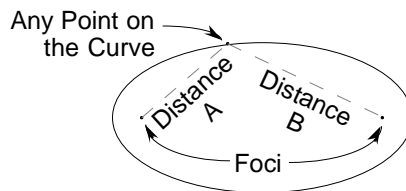

An ellipse also results from the intersection of a circular cone and a plane cutting completely through the cone. The maximum diameter is called the major axis. It determines the size of an ellipse. Half the maximum diameter, the distance from the center of the ellipse to one end, is called the semi-major axis.

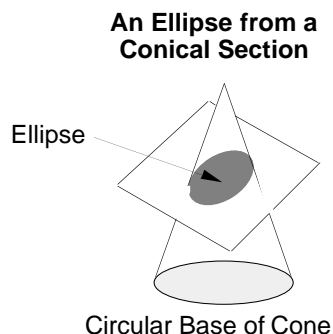

Major And Minor Axes

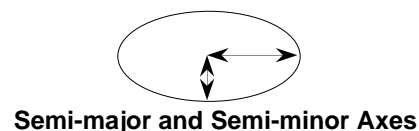
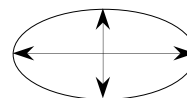

The shape of an ellipse is determined by how close together the foci are in relation to the major axis. Eccentricity equals the distance between the foci divided by the major axis. If the foci coincide, the ellipse is a circle. Therefore, a circle is an ellipse with an eccentricity of zero.

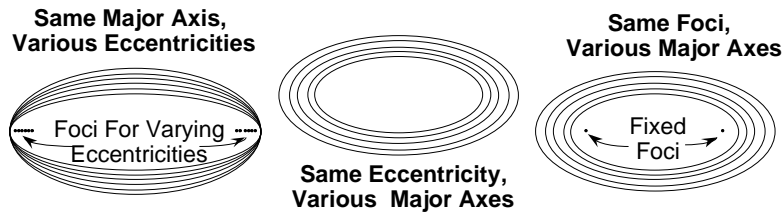

Recap

1. The definition of an ellipse is a closed plane curve generated in such a way that the sums of its distances from the two fixed points (the foci) is _____ .
2. Eccentricity equals the distance between the foci divided by the _____ axis.
3. If the foci coincide, the ellipse is a _____ .

1. constant 2. major 3. circle

Newton's Principles of Mechanics

Newton realized that the force that makes apples fall to the ground is the same force that makes the planets "fall" around the sun. Newton had been asked to address the question of why planets move as they do. He established that a force of attraction toward the sun becomes weaker in proportion to the square of the distance from the sun.

Newton postulated that the shape of an orbit should be an ellipse. Circular orbits are merely a special case of an ellipse where the foci are coincident. Newton described his work in the *Mathematical Principles of Natural Philosophy* (often called simply the *Principia*), which he published in 1685. Newton gave his laws of motion as follows:

- I. Every body continues in a state of rest, or of uniform motion in a straight line, unless it is compelled to change that state by forces impressed upon it.
- II. The change of motion (linear momentum) is proportional to the force impressed and is made in the direction of the straight line in which that force is impressed.
- III. To every action there is always an equal and opposite reaction; or, the mutual actions of two bodies upon each other are always equal, and act in opposite directions.

(Notice that Newton's laws describe the behavior of inertia, they do not explain its nature.)

There are three ways to modify the momentum of a body. The mass can be changed, the velocity can be changed (acceleration), or both.

$$\text{mass (M) x change in velocity (acceleration, A) = force (F)}$$

or

$$\mathbf{F} = \mathbf{MA}$$

Acceleration may be produced by applying a force to an object. If applied in the same direction as an object's velocity, the velocity increases in relation to an unaccelerated observer. If acceleration is produced by applying a force in the opposite direction from the object's original velocity, it will slow down. If the acceleration is produced by a force at some other angle to the velocity, the object will be deflected.

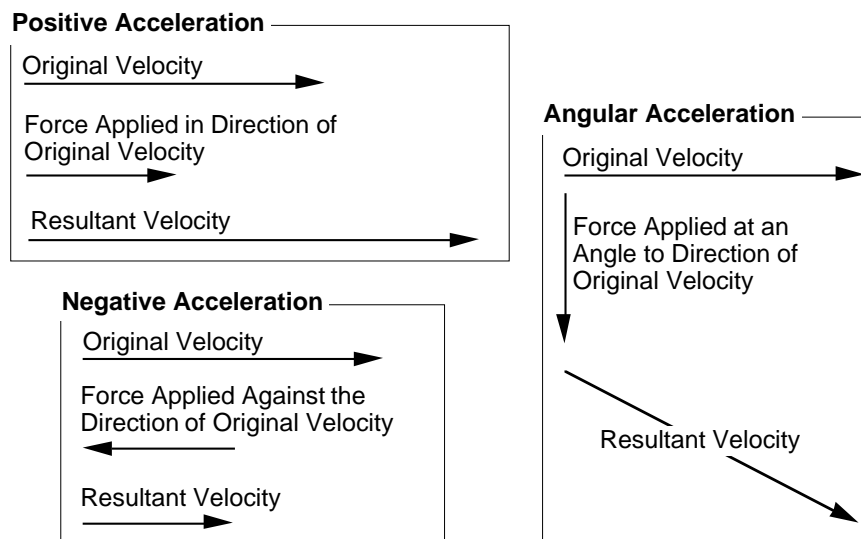

In order to measure mass, we must agree to a standard. The world standard of mass is the kilogram, whose definition is based on the mass of a metal cylinder kept in France. Previously, the standard was based upon the mass of one cubic centimeter of water being one gram (this is approximately correct). Force can now be expressed numerically. A unit of force is the dyne, which is equal to the force required to accelerate a mass of 1 gram 1 cm per second per second. Another is the Newton, the force required to accelerate a 1-kg mass 1 m/sec². A Newton is equal to the weight of about 100 grams of water, or about 1/2 cup.

Recap

1. Gravitation is the mutual _____ of all masses in the universe.
2. Newton postulated that the shape of an orbit should be an _____.
3. Circular orbits are merely a special case of an ellipse where the foci are _____.
4. If acceleration is produced in the opposite direction of velocity, the object will _____.

1. attraction 2. ellipse 3. coincident 4. slow down

Acceleration in Orbit

Newton's first law describes how, once in motion, planets remain in motion. What it does not do is explain how the planets are observed to move in nearly circular orbits rather than straight lines. Enter the second law. To move in a curved path, a planet must have an acceleration toward the center of the circle. This is called centripetal acceleration and is supplied by the mutual gravitational attraction between the sun and the planet.

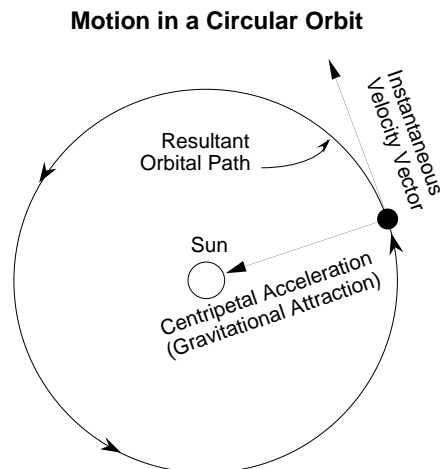

Kepler's Laws

Kepler's laws, as expressed by Newton, are:

- I. If two bodies interact gravitationally, each will describe an orbit that is a conic section about the common mass of the pair. If the bodies are permanently associated, their orbits will be ellipses. If they are not permanently associated with each other, their orbits will be hyperbolas (open curves).
- III. If two bodies revolve around each other under the influence of a central force (whether or not in a closed elliptical orbit), a line joining them sweeps out equal areas in the orbital plane in equal intervals of time.

- III. If two bodies revolve mutually about each other, the sum of their masses times the square of their period of mutual revolution is in proportion to the cube of the semi-major axis of the relative orbit of one about the other.

The major application of Kepler's first law is to precisely describe the geometric shape of an orbit: an ellipse, unless perturbed by other objects. Kepler's first law also informs us that if a comet, or other object, is observed to have a hyperbolic path, it will visit the sun only once, unless its encounter with a planet alters its trajectory again.

Kepler's second law addresses the velocity of an object in orbit. Conforming to this law, a comet with a highly elliptical orbit has a velocity at closest approach to the sun that is many times its velocity when farthest from the sun. Even so, the area of the orbital plane swept is still constant for any given period of time.

Time Versus Area Swept by an Orbit

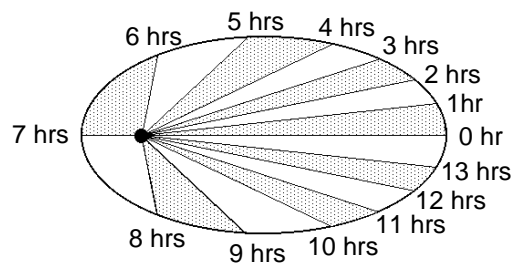

Kepler's third law describes the relationship between the masses of two objects mutually revolving around each other and the determination of orbital parameters. Consider a small star in orbit about a more massive one. Both stars actually revolve about a common center of mass, which is called the barycenter. This is true no matter what the size or mass of each of the objects involved. Measuring a star's motion about its barycenter with a massive planet is one method that has been used to discover planetary systems associated with distant stars.

Obviously, these statements apply to a two-dimensional picture of planetary motion, which is all that is needed for describing orbits. A three-dimensional picture of motion would include the path of the sun through space.

Gravity Gradients (Tidal Forces)

Gravity's strength is inversely proportional to the square of the objects' distance from each other. For an object in orbit about a planet, the parts of the object closer to the planet feel a slightly stronger gravitational attraction than do parts on the other side of the object. This is known as gravity gradient. It causes a slight torque to be applied to any mass which is non-spherical and non-symmetrical in orbit, until it assumes a stable attitude with the more massive parts pointing toward the planet. An object whose mass is distributed like a bowling pin would end up in an attitude with its more massive end pointing toward the planet, if all other forces were equal.

In the case of a fairly massive body such as our moon in Earth orbit, the gravity gradient effect has caused the moon, whose mass is unevenly distributed, to assume a stable rotational rate, which keeps one face towards Earth at all times, like the bowling pin described above.

The moon acts upon the Earth's oceans and atmosphere, causing two bulges to form. The bulge on the side of the Earth that faces the moon is caused by the proximity of the moon and its

relatively stronger gravitational pull on that side. The bulge on the opposite side of the earth results from that side being attracted toward the moon less strongly than is the central part of the earth. The earth's crust is also affected to a small degree. Other factors, including Earth's rotation and surface roughness, complicate the tidal effect. On planets or satellites without oceans, the same forces apply, but they cause slight deformations in the body rather than oceanic tides. This mechanical stress can translate into heat as in the case of Jupiter's volcanic Io.

Recap

1. To move in a circular path a planet must have applied a constant acceleration toward the center of the circle. This acceleration is called _____ acceleration.
2. When closest to the sun, an object is moving at higher velocity than when it is farthest from the sun; however, the _____ of the orbital plane swept is constant for any given period of time.
3. (Two) stars actually revolve about a common center of mass, which is called the _____.
4. For an object in orbit about a planet, the parts of the object closer to the planet feel a slightly stronger... attraction than do parts on the other side of the object. This is known as _____.

1. centripetal 2. area 3. barycenter 4. gravity gradient

How Orbits Work

The drawings on the next page simplify the physics of orbiting Earth. We see Earth with a huge, tall mountain rising from it. The mountain, as Isaac Newton first envisioned, has a cannon at its summit. When the cannon is fired, the cannonball follows its ballistic arc, falling as a result of Earth's gravity, and it hits Earth some distance away from the mountain. If we put more gunpowder in the cannon, the next time it's fired, the cannonball goes halfway around the planet before it hits the ground. With still more gunpowder, the cannonball goes so far that it just never touches down at all. It falls completely around Earth. It has achieved orbit.

If you were riding along with the cannonball, you would feel as if you were falling. The condition is called free fall. You'd find yourself falling at the same rate as the cannonball, which would appear to be floating there (falling) beside you. You'd just never hit the ground. Notice that the cannonball has not escaped Earth's gravity, which is very much present—it is causing the mass to fall. It just happens to be balanced out by the speed provided by the cannon.

In the third drawing in the figure, you'll see that part of the orbit comes closer to Earth's surface than the rest of it does. This is called the periastron of the orbit. It also has various other names, depending on which body is being orbited. For example, it is called perigee at Earth, perijove at Jupiter, periselene or perilune in lunar orbit, and perihelion if you're orbiting the sun. In the drawing, the mountain represents the highest point in the orbit. That's called apoapsis (apogee, apojoove, aposelene, apolune, aphelion). The time it takes, called the orbit period, depends on altitude. At space shuttle altitudes, say 200 kilometers, it's 90 minutes.

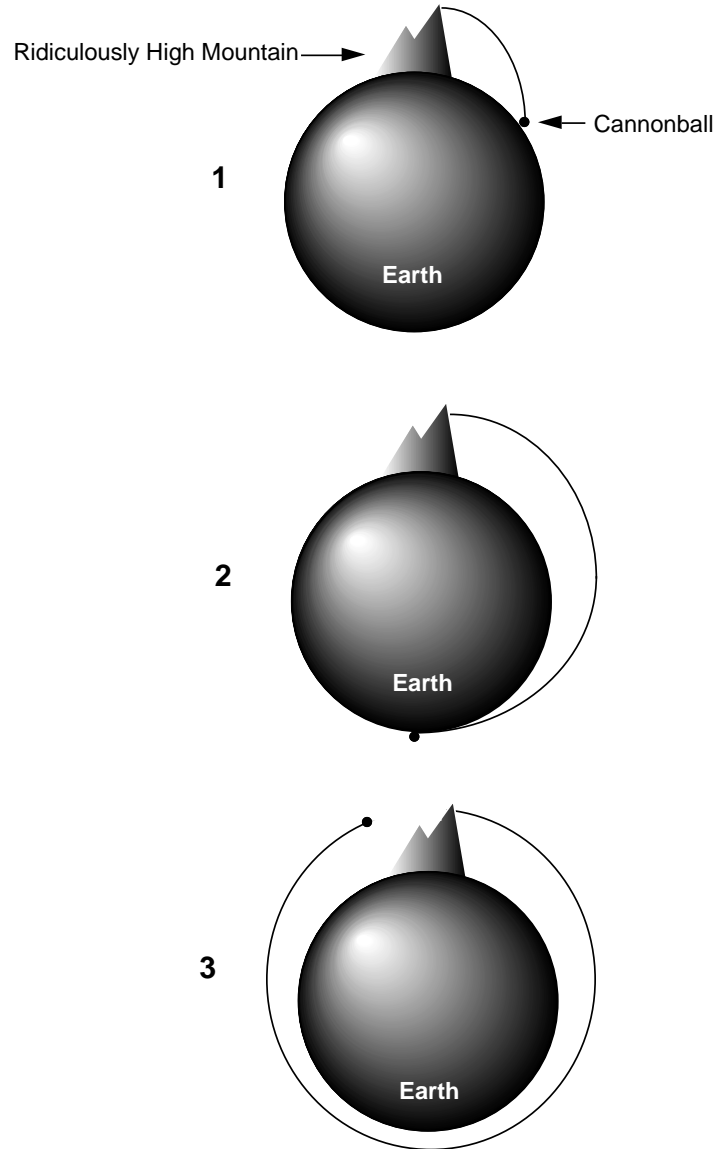

The cannonball provides us with a pretty good analogy. It makes it clear that to get a spacecraft into orbit, you need to raise it up (the mountain) to a high enough altitude so that Earth's atmosphere isn't going to slow it down too much. You have to accelerate it until it is going so fast that as it falls, it just falls completely around the planet.

In practical terms, you don't generally want to be less than about 150 kilometers above the surface of Earth. At that altitude, the atmosphere is so thin that it doesn't present much frictional drag to slow you down. You need your rocket (or cannon) to speed the spacecraft up to the neighborhood of 30,000 kilometers (about 19,000 miles) per hour. Once you've done that, your spacecraft will continue falling around Earth. No more propulsion is necessary, except for occasional minor adjustments. These very same mechanical concepts apply whether you're talking about orbiting Earth, the moon, the sun, or anything. Only the terms and numbers are different. The cannonball analogy is good, too, for talking about changes you can make to an orbit. Looking at the third drawing, imagine that the cannon has still more gunpowder in it, sending the cannonball out a little faster. With this extra speed, the cannonball will miss Earth's surface by a greater margin. The periapsis altitude is raised by increasing the spacecraft's speed at apoapsis.

This concept is very basic to space flight. Similarly, decrease the speed when you're at apoapsis, and you'll lower the periapsis altitude. Likewise, if you increase speed when you're at periapsis, this will cause the apoapsis altitude to increase. Decelerating at periapsis will lower the apoapsis.

Recap

1. Periapsis is also called _____ at Jupiter and _____ orbiting the sun.
2. The periapsis altitude is _____ by increasing speed at apoapsis.
3. Decelerating at periapsis will _____ the apoapsis altitude.

1. perijove . . . perihelion 2. raised 3. lower

Chapter 4. Interplanetary Trajectories

Objectives: Upon completion of this chapter you will be able to describe the use of Hohmann transfer orbits in general terms, and how spacecraft use them for interplanetary travel. You will be able to describe in general terms the exchange of angular momentum between planets and spacecraft on gravity assist trajectories.

Hohmann Transfer Orbits

To launch a spacecraft to an outer planet such as Mars, using the least propellant possible, first consider that the spacecraft is already in solar orbit as it sits on the launch pad. Its existing solar orbit must be adjusted to cause it to take the spacecraft to Mars. In other words, the spacecraft's perihelion (closest approach to the sun) will be Earth's orbit, and the aphelion (farthest distance from the sun) will intercept the orbit of Mars at a single point. This is called a Hohmann Transfer Orbit. The portion of the solar orbit that takes the spacecraft from Earth to Mars is called its trajectory.

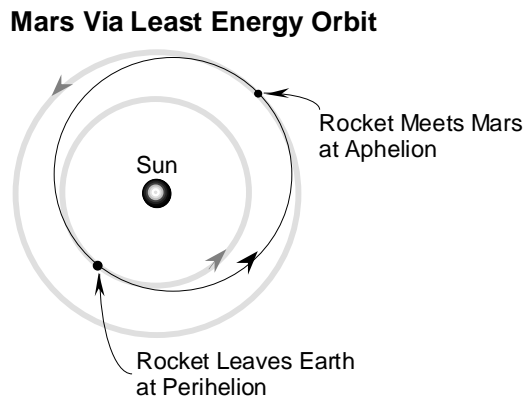

To achieve such a trajectory, the spacecraft lifts off the launch pad, rises above Earth's atmosphere, and is accelerated in the direction of Earth's revolution around the sun to the extent that it becomes free of Earth's gravitation, and that its new orbit will have an aphelion equal to Mars' orbit. After a brief acceleration away from Earth, the spacecraft has achieved its new orbit, and it simply coasts the rest of the way. To get to the planet Mars, rather than just to its orbit, requires that the spacecraft be inserted into the interplanetary trajectory at the correct time to arrive at the Martian orbit when Mars will be at the point where the spacecraft will intercept the orbit of Mars. This task might be compared to throwing a dart at a moving target. You have to lead the aim point by just the right amount to hit the target. The opportunity to launch a spacecraft on a transfer orbit to Mars occurs about every 25 months.

To be captured into a Martian orbit, the spacecraft must then decelerate relative to Mars (using a retrograde rocket burn or some other means). To land on Mars, the spacecraft must decelerate even further (using a retrograde burn, or spring release from a mother ship) to the extent that the lowest point of its Martian orbit will intercept the surface of Mars. Since Mars has an atmosphere, final deceleration may be performed by aerodynamic braking, and/or a parachute, and/or further retrograde burns.

To launch a spacecraft to an inner planet such as Venus using the least propellant possible, its existing solar orbit must be adjusted so that it will take it to Venus. In other words, the spacecraft's aphelion will be on Earth's orbit, and the perihelion will be on the orbit of Venus. As with the case of Mars, the portion of this orbit that takes the spacecraft from Earth to Venus is called a trajectory. To achieve an Earth to Venus trajectory, the spacecraft lifts off the launch pad, rises above Earth's atmosphere, and is accelerated opposite the direction of Earth's revolution around the sun (decelerated) to the extent that its new orbit will have a perihelion equal to Venus's orbit. Of course the spacecraft will end up going in the same direction as Earth orbits, just a little slower. To get to Venus, rather than just to its orbit, again requires that the spacecraft be inserted into the interplanetary trajectory at the correct time to arrive at the Venusian orbit when Venus will be at the point where the spacecraft will intercept the orbit of Venus. Venus launch opportunities occur about every 19 months.

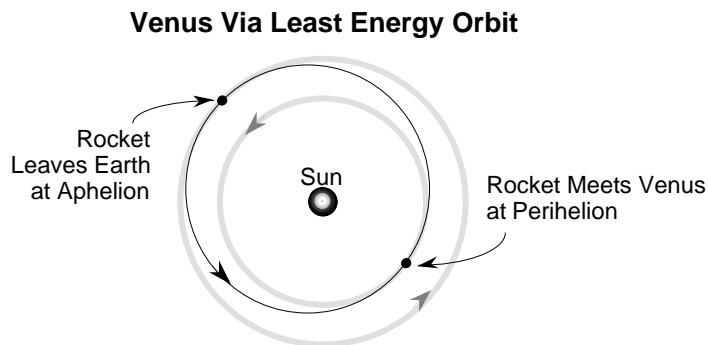

Gravity Assist Trajectories

The first chapter pointed out that the planets retain the vast majority of the solar system's angular momentum. It is this momentum that is used to accelerate spacecraft on so-called "gravity-assist" trajectories. It is commonly stated in newspapers that spacecraft such as Voyager and Galileo use a planet's gravity during a flyby to slingshot it farther into space. How does this work? In a gravity-assist trajectory, angular momentum is transferred from the orbiting planet to a spacecraft approaching from behind. Gravity assists would be more accurately described as angular-momentum assists.

Consider Voyager 2, which toured the Jovian planets. The spacecraft was launched on a standard Hohmann transfer orbit to Jupiter. Had Jupiter not been there at the time of the spacecraft's arrival, the spacecraft would have fallen back toward the sun, and would have remained in elliptical orbit as long as no other forces acted upon it. Perihelion would have been at 1 AU, and aphelion at Jupiter's distance of about 5 AU.

However, the spacecraft's arrival was carefully timed so that it would pass behind Jupiter in its orbit around the sun. As the spacecraft came into Jupiter's gravitational influence, it fell toward Jupiter, increasing its speed toward maximum at closest approach to Jupiter. Since all masses in the universe attract each other, Jupiter sped up the spacecraft substantially, and the spacecraft slowed down Jupiter in its orbit by a tiny amount, since the spacecraft approached from behind. As the spacecraft passed by Jupiter (its speed was greater than Jupiter's escape velocity), of course it slowed down again relative to Jupiter, climbing out of Jupiter's gravitational field. Its Jupiter-relative velocity outbound was the same as its velocity inbound. But relative to the sun, it never slowed all the way to its initial approach speed. It left the Jovian environs carrying an increase in angular momentum stolen from Jupiter. Jupiter's gravity served to connect the spacecraft with the planet's huge reserve of angular momentum. This technique was repeated at Saturn and Uranus.

Voyager 2 Gravity Assist Velocity Changes

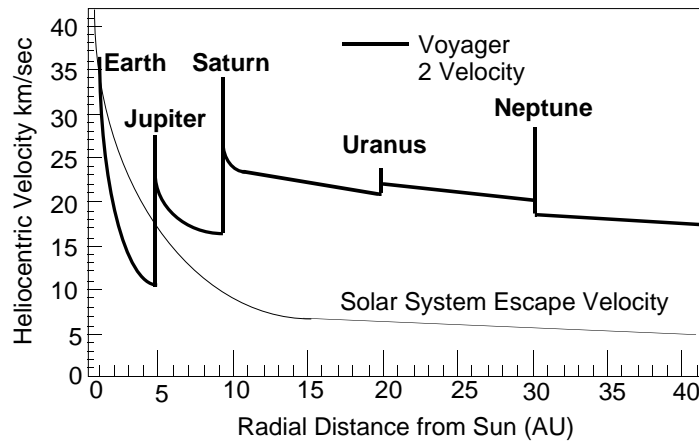

The same can be said of a baseball's acceleration when hit by a bat: angular momentum is transferred from the bat to the slower-moving ball. The bat is slowed down in its "orbit" about the batter, accelerating the ball greatly. The bat connects to the ball not with the force of gravity from behind as was the case with a spacecraft, but with direct mechanical force (electrical force, on the molecular scale, if you prefer) at the front of the bat in its travel about the batter, translating angular momentum from the bat into a high velocity for the ball.

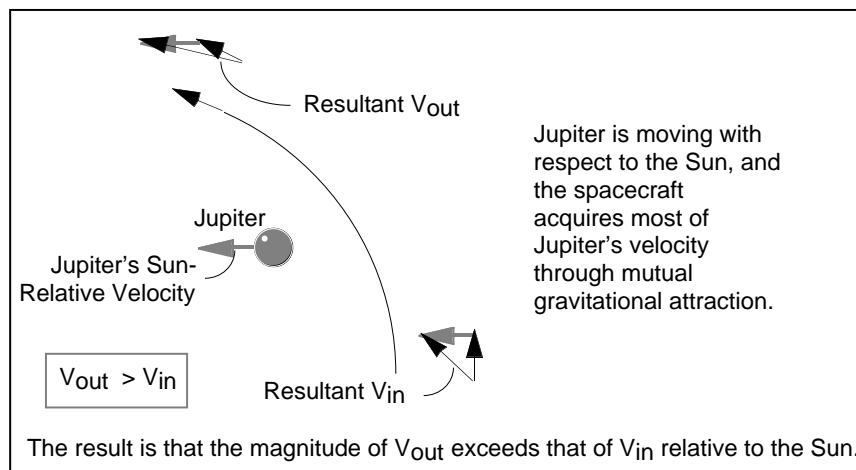
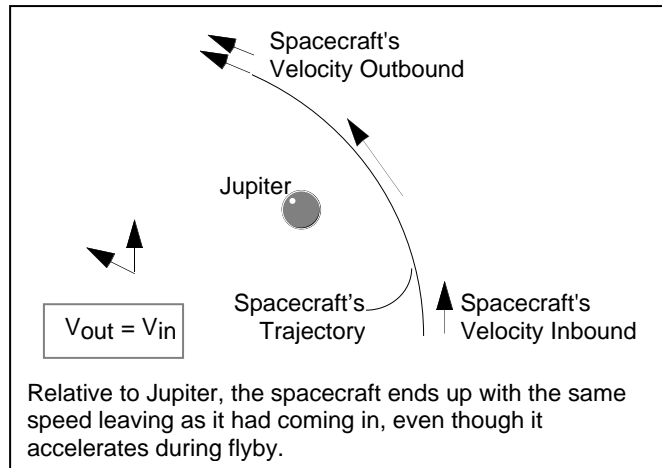

Gravity assists can be also used to decelerate a spacecraft, by flying in front of a body in its orbit, donating some of the spacecraft's angular momentum to the body. When the Galileo spacecraft arrived at Jupiter, passing close in front of Io in its orbit, Galileo experienced deceleration, helping it achieve Jupiter orbit insertion.

The gravity assist technique was pioneered by Michael Minovitch in the early 1960s. He was a UCLA graduate student who worked summers at JPL.

Recap

1. To launch a spacecraft to an outer planet such as Mars... its existing _____ must be adjusted to cause it to take it to Mars.
2. The portion of the solar orbit that takes the spacecraft from Earth to Mars is called a _____.
3. To get to Mars, rather than just its orbit, will require that the spacecraft be inserted into the interplanetary trajectory at the correct _____.
4. To orbit Mars, the spacecraft must _____ sufficiently... to be captured in a martian orbit.
5. In a gravity-assist trajectory, _____ is transferred from the orbiting planet to a spacecraft approaching from behind.

1. solar orbit 2. trajectory 3. time 4. decelerate 5. angular momentum

Chapter 5. Planetary Orbits

Objectives: Upon completion of this chapter you will be able to describe in general terms the characteristics of various types of planetary orbits. You will be able to describe the general concepts and advantages of geosynchronous orbits, polar orbits, walking orbits, sun-synchronous orbits, and some requirements for achieving them.

Orbital Parameters and Elements

The terms orbit period, periapsis, apoapsis, etc., were introduced at the end of Chapter 3.

The direction a body travels in orbit can be direct, or prograde, in which the spacecraft moves in the same direction as the planet rotates, or retrograde, going in a direction opposite the planet's rotation. True anomaly is a term used to describe the locations of various points in an orbit. It is the angular distance of a point in an orbit past the point of periapsis, measured in degrees. For example, a spacecraft might cross a planet's equator at 10° true anomaly. Nodes are points where an orbit crosses a plane. As an orbiting body crosses the ecliptic plane going north, the node is referred to as the ascending node; going south, it is the descending node.

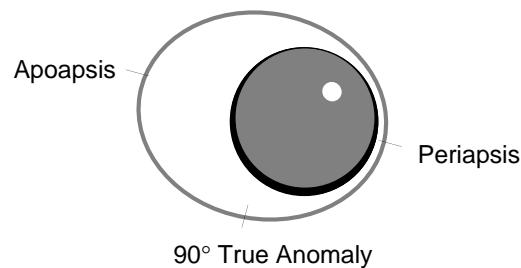

To completely describe an orbit mathematically, six quantities must be calculated. These quantities are called orbital elements, or Keplerian elements. They are: Semi-major axis (1) and eccentricity (2), which are the basic measurements of the size and shape of the orbit's ellipse (described in Chapter 3. Recall an eccentricity of zero indicates a circular orbit). The orbit's inclination (3) is the angular distance of the orbital plane from the plane of the planet's equator (or from the ecliptic plane, if you're talking about heliocentric orbits), stated in degrees: an inclination of 0° means the spacecraft orbits the planet at its equator, and in the same direction as the planet rotates. An inclination of 90° indicates a polar orbit, in which the spacecraft passes over the north and south poles of the planet. An inclination of 180° indicates an equatorial orbit in which the spacecraft moves in a direction opposite the planet's rotation (retrograde). The argument of periapsis (4) is the argument (angular distance) of periapsis from the ascending node. Time of periapsis passage (5) and the celestial longitude of the ascending node (6) are the remaining elements. Generally, three astronomical or radiometric observations of an object in an orbit are enough to pin down each of the above six Keplerian elements.

Elements of Magellan's Initial Orbit at Venus

(1)	Semimajor Axis:	10434.162 km
(2)	Eccentricity:	0.2918967
(3)	Inclination:	85.69613°
(4)	Argument of Periapsis:	170.10651°
(5)	1990 Day of Year	222 19:54 UTC ERT
(6)	Longitude of Ascending Node:	-61.41017°
	(Orbital Period:	3.26375 hr)

Types of Orbits**Geosynchronous Orbits**

A geosynchronous orbit (GEO) is a direct, circular, low inclination orbit about Earth having a period of 23 hours, 56 minutes, 4 seconds. A spacecraft in geosynchronous orbit maintains a position above Earth constant in longitude. Normally, the orbit is chosen and station keeping procedures are implemented to constrain the spacecraft's apparent position so that it hangs motionless above a point on Earth. In this case, the orbit may be called geostationary. For this reason this orbit is ideal for certain kinds of communication satellites, or meteorological satellites. To attain geosynchronous orbit, a spacecraft is first launched into an elliptical orbit with an apoapsis altitude in the neighborhood of 37,000 km. This is called a Geosynchronous Transfer Orbit (GTO). It is then circularized by turning parallel to the equator and firing its rocket engines at apoapsis.

Polar Orbits

Polar orbits are 90° inclination orbits, useful for spacecraft that carry out mapping or surveillance operations. Since the orbital plane is, nominally, fixed in inertial space, the planet rotates below a polar orbit, allowing the spacecraft low-altitude access to virtually every point on the surface. The Magellan spacecraft used a nearly-polar orbit at Venus. Each periapsis pass, a swath of mapping data was taken, and the planet rotated so that swaths from consecutive orbits were adjacent to each other. When the planet rotated once, all 360° longitude had been exposed to Magellan's surveillance.

To achieve a polar orbit at Earth requires more energy, thus more propellant, than does a direct orbit of low inclination. To achieve the latter, launch is normally accomplished near the equator, where the rotational speed of the surface contributes a significant part of the final speed required for orbit. A polar orbit will not be able to take advantage of the "free ride" provided by Earth's rotation, and thus the launch vehicle must provide all of the energy for attaining orbital speed.

Walking Orbits

Planets are not perfectly spherical, and they do not have evenly distributed mass. Also, they do not exist in a gravity “vacuum”—other bodies such as the sun, or satellites, contribute their gravitational influences to a spacecraft in orbit about a planet. It is possible to choose the parameters of a spacecraft’s orbit to take advantage of some or all of these gravitational influences to induce precession, which causes a useful motion of the orbital plane. The result is called a walking orbit or a precessing orbit, since the orbital plane moves slowly with respect to fixed inertial space.

Sun-synchronous Orbits

A walking orbit whose parameters are chosen such that the orbital plane precesses with nearly the same period as the planet’s solar orbit period is called a sun-synchronous orbit. In such an orbit, the spacecraft crosses periapsis at about the same local time every orbit. This can be useful if instruments on board depend on a certain angle of solar illumination on the surface. Mars Global Surveyor’s intended orbit at Mars is a 2-pm Mars local time sun-synchronous orbit. It may not be possible to rely on use of the gravity field alone to exactly maintain a desired synchronous timing, and occasional propulsive maneuvers may be necessary to adjust the orbit.

Recap

1. An inclination of zero means the spacecraft orbits the planet at its _____, and an inclination of 90° indicates a _____ orbit.
2. A spacecraft in _____ orbit appears to hang motionless above one position on Earth.
3. _____ orbits are high-inclination orbits, useful for spacecraft that carry out planetary mapping or surveillance operations.
4. To completely describe an orbit mathematically, _____ quantities must be calculated.
5. A walking orbit whose... orbital plane precesses with nearly the same period as the planet’s solar day is called a _____ orbit.

1. equator... polar 2. geostationary 3. polar 4. six 5. sun-synchronous

Chapter 6. Electromagnetic Phenomena

Objectives: Upon completion of this chapter you will be able to describe in general terms characteristics of natural and artificial emitters of radiation. You will be able to describe bands of the spectrum from DC to gamma rays, and the particular usefulness radio frequencies have for deep-space communication. You will be able to describe the basic principles of spectroscopy, Doppler, reflection and refraction.

Electromagnetic Radiation

Electromagnetic radiation (radio waves, light, etc.) consists of interacting, self-sustaining electric and magnetic fields which propagate through empty space at the speed of 299,792 km per second. Thermocuclear reactions in the cores of stars (including the sun) provide the energy that eventually leaves stars primarily in the form of electromagnetic radiation. These waves cover a wide spectrum of frequencies. Sunshine is a familiar example of electromagnetic radiation that is naturally emitted by the sun. Starlight is the same thing from “suns” that are much farther away.

When a direct current (DC) is applied to a wire (conductor) the current flow builds an electromagnetic field around the wire, propagating a wave outward from the wire. When the current is removed the field collapses, again propagating a wave. If the current is applied and removed repeatedly over a period of time, or if the applied current is made to alternate its polarity with a uniform period of time, a series of waves is propagated at a discrete frequency. This phenomenon is the basis of electromagnetic radiation.

Electromagnetic radiation is propagated nominally in a straight line at the speed of light in a vacuum, and does not require a medium for transmission. It is slowed as it passes through a medium such as air, water, glass, etc. The amount of energy arriving at a detecting device of fixed area located at a given distance from an isotropic source is proportional to the amount of energy passing the surface of an imaginary sphere with a radius of the given distance.

Therefore, the amount of electromagnetic energy passing through a unit area decreases with the square of the distance from the source. This relationship is known as the inverse-square law of (electromagnetic) propagation. It accounts for loss of signal strength over space, called space loss.

The inverse-square law is significant to the exploration of the universe, because it means that the observable electromagnetic radiation decreases very rapidly as the distance from the emitter is increased. Whether the emitter is a spacecraft with a low-power transmitter or an extremely powerful star, it will deliver only a small amount of electromagnetic energy to a detector on Earth because of the very great distances, and the small area that Earth subtends on the huge imaginary sphere.

Recap

1. When a... current is applied to a wire the current flow builds an _____ field around the wire propagating a wave outward...
2. If the applied current were made to alternate with a uniform period of time, a series of waves will be propagated at a discrete _____ .
3. ...the amount of electromagnetic energy passing through a unit area decreases with the _____ of the distance from the source.

1. *electromagnetic* 2. *frequency* 3. *square*

Electromagnetic Spectrum

Light is electromagnetic radiation at those frequencies that can be sensed by the human eye. But the electromagnetic spectrum has a much broader range of frequencies than the human eye can detect, including, in order of increasing frequency: radio frequency (RF), infrared (IR, meaning “below red”), light, ultraviolet (UV, meaning “above violet”), X rays, and gamma rays. These designations describe only different frequencies of the same phenomenon: electromagnetic radiation.

The speed of light in a vacuum, 299,792 km per second, is the rate of propagation of all electromagnetic waves. The wavelength of a single oscillation of electro-magnetic radiation is the distance that the wave will propagate during the time required for one oscillation. There is a simple relationship between the frequency and wavelength of electromagnetic energy. Since electromagnetic energy is propagated at the speed of light, the wavelength equals the speed of light divided by the frequency of oscillation.

$\text{Wavelength} = \frac{\text{Speed of Light}}{\text{Frequency of Oscillation}}$ $\text{Frequency of Oscillation} = \frac{\text{Speed of Light}}{\text{Wavelength}}$

The Electromagnetic Spectrum: Wavelength/frequency chart

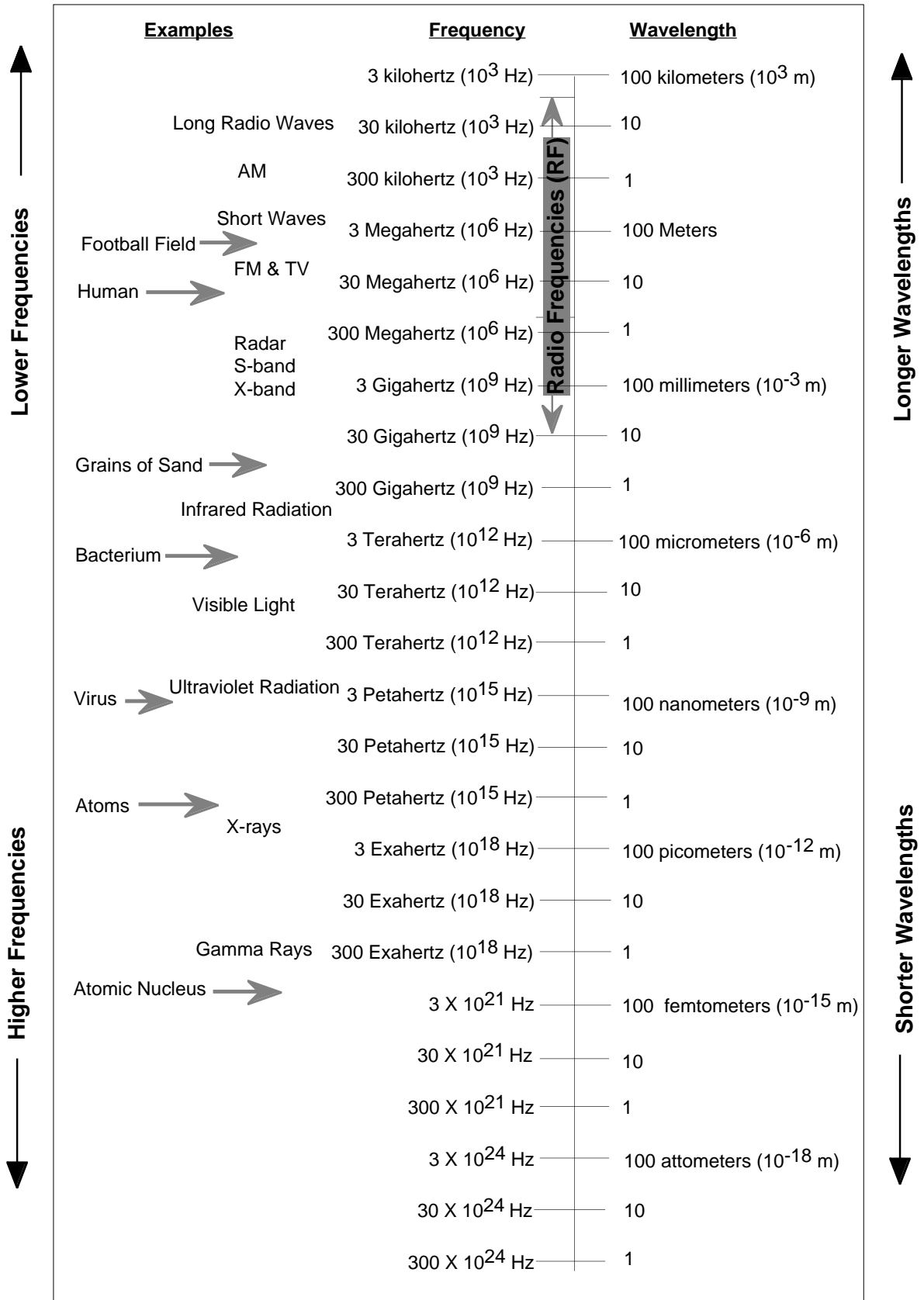

Natural and Artificial Emitters

Deep space communication antennas and receivers are capable of detecting many different kinds of natural emitters of electromagnetic radiation, including the stars, the sun, molecular clouds, and gas giant planets such as Jupiter. Although these sources do not emit at truly random frequencies, without sophisticated signal processing, their signals appear as “noise” (pseudo-random frequencies and amplitude). Radio astronomy is the term given to the activities of acquiring and processing electromagnetic radiation from natural emitters. The JPL Deep Space Network (DSN) participates in radio astronomy research.

All deep space vehicles are equipped with radio transmitters and receivers for sending signals (electromagnetic radiation) to and from Earth-based tracking stations. These signals are at pre-established discrete frequencies. Various natural and human-made emitters combine to create a background level of electromagnetic noise from which the spacecraft signals must be detected. The ratio of the signal level to the noise level is known as the signal-to-noise ratio (SNR).

Recap

1. Radio... infrared, light, ultraviolet, X rays, and gamma rays... describe only a difference in frequency of the same phenomenon: _____
_____ .
2. Since electromagnetic energy is always propagated at the speed of light, the wavelength equals the speed of light divided by the _____ .
3. The ratio of the signal level to the noise level is known as the (abbreviation) ____ ____ ____ .

1. *electromagnetic radiation* 2. *frequency* 3. *SNR*

Radio Frequencies

Electromagnetic radiation with frequencies between about 10 kHz and 100 GHz are referred to as radio frequencies (RF). Radio frequencies are divided into groups which have similar characteristics, called “bands,” such as “S-band,” “X-band,” etc. The bands are further divided into small ranges of frequencies called “channels,” some of which are allocated for the use of deep space telecommunications. Many deep-space vehicles use S-band and X-band frequencies which are in the neighborhood of 2 to 10 GHz. These frequencies are among those referred to as microwaves, because their wavelength is short, on the order of centimeters. Deep space telecommunications systems are being developed for use on the even higher frequency K-band.

Band	Range of Wavelengths (cm)	Frequency (GHz)
L	30 - 15	1 - 2
S	15 - 7.5	2 - 4
C	7.5 - 3.75	4 - 8
X	3.75 - 2.4	8 - 12
K	2.4 - 0.75	12 - 40

Note: Band definitions vary slightly among different sources. These are ballpark values.

Spectroscopy

The study of the production, measurement, and interpretation of electromagnetic spectra is known as spectroscopy. This branch of science pertains to space exploration in many different ways. It can provide such diverse information as the chemical composition of an object, the speed of an object's travel, its temperature, and more—information that cannot be gleaned from photographs. Today, spectroscopy deals with closely viewed sections of the electromagnetic spectrum. For purposes of introduction, imagine sunlight passing through a glass prism, casting a bright rainbow (spectrum) onto a piece of paper. Imagine bands of color going from red on the left to violet on the right. Frequencies of the light increase from left to right; the wavelengths decrease. Each band of color is actually a wide range of individual frequencies which cannot be discerned by the human eye, but which are detectable by instruments.

Now, instead of the green band near the middle, imagine a dark band, like a shadow at that point, as if something had absorbed all the green out of the sunlight. Call this a “dark line.” What is spoken of as a “bright line” could be imagined as an excessively bright color band, say for example if the green were several times brighter than it normally would appear, as though the sunlight were somehow augmented at this band. In actuality, the bright and dark lines spoken of in spectroscopy are extremely narrow, representing only a very specific shade of color, one discrete frequency at a time. In principle, a bright line represents the emission of radiation at a particular frequency, and a dark line indicates the absorption of a frequency otherwise expected to be seen at that point.

In 1859, Gustav Kirchhoff (1824-1887) described spectroscopy in terms of the three laws of spectral analysis:

- I. A luminous (glowing) solid or liquid emits light of all wavelengths (white light), thus producing a continuous spectrum.
- II. A rarefied luminous gas emits light whose spectrum shows bright lines (indicating light at specific wavelengths), and sometimes a faint superimposed continuous spectrum.
- III. If the white light from a luminous source is passed through a gas, the gas may absorb certain wavelengths from the continuous spectrum so that those wavelengths will be missing or diminished in its spectrum, thus producing dark lines.

By studying the bright and dark lines (emission and absorption lines) in the spectra of stars, in the spectra of sunlight reflected off planetary surfaces, or of starlight passing through planetary atmospheres, much can be learned about the composition of these bodies. Historically, spectral observations have taken the form of photographic prints showing spectral bands, in which light and dark lines can be discerned. Modern spectrometers (discussed again under Chapter 12, Typical Science Instruments) have largely done away with the photographic process, producing their high-resolution results in the form of X-Y graphic plots, whose peaks and valleys reveal intensity on the vertical axis versus frequency or wavelength along the horizontal. Peaks of high intensity in this scheme represent bright spectral lines, and troughs of low intensity represent dark lines.

Atmospheric Transparency

Because of the absorption phenomena, observations are impossible at certain wavelengths from the surface of Earth, since they are absorbed by Earth's atmosphere. There are a few "windows" in its absorption characteristics which make it possible to see visible light, and receive radio frequencies, for example, but the atmosphere presents an opaque barrier to much of the electromagnetic spectrum.

Even though the atmosphere is transparent at X-band frequencies as seen above, there is a problem when liquid or solid water is present. Water exhibits noise at X-band frequencies, so precipitation at a receiving site increases the system noise temperature, and this can drive the SNR too low to permit communications reception.

Atmospheric Windows to Electromagnetic Radiation

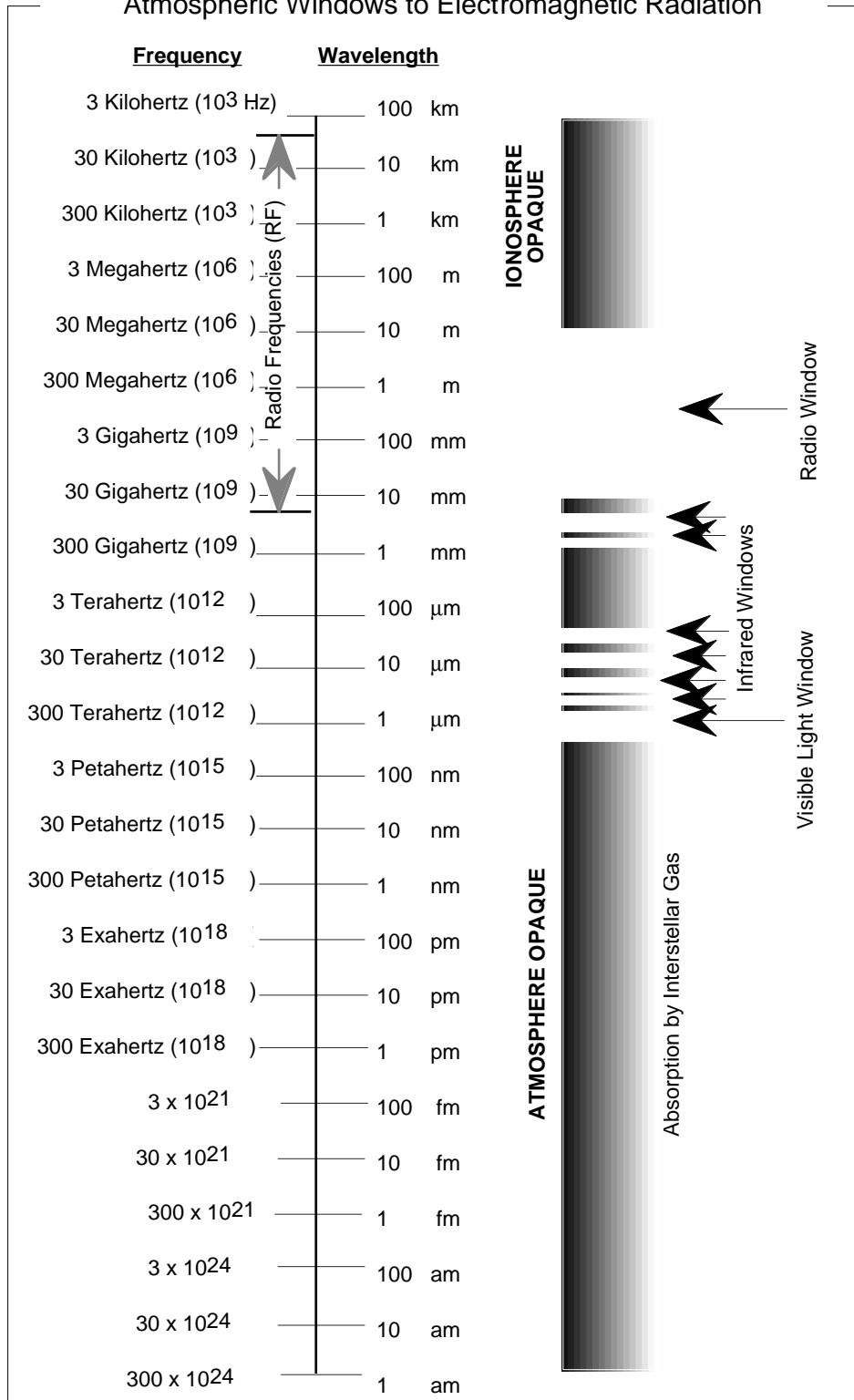

Radio Frequency Interference

In addition to the natural interference which comes from water at X-band, there may be other sources, such as man-made radio interference. Welding operations on an antenna produce a wide spectrum of radio noise. Many Earth-orbiting spacecraft have strong downlinks near the frequency of signals from deep space. Goldstone Solar System Radar (described further in this chapter) uses a powerful transmitter, which can interfere with reception at a nearby station. Whatever the source of radio frequency interference (RFI), its effect is to increase the noise, thereby decreasing the SNR and making it more difficult, or impossible, to receive valid data from a deep-space craft.

Recap

1. A luminous solid or liquid emits light of all wavelengths, producing a _____ spectrum.
2. A luminous gas emits light whose spectrum shows bright lines indicating light emitted at _____ wavelengths.
3. Gas may absorb certain wavelengths from a continuous spectrum so that those wavelengths will be _____ or _____ in its spectrum, producing dark lines.

1. *continuous* 2. *specific* 3. *missing ... diminished*

Doppler Effect

Regardless of the frequency of a source of electromagnetic waves, they are subject to the Doppler effect. The Doppler effect causes the observed frequency of a source to differ from the radiated frequency of the source if there is motion that is increasing or decreasing the distance between the source and the observer. The same effect is readily observable as variation in the pitch of sound between a moving source and a stationary observer, or vice-versa.

When the distance between the source and receiver of electromagnetic waves remains constant, the frequency of the source and received wave forms is the same. When the distance between the source and receiver of electromagnetic waves is increasing, the frequency of the received wave forms is lower than the frequency of the source wave form. When the distance is decreasing, the frequency of the received wave form will be higher than the source wave form.

Doppler Effects

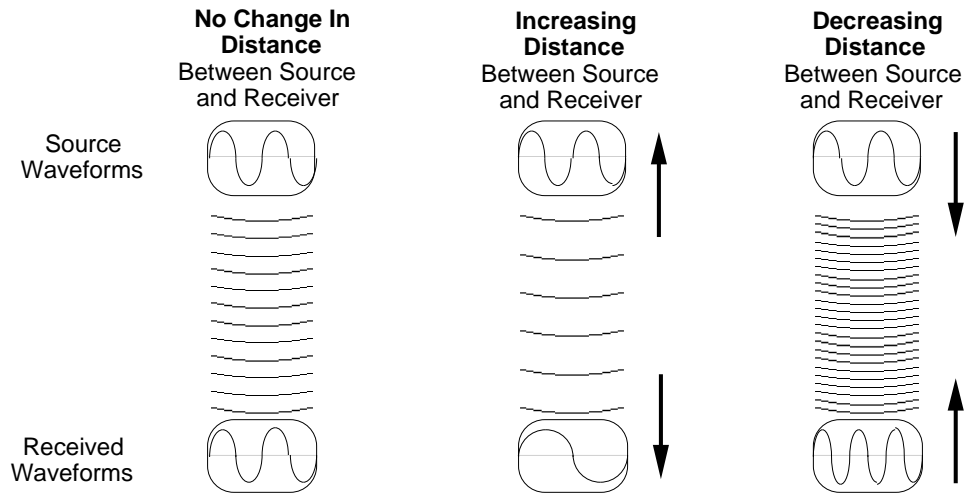

The Doppler effect is routinely observed in the frequency of the signals received by ground receiving stations when tracking spacecraft. The increasing or decreasing of distances between the spacecraft and the ground station may be caused by the spacecraft's trajectory, its orbit around a planet, Earth's revolution about the sun, or Earth's daily rotation on its axis. A spacecraft approaching Earth will add a positive frequency bias to the received signal. However, if it flies by Earth, the received Doppler bias will become zero as it passes Earth, and then become negative as the spacecraft moves away from Earth. A spacecraft's revolutions around another planet such as Mars adds alternating positive and negative frequency biases to the received signal, as the spacecraft first moves toward and then away from Earth. Earth's rotation adds a positive frequency bias to the received signal as the spacecraft rises in the east at a particular tracking station, and adds a negative frequency bias to the received signal as the spacecraft sets in the west.

Differenced Doppler

If two widely-separated tracking stations on Earth observe a single spacecraft in orbit about another planet, they will each have a slightly different view, and there will be a slight difference in the amount of Doppler shift observed by each station. For example, if one station has a view exactly edge-on to the spacecraft's orbital plane, the other station would have a view slightly to one side of that plane. Information can be extracted from the differencing of the two received signals that describes the spacecraft's arc through space in three dimensions. This data type, differenced Doppler, is a useful form of navigation data which can yield a very high degree of spatial resolution. It is further discussed in Chapter 13, Spacecraft Navigation.

Recap

1. The observed frequency of a source will differ from its radiated frequency if there is _____ which is increasing or decreasing the distance between the source and the observer.
2. When the distance is increasing between the source and receiver of electromagnetic waves, the frequency of the received waves will _____.
3. Earth's rotation adds a positive frequency bias to the received signal when the spacecraft rises in the east at a particular tracking station, and adds a _____ frequency bias to the received signal as the spacecraft sets in the west.

1. motion 2. decrease 3. negative

Reflection

RF electromagnetic radiation generally travels through space in a straight line. The exception is that it is bent slightly by the gravitation of large masses in accordance with general relativity. RF waves can be reflected by certain substances, much in the same way that light is reflected by a mirror. The angle at which RF is reflected from a smooth metal surface, for example, will equal the angle at which it approached the surface. In other words, the angle of reflectance of RF waves equals their angle of incidence.

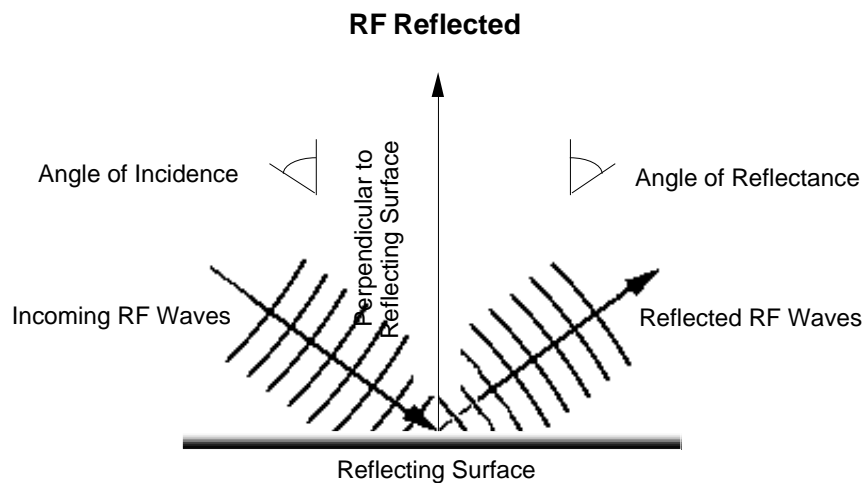

This principle of RF reflection is used in antenna design to focus transmitted waves into a narrow beam and to collect and concentrate received RF signals for a receiver. If a reflector is designed with the reflecting surface shaped like a paraboloid, electromagnetic waves approaching on-axis will be reflected and will focus above the surface of the reflector at the feed horn. This arrangement is called prime focus, and provides the large aperture necessary to receive very weak signals. The same configuration allows the narrow focusing of signals transmitted from the feed horn, concentrating the transmitted electromagnetic waves into a narrow beam. A major problem with prime focus arrangements for large aperture antennas is that the equipment required at the prime focus is heavy and the supporting structure tends to sag under the weight of the equipment,

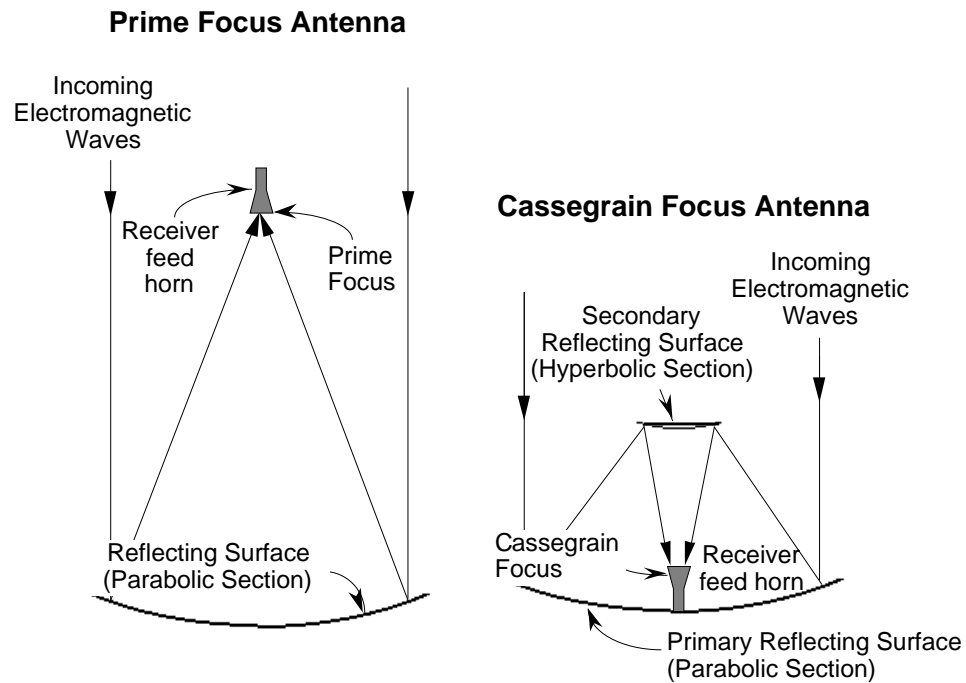

thus affecting calibration. A solution is the Cassegrain Focus arrangement. Cassegrain antennas add a secondary reflecting surface to “fold” the electromagnetic waves back to a prime focus near the primary reflector. The DSN’s antennas are of this design because it accommodates large apertures and is structurally strong, allowing bulky equipment to be located nearer the structure’s center of gravity.

The reflective properties of electromagnetic waves have also been used to investigate the planets using a technique called planetary radar. With this technique, electromagnetic waves are transmitted to the planet, where they reflect off the surface of the planet and are received at one or more Earth receiving stations. Using very sophisticated signal processing techniques, the receiving stations dissect and analyze the signal in terms of time, amplitude, phase, and frequency. JPL’s application of this radar technique, called Goldstone Solar System Radar (GSSR), has been used to develop images of the surface features of Venus, eternally covered with clouds, Mercury, difficult to see in the glare of the sun, and some of the satellites of the Jovian planets.

Recap

1. Radio frequency electromagnetic radiation generally travels through space in a _____ .
2. The angle of reflectance of RF waves equals their angle of _____ .
3. DSN's antennas are of the Cassegrain design because it accommodates large apertures, and is structurally _____ allowing bulky equipment to be located nearer the structure's center of gravity.
4. JPL's application of this radar technique, called _____ _____ (GSSR), has been used to develop images of the surface features of Venus.

1. *straight line* 2. *incidence* 3. *strong* 4. *Goldstone Solar System Radar*

Refraction

Refraction is the deflection or bending of electromagnetic waves when they pass from one kind of transparent medium into another. The index of refraction is the ratio of the speed of light in a vacuum to the speed of light in the substance of the observed medium. The law of refraction states that electromagnetic waves passing from one medium into another (of a differing index of refraction) will be bent in their direction of travel. Air and glass have different indices of refraction. Therefore, the path of electromagnetic waves moving from air to glass at an angle will be bent toward the perpendicular as they travel into the glass. Likewise, the path will be bent to the same extent away from the perpendicular when they exit the other side of glass.

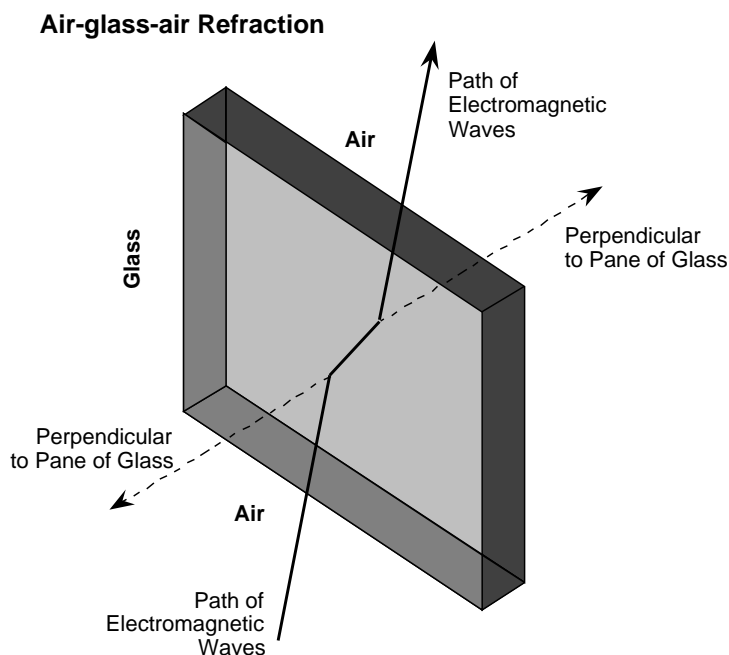

In a similar manner, electromagnetic waves entering Earth's atmosphere from space are slightly bent by refraction. Atmospheric refraction is greatest for signals near the horizon, and cause the apparent altitude of the signal to be on the order of half a degree higher than the true height. As Earth rotates and the object gains altitude, the refraction effect reduces, becoming zero at zenith (directly overhead). Refraction's effect on the sun adds about 5 minutes to the daylight at equatorial latitudes, since it appears higher in the sky than it actually is.

Refraction in the Earth's Atmosphere

Note: Angles have been greatly exaggerated to emphasize the effect

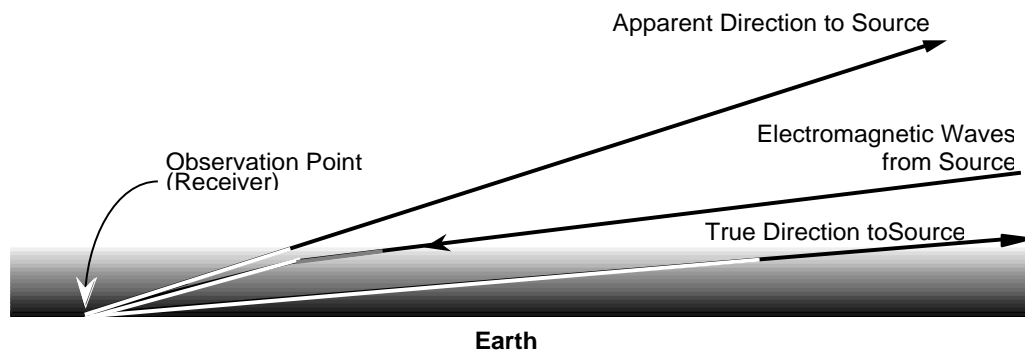

If the signal from a spacecraft goes through the atmosphere of another planet, the signals leaving the spacecraft will be slightly bent by the atmosphere of that planet. This bending will cause occultation (spacecraft moving into a planet's RF shadow of Earth) to occur later than otherwise expected, and exit from occultation will occur prior to when otherwise expected. Ground processing of the received signals reveals the extent of atmospheric bending (and also of absorption at specific frequencies and other modifications), and provides a basis for inferring the composition and structure of a planet's atmosphere.

Phase

As applied to waves of electromagnetic radiation, phase is the relative measure of the alignment of two waveforms of similar frequency. They are said to be in phase if the peaks and troughs of the two waves match up with each other in time. They are said to be out of phase to the extent that they do not match up. Phase is expressed in degrees from 0 to 360.

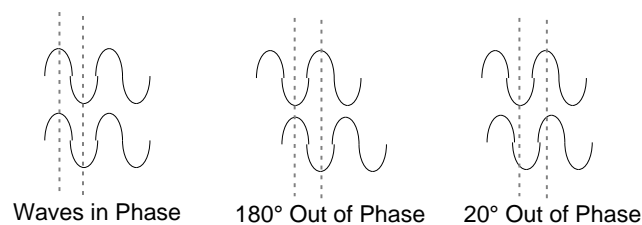

Recap

1. Refraction is the _____ of electromagnetic waves when they pass from one kind of transparent medium into another.
2. The path of electromagnetic waves moving from air to glass at an angle will be bent toward the _____ as they travel through the glass.
3. If the signal from a spacecraft goes through the atmosphere of another planet, the signals leaving the spacecraft will be slightly _____ by the atmosphere of that planet.
4. Waves are said to be in _____ if their peaks and troughs match up.

1. deflection or bending 2. perpendicular 3. bent 4. phase

SECTION II. SPACE FLIGHT PROJECTS

Chapter 7. Overview of Mission Inception

Objectives: Upon completion of this chapter you will be able to describe activities typical of the following mission phases: conceptual effort, preliminary analysis (proof of concept), definition, design, and development. You will be conversant with typical design considerations included in mission inception.

In this discussion, we will consider projects suitable for sponsorship by the U.S. National Aeronautics and Space Administration (NASA). Many JPL projects have different sponsors. This discussion considers a hypothetical example. In reality, there may be many deviations from this nominal process.

There is no single avenue by which a mission must be initiated. An original concept may come from members of the science community who are interested in particular aspects of certain solar system bodies, or it may come from an individual or group, such as a navigation team, who show a unique opportunity approaching from an astronomical viewpoint. As a project matures, the effort goes through different phases:

- Pre-Phase A, Conceptual Study
- Phase A, Preliminary Analysis
- Phase B, Definition
- Phase C/D, Design and Development
- Operations Phase

Formal reviews are used as control gates at critical points in the full system life cycle to determine whether the system development process should continue, or what modifications are required.

Conceptual Study

A person or group petitions NASA with an idea or plan. The proposal is studied and evaluated for merit, and, if accepted, the task of screening feasibility is delegated to a NASA Center. In the case of unmanned deep space exploration, that center has historically been JPL in many cases.

Prior to Phase A, the following activities typically take place: NASA Headquarters establishes a Science Working Group (SWG). The SWG develops the science goals and requirements, and prepares a preliminary scientific conception of the mission. Based on the high-level concept and the work of the SWG, a scientific document called the “Announcement of Opportunity” (AO) is sent out by NASA Headquarters to individuals (scientists) at universities, NASA centers, and

science organizations around the world. The AO defines the existing concept of the mission and the scientific opportunities, goals, requirements, and system concepts. The AO specifies a fixed amount of time for the scientific community to respond to the announcement. All proposals for new experiments are reviewed for science merit as related to the goal of the mission. Items such as mass, power consumption, science return, safety, ability to support the mission from the “home institution” are key issues. JPL develops a library of launch possibilities which becomes available to the project. Depending on the nature of the tasks at hand, they will be delegated to various sections within JPL.

A project is started by making funding available to Section 312 (Mission Design). The Mission Design Section then tasks personnel from appropriate divisions or sections as needed, for example:

- Section 313 (Spacecraft Systems Engineering) for Spacecraft Design
- Section 314 (Navigation Systems) for Navigation Design
- Section 317 (Mission Information Systems Engineering) for Ground Data System Design
- Division 390 (Information Systems Development and Operations) for Mission Operations

Usually the presentation of the study concept to NASA Headquarters by JPL personnel and NASA’s approval to proceed to Phase A signify the end of Conceptual Study.

Full System Life Cycle

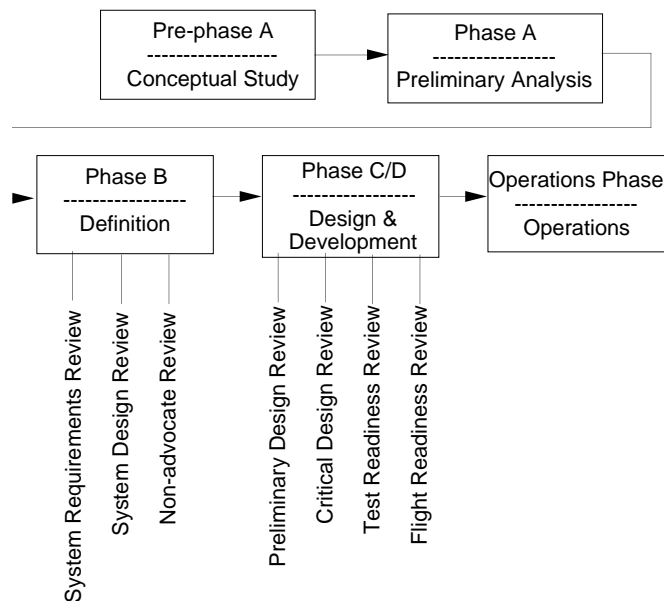

Phase A: Preliminary Analysis (Proof of Concept)

The Project creates a preliminary design and project plan specifying what to build, when to launch, the course the spacecraft is to take, what is to be done during cruise, when the spacecraft will reach the target, and what operations will be carried out. The preliminary plan also addresses build-versus-buy decisions, what spacecraft instruments are needed, where system tests will be

performed, who performs mission operations, what Ground Data System (GDS) capabilities are required, and who the experimenters are. Generally speaking, publication of the preliminary plan with costing data marks the completion of Phase A: Preliminary Analysis.

Phase B: Definition

The definition phase converts the preliminary plan into a baseline technical solution. Requirements are defined, schedules are determined, and specifications are prepared to initiate system design and development. Major reviews commonly conducted as part of the definition phase are: System Requirements Review, System Design Review, and Non-advocate Review. The proposed experiments are divided into two classes based on facilities and experimenters. The facilities form teams around a designated set of hardware. Facilities are selected based on existing resources and past performance. Experimenters were specified in the preliminary plan. However, individuals are encouraged to respond with modifications and to step forward with their own ideas. These ideas could include the addition of another experiment.

A NASA peer group reviews all new proposals and “grades” them. After that, a sub-committee from NASA Headquarters’ Office of Space Science and Applications (OSSA) Steering Committee (SC) makes the final experiment selection, based on scientific value, cost, management, engineering, and safety.

Personnel teams are established to build and operate the instruments and evaluate the data returned. There is usually one team for each experiment, with one individual from that team chosen as the team leader and Principal Investigator (PI). In most cases, the Non-Advocate Review marks the end of Phase B: Definition.

Recap

1. As a project matures, the effort goes through different phases (including) Pre-Phase A _____ .
2. Formal _____ are used as control gates at critical points in the full system life cycle to determine whether the system development process should continue...
3. The SWG, or _____ develops the science goals and requirements, and prepares a preliminary scientific conception of the mission.
4. The AO, or _____ defines the existing concept of the mission and the scientific opportunities, goals, requirements, and system concepts.
5. Publication of the preliminary plan with _____ data marks the completion of Phase A: Preliminary Analysis.
6. The definition phase converts the preliminary plan into a baseline _____ solution.

1. *conceptual study* 2. *reviews* 3. *Science Working Group* 4. *announcement of opportunity*
5. *costing* 6. *technical*

Phase C/D: Design and Development

During the design and development phase, schedules are negotiated, and the space flight system is designed and developed. Then, in a process called ATLO (Assembly, Test, and Launch Operations), it is integrated, tested, launched and/or deployed, and verified. The design and development phase begins with the building and integration of experiments into a single spacecraft. The complete spacecraft science package is tested together in a simulated space environment prior to launch. Ground systems to support the mission are also developed in parallel with the spacecraft development. Phase C/D typically lasts until 30 days after launch. Reviews commonly conducted as part of the design and development phase include: Preliminary Design Review, Critical Design Review, Test Readiness Review, and Flight Readiness Review.

Operations Phase

The long-term operations phase, that is flying the spacecraft and obtaining science data for which the mission was designed, is described in later sections of this training module: Chapters 14 through 17 present details of Launch, Cruise, Encounter, Extended Operations, and Project Closeout.

Design Considerations

The process by which a mission is conceived and brought through the phases described above includes consideration of many variables. The remainder of this chapter touches upon a few of them.

Budget

Trajectories are constrained by the laws of celestial mechanics, but the realities of budgets constrain the desires and needs of project science to determine the final choices. Should the mission use a quick, direct path that can be achieved only with a massive upper stage, or an extended cruise with gravity assists for “free” acceleration? Can significant science be accomplished by going only a few weeks out of the way? Which options can be justified against the cost in personnel and time? This task of balancing the political and the physical is ordinarily resolved before most project personnel are assigned.

Design Changes

The purpose, scope, timing and probable budget for a mission must be clearly understood before realistic spacecraft design can be accomplished. But even a final, approved and funded design may be altered when assumed conditions change during its lifetime. Design changes are always costly. The Galileo mission design, for example, underwent many significant and costly changes before it was finally launched. The Space Station Freedom spent tens of billions of dollars over several years prior to having comprehensive design changes imposed.

Resource Contention

Timing for many JPL missions is affected most directly by solar system geometry, which dictates optimum launch periods. It correspondingly implies the “part of the sky” that the proposed spacecraft will occupy and how many other spacecraft it may have to compete with for DSN antenna time. If possible, it is very advantageous to fly a mission toward an area where the spacecraft will share little or none of its viewperiod with other missions (viewperiod is the span of time during which one DSS can observe a particular spacecraft above its local horizon). Years before launch, mission designers request a “what-if” study by Section 391’s Resource Analysis Team to determine the probable degree of contention for DSN tracking time during the mission. Such a study can assist project management in the selection of launch date and mission profile with the least contention for external resources, and maximized science return for the mission.

Spacecraft Right Ascension, 1993

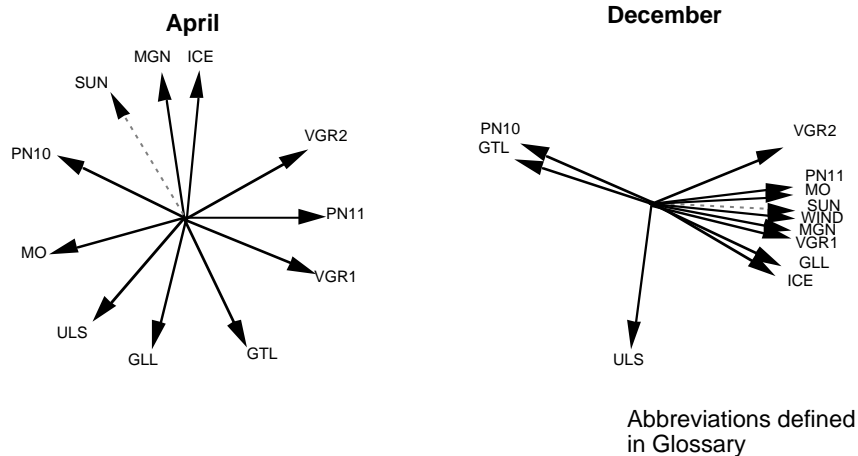

The diagram above illustrates how viewperiods may cause different spacecraft to compete for DSN resources. When spacecraft occupy different areas of the sky, as in the April 1993 example, contention is at a minimum. However, when several spacecraft are bunched together in the same part of the sky, as they are for December, contention for DSN resources within heavily populated bunches may be formidable. Diagrams such as those shown above are produced by the Resource Allocation Team for ten year periods. They represent the situation on the 15th of the month shown. The arrow indicates the center of a spacecraft view from Earth. Extend 60 degrees on both sides of an arrow to describe an 8-hour viewperiod for a spacecraft.

Tracking Capabilities

DSN tracking capabilities must be considered when designing on-board storage, telemetry rates, trajectory and launch periods. Magellan, for example, acquired radar data at 800 kilobits per second. Since it used its high-gain antenna for both mapping and high rate communications, it required on-board storage sufficient to record its data during each mapping pass. The project needed assurance that it could count on DSN tracking time nearly 24 hours a day for the duration of the mission. The data for each orbit had to be downlinked immediately after being acquired or it would be lost, overwritten by data from the next orbit. This scheme made good use of the highly elliptical orbit that Magellan occupied during mapping phase. High-rate data acquisition

took place during the 20 or 30 minutes near periapsis, and the hour-long outbound and inbound legs of each orbit were necessary to transmit the data to Earth at the lower rate of 268.8 kbps.

The Mars Global Surveyor spacecraft also has limited on-board storage that will require at least one tracking pass daily to avoid data loss. The high transmission rate and the maximum distance to Mars must be taken into account when designers determine such things as transmitter power and high-gain antenna size.

Data Complexity

The proposed volume and complexity of the mission's telemetry influences the cost of ground processing. If telemetry does not present significant differences from recent missions, it may be economical to use an adaptation of the existing Advanced Multimission Operations System (AMMOS) rather than develop one that is mission-specific.

Recap

1. During the _____ and _____ phase the system is designed, developed, integrated, tested, launched and or deployed, and verified.
2. Phase C/D: Design & Development typically lasts until 30 days after _____ .
3. DSN _____ capabilities must be considered when designing on-board storage, telemetry rates, trajectory and launch periods.

1. design and development 2. launch 3. tracking

Chapter 8. Experiments

Objectives: Upon completion of this chapter you will be able to identify what is referred to as the scientific community, describe the typical background of principal investigators involved with space flight, and describe options for gathering science data. You will be aware that radio science applies sensing techniques to planetary atmospheres, rings, and mass, solar corona, and gravitational wave searches. You will be able to describe avenues for disseminating experiment results.

Obtaining information about a particular aspect of the solar system is the primary reason for launching a robotic deep-space mission. Information is obtained by conducting an experiment under controlled conditions to collect and analyze data. After extensive analysis, that information is made available to the science community and at the same time, to the public at large. Frequently, however, JPL imaging data are released to the media by the Public Information Office shortly after collecting them, before long-term analysis has been accomplished and published within the scientific community.

The Scientific Community

The scientific community involved in JPL's experiments is worldwide, and typically is composed of PhD-level scientific professionals tenured in academia and their graduate students, similar-level professional scientists and their staff from industry, scientific institutions, and professional societies.

Gathering Scientific Data

Some experiments have a dedicated instrument aboard the spacecraft to measure a particular physical phenomenon, and some do not. A designated principal investigator (PI), and in many cases a team, determines or negotiates the experiment's operation, and decides who will analyze its data and publish the scientific results. Members of these teams may have been involved in the design of the instrument. Some examples of this kind of experiment are

- the Radar Sensor on the Magellan spacecraft and the associated Radar Investigation Group of 26 scientists worldwide headed by a PI at MIT;
- the Photopolarimeter experiments on the Voyager spacecraft and their PI at JPL;
- the Solid State Imaging experiment on the Galileo spacecraft, and the imaging team headed by a PI at the University of Arizona.

Details of individual instruments aboard spacecraft which are used to gather data for these experiments appears in Chapter 11.

Other experiments are undertaken as opportunities arise to take advantage of a spacecraft’s special capabilities or unique location or other circumstance. Some examples of this kind of experiment are

- the gravitational wave search using the DSN and telecommunications transceivers aboard the Ulysses, Mars Observer, and Galileo spacecraft (the PI is at Caltech);
- the UV spectral observations of various astronomical sources using the Voyager UV spectrometer by various members of the astronomical community; and
- Venus atmospheric density studies using the attitude reaction wheels aboard the Magellan spacecraft by the PI at Langley.

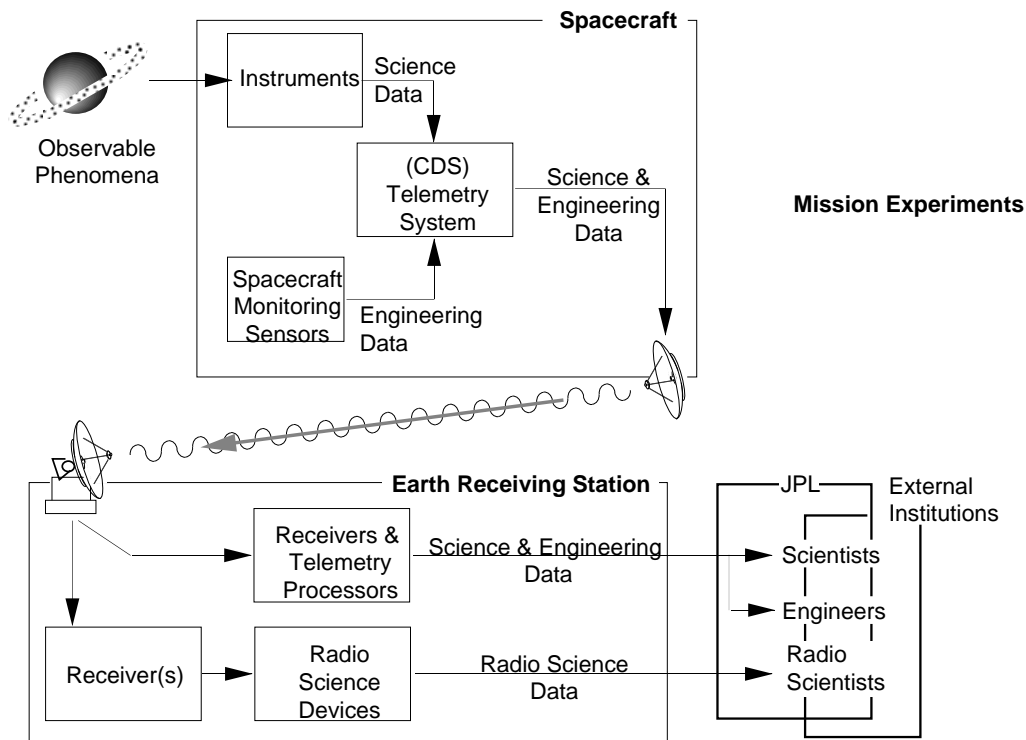

Science and Engineering Data

Data acquired by the spacecraft’s scientific instruments and telemetered to Earth, or acquired by ground measurements of the spacecraft’s radio signal, in support of scientific experiments, are referred to as “science” data. The other category of data telemetered from a spacecraft, its health and status data, are referred to as “engineering” data. The latter are normally more of a repetitive nature, and if some are lost, the same measurements can be seen again in a short time. Except in cases of spacecraft anomalies or critical tests, the science data are always given a higher priority than engineering data, because the former is a mission’s end product, while the latter is the data used in carrying out spacecraft operations involved in obtaining the science data.

The Science Data Pipeline

Science data from on-board instruments, once received at the antennas of the DSN, flows through a string of computers and communications links known collectively as the Ground Data

System (GDS). The functions of the GDS can be viewed as generally divided into two high-level segments: front end and back end. Front end processing consists of frame synchronizing the data stream, restoring the formats created by the spacecraft computers, and providing real-time visibility of engineering and tracking data for analysts and science instrument teams. Back end processing consists of data management, data products production, and data access systems. While there typically is some front-end visibility into the science data in real time, it is mainly through the back end systems that science teams (for whom the missions are flown) are formally given access to complete sets of their science data.

When science telemetry data are first received by the data management system, they are stored in a time-ordered data base. It is common for significant segments of this preliminary data to be missing. A data management team must first determine what gaps exist and ascertain whether or not those data are recoverable. Data that are easily recoverable are data that reached the ground and were recorded either at a DSN station or at some intermediate subsystem in the GDS front end, but were missing from the back end due to some failure in the pipeline.

Once identified and located, recovered data are transferred to data management system storage and integrated with data received earlier. The problem is more time consuming if DSN station problems or sudden rain over a station prevented reception of the data. In such cases, if the data are of great value, the project may be able to recover them by commanding the spacecraft to replay a specific portion of the tape before it is overwritten.

Final science data products usually consist of time-ordered, gap controlled sets of instrument-specific data records known as Experiment Data Records (EDRs). Other products that support analysis of the science data include collections of DSN monitor data which indicates the performance of DSN receivers, tracking and telemetry equipment, selected spacecraft engineering data, spacecraft ephemeris and pointing data. These are known as Supplementary Experiment Data Records (SEDRs) or the equivalent. SEDRS track the history of pointing of the instruments (discussed in Chapter 12), which details the instrument's "footprint" on the object being imaged.

While data products are produced within the Data Management Systems of some projects, Cassini is an example of a new plan calling for its science teams to produce all the science data products that are the result of data compilation and analysis. The Advanced Multimission Operations System (AMMOS) that supports Cassini will perform some data management functions, but will not produce the basic science products.

Radio Science

It was mentioned in the beginning of this chapter that not all science experiments use dedicated instruments aboard the spacecraft. Radio science experiments use the spacecraft radio and the DSN as their instrument. They are interested in the attenuation, refraction, Doppler shifts, and other modifications of the signal as it is occulted by the atmosphere of a planet, moons, or by structures such as planetary rings. From these data, radio scientists are able to derive a great deal of information about the structure and composition of an atmosphere and particle sizes in rings. The "atmosphere" of the sun is another target of great interest which can be observed by radio science. The solar corona causes a scintillation of the spacecraft's radio signal which can be measured while a spacecraft is within a few tens of degrees from the sun as viewed from Earth. When a spacecraft is near superior conjunction with the sun, radio science experiments may be conducted to quantify the general-relativistic gravitational bending imposed on the spacecraft's radio link as it grazes the sun. Such bending results in a slight increase in the apparent distance to the spacecraft.

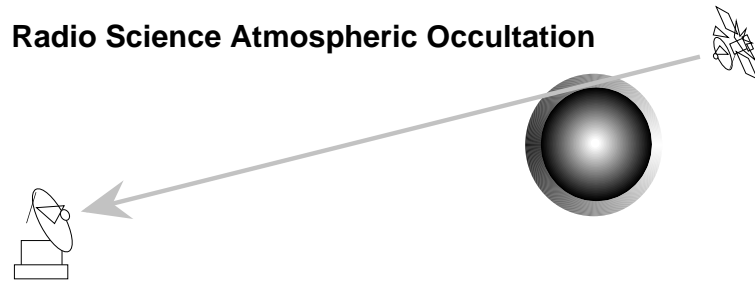

Another Radio Science experiment is the gravitational wave search. Gravitational waves are predicted by Einstein's general theory of relativity, but as of 1995 they have never been detected. Measuring minute Doppler shifts of a spin-stabilized spacecraft in interplanetary space over long periods of time might yield the discovery. The spacecraft's distance would be observed to increase and then decrease on the order of millimeters as a gravitational wave passes through the solar system. Even if these gravitational wave searches have negative results, this information is useful, in that it places limits on the magnitude of gravitational waves at long wavelengths.

Gravity Field Surveys

Another science experiment, like radio science, does not use an instrument aboard the spacecraft. Gravity field surveys (not to be confused with gravitational wave searches) use the spacecraft's radio and the DSN to measure minute Doppler shifts of a vehicle in planetary orbit. After subtracting out the Doppler shifts induced by planetary movement, the spacecraft's primary orbital motion, and small force factors such as the solar wind and atmospheric friction, the residual Doppler shifts are indicative of small spacecraft accelerations and decelerations. These are evidence for variations in the planet's gravity field strength associated with high and low concentrations of mass at and below the planet's surface. Mapping the planet's mass distribution in this way yields information that complements other data sets such as imaging or altimetry in the effort to understand geologic structure and processes at work on the planet.

Dissemination of Results

Publication of the results of the experiments takes place in the literature of the scientific community, notably the journals *Science* (American Association for the Advancement of Science, AAAS), *Nature*, the international weekly journal of science, *JGR (Journal of Geophysical Research)*, and *Icarus*. Presentations are made at virtually every annual convention of various scientific societies, such as the American Astronomical Society (AAS) by experimenters who use JPL's spacecraft. The news media and several magazines keep a close eye on all these journals and proceedings and report items of discovery from them. The thin weekly magazine *Science News* is a notable example, as is the amateur astronomers' monthly *Sky & Telescope* magazine. Splendid photography from JPL's missions occasionally appears in *National Geographic* magazine, and many a JPL mission has enjoyed very good treatment in public television's science series *Nova*.

Regional Planetary Imaging Data Facilities (RPIF) are operated by NASA at over a dozen sites around the United States and overseas. Each maintains a complete photographic library of images from NASA's lunar and planetary missions. They are open to members of the public by

appointment for browsing, and their staff can assist individuals in selecting and ordering materials. All of NASA's planetary imaging data is made available for researchers who are funded by NASA, in photographic format and digital data format, via the Planetary Data System (PDS). The PDS consists of a central on-line catalog at JPL, and a number of nodes located at various research facilities from which data may be retrieved on line.

Educators may obtain a wide variety of materials and information from NASA's flight projects through the network of Teacher Resource Centers (TRC) in cooperation with educational institutions around the country. Each TRC also supports a center for distribution of audiovisual materials called the Central Operation of Resources for Educators (CORE). Members of the public may purchase photographic images and videotapes through contractor facilities associated with JPL's Public Information Office (PIO). The PIO can serve as a clearinghouse for information about access to all of the various avenues for dissemination. Increasing use is being made of the World-Wide Web to disseminate scientific results.

Recap

1. Most experiments have an associated _____ on board the spacecraft to measure a particular physical phenomenon.
2. The data produced by the spacecraft instrument suite in support of the experiments are generally referred to as _____ data.
3. _____ experiments use the spacecraft radio and the DSN as their instrument.
4. The ____ ____ ____ (at JPL) can serve as a clearinghouse for information about access to all of the various avenues for dissemination.

1. *instrument* 2. *science* 3. *radio science* 4. *PIO*

Chapter 9. Spacecraft Classification

Objectives: Upon completion of this chapter you will be able to state the characteristics of various types of spacecraft: flyby spacecraft, orbiter spacecraft, atmospheric probe spacecraft, penetrator spacecraft, lander and surface rover spacecraft, and balloon experiments. You will be able to categorize several of JPL's spacecraft.

Spacecraft designed and constructed to achieve science data gathering are specialized systems intended to function in a specific hostile environment. Their complexity varies greatly. They may be broadly categorized according to the missions they are intended to fly. This chapter identifies a selection of different classifications.

Flyby Spacecraft

Flyby spacecraft follow a continuous trajectory, never to be captured into a planetary orbit. They must have the capability of using their instruments to observe passing targets, and ideally, compensating for the target's apparent motion in optical instruments' field of view. They must downlink data at high rates to Earth, storing data onboard during the periods when their antennas are off Earthpoint. They must be able to survive for many years of long interplanetary cruise. Examples of flyby spacecraft include Pioneers 10 and 11, Voyagers 1 and 2 (each of which have achieved solar escape velocity), and the Pluto fast-flyby mission currently being considered. Flyby spacecraft were used in the initial reconnaissance phase of solar system exploration.

Orbiter Spacecraft

A spacecraft designed to travel to a distant planet and enter into orbit must carry with it a substantial propulsive capability to decelerate it at the right moment to achieve orbit insertion. It has to be designed to live with the fact that solar occultations will occur wherein the planet shadows the spacecraft, cutting off solar panels' production of electrical power, and subjecting the vehicle to extreme thermal variation. Earth occultations will also occur, cutting off uplink and downlink communications with Earth. Orbiter spacecraft are being used in the second phase of solar system exploration, following up the initial reconnaissance with in-depth study of the planets. These include Magellan, Galileo, Mars Global Surveyor, and Cassini.

Atmospheric Probe Spacecraft

Some missions employ one or more smaller instrumented craft which separate from the main spacecraft prior to closest approach to a planet to study the gaseous atmosphere of the body as it drops through it. The atmospheric probe spacecraft is deployed by the release of springs or other devices that simply separate it from the mother ship without making significant modification to its trajectory. The mother ship typically would then execute a trajectory correction maneuver to prevent its own atmospheric entry so that it can continue on with other mission activities.

An aeroshell protects the atmospheric probe spacecraft from the thousands of degrees of heat created by atmospheric friction during entry. The shell is ejected, and a parachute then slows the craft's descent while it undertakes its agenda of scientific observations. Data are typically telemetered from the atmospheric probe to the mother craft where they are recorded onboard for later transmission to Earth.

Galileo, the Jupiter orbiter spacecraft, carried an atmospheric probe that descended into Jupiter's atmosphere during the orbiter's first pass over the planet. The Pioneer 13 spacecraft carried four atmospheric probes which radioed their data directly to Earth during descent into the Venusian atmosphere. Cassini, being designed to orbit Saturn, will carry a probe to be released into the hazy nitrogen atmosphere of Titan, Saturn's largest satellite.

Atmospheric Balloon Packages

Balloon packages are designed for suspension from a buoyant gas bag to float and travel with the wind. Tracking of the balloon's progress across the face of a planet yields data on the circulation of the planet's atmosphere. They have a limited complement of spacecraft subsystems aboard: for example, they may have no need for propulsion subsystems or attitude and articulation control system (AACS) subsystems at all. They do require a power supply, which may simply be batteries, and telecommunications equipment to permit tracking. They may also be outfitted with instrumentation for direct-sensing science experiments to take measurements of an atmosphere's composition, temperature, pressure, density, cloud content and lightning.

Lander Spacecraft

Lander spacecraft are designed to reach the surface of a planet and survive long enough to telemeter data back to Earth. Examples have been the highly successful Soviet Venera landers which survived the harsh conditions on Venus while carrying out chemical composition analyses of the rocks and relaying color images, JPL's Viking landers at Mars, and the Surveyor series of landers at Earth's moon, which carried out similar experiments. The Mars Pathfinder project, which launches in 1996, is intended to be the first in a series of landers on the surface of Mars at widely distributed locations to study the planet's atmosphere, interior, and soil. A system of actively-cooled, long-lived Venus landers designed for seismology investigations, is being studied for a possible future mission.

Surface Penetrator Spacecraft

Surface penetrators have been designed for entering the surface of a body, such as a comet, surviving an impact of hundreds of Gs, measuring, and telemetering the properties of the penetrated surface. Penetrator data would typically be telemetered to the mother craft for re-transmission to Earth. The Comet Rendezvous / Asteroid Flyby (CRAF) mission included a cometary penetrator, but the mission was cancelled in 1992 due to budget constraints. Plans for the Russian MARS '98 mission include a surface penetrator craft.

Surface Rover Spacecraft

Electrically-powered rover spacecraft are being designed and tested by JPL as part of the Mars exploration effort. Mars Pathfinder includes a small mobile instrument (rover) to be deployed on Mars. Mars rovers are also being developed by Russia with a measure of support from The Planetary Society. These rover craft will be semi-autonomous, and will be steerable from Earth, taking images and soil analyses for telemetering back to Earth.

Recap

1. _____ spacecraft follow a continuous trajectory, never to be captured into a planetary orbit.
2. A spacecraft designed to travel to a distant planet and enter into orbit must carry with it a substantial _____ capability to decelerate.
3. An aeroshell protects the _____ spacecraft from the thousands of degrees of heat created by atmospheric friction during entry.
4. Balloon packages... have a _____ complement of spacecraft subsystems aboard.
5. _____ spacecraft are designed to reach the surface of a planet and survive long enough to telemeter data back to Earth.

1. Flyby 2. propulsive 3. atmospheric probe 4. limited 5. Lander

The following is a list of space flight projects currently funded at JPL as of fiscal year 1996. Drawings on subsequent pages illustrate a sampling of various classifications of spacecraft connected with JPL in the past, present, and future. These drawings are not to scale with each other. Detailed models of many of them, as well as other spacecraft, may be found in the Von Kármán Museum, JPL Building 186, and in the Spacecraft Assembly Facility (SAF) north viewing gallery, Building 179.

Current Space Science Missions at JPL:

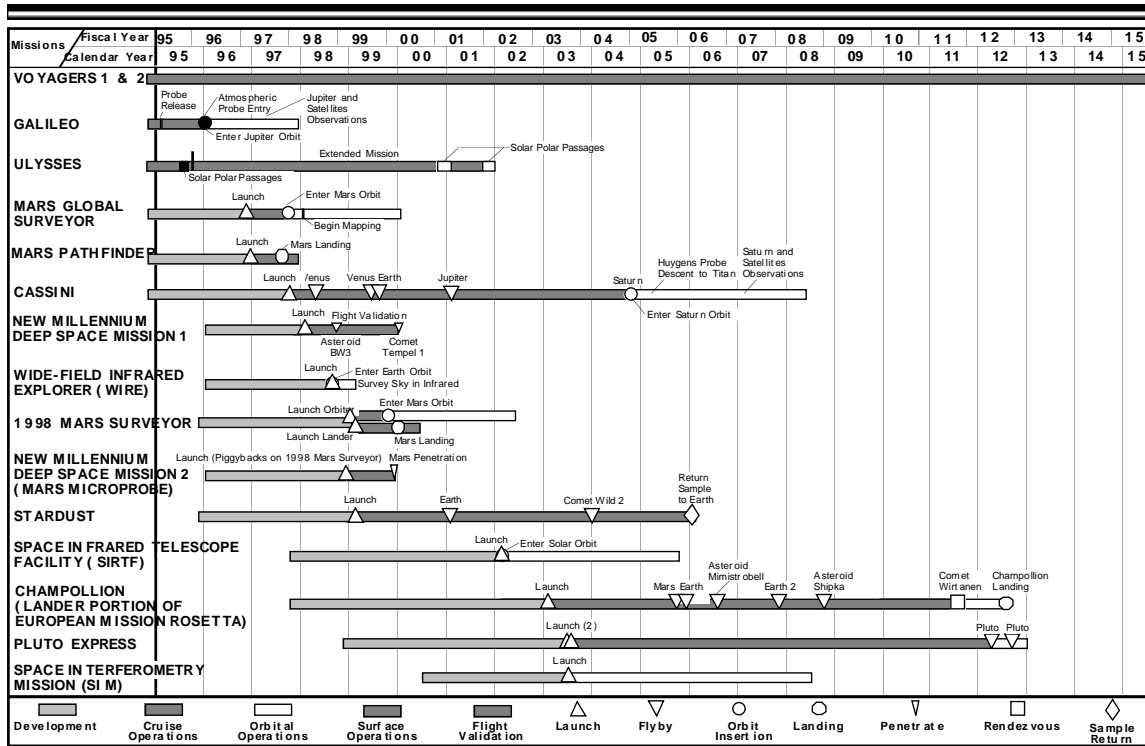

SPACE AND EARTH SCIENCE PROGRAMS DIRECTORATE • 1/96

Projects Currently Being Studied at JPL:

To be added.

Voyagers 1 & 2

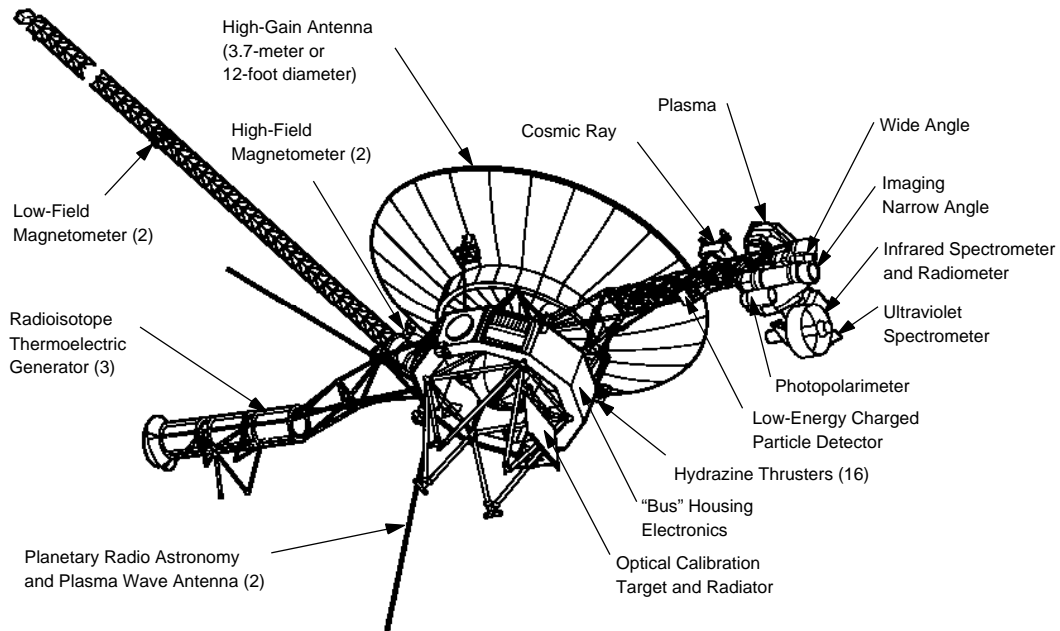

Classification: Flyby spacecraft

Mission: Jovian planets and interstellar space

Features: The Voyager 1 and Voyager 2 spacecraft were launched in late 1977 aboard Titan III launch vehicles with Centaur upper stages. They completed highly successful prime mission flybys of Jupiter in 1979 and Saturn in 1980 and 1981. Voyager 2's extended mission succeeded with flybys of Uranus in 1986 and Neptune in 1989. Both spacecraft are still healthy in 1995, and are conducting studies of interplanetary space enroute to interstellar space. Voyager 1 and Voyager 2 recently identified low frequency radio emissions from the heliopause, estimated to be about 50 AU away from the spacecraft. Science data return is expected to continue well into the next century.

Stabilization: Three-axis stabilized via thrusters.

Magellan

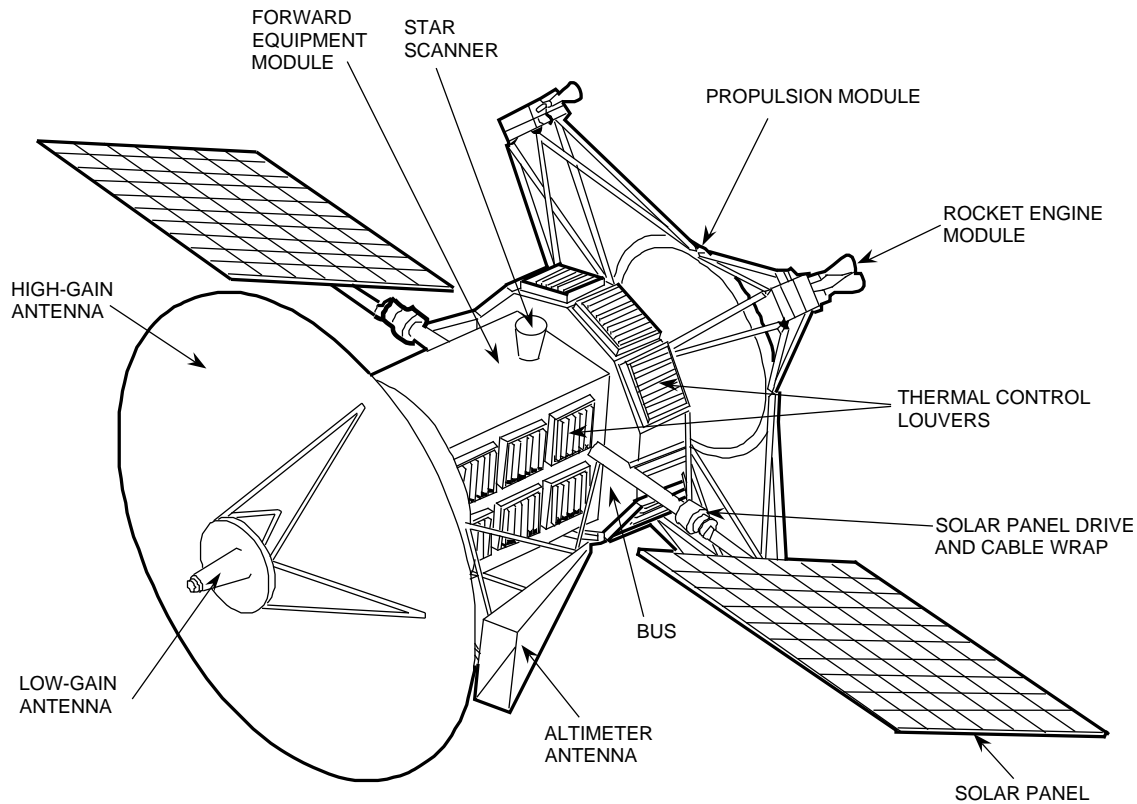

Classification: Orbiter spacecraft

Mission: Venus mapping

Features: The Magellan spacecraft was launched in early 1989 via the Space Shuttle Atlantis and an IUS upper stage. By the end of its fourth Venus-rotation cycle (243 days each) four years after launch, Magellan had mapped 98% the surface of Venus with imaging, altimetry, and radiometry, performed several radio science experiments, and had surveyed the gravity field at low latitudes all the way around the planet. The imaging resolution was about 100 m, close enough to discern the various geologic processes for the first time. Magellan's periapsis was lowered into Venus's atmosphere for a thousand orbits, aerobraking into a nearly circular orbit. Magellan's periapsis was then raised out of the atmosphere, and it completed high-resolution mapping of the planet's gravity field from low circular orbit. Magellan was then intentionally flown to its destruction in Venus's atmosphere in October 1994, all the while carrying out additional experiments.

Stabilization: Three-axis stabilized via reaction wheels and thrusters.

Ulysses

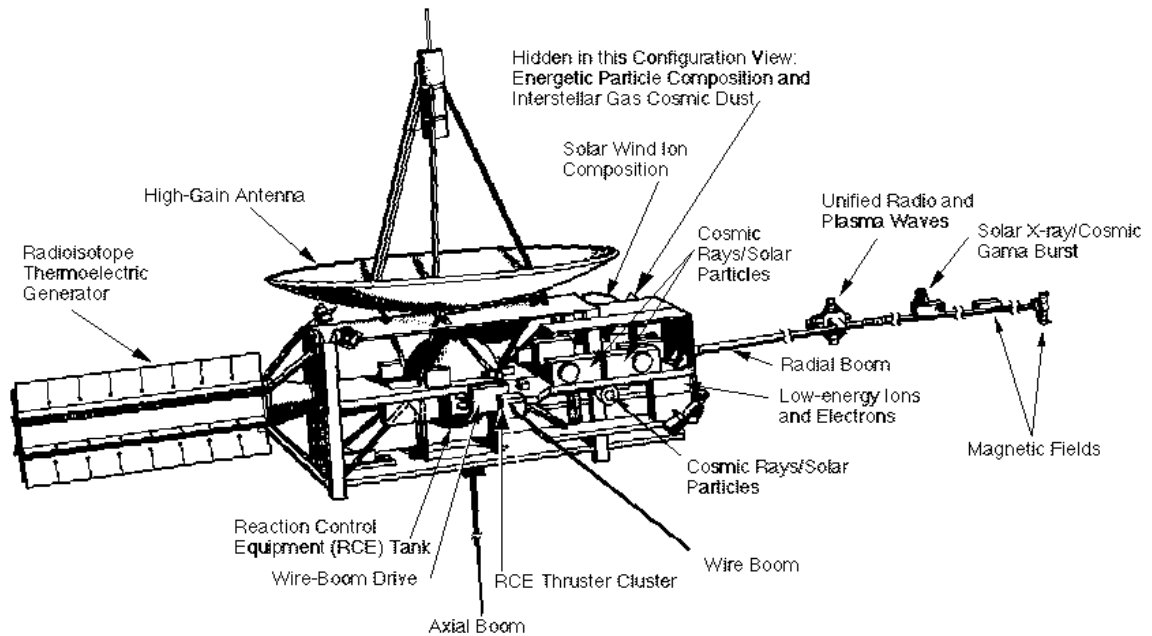

Classification: Orbiter spacecraft

Mission: Study the sun from solar polar latitudes

Features: The Ulysses spacecraft is a joint project between NASA and the European Space Agency (ESA). It was launched in late 1990 via the Space Shuttle with an IUS upper stage and Payload Assist Module (PAM-S). It encountered Jupiter early in 1992 for a gravity assist to achieve a trajectory at nearly right angles to the ecliptic plane. It explored the Sun's high southern latitudes during June through October 1994. It passed over the Sun's north polar region between June and September 1995. At no time will it approach less than 1 AU from the sun. While within Jupiter's environs for its gravity assist, it made significant observations of the Jovian system. Ulysses carries fields and particles instruments. Its U.S. counterpart, a second spacecraft with imaging instruments, designed to travel simultaneously over the opposite Solar poles, was cancelled by the U.S.

Stabilization: Spin stabilized.

TOPEX/Poseidon

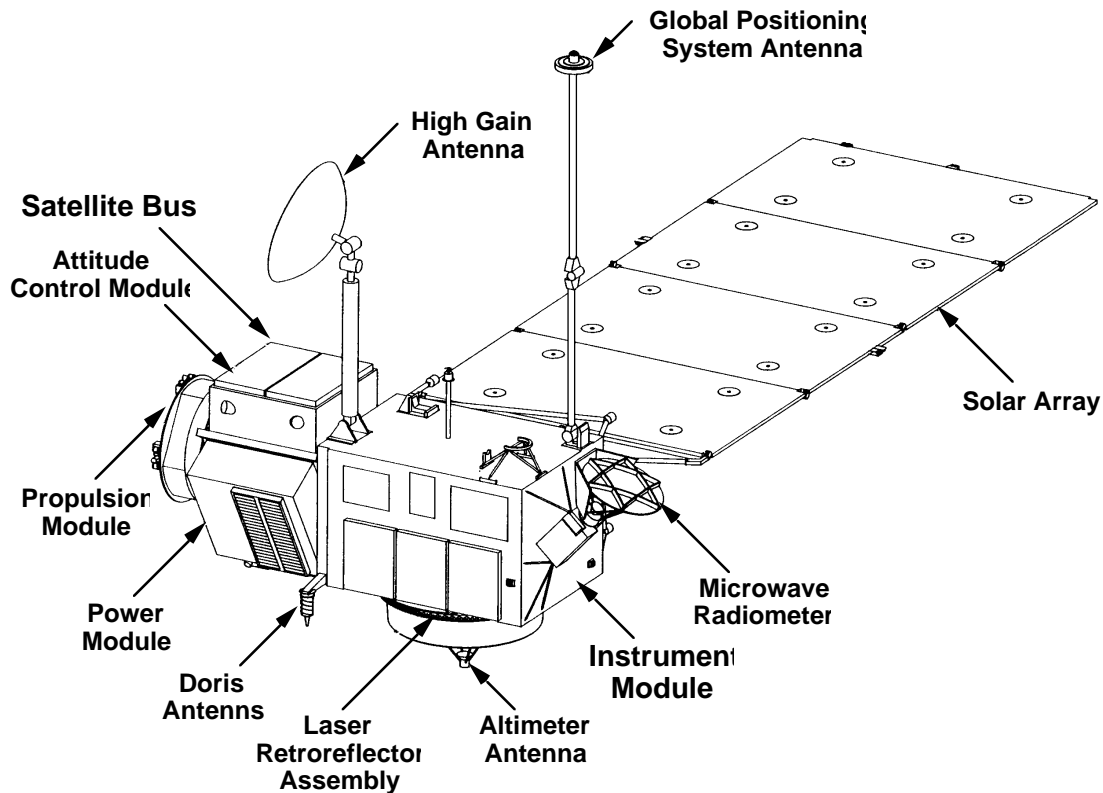

Classification: Orbiter spacecraft

Mission: Global view of Earth's oceans

Features: Topex/Poseidon is a joint project between NASA and Centre National d'Études Spatiales (CNES) launched in mid 1992 aboard an Ariane 4. The spacecraft occupies a 1336-km-high Earth orbit inclined 66°. Revealing minute differences in the oceans' heights, Topex/Poseidon's data should lead to improved understanding of oceanic circulation and forecasting of global environment.

Stabilization: Three-axis stabilized via reaction wheels and thrusters.

Pioneers 10 & 11

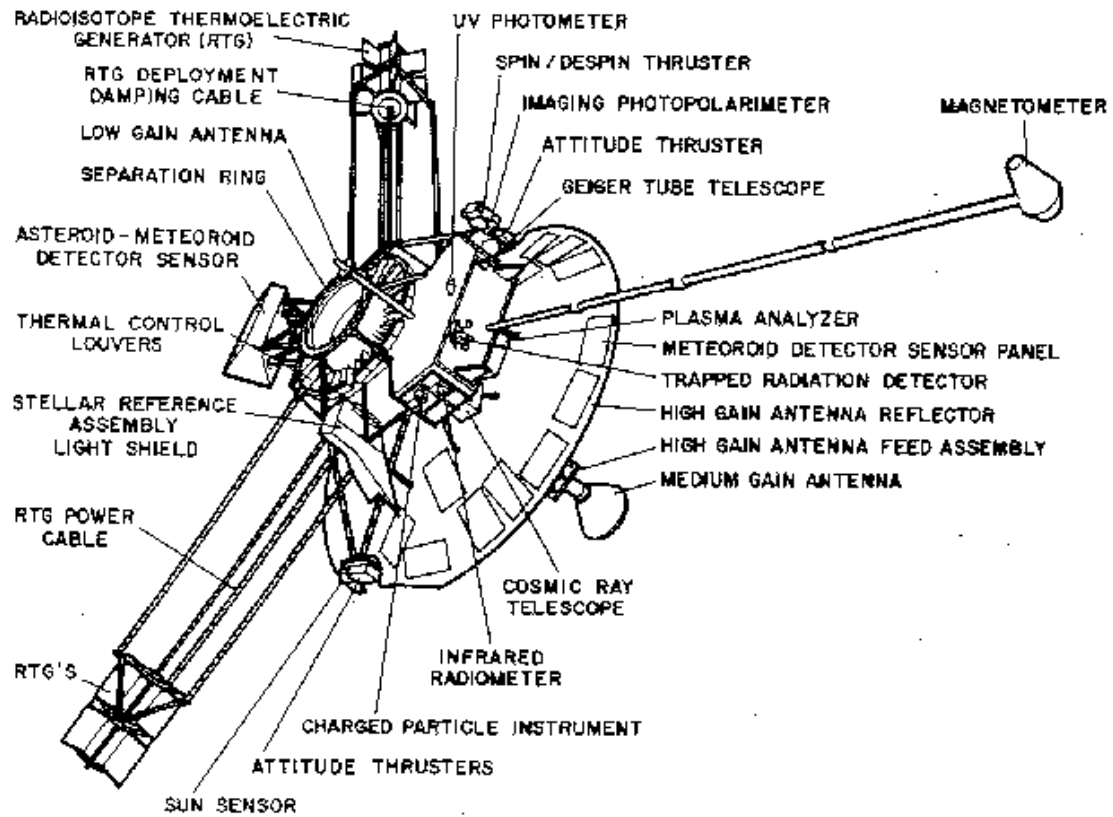

Classification: Flyby spacecraft

Mission: Jupiter, Saturn, and interstellar space

Features: Pioneer 10 and 11 launched in 1972 and 1973, and penetrated the asteroid belt. Pioneer 10 was the first spacecraft to study Jupiter and its environment, and obtain spin-scan images of the planet. Pioneer 11 also encountered Jupiter, and went on to become the first to encounter Saturn, its rings and moons. Pioneer 10 and 11 are still operative in the far reaches of the outer solar system, and are still being tracked in November 1995. Pioneer 11 has run out of sufficient electrical power to continue operations and is expected to lose communications with Earth within a few months. It is likely that Pioneer 10 will follow suit within a few years.

Stabilization: Spin stabilized.

Viking Lander

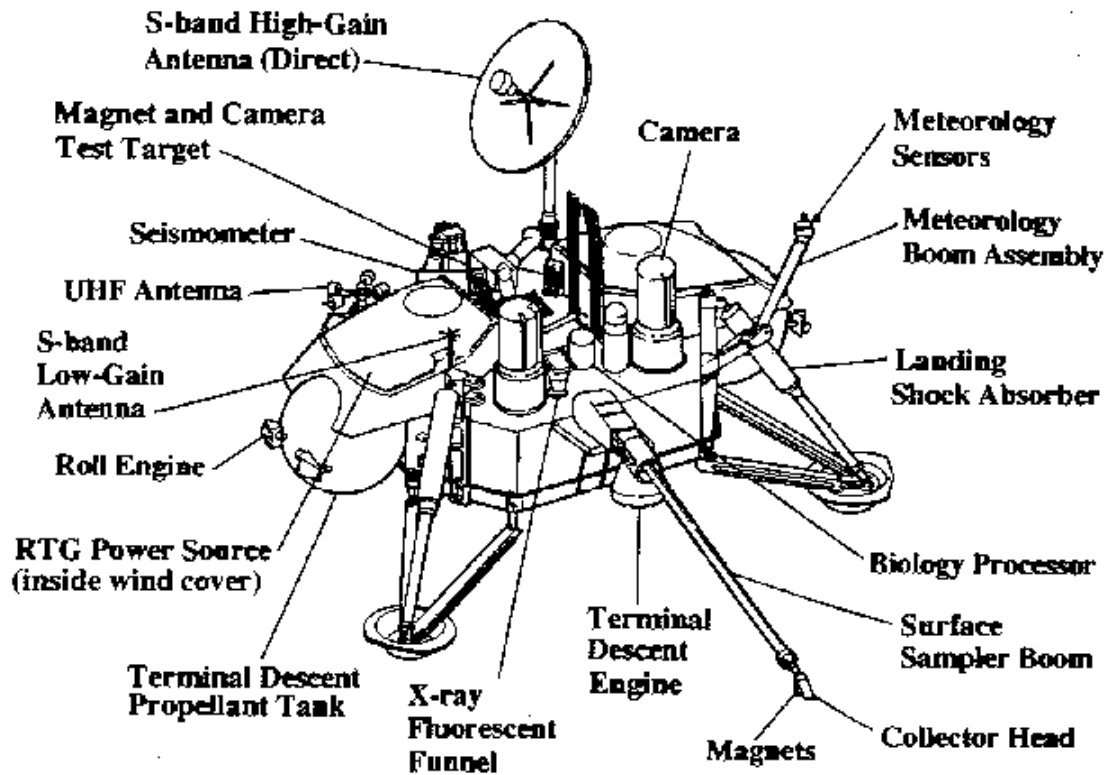

Classification: Lander spacecraft

Mission: Survey Martian landscape

Features: The Viking Lander 1 spacecraft touched down on Mars in July 1976, followed by the Viking 2 Lander the following month. These automated scientific laboratories photographed their surroundings, and gathered data on the structure, surface, and atmosphere of the planet, and carried out an investigation into the possibility of past and present life forms.

Mars Observer

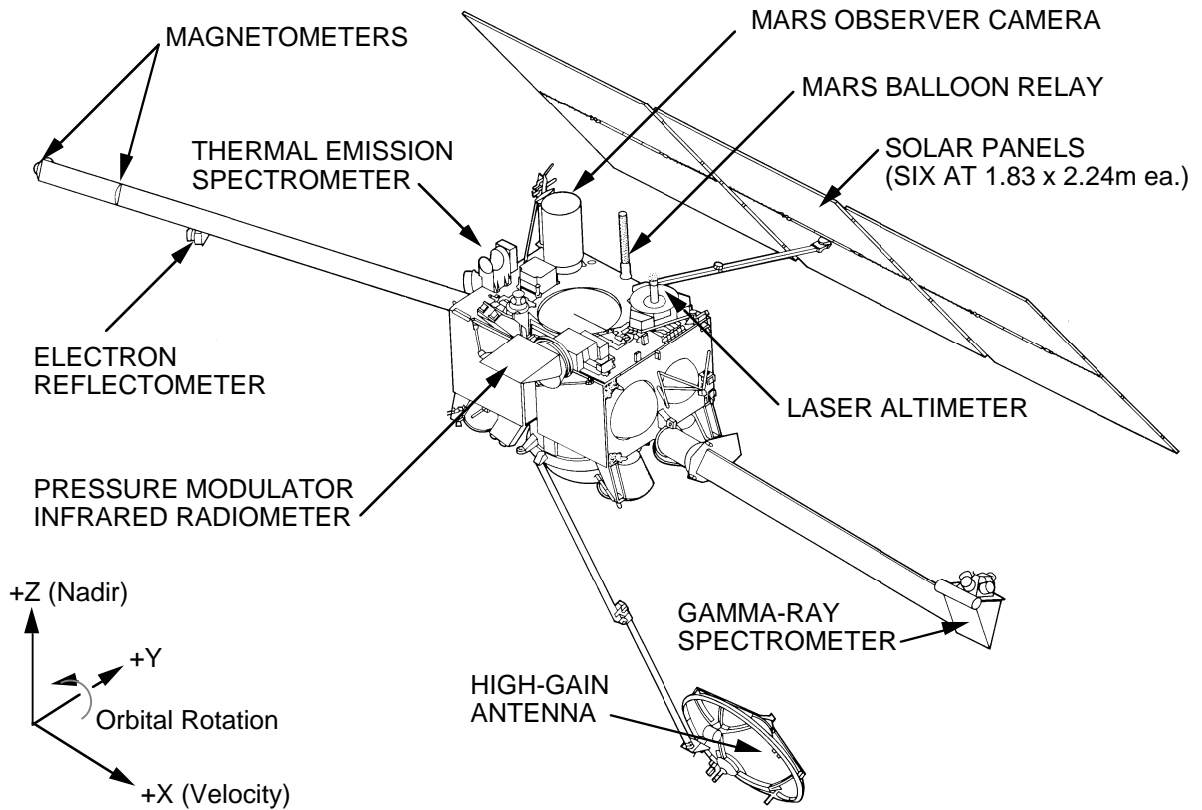

Classification: Orbiter spacecraft

Mission: Mars mapping

Features: The Mars Observer spacecraft was launched in 1992 aboard a Titan III with a Transfer Orbit Upper Stage. Unfortunately, communications with the spacecraft were lost just before its orbit insertion maneuver. Based upon the design for an Earth-orbiting spacecraft, it was to observe Mars for one continuous Martian year (687 Earth days), studying surface mineralogy and morphology, topography, atmospheric circulation and the movement of water, dust, fog and frost. It was to characterize the gravitational field and the magnetic field. It also would have provided Earth relay capability for Russian landers and the Mars Balloon.

Stabilization: Three-axis stabilized via reaction wheels and thrusters.

Mars Global Surveyor

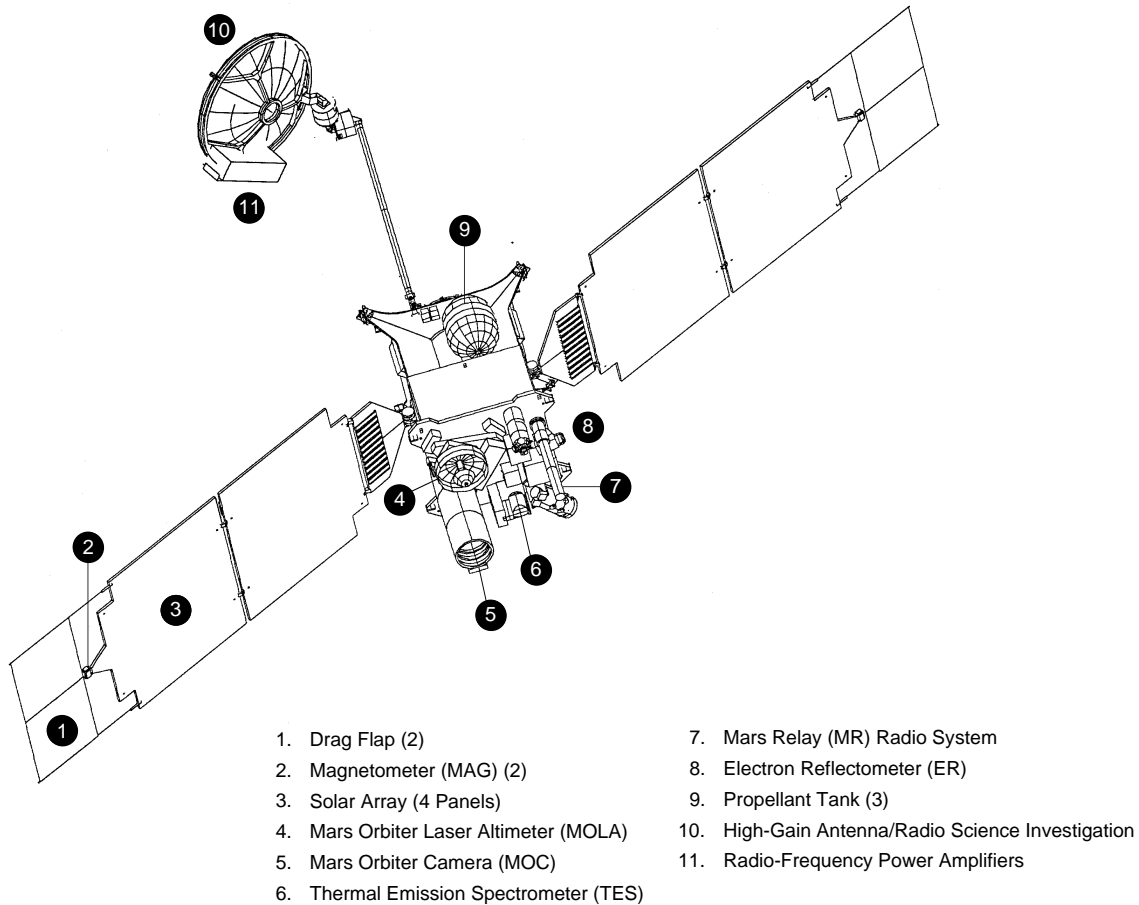

Classification: Orbiter spacecraft.

Mission: Mars mapping

Features: The Mars Global Surveyor spacecraft will be launched in November 1996 on a Delta 7925 launch vehicle. It will carry all but two of the eight science instruments that were aboard Mars Observer, providing high-resolution, global maps of the Martian surface, profiling the planet's atmosphere, and studying the nature of the magnetic field. Mars Global Surveyor will take ten months to reach Mars, entering a polar orbit around the planet in September 1997.

Stabilization: Three-axis stabilized via reaction wheels and thrusters.

Galileo Orbiter

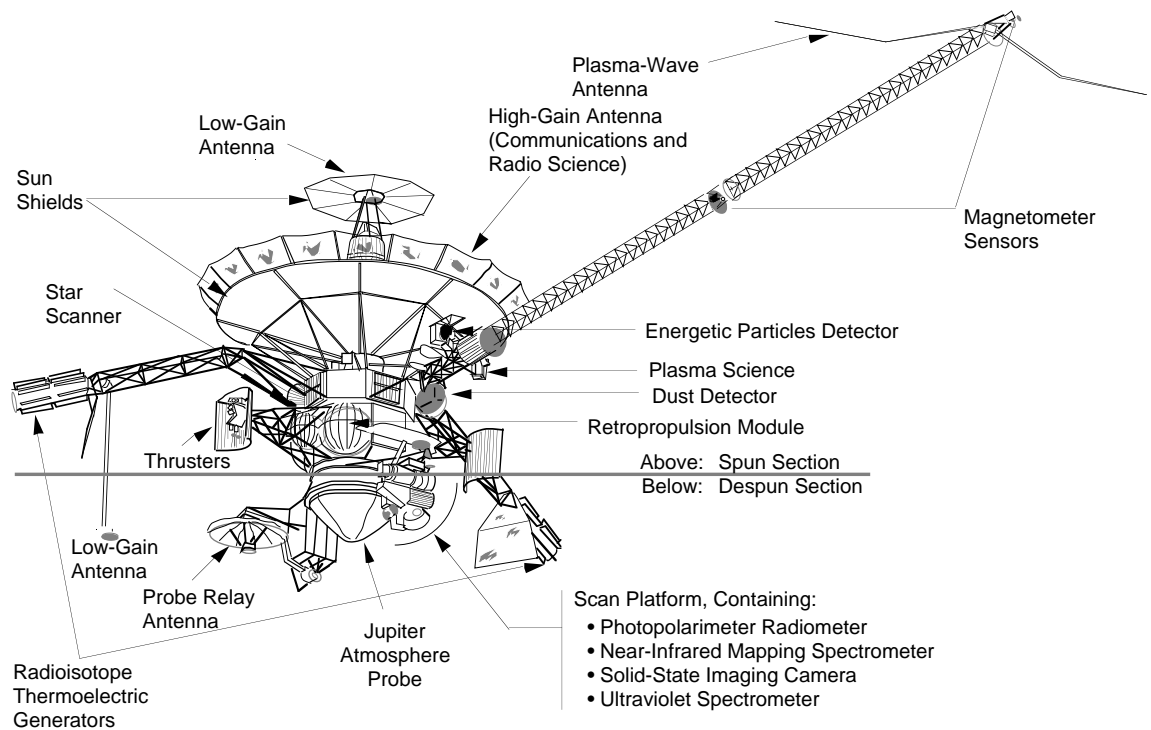

Classification: Orbiter spacecraft

Mission: Investigate Jupiter's atmosphere, magnetosphere, and satellites.

Features: Galileo was launched aboard the Space Shuttle in October 1989. It executed science observations during gravity-assist flybys of Venus and Earth, as well as during two asteroid flybys. It observed Comet Shoemaker-Levy 9's impact with Jupiter in July 1994. Galileo entered Jovian orbit December 1995 shortly after receiving the data from its atmospheric probe, which entered Jupiter's atmosphere.

Stabilization: Spin stabilized.

Note: See also the detailed foldout illustration of the Galileo Orbiter in Chapter 11.

Galileo Atmospheric Probe

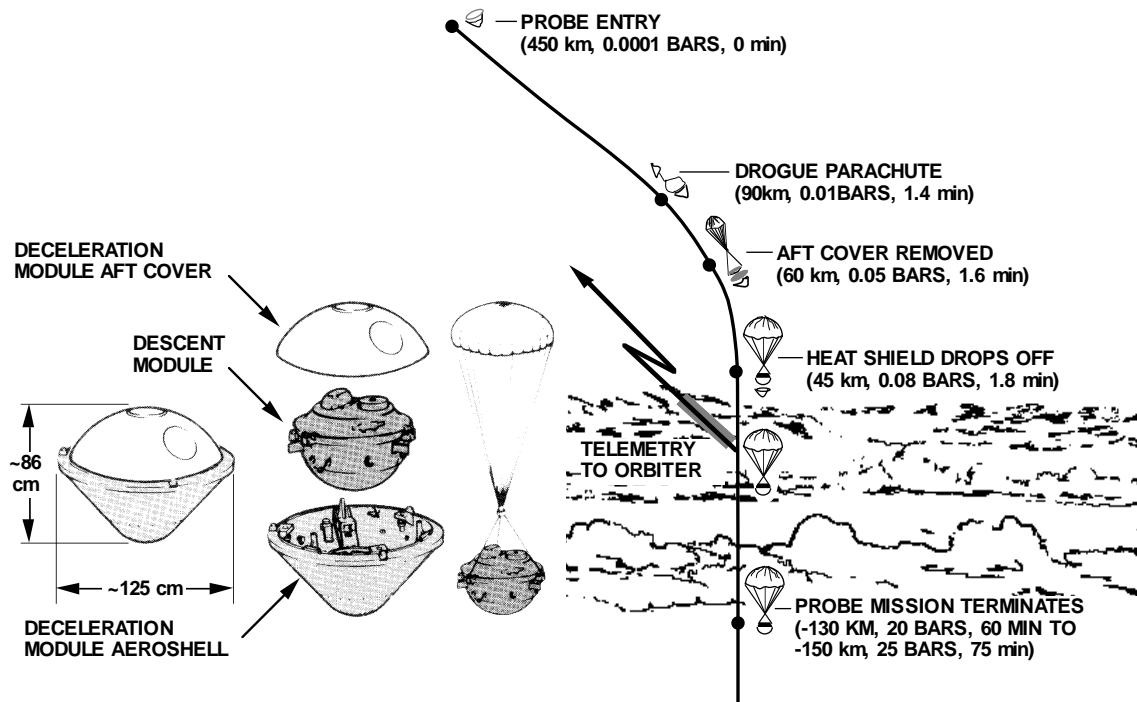

Classification: Atmospheric probe spacecraft

Mission: Investigate Jupiter's atmosphere

Features: The Galileo Atmospheric Probe was released from the Galileo orbiter spacecraft in July 1995, about 100 days before arrival at Jupiter. Atmospheric entry took place on 7 December 1995 as the orbiter tracked the probe and recorded its data for later relay to Earth. Probe instruments investigated the chemical composition and the physical state of the atmosphere. The probe returned data for just over an hour before it was overcome by the pressure of Jupiter's atmosphere.

Stabilization: Spin stabilized.

Cassini

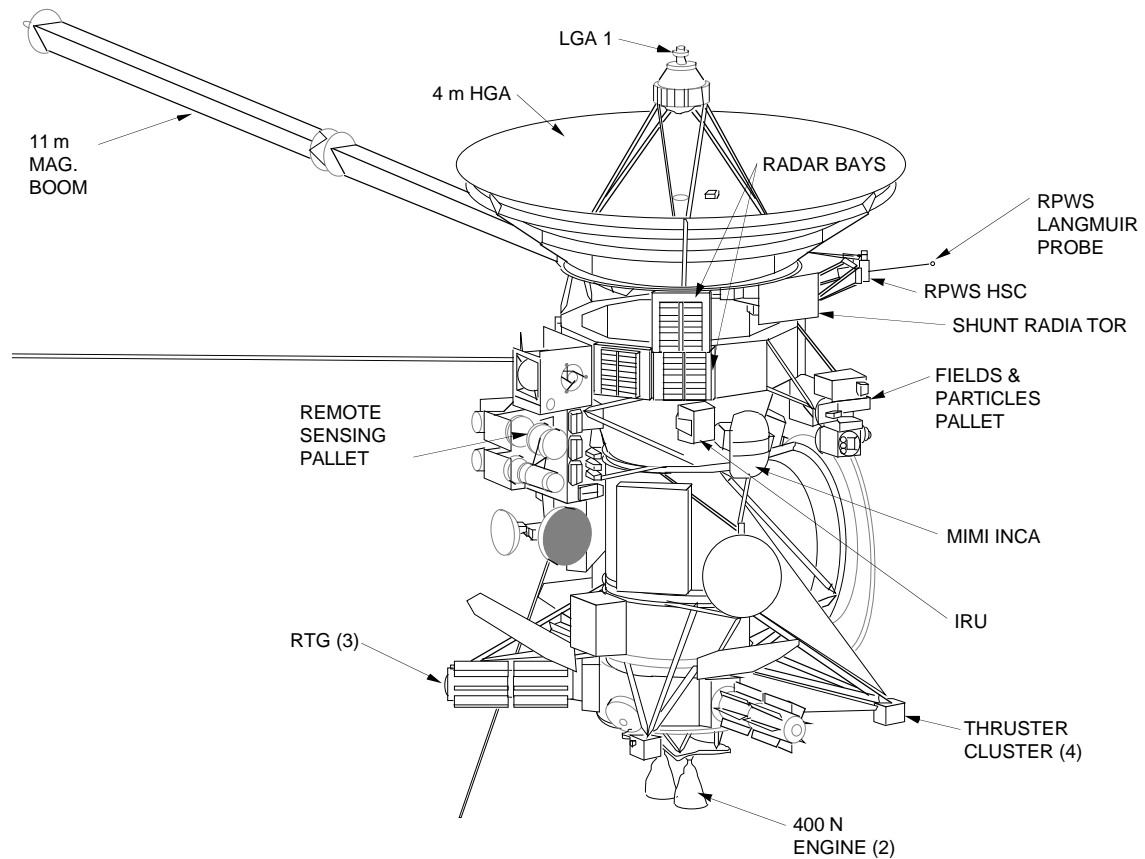

Classification: Orbiter spacecraft

Mission: Explore Saturnian system

Features: Cassini is scheduled for launch aboard a Titan IV with a Centaur upper stage in 1997. It will encounter Venus, Earth and Jupiter for gravity assists, and will reach Saturn in 2004. It will spend four years conducting a detailed examination of Saturn's atmosphere, rings, and magnetosphere, and close-up studies of its satellites. It will radar map portions of Titan's surface. Cassini will also carry the Huygens probe which will be deployed into the atmosphere of Titan.

Stabilization: Three-axis stabilized via reaction wheels and thrusters.

Huygens Probe

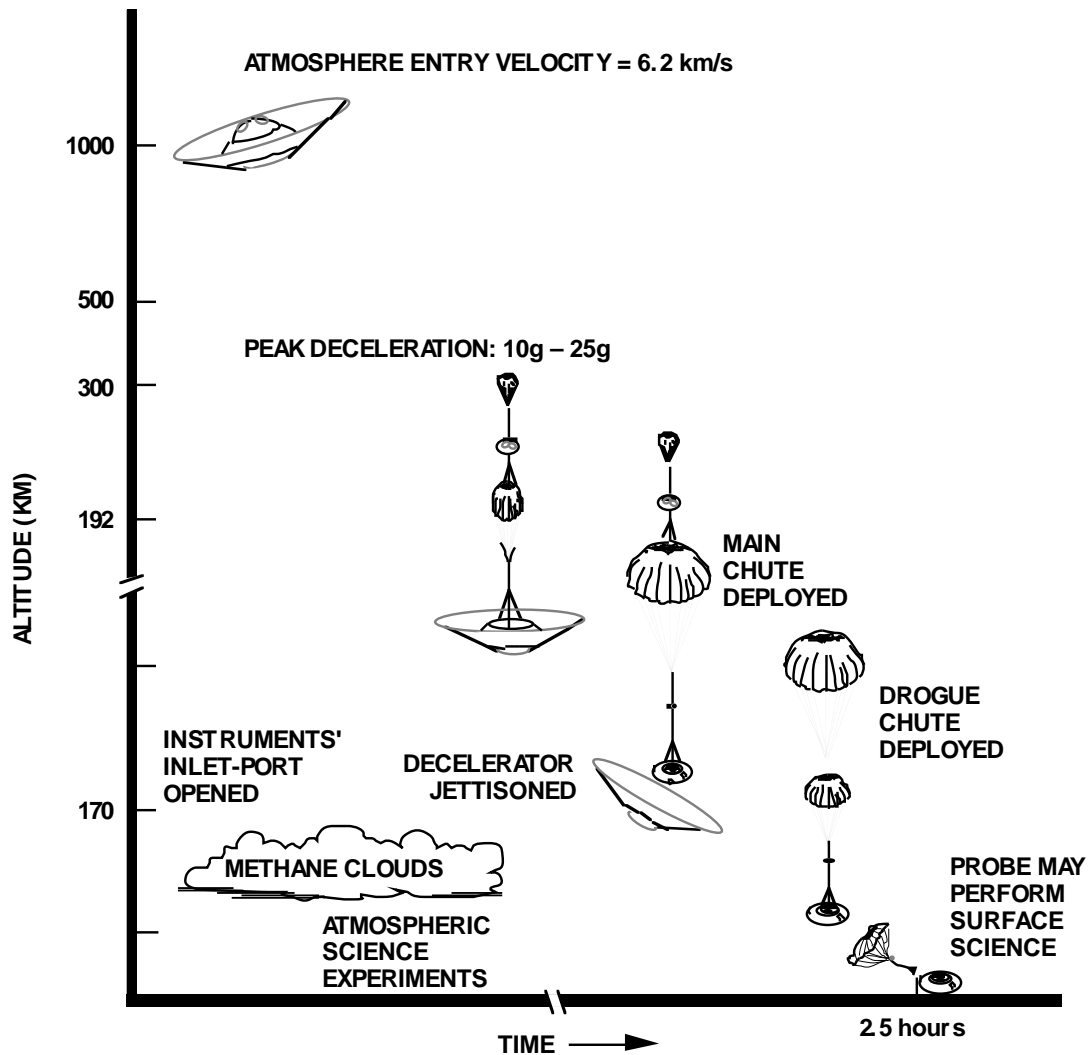

Classification: Atmospheric probe spacecraft

Mission: Investigate Titan's atmosphere

Features: The Huygens Probe, supplied by ESA, will be carried by the Cassini spacecraft to Titan, Saturn's largest moon, and deployed carrying six science instruments into Titan's atmosphere in the year 2004. If it survives impact with the surface of Titan, it may be able to continue to transmit science data from the surface.

Stabilization: Spin stabilized.

Mars Pathfinder

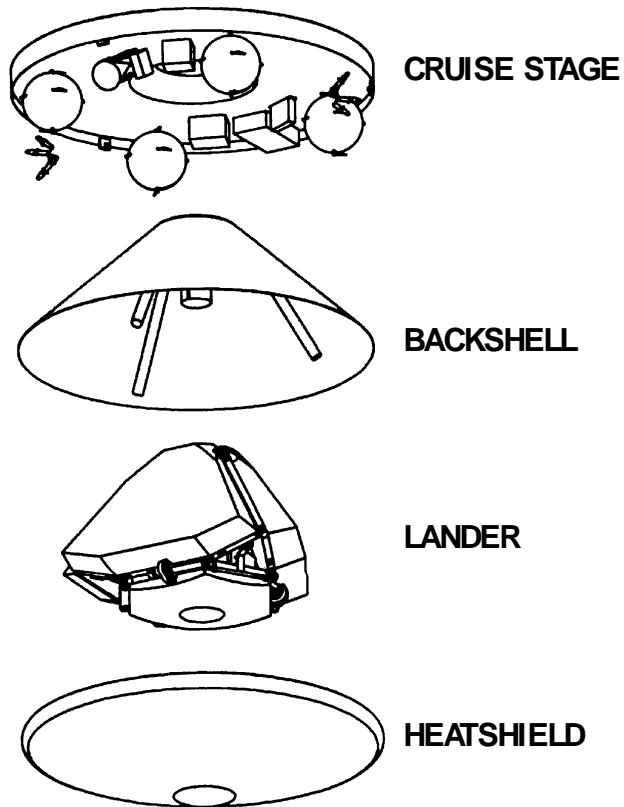

Classification: Lander spacecraft carrying surface rover

Mission: Analyze Martian soil and atmosphere

Features: Pathfinder is a low-cost mission with a single flight system to be launched in mid 1996, for a Mars landing late in 1997. The spacecraft will enter the atmosphere directly from its transfer trajectory and will analyze the atmosphere on the way in.

Stabilization: Spin stabilized.

Mars Pathfinder Lander Deployed

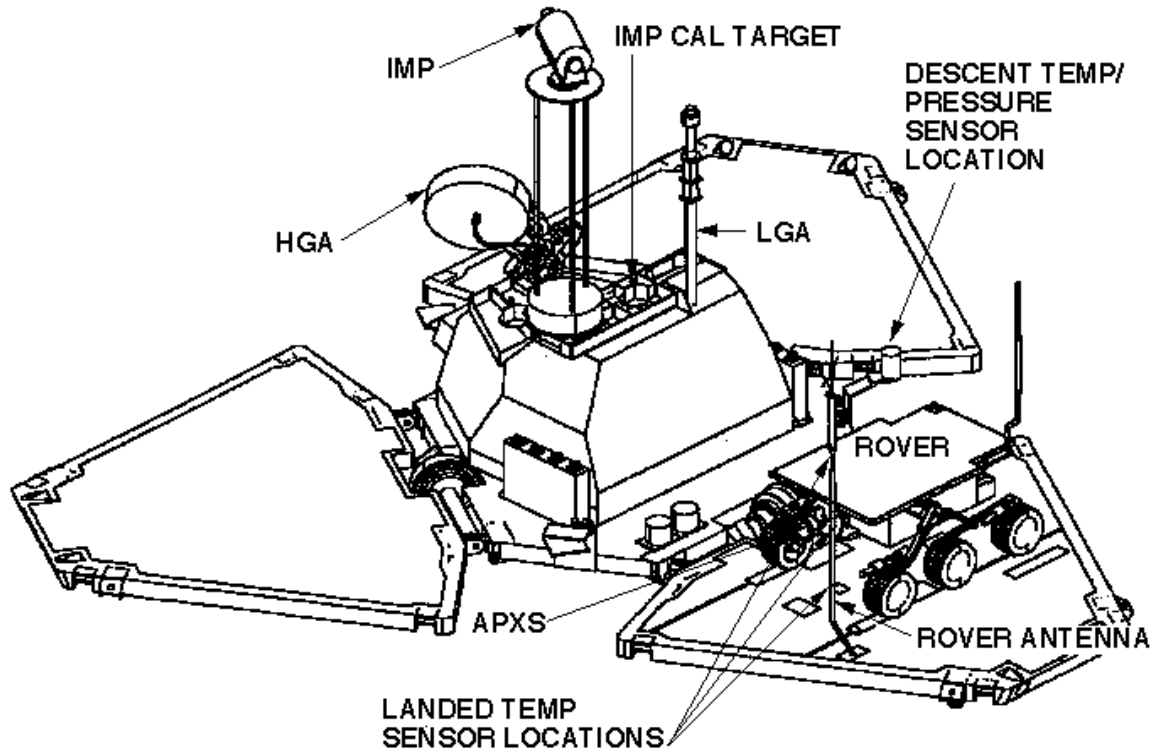

Classification: Lander spacecraft with surface rover

Mission: Analyze Martian soil

Features: The lander will parachute to the surface. One second before impact on the Martian surface, three airbags will inflate on each of the three folded “petals” of the lander, cushioning its impact. After the airbags have deflated, the petals then deploy, exposing solar panels to the sunlight, and righting the lander. The rover is then deployed by driving off the solar panel and onto the Martian soil. The lander is designed to operate on the surface for over 30 Martian days and nights, and return a panoramic view of the Martian landscape. It will also measure the soil’s chemistry and characterize the seismic environment.

Mars Balloon

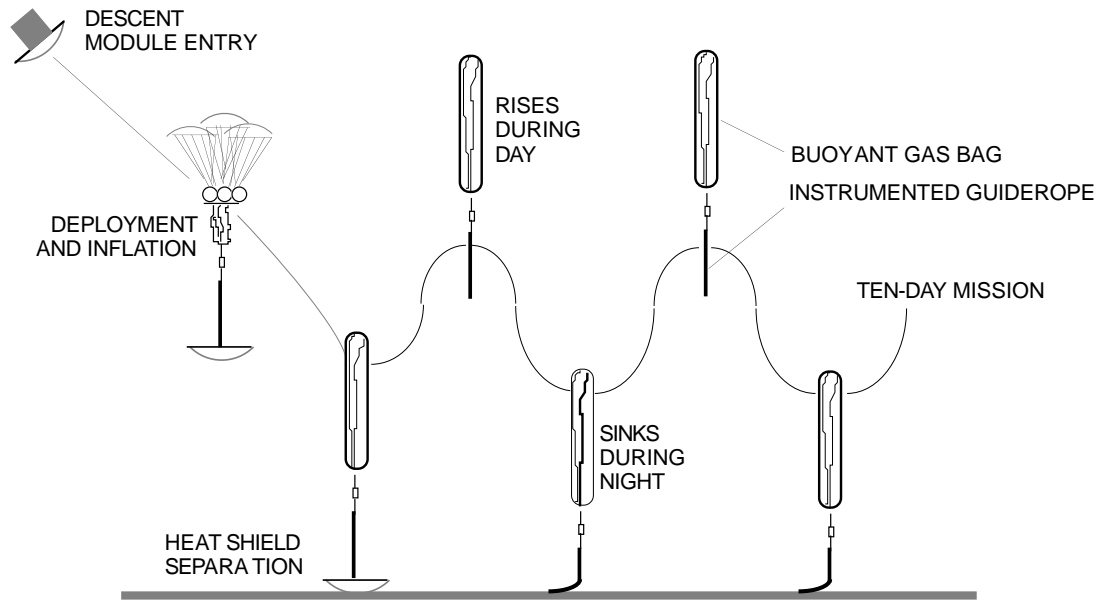

Classification: Balloon package

Mission: Explore the Martian landscape

Features: The balloon is designed to become buoyant enough to lift its instrumented guide rope when heated by the sun in the daytime, and to sink when cooled at night, letting the guide rope contact the surface. Electronics are fitted within 24 interconnected, partially nested, articulated conical titanium segments which make up the snake or guide rope. It carries various sensors and spectrometers, radar, data management system, transmitter, and batteries. It is intended to survive for ten Martian days and nights.

Pluto Spacecraft

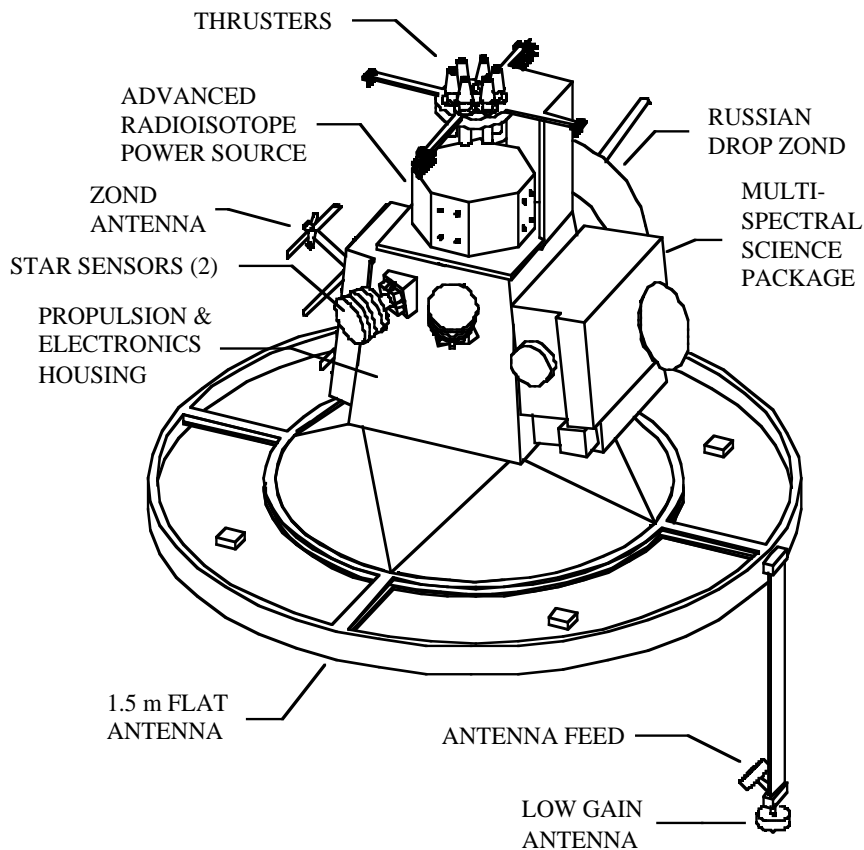

Classification: Flyby spacecraft

Mission: Conduct the first reconnaissance of Pluto

Features: Two low-mass spacecraft are being considered for separate launches on fast, direct trajectories to reach the Pluto-Charon system in 6 to 8 years. Science objectives established by NASA's Outer Planets Science Working Group and the Solar System Exploration Subcommittee include characterizing the global geology and geomorphology, and mapping the surface composition of both bodies, and characterize the tenuous atmosphere. It would carry an imaging camera, and UV and IR spectrometers. The fast trajectories would allow the spacecraft to reach their target before the atmosphere precipitates to the surface, which is predicted to occur around the year 2015 as Pluto moves farther from the sun. The proposed spacecraft would have a mass of about 150 kg including propellant, would operate on 60 watts of electrical power, and provide a downlink at a maximum of 40 bps. The launch vehicle candidates are Titan IV with Centaur upper stage, or Proton.

Stabilization: Three-axis stabilized by thrusters.

Recap

1. Detailed models of many spacecraft may be found in the _____
Museum, JPL Building 186 and in the SAF North Viewing Gallery, Building _____.
2. Voyagers 1 and 2 are classified as _____ spacecraft.
3. Magellan, Mars Observer, and Cassini are classified as _____ spacecraft.
4. The Mars Pathfinder mission will deploy multiple _____ spacecraft on Mars.

1. Von Kármán , 179 2. flyby 3. orbiter 4. lander

Chapter 10. Telecommunications

Objectives: Upon completion of this chapter you will be aware of the major factors involved in communicating across interplanetary distances. You will also be aware that detailed coverage of this subject appears in a separate course.

This chapter gives a broad view of some telecommunications issues, including both spacecraft and Earth-based communication. This view is of abbreviated depth, and the subject is covered further by a separate Space Flight Operations Multi-team Training Module for employees at JPL, “End-to-end Information System” (refer to the illustration in the Introduction on page 1). Details of onboard spacecraft equipment for telecommunications are covered under Telecommunications Subsystems in Chapter 11.

Signal Power

Your local entertainment radio broadcast station may have a radiating power of 50 kW, and the transmitter is probably no more than 100 km away. Your portable receiver probably has a simple antenna inside its case. Spacecraft have nowhere near that amount of power available for transmitting, yet they must bridge distances measured in tens of billions of kilometers. A spacecraft might have a transmitter with no more than 20 watts of radiating power. How can that be enough? One part of the solution is to employ microwave frequencies, concentrate all available power into a narrow beam, and then to send it in one direction instead of broadcasting in all directions. This is typically done using a parabolic dish antenna on the order of 1 or 5 meters in diameter. Even when these concentrated signals reach Earth, they have vanishingly small power. The rest of the solution is provided by the DSN’s large aperture reflectors, cryogenically-cooled low-noise amplifiers and sophisticated receivers, as well as data coding and error-correction schemes.

Uplink and Downlink

The radio signal transmitted to a spacecraft is known as uplink. The transmission from spacecraft to Earth is downlink. Uplink or downlink may consist of a pure RF tone, called a carrier, or carriers may be modulated to carry information in each direction. Commands transmitted to a spacecraft are sometimes referred to as an upload. Communications with a spacecraft involving only a downlink are called one-way. When an uplink is being received by the spacecraft at the same time a downlink is being received at Earth, the communications mode is called “two-way.”

Modulation and Demodulation

Consider the carrier as a pure tone of, say, 3 GHz, for example. If you were to quickly turn this tone off and on at the rate of a thousand times a second, we could say it is being modulated with a

frequency of 1 kHz. Spacecraft carrier signals are modulated, not by turning off and on, but by shifting each waveform's phase slightly at a given rate. One scheme is to modulate the carrier with a frequency, for example, near 1 MHz. This 1 MHz modulation is called a subcarrier. The subcarrier is in turn modulated to carry individual phase shifts that are designated to represent groups of binary 1s and 0s—the spacecraft's telemetry data. The amount of phase shift used in modulating data onto the subcarrier is referred to as the modulation index, and is measured in degrees. The same kind of scheme is also used on the uplink.

Demodulation is the process of detecting the subcarrier and processing it separately from the carrier, detecting the individual binary phase shifts, and decoding them into digital data for further processing. The same processes of modulation and demodulation are used commonly with Earth-based computer systems and fax machines transmitting data back and forth over a telephone line. The device used for this is called a modem, short for modulator / demodulator. Modems use a familiar audio frequency carrier which the telephone system can readily handle.

Binary digital data modulated onto the uplink is called command data. It is received by the spacecraft and either acted upon immediately or stored for future use or execution. Data modulated onto the downlink is called telemetry, and includes science data from the spacecraft's instruments and spacecraft health data from sensors within the various onboard subsystems.

Multiplexing

Not every instrument and sensor aboard a spacecraft can transmit its data at the same time, so the data are multiplexed. In the time-division multiplexing (TDM) scheme, the spacecraft's computer samples one measurement at a time and transmits it. On Earth, the samples are demultiplexed, that is, assigned back to the measurements that they represent. In order to maintain synchronization between multiplexing and demultiplexing (also called mux and demux) the spacecraft introduces a known binary number many digits long, called the pseudo-noise (PN) code at the beginning of every round of sampling (telemetry frame), which can be searched for by the ground data system. Once recognized, it is used as a starting point, and the measurements can be demuxed since the order of muxing is known.

Newer spacecraft use packetizing rather than TDM. In the packetizing scheme, a burst or packet of data is transmitted from one instrument or sensor, followed by a packet from another, and so on, in non-specific order. Each burst carries an identification of the measurement it represents for the ground data system to recognize it and handle it properly. These schemes generally adhere to the International Standards Organization (ISO)'s Open Systems Interconnection (OSI) protocol suite, which recommends how computers of various makes and models can inter communicate. The ISO OSI is distance independent, and holds for spacecraft light-hours away as well as between workstations.

Coherence

Aside from the information modulated on the downlink as telemetry, the carrier itself is used for tracking the spacecraft, and for carrying out some types of science experiments. For each of these uses, an extremely stable downlink frequency is required, so that Doppler shifts on the order of fractions of a Hertz may be detected out of many GHz over periods of hours. But it would be impossible for any spacecraft to carry the massive equipment on board required to generate and

maintain such stability. The solution is to have the spacecraft generate a downlink which is phase coherent to the uplink it receives.

Down in the basement of each DSN Signal Processing Center, there looms a hydrogen-maser based frequency standard in an environmentally controlled room. This is used as a reference for generating an extremely stable uplink frequency for the spacecraft to use in generating its coherent downlink.

The resulting spacecraft downlink, based on and coherent with an uplink, has the same extraordinarily high frequency stability as does the massive hydrogen maser-based system in its controlled environment in the DSN basements. It can thus be used for precisely tracking the spacecraft, and for carrying out science experiments. The spacecraft also carries a low mass oscillator to use as a reference in generating its downlink for periods when an uplink is not available, but it is not highly stable, and its output frequency is affected by temperature variations on the spacecraft. Some spacecraft carry an Ultra-Stable Oscillator (USO), discussed further in Chapter 16. Because of the stringent frequency requirements for spacecraft operations, JPL stays at the forefront of frequency and timing standards technology.

Most spacecraft may also invoke a non-coherent mode which does not use the uplink frequency as a downlink reference. Instead, the spacecraft uses its onboard oscillator as a reference for generating its downlink frequency. This mode is known as Two-Way Non-Coherent (TWNC, pronounced “twink”). When TWNC is on, the downlink is non-coherent.

Recall that “two-way” means there is an uplink and there is a downlink, and doesn’t indicate whether the spacecraft’s downlink is coherent to that station’s uplink or not. However, in common usage, operations people commonly say “two-way” to mean “coherent,” which is generally the case. Correctly stated, a spacecraft’s downlink is coherent when it is two-way with TWNC off. When a spacecraft is receiving an uplink from one station and its coherent downlink is being received by another station, the downlink is said to be “three-way” coherent.

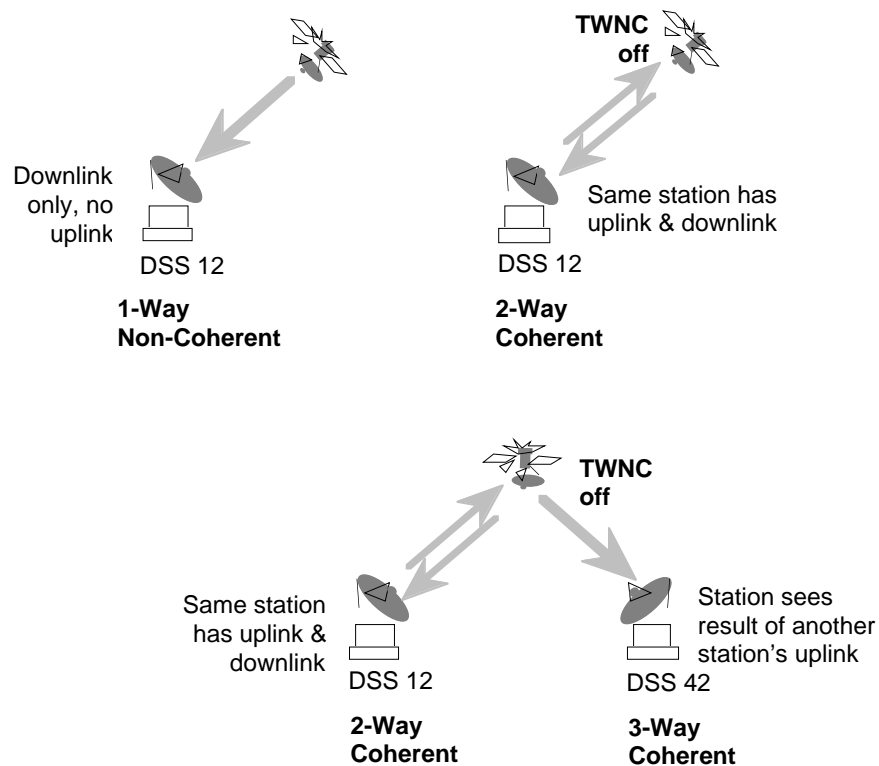

Recap

1. The subject of telecommunications is covered further by a separate Space Flight Operations Multi-team Training Module for employees at JPL, “ _____ - ____ - _____
_____ .”
2. When an uplink is being received by the spacecraft at the same time a downlink is being received at Earth, the communications mode is called _____ - _____.
3. Spacecraft carrier signals are modulated, not by turning off and on; but by shifting each waveform’s _____ slightly at a given rate.
4. A spacecraft downlink, based on and coherent with an uplink, has the same extraordinarily high _____ stability as does the massive hydrogen maser-based system in its controlled environment.
5. A spacecraft’s downlink is _____ when it is two-way with TWNC off.

1. *End-to-end Information System* 2. *two-way* 3. *phase* 4. *frequency* 5. *coherent*

Chapter 11. Typical Onboard Subsystems

Objectives: Upon completion of this chapter you will be able to describe a typical spacecraft structural subsystem, the role of data handling subsystems, attitude and articulation control subsystems, telecommunications subsystems, electrical power and distribution subsystems, and propulsion subsystems on typical spacecraft. You will be able to list advanced technologies being considered for use on future spacecraft.

Subsystems and Systems

Individual spacecraft can be very different from one another, and they display many different approaches to solving similar problems. Some newer spacecraft are designed to be smaller and less massive than some of their predecessors. Yet there are common functions that are carried out by many deep-space traveling robots, no matter how massive or miniature the spacecraft. Not all classifications of spacecraft have the same subsystems, though. Atmospheric balloon packages, for example, are simple packages compared to a typical orbiter. The following discussions address a number of different subsystems that satisfy the requirements typical of orbiter or flyby class spacecraft. Subsystems typical of the ones described below become integrated into a total space flight system, the spacecraft.

Structural Subsystems

The spacecraft bus is a major part of the structural subsystem which provides a place to attach components internally and externally, and to house delicate modules requiring the protection of an environment with a measure of thermal and mechanical stability. It is an integral card chassis for supporting the circuit boards of radio equipment, data recorders, computers, gyroscopes, and other components. The bus also establishes the basic geometry of the spacecraft, and it provides the attachment points for appendages such as booms, antennas, and scan platforms. It also provides attachment points that allow movement of the spacecraft during construction, testing, transportation, and launch.

The magnetometer boom is typically the longest appendage on a spacecraft. Since magnetometers (discussed in Chapter 12) are sensitive to electric currents and ferrous components on or near the spacecraft bus, they are placed at the greatest practical distance from them on a boom. The Voyager magnetometers are mounted 6 and 13 meters out the boom from the spacecraft bus. At launch, the mag boom, constructed of thin, non-metallic rods, is typically collapsed very compactly into a protective canister. Once deployed in flight, it cannot be retracted.

Data Handling Subsystems

The onboard computer responsible for overall management of a spacecraft's activity is generally the same one which maintains timing, interprets commands from Earth, collects, processes, and

formats the telemetry data which is to be returned to Earth, and manages high-level fault protection and safing routines. This computer is sometimes referred to as the command and data subsystem (CDS). For convenience, that term will be used here, recognizing that other names may apply to similar subsystems or sets of subsystems which accomplish some or all of the same tasks. Some examples are: Command and Data Handling subsystem (C&DH), Computer Command subsystem (CCS), and Flight Data Subsystem (FDS).

A portion of the CDS memory is managed as storage space for command sequences and programs uplinked from Earth. These sequence loads are typically created by the project's sequence team with inputs from the spacecraft team and the science teams.

Spacecraft Clock

The spacecraft clock (SCLK, pronounced "sklock") is a counter maintained by the CDS. It meters the passing of time during the life of the spacecraft. Nearly all activity within the spacecraft systems is regulated by the SCLK. The spacecraft clock may be very simple, incrementing every second and bumping its value up by one, or it may be more complex, with several main and subordinate fields that can track and control activity at multiple granularities. The Ulysses clock, for instance, increments its single field by one count every two seconds. The Galileo and Magellan clocks, on the other hand, consist of four fields of increasing resolution. Many types of commands uplinked to the spacecraft are set to begin execution at specific SCLK counts. In the downlinked telemetry, SCLK counts indicating telemetry-frame creation time are included with engineering and science data to facilitate processing, distribution, and analysis.

Telemetry Packaging and Coding

The telemetry returned from JPL spacecraft is typically a mixture of science data from the experiments and spacecraft engineering or health data. These data from science instruments and spacecraft subsystems' transducers are received at the CDS, where they are assembled into quanta appropriate to the telemetry frame or packet scheme in use. If the spacecraft is transmitting data in real time, the packet or frame may be sent to the transmitter. Otherwise, telemetry may be written to a mass storage device such as tape recorder or stored in RAM until transmission is feasible.

Spacecraft engineering or health data is composed of a wide range of measurements, from switch positions and subsystem states to voltages, temperatures, and pressures. Literally thousands of these "channels" of data (so named because repetitive measurements are identified with a single multiplexing division or channel) are collected and inserted into the telemetry. A spacecraft may use one or more of a variety of multiplexing schemes to downlink and display all the various measurements.

The capability to alter the telemetry format and content must be provided in order to accommodate various mission phases or downlink rates, as well as to enable diagnosis of anomalies. In the case of anomalies, it may be necessary to temporarily terminate the collection of science data and to return only an enriched or specialized stream of engineering and housekeeping data.

Some data processing may take place within the CDS before science and engineering data are stored or transmitted. Data compression may be applied to reduce the number of bits to be transmitted, and encoding is applied to take advantage of error-correcting schemes that reduce data loss. Viterbi encoding (characterized as "maximum likelihood convolutional coding"), Golay, and Reed-Solomon encoding are commonly used for this purpose. Though some over-

head is added to the telemetry stream, the net effect is that more data are transmitted and successfully received error-free per unit time. The data are decoded once captured by the DSN.

Data Storage

It is rare for a mission to be provided the constant support of real-time tracking. For this and other reasons, spacecraft data handling subsystems are provided with one or more data storage devices such as tape recorders, or the solid-state equivalent of tape recorders that store large quantities of data in banks of RAM without any moving parts. The storage devices are commanded to play out their stored data for downlink when DSN resources are available.

Fault Protection

A robotic space flight system must have the intelligence and autonomy to monitor and control itself to a degree throughout its useful life at a great distance from Earth. Though ground teams also monitor and control the spacecraft, the ever-increasing light time limits the ability to respond to conditions on the spacecraft in a timely manner. Fault protection algorithms, which normally reside in more than one of the spacecraft's subsystems, insure the ability both to prevent a mishap and to re establish contact with Earth if a mishap occurs and contact is interrupted. Among the capabilities devised is safing—shutting down or reconfiguring components to prevent damage either from within or from the external environment. Another fault protection capability is an automated, methodical search to re-establish Earth-pointing and regain communications. Usually a minimal set of safing instructions is installed in ROM (1K on Magellan) where it can hide from even the worst imaginable scenarios of runaway computer program execution or power outage. More intricate safing routines (also called “contingency modes”) and fault protection routines reside in RAM, as well as parameters for use by the ROM code, where they can be updated as necessary during the life of the mission.

One example of a common fault-protection routine is the Command-Loss Timer. This is a software timer running in CDS which is reset to a predetermined value every time the spacecraft receives a command from Earth. If the timer decrements all the way to zero, the assumption is that the spacecraft has experienced a failure in its receiver or command decoder, or other hardware in the command string. The routine takes actions such as swapping to redundant hardware in an attempt to re establish the ability to receive commands.

Recap

1. Subsystems... become integrated into a total space flight _____, the spacecraft.
2. The _____ establishes the basic geometry of the spacecraft, and provides the attachment points for appendages.
3. A portion of the CDS memory is managed as storage space for _____ and programs uplinked from Earth.
4. Many types of commands uplinked to the spacecraft are set to begin execution at specific _____ counts.
5. _____ encoding (characterized as “maximum likelihood convolutional coding”), Golay, and Reed-Solomon encoding are commonly used.
6. _____ algorithms... insure the ability both to prevent a mishap and to re-establish contact with Earth if contact is interrupted.

1. system 2. bus 3. command sequences 4. SCLK 5. Viterbi 6. Fault protection

Attitude and Articulation Control Subsystems

A spacecraft's attitude, its orientation in space, must be stabilized and controlled so that its high-gain antenna may be accurately pointed to Earth, so that onboard experiments may accomplish precise pointing for accurate collection and subsequent interpretation of data, so that the heating and cooling effects of sunlight and shadow may be used intelligently for thermal control, and so that propulsive maneuvers may be executed in the right direction.

Stabilization can be accomplished by setting the vehicle spinning, as do the Pioneers 10 and 11 spacecraft in the outer solar system and the Galileo spacecraft orbiting Jupiter. The gyroscopic action of the rotating spacecraft mass is the stabilizing mechanism. Propulsion system thrusters are fired to make desired changes in the spin-stabilized attitude.

Alternatively, the spacecraft may be designed for active three-axis stabilization. One method is to use small propulsion-system thrusters to nudge the spacecraft back and forth within a deadband of allowed attitude error. Voyagers 1 and 2 have been doing that since 1977. Another method is to use electrically-powered reaction wheels, also called momentum wheels. Massive wheels are mounted in three orthogonal axes aboard the spacecraft. To rotate the vehicle in one direction, you spin up the proper wheel in the opposite direction. To rotate the vehicle back, you slow down the wheel. Excess momentum that builds up in the system due to external torques (caused, for example, by solar photon pressure or gravity gradient), must be occasionally removed from the system via propulsive maneuvers.

There are advantages and disadvantages to either approach. Spin stabilized craft provide a continuous sweeping desirable for fields and particles instruments, but they may require complicated systems to de-spin antennas or optical instruments which must be pointed at targets. Three-axis controlled craft can point optical instruments and antennas without having to de-spin them,

but they may have to carry out rotation maneuvers to best utilize their fields and particle instruments.

The attitude and articulation control subsystem (AACS) computer manages the tasks involved in stabilization via its interface equipment. For attitude reference, star trackers, star scanners, solar trackers, sun sensors, and planetary limb trackers come into use. Voyager's AACS uses a sun sensor for yaw and pitch reference, and a star tracker trained continuously on a bright star at right angles to sunpoint for roll reference. Galileo takes its references from a star scanner which rotates with the spinning part of the spacecraft, and a sun gate is available for use in maneuvers. Magellan used a star scanner to take a fix on two bright stars during a special maneuver once every orbit or two, and its solar panels each had a sun sensor.

Gyroscopes are carried for attitude reference for those periods when celestial references are not being used. For some spacecraft, such as Magellan, this is the case nearly continuously, since celestial references are used only during star scan maneuvers once every orbit or two. Other spacecraft are designed to use celestial reference nearly continuously, and they rely on gyroscopes for their attitude reference only during relatively short maneuvers when celestial reference is lost. In either case, gyro data must be taken with a grain of salt; today's gyroscopes are mechanical, so they precess and drift due to internal friction. Great pains are taken to calibrate their rates of drift, so that the AACS may compensate for it when it computes its attitude knowledge.

AACS also controls the articulation of a spacecraft's moveable appendages such as solar panels, high-gain antennas, de-spun components, or optical instrument scan platforms. The AACS is a likely candidate for doing this because it keeps track of the spacecraft's attitude, the sun's and Earth's locations, and it can compute the direction to point the appendages.

Telecommunications Subsystems

This section deals specifically with telecommunications equipment on board a spacecraft. A broader view of the whole telecommunications system, including Earth-based components may be found in Chapter 10.

Telecommunications subsystem components are chosen for a particular spacecraft in response to the requirements of the mission profile. Anticipated maximum distances, planned frequency bands, data rates and available on-board transmitter power are all taken into account. Each of the components of this subsystem is discussed below:

High-Gain Antennas

Dish-shaped high-gain antennas (HGAs) are the spacecraft antennas principally used for communications with Earth. The amount of gain achieved by an antenna (indicated in this workbook as high, low, or medium) refers to the amount of incoming radio power it can collect and focus into the spacecraft's receiving subsystems. In the frequency ranges used by spacecraft, this means that HGAs incorporate large paraboloidal reflectors. The cassegrain arrangement, described in Chapter 6, is the HGA configuration used most frequently aboard interplanetary spacecraft. Ulysses, which uses a prime focus feed, is one exception.

HGAs may be either steerable or fixed to the spacecraft bus. The Magellan HGA, which also served as a radar antenna for mapping (and as a drogue for aerobraking), was not articulated; the whole spacecraft had to be maneuvered to point the HGA to Earth for communications.

Magellan's HGA, by the way, also served as a fine sunshade. Mission ops people routinely pointed it to the sun in order to provide some needed shade for the rest of the spacecraft.

The Mars Global Surveyor HGA is on an articulated arm to allow the antenna to maintain Earth-point independent of the spacecraft's attitude while it maps the surface of Mars. Galileo's HGA was designed to unfold like an umbrella after launch. This enabled the use of a larger diameter antenna than would have fit in the Space Shuttle cargo bay if a fixed antenna had been chosen. However, the project has been unable to fully deploy the antenna, thus severely limiting communications with the spacecraft. Efforts to overcome this problem have not met with success, and the project is carrying out the mission using Galileo's low gain antennas constrained to low data rates. Now onboard software and improvements in the DSN will permit recovery of 70% of the originally planned science data.

The larger the collecting area of an HGA, the higher the gain, and the higher the data rate it will support. The higher the gain, the more highly directional it is. When using an HGA, it must be pointed to within a fraction of a degree of Earth for communications to be feasible. Once this is achieved, communications may take place at a high rate over the highly focused radio signal. This is analogous to using a telescope, which provides magnification (gain) of a weak light source, but it requires accurate pointing. No magnification is achieved with the naked eye, but it covers a very wide field of view, and need not be pointed with great accuracy to detect a source of light, as long as it is bright enough. In case AACS fails to be able to point a spacecraft's HGA with high accuracy for one reason or another, there must be some other means of communicating with the spacecraft.

Low-gain Antennas

Low-gain antennas (LGAs) provide wide-angle coverage (the "naked-eye," to continue the analogy) at the expense of gain. Coverage is nearly omnidirectional, except for areas that may be shadowed by the spacecraft body. LGAs are designed to be useable for relatively low data rates, as long as the spacecraft is within relatively close range, several AU for example, and the DSN transmitter is powerful enough. Magellan could use its LGA at Venus's distance, but Voyager must depend on its HGA since it is over 40 AU away. Some LGAs are mounted atop the HGA's subreflector, as in the following diagram. This is the case with Voyager, Magellan, and Galileo. A second LGA, designated LGA 2, was added to the Galileo spacecraft in the redesign which included an inner-solar system gravity assist. LGA-2 faces aft, providing Galileo with fully omnidirectional coverage by accommodating LGA-1's blind spots.

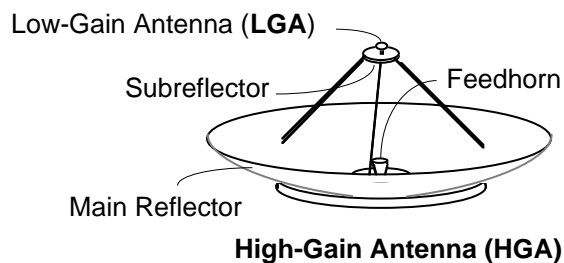

Medium-gain Antennas

MGAs are a compromise, providing more gain than an LGA, with wider angles of pointing coverage than an HGA, on the order of 20 or 30 degrees. Magellan carried an MGA consisting of

a large cone-shaped feed horn, which was used during some maneuvers when the HGA is off Earth-point.

Spacecraft Transmitters

A transmitter is an electronic device which generates a tone at a single designated radio frequency, typically in the S-band (~2 GHz) or X-band (~5 GHz) range. This tone is called the carrier. The carrier can be sent from the spacecraft to Earth as it is, or it can be modulated with a data carrying subcarrier within the transmitter. The signal generated by the spacecraft transmitter is passed to a power amplifier, where its power is boosted to the neighborhood of tens of watts. This microwave-band power amplifier may be a solid state amplifier (SSA) or a traveling wave tube (TWT, also TWTA, pronounced “tweeta,” for TWT Amplifier). A TWTA uses the interaction between the field of a wave propagated along a waveguide, and a beam of electrons traveling along with the wave. The electrons tend to travel slightly faster than the wave, and on the average are slowed slightly by the wave. The effect amplifies the wave’s total energy.

Travelling Wave Tube Amplifier

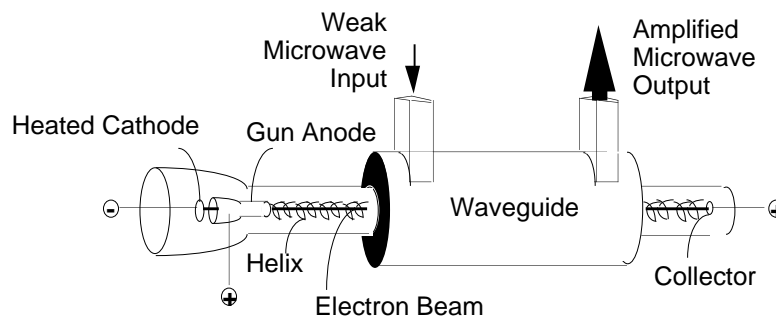

The output of the power amplifier is ducted through waveguides and commandable waveguide switches to the antenna of choice: HGA, MGA, or LGA.

Spacecraft Receivers

Commandable waveguide switches are also used to connect the antenna of choice to a receiver. The receiver is an electronic device that is sensitive to a narrow band of frequency, generally a width of plus and minus a few kHz of a single frequency selected during mission design. Once an uplink is detected within its bandwidth, the receiver’s phase lock-loop circuitry (PLL) will follow any changes in the uplink’s frequency within its bandwidth. JPL invented PLL technology in the early 1960s, which has since become standard in the telecommunications industry. The receiver can provide the transmitter with a frequency reference keyed to the received uplink. The received uplink, once detected, locked onto, and stepped down in frequency, is stripped of its command-data-carrying subcarrier, which is passed to circuitry called a command detector unit (CDU). This unit converts the analog phase-shifts which were modulated onto the uplink’s subcarrier into binary 1s and 0s, which are then typically passed to the spacecraft’s CDS.

Frequently, transmitters and receivers are combined into one electronic device which is called a transponder.

Recap

1. When using an _____, it must be pointed to within a fraction of a degree of Earth.
2. LGA coverage is nearly _____, except for areas shadowed by the spacecraft body.
3. The output of the _____ is ducted through waveguides and commandable waveguide switches to the antenna.
4. The receiver's _____ - _____ - _____ circuitry will follow any changes in the uplink's frequency.

1. HGA 2. omnidirectional 3. power amplifier 4. phase-lock loop

Electrical Power Supply and Distribution Subsystems

Roughly between 300 W and 2.5 kW of electricity is required to power a spacecraft the likes of Voyager, Galileo, or Magellan. The power supply must provide a large percentage of its rated power over a lifetime measured in years or decades. Choices of technology to meet these requirements are constrained largely to two: photovoltaics and radioisotope thermo-electric generators (RTGs).

Photovoltaics

As the term suggests, photovoltaic materials convert light to electricity. Crystalline silicon and gallium arsenide are typical choices of materials for deep-space applications. Gallium arsenide crystals are grown especially for photovoltaic use, but silicone crystals are available in less-expensive standard ingots which are produced mainly for consumption in the microelectronics industry.

When exposed to direct sunlight at 1 AU, a current of about an ampere at 0.25 volt can be produced by a 6-cm-diameter silicon cell. Gallium arsenide is notably tougher and more efficient. Crystalline ingots are sliced into wafer-thin circles, and metallic conductors are deposited onto each surface: a thin grid on the sun-facing side and a flat sheet on the other. Spacecraft solar panels are constructed of these cells trimmed into appropriate shapes and cemented onto a substrate, and electrical connections are made in series-parallel to determine total output voltage. The cement and the substrate must be thermally conductive, because in flight the cells absorb a lot of infra-red energy and want to reach high temperatures. They are more efficient when kept to lower temperatures. The resulting assemblies are called solar panels or solar arrays.

Solar power is practical for spacecraft operating no farther from the sun than about the orbit of Mars. Magellan and Mars Observer used solar power, as will Mars Global Surveyor and Pathfinder. Topex/ Poseidon, the Hubble Space Telescope, and most other Earth orbiters use solar power. The solar panels must be aimed so that they may be maintained at optimum sun point, and they may be off-pointed slightly for periods when it may be desirable to generate less power.

Prolonged exposure to sunlight causes photovoltaics' performance to degrade in the neighborhood of a percent or two per year, and more rapidly if exposed to particle radiation from solar flares.

Radioisotope Thermoelectric Generators

Radioisotope thermoelectric generators (RTGs), are used when spacecraft must operate at significant distances from the sun (usually beyond the orbit of Mars), or where the availability of sunlight and therefore the use of solar arrays is otherwise infeasible. RTGs as currently designed for space missions contain several kilograms of an isotopic mixture of the radioactive element plutonium in the form of an oxide, pressed into a ceramic pellet. The primary constituent of these fuel pellets is isotope 238 (Pu-238). The pellets are arranged in a converter housing and function as a heat source to generate the electricity provided by the RTG. The radioactive decay of the plutonium produces heat, some of which is converted into electricity by an array of thermocouples made of silicon germanium junctions. Waste heat is radiated into space from an array of metal fins.

Plutonium, like all radioactive materials and many non-radioactive materials, can be a health hazard under certain circumstances and in sufficient quantity. RTGs are designed, therefore, with the goal of surviving credible launch accident environments without releasing plutonium. The safety design features of RTGs are tested by the US Department of Energy to verify the survival capabilities of the devices.

Presidential approval is required for the launch of RTGs. Prior to the launch of a spacecraft carrying an RTG, a rigorous safety analysis and review is performed by the Department of Energy, and the results of that analysis are evaluated by an independent panel of experts. These analyses and reviews are used by the Office of Science and Technology Policy (OSTP) in the White House to evaluate the overall risk presented by the mission.

RTGs must be located on the spacecraft in such a way as to minimize their impact on particle-detecting or infra-red detecting science instruments. Galileo's RTGs are mounted behind shields to shade the near-infrared mapping spectrometer from their thermal radiation. Much of the spacecraft's mass shields Galileo's high-energy particle detector instrument from the RTG's gamma radiation.

RTGs performance degrades in flight about one to two percent per year, which is slightly faster degradation than for photovoltaics.

Electrical Power Distribution

Virtually every electrical or electronic component on a spacecraft may be switched on or off via command. This is accomplished using solid-state or mechanical relays which connect or disconnect the component from the common distribution circuit, called a main bus. On some spacecraft, it is necessary to power off some set of components before switching others on, in order to keep the electrical load within the limits of the supply. Voltages are measured and telemetered from the main bus and a few other points in the electrical system, and currents are measured and telemetered for many individual spacecraft components and instruments to show their consumption.

Typically, a shunt-type regulator maintains a constant voltage from the power source. The voltage applied as input to the shunt regulator is generally variable but higher than the spacecraft's required constant bus voltage. The shunt regulator converts excess electrical energy into heat, which is radiated away into space via a radiating plate. On spacecraft equipped with articulating solar panels, it is sometimes possible, and desirable for reasons of spacecraft thermal control, to off-point

the panels from the sun to reduce the regulator input voltage, and thus reduce the amount of heat generated by the regulator.

Electrical Power Storage

Spacecraft that use photovoltaics usually are equipped with rechargeable batteries, which receive a charge from the main bus when the solar panels are in the sunlight, and discharge into the bus to maintain its voltage whenever the solar panels are shadowed by the planet or off pointed during spacecraft maneuvers. Nickel-cadmium batteries are frequently used. After hundreds of charge-discharge cycles, this type of battery degrades in performance, but may be rejuvenated by carefully controlled deep discharge and recharge, an activity called reconditioning.

Recap

1. Roughly between _____ and _____ of electricity is required to power a spacecraft the likes of Voyager, Galileo, or Magellan.
2. _____ materials convert light to electricity.
3. In RTGs... thermal radiation is converted directly into electricity by an array of _____ made of silicon-germanium junctions.
4. The shunt regulator converts excess electrical energy into _____, which is radiated away into space.

1. 300 W and 2.5 kW 2. photovoltaic 3. thermocouples 4. heat

Environmental Subsystems

Passive Cooling

Active cooling systems are generally not practical on interplanetary spacecraft. Instead, painting, shading, and other techniques provide efficient passive cooling. Internal components will radiate more efficiently if painted black, helping to transfer their heat to the outside. White thermal blankets reflect IR, helping to protect the spacecraft from excess solar heating. Gold is a very efficient IR reflector, and is used to shade critical components. Optical solar reflectors (OSRs), which are quartz mirror tiles, may be used for the same purpose. They were used extensively on Magellan, including the back side of solar panels. Mechanical louvers are frequently used to control thermal radiation from within parts of a spacecraft. Bi-metallic strips, not unlike the ones in a wall thermostat, mechanically open or close the louvers to retain or release IR.

Active Heating

Resistive electric heaters, controlled either autonomously or via command, are applied to various components to keep them above their minimum allowable temperatures. Radioisotope heaters,

typically containing small amounts of plutonium, are installed where necessary to provide components with a permanent supply of heat.

Micro-meteoroid Protection

Tough blankets made with Kevlar or other strong fabrics cover interplanetary spacecraft to absorb the energy from high-velocity micro meteoroids before they can do any damage to spacecraft components. These hazards are greatest when crossing the ring planes of the Jovian planets. Voyager recorded thousands of hits in these regions, fortunately from particles about the size of particles of smoke. Spacecraft sent to comets, such as Giotto, carry massive shields to protect from hits by larger particles.

Jovian Radiation

Bringing a spacecraft into close proximity to Jupiter presents a radiation hazard mostly from ionized particles in the Jovian environment. Spacecraft designed to carry out observations at Jupiter must be designed with radiation-hardened components and shielding. Spacecraft using Jupiter for a gravity-assist course correction are also exposed to a harsh radiation dose. Instruments not intended to operate at Jupiter must be protected by being powered off and by having detectors covered. Components on such a spacecraft must be selected with the Jovian environment in mind.

Propulsion Subsystems

In order to maintain or restore three-axis stability, to control spin, to execute maneuvers and make minor adjustments in trajectory, spacecraft are provided with sets of propulsive devices. The more powerful devices are usually called engines, and they may provide a force of several hundred Newtons. These may be used to provide the large torques necessary to maintain stability during a solid rocket motor burn, or they may be the only rockets used for orbit insertion.

The set of smaller devices, generating between less than 1 N and 10 N, are typically used to provide the delta-V for interplanetary trajectory correction maneuvers, orbit trim maneuvers, reaction wheel desaturation maneuvers, or routine three-axis stabilization or spin control.

Other components of propulsion subsystems include propellant tanks, plumbing circuits with electrically or pyrotechnically operated valves, and helium tanks to supply pressurization for the propellant tanks. Some propulsion subsystems, such as Galileo's, use hypergolic propellants—two compounds stored separately which ignite spontaneously upon being mixed in the engines or thrusters. Other spacecraft use hydrazine, which decomposes explosively when brought into contact with an electrically heated metallic catalyst within the engines or thrusters. Cassini, whose propulsion system appears in the following diagram, uses both hypergolics and hydrazine monopropellant. Many of the activities of propulsion subsystems are routinely initiated by AACS. Some or all may be directly controlled by or through CDS.

Cassini's Propulsion System

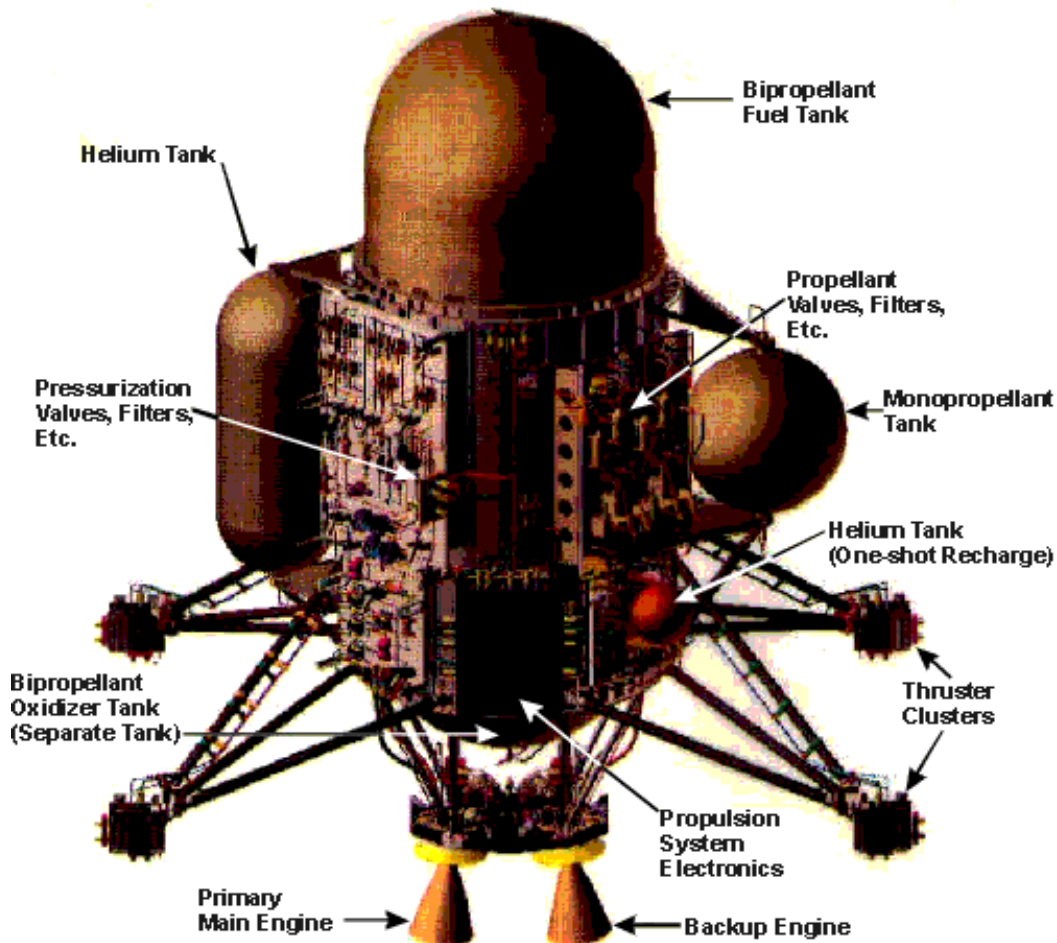

Pyrotechnic Subsystems

Electrically initiated pyrotechnic devices are used to operate certain valves, ignite solid rocket motors, and explode bolts to separate from or jettison hardware, or to deploy appendages. They obtain their electrical power from a bank of capacitors which are charged from the main bus several minutes prior to the planned detonation of a device. Typically called a pyrotechnic switching unit (PSU), this device helps to insure successful initiation of the pyrotechnic device, and also protects the main bus from a momentary power drain when a pyro device is activated.

Block Diagram Illustration

The block diagram on the next page illustrates the combination of many of the subsystems discussed in this chapter into a space flight system, the Magellan spacecraft. Magellan carried only one science instrument, the Radar Subsystem, depicted in the lower right. Otherwise, the spacecraft had many subsystems which are typical of those found on many other spacecraft.

Boxes within the diagram are shown double or triple, to indicate the presence of two or three units of the same name. The numbers 12, 4, and 8 below the rocket engines indicate the quantity of each kind installed.

Block Diagram of Magellan Space Flight System

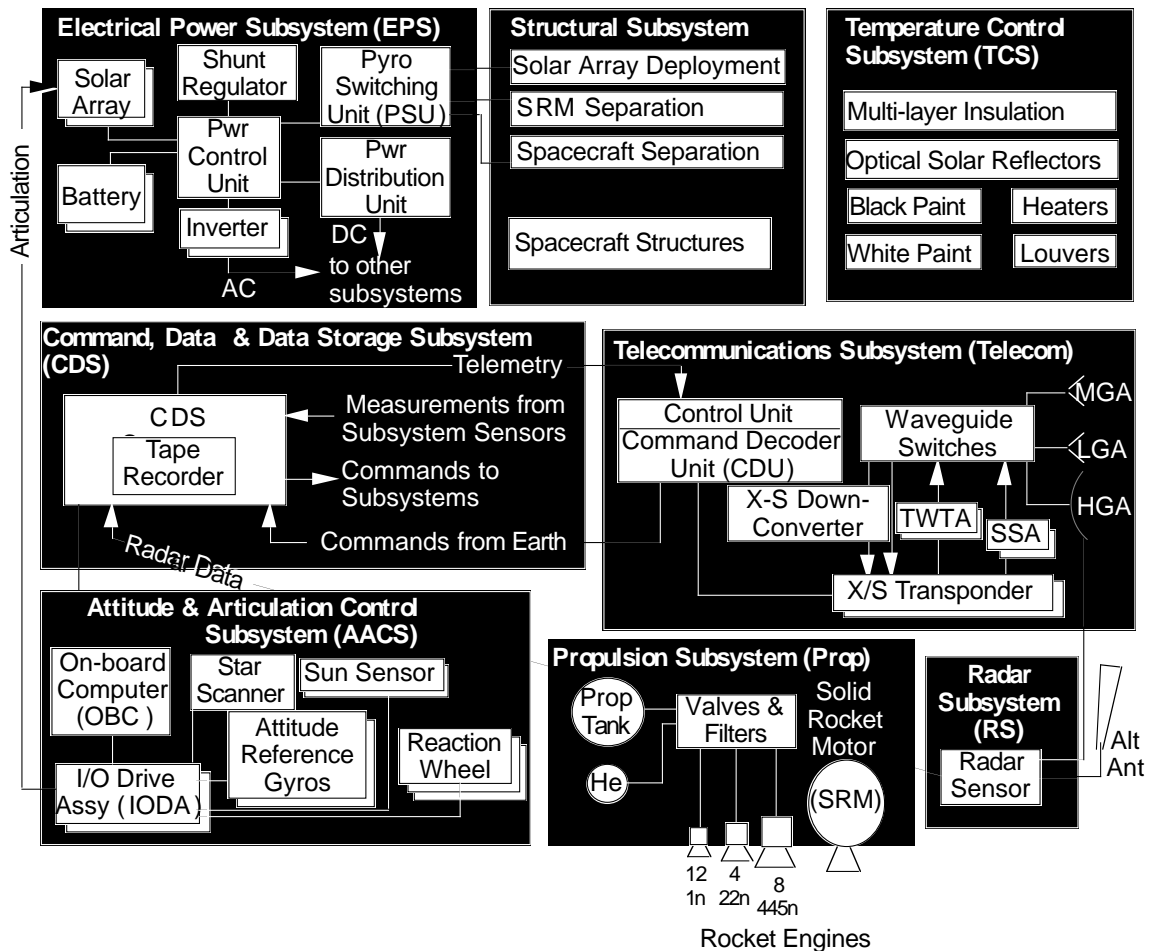

Redundancy and Flexibility

The hallmark of modern automated spacecraft is flexibility: the ability to maintain or restore functionality after component failure, or to increase or extend functionality based on newly conceived techniques. Components fail unexpectedly during the life of a mission. Most of those upon which the success of the mission depends have redundant backups, and the means to reroute functional flow to accommodate their use either autonomously or via commanding in real time. Several spacecraft continue to operate today, such as Voyager and Pioneer, returning valuable science data long after their primary missions have been completed, thanks entirely to the on-board availability of redundant transmitters, receivers, tape recorders, gyroscopes, antennas, and the all-important ability to modify on-board flight software.

Advanced Technologies

Ongoing research at JPL and other institutions is producing new technologies for less costly and more capable, reliable and efficient spacecraft for future space missions throughout and beyond the solar system. Advances in such areas as spacecraft power, propulsion, communications, data handling systems, pointing control and materials is expected to increase by factors of 10 to 1000 the potential science returns from future missions.

The Space Power-100 (SP-100) Project at JPL is developing key components of a nuclear reactor power system for use in planet and asteroid exploring missions. An array of thermocouples converts heat from the reactor to provide more than 25 times the power of a typical RTG.

Once outside Earth's atmosphere and in freefall, solar-powered electric drives, or nuclear-powered electric drive systems, can be used to accelerate spacecraft. Ion engines produce thrust when a electrically charged propellant, such as xenon, is accelerated through a nozzle to a typical velocity of 50 km/sec. These electric engines use much less propellant than the most advanced chemical engines. With their high nozzle exit velocities, they can permit spacecraft to achieve the high velocities required for interplanetary or interstellar flight. Solar sails, which use solar radiation pressure in much the same way that a sailboat uses wind, may also provide a means for high-speed interplanetary or interstellar propulsion.

Another JPL research effort is developing an Autonomous Star Tracker to identify guide stars for more robust methods of attitude determination and recovery from loss of orientation. They may also provide instruments with the capability to track points of interest easily and eliminate the need for tedious mosaicking and overlapping of images.

Telecommunications systems are being developed to operate in K and Ku bands, higher frequencies than the current S- and X-band systems. Laser telecommunications systems are also being developed which modulate data onto beams of coherent light instead of radio. Among the advantages to laser telecom are low power consumption, much higher data rates, and reduced-aperture Earth stations. The pointing requirements for laser communication are much more stringent than for microwave radio communication. During Galileo's Earth-2 flyby enroute to Jupiter, JPL succeeded in transmitting laser signals to Galileo, which received them as points of light detected by the Solid State Imaging System (SSI). Additional experiments are being planned for Space Shuttle missions to transmit data by laser at very high rates, overcoming interference from sunlight.

Laser gyroscopes are being developed which replace the moving components of mechanical gyroscopes, which are very susceptible to wear, with kilometer-lengths of fiber optic coils, using the Doppler shift of light moving through them to sense spacecraft rotation rates.

The Thousand AU mission (TAU) previously under study at JPL, has been funded from the Director's discretionary fund. Its mission is to use many of these advanced technologies to fly a spacecraft to a distance of one thousand AU within 50 years flight time. Its objective would be to make measurements of stellar parallax, providing the next generation of astronomers a new dimension of data on stellar distances within our galaxy.

Recap

1. Mechanical _____ are frequently used to control thermal radiation from within parts of a spacecraft.
2. _____ propellants are two compounds stored separately which ignite spontaneously upon being mixed in the engines or thrusters.
3. Most components... upon which the success of the mission depends have redundant _____ .
4. Laser _____ systems are being developed which modulate data onto beams of light instead of radio.

1. louvers 2. Hypergolic 3. backups 4. telecommunications

This fold-out illustration of the Galileo Jupiter orbiter spacecraft, with its atmospheric probe, serves as an illustration to Chapters 11 and 12.

The Galileo Spacecraft

Science experiments are described in italics, and have blue connecting lines. Engineering components are shown with red connecting lines.

Spacecraft Spin Section: The spin section provides attitude control and stabilization for attitude control and command processing. Also houses science components such as radars, data storage tape recorder, and support systems.

Retro Propulsion Module (RPM): The entire propulsion system is a single module provided by the Federal Republic of Germany. It contains two AIC thrusters, two AIC thruster booms, one central 400N thruster, four tanks of fuel and oxidizer, and two tanks of helium pressurant. The HGS, RTGs, and Science Boom are also part of the spin section.

Spin Bearing Assembly (SBA): Connects the spin and the despun sections of the spacecraft. In addition to mechanical coupling, 48 slip-rings provide high-rate data, and rotary transformers provide a coupling for high-rate data. An optical encoder provides relative position information.

Spacecraft Despun Section: The scan platform and its optical instruments and the probe radio relay hardware are despun via the spin section. The despun atmospheric probe is carried as part of the despun section.

Spacecraft Spin: The spin section spins about the roll axis at roughly 3 rpm. The probe release maneuver and the Jupiter orbit insertion maneuver, the entire spacecraft spun together at about 10 RPM. Spin direction is indicated at left.

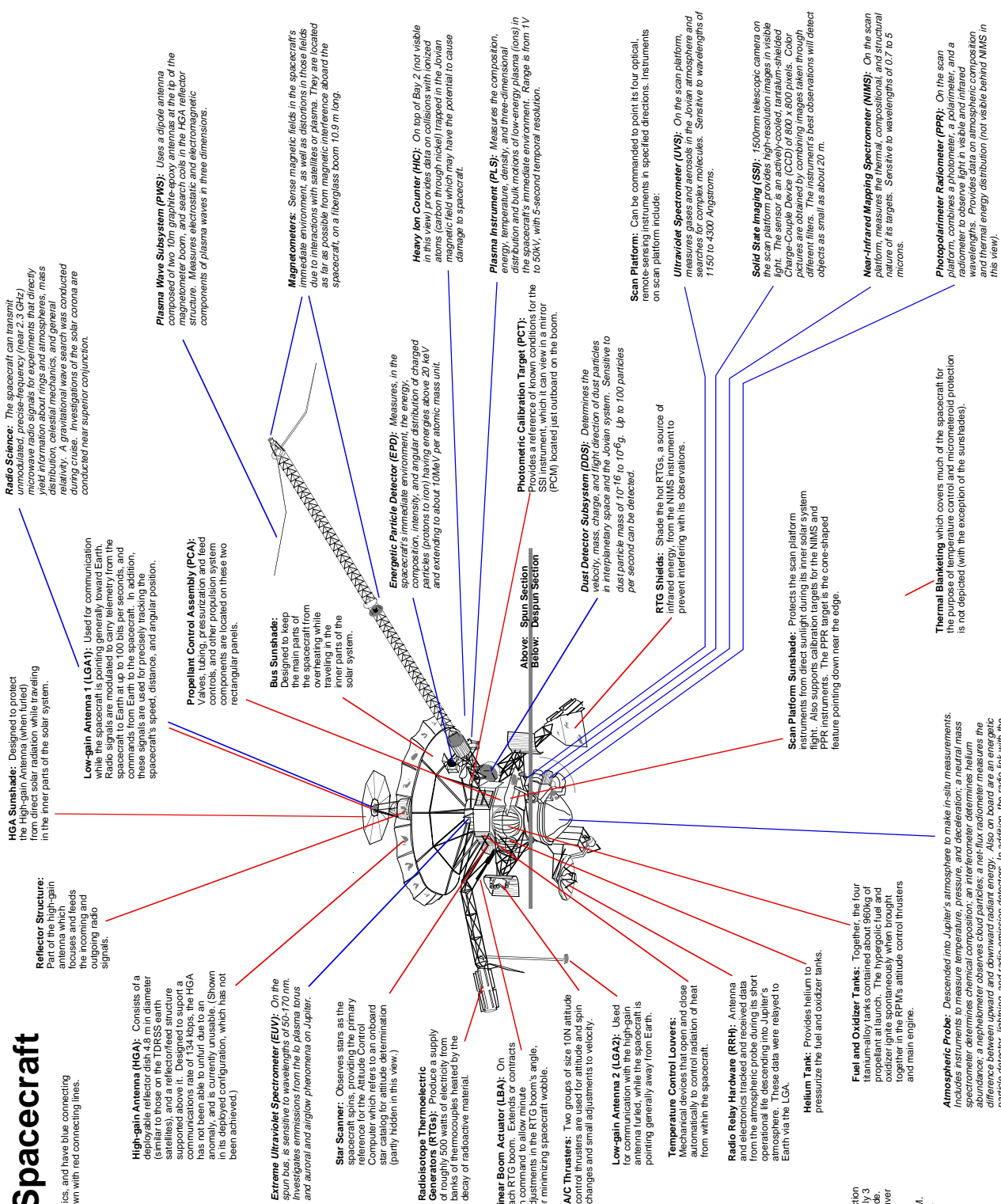

Radio Science: The spacecraft can transmit unmodulated, precise-frequency (near 2.3 GHz) microwave radio signals for experiments that directly measure the gravitational fields, mass distribution, equatorial bulge, and general relativity. A gravitational wave search was conducted during cruise. Investigations of the solar corona are conducted near superior conjunction.

Low-gain Antenna 1 (LGA1): Used for communication while the spacecraft is pointing generally toward Earth. Radio signals are modulated to carry telemetry from the spacecraft to Earth at up to 100 bits per second, and commands from Earth to the spacecraft. In addition, LGA1 is used for attitude control, speed, distance, and angular position.

Reflector Structure: Part of the high-gain antenna which focuses and feeds the incoming and outgoing radio signals.

High-gain Antenna (HGA): Consists of a deployable reflector dish 4.8 m in diameter (similar to those on the TDRSS earth satellites), and a reinforced structure (the antenna boom). Due to the HGA communications rate of 134 kbps, the HGA has not been able to unfurl due to an anomaly, and is currently unusable. (Shown in its deployed configuration, which has not been achieved.)

Extreme Ultraviolet Spectrometer (EUV): On the spin bus, is sensitive to wavelengths of 60-170 nm. Investigates emissions from the Io plasma torus and auroral and angular phenomena on Jupiter.

Star Scanner: Observes stars as the spacecraft spins, providing the primary reference for the Attitude Control Computer which refers to an onboard gyroscope for attitude determination (partly hidden in this view).

Radiosotope Thermoelectric Converter (RTG): Provides a supply of roughly 500 watts of electricity from banks of thermocouples heated by the decay of radioactive material.

Linear Boom Actuator (LBA): On each RTG boom. Extends or contracts adjustments in the RTG boom's angle, for minimizing spacecraft wobble.

A/C Thrusters: Two groups of size 10N attitude control thrusters are used for attitude and spin changes and small adjustments to velocity.

Low-gain Antenna 2 (LGA2): Used for communication with the high-gain antenna (unfurl), while the spacecraft is pointing generally away from Earth.

Temperature Control Louvers: Mechanical devices that open and close automatically to control radiation of heat from within the spacecraft.

Radio Relay Hardware (RRH): An antenna and electronics tracked and received data from the atmospheric probe during its short operational life descending into Jupiter's atmosphere. These data were relayed to Earth via the LGA.

Helium Tank: Provides helium to pressurize the fuel and oxidizer tanks.

Fuel and Oxidizer Tanks: Together, the four titanium-alloy tanks contained about 960kg of propellant at launch. The hypergolic fuel and oxidizer tanks are mounted together in the RPM's attitude control thrusters and main engine.

Atmospheric Probe: Descended into Jupiter's atmosphere to make in-situ measurements. Includes instruments to measure temperature, pressure, and deceleration; a neutral mass spectrometer determines chemical composition; an interferometer determines helium abundance; a nephelometer observes cloud particles; a net-flux radiometer measures the probe's radiative energy balance; a laser Doppler velocimeter measures the probe's velocity; a laser altimeter measures the probe's altitude; and a radio emission detector. The probe separated from the Orbiter in July, 1995, and successfully completed its mission on December 7, 1995.

Plasma Wave Subsystem (PWS): Uses a dipole antenna composed of two 10m graphite-epoxy antennas at the tip of the magnetometer boom, and search coils in the HGA reflector structure. Measures the electric and magnetic components of plasma waves in three dimensions.

Magnetometers: Sense magnetic fields in the spacecraft's immediate environment, as well as distortions in those fields due to interactions with satellites or plasma. They are located as far as possible from magnetic interference aboard the spacecraft, on a fiberglass boom 10.9 m long.

Heavy Ion Counter (HIC): On top of Bay 2 (not visible in this view) provides data on collisions with ionized atoms (carbon through nickel) trapped in the Jovian magnetic field which may have the potential to cause damage to spacecraft.

Plasma Instrument (PLS): Measures the composition, energy, temperature, density, and three-dimensional distribution and bulk motions of low-energy plasma (ions) in the spacecraft's immediate environment. Range is from 1V to 50kV, with 5-second temporal resolution.

Photometric Calibration Target (PCT): Provides a reference of known conditions for the SSI instrument, which it can view in a mirror (PCM) located just outboard on the boom.

Energetic Particle Detector (EPD): Measures, in the spacecraft's immediate environment, the energy, composition, intensity, and angular distribution of charged particles (protons to iron) having energies above 20 keV and extending to about 10MeV per atomic mass unit.

Above: Spin Section Below: Despun Section

Dust Detector Subsystem (DDS): Determines the velocity, mass, charge, and light direction of dust particles in interplanetary space and the Jovian system. Sensitive to dust particle mass of 10⁻¹⁶ to 10⁻⁶g. Up to 100 particles per second can be detected.

RTG Shields: Shade the hot RTGs, a source of infrared energy, from the NIMS instrument to prevent interfering with its observations.

Ultraviolet Spectrometer (UVS): On the scan platform, measures gases and aerosols in the Jovian atmosphere and interplanetary space. Sensitive to wavelengths of 1150 to 4300 Angstroms.

Solid State Imaging (SSI): 1500mm telescopic camera on the scan platform provides high-resolution images in visible light. The sensor is an actively-cooled, tantalum-shielded CCD array. Images are obtained by combining images taken through different filters. The instrument's best observations will detect objects as small as about 20 m.

Near-Infrared Mapping Spectrometer (NIMS): On the scan platform, measures the thermal, compositional, and structural characteristics of its targets. Sensitive to wavelengths of 0.7 to 5 microns.

Photodiode Radiometer (PDR): On the scan platform, combines a photometer, a radiometer, and a radiometer to observe light in visible and infrared wavelengths. Provides data on atmospheric composition and thermal energy distribution (not visible behind NIMS in this view).

Thermal Blanketing which covers much of the spacecraft for the purpose of temperature control and micrometeoroid protection is not depicted (with the exception of the sunshades).

Chapter 12. Typical Science Instruments

Objectives: Upon completion of this chapter you will be able to distinguish between remote and direct sensing, and state characteristics of remote sensing instruments, including radar, radiometers, and polarimeters. You will be able to state characteristics of direct-sensing instruments including plasma instruments, dust detectors, cosmic ray, energetic particle detectors, magnetometers, and planetary radio astronomy instruments.

Science Payload

The point has been made that our spacecraft are flown to do science. All the subsystems and components discussed up to this point serve the purpose of enabling science instruments and experiments to carry out their observations. A typical complement of science instruments covers large portions of the electromagnetic spectrum, from near DC to high energy particles, and includes both remote- and direct-sensing components.

Direct and Remote Sensing

Direct-sensing instruments interact with phenomena in their immediate vicinity, and register characteristics of them. The Heavy Ion Counter on Galileo uses direct sensing; it registers the characteristics of ions in the spacecraft's vicinity which enter the instrument. It does not attempt to form any image of the ions' source. Remote sensing instruments record characteristics of objects at a distance, sometimes forming an image by gathering, focusing, and recording reflected light from the sun, or reflected radar waves which were emitted by the spacecraft itself. When an instrument provides the illumination, as does radar, it is referred to as an active remote sensing instrument. If the illumination is not provided by the instrument, as in the case of cameras observing planets in sunlight, it is passive remote sensing.

Direct-Sensing Science Instruments

High-energy Particle Detectors

High-energy Particle Detector instruments measure the energy spectra of trapped energetic electrons, and the energy and composition of atomic nuclei. They may employ several independent solid-state-detector telescopes. The Cosmic Ray instrument on Voyager measures the presence and angular distribution of electrons of 3-110 MeV and nuclei 1-500 MeV from hydrogen to iron. The Energetic Particle Detector on Galileo is sensitive to the same nuclei with energies from 20 keV to 10 MeV.

Low-Energy Charged-Particle Detectors

A low-energy charged-particle detector (LECP) is a mid-range instrument designed to characterize the composition, energies, and angular distributions of charged particles in interplanetary

space and within planetary systems. One or more solid-state particle detectors may be mounted on a rotating platform. Voyager's LECP is sensitive from around 10 keV up into the lower ranges of the Cosmic Ray detector. Ulysses' LECP is similar, and is named GLG for its Principal Investigators Gloeckler and Geiss.

Plasma Instruments

Plasma detectors serve the low-end of particle energies. They measure the density, composition, temperature, velocity and three-dimensional distribution of plasmas, which are soups of positive ions and electrons, that exist in interplanetary regions and within planetary magnetospheres. Plasma detectors are sensitive to solar and planetary plasmas, and they observe the solar wind and its interaction with a planetary system.

Dust Detectors

Some spacecraft carry a dust detector which measures the velocity, mass, charge, flight direction and number of dust particles striking the instrument. Galileo's instrument can register up to 100 particles per second and is sensitive to particle masses of between 10^{-16} and 10^{-6} g.

Magnetometers

Magnetometers are direct-sensing instruments which detect and measure the interplanetary and solar magnetic fields in the vicinity of the spacecraft. They typically detect the strength of magnetic fields in three planes. As a magnetometer sweeps an arc through a magnetic field when the spacecraft rotates, an electrical signature is produced proportional to the strength and structure of the field.

Plasma Wave Detectors

Plasma wave detectors typically measure the electrostatic and electromagnetic components of local plasma waves in three dimensions. Plasma wave data provides key information on phenomena related to the interaction of plasma and particles that control the dynamics of a magnetosphere. The instrument functions like a radio receiver sensitive to the wave lengths of plasma in the solar wind, from about 10 Hz to about 60 kHz. When within a planet's magnetosphere, it can be used to detect atmospheric lightning, and events when dust and ring particles strike the spacecraft. Voyager's Plasma Wave data has been used to produce digital sound recordings of the particle bombardment the spacecraft experienced as it passed through the ring planes of the outer planets.

Remote-Sensing Science Instruments

Planetary Radio Astronomy Instruments

A planetary radio astronomy instrument measures radio signals emitted by a target such as a Jovian planet. The instrument on Voyager is sensitive to signals between about 1 kHz and 40 MHz, and uses a dipole antenna 10 m long, which it shares with the plasma wave instrument.

The planetary radio astronomy instrument detected emissions from the heliopause in 1993 (see the illustration in Chapter 1). Ulysses carries a similar instrument.

Imaging Instruments

Optical imaging is performed by two families of detectors: vidicons and the newer charge coupled devices (CCDs). Although the detector technology differs, in each case an image is focused by a telescope onto the detector, where it is converted to digital data. Color imaging requires three exposures of the same target, through three different color filters selected from a filter wheel. Ground processing combines data from the three black and white images, reconstructing the original color by utilizing the three values for each picture element (pixel).

A vidicon is a vacuum tube resembling a small CRT. An electron beam is swept across a phosphor coating on the glass where the image is focused, and its electrical potential varies slightly in proportion to the levels of light it encounters. This varying potential becomes the basis of the video signal produced. Viking, Voyager, and many earlier spacecraft used vidicon-based imaging systems.

A CCD is typically a large-scale integrated circuit which has a two dimensional array of hundreds of thousands of charge-isolated wells, each representing a pixel. Light falling on a well is absorbed by a photoconductive substrate, such as silicon, and releases a quantity of electrons proportional to the intensity of the light. The CCD detects and stores an accumulated electrical charge representing the light level on each well. These charges are subsequently read out for conversion to digital data. CCDs are much more sensitive to light of a wider spectrum than vidicon tubes, they are less massive, they require less energy, and they interface more easily with digital circuitry.

Galileo's Solid State Imaging instrument (SSI) contains a CCD with an 800 x 800 pixel array. The cameras on the Mars Observer spacecraft were unique in that they employed a single-dimensional CCD array. The orbital motion of the vehicle over the surface of Mars supplied the second dimension required for image formation.

Solid State Video Imaging With Charge-Coupled Device (CCD) Array System

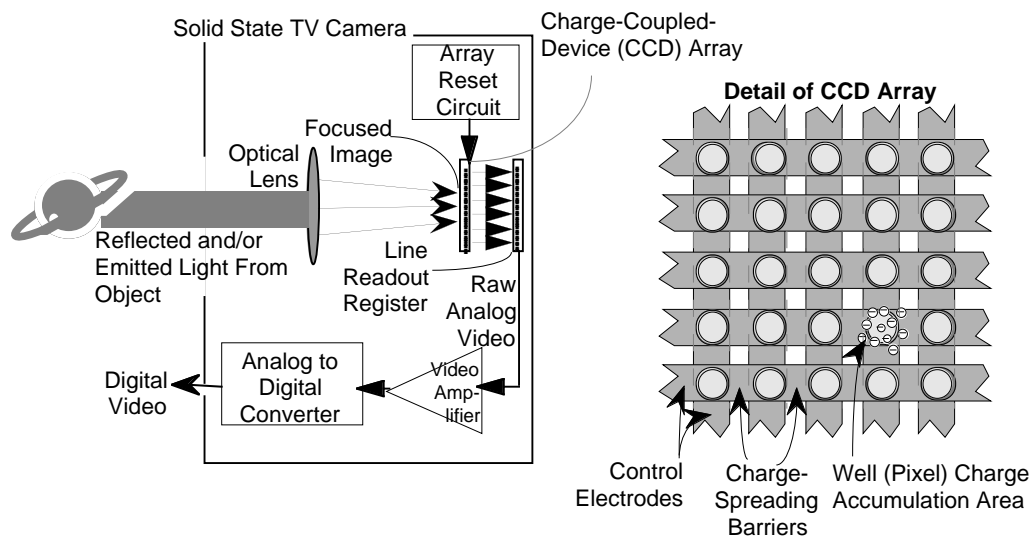

Polarimeters

Polarimeters are optical instruments which measure the direction and extent of the polarization of light reflected from their targets. Polarimeters consist of a telescope fitted with a selection of polarized filters and optical detectors. Careful analyses of polarimeter data can infer information about the composition and mechanical structure of the objects reflecting the light, such as various chemicals and aerosols in atmospheres, ring arcs, and satellite surfaces reflect light with differing polarizations. The molecules of crystals of most materials are optically asymmetrical; that is, they have no plane or center of symmetry. Asymmetrical materials have the power to rotate the plane of polarization of plane-polarized light.

Photometers

Photometers are optical instruments that measure the intensity of light from a source. They may be directed at targets such as planets or their satellites to quantify the intensity of the light they reflect, thus measuring the object's reflectivity or albedo. Also, photometers can observe a star while a planet's rings or atmosphere intervene during occultation, thus yielding data on the density and structure of the rings or atmosphere.

Spectrometers

Spectrometers are optical instruments which split the light received from objects into their component wavelengths by means of a diffraction grating. (A good example of a diffraction grating is the common compact disc which stores music or data in microscopic tracks. Observing a bright light shining on its surface demonstrates the effect which diffraction gratings produce, separating light into its wavelength, or color, components.) They then measure the amplitudes of the individual wavelengths. This data can be used to infer the composition and other properties of materials that emitted the light or which absorbed specific wavelengths of the light as it passed through the materials. This is useful in analyzing planetary atmospheres. Spectrometers carried on spacecraft are typically sensitive in the infrared and ultraviolet wavelengths. The near-infrared mapping spectrometer (NIMS) on Galileo maps the thermal, compositional, and structural nature of its targets using a two-dimensional array of pixels. (Spectroscopy was discussed in Chapter 6).

Infrared Radiometers

An infrared radiometer is a telescope-based instrument that measures the intensity of infrared (thermal) energy radiated by the targets. By filling the field of view completely with the disc of a planet and measuring its total thermal output, the planet's thermal energy balance can be computed revealing the ratio of solar heating to the planet's internal heating.

Combinations

Sometimes various optical functions are combined into a single instrument, such as photometry and polarimetry combined into a photopolarimeter, or spectroscopy and radiometry combined into a radiometer-spectrometer instrument.

Scan Platforms

Optical instruments are sometimes installed on an articulated, powered appendage to the spacecraft bus called a scan platform, which points in commanded directions, allowing optical observations to be taken independently of the spacecraft's attitude.

Active Sensing Science Instruments

Synthetic Aperture Radar Imaging

Some solar system objects that are candidates for radar imaging are covered by clouds or haze, making optical imaging difficult or impossible. These atmospheres are transparent to radio frequency waves, and can be imaged using Synthetic Aperture Radar (SAR) instruments, which provide their own penetrating illumination with radio waves. SAR synthesizes the angular resolving power of an antenna many times the size of the antenna aperture actually used. A SAR illuminates its target to the side of its direction of movement, and travels a distance in orbit while the reflected, phase shift-coded pulses are returning and being collected. This provides the basis for synthesizing an antenna (aperture) on the order of kilometers in size, using extensive computer processing.

For a SAR system to develop the resolution equivalent to optical images, the spacecraft's position and velocity must be known with great precision, and its attitude must be controlled tightly. This levies demands on the spacecraft's AACS and requires spacecraft navigation data to be frequently updated. SAR images are constructed of a matrix where lines of constant distance or range intersect with lines of constant Doppler shift.

Magellan's radar instrument alternated its active operations as a SAR imaging system and radar altimeter, with a passive microwave radiometer mode several times per second in orbit at Venus.

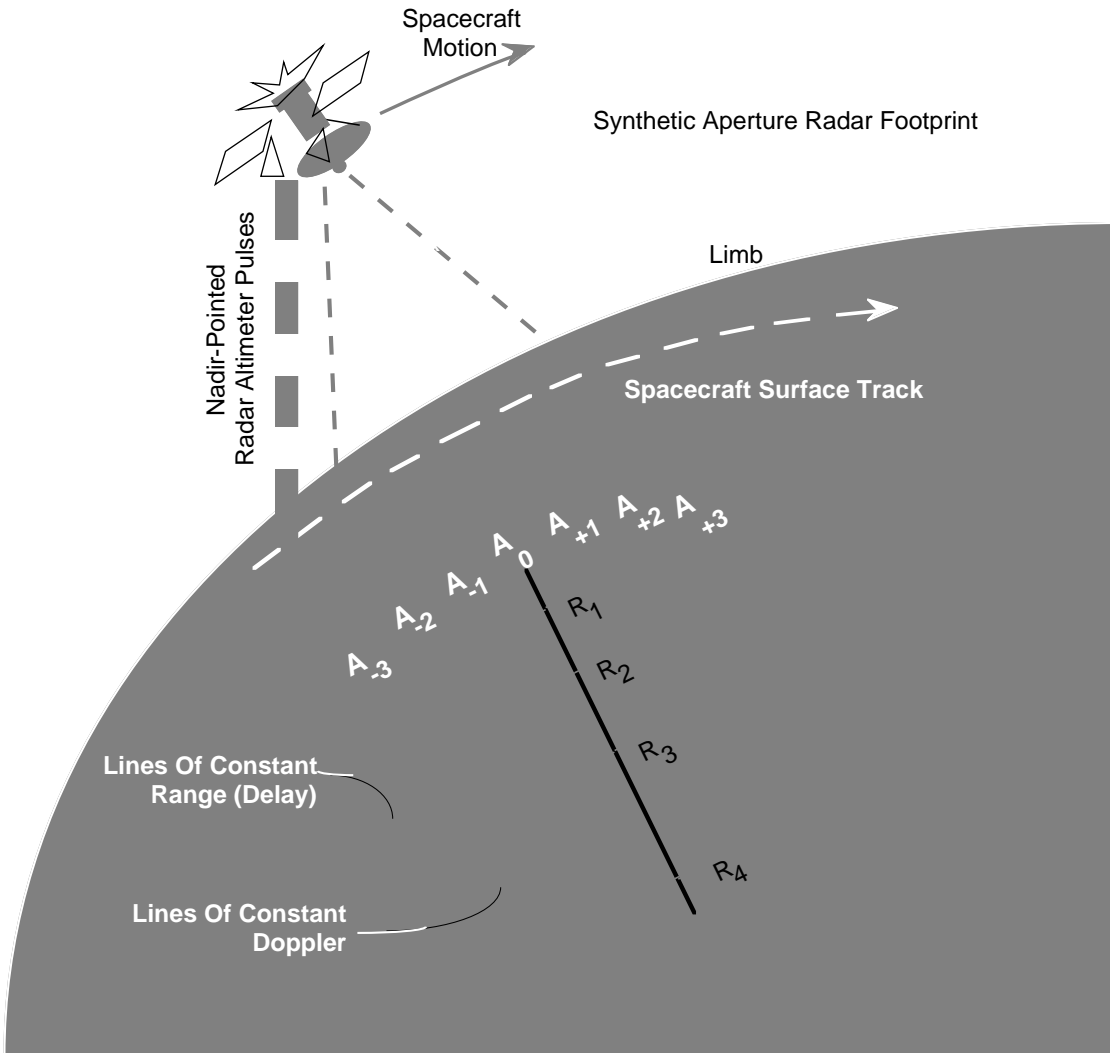

Altimeters

Radar pulses may be directed straight down to a planet's surface, the nadir, from a spacecraft in orbit, to measure variations in the height of terrain being overflown. The coded, pulsed signals are timed from the instant they leave the instrument until they are reflected back, and the distance is obtained by dividing by the speed of light. Terrain height is then judged based upon knowledge of the orbital position of the spacecraft. The Pioneer 12 spacecraft and the Magellan spacecraft used radar altimeters at Venus. Laser light may also be used in the same manner for altimetry. Laser altimeters generally have a smaller footprint, and thus higher spatial resolution, than radar altimeters. They require less power. Mars Global Surveyor carries a laser altimeter which uses a small cassegrain telescope.

Recap

1. The Heavy Ion Counter on Galileo uses _____ sensing: it registers the characteristics of ions which enter the instrument.
2. _____ are direct-sensing instruments which detect and measure the interplanetary and solar magnetic fields in the vicinity of the spacecraft.
3. Optical imaging is performed by two families of detectors: vidicons and the newer _____ (CCDs).
4. Spectrometers are optical instruments which split the light received from objects into their component _____ by means of a diffraction grating.
5. Sometimes various optical functions are combined into a single instrument, such as photometry and polarimetry combined into a _____ .
6. SAR... travels a distance in orbit while the reflected... pulses are returning. This provides the basis for synthesizing an antenna (aperture) on the order of _____ in size.

1. *direct* 2. *Magnetometers* 3. *charge coupled devices* 4. *wavelengths* 5. *photopolarimeter*
6. *kilometers*

Chapter 13. **Spacecraft Navigation**

Objectives: Upon completion of this chapter you will be able to describe basic principles of spacecraft navigation, including spacecraft velocity and distance measurement, angular measurement, and orbit determination. You will be able to describe spacecraft trajectory correction maneuvers and orbit trim maneuvers.

Navigating a spacecraft involves measuring its radial distance and velocity, the angular direction to it, and its velocity in the plane-of-sky. From these data, a mathematical model may be constructed and maintained, describing the history of a spacecraft's location in three dimensional space over time. Any necessary corrections to a spacecraft's trajectory or orbit may be identified based on the model. The navigation history of a spacecraft is incorporated in the reconstruction of its observations of the planet it encounters; it may be applied to the construction of SAR images. Some of the basic factors involved in acquiring navigation data are described below.

Data Types

The art of spacecraft navigation draws upon tracking data, which includes measurements of the Doppler shift of the downlink carrier and the pointing angles of DSN antennas. Navigation also uses data categorized as very long baseline interferometry (VLBI), explained below. These data types differ from the telemetry data, generated by science instruments and spacecraft health sensors, which is transmitted via modulated subcarrier.

Spacecraft Velocity Measurement

In two-way coherent mode, recall from Chapter 10 that a spacecraft determines its downlink frequency based upon a very highly stable uplink frequency. This permits the measurement of the induced Doppler shift to within 1 Hz, since the uplink frequency is known with great precision. The rates of movement of the Earth in its revolution about the sun and its rotation are known to a high degree of accuracy, and are removed. The resulting Doppler shift is directly proportional to the radial component of the spacecraft's velocity, and the velocity is thus computed.

Spacecraft Distance Measurement

A uniquely coded ranging pulse may be added to the uplink to a spacecraft, and its transmission time is recorded. When the spacecraft receives the ranging pulse, it returns the pulse on its downlink. The time it takes the spacecraft to turn the pulse around within its electronics is known from pre-launch testing. When the pulse is received at the DSN, its true elapsed time is determined, and the spacecraft's distance is then computed. Distance may also be determined as well as its angular position, using triangulation. This is described below.

Spacecraft Angular Measurement

The angles at which the DSN antennas point are recorded with an accuracy of thousandths of a degree. These data are useful, but even more precise angular measurements can be provided by VLBI, and by differenced Doppler. A VLBI observation of a spacecraft begins when two DSN stations on separate continents, separated by a very long baseline, track a single spacecraft simultaneously. High-rate recordings are made of the downlink's wave fronts by each station, together with precise timing data. DSN antenna pointing angles are also recorded. After a few minutes, and while still recording, both DSN antennas slew directly to the position of a quasar, which is an extragalactic object whose position is known with high accuracy. Then they slew back to the spacecraft, and end recording a few minutes later. Correlation and analysis of the recorded data yields a very precise triangulation from which both angular position and radial distance may be determined. This process requires knowledge of each station's location with respect to the location of Earth's axis with very high precision. Currently, these locations are known to within 3 cm. Their locations must be determined repeatedly, since the location of the Earth's axis varies several meters over a period of a decade.

Differenced Doppler can provide a measure of a spacecraft's changing three-dimensional position. To visualize this, consider a spacecraft orbiting a planet. If the orbit is in a vertical plane edge on to you, you would observe the downlink to take a higher frequency as it travels towards you. As it recedes away from you, and behind the planet, you notice a lower frequency. Now, imagine a second observer halfway across the Earth. Since the orbit plane is not exactly edge-on as that observer sees it, the other observer will record a slightly different Doppler signature. If you and the other observer were to compare notes and difference your data sets, you would have enough information to determine both the spacecraft's changing velocity and position in three-dimensional space. Two DSSs separated by a large baseline do exactly this. One DSS provides an uplink to the spacecraft so it can generate a stable downlink, and then it receives two-way. The other DSS receives a three-way downlink. The differenced data sets are frequently called "two-way minus three-way." High-precision knowledge of DSN Station positions, as well as a highly precise characterization of atmospheric refraction, makes it possible for DSN to measure spacecraft velocities accurate to within hundredths of a millimeter per second, and angular position to within 10 nano-radians.

Optical Navigation

Spacecraft which are equipped with imaging instruments can use them to observe the spacecraft's destination planet against a known background starfield. These images are called OPNAV images. Interpretation of them provides a very precise data set useful for refining knowledge of a spacecraft's trajectory.

Orbit Determination

The process of spacecraft orbit determination solves for a description of a spacecraft's orbit in terms of its Keplerian elements (described in Chapter 5) based upon the types of observations and measurements described above. If the spacecraft is enroute to a planet, the orbit is heliocentric; if it is in orbit about a planet, the orbit determination is made in reference to that planet. Orbit determination is an iterative process, building upon the results of previous solutions. Many different data inputs are selected as appropriate for input to computer software which uses the

laws of Newton and Kepler. The inputs include the various types of navigation data described above, as well as data such as the mass of the sun and planets, their ephemeris and barycentric movement, the effects of the solar wind, a detailed planetary gravity field model, attitude management thruster firings, atmospheric friction, and other factors.

The highly automated process of orbit determination is fairly taken for granted today. During the effort to launch America's first artificial Earth satellite, the JPL craft Explorer 1, a room-sized IBM computer was employed to figure a new satellite's trajectory using Doppler data acquired from Cape Canaveral and a few other tracking sites. The late Caltech physics professor Richard Feynman was asked to come to the Lab and assist with difficulties encountered in processing the data. He accomplished all of the calculations by hand, revealing the fact that Explorer 2 had failed to achieve orbit, and had come down in the Atlantic ocean. The IBM mainframe was coaxed to reach the same result, hours after Professor Feynman had departed for the weekend.

Trajectory Correction Maneuvers

Once a spacecraft's solar or planetary orbital parameters are known, they may be compared to those desired by the project. To correct any discrepancy, a Trajectory Correction Maneuver (TCM) may be planned and executed. This involves computing the direction and magnitude of the vector required to correct to the desired trajectory. An opportune time is determined for making the change. For example, a smaller magnitude of change would be required immediately following a planetary flyby, than would be required after the spacecraft had flown an undesirable trajectory for many weeks or months. The spacecraft is commanded to rotate to the attitude in three-dimensional space computed for implementing the change, and its thrusters are fired for a determined amount of time. TCMs generally involve a velocity change (ΔV) on the order of meters or tens of meters per second. The velocity magnitude is necessarily small due to the limited amount of propellant typically carried.

Orbit Trim Maneuvers

Small changes in a spacecraft's orbit around a planet may be desired for the purpose of adjusting an instrument's field-of-view footprint, improving sensitivity of a gravity field survey, or preventing too much orbital decay. Orbit Trim Maneuvers (OTMs) are carried out generally in the same manner as TCMs. To make a change increasing the altitude of periapsis, an OTM would be designed to increase the spacecraft's velocity when it is at apoapsis. To decrease the apoapsis altitude, an OTM would be executed at periapsis, reducing the spacecraft's velocity. Slight changes in the orbital plane's orientation may also be made with OTMs. Again, the magnitude is necessarily small due to the limited amount of propellant typically carried.

Recap

1. Spacecraft navigation draws upon _____ data, which includes measurements of the Doppler shift of the spacecraft's downlink carrier.
2. The resulting Doppler shift is directly proportional to the _____ component of the spacecraft's velocity.
3. A VLBI observation of a spacecraft begins when two DSN stations on separate _____ track the spacecraft simultaneously.
4. If the spacecraft is enroute to a planet, the orbit determined is _____ .
5. TCMs generally involve a velocity change (delta-V) on the order of _____ or tens of _____ per second.

1. tracking 2. radial 3. continents 4. heliocentric 5. meters - or tens of - meters

SECTION III. SPACE FLIGHT OPERATIONS

Chapter 14. Launch Phase

Objectives: Upon completion of this chapter you will be able to describe the role launch sites play in total launch energy, state the characteristics of various launch vehicles, and list factors contributing to determination of launch windows. You will be able to describe how the launch day of the year and hour of the day affect interplanetary launch energy, and list the major factors involved in preparations for launch.

Launch Vehicles

To date, the only way to achieve the propulsive energy to successfully launch spacecraft has been by combustion of chemical propellants, although there are a few other approaches currently being researched. There are two groups of rocket propellants, liquids and solids. Many spacecraft launches involve the use of both types of rockets, for example the solid rocket boosters attached to liquid-propelled expendable rockets, or the space shuttle. Hybrid rockets, which use a combination of solid and liquid, are also being developed. Solid rockets are generally simpler than liquid, but they cannot be shut down once ignited. Liquid and hybrid engines may be shut down after ignition, and conceivably could be re-ignited. A sampling of commonly used launch vehicles follows.

Delta

Delta is a family of two- or three-stage liquid-propelled expendable launch vehicle (ELV), produced by McDonnell Douglas, that use multiple strap-on solid boosters in several configurations. The liquid engines burn kerosene and liquid oxygen (LOX). A Delta II is capable of placing payloads of up to 2200 kg into low equatorial orbit (LEO). A Delta II placed the German X-Ray Observatory ROSAT into orbit in 1990, and launched the Japanese Geotail satellite in 1992.

Titan

Titan, produced by Martin Marietta Aerospace Group in Denver, Colorado, is a liquid-propelled, multiple stage ELV that can accommodate solid propellant strap-on boosters. The liquid engines burn hydrazine and nitric acid. Depending on the upper stage used, the Titan IV can put payloads of up to 18,000 kg into LEO, over 14,000 kg into polar orbit, or 4,500 kg into a geostationary transfer orbit (GTO). A Titan III launched the Viking spacecraft to Mars in 1975. Titan III vehicles launched JPL's Voyager 1 and 2 in 1977, and the Mars Observer spacecraft from the Kennedy Space Center (KSC), Cape Canaveral in 1992. The smaller Titan II can place about 2,000 kg into LEO.

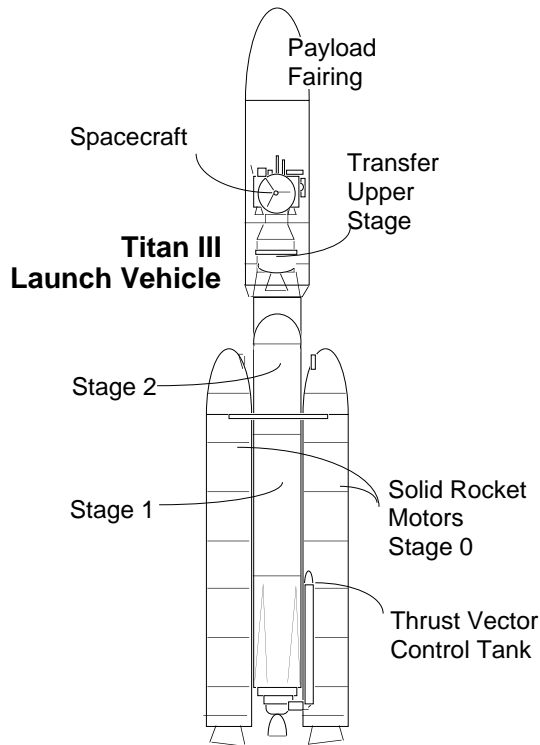

Atlas

Atlas, produced by General Dynamics Corporation, is a liquid-propelled ELV which accommodates a variety of upper stages. Its engines burn kerosene and LOX. With a Centaur upper stage, Atlas is capable of placing 4000 kg into LEO. A Titan IV, equipped with two upgraded solid rocket boosters and a Centaur upper stage, will launch the Cassini Spacecraft on its interplanetary trajectory in 1997. An Atlas/Centaur launched the Infrared Astronomical Satellite (IRAS) into Earth orbit in 1985, and an Atlas is planned to launch the Space Infrared Telescope Facility (SIRTF) into solar orbit in 1998.

Ariane

Ariane is a system of highly reliable liquid-propelled ELVs combined with a selectable number of solid strap-on boosters or liquid boosters. They are launched from the Kourou Space Center in French Guiana by Arianespace, the first space transportation company in the world, composed of a consortium of 36 European aerospace companies, 13 European banks, and the Centre National d'Études Spatiales (CNES). Ariane 4 is capable of placing 4200 kg in GTO. Ariane 4 launched the Topex/Poseidon spacecraft into a high-altitude Earth orbit in 1992. An Ariane 5 launcher is under development, targeted to fly the manned Hermes mini-shuttle and 18,000 kg into LEO.

Proton

The Proton is a liquid-propellant ELV developed by the Soviet CIS Interkosmos. It is launched by Russia from the Baykonur Kosmodrome in Kazakhstan, and is capable of placing 20,000 kg into LEO. It has launched many Earth satellites and interplanetary spacecraft, and is scheduled to send an additional spacecraft to Mars in 1994, with cooperation from the U.S. and France. A

western-built satellite for Inmarsat, the 67-country consortium, is planned to be launched by Proton in 1995.

Space Transportation System

America's space shuttle, as the Space Transportation System (STS) is commonly known, is a reusable launching system whose main engines burn liquid hydrogen and LOX. After each flight, its main components, except the external propellant tank, are refurbished to be used on future flights. The STS can put payloads of up to 30,000 kg in LEO. With the appropriate upper stage, spacecraft may be boosted to a geosynchronous orbit or injected into a planetary transfer orbit. Galileo, Magellan, and Ulysses were launched by the STS, using an Inertial Upper Stage (IUS), which is a two-stage solid-propellant vehicle. The STS may be operated to transport spacecraft to orbit, perform satellite rescue, and to carry out a wide variety of scientific missions ranging from the use of orbiting laboratories to small self-contained experiments.

Smaller Launch Vehicles

Many NASA experiments, as well as commercial and military payloads, are becoming smaller and lower in mass, as the art of miniaturization advances. The range of payload mass broadly from 100 to 1300 kg is becoming increasingly significant as smaller spacecraft are designed to have more operational capability. The market for launch vehicles with capacities in this range is growing.

Pegasus is a small, winged solid-propellant ELV built by Orbital Sciences Corporation. It resembles a cruise missile, and is launched from under the wing of an aircraft in flight at high altitude, currently a B-52. It is planned to be able to lift 400 kg into LEO. The Scout was a ground-launched, reliable solid-propellant ELV capable of placing 200 kg into LEO.

The Conestoga space launch vehicle is a low-cost, solid-propellant launcher made by Space Services, Inc., SSI, in Houston, and is capable of placing payloads of up to 1360 kg into LEO and 450 kg into GTO. Conestoga is a name aptly reminiscent of 19th-century broad-wheeled covered wagons, the expendable "launch" vehicles used by American pioneers to cross the prairie. They were named after the town where they were manufactured in Lancaster County, Pennsylvania.

Launch Sites

If a spacecraft is launched from a site near Earth's equator, it can take optimum advantage of Earth's substantial rotational speed. Sitting on the launch pad near the equator, it is already moving at a speed of over 1650 km per hour relative to Earth's center, a velocity which can be applied to the speed required to orbit Earth (approximately 28,000 km per hour). This means that the launch vehicle needs less propellant for launch, or that a given vehicle can launch a more massive spacecraft into orbit. A spacecraft intended for a high-inclination Earth orbit has no such free ride, though. As mentioned in Chapter 5, the launch vehicle must provide a much larger part, or all, of the energy for the spacecraft's orbital speed.

For interplanetary launches, the vehicle must take advantage of Earth's orbital motion as well, to accommodate the limited energy available from today's launch vehicles. In the diagram below, the launch vehicle is, in addition to using Earth's rotational speed, accelerating generally in the

Launch Using Earth's Rotational and Orbital Velocities

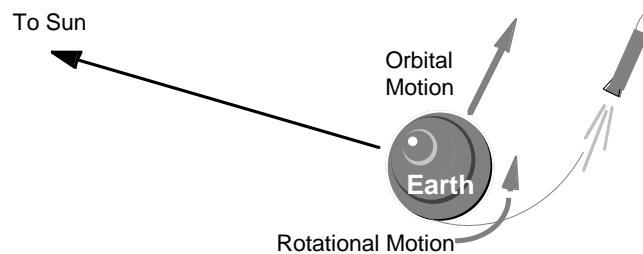

direction of Earth's orbital motion, which has an average velocity of approximately 100,000 km per hour along its orbital path. Of course, the spacecraft must fly a specific direction for its particular trajectory, but it can utilize at least a major component of Earth's pre-existing motion. In the case of a spacecraft embarking on a Hohmann interplanetary transfer orbit, recall that Earth's orbital speed represents the speed at aphelion or perihelion of the transfer orbit, and the spacecraft's velocity merely needs to be increased or decreased in the tangential direction to achieve the desired transfer orbit.

The launch site must also have a clear pathway downrange so the launch vehicle will not fly over populated areas, in case of accidents. The STS has the additional constraint of requiring a landing strip with acceptable wind, weather, and lighting conditions near the launch site as well as at landing sites across the Atlantic Ocean, in case an emergency landing must be attempted.

Launches from the east coast of the United States (the Kennedy Space Center at Cape Canaveral, Florida) are suitable only for low inclination orbits because major population centers underlie the trajectory required for high-inclination launches. The latter are accomplished from Vandenberg Air Force Base on the west coast, in California, because the trajectory for high-inclination Earth orbits is out over the Pacific Ocean. An equatorial site is not required for high-inclination orbital launches.

Complex ground facilities are required for heavy launch vehicles, but smaller vehicles such as the Conestoga require only trailer-mounted facilities, and the Pegasus requires none except its parent airplane.

Launch Windows

A launch window is the span of time during which a launch may take place while satisfying the constraints imposed by safety and mission objectives. For an interplanetary launch, the window is constrained typically within a number of weeks by the location of Earth in its orbit around the sun, in order to permit the vehicle to use Earth's orbital motion for its trajectory, as well as timing it to arrive at its destination when the target planet is in position. The launch window is also constrained typically to a number of hours each day of the previously described window, in order to take advantage of Earth's rotational motion. In the illustration at the top of this page, the vehicle is launching from a site near Earth's terminator, which is going into night time hours as the Earth's rotation takes it around away from the sun. If the example in the illustration were to launch in the early morning hours on the other side of the depicted Earth, it would be launching in a direction opposite Earth's orbital motion. These illustrations are over-simplified, in that they do not differentiate between launch from Earth's surface and injection into interplanetary trajectory. It is actually the latter that must be timed to occur on the proper side of Earth. Actual launch

times must also consider how long the spacecraft is to remain in low Earth orbit before its upper stage places it on the desired trajectory (this is not shown in the illustration).

The daily launch window may be further constrained by other factors, for example, the STS's emergency landing site constraints. Of course, a launch which is to rendezvous with another vehicle in Earth orbit must time its launch with the orbital motion of that object. This was the case with the Hubble Space Telescope repair mission executed in December 1993.

Preparations For Launch

The spacecraft must be transported from the site where it was built and tested to the launch site. The spacecraft is sealed inside an environmentally controlled carrier for the trip, and internal conditions are carefully monitored throughout the journey. Once at the launch site, additional testing takes place, and propellants are loaded aboard. Then the spacecraft is mated to its upper stage, and the stack is mated to the launch vehicle.

Pre-launch and launch operations of a JPL spacecraft are typically carried out by personnel at the launch site while in direct communication with persons at the Space Flight Operations Facility at JPL. Additional controllers and engineers at a different location are typically involved with the particular upper stage vehicle, such as the Lockheed personnel at Sunnyvale, California, controlling the inertial upper stage (IUS). The spacecraft's telecommunications link is maintained through ground facilities close to the launch pad prior to launch and during launch, linking the spacecraft's telemetry to controllers and engineers at JPL. Command sequences must be loaded aboard the spacecraft, verified, and initiated at the proper time prior to launch. Spacecraft health must be monitored, and the launch process interrupted if any critical tolerances are exceeded.

Once the spacecraft is launched, the DSN begins tracking, acquiring the task from the launch-site tracking station, and the cruise phase is set to begin.

Recap

1. Ariane 4 is capable of placing _____ kg in GTO.
2. If a spacecraft is launched from a site near Earth's equator, it can take advantage of Earth's substantial _____ speed.
3. Launches from the east coast of the United States are suitable only for _____ inclination orbits.
4. For an interplanetary launch, the window is constrained... by the location of Earth in its orbit around the sun, in order to permit the vehicle to use Earth's _____ motion for its trajectory.
5. Launch operations of a JPL spacecraft are typically carried out by personnel at the launch site while in direct communication with persons at the _____ _____ Facility at JPL.

1. 4200 2. rotational 3. low 4. orbital 5. Space Flight Operations

Chapter 15. Cruise Phase

Objectives: Upon completion of this chapter, you will be able to list the major factors involved in spacecraft checkout and characterization, and preparation for encounter. You will be able to characterize typical daily flight operations.

Cruise phase is bounded by launch phase at the beginning, and encounter phase at the end. It is a time during which ground system upgrades and tests may be conducted, and spacecraft flight software modifications are implemented and tested. Cruise operations are typically carried out from the Space Flight Operations Facility at JPL.

Spacecraft Checkout and Characterization

After launch, the spacecraft is commanded to configure for cruise. Appendages which might have been stowed in order to fit within the launch vehicle are deployed either fully or to intermediate cruise positions. Telemetry is analyzed to determine the health of the spacecraft, indicating how well it survived its launch. Any components that appear questionable might be put through tests specially designed and commanded in real time, and their actual state determined as closely as possible by subsequent telemetry analysis.

During the cruise period, additional command sequences are uplinked and loaded aboard for execution, taking the spacecraft through its routine operations, such as tracking Earth with the HGA and monitoring celestial references. The flight team members begin to get the feel of their spacecraft in flight. Inevitably, unforeseen problems arise, and the onboard fault protection algorithms receive their inadvertent tests; the spacecraft will, more likely than not, go into safing or contingency modes (as described in Chapter 11), and it must be painstakingly recovered.

TCMs are executed to fine tune the trajectory. Eventually, as the spacecraft nears its target, the science instruments are powered on and calibrated, if they have not already been powered on earlier during cruise.

Real-time Commanding

Frequently, commands stored on board during cruise or other phases must be augmented by real-time commands, as new activities become desirable, or, rarely, as mistakes are discovered in the on-board command sequence. There is an inherent risk in real-time commanding; it is always possible that the wrong commands may be sent. The longer, planned sequences of commands (generally just called “sequences”) typically benefit from a long process of extensive debate and selection, testing and checking and simulation prior to uplink. These factors may limit the desirability of undertaking many activities by real-time commands that do not have the benefit of the full sequence development process, but the necessity, as well as the convenience, of real-time commanding frequently prevails.

Typical Daily Operations

Usually, at least one person is on duty 24 hours a day, seven days a week at JPL to watch the spacecraft while in flight, and respond to any anomalous indications. The person so designated is typically the mission controller or ACE. The ACE is a person on the Mission Control Team who is the single point of contact between the entire flight team, consisting of the Spacecraft Team, the Navigation Team, Science and other teams, and the teams and facilities external to the project such as DSN, SFOF Facilities, Mission Control and Computing Center (MC³), Operations Planning and Control Team (OPCT), Ground Communications Facility (GCF), AMMOS, and the Information Processing Center (IPC).

“ACE” is not an acronym, despite all attempts to make it one. It simply refers to one single point of contact for a project’s real-time flight operations, not too inappropriately a pun for an expert combat pilot. The ACEs are multimission personnel, and one ACE may be serving more than one flight project at a time. For example, in 1993, one ACE was in charge of Magellan, Voyager 1, and Voyager 2 simultaneously. The ACE executes commanding, manages the ground systems, insures the capture of telemetry and tracking data, watches for alarms, evaluates data quality, performs real-time analyses to determine maneuver effectiveness and spacecraft health, and coordinates the activities of the DSN and other teams in support of the projects. Typically, a large portion of the ACE’s interactions are with the Spacecraft Team, the DSN, and the OPCT.

Monitoring Spacecraft and Ground Events

An accurate list of expected events is needed to compare with spacecraft events as they occur in real time, in order to make sure the spacecraft is operating as planned. It is also required for the purpose of directing DSN station activity, and to be able to plan command uplinks and other real time operations. That list is called the integrated sequence of events (ISOE). Integrated means that it contains both spacecraft events and DSN ground events. Compiling an ISOE begins with a list of the commands that will be placed in the spacecraft’s memory, and which will be executing over a period of typically a week or two into the future. Times of the events are included with the commands. These are supplied in a spacecraft event file (SEF) supplied by the spacecraft team. They are adjusted for light time, and are combined with DSN station information and events. A subset of the list is provided to the DSN as a keyword file (KWF), which the DSN then combines

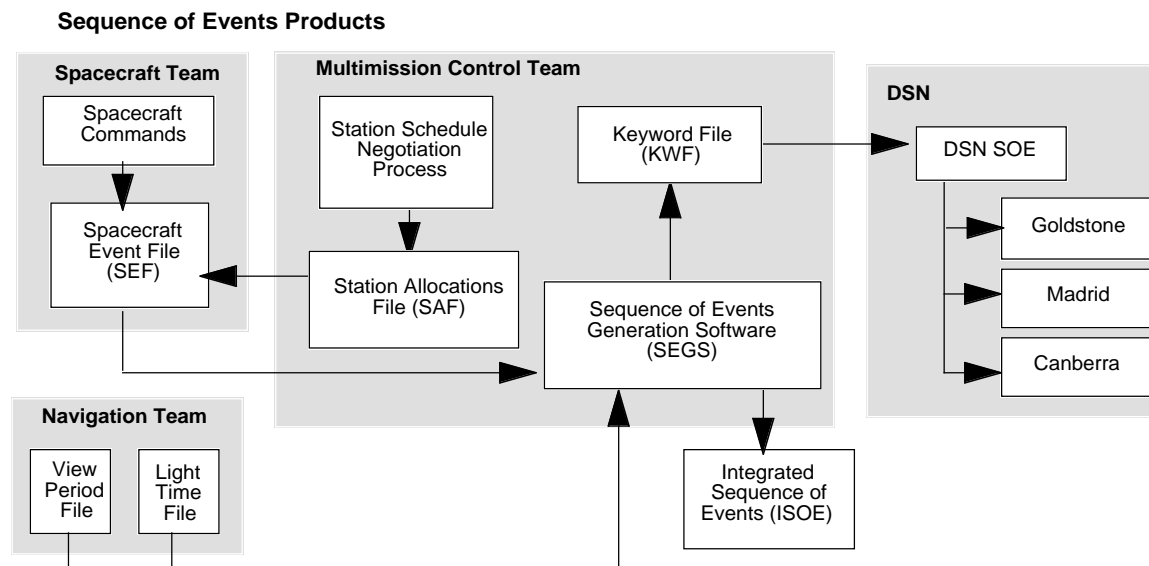

with similar listings from other projects to create a sequence of events (SOE) for each particular station. The illustration below shows an excerpt of activities typical on a flight project that contribute to the generation of SOE products.

Tracking the Spacecraft in Flight

DSN tracking schedules have been negotiated months or years in advance. Now the spacecraft is in flight. Near the time when the spacecraft will be rising in the sky due to Earth's rotation, its assigned DSN tracking activity begins. During the period allotted for "precal" activities, the Link Monitor and Control (LMC) operator sits down at his or her console in the Signal Processing Center (SPC) of one of the DSN's three Deep Space Communications Complexes (DSCC). The operator will be controlling and monitoring the assigned antenna, called a Deep Space Station (DSS), an assigned set of computers that control its pointing, tracking, commanding, receiving, telemetry processing, ground communications, and other functions.

This string of equipment from the antenna to the project people at JPL is called a link, referring to the two-way communications link between the spacecraft and the project. Prior to the LMC operator's arrival, the Complex Monitor and Control (CMC) operator will have assigned, via directives sent out to the station components over a local area network (LAN), applicable equipment to become part of the link. Now the LMC operator begins sending more directives over the LAN to configure each of the link components specifically for the upcoming support. Predict sets containing uplink and downlink frequencies and Doppler bias ramp rates, pointing angles and bit rates, command modulation levels, and hundreds of other parameters are all sent to the link components. Problems are identified and corrected.

At the end of the precal period, the LMC operator checks the DSS area via closed circuit TV, makes a warning announcement over its outdoor loudspeakers, and the DSS antenna swings to point precisely to the spacecraft's location in the eastern sky. The transmitter comes on, and red beacons on the antenna illuminate as a warning. Upon locking the receivers, telemetry, and tracking equipment to the spacecraft's signal, the link is established. This marks the Beginning of Track (BOT) and Acquisition of Signal (AOS). Depending on the nature of the spacecraft's activities, there may be Loss of Signal (LOS) when the spacecraft turns away to maneuver, or if it goes into occultation behind a planet. This LOS would presumably be followed by another AOS when the maneuver or occultation is complete. During the day, the DSS antenna moves slowly to follow, or track, the spacecraft as Earth rotates.

Near the end of the LMC operator's shift, the DSS is pointing lower on the western horizon. At the same time, another LMC operator inside the SPC of another DSCC a third of the way around the world, is doing his or her precal as the same spacecraft is rising in the east. To accomplish an uplink transfer, the setting DSS's transmitter is turned off precisely two seconds after the rising DSS's transmitter comes on. Scheduled End of Track (EOT) arrives, and the LMC operator at the setting DSS begins postcal activities, idling the link components and returning control of them to the CMC operator.

Preparation for Encounter

Command loads uplinked to the spacecraft are valid for varying lengths of time. So-called quiescent periods such as the lengthy cruises between planets require relatively few activities, and a command load may be valid for several weeks. By comparison, during the closest-approach

part of a flyby encounter, a very long and complex load may execute in a matter of hours. Prior to encounter, the spacecraft is generally sent a command sequence that takes it through activities simulating the activities of encounter. Changes in data rate and format, and spacecraft maneuvers, are designed to put the flight team and ground systems through their paces during a realistic simulation, in order to provide some practice for readiness, to shake down the systems and procedures, and to try to uncover flaws or areas for improvement.

Instrument calibrations are undertaken prior to encounter to be sure that experiments are being carried out in a controlled fashion. Optical instruments, for example, may be commanded to take observations of empty space, in order to gain knowledge of flaws or idiosyncrasies in the instrument, which can then be removed from later encounter observations.

Recap

1. _____ phase is a time during which time ground system upgrades and tests may be conducted, and spacecraft flight software modifications are implemented and tested.
2. Any components which appear questionable might be put through _____ which are specially designed and commanded in real time.
3. There is an inherent _____ in real-time commanding.
4. The _____ is the single point of contact between the flight team and the teams external to the project.
5. The string of equipment from the antenna to the project people at JPL is called a _____.
6. Prior to encounter, the spacecraft is generally sent a command sequence which takes it through activities _____ the activities of encounter.

1. *Cruise* 2. *tests* 3. *risk* 4. *ACE* 5. *Link* 6. *simulating*

Chapter 16. Encounter Phase

Objectives: Upon completing this chapter, you will be able to describe major factors involved in flyby operations, planetary orbit insertion, planetary mapping, and gravity field surveying. You will be able to describe the unique opportunities for science data acquisition presented by occultation and problems involved. You will be able to describe the concepts of using aerobraking to alter orbital geometry or decelerate for landing, atmospheric entry, balloon tracking, and sampling.

The term “encounter” is used in this chapter to indicate the high-priority data-gathering period of operations for which the mission was intended. It may last a few months or weeks or less as in the case of a flyby encounter or atmospheric probe entry, or it may last a number of years as in the case of an orbiter. Encounter operations are typically carried out from the Space Flight Operations Facility at JPL, Buildings 230 and 264.

Flyby Operations

All the interplanetary navigation and course corrections accomplished during cruise result in placement of the spacecraft at precisely the correct point and at the correct time to carry out its encounter observations and obtain any planned gravity assist. A flyby spacecraft has a limited opportunity to gather data. Once it has flown by its target, it cannot return to recover lost data. Its operations are planned years in advance of the encounter and refined and practiced in the months prior to the encounter date. Sequences of commands are prepared by the flight team to carry out operations in various phases of the flyby, depending on the spacecraft’s distance from its target. During each of the six Voyager encounters, the phases were titled observatory phase, far encounter phase, near encounter phase, and post encounter phase. They may have different names for different spacecraft, but many of the functions most likely will be similar.

In a flyby operation, observatory phase (OB) is defined as the period when the target can be better resolved in the spacecraft’s optical instruments than it can from Earth-based instruments. This phase generally begins a few months prior to the date of flyby. OB is marked by the spacecraft being completely involved in making observations of its target, and ground resources are completely operational in support of the encounter. This phase marks the end of interplanetary cruise phase, during which time ground system upgrades and tests are conducted, and spacecraft flight software modifications are implemented and tested.

Far encounter phase (FE) includes time when the full disc of a planet can no longer fit within the field of view of the instruments. Observations are designed to accommodate parts of the planet rather than the whole disc, and to take best advantage of the higher resolution available. Near encounter phase (NE) includes the period of closest approach to the target. It is marked by intensely active observations by all of the spacecraft’s science experiments, including onboard instruments, and by radio science investigations. It includes the opportunity to obtain the highest resolution data about the target. Radio science observations include ring plane measurements during which ring structure and particle sizes can be determined, celestial mechanics observations which determine the planet’s or satellites’ mass, and atmospheric occultations which determine atmospheric structures and composition.

Observations must be planned in detail many months or years prior to NE, but precise navigation data may not be available to program accurate pointing of the instruments until only a few days before. Late updates of stored parameters on the spacecraft can be made to supply the pointing data just in time. OPNAVs, discussed in Chapter 13, may be an important navigational input to the process of determining values for late parameter updates. Some observations of the target planet or its environs may be treated as reprogrammable late in the encounter, in order to observe features which had not been seen until FE.

During the end of FE or the beginning of NE, a bow shock crossing may be identified through data from the magnetometer, plasma and plasma wave instruments, as the spacecraft flies into a planet's magnetosphere and leaves the solar wind. When the solar wind is in a state of flux, these crossings may occur again and again as the magnetosphere and the solar wind push back and forth over millions of kilometers. (Traditionally, PIs are not above wagering on the time and distance from a planet where these crossings will take place).

Post encounter phase (PE) begins when NE completes, and the spacecraft is receding from the planet. It is characterized by day after day of observations of a diminishing, thin crescent of the planet just encountered. This is the opportunity to make extensive observations of the night side of the planet. After PE is over, the spacecraft stops observing its target planet, and returns to the activities of cruise phase. DSN resources are relieved of their continuous support of the encounter, and they are generally scheduled to provide less frequent coverage to the mission.

After encounter, instrument calibrations are repeated to be sure that any changes in the instrument's state are accounted for.

Planetary Orbit Insertion

The same type of highly precise interplanetary navigation and course correction for flyby missions are also applied during cruise for an orbiter spacecraft. This process places the spacecraft at precisely the correct location at the correct time to enter into planetary orbit. Orbit insertion requires not only the precise position and timing, but also controlled deceleration. As the spacecraft's trajectory is bent by the planet's gravity, the command sequence aboard the spacecraft fires its engine(s) at the proper moment, and for the proper duration. Once the retro-burn has completed, the spacecraft has been captured into orbit by its target planet. If the retro-burn fails, the spacecraft will continue to fly on past the planet. It is common for the retro-burn to occur on the far side of a planet as viewed from Earth.

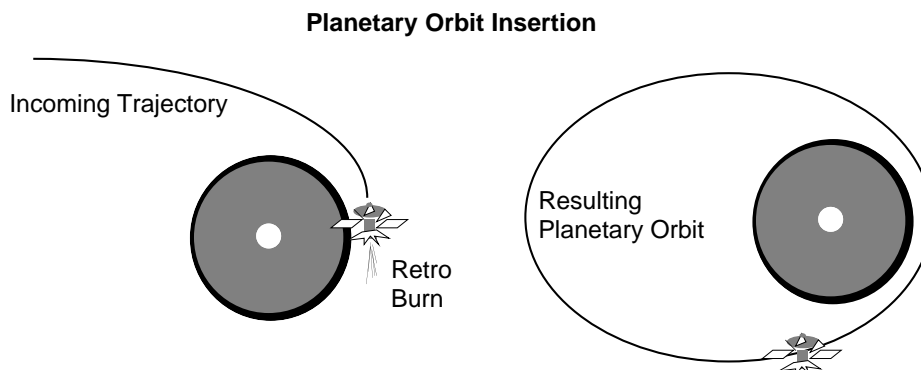

Once inserted into a highly elliptical orbit, Mars Global Surveyor will continue to adjust its orbit via OTMs near periapsis which decelerate the spacecraft further, causing a reduction in the apoapsis altitude, and establishing a close circular orbit at Mars. Galileo used a gravity assist from a close flyby of Jupiter's moon Io to decelerate, augmenting the deceleration provided by the 400 N rocket engine. Thereafter, additional OTMs over a span of two years will vary the orbit slightly to choreograph multiple encounters with the Galilean satellites and the magnetosphere.

System Exploration and Planetary Mapping

At least two broad categories of orbital operations may be identified. Exploring a planetary system includes making observations of the planet and the satellites and rings, etc., in its neighborhood. On the other hand, mapping a planet obtains data mainly from the planet's surface. Galileo will be exploring the entire Jovian system, including its satellites, rings, magnetosphere, the planet, and its environment. At Saturn, Cassini will accomplish a similar exploratory mission, exploring planet's rings and environs, and the large satellite Titan with its atmosphere. Magellan, a planetary mapper, covered 98% the surface of Venus, in great detail, using SAR imaging, altimetry, radiometry, and gravity. Mars Global Surveyor will map the surface of its planet also, using imaging, altimetry, spectroscopy, and gravity survey.

An orbit of low inclination at the target planet is well suited to a system exploration mission, because it provides repeated exposure to satellites orbiting within the equatorial plane, as well as adequate coverage of the planet and its magnetosphere. An orbit of high inclination is better suited for a mapping mission, since the target planet or body will rotate fully below the spacecraft's orbit, providing eventual exposure to every part of the planet's surface.

In either case, during system exploration or planetary mapping, the orbiting spacecraft is involved in an extended encounter period, requiring continuous or nearly continuous support from the flight team members, the DSN, and other institutional teams.

Recap

1. The term _____ is used to indicate the high-priority data-gathering period of operations for which the mission was intended.
2. A flyby spacecraft has a limited _____ to gather data.
3. Orbit insertion requires not only the precise position and timing, but also controlled _____.
4. An orbit of _____ inclination at the target planet is well suited to a system-exploration mission.
5. An orbit of _____ inclination is better suited for a mapping operation.

1. *encounter* 2. *opportunity* 3. *deceleration* 4. *low* 5. *high*

Occultations

Occultations provide unique opportunities for experiments. Occultations of interest include Earth, the sun, or another star disappearing behind a planet, behind its rings, or behind its atmosphere, as viewed from the spacecraft. During the one-time only occultation opportunity by a planet during a flyby encounter, or repeatedly during an orbital mission, onboard optical instruments may make unique observations. For example, an ultraviolet spectrometer may watch the sun as it disappears behind a planet's atmosphere, and obtain data on the composition and structure of the atmosphere. A photometer watching a bright distant star as it passes behind a ring system yields high-resolution data on the sizes and structures of the ring and its particles.

The spacecraft's radio signal may be observed on Earth as the spacecraft passes behind a planet, and this yields data on the composition and structure of the atmosphere and rings. Observations of the Doppler shift as the spacecraft passes near a planet or satellite can provide direct measurement of the planet's mass to a high degree of accuracy. This is known as a celestial mechanics experiment. Both occultation and celestial mechanics experiments are radio science investigations. Radio science investigations require a stable downlink frequency from the spacecraft. This means it must be in two- or three-way coherent mode, receiving an uplink from the DSN as discussed in Chapter 10. However, this is generally possible on ingress only; the spacecraft is likely to lose the uplink from DSN when it passes behind the planet, and therefore cannot maintain a coherent downlink. For this reason, some spacecraft are equipped with an Ultra Stable Oscillator (USO) in a temperature controlled "oven" which is capable of providing a fairly stable downlink frequency when an uplink is not available.

The first occultation experiment was proposed when JPL was characterizing the precise refraction effects of Earth's atmosphere, with a known structure and composition, for the purpose of tracking spacecraft. It was realized that measurements of the refraction effects induced by another planet's atmosphere could be used to "reverse-engineer" its structure and composition.

Gravity Field Surveying

Planets are not perfectly spherical. Terrestrial planets are rough surfaced, and most planets are at least slightly oblate. Thus they have variations in their mass concentrations, sometimes associated with mountain ranges or other features visible on the surface. A gravity field survey identifies local areas of a planet which exhibit slightly more or slightly less gravitational attraction. These differences are due to the variation of mass distribution.

There are two reasons for surveying the gravity field of a planet. First, highly accurate navigation in orbit at a planet requires a good model of variations in the gravity field, which can be obtained by such a survey. Second, gravity field measurements have the unique advantage of offering scientists a "view" of mass distribution both at and below the surface. They are extremely valuable in determining the nature and origin of features identifiable in imaging data. JPL has pioneered the field of mapping planetary mass concentrations. Application of these techniques to Earth helps geologists locate petroleum and mineral deposits.

To obtain gravity field data, a spacecraft is only required to provide a downlink carrier signal coherent with a highly stable uplink from the DSN. It may be modulated or unmodulated. After the removal of known Doppler shifts induced by planetary motions and the spacecraft's primary orbital motion and other factors, the residual Doppler shifts are indicative of miniscule spacecraft accelerations resulting from variations in mass distribution at and below the surface of the planet.

The gravity feature size that can be resolved is roughly equal to the spacecraft's altitude; with a 250-km altitude, a spacecraft should resolve gravity features roughly 250 km in diameter.

With an X-band (3.6 cm) uplink received at a spacecraft, and a coherent X-band downlink, spacecraft accelerations can be measured to tens of micrometers per second squared. This translates to a sensitivity of milligals in a planetary gravity field. (one gal represents to a gravitational acceleration of 1 cm/sec²).

The best gravity field coverage is made from low circular orbit. Mars Global Surveyor will be conducting a gravity field survey from circular orbit as one of its first-priority investigations. Magellan's orbit was elliptical during its primary mission, and meaningful gravity data could be taken only for that portion of the orbit plus and minus about 30° true anomaly from periapsis, which occurred at about 10° north latitude.

Atmospheric Entry and Aerobraking

Aerobraking, as the name implies, is the process of decelerating by converting velocity into heat through friction with a planetary atmosphere. Galileo's atmospheric probe was a typical example of an atmospheric entry and aerobraking mission. The probe was designed with an aeroshell that sustained thousands of degrees of heat as it entered the Jovian atmosphere. It decelerated at hundreds of Gs, until it reached a speed where its parachute became effective. At that time, the spent aeroshell was discarded, and the probe carried out its experiments.

The Magellan spacecraft was not designed for atmospheric entry. However, the periapsis altitude of Magellan's orbit was lowered by the use of propulsive maneuvers into the upper reaches of Venus's atmosphere near 140 km above the surface. This is still high above the cloudtops, which are at about 70 km. Flying at this altitude induced deceleration via atmospheric friction during the portion of the spacecraft's orbit near periapsis, thus reducing the height to which it could climb to apoapsis. The solar array, consisting of two large square panels, was kept flat-on to the velocity vector during each pass through the atmosphere, while the HGA trailed in the wind. The solar array reached a maximum of 160°C, and the HGA a maximum of 180°C. After approximately 70 earth days and one thousand orbits of encountering the free molecular flow and decelerating a total of about 1250 m/sec, the apoapsis altitude was lowered to a desirable altitude. The periapsis altitude was then raised to achieve a nearly circular orbit. The objectives of this aerobraking experiment were to demonstrate the use of aerobraking for use on future missions, to characterize the upper atmosphere of Venus, and to be in position to conduct a full-planet gravity field survey from a nearly circular orbit.

Landing

Landing on a planet is generally accomplished first by aerobraking while entering the planet's atmosphere under the protection of an aeroshell. From there, the lander might be designed to parachute to the surface, or to use a propulsion system to soft-land, or both, as did the Viking landers on Mars. The Soviet Venera spacecraft parachuted to the surface of Venus by means of a small rigid disk integral with the spacecraft's structure which helped slow their descent sufficiently through the very dense atmosphere. A crushable foot pad absorbed the energy from their final impact on the surface.

The lander that is a part of the Mars Pathfinder mission is being designed to absorb landing impact with an array of large air bags. Once the lander is on the surface, petals deploy to expose the instruments and solar panels before operations begin. For a possible future mission, the international science community desires to land a network of seismometer-equipped spacecraft on the surface of Venus to measure seismic activity over a period of months or years.

Balloon Tracking

Once deployed within a planet's atmosphere, having undergone atmospheric entry operations as discussed above, a balloon may ride with the wind and depend on the DSN to track its progress. In 1986, DSN tracked the balloons deployed by the Soviet Vega spacecraft on its way to encounter comet Halley. The process of tracking the balloon across the disc of Venus yielded data on the circulation of the planet's atmosphere.

The Mars Balloon, expected to be deployed in 1996, will descend to just above the surface. Carrying an instrument package, including a camera, within a long, snake- or rope-like structure, it will rise and float when heated by the daytime sunlight, and will sink and allow the "rope" to rest on the surface at night. In this way it is hoped that the balloon package will visit many different locations pseudo-randomly as the winds carry it. In doing so, it will also yield information on atmospheric circulation patterns. The Mars Global Surveyor spacecraft carries radio relay equipment designed to relay information from the balloon-borne instrument package. The Mars Balloon was designed jointly by Russia, CNES, and The Planetary Society, a public non-profit space-interest group in Pasadena.

Sampling

One of the major advantages of having a spacecraft land on the surface of a planet is that it can take direct measurements of the soil. The several Soviet Venera landers accomplished this on the 900°C surface of Venus, and the Viking landers accomplished this on the surface of Mars. Samples are taken from the soil and transported into the spacecraft's instruments where they are analyzed for chemical composition, and the data are relayed back to Earth. The scientific community desires a robotic sample return mission from Mars sometime in the future. Several different scenarios are envisioned for accomplishing this, some of which include a rover to go around and gather up rock and soil samples to deposit inside containers aboard the return vehicle.

Sampling of cosmic dust in the vicinity of the Earth has also become an endeavor of great interest, since interplanetary dust particles can reveal some aspects of the history of solar system formation. Space shuttle experiments have so far been successful at capturing three 10 μm particles from Earth orbit, one intact. Additional attempts to capture interplanetary dust particles are planned.

Recap

1. Occultations of interest include Earth, the sun, or another star _____ behind a planet, or behind its rings or its atmosphere, as viewed from the spacecraft.
2. Some spacecraft are equipped with an _____ _____ (USO) in a temperature controlled “oven” which is capable of providing a fairly stable downlink frequency when an uplink is not available.
3. Gravity field measurements have the unique advantage of offering scientists a “view” of _____ _____ both at and below the surface.
4. Aerobraking is the process of decelerating by converting velocity into _____ through friction with a planetary atmosphere.
5. A spacecraft on the surface of a planet can take _____ measurements of the soil.

1. disappearing 2. Ultra Stable Oscillator 3. mass distribution 4. heat 5. direct

Chapter 17. Extended Operations Phase

Objectives: Upon completion of this chapter, you will be able to describe completion of primary objectives of a mission, and obtaining additional science data after their completion. You will consider how depletion of resources contributes to the end of a mission, identify resources which affect mission life, and describe logistics of closeout of a mission.

Completion of Primary Objectives

A mission's primary experimental objectives are spelled out well in advance of the spacecraft's launch. The efforts of all of the flight team members are concentrated during the life of the mission toward achieving those objectives. A measure of a mission's success is whether it has gathered enough data to complete or exceed its originally stated objectives. During the course of a mission, there may be inadvertent losses of data. In the case of an orbiter mission, the lost data can be recovered by making repeated observations of the areas of a planet where the loss was sustained when the planet rotates until the spacecraft's orbit coincides once again with areas of the surface that were missed. Such data recovery might add additional time to the portion of a mission when its primary objectives are being achieved. Major outages and their recovery may be planned for during the course of a mission, as in the case of the planet approaching superior conjunction, when the sun obstructs communications with the spacecraft for a number of days.

Additional Science Data

Once a spacecraft has completed its primary objectives, it may still be in a healthy and operable state. Since it has already undergone all the efforts involved in conception, design and construction, launch, cruise and perhaps orbit insertion, it can be very economical to operate an existing spacecraft toward accomplishing new objectives, and retrieve data over and above the initially planned objectives. This has been the case with several JPL spacecraft: it is common for a flight project to have goals in mind for extended missions to take advantage of a still-viable spacecraft in a unique location when the original funding expires.

Voyager was originally approved as a mission to Jupiter and Saturn. Voyager 2's original trajectory had been selected with the hope that the spacecraft might be healthy after a successful Saturn flyby, and that it could take advantage of that good fortune. After Voyager 1 was successful in achieving its objective of reconnaissance of the Saturnian system, including a tricky solar occultation of Titan and associated observations, Voyager 2 was not required to be used solely as a backup spacecraft to duplicate these experiments. Voyager 2's trajectory to Uranus and Neptune was preserved and executed. Approval of additional funding enabled making modifications which were necessary, both in the GDS and in the onboard flight software to continue on to Uranus and Neptune.

By the time Voyager 2 reached Uranus after a five-year cruise from Saturn, it had many new capabilities, such as increased three-axis stability, extended imaging exposure modes, image motion compensation, data compression, and new error-correction coding. In 1993, after 15

years of flight, Voyagers 1 and 2 discovered the first direct evidence of the long-sought-after heliopause. They identified a low frequency signature of solar flare material interacting with the heliopause at an estimated distance of 40 to 70 AU ahead of Voyager 1's location, which was 52 AU from the sun at the time..

The Magellan mission accomplished special stereo imaging tests, and interferometric observation tests after fulfilling its goal of mapping at least 70% of the surface. Once mapping had tallied 98%, and the low latitude gravity survey was completed, all of its original objectives had been met and exceeded. Rather than abandon the spacecraft in orbit, the Project applied funding which had been saved over the course of the primary mission to begin the adventurous Transition Experiment, pioneering the use of aerobraking to attain a nearly circular orbit.

End of Mission

Resources give out. Due to the age of their RTGs, the Pioneers 10 and 11 spacecraft are facing a need in the near future to turn off electrical heaters for the propellant lines in order to conserve electrical power for continued operation of science instruments. Doing so would allow propellant to freeze, possibly making it impossible to re-thaw for use in additional spacecraft maneuvers. This will prevent them from being kept on Earth-point.

Voyagers 1 and 2 are expected to survive until the sunlight they observe is too weak to register on their sun sensors, causing a loss of attitude reference. This is forecast to happen near the year 2015, which may or may not be after they have crossed the heliopause. Electrical energy from their RTGs may fall below a useable level about the same time. Or the spacecraft's supply of hydrazine may become depleted near the same time, making continued three-axis stabilization impossible. Pioneer 12 ran out of hydrazine propellant in 1993, and was unable to further resist the slow decay of its orbit resulting from friction with the tenuous upper atmosphere of Venus. It entered the atmosphere and burned up like a meteor after fourteen years of service.

Components wear out and fail. The Hubble Space Telescope was fitted with many new components, including new attitude-reference gyroscopes, to replace failed and failing units in late 1993. Two of Magellan's attitude-reference gyroscopes had failed prior to the start of the Transition experiment, but of course no replacement was possible. To date, a JPL mission has not been turned off because of lack of funding. But this might not continue to be the case in the future.

Once a mission has ended, the flight team personnel are disbanded, and the ground hardware is returned to the loan pool or sent into long-term storage. DSN resources are freed of contention from the mission, and the additional tracking time allocations may be available to missions currently in their prime.

While layoffs are not uncommon, many personnel from a disbanded flight team are assigned by their section management to new flight projects or other interim work. Many Viking team members joined the Voyager mission after Viking had achieved its success at Mars in the late 1970s. Many of the Voyager flight team members joined the Magellan project after Voyager's last planetary encounter ended in October 1989. Many other ex-Voyager people joined the Galileo and Topex/ Poseidon missions. Some ex-Magellan people are working on Cassini, Mars Global Surveyor, and Mars Pathfinder. Mission's end also provides a convenient time for some employees to begin their retirement.

Recap

1. A measure of a mission's success is whether it has gathered enough _____ to complete or exceed its originally stated objectives.
2. It can be very economical to operate an existing spacecraft toward accomplishing _____ objectives.
3. ____ ____ ____ resources are freed of contention from the mission, and the additional tracking time allocations may be available to missions currently in their prime.

1. data 2. new 3. DSN

You have completed the Basics of Space Flight training module.

You may wish to fill in the Certificate of Completion on the next page, and send a copy of it to your supervisor for inclusion in your personal file. The next module in this training series is the End-to-End Information System module.

Certificate of Completion

This is to certify that I, _____, have completed

Print Name

the

Basics of Space Flight

M6 MOPS 0513-02-00

Training Module, and have accomplished its stated learning objectives to my own satisfaction.

This represents approximately _____ hours of study.

Signature

Date

Upon completion of the training module, complete this certificate and send a copy of it to your supervisor for inclusion in your personnel file.

GLOSSARY

A	Acceleration.
Å	Angstrom (0.0001 micrometer, 0.1 nm).
AAAS	American Association for the Advancement of Science.
AACS	Attitude and Articulation Control Subsystem onboard a spacecraft.
AAS	American Astronomical Society.
AC	Alternating current.
ALT	Altitude.
ALT	Altimetry data.
AM	Ante meridiem (Latin: before midday), morning.
am	Attometer (10^{-18} m).
AMMOS	Advanced Multimission Operations System.
AO	Announcement of Opportunity.
AOS	Acquisition Of Signal, used in DSN operations.
Aphelion	Apoapsis in solar orbit.
Apoapsis	The farthest point in an orbit from the body being orbited.
Apogee	Apoapsis in Earth orbit.
Apojove	Apoapsis in Jupiter orbit.
Apolune	Apoapsis in lunar orbit.
Apselene	Apoapsis in lunar orbit.
Argument	Angular distance.
Argument of periapsis	The argument (angular distance) of periapsis from the ascending node.
Ascending node	The point at which an orbit crosses the ecliptic plane going north.
Asteroids	Small bodies composed of rock and metal in orbit about the sun.
Attometer	10^{-18} meter.
AU	Astronomical Unit, mean Earth-to-sun distance, approximately 150,000,000 km.
AZ	Azimuth.
Barycenter	The common center of mass about which two or more bodies revolve.
BOT	Beginning Of Track, used in DSN operations.
BPS	Bits Per Second, same as Baud rate.
c	The speed of light, 300,000 km per second.

Caltech	California Institute of Technology.
Carrier	The main frequency of a radio signal generated by a transmitter prior to application of modulation .
C-band	A range of microwave radio frequencies in the neighborhood of 4 to 8 GHz.
CCD	Charge Coupled Device, a solid-state imaging detector.
C&DH	Command and Data Handling subsystem on board a spacecraft, similar to CDS.
CCS	Computer Command subsystem on board a spacecraft, similar to CDS.
CDS	Command and Data Subsystem onboard a spacecraft.
CDU	Command Detector Unit onboard a spacecraft.
Centimeter	10 ⁻² meter.
Centrifugal force	The outward-tending apparent force of a body revolving around another body.
Centripetal	The inward acceleration of a body revolving around another body. force
CIT	California Institute of Technology, Caltech.
CMC	Complex Monitor and Control, a subsystem at DSCCs.
CNES	Centre National d'Études Spatiales, France.
Coherent	Two-way communications mode wherein the spacecraft generates its downlink frequency based upon the frequency of the uplink it receives.
Coma	The cloud of diffuse material surrounding the nucleus of a comet.
Comets	Small bodies composed of ice and rock in various orbits about the sun.
CRAF	Comet Rendezvous / Asteroid Flyby mission, cancelled.
CRT	Cathode ray tube video display device.
DC	Direct current.
DEC	Declination, the measure of a celestial body's apparent height above or below the celestial equator.
Descending node	The point at which an orbit crosses the ecliptic plane going south.
Downlink	Signal received from a spacecraft.
DSCC	Deep Space Communications Complex, one of three DSN tracking sites at Goldstone, California; Madrid, Spain; and Canberra, Australia; spaced about equally around the Earth for continuous tracking of deep-space vehicles.
DSN	Deep Space Network, JPL's worldwide spacecraft tracking facility.
DSS	Deep Space Station, the antenna front-end equipment at DSCCs.
Dyne	A unit of force equal to the force required to accelerate a 1g mass 1cm per second per second (1cm/sec ²). Compare with Newton.

E	East.
Earth	Third planet from the sun, a terrestrial planet.
Eccentricity	The distance between the foci of an ellipse divided by the major axis.
Ecliptic	The plane in which Earth orbits the sun.
EDR	Experiment Data Record.
EHz	ExaHertz (10^{18} Hz)
EL	Elevation.
Ellipse	A closed plane curve generated in such a way that the sums of its distances from the two fixed points (the foci) is constant.
ELV	Expendable launch vehicle.
EOT	End Of Track, used in DSN operations.
Equator	An imaginary circle around a body which is everywhere equidistant from the poles, defining the boundary between the northern and southern hemispheres.
ERT	Earth-received time, UTC of an event at DSN receive-time, equal to SCET plus OWLT.
ESA	European Space Agency.
ET	Ephemeris time, a measurement of time defined by orbital motions. Equates to Mean Solar Time corrected for irregularities in Earth's motions.
eV	Electron volt, a measure of the energy of subatomic particles.
F	Force.
FE	Far Encounter phase of mission operations.
FDS	Flight Data Subsystem.
Femtometer	10^{-15} meter.
FY	Fiscal year.
Fluorescence	The phenomenon of emitting light upon absorbing radiation of an invisible wavelength.
fm	Femtometer (10^{-15} m)
FM	Frequency modulation.
G	Giga (billion).
g	Gram, a thousandth of the metric standard unit of mass (see kg). The gram was originally based upon the weight of a cubic centimeter of water.
Gal	Unit of gravity field measurement corresponding to a gravitational acceleration of 1 cm/sec^2 .

Galaxy	One of billions of systems, each composed of numerous stars, nebulae, and dust.
Galilean	The four large satellites of Jupiter so named because Galileo discovered them when he turned his telescope toward Jupiter: Io, Europa, Ganymede, and Callisto.
Gamma rays	Electromagnetic radiation in the neighborhood of 100 femtometers wavelength.
GCF	Ground Communications Facilities, provides data and voice communications between JPL and the three DSCCs.
GDS	Ground Data System, encompasses DSN, GCF, MCCC, and project data processing systems.
GEO	Geosynchronous Earth Orbit.
Geostationary	A geosynchronous orbit in which the spacecraft is constrained to a constant latitude.
Geosynchronous	A direct, circular, low inclination orbit about the Earth having a period of 23 hours 56 minutes 4 seconds.
GHz	Gigahertz (10^9 Hz).
GLL	Galileo spacecraft.
GMT	Greenwich Mean Time, similar to UTC but not updated with leap seconds.
Gravitation	The mutual attraction of all masses in the universe.
Gravitational waves	Einsteinian distortions of the space-time medium predicted by general relativity theory (not yet detected as of November 1995).
Gravity waves	Certain atmospheric waves within a planet's atmosphere.
Great circle	An imaginary circle on the surface of a sphere whose center is at the center of the sphere.
GSSR	Goldstone Solar System Radar, a technique which uses very high-power X and S-band transmitters at DSS 14 to illuminate solar system objects for imaging.
GTL	Geotail spacecraft.
GTO	Geostationary (or geosynchronous) Transfer Orbit.
HA	Hour Angle, the angular distance of a celestial object measured westward along the celestial equator from the zenith crossing. In effect, HA represents the RA for a particular location and time of day.
Heliopause	The boundary theorized to be roughly circular or teardrop-shaped, marking the edge of the sun's influence, perhaps 100 AU from the sun.
Heliosphere	The space within the boundary of the heliopause, containing the sun and solar system.
HGA	High-Gain Antenna onboard a spacecraft.
Horizon	The line marking the apparent junction of Earth and sky.

h	Hour.
Hz	Hertz, cycles per second.
ICE	International Cometary Explorer spacecraft.
Inclination	The angular distance of the orbital plane from the plane of the planet's equator, stated in degrees.
Inferior planet	Planet which orbits closer to the Sun than the Earth's orbit.
Inferior conjunction	Alignment of Earth, sun, and an inferior planet on the same side of the sun.
Ion	A charged particle consisting of an atom stripped of one or more of its electrons.
IPC	Information Processing Center, JPL's computing center on Woodbury Avenue in Pasadena.
IR	Infrared, meaning "below red" radiation. Electromagnetic radiation in the neighborhood of 100 micrometers wavelength.
IRAS	Infrared Astronomical Satellite.
ISOE	Integrated Sequence of Events.
Isotropic	Having uniform properties in all directions.
IUS	Inertial Upper Stage.
JGR	Journal Of Geophysical Research.
Jovian	Jupiter-like planets, the gas giants Jupiter, Saturn, Uranus, and Neptune.
JPL	Jet Propulsion Laboratory, operating division of the California Institute of Technology.
Jupiter	Fifth planet from the sun, a gas giant or Jovian planet.
k	Kilo (thousand).
K-band	A range of microwave radio frequencies in the neighborhood of 12 to 40 GHz.
kg	Kilogram, the metric standard unit of mass, based on the mass of a metal cylinder kept in France. See g (gram).
kHz	kilohertz.
Kilometer	10 ³ meter.
km	Kilometers.
KSC	Kennedy Space Center, Cape Canaveral, Florida.
KWF	Keyword file of events listing DSN station activity.
LAN	Local area network for inter-computer communications.
Laser	Light Amplification by Stimulated Emission of Radiation.
Latitude	Circles in parallel planes to that of the equator defining north-south measurements, also called parallels.

L-band	A range of microwave radio frequencies in the neighborhood of 1 to 2 GHz.
Leap Year	Every fourth year, in which a 366th day is added since the Earth's revolution takes 365 days 5 hr 49 min.
LECP	Low-Energy Charged-Particle Detector onboard a spacecraft.
LEO	Low Equatorial Orbit.
LGA	Low-Gain Antenna onboard a spacecraft.
Light	Electromagnetic radiation in the neighborhood of 1 nanometer wavelength.
Light speed	299,792 km per second, the constant <i>c</i> .
Light time	The amount of time it takes light or radio signals to travel a certain distance at light speed.
Light year	The distance light travels in a year.
LMC	Link Monitor and Control subsystem at the SPCs.
Local time	Time adjusted for location around the Earth or other planets in time zones.
Longitude	Great circles that pass through both the north and south poles, also called meridians.
LOS	Loss Of Signal, used in DSN operations.
LOX	Liquid oxygen.
M	Mass.
M	Mega (million).
m	Meter (U.S. spelling; elsewhere, metre), the international standard of linear measurement.
Major axis	The maximum diameter of an ellipse.
Mars	Fourth planet from the sun, a terrestrial planet.
Maser	Microwave Amplification by Stimulated Emission of Radiation.
MC³	Mission Control and Computing Center.
MCCC	Mission Control and Computing Center.
MCT	Mission Control Team, Section 391 project operations.
Mean solar time	Time based on an average of the variations caused by Earth's non-circular orbit.
Mercury	First planet from the sun, a terrestrial planet.
Meridians	Great circles that pass through both the north and south poles, also called lines of longitude.
MESUR	The Mars Environmental Survey project at JPL, the engineering prototype of which is called MESUR Pathfinder.

Meteor	A meteoroid which is in the process of entering Earth's atmosphere.
Meteorite	Rocky or metallic material which has fallen to Earth or to another planet.
Meteoroid	Small bodies in orbit about the sun which are candidates for falling to Earth or to another planet.
MGA	Medium-Gain Antenna onboard a spacecraft.
MGN	Magellan spacecraft.
MGSO	Multimission Ground Systems Office at JPL (formerly called MOSO).
MHz	Megahertz (10^6 Hz).
Micrometer	μm (10^{-6} m).
Micron	Obsolete term for micrometer, μm (10^{-6} m).
Milky Way	The galaxy which includes the sun and Earth.
Millimeter	10^{-3} meter.
MIT	Massachusetts Institute of Technology.
mm	millimeter (10^{-3} m).
MO	Mars Observer spacecraft.
Modulation	The process of modifying a radio frequency by shifting its phase, frequency, or amplitude to carry information.
Moon	A small natural body which orbits a larger one. A natural satellite.
MOSO	Multimission Operations Systems Office at JPL; now called MGSO.
μm	Micrometer (10^{-6} m).
N	Newton, a unit of force equal to the force required to accelerate a 1kg mass 1m per second per second ($1\text{m}/\text{sec}^2$). Compare with dyne.
N	North.
Nadir	The direction from a spacecraft directly down toward the center of a planet. Opposite the zenith.
NASA	National Aeronautics and Space Administration.
NE	Near Encounter phase in flyby mission operations.
Neptune	Eighth planet from the sun, a gas giant or Jovian planet.
NIMS	Near-Infrared Mapping Spectrometer onboard the Galileo spacecraft.
nm	Nanometer (10^{-9} m).
nm	Nautical Mile, equal to the distance spanned by one minute of arc in latitude, 1.852 km.
Nodes	Points where an orbit crosses a plane.
Non-coherent	Communications mode wherein a spacecraft generates its downlink frequency independent of any uplink frequency.
Nucleus	The central body of a comet.

OB	Observatory phase in flyby mission operations encounter period.
One-way	Communications mode consisting only of downlink received from a spacecraft.
Oort cloud	A large number of comets theorized to orbit the sun in the neighborhood of 50,000 AU.
OPCT	Operations Planning and Control Team, "OPSCON."
OSR	Optical Solar Reflector, thermal control component onboard a spacecraft.
OSSA	Office Of Space Science and Applications, NASA.
OTM	Orbit Trim Maneuver, spacecraft propulsive maneuver.
OWLT	One-Way Light Time, elapsed time between Earth and spacecraft or solar system body.
PAM	Payload Assist Module upper stage.
Parallels	Circles in parallel planes to that of the equator defining north-south measurements, also called lines of latitude.
Pathfinder	The Mars Environmental Survey (MESUR) engineering prototype.
PDS	Planetary Data System.
PDT	Pacific Daylight Time.
PE	Post Encounter phase in flyby mission operations.
Periapsis	The point in an orbit closest to the body being orbited.
Perigee	Periapsis in Earth orbit.
Perihelion	Periapsis in solar orbit.
Perijove	Periapsis in Jupiter orbit.
Perilune	Periapsis in lunar orbit.
Periselene	Periapsis in lunar orbit.
Phase	The angular distance between peaks or troughs of two waveforms of similar frequency.
Phase	The particular appearance of a body's state of illumination, such as the full phase of the moon .
Photovoltaic	Materials that convert light into electric current.
PHz	Petahertz (10^{15} Hz).
PI	Principal Investigator, scientist in charge of an experiment.
PIO	JPL's Public Information Office.
Plasma	Electrically conductive fourth state of matter from solid, liquid, and gas, consisting of ions and electrons.
PLL	Phase-lock-loop circuitry in telecommunications technology.
Pluto	Ninth planet from the sun, sometimes classified as a small terrestrial planet.

pm	Picometer (10^{-12} m).
PM	Post meridiem (Latin: after midday), afternoon.
PN10	Pioneer 10 spacecraft.
PN11	Pioneer 11 spacecraft.
PST	Pacific Standard Time.
PSU	Pyrotechnic Switching Unit onboard a spacecraft.
RA	Right Ascension, the angular distance of a celestial object measured in hours, minutes, and seconds along the celestial equator eastward from the vernal equinox.
Radian	Unit of angular measurement equal to the angle at the center of a circle subtended by an arc equal in length to the radius. Equals about 57.296 degrees.
RAM	Random Access Memory.
Red dwarf	A small star, on the order of 100 times the mass of Jupiter.
Refraction	The deflection or bending of electromagnetic waves when they pass from one kind of transparent medium into another.
RF	Radio Frequency.
RFI	Radio Frequency Interference.
ROM	Read Only Memory.
RPIF	Regional Planetary Imaging Data Facilities.
RTG	Radioisotope Thermo-Electric Generator onboard a spacecraft.
RTLTL	Round-Trip Light Time, elapsed time roughly equal to 2 x OWLT.
S	South.
SA	Solar Array, photovoltaic panels onboard a spacecraft.
SAF	Spacecraft Assembly Facility, JPL Building 179.
SAR	Synthetic Aperture Radar.
Satellite	A small body which orbits a larger one. A natural or an artificial moon. Earth-orbiting spacecraft are called satellites. While deep-space vehicles are technically satellites of the sun or of another planet, or of the galactic center, they are generally called spacecraft instead of satellites.
Saturn	Sixth planet from the sun, a gas giant or Jovian planet.
S-band	A range of microwave radio frequencies in the neighborhood of 2 to 4 GHz.
SC	Steering Committee.
SCET	Spacecraft Event Time, equal to ERT minus OWLT.
SCLK	Spacecraft Clock Time, a counter onboard a spacecraft.
Sec	Second.
SEDR	Supplementary Experiment Data Record.

SEF	Spacecraft event file.
SEGS	Sequence of Events Generation Subsystem.
Semi-major axis	Half the distance of an ellipse's maximum diameter, the distance from the center of the ellipse to one end.
Shepherd moons	Moons which gravitationally confine ring particles.
Sidereal time	Time relative to the stars other than the sun.
SIRTF	Space Infrared Telescope Facility.
SOE	Sequence of Events.
SNR	Signal-to-Noise Ratio.
SP-100	JPL's Space Power-100 Project developing nuclear reactors for use in space.
SPC	Signal Processing Center at each DSCC.
SSA	Solid State Amplifier in a spacecraft telecommunications subsystem, the final stage of amplification for downlink.
SSI	Solid State Imaging Subsystem, the CCD-based cameras on Galileo.
SSI	Space Services, Inc., Houston, manufacturers of the Conestoga launch vehicle.
STS	Space Transportation System (Space Shuttle).
Subcarrier	Modulation applied to a carrier which is itself modulated with information-carrying variations.
Superior planet	Planet which orbits farther from the sun than Earth's orbit.
Superior conjunction	Alignment between Earth and a planet on the far side of the sun.
SWG	Science Working Group.
TAU	Thousand AU Mission.
TCM Trajectory	Correction Maneuver, spacecraft propulsive maneuver.
TDM	Time-division multiplexing.
Three-way	Coherent communications mode wherein a DSS receives a downlink whose frequency is based upon the frequency of an uplink provided by another DSS.
THz	Terahertz (10^{12} Hz).
TOS	Transfer Orbit Stage, upper stage.
Transducer	Device for changing one kind of energy into another, typically from heat, position, or pressure into a varying electrical voltage or vice versa, such as a microphone or speaker.
Transponder	Electronic device which combines a transmitter and a receiver.
TRC	NASA's Teacher Resource Centers.

TRM	Transmission Time, UTC Earth time of uplink.
True anomaly	The angular distance of a point in an orbit past the point of periapsis, measured in degrees.
TWNC	Two-Way Non-Coherent mode, in which a spacecraft's downlink is not based upon a received uplink from DSN.
Two-way	Communications mode consisting of downlink received from a spacecraft while uplink is being received at the spacecraft. (See also "coherent.")
TWT	Traveling Wave Tube, downlink power amplifier in a spacecraft telecommunications subsystem, the final stage of amplification for downlink (same unit as TWTA).
TWTA	Traveling Wave Tube Amplifier, downlink power amplifier in a spacecraft telecommunications subsystem, the final stage of amplification for downlink (same unit as TWT).
ULS	Ulysses spacecraft.
µm	Micrometer (10^{-6} m).
Uplink	Signal sent to a spacecraft.
Uranus	Seventh planet from the sun, a gas giant or Jovian planet.
USO	Ultra Stable Oscillator, in a spacecraft telecommunications subsystem.
UTC	Universal Time, Coordinated.
UV	Ultraviolet (meaning "above violet") radiation. Electromagnetic radiation in the neighborhood of 100 nanometers wavelength.
Venus	Second planet from the sun, a terrestrial planet.
VGR1	Voyager 1 spacecraft.
VGR2	Voyager 2 spacecraft.
VLBI	Very Long Baseline Interferometry.
W	Watt, a measure of electrical power equal to potential in volts times current in amps.
W	West.
Wavelength	The distance that a wave from a single oscillation of electromagnetic radiation will propagate during the time required for one oscillation .
WWW	World-wide Web.
X-band	A range of microwave radio frequencies in the neighborhood of 8 to 12 GHz.
X-ray	Electromagnetic radiation in the neighborhood of 100 picometers wavelength.
Z	Zulu in phonetic alphabet, stands for GMT.
Zenith	The point on the celestial sphere directly above the observer. Opposite the nadir.

INDEX

A

ACE 132
 Aerobraking 139
 Altimeters 118
 Announcement of Opportunity (AO) 57
 Antennas, mounting systems 21
 Apoapsis 32
 Argument of periapsis 39
 Ariane rocket 126
 Asteroids 13
 Astronomical unit (AU) 6
 Atlas rocket 126
 Atmospheric balloon packages 70
 Atmospheric entry 139
 Atmospheric probes 69
 Attitude and Articulation Control (AACCS) 98
 Autonomous Star Tracker 108
 AZ-EL system 21

B

Balloon tracking 140
 Barycenter 31
 Bow shock crossing 136
 Bus 95

C

Callisto 10
 Carrier 101
 Cassegrain focus 53
 Cassini 83, 137
 Celestial sphere 20–21
 AZ-EL system 21
 Declination (DEC) 21
 HA-DEC system 21
 Hour angle (HA) 21
 Nadir 21
 Observer's meridian 21
 Vernal equinox 21
 Zenith 21
 Centre National d'Études Spatiales (CNES) 126
 Centripetal acceleration 30
 Charge coupled devices (CCDs) 115
 Coherence 92
 Comets 13–15
 Oort Cloud 13
 Shoemaker-Levy 9 14
 Command and data handling subsystem
 (C&DH) 96

Command and data subsystem (CDS) 96
 Command detector unit (CDU) 101
 Command-Loss Timer 97
 Commanding in real time 131
 Complex Monitor and Control (CMC) 133
 Computer command subsystem (CCS) 96
 Conestoga launch vehicle 127
 Contingency mode 97
 Cruise phase 131–135
 Crystalline silicon 102

D

Data
 Command data 92
 Ground Data System (GDS) 64
 Maximum likelihood convolutional coding 96
 Multiplexing 92
 Packetizing 92
 Radio science experiments 65
 Science. *See* Science: Instruments
 Science data flow 64
 Science vs. engineering 64
 Storage on spacecraft 97
 Telemetry data 92
 Telemetry packaging and coding 96
 Viterbi encoding 96
 Declination (DEC) 21
 Deep Space Network
 Complex Monitor and Control (CMC) 133
 Deep Space Station (DSS) 133
 Signal Processing Center (SPC) 133
 Delta rocket 125
 Differenced Doppler 51
 Doppler effect 50
 Gravity field surveys 66
 Dust detectors 114

E

Earth 18
 Celestial sphere 20–21
 Oblateness 18
 Precession of axis 18
 Revolution around sun 19
 Rotation 18
 Tidal Forces 31
 Earth-received time (ERT) 23
 Eccentricity 39

Ecliptic 5
 Electromagnetic phenomena 43–56
 Electromagnetic radiation 43
 Differenced Doppler 51
 Doppler effect 50
 Inverse-square law 43
 Natural emitters 46
 Phase 55
 Radio astronomy 46
 Radio frequencies (RF) 46
 Reflection 52
 Cassegrain focus 53
 Goldstone Solar System Radar (GSSR) 53
 Planetary radar 53
 Prime focus 52
 Refraction 54
 RF band definitions 47
 Signal-to-noise ratio 46
 Electromagnetic spectrum 44
 Atmospheric transparency 48
 Laws of spectral analysis 47
 Spectroscopy 47
 Ellipses 27–28
 Encounter phase 135–141
 Aerobraking 139
 Atmospheric entry 139
 Balloon tracking 140
 Bow shock crossing 136
 Far encounter phase (FE) 135
 Flyby Operations 135
 Gravity field surveying 138
 Landing 139
 Near encounter phase (NE) 135
 Observatory phase (OB) 135
 Occultations 138
 Planetary mapping 137
 Planetary orbit insertion 136
 Post encounter phase (PE) 136
 Preparation for 133
 Sampling 140
 System exploration 137
 End of mission 144–147
 Ephemeris Time (ET) 24
 Equator 17
 Europa (Jupiter satellite) 10
 Experiments 63–67

F

Far encounter phase (FE) 135
 Fault protection 97
 Flight Data Subsystem (FDS) 96
 Flyby Operations 135
 Flyby spacecraft 69
 Force, standard unit 29

G

Galilean satellites 10
 Galileo 137, 139
 Galileo Atmospheric Probe 79
 Gallium arsenide 102
 Ganymede 10
 Geostationary orbit 40
 Geosynchronous orbits 40
 Geosynchronous transfer orbit 40
 Goldstone Solar System Radar (GSSR) 53
 Gravitation and Mechanics 27–35
 Gravitational wave search 66
 Gravity assist trajectories 36–38
 Gravity field surveys 66, 138
 Gravity gradients (tidal forces) 31–32
 Greenwich Mean Time (GMT) 23

H

HA-DEC system 21
 Heavy Ion Counter 113
 Heliopause 7
 High-energy particle detectors 113
 High-gain antennas 99
 Hohmann transfer orbits 35–36
 Hour angle (HA) 21
 Hubble Space Telescope 144
 Huygens Probe 84

I

Imaging instruments 115
 Inclination 39
 Inferior conjunction 12
 Infrared radiometer 116
 Integrated sequence of events (ISOE) 24, 132
 Inverse-square law 43
 Io (Jupiter satellite) 10
 Ion engines 108
 ISO OSI 92

J

no entries

K

Keplerian elements. *See* Orbits: Keplerian elements
 Kepler's Laws 30–31
 Keyword file (KWF), DSN 132
 Kirchhoff, Gustav 47

L

Lander spacecraft 70
 Landing 139
 Large Magellanic Cloud 5

Laser gyroscopes 108
 Laser telecommunications systems 108
 Latitude 17
 Launch phase 125–131
 Preparations 129
 Sites 127–128
 Vehicles 125–127
 Ariane 126
 Atlas 126
 Conestoga 127
 Delta 125
 Pegasus 127
 Proton 126
 Scout 127
 Space Transportation System 127
 Titan 125
 Windows 128
 Light year 5
 Link Monitor and Control (LMC) 133
 Local time 23
 Longitude 17
 Longitude of ascending node 39
 Low-energy charged-particle detectors 113
 Low-gain antennas 100

M

Magellan 73, 137, 139, 144
 Magnetometer boom 95
 Magnetometers 114
 Main bus (spacecraft power) 103
 Mars Balloon 86, 140
 Mars Global Surveyor 137, 139, 140
 Mars Observer 78
 Mars Pathfinder 85, 140
 Mass, standard unit 29
 Maximum likelihood convolutional coding 96
 Mean Solar Time 24
 Medium-gain antennas 100
 Meridians 17
 Meteoroids 16–17
 Metric to English conversion 3
 Milky Way 5
 Miranda 10
 Mission design 58
 Mission inception 57–63
 Announcement of Opportunity (AO) 57
 Design and development 60
 Mission definition 59
 Proof of concept 58
 Proposal 57
 Science Working Group (SWG) 57
 Modulation index 92
 Multiplexing 92
 Pseudo-noise (PN) 92
 Time-division multiplexing (TDM) 92

N

Nadir 21
 Near encounter phase (NE) 135
 Newton's Laws 28
 Non-coherence 93
 North Star 22

O

Oberon 10
 Observation phase (OB) 135
 Observer's meridian 21
 Occultations 138
 One-way light time (OWLT) 23
 Oort Cloud 13
 Operations phase 132–133
 Complex Monitor and Control (CMC) 133
 Extended operations 143
 Integrated sequence of events (ISOE) 132
 Keyword file (KWF), DSN 132
 Link Monitor and Control (LMC) 133
 Preparation for Encounter 133
 Sequence of events (SOE) 132
 Spacecraft event file (SEF) 132
 Tracking the spacecraft 133
 Optical solar reflectors (OSRs) 104
 Orbiters 69
 Orbits 39–41
 Apoapsis 32
 Barycenter 31
 Geostationary 40
 Geosynchronous 40
 Geosynchronous transfer orbit 40
 Hohmann transfer orbits 35–36, 128
 How they work 32–35
 Keplerian elements 39
 Argument of periapsis 39
 Eccentricity 39
 Inclination 39
 Longitude of ascending node 39
 Semi-major axis 39
 Time of periapsis passage 39
 Kepler's Laws 30
 Nodes 39
 Periapsis 32
 Planetary orbit insertion 136
 Polar 40
 Prograde 39
 Retrograde 39
 Sun-synchronous 41
 True anomaly 39
 Walking 41

P

Packetizing 92
 Parallels 17
 Pegasus rocket 127
 Periapsis 32
 Phase lock-loop circuitry (PLL) 101
 Phases of illumination 12
 Inferior conjunction 12
 Superior conjunction 12
 Photometers 116
 Photopolarimeter 116
 Photovoltaics 102
 Pioneers 10 & 11 76
 Planetary limb trackers 99
 Planetary mapping 137
 Planetary orbit insertion 136
 Planetary radar 53
 Planetary system exploration 137
 Planets
 Earth 8
 Gas giants 10
 Inferior 12
 Jovian 10–12
 Callisto (Jupiter satellite) 10
 Data summary 11
 Europa (Jupiter satellite) 10
 Galilean satellites 10
 Ganymede (Jupiter satellite) 10
 Io (Jupiter satellite) 10
 Jupiter 10
 Miranda (Saturn satellite) 10
 Neptune 10
 Oberon (Saturn satellite) 10
 Rings 10
 Saturn 10
 Shepherd moons 10
 Titan (Saturn satellite) 10
 Titania (Uranus satellite) 10
 Triton (Neptune satellite) 10
 Umbriel (Saturn satellite) 10
 Uranus 10
 Mars 8
 Mercury 8
 Phases of illumination 12
 Pluto 10
 Superior 12
 Terrestrial 8–10
 Data summary 9
 Mass 8
 Radii 8
 Rotation period 8
 Venus 8
 Plasma 7
 Plasma instruments 114

Plasma wave detectors 114
 Pluto Spacecraft 87
 Polar orbits 40
 Polarimeters 116
 Polaris 22
 Post encounter phase (PE) 136
 Precession of Earth axis 18
 Prime focus 52
 Prime meridian 17
 Prograde orbits 39
 Proton rocket 126
 Proxima Centauri 5, 6
 Pseudo-noise (PN) 92
 Pyrotechnic switching unit (PSU) 106

Q

no entries

R

Radio astronomy 46
 Radio astronomy instruments 114
 Radio frequency (RF) radiation 46
 Band definitions 47
 Radio frequency interference 50
 RF interference 50
 Radioisotope thermoelectric generators 103
 Radiometer-spectrometer 116
 Reflection 52
 Refraction 54
 Retrograde orbits 39
 Right ascension (RA) 21
 Rings (planetary)
 10
 Rotation of Earth 18
 Round-trip light time (RTL) 24

S

Safing mode 97
 Sampling 140
 Scan platforms 117
 Science
 Announce of Opportunity (AO) 58
 Data flow 64
 Dissemination of results 66
 Experiments 63–67
 Gravity field surveys 66
 Instruments 113–119
 Altimeters 118
 Charge coupled devices (CCDs) 115
 Direct vs. remote sensing 113
 Dust detectors 114
 Heavy Ion Counter 113
 High-energy particle detectors 113
 Imaging 115

- Infrared radiometer 116
- Low-energy charged-particle detectors 113
- Magnetometers 114
- Photometers 116
- Photopolarimeter 116
- Planetary radio astronomy 114
- Plasma 114
- Plasma wave detectors 114
- Polarimeters 116
- Radiometer-spectrometer 116
- Scan platforms 117
- Solid-state imaging (SSI) 115
- Spectrometers 116
- Synthetic Aperture Radar Imaging 117
- Vidicon 115
- Principal investigator (PI) 63
- Radio science experiments 65
- Teacher Resource Centers (TRC) 67
- Science Working Group (SWG) 57
- Scout launch vehicle 127
- Semi-major axis 39
- Sequence of events (SOE) 132
- Shepherd moons 10
- Shoemaker-Levy 9 14
- Signal power 91
- Signal Processing Center (SPC) 133
- Signal-to-noise ratio 46
- Small Magellanic Cloud 5
- Solar power (spacecraft) 102
- Solar sails 108
- Solar system 5–16
 - Mass distribution 6
- Solar trackers 99
- Solar wind 7
- Solid-state imaging instrument (SSI) 115
- Soviet CIS Interkosmos 127
- Soviet Vega spacecraft 140
- Soviet Venera landers 140
- Soviet Venera spacecraft 139
- Space Power-100 (SP-100) Project 108
- Space Shuttle 127
- Space Transportation System 127
- Spacecraft 69–74
 - Atmospheric balloon packages 70
 - Atmospheric probes 69
 - Cassini 83, 137
 - Contingency mode 97
 - Current JPL projects 71
 - Flyby 69
 - Galileo 137, 139
 - Galileo Atmospheric Probe 79
 - Hubble Space Telescope 144
 - Huygens Probe 84
 - Landers 70
 - Magellan 73, 137, 139, 144
 - Mars Balloon 86, 140
 - Mars Global Surveyor 137, 139, 140
 - Mars Observer 78
 - Mars Pathfinder 85, 140
 - Mars Pathfinder Lander 86
 - Orbiters 69
 - Pioneers 10 & 11 76
 - Pluto Spacecraft 87
 - Real-time commanding 131
 - Safing mode 97
 - Science instruments. *See* Science: Instruments
 - Signal. *See* Telecommunications
 - Signal power 91
 - Soviet Vega 140
 - Soviet Venera 139
 - Soviet Venera landers 140
 - Surface penetrators 70
 - Surface rovers 71
 - TOPEX/Poseidon 75
 - Tracking 133
 - Ulysses 74
 - Viking landers 77, 140
 - Voyagers 1 & 2 73, 135, 143, 144
- Spacecraft clock 96
- Spacecraft clock time (SCLK) 24
- Spacecraft event file (SEF) 132
- Spacecraft event time (SCET) 24
- Spacecraft subsystems 95–113
 - Attitude and articulation control 98–99
 - Autonomous Star Tracker 108
 - Laser gyroscopes 108
 - Stabilization 98
- Block diagram 106
- Data handling
 - Command and Data Handling subsystem (C&DH) 96
 - Command and data subsystem (CDS) 96
 - Command-Loss Timer 97
 - Computer command subsystem (CCS) 96
 - Data storage 97
 - Flight data subsystem (FDS) 96
 - Spacecraft clock 96
- Environmental 104
 - Active heating 104
 - Jovian radiation 105
 - Micro-meteoroid protection 105
 - Optical solar reflectors (OSRs) 104
 - Passive cooling 104
- Fault protection 97
- Power 102–104
 - Distribution 103
 - Radioisotope thermoelectric generators (RTG) 103
 - Space Power-100 (SP-100) Project 108
 - Storage 104

- Propulsion 105
 - Ion engines 108
 - Photovoltaic power 102
 - Solar sails 108
 - Pyrotechnic 106
 - Redundancy and flexibility 107
 - Structural
 - Bus 95
 - Magnetometer boom 95
 - Telecommunications 99. *See also* Telecommunications
 - High-gain antennas 99
 - Lasers 108
 - Low-gain antennas 100
 - Medium-gain antennas 100
 - Receivers 101
 - Transmitters 101
 - Transponder 101
 - Traveling wave tube amplifier (TWTA) 101
 - Spectrometers 116
 - Spectroscopy 47–48
 - Star scanners 99
 - Star trackers 99
 - Subcarrier 92
 - Sun 6–7
 - Sun sensors 99
 - Sun-synchronous orbits 41
 - Superior conjunction 12
 - Surface penetrator spacecraft 70
 - Surface rover spacecraft 71
 - Synthetic aperture radar imaging 117
- T**
- Teacher Resource Centers (TRC) 67
 - Telecommunications 91–95
 - Carrier signal 91, 101
 - Coherence 92
 - Command data 92
 - Command detector unit (CDU) 101
 - ISO OSI 92
 - Laser systems (spacecraft) 108
 - Modulation and demodulation 91
 - Modulation index 92
 - Multiplexing 92
 - Non-coherence 93
 - Packetizing data 92
 - Phase lock-loop circuitry (PLL) 101
 - Pseudo-noise (PN) 92
 - Spacecraft subsystems 99–102. *See also* Spacecraft subsystems
 - Subcarrier 92
 - Telemetry data 92
 - Three-way coherence 93
 - Time-division multiplexing (TDM) 92
 - Transponder 101
 - Two-Way non-coherence (TWNC) 93
 - Uplink vs. downlink 91
 - Terrestrial coordinates 17–18
 - Equator 17
 - Latitude 17
 - Longitude 17
 - Meridians 17
 - Parallels 17
 - Prime meridian 17
 - Terrestrial Dynamical Time (TDT) 24
 - Terrestrial Time (TT) 24
 - Thousand AU mission (TAU) 108
 - Three-way coherence 93
 - Tidal forces 31
 - Time conventions 23–27
 - Earth-received time (ERT) 23
 - Ephemeris Time (ET) 24
 - Greenwich Mean Time (GMT) 23
 - Local time 23
 - Mean Solar Time 24
 - One-way light time (OWLT) 23
 - Round-trip light time (RTL) 24
 - Spacecraft clock time (SCLK) 24
 - Spacecraft event time (SCET) 24
 - Terrestrial Dynamical Time (TDT) 24
 - Terrestrial Time (TT) 24
 - Transmission time (TRM) 24
 - Universal Time (UT) 23
 - Universal Time Coordinated (UTC) 23
 - Time of periapsis passage 39
 - Time-division multiplexing (TDM) 92
 - Titan (Saturn satellite) 10
 - Titan rocket 125
 - Titania (Uranus satellite) 10
 - TOPEX/Poseidon 75
 - Tracking the spacecraft 133
 - Transmission time (TRM) 24
 - Transmitters (spacecraft) 101
 - Transponder 101
 - Traveling wave tube amplifier (TWTA) 101
 - Triton (Neptune satellite) 10
 - True anomaly 39
 - Two-way non-coherence (TWNC) 93
- U**
- Ulysses 74
 - Umbriel (Uranus satellite) 10
 - Units of measure 3
 - Universal Time (UT) 23
 - Universal Time Coordinated (UTC) 23

V

Vernal equinox 21
Vidicon 115
Viking landers 77, 140
Viterbi encoding 96
Voyagers 1 & 2 73, 135, 143, 144

W

Walking orbits 41

X

no entries

Y

no entries

Z

Zenith 21

This hardcopy edition was produced on an Apple© Macintosh PowerPC 7500 using Adobe® PageMaker® 6.0 and Claris® MacDraw®Pro and ClarisDraw™ illustration software. The text is set in Times 12 point. The document was printed on a Hewlett-Packard LaserJet4M+® printer.