

Comparison and Simulation of Digital Modulation Recognition Algorithms

Wei Su
U.S. Army CECOM RDEC
Intelligence and Information Warfare Directorate
AMSEL-RD-IW-I
Fort Monmouth, NJ 07703
1-732-427-6332
wei.su@us.army.mil

John Kosinski
U.S. Army CECOM RDEC
Intelligence and Information Warfare Directorate
AMSEL-RD-IW-I
Fort Monmouth, NJ 07703
1-732-427-5605
john.kosinski@us.army.mil

Abstract - Modulation recognition has been studied for decades with numerous amounts of papers published. Modulation classifiers are developed under assumptions and may not be robust in some applications. This paper studies and simulates several popular digital modulation recognition methods and discusses the pros and cons of those algorithms based on the robustness of the modulation feature and algorithm fundamentals.

Index Terms – electronic warfare, communication, modulation recognition, signal classification, algorithm comparison, modulation feature.

I. INTRODUCTION

Modulation recognition is an important subject not only in commercial application but also in classifying emitter types for military electronic support cases [1-4]. Modulation recognition is a non-cooperative communication practice which, in general, starts with signal processing to remove center frequency, re-sample the signal, synchronize baud rate and carrier phase, and equalize the channel distortion. It is followed by modulation feature extraction to obtain unique information related to amplitude, phase, and frequency. Then, feature recognition is applied by using logic analysis to match features to known templates, or using statistical analysis to find a solution based on probabilities. Therefore, based on the techniques being used, a successful modulation recognition technique may depend not only on factors such as: signal bandwidth, available signal length, digitization method, number of samples per symbol, modulation types, transmission environment, signal noise ratio, frequency stability, processing power, processing time, implementation cost, and dimension of confusion matrix, but also on qualities of baud rate estimation, pulse synchronization, pulse re-sampling, carrier synchronization, etc. Many publications assume to have perfect knowledge of center frequency, baud rate, and pulse shape so that a fair comparison of different algorithms becomes a challenge. To compare algorithms based solely on signal to noise ratio (SNR) and probability of success may have little value.

Fundamental similarities and differences between the algorithmic bases should be explored.

II. ALGORITHM COMPARISON

The modulation recognition includes converting the analog RF signal to a digital IF signal, extracting modulation features, and recognizing modulation types. Some classifiers can extract modulation features directly from an IF signal. But, in most cases, a coarse estimation is needed to convert IF signal to I and Q components, and extract modulation features with the presence of pass-band signal residuals such as center frequency offset (CFO) or timing errors. Many classifiers extract features by assuming to have perfect base-band symbols since those features are very sensitive to pass-band disturbances. The modulation recognition is conducted by searching the best match between modulation features and given templates. The result of modulation recognition could be a confusion-matrix, which is a table of statistical values obtained with a specified signal-to-noise ratio (SNR). This table provides the values of probability-of-success in respect to a list of candidate modulation types. The result of modulation recognition could also be a set of curves representing candidate modulation types. Each curve gives the probability-of-success versus SNR for a given modulation type. Since modulation classifiers are developed under various assumptions and objectives, the algorithm comparison is nontrivial. Probability-of-success will be a performance measurement only if two classifiers are developed under the same assumptions. Probability-of-false-alarm should also be included to measure the failures that an unknown type is forced to a known template. Therefore, fundamental differences between the algorithms should be studied.

A. Phasor Variation Analysis Classifier

Phasor analysis approach utilizes the phase variation and amplitude variation as features in modulation recognition. In this approach, the IF signal is down-converted to base-band and the symbols are extracted for analysis. Many algorithms assume the unknown signal is transmitted through an ideal channel so that the

white Gaussian AWGN is the only concern in estimation error, some of the algorithms, such as Azzouz and Nandi's modulation classifier [5,6], also assume a perfect recovery of signal symbols. Azzouz and Nandi's classifier recognize both analog and digital modulation types. The digital modulation includes: ASK2, ASK4, FSK2, FSK4, PSK2, and PSK4, Figure 1. The standard-deviation of modulation parameters: nonlinear component of the phase, the absolute value of the nonlinear component of the phase, the absolute value of the normalized-centered instantaneous amplitude, and the absolute value of the normalized-centered frequency are used as features. These standard deviation features are used together with the amplitude power spectrum density in a logic flowchart to match the predetermined feature thresholds to determine the modulation type. Reference [5] is a good tutorial for this type of general modulation recognition. However, the variance of the nonlinear component of the phase and the variance of the absolute value of the nonlinear component of the phase require the removal of the center frequency and linear phase components from the carried signal. Since most communication systems employ some type of filtering prior to transmission for shaping the signal for bandwidth efficiency, as shown in Figure 2, the pulse function of a PSK signal will have a smooth transition and the pulse shape will not be as rectangular as shown by the dashed-line of Figure 2. The linear component of the phase will not be removed easily. In this case, the performance of phase variation and absolute phase variation tests will be failed.

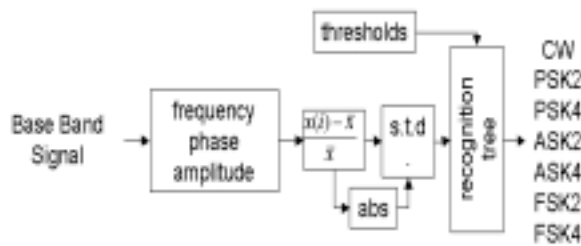

Figure 1. Feature Variation Analysis Modulation Classifier

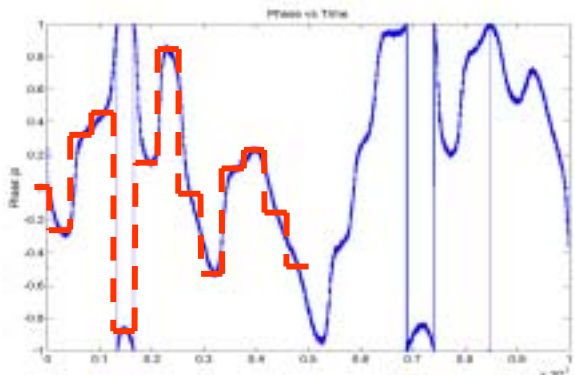

Figure 2 Phase Plot of A PSK Signal

Furthermore, if the center frequency is not removed perfectly, the phase samples $\phi(i) = \phi(i-1) + 2\pi \frac{f_c}{f_s}$ will drift in time as shown in Figures 3 for a BPSK modulation and Figure 8 for a PSK8 modulation, where f_s is the sampling frequency and f_c is the center frequency offset. Carrier timing is another issue in this approach, if one of the PSK phase states is located close to the constellation point π as shown in Figure 4, the phase plot may wrap between $-\pi$ and π , as shown in Figure 5, due to the random noise. This wrap effect may generate large phase variations to fail the standard deviation test.

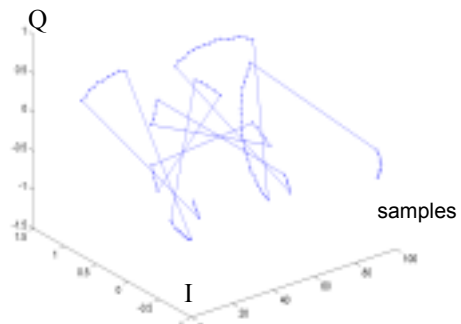

Figure 3 Phase Plot of A BPSK Signal with CFO

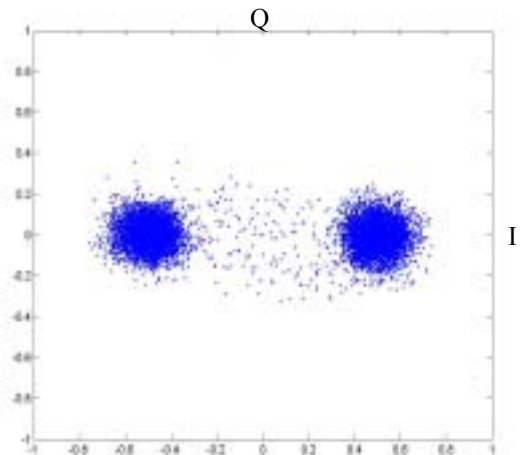

Figure 4 Constellation Diagram of BPSK

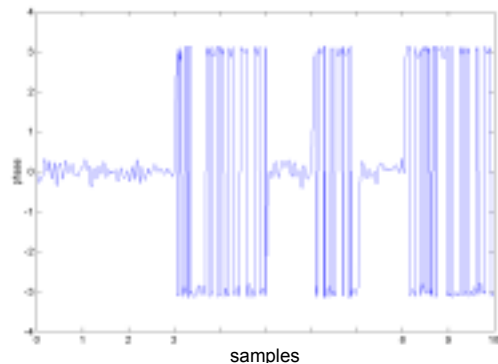

Figure 5 Phase Plot of A BPSK Signal with Phase Wrap

This approach may be extended [7] by adding a frequency estimator, a symbol phase tracker, and a timing device as shown in Figure 6. The frequency estimator provides the instantaneous center frequency of the IF signal. The frequency variance can be used to determine if it is a single tone modulation type. If the frequency variance is large, the standard deviations of the estimated frequency and the absolute value of the frequency are sent to recognition block. Otherwise, the signal will be down modulated to base-band using the estimated center frequency. A timing-recovery circuit is applied to extract amplitude, phase, and frequency symbols. Since the carrier estimated by the frequency estimator may not be accurate and the center frequency may be unstable, a phase tracking and correction block has to be used to remove the residual carrier frequency and prevent phase warp. Figure 7 illustrates that the phase drift of the PSK2 signal in Figure 3 is corrected by using a blind carrier phase tracking algorithm [8].

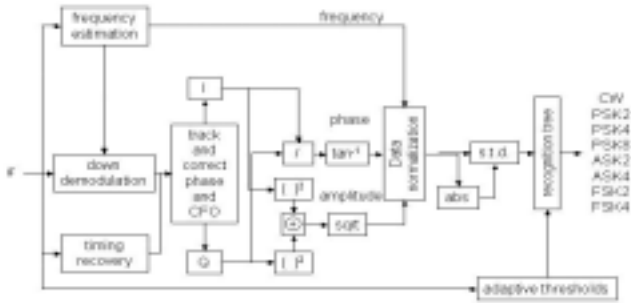

Figure 6. Modified Feature Variation Analysis Classifier

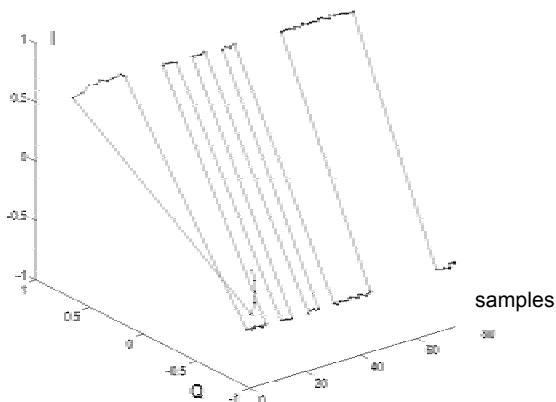

Figure 7. Corrected Phase Plot of BPSK with CFO

To solve the center frequency offset problem, Liedtke [9] adapted delta-phase (the phase difference between two adjacent phase symbols) as a feature rather than phase itself. Figure 8 illustrates the constellation diagram of a PSK8 signal with center frequency offset.

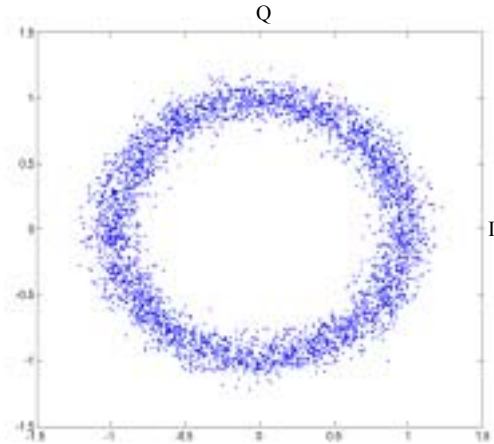

Figure 8. Phase Constellation Diagram of PSK8

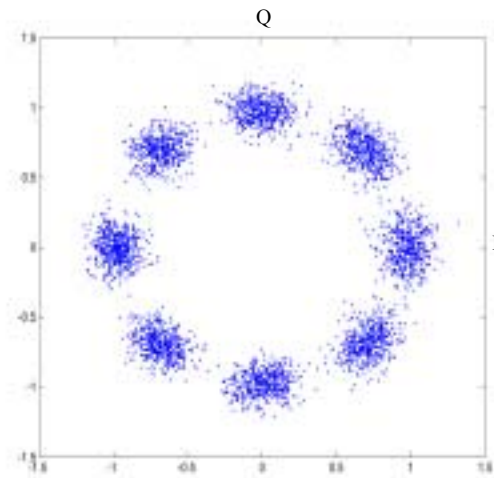

Figure 9. Delta-Phase Constellation Diagram of PSK8

The PSK8 phase feature cannot be observed due to the phase rotation caused by center frequency offset. Figure 9 shows the same signal plotted with delta phase. The clusters of PSK8 are recovered. Liedtke recognizes modulation types: ASK2, FSK2, PSK2, PSK4, PSK8 and CW, Figure 10, by utilizing the histograms of delta-phase. This algorithm only assumes to roughly know the center frequency of the signal and symbol rate. The signal is converted to almost base-band with the residual center frequency by using a concentric FIR filter bank centered at the center frequency. A symbol recovery circuit is employed to extract a sinusoidal waveform with an appropriately tuned narrow band pass filter centered at the symbol rate. This waveform is used to recover the PSK and FSK symbols. Then, the symbol amplitudes and the delta-phase are obtained. The frequency measurement is conducted by taking the phase difference of two time samples. The amplitude variance and frequency variance are used as features for separating modulation types among PSK, ASK, and FSK. The delta-phase histogram is used for probability density analysis to separate PSK2, PSK4, and PSK8. An

addition-only sub-optimal histogram separation process is used to recognize PSK modulation types automatically. The advantage of using the delta-phase as a feature is that the center frequency offset will be eliminated in PSK recognition. Figures 11 and 12 show the deference between phase sample histogram and the delta-phase symbol histogram of a DQPSK signal. Furthermore, with the timing recovery circuit, all feature parameters are observed at the Nyquist sampling rate, and pulse shaping will no longer significantly affect the recognition result.

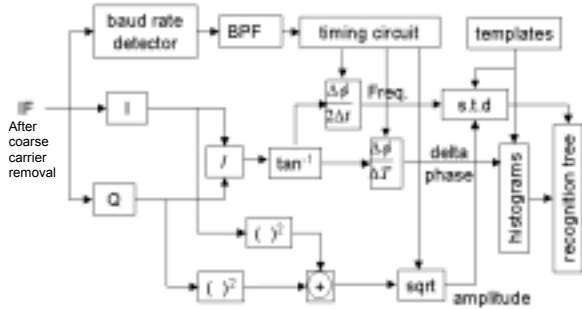

Figure 10. Universal Demodulator

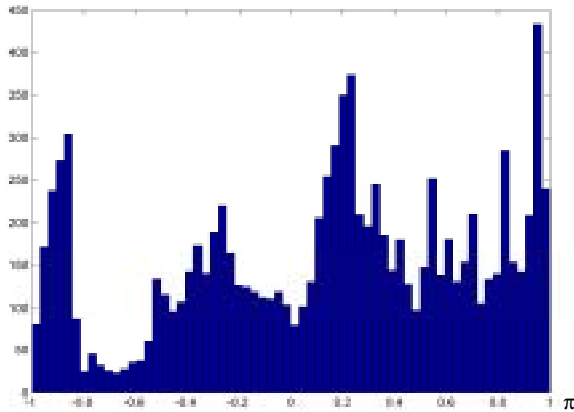

Figure 11 Histogram of Phase Samples of DQPSK

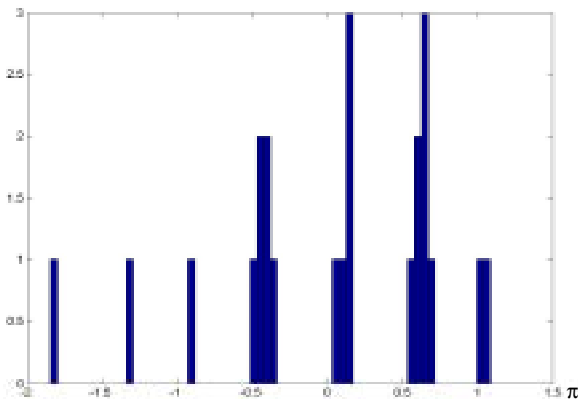

Figure 12 Histogram of Delta-Phase Symbols of DQPSK

This approach may be extended [10] by adding a frequency estimator and an automated timing-recovery device to replace the manual tuning. Since the delta-phase is used as the phase feature, the residual carrier frequency will be eliminated and the phase tracking and correction operation is not needed. If the frequency variance is larger than the threshold value, FSK modulation recognition will be considered. Otherwise, the signal will be down modulated and CW/PSK/ASK modulation recognition will be processed. The modulation feature recognition of the phasor variation analysis approach could be conducted by comparing the feature variances to thresholds [5, 6, 9, 25, 26]. Since the variance is quite sensitive to SNR, this method is better being used for top-level classification. Histograms analysis [9, 25, 26] is another frequently used technique and it is usually use for PSK modulation types. If the perfect symbol recovery is possible, maximum likelihood classifiers [11-21] will be an optimal approach for MPSK and QAM modulation recognitions. It may also be possible to treat constellation plot as image pixels so that many image recognition algorithms [22-24] can be useful in classifying the PSK and QAM modulation types.

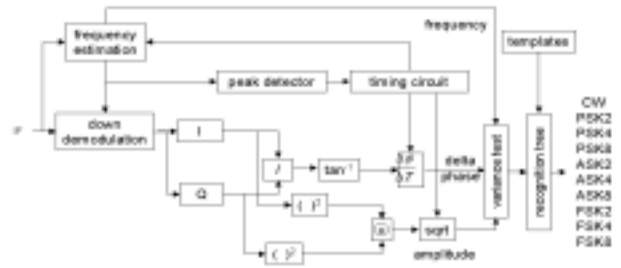

Figure 13 Modified Universal Demodulator

B. Zero-Crossing Modulation Classifier

Hsue and Soliman [25,26] introduced a modulation recognizer for PSK2, PSK4, PSK8, FSK2, FSK4, and FSK8 modulation types based only on the zero-crossing characteristics of signals as shown in Figure 14. The modulation classification procedure extracts the zero-crossing interval sequence for frequency estimation. The estimated frequency is then used together with the zero-crossing sequence for phase estimation. Similar to Liedtke's method, variances are used to separate FSK from single tone signals, and delta-phase histograms are used for parameter variation estimation of PSK signals. Variance thresholds, histogram templates, and likelihood ratio tests are employed for making the modulation decision. Frequency histogram is used for FSK recognition although the classification of a frequency histogram is not trivial. Unlike Liedtke's method, Hsue and Soliman use zero-crossing carrier

estimation instead of manual tuning. Although the estimation is not accurate enough to provide a precise carrier frequency, the delta-phase approach will overcome the center frequency offset in PSK recognition. However, the accuracy of zero-crossing frequency estimation is very sensitive to the SNR as shown in Figures 15 and 16. When SNR is low, the noise may produce additional zero-crossing points. A good resolution of zero-crossing measurement requires a very high sampling rate as shown in Figure 15 for a BPSK signal, where the solid-line is has 80 samples per symbol and the dashed-line has only 4 samples per symbol. The low sample rate will reduce recognition performance greatly, but the high sample rate will pick up thermal noises. Since some data collecting devices requires only two samples per symbol, zero-crossing modulation classifier has to up-sample the data before processing. Our simulation also shows that the rising-edge/falling edge zero-crossing estimation is less noisy than the either-edge zero-crossing estimation as shown in Figure 16, where the smooth dashed-line stands for the frequency estimation of a FSK signal using rising-edge zero-crossing and the noisy solid-line stands for the frequency estimation using either-edge zero-crossing. Furthermore, zero-crossing frequency estimation may yield a single frequency result for an unknown signal with multiple instantaneous frequencies.

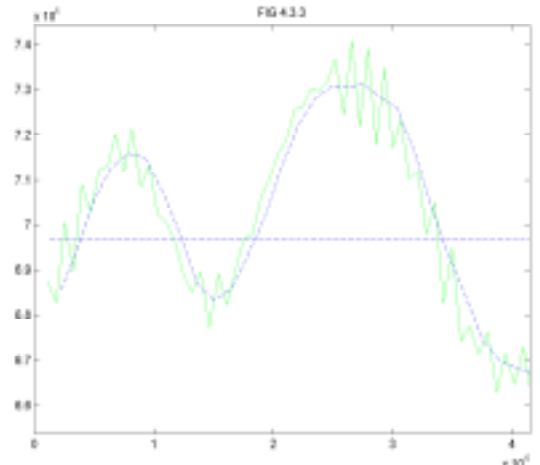

Figure 16 Zero-crossing Frequency Plot of A FSK Signal

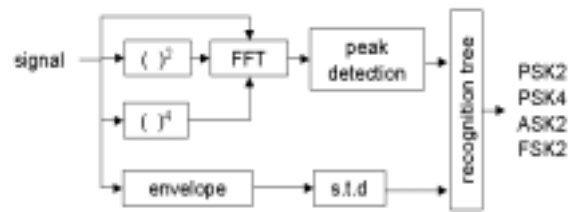

Figure 17. Power-Law Modulation Classifier

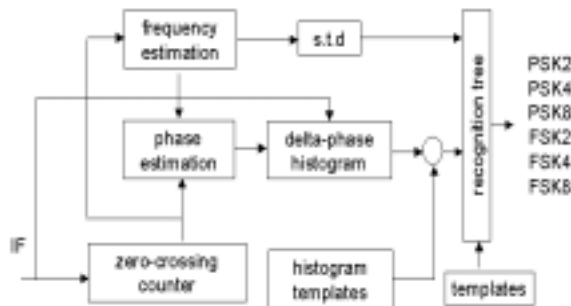

Figure 14. Zero-Crossing Modulation Classifier

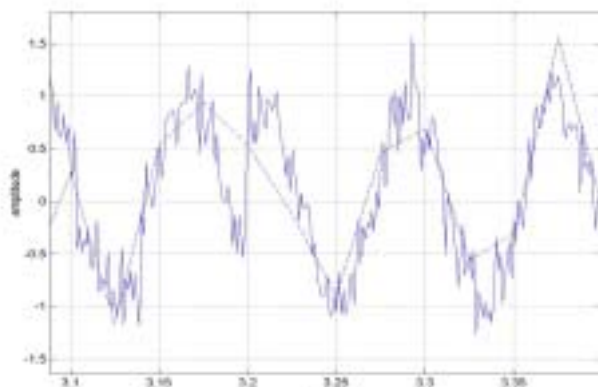

Figure 15. BPSK signal with Two Different Sampling Rates

C. Power-Law Modulation Classifier

DeSimio and Glenn [27] introduced a technique to classify digital modulations: ASK2, PSK2, PSK4, and FSK2, as shown in Figure 17. In this recognizer a power-law classification is conducted to obtain the squared and the fourth power of a signal. Therefore, the key features are magnitude and location of the spectrum peaks in the frequency domain. That is, the magnitude of the spectral component at twice the carrier frequency of the signal raised to the second power, or the magnitude of the spectral component at four times the carrier frequency of the signal raised to the fourth power. For example, Figure 18 is the frequency spectrum of 100 symbols of a QPSK signal with center frequency f_c at 12 KHz, sampling frequency at 160 KHz, and SNR=10dB. Figure 19 is the spectrum of the same signal after taking the fourth power. A peak of $4f_c$ is shown at 48 KHz, which indicates the QPSK modulation type. This peak will not be seen in Figure 18 or in the spectrum of the squared signal. The mean and variance of the signal envelope are used for ASK recognition. A decision tree is used to recognize modulation type based on the values of above features. The concept of power-law classification is based on the fact that squaring of an MPSK signal is another PSK

with $M/2$ phase states. The power-law approach has the convenience of recognizing modulation type without converting the signal to base-band. Although band pass filtering of the spectrum peak requires knowledge of the center frequency, the exact carrier frequency and pulse shape are not necessary. However, this method is limited by the sampling rate. The signal must be sufficiently over-sampled (for example: 2X for PSK2 or 4X for PSK4) in order to satisfy the sampling theorem. Figure 20 shows the same signal sampled at a lower rate of 80 KHz. Since the sampling theorem limit the frequency range to 40 KHz, the peak at 48KHz will not be displayed at Figure 20. Although the image of $4f_c$ exists at 32 KHz, it is too noisy to be properly detected. The peak of $4f_c$ can be detected by correlating the spectrum of the signal with a $\text{sinc}^2(x)$ reference function [27], but a high resolution spectrum may be needed. Our simulation also shows that the detection of spectrum peak becomes more difficult if the pulse shaping is used. The capability in FSK modulation recognition is limited in this approach.

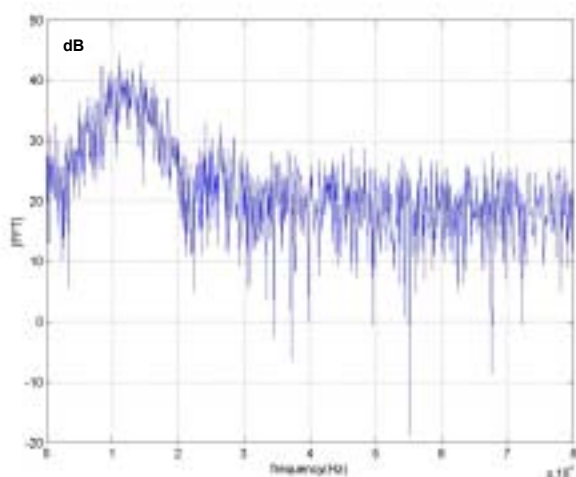

Figure 18 Frequency Spectrum of A QPSK Signal

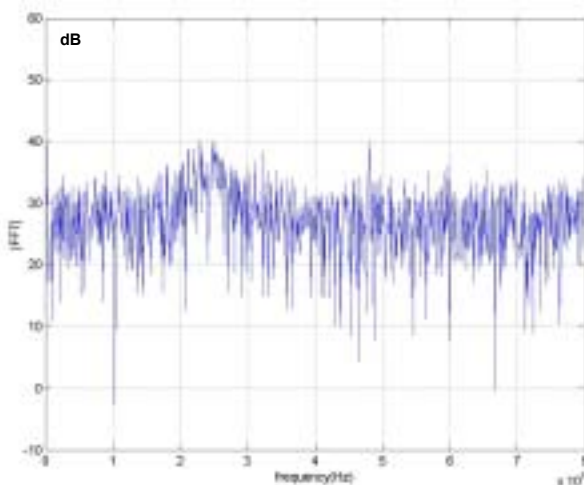

Figure 19 Spectrum of A QPSK Signal with Forth-Power

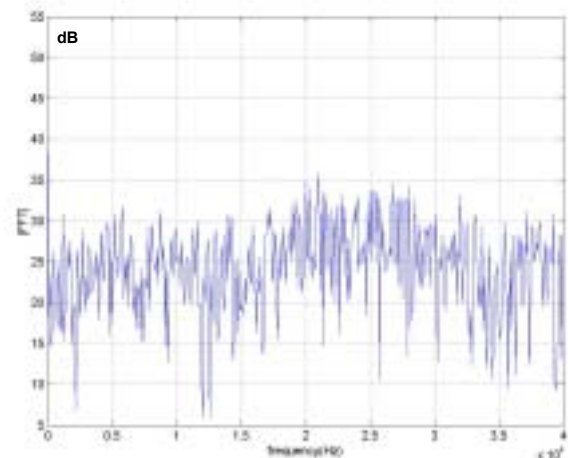

Figure 20 Under-Sampled QPSK Signal with Forth-Power

III. CONCLUSION

Some well-known modulation recognition algorithms are studied and simulated. The comparison of modulation recognition algorithms is not straightforward since algorithms are developed under different motivations and they are all good in solving certain problems. Our analysis is based on our application requirements, which may not apply to other cases. All signal plots used in this paper are simulated by MATLAB software and are not associated with any commercial or military devices/systems. Modulation classifiers may be sensitive to center frequency offset, and pulse shaping, symbol or carrier timing, and sampling frequency. The assumptions, limitations, and the fundamental similarities and differences between the algorithms should be explored in algorithm comparison.

IV. REFERENCES

- [1] W. Su, "Computing and simulation of optimal location for RF emitters over rough terrain," in *Proc. of the 46th Joint Electronic Warfare Conference*, May 2000.
- [2] B. Abbe et al., "Use of unconventional battlefield systems for IO," in *Proc. of the 45th Annual Joint Electronic Warfare Conference*, May 1999.
- [3] W. Su and T. Huyuh, "A novel method in automated map based intelligence support systems," in *Proc. of 1998 Joint Electronic Warfare Conference*, April 1998.
- [4] T. Huynh and W. Su, "Analysis of a back-propagation approach for automated jammer deployment," in *Research and Development Technical Report*, CECOM-TR-99-1, April 1999.

- [5] E. Azzouz and A. Nandi, "Automatic modulation recognition of communication signals," *Kluwer Academic Publishers*, 1996.
- [6] E. Azzouz and A. Nandi, "Automatic Identification of Digital Modulations," *Signal Processing*, Vol. 47, No. 1, Nov. 1995, pp.55-69.
- [7] W. Su and J. Kosinski, "Comparison and modification of automated communication modulation recognition methods," in Proc. of MILCOM'02, October 2002.
- [8] Belouchrani and W. Ren, "Blind Carrier Phase Tracking with Guaranteed Global Convergence," *IEEE Trans. on Signal Processing*, Vol.45, No.7, July 1997.
- [9] F. Liedtke, "Computer simulation of an automatic classification procedure for digitally modulated communications signals with unknown parameters," *Signal Processing*, Vol 6, No. 4, pp. 311-323, August 1984.
- [10] W. Su and J. Kosinski, "Application of COTS algorithms to automated modulation recognition and signal classification method," *2001 AOC Intelligence Electronic Warfare Conference*, August 2001.
- [11] K. Kim and A. Polydoros, "Digital modulation classification: the BPSK versus QPSK case", in *Proc. IEEE Conf.*, 1988, pp. 431-436.
- [12] C. Y. Huang and A. Polydoros, "Likelihood methods for MPSK modulation classification", *IEEE Trans. Commun.*, vol. 43, No. 2/3/4, pp. 1493-1504, Feb./March/April 1995
- [13] C. Long, K. Chugg and A. Polydoros, "Further results in likelihood classification of QAM signals," in *Proc. MILCOM'94*, Oct. 1994.
- [14] K. M. Chugg, C. S. Long and A. Polydoros, "Combined likelihood power estimation and multiple hypothesis modulation classification", in *Proc 29th Asilomar Conf.*, pp. 1137-1141, 1996
- [15] J.A. Sills, "Maximum-likelihood modulation classification for PSK/QAM", in *Proc. IEEE MILCOM*, vol.1, Oct. 1994, pp. 57-61.
- [16] W. Wei and J. M. Mendel, "Maximum-likelihood classification for digital amplitude-phase modulations", *IEEE Trans. Commun.*, vol. 48, No. 2, pp. 189-193, Feb. 2000.
- [17] P. C. Sapiano and J. D. Martin, "Maximum likelihood PSK classifier", in *Proc. IEEE ICASSP*, 1996, pp. 1010-1014.
- [18] D. Boiteau and C. Le Martret, "A generalized maximum likelihood framework for modulation classification", in *Proc. IEEE ICASSP*, vol. 4, pp. 2165-2168, May 1998.
- [19] P. Panagiotou, A. Anastasopoulos and A. Polydoros, "Likelihood ratio tests for modulation classification", in *Proc. IEEE*, 2000, pp. 670- 674.
- [20] A. Polydoros and K. Kim, "On the detection and classification of quadrature digital modulations in broad-band Noise", *IEEE Trans. Commun.*, vol. 38, No. 8, pp. 1199-1211, Aug. 1990.
- [21] M. Moeneclaey and G. D. Jonghe, "ML-Oriented NDA carrier synchronization for general rotationally symmetric signal constellations," *IEEE Transactions on communications*, Vol 42, No.8, pp. 2531-2533, August 1994.
- [22] Y. Shi et al., "A Shift-Invariant Modified Kohonen Neural Network," in *Proc. of 2000 International Conference on Signal Processing Application and Technology*, October 2000.
- [23] W. Su, "Method and Apparatus to Process Drawing Images," *US Patent* Number 5,946,415, August 31, 1999.
- [24] W. Su, "A Simple and Quick Approach in Processing Drawing Images," in *Proc. of 1995 International Conference on Signal Processing Applications and Technology*, August 1995.
- [25] S-Z. Hsue and Samir S. Soliman, "Automatic Modulation Recognition of Digitally Modulated Signals," in *Proc. of MILCOM'89*, 1989.
- [26] S-Z. Hsue and Samir S. Soliman, "Automatic modulation classification using zero-crossing," *IEE Proceedings*, vol.137, Pt. F, No.6, pp.459-464, December 1990.
- [27] M. DeSimio, E. Glenn, "Adaptive Generation of Decision Functions for Classification of Digitally Modulated Signals," in *Proc. Of NAECON'88*, pp. 1010-1014.