

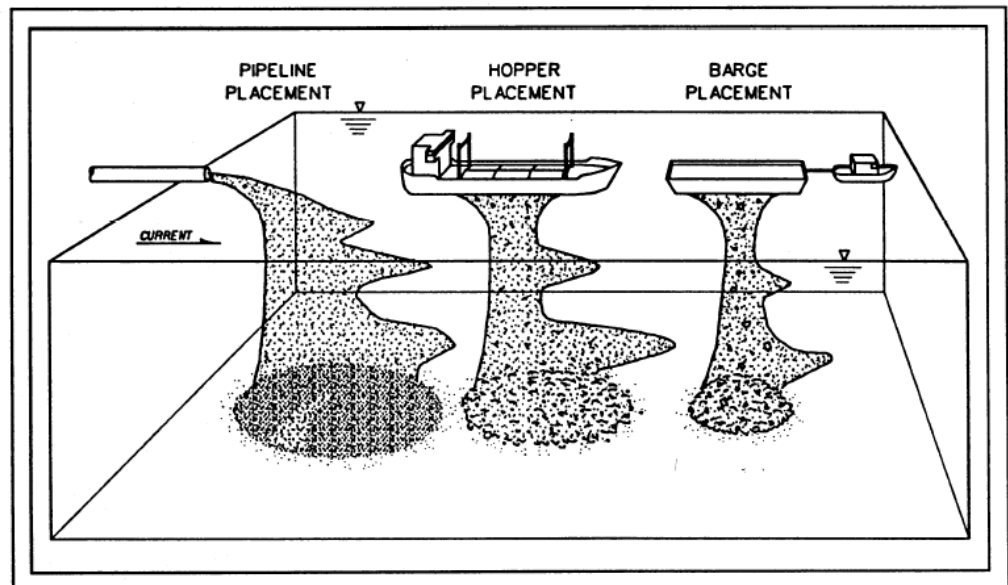

US Army Corps
of Engineers

Evaluating Environmental Effects of Dredged Material Management Alternatives— A Technical Framework

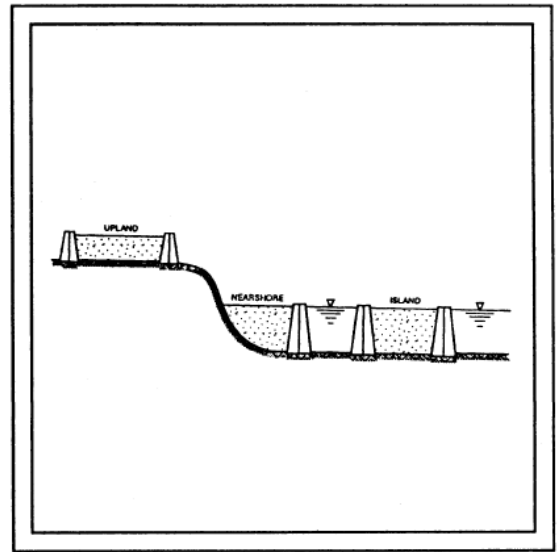
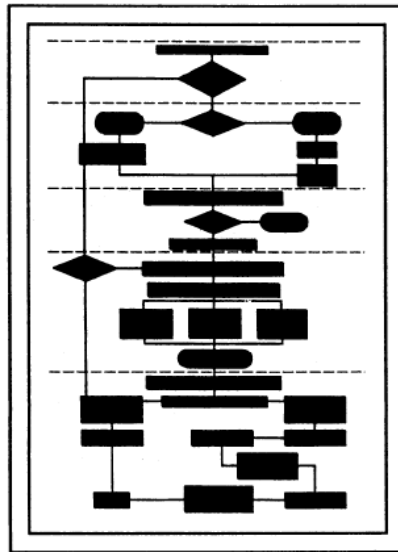

**United States Environmental Protection Agency
Office of Water (4504F)
Department of The Army
U.S. Army Corps of Engineers
EPA842-B-92-008 Revised
May 2004**

**Evaluating Environmental Effects
Of Dredged Material Management Alternatives --
A Technical Framework**

Prepared by

**DEPARTMENT OF THE ARMY
United States Army Corps of Engineers
Washington, DC**

and

**United States Environmental Protection Agency
Washington, DC**

**November 1992
Revised May 2004**

TABLE OF CONTENTS

PREFACE	iv
ACRONYMS	v
1.0 INTRODUCTION	1
1.1 Purpose	1
1.2 Applicability	1
1.3 Background	2
1.4 Regulatory Overview	3
2.0 OVERVIEW OF DREDGING OPERATIONS AND DREDGED MATERIAL MANAGEMENT ALTERNATIVES.....	7
2.1 General	7
2.2 Dredging Process Equipment and Techniques	7
2.3 Transportation of Dredged Material	10
2.4 Placement or Disposal Operations	10
3.0 FRAMEWORK FOR DETERMINING ENVIRONMENTAL ACCEPTABILITY	15
3.1 Overview	15
3.2 Evaluation of Dredging Project Requirements	15
3.3 Identification of Alternatives	20
3.4 Initial Screening of Alternatives	20
3.5 Detailed Assessment of Alternatives	22
3.6 Alternative Selection	26
4.0 ASSESSMENT OF OPEN-WATER DISPOSAL.....	27
4.1 Determination of Characteristics of Open-water Sites	27
4.2 Evaluation of Direct Physical Effects and Site Capacity	29
4.3 Evaluation of Contaminant Pathways of Concern	31
4.4 Evaluation of Management Actions and Controls for Open-water Disposal	33
4.5 Retention of Environmentally Acceptable Open-water Alternatives	35
5.0 ASSESSMENT OF CONFINED (DIKED) DISPOSAL	36
5.1 Determination of Characteristics of Confined Sites	36
5.2 Evaluation of Direct Physical Impacts and Site Capacity	37
5.3 Evaluation of Contaminant Pathways of Concern for CDFs.....	38
5.4 Evaluation of Management Actions and Contaminant Control Measures for CDFs.....	46
5.5 Retention of Environmentally Acceptable Confined Alternatives	52

6.0 ASSESSMENT OF BENEFICIAL USE ALTERNATIVES	53
6.1 Beneficial Use as an Alternative	53
6.2 Identification of Beneficial Use Needs and Opportunities	54
6.3 Evaluate Physical Suitability of Material	57
6.4 Logistical Considerations for Beneficial Use	58
6.5 Determination of Environmental Suitability	58
6.6 Retention of Environmentally Acceptable Beneficial Use Alternatives	59
7.0 ALTERNATIVE SELECTION	61
7.1 Evaluation of Socioeconomic, Technical, and Other Applicable Environmental Considerations	61
7.2 Environmental Coordination/Documentation/ Recommended Alternative.....	63
7.3 Final Decision Document	65
8.0 REFERENCES	66
APPENDIX A: GLOSSARY	A1
APPENDIX B: FEDERAL LEGISLATION AND PROGRAMS	B1

LIST OF FIGURES

1-1 Geographical Jurisdictions of the MPRSA and CWA	4
2-1 Commonly Used Dredges	8
2-2 Open-water Placement Operations	11
2-3 Upland, Nearshore, and Island CDFs	13
4-1 Contaminant Pathways for Open-water Disposal	31
5-1 Contaminant Pathways for Upland CDFs	39
5-2 Contaminant Pathways for Nearshore CDFs	40

LIST OF FLOWCHARTS

3-1 Framework for Determining Environmental Acceptability of Dredged Material Disposal Alternatives	16
3-2 Framework for Testing and Evaluation for Open-water Disposal	17
3-3 Framework for Testing and Evaluation for Confined (Diked) Disposal	18
3-4 Framework for Testing and Evaluation for Beneficial Use Applications	19
B-1 NEPA Process for Dredged Material Disposal Projects	B2

PREFACE

The U.S. Army Corps of Engineers (USACE) and the U.S. Environmental Protection Agency (USEPA) share the responsibility of regulating dredged material management activities under the Marine Protection, Research, and Sanctuaries Act (MPRSA), and the Federal Water Pollution Control Act Amendments of 1972, also called the Clean Water Act (CWA). Such management activities must also comply with the applicable requirements of the National Environmental Policy Act (NEPA).

This document provides a consistent technical framework for USACE and USEPA personnel to follow in identifying environmentally acceptable alternatives for the management of dredged material. The framework presented herein is consistent with and meets the substantive and procedural requirements of NEPA, CWA, and MPRSA and is applicable to dredged material management alternatives. The technical guidance provided by other documents such as the MPRSA and CWA testing manuals should be applied within this framework. Application of this framework will enhance consistency and coordination in USACE/USEPA decision making in accordance with Federal environmental statutes regulating dredged material management.

This manual was prepared by a joint USACE/USEPA work group consisting of the following members: Dr. Michael R. Palermo, Mr. Norman R. Francingues, and Dr. Thomas Wright, Environmental Laboratory, U.S. Army Engineer Waterways Experiment Station, Vicksburg, MS; Mr. Jim Reese, U.S. Army Engineer Division, North Pacific, Portland, OR; Dr. Susan Ivester Rees, U.S. Army Engineer District, Mobile, Mobile, AL; Mr. David Mathis, Headquarters, U.S. Army Corps of Engineers, Washington, DC; Ms. Shannon Cunniff, Mr. John Goodin, Mr. Tom Chase, Mr. Mike Kravitz, Mr. Barry Burgan, and Mr. John Lishman, Headquarters, USEPA, Washington, DC; Dr. Bill Muir, USEPA, Region III, Philadelphia, PA; Mr. Bob Howard, USEPA, Region IV, Atlanta, GA; and Mr. John Malek, USEPA, Region X, Seattle, WA. Much of the information in this manual was taken from various USACE and USEPA publications, and the contributions of the original authors are gratefully acknowledged. The manual was updated in 2004 to reflect the publication of the Inland Testing Manual, the Upland Testing Manual and other recent references. This work was completed by Trudy J. Estes, Michael R. Palermo, and Paul R. Schroeder, Environmental Laboratory, Environmental Research and Development Center Waterways Experiment Station (ERDC WES).

This document should be cited as:

USEPA/USACE. 2004. "Evaluating Environmental Effects of Dredged Material Management Alternatives - A Technical Framework," EPA842-B-92-008, U.S. Environmental Protection Agency and U.S. Army Corps of Engineers, Washington, D.C.

ACRONYMS

ADDAMS	- Automated Dredging and Disposal Alternatives Management System
ARCS	- Assessment and Remediation of Contaminated Sediments
ASTM	- American Society for Testing and Materials
CAMP	- Comprehensive Analysis of Migration Pathways
CDF	- Confined Disposal Facility
CEQ	- Council on Environmental Quality
CFR	- Code of Federal Regulations
CWA	- Clean Water Act
DOTS	- Dredging Operations Technical Support
DTPA	- Diethylenetriamine-pentaactic Acid
EA	- Environmental Assessment
EIS	- Environmental Impact Statement
EM	- Engineer Manual
ER	- Engineer Regulation
ERDC WES	- Environmental Research and Development Center Waterways Experiment Station
FONSI	- Finding of No Significant Impact
HELPQ	- Hydrologic Evaluation of Leachate Production and Quality
HELP	- Hydrologic Evaluation of Landfill Performance
LDC	- London Dumping Convention
MEPAS	- Multimedia Environmental Pollutant Assessment System
MPRSA	- Marine Protection, Research, and Sanctuaries Act
NED	- National Economic Development
NEPA	- National Environmental Policy Act
PCB	- Polychlorinated Biphenyls
PUP	- Plant Uptake Program
ROD	- Record of Decision
S/S	- Solidification/Stabilization
SLRP	- Simplified Laboratory Runoff Procedure
SOF	- Statement of Findings
USACE	- U.S. Army Corps of Engineers
USEPA	- United States Environmental Protection Agency
UV	- Ultraviolet light

1.0 INTRODUCTION

1.1 Purpose

This document is intended to serve as a consistent "roadmap" for U.S. Army Corps of Engineers (USACE) and U.S. Environmental Protection Agency (USEPA) personnel in evaluating the environmental acceptability of dredged material management alternatives. Specifically, its major objectives are to provide:

- A general technical framework for evaluating the environmental acceptability of dredged material management alternatives (open-water disposal, confined (diked) disposal, and beneficial uses).
- Additional technical guidance to augment present implementation and testing manuals for addressing the environmental acceptability of available management options for the discharge of dredged material in both open water and confined sites.
- Enhanced consistency and coordination in USACE/USEPA decision making in accordance with Federal environmental statutes regulating dredged material management.

1.2 Applicability

The "Technical Framework" was developed to provide a consistent approach to identifying environmentally acceptable dredged material management alternatives that meet the substantive and procedural requirements of the National Environmental Policy Act (NEPA), the Clean Water Act (CWA), and the Marine Protection, Research, and Sanctuaries Act (MPRSA). This document provides that framework and augments other technical guidance documents (e.g., the MPRSA and CWA dredged material testing manuals) for evaluating environmental acceptability. Since this document was first published in 1992, advances have been made in testing and evaluation procedures, and in the area of risk assessment. Although the basic framework described in the original document remains largely unchanged, some new tools are available to facilitate the recommended evaluations. Additionally, formal risk assessment is emerging as a commonly used tool for dredged material evaluation in cases where definitive criteria are not available by which to assess potential environmental impacts. These procedures and references were included in this 2004 updated version of the Technical Framework.

This document is applicable to proposed actions involving the disposal and management of dredged material from both the new-work construction and navigation project maintenance programs of the USACE as well as proposed dredged material discharge actions regulated by the USACE. Further, the document addresses the broad

range of dredged materials, both clean and contaminated, and the broad array of management alternatives, confined (diked nearshore or upland) disposal, open-water (aquatic) disposal, and beneficial use. This document does not present guidance on evaluation of the No-Action alternative as required for evaluation under NEPA.

Application of this framework will facilitate decision making across the statutory boundaries of the MPRSA, CWA, and NEPA. The technical framework and guidance established herein should reduce confusion by both regulators and the regulated community in all future evaluations.

This framework provides only a general overview of other non-environmental factors to be considered in decision making. An in-depth discussion of all decision-making principles regarding selection of a preferred alternative is beyond the scope of this document. The reader is referred to applicable USACE regulations (33 Code of Federal Regulations (CFR) 320-330, 33 CFR 335-338, Engineer Regulation (ER) 1105-2-100) for further guidance and information on procedures employed by the USACE in its required public interest review. However, this document supports the identification, evaluation, and selection of environmentally acceptable dredged material discharge alternatives that are fully adaptable and applicable in the broader context of decision making.

1.3 Background

Several hundred million cubic yards of sediment must be dredged from waterways and ports each year to improve and maintain the nation's navigation system and to maintain coastal national defense readiness. Alternatives for the management of dredged material from these projects must be carefully evaluated from the standpoint of environmental acceptability, technical feasibility, and economics.

Three management alternatives may be considered for dredged material: open-water disposal, confined (diked) disposal, and beneficial use.¹ Open-water disposal is the placement of dredged material in rivers, lakes, estuaries, or oceans via pipeline or release from hopper dredges or barges. Confined disposal is placement of dredged material within diked nearshore or upland confined disposal facilities via pipeline or other means.

Beneficial use involves the placement or use of dredged material for some productive purpose. Beneficial use options should be given full and equal consideration with other alternatives. It is USACE policy to fully consider all aspects of the dredging and disposal operations with a view toward maximizing public benefits. Generally, beneficial use is an adjunct to or involves either open-water or confined placement in some form, although some beneficial uses involve unconfined disposal (e.g., wetland creation, island creation, or beach nourishment). Descriptions of open-water and confined disposal processes and of the categories of beneficial use are given in Part 2.4 and in Chapters 4, 5, and 6, respectively.

¹ A glossary of terms is presented in Appendix A.

Potential environmental impacts resulting from dredged material disposal may be physical, chemical, or biological in nature. Because many of the waterways are located in industrial and urban areas, sediments often contain contaminants from these sources. Unless properly managed, dredging and disposal of contaminated sediment can adversely affect water quality and aquatic or terrestrial organisms. Sound planning, design, and management of projects are essential if dredged material disposal is to be accomplished with appropriate environmental protection and in an efficient manner. The selection of a preferred alternative for dredged material management must be based on a weighing and balancing of a number of considerations that include environmental acceptability, technical feasibility, and economics. Although the intended scope of this document is limited to considerations for determining environmental acceptability, other factors which must be considered in the decision-making process are also mentioned where appropriate.

1.4 Regulatory Overview

Regulation of dredged material disposal within waters of the United States and ocean waters is a complex issue and is a shared responsibility of the USEPA and USACE. The primary Federal environmental statute governing transportation of dredged material to the ocean for the purpose of disposal is the MPRSA, also called the Ocean Dumping Act. The primary Federal environmental statute governing the discharge of dredged or fill material into waters of the United States (inland of and including the territorial sea) is the Federal Water Pollution Control Act Amendments of 1972, also called the CWA. The regulatory path for disposal of dredged material in confined disposal facilities (CDFs) is not as clear (USACE 2003). However, both the CWA and NEPA provide strong mandates for USACE regulation of placement in CDFs. The discharge of return flow (effluent and surface runoff) to waters of the United States is specifically defined as a dredged material discharge under the CWA.

All proposed dredged material disposal activities regulated by the MPRSA and CWA must also comply with the applicable requirements of NEPA and its implementing regulations. In addition to MPRSA, CWA, and NEPA, a number of other Federal laws, Executive orders, etc., must be considered in evaluation of dredging projects. An overview of MPRSA, CWA, and NEPA is given in the following paragraphs. Additional discussion of these and other applicable Federal laws is found in Appendix B.

1.4.1 Jurisdiction of MPRSA and CWA

The geographical jurisdictions of the MPRSA and CWA are indicated in Figure 1-1. As shown in Figure 1-1, an overlap of jurisdiction exists within the territorial sea. The precedence of MPRSA or CWA in the area of the territorial sea is defined in 40 CFR 230.2 (b) and 33 CFR 336.0 (b). Material dredged from waters of the United States and disposed in the territorial sea is evaluated under MPRSA. In general, dredged material discharged as fill (e.g., beach nourishment, island creation, or underwater berms) and placed within the territorial sea is evaluated under the CWA.

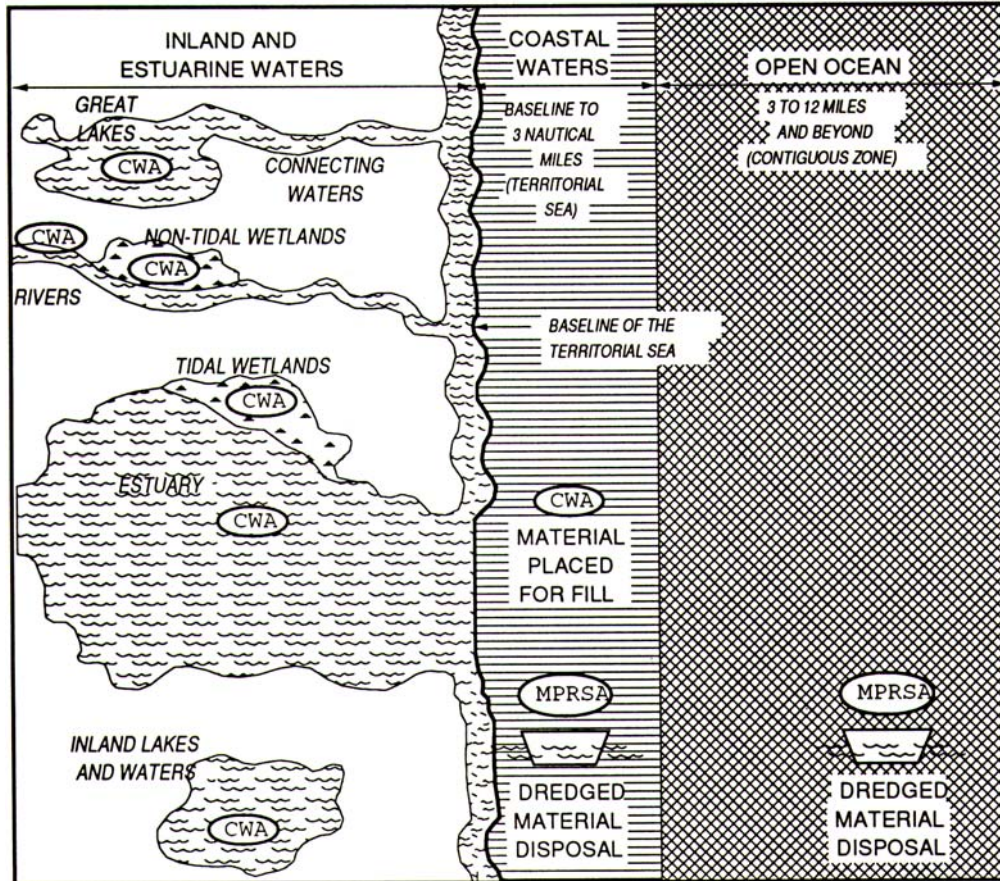

Figure 1-1. Geographical Jurisdictions of the MPRSA and CWA

1.4.2 Overview of MPRSA

Section 102 of the MPRSA requires USEPA, in consultation with USACE, to develop environmental Criteria² that must be complied with before any proposed ocean-disposal activity is allowed to proceed. Section 103 of the MPRSA assigns to the USACE the specific responsibility for authorizing the ocean disposal of dredged material. In evaluating proposed ocean-disposal activities, the USACE is required to apply the Criteria developed by USEPA relating to the effects of the proposed disposal activity. In addition, in reviewing permit applications, the USACE is also required to consider navigation, economic, and industrial development, and foreign and domestic commerce, as well as the availability of alternatives to ocean disposal. USEPA has a major environmental oversight role in reviewing the USACE determination of compliance with the ocean-disposal Criteria relating to the effects of the proposed disposal. If USEPA determines ocean-disposal Criteria are not met, disposal may not occur without a waiver

² For purposes of this report, Criteria (capitalized) refer to criteria developed by the Environmental Protection Agency under Section 102 of MPRSA relating to the effects of the proposed dumping.

of the Criteria by USEPA [40 CFR 225.2 (e)]. In addition, USEPA has authority under Section 102 to designate ocean-disposal sites. The USACE is required to use such sites for ocean disposal to the extent feasible. Section 103 does authorize the USACE, where use of a USEPA-designated site is not feasible or a site has not been designated by USEPA, to select ocean-disposal sites for project(s)-specific use. In exercising this authority, the USACE utilizes the USEPA site-selection criteria (40 CFR 228), and the site selection is subject to USEPA review as part of its permit review responsibilities.

1.4.3 Overview of CWA

Section 404 of the CWA requires USEPA, in conjunction with the USACE, to promulgate Guidelines³ for the discharge of dredged or fill material to ensure that such proposed discharge will not result in unacceptable adverse environmental impacts to waters of the United States. Section 404 assigns to the USACE the responsibility for authorizing all such proposed discharges, and requires application of the Guidelines in assessing the environmental acceptability of the proposed action. Under the Guidelines, the USACE is also required to examine practicable alternatives to the proposed discharge, including alternatives to disposal in waters of the United States and alternatives with potentially less damaging consequences. The USACE and USEPA also have authority under Section 230.80 to identify, in advance, sites that are either suitable or unsuitable for the discharge of dredged or fill material in waters of the United States. USEPA is responsible for general environmental oversight under Section 404 and, pursuant to Section 404(c), retains permit veto authority. In addition, Section 401 provides the States a certification role as to project compliance with applicable State water quality standards.

1.4.4 Overview of NEPA

Dredged material disposal activities must comply with the applicable NEPA requirements regarding identification and evaluation of alternatives. The basic NEPA process discussed in this framework is that specifically associated with the dredging project (as opposed to other related actions such as ocean-site designation which may require an entirely separate NEPA process).

Section 102(2) of NEPA requires the examination of reasonable⁴ alternatives to the action proposed by the lead agency. The alternatives analyzed in an Environmental Assessment (EA) or Environmental Impact Statement (EIS) must include not only all reasonable alternatives but also those that were eliminated from further study (Part 1502.14) by the agency responsible for the final decision. The NEPA document must rigorously address reasonable alternatives that are beyond the capability of the applicant

³ For purposes of this report, Guidelines (capitalized) refer to the CWA Section 404(b)(1) Guidelines.

⁴ The terms practicable (CWA), feasible (MPRSA), and reasonable (NEPA) all have specific regulatory meaning. However, in this document, the term reasonable is used generically and not in a strict regulatory sense. Reasonable is herein defined as practical or feasible from the technical and economic standpoint and using common sense, rather than simply desirable from the standpoint of the project proponent or applicant.

or project proponent or are beyond the jurisdiction of the lead agency. The Council on Environmental Quality (CEQ) regulations for implementing the procedural provisions of NEPA are found at 40 CFR 1500-1508. For USACE dredging projects, the USACE is responsible under NEPA for developing alternatives for the discharge of dredged material, including all facets of the dredging and discharge operation, including cost, technical feasibility, and overall environmental protection. The USACE regulations provide that the preferred alternative must be the least costly plan that is consistent with environmental statutes, as set forth in the National Economic Development (NED) Plan for new work projects (ER 1105-2-100) or as the Federal Standard for required maintenance dredging of existing projects (33 CFR 335-338). Compliance with the environmental Criteria of the MPRSA and/or with the CWA Section 404(b)(1) Guidelines is a controlling factor used by the USACE in determining the environmental acceptability of disposal alternatives.

Both the MPRSA and CWA specify similar approaches in evaluating potential environmental impacts of dredged material discharged in ocean waters or waters of the United States, respectively. In many regards, these same evaluations provide essential input in meeting overall NEPA requirements. However, procedural implementation of the three environmental statutes has evolved more or less separately over time, and substantial inconsistencies have, in turn, developed particularly in the alternatives evaluations required by these environmental statutes. For example, while NEPA, CWA, and MPRSA all require both a detailed evaluation of alternatives to the proposed action and preparation of appropriate NEPA documentation, present guidance does not provide clear technical and/or procedural guidance for how such evaluations are to be undertaken.

2.0 OVERVIEW OF DREDGING OPERATIONS AND DREDGED MATERIAL MANAGEMENT ALTERNATIVES

2.1 General

This section of the report is intended to provide a brief introduction and overview of the dredging process, including types of dredges, transportation systems, and the placement or disposal practices commonly used in navigation dredging projects. References throughout this part provide more detailed discussion and explanation of different kinds of dredges, transport equipment, and disposal practices.

The removal or excavation, transport, and placement of dredged sediments are the primary components of the "dredging process." In design and implementation of any dredging project, each part of the dredging process must be closely coordinated to ensure a successful dredging operation.

The excavation process commonly referred to as "dredging" involves the removal of sediment in its natural (new-work construction) or recently deposited (maintenance) condition, either mechanically or hydraulically. After the sediment has been excavated, it is transported from the dredging site to the placement site or disposal area. This transport operation, in many cases, is accomplished by the dredge itself or by using additional equipment such as barges, scows, and pipelines with booster pumps.

Once the dredged material has been collected and transported, the final step in the dredging process is placement in either open-water, nearshore, or upland locations. The choice of management alternatives involves a variety of factors related to the dredging process including environmental acceptability, technical feasibility, and economic feasibility of the chosen alternative.

2.2 Dredging Process Equipment and Techniques

Compatibility must exist between the dredging equipment and techniques used for excavation and transport of the material and the management alternatives considered. The types of equipment and methods used by both the USACE and private industry vary considerably throughout the United States. The most commonly used dredges are illustrated in Figure 2-1. Dredging equipment and dredging operations resist precise categorization. As a result of specialization and tradition in the industry, numerous descriptive, often overlapping, terms categorizing dredges have developed. For example, dredges can be classified according to: the basic means of moving material (mechanical or hydraulic); the device used for excavating sediments (clamshell, cutterhead, dustpan, and plain suction); the type of pumping device used (centrifugal, pneumatic, or airlift);

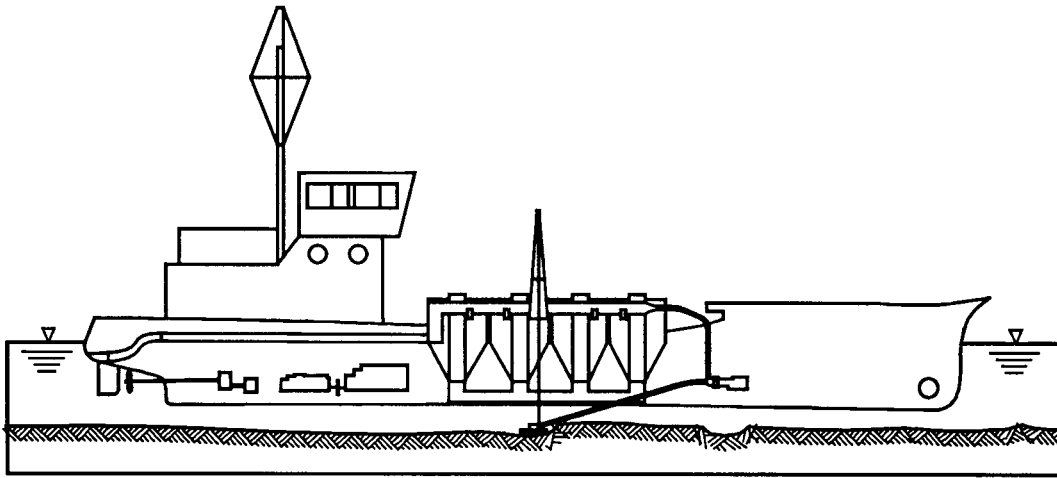

a. Self-propelled hopper dredge

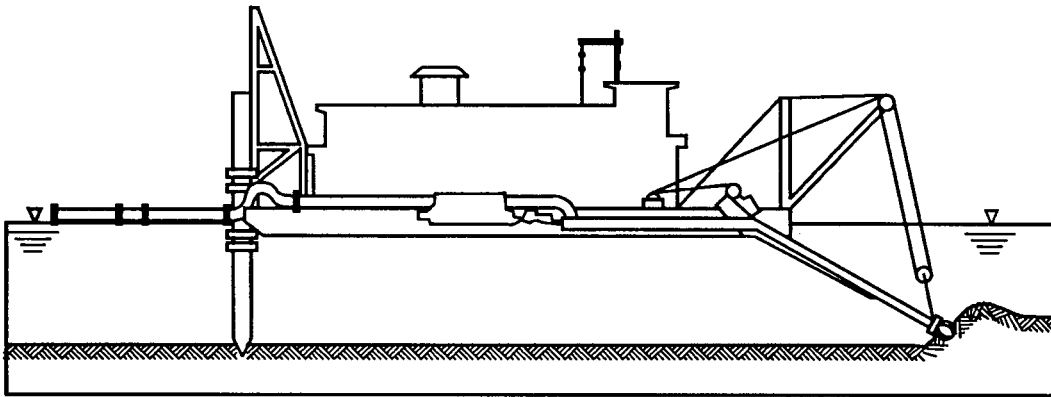

b. Cutterhead pipeline dredge

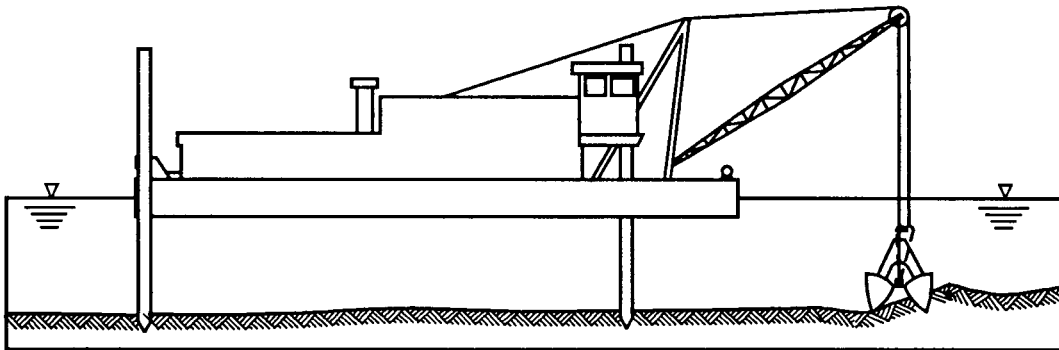

c. Clamshell dredge

Figure 2-1. Commonly Used Dredges

and others. However, for the purposes of this document, dredging is actually accomplished basically by only two mechanisms:

- Hydraulic dredging--Removal of loosely compacted materials by cutterheads, dustpans, hoppers, hydraulic pipeline plain suction, and sidecasters, usually for maintenance dredging projects.
- Mechanical dredging--Removal of loose or hard, compacted materials by clamshell, dipper, or ladder dredges, either for maintenance or new-work projects.

Hydraulic dredges remove and transport sediment in liquid slurry form. They are usually barge mounted and carry diesel or electric-powered centrifugal pumps with discharge pipes ranging from 6 to 48 in. in diameter. The pump produces a vacuum on its intake side, and atmospheric pressure forces water and sediments through the suction pipe. The slurry is transported by pipeline to a disposal area. Hopper dredges are included in the category of hydraulic dredges for this report even though the dredged material is simply pumped into the self-contained hopper on the dredge rather than through a pipeline. It is often advantageous to overflow hopper dredges to increase the load; however, this may not always be acceptable due to water quality concerns near the dredging site.

Mechanical dredges remove bottom sediment through the direct application of mechanical force to dislodge and excavate the material at almost in situ densities. Backhoe, bucket (such as clamshell, orange-peel, and dragline), bucket ladder, bucket wheel, and dipper dredges are types of mechanical dredges. Sediments excavated with a mechanical dredge are generally placed into a barge or scow for transportation to the disposal site.

Selection of dredging equipment and method used to perform the dredging will depend on the following factors:

- Physical characteristics of material to be dredged.
- Quantities of material to be dredged.
- Dredging depth.
- Distance to disposal area.
- Physical environment of the dredging and disposal areas.
- Contamination level of sediments.
- Method of disposal.
- Production required.
- Type of dredges available.
- Cost.

More detailed descriptions of dredging equipment and dredging processes are available in Engineer Manuals (USACE 1983 and USACE in preparation), Houston (1970), and Turner (1984).

2.3 Transportation of Dredged Material

Transportation methods generally used to move dredged material include the following: pipelines, barges or scows, and hopper dredges. Pipeline transport is the method most commonly associated with cutterhead, dustpan, and other hydraulic dredges. Dredged material may be directly transported by hydraulic dredges through pipelines for distances of up to several miles, depending on a number of conditions. Longer pipeline pumping distances are feasible with the addition of booster pumps, but the cost of transport greatly increases. Barges and scows, used in conjunction with mechanical dredges, have been one of the most widely used methods of transporting large quantities of dredged material over long distances. Hopper dredges are capable of transporting the material for long distances in a self-contained hopper. Hopper dredges normally discharge the material from the bottom of the vessel by opening the hopper doors; however, some hopper dredges are equipped to pump out the material from the hopper much like a hydraulic pipeline dredge.

2.4 Placement or Disposal Operations

Selection of proper dredging and transport equipment and techniques must be compatible with disposal site and management requirements. Three major alternatives are available:

- Open-water disposal.
- Confined disposal.
- Beneficial use.

Each of the major alternatives involves its own set of unique considerations, and selection of a management alternative should be made based on environmental, technical, and economic considerations.

2.4.1 Description of Open-Water Disposal

Open-water disposal is the placement of dredged material in rivers, lakes, estuaries, or oceans via pipeline or release from hopper dredges or barges. Such disposal may also involve appropriate management actions or controls such as capping. The potential for environmental impacts is affected by the physical behavior of the open-water discharge. Physical behavior is dependent on the type of dredging and disposal operation used, the nature of the material (physical characteristics), and the hydrodynamics of the disposal site.

Dredged material can be placed in open-water sites using direct pipeline discharge, direct mechanical placement, or release from hopper dredges or scows. A conceptual illustration of open-water disposal using the most common placement techniques is shown in Figure 2-2.

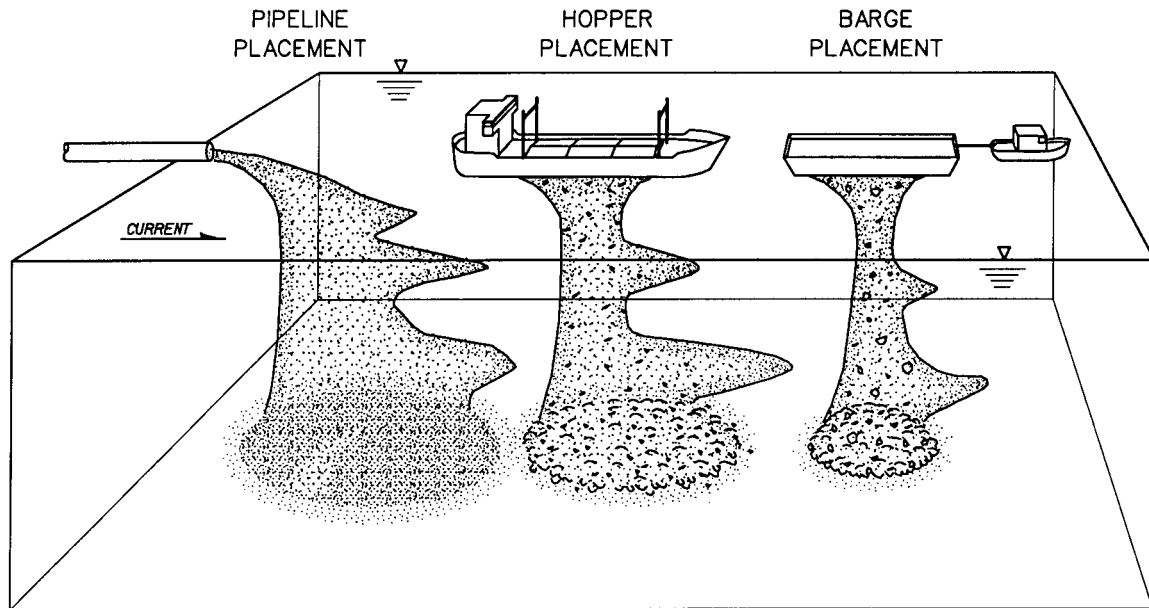

Figure 2-2. Open-water Placement Operations

Pipeline dredges are commonly used for open-water disposal adjacent to channels. Material from this dredging operation consists of a slurry with solids concentration ranging from a few grams per liter to several hundred grams per liter. Depending on material characteristics, the slurry may contain clay balls, gravel, or coarse sand material. This coarse material quickly settles to the bottom. The mixture of dredging site water and finer particles has a higher density than the disposal site water and therefore can descend to the bottom forming a fluid mud mound. Continuing the discharge may cause the mound to spread. Some fine material is "stripped" during descent and is evident as a turbidity plume. Characteristics of the plume are determined by: discharge rate, characteristics of the slurry (both water and solids), water depth, currents, meteorological conditions, salinity of receiving water, and discharge configuration.

The characteristics and operation of hopper dredges result in a mixture of water and solids stored in the hopper for transport to the disposal site. At the disposal site, hopper doors in the bottom of the ship's hull are opened, and the entire hopper contents are emptied in a matter of minutes; the dredge then returns to the dredging site to reload. This procedure produces a series of discrete discharges at intervals of perhaps one to several hours. Upon release from the hopper dredge at the disposal site, the dredged material falls through the water column as a well-defined jet of high-density fluid, which may contain blocks of solid material. Ambient water is entrained during descent. After it hits bottom, most of the dredged material comes to rest. Some material enters the horizontally spreading bottom surge formed by the impact and is carried away from the impact point until the turbulence of the surge is sufficiently reduced to permit its deposition.

Bucket or clamshell dredges remove the sediment being dredged at nearly its in situ density and place it on a barge or scow for transportation to the disposal area. Although several barges may be used so that the dredging is essentially continuous, disposal occurs as a series of discrete discharges. Barges are designed with bottom doors or with a split-hull, and the contents may be emptied within seconds, essentially as an instantaneous discharge. Often sediments dredged by clamshell remain in fairly large consolidated clumps and reach the bottom in this form. Whatever its form, the dredged material descends rapidly through the water column to the bottom, and only a small amount of the material remains suspended. Clamshell dredge operations may also be used for direct material placement adjacent to the area being dredged. In these instances, the material also falls directly to the bottom as consolidated clumps.

Dredge hoppers and scows are commonly filled past the point of overflow to increase the load. The gain in hopper or scow load and the characteristics of the associated overflow are dependent on the characteristics of the material being dredged and the equipment being used. There is little debate that the load can be increased by overflow if the material dredged is coarse grained or forms clay balls, as commonly occurs with new-work dredging. For fine-grained maintenance material, significant disagreement exists as to whether a load gain can be achieved by overflow. Environmental considerations of overflow may be related to aesthetics, potential effects of water-column turbidity, potential effects of deposition of solids, or potential effects of sediment-associated contaminants (Palermo and Randall 1990).

Open-water disposal sites can be either predominantly nondispersive or predominantly dispersive. At predominantly nondispersive sites, most of the material is intended to remain on the bottom following placement and may be placed to form mounds. At predominantly dispersive sites, material may be dispersed either during placement or eroded from the bottom over time and transported away from the disposal site by currents and/or wave action. However, both predominantly dispersive and predominantly nondispersive sites can be managed in a number of ways to achieve environmental objectives or reduce potential operational conflicts. Additional discussion of open-water disposal processes is found in Chapter 4.

2.4.2 Description of Confined Disposal

Confined disposal is placement of dredged material within diked nearshore or upland confined disposal facilities⁵ (CDFs) via pipeline or other means. The term CDF is used in this document in its broadest sense. CDFs may be constructed as upland sites, nearshore sites with one or more sides in water (sometimes called intertidal sites), or as island containment areas as shown in Figure 2-3.

⁵ The terms "confined disposal facility," "confined disposal area," "confined disposal site," "diked disposal site," and "containment area" all appear in the literature and refer to an engineered structure for containment of dredged material. The confinement dikes or structures in a CDF enclose the disposal area above any adjacent water surface, isolating the dredged material from adjacent waters during placement. In this document, confined disposal does not refer to subaqueous capping or contained aquatic disposal (see Chapter 4).

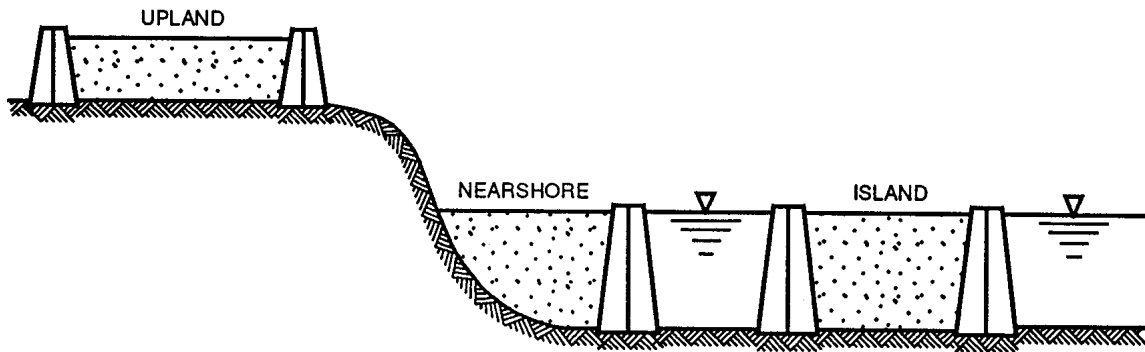

Figure 2-3. Upland, Nearshore, and Island CDFs

The two objectives inherent in design and operation of CDFs are to provide for adequate storage capacity for meeting dredging requirements and to maximize efficiency in retaining the solids. However, if contaminants are present, control of contaminant releases may also be an objective. Basic guidance for design, operation, and management of CDFs is found in Engineer Manuals (USACE 1983, 1987 and in preparation).

Hydraulic dredging adds several volumes of water for each volume of sediment removed, and this excess water is normally discharged as effluent from the CDF during the filling operation. The amount of water added depends on the design of the dredge, physical characteristics of the sediment, and operational factors such as pumping distance. When the dredged material is initially deposited in the CDF, it may occupy several times its original volume. The settling process is a function of time, but the sediment will eventually consolidate to its in situ volume or less if desiccation occurs. Adequate volume must be provided during the dredging operation to contain the total volume of sediment to be dredged, accounting for any volume changes during placement.

Some CDFs are filled by mechanically rehandling dredged material from barges filled by mechanical dredges. Material placed in the CDF in this manner is at or near its in situ water content. If such sites are constructed in water, the effluent volume may be limited to the water displaced by the dredged material, and the settling behavior of the material is not as important.

In most cases, CDFs must be used over a period of many years, storing material dredged periodically over the design life. Long-term storage capacity of these CDFs is therefore a major factor in design and management. Once water is drained from the CDF following active disposal operations, natural drying forces begin to dewater the dredged material, adding additional storage capacity. The gains in storage capacity are therefore influenced by consolidation and drying processes and the techniques used to manage the site both during and following active disposal operations. Additional discussion of confined disposal processes is found in Chapter 5.

2.4.3 Categories of Beneficial Use

Beneficial use includes a wide variety of options, which utilize the material for some productive purpose. Dredged material is a manageable, valuable soil resource, with beneficial uses of such importance that they should be incorporated into project plans and goals at the project's inception to the maximum extent possible.

Ten broad categories of beneficial uses have been identified, based on the functional use of the dredged material or site. They are:

- Habitat restoration/enhancement (wetland, upland, island, and aquatic sites including use by waterfowl and other birds).
- Beach nourishment.
- Aquaculture.
- Parks and recreation (commercial and noncommercial).
- Agriculture, forestry, and horticulture.
- Strip mine reclamation and landfill cover for solid waste management.
- Shoreline stabilization and erosion control (fills, artificial reefs, submerged berms, etc.).
- Construction and industrial use (including port development, airports, urban, and residential).
- Material transfer (fill, dikes, levees, parking lots, and roads).
- Multiple purpose.

Opportunities for beneficial use applications under each of these categories are discussed in Chapter 6. Detailed guidelines for various beneficial use applications are given in Engineer Manuals (USACE 1983, 1986 and in preparation). Additional information and case studies on beneficial use are available at the following website, which is a collaborative effort between USACE and USEPA:

<http://www.wes.army.mil/el/dots/budm/budm.html>

3.0 FRAMEWORK FOR DETERMINING ENVIRONMENTAL ACCEPTABILITY

3.1 Overview

This framework for determining environmentally acceptable placement alternatives for dredged material can be applied nationwide and is relatively general, but comprehensive. This framework addresses a wide range of dredged material characteristics, dredging techniques, and management alternatives. Because this framework provides national guidance, flexibility is necessary. It should be used as a technical guide to evaluate the commonly important factors to be considered in managing dredged material in an environmentally acceptable manner.

The overall technical framework for developing environmentally acceptable alternatives for the discharge of dredged material is illustrated in Flowchart 3-1. As indicated in the flowchart, the framework determines the environmental acceptability of any of several alternatives considered. The framework presented is consistent with and incorporates the evaluations conducted under NEPA, CWA, and MPRSA and consists of the following broad steps, as illustrated in Flowchart 3-1:

- Evaluation of dredging project requirements.
- Identification of alternatives.
- Initial screening of alternatives.
- Detailed assessment of alternatives.
- Alternative selection.

The framework logic is discussed in detail in the following paragraphs. The respective paragraph numbers are referenced as appropriate in the blocks of Flowchart 3-1. Additional portions of the framework pertaining to the detailed assessments of open-water disposal, confined disposal, and beneficial use alternatives are illustrated in Flowcharts 3-2, 3-3, and 3-4 and are described in Chapters 4, 5, and 6, respectively.

3.2 Evaluation of Dredging Project Requirements

3.2.1 Dredging Needs

The need for dredging and the requirements for disposal must be established. Information gathered at this stage would include the dredging location(s), required volumes to be dredged, etc. Within the context of NEPA, the initial impact assessment for dredging projects relates to the purpose and need for the proposed action in the case of new work or continued viability (purpose, need, and effect of new information on

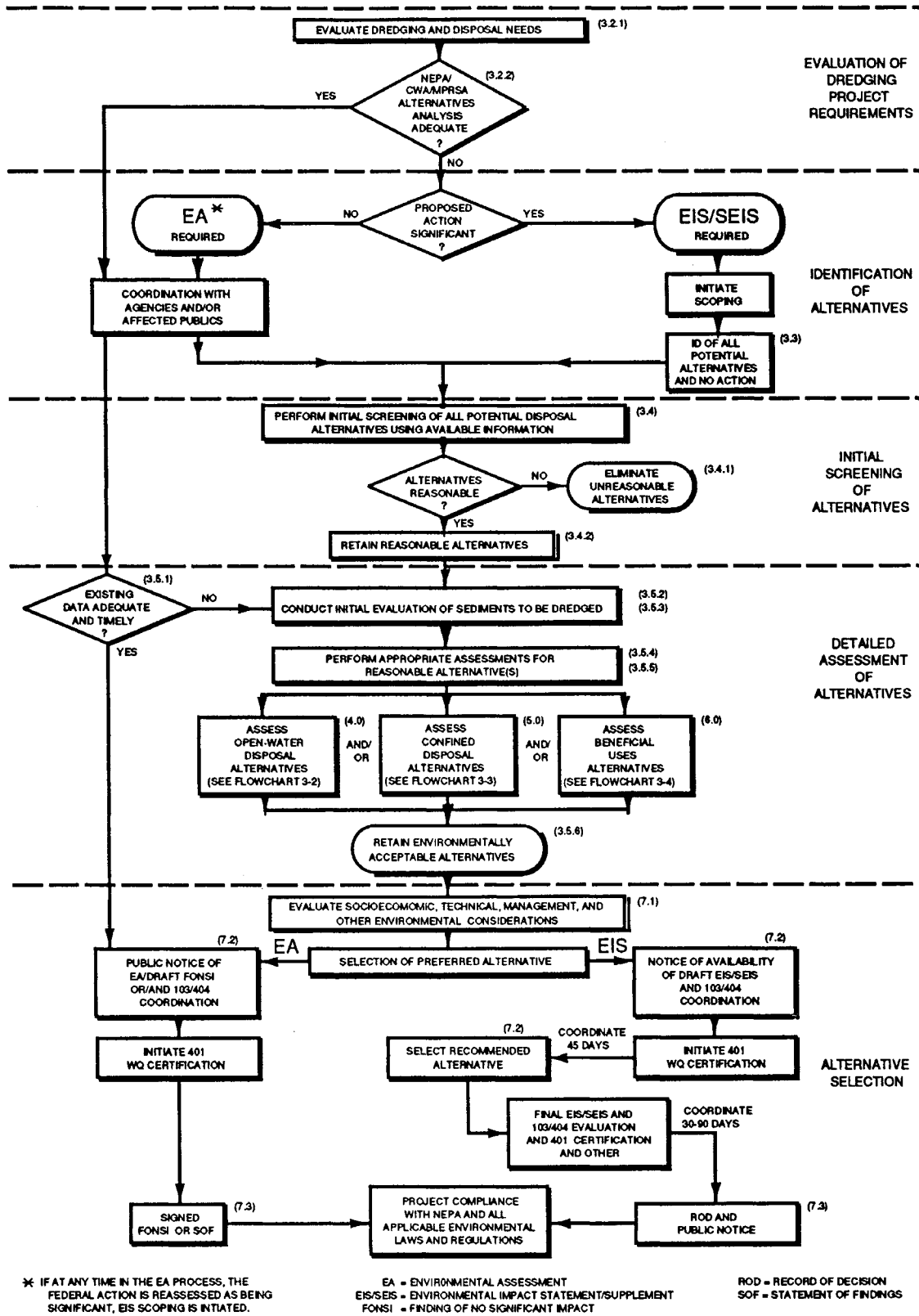

Flowchart 3-1. Framework for Determining Environmental Acceptability of Dredged Material Disposal Alternatives

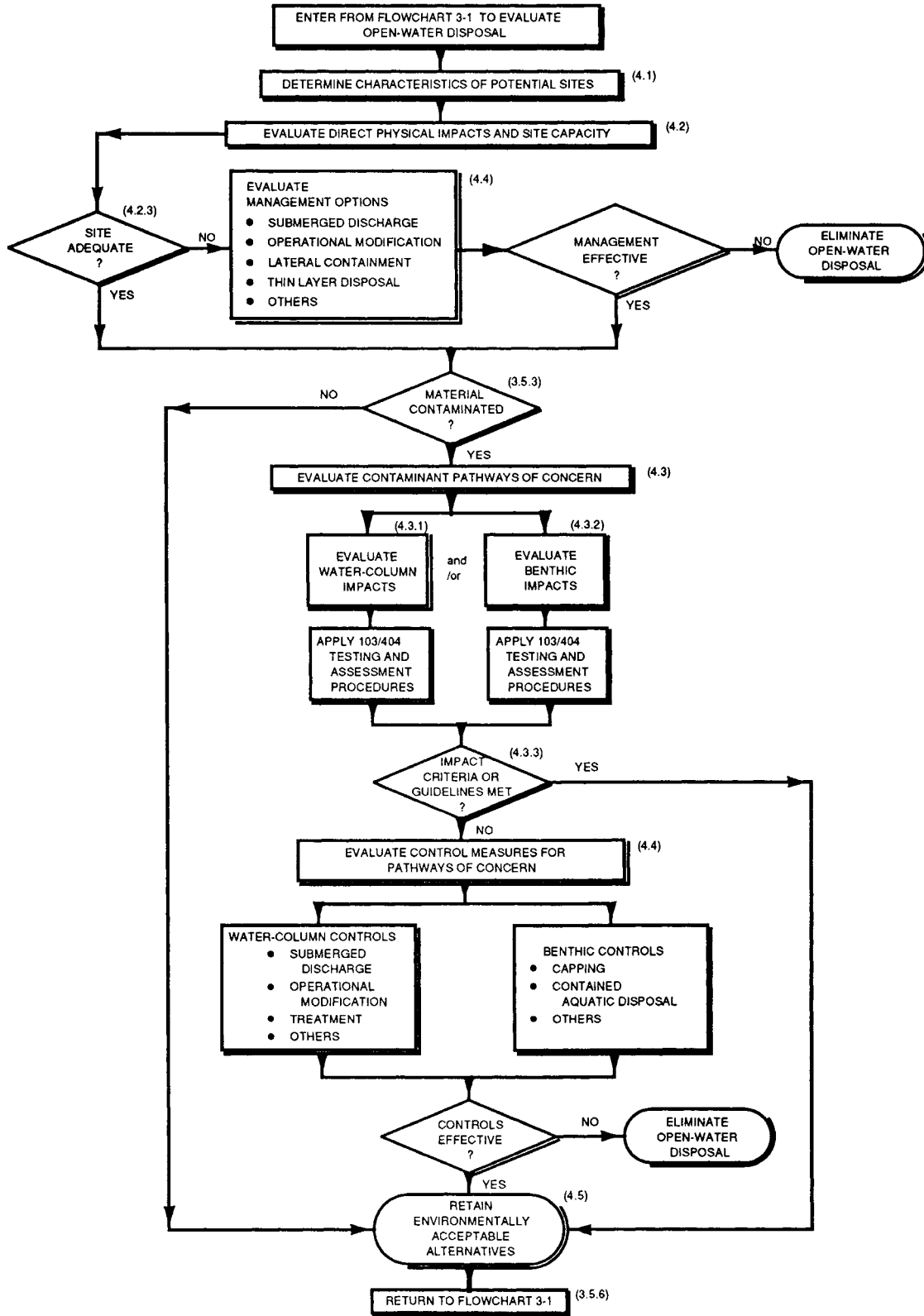

Flowchart 3-2. Framework for Testing and Evaluation for Open-water Disposal

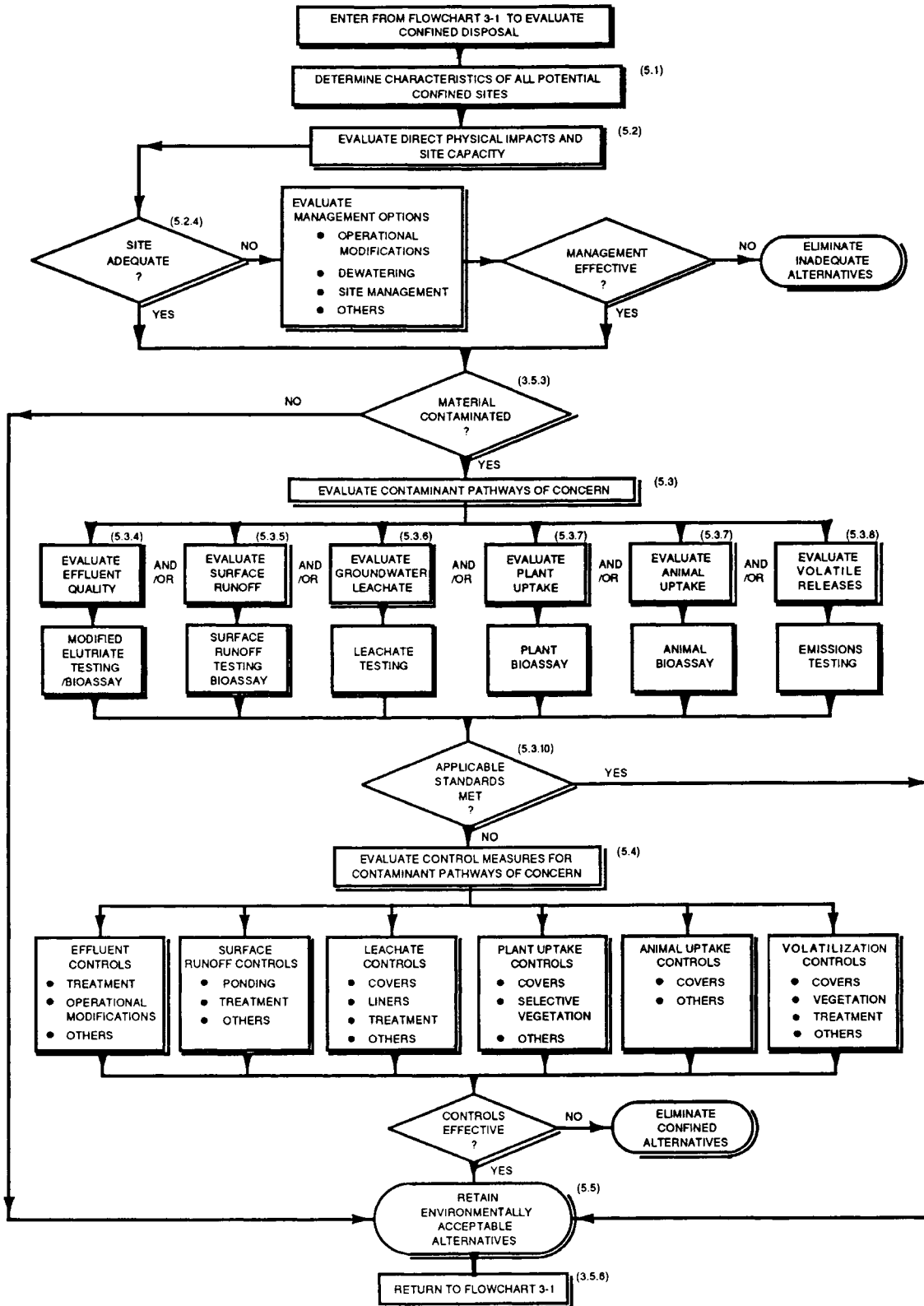

Flowchart 3-3. Framework for Testing and Evaluation for Confined (Diked) Disposal

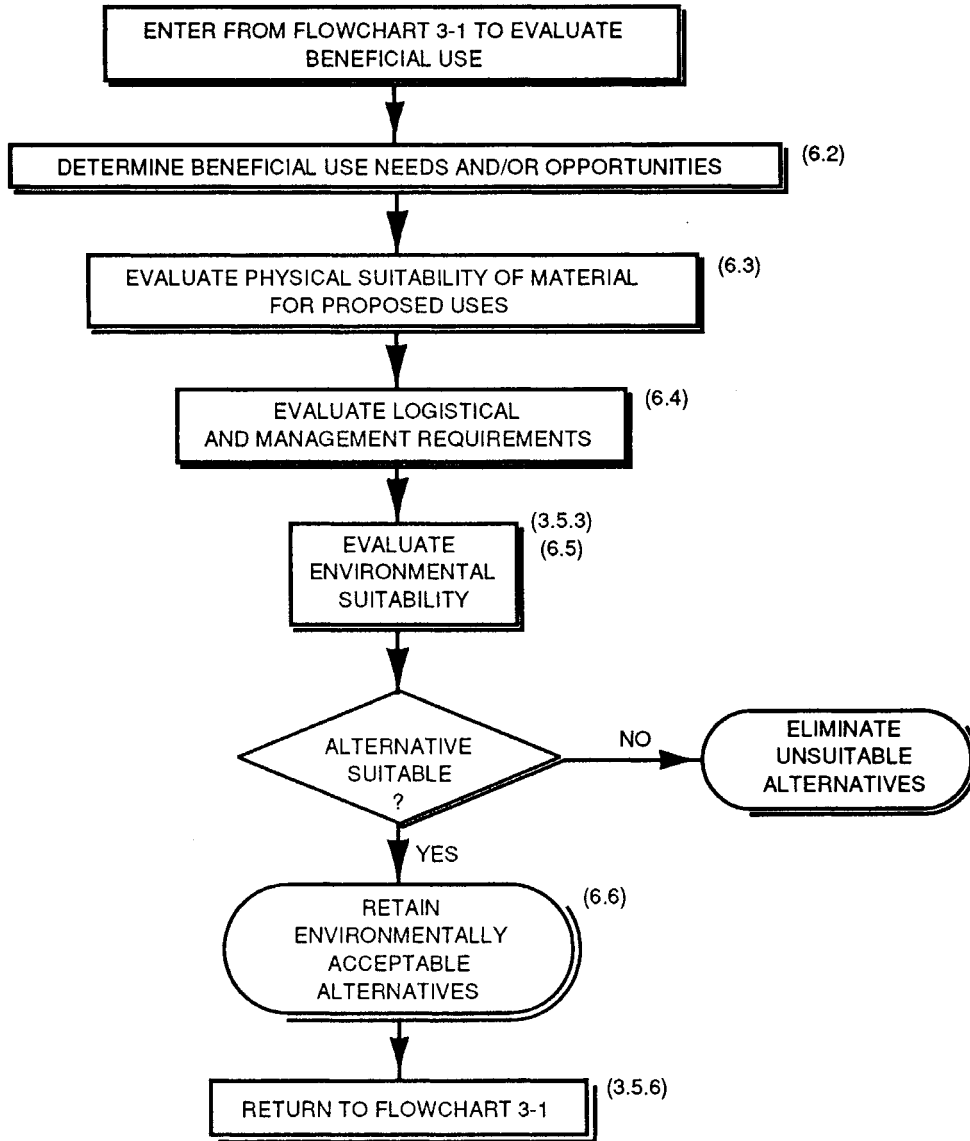

Flowchart 3-4. Framework for Testing and Evaluation for Beneficial Use Applications

environmental acceptability of the proposal) in the case of existing projects. In contrast, the needs and determinations under CWA or MPRSA are specifically concerned with a justification of the need for dredged material disposal in waters of the United States or ocean waters, respectively. Both types of determinations are addressed in the detailed evaluation of alternatives in the NEPA document and may also be addressed in the project's purpose and need statement, compliance with environmental statutes, and other sections of the NEPA document where appropriate. In identifying reasonable alternatives to pursue, environmental impact, cost, and agency policy/regulation, among other factors, may be considered.

3.2.2 Determination of Availability of Alternatives and Coverage in Existing NEPA Document

A review of the project requirements in terms of all reasonable alternatives and the adequate coverage of these alternatives in the existing NEPA document should be made. Supplemental NEPA documentation is required when significant changes are made in the proposed alternative, or when significant new circumstances or information relevant to environmental concerns and bearing on the proposed action or its impacts exist (40 CFR 1502.9 (c)). In particular, CWA/MPRSA alternatives analyses should be reviewed for adequacy. Evaluations conducted for purposes of MPRSA or CWA compliance indicating potential environmental impacts not previously considered in the selection of an alternative may trigger the need for a supplemental EA or EIS to ensure NEPA compliance.

3.3 Identification of Alternatives

Under the NEPA process, the potential environmental impacts of the discharge of dredged material including confined (diked), open water (CWA and/or MPRSA sites), and beneficial uses, must be considered, taking into consideration the nature and needs of the dredging projects and the material to be dredged. The NEPA scoping process encourages the identification of all potential alternatives for dredged material management. Proposed alternatives may consist of any combination of options as warranted by local conditions. Beneficial use of dredged material should be fully considered to ensure that benefits are maximized.

When a large number of potential alternatives exist, a reasonable number of examples covering the full spectrum of alternatives must be analyzed and compared in the NEPA document (40 CFR 1502.9(c)). The NEPA document must rigorously address reasonable alternatives that are beyond the capability of the applicant or project proponent or are beyond the jurisdiction of the lead agency. Under CEQ regulations, the No-Action (no dredging or continuation of an existing practice) alternative must also be included and retained throughout the NEPA process as a basis for impact comparison. Subsequent evaluations in the framework determine the reasonableness of alternatives identified at this level.

3.4 Initial Screening of Alternatives

An initial screening is undertaken to eliminate from further consideration those management alternatives that clearly are not reasonable for the specific project. Reasonable alternatives include those that are practical or feasible from the environmental, technical, and economic standpoint (40 CFR 1502.9 (c)), and use common sense, rather than being simply desirable from the standpoint of the project proponent or applicant. The screening should utilize all available information and should consider factors such as environmental concerns (e.g., endangered species), cost, technical feasibility (e.g., site availability and site characteristics that may be

incompatible with dredged sediment volume or characteristics or available dredging plant), and legal considerations.

All potential alternatives are evaluated with respect to the availability of the required site(s) and the likelihood that the site can be used. If there are no existing sites available, then a determination is made as to whether a site(s) can be designated and/or selected after taking into consideration the reasonableness of doing so for the project in question. For example, the time frame for designating an ocean site under MPRSA or selecting a CWA open-water site would have to be factored into this determination. In those cases where site designation by USEPA under Section 102 of MPRSA is required, the NEPA process for site designation and for the dredging project may be performed jointly or concurrently.

Consideration must also be given to design limitations of the project, climatic conditions, dredging equipment availability, physical and chemical aspects of the material to be dredged, local interests, public concerns, and known environmental and economic constraints. Maintenance history of the project in question or projects in the general area and the experience and knowledge of the public and resource agencies provide a basis for the screening process.

3.4.1 Eliminate Unreasonable Alternatives

Although the identification of innovative solutions is encouraged, the nature and needs of the dredging project must be considered in determining the reasonableness of alternatives. Alternatives that require sites that are not available, conflict with other site uses, violate applicable environmental regulations, or are found to be clearly technically or economically infeasible during the screening process, are eliminated from further detailed consideration. An alternative may be considered unreasonable and therefore eliminated from further consideration if the scoping process has determined it to be unreasonable. The rationale for eliminating alternatives should be clearly documented in the NEPA document. After application of these considerations by the lead agency⁶, those alternatives that remain are scrutinized further for environmental, technical, and economic feasibility.

3.4.2 Retain Reasonable Alternative(s)

The above evaluation will result in an identification of alternatives that are reasonable from an environmental, technical, and economic standpoint. Each remaining option is then carried forward for detailed evaluation via the NEPA/CWA/MPRSA process. The final outcome of the detailed evaluation could be that the No-Action alternative is selected or the project not continued.

⁶ See Guidance in 33 CFR 335-338 and ER 1105-2-100 and NEPA Regulations to define lead agency roles and responsibilities.

3.5 Detailed Assessment of Alternatives

For purposes of determining environmental acceptability, the detailed assessment of alternatives should include the following:

- Evaluation of the adequacy and timeliness of existing data.
- Evaluation of the physical characteristics of the sediment.
- Initial evaluation of sediment contamination.
- Performing appropriate testing and assessments (to include required CWA or MPRSA testing).
- Evaluation of management options or control measures.

Prior to conducting a detailed analysis of alternatives, conducting appropriate coordination between USACE, USEPA, and other agencies as appropriate is critical to ensure that any required sampling, testing, and evaluations are satisfactorily conducted.

Procedures for conducting the detailed evaluation of alternatives are described in the following paragraphs. Since the procedures for conducting detailed evaluations for open-water disposal, confined disposal, and beneficial use alternatives differ, additional details are presented in Chapters 4, 5, and 6, respectively. A wide variety of technical guidance documents are available and are referenced as appropriate in Chapters 4, 5, and 6. Computer-assisted management tools are also available for conducting many of the detailed assessments, which may be required (Schroeder et al. 2004).

In addition to those considerations for environmental acceptability, a detailed assessment of alternatives includes a comparative review of cost, technical feasibility, and other factors, as appropriate. Even though these additional considerations would normally be assessed as a part of the NEPA process for the project, they are beyond the scope of this document.

3.5.1 Adequacy and Timeliness of Data

Projects for which all reasonable alternatives have been identified and adequately evaluated still must be assessed in light of the CWA or MPRSA evaluation requirements. For those projects in the operations and maintenance or permit renewal category for which conditions have not changed, a preliminary assessment is made to determine the adequacy and relevance of previous information for the continuance of the dredging/disposal activities. If the existing data are sufficient to determine compliance with CWA or MPRSA, no additional data are required prior to preparation of the CWA or MPRSA evaluation and coordination of the Public Notice (see paragraph 3.6). For new-work Federal navigation projects, new permit applications, or projects for which information is insufficient, additional assessment following the framework as described here and in Chapters 4, 5, and 6 are required to determine the environmentally acceptable alternative(s).

3.5.2 Evaluate Physical Characteristics of Sediment

Evaluation of the physical characteristics of sediments proposed for discharge is necessary to determine potential environmental impacts of disposal, the need for additional chemical or biological testing, as well as potential beneficial use of the dredged material. If this information has not been gathered during the project evaluation phase, it must be obtained at this point in the framework. The physical characteristics of the dredged material include: particle-size distribution, water content or percent solids, specific gravity of solids, and plasticity characteristics. The sediment physical characteristics should also be evaluated from the standpoint of compatibility with different kinds of biological communities likely to develop for the disposal environments under consideration.

3.5.3 Conduct Initial Evaluation of Sediment Contamination

The initial screening for contamination is designed to determine, based on available information, if the sediments to be dredged contain any contaminants in forms and concentrations that are likely to cause unacceptable impacts to the environment. During this screening procedure, specific contaminants of concern are identified in a site-specific sediment, so that any subsequent evaluation is focused on the most pertinent contaminants.

Initial considerations should include but are not limited to:

- Potential routes by which contaminants could reasonably have been introduced to the sediments.
- Data from previous sediment chemical characterization and other tests of the material or other similar material in the vicinity, provided the comparisons are still appropriate.
- Probability of contamination from agricultural and urban surface runoff.
- Spills of contaminants in the area to be dredged.
- Industrial and municipal waste discharges (past and present).
- Source and prior use of dredged materials (e.g., beach nourishment).
- Substantial natural deposits of minerals and other natural substances.

Under CWA, some materials may be excluded from testing as specified in 40 CFR 230.60. Under MPRSA, testing must be conducted unless the exclusions in 227.13 (b) are met.

If the material does not meet the exclusions, contaminants must be addressed with respect to their potential for biological effects and/or release through applicable pathways. If such potential exists, the specific tests and assessments for contaminant pathways described in Section 3.5.4 will be required. If ocean-disposal alternatives are being considered, particular attention must be given to the presence of certain prohibited materials (40 CFR 227.6) other than as trace contaminants. Detailed guidance for chemical testing and evaluation of sediments can be found in USEPA/USACE (1995).

3.5.4 Perform Appropriate Testing and Assessments

Appropriate testing and assessments may be required to determine the physical behavior of the material at the disposal site. Also, testing and assessments for one or more potential contaminant pathways of concern may be required.

Physical testing and assessment should focus on both the short-term and long-term physical behavior of the material. For open-water alternatives, these assessments might include an analysis of water-column dispersion, mound development, and long-term mound stability or dispersion. For confined alternatives, these assessments might include an analysis of solids retention and storage requirements during disposal and long-term consolidation behavior in the CDF. Guidance for conducting physical testing and assessments is described in Chapters 4, 5, and 6.

Any contaminant testing should focus on those contaminant pathways where contaminants may be of environmental concern, and the testing should be tailored to the available disposal site. The considerations for identifying contaminant pathways of concern for open-water disposal and confined disposal alternatives are discussed in Chapters 4 and 5, respectively. For open-water alternatives, contaminant problems may be related to either the water column or benthic environment, and the appropriate testing and assessments would include required CWA or MPRSA testing. For confined sites, potential contaminant problems may be either water quality related (return water effluent, surface runoff, and groundwater leachate), contaminant uptake related (plant or animal), or air related (gaseous release).

The identification of pathways of concern should be based on the initial evaluation of sediment contamination and on the known characteristics of disposal sites under consideration. One of the following determinations will result for each pathway:

- If the initial evaluation of sediment contamination and site characteristics reveals that the material can be excluded from further testing or that adequate data already exist for a given contaminant pathway, then no additional contaminant testing for that pathway is required.
- In some cases, past evaluations of sediment contamination and site characteristics may indicate that contaminants would clearly result in unacceptable impacts through a given pathway. In this case, a determination can be made without further testing that management actions or control measures will be required for that pathway.
- Finally, there may not be sufficient technical information to allow for a factual determination for one or more pathways of concern. The potential impact of specific contaminant pathways must then be evaluated using appropriate testing and evaluations for those pathways. Risk assessment is employed implicitly in making a factual determination, as an integral part of development of many sediment and water quality criteria. If conventional

pathway testing and evaluation does not yield a definitive determination, however, risk assessment may be employed explicitly to reach a factual determination (USEPA 1998; Moore, Bridges and Cura 1998).

Design of a testing program for the sediment to be dredged depends on the pathways of concern for the alternative being evaluated. Protocols have been developed to evaluate contaminant pathways of concern and consider the unique nature of dredged material and the physicochemical conditions of each disposal site under consideration.

The testing guidelines that have been developed jointly by the USEPA and USACE incorporate a tiered approach and scientifically based decision process that uses only the level of testing necessary to provide the technical information needed to assess the potential chemical and biological effects of the proposed disposal activity. Detailed testing procedures for evaluation of ocean disposal under the MPRSA are found in the Ocean Testing Manual (USEPA/USACE 1991), while detailed testing procedures for evaluation of placement in U.S. waters under the CWA are found in the Inland Testing Manual (USEPA/USACE 1998). The Upland Testing Manual (USACE 2003) provides detailed procedures for evaluation of dredged material proposed for disposal at CDFs. Other relevant procedures are available (Francingues et al. 1985; Lee et al. 1991). Testing and evaluations for specific contaminant pathways for open-water and confined-disposal alternatives is discussed in more detail in Chapters 4 and 5, respectively.

3.5.5 Evaluate Management Actions or Control Measures to Minimize Impacts

In cases where results of tests or assessments indicate that the MPRSA impact Criteria or CWA Guidelines for a given pathway will not be met, management actions should be considered to reduce potential environmental impacts (33 CFR 335-338; Francingues et al. 1985; Lee et al. 1991; Cullinane et al. 1986). Management actions or control measures may be considered for physical and/or contaminant impacts.

Possible controls for open-water alternatives include operational modifications, use of submerged discharge, treatment, lateral containment, and capping or contained aquatic disposal. Possible controls for confined (diked) disposal include operational modifications, treatment, and various site controls (e.g., covers and liners). Descriptions of management and control measures for open-water and confined alternatives and procedures for assessing site-specific effectiveness are given in Chapters 4 and 5, respectively.

The effectiveness of management controls for contaminated sediments must be carefully considered, since no disposal option and/or management action or control measure is without risk. When considering the use of management actions or controls, the following factors must be considered:

- Probability of success of a given control.
- Monitoring required to confirm the effectiveness of the control.

- Duration and significance of adverse effects should a given control prove to be ineffective.
- Availability, feasibility, timeliness, and cost of additional management actions should they be required.

3.5.6 Retention of Environmentally Acceptable Alternatives

With the completion of detailed testing and assessments and the consideration of management and control measures for the respective alternatives, a determination of environmental acceptability is made. This determination must ensure that all applicable standards or criteria are met. If control measures were considered, a determination of the effectiveness of the control measure in meeting the standards or criteria must be made. If all standards or criteria are met, the alternative can be considered environmentally acceptable. At this point in the framework, socioeconomic, technical, and other applicable environmental considerations must be evaluated prior to the selection of a management alternative.

3.6 Alternative Selection

The detailed assessment of alternatives may result in one or more alternatives which are environmentally acceptable. Weighing and balancing of all environmental, technical, and economic factors must be conducted before the selection of the preferred/proposed alternative by the lead agency. The process for conducting this weighing and balancing is described in the implementing regulations of NEPA/CWA/MPRSA.

The major steps for coordination and documentation associated with alternative selection are illustrated in Flowchart 3-1. The coordination and documentation process includes draft and final NEPA/CWA/MPRSA documents, Public Notices, and a final-decision document which addresses comments on the draft NEPA/CWA/MPRSA documents.

The selection of a preferred/proposed alternative is based on environmental acceptability, technical feasibility, costs, and other factors, as appropriate. A detailed discussion of factors in decision making other than environmental acceptability is beyond the scope of this document. However, considerations in alternative selection, including a description of the procedures to be followed with respect to NEPA, CWA, and MPRSA, are discussed in Chapter 7. Once an alternative has been selected, proper coordination and documentation has been completed, and a final-decision document has been issued, the project should be in compliance with NEPA and all applicable environmental laws and regulations.

4.0 ASSESSMENT OF OPEN-WATER DISPOSAL

This chapter describes the detailed assessment of open-water disposal including testing and management options and control measures. The portion of the framework for detailed assessment of open-water disposal alternatives is illustrated in Flowchart 3-2. The paragraph numbers in the text are shown as appropriate in the flowchart. The detailed assessment described in this chapter may be performed following a determination of the need for such an assessment as described in Chapter 3.

4.1 Determination of Characteristics of Open-water Sites

A knowledge of site characteristics is necessary for assessments of potential physical impacts and contaminant impacts. Information on site characteristics needed for assessments may include the following:

- Currents and wave climate.
- Water depth and bathymetry.
- Potential changes in circulation patterns or erosion patterns related to refraction of waves around the disposal mound.
- Bottom sediment physical characteristics including sediment grain-size differences.
- Sediment deposition versus erosion.
- Salinity and temperature distributions.
- Normal levels and fluctuations of background turbidity.
- Chemical and biological characterization of the site and environs (e.g., relative abundance of various habitat types in the vicinity, relative adaptability of the benthos to sediment deposition, presence of submerged aquatic vegetation, and presence of unique, rare or endangered, or isolated populations).
- Potential for recolonization of the site.
- Previous disposal operations.
- Availability of suitable equipment for disposal at the site.
- Ability to monitor the disposal site adequately for management decisions.
- Technical capability to implement management options should they appear desirable.
- Ability to control placement of the material.
- Volumetric capacity of the site.
- Other site uses and potential conflicts with other activities (e.g., sport or commercial fisheries, shipping lanes, and military use).
- Established site management or monitoring requirements.
- Public and regulatory acceptability to use of the site.

4.1.1 Site Selection under MPRSA

The intent of the criteria for site selection is to avoid unacceptable, adverse impacts on biota and other amenities. This requires that sufficient information be assembled such that reasonable assurance can be given that the criteria will be met. As a rule, the majority of amenities, such as fishing, shipping, mineral extraction, spawning, breeding, nursery grounds, and cultural or historical features, may be addressed with existing information. If so, primary concern is then directed to biological resources in and adjacent to the proposed disposal site. These concerns are addressed by ensuring that any geographically limited or especially significant living resources are not present within the site nor outside the site in such a location as to be adversely impacted by movement of material off the site if it is a dispersive site (USACE/USEPA 1984). Resources within the site may suffer physical impacts from the deposition of the dredged material, and sites should be designated/selected to ensure such impacts are acceptable.

The criteria provide that ocean dumping sites will be designated beyond the edge of the continental shelf, wherever feasible, and at other sites that have been historically used unless monitoring data or other information indicate the potential for significant adverse impacts.

If little is known concerning the resources or the characteristics of the site and its environs, appropriate investigations and studies must be performed. The USACE has prepared an ocean-site designation manual (Pequegnat, Gallaway, and Wright 1990), which provides useful guidance and procedures for conducting the appropriate investigations and studies. In addition, overview manuals for site designation have been developed (USACE/USEPA 1984; USEPA 1986). Procedures for application of risk assessment to the aquatic environment can be found in Cura et al. (2001).

4.1.2 Site Specification under CWA

The specification of disposal sites under the CWA is addressed specifically in the Section 404 (b)(1) Guidelines. The Guidelines establish a sequential review of a proposed project, the first step of which is avoidance of adverse impacts to the aquatic environment through an evaluation of practicable alternatives which would have less impact on that environment [40 CFR 230.10 (a)]. In general, the same concerns as given above for ocean-site designation are applied to site specification under CWA. These include potential impacts on physical and chemical characteristics of the aquatic ecosystem, potential impacts on biological characteristics of the aquatic ecosystem, potential effects on special aquatic sites, and potential effects on human-use characteristics (40 CFR 230 Subpart C-F).

The specification of an appropriate site under CWA takes into account that CWA disposal sites may be located in estuaries, rivers, and lakes that may have limited assimilative capacity. Geographic and operational constraints as well as site capacity may severely constrain potentially available sites.

There are also special concerns if the site is a special aquatic site (e.g., a wetland) as defined in Section 404 (40 CFR 230 Subpart E). For example, if the proposed disposal site is a special aquatic site and the activity for which disposal is required is not water-dependent, the Guidelines presume that nonaquatic alternatives are available [40 CFR 230.10 (a) (3)].

Physical compatibility between the characteristics of the dredged material and proposed disposal site is not the sole factor to be used in determining compliance with the Guidelines. Other requirements of the Guidelines, specifically Section 230.10, must also be considered in the evaluation of dredged materials. In addition, under Section 230.11(g), the Guidelines require that the cumulative impact of the individual discharges of dredged material on the aquatic ecosystem be included in the evaluation of individual permits. Therefore, dredged material disposal, like all other discharges of dredged or fill material into waters of the United States, cannot be permitted unless it has been demonstrated to comply with all requirements of the CWA Section 404(b)(1) Guidelines.

The USACE and USEPA may jointly identify, in advance, sites generally suitable or unsuitable for discharge of dredged material (40 CFR 230.80). The advanced identification of sites does not permit or prohibit the discharge of dredged or fill material, but does facilitate individual or general permit application and processing. Under the authority of Section 404(c), however, USEPA may prohibit, withdraw, or restrict the discharge of dredged or fill material if it determines that the discharge would have unacceptable adverse effects. As mentioned previously, procedures for application of risk assessment to the aquatic environment can also be found in Cura et al. (2001).

4.1.3 Site Monitoring

Site monitoring may be a requirement resulting from the site designation/specification process, or may be required as a part of an established site management plan. Detailed guidance on site-monitoring equipment and techniques and on development of monitoring plans is available (Marine Board 1990; Pequegnat, Gallaway, and Wright 1990; Fredette et al. 1990a, 1990b).

4.2 Evaluation of Direct Physical Effects and Site Capacity

An evaluation of direct physical impacts and site capacity should precede any evaluations of potential contaminant impacts, since elimination of alternatives or sites based on unacceptable physical impacts or inadequate site capacity is needed prior to testing for contaminant effects.

4.2.1 Direct Physical Impacts

Direct physical impacts will almost always result from the disposal of dredged material. Benthic organisms at the disposal site may be buried and may not be able to migrate through the material. If the substrate is changed from what was previously

present, the organisms which recolonize the site may be different from those present prior to disposal.

Suspended solids may also affect water column organisms, although these effects are uncommon because of the large dilution factor. Potential physical effects are addressed during the site designation/specification process. If at all possible, a site should not be located where significant undesirable effects will occur on or off the site. Prior to disposal, the physical characteristics of the material should be evaluated to determine if it is compatible with the use of a particular site. Models are frequently used to predict the behavior of the material during and after disposal, and, in some instances, monitoring may be needed to verify the model predictions. Both USACE and USEPA have generated a large database on potential physical effects through the large number of site-designation surveys performed nationwide.

If site conditions and uses are unchanged, collection of additional data to evaluate direct physical impacts would generally be unnecessary for evaluation of a proposed discharge of material under MPRSA because such impacts were evaluated as a part of the site-designation process as well as during the site monitoring and management activities. However, for Section 404 open-water disposal, direct physical impacts must be considered as a part of the site-specification process for the specific discharge. Under both MPRSA and CWA, appropriate site management and monitoring concerns must be addressed.

4.2.2 Site Capacity

The physical capacity of predominantly nondispersive sites to hold the dredged material without (1) resuspension and transport of disposed material by surface waves or (2) interference with navigation traffic or other operational conflicts, must also be evaluated. This may involve (1) setting a maximum height for mounds of disposed dredged material or (2) estimating mounding rates over the long term, taking into account erosion and consolidation of the mound (Dortch et al. 1990; Scheffner 1991; Poindexter-Rollings 1990). Site capacity of predominantly dispersive sites is not normally a concern.

4.2.3 Need for Management Actions

If the evaluation of direct physical impacts and evaluation of site capacity indicate that the site is adequate, the evaluation of contaminant pathways can be initiated. If the evaluations of direct physical impacts and site capacity indicate unacceptable impacts will result, or that site capacity is inadequate, management actions are required to reduce physical impacts. Management actions to reduce physical impacts to acceptable levels may include operational modification, submerged discharge, lateral confinement, or thin-layer placement. These same management approaches can be considered to extend the physical capacity of the site. Management actions are described in paragraph 4.4. If the management actions are determined to be effective, the evaluation of contaminant pathways can be initiated. If not, then the open-water disposal alternative at the site under consideration should be eliminated.

4.3 Evaluation of Contaminant Pathways of Concern

The main emphasis of contaminant pathway testing for open-water disposal is aimed at determining if a given dredged material is acceptable for open-water disposal from the standpoint of contamination. If dredged material is found to be environmentally unacceptable for disposal in the ocean, it also would probably be environmentally unacceptable for disposal in Section 404 waters.

As shown in Figure 4-1, the potential contaminant pathways for open-water disposal are water column and benthic. Water-column contaminant impacts must be considered from the standpoint of water quality (chemical) and toxicity (biological). Benthic impacts must be considered from the standpoint of toxicity and bioaccumulation. A tiered approach to contaminant testing and assessments is described in detail in the dredged material testing manuals for MPRSA and CWA (USEPA/USACE 1991; USEPA/USACE 1998; USACE 2003).

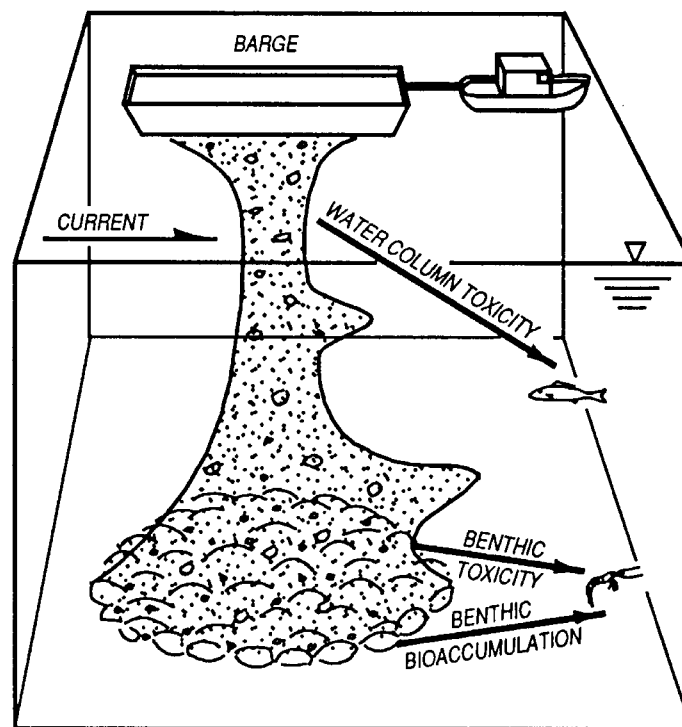

Figure 4-1. Contaminant Pathways for Open-water Disposal

4.3.1 Water-Column Impacts

Potential water-column contaminant effects are evaluated by comparing contaminant release in an elutriate of the material to be disposed with applicable water-quality criteria or standards as appropriate. In addition, acute water-column toxicity bioassays considering initial mixing may be needed. The procedures to be used in elutriate or water-column bioassays are provided in the MPRSA and CWA testing manuals (USEPA/USACE 1991; USEPA/USACE 1998; USACE 2003). For disposal operations under the MPRSA, specific criteria for water quality and water-column toxicity must be met, and specific allowances are specified for initial mixing (USEPA/USACE 1991). For disposal operations under CWA, water quality and water-column toxicity standards and allowances for initial mixing are specified by the States as a part of the Section 401 water-quality certification requirements. Models are available for mixing calculations (USEPA/USACE 1991; USEPA/USACE 1998; USACE 2003).

4.3.2 Benthic Impacts

In assessing potential benthic effects of contaminants under MPRSA, if the exclusion criteria of 40 CFR 227.13 (b) are met, biological testing of the dredged material is not necessary. If the exclusion criteria are not met, toxicity and bioaccumulation information is required to evaluate the suitability of the material for disposal. If disposal is under the authority of the CWA, a chemical comparison of the material to be disposed and a reference sediment may be conducted. If contaminant concentrations in the dredged material and an adjacent disposal site are substantially similar and contaminants will not leave the adjacent disposal site or if controls are available to reduce contamination to acceptable levels within the disposal site, no further evaluation may be required [40 CFR 230.60(c) and (d)]. If this is not the case, bioassays and bioaccumulation tests are required to complete the evaluation.

Contaminants may affect benthic organisms through acute toxicity or by the uptake of the contaminants (bioaccumulation). The evaluations compare acute toxicity and/or bioaccumulation in benthic organisms exposed to the material to be disposed with organisms exposed to a reference sediment. Procedures for conducting and interpreting the acute toxicity and bioaccumulation evaluations are described in detail in the MPRSA Ocean Testing Manual (USEPA/USACE 1991) and CWA Inland Testing Manual (USEPA/USACE 1998). The Upland Testing Manual (USACE 2003) provides detailed procedures for evaluation of dredged material proposed for disposal at CDFs.

4.3.3 Need for Contaminant Controls

If the contaminant pathway testing indicates that the impact Criteria or Guidelines are met, the open-water disposal alternative is environmentally acceptable from the standpoint of contaminant effects. If the impact Criteria or Guidelines are not met, contaminant control measures must be considered to reduce impacts to acceptable levels if the open-water alternative is to be further considered.

Control measures to minimize contaminant impacts may include operational modification, submerged discharge, lateral confinement, treatment, and capping. These control measures are described in paragraph 4.4. If the control measures are determined to be effective, then the alternative is environmentally acceptable from the standpoint of contaminants. If not, then the open-water disposal alternative at the site under consideration should be eliminated.

4.4 Evaluation of Management Actions and Controls for Open-water Disposal

In cases where evaluations of direct physical impacts, site capacity, or contaminant pathways indicate the Criteria or Guidelines will not be met when conventional open-water disposal techniques are used, a variety of management actions and contaminant control measures may be considered. Such techniques include operational modifications, use of subaqueous discharge points, use of diffusers, subaqueous lateral confinement of material, thin-layer placement, or capping of contaminated material with clean material.

Descriptions of the commonly used management actions and contaminant controls are given in the following paragraphs. Additional guidance on selection of contaminant controls for open-water disposal is found in Francingues et al. (1985), Cullinane et al. (1986), and Truitt (1987a and 1987b).

The primary consideration in selecting management or control options is to identify the impacts to be addressed by the management or control options and choose an option that best addresses the issue(s) of concern. The management and contaminant controls discussed in this section are to be considered and implemented on both a site-specific and case-specific basis. General considerations for each option are presented within each section below. It is important to note that not all options work under all situations or in all cases. Before any option is selected for implementation, a complete review of the material-specific and site-specific conditions and circumstances should be completed.

4.4.1 Modification of Dredging and Disposal Operations

Modifications of dredging and disposal operations can be an effective control for both physical effects and water-column or benthic contaminant pathways. The purpose of operational modification as a control is to reduce water-column dispersion and/or spread of material on the bottom. The most obvious control measure for open-water disposal is a modification in the technique or equipment used for placement. For example, if water-column concentrations of dredged material exceed water-quality criteria or toxicity criteria for a proposed hopper dredge discharge, an operational modification to clamshell dredging with discharge from barges would reduce the water-column release. Discharge of mechanically dredged material from barges also results in less spread of material as compared with hopper discharge. Other operational modifications include constraints on location of disposal, rate of disposal, and timing of disposal.

4.4.2 Submerged Discharge

Submerged discharge is a control measure which may be considered to reduce water-column impacts. The use of a submerged point of discharge reduces the area of exposure in the water-column and the amount of material suspended in the water column susceptible to dispersion. The use of submerged diffusers also reduces the exit velocities for hydraulic placement, allowing more precise placement and reducing both resuspension and spread of the discharged material. Considerations in evaluating feasibility of a submerged discharge and/or use of a diffuser include water depth, bottom topography, currents, type of dredge, and site capacity. Design specifications for submerged diffusers are available, and the diffusers have been successfully used for disposal operations (Neal, Henry, and Green 1978, Palermo 1994).

4.4.3 Lateral Containment

Lateral containment is a control measure which may be considered to reduce benthic impacts. The use of subaqueous depressions or borrow pits or the construction of subaqueous dikes can provide containment of material reaching the bottom during open-water disposal, resulting in a reduced bottom area being affected by the placement. Such techniques reduce the areal extent of a given disposal operation, thereby reducing both physical benthic effects and the potential for release of contaminants. Considerations in evaluating feasibility of lateral containment include type of dredge, water depth, bottom topography, bottom sediment type, and site capacity.

Simply selecting a site amenable to lateral containment such as an existing bottom depression or valley can be effective. Placement of material in constructed depressions such as abandoned borrow pits has also been proposed. Submerged dikes or berms for purposes of lateral containment have been constructed or proposed at several sites. Such a proposal would not necessarily involve added expense to the project if the material used for the berm comes from the same or another dredging project.

4.4.4 Thin-Layer Placement

The intentional spreading of hydraulically pumped dredged material over broad areas to achieve overburdens less than 12 inches thick has been termed “thin-layer” placement. The objective of thin-layer placement is to minimize impacts on benthic fauna and to speed their recovery, particularly in estuarine environments. This strategy is based upon knowledge that a portion of the benthos can migrate upward through the dredged material overburden, usually present as a fluid mud layer. This concept has been developed and demonstrated in Mississippi Sound by the Mobile District. Results of monitoring studies indicated that recovery was enhanced in shallow, turbid Gulf coast estuaries. A distinction should be made between thin-layer placement in open-water applications and high-pressure spray disposal on marsh surfaces. Although sometimes referred to as thin-layer placement, the latter case involves different equipment requirements and generally is suitable for relatively small volumes of dredged material, whereas open-water thin-layer placement uses conventional hydraulic equipment (with

modification of the discharge terminus for mobility) and is potentially suitable for large quantities of dredged material. There are few references in the literature on this topic. A brief discussion can be found in Nester and Rees (1988).

4.4.5 Capping and Contained Aquatic Disposal

Capping is the controlled placement of contaminated material at an open-water site followed by a covering or cap of clean isolating material. Capping is a control measure for the benthic contaminant pathway. Level bottom capping is a term used for capping without means of lateral containment. If some form of lateral containment is used in conjunction with the cap, the term contained aquatic disposal is used. Considerations in evaluating the feasibility of capping include site bathymetry, water depth, currents, wave climate, physical characteristics of contaminated sediment and capping sediment, and placement equipment and techniques. Because long-term stability of the cap is of concern, capping is generally considered to be more technically feasible in low-energy environments. Precise placement of material is necessary for effective capping, and use of other control measures such as submerged discharge and lateral containment increase the effectiveness of capping. Guidelines and recommendations are available for planning and design of capping projects (Palermo et al. 1998a and 1998b; Fredette et al. 2000).

4.4.6 Treatment

Treatment of discharges into open water may be considered to reduce certain water-column or benthic impacts. For example, the Japanese have used an effective in-line dredged material treatment scheme for highly contaminated harbor sediments (Barnard and Hand 1978). However, this strategy has not been widely applied, and its effectiveness has not been demonstrated for solution of the problem of contaminant release during open-water disposal.

4.4.7 Monitoring

Monitoring is a management action which may be used to establish the effectiveness of other specific management actions and the need for modification of such actions, the necessity of which is a case-by-case decision. Technical guidance for monitoring open-water disposal sites (physical and biological) is available (Marine Board 1990; Fredette et al. 1990a, 1990b).

4.5 Retention of Environmentally Acceptable Open-water Alternatives

Once appropriate open-water assessments are complete, a determination of environmental acceptability is made. This determination must ensure that all applicable standards or criteria are met. If control measures were considered, a determination of the effectiveness of the control measure in meeting the standards or criteria must be made. If all standards or criteria are met, the open-water alternative can be considered environmentally acceptable. At this point in the framework, other factors can be considered in the selection of an alternative as described in paragraph 3.6 and Chapter 7.

5.0 ASSESSMENT OF CONFINED (DIKED) DISPOSAL

This part of the report describes detailed assessments for alternatives involving confined (diked) disposal facilities (hereinafter referred to as CDFs). In general, disposal of dredged material in CDFs is regulated under the CWA. It is also important to note that the CDF itself must comply with the Guidelines if it is sited in waters of the United States. In addition, there may be other regulatory requirements under NEPA and other applicable laws and regulations on a case-by-case basis.

CDFs differ in their geohydrology, sediment chemistry, carrier water removal, contaminant release rates, and contaminant pathways affected. Therefore, the testing and assessments required will vary somewhat accordingly, although the procedures are based on similar scientific and engineering principles. The framework for assessing confined disposal is illustrated in Flowchart 3-3. The detailed assessments described in this chapter may be performed following a determination of the need for such assessments as described in Chapter 3.

5.1 Determination of Characteristics of Confined Sites

Site specification for CDFs in many ways can be more complex than for open-water sites. Real estate considerations are a major factor in determining the availability of potential sites. Most navigation project authorizations require the local project sponsors to provide the lands, easements, and rights of way for CDFs; some authorizations require the sponsor to provide dikes and site management. CDFs therefore represent a substantial economic investment on the part of the sponsor. In many instances, the sponsors will only provide sites which meet short-term requirements, and additional sites may be required in the future. Another consideration for CDF site specification is the fact that such sites are normally visible to the public and are viewed as a competing interest for land use, especially in coastal areas where there is intense pressure for both development and preservation of lands.

A knowledge of CDF site characteristics is necessary for assessments of potential physical impacts and contaminant impacts. Information on site characteristics needed for assessments includes the following:

- Available area and volumetric storage capacity to contain the material for the required life of the site.
- Real estate considerations.
- Site configuration and access.
- Proximity to sensitive ecological environments.

- Topography to include potential changes in elevation and runoff patterns and adjacent drainage.
- Ability of the dredged material to eventually dry and oxidize.
- Groundwater levels, flow and direction, and potential impact on groundwater discharge and recharge.
- Meteorology and climate.
- Foundation soil properties and stratigraphy.
- Potential groundwater receptors.
- Potential alteration of the existing habitat type.
- Potential for effluent, leachate, and surface runoff impacting adjacent ground and surface water resources.
- Potential for direct uptake and movement of contaminants into food webs.
- Potential for volatilization of contaminants.
- Potential for dust, noise, or odor problems.
- Potential to implement management activities when deemed necessary.
- Potential accessibility of the site by the public.
- Contamination history of proposed site.

Field exploration programs are necessary to assess many of the above considerations in determining the suitability of a site for use as a CDF. Foundation explorations are especially important for dike design and groundwater assessments. Additional information regarding sampling techniques and equipment and development of field exploration programs for CDFs is given in EM 1110-2-5027 (USACE 1987).

5.2 Evaluation of Direct Physical Impacts and Site Capacity

An evaluation of direct physical impacts and initial and long-term CDF site capacity should precede any evaluations of contaminant impacts, since elimination of alternatives based on unacceptable physical impacts or inadequate site capacity could reduce the need for more expensive and involved testing for contaminant effects.

5.2.1 Direct Physical Impacts

Direct physical impacts because of construction of the CDF must be assessed. Such impacts may include alteration of habitat, changes in hydrological conditions (e.g., circulation patterns in surface waters and groundwater recharge), restrictions to navigation, and aesthetic, cultural, and land-use impacts. Guidance on evaluation of such physical impacts in waters of the United States is available (40 CFR 230).

5.2.2 Initial Storage Capacity and Solids Retention

A CDF must be designed and operated to provide adequate initial storage volume and surface area to hold the dredged material solids during an active filling operation and if hydraulically filled, to retain suspended solids such that clarified water is discharged. The required initial storage capacity and surface area is governed by zone, flocculent, and compression-settling processes which occur in a CDF during placement of fine-grained

dredged material. Procedures to evaluate the required surface area and volume during active filling operations, to estimate effluent suspended solids concentrations, and to design other features for CDFs are described in engineer manuals (USACE 1983, 1987 and in preparation). Expert systems for evaluation of initial storage capacity and solids retention are described in Hayes and Schroeder (1992).

5.2.3 Long-Term Storage Capacity

In addition to initial capacity during active filling, an evaluation of long-term storage capacity is required if a CDF is intended for use over multiple dredging cycles. The long-term storage capacity of a given site is dependent on the material consolidation and desiccation properties, climate, and operational conditions. Procedures to evaluate long-term storage capacity of CDFs are provided in Engineer Manuals (USACE 1983, 1987 and in preparation). Expert systems for evaluation of long-term consolidation are described in Schroeder et al. (2004).

5.2.4 Need for Management Actions

If the evaluation of direct physical impacts and evaluation of site capacity indicate that the site is adequate, the remaining assessments can be conducted. If the evaluations of direct physical impacts and site capacity indicate unacceptable impacts will result or that site capacity is inadequate, management actions can be considered.

Management actions to minimize physical impacts of CDF construction may include site management to reduce effluent solids discharge or dewatering of dredged material between filling operations to extend capacity and reduce the need for a larger site. Management actions are described in paragraph 5.4. If the management actions are determined to be effective, the remaining assessments can then be conducted. If not, then the confined-disposal alternative at the site under consideration should be eliminated.

5.3 Evaluation of Contaminant Pathways of Concern for CDFs

If the initial evaluation of sediment contamination described in paragraph 3.5.3 reveals that contaminants are not of concern for specific pathways, then no additional contaminant testing is required for those pathways. However, if contaminants are of concern, an analysis of appropriate pathways must be conducted that may include possible testing.

5.3.1 Contaminant Pathways for CDFs

The possible migration pathways of contaminants from confined disposal facilities in the upland environment are illustrated in Figure 5-1. These pathways include effluent discharges to surface water during filling operations and subsequent settling and dewatering, rainfall surface runoff, leachate into groundwater, volatilization to the atmosphere, and direct uptake. Direct uptake includes plant uptake and subsequent cycling through food webs and direct uptake by animal populations living in close

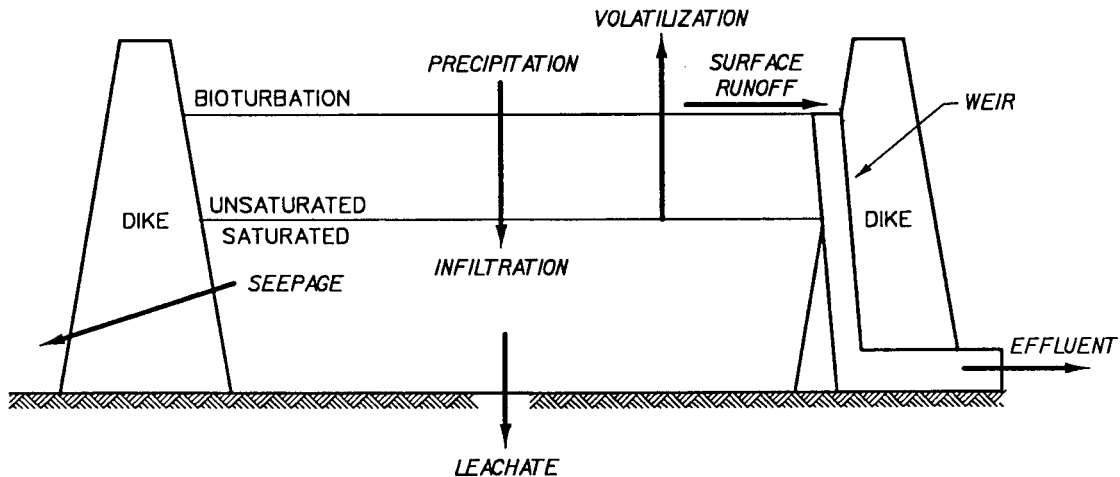

Figure 5-1. Contaminant Pathways for Upland CDFs

association with the dredged material. Effects on surface water quality, groundwater quality, air quality, plants, and animals depend on the characteristics of the dredged material, management and operation of the site during and after filling, and the proximity of the CDF to potential receptors of the contaminants.

Migration pathways affected by nearshore CDFs are illustrated in Figure 5-2 and include all of the pathways previously discussed. Additional considerations for nearshore sites (with one or more sides within the influence of water level fluctuations) are soluble convection through the dike in the partially saturated zone and soluble diffusion from the saturated zone through the dike. Groundwater seepage into or through the site can also be a factor affecting contaminant migration. These additional potential fluxes primarily affect the surface water pathway.

5.3.2 Geochemical Environments for CDFs

When dredged material is placed in an upland environment, physical and/or chemical changes may occur (Francingues et al. 1985). The dredged material initially is dark in color and reduced, with little oxygen. If the material is hydraulically placed in the CDF, the ponded water will usually become oxygenated. This may affect the release of contaminants in effluent discharged during hydraulic filling.

Once disposal operations are completed, and any ponded water has been removed from the surface of the CDF, the exposed dredged material will become oxidized and lighter in color. The dredged material may begin to crack as it dries out. Accumulation of salts will develop on the surface of the dredged material and especially on the edge of the cracks. Rainfall events will tend to dissolve and remove these salt accumulations in surface runoff. Certain metal contaminants may become dissolved in surface runoff.

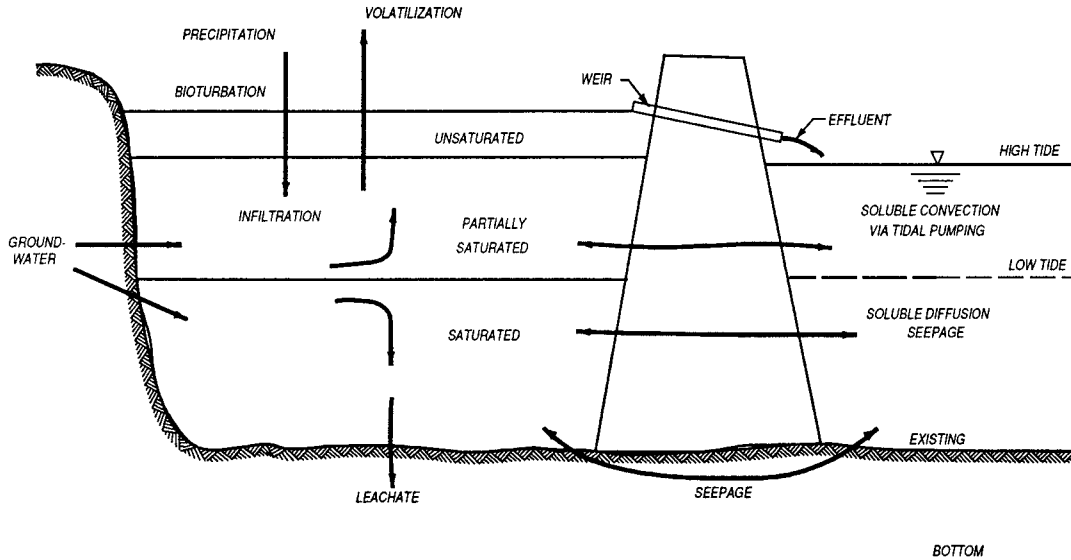

Figure 5-2. Contaminant Pathways for Nearshore CDFs

During the drying process, organic complexes become oxidized and decompose. Sulfide compounds also become oxidized to sulfate salts, and the pH may drop drastically. These chemical transformations can release complex contaminants to surface runoff, soil pore water, and leachate. In addition, plants and animals that colonize the upland site may take up and bioaccumulate these released contaminants.

Volatilization of contaminants depends on the types of contaminants present in the dredged material and the mass transfer rates of the contaminants from sediment to air, water to air, and sediment to water. Release of the dredged material slurry above the water level in the CDF surface will enhance volatilization as the slurry impacts the CDF surface, creating turbulence and releasing dissolved gases. The transfer rate for organics such as polychlorinated biphenyls (PCBs) from water to air is generally slower, but of longer duration, than from sediment to air (Thibodeaux 1989).

CDFs constructed totally or partially in water will usually receive dredged material until the final elevation is above the high-water elevation. Three distinct physicochemical environments may eventually exist at such a site: upland (dry unsaturated layer), intermediate (partially or intermittently saturated layer), and aquatic (totally saturated layer) (Lee et al. 1991).

When material is initially placed in an in-water CDF, it will all be flooded or saturated throughout the vertical profile. The saturated condition is anaerobic and reduced, which favors immobility of contaminants, particularly heavy metals. After the site is filled and dredging ceases, the dredged material above the water level begins to dewater and consolidate through movement of water downward as leachate, upward and out of the site as surface drainage or runoff, and laterally as seepage through the dike. As

the material desiccates through evapotranspiration, it becomes aerobic and oxidized, mobilizing some contaminants as described previously. At this point, the surface layer has characteristics similar to that of material in an upland CDF.

The bottom of an in-water CDF below the low-tide or groundwater elevation remains saturated and anaerobic, favoring insolubility and contaminant attraction to particulate matter. After dewatering of the dredged material above the flooded zone ceases and consolidation of the material in the flooded zone reaches its final state, water movement through the flooded material is minimal and the potential for migration of contaminants is low.

The intermediate layer between the saturated and unsaturated layers will be a transition zone and may alternately be saturated and unsaturated as the water surface fluctuates. The depth of this zone and the volume of dredged material affected depend on the difference in tide elevations and on the permeability of the dike and of the dredged material. With low-permeability material, the volume of CDF material impacted by this pumping is very small compared with the in-water CDF's total volume.

5.3.3 Analysis of Pathways for CDFs

Guidance for analysis of contaminant pathways for CDFs is provided in the Upland Testing Manual or UTM (USACE 2003). This manual is a resource document providing detailed testing procedures and approaches for evaluation of potential contaminant migration pathways from diked confined disposal facilities (CDFs). Consideration of pathways for migration of contaminants from the site and potential contaminant impacts is required to determine the need for operational or engineered measures to control contaminant releases. During the 1980s and 1990s, a number of evaluation procedures and laboratory tests were developed for CDF pathway evaluations and serve as the technical basis for procedures in the UTM (Environmental Laboratory 1987, Francingues and Averett 1988, Palermo et al. 1989, Brannon et al. 1990, and Myers 1990).

The UTM uses a tiered approach similar to that long used for evaluation of open water placement of dredged material (USEPA/USACE 1991 and 1998). The pathways of concern for CDFs include effluent discharges to surface water during filling operations, rainfall surface runoff, leachate into groundwater, volatilization to the atmosphere, and direct uptake by plants and animals on site and subsequent cycling through food webs. Additional discussion of the respective CDF pathways including appropriate testing protocols and evaluation procedures are given in the following paragraphs.

5.3.4 Effluent Discharge

The effluent from a CDF may contain both dissolved and particulate-associated contaminants. A large portion of the total contaminant concentration is tightly bound to the particulates. Effluent from a CDF is considered a dredged material discharge under

Section 404 of the CWA and is also subject to water quality certification under Section 401 State/Tribal water quality standards.

Prediction of effluent quality may be made using partitioning analysis (Estes, Schroeder, and Bailey in preparation), or the effluent elutriate test procedure (Palermo 1985; Palermo and Thackston 1988, USEPA/USACE 1998, USACE 2003). Partitioning analysis provides an estimate of effluent concentrations that will result for measured sediment and carrier water concentrations. This can be helpful in narrowing the constituents of concern to those that appear to be present at concentrations that may be environmentally problematic. The modified elutriate test simulates the geochemical and physical processes occurring during confined disposal. This test provides additional information on dissolved and particulate contaminant concentrations. The column settling test (USACE 1987) and expert system SETTLE (Hayes and Schroeder 1992) used for CDF design provide an estimate of the effluent solids concentrations. Results of both elutriate and settling tests can be used to predict a total concentration of contaminants in the effluent. The predicted effluent quality, with allowance for any mixing zone, can be compared directly with water quality standards. Computerized programs are also available to compare predicted effluent concentrations with water quality criteria (Palermo and Schroeder 1991).

Where water quality standards are unavailable or are predicted to be exceeded, risk assessment may be necessary to further evaluate the environmental impacts associated with the effluent discharge. Guidance regarding effluent toxicity bioassays and ecological and human health risk assessment in aquatic environments can be found in Brandon, Schroeder, and Lee (1997a) and Cura et al. (2001), respectively. The modified elutriate test can be used to develop the water medium for bioassays if a biological approach to evaluation of effluent quality is needed. These bioassays are conducted in a manner similar to those for open-water disposal. The quality of a reference water (usually the receiving water) should be considered in test interpretation.

If impacts of effluent contaminant concentrations are unacceptable, appropriate controls should be considered. Control measures available for effluent discharge include improved settling design or reduced flow to the containment area, chemical clarification or filtration to remove particulate contaminants, and removal of dissolved contaminants by more sophisticated treatment processes.

5.3.5 Surface Runoff

Immediately after material placement in a CDF and after ponding water is decanted, the settled material may experience surface runoff. Rainfall during this initial period will likely be erosive, and runoff will contain elevated solids concentrations. Geochemically speaking, the contaminant release is controlled by anaerobic conditions. Once the surface is allowed to dry, the runoff will contain a lesser concentration of solids, but the release is now controlled by aerobic conditions, and release of some dissolved contaminants may be elevated. Runoff water quality requirements may be a condition of the water quality certification or considered as part of the NEPA process.

As for effluent, partitioning analysis may be used to provide an initial estimate of runoff concentrations, and this can be done for both oxidized and unoxidized conditions (Price, Schroeder, and Estes in preparation). There also is now available a simplified test procedure for prediction of runoff quality (SLRP) (Price, Skogerboe and Lee 1998 and USACE 2003). A soil lysimeter testing protocol (Lee and Skogerboe 1983 and USACE 2003) has also been used to predict surface runoff quality with good results. The lysimeter is equipped with a rainfall simulator and can be used in the laboratory or transported to the field site. The soil lysimeter is a more expensive and elaborate testing protocol, requiring large volumes of sediment and approximately 8 months for test completion.

Computerized programs are available to compare predicted runoff concentrations with water quality criteria (Schroeder, Gibson, and Dardeau 1995). If runoff concentrations exceed water quality standards, appropriate controls may include placement of a surface cover or cap on the site, maintenance of ponded water conditions (although this may conflict with other management goals), vegetation to stabilize the surface, treatments such as liming to raise pH, or treatment of the runoff as for effluent (Lee and Skogerboe 1987). Risk assessment may be used to evaluate the environmental effects associated with runoff and determine the need for controls where standards are predicted to be exceeded, or standards are not available (Cura, Wickwire and McArlde in preparation). Procedures for evaluation of runoff toxicity bioassay tests can also be found in Brandon, Schroeder, and Lee (1997b).

5.3.6 Leachate

Subsurface drainage from upland CDFs may reach adjacent aquifers or may enter surface waters. Fine-grained dredged material tends to form its own disposal-area liner as particles settle with percolation of water, but some time may be required for sufficient consolidation to occur. Particulate transport in leachate is also minimal. Constituents present in leachate are primarily found in the dissolved fraction.

Evaluation of the leachate quality from a CDF must include a prediction of which contaminants may be released in leachate and the relative degree of release or mass of contaminants (Schroeder 2000). Pore water analysis may provide a good preliminary estimate of leachate quality. Partitioning analysis may also be used to estimate concentrations of constituents in leachate, based on measured sediment concentrations (Myers, Schroeder and Estes in preparation (a)). Experimental procedures have been developed for prediction of leachate quality from dredged material (Myers and Brannon 1991; Brannon, Myers and Tardy 1994; Myers, Brannon and Tardy 1996, USACE 2003). These procedures are based on theoretical analysis and laboratory batch testing and column testing, but have not been routinely applied due to the time required to perform these tests and the associated cost.

The experimental testing procedures only give data on leachate quality. Estimates of leachate quantity must be made by considering site-specific characteristics and groundwater hydrology. Computerized procedures such as the USEPA Hydrologic

Evaluation of Landfill Performance model (Schroeder et al. 1984) have also been used to estimate water balance (budget) for dredged material CDFs (Palermo et al. 1989; Francingues and Averett 1988). Additional procedures and computer estimating tools are also available to estimate attenuation of contaminants in the subsurface (Schroeder and Aziz 2003; Aziz and Schroeder 1999a; Aziz and Schroeder 1999b; Schroeder et al. 1994a; Schroeder et al. 1994b; Schroeder et al. 2004). Source terms for partitioning analysis and attenuation calculations can be found in Streile et al. (1996).

If leachate concentrations exceed applicable criteria, or criteria are not available and effects cannot be shown to be acceptable using risk assessment (USEPA 1998; Cura, Wickwire and McArde in preparation), controls for leachate must be considered. These may include proper site specification to minimize potential movement of water into aquifers, dewatering to reduce leachate generation, chemical modifications to retard or immobilize contaminants, physical barriers such as clay and synthetic liners, capping/vegetating the surface to reduce leachate production, or collection and treatment of the leachate.

5.3.7 Plant and Animal Uptake

Some contaminants can be bioaccumulated in plant tissue and become further available to the food chain. There are few reference values available specifically for assessing the potential for adverse plant or animal uptake from dredged material. Criteria established for sewage sludge are sometimes used, but apply to a limited number of metals, and are based on conservative assumptions that are not directly applicable to a disposal area. A computerized screening program has been developed which compares measured sediment concentrations to available reference values. The Diethylenetriamine-pentaacetic acid (DTPA) extract test has also been utilized to provide a simplified assessment of the potential for plant and animal uptake (Lee et al. 1978; Folsom, Lee, and Bates 1981; Lee, Folsom, and Engler 1982; Lee, Folsom, and Bates 1983; U.S. Army Engineer Waterways Experiment Station 1987, USACE 2003). A computerized program, the Plant Uptake Program (PUP) uses the results of the DTPA extraction procedure to predict bioaccumulation of metals from freshwater dredged material by freshwater plants and compare the results to a background or reference sediment or soil (Folsom and Houck 1990).

If the contaminants are identified in the dredged material at levels, which cause a concern, a more extensive evaluation may be performed based on a plant or animal bioassay. Appropriate plant or animal species are grown in either a flooded or dry soil condition using the appropriate experimental procedure and laboratory or field test apparatus (Folsom and Lee 1985; Simmers, Rhett, and Lee 1986; American Society for Testing and Materials (ASTM) 1997; USACE 2003). Contaminant uptake is then measured by chemical analysis of the biomass (tissue). Growth, phytotoxicity, and bioaccumulation of contaminants are monitored during the growth period in the case of the plant bioassay. An index species is also grown to serve as a mechanism to extrapolate the results to allow use of other databases, such as metals uptake by agricultural food crops. This indexing procedure provides information upon which a decision can be made

regarding potential for human health effects and for beneficial uses of the site or dredged material. Levels of contaminants in the biomass are compared with Federal criteria for food or forage. Risk assessment may also be performed to evaluate the potential effects of plant and animal uptake on sensitive species subject to primary or secondary exposure (Cura, Wickwire, and McArlde in preparation).

From the test results, appropriate management strategies can be formulated regarding where to place dredged material to minimize plant or animal uptake or how to control and manage the species on the site so that desirable species that do not take up and accumulate contaminants are allowed to colonize the site, while undesirable species are removed or eliminated.

5.3.8 Volatilization to Air

Contaminant transport from in situ sediment to air is a relatively slow process, because most contaminants must first be released to the water phase prior to reaching the air. Potential for volatilization should be evaluated in accordance with regulatory requirements of the Clean Air Act. Thibodeaux (1989) discusses volatilization of organic chemicals during dredging and disposal and identifies four locales where volatilization may occur:

- Dredged material exposed directly to air.
- Dredging site or other water area where suspended solids are elevated.
- Poned CDF with a quiescent, low-suspended solids concentration.
- Dredged material covered with vegetation.

In cases where highly contaminated sediments are disposed, airborne emissions must be considered to protect workers and others who could inhale contaminants released through this pathway.

Rate equations based on chemical vapor equilibrium concepts and transport phenomena fundamentals have been used to predict chemical flux (Thibodeaux 1989; Semmler 1990). Computerized programs have been developed utilizing these rate equations for the evaluation of volatile emissions from dredged material (Myers, Schroeder and Estes in preparation (b)). Since the original publication of this document, considerable effort has also been directed to testing procedures for direct measurement of volatile emissions (Price et al. 1997; Price et al. 1998; Price et al. 1999, USACE 2003).

Emission rates are primarily dependent on the chemical concentration at the source, the surface area of the source, and the degree to which the dredged material is in direct contact with the air. The magnitude of release from exposed dredged material is initially higher than for ponded conditions. This is of limited duration however. Volatilization from ponded areas occurs at a lower rate, but is continuous, and may result in a higher mass flux over time.

Effects associated with volatilization of contaminants are evaluated based on estimated exposure to selected receptors, and appropriate inhalation reference doses (Myers, Schroeder and Estes in preparation (b)). Risk assessment may also be employed in assessing the effects associated with exposure (Cura, Wickwire, and McArlde in preparation).

5.3.9 Particulate Transport

Airborne transport of particulates from the surface of a CDF is also potentially of concern. Exposure to contaminants may occur through inhalation of fine particles or from direct contact with or ingestion of particles re-deposited in areas off-site. Tools to quantify particulate transport are not well developed. Qualitative analysis of expected surface conditions may identify periods when particulate transport will be of concern; primarily when the material surface is dry, net precipitation is low, and prevailing winds are sufficient to effect transport. Vegetation or surface covers may provide effective control of particulate transport, although implementation may be logistically difficult due to the size of the areas involved and the limited weight bearing capacity of the material while it is still consolidating.

5.3.10 Need for Contaminant Controls

If the analysis of contaminant pathways and associated testing indicates that the standards or Guidelines, as appropriate, are met, the CDF alternative is environmentally acceptable from the standpoint of contaminant effects for that pathway. If the applicable standards or Guidelines are not met, contaminant control measures can be considered to reduce impacts to acceptable levels.

Control measures to minimize contaminant impacts may include operational modification, treatment, site controls (e.g., liners or covers), and other site management actions. These control measures are described in paragraph 5.4. If the control measures are determined to be effective, then the alternative is environmentally acceptable from the standpoint of contaminants. If there are no effective control measures for one or more pathways, then disposal at the CDF under consideration should be eliminated.

5.4 Evaluation of Management Actions and Contaminant Control Measures for CDFs

In cases where evaluations of direct physical impacts, site capacity, or contaminant pathways indicate impacts will be unacceptable when conventional CDF disposal techniques are used, management actions and contaminant control measures may be considered. It should be noted that a CDF is neither a conventional wastewater treatment facility nor a conventional solids-handling facility. The dredged materials placed in CDFs typically contain 10 to 50 percent solids; therefore, an effective CDF must incorporate features of both wastewater treatment and solids-handling facilities in a combination that is unlike either (Averett et al. 1990).

Descriptions of the commonly used management actions and contaminant controls are given in the following paragraphs. Additional guidance on selection of management actions and contaminant controls for CDFs is available (USACE 1983, 1987 and in preparation; Francingues et al. 1985; Cullinane et al. 1986; Averett et al. 1990). These references contain testing procedures and criteria needed for evaluating and selecting appropriate contaminant control measures for CDFs, and should be consulted for additional detailed discussions of the attributes of the various technologies.

Management actions may include managing or modifying the proposed placement operation, modification of the CDF design or geometry, treatment of effluent, runoff, or leachate discharges, and physical management such as covers, liners, or barrier systems (USACE 2003). Recent references relevant to application of management actions at CDFs include USEPA (1994); National Research Council (1997); Permanent International Association of Navigation Congresses (PIANC) (1996 and 2003); Palermo and Averett (2000).

5.4.1 Management Actions for Physical Impacts and Storage Capacity

A number of management techniques have been developed and used that can eliminate or minimize adverse direct physical impacts resulting from construction of CDFs. These include:

- Management of the CDF for dewatering the dredged material, thereby reducing the volume of material and reducing the need for larger or additional sites (USACE 1987).
- Treatment of effluent to remove additional solids and reduce turbidity of the discharge (USACE 1987).
- Implementation of Disposal Area Reuse Management involving removal of material from the CDF for some beneficial use, thereby restoring the capacity of the CDF (USACE 1987; Lee 1999; Olin-Estes and Palermo 2000a; Olin-Estes and Palermo 2000b; Olin-Estes 2000; Lee 2000; Spaine et al. 2001; Lee 2001; Olin-Estes et al. 2002b).
- Mitigation to include creation of alternative habitat and designated resource management onsite.
- Modification of site through landscaping and screening to improve site aesthetics and features to protect cultural resources.

5.4.2 Treatment of Liquid Streams

The objective of liquid streams controls is to remove residual contaminants from the liquids produced as discharges from a CDF operation such as:

- Effluent discharges from active filling operations.
- Surface runoff.
- Leachate.
- Water produced from dewatering or treatment processes.

Contaminants in these streams will present a wide array of concentrations depending on their source, and individual sources are often highly variable in concentrations and flows. Most of the contaminants for these streams (with the exception of leachate) are associated with the suspended solids and will be removed by effective suspended solids removal. Another characteristic of these streams is their variety of contaminants, both organic and inorganic, as well as potentially toxic contaminants. These characteristics may require more than one treatment process. Commonly used wastewater treatment processes are available to achieve effluent limits for most contaminants. However, application of treatment processes for dredged material effluent has been generally limited to removal of suspended solids and contaminants associated with these particulates.

Liquid treatment technologies can be classified as metals removal processes, organic treatment processes, and suspended solids removal processes. Many of these processes concentrate contaminants into another phase, which may require special treatment or disposal. This discussion focuses on suspended solids, toxic organics, and heavy metals. Conventional contaminants, such as nutrients, ammonia, oxygen-demanding materials, and oil and grease, may also be a concern for dredged material effluents. Most of the processes for dissolved organics removal are suitable for these contaminants.

5.4.2.1 Suspended Solids Removal

Suspended solids removal is the most important liquid streams technology because it offers the greatest benefits in improving effluent quality not only by reducing turbidity but also by removing particulate-associated contaminants. Suspended solids removal processes differ from dewatering processes because for this application the solids concentration is much lower than for a dredged material slurry. Settling mechanisms for these streams are characterized by flocculent settling rather than zone or compression settling. For CDF liquid streams, the solids remaining will be clay or colloidal size material that may require flocculants to promote further settling in clarifiers or sedimentation ponds. Chemical clarification using organic polyelectrolytes is a proven technology for CDF effluents (Schroeder 1983). Filtration, permeable dikes, sand-filled weirs, and wetlands have also been used on occasion for CDF demonstrations or pilot evaluations. More detailed guidance on suspended solids removal processes as applied to CDFs is available (USACE 1987; Cullinane et al. 1986).

5.4.2.2 Metals Removal

Metals removal processes that may be considered for application at CDFs are similar to those commonly used for industrial applications. Flocculation is effective for removal of metals associated with particulate matter. Polymers and inorganic flocculants have been demonstrated to be effective for removal of suspended solids from dredging effluents, but removal of dissolved heavy metals has not been evaluated in field applications. Ion exchange and precipitation are probably two of the more efficient metals removal processes, but they must generally be designed for specific metals and

often require major investments in operational control for efficient operation. Natural ion-exchange media, such as zeolites, may be effective but have not been demonstrated in this application. Use of man-made wetlands for retention of heavy metals and other contaminants from effluents could represent a viable option for certain sites and contaminants (Fennessy and Mitsch 1989). Less likely choices include biological ion exchange, electrocoagulation, and ultrafiltration. More detailed guidance on metals treatment processes as applied to CDFs is available (Cullinane et al. 1986; Averett et al. 1990).

5.4.2.3 Organics Treatment

The applicability and effectiveness of options for treatment of dissolved organic contaminants are mostly dependent on the concentration and flow of the liquid stream. Mechanical biological wastewater treatment processes are typically not considered because it is doubtful that sufficient organic matter would be available to support biological growth and because operation of biological systems under the conditions of fluctuating flows and temperatures would be difficult. Biological processes such as nitrification, nutrient catabolism, and photosynthesis are important degradation mechanisms for nutrients, oxygen-demanding materials, and other organics in CDFs. The principal process for dissolved refractory organic contaminants that has been applied to dredged material effluent is carbon adsorption, which was applied to a PCB spill on the Duwamish Waterway in the 1970s (Blazevich et al. 1977). Air and steam stripping could be used for volatile contaminants, but these are generally not a problem for contaminants originating in most dredged sediments. Ultraviolet light (UV) and chemical oxidation processes offer destruction of organic contaminants and are being extensively investigated in the field for a wide range of contaminants. Created wetlands also offer potential for retention and degradation of organics. The more effective organic treatment process options are:

- Carbon adsorption.
- Chemical oxidation using ozone.
- UV/hydrogen peroxide.
- UV/ozone.
- Oil separation.
- Resin adsorption.
- Steam stripping.
- Created wetlands.

More detailed guidance on organics treatment processes as applied to CDFs is available (Cullinane et al. 1986; Averett et al. 1990; USACE 1983 and USACE in preparation).

5.4.3 Site Controls

Site controls (e.g., surface covers and liners) can be effective control measures applied at a CDF to prevent migration of contaminants from the dredged material (Cullinane et al. 1986; Averett et al. 1990). The implementability and effectiveness of

these controls is highly specific to the CDF location and the dredged material characteristics.

Use of site controls such as liners, slurry walls, groundwater pumping, and subsurface drainage are limited in most nearshore, in-water CDFs. Graded stone dikes with sand or steel sheet pile cutoffs have been used or proposed at upland CDFs and a few in-water CDFs to control leachate migration. The low permeability of fine-grained sediments following compaction can reduce the need for liners in many cases, but it can also limit the effectiveness and implementability of groundwater pumping and subsurface drainage controls.

A cover can be highly effective in reducing leachate generation by avoiding rainfall infiltration, isolation from bioturbation and uptake by plants and animals, minimizing volatilization of contaminants from the surface, and eliminating detachment and transport of contaminants by rainfall and runoff. A layer of clean material can achieve the last three benefits mentioned. However, prevention of infiltration requires a barrier of very low permeability, such as a flexible membrane or a compacted clay layer, both of which are not easily or reliably implemented for CDFs. Other leachate control measures include groundwater pumping, liners, subsurface drainage, sheet pile walls, slurry walls, and surface drainage. Liners have not been used extensively for contaminated dredged material sites because of the inherent low permeability of fine-grained dredged material, the retention of contaminants on solids, and the difficulty and expense of construction of a reliable liner system for wet dredged material, particularly for in-water or nearshore sites. Leachate collection techniques, such as groundwater pumping and subsurface drainage, have been evaluated in a limited number of situations, but these techniques appear to have limited feasibility for in-water sites. Sheet pile walls and slurry walls can be used to provide barriers to leachate and seepage movement from a CDF. To be effective, the barrier should tie to a geologic formation with very low permeability. Sheet pile walls are not leakproof and deteriorate over time; therefore, they should not be considered as a primary containment measure. More detailed guidance on site controls for CDFs is available (Cullinane et al. 1986; Averett et al. 1990; USACE 1983 and USACE in preparation).

5.4.4 Treatment of Dredged Material Solids

Treatment of the dredged material might be considered if this would facilitate beneficial use of the material, or provide a cost effective alternative to treatment of the various discharges from a CDF. A variety of treatment processes have been proposed for dredged material solids (i.e., the mass of dredged material following placement within a CDF) or dredged material slurries. These processes fall under one of the following categories: bioremediation (use of bacteria, fungi, or enzymes to break down organic contaminants), chemical treatment (e.g., oxidation, reduction, chelation, hydrolysis, detoxification, nucleophilic substitution, and thionation processes), extraction (removal of contaminants by dissolution in fluid), thermal (e.g., incineration), immobilization (processes which limit the mobility of contaminants) and volume reduction (physical separation of contaminated fractions).

Some of these treatment processes have been applied in pilot-scale demonstrations, and some have been applied full scale (Myers and Bowman 1999; Myers, Bowman, and Myers 2003; Olin-Estes et al. 2002a; USACE Los Angeles District 2002; USEPA 1999; Tetra Tech and Averett 1994). Recent work on phytoremediation of lead contaminated sediments can be found in Lee and Price (2003). Potential for biotreatment or phytoremediation of contaminated sediments is discussed in the following references (Price and Lee 1999; Fredrickson et al. 1999; Price, Lee and Simmers 1999; Myers and Williford 2000).

The cost of treatment alternatives relative to the cost of conventional disposal is a major constraint on their potential use. The potential for implementation of immobilization processes is better than other treatment processes, because they are not as sensitive to process-control conditions, and they are relatively cost effective techniques for reducing contaminant mobility. The opportunity for applying these processes in situ in a CDF is also an advantage.

The environmental pathway most affected by immobilization processes is transport of contaminants as leachate to the groundwater or surface water. Most of the immobilization processes fall into the category of solidification/stabilization (S/S). Objectives of S/S are generally to improve the handling and physical characteristics of the material, decrease the surface area of the sediment mass across which transfer or loss of contaminants can occur, and/or limit the solubility of contaminants by pH adjustment or sorption phenomena. Effectiveness of S/S processes is usually evaluated in terms of reduction of leaching potential. Reductions are process and contaminant specific, with immobilization of some contaminants accompanied by increased mobility of other contaminants.

5.4.5 Site Operations

Site operations can be used as a control measure for CDFs to reduce the exposure of material through the surface water, volatilization, and groundwater pathways. Operational controls may include management of the site pond during and after disposal operations. Mobilization of contaminants from dredged material depends on the oxidation state of the solids. Most metals are much less mobile when maintained in an anaerobic reduced condition. On the other hand, aerobic sediments generally improve conditions for biodegradation of organic contaminants. Maintaining ponded water on the site may decrease the rate at which volatilization occurs (though not necessarily the overall mass flux) but produces a hydraulic gradient that increases the potential for movement of leachate through the site. Whether to cultivate or inhibit plant and animal propagation is also an issue. Management of the site both during filling and after disposal requires a comprehensive understanding of the migration pathways and the effects various contaminant controls have on the overall mass balance and rate of contaminant releases. The decision to apply certain management options requires trade-offs for the site and contaminant-specific conditions for the project.

5.5 Retention of Environmentally Acceptable Confined Alternatives

Once appropriate confined-disposal tests and assessments are complete, a determination of environmental acceptability can be made. This determination must ensure that all applicable standards or criteria are met. If control measures were considered, a determination of the effectiveness of the control measures in meeting the standards or criteria must be made. If all standards or criteria are met, the confined-disposal alternative can be considered environmentally acceptable. At this point, other factors can be considered in the selection of an alternative as described in paragraph 3.6 and Chapter 7.

6.0 ASSESSMENT OF BENEFICIAL USE ALTERNATIVES

This chapter contains descriptions of various beneficial uses of dredged material and assessment procedures for beneficial use alternatives. The framework for assessments for beneficial uses is illustrated in Flowchart 3-4. The detailed assessments described in this chapter may be performed following a determination of the need for such assessments as described in Chapter 3.

6.1 Beneficial Use as an Alternative

Dredged material is a manageable, valuable soil resource, with beneficial uses of such importance that plans for the ultimate use of disposal sites should be incorporated into project plans and goals at the project's inception to the maximum extent possible. It is the policy of the USACE to fully consider all aspects of dredging and disposal operations with a view toward maximizing public benefits. Integral to this analysis is a requirement to provide full and equal consideration to all practicable alternatives, including beneficial uses of dredged material (see for example 33 CFR 337.9).

Whenever the dredging cycle and beneficial use needs have been found to coincide, beneficial use of dredged material has been considered as a management option. In many cases, beneficial use of dredged material has been identified as the preferred alternative. Unexpected new beneficial use needs may periodically arise (e.g., severe beach erosion from severe storms) and other factors such as development of more cost-effective dredging technologies may from time to time dictate a reevaluation of beneficial use options.

Authorities and constraints related to the beneficial use of dredged material are in a state of change. Provisions in the Water Resources Development Act of 1990 have now assigned to the USACE new authorities to pursue high-priority Fish and Wildlife Restoration projects where such projects can most efficiently or appropriately be accomplished in conjunction with existing or planned navigation projects. In addition, this legislation has assigned such projects equal mission status with navigation and flood control projects of the USACE. Thus, future beneficial use applications may, on a case-by-case basis, be either the preferred alternative for a navigation project, a cost-shared (ranging from 25 to 100 percent total local funding) action undertaken in association with the navigation project, or a separate, cost-shared project undertaken within the navigation project boundaries.

6.2 Identification of Beneficial Use Needs and Opportunities

The first step in assessment of beneficial use alternatives is to identify the local needs and opportunities for beneficial use. This may involve surveys of activities which may need material with certain characteristics or surveys of needs for certain site uses. Likewise, if the dredged material from a project is known to have desirable characteristics for a number of beneficial uses, then a survey of potential opportunities for use of that material or specific placement sites should be made. A general description of the major categories of beneficial use is given in the following paragraphs. Each of these categories should be considered in identifying needs and opportunities for beneficial use for the specific project conditions. Additional details on each of the categories are found in EM 1110-2-5026 (USACE 1986).

6.2.1 Habitat Restoration/Enhancement

Habitat development refers to the establishment and management of relatively permanent and biologically productive plant and animal habitats. Use of dredged material as the substrate for habitat development is one of the most common and most important beneficial use categories. The use of dredged material for habitat development offers a disposal technique that is an attractive and feasible alternative to more conventional disposal options. Within various habitats, several distinct biological communities may occur. For example, the development of a dredged material island may involve a wide variety of wetland, upland, island, and aquatic habitats.

Wetland habitat is a broad category of periodically inundated communities, characterized by vegetation which survives in wet soils. These are most commonly tidal freshwater and saltwater marshes, bottomland hardwoods, freshwater swamps, and freshwater riverine and lake habitats. Disposal of dredged material on a viable wetland so that the wetland is destroyed and converted into a disposal site is never an environmentally preferable alternative. However, restoration/enhancement of wetlands is an alternative that can benefit the environment and has the potential of gaining wide public acceptance when some other techniques cannot. In general, restoration of a former wetland is more likely to be successful than creation of a new wetland where none had existed previously (Kusler and Kentula 1990). In selecting a site, alteration of substrate and changes in circulation and sedimentation patterns should be considered. In general, the material used for wetland restoration should remain water-saturated, reduced, and near neutral in pH. These characteristics have a great influence on the environmental activity of any chemical contaminants which may be present. Extensive discussion on and procedures regarding development of wetland sites can be found in Hayes et al. (2000).

Upland habitat includes a broad category of terrestrial communities, characterized by vegetation that is not normally subject to inundation. Types may range from bare ground to mature forest. Regardless of the condition or location of a disposal area, considerable potential exists to convert it into a more productive habitat. Small sites in densely populated areas may be keyed to small animals adapted to urban life, such as

seed-eating birds and small mammals. Larger tracts may be managed for a variety of wildlife including waterfowl, game mammals, and rare or endangered species. The knowledge that a disposal site will ultimately be developed into a useful area, be it a residential area, a park, or wildlife habitat, improves public acceptance of the dredged material disposal alternative.

Many island habitats have been created by placement of dredged material, varying in size and characteristics and ranging in age from newly formed to those estimated to be 50 years old. The primary wildlife species utilizing dredged material islands as part of their life requirements are species of colonial-nesting waterbirds. Natural islands have been altered and developed to such a large extent that some areas no longer have coastal islands that are still suitable wildlife habitat. Dredged material islands have provided this vital habitat in many areas.

Aquatic habitats are typical submerged habitats extending from near sea, river, or lake level down several feet. Aquatic habitat development is the establishment of biological communities on dredged material placed at or below mean tide in coastal areas and in permanent water in lakes and rivers. Potential developments include such communities as tidal flats, seagrass meadows, oyster beds, clam flats, fishing reefs, and freshwater aquatic plant establishment. The bottom of many water bodies potentially could be altered using dredged material; this could simultaneously improve the characteristics of the site for selected aquatic species.

6.2.2 Beach Nourishment

Shore erosion is a major problem along many ocean and estuary beaches and the shoreline of the Great Lakes. Beach nourishment is usually accomplished by dredging sand from inshore or offshore locations and transporting the sand by truck, by split-hull hopper dredge, or by hydraulic pipeline to an eroding beach. These operations may result in displacement of the substrate, changes in the topography or bathymetry of the borrow and replenishment areas, and destruction of nonmotile benthic communities. However, a well-planned beach nourishment operation can minimize these effects by taking advantage of the resiliency of the beach and nearshore environment and its associated biota, and by avoiding sensitive resources. When dredged material is used for beach nourishment, it should closely match the sediment composition of the eroding beach and be low in fine sediments, organic material, and pollutants. Beach nourishment and protection can also be accomplished by placement of dredged material mounds or berms on the bottom, where much of the material would be carried by wave action to the beach.

6.2.3 Aquaculture/Mariculture

Because of the increasing difficulty and expense of obtaining CDFs for use as single purpose disposal areas, the development of a multiple-use strategy such as aquaculture or mariculture is desirable. Dredged material containment sites commonly possess structural features such as dikes and water control devices that may enhance their suitability as aquaculture areas. It is possible that future site availability would be

improved by increased value of acreage leased to dredging project sponsors because land-owners could enter separate and profitable lease agreements with aquaculturists. See also section 6.2.1.

6.2.4 Parks and Recreation

Of all types of beneficial uses, recreation on dredged material containment sites is one of the most prevalent land uses in terms of actual acres. It is not surprising to find many examples of such use since there is such a demand for recreational sites in urban areas where much dredging occurs. The nature of recreation sites with requirements for open space and lightweight structures is especially suited to the weak foundation conditions associated with fine-grained dredged material. Recreational land also is generally for public use, and high demand for public water-oriented recreation encourages the development of recreational land use projects on dredged material. Finally, legislation relating to wetlands, coastal zone management, and flood control is biased in favor of this type of use. The recreational land use of dredged material containment sites is one of the more promising and implementable beneficial uses of dredged material, but is heavily dependent on financial backing at the local level.

6.2.5 Agriculture, Horticulture, and Forestry

Broad use of dredged material disposal sites has been made by the agriculture, forestry, and horticulture industries. Some disposal sites, especially in river systems, have provided livestock pastures following seeding or even natural colonization. Other uses involve actively incorporating dredged material into marginal soils. An attractive alternative for disposing of dredged material is to use this rich material to amend marginal soils for agriculture, forestry, and horticulture purposes. By the addition of dredged material, the physical and chemical characteristics of a marginal soil can be altered to such an extent that water and nutrients become more available for crop growth. In some cases, raising the elevation of the soil surface with a cover of dredged material may improve surface drainage and reduce flooding, thereby lengthening the growing season.

6.2.6 Strip Mine Reclamation and Landfill Cover for Solid Waste

Two beneficial uses of dredged material that are still fairly new concepts have proven to be feasible in laboratory and field tests. These are the reclamation of abandoned strip mine sites that are too acidic for standard reclamation practices and the covering of solid waste landfills. Both uses would require large quantities of dewatered dredged material that could be moderately contaminated and still be acceptable. Both uses would ultimately provide nonconsumptive vegetative cover to unsightly areas, and the areas could be further reclaimed for minimal-use recreation sites and/or wildlife habitat.

6.2.7 Industrial/Commercial Development

Industrial/commercial development near waterways can be aided by the availability of hydraulic fill material from nearby dredging activities. The use of dredged material to expand or enhance port-related facilities has generally received local support because of the readily apparent potential benefits to the local economy. Approval of the disposal operation is generally predicated on the advancement of the port development project and not on the incidental need for proper disposal of the dredged sediments. Use of dredged material to reclaim former industrial sites (brownfields) for other uses has also been considered in some areas.

6.2.8 Material Transfer for Fill

Dredged material is commonly used in construction of dikes, levees, and CDFs. Dredged material, pumped on site and dewatered, readily lends itself to these uses. By using dredged material to build or increase capacity in CDFs, or for dikes and levees, overall project costs may be reduced by not having to use off-site material for these purposes. Some local and state agency and private use is made of dredged material for dikes and levees in certain situations such as for erosion and flood protection. Thousands of cubic yards of dredged material have been dewatered in holding areas, then provided to public or private interests for fill material. Often, the material is provided free of charge to make room in disposal sites for subsequent disposal.

6.2.9 Multipurpose Uses and Other Land-Use Concepts

With careful engineering design, construction, long-term coordination and planning, and proper implementation of operational and maintenance procedures, a disposal site having combinations of uses may be developed. A park and recreational development built over an existing solid waste landfill using dredged material as a cover is an example of how several of the beneficial uses discussed in the preceding sections can be lumped into a multipurpose project. There are a number of actual and planned examples of multipurpose sites. Often, multipurpose objectives do not involve substantial cost increases to the dredging project when plans are made in the initial phases of design and construction. Frequently, recreational use and wildlife and fish habitat can be developed simultaneously on a disposal site. Potential problems with development of multipurpose projects are usually related to conflicting user groups of the proposed disposal/development site. Careful selection of compatible potential users can avoid situations where the projected uses conflict.

6.3 Evaluate Physical Suitability of Material

Basic data on physical characteristics of the sediments to be dredged (see section 3.5.2) can often serve as an effective initial screen to determine if proposed beneficial use options as identified above are sufficiently feasible to warrant more detailed evaluations. Grain-size compatibility with the intended beneficial use is often a major consideration. In most cases, clean, coarse-grained sediments (sands) are suitable for a wide range of

beneficial uses. However, fine-grained sediments are also suitable for some beneficial uses, such as wetland habitat development, soil creation and improvement and construction blocks. Testing procedures to determine the suitability of dredged material for beneficial uses is provided in Winfield and Lee (1999). Dredged material that is contaminated may be useful for beneficial uses if some treatment is applied to reduce contamination. Low-cost treatment alternatives include bioremediation and phytoremediation. Procedures for determining the suitability of dredged material for these remediation alternatives are provided by Fredrickson et al. (1999) and Price and Lee (1999).

6.4 Logistical Considerations for Beneficial Use

A number of procedural and logistic factors can also greatly influence the feasibility of specific beneficial use proposals. Examples of logistic considerations include: distance of the proposed beneficial use site from the dredging project; site accessibility; required equipment to dredge the channel (e.g., hopper dredge in high-energy approach channels) versus equipment required to efficiently transport the material to the site (e.g., quite often a pipeline dredge); material rehandling requirements; size of project versus intended beneficial use and size of disposal site (e.g., a 30-in. dredge required to efficiently move large volumes of shoal material may very quickly overwhelm a small wetland restoration site); and timing of the beneficial use need (e.g., beach nourishment) versus maintenance dredging needs.

Less understood, but perhaps one of the greatest potential constraints to many potential beneficial use proposals is what may collectively be termed real estate considerations. These include state, county, and local land-use zoning laws (which can be extremely variable and complex); issues of ownership of the material (e.g., Submerged Lands Act); whether disposal sites are fee-owned or disposal is through easements; and the closely related issue of sponsor requirements for acquiring and managing disposal sites as contained in the project-specific authorizing legislation. A typical example would be disposal sites acquired through easement by the project sponsor under his assigned responsibility within the authorizing project legislation. Ownership of the material may well reside with the landowner, not the Federal government or project sponsor, which could eliminate further consideration of that site for certain beneficial uses. In some cases, such constraints might be overcome if the sponsored landowners are willing to renegotiate the real estate agreements. In other cases, however, specific Federal and/or state/local legislation would be required to overcome such constraints.

6.5 Determination of Environmental Suitability

Generally speaking, highly contaminated sediments will not normally be suitable for most proposed beneficial uses and particularly for proposed habitat creation/restoration projects. Conversely, if the material is exempt from testing (e.g., 40 CFR 230.60) or testing indicates the material is suitable for open-water disposal, that material would likely be deemed suitable for a wide range of beneficial use applications from the standpoint of contamination. Most beneficial uses involve either open-water or

confined placement as an integral part of the application or an initial step in developing the application. Therefore, the testing and assessment procedures as well as compliance with the overall 404 Guidelines themselves, must also be considered for beneficial uses (see Chapters 4 and 5).

There is considerable interest in removing dredged material from confined placement and using the material as a resource for construction material or topsoil to restore capacity of existing CDFs. Many dredged materials currently contained in CDFs will support desirable vegetation with little input other than fertilizer. Efforts to alter undesirable dredged material characteristics by adding organic materials such as yard litter (leaves, grass and tree trimmings) animal manures or other biosolids can provide characteristics necessary to produce soil material for containerized plants, bedding plants and turf grass. With local support to provide materials that are normally considered waste (yard litter and biosolids), valuable soil materials can be produced for use in local projects such as brownfield redevelopment, road construction, parks and recreation fields. Since the purpose of most CDFs is to contain contaminated materials, the issue of reuse poses some question as to the suitability of the material for beneficial uses outside the CDF and there is currently no clear guidance specifically addressing suitability of dredged material for beneficial uses. Some states have set standards for contaminants in industrial waste materials and have included dredged material in that category. Other criteria may be applicable, such as Ecological Soil Screening Levels or USEPA 503 Regulations for the application of biosolids, but the criteria for suitability will be determined by the State or local authority where the dredged material will be used. The Great Lakes Upland Testing and Evaluation for Beneficial Use project is an interagency effort to compile existing guidance, criteria, testing recommendations and case studies to facilitate consensus building in the regulatory and scientific communities for beneficial use of dredged material. A briefing paper that also includes an extensive annotated bibliography with references relevant to beneficial use of dredged material has been published by the working group (Great Lakes Commission 2004).

For ongoing activities, periodic reevaluations are advisable to ensure that the conditions regarding sediment contaminants have not changed since the last dredging cycle. For new applications and particularly for habitat development applications, it will, at times, be advisable (depending on the nature and source of the dredged material) to conduct limited plant and/or animal bioassays to ensure that the material will not be harmful to the target species. Examples of such situations may be when highly saline material is to be used in a brackish or freshwater habitat development project, or if the material is to be used for upland habitat development or portions of the site will be emergent. In some cases, chloride and/or heavy metal toxicity may or may not be problematic but should be sufficiently evaluated for this potential.

6.6 Retention of Environmentally Acceptable Beneficial Use Alternatives

Once appropriate assessments are complete, a determination of environmental acceptability can be made. This determination must ensure that all applicable standards or criteria are met. If control measures were considered, a determination of the effectiveness

of the control measure in meeting the standards or criteria must be made. If all standards or criteria are met, the beneficial use alternative can be considered environmentally acceptable. At this point, other factors can be considered in the selection of an alternative as discussed in paragraph 3.6 and Chapter 7.

7.0 ALTERNATIVE SELECTION

Chapters 3 through 6 provide an objective framework for evaluating the environmental acceptability of various management alternatives. In most cases, these evaluations may result in one or more open-water, confined, or beneficial use alternatives that clearly meet all applicable environmental standards and criteria and are, therefore, environmentally acceptable. This chapter describes the alternative selection process. As shown in Flowchart 3-1, the alternative selection process includes evaluation of socio-economic, technical, management, and other environmental considerations, selection of a preferred alternative, and appropriate environmental coordination and documentation.

7.1 Evaluation of Socioeconomic, Technical, and Other Applicable Environmental Considerations

Over 30 major environmental statutes, Executive orders, and government regulations exist that may, on a case-by-case basis, govern the manner in which dredged material is managed and/or disposed. The major statutes are discussed in more detail in Appendix B; however, procedures for meeting the requirements of these statutes are beyond the scope of this document. While the intent of the statutes and this management framework is to afford maximum environmental protection to each specific environmental resource at potential risk, this must be pursued within the broader context of overall environmental protection.

A final decision on the alternative or alternatives selected for a specific navigation project or permit activity often requires weighing and balancing a much broader set of relevant environmental, engineering, and economic factors. An in-depth discussion of these broader decision-making principles is beyond the scope of this document, and the reader is referred to applicable USACE regulations (33 CFR 320-330; 33 CFR 335-338; ER 1105-2-100) for further guidance and information on procedures used by the USACE in its required public interest analysis. However, several of these decision-making concepts and considerations are particularly relevant to this document and to considerations under NEPA, CWA, and MPRSA, and warrant a limited discussion.

7.1.1 Authorized Project Purposes

Navigation project status (i.e., new work or maintenance) may often influence the range of available management alternatives for dredged material. For projects in the planning stage (either new projects or projects undergoing reformulation studies), USACE policy is to maximize public benefits associated with the project. This is accomplished through the development of a NED plan and is derived through an incremental analysis of appropriate benefits versus costs. A wide range of potential environmental benefits (e.g., beneficial use of dredged material, the environmentally

preferred alternative(s)) may be pursued in such studies, assuming that they can be incrementally justified, and, in turn, approved and authorized by Congress.

For existing projects requiring periodic maintenance, project benefits/purposes have previously been established by Congress. With few exceptions, the USACE cannot unilaterally change or add to these project-specific purposes and benefits. As such, USACE policy is to maintain these established project purposes(s) and benefits in the least-cost and environmentally acceptable manner. As discussed in Chapter 1, compliance with the MPRSA Criteria and/or CWA Section 404(b)(1) Guidelines is a major factor in arriving at a decision of "environmental acceptability."

7.1.2 Environmentally Preferred Alternative(s)

Technically, no one management option can be considered a panacea for dredged material nor can it be ruled out a priori in project-specific evaluations other than for sound economic, environmental, or engineering reasons. Thus, unless specifically prohibited by Federal environmental statute, the intention of this document is to encourage full and balanced consideration of all practicable alternatives for the management of dredged material.

CEQ NEPA regulations (40 CFR 1505.2) require that the Record of Decision (ROD) for an EIS specifically identify, where applicable, the alternative or alternatives that were considered to be environmentally preferable. These regulations further require the ROD to identify and discuss relevant economic and technical issues and agency statutory missions, including any essential considerations of national policy that were balanced by the agency in making its alternative(s) selection. All other factors being equal, the environmentally preferable alternative should also be the preferred/recommended alternative.

Unfortunately, hard and fast guidelines for identifying the alternative that is preferable from an environmental standpoint would be difficult to develop and apply. Such guidelines would require objective criteria or standards for comparing environmental impacts and/or the value of resources in aquatic, upland, and wetland environments. In some cases, such environmental impacts/benefits can be quantified (e.g., impacts to commercially important shellfish beds). In many other cases, however, the relative environmental costs of adverse impacts and the relative environmental value of resources and environmental enhancements in various environments are largely subjective.

Subjective comparison between alternatives found to be environmentally acceptable is possible. Further, it is likely that one alternative would be clearly preferable from an environmental standpoint. Environmental preferability may be based on lesser adverse impacts or on greater environmental benefits, perhaps in the form of beneficial use of dredged material. For example, if a clean sand is to be dredged, beach nourishment is clearly an environmentally preferable alternative as compared with open-water or confined disposal, assuming that there are beach nourishment needs. Or, if

noncontaminated, fine-grained material is to be dredged, the creation of wetlands or other beneficial use is clearly an environmentally preferable alternative as compared with open-water or confined disposal, assuming that the beneficial use need is demonstrated.

Such comparisons will necessarily be qualitative even though many characteristics of the dredged material and the disposal site are measured quantitatively. The process depends heavily on professional judgment and subjective evaluation rather than on strict adherence to numerical calculations.

7.1.3 Alternative Selection

In assessing suitable alternatives for dredged material disposal, both the MPRSA and CWA specifically recognize that a balance must at times be struck between critical navigation and environmental protection.

Section 404(b)(2) of the CWA requires appropriate balancing of established environmental guidelines with the economic impacts, to navigation and anchorage of not allowing the proposed disposal to proceed. The baseline for this analysis is that disposal must not result in unacceptable adverse impact to the environment (Section 404(c)).

Section 103(b) of the MPRSA requires the USACE to determine the need for ocean disposal based on USEPA's established environmental criteria as well as on an evaluation of the impact of permit denial on critical navigation and related economic considerations. The baseline for this analysis is that the disposal must not result in unreasonable environmental degradation or endangerment to human health (Section 103 (a)).

In practice, however, this level of decision making has generally been found to be a "worst case" situation (i.e., the economic waiver provision of Section 103(d) of the MPRSA has never been formally invoked). For Federal navigation projects, USACE standard policy is to select the least-cost, environmentally acceptable alternative. Compliance with the MPRSA and/or CWA Section 404(b)(1) Guidelines is prerequisite to a USACE determination of an "environmentally acceptable" management alternative for dredged material.

7.2 Environmental Coordination/Documentation/Recommended Alternative

The weighing and balancing of all environmental, technical, and economic factors will result in selection of the preferred/proposed alternative by the lead agency. Coordination and environmental documentation associated with alternative selection is illustrated in Flowchart 3-1.

Documentation of this recommended plan occurs formally in either a draft NEPA document (along with alternatives) or a Section 404 or 103 Public Notice. These documents are available to the public and concerned agencies for review and comment. In some instances, circulation of Public Notices and the NEPA document may occur

simultaneously, although this is unusual. The draft NEPA document, as well as public and agency comments used in making that selection, is circulated prior to the selection of a recommended alternative. Specific evaluations of the 404(b)(1) Guidelines and the 103 Criteria must be made and are typically prepared as appendices to the NEPA document and circulated concurrently. For construction projects, this process may take place months or years before actual project construction begins. In such cases, another Public Notice is often issued immediately prior to when the actual dredging and disposal are to begin to ensure appropriate coordination.

USEPA's environmental review program is conducted pursuant to Section 102(2)(c) of NEPA and Section 309 of the Clean Air Act. These laws establish USEPA's responsibility to review and comment upon the "environmental impact of any matter relating to USEPA's duties and responsibilities." Under this authority, USEPA may choose to review and comment on EISs, EAs, and other proposed Federal actions. USEPA comments on NEPA documents are advisory, but by USACE policy are given great weight. In cases where USEPA and the USACE cannot resolve differences, the dispute may be referred by USEPA to CEQ.

Section 309 of the Clean Air Act also establishes that when the Administrator determines that any legislation proposed by a federal agency, action or regulation falling under the purview of the Administrator's review responsibilities is "unsatisfactory from the standpoint of public health or welfare or environmental quality, he shall publish his determination and the matter shall be referred to the Council on Environmental Quality."

Under CWA and MPRSA, Public Notices are the formal mechanism by which USEPA concurs or does not concur with a recommended action, whether it is a proposed permit or USACE activity. In addition, under the CWA, a 404(q) elevation and/or a 404(c) veto of a permit may be undertaken by USEPA if differences between the agencies cannot be resolved at an earlier stage. Under the MPRSA, if USEPA determines that the Criteria are not met, the proposed action cannot proceed unless a waiver is granted by USEPA.

NEPA review staff and CWA and/or MPRSA program staff are separate offices in some USEPA regions; therefore, care should be taken to ensure that NEPA documents, when prepared, are furnished to the appropriate program office for review as well as to the NEPA review office. Within USEPA, NEPA reviewers and 404/103 staff also should be coordinating closely. Often, the NEPA evaluation of the overall project may be adequate, but program-specific information (e.g., sediment testing results and site monitoring results) may need updating. Such updates may be accomplished by an EA and Finding of No Significant Impact (FONSI) and/or by revision of the 404(b)(1) or 103 evaluation, rather than reopening the original EIS. It is recommended that these revisions always be coordinated with USEPA.

7.3 Final Decision Document

The completion of the NEPA process is documented in two ways depending upon the determination of significance of impacts associated with the proposed activity. The FONSI is prepared when an EA determines that preparation of an EIS is unnecessary. The FONSI is the environmental decision document. In addition, a Statement of Findings (SOF) is typically prepared upon completion of the evaluation process, including required coordination, receipt or waiver of required certifications, and completion of appropriate environmental documentation (e.g., the EA/FONSI and 404/103 evaluations). When an EIS is prepared, a ROD is prepared which specifies the entire recommended action, alternatives considered, and any comments that were received on the final EIS. The ROD, not the final EIS, is the decision document. Typically the ROD is prepared in lieu of the SOF, provided that the substantial parts of 33 CFR 337.6 are included in the ROD. These documents are signed at various levels within the USACE structure and allow the USACE to proceed with the proposed action. Preparation of the FONSI, ROD, and SOF (if appropriate) typically occur after USEPA has provided comments on draft and/or final documents. Copies of the FONSI and/or ROD should routinely be provided to the USEPA NEPA review office as well as CWA/MPRSA program office.

The Public Notice also provides the formal opportunity for USEPA to exercise its statutory environmental oversight under the CWA and MPRSA. Because of shared enforcement responsibilities under the CWA and MPRSA between the USACE and USEPA, coordinating permit conditions or management restrictions is a good practice. Each USACE District and USEPA region should have acceptable arrangements and practices that do not burden or delay the process.

8.0 REFERENCES

- American Society for Testing and Materials (ASTM). 1997. "Standard guide for conducting laboratory soil toxicity or bioaccumulation tests with the lumbriced earthworm *eisenia fetida*," ASTM SE-1676, West Conshohocken, PA.
- Averett, Daniel E., Perry, Bret D., Torrey, Elizabeth J., and Miller, Jan A. 1990. "Review of Removal, Containment, and Treatment Technologies for Remediation of Contaminated Sediment in the Great Lakes," Miscellaneous Paper EL-90-25, U.S. Army Engineer Waterways Experiment Station, Vicksburg, MS.
- Aziz, N. M., and Schroeder, P. R. 1999a. "Documentation of the Hydrologic Evaluation of Leachate Production and Quality (HELPQ) Module," Dredging Research Technical Note EEDP-06-20, U.S. Army Engineer Waterways Experiment Station, Vicksburg, MS.
- Aziz, N. M., and Schroeder, P. R. 1999b. "ADDAMS Application: Hydrologic Evaluation of Leachate Production and Quality (HELPQ) Module in CDFs," Dredging Research Technical Note EEDP-06-21, U.S. Army Engineer Waterways Experiment Station, Vicksburg, MS.
- Barnard, W. D., and Hand, T. D. 1978. "Treatment of Contaminated Dredged Material," Technical Report DS-78-14, U.S. Army Engineer Waterways Experiment Station, Vicksburg, MS.
- Blazevich, J. N., Gahler, A. R., Vasconcelos, G. J., Rieck, R. H., and Pope, S. V. W. 1977. "Monitoring of Trace Constituents During PCB Recovery Dredging Operations Duwamish Waterways," EPA Report 910/9-77-039 August 1977, USEPA Region X, Seattle, WA.
- Brandon, D. L., Schroeder, P. R., and Lee, C. R. 1997a. "Computerization of the Decision-making Framework: Effluent Toxicity Bioassay Test Results (LAT-E Program)," *Environmental Effects of Dredging Technical Notes* EEDP-04-27, U.S. Army Engineer Waterways Experiment Station, Vicksburg, MS.
- Brandon, D. L., Schroeder, P. R., and Lee, C. R. 1997b. "Computerization of the Decision-making Framework: Runoff Toxicity Bioassay Test Results (LAT-R Program)," *Environmental Effects of Dredging Technical Notes* EEDP-04-28, U.S. Army Engineer Waterways Experiment Station, Vicksburg, MS.
- Brannon, J. M., Myers, T. E., and Tardy, B. A. 1994. "Leachate Testing and Evaluation for Freshwater Sediments," Miscellaneous Paper D-94-1, U.S. Army Engineer Waterways Experiment Station, Vicksburg, MS.

- Brannon, J. M., Pennington, J. C., Gunnison, D., and Myers, T. E. 1990. "Comprehensive Analysis of Migration Pathways (CAMP): Contaminant Migration Pathways at Confined Dredged Material Disposal Facilities," Miscellaneous Paper D-90-5, U.S. Army Engineer Waterways Experiment Station, Vicksburg, MS.
- Cullinane, M. J., Averett, D. E., Shafer, R. A., Male, J. W., Truitt, C. L., and Bradbury, M. R. 1986. "Guidelines for Selecting Control and Treatment Option for Contaminated Dredged Material Requiring Restrictions," Puget Sound Dredged Disposal Analysis, U.S. Army Engineer District, Seattle, Seattle, WA.
- Cura, J., Heiger-Berneys, W., Bridges, T., and Moore, D. 1999. "Ecological and Human Health Risk Assessment Guidance for Aquatic Environments," Technical Report DOER-4, U.S. Army Engineer Research and Development Center, Vicksburg, MS.
www.wes.army.mil/el/dots/doer
- Cura, J., Wickwire, T., and McArlde, M. (in preparation) "Ecological and Human Health Risk Assessment Guidance for Terrestrial Environments," DOER Technical Report, U.S. Army Engineer Research and Development Center, Vicksburg, MS.
- Dortch, M. S., Hales, L. Z., Letter, J. V., and McAnally, W. H., Jr. 1990. "Methods of Determining the Long-Term Fate of Dredged Material for Aquatic Disposal Sites," Technical Report D-90-1, U.S. Army Engineer Waterways Experiment Station, Vicksburg, MS.
- Environmental Laboratory. 1987. "Disposal Alternatives for PCB-Contaminated Sediments from Indiana Harbor, Indiana," Miscellaneous Paper EL-87-9, U.S. Army Engineer Waterways Experiment Station, Vicksburg, MS.
- Estes, T. J., Schroeder, P. R., and Bailey, S. E. In preparation. "Screening Evaluations for Confined Disposal Facility Effluent Quality," *DOER Technical Notes Collection* (ERDC TN-DOER-XX), U.S. Army Engineer Research and Development Center, Vicksburg, MS.
- Fennessy, S. M., and Mitsch, W. J. 1989. "Design and Use of Wetlands for the Renovation of Drainage from Coal Mines," in *Ecological Engineering: An Introduction to Ecotechnology*, W. J. Mitsch and S. E. Jorgensen (Eds.), John Wiley & Sons, New York, pp 231-253.
- Folsom, B. L., Jr., and Houck, M. H. 1990. "A Computerized Procedure for Predicting Plant Uptake of Heavy Metals from Contaminated Freshwater Dredged Material," *Environmental Effects of Dredging Technical Notes* EEDP-04-12, U.S. Army Engineer Waterways Experiment Station, Vicksburg, MS.
- Folsom, B. L., and Lee, C. R. 1985. "Plant Bioassay of Dredged Material," *Environmental Effects of Dredging Technical Notes* EEDP-02-1, U.S. Army Engineer Waterways Experiment Station, Vicksburg, MS.

- Folsom, B. L., Jr., Lee, C. R., and Bates, D. J. 1981. "Influence of Disposal Environment on Availability and Plant Uptake of Heavy Metals in Dredged Material," Technical Report EL-81-12, U.S. Army Engineer Waterways Experiment Station, Vicksburg, MS.
- Francingues, N. R., and Averett, D. E. 1988. "New Bedford Harbor Superfund Project, Acushnet River Estuary Engineering Feasibility Study of Dredging and Dredged Material Disposal Alternatives, Report 1, Study Overview," Technical Report EL-88-15, Report 1, U.S. Army Engineer Waterways Experiment Station, Vicksburg, MS.
- Francingues, N. R., Palermo, M. R., Lee, C. R., and Peddicord, R. K. 1985. "Management Strategy for Disposal of Dredged Material: Contaminant Testing and Controls," Miscellaneous Paper D-85-1, U.S. Army Engineer Waterways Experiment Station, Vicksburg, MS.
- Fredette, T. J., Clausner, J. E., Nelson, D. A., Hands, E. B., Miller-Way, T., Adair, J. A., Sotler, V. A., and Anders, F. J. 1990a. "Selected Tools and Techniques for Physical and Biological Monitoring of Aquatic Dredged Material Disposal Sites," Technical Report D-90-11, U.S. Army Engineer Waterways Experiment Station, Vicksburg, MS.
- Fredette, T. J., Nelson, D. A., Clausner, J. E., and Anders, F. J. 1990b. "Guidelines for Physical and Biological Monitoring of Aquatic Dredged Material Disposal Sites," Technical Report D-90-12, U.S. Army Engineer Waterways Experiment Station, Vicksburg, MS.
- Fredette, T. J., Jackson, P. E., Demos, C. J., Hadden, D. A., Wolf, S. H., Nowak, T. A. Jr., and DeAngelo, E. 2000. "The Boston Harbor Navigation Improvement Project CAD Cells: Recommendations for Future Projects Based on Field Experience and Monitoring," *Proceedings of the Western Dredging Association*, Twentieth Technical Conference and Twenty-second Texas A&M Dredging Seminar, June 25-28, Warwick, RI, pp 291-302.
- Fredrickson, H., Gunnison, D., Perkins, E., and Ringelberg, D. 1999. "Screening Tests for Assessing the Bioreclamation of Dredged Materials," *DOER Technical Note Collection* (TN DOER-C4), U.S. Army Engineer Research and Development Center, Vicksburg, MS. www.wes.army.mil/el/dots/doer
- Great Lakes Commission. 2004. "Testing and Evaluating Dredged Material for Upland Beneficial Uses: A Regional Framework for the Great Lakes," Ann Arbor, MI.
- Hayes, D. F., Olin, T. J., Fischenich, J. C., and Palermo, M. R. 2000. "Wetlands Engineering Handbook," ERDC/EL TR-WRP-RE-21, U.S. Army Engineer Waterways Experiment Station, Vicksburg, MS.
- Hayes, D. L., and Schroeder, P. R. 1992. "Documentation of the SETTLE Module for ADDAMS: Design of Confined Disposal Facilities for Solids Retention and Initial

- Storage,” *Environmental Effects of Dredging Technical Notes* EEDP-06-18, U.S. Army Engineer Waterways Experiment Station, Vicksburg, MS.
- Houston, J. 1970. *Hydraulic Dredging Theoretical and Applied*. Curnell Montime Press, Cambridge, MD.
- Kusler, J. A., and Kentula, M. E. (Eds.). 1990. "Wetland Creation and Restoration: The Status of the Science," Island Press, Washington, DC.
- Lee, C. R. 1999. "Case studies: Characterization Tests to Determine Dredged Material Suitability for Beneficial Uses," *DOER Technical Notes Collection* (TN DOER-C7), U.S. Army Engineer Research and Development Center, Vicksburg, MS.
www.wes.army.mil/el/dots/doer
- Lee, C. R. 2000. "Reclamation and Beneficial Use of Contaminated Dredged Material: Implementation Guidance for Select Options," *DOER Technical Notes Collection* (ERDC TN-DOER-C12), U.S. Army Engineer Research and Development Center, Vicksburg, MS. www.wes.army.mil/el/dots/doer
- Lee, C. R. 2001. "Manufactured Soil Field Demonstrations on Brownfields and Abandoned Minelands," *DOER Technical Notes Collection* (ERDC TN-DOER-C25), U.S. Army Engineer Research and Development Center, Vicksburg, MS.
www.wes.army.mil/el/dots/doer
- Lee, C. R., Folsom, B. L., Jr., and Engler, R. M. 1982. "Availability and Uptake of Heavy Metals from Contaminated Dredged Material Placed in Flooded and Upland Disposal Environments," *Environment International*, (7), 65-71.
- Lee, C. R., Folsom, B. L., Jr., and Bates, D. J. 1983. "Prediction of Plant Uptake of Toxic Metals Using a Modified DTPA Soil Extractant," *The Science of the Total Environment*, (28), 191-202.
- Lee, C. R., and Price, R. A. 2003. "Review of Phytoreclamation and Management Approaches for Dredged Material Contaminated with Lead," *DOER Technical Notes Collection* (ERDC TN-DOER-C29), U.S. Army Engineer Research and Development Center, Vicksburg, MS. www.wes.army.mil/el/dots/doer
- Lee, C. R., and Skogerboe, J. G. 1983. "Prediction of Surface Runoff Water Quality from an Upland Dredged Material Disposal Site," *Proceedings, International Conference on Heavy Metals in the Environment*, Heidelberg, Germany.
- Lee, C. R., and Skogerboe, J. G. 1987. "Upland Site Management for Surface Runoff Water Quality," *Environmental Effects of Dredging Technical Notes* EEDP-02-3, U.S. Army Engineer Waterways Experiment Station, Vicksburg, MS.

- Lee, C. R., Smart, R. M., Sturgis, T. C., Gordon, R. N., and Landin, M. C. 1978. "Prediction of Heavy Metal Uptake by Marsh Plants Based on Chemical Extraction of Heavy Metals from Dredged Material," Technical Report D-78-6, U.S. Army Engineer Waterways Experiment Station, Vicksburg, MS.
- Lee, C. R., Tatem, H. E., Brandon, D. L., Kay, S. H., Peddicord, R. K., Palermo, M. R., and Francingues, Jr., N. R. 1991. "General Decisionmaking Framework for Management of Dredged Material: Example Application to Commencement Bay, Washington," Miscellaneous Paper D-91-1, U.S. Army Engineer Waterways Experiment Station, Vicksburg, MS.
- Marine Board National Research Council. 1990. *Managing Troubled Waters -- The Role of Marine Environmental Monitoring*. National Academy Press, Washington, DC.
- Moore, D. W., Bridges, T. S., and Cura, J. 1998. "Use of Risk Assessment in Dredging and Dredged Material Management," *DOER Technical Notes Collection* (TN DOER-R1), U.S. Army Engineer Waterways Experiment Station, Vicksburg, MS.
www.wes.army.mil/el/dots/doer
- Myers, T. E. 1990. "Preliminary Guidelines and Conceptual Framework for Comprehensive Analysis of Migration Pathways (CAMP) of Contaminated Dredged Material," *Environmental Effects of Dredging Technical Notes* EEDP-06-11, U.S. Army Engineer Waterways Experiment Station, Vicksburg, MS.
- Myers, T. E., and Bowman, D. W. 1999. "Bioremediation of PAH-contaminated Dredged Material at the Jones Island CDF: Materials, Equipment, and Initial Operations," *DOER Technical Notes Collection* (TN DOER-C5), U.S. Army Engineer Research and Development Center, Vicksburg, MS. www.wes.army.mil/el/dots/doer
- Myers, T. E., Bowman, D. W., and Myers, K. F. 2003. "Dredged Material Composting at Milwaukee and Green Bay, WI, Confined Disposal Facilities," *DOER Technical Notes Collection* (ERDC TN-DOER-C33), U.S. Army Engineer Research and Development Center, Vicksburg, MS. www.wes.army.mil/el/dots/doer
- Myers, T. E., and Brannon, J. M. 1991. "Technical Considerations for Application of Leach Tests to Sediments and Dredged Material," *Environmental Effects of Dredging Technical Notes* EEDP-02-15, U.S. Army Engineer Waterways Experiment Station, Vicksburg, MS.
- Myers, T. E., Brannon, J. M., and Tardy, B. A. 1996. "Leachate Testing and Evaluation for Estuarine Sediments," Technical Report D-96-1, U.S. Army Engineer Waterways Experiment Station, Vicksburg, MS.
- Myers, T. E., Schroeder, P. R. and Estes, T.J. In preparation (a). "Screening Evaluations for Confined Disposal Facility Leachate Quality," *DOER Technical Notes*

Collection (ERDC TN-DOER-XX), U.S. Army Engineer Research and Development Center, Vicksburg, MS.

Myers, T. E., Schroeder, P. R., and Estes, T. J. In preparation (b). "Screening Evaluations for Confined Disposal Facility Volatile Losses," *DOER Technical Notes Collection* (ERDC TN-DOER-XX), U.S. Army Engineer Research and Development Center, Vicksburg, MS.

Myers, T. E., and Williford, C. W. 2000. "Concepts and Technologies for Bioremediation in Confined Disposal Facilities," *DOER Technical Notes Collection* (ERDC TN-DOER-C11), U.S. Army Engineer Research and Development Center, Vicksburg, MS. www.wes.army.mil/el/dots/doer

National Research Council. 1997. *Contaminated Sediments in Ports and Waterways*. National Academy Press, Washington, DC.

Neal, W., Henry, G., and Green, S. H. 1978. "Evaluation of the Submerged Discharge of Dredged Material Slurry During Pipeline Dredge Operations," Technical Report D-78-44, U.S. Army Engineer Waterways Experiment Station, Vicksburg, MS.

Nester, R. D., and Rees, S. I. 1988. "Thin-Layer Dredged Material Disposal - Fowl River, Alabama, Test Case," Information Exchange Bulletin D-88-4, U.S. Army Engineer Waterways Experiment Station, Vicksburg, MS.

Olin-Estes, T. J. 2000. "Determining Recovery Potential of Dredged Material for Beneficial Use – Site Characterization: Statistical Approach," *DOER Technical Notes Collection* (ERDC TN-DOER-C15), U.S. Army Engineer Research and Development Center, Vicksburg, MS. www.wes.army.mil/el/dots/doer

Olin-Estes, T. J., Bailey, S. E., Brandon, D. L. and Bowman, D. W. 2002a. "Soil Separation Mobile Treatment Plant Demonstration, Bayport Confined Disposal Facility, Green Bay, Wisconsin," ERDC/EL TR-02-38, U.S. Army Engineer Research and Development Center, Vicksburg, MS.

Olin-Estes, T. J., Bailey, S. E., Heisey, S. A., and Hofseth, K. D. 2002b. "Planning Level Cost-benefit Analysis for Physical Separation at Confined Disposal Facilities," *DOER Technical Notes Collection* (ERDC TN-DOER-C27), U.S. Army Engineer Research and Development Center, Vicksburg, MS. www.wes.army.mil/el/dots/doer

Olin-Estes, T. J., and Palermo, M. R. 2000a. "Determining Recovery Potential of Dredged Material for Beneficial Use – Soil Separation Concepts," *DOER Technical Notes Collection* (ERDC TN-DOER-C13), U.S. Army Engineer Research and Development Center Waterways Experiment Station, Vicksburg, MS. www.wes.army.mil/el/dots/doer

Olin-Estes, T. J., and Palermo, M. R. 2000b. "Determining Recovery Potential of Dredged Material for Beneficial Use – Site Characterization: Prescriptive Approach," *DOER Technical Notes Collection* (ERDC TN-DOER-C14), U.S. Army Engineer Research and Development Center, Vicksburg, MS. www.wes.army.mil/el/dots/doer

Palermo, M. R. 1985. "Interim Guidance for Predicting the Quality of Effluent Discharged from Confined Dredged Material Disposal Areas," *Environmental Effects of Dredging Technical Notes* EEDP-04-1 through 4, U.S. Army Engineer Waterways Experiment Station, Vicksburg, MS.

Palermo, M. R. 1994. "Options for Submerged Discharge of Dredged Material," *Proceedings of the 25th Dredging Seminar and Western Dredging Association XIII Annual Meeting*, May 18-20, 1994, San Diego, CA.

Palermo, M. R., Clausner, J. E., Rollings, M. P., Williams, G. L., Myers, T. E., Fredette, T. J., and Randall, R. E. 1998a. "Guidance for Subaqueous Dredged Material Capping," Technical Report DOER-1, U.S. Army Engineer Waterways Experiment Station, Vicksburg, MS. www.wes.army.mil/el/dots/doer

Palermo, M. R., Miller, J., Maynard, S., and Reible, D. 1998b. "Guidance for In-Situ Subaqueous Capping of Contaminated Sediments," EPA 905-B96-004, Great Lakes National Program Office, U.S. Environmental Protection Agency, Chicago, IL. <http://www.epa.gov/glnpo/sediment/iscmain/index.html>

Palermo, M. R., and Averett, D. E. 2000. "Confined Disposal Facility (CDF) Containment Measures: A Summary of Field Experience," *DOER Technical Notes Collection* (ERDC TN-DOER-C18), U.S. Army Engineer Research and Development Center, Vicksburg, MS. www.wes.army.mil/el/dots/doer

Palermo, M. R., and Randall, R. E. 1990. "Practices and Problems Associated with Economic Loading and Overflow of Dredge Hoppers and Scows," Technical Report DRP-90-1, U.S. Army Engineer Waterways Experiment Station, Vicksburg, MS.

Palermo, M. R., and Schroeder, P. R. 1991. "Documentation of the EFQUAL Module for ADDAMS: Comparison of Predicted Effluent Water Quality with Standards," *Environmental Effects of Dredging Technical Notes* EEDP-06-13, U.S. Army Engineer Waterways Experiment Station, Vicksburg, MS.

Palermo, M. R., Shafer, R. A., Brannon, J. M., Myers, T. E., Truitt, C. L., Zappi, M. E., Skogerboe, J. G., Sturgis, T. C., Wade, R., Gunnison, D., Griffin, D. M., Tatum, H., and Portzer, S. 1989. "Evaluation of Dredged Material Disposal Alternatives for U.S. Navy Homeport at Everett, Washington," Technical Report EL-89-1, U.S. Army Engineer Waterways Experiment Station, Vicksburg, MS.

Palermo, M. R., and Thackston, E. L. 1988. "Test for Dredged Material Effluent Quality," *Journal of Environmental Engineering*, American Society of Civil Engineers, Vol 114, No. 6.

Pequegnat, W. E., Gallaway, B. J., and Wright, T. D. 1990. "Revised Procedural Guide for Designation Surveys of Ocean Dredged Material Disposal Sites," Technical Report D-90-8, U.S. Army Engineer Water ways Experiment Station, Vicksburg, MS.

Poindexter-Rollings, M. E. 1990. "Methodology for Analysis of Subaqueous Mounds," Technical Report D-90-2, U.S. Army Engineer Waterways Experiment Station, Vicksburg, MS.

Permanent International Association of Navigation Congresses (PIANC). 1996. "Handling and Treatment of Contaminated Dredged Material from Ports and Inland Waterways - CDM," Report of Working Group No. 17 of the Permanent Technical Committee I, Permanent International Association of Navigation Congresses, Brussels, Belgium. (In two volumes, available on CD from PIANC)

_____. 2003. "Environmental Guidelines for Marine, Nearshore, and Inland Confined Disposal Facilities (CDFs) for Contaminated Dredged Material," Report of Working Group No. 5 of the Permanent Environmental Committee, Permanent International Association of Navigation Congresses, Brussels, Belgium.

Price, C., Brannon, J., Myers, T., Valsaraj, K., Thibodeaux, L., and Reible, D. 1997. "Development of Laboratory Procedures to Predict Volatile Losses from Contaminated Sediments," *Environmental Effects of Dredging Technical Notes* EEDP-02-23, U.S. Army Engineer Waterways Experiment Station, Vicksburg, MS.

Price, C., Brannon, J., Yost, S., Valsaraj, K., and Ravikrishna, R. 1998. "Volatile Losses from Exposed Sediment," *Dredging Research Technical Note* EEDP-02-24, U.S. Army Engineer Waterways Experiment Station, Vicksburg, MS.

Price, C., Brannon, J., Yost, S., Valsaraj, K., and Ravikrishna, R. 1999. "Volatile Losses from Aged Field Sediments," *Dredging Research Technical Note* EEDP-02-26, U.S. Army Engineer Waterways Experiment Station, Vicksburg, MS.

Price, R. A., and Lee, C. R. 1999. "Evaluation of Dredged Material for Phytoreclamation Suitability," *DOER Technical Notes Collection* (TN DOER-C3), U.S. Army Engineer Research and Development Center, Vicksburg, MS.
www.wes.army.mil/el/dots/doer

Price, R. A., Lee, C. R., and Simmers, J. W. 1999. "Phytoreclamation of Dredged Material: A working Group Summary," *DOER Technical Notes Collection* (TN-DOER-C9), U.S. Army Engineer Research and Development Center, Vicksburg, MS.
www.wes.army.mil/el/dots/doer

- Price, R. A., Schroeder, P. R., and Estes, T.J. In preparation. "Screening Evaluations for Confined Disposal Facility Surface Runoff Quality," *DOER Technical Notes Collection* (ERDC TN-DOER-XX), U.S. Army Engineer Research and Development Center, Vicksburg, MS.
- Price, R. A., Skogerboe, J. G. and Lee, C. R. 1998. "Predicting Surface Runoff Water Quality from Upland Disposal of Contaminated Dredged Material," *Dredging Research Technical Note* EEDP-02-25, May 1998, USAE Waterways Experiment Station, Vicksburg, MS.
- Scheffner, N. W. 1991. "A Generalized Approach to Site Classification - Dispersive or Non-Dispersive," *Dredging Research Information Exchange Bulletin*, Vol DRP-91-1, U.S. Army Engineer Waterways Experiment Station, Vicksburg, MS.
- Schroeder, P. R. 1983. "Chemical Clarification Methods for Confined Dredged Material Disposal," Technical Report D-83-2, U.S. Army Engineer Waterways Experiment Station, Vicksburg, MS.
- Schroeder, P. R. 2000. "Leachate Screening Considerations," *DOER Technical Notes Collection* (ERDC TN-DOER-C16), U.S. Army Engineer Research and Development Center, Vicksburg, MS. www.wes.army.mil/el/dots/doer
- Schroeder, P. R., and Aziz, N. M. 2003. "Effects of Confined Disposal Facility and Vadose Zone Characteristics on Leachate Quality," *DOER Technical Notes Collection* (ERDC TN-DOER-C31), U.S. Army Engineer Research and Development Center, Vicksburg, MS. www.wes.army.mil/el/dots/doer
- Schroeder, P. R., Aziz, N. M., Lloyd, C. M., and Zappi, P. A. 1994a. "The Hydrologic Evaluation of Landfill Performance (HELP) Model: User's Guide for Version 3," EPA/600/R-94/168a, U.S. Environmental Protection Agency Office of Research and Development, Washington, DC.
- Schroeder, P. R., Dozier, T. S., Zappi, P. A., McEnroe, B. M., Sjostrom, J. W., and Peyton, R. L. 1994b. "The Hydrologic Evaluation of Landfill Performance (HELP) Model: Engineering Documentation for Version 3," EPA/600/R-94/168b, U.S. Environmental Protection Agency Office of Research and Development, Washington, DC.
- Schroeder, P. R., Gibson, A. C., and Dardeau, E. A., Jr. 1995. "Documentation of the RUNQUAL Module for ADDAMS: Comparison of Predicted Runoff Quality with Standards," *Environmental Effects of Dredging Technical Notes* EEDP-06-19, U.S. Army Engineer Waterways Experiment Station, Vicksburg, MS.
- Schroeder, P. R., Morgan, J. M., Walski, T. M., and Gibson, A. C. 1984. "The Hydrologic Evaluation of Landfill Performance (HELP) Model; Vol I, User's Guide for

Version I," EPA/5-30-SW-84-009, Municipal Environmental Research Laboratory, Cincinnati, OH, and Office of Solid Waste and Emergency Response, Washington, DC.

Schroeder, P. R., Palermo, M. R., Myers, T.E. and Lloyd, C.M. 2004. "The Automated Dredging and Disposal Alternatives Modeling System (ADDAMS)," *Environmental Effects of Dredging Technical Notes* EEDP-06-12, U.S. Army Engineer Research and Development Center, Vicksburg, MS.

Semmler, J. A. 1990. "PCB Volatilization from Dredged Material, Indiana Harbor, Indiana," *Environmental Effects of Dredging Technical Notes* EEDP-02-12, U.S. Army Engineer Waterways Experiment Station, Vicksburg, MS.

Simmers, J. W., Rhett, R. G., and Lee, C. R. 1986. "Upland Animal Bioassays of Dredged Material," *Environmental Effects of Dredging Technical Notes* EEDP-02-2, U.S. Army Engineer Waterways Experiment Station, Vicksburg, MS.

Spaine, P. A., Thompson, D. W., Jones, L. W., and Myers, T. E. 2001. "Determining Recovery Potential of Dredged Material for Beneficial Use – Debris and Trash Removal," *DOER Technical Notes Collection* (ERDC TN-DOER-C24), U.S. Army Engineer Research and Development Center, Vicksburg, MS.
www.wes.army.mil/el/dots/doer/

Streile, G. P., Shields, K. D., Stroh, J. L., Bagaasen, L. M., Whelan, G., McDonald, J. P., Droppo, J. G., and Buck, J. W. 1996. "Multimedia Environmental Pollutant Assessment System (MEPAS): Source Term Formulations," PNL-11248, Pacific Northwest National Laboratory, Richland, WA.

Tetra Tech, and Averett, D. 1994. "Options for Treatment and Disposal of Contaminated Sediments from New York/ New Jersey Harbor," Miscellaneous Paper EL-94-1, U.S. Army Engineer Waterways Experiment Station, Vicksburg, MS.

Thibodeaux, L. J. 1989. "Theoretical Models for Evaluation of Volatile Emissions to Air During Dredged Material Disposal with Applications to New Bedford Harbor, Massachusetts," Miscellaneous Paper EL-89-3, U.S. Army Engineer Waterways Experiment Station, Vicksburg, MS.

Truitt, C. L. 1987a. "Engineering Considerations for Subaqueous Dredged Material Capping - Background and Preliminary Planning," *Environmental Effects of Dredging Technical Notes* EEDP-01-3, U.S. Army Engineer Waterways Experiment Station, Vicksburg, MS.

_____. 1987b. "Engineering Considerations for Subaqueous Dredged Material Capping - Design Concepts and Placement Techniques," *Environmental Effects of Dredging Technical Notes* EEDP-01-3, U.S. Army Engineer Waterways Experiment Station, Vicksburg, MS.

- Turner, T. M. 1984. *Fundamentals of Hydraulic Dredging*. Council Maritime Press, Centerville, MD.
- U.S. Army Corps of Engineers (USACE). 1983. "Dredging and Dredged Material Disposal," Engineer Manual 1110-2-5025, Office, Chief of Engineers, Washington, DC.
- _____. 1986. "Dredged Material Beneficial Uses," Engineer Manual 1110-2-5026, Office, Chief of Engineers, Washington, DC.
- _____. 1987. "Confined Disposal of Dredged Material," Engineer Manual 1110-2-5027, Office, Chief of Engineers, Washington, DC.
- _____. 2003. "Evaluation of Dredged Material Proposed for Disposal at Island, Nearshore, or Upland Confined Disposal Facilities - Testing Manual," Technical Report ERDC/EL TR-03-1, U.S. Army Engineer Research and Development Center, Vicksburg, MS.
- _____. In preparation. "Dredging and Dredged Material Management," Engineer Manual 1110-2-XXXX, Office, Chief of Engineers, Washington, DC.
- USACE, Los Angeles District. 2002. "Los Angeles County Regional Dredged Material Management Plan - Pilot Studies," Los Angeles District, Los Angeles, CA
- USACE/U.S. Environmental Protection Agency (USEPA). 1984. "General Approach to Designation Studies of Ocean Dredged Material Disposal Sites," U.S. Army Engineer Water Resources Support Center, Ft. Belvoir, VA.
- USEPA. 1986. "U.S. Environmental Protection Agency, Ocean Dumping Site Designation Delegation Handbook," Office of Marine and Estuarine Protection, Washington, DC.
- _____. 1989. "Wetlands and 401 Certification, Opportunities and Guidelines for States and Eligible Indian Tribes," Office of Water, U.S. Environmental Protection Agency, Washington, DC.
- _____. 1994. "Assessment and Remediation of Contaminated Sediments (ARCS) Program – Remediation Guidance Document," EPA 905-R94-003, U.S. Environmental Protection Agency, Great Lakes National Program Office, Chicago, IL.
- _____. 1998. "Guidelines for Ecological Risk Assessment," EPA/630/R-95/002F, Office of Research and Development, Washington, DC.
- _____. 1999. "Fast Track Dredged Material Decontamination Demonstration for the Port of New York and New Jersey," EPA 000-0-99000, U.S. Environmental Protection Agency, Region 2.

USEPA/USACE. 1991. "Evaluation of Dredged Material Proposed for Ocean Disposal (Testing Manual)," EPA-503/8-91/001, Office of Water, U.S. Environmental Protection Agency, Washington, DC.

_____. 1995. "QA/QC Guidance for Sampling and Analysis of Sediments, Water, and Tissues for Dredged Material Evaluations - Chemical Evaluations," EPA 823-B-95-001, Office of Water, U.S. Environmental Protection Agency, Washington, DC.

_____. 1998. "Evaluation of Dredged Material Proposed for Discharge in Waters of the U.S. – Testing manual," EPA-823 -B-98 -004, Office of Water, U.S. Environmental Protection Agency, Washington, D.C.

Winfield, L. E., and Lee, C. R. 1999. "Dredged Material Characterization Tests for Beneficial Use Suitability," *DOER Technical Notes Collection* (TN DOER-C2), U.S. Army Engineer Research and Development Center, Vicksburg, MS.

www.wes.army.mil/el/dots/doer

APPENDIX A: GLOSSARY

Definitions of terms as they are used in this document are given below.

Aquatic environment

The geochemical environment in which dredged material is submerged under water and remains water saturated after disposal is completed.

Aquatic ecosystem

Bodies of water, including wetlands, which serve as the habitat for interrelated and interacting communities and populations of plants and animals.

Baseline

Belt of the seas measured from the line of ordinary low water along that portion of the coast that is in direct contact with the open sea and the line marking the seaward limit of inland waters (see Figure 1-1 in the main text).

Beneficial uses

Placement or use of dredged material for some productive purpose. Beneficial uses may involve either the dredged material or the placement site as the integral component of the beneficial use.

Bioaccumulation

The accumulation of contaminants in the tissues of organisms through any route, including respiration, ingestion, or direct contact with contaminated water, sediment, or dredged material.

Capping

The controlled, accurate placement of contaminated material at an open-water site, followed by a covering or cap of clean isolating material.

Coastal zone

Includes coastal waters and the adjacent shorelands designated by a State as being included within its approved coastal zone management program. The coastal zone may include open waters, estuaries, bays, inlets, lagoons, marshes, swamps, mangroves, beaches, dunes, bluffs, and coastal uplands. Coastal-zone uses can include housing, recreation, wildlife habitat, resource extraction, fishing, aquaculture, transportation, energy generation, commercial development, and waste disposal.

Confined disposal

Placement of dredged material within diked nearshore or upland confined disposal facilities (CDFs) that enclose the disposal area above any adjacent water surface,

isolating the dredged material from adjacent waters during placement. Confined disposal does not refer to subaqueous capping or contained aquatic disposal.

Confined disposal facility (CDF)

An engineered structure for containment of dredged material consisting of dikes or other structures that enclose a disposal area above any adjacent water surface, isolating the dredged material from adjacent waters during placement. Other terms used for CDFs that appear in the literature include "confined disposal area," "confined disposal site," and "dredged material containment area."

Contained aquatic disposal

A form of capping which includes the added provision of some form of lateral containment (for example, placement of the contaminated and capping materials in bottom depressions or behind subaqueous berms) to minimize spread of the materials on the bottom.

Contaminant

A chemical or biological substance in a form that can be incorporated into, onto, or be ingested by and that harms aquatic organisms, consumers of aquatic organisms, or users of the aquatic environment.

Contaminated sediment or contaminated dredged material

Contaminated sediments or contaminated dredged materials are defined as those that have been demonstrated to cause an unacceptable adverse effect on human health or the environment.

Control measure

See Management action.

Disposal site or area

A precise geographical area within which disposal of dredged material occurs.

Dredged material

Material excavated from waters of the United States or ocean waters. The term dredged material refers to material which has been dredged from a water body, while the term sediment refers to material in a water body prior to the dredging process.

Dredged material discharge

The term dredged material discharge as used in this document means any addition of dredged material into waters of the United States or ocean waters. The term includes open- water discharges; discharges resulting from unconfined disposal operations (such as beach nourishment or other beneficial uses); discharges from confined disposal facilities that enter waters of the United States (such as effluent, surface runoff, or leachate); and overflow from dredge hoppers, scows, or other transport vessels.

Effluent

Water that is discharged from a confined disposal facility during and as a result of the filling or placement of dredged material.

Emergency

In the context of dredging operations, emergency is defined in 33 CFR Part 335.7 as a "situation which would result in an unacceptable hazard to life or navigation, a significant loss of property, or an immediate and unforeseen significant economic hardship if corrective action is not taken within a time period of less than the normal time needed under standard procedures."

Federal project

Herein, any work or activity of any nature and for any purpose that is to be performed by or for the Secretary of the Army acting through the Chief of Engineers pursuant to Congressional authorizations. It does not include work requested by any other Federal agency on a cost reimbursable basis.

Federal standard

The dredged material disposal alternative or alternatives identified by the U.S. Army Corps of Engineers that represent the least costly alternatives consistent with sound engineering practices and meet the environmental standards established by the 404(b)(1) evaluation process or ocean-dumping criteria (33 CFR 335.7).

Habitat

The specific area or environment in which a particular type of plant or animal lives. An organism's habitat provides all of the basic requirements for the maintenance of life. Typical coastal habitats include beaches, marshes, rocky shores, bottom sediments, mudflats, and the water itself.

Leachate

Water or any other liquid that may contain dissolved (leached) soluble materials, such as organic salts and mineral salts, derived from a solid material. For example, rainwater that percolates through a confined disposal facility and picks up dissolved contaminants is considered leachate.

Level bottom capping

A form of capping in which the contaminated material is placed on the bottom in a mounded configuration.

Local sponsor

A public entity (e.g., port district) that sponsors Federal navigation projects. The sponsor seeks to acquire or hold permits and approvals for disposal of dredged material at a disposal site (USACE 1986).⁷

⁷ References cited in this appendix are included in the References at the end of the main text.

Major federal action

Includes actions with effects that may be major and that are potentially subject to Federal control and responsibility. Major refers to the context (meaning that the action must be analyzed in several contexts, such as the effects on the environment, society, regions, interests, and locality) and intensity (meaning the severity of the impact). It can include (a) new and continuing activities, projects, and programs entirely or partly financed, assisted, conducted, regulated, or approved by Federal agencies; (b) new or revised agency rules, regulations, plans, policies, or procedures; and (c) legislative proposals. Action does not include funding assistance solely in the form of general revenue-sharing funds where there is no Federal agency control over the subsequent use of such funds. Action does not include judicial or administrative civil or criminal enforcement action.

Management action

Those actions or measures that may be considered necessary to control or reduce the potential physical or chemical effects of dredged material disposal.

Mitigation

Defined in the Council on Environmental Quality's regulation 40 CFR 1508.20 (a-e).

Open-water disposal

Placement of dredged material in rivers, lakes, estuaries, or oceans via pipeline or surface release from hopper dredges or barges.

Record of decision

A comprehensive summary required by National Environmental Policy Act that discusses the factors leading to U.S. Army Corps of Engineers (USACE) decisions on regulatory and Civil Works matters and is signed by the USACE District Engineer after completion of appropriate environmental analysis and public involvement.

Regulations

In the context of the Marine Protection, Research, and Sanctuaries Act, means those regulations published in the Code of Federal Regulations, Title 40, Parts 220-227, and Title 33, Parts 209, 320-330, and 335-338 for evaluating proposals for dumping dredged material in the ocean. In the context of the Clean Water Act, refers to regulations published in the Code of Federal Regulations, Title 40, Parts 230, 231, and 233, and Title 33, Parts 209, 320-330, and 335-338 for evaluating proposals for the discharge of dredged material into waters falling under the jurisdiction of the Clean Water Act.

Runoff

The liquid fraction of dredged material or the surface flow caused by precipitation on upland or nearshore dredged material disposal sites.

Sediment

Material, such as sand, silt, or clay, suspended in or settled on the bottom of a water body. Sediment input to a body of water comes from natural sources, such as erosion of soils and weathering of rock, or as the result of anthropogenic activities, such as forest or agricultural practices, or construction activities. The term dredged material refers to material which has been dredged from a water body, while the term sediment refers to material in a water body prior to the dredging process.

Suspended solids

Organic or inorganic particles that are suspended in water. The term includes sand, silt, and clay particles as well as other solids, such as biological material, suspended in the water column.

Territorial sea

The strip of water immediately adjacent to the coast of a nation measured from the baseline as determined in accordance with the Convention on the territorial sea and the contiguous zone (15 UST 1606; TIAS 5639), and extending a distance of 3 nmi from the baseline.

Toxicity

Level of mortality or other end point demonstrated by a group of organisms that has been affected by the properties of a substance, such as contaminated water, sediment, or dredged material.

Toxic pollutant

Pollutants, or combinations of pollutants, including disease-causing agents, that after discharge and upon exposure, ingestion, inhalation, or assimilation into any organism, either directly from the environment or indirectly by ingestion through food chains, will, on the basis of information available to the Administrator of the U.S. Environmental Protection Agency, cause death, disease, behavioral abnormalities, cancer, genetic mutations, physiological malfunctions, or physical deformations in such organisms or their offspring.

Turbidity

An optical measure of the amount of material suspended in the water. Increasing the turbidity of the water decreases the amount of light that penetrates the water column. Very high levels of turbidity can be harmful to aquatic life (USACE 1986).

Upland environment

The geochemical environment in which dredged material may become unsaturated, dried out, and oxidized.

Wetlands

Areas that are inundated or saturated by surface or groundwater at a frequency and duration sufficient to support and that, under normal circumstances, do support a prevalence of vegetation typically adapted for life in saturated-soil conditions. Wetlands generally include swamps, marshes, bogs, and similar areas (40 CFR Part 230).

Wetlands restoration

Involves either improving the condition of existing degraded wetlands so that the functions that they provide are of a higher quality or reestablishing wetlands where they formerly existed before they were drained or otherwise converted.

Zoning

To designate, by ordinances, areas of land reserved and regulated for specific land uses.

APPENDIX B: FEDERAL LEGISLATION AND PROGRAMS

AN OVERVIEW OF THE LEGAL AND POLICY FRAMEWORK

A number of Federal environmental Executive orders, regulations, and Federal statutes control dredging and disposal operations. The General Survey Act of 1824 directed the U.S. Army Corps of Engineers (USACE) to develop and improve harbors and navigation, and Section 10 of the River and Harbor Act of 1899 required USACE to issue permits for any work in navigable waters. Dredging and disposal operations were considered more fully by Congress in the major environmental statutes passed after 1969. A brief discussion of these follows.

NATIONAL ENVIRONMENTAL POLICY ACT (NEPA) OF 1969

The NEPA [(Pub. L. No. 91-190) (42 U. S. C. 4321 et seq.)] applies to major Federal actions (e.g., proposals, permits, and legislation) that may significantly affect the environment. USACE activities in the areas of dredging and disposal, including regulatory actions, come under the NEPA jurisdiction. It is through the NEPA process that the dredged material disposal alternatives including no action, open-water disposal, or confined disposal of dredged material are evaluated, documented, and publicly disclosed.

A flowchart illustrating the NEPA process as it is applied to dredging projects is shown in Flowchart B-1. The components of this process have been incorporated in the framework for determining environmental acceptability of alternatives described in Chapter 3 of the main text.

The NEPA requires that government use all practicable means, consistent with the act and other essential considerations of national policy, to fulfill the requirements of the act. This requirement specifically applies to Federal agencies, their plans, regulations, programs, and facilities. The process that has been established under the guidelines of the NEPA helps public officials to make decisions based on an understanding of their environmental consequences and to take actions that protect, restore, and enhance the environment. The public disclosure document in this process is the preparation of a report that provides information about the environmental impact of a proposed action. This document is either an Environmental Impact Statement (EIS) or an Environmental Assessment (EA)/ Finding of No Significant Impact (FONSI).

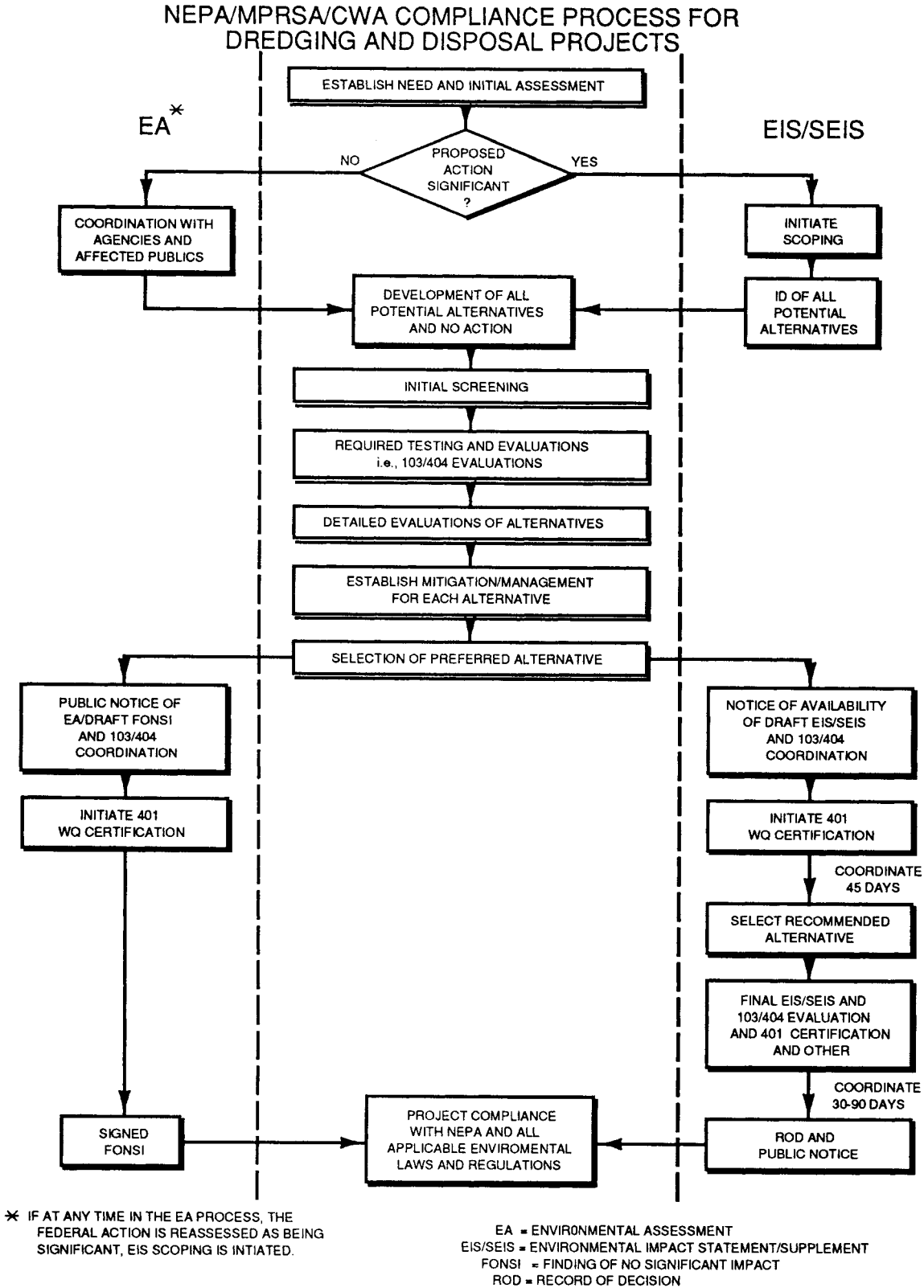

Flowchart B-1. NEPA Process for Dredged Material Disposal Projects

Existing Federal navigation projects and existing permits will have had an environmental evaluation accomplished at some time in their history. Evaluation of environmental acceptability of an alternative will have been done in the NEPA compliance documents, in the Section 404 or Section 103 evaluations and the Public Notice, and to some extent in the engineering or project reports. Existing project and permit reevaluations will normally require a comparison of what is to be done with the existing NEPA document discussed. If the alternative is to remain the same or was discussed in detail in the NEPA document and there is no reason to believe any new significant issues or information have raised since the issuance of the NEPA document, then no additional NEPA coverage is warranted.

If, however, new significant issues such as new disposal options not addressed in the EIS/EA, public interest concerns, or reason to believe significant new contaminants are present, then NEPA requirements should be updated with either an EA/FONSI or a supplement to the existing EIS. In either of the above cases whether additional NEPA documentation is required or not, all other environmental laws and regulations must be followed (see Appendix A for a discussion of necessary compliance). This is either done in the compliance and coordination section of the EA/EIS or in the Section 404 or Section 103 evaluations. If the former is done, the 404/103 evaluation should be appended to and discussed in the NEPA document. In either case, there is full public disclosure of the information in the public review process for NEPA or in the Public Notice for the 404/103 evaluation process and an opportunity for public comment prior to selection of the preferred alternative.

Federal navigation projects involving new work (i.e., new channels or improvements to existing channels) and new 404/103 permit applications will normally not have complied with NEPA, and will require compliance with the Council on Environmental Quality regulations for implementing NEPA. This will be initiated as early in the evaluation process as possible. For a more detail discussion of the USACE regulations implementing NEPA, refer to 33 Code of Federal Regulations (CFR) Parts 230 and 325.

IMPLEMENTING REGULATIONS OF THE COUNCIL ON ENVIRONMENTAL QUALITY (CEQ)

Subchapter II of the NEPA established the CEQ as part of the Executive Office of the President. Exercising its mandate to oversee the implementation of the NEPA, in 1978 the CEQ issued regulations (40 CFR Parts 1500-1508) covering the procedural provisions of the Act. The regulations state that the NEPA procedures are designed to ensure that high-quality information on environmental consequences relative to significant issues is available to public officials and private citizens before decisions are made.

FEDERAL WATER POLLUTION CONTROL ACT--1972 AND 1977 (CWA)

Under Section 404 of the CWA, USACE authorizes discharges of dredged or fill material in "waters of the United States." The USACE jurisdiction includes most freshwater areas, estuaries, and nearshore coastal areas including many wetlands inside the 3-mile limit. Material dredged from waters of the United States and disposed in the territorial sea is evaluated under MPRSA. In general, dredged material discharged as fill (e.g., beach nourishment, island creation, or underwater berms) and placed within the territorial sea is evaluated under the CWA.

The States also review permit applications for discharges in fresh water, estuaries, and the territorial sea (along with Federal resource agencies). Under Section 401 of CWA, these disposal operations must be certified by the affected State as complying with applicable State water quality standards (USEPA 1989).⁸

MARINE PROTECTION, RESEARCH, AND SANCTUARIES ACT (MPRSA) OF 1972

Under Section 103 of the MPRSA, USACE must evaluate proposed projects that require the transportation of dredged material for the purpose of disposal in the open ocean beyond the baseline. The evaluation of these activities is based on Criteria promulgated in 1977 by the U.S. Environmental Protection Agency (USEPA) after consultation with USACE and other Federal agencies. These Criteria are revised from time to time to maintain compatibility with disposal constraints set forth in the London Dumping Convention to which the United States is a signatory. Non-Corps Federal projects and private projects that are approved receive an ocean-dumping permit from USACE. USACE projects are evaluated in accordance with the same Criteria, but they do not receive formal permits. If a permit does not comply with established Criteria, disposal of the material cannot proceed unless a waiver is obtained from USEPA.

The USEPA has the primary responsibility for designating ocean-disposal sites within and beyond the 3-mile limit, i.e., within and beyond the territorial sea. USACE can and has selected a few ocean-disposal sites, as in the Portland and Mobile Districts, when USEPA does not have a designated site where one is needed by USACE to carry out its dredging responsibilities.

LONDON DUMPING CONVENTION (1972)

The London Dumping Convention (LDC) [Convention on the Prevention of Marine Pollution by Dumping of Waste and Other Matter, December 29, 1972 (26 UST 2403:TIAS 8165)], to which the United States is a signatory, is an international treaty that deals with marine-waste disposal. The Convention entered into force for the United States on August 30, 1975. The LDC prescribes a duty to "take all practicable steps" to prevent pollution resulting from ocean dumping. The dumping of wastes is regulated by

⁸ For purposes of this report Criteria (capitalized) refers to criteria developed by the Environmental Protection Agency under Section 102 of MPRSA relating to the effects of the proposed disposal action.

three annexes to the LDC. LDC jurisdiction includes all waters seaward of the baseline of the territorial sea. The ocean-dumping Criteria developed under the MPRSA are required by Section 102(a) to "apply the standards and criteria binding upon the United States under the Convention, including its Annexes." These criteria must, at a minimum, reflect the standards set forth by LDC. Therefore, the LDC places environmental constraints upon the ocean disposal of dredged material and directly affects the policy, regulatory, and technical aspects of the dredged material ocean-disposal program.

ADDITIONAL APPLICABLE FEDERAL LEGISLATION

COASTAL ZONE MANAGEMENT ACT

The Coastal Zone Management Act requires USACE to coordinate permit review and Federal projects with all State level coastal zone review agencies. Under this act, coastal States are required to formulate a management program for the land and water resources of its coastal zone, which extends out to the seaward limit of the territorial sea, and submit it for approval to the Secretary of Commerce. After final approval by the Secretary of Commerce of a State's management program, any applicant for a Federal permit must have certification that the proposed disposal complies with the State's approved program.

RIVERS AND HARBORS ACT OF 1899

The Rivers and Harbors Act of 1899 requires a USACE permit for any work or structure, including fill material discharges, in navigable waters of the United States. The primary purpose of Section 10 is to ensure that private structures do not adversely affect Federal interstate navigation. It empowers USACE to review applications and issue approved construction permits for dredging and fill projects for any structure in the water (e.g., piers, pipelines, and bridges).

FISH AND WILDLIFE COORDINATION ACT OF 1958

The Fish and Wildlife Coordination Act of 1958 provides that, for any proposed Federal project or permit that may affect a stream or other body of water, USACE must first consult with Federal and State fish and wildlife agencies. This consultation must address the prevention of damages to wildlife resources and provide for the development and improvement of wildlife resources.

ENDANGERED SPECIES ACT OF 1973

Section 7 of the Endangered Species Act of 1973 establishes a consultation process between Federal agencies and the Secretaries of the Interior or Commerce for conducting programs for the conservation and protection of endangered species. Pursuant to this act, a biological assessment is performed to determine whether an endangered species or a critical habitat will be impacted by a proposed action.

WATER RESOURCES DEVELOPMENT ACT OF 1986

The passage of the Water Resources Development Act of 1986 created a financing arrangement for dredging associated with navigation improvement and maintenance projects. In a cost-sharing program between the local sponsors and USACE, local sponsors will finance one-half the cost of improvements and one-half the cost for additional maintenance dredging resulting from the improvements. USACE will finance the other half of these costs. This tremendous amount of work, in addition to the annual USACE maintenance dredging requirements, the Navy's annual maintenance work, and private dredging requirements, will have a significant impact on dredging and dredged material disposal practices.

NATIONAL HISTORIC PRESERVATION ACT OF 1966

USACE is directed to take into account the effects of the proposed project on any site, building, structure, or object that is included or is eligible for inclusion in the National Register of Historic Places. Comments from the Advisory Council on Historic Preservation, both Federal and State, must be sought prior to granting a permit for construction or disposal. Local historical and archeological societies may also be useful sources of this kind of information about the site. Magnetometer surveys to locate any possible objects of historic value under water may be required prior to the preparation of an EIS.

OTHER FEDERAL STATUTES

Requirements of additional Federal statutes such as the Comprehensive Environmental Response, Compensation, and Liability Act of 1980, Rivers and Harbors Improvement Act of 1978, Submerged Lands Act of 1953, Rivers and Harbors, Flood Control Acts of 1970, the National Fishing Enhancement Act of 1984, as amended, should also be considered in the evaluation of proposed projects, as these requirements may influence the disposal of dredged material in certain circumstances.