

Ground & Urban Direction Finding Team Tasks



24 May 2004

Developed as part of the
National Emergency Services Curriculum Project

NATIONAL EMERGENCY SERVICES CURRICULUM
GROUND & URBAN DIRECTION FINDING TEAM TASKS

The following tasks are included in this task guide.

Task # **Task Title**

Command Tasks

NONE

Operations Tasks

- O-0001 PREPARE INDIVIDUAL EQUIPMENT
- O-0002 CONDUCT INDIVIDUAL REFIT
- O-0003 PREVENT AND TREAT HOT WEATHER INJURIES
- O-0004 PREVENT AND TREAT COLD WEATHER INJURIES
- O-0005 INSPECT TEAM MEMBERS
- O-0006 INSPECT TEAM EQUIPMENT
- O-0007 DIRECT TEAM REFIT AFTER SORTIE
- O-0010 PREPARE URBAN DF TEAM INDIVIDUAL EQUIPMENT
- O-0101 IDENTIFY NATURAL HAZARDS
- O-0102 PREVENT AND TREAT FATIGUE
- O-0103 CONDUCT FIELD SANITATION AND HYGIENE
- O-0104 SETUP SHELTER
- O-0201 USE A COMPASS
- O-0202 MEASURE DISTANCE WITH PACE COUNT
- O-0203 NAVIGATE PAST AN OBSTACLE
- O-0204 LOCATE A POINT ON A MAP USING LATITUDE AND LONGITUDE
- O-0205 LOCATE A POINT ON A MAP USING THE CAP GRID SYSTEM
- O-0209 IDENTIFY THE MAJOR TERRAIN FEATURES ON A MAP
- O-0210 IDENTIFY TOPOGRAPHIC SYMBOLS ON A MAP
- O-0211 DETERMINE ELEVATION ON MAP
- O-0212 MEASURE DISTANCE ON A MAP
- O-0213 CONVERT BETWEEN MAP AND COMPASS AZIMUTHS
- O-0214 DETERMINE AND PLOT AN AZIMUTH ON A MAP
- O-0215 DETERMINE AZIMUTHS ON A MAP USING TWO POINTS
- O-0216 ORIENT A MAP TO THE GROUND USING TERRAIN ASSOCIATION
- O-0217 ORIENT A MAP TO NORTH USING A COMPASS
- O-0218 LOCATE OWN POSITION ON A MAP USING TERRAIN ASSOCIATION
- O-0220 MOVE FROM POINT TO POINT IN A VEHICLE USING A MAP
- O-0301 DETERMINE DISTRESS BEACON BEARING
- O-0302 LOCATE A DISTRESS BEACON
- O-0303 DEACTIVATE A DISTRESS BEACON
- O-0304 TRIANGULATE ON A DISTRESS BEACON SIGNAL
- O-0401 WORK WITH CANINE SEARCH TEAMS
- O-0403 EMPLOY SCANNING TECHNIQUES WHILE ON FOOT
- O-0404 MOVE AS PART OF A SEARCH LINE
- O-0405 COMMUNICATE TO OTHER MEMBERS OF A SEARCH LINE
- O-0406 USE WHISTLE SIGNALS
- O-0407 CONDUCT ATTRACTION TECHNIQUES
- O-0408 IDENTIFY AIRCRAFT SEARCH CLUES

<u>Task #</u>	<u>Task Title</u>
O-0409	IDENTIFY MISSING PERSON SEARCH CLUES
O-0410	MARK A ROUTE
O-0411	CONDUCT INDIVIDUAL ACTIONS ON LOCATING A CLUE
O-0412	CONDUCT INDIVIDUAL ACTIONS ON FIND
O-0413	PARTICIPATE IN A HASTY SEARCH
O-0416	PLAN SEARCH LINE OPERATIONS
O-0417	ORGANIZE A SEARCH LINE
O-0418	CONTROL A SEARCH LINE
O-0419	PLAN AND ORGANIZE A HASTY SEARCH
O-0420	PERFORM AN AIRFIELD SEARCH (RAMP CHECK)
O-0421	DIRECT TEAM ACTIONS ON LOCATING A CLUE
O-0422	DIRECT TEAM ACTIONS ON FIND
O-0502	PARTICIPATE IN A LITTER CARRY
O-0601	CONDUCT ACTIONS IF LOST
O-0605	EXTINGUISH A SMALL FIRE
O-0701	RECOGNIZE AND REACT TO AIR/GROUND SIGNALS
O-0702	USE A SIGNAL MIRROR
O-0703	EMPLOY GROUND TO AIR SIGNALS
O-0802	PLAN AND ORGANIZE SITE SURVEILLANCE
O-0803	SUPERVISE A SITE SURVEILLANCE SHIFT
O-0804	SIGN OVER A SITE
O-0902	EXERCISE UNIVERSAL PRECAUTIONS
O-1001	DIRECT TEAM ACTIONS AT MEETING POINT
O-1002	ESTABLISH A HELICOPTER LANDING ZONE
O-1101	CONDUCT WITNESS INTERVIEW

Planning Tasks

P-0101	KEEP A LOG
P-0102	CONDUCT A PHONE ALERT
P-0201	SIGN-IN TEAM AT MISSION
P-0202	PLAN AND BRIEF SORTIE
P-0203	CONDUCT REHEARSALS
P-0204	CONDUCT AFTER ACTION REVIEW

Logistics Tasks

L-0001	BASIC COMMUNICATIONS PROCEDURES FOR ES OPERATIONS
L-0002	PERFORM RADIO OPERATING PROCEDURES
L-0003	EMPLOY APPROPRIATE RADIO FREQUENCIES AND REPEATERS
L-0101	INSPECT A VEHICLE

Finance/Administrative Tasks

None

O-0001
PREPARE GROUND TEAM INDIVIDUAL EQUIPMENT

CONDITIONS

You are a member of a ground team at home prior to a mission.

OBJECTIVE

Collect and efficiently pack all items required of a ground team member. The enclosed list is the suggested national list. Wings may have supplemented this list to suit their environment with national approval, so be sure to use your approved wing list.

TRAINING AND EVALUATION

Training Outline

1. Your individual equipment is designed to keep you functional in the field and to help you do your job.

a. Equipment is divided into two parts -- the 24-hour pack for short activities (typical field gear) and the 72 hour pack for longer duration activities (typically called base gear). This gear list was derived from the gear lists suggested by several CAP wings and other organizations including the National Association for Search and Rescue (NASAR), and modified to meet CAP needs.

1) The 24 hour pack is what you carry while searching. As its name infers, in case of an emergency, this equipment will help you survive in the wilderness for 24 hours. In addition, your 24 hour pack is part of your uniform -- when the public sees you on a mission, they will probably see you wearing your field gear. Because of this, your 24 hour pack must present a professional uniform appearance. Though packs do not need to be identical, it is advantageous for unit members to have similar 24-hour packs. Every ground team member will have this equipment.

2) The extended duration pack is designed to help you live in the field for more than one day, typically 48 to 72 hours. It includes your sleeping bag, tent, and other long term comfort items. The extended duration is not subject to uniformity -- color and size does not matter. The major constraint is how much you can carry. Even if the mission is only expected to last one day, you should always bring your base gear. You never know how long a mission will last, or whether you will go straight to another mission from the current one.

b. For your equipment to be effective, you must insure it is clean and serviceable. Occasionally you will have to replace items such as medicine, batteries or food because it has passed its expiration date.

c. You must be able to carry all your equipment at once, in case you must "hike in" to a mission base. Normally, this means leaving room in your base gear pack to stow all of your field gear.

d. Ensure your gear is properly secured -- nothing should be flapping loose where it could snag in the brush or bang against your body when moving.

e. Restrictions on Knives: You may only wear a sheath knife if authorized by your team leader. Sheath knives cannot have a blade longer than 6" or a total length of greater than 11". The sheath must adequately secure the knife and protect the wearer from the blade. If authorized, sheath knives will be worn only on the pistol belt or carried inside the pack. The following knife types are not authorized: boot knives, butterfly knives, switch blades, double edged knives, "Rambo" style survival knives, or knives with retracting sheaths. Machetes or hatchets can only be carried by senior members when needed for that specific sortie. No knives may be visible when the member is performing crash sight surveillance duty.

2. The gear list below is the minimum required equipment. Items required of trainees are marked with a "T." You may carry additional equipment subject to team leader approval and your ability to secure and carry it -- remember, you may have to walk a long way carrying it all.

a. 24 hour pack

1) On your person:

a) Complete BDU uniform with BDU cap. The BDU cap may be replaced by a hard hat or bright colored cap based on mission needs.(T)

b) Notepad and pencil (T)

c) All CAP Identification, including 101 card, 76 card, First Aid card, etc. (T)

d) Watch (T)

e) Handkerchief or Tissues

f) Vest, reflective, orange (T)

g) Comb or brush (optional, carry if needed) (T)

h) Ground Team Member's Handbook

i) Signal Mirror

j) Whistle

k) Pocket or utility-type knife, multipurpose with can opener. Swiss Army knives, Leatherman, or Gerber Tools are recommended. (T)

2) Day pack (preferably red or orange), webbed gear, or other SAR/Survival Vest (T) containing:

a) First Aid Kit, stored in zip-lock bag or other waterproof container, recommended that it consists of the following:

(1) 2 Antiseptic cleansing pads

(2) Antiseptic ointment

(3) 6 Band-Aids, various sizes

(4) Moleskin, 2" X 4"

(5) Roller bandage

(6) 2 Safety pins, large

(7) 4 gauze pads

(8) 1 Triangular Bandage

(9) Tape, first aid

(10) Any personal medication (your team leader should know what you have and where you carry it.)(T)

(11) Rubber surgical gloves (two pair minimum)

b) Survival Kit, stored in zip-lock bag or other waterproof container, consisting of:

(1) Duct tape, 5-10 feet (does not need to be a whole roll. May be wrapped around a stick.

(2) Leaf bag, large

(3) 12 wooden, waterproofed matches (T)

(4) Match container, waterproof, with striking surface

(5) 1 Chemical Light Stick, Green (T)

(6) 50' of nylon line (paracord or similar line).

c) SAR Equipment stored in zip-lock bags, consisting of:

(1) Change of socks (T)

(2) Flagging Tape, 1 roll

(3) Flashlight (with red or blue lens), with spare bulb and batteries

(4) Spare flashlight (penlight will do) (T)

(5) Insect repellent

(6) Lip balm, with sunscreen.

(7) Sunscreen lotion

(8) Tissue Paper (T)

- (9) Work Gloves, leather (T)
- (10) Interviewing Form(s), blank
- (11) 4 Moist Towelettes, clean, in foil wrapper
- (12) Change for phone calls, calling card, or cellular phone (T) to call mission base
- d) 2 meals (T)
- e) Shelter Material, preferably 8' X 10' (spare military poncho meets the need)
- f) Coat for appropriate climate, if necessary (in pack if not wearing it)(T)
- g) Poncho, (T)
- h) Canteen(s) to carry 2 quarts of water (Some wings require their personnel to have at least one one-quart canteen on a belt while the other is stored in the field pack. At least one quart of water must be carried by all personnel)(T)

i) Compass Pouch, containing compass, lensatic or orienteering (orienteering preferred).
Compass should have a "glow in the dark" dial.

j) Leader's Equipment -- only required of Ground Team Leaders

- (1) Protractor -- for map work.
- (2) Map Case (Large Zip-Loc bags can be used if necessary)
- (3) Pencil, with eraser (plus sharpener if not a mechanical pencil)
- (4) Alcohol Pens, fine tip, at least 2 colors (neither the color of your colored flashlight lens)
- (5) Some way to erase alcohol pens marks on the map case, such as alcohol swabs or a special alcohol pen eraser.
- (6) A straightedge ruler, at least 6" long (Some protractors may have a ruler as well).

(7) Ground Team Leader Handbook

b. Extended duration pack: a backpack (preferably with frame) (T) containing:

- 1) Tent (optional, if you are sharing a tent with someone else who is carrying it) (T)
- 2) Spare rank and CAP cutouts (for cadets)
- 3) 5 meals (T)
- 4) 2 Leaf Bags, large
- 5) Bag, waterproof (T), containing:
 - (a) Spare uniform,
 - (b) Underwear and socks, 3 changes (T)
- 6) Sleeping pad, foam or inflatable.
- 7) Spare boot laces.
- 8) Kit, sewing, with spare buttons.
- 9) Shoe Shine Kit
- 10) Toilet Kit, that should contain:
 - (a) Toothbrush and paste (T)
 - (b) Shaving Kit (if you shave) (T)
 - (c) Deodorant (T)
 - (d) Washcloth and soap (T)
 - (e) Towel (T)
- 11) Sleeping Bag or Bedroll appropriate to climate (T)

c. Optional Items

- (1) Rainwear, durable
- (2) Webbing, nylon, 1" wide, 20' long.
- (3) Handheld FM Transceiver (highly recommended for Ground Team Leaders)
- (4) Water Purification Tablets
- (5) Eye Protection (highly recommended)
- (6) Entrenching Tool (highly recommended for base gear)

Additional Information

More detailed information on this topic is available in Chapter 2 of the Ground Team Member & Leader Reference Text.

Evaluation Preparation

Setup: None

Brief Student:

1. Tell the student to lay out his gear, on top of the 8' X 10' shelter material. Tell him to lay out all items in the order listed on the above list, in rows from left to right (except for the uniform the member is wearing. of course). Inspect all items for presence and serviceability.
2. After inspection of all items, tell the student to reassemble his/her field gear and put it on. Inspect for proper fit and balance.
3. Tell the student to put on all gear, base and field (field gear may be stowed in or secured to the base pack). Inspect for proper fit and balance.

Evaluation

<u>Performance measures</u>	<u>Results</u>	
The individual:		
1. Has all required items of the 24-hour pack.	P	F
2. Has all required items of the extended duration pack (GTM-2 & 1 Only).	P	F
3. When worn, the 24-hour pack is secure from undue shifting, snagging or movement.	P	F
4. All knives are of an approved type, and are worn correctly	P	F
5. When the extended duration pack is worn (with 24-hour pack stowed, worn or secured), Items are secure from undue shifting or movement (GTM-2 & 1 Only).	P	F

NOTE: ALL REQUIRED ITEMS MUST BE PRESENT IN ORDER FOR THE STUDENT TO PASS THIS TASK AT THE LEVEL THEY ARE TESTING FOR. ALL ITEMS MUST MATCH THE DESCRIPTIONS LISTED ABOVE. NO EXCEPTIONS OR SUBSTITUTIONS. TRAINEES ONLY HAVE TO HAVE THE ITEMS MARKED WITH A "T". TEAM LEADERS MUST HAVE ALL LEADER'S EQUIPMENT AS WELL IN ORDER TO PASS.

Student must receive a pass on all performance measures to qualify in this task. If the individual fails any measure, show what was done wrong and how to do it correctly.

O-0002
CONDUCT INDIVIDUAL REFIT

CONDITIONS

You are a ground team member who has just completed a sortie or has returned home following a mission.

OBJECTIVES

Correctly identify and explain the steps to be taken to prepare yourself for the next sortie or mission, using the “4 R’s”.

TRAINING AND EVALUATION

Training Outline

1. The minute a sortie or mission is completed, a team member should prepare for the next sortie or mission. This means taking care of your equipment and yourself. There is a great temptation after a hard day in the field to not worry about your equipment for a while. But on a mission, you must be prepared to leave on another sortie at a moment’s notice. Even when the mission is complete, you may be alerted for another mission within hours -- it happens!

2. As soon as you complete a sortie or mission, perform the following steps, known as the “**4 R’s**”:

a. REPLENISH

1) After a sortie, ensure you still have all required equipment. If something is missing, see if a team mate has a spare. If not, inform your team leader. He or she might be able to arrange for you to purchase the item before the next sortie. Also replenish anything you used, especially food and water. Don’t be caught without a meal in your field gear and full canteens. Also check things like flashlight batteries, medical supplies, matches, etc. These items can expire, be used up, or (for medical supplies) be damaged and no longer sterile. Inform your team leader if you need certain supplies replenished.

2) After a mission, purchase any replacements you need.

b. REPAIR

1) After a sortie, this means inspecting all your equipment to see what is broken, and making what field repairs you can. This includes repairing rips in clothing, patching holes in ponchos or tents with duct tape, etc. Make the repair now, before you need to use that item. Remove mud from boots, and polish them to maintain water resistance.

2) After a mission, this also means cleaning uniforms and other items. Dirty clothing and sleeping bags do not insulate well. Wet tents can mildew -- set them up and dry them out. Air out your sleeping bag.

c. REPACK -- after the above steps, repack your gear so you can move out at a moment’s notice. Don’t be caught with your equipment spread throughout the house (or your tent at mission base) when the call to move occurs.

d. REST - AFTER you have prepared your gear for the next mission or sortie, get a well-deserved rest. The next sortie or mission could happen at night.

3. Your team leader may also make you responsible for team equipment. Make sure that equipment gets REPLENISHED, REPAIRED, and REPACKED as well before you REST.

Additional Information

More detailed information on this topic is available in Chapter 2 of the Ground Team Member & Leader Reference Text.

Evaluation Preparation

Setup: None

Brief Student: Ask the student to describe how he or she would conduct the “4 R’s” of individual refit after a sortie. Then ask how he or she would conduct the “4 R’s” after a mission.

Evaluation

<u>Performance measures</u>	<u>Results</u>	
1. Describes, in order, how to REPLENISH, REPAIR, REPACK and REST after a sortie.	P	F
2. Describes, in order, how to REPLENISH, REPAIR, REPACK and REST after a mission.	P	F

Student must receive a pass on all performance measures to qualify in this task. If the individual fails any measure, show what was done wrong and how to do it correctly.

O-0003
PREVENT AND TREAT HOT WEATHER INJURIES

CONDITIONS

You are part of a ground team on a mission during on a hot day. Members of your team begin to exhibit symptoms of heat-related injuries.

OJECTIVES

Take steps to prevent hot weather injuries and recognize and treat those that do occur.

TRAINING AND EVALUATION

Training Outline

1. Heat injuries (sometimes called heat stress) are the result of overexertion and dehydration. These conditions can occur at any time during the year, but are most common during the summer months with high temperatures and humidity.

2. To prevent heat stress:

a. Ensure you are drinking enough water per day. Two quarts per day is the absolute minimum on a mild day. On a hot summer day, drink 6-8 quarts a day or 1 quart an hour. Frequent sipping is better than trying to drink an entire quart at a time.

b. Monitor the color of your urine. It should be almost clear in color. If it is brown or dark yellow, you are becoming dehydrated.

c. Wear loose fitting and open clothing.

d. Do not overexert yourself. Know your limits and do not exceed them. Take frequent breaks.

e. Avoid sunburn by using sunscreen or keeping your sleeves down.

f. Watch other members of the team for beginning signs of heat stress. Immediately stop, rest and drink some water. Once a person succumbs to a heat injury, he will not be back for the rest of the day.

g. Use the buddy system -- assign everyone a partner to watch for heat stress and to monitor water intake.

3. There are three major types of heat injuries: heat cramps, heat exhaustion, and heat stroke.

a. Heat cramps are usually the first stage of heat stress. They are the result of dehydration and loss of electrolytes in body tissues.

1). Symptom of heat cramps:

a) Severe muscle cramps, usually in the legs and abdomen.

- b) General Weakness
- c) Sometimes dizziness and faintness.

2) Treatment of heat cramps:

- a) Move the patient to a cool, shady place.
- b) Provide salted water or a commercial electrolyte (i.e. Gatorade).
- c) Massage the cramped area.
- d) Apply some pressure to the cramped area, but stop if it makes the patient more uncomfortable.
- e) Apply moist towels to the patient's forehead and the cramped muscle.
- f) If symptoms worsen, immediately transport the person to a medical care facility.

b. Heat exhaustion is the next phase of heat stress (although some individuals may never develop heat cramps before going into heat exhaustion).

1). Symptoms of heat exhaustion:

- a) Rapid and shallow breathing.
- b) Weak pulse.
- c) Cold and clammy skin.
- d) Heavy perspiration
- e) Weakness and dizziness that may lead to unconsciousness

2) Treatment of heat exhaustion:

- a) Move the patient to a cool, shady place and keep him at rest.
- b) Remove enough clothing to cool (not chill) the patient.
- c) Fan the patient's skin to promote sweat evaporation.
- d) If the patient is conscious, provide salted water or a commercial electrolyte (i.e. Gatorade).
- e) Treat for shock and transport the patient to a medical care facility.

c. Heat Stroke is the final phase of heat stress. It is a life-threatening condition. It is the result of the body's absolute failure to regulate heat, and as a result the body's core temperature starts to rise (hyperthermia).

This leads to the rapid destruction of body tissues and brain cells. Permanent brain damage and death are possible outcomes of heat stroke. Even if successfully treated, it will take days for the patient to recover.

1) Symptoms of heat stroke:

- a) Deep breathing becoming progressively shallower.
- b) A rapid, strong pulse becoming weaker.
- c) Dry and hot skin
- d) Dilated pupils.
- e) Possible unconsciousness, seizures, and muscular twitching.

2) Treatment of heat stroke. The key is to cool the patient as rapidly as possible.

- a) Remove the person from any heat sources and remove clothing.
- b) If possible immerse the patient in cool water, or use cold wet towels or ice packs in the patient's armpits, groin, under neck and behind knees..
- c) Treat for shock and transport the patient to a medical care facility.

Additional Information

More detailed information on this topic is available in Chapter 2 of the Ground Team Member & Leader Reference Text.

Evaluation Preparation

Setup: None

Brief Student: Ask the student to answer the questions listed below, one at a time.

Evaluation

<u>Performance measures</u>	<u>Results</u>	
The individual:		
1. Describes three ways to help prevent heat stress	P	F
2. Describes three signs of heat cramps	P	F
3. Describes three treatment steps for heat cramps	P	F
4. Describes three signs of heat exhaustion	P	F
5. Describes three treatment steps for heat exhaustion	P	F
6. Describes three signs of heat stroke	P	F
7. Describes three treatment steps for heat stroke	P	F

Student must receive a pass on all performance measures to qualify in this task. If the individual fails any measure, show what was done wrong and how to do it correctly.

O-0004

PREVENT AND TREAT COLD WEATHER INJURIES

CONDITIONS

You are part of a ground team on a mission during on a cold day. Members of your team begin to exhibit symptoms of cold-related injuries.

OJECTIVES

Take steps to prevent cold weather injuries and recognize and treat those that do occur

TRAINING AND EVALUATION

Training Outline

1. You are part of a ground team on a mission during on a cold day. Members of your team begin to exhibit symptoms of cold-related injuries. In order to continue your mission, you must treat these injuries and prevent them from happening again.
2. Cold injuries are a result of unstopped cooling of body parts of the whole body. To prevent cold weather injuries, it is essential to remain warm and dry. If the skin is wet, it will lose heat twenty times faster than if it is dry. People who have had cold weather injuries in the past are more likely to have them again.
3. To avoid cold weather injuries.
 - a. Cover all extremities by using gloves, wool socks and a knit hat or hood over your ears.
 - b. Use the layer principle -- several loose layers of clothing keep a person warmer than one bulky item of clothing. The multiple layers trap warm air pockets, which help maintain a uniform body temperature. As you exert yourself and begin heating up, remove layers as needed. Put them back on as you cool down. Layers can include underwear, socks, thermal underwear, sweater or sweatshirt, uniform, field jacket liner, field jacket, knit hat, glove liners and gloves.
 - c. Choose clothing that will trap air pockets yet allow moisture to pass through. Wool, polypropylene and Gore-Tex are good fabric choices that remain warm when wet. Rubber or vinyl coats are extremely bad, as they hold the body's moisture in.
 - d. Avoid getting wet, especially your feet. Stay out of streams and muddy places.
 - e. Avoid overexertion that could cause you to sweat.
 - f. Identify all personnel in your team who have a history of cold weather injuries, and watch them carefully.
 - g. Change clothing when it is dirty or wet, especially socks.
 - h. Use the buddy system -- assign each person a partner. Each pair watches each other for signs of cold weather injuries.

4. The main cold weather injuries of concern to ground teams are frostbite and hypothermia.

a. Frostbite occurs in the body extremities (fingers, toes, feet, hands, tip of nose and ears) when the body part is exposed to intensely cold air or liquid. Freezing of the affected area begins and ice crystals begin forming in the skin. In severe cases, the body tissue dies and gangrene sets in, leading to the loss of the body part. Frostbite usually takes time to develop, but most people are unaware that it has begun. Frostbite occurs in two stages that have different treatments:

1) Early Stage of Frostbite:

a) Symptoms:

(1) Skin turns from red to white and waxy.

(2) Numbness in the affected area

b) Treatment: Warm the affected area using body heat. Hands and feet can be placed in another team member's armpit for warmth. Patient will probably sense tingling or burning in the affected area as it is re-warmed. **DO NOT MASSAGE A FROSTBITTEN BODY PART.**

2) Later Stage of Frostbite (if early stage is not treated)

a) Symptoms: Skin turns mottled or blotchy, yellow, and finally greyish-blue

b) Treatment:

(1) Transport the patient to medical care immediately.

(2) If transport is not immediately available, immerse the affected area in warm (not hot) water until circulation and re-warming occur. Do not let the affected part touch the sides of the container the body part is immersed in. **DO NOT MASSAGE A FROSTBITTEN BODY PART.**

b. Hypothermia is the systemic cooling of the entire body. The body's core temperature falls below average and starts affecting the body's circulatory system. Like frostbite, hypothermia has two stages that require different treatments:

1) Early Stage of Hypothermia:

a) Symptoms:

(1) Uncontrollable shivering.

(2) Numbness.

b) Treatment:

(1) Keep the patient warm and dry.

(2) Remove wet clothing.

(3) Warm the central body before the extremities, to keep blood from flowing away from the major organs. If available, place hot packs on the neck, in the armpits, and in the groin.

2) Later Stage of Hypothermia (if early stage is not treated)

a) Symptoms:

- (1) Drowsiness, inability to perform simple actions.
- (2) Slow pulse and breathing rate.
- (3) Failing eyesight and a “glassy stare.”
- (4) Finally, unconsciousness

b) Treatment:

- (1) All treatment steps for early hypothermia
- (2) Handle the patient gently, and place in a head-down position.
- (3) Transport the patient to medical care immediately.

Additional Information

More detailed information on this topic is available in Chapter 2 of the Ground Team Member & Leader Reference Text.

Evaluation Preparation

Setup: None

Brief Student: Ask the student to answer the questions listed below, one at a time.

Evaluation

<u>Performance measures</u>	<u>Results</u>	
1. Describes three ways to help prevent cold injuries	P	F
2. Explains the layer principle	P	F
2. Describes two signs of early frostbite	P	F
3. Describes the treatment for early frostbite	P	F
4. Describes the sign of late frostbite	P	F
5. Describes two treatment steps for late frostbite	P	F
6. Explains that you never massage a frostbitten body part	P	F
7. Describes two signs of early hypothermia	P	F
8. Describes three treatment steps for early hypothermia	P	F
9. Describes two signs of late hypothermia	P	F
10. Describes three treatment steps for late hypothermia	P	F

Student must receive a pass on all performance measures to qualify in this task. If the individual fails any measure, show what was done wrong and how to do it correctly.

O-0005
INSPECT TEAM MEMBERS

CONDITIONS

You are a team leader, and your team is about to depart for a sortie.

OBJECTIVE

Inspect your team members for appearance, safety, and mission readiness.

TRAINING AND EVALUATION

Training Outline

1. It is the team leader's responsibility to ensure his personnel are equipped to perform their job safely and effectively. Although gear purchase is an individual's responsibility, the team leader has the authority to restrict any team member from participating because of uniform or equipment problems. A team member missing critical items, or with unserviceable equipment, might be unsafe, become a burden to his team, or an embarrassment to the Civil Air Patrol.

a. Inspections in the field cannot be as lengthy as a full gear layout (see tasks O-0001 and O-0010). Instead the leader should only inspect those critical items necessary for the performance of the mission, the member's safety, and his appearance.

b. Asking a team member if he is carrying a meal is not an inspection. The leader should ask to see the thing he is inspecting. This eliminates misunderstandings, or memory errors

2. The best way to inspect a unit is to line them up, and announce what items you are going to inspect. That way, they can get the items out before you get to them, which speeds the process up

3. As you inspect, you check each item for *serviceability*. Having a flashlight is good. Having a *working* flashlight much better. Don't assume that compasses point to north, that canteens are full, or that medication is not four years old and stale. Check these things.

4. Utilize the published minimum equipment list to complete the following inspection checklist:

a. Safety -

1) Adequate clothing, food and water. (remember to check orange vests for ground teams and appropriate uniforms for UDF team members)

2) Documentation for any allergies or medical problems? Any medication he needs.

3) Adequate survival equipment in case he gets lost.

4) Is the member overloaded?

5) Is the member sick or fatigued?

b. Mission readiness.

1) The equipment needed for this mission (for example, a flashlight and extra batteries for night work, or marking tape for line searches).

2) Is all equipment secured on the person, without excess straps hanging off? Is the person's load balanced for hiking?

3) Current CAP ID Card, CAPF 101, first aid card, communications certification, State Driver's license and CAP driver's license (if applicable).

c. Appearance.

1) Is the member in a complete, clean and serviceable uniform?

2) Has he shaved, washed, etc.?

5. If you find problems, you have to decide how to deal with them. For example, you might be able to find a meal for a team member who doesn't have one. You might not let the team member with an unsightly uniform man a crash site surveillance post in full view of the public, but perhaps he could monitor the radio in the vehicle. But if it is a safety issue, it is your responsibility not to let the team member participate where he could be injured.

Additional Information

More detailed information on this topic is available in Chapter 2 of the Ground Team Member and Leader Reference Text.

Evaluation Preparation

Setup: Provide one member in uniform with appropriate equipment. Ensure there are at least 5 discrepancies from the above categories in the member's uniform or equipment (at least three should be in the equipment).

Brief Team Leader: Tell the team leader to inspect the member, and tell you what problems he finds. Tell him what sort of sortie the member is about to participate in. After the team leader notes the discrepancies, ask him if he would take this team member on the sortie.

Evaluation

<u>Performance measures</u>	<u>Results</u>	
1. The team leader identifies 4 of the five uniform/equipment discrepancies	P	F
2. The team leader correctly determines if the team member can participate in the sortie, and if any corrective actions are needed.	P	F

Student must receive a pass on all performance measures to qualify in this task. If the individual fails any measure, show what was done wrong and how to do it correctly.

O-0006
INSPECT TEAM EQUIPMENT

CONDITIONS

You are a team leader, and your team is about to depart for a sortie.

OBJECTIVE

Inspect your team equipment for appearance, safety, and mission readiness.

TRAINING AND EVALUATION

Training Outline

1. Prior to departing for mission base, you should inspect your team's equipment. This inspection is conducted to ensure that all required team equipment is present and functioning properly. This is especially important for team gear:

a. Utilize the team equipment list provided by your wing to assess your team's equipment capability.

b. As you perform the inspection, check for the *serviceability* of items. Make sure items work by testing them. If the distress beacon Direction Finder has no batteries, it is worthless. Make sure you check team radios to make sure they can transmit and receive.

2. To perform an inspection,

a) Announce what you are inspecting, and have your team get the items out ahead of time. For example, if you have two vehicles and you are checking fire extinguishers, have the drivers pull the extinguishers out and show them to you.

b) Make sure you see the items yourself. Don't just ask someone if they have something. They could make a mistake, or not know that someone else has taken or broken the item.

c) Determine what equipment is mission critical, and pay special attention to it. For example: maps of the search area, the distress beacon DF for aircraft searches, etc.

d) Inspect for accountability and serviceability - do you have it, and does it work.

e) Use the following checklist, or your wing's equipment list.

GROUND TEAM EQUIPMENT LIST

MANDATORY EQUIPMENT

Vehicle- Mounted FM transceiver
Handheld FM transceiver
Signal Panels, (2'x6'), 6
Water, 5 gallons
Blood Borne Pathogen Kit (s)
Shovel/E-Tool
Camera with film (instant preferred, 35mm acceptable)

MISSION KIT

CAPF-78, 5
CAPF-106, 25
CAPF-109, 10
ICSF 214, 10
Road Map
Aeronautical Sectional Chart
Ground and UDF Team Task Guide

DISTRESS BEACON-DF KIT

Direction Finding Unit With Antennas
1/4 Wave Vehicle Antenna
Rubber Or Telescoping Antenna
Spare Batteries, Tools To Install Them

CRASH SITE SURVEILLANCE KIT

Staple Gun with Spares
Warning Placards, 20
Binoculars
Instant Camera
Barrier Tape, 500 meters

FIRST AID KIT

Backpack-Type Bag
4"X4" Gauze Pads, Wrapped, 25
Eye Pads, Wrapped, 5
Trauma/Combine Dressings, 10
Triangular Bandages, 10
Kling Roll Bandage, 3 And 6", 10
Handi-Wipes/Alcohol Pads
Latex Gloves
Antiseptic Swabs, 20
Adhesive Tape, 1" X 10 yd, 2
Adhesive Tape, 2" X 10 yd, 2
Triage Tags, 10 (opt.)
Notepad, Pencil
Cold Packs, 4 (opt.)
Hot Packs, 4 (opt.)
BP Cuff, Stethoscope (opt.)
Bandage Scissors (opt.)
Forceps (opt.)
Utility Scissors
Penlight

ADVANCED EQUIPMENT

Litter, stokes or folding
Spotlight, vehicle
Cyalume Lightsticks
Global Positioning System
Tape Recorder
Public Address System
Radiological Monitoring Kit
Night Vision Devices
Nylon Rope, 1/2"x100'
Generator/light Set

URBAN DF TEAM EQUIPMENT LIST

Vehicle-Mounted FM transceiver, Handheld FM transceiver, or Cellular Phone
Signal Panels, (2'x6'), 6 (Optional)
Camera with film (instant preferred, 35mm acceptable, Optional)
Appropriate local Maps and Charts
Ground and UDFT Task Guide
Flashlight with spare batteries
Spare Notepad with pens/pencils
Direction Finding Unit With Antennas
1/4 Wave Vehicle Antenna
Rubber Or Telescoping Antenna
Spare Batteries for DF unit and Tools To Install Them
Global Positioning System (Optional)

3. If mission essential items are missing or broken, try to borrow one from another team or purchase new equipment immediately. If the lack of the item might hinder the mission, let the Ground Branch know.

Additional Information

More detailed information on this topic is available in Chapter 2 of the Ground Team Member and Leader Reference Text.

Evaluation Preparation

Setup: Inventory a team vehicle, and determine what is missing and unserviceable. Provide the team member with a vehicle loaded with team equipment, and the gear checklist. Provide a driver who knows where everything is located.

Brief Team Leader: Tell the team leader to inspect the team equipment and determine what is missing or unserviceable.

Evaluation

<u>Performance measures</u>	<u>Results</u>	
1. The team leader determines what items are missing	P	F
2. The team member checks all items, especially electrical items, for serviceability	P	F
3. The team member determines what items are unserviceable	P	F

Student must receive a pass on all performance measures to qualify in this task. If the individual fails any measure, show what was done wrong and how to do it correctly.

DIRECT TEAM REFIT AFTER SORTIE

CONDITIONS

You are a ground team leader of a team that has just completed a sortie and returned to mission base.

OBJECTIVES

Correctly identify and explain the steps taken to prepare yourself for the next sortie or mission, using the “4 R’s”:

TRAINING AND EVALUATION

Training Outline

1. The minute a sortie is completed, the team must begin preparing for the next sortie. This means taking care of team equipment, individual equipment, and team members’ personal needs. There is a great temptation after a hard day in the field to not worry about your equipment for a while. But on a mission, you must be prepared to leave on another sortie at a moment’s notice. As team leader, you must direct refit actions, and inspect to ensure these actions are completed.

2. As soon as you complete a sortie or mission, while you are going to debrief, you should direct your team to begin refit according to the “4 R’s”. Each person refits their individual gear. You should assign individuals to refit items of team gear. Give specific tasks to specific people - don’t assume “somebody will do it”.

a. **REPLENISH** - Replacing lost or used up items.

1) Team Equipment: After a sortie, ensure you still have all required equipment. Use your copy of the Ground Team Resource form to inventory team gear. If something is missing, see if another team has a spare. Refill water cans, check batteries, fuel vehicles, replace medical supplies, etc. Make a list of those items you need to purchase or acquire.

2) Individual equipment - Each person checks their own equipment, fills canteens, puts a new meal in their field gear etc. They should inform you of items they have lost, or cannot replenish.

b. **REPAIR** - inspecting items for serviceability and making what field repairs you can.

1) Team Equipment - check any item you used. Clean vehicle windows and headlights.

2) Individual Equipment. This includes repairing rips in clothing, patching holes in ponchos or tents with duct tape, etc. Remove mud from boots, and polish them to maintain water resistance.

c. **REPACK** - after the above steps, repack your team and individual gear so you can move out at a moment’s notice. Don’t be caught with your equipment spread throughout the house (or your tent at mission base) when the call to move occurs.

d. **REST** - AFTER you have inspected your team to make sure refit is complete, ensure they are resting. The next sortie or mission could happen at night. Keep track of where your team members are, so you can assemble them quickly when needed.

Additional Information

More detailed information on this topic is available in Chapter 2 of the Ground Team Member and Leader Reference Text.

Evaluation Preparation

Setup: Prepare a Ground Team Resource Form to represent a fictional 8 person, 2 vehicle ground team. Give it to the team leader.

Brief Team Leader: Tell the team leader that he has just returned from a search sortie with this team. Ask the team leader brief you on his plan for refit. Then ask him what he would do when the refit tasks are complete.

Evaluation

Performance measures

Results

The individual:

- | | | |
|--|---|---|
| 1. Describes, in order, how to REPLENISH, REPAIR, REPACK and REST after a sortie. | P | F |
| 2. Gives responsibility for specific items of team equipment to specific personnel | P | F |
| 3. States and describes what he will inspect before beginning the REST activity. | P | F |

Student must receive a pass on all performance measures to qualify in this task. If the individual fails any measure, show what was done wrong and how to do it correctly.

O-0010
PREPARE URBAN DF TEAM INDIVIDUAL EQUIPMENT

CONDITIONS

You are a member of a urban DF team at home prior to a mission.

OBJECTIVE

Collect and efficiently pack all items required of a urban DF team member. The enclosed list is the suggested national list. Wings may have supplemented this list to suit their environment with national approval, so be sure to use your approved wing list.

TRAINING AND EVALUATION

Training Outline

1. Your individual equipment is designed to keep you functional in the field and to help you do your job. Urban DF Teams are not expected to go off road or stay overnight in the field, but they do need to have certain tools available to do their job in an appropriate manner.

2. The gear list below is the minimum required equipment. Items required of trainees are marked with a "T." You may carry additional equipment if you would be added on to a full ground team at a later time but remember, you may have to walk a long way carrying it all.

a. On your person:

- 1) Complete uniform appropriate to the environment in which you will be working. (T)
- 2) Notepad and pencil (T)
- 3) All CAP Identification, including 101 card, 76 card, First Aid card, etc. (T)
- 4) Watch (T)
- 5) Handkerchief or Tissues
- 6) Vest, reflective, orange (T)
- 7) Comb or brush (optional, carry if needed) (T)
- 8) Ground and UDF Team Task Guide (T)
- 9) Flashlight (with red or blue lens), with spare bulb and batteries
- 10) Change for phone calls, calling card, or cellular phone (T) to call mission base
- 11) Compass, lensatic or orienteering (orienteering preferred). Compass should have a "glow in the dark" dial.
- 12) Protractor -- for map work.
- 13) Map Case (Large Zip-Loc bags can be used if necessary)
- 14) Pencil, with eraser (plus sharpener if not a mechanical pencil)
- 15) Alcohol Pens, fine tip, at least 2 colors (neither the color of your colored flashlight lens)
- 16) Some way to erase alcohol pens marks on the map case, such as alcohol swabs or a special alcohol pen eraser.
- 17) A straightedge ruler, at least 6" long (Some protractors may have a ruler as well).
- 18) One Meal or personal funds to purchase a meal while prosecuting the mission if appropriate.

(T)

Additional Information

More detailed information on this topic is available in Chapter 2 of the Ground Team Member & Leader Reference Text.

Evaluation Preparation

Setup: None

Brief Student:

1. Tell the student to lay out his gear. Tell him to lay out all items in the order listed on the above list, in rows from left to right (except for the uniform the member is wearing, of course). Inspect all items for presence and serviceability.
2. After inspection of all items, tell the student to reassemble his/her equipment and put it on.

Evaluation

Performance measures

Results

The individual:

1. Has all required items.

P F

NOTE: ALL REQUIRED ITEMS MUST BE PRESENT IN ORDER FOR THE STUDENT TO PASS THIS TASK. ALL ITEMS MUST MATCH THE DESCRIPTIONS LISTED ABOVE. NO EXCEPTIONS OR SUBSTITUTIONS. TRAINEES ONLY HAVE TO HAVE THE ITEMS MARKED WITH A "T".

Student must receive a pass on all performance measures to qualify in this task. If the individual fails any measure, show what was done wrong and how to do it correctly.

O-0101
IDENTIFY NATURAL HAZARDS

CONDITIONS

You are part of a ground team moving through the wilderness.

OBJECTIVES

Recognize and avoid the various types of natural hazards.

TRAINING AND EVALUATION

Training Outline

There are three categories of natural hazards: terrain, plants and animals.

1. Terrain

- a. Cliffs and steep terrain. These can often be identified on maps by closely spaced contour lines. Choose routes around these features. If you must search the area, search parallel to the slope, rather than climbing or descending it.
- b. Drainage and flood areas. These are sometimes marked on maps. Avoid moving through these areas. If the search requires you, ensure your team is properly dressed, and exercise extreme care.
- c. Rough terrain, such as boulder fields. You will often have to search through these areas. Slow your rate of movement to allow all team members to exercise proper caution.

2. Plants. Search teams can avoid most poisonous plants simply by not eating any berries or wild plants. There are, however, "irritant" plants that can affect team members who touch them. All three can cause an irritating rash that may take one to three days to develop.

- a. There are three irritant plants -- poison ivy, poison oak, and poison sumac:

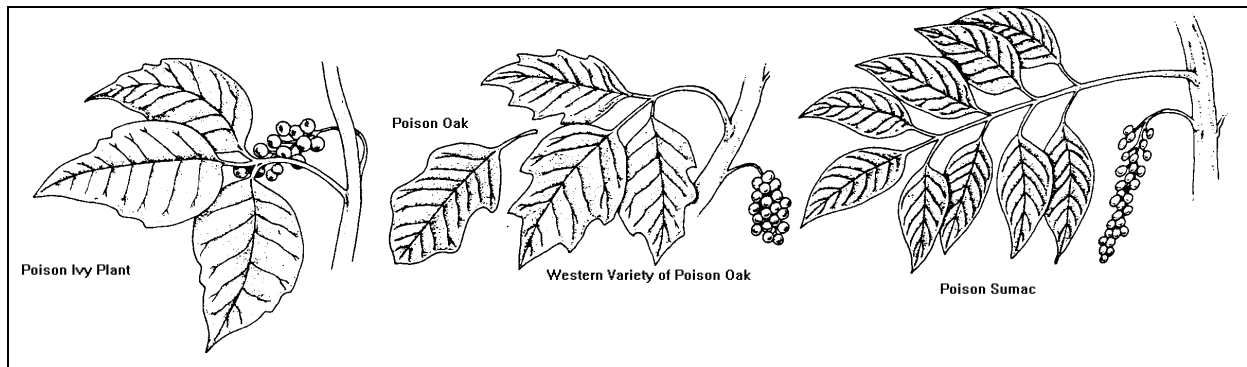

1) Poison ivy is an irritant vine that grows close to the ground and along the trunks of trees. The vine has green almond shaped leaves in sets of three, and is prevalent in the spring through the fall.

2) Poison oak is very similar to poison ivy, with green, three leafed vines. However the leaves are broader and flatter.

3) Poison sumac is a similar plant, but the leaves can come in sets of nine to ten or more and there are small red berries attached to the plants.

b. To avoid exposure to these plants:

1) Cover exposed skin when in the woods (long sleeves, gloves, etc.).

2) Do not handle any plants or vines unnecessarily.

3) To avoid poison ivy and oak, remember the adage “IF LEAVES ARE THREE, LET THIS PLANT BE.”

4) If you are exposed to one of these plants, wash the affected area thoroughly to remove any resin from the plant on the skin. If you have resin on your clothes, change them as well.

3. Animals. Ground teams avoid any animals in wilderness areas.

a. There are certain animals that do represent a direct hazard to humans who disturb them.

1) Rodents. Raccoons, skunks, squirrels, rats and possums fall into this category. The main danger from these animals is that they carry rabies. In addition, skunks will use its scent sprayer if cornered.

a) Identification: All are four legged, small and furry. Skunks are black with a white stripe down the length of their backs.

b) Avoidance:

(1) Do not put your hands or feet under logs or into holes where these animals may have nests.

(2) Give all small, furry animals a wide berth. Do not attempt to pet, feed or provoke any animal in its own habitat.

2) Insects. Bees, wasps, mosquitoes, and fire ants are stinging insects that tend to plague searchers in the wilderness. To avoid these insects :

a) Be watchful for bees' and wasps' nests and fire ant hills, and do not disturb them.

b) Dispose of trash properly to avoid attracting insects.

c) If you are allergic to bees stings, carry your medication and ensure everyone on your team is aware of your condition and where your medication is.

d) The only way to avoid mosquitoes is with an appropriate insect repellent. Apply repellent to all areas of exposed skin, especially around wrists, ankles, arms, legs and neck. Do not spray repellent directly on your face; instead spray it on your hands and rub it on your face. Be careful with repellent on your forehead - sweat can make it drip into your eyes. You can spray repellent to the brim of your hat instead of your forehead.



Fire Ant



Honey/Bumble Bee



Wasp

3) Spiders. Spiders tend to be more of a nuisance than a danger. Only two spiders in North America are considered poisonous - the Black Widow and the Brown Recluse. The bite of either of these spiders is painful but rarely fatal. Approximately 5% of the population will have an allergic reaction to the bite and a few people may develop shock. Hypersensitive people will develop anaphylactic shock that can become life threatening.

a) Identification: The black widow is a ground dwelling spider found mostly in the Western United States. It is black with a yellow-orange hourglass marking on its underside. The brown recluse another ground dwelling spider. It is furry and brown, with a dark fiddle-shape mark on it's back right between the eyes.

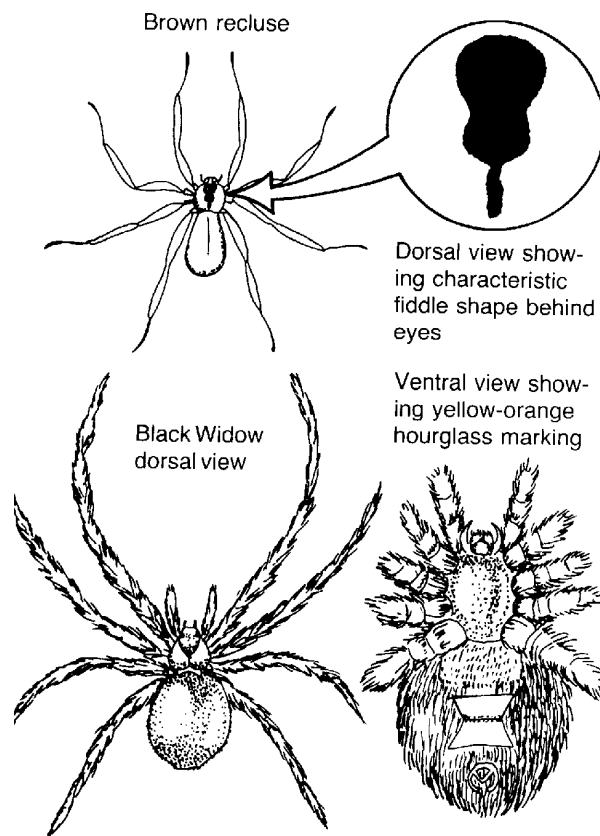

Identification of Brown Recluse and Black Widow.

b) Avoidance:

(1) Don't put your hands anywhere you haven't looked first.

(2) Avoid contact with all spiders.

4) Snakes. Approximately 50,000 people per year are bitten by snakes in the US, with poisonous snakes accounting for 15% of these bites. Even with over 7,500 poisonous snake bites per year, fewer than 10 people die per year (less than the number from bee and wasp stings). There are two kinds of poisonous snakes in the US: pit vipers and neurotoxic snakes. Pit vipers are distinguished by the small pit in the snake's head directly between the eyes. This pit is essentially a heat sensor that the snake uses to find warm-blooded creatures. Pit vipers have long fangs, that are used to bite and inject poison into the victim. The poison is carried by the blood to other body tissues. Neurotoxic snakes are similar, but their poison affects the nervous system rather than the blood stream.

a) Identification. In the US, there are three common types of pit vipers (water moccasins, rattlesnakes, and copperheads) and one neurotoxic snake (coral snake):

(1) Water Moccasins. Water moccasins are dark snakes often called cottonmouths because of the bright white interior of their mouths when fully opened. They are usually found in lakes, ponds, swamps, and rivers.



Cottonmouth / Water Moccasin

(2) Rattlesnakes. Rattlesnakes are usually dark or brown snakes noted for the rattle on the tail. The rattle is used to distract prey or as a warning when the snake is cornered. It can be easily heard when you get close to the snake. They are also known as diamondbacks because of the colored patterns formed on their backs.

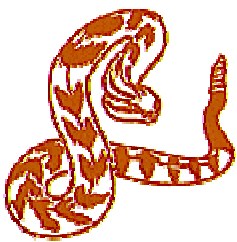

Canebrake Rattlesnake

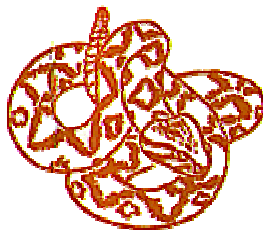

Eastern Diamondback Rattlesnake

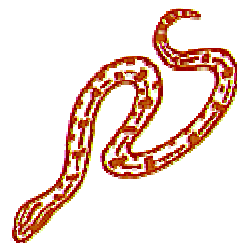

Pigmy Rattlesnake

(3) Copperheads. Copperheads are brown-orange in color with alternating bands of color along their backs. Frequently, a strong "cucumber" smell is noted in the area.



Copperhead Snake



Copperhead Snake Closeup

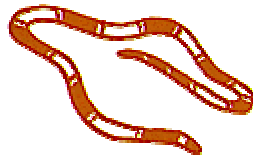

(4) Coral Snakes. Coral snakes are small, with alternating black and red-orange bands along their length, separated by thin yellow bands. Its mouth is small, usually only wide enough to bite on a finger or a two.

Coral Snake

b) Avoidance:

(1) Avoid putting your hands and feet anywhere you haven't visually inspected, especially holes or under rocks and logs.

(2) Wear leather boots and gloves.

Additional Information

More detailed information on this topic is available in Chapter 4 of the Ground Team Member & Leader Reference Text.

Evaluation Preparation

Setup: Obtain pictures (preferably color) of at least one hazardous plant, five hazardous animals, and a drawing/picture of a hazardous terrain feature.

Brief Student: Show the student the pictures, one at a time, and ask him to identify the hazard, and give two ways of avoiding it.

Evaluation

<u>Performance measures</u>	<u>Results</u>	
1. Correctly identifies 6 of the seven pictures	P	F
2. For at least 6 of the pictures, identifies two ways of avoiding each hazard	P	F

Student must receive a pass on all performance measures to qualify in this task. If the individual fails any measure, show what was done wrong and how to do it correctly.

O-0102
PREVENT AND TREAT FATIGUE

CONDITIONS

Given a scenario in which the individual has been operating in the field for some time.

OJECTIVES

Recognize and react to fatigue symptoms in yourself and others.

TRAINING AND EVALUATION

Training Outline

1. Search and rescue operations are frequently conducted in adverse weather and terrain conditions and at night. These are all conditions that will accelerate fatigue in individual team members and leaders. At a minimum, team member fatigue results in reduced search effectiveness due to a lack of concentration. More serious results are endangering yourself and others in the field. Vehicle operators are especially susceptible to fatigue, sometimes with tragic results. The chances of field injuries are also greatly increased.

2. Fatigue symptoms should be recognized by all team members. Recognize them in yourself and others so that you know when you have to stop and rest. Some symptoms are:

- a. Inability to concentrate.
- b. Slurring words, incomplete sentences and speech patterns.
- c. 'Bloodshot' eyes and haggard expressions
- d. Inability to walk properly.
- e. Drooping eyelids.
- f. False energy or 'slap happiness'.

Individuals showing these signs are ineffective as searchers and represent dangers to themselves and other

3. Ways of preventing or relieving fatigue are:

- a. Taking frequent breaks or catnaps when not on duty.
- b. Eating light snacks through the day.
- c. Changing seating arrangements in vehicles regularly.
- d. Ensuring that team members sleep for as long as possible during the night or when off duty (at least 6 to 8 hours per night).
- e. Eating complete meals and ensuring adequate water intake.
- f. Sit, lay down, rest, sleep whenever possible.

g. Do not engage in unnecessary physical activity when waiting for an assignment.

h. Use the buddy system - assign members in pairs. Each member of the pair watches the other for signs of fatigue.

i. If a member of the team shows signs of fatigue, take them off duty and allow them to rest until they can be effective searchers.

Additional Information

More detailed information on this topic is available in Chapter 4 of the Ground Team Member & Leader Reference Text.

Evaluation Preparation

Setup: None

Brief Student: Ask the student to identify four fatigue symptoms, and three ways to relieve fatigue.

Evaluation

<u>Performance measures</u>	<u>Results</u>	
1. Identifies four fatigue symptoms	P	F
2. Identifies three ways to relieve fatigue	P	F

Student must receive a pass on all performance measures to qualify in this task. If the individual fails any measure, show what was done wrong and how to do it correctly.

O-0103
CONDUCT FIELD SANITATION AND HYGIENE

CONDITIONS

You are part of a ground team on an extended mission in the field.

OJECTIVES

Throughout the mission, take measures for:

1. Care of the feet.
2. Avoiding unpurified water.
3. Proper disposal of waste.
4. Proper personal hygiene.

TRAINING AND EVALUATION

Training Outline

1. Proper field sanitation and hygiene will keep you and your team healthy while living and working in the field. If you become sick or injured, you are incapable of doing your job and become a burden on your team.
2. Taking Care of the Feet. As a ground team member, your feet are your primary mode of transportation. If they are not functioning, you cannot function. While anyone can walk in the woods for a while, extended operations require you to actively take care of your feet.
 - a. Before Movement.
 - 1) Make sure your boots are correctly fitted and broken in. Do not wear new boots to the field.
 - 2) Make sure your socks are clean, fitted, and free of holes and knotty darns that might rub your foot raw. Always bring extra socks and foot powder.
 - 3) Treat and protect blisters, pressure spots and infections before each sortie.
 - b. During Movement.
 - 1) Keep your feet as dry as possible. Never walk in water or mud if you can avoid it. It takes days for boots to dry out fully.
 - 2) Change damp or dirty socks as soon as possible.
 - 3) Dust your feet with foot powder to keep them dry.

4) If your feet begin to bother you, adjust your socks and boot lacing to relieve pressure on sensitive spots.

c. Blisters. If you get a blister, clean it with soap and water. Watch for signs of redness, throbbing and drainage. If this occurs, seek medical treatment.

2. Avoid unpurified water, Only drink and fill canteens from known pure water, such as from a faucet. Anything else can make you very sick. Avoid all streams and lake water. If you must purify water, get your team leader's approval and follow the instructions on whatever water purification chemicals you use (NOTE: This is as a last resort only).

3. Waste Disposal. One of the quickest ways to make you and your team sick is to improperly dispose of garbage or human waste. If this material ends up in someone's food or water, it can incapacitate everyone who ingests it. In addition, waste can draw disease carrying insects and wild animals.

a. Human Waste. Whenever possible, use bathrooms/latrines. If none are available, then dig a "cat hole" at least one foot deep. Make sure the hole is at least 100 yards down wind from any bivouac site. Also make sure your hole is not uphill from the bivouac to avoid drainage problems. After use, fill the hole back in.

b. Garbage. Only put garbage in designated trash cans and bags. If none are available, seal your garbage in plastic bags and pack it out of the field.

c. Cooking Gear. If you use reusable utensils, mess kits, canteen cups, etc., wash them with hot water and soap after each use.

4. Personal Hygiene:

a. Brush your teeth at least once a day, preferable after every meal.

b. Whenever water is available, wash your hands after using the latrine and before every meal.

Additional Information

More detailed information on this topic is available in Chapter 4 of the Ground Team Member & Leader Reference Text.

Evaluation Preparation

Setup: This task is tested over the course of an overnight field exercise. The exercise should include at least two miles of dismounted movement. You should observe the students over the course of the exercise and evaluate them at the conclusion of the exercise. Anything not directly observed (such as the use of a cathole) should be evaluated through oral questioning.

Brief Student: Inform the individuals to be tested that they will be evaluated over the course of the next 24 hours on their ability to conduct field sanitation and hygiene.

Evaluation

<u>Performance measures</u>	<u>Results</u>	
The individual:		
1. Takes proper care of feet:		
a. Before movement	P	F
1) Makes sure boots are properly fitted.		
2) Makes sure boots are broken in (not new boots)		
3) Wears clean socks, free of holes and knotty darns.		
b. Takes proper care of the feet during movement	P	F
1) Keeps feet as dry as possible.		
2) Changes damp socks.		
3) Dusts feet lightly with foot powder.		
4) Adjusts footgear to relieve the tender spots on the feet		
c. Takes care of blisters:	P	F
1) Washes the blister and surrounding area with soap and water.		
2) Seeks medical treatment for painful blisters or signs of infection, such as redness, throbbing and drainage.		
2. Avoids unpurified water whenever possible. If forced to use such water, checks with the team leader and then correctly purifies the water in accordance with the water purification tablet instructions.	P	F
3. Properly disposes of waste:		

- | | | |
|---|---|---|
| a. Properly uses cat holes to dispose of human waste. | P | F |
| 1) Digs at least one foot deep and fills it in afterwards. | | |
| 2) Digs hole at least 100 meters, downwind, and not uphill from the bivouac site. | | |
| b. Disposes of garbage only in designated containers. Otherwise, packs out all garbage in waterproof bags. | P | F |
| c. Washes all utensils, cups, mess kits, etc. with hot water and soap after use. | P | F |
| 4. Practices personal hygiene: | | |
| a. Brushes teeth daily | P | F |
| b. When water is available, washes hands after using the latrine and before eating. If not available, uses alternative method like alcohol prep pads. | P | F |

Student must receive a pass on all performance measures to qualify in this task. If the individual fails any measure, show what was done wrong and how to do it correctly.

O-0104
SETUP SHELTER

CONDITIONS

You are a member of a ground team required to spend the night in the field. You have your field and base gear with you.

OJECTIVES

Setup a shelter considering the terrain and weather within 30 minutes.

TRAINING AND EVALUATION

Training Outline

1. Protecting yourself from the elements when remaining overnight in the wilderness should be a primary concern. The shelter should be placed and constructed to protect you from wind, water, and ground obstacles. Taking the time to ensure that you will have a relatively comfortable night's sleep will make you more alert and efficient for the next day's activities.

2. Shelter site preparation

a. Clear the entire area under the shelter to the bare ground. Remove any rocks, pebbles, branches or roots in the area. If they cannot be removed, find another site. Small bumps under your back at dusk will feel like boulders by dawn. Also check for wildlife such as snakes or insects that might already be there. This will prevent a nasty surprise in the middle of the night.

b. In order to preserve warmth, it is strongly suggested that you re-cover the shelter site with loose leaves, pine needles, etc. and cover with a tarp. A good layer of leaves will act as a mattress and insulation. Remember your body heat is being transferred to the earth while you are sleeping, not the other way around. Insulation will keep you warm and comfortable overnight.

c. Point the opening of the shelter away from or broadside to the wind when constructing it. This will prevent a 'ballooning' effect when the wind gusts. It will also prevent rain from being blown into the shelter opening and onto you.

d. Always suspect heavy rains overnight. Ensure that your shelter is on high ground, not in a dry wash or gully. Dig a four inch deep trench around the perimeter of your shelter with an additional runoff trench pointing down hill. Flowing water will go into the trench and around your shelter instead of under or through it.

Additional Information

More detailed information on this topic is available in Chapter 4 of the Ground Team Member & Leader Reference Text.

Evaluation Preparation

Setup: Ensure the student has his base and field gear. If two students share a shelter, test them together. The students may use any item in his field gear, including this manual, while being tested.

Brief Student: Tell the student to choose a spot nearby and correctly set up their shelter.

Evaluation

<u>Performance measures</u>	<u>Results</u>	
The individual:		
1. Identifies the wind direction in the shelter area	P	F
2. Builds an adequate trench around shelter	P	F
3. Ensures adequate drainage by choosing high ground or digging a trench	P	F
4. Builds shelter with opening away from wind	P	F
5. Completes all steps within 30 minutes (45 if a trench was dug)	P	F

Student must receive a pass on all performance measures to qualify in this task. If the individual fails any measure, show what was done wrong and how to do it correctly.

O-0201
USE A COMPASS

CONDITIONS

Given a compass, the magnetic azimuth and distance to a destination point. Your team has been given a point to travel dismounted. You have been designated the compass person. Or, you spot an object in the distance and want to know the azimuth to that point.

OJECTIVES

1. Successfully give the magnetic azimuth to a distant object +/- 5 degrees within 2 minutes.
2. Successfully move at least 600 meter's distance along the azimuths given with enough accuracy to find coffee-can sized targets suspended at eye level within 45 minutes.

TRAINING AND EVALUATION

Training Outline

1. There are two techniques to holding and determining an azimuth with a compass: the Centerhold Technique and the Compass-to-Cheek Technique.

a. The Centerhold Technique can be used with lensatic or orienteering compasses.

1) If you have a lensatic compass, open it up to its fullest so the cover forms a straightedge with the base. Then move the lens (rear sight) to the rearmost position to allow the compass dial to float freely.

2) Hold the compass at waist level, with your elbows firmly against your sides, with your hands in the position shown below:

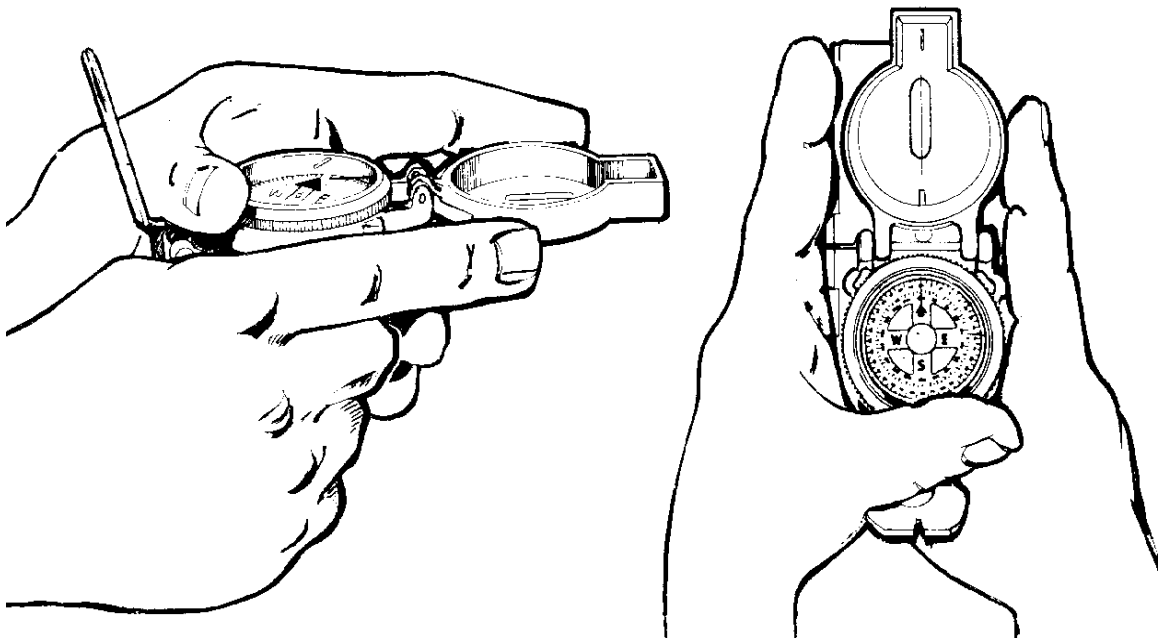

The centerhold technique used with a lensatic compass. You can hold an orienteering (Silva compass) the same way.

3) To use a lensatic compass while holding it this way, simply look down and read the number under the black reference line. This is the azimuth of the direction you index fingers are pointing.

4) To use an orienteering compass while holding it this way, rotate the compass dial until the “N” is under the needle while pointing at the target with your index fingers. Then read the dial number aligned with the “read bearing here” line. This is the azimuth of the direction you index fingers are pointing.

b. The Compass-to-Cheek Technique is typically used with a lensatic compass, though some newer orienteering compasses have sighting lenses and reference lines as well.

1) Hold the compass as shown below.

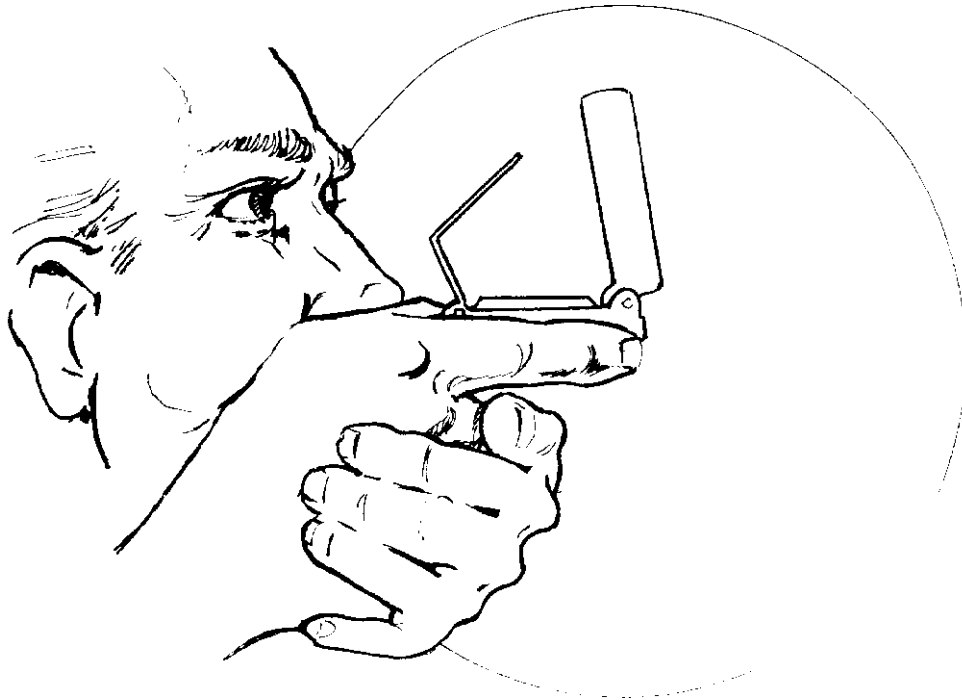

2) To use the compass when holding it this way, look through the rear sight notch and align the front sighting wire with your target. Look down through the lens one rear sight and read the number under the black reference line. This is the azimuth of the direction you are sighting.

3) This technique can be more accurate, but takes longer. If you are wearing metal glasses, they may affect the compass when held this close to your face.

2. Following an azimuth with a compass (Daylight).

a. With a lensatic compass:

1) Use the centerhold technique.

2) Rotate your body until the desired azimuth fall under the fixed black index line.

3) Turn the bezel ring until the luminous line is aligned with the north-seeking arrow. Once you obtain alignment, the compass is preset.

4) To follow an azimuth, keep the north seeking arrow aligned with the luminous line. Look along the way your fingers are pointing, and pick out a distinctive terrain feature along the azimuth and walk toward it. Occasionally recheck the compass to ensure the north seeking arrow is still aligned with the luminous line.

b. With an orienteering compass.

1) Turn the compass dial until the desired azimuth is aligned with the “Read Bearing Here” line.

2) Use the centerhold technique.

3) Rotate your body until north seeking arrow is aligned with the “N” on the compass dial.

4) To follow an azimuth, keep the north seeking arrow aligned with the “N” on the compass dial. Look along the way your fingers are pointing, and pick out a distinctive terrain feature along the azimuth and walk toward it. Occasionally recheck the compass to ensure the north seeking arrow is still aligned with the “N” on the compass dial.

3. Following an azimuth with a lensatic or orienteering compass at night is the same as daytime, except you cannot normally use terrain features for reference as you walk. Simply:

1) Use a flashlight to set the appropriate azimuth as listed under daylight compass work (above). Use a red or blue lens to avoid night blindness.

2) To follow an azimuth:

a) Orienteering Compass: To follow an azimuth, keep the north seeking arrow aligned with the “N” on the compass dial. This only works if the arrow and the “N” are luminous.

c) Lensatic Compass: To follow an azimuth, keep the north seeking arrow aligned with the luminous line.

3) Occasionally “recharge” the luminous marks by cupping your hand around a white light flashlight and the compass dial, ensuring the compass gets the light without blinding any team members.

4. At all times avoid metal objects and electrical sources. These can affect compass accuracy. The following safe operating distances are suggested:

a. High Tension Power Lines -- 55 meters.

b. Vehicles -- 10 meters

c. Telephone poles or metal fences -- 10 meters.

Additional Information

More detailed information on this topic is available in Chapter 5 of the Ground Team Member & Leader Reference Text.

Evaluation Preparation

Setup:

1. Before the student arrives. Choose a wooded area where a course can be established that is at least 600 meters long. Choose a start and a finish point and turning points along the course as necessary, and determine the magnetic azimuth and distance between them. Hang a brightly covered coffee-can or similar object at eye level at the destination point and other turn points on the course. Mark the can with a large letter or number. Hang at least three other cans with different numbers at least 100 meters away from the actual destination point. Choosing a distant terrain feature that is visible from the start point as the destination target is suggested, but if necessary the evaluator may select a different terrain feature for personnel to demonstrate how to properly determine an azimuth.

2. Be sure that the individual has a compass, piece of paper, and pencil.

Brief Student: Give the individual a compass and point out a distant object. Ask him to determine the magnetic azimuth to that point. Then give him the azimuth and distance to the target can. Tell him to move to that point, and then return and tell you the number or letter written on the target.

Evaluation

<u>Performance measures</u>	<u>Results</u>	
Determines an azimuth.		
1. Correctly uses the centerhold or compass-to-cheek technique.	P	F
2. Determines the azimuth to the distant point +/- 5 degrees	P	F
3. Completes the above steps within 2 minutes.	P	F
Follows an azimuth.		
1. Successfully moves to the target and determines it's marking.	P	F
2. Completes the task in less than 45 minutes	P	F

Student must receive a pass on all performance measures to qualify in this task. If the individual fails any measure, show what was done wrong and how to do it correctly.

O-0202
MEASURE DISTANCE WITH PACE COUNT

CONDITIONS

Your team has been given a point to travel dismounted. You have been designated the pace person. You must ensure that the team travels the required distance and does not overshoot.

OJECTIVES

Successfully move the specified number of meters up along the route using your pace count +/- 50 meters.

TRAINING AND EVALUATION

Training Outline

1. A pace is equal to one natural step, about 30 inches long for an average adult male. In order to measure distance, you must know your pace count, which is the number of paces it takes you to cover 100 meters. You do this by measuring your pace over a pre-measured course.

a. The terrain of the course should be similar to the terrain you will be walking over on the mission. You will cover a lot more distance on a paved road than you will across rough terrain.

b. The course should be between 100 and 600 meters long, in even multiples of 100. (If the course is 600 meters long, divide your total paces by 6 to determine your 100 meter pacecount. If the course is 300 meters long, divide by 3, etc.)

2. To use your pace count:

a. Determine how far you have to travel in meters

b. Calculate how many paces this is.

1) For every hundred meters you must travel, add your pace count.

2) For the last fraction of a hundred meters, use a equal fraction of your pace count.

3) EXAMPLE: If your pacecount was 110 and the distance you had to travel was 325 meters:

$$\begin{array}{r} 110 \text{ paces (100 meters)} \\ 110 \text{ paces (100 meters)} \\ 110 \text{ paces (100 meters)} \\ + \quad 28 \text{ paces (25 meters is } 1/4 \text{ of 100 meters, so } 1/4 \text{ of your pacecount is about 28)} \\ \hline \mathbf{358 \text{ paces (325 meters)}} \end{array}$$

c. Adjust this pace count for the following factors (a shorter pace means more paces in 100 meters).

1) Slopes. Your pace will lengthen on a downslope and shorten on an upgrade. Keeping this in mind, if it normally takes you 120 paces to walk 100 meters, your pace count may increase to 130 or more when walking up a slope.

2) Winds. A head wind shortens the pace and a tail wind increases it.

3) Surfaces. Sand, gravel, mud, snow, and similar surface materials tend to shorten the pace.

4) Elements. Snow, rain, or ice cause the pace to reduced in length.

5) Clothing. Excess clothing and boots with poor traction affect the pace length.

6) Visibility. Poor visibility, such as fog, rain, or darkness, will shorten the pace.

d. Begin walking, and keep track of the distance you travel. Do not try to remember the count in your head; use a technique like one of the following:

1) Put a pebble in your pocket every time you have walked 100 meters according to your pace count.

2) Tie knots in a string.

3) Put marks in a notebook.

4) Pace counter string.

Additional Information

More detailed information on this topic is available in Chapter 5 of the Ground Team Member & Leader Reference Text.

Evaluation Preparation

Setup: Clearly mark a route at least 500 meters long. It is best if this route has sections on different types of terrain. Put a numbered marked at the end point. Then put other numbered markers before and after the end point markers along the route. Keep the exact number and locations of these markers secret.

Brief Student: Put the student at the start point. Show him the route markings, and what the end markers looks like. Give him the distance to the end point, and tell him go that distance, get the number off the marker, and return with that number.

Evaluation

Performance measures

Results

1. Correctly identifies the end marker, or another marker within 50 meters of the end marker. P F

Student must receive a pass on all performance measures to qualify in this task. If the individual fails any measure, show what was done wrong and how to do it correctly.

O-0203
NAVIGATE PAST AN OBSTACLE

CONDITIONS

Given a compass. You are moving on foot following an azimuth and pace count. You encounter an obstacle that you must go around, while continuing to keep track of your azimuth and pace count.

OBJECTIVE

The team member "boxes" his steps around the obstacle, returns to the same azimuth, and continues to the destination point.

TRAINING AND EVALUATION

Training Outline

1. Spot the obstacle and halt.
2. Record pace count up to this point (hereafter called your traveling pace count)
3. Determine if it is easier to go right or left around the obstacle.
4. If you decide to go right (if you go left, switch all references to left and right):
 - a. Using the compass, turn 90 degrees to the right
 - b. Walk in that direction, starting a new pace count from zero (called the lateral pace count). Continue walking until you have moved far enough right to get around the obstacle.
 - c. Halt and record how far you've walked in this direction.
 - d. Turn left back to your original azimuth (the one you were on when you ran into the obstacle).
 - e. Look up the pace count you were at when you spotted the obstacle and halted (your traveling pace count).
 - f. Start walking along your original azimuth, adding your steps to your traveling pace count.
 - g. When you are clear of the obstacle on your left, halt and record your total traveling pace count.
 - h. Using the compass, turn left 90 degrees. Look up your lateral pace count (the number of steps you moved to the right of the obstacle).
 - i. Walk in this direction, starting a new pace count from zero. When you have walked the same distance as your recorded lateral pace count, halt. You should now be on the direct opposite side of the obstacle from where you started.
 - j. Turn right back to your original azimuth.

5. Look up your total traveling pace count.

6. Start walking along your original azimuth, adding your steps to your total traveling pace count. Continue on to your destination.

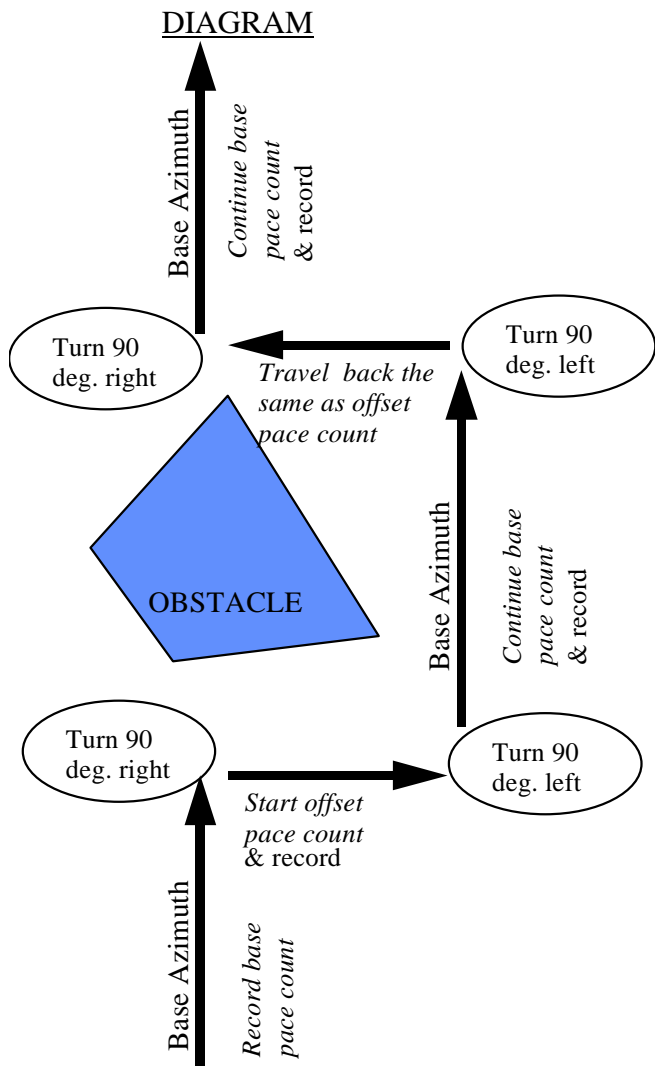

Example of Bypassing an Obstacle

Additional Information

More detailed information on this topic is available in Chapter 5 of the Ground Team Member & Leader Reference Text.

Evaluation Preparation

Setup: Set up a start and end point at least 400 meters apart in a wooded area. Clearly mark the destination point with a brightly colored coffee-can or similar marker hanging at eye level. Ensure there is point obstacle (pond, building, etc.) along the route of travel. Provide the ground team member with a compass, piece of paper, pencil, and the azimuth and distance to the destination. Ensure there is a point obstacle (pond, building, etc.) along the route of travel.

Brief Team Leader: Tell the team leader to move to the destination point. Warn him that there will be an obstacle along the way that must be navigated around.

Evaluation

<u>Performance Measures</u>	<u>Results</u>	
1. Identifies the obstacle and halts and records pace count.	P	F
2. Turns 90 degrees right (left) and moves clear of the obstacle and records pace count.	P	F
3. Turns 90 degrees to the left (right) to the original azimuth and continues the original pace count until the obstacle is cleared while recording the pace count.	P	F
4. Turns 90 degrees to left (right) and moves the same distance moved in step 2.	P	F
5. Turns 90 degrees and continues from the original pace count. (sum of 1 + 3)	P	F
6. Locates the destination point.	P	F

Student must receive a pass on all performance measures to qualify in this task. If the individual fails any measure, show what was done wrong and how to do it correctly.

LOCATE A POINT ON A MAP USING LATITUDE AND LONGITUDE

CONDITIONS

Given an aeronautical chart, road map, or topographical map with latitude and longitude lines. You are away from mission base, mounted or dismounted, and must locate your location on map in order to report your location to mission base, an aircraft or another ground element using latitude and longitude. Or, you are coordinating with another search element (ground or air) who has told you his location using the latitude and longitude. You want to plot this point on your map.

OBJECTIVES

Within 1 minute, the team member announces the correct latitude and longitude of the marked point (using the smallest gradations of latitude and longitude printed on the map), using correct terminology, and, within 1 minute, can plot a point on the map given the latitude and longitude orally.

TRAINING AND EVALUATION

Training Outline

1. Latitude and longitude are the objective position measurements used on aeronautical charts. Many road maps and topographical maps also are gridded using this system.
 - a. Lines of longitude run north-south on the map. Lines of latitude run east-west.
 - b. Both latitude and longitude are measured in degrees, minutes and seconds. One minute is 1/60th of a degree, and one second is 1/60th of a minute. In the continental US, latitude numbers are read from south to north (bottom to top), and longitude numbers are read from east to west (right to left)
 - c. Each line of latitude is labeled as either North (if it is above the equator) or South (if it is below the equator). Each line of longitude is labeled as East (if it is east of a longitude line called the Prime Meridian) or West (if it is west of the Prime Meridian)
 - d. To read a lat-long coordinates the symbol “°” means degrees, an apostrophe (“ ’ ”) means minutes, and a double apostrophe (“ ″ ”) means seconds. Always read the latitude before the longitude.
 - e. Example: 32° 33’ 44” N, 45° 12’ 52” E means “32 degrees, 33 minutes, and 44 seconds North Latitude, 45 degrees 12 minutes and 52 seconds East Longitude”
 - f. On larger scale maps, or when pinpoint accuracy is not required, seconds are not used. For example, 45° 12’ N, 22° 36’ W is read as “45 degrees, 12 minutes North Latitude, 22 degrees 36 minutes West Longitude.”
2. To find the lat-long designation of a known point on the map
 - a. Find the latitude:
 - 1) Find the numbers of the latitude degree lines to the immediate north and south of the point. Write down the lower of the two. (For example, if the point is between 45° and 46° North latitude, write down

“45°”. Also write down if that latitude line is labeled as “North” or “South” (above the equator it will always be “North”).

2) From latitude line chosen above, count up the number of minutes that the point is from the line using the tick marks on the edge of the map (or in the grids if the map is gridded) until you reach the last minute marking before your point. Write down the number of minutes.

3) From the last minute mark, count up the number of seconds to your point (if the map is of a large scale, such as an aviation chart, it will not have marks for seconds. Either stop with the minute measurement, or estimate seconds). Write down the number of seconds.

b. Find the longitude.

1) Find the numbers of the longitude degree lines to the immediate east and west of the point. Write down the lower of the two. (For example, if the point is between 22° and 23° West longitude, write down “22°”). Also write down if that longitude line is labeled as “East” or “West” (in the western hemisphere it will always be “West”).

2) From longitude line chosen above, count left the number of minutes that the point is from the line using the tick marks on the edge of the map (or in the grids if the map is gridded) until you reach the last minute marking before your point. Write down the number of minutes.

3) From the last minute mark, count left the number of seconds to your point (if the map is of a large scale, such as an aviation chart, it will not have marks for seconds. Either stop with the minute measurement, or estimate seconds). Write down the number of seconds.

c. NOTE: If the map is not marked with minutes or seconds, you will have to estimate. Remember, there are 60 minutes in a degree and 60 seconds in a minute. So, if the point is halfway between two degrees, it is at the 30 minute point. If it is one quarter the distance from one degree to another, it is at the 15 minute point. Use the same logic to determine seconds if the map is only graduated in degrees and minutes.

c. Make sure the lat-long coordinate you have written down is in the format Degrees°, Minutes', Seconds" (North or South) Latitude, Degrees°, Minutes', Seconds" (East or West) Longitude,

3. To plot a point given the lat-long coordinate:

a. Find the correct latitude line and count up the correct number of minutes and seconds (below the equator you would count down, not up).

b. Find the correct longitude line and count left the correct number of minutes and seconds (in the eastern hemisphere you would count right, not left).

c. Mark the point.

Additional Information

More detailed information on this topic is available in Chapter 5 of the Ground Team Member and Leader Reference Text.

Evaluation Preparation

Setup: Mark a point on a map or chart gridded with latitude and longitude, and give the map to the student. . Tell him whether or not she must report seconds, or just degrees and minutes (depends on the scale of the map). Pick a different grid location from the point and write down the latitude and longitude coordinates. Ensure you have a timer. Because this task is timed, it is necessary to make sure that the student and work area is prepared for testing. The map should be open and complete. If copies of maps are used, they should include all references normally available on the full map to take the exam.

Brief Student: Ask the student if s/he is prepared. Tell the student to tell you the latitude and longitude of the point. Then orally give him the latitude and longitude you wrote down and tell him to show you where that point is on the map.

Evaluation

Performance Measures

Results

Determining the grid of a known point. The student:

- | | | |
|--|---|---|
| 1. Announces the correct latitude degrees, minutes and seconds within tolerance (see below) | P | F |
| 2. Announces the correct latitude designation "North" or South" | P | F |
| 3. Announces the correct longitude degrees, minutes and seconds within tolerance (see below) | P | F |
| 4. Announces the correct longitude designation "East" or "West" | P | F |
| 5. Performs the above steps within 1 minute of time | P | F |

NOTE: The minimum accuracy for this task is to be within 30 seconds of the correct answer for a map graduated in minutes. If the map is large enough scale to be graduated in seconds, then the needed accuracy should be increased. For dismounted work, a ground team with proper maps should be able to plot positions within 10 seconds.

The individual determines the location of a designated grid:

- | | | |
|---|---|---|
| 6. Plots a point on the map within 1 minute using the correct latitude and longitude degrees, minutes and seconds within tolerance (see accuracy note above). | P | F |
|---|---|---|

Student must receive a pass on all performance measures to qualify in this task. If the individual fails any measure, show what was done wrong and how to do it correctly.

LOCATE A POINT ON A MAP USING THE CAP GRID SYSTEM

CONDITIONS

Given an aeronautical chart, road map, or topographical map gridded with the CAP grid system. You are away from mission base, mounted or dismounted, and must plot your location on a CAP gridded map in order to report it, an aircraft or another ground element. Or, you are coordinating with another search element (ground or air) who has told you his location using the CAP grid system. You want to plot this point on your map.

OBJECTIVES

Within 1 minute, the team member announces the CAP grid and sub-grid that the point is located in, using correct terminology, and can plot a point on the map given the CAP grid coordinates orally.

TRAINING AND EVALUATION

Training Outline

1. The CAP grid system is designed for use on aeronautical charts, but can be adapted to any map with latitude/longitude markings around the edge.
2. A grid is a 15 minute latitude by 15 minute longitude box. This is done by dividing the 30 minute by 30 minute boxes already on the aeronautical chart into fourths. Each grid is identified with a number. (For example “I am located in Grid 54”).
3. To locate a position more precisely, mentally divide each grid into four quadrants. The Northwest quadrant is “A”, the Northeast is “B”, the Southwest is “C”, and the Southeast is “D”. Say the quadrant letter after the grid number (for example, “I am in grid 54 B”).

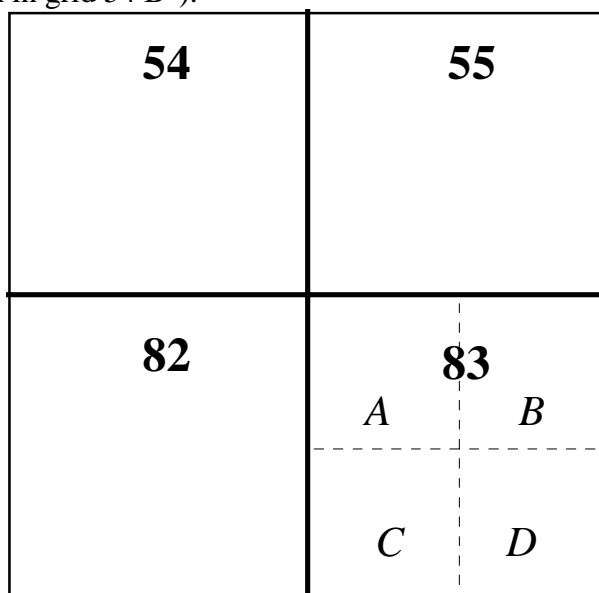

Example of CAP grids (54,55,82 and 83) and lettered quadrants (83A, 83B, 83C, and 83D)

4. To find the grid designation of a known point on the map

- a. Find the grid number the point is in.
 - b. Determine which quadrant of the grid the point is in (A, B, C, or D)
5. To plot a point given a grid number and quadrant letter:
- a. Find the appropriate grid on the map (the grid numbers increase as you look left to right and top to bottom on the map).
 - b. Mark the point in the appropriate lettered quadrant of that grid.

Additional Information

More detailed information on this topic is available in Chapter 5 and Attachment D of the Ground Team Member and Leader Reference Text.

Evaluation Preparation

Setup: Mark a point on a CAP gridded map or chart and give the map to the student. Pick a different grid location from the point and write down the grid and quadrant. Ensure you have a timer.

Brief Student: Tell the student to tell you the CAP grid and quadrant designation of the point. Then orally give him the grid and quadrant of the point you wrote down and tell him to show you where that point is on the map.

Evaluation

<u>Performance Measures</u>	<u>Results</u>
The individual determines the grid of a known point:	
1. Announces the correct grid number and quadrant within 1 minute	P F
The individual determines the location of a designated grid:	
2. Finds the correct numbered grid and quadrant within 1 minute	P F

Student must receive a pass on all performance measures to qualify in this task. If the individual fails any measure, show what was done wrong and how to do it correctly.

O-0209

IDENTIFY THE MAJOR TERRAIN FEATURES ON A MAP

CONDITIONS

Given a objective topographical map

OBJECTIVES

Correctly identify the five major terrain features on the map.

TRAINING AND EVALUATION

Training Outline

1. Hill -- A point or small area of high ground. From the hilltop, terrain slopes down in all directions. On the map a hill is depicted by contour lines forming concentric circles.

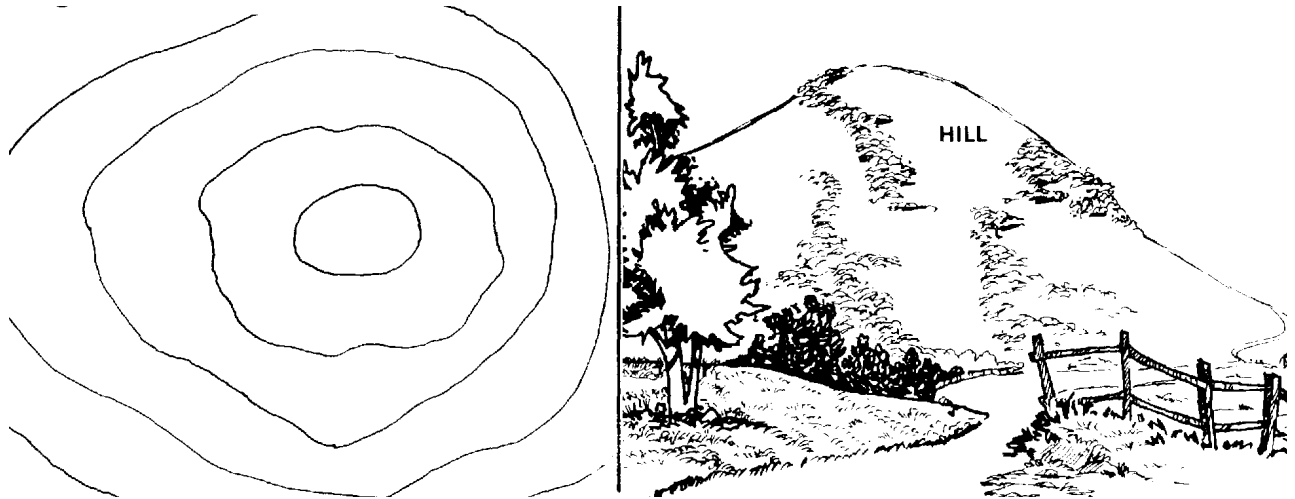

A hilltop on the map (left) and in the wilderness (right)

2. Valley -- Terrain goes up in three directions, and down in one, usually a river or a stream flows in it.

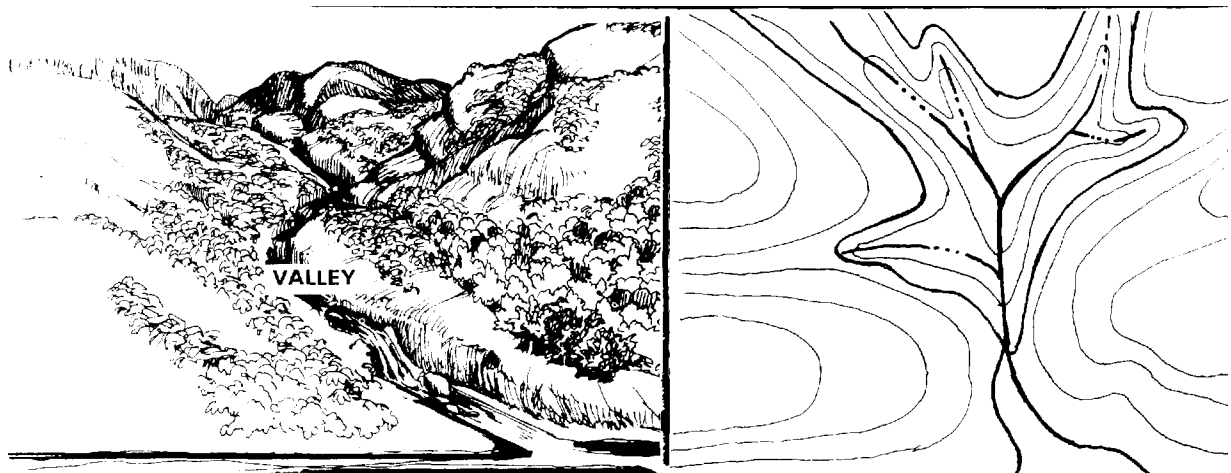

3. Ridge -- A line of high ground with height variations along its crest. The terrain slopes down in three directions and up in one.

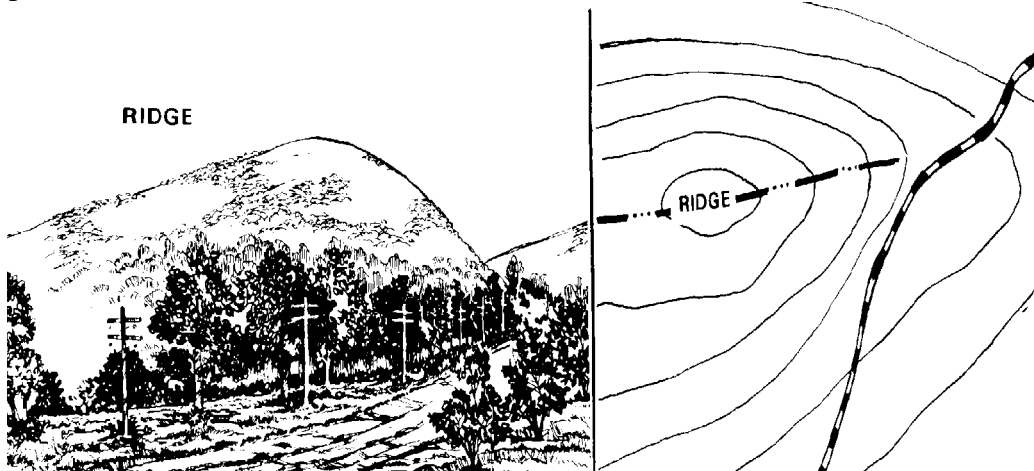

4. Saddle -- A dip or low point, usually along the crest of a ridge. Terrain goes down in two directions and up in the other two.

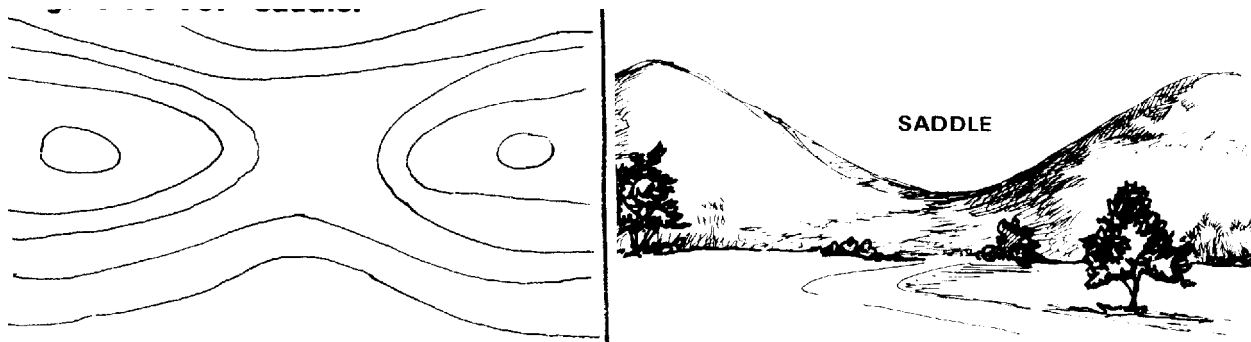

5. Depression -- A low point or hole in the ground. Terrain goes up in all directions. Hash marks indicate decreasing elevation.

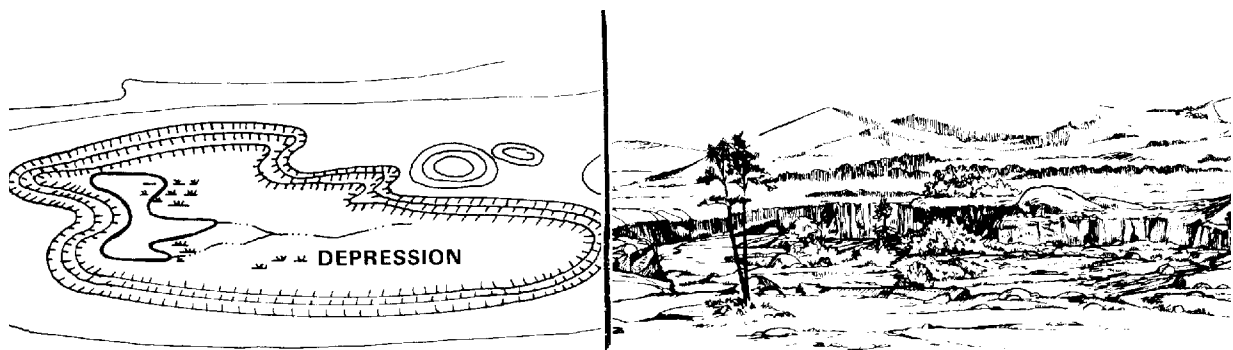

Additional Information

More detailed information on this topic is available in Chapter 5 of the Ground Team Member and Leader Reference Text.

Evaluation Preparation

Setup: On an appropriate topographical map, circle an example of each major terrain feature.

Brief Student: Tell the student to identify the circled items.

Evaluation

Performance measures

Results

The student correctly identifies the following:

1. Hill	P	F
2. Valley	P	F
3. Ridge	P	F
4. Saddle	P	F
5. Depression	P	F

Student must receive a pass on all performance measures to qualify in this task. If the individual fails any measure, show what was done wrong and how to do it correctly.

O-0210
IDENTIFY TOPOGRAPHIC SYMBOLS ON A MAP

CONDITIONS

Given a objective topographical map

OBJECTIVE

Correctly identify the topographical symbols, colors, and marginal information on a map.

TRAINING AND EVALUATION

Training Outline

1. In order to navigate using a map, the ground team member must know how terrain features are depicted on a map.
2. Ideally, every feature on the Earth's surface can be shown on a map in its true shape and size. Unfortunately this is impossible due to the limitations on detail that can be legibly transferred to paper. The amount of detail that can be shown on a map varies as the scale of a map. Small scale map such as 1:24,000 USGS quadrangles will show considerably more detail then 1:500,000 aeronautical sectionals.
3. Symbols are used on topographical maps to show features and details. On most topographic map the following colors are used to classify these symbols.
 - a. Black -- manmade or cultural features such as buildings, roads, railroads, names and boundaries.
 - b. Blue is used for water or hydrographic features such as lakes, rivers, canals and swamps.
 - c. Brown -- used for relief or contour and to show relief features such as cuts, fills, sand dunes, and glaciers.
 - d. Green -- is used for woodland cover and vegetation such as scrub, vineyards, forests, etc.
 - e. Red -- emphasizes important roads and highways.
 - f. Purple -- used to show revisions from previous map editions.
4. The shape and size of an object on the map will indicate it's actual shape and size on the ground. A black solid square is a building and an irregular blue item is a lake or pond. Interpreting symbols is a matter of knowing what color it is and how that relates to the above list, and matching the symbol to the map's legend. The map's legend is table of symbols and what they represent. It is usually located on the bottom of the map sheet in the marginal information or it is published separately for the objective types of topographic maps in use.
5. The marginal information on a map shows the mapsheets relationship to the rest of the Earth. Marginal information includes:
 - a. The geographic location of the map.

- b. The name of the mapsheet and adjoining mapsheets.
- c. Agency preparing the map and date of printing.
- d. Scale of the map and bar scales for meters, yards, and miles.
- e. Contour interval of contour lines.
- f. Grid to magnetic north declination diagram, or simply the magnetic variation angle.

Additional Information

More detailed information on this topic is available in Chapter 5 of the Ground Team Member and Leader Reference Text.

Evaluation Preparation

Setup: On an appropriate topographical map, circle an example of each item of marginal information and an item shown on the map by color.

Brief Student: Tell the student to identify the circled items.

Evaluation

<u>Performance measures</u>	<u>Results</u>	
1. Identifies the sheet name	P	F
2. Identifies the contour interval and lines	P	F
3. Identifies the G-M angle declination diagram	P	F
4. Identifies the legend	P	F
5. Identifies the bar scales	P	F
6. Identifies the adjoining sheets reference	P	F
7. Identifies man-made features	P	F
8. Identifies hydrographic (water) features	P	F
9. Identifies vegetation features	P	F

Student must receive a pass on all performance measures to qualify in this task. If the individual fails any measure, show what was done wrong and how to do it correctly.

O-0211
DETERMINE ELEVATION ON A MAP

CONDITIONS

Given a objective topographical map. Your team is has been ordered to move dismounted to a destination. Before beginning movement, you want to get an idea for the “ups and downs” of the terrain you will be traveling over. Or, your team is having problems contacting mission base, and you wish to find a high point to transmit form.

OBJECTIVE

Correctly identify the elevation of any point on the map +/- 1/2 the contour interval.

TRAINING AND EVALUATION

Training Outline

1. Topographical maps depict the elevation of the ground through the use of contour lines. A contour line represents an imaginary line on the ground, above or below sea level connecting points of equal elevation. Contour lines are normally brown. There a three types of contour lines:

a. Index Contour Lines are heavier than other lines, and are labeled with a number. This number is the elevation of that line, in feet, yards or meters. The top of the elevation number always points uphill.

b. Intermediate Contour Lines are the solid lines that fall between Index Contour Lines. These lines do not have the elevation listed on them, but represent increments of the *contour interval* (see 2, below).

c. Supplementary Contour Lines. These contour lines resemble dashes. They show sudden changes in elevation of at least one-half the contour interval.

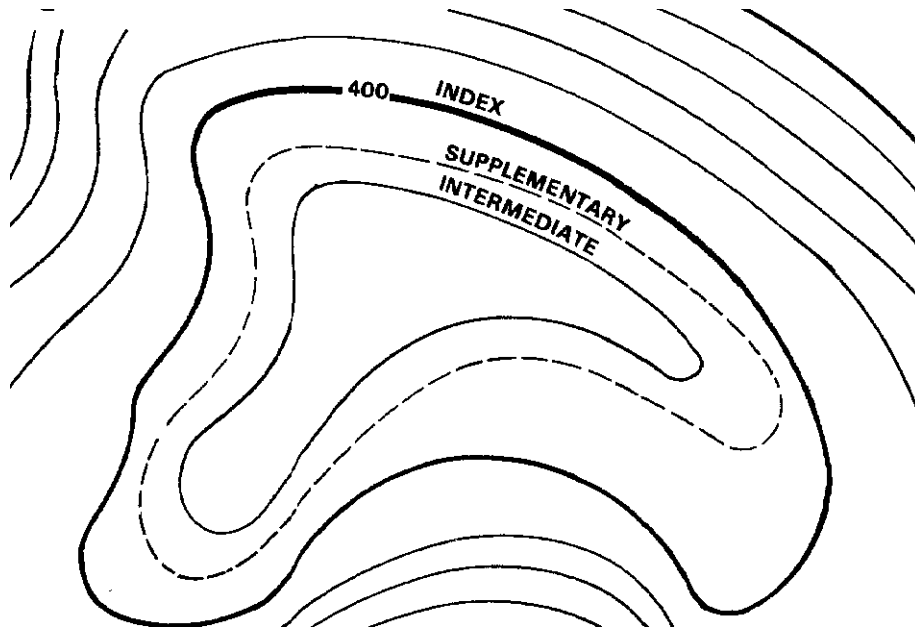

Index, Intermediate, and Supplementary contour lines. As indicated by the orientation of the “400,” the terrain slopes down towards the center of this area.

2. Before you can read the contour lines, you must know the contour interval of the map. The contour interval will be printed in the marginal information, near the map legend. The contour interval is the number of feet, meters or yards that each intermediate contour line represents. (EXAMPLE: if the contour interval is 10 meters, then the Index Contour line marked with “100” is 100 meters above sea level, and each intermediate line above it is 10 more meters)

3. To determine the elevation of a point on the map:

a. Determine the contour interval of the map, and the unit of measure used (feet, meters or yards).

b. Find the numbered index contour line nearest the point.

c. Determine if you are going from lower elevation to higher, or vice versa. For example, if the point was somewhere between the “500” and the “600” Index contour lines, you know the terrain gets higher as it gets closer to the “600” line.

d. Start at the Index contour line below the point (in the above example, the “500” line) and count the number of Intermediate contour lines between the lower Index contour line and the point. For each intermediate line, add the contour interval.

e. If the point is halfway between two contour lines, add half the contour interval.

f. If the point is a hilltop, determine the elevation of the contour line closest to the hilltop and add half the contour interval.

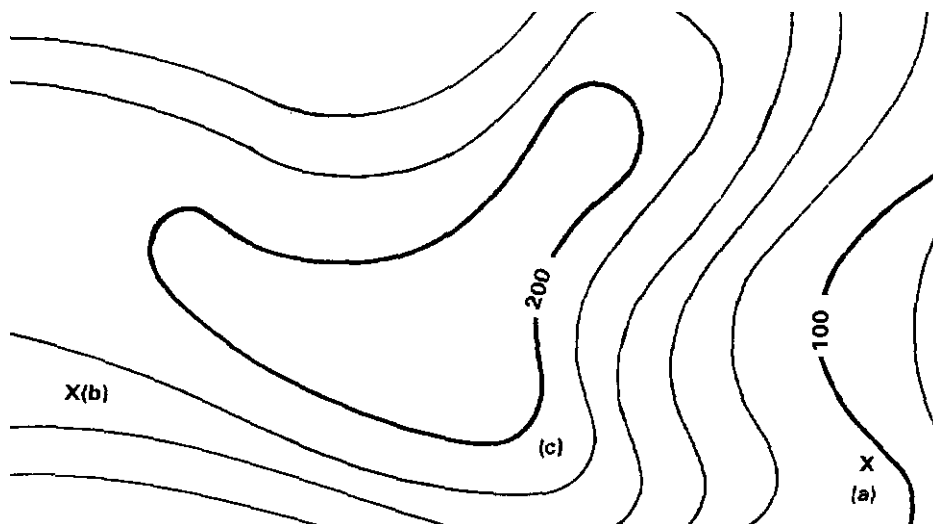

EXAMPLE: If the above map has a contour interval of 20 meters, point (a) is slightly above 100 meters in elevation, point (b) is at approximately 170 meters, and point (c) is at approximately 190 meters.

4. Depressions. Depressions (the opposite of a hilltop) are often marked with small hatchmarks on the contour line pointing inward towards the center of the depression. To determine the depth of the depression, determine the elevation of the innermost contour line of the depression and *subtract* half the contour interval.

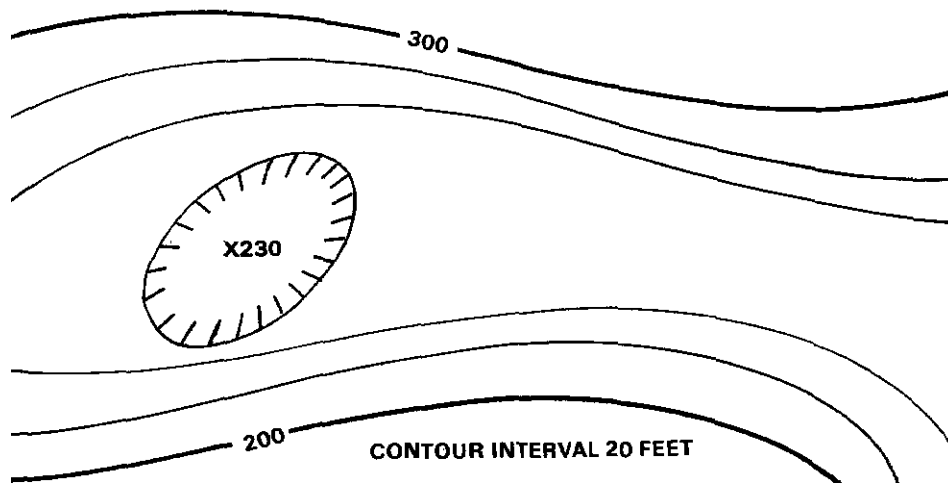

Given the contour interval of 20 feet, the rim of the depression is at an elevation of 240 feet, and the center of the depression is at 230 feet.

Additional Information

More detailed information on this topic is available in Chapter 5 of the Ground Team Member and Leader Reference Text.

Evaluation Preparation

Setup: On an appropriate topographical map, mark five points on the map, including one hilltop and one depression.

Brief Team Leader: Tell the team leader to determine the elevation of all five points.

Evaluation

Performance measures

Results

1. Identifies the elevation of four of the five points +/- 1/2 the contour interval

P F

Student must receive a pass on all performance measures to qualify in this task. If the individual fails any measure, show what was done wrong and how to do it correctly.

O-0212
MEASURE DISTANCE ON A MAP

CONDITIONS

Given a objective topographical or aeronautical map with bar scales, a piece of paper, pencil, and straight edge. You are away from mission base, mounted or dismounted, and must move to another location. You have plotted your position on the map, and the position to which you are to move. Now you want to determine the distance you will have to move.

OBJECTIVES

1. Determine the straight-line distance between two points with no more than five percent error, within 2 minutes.
2. Determine the road distance between two points with no more than 10 percent error, within 2 minutes.

TRAINING AND EVALUATION

Training Outline

1. Background information:

- a. Distance can be straight line (if you are walking cross country) or along a curved road or path.
- b. Distance for mounted travel should be determined in miles, since car odometers are graduated in miles. Distance for walking should be determined in meters, so you can use your pace count. There are 0.62 miles in a kilometer (1000 meters) and 1600 meters in a mile.
- c. All topographical maps are drawn to scale (1:24,000:, 1:62,500:, etc.). This means that a one millimeter of map distance equals 24,000 millimeters (24 meters) ground distance for a objective 1:24,000 USGS quadrangle.

2. Methods of Measuring Straight-line Distance:

- a. One method of determining ground distance from a map is to use a ruler to measure the distance between two map points and multiply that by the scale factor. However, this involves doing somewhat complicated multiplication in the field.
- b. A simpler way is to use the bar scales located at the bottom of the map. These scales are usually printed in meters, yards, and miles. By taking the ruler or the edge of a piece of paper and mark on it the straight-line distance between the two map points. Then put the ruler or piece of paper under the appropriate bar scale and read the ground distance in the appropriate units.

3. To find the road distance between two points on a map, place a tick mark on edge of the piece of paper and then place the tick mark at the first point. Align the paper with the road edge until you come to a curve, mark the paper and the map at the curve. Pivot the paper so that it continues to follow the road edge to the next curve. Repeat the process until you get to the second point, where you make the final tick mark on the paper. At this point you can take the paper to the appropriate bar scales and determine the ground distance between the first and last tick marks. This will be the road distance between the two points on the map.

Additional Information

More detailed information on this topic is available in Chapter 5 of the Ground Team Member and Leader Reference Text.

Evaluation Preparation

Setup: On an appropriate topographical map, mark two points on the map as A and B (these points should be 3,000 to 4,000 meters apart in ground distance). On a road or trail on the map, mark two points C and D at least 3,000 meters apart ground distance. Give the student the map, a pencil, a strip of paper, and a ruler.

Brief Student: Tell the student to determine the straight-line distance between points A and B to within a 5 percent error and the road distance from C to D to within a 10 percent error.

Evaluation

Performance measures

Results

The individual calculates the Straight-line Distance:

- | | | |
|--|---|---|
| 1. Measures the straight line distance using the straight edge | P | F |
| 2. Determines the straight-line distance on the bar scale within 5 percent | P | F |
| 3. Completes the above within 2 minutes | P | F |

The individual calculates the Road Distance:

- | | | |
|--|---|---|
| 4. Measures the road distance using the piece of paper | P | F |
| 5. Determines the road distance on the bar scale within 10 percent | P | F |
| 6. Completes the above within 2 minutes | P | F |

Student must receive a pass on all performance measures to qualify in this task. If the individual fails any measure, show what was done wrong and how to do it correctly.

O-0213
CONVERT BETWEEN MAP AND COMPASS AZIMUTHS

CONDITIONS

Given a gridded map and an aviation map, each with magnetic variation information.

OBJECTIVES

Perform each of the following within one minute each: convert a magnetic azimuth to a grid azimuth, convert a grid azimuth to a magnetic azimuth, convert a magnetic azimuth to a true azimuth, and convert a true azimuth to a magnetic azimuth.

TRAINING AND EVALUATION

Training Outline

1. In order work with a map and compass, you must understand the concept of *Magnetic Variation (sometimes called declination)*:

a. There are 360 degrees in a circle, with 0° (which is also 360°) pointing north, 90° pointing east, 180° pointing south, and 270° pointing west.

b. There are actually three different “norths”: true, grid, and magnetic. You must be able to work with all three.

1) True North is the direction along the earth’s toward the north pole. Lines of longitude are “true north” lines, since they converge at the north pole. Aviation charts are “True North” maps.

2) Grid North is used by maps that are not gridded in longitude (such a military UTM maps). Grid lines are straight and do not converge at the north pole, so grid north can be different from true north, especially as you get near either pole.

3) Magnetic North is direction along the earth’s surface toward the north MAGNETIC pole. This is NOT the same as the north pole -- the north magnetic pole drifts slowly each year, and is never exactly at the north pole. In Maryland, for example, magnetic north is 10° - 11° off of True North. This is important, because your compass will point to magnetic north, but your map will either be drawn to true north or Grid North.

2. Converting from map to compass headings:

a. To convert between Magnetic North and True North on a True North Map:

1) Find the Magnetic Variation (sometimes called declination on non-aviation maps).

a) On an aviation chart, there will be magenta lines running generally from north to south on the chart with degree markings on them (for example “10° W”). Choose the line halfway between the two points you have marked on the chart.

b) On other maps, look to the legend. It should note the magnetic variation, or declination, of the map.

2) Note the number of degrees and whether it labeled East or West

3) To convert True (map) azimuths to Magnetic (compass) azimuths, remember the saying “EAST IS LEAST, WEST IS BEST”.

a) If the Magnetic Variation is East, *subtract* the Magnetic Variation from the True azimuth.

b) If the Magnetic Variation is West, *add* the Magnetic Variation from the True azimuth.

4) To convert Magnetic (compass) azimuths to True (map) azimuths, do the opposite of above.

a) If the Magnetic Variation is East, *add* the Magnetic Variation from the True azimuth.

b) If the Magnetic Variation is West, *subtract* the Magnetic Variation from the True azimuth.

b. To convert between Magnetic North and Grid North on a Grid North Map:

1) Find the Magnetic Variation (sometimes called declination on non-aviation maps or the G-M Angle (Grid-Magnetic) on military maps. This should be in the legend, or in a small box near the legend.

2) Note the number of degrees and whether it labeled East or West

3) To convert Grid (map) azimuths to Magnetic (compass) azimuths:

a) If the Magnetic Variation is East, *subtract* the Magnetic Variation from the True azimuth.

b) If the Magnetic Variation is West, *add* the Magnetic Variation from the True azimuth.

4) To convert Magnetic (compass) azimuths to True (map) azimuths, do the opposite of above.

a) If the Magnetic Variation is East, *add* the Magnetic Variation from the True azimuth.

b) If the Magnetic Variation is West, *subtract* the Magnetic Variation from the True azimuth.

Additional Information

More detailed information on this topic is available in Chapter 5 of the Ground Team Member and Leader Reference Text.

Evaluation Preparation

Setup: Provide the student with a gridded topographical map and an aviation map. Ensure each map contains magnetic variation information. Mark a spot on each map. Provide the student with paper and a pencil or pen.

Brief Student: Tell the student that he will have one minute for each of four conversions, and may use paper and pencil for the math. Show the student the marked spot on each map. Tell him that the first two conversions are on the gridded topographical map. Then give the student a magnetic azimuth and ask him to tell you the grid azimuth. Then give him a grid azimuth and ask him to tell you the magnetic azimuth. Now tell him to use the aviation chart. Give him a magnetic azimuth and ask him to tell you the true azimuth. Finally, give him a true azimuth and ask him to tell you the magnetic azimuth.

Evaluation

<u>Performance measures</u>	<u>Results</u>	
1. Correctly converts a magnetic to a grid azimuth within 1 minute.	P	F
2. Correctly converts a grid to a magnetic azimuth within 1 minute.	P	F
3. Correctly converts a magnetic to a true azimuth within 1 minute.	P	F
4. Correctly converts a true to a magnetic azimuth within 1 minute.	P	F

Student must receive a pass on all performance measures to qualify in this task. If the individual fails any measure, show what was done wrong and how to do it correctly.

O-0214
PLOT AN AZIMUTH ON A MAP

CONDITIONS

Given a map, pencil, a straight edge, a known point and a grid azimuth.

OBJECTIVE

Within 2 minutes, plot the azimuth from the given point on a map.

TRAINING AND EVALUATION

Training Outline

1. In some situations, a team might be given an azimuth to plot. A good example would be if another ground team has determined a bearing to a distress beacon from their location. Plotting this azimuth on your map could help with the search.
2. To plot an azimuth.
 - a. Plot the point on the map.
 - b. Ensure that the azimuth is a grid, not a magnetic azimuth. If it is magnetic, convert to a grid azimuth.
 - c. Place the protractor on the point with the “0” degree mark oriented to grid north. Place a pencil mark at the degree mark on protractor corresponding to the azimuth.
 - d. With a straightedge, draw a line from the first point (the position) through the mark you just made.

Additional Information

More detailed information on this topic is available in Chapter 5 of the Ground Team Member and Leader Reference Text.

Evaluation Preparation

Setup: On a map, mark a point. Give the student the map, a pencil, a straightedge, and a protractor.

Brief Team Leader: Verbally give the team leader a grid azimuth. Tell the team leader to plot the azimuth from the point marked on the map within 2 minutes.

Evaluation

Performance measures

Results

- | | | |
|---|---|---|
| 1. Draws a line from the point along the correct azimuth +/- 2 degrees within 2 minutes | P | F |
|---|---|---|

Student must receive a pass on all performance measures to qualify in this task. If the individual fails any measure, show what was done wrong and how to do it correctly.

O-0215

DETERMINE AZIMUTHS ON A MAP USING TWO POINTS

CONDITIONS

Given a protractor, pencil, straightedge, and a map. You are away from mission base, and must move to another location. You have plotted your position on the map, and the position you are to move to. Now you want to determine the direction to move. Or, you have shot a magnetic bearing to a landmark, and wish to plot this bearing on a map from your position in order to verify the landmark.

OBJECTIVES

Within 2 minutes, the team leader determines the azimuth from one point to another on the map and converts it to the magnetic azimuth. Within 2 minutes, the team member must convert a magnetic azimuth to a grid azimuth and plot it from a known point on a map.

TRAINING AND EVALUATION

Training Outline

1. This task is essential for using a compass and map together. In order to navigate, you must be able to convert a compass heading to a line on a map, and convert a line on a map to a compass heading. Before you train on this task, ensure you can perform task O-0213, Convert Between Map And Compass Azimuths.
2. To determine a magnetic azimuth between two points on a map
 - a. The objective (protractor) method:
 - 1) Plot both points on a map.
 - 2) Draw a line between the two points (and beyond the second point if necessary to ensure the line is longer than the radius of the protractor).
 - 3) Position a protractor with the center point over the first point (your location), and ensure that the “0°” mark on the protractor points is aligned with north on the map (called grid north)
 - 4) Read the number off the protractor that is on the line. This is the map (either True or Grid, depending on the map) azimuth.
 - 5) Convert the azimuth to a magnetic azimuth (see separate task O-0213).
 - b. Alternate method for measuring azimuths without a protractor. First draw the line between the points as described above, and then:
 - 1) With an orienteering (Silva) compass:
 - (a) Place the compass on the map with one of the baseplate side edges on the line you drew.

(b) While keeping the baseplate still, rotate the compass dial until the “N” on the dial points to grid (or true) north on the map.

(c) Read the number on the compass dial that is in line with “Read Bearing Here” arrow on the baseplate. This is your grid (or true) azimuth).

2. With a lensatic compass (this is less accurate than using a protractor or orienteering compass):

(a) Orient the map to magnetic north (see separate task O-0217)

(b) Place the compass on the map so that the straightedge on the left side of the compass on the line you drew (if your compass does not have a straightedge, use the sighting wire. This is less accurate).

(c) Read the number on the compass dial under the fixed black index line on the glass. This is your magnetic azimuth. If you need a true or grid azimuth, convert as needed (see separate task O-0213).

4. To plot an azimuth on a map.

a. Using a protractor:

1) Ensure you are working with a grid azimuth. If not, convert it (see separate task O-0213).

2) Mark the location you wish to plot the azimuth from on the map.

3) Place the center hole of the protractor on that point, with the 0 degree mark aligned with grid north on the map.

4) Place a mark by the point on the protractor corresponding with the grid azimuth.

5) With a straightedge, connect the two marks.

b. Using an orienteering compass.

1) Ensure you are working with a grid azimuth. If not, convert it (see separate task O-0213).

2) Rotate the compass dial until the azimuth you want to plot is in line with the “Read Bearing Here” line on the base plate.

3) Mark the location you wish to plot the azimuth from on the map.

4) Without rotating the compass dial. Place the center of the compass dial over that point, with the 0 degree (North) mark on the compass dial, oriented with true north.

5) Place a mark on the map at the end of the “Read Bearing Here” line.

6) With a straightedge, connect the two marks.

c. Using a lensatic compass (less accurate):

1. Orient the map to magnetic north (see separate task O-0216)
2. Ensure you are working with a magnetic azimuth. If not, convert it
- 3) Mark the location you wish to plot the azimuth from on the map.
- 4). Place one end of the straight edge on the side of the compass on the mark you made on the map.
- 5) Keeping the straight edge of the compass on the mark, rotate the compass until the index mark lines up with the magnetic azimuth you wish to plot.
- 6) Draw a line along the compass straight edge. (If your compass does not have a straightedge, you can use the sighting wire, but this is not very accurate).

Additional Information

More detailed information on this topic is available in Chapter 5 of the Ground Team Member and Leader Reference Text.

Evaluation Preparation

Setup: Provide the individual with a protractor, a pencil, a straightedge, and a map with a two points marked on it. Show him which is the start point, and which is the point he wants to go to.

Brief Team Leader: Tell the ground team leader to tell you the magnetic azimuth from the start point to the finish point. Then give him a magnetic azimuth, and instruct him to plot that from the same start point on the map.

Evaluation

Performance Measures

Results

NOTE: IF THE MAP IS A TRUE NORTH MAP, THE MEMBER SHOULD CONVERT TO AND FROM TRUE NORTH, OTHERWISE, THE MEMBER SHOULD CONVERT TO AND FROM GRID NORTH.

The individual determines a Magnetic Azimuth:

- | | | |
|--|---|---|
| 1. Determines the correct true (or grid) azimuth from the start to the finish point +/- 2 degrees. | P | F |
| 2. Correctly converts it to a magnetic azimuth | P | F |
| 3. Performs steps 1 and 2 within 2 minutes | P | F |

The individual Plots a Magnetic Azimuth:

- | | | |
|--|---|---|
| 4. Correctly converts it to a grid (or true) azimuth | P | F |
| 5. Plots it from the start point +/- 2 degrees | P | F |
| 6. Performs steps 4 and 5 within 2 minutes | P | F |

Student must receive a pass on all performance measures to qualify in this task. If the individual fails any measure, show what was done wrong and how to do it correctly.

ORIENT A MAP TO THE GROUND USING TERRAIN ASSOCIATION

CONDITIONS

Given a objective topographical map in the daylight

OBJECTIVES

Orient the map to North to within 30 degrees within 4 minutes.

TRAINING AND EVALUATION

Training Outline

1. In order to use your map for navigation, you must “orient” the map to the ground. A map is considered oriented when it is in a horizontal position with it's north and south corresponding to north and south on the ground. This allows you to easily see the terrain on the map as it corresponds to the terrain around you. Orienting the map can be quickly done without a compass if there are prominent terrain features nearby.

2. To orient the map:

a. Look at the map and the ground to find two or more terrain features common to both. Examples are hills, saddles, valleys, ridges or cultural features such as buildings or radio towers.

b. Rotates the map until the terrain features are aligned with the map. (For example, if there is a tower to your right and the mountain in front of you, rotate the map until the tower on the map is on the right and the mountain on the map is towards the top). By aligning the terrain features on the map with the same terrain features on the ground, the map is oriented.

c. Whenever possible, use three features, to ensure you do not accidentally orient the map 180 degrees out.

Additional Information

More detailed information on this topic is available in Chapter 5 of the Ground Team Member and Leader Reference Text.

Evaluation Preparation

Setup: Choose an outdoor location with good visibility and readily identifiable terrain features. Provide a map of the area that lists those terrain features to the student.

Brief Student: Tell the student orient the map to the ground. Tell him to describe out loud all the steps he takes.

Evaluation

<u>Performance measures</u>	<u>Results</u>	
1. Identifies three prominent terrain features	P	F
2. Orients the map to north to within 30 degrees	P	F
3. Completes all steps within 4 minutes	P	F

Student must receive a pass on all performance measures to qualify in this task. If the individual fails any measure, show what was done wrong and how to do it correctly.

O-0217
ORIENT A MAP TO NORTH USING A COMPASS

CONDITIONS

Given a objective topographical map and a compass in the daylight

OBJECTIVES

Orient the map to North to within 10 degrees in less than 4 minutes.

TRAINING AND EVALUATION

Training Outline

1. You want to use your map for navigation. First, you must “orient” the map to the ground. A map is considered oriented when it is in a horizontal position with its north and south corresponding to north and south on the ground. This allows you to easily see the terrain on the map as it corresponds to the terrain around you. Orienting the map with a compass is more accurate than using terrain association, and can be done when there are no visible prominent terrain features.
2. To orient the map using a compass:
 - a. Hold the map horizontally or place on a flat surface (DO NOT USE THE HOOD OF A VEHICLE OR ANY OTHER METAL SURFACE -- IT MIGHT ATTRACT THE COMPASS NEEDLE)
 - b. Look at the map and define the north/south grid lines and magnetic variation (see task O-0213 - Convert Between Map And Compass Azimuths). Determine where magnetic north is on the map
 - c. Hold the compass in front of you such that the north seeking arrow is free to rotate. Rotate your body until the arrow is pointing directly in front of your body.
 - d. Rotate the map until magnetic north on the map is pointing the same direction as the compass arrow.
 - e. Verify the map’s orientation by checking the location of prominent terrain features.

Additional Information

More detailed information on this topic is available in Chapter 5 of the Ground Team Member and Leader Reference Text.

Evaluation Preparation

Setup: Provide a map of the area and a compass to the student.

Brief Student: Tell the student to orient the map to magnetic north using the compass. Tell him to describe out loud all the steps he takes.

Evaluation

<u>Performance measures</u>	<u>Results</u>	
The individual:		
1. Identifies the magnetic north on the map	P	F
2. Locates magnetic north per the compass	P	F
3. Orients the map to magnetic north within 10°	P	F
4. Checks map orientation with terrain association	P	F

Student must receive a pass on all performance measures to qualify in this task. If the individual fails any measure, show what was done wrong and how to do it correctly.

O-0218

LOCATE OWN POSITION ON A MAP USING TERRAIN ASSOCIATION

CONDITIONS

In the field during daylight, while at an unknown location on the ground, given a objective topographic map, protractor, and a known point on the ground.

OBJECTIVE

Point out your position within a 100 meter tolerance within 5 minutes.

TRAINING AND EVALUATION

Training Outline

1. Determine the four cardinal directions.
2. Determine the type of terrain feature on which you are located. (see task O-0209, Identify the Major Terrain Features on the Map.)
3. Determine what type of terrain features surround your position.
4. Orient the Map. (see task O-0216 - Orient a Map to the Ground Using Terrain Association).
5. Relate the terrain features on the ground to the ones shown on the map.
6. Point out your position on the map.

Additional Information

More detailed information on this topic is available in Chapter 5 of the Ground Team Member and Leader Reference Text.

Evaluation Preparation

Setup: Select a relatively open area that has prominent terrain features shown on the map. Provide a map, pencil, paper, protractor and compass to the student.

Brief Student: Tell the student to locate his position on the map.

Evaluation

<u>Performance measures</u>	<u>Results</u>	
1. Determines 4 cardinal directions	P	F
2. Identifies the terrain feature on which he is located	P	F
3. Identifies terrain features around location	P	F
4. Orients map to ground	P	F
5. Relates the terrain features on the ground to those of the map.	P	F
6. Identifies own location on Map (+/- 100 meters)	P	F
7. Performs all steps within 5 minutes	P	F

Student must receive a pass on all performance measures to qualify in this task. If the individual fails any measure, show what was done wrong and how to do it correctly.

O-0220

MOVE FROM POINT TO POINT IN A VEHICLE USING A MAP

CONDITIONS

Given a vehicle with driver, state road map, topographical map, and compass.

OBJECTIVES

Successfully navigate to three designated points and return to the start point within 1 hour.

TRAINING AND EVALUATION

Training Outline

1. Virtually every sortie begins with driving to some point. Additionally, entire hasty searches must be done mounted (in a vehicle). Because of this, team leaders must become proficient at mounted navigation.
2. To find a point by mounted navigation
 - a. On the map, determine the route you will take (see task O-0209 - Identify Topographical Symbols on a Map)
 - b. Choose checkpoints along the way. These should be easily recognizable features along your route, such as bridges or road intersections. Every point where you will turn should be a checkpoint.
 - c. Measure the distance between each checkpoint (see task O-0211 - Measure Distance on a Map) and write it down.
 - d. Move to the point:
 - 1) Don't try to navigate and drive. Let someone else drive so you can concentrate on the map.
 - 2) Use the odometer to measure the distance between points. That way you'll know when checkpoints are coming up, or if you passed them by accident.
 - 3) Rely on terrain association whenever possible (see task O-0217 - Locate Own Position by Terrain Association). The metal in your vehicle will make compasses unreliable.
 - 4) If you must use a compass. Get out of the vehicle and move at least 10 yards away from it. This keeps the metal in the vehicle from affecting the compass (See task O-0201 - Use a Compass).
 - 5) Don't speed, stop abruptly, block traffic or break any traffic laws. Make sure to park clear of the road when stopping, and be careful when exiting the vehicle when traffic is driving by.

Additional Information

More detailed information on this topic is available in Chapters 3, 5 and 7 of the Ground Team Member and Leader Reference Text.

Evaluation Preparation

Setup: Pick at least three points, approximately 5 to 10 miles apart. At each point, place a marker, clearly visible from the road, with a number on it. Choose points that are located on the topographical map, but are not marked on the objective state road map. Provide the team leader with a vehicle and driver, a compass, a state road map marked with all three points (their approximate locations) and a topographical map marked with all three exact locations.

Brief Team Leader: Tell the team leader what the signs at each point look like. Tell the team leader to travel to each point, record the number on the sign, and then return to you within 1 hour. (You may allow more time if the route chose requires driving at slow speeds).

NOTE: If you are testing a group of people, pick more than three points, and have each person go to different combinations of points.

Evaluation

<u>Performance measures</u>	<u>Results</u>	
1. Successfully finds all three points, and reports the numbers	P	F
2. Returns within 1 hour	P	F
3. Does not perform any unsafe action (such as speeding), or direct the driver to perform any un-safe action.	P	F

Student must receive a pass on all performance measures to qualify in this task. If the individual fails any measure, show what was done wrong and how to do it correctly.

O-0301
DETERMINE DISTRESS BEACON BEARING

CONDITIONS

You are a member of a ground team searching for an distress beacon that is at least 1/2 a mile away. You have been given the task of operating the detection finding (DF) equipment.

OJECTIVES

Indicate the direction to the distress beacon +/- 10 degrees within 10 minutes.

TRAINING AND EVALUATION

Training Outline

1. The majority of CAP search missions are electronic searches for distress beacons. Correct use of DF equipment is critical to these searches. The first step to locating distress beacon is to determine the general direction to the location of the distress beacon. (NOTE: This section was written using the popular L-tronics LH-16 l-per as the DF unit. Technical procedures should be adapted by units with other equipment).

2. To determine the bearing to a distress beacon:

a. Assemble the LH-16 on the antenna mast assembly and hold vertically in front of you, such that you can see the receiver controls.

b. Turn the unit on, turn the volume and sensitivity full up, set the MODE knob to DF. Set the FREQUENCY KNOB to the appropriate frequency (121.775 for practice distress beacons, 121.5 and 243 (military distress beacons or harmonic transmitted by basic distress beacons) for actual distress beacons, many military aircraft carry civilian distress beacons; civilian distress beacons by law transmit on both frequencies.). Listen for the distress beacon signal. If you have no signal, move to some other location where you do.

c. Once you have the signal, swing the antenna slowly through a full circle around you and determine where the needle centers. If it centers more than twice, analyze your location to determine if you might be dealing with more than one signal, reflections or interference from power lines, etc. Remember all directions where the needle centers.

d. Switch to the REC mode and determine where the signal strength is greatest (needle deflected farthest to the right, signal direction is off the left antenna mast). The strongest signal direction should be in one of the same directions that the needle centered in the DF mode.

e. Switch back to the DF mode and locate where the needle centers in the direction where the REC mode receives a maximum signal. While one person keeps the unit aligned on the signal, another stands behind him and takes a compass bearing (see task O-0201 - Use a Compass.)

f. As you get closer to the signal, decrease the sensitivity to avoid overloading the receiver.

Additional Information

More detailed information on this topic is available in Chapter 6 of the Ground Team Member & Leader Reference Text.

Evaluation Preparation

Setup: Set up a practice beacon transmitting on 121.775 MHz at least one half mile away from the test site. Take a set of DF equipment, and ensure that one can get a good strong signal to the practice beacon (verify the direction off a map). With a compass, determine the magnetic bearing to the practice beacon. Disassemble the DF equipment and give it to the student.

Brief Student: Tell the student to assemble the DF gear, determine the direction to the practice beacon, and point it out to you. When he points, check the bearing with a compass.

Evaluation

<u>Performance measures</u>	<u>Results</u>	
1. Correctly put the DF equipment into operation.	P	F
2. Uses DF and REC (as applicable) to determine the direction to the practice beacon.	P	F
3. Points out the direction to the practice beacon +/- 10 degrees.	P	F
4. Completes all steps within 10 minutes	P	F

Student must receive a pass on all performance measures to qualify in this task. If the individual fails any measure, show what was done wrong and how to do it correctly.

O-0302
LOCATE A DISTRESS BEACON

CONDITIONS

You are a member of a ground team searching for a distress beacon (ELT/EPIRB). You have been given the task of operating the detection finding (DF) equipment. You have used the direction finding (DF) technique to close in on the signal, and now you know the distress beacon is nearby.

OJECTIVES

Within 30 minutes, use signal strength techniques to locate a practice beacon located within 200 meters of your location. (This is for a wooded area. More time should be allotted for an urban or airport environment).

TRAINING AND EVALUATION

Training Outline

1. Once the team has moved close to the distress beacon using the DF technique, that technique may become less effective. You know you are close when the signal is loud even with the sensitivity turned down. At this point signal strength techniques may be used easily. There are two techniques - normal signal strength and body blocking. These techniques can be used with DF equipment, or any portable radio or scanner that can pick up the distress beacon frequency (121.775 for practice, 121.5 and 243 for civilian and military distress beacons respectively).

2. To locate the distress beacon:

a. Assemble the DF gear or radio and tune to the appropriate frequency. Use a short antenna (such as a “rubber duck” flexible antenna). Ensure you can hear the signal of the distress beacon. Adjust the sensitivity and volume so that you can barely hear the signal.

b. Body Blocking. To determine a bearing to the distress beacon, place the receiver at waist level and rotate in a circle until weakest signal is heard. At this point the target distress beacon should be directly behind you, since your body is blocking the signal from the distress beacon.

c. Signal Strength. If you are sure the distress beacon is located nearby (for example, if you are at an airfield and you are sure it is in one of the planes) simple walk through the area.. As the signal strength increases rapidly, you are getting closer to the distress beacon. Decrease the sensitivity (or increase squelch), reduce the antenna height or slightly offset the receiver frequency as you get closer to permit body-blocking.

Additional Information

More detailed information on this topic is available in Chapter 6 of the Ground Team Member & Leader Reference Text.

Evaluation Preparation

Setup: Hide a practice beacon transmitting on the practice frequency approximately 200 meters from the test site. Take a set of DF equipment, and ensure that one can get a good strong signal to the practice beacon. Disassemble the DF equipment and give it to the student. The evaluator should be prepared to document the time it takes each student to locate the practice beacon. If multiple students have difficulty locating the practice beacon within the time allotted, the evaluator may need to re-evaluate students or the time allotted based on location.

Brief Student: Tell the student to locate the practice beacon within 30 minutes (add more time if the practice beacon is in an urban or airport environment).

Evaluation

<u>Performance measures</u>	<u>Results</u>	
Within 30 minutes the individual:		
1. Correctly puts the DF equipment into operation.	P	F
2. Locates the distress beacon/practice beacon within 30 minutes (more may be needed for urban/airport searches)	P	F

Student must receive a pass on all performance measures to qualify in this task. If the individual fails any measure, show what was done wrong and how to do it correctly.

O-0303
DEACTIVATE A DISTRESS BEACON

CONDITIONS

You are part of a ground team that has found a distress beacon. Either there were no victims, or the victims have been taken care of, and the site is considered safe.

OBJECTIVES

Take the proper steps to deactivate the distress beacon.

TRAINING AND EVALUATION

Training Outline

1. It is essential to turn off any distress beacon (ELTs, EPIRBs, PLBs, or other transmitters. A transmitting distress beacon can mask other distress signals. The vast majority of distress beacon finds are non-distress situations, where an distress beacon has gone off accidentally. In a distress situation, the primary responsibility is to help any victims. Additionally, no one should put themselves in danger to deactivate an distress beacon.
2. Once the distress beacon has been found the following procedures should be followed (only a, c, e and f apply in distress situations):
 - a. Immediately report the find to mission base.
 - b. Attempt to locate the aircraft/boat owner in order to gain access to the distress beacon.
 - c. If the owner is unavailable, contact the FBO or harbor master and local law enforcement officials to permit access to the aircraft or boat.
 - d. Locate and deactivate the distress beacon, monitoring 121.5 Mhz to insure the signal ceases. If possible disconnect the battery. Distress Beacons are normally located in the tail section of small planes. Large commercial planes sometimes have a small access door on the fuselage to access an on/off switch to the distress beacon. **ALWAYS MAKE SURE THE SIGNAL HAS STOPPED - YOU MIGHT HAVE THE WRONG DISTRESS BEACON.**
 - e. Leave a distress beacon deactivation sticker, so that the owner knows that his distress beacon has been deactivated if not present when silenced. If you don't have a sticker, leave a note where the pilot will find it.
 - f. Immediately inform the incident commander and pass on the following information:
 - 1) Manufacturer, make, model and serial # of the distress beacon.
 - 2) Battery type and expiration date.
 - 3) Time of deactivation.
 - 4) Aircraft or boat ID # (if appropriate)
 - 5) Any other pertinent information.
 - g. If the distress beacon cannot be deactivated, disconnect the antenna or construct an 'antenna tent' with aluminum foil so that the signal will no longer interfere with SARSAT. While this process is going on, the team leader should contact the incident commander to keep him informed and to receive further instructions.

Additional Information

More detailed information on this topic is available in Chapter 6 of the Ground Team Member and Leader Reference Text.

Evaluation Preparation

Setup: Provide the team member with a distress beacon or a mockup with a power switch, battery and data plate. Have a distress beacon deactivation sticker available, but don't provide it unless the team member mentions it.

Brief Team Leader: Tell the team leader that he has located an active distress beacon in a locked airplane at an airport. Ask the team member what steps he or she would take to deactivate it. When the team member states that he/she would try to find the owner, ask the team member what he/she would do if the owner is not available. After this, give the team member the distress beacon and ask him to demonstrate what he/she would do. Finally, ask what the team member would do if the distress beacon could not be deactivated.

Evaluation

<u>Performance measures</u>	<u>Results</u>	
The team member states he or she would:		
1. Immediately report the find to mission base.	P	F
2. Attempt to find owner	P	F
3. If owner is not available, attempt to locate FBO, marina operator or law enforcement.	P	F
4. Turns off distress beacon and disconnects battery (actually demonstrates this) .	P	F
5. Monitor 121.5 to ensure distress beacon is deactivated.	P	F
6. Leave a distress beacon sticker or note behind	P	F
7. Inform the mission coordinator: (actually gather this information off the distress beacon)	P	F
a. Manufacturer, make, model and serial # of the distress beacon.		
b. Battery type and expiration date.		
c. Time of deactivation.		
d. Aircraft or boat ID # (if applicable)		
e. Any other pertinent information.		
8. If the distress beacon cannot be deactivated, cover the antenna with an antenna tent.	P	F

Student must receive a pass on all performance measures to qualify in this task. If the individual fails any measure, show what was done wrong and how to do it correctly.

TRIANGULATE ON A DISTRESS BEACON SIGNAL

CONDITIONS

You are part of a ground or urban direction finding team assigned to locate a distress beacon that is 4 kilometers away. Your team has a direction finder, and has taken magnetic azimuths to the distress beacon from two points that are at least 45 degrees apart. You have a map, protractor, straightedge and a pencil.

OBJECTIVE

Utilizing the azimuths recorded, within 10 minutes, plot the location of the distress beacon within 500 meters by triangulation on a topographic map or aeronautical chart.

TRAINING AND EVALUATION

Training Outline

1. When involved in a distress beacon search, the ground or urban direction finding team will probably be given a fairly large area to cover. Through the use of triangulation, the team leader can quickly narrow the search area.
2. In order to locate a distress beacon by triangulation:
 - a. Conduct a map study to determine where to take reading from. Specifically look for:
 - 1) High terrain features. these are normally places where you are most likely to receive the signal.
 - 2) Travel routes.- to determine how to traverse the area.
 - 3) Presence of major power lines and buildings, which can block the distress beacon signal. These are bad places to take a reading.
 - b. Obtaining readings from at least two locations. Two methods can be used to determine where to take readings.
 - 1) Connect the DF unit to an external 1/4 wave-2 meter antenna mounted on the team vehicle. Drive around the search area in a set pattern until the signal is heard, at which point direction finding can be accomplished using the mast antenna assembly.
 - 2) Drive to high, clear locations and attempt to take readings using the mast antenna assembly. If no signal is heard, proceed to the next location.
 - c. At each site where a reading can be taken.
 - 1) Plot the point on the map where you took the reading.
 - 2) Determine the azimuth to the distress beacon (see task O-0301: Determine Distress Beacon Bearing).

3) Plot the azimuth on the map, making sure to convert from magnetic to grid azimuth (see task Determine and Plot Azimuths on a Map).

4) Remember to report each reading to mission base. Include your location, the bearing to the distress beacon, and the signal strength.

d. **TRIANGULATION:** Extend the line you drew for each azimuth until they cross. The distress beacon should be located at or near the intersection of the lines (this technique is most accurate when the lines intersect at a 90 degree angle. The more parallel the lines, the less accurate the plot). Take additional readings and draw more lines to increase the accuracy of the plot.

Additional Information

More detailed information on this topic is available in Chapters 5 and 6 of the Ground Team Member and Leader Reference Text.

Evaluation Preparation

Setup: On a map, determine a distress beacon location. Determine two points where DF readings could be taken and mark them on a map. Make sure to choose two points which will result in azimuths to the practice beacon that will intersect at no less than a 45 degree angle and are about 4 kilometers from the practice beacon. Determine the azimuth from both points to the practice beacon location, but don't mark these, or the practice beacon location on the map. Convert the azimuths to magnetic azimuths. On a sheet of paper, write down the practice beacon location and the magnetic azimuths from each point. Provide the individual to be tested with the map, a pencil, a protractor, and a straight edge.

Brief Team Leader: Tell the team leader that he is leading a team on a practice beacon search. Ask the team leader to describe two methods of finding a points to take DF readings from. Then tell the team leader that his team has taken readings from the two marked points. Give the team leader the magnetic azimuth from each point, and tell him or her to locate the practice beacon by triangulation within 10 minutes.

Evaluation

<u>Performance measures</u>	<u>Results</u>	
1. Describes both methods of determining locations to DF from.	P	F
2. Locates the practice beacon within 500 meters.	P	F
3. Completes step 2 within 10 minutes.	P	F

Student must receive a pass on all performance measures to qualify in this task. If the individual fails any measure, show what was done wrong and how to do it correctly.

O-0401
WORK WITH CANINE SEARCH TEAMS

CONDITIONS

You are part of a ground team that has been assigned to work with a canine search team on a sortie.

OBJECTIVES

Position and conduct yourself to remain safe and avoid interfering with the dog team's work. You may provide radio communications support for the canine handler.

TRAINING AND EVALUATION

Training Outline

1. CAP will often work with canine search teams, including those of the police and volunteer agencies. Dogs are especially useful in missing persons searches. CAP ground teams must know how to work with the dog team without interfering with the dog's search abilities.
2. Search dogs fall into three categories: tracking, trailing and air-scenting.
 - a. There are specialized air-scent dogs for underwater, avalanche, cadaver, drug, and weapons searches. The rules for working with any specialized dog teams are the same. Air-scent dogs are deployed downwind of the search area and are trained to detect human scents traveling on the wind. These dogs may also work at times in the tracking or trailing mode. These dogs are usually the preferred resource.
 - b. Tracking dogs are trained to follow a specific scent and are not necessarily affected by other humans. An article of the missing person's clothing is held under the dogs nose until he 'gets the scent'. The dog is then capable of tracking that scent on the ground through the woods to the missing person. They can be confused by "additional scents" that mask the target scent. These dogs may also be confused by a broken track. For this reason that this type of dog is deployed early in the missing person search, i.e. before the target scent fades or the search area is filled with other search resources.
 - c. Trailing dogs are similar to tracking canines, but pick up scent that originates in a addition to the original track. A person brushes against items and leaves a trail of dead skin cells and other items fallen off from the body.
3. Search dogs and their handlers are highly trained search resources. The dogs are not always considered friendly or as pets.
4. Search dog teams have a approximate 50% to 80% probability of detection (POD) on any given sortie for a well trained dog. Good handlers will have a more accurate estimate of their team's POD.
5. The five rules for working with dog teams are:
 - a. Coordinate your team's actions with the dog handler.
 - b. Clear the upwind search area of any personnel and stay downwind of the dog and handler at all times. (especially important when working with air-scent dogs)

c. When searching or traveling with an air-scent team, keep a good distance behind the dog and handler (as defined by the handler) and allow them to work unimpeded.

d. When in doubt, follow the instructions of the dog handler.

e. Unless the handler specifically allows it, keep all personnel away from the search dogs in the field and at base camp. **DO NOT ALLOW ANYBODY TO FEED OR PLAY WITH THE DOGS. KEEP ALL MOTOR VEHICLES AWAY FROM THE DOGS AS THE EXHAUST DEADENS THE SCENT AND SENSE OF SMELL. DO NOT SMOKE AROUND DOGS.**

Evaluation Preparation

Setup: None

Brief Student: Tell the student to describe the deployment and uses of an air-scent dog, tracking dog and trailing dog, and then list four rules for working with dog teams.

Additional Information

More detailed information on this topic is available in Chapter 7 of the Ground Team Member & Leader Reference Text.

Evaluation

<u>Performance measures</u>	<u>Results</u>	
1. Describes the deployment and uses of an air-scent dog	P	F
2. Describes the deployment and uses of a tracking dog	P	F
3. Describes the deployment and uses of a trailing dog	P	F
3. List four of the five rules for working with dog teams	P	F

Student must receive a pass on all performance measures to qualify in this task. If the individual fails any measure, show what was done wrong and how to do it correctly.

O-0403

EMPLOY SCANNING TECHNIQUES WHILE ON FOOT

CONDITIONS

You are part of a ground team on a search mission in the field.

OBJECTIVES

Employ appropriate scanning techniques and identify clues while moving across the terrain.

TRAINING AND EVALUATION

Training Outline

1. Searching systematically is the mission of the ground search and rescue team. Individual team members accomplish this by scanning their assigned search sector systematically to ensure that the entire area is covered. Night scanning is similar to day scanning, but relies more on peripheral vision, which is more effective than direct vision in limited visibility conditions.

2. The following rules apply to individuals moving as part of a search line or team:

- a. Scan the entire area in front of you from left to right and then from right to left.
- b. Observe areas blocked by foliage or terrain that should be investigated closely.
- c. Look down at the ground close at hand and up in the tree branches for clues.
- d. As you move through the woods investigate the areas that were blocked by foliage on your initial scan.
- e. Remember that clue-consciousness is critical. Look for the clues that will lead you to the target, not just the target itself.
- f. Occasionally stop for a moment and listen for clues.
- g. Turn around and observe the area behind you for clues that could have been missed as you passed through.
- h. Individual searchers do not need to maintain an absolutely straight line when moving through the woods. Move around as required to investigate and search the entire area. Ensure that you know and do maintain the teams base direction of movement.

3. At night, the following additional rules apply:

- a. Do not stare at any one spot too long.
- b. Do not use white light (unless conducting a full light search). White light will destroy your night vision.

c. Avoid white light for 30 minutes prior to the search to give your eyes time to adjust. If you are moving to the search site by car, turn off the overhead dome light.

d. Be especially alert for movement or noise.

Additional Information

More detailed information on this topic is available in Chapter 7 of the Ground Team Member & Leader Reference Text.

Evaluation Preparation

Setup: Choose a wooded area to search. Place five identifiable clues in the area to be searched

Brief Student: Inform the student that he is part of a search line. Indicate the direction of search. Tell him to move through the woods and scan for clues. Then ask him to describe the additional rules for night search.

Evaluation

<u>Performance measures</u>	<u>Results</u>	
1. Scans the search area in front of him systematically (right, left, up & down)	P	F
2. Observes behind him for clues	P	F
3. Recognizes and investigates blocked areas	P	F
4. Identifies 3 out of 5 clues placed by the evaluator	P	F
5. Maintains the teams base direction	P	F
6. Identifies 3 of the additional rules for night search	P	F

Student must receive a pass on all performance measures to qualify in this task. If the individual fails any measure, show what was done wrong and how to do it correctly.

O-0404
MOVE AS PART OF A SEARCH LINE

CONDITIONS

You are a member of a ground team moving through the woods on a line search.

OBJECTIVES

Maintain the specified interval, direction, and speed, expanding and contracting on the base man as needed, while remaining alert for both the search target and commands from the team leader.

TRAINING AND EVALUATION

Training Outline

1. When moving in a line search it is extremely important to maintain the proper interval, direction and speed. As a team member, you must maintain this direction and your interval while moving through varying terrain in order to ensure an efficient search.

a. The interval between members is specified by the team leader to insure a certain level of coverage. Team interval is defined as the number of team members to your left and right you must keep in sight. For a very spread out search, the team leader will specify that you only need to see one person on your left and right. For a very concentrated search, you might be told to keep two or three people on each side within your sight.

b. The search line also has a direction of movement. This is determined by guiding on something such as a compass azimuth, a terrain feature like a road, or a marked line left by the team's last sweep through the area. One team member will normally be designated as the *base* team member. He or she is responsible for maintaining direction. This will normally be the person at one end of the search line, following a terrain feature or marked route. It could be someone in the middle, though, if the team is following an azimuth or a terrain feature in the middle of the search line. In very spread out searches (with an interval of one person on either side in sight), it is probable that all members of the team might be given the compass azimuth to follow.

c. Search lines move as fast as the slowest searcher. Some parts of the search area might be harder to search or more difficult to travel through. The team should always slow down for the slowest searcher, not make that person speed up and possibly miss a clue.

d. Search lines do not have to be silent. Feel free to talk to the team members on your left and right in order to maintain proper interval, direction and speed. Don't confuse this for idle chit-chat being acceptable. Remember to stay focused on your job.

2. To move as part of a search line:

a. Know the appropriate interval, direction and location of the base team member (to your left or right).

b. As you move, space yourself so you can barely see the number of team members on either side specified by the interval.

c. If the terrain changes and you cannot see the required number of team members, move towards the base. If you cannot see the persons farther away from the base than you, then advise them to move in as well.

- d. Maintain proper direction either with your own compass (if specified) or by observing the team members closer to the base member than you.
- e. You do not have to keep an absolutely straight line as you walk. You can move about in order to effectively search all the terrain, as long as you maintain the appropriate general direction.
- f. Try to stay on-line with other members. If they stop, you stop.
- g. Do not rush to catch up. If it is taking longer to search the area you are in, have the other team members slow down.
- h. Any team member may halt the line for safety or possible clue/find, but only the leader can forward the line.

Additional Information

More detailed information on this topic is available in Chapter 7 of the Ground Team Member & Leader Reference Text.

Evaluation Preparation

Setup: Place the individual on a search line of at least five people. Choose an area of restricted visibility terrain, such as woods, to move through.

Brief Student: Inform the team that you will act as the team leader. Provide the team with a direction, designate a base student, and specify an interval of 2 individuals. Forward the team and observe. At some point during the movement, change the interval to 3 individuals.

Evaluation

<u>Performance measures</u>		<u>Results</u>	
1. Maintains correct interval	P	F	
2. Maintains correct direction	P	F	
3. Maintains proper speed.	P	F	
4. Communicates with other members to maintain interval, direction and speed.	P	F	
5. Adequately searches assigned area.	P	F	
6. Remains alert to team leader commands.	P	F	
7. Correctly adjusts interval as directed.	P	F	

Student must receive a pass on all performance measures to qualify in this task. If the individual fails any measure, show what was done wrong and how to do it correctly.

O-0405

COMMUNICATE TO OTHER MEMBERS OF THE SEARCH LINE

CONDITIONS

You are a part of a team conducting a line search, and the team leader issues a verbal command to the team or a team member calls for the team leader.

OJECTIVES

Quickly relay all verbal commands and reports to team members farther from the speaker.

TRAINING AND EVALUATION

Training Outline

1. The primary means of communication within a search line is verbal. Since a team is spread out to cover a large search area, not everyone can hear everyone else. To solve this problem, team members relay leader commands and member reports to other members of the team who are further away from the speaker or whistle signals are utilized in accordance with task O-0406.

2. To relay a command or a report.

a. Immediately obey the command. (If you hear "HALT THE LINE," then halt immediately before relaying the command.)

b. Determine from which direction the command came.

c. Repeat the message exactly, shouting it in the direction of team members farther from the speaker than yourself. If you are sure that there is no one farther from the speaker than you, you need not repeat the message.

d. Example: You hear "FORWARD THE LINE" from someone on your left. Start moving. Then turn to the team members on your right, and shout "FORWARD THE LINE."

3. To send a verbal message:

a. Shout your message toward where you believe the team leader is.

b. Listen to ensure that the team members on either side of you have relayed your message appropriately. If no response is heard, repeat your message until the team members at your side do respond.

Additional Information

More detailed information on this topic is available in Chapter 7 of the Ground Team Member & Leader Reference Text.

Evaluation Preparation

Setup: Position the student in a field facing a specific direction. Stand to his left or right and act as the team leader

Brief Student: Brief the student that he is on a search line at position number seven, that you are the team leader, and that there are other team members to his right and left. Issue the command “Forward the Line” and have the student respond. Then have the student halt the entire search line by verbal command.

Evaluation

<u>Performance measures</u>	<u>Results</u>	
1. The student begins moving and shouts “FORWARD THE LINE” in the opposite direction.	P	F
2. The student shouts “HALT THE LINE” and listens for response.	P	F

Student must receive a pass on all performance measures to qualify in this task. If the individual fails any measure, show what was done wrong and how to do it correctly.

O-0406
USE WHISTLE SIGNALS

CONDITIONS

You are part of a team in the field, and wish to communicate using a whistle.

OJECTIVES

Demonstrate the four whistle signals correctly.

TRAINING AND EVALUATION

Training Outline

1. Whistle signals are used to transmit commands along the search line or whenever team members are separated too far for voice communications.
2. Normally, team members do not repeat whistle signals that they here. This can cause confusion. However, if you believe the signal can't be heard by some members of the team, repeat the signal you hear.
3. The whistle signals are:
 - a. 1 short blast -- Forward the line (team moves forward)
 - b. 2 short blasts -- Stop the line (team stops). If you are moving and hear only one blast, stop anyway.
 - c. 3 short blasts -- Help or danger signal (Stop immediately)
 - d. 1 long blast -- Assemble on the signal origin (the person blowing the whistle)

Additional Information

More detailed information on this topic is available in Chapter 7 of the Ground Team Member & Leader Reference Text.

Evaluation Preparation

Setup: Ensure that the student has a whistle.

Brief Student: Tell the student to demonstrate, one at a time, the whistle signals listed below.

Evaluation

<u>Performance measures</u>	<u>Results</u>	
1. Demonstrates the halt whistle signal	P	F
2. Demonstrates the assemble whistle signal	P	F
3. Demonstrates the help whistle signal	P	F
4. Demonstrates the forward whistle signal	P	F

Student must receive a pass on all performance measures to qualify in this task. If the individual fails any measure, show what was done wrong and how to do it correctly.

CONDUCT ATTRACTION TECHNIQUES

CONDITIONS

You are part of a ground team on a search for a missing person or persons. You want to make it easy for the missing persons to find YOU.

OJECTIVES

Identify sound and light attraction techniques that a team can conduct.

TRAINING AND EVALUATION

Training Outline

1. If the target of a search is conscious, it is advantageous to let the target know you are in the area. That way, even if you don't spot him, he may signal you. This is done by conducting *attraction tasks* - basically being visible and easily heard. Stealth is not a good thing on a search line. However, you still need moments of silence when you listen for the target's response. By day, noise is the primary attraction. At night, noise and light are effective.

2. Sound Attraction Techniques (usable day or night).

- a. Shouting out the target's name (make sure it has been released by the Public Affairs Officer first.)
- b. Honking vehicle horns during route searches.
- c. Use of public address systems.
- d. The "Sound Sweep:

1) On command from the team leader, the team halts and all members blow their whistles for 15 seconds.

2) After blowing the whistle, the team remains stationary and silent for one minute listening for a response.

3. Light Attraction Techniques (usable at night):

- a. Building a bonfire (when stationary for long periods).
- b. Hanging light sticks in the trees (when stationary). Be sure to collect them when you leave.
- c. Shining Flashlights. Avoid blinding team members. IF you are searching without lights, use a red or blue lens for an attraction light (to avoid night blindness).
- d. Car headlights during vehicle searches.
- e. Hanging signs that direct the lost person towards your camp or base.

Additional Information

More detailed information on this topic is available in Chapter 7 of the Ground Team Member & Leader Reference Text.

Evaluation Preparation

Setup: None

Brief Student: Ask the student to identify three day and three night attraction techniques and describes their use.

Evaluation

<u>Performance measures</u>	<u>Results</u>	
1. Identifies three day attraction techniques and describes their use.	P	F
2. Identifies three night attraction techniques and describes their use.	P	F

Student must receive a pass on all performance measures to qualify in this task. If the individual fails any measure, show what was done wrong and how to do it correctly.

O-0408
IDENTIFY AIRCRAFT SEARCH CLUES

CONDITIONS

You are part of a ground team searching for a missing aircraft.

OJECTIVES

Identify search clues for which to look.

TRAINING AND EVALUATION

Training Outline

1. Searching for a missing aircraft is an exercise in locating clues that will lead to the location of the aircraft. These clues are found by conducting air and ground search, airfield searches (“ramp checks”), and witness interviews.

2. Ground team members on searches in wilderness areas should look for the following:

a. Changes in the Terrain:

- 1) Broken or disturbed trees and underbrush.
- 2) Landslides
- 3). Horsetails caused by windblown snow or sand
- 4). Breaks in terrain.
- 5). Blackened or discolored areas
- 6) Smoke
- 7) Presence of scavengers (vultures, wolves)

b. Smells:

- 1) Smoke
- 2) Decomposition odors.
- 3) Fuel, oil, or brake fluid

c. Signs of the Aircraft

- 1) Pieces of wreckage (twisted metal, seats, etc.)
- 2) Fuel, oil, or brake fluid.

d. Signs of the Pilot/Passengers

- 1) Bits of clothing or personal effects
- 2) Trail markings
- 3) Footprints
- 4) Campfires
- 5) Garbage
- 6) Signals (mirrors, etc.)

e. Unusual sounds (voices, creaking metal)

3. Downed aircraft do not usually come down intact and do not usually even look like aircraft on the ground. YOU ARE NOT LOOKING FOR AN AIRPLANE - YOU ARE LOOKING FOR SIGNS OF AN AIRPLANE CRASH. Recognition and detection of clues to the aircraft location is critical.

Additional Information

More detailed information on this topic is available in Chapter 7 of the Ground Team Member & Leader Reference Text.

Evaluation Preparation

Setup: None

Brief Student: Brief the student that he is on a missing aircraft search. Tell him to identify eight clues to aircraft crash locations.

Evaluation

Performance measures

Results

1. Identifies eight specific aircraft search clues from the above list

P F

Student must receive a pass on all performance measures to qualify in this task. If the individual fails any measure, show what was done wrong and how to do it correctly.

O-0409
IDENTIFY MISSING PERSON SEARCH CLUES

CONDITIONS

You are part of a ground team on a search for a missing person or persons.

OJECTIVES

Identify search clues for which to look.

TRAINING AND EVALUATION

Training Outline

1. Searching for a missing person is an exercise in locating clues that will lead you to the location of the individual or group. These clues are found by conducting ground searches, air search, and witness interviews.

2. Ground team members on searches in wilderness areas should look for the following:

a. Physical clues

- 1) Pieces of clothing or equipment.
- 2) Smoke, by sight or smell.
- 3) Food wrappers or trash, cigarette butts.
- 4) Broken or disturbed trees and underbrush.
- 5) Presence of scavengers (vultures, wolves, etc.).
- 6) Signs of human passage or occupation.
- 7) Decomposition odors.

b. Recorded Clues

- 1) Trail registers
- 2) Sign-in logs

c. People

- 1) Witnesses
- 2) Family and friends

d. Events

- 1) Signals
- 2) Falling rocks
- 3) Unusual noises

3. Missing people are considered to be clue generators. Rarely can any person travel through or be in the woods without leaving signs of their passage. Clue-consciousness on the team member's part is critical. Do not look for the missing person, look for the clues that lead you to him.

Additional Information

More detailed information on this topic is available in Chapter 7 of the Ground Team Member & Leader Reference Text.

Evaluation Preparation

Setup: None

Brief Student: Brief the student that he is on a missing person search. Tell him to identify eight missing person search clues.

Evaluation

Performance measures

Results

- 1. Identifies eight missing person search clues

P F

Student must receive a pass on all performance measures to qualify in this task. If the individual fails any measure, show what was done wrong and how to do it correctly.

O-0410
MARK A ROUTE

CONDITIONS

Given a roll of surveyor's tape or other marking paper or tape and daylight. You are the end person on a search line, or the designated marker while moving in column. Your team leader has told you to mark your route through the woods.

OJECTIVES

Mark a route of travel so that you can you can back track on it.

TRAINING AND EVALUATION

Training Outline

- 1.. Route marking is very important when searching. If a team marks the edges of the area it searches, it can ensure it does not miss or "double cover" any terrain. Marking can also be important in other situations, such as marking the route to an isolated crash site in order to assist emergency workers in getting to the site.
2. Normally a team marks both the left and right side of the area it searches unless:
 - a. One side of the search area is a clearly definable linear terrain feature, such as a road, stream, or edge of a forest.
 - b. One side is already marked from the teams previous pass through the area.
3. To mark a route:
 - a. Determine what color of marking tape to use. It is best to use a different color for each end of the line. Also, to avoid confusion, ensure the area does not already contain old markings in the same color.
 - b. As you walk, tie a band of surveyor's tape at eye level around a tree, fence post or other feature. If moving through a field, use the highest plant you can find.
 - c. Ensure the tape is visible from all directions.
 - d. Place tape at intervals where you can always see the next band from the previous one, in either direction. Tie bands more frequently as the terrain restricts visibility.
 - e. Slow the search line down as necessary in order to have time to leave good marks. Do not get in a hurry and do a poor marking job.

Additional Information

More detailed information on this topic is available in Chapter 7 of the Ground Team Member & Leader Reference Text.

Evaluation Preparation

Setup: Choose a wooded area at least 400 meters long. Give a roll of marking tape to the student.

Brief Student: Have the student follow you (or walk on the end of a search line) for at least 400 meters while marking the route.

Evaluation

<u>Performance measures</u>	<u>Results</u>	
1. Leaves markings at eye level, visible in all directions	P	F
2. Ensures markings are close enough to see the next mark from the last one in both directions.	P	F
3. Lets the team leader know if the team is moving too fast for good marking.	P	F

Student must receive a pass on all performance measures to qualify in this task. If the individual fails any measure, show what was done wrong and how to do it correctly.

O-0411
CONDUCT INDIVIDUAL ACTIONS ON LOCATING A CLUE

CONDITIONS

You are moving as part of a search team when you discover a clue.

OBJECTIVES

Demonstrate the appropriate actions on finding a clue

TRAINING AND EVALUATION

Training Outline

1. If an individual team member spots a clue relating to the search objective (missing aircraft or person), the primary concern is to relay this information to mission base. Mission base can then re-prioritize search resources based on the new information. Clues are found during ground searches, ramp checks, distress beacon searches, and witness interviews.
2. The actions that an individual team member would take are the same no matter what the source of the clue.
 - a. Halt in place. On a ground search, immediately call "Halt the line" and ensure that the search team stops in place.
 - b. Alert the team leader of a possible clue find and your position on the line.
 - c. From your position visually survey the surrounding area for safety hazards such as falling tree limbs, wreckage, etc.
 - d. Do not disturb anything in the area or disturb the clue in anyway. If it is clothing, do not pick it up as your scent on it will interfere with search dog resources.
 - e. Brief the team leader on what you see and any safety hazards when he arrives at your position.
 - f. In the woods, secure the area around the clue with marking tape to keep others away from it.

Additional Information

More detailed information on this topic is available in Chapters 7 and 15 of the Ground Team Member & Leader Reference Text.

Evaluation Preparation

Setup: None.

Brief Student: Brief the student that he is on a missing aircraft search and he has just spotted a possible clue (piece of metal) approximately 20 meters in front of him. He is position #4 on the search line. Tell him to demonstrate the actions he would take.

Evaluation

<u>Performance measures</u>	<u>Results</u>	
1. Halts in place	P	F
2. Halts the team immediately	P	F
3. Calls for team leader with position number	P	F
4. Performs safety survey and identifies hazards.	P	F
5. Does not disturb the clue	P	F
6. Briefs the team leader upon arrival	P	F
7. Secures area with marking tape	P	F

Student must receive a pass on all performance measures to qualify in this task. If the individual fails any measure, show what was done wrong and how to do it correctly.

O-0412
CONDUCT INDIVIDUAL ACTIONS ON FIND

CONDITIONS

You are moving as part of a search team when you discover the search target.

OJECTIVES

Demonstrate the appropriate actions on finding the search target.

TRAINING AND EVALUATION

Training Outline

1. At the point when an individual team member first sights the object of a SAR mission, the search phase ends and the rescue and recovery phase begins. In this process, the safety of the search objective, the individual team member, and the team as a whole is a primary concern.
2. The actions an individual takes are the same for a missing aircraft or a missing person search.
 - a. Halt in place. Immediately call "Halt the line" or use the appropriate whistle signal to halt the team and ensure that the search team stops in place.
 - b. Alert the team leader of a possible find and your position on the line.
 - c. From your position visually survey the surrounding area for safety hazards such as falling tree limbs, wreckage, etc.
 - d. Brief the team leader on what you see and any safety hazards when he arrives at your position.

Additional Information

More detailed information on this topic is available in Chapters 7 and 15 of the Ground Team Member & Leader Reference Text.

Evaluation Preparation

Setup: None.

Brief Student: Brief the student that he is on a missing aircraft search and he has just spotted aircraft wreckage approximately 20 meters in front of him. He is position #4 on the search line. Tell him to demonstrate the actions he would take.

Evaluation

<u>Performance measures</u>	<u>Results</u>	
1. Halts in place	P	F
2. Halts the team immediately	P	F
3. Calls for team leader with position number	P	F
4. Performs safety survey and identifies hazards	P	F
5. Briefs team leader on arrival	P	F

Student must receive a pass on all performance measures to qualify in this task. If the individual fails any measure, show what was done wrong and how to do it correctly.

O-0413
PARTICIPATE IN A HASTY SEARCH

CONDITIONS

You are a member of a ground team assigned to perform a hasty search of a specific area.

OJECTIVES

Search an assigned area with minimal assistance and report back to the team leader with the results.

TRAINING AND EVALUATION

Training Outline

1. In the course of conducting a search ground team are often broken up into smaller teams of qualified personnel to search very specific areas. Typically this team is made up of two or three personnel with advanced training to be able to assist survivors if found before a full team arrives. The suggested make-up of this team is:

- a. A qualified Ground Team Leader. This person may be serving as the assistant team leader for the larger team, but has the necessary skills to lead the team if necessary.
- b. A Communicator. This person has the skills to communicate effectively with the larger team and mission base as necessary including finding better locations to transmit from.
- c. A Medic, First Responder or other higher qualified medical person. This person must have the basic skills to handle the initial medical problems encountered in victims before the larger team or local EMS arrives.

2. Many searches are resolved via hasty searches of "hot spots" assigned by the mission coordinator. Examples of these hot spots include:

- a. Trails, fire roads, or other access points to the area of high probability.
- b. Streams, rivers, drainages, lake edges and other runoff points.
- c. Routes towards known gathering places.
- d. Known visited places by the missing.
- e. Common aircraft accident locations.
- f. Other logical places the missing might go.

3. It is essential that this team maintain adequate communications. Though this team could probably deal with incidents effectively for the short term, members could easily be overwhelmed by tasks necessary to accomplishing the mission. Quick and effective requests for assistance should be accomplished as soon possible on finding the objective. Don't be a hero, lives are at stake.

Additional Information

More detailed information on this topic is available in Chapter 7 of the Ground Team Member & Leader Reference Text.

Evaluation Preparation

Setup: None

Brief Student: Brief the student that he is to be assigned to a hasty search of a specific area. Ask him to describe who is normally a part of a hasty search, and the areas normally searched by a hasty team.

Evaluation

<u>Performance measures</u>	<u>Results</u>	
1. Student identifies the three key personnel/assignments of the normal team assigned to a hasty search.	P	F
2. The Student is able to list at least five common places that a hasty search may be used.	P	F

Student must receive a pass on all performance measures to qualify in this task. If the individual fails any measure, show what was done wrong and how to do it correctly.

O-0416
PLAN SEARCH LINE OPERATIONS

CONDITIONS

You are leading a team in the field, and are assigned to grid search an area.

OBJECTIVE

Conduct an effective team grid search of the assigned area.

TRAINING AND EVALUATION

Training Outline

1. The ground search function is the most physically demanding and trying operation that a ground team must be prepared to conduct. This is where ground team leaders spend most of their training time and leadership ability. In order to effectively search an area, the team leader must make several decisions based on his assignment, the time available, and his team.

2. Team Leaders will usually be given a section of ground to search and a briefing on how thoroughly the area must be searched. The particulars of actually performing the operation are at the discretion of the team leader based on his evaluation of the terrain, visibility, and his team. The team leader needs to decide:

- a. What search pattern to use
- b. What search formation to use
- c. What interval to have between team members
- d. From what directions to sweep the search area.
- e. Where the team is to stop, turn, or regroup.
- f. Panic direction if a team member gets lost
- g. What hazards to avoid in the area

3. **SEARCH PATTERNS.** The terrain will usually dictate what search pattern is used to sweep an area. The most common ones are:

a. The creeping line - is the most commonly used pattern. The team starts in one corner of the search area, proceeds to the adjacent corner, offsets the line and proceeds across the search area.

b. The expanding rectangle - is used for small search areas where the target is believed to be and a high probability of detection is desired. To execute this pattern requires extremely good compass/mapwork, pace counting, and blazing abilities. The modified expanding rectangle is used when the search area is on one side of a linear feature such as a road or river. If a repeated search is made, the center position should be made diagonally from the first leg. This type of search pattern is often used after a clue is found.

c. Spiral - or contour pattern is used when the search area encompasses a hill or mountain. The team starts at the top and spirals down and outward according to the contour of the land. Again this pattern requires a high degree of orienteering skill.

d. Route - searches are frequently for missing person searches. The GSAR team will be instructed to search along roads or trails as they represent high probability areas. To do this the team splits into two sections to cover both sides of the road. The team leader walks along the road in a position where he can control both flanks.

4. SEARCH FORMATIONS. There are three objective search formations used: the line, contour and wedge.

a. Line (sometimes referred to as a skirmish line): x x x x x x x x
x

The skirmish line is used in open, flat terrain or when there is a large number of search team members on the line. The team leader positions himself far enough in the rear to maintain control over the entire line. For large lines, it may be necessary to assign squad leaders to control part of the line while the team leader directs the squad leaders. Usually the most experienced searchers are the ends and center of the line or are scouts sent ahead to warn the team leader of upcoming hazards.

b. Contour (or Echelon):
x
x
x ---> Higher Ground in this direction
x x
x

The echelon or contour pattern is used on hilly steep terrain, with the line of searchers conforming to the contour of the ground. This formation ensures that rubble dislodged members on higher ground does not roll down and strike other members. Again the team leader positions himself where he can best control the line. Guidelines concerning placement of experienced members and squad leaders still apply.

c. Wedge (or double echelon):
x
x x
x x x
x x x

The double echelon or inverted V formation is used in flat, wooded or overgrown terrain. It's advantages are that the team leader maintains better control over the team members and the area is better covered by overlapping lines of sight.

5. SEARCH INTERVAL. The search coverage factor or probability of detection for a sortie will usually be assigned by the ground search coordinator. This number is usually based on how far apart searchers are spaced on a line. However; in the field it is extremely difficult to judge how many feet or meters to separate people and to maintain this exact separation as a team moves through varying terrain. To solve this the team leader can base his decision on how far apart to separate his searchers based on the terrain and visibility according to the following rules of thumb:

a. Spacing team members such that when on line any given team member can barely see only the team member to his left or right gives approximately a 50% probability of detection.

b. Spacing team members such that when on line any given team member can barely see the team member two positions to his left or right gives approximately a 75-80% probability of detection.

c. Spacing team members such that when on line any given team member can barely see the team member three positions to his left or right gives approximately a 95% probability of detection.

Using these rules allows the team leader to expand or contract his team spacing as required to maintain the assigned POD through varying terrain.

6. **SEARCH DIRECTION.** An important decision is from what direction to head the team in order to cover the area. In flat terrain, almost any direction will do, so the team leader can choose the long axis of his search area to minimize turning points or choose to follow surrounding roads as guides. In hilly terrain, it is best to search along the contour of the ground. Trying to search up and down hill will unnecessarily fatigue team members. A search direction may already be assigned by the ground branch director, particularly if the area has been previously searched in another direction.

7. **HAZARDS.** Before starting a search the team leader must conduct at least a map study and if possible a quick inspection of the assigned area for terrain hazards. Team members should be briefed on all hazards they can expect to encounter to including: rock fields, cliffs, thick underbrush, mine shafts, etc.

8. **'PANIC' AZIMUTH.** The team leader must also pick the points or terrain features that determine where his team is to stop searching and turn in a different direction. Also determine a compass azimuth that will lead an individual out of the search area in a safe direction, preferably toward a linear feature. Team members are briefed on this 'panic azimuth' and told to follow it if they become lost.

Additional Information

More detailed information on this topic is available in Chapters 7, 18 and 19 of the Ground Team Member and Leader Reference Text.

Evaluation Preparation

Setup: Provide the team leader with a map the search area. A topographical map is preferable, or a copy of one.

Brief Team Leader: The team leader is to develop a plan for searching the entire area based on having a ten man team an assigned POD. He will describe this plan in detail to the instructor. The team leader has ten minutes to prepare his plan.

Evaluation

<u>Performance measures</u>	<u>Results</u>	
1. The team leader determines the correct search pattern	P	F
2. The team leader determines the correct search formation	P	F
3. The team leader determines the correct interval	P	F

- | | | |
|---|---|---|
| 4. The team leader evaluates and finds safety hazards | P | F |
| 5. The team leader defines end, turning points and search direction | P | F |
| 6. The team leader determines a panic azimuth | P | F |

Student must receive a pass on all performance measures to qualify in this task. If the individual fails any measure, show what was done wrong and how to do it correctly.

O-0417
ORGANIZE A SEARCH LINE

CONDITIONS

You are leading a team in the field, and are assigned to grid search an area. You have already planned how you will search the area.

OBJECTIVE

Organize the assigned team members into a search line and brief them on the search.

TRAINING AND EVALUATION

Training Outline

1. Before a team moves through the woods on a search, the team members must be organized into an effective unit rather than a bunch of individuals. The team leader must perform this organization and brief his people with the required knowledge to properly perform their jobs.
2. The team leader should perform the following actions:
 - a. Line team members up in the required search formation. Assign post numbers to each individual.
 - b. Assign team members to mark the search route. Usually one or both end members of the line (also usually the most experienced team members). Check to make sure marking materials are available, and instruct on what colors to use.
 - c. Assign team members to the roles of the base man (either compass bearer or terrain feature follower) and pace keeper (if required). Remember, the team leader is still responsible for determining the team's location. The compass and pace keepers are there as backups.
 - d. Assign a team member to be the communicator (if the team leader doesn't perform this function), and team members to carry first aid kits, rope, etc. Take into account the skills and carrying capacity of the team members.
 - e. Determine where the team leader will position himself. A team leader can be centered on and behind the team for maximum control, with the base man in order to direct the teams movement, or in front as a scout.
 - f. Brief the team on the following items:
 - 1) The chain of command for the team (who's in charge if the team leader is absent or injured).
 - 2) Search interval and pattern
 - 3) Turning and end points of travel
 - 4) Terrain hazards and panic azimuth
 - 5) Actions on clue find or target find.

- 6) Where the team leader will be located.
- 7) Specific clues to search for (remind the team what the target is).
- 8) Review signals to be used to control the line (commands, whistles, etc.).

Additional Information

More detailed information on this topic is available in Chapter 7 of the Ground Team Member and Leader Reference Text.

Evaluation Preparation

Setup: Provide the team leader with a 5 to 7 people to act as a search team. Provide the team leader with a map of the area with the search area marked, including turning and stopping points.

Brief Team Leader: Brief the individual that he is the team's leader. Present him with or have him prepare a plan to search his assigned area. The team leader is to organize the people into a search formation and brief them on the assigned sortie.

Evaluation

<u>Performance measures</u>		<u>Results</u>
1. The team leader lines people up and assigns post numbers	P	F
2. The team leader assigns tasks to team members	P	F
3. The team leader briefs on end and turning points	P	F
4. The team leader briefs on safety hazards and panic azimuth	P	F
5. The team leader briefs on his location during the search	P	F
6. The team leader briefs on the chain-of-command	P	F
7. The team leader briefs on specific search clues	P	F
8. Reviews signals used to control the line.	P	F

Student must receive a pass on all performance measures to qualify in this task. If the individual fails any measure, show what was done wrong and how to do it correctly.

O-0418
CONTROL A SEARCH LINE

CONDITIONS

You are a ground team leader. You have planned and organized a search line, and are preparing to begin the search.

OBJECTIVES

Conduct a proper search, maintaining proper direction, interval and speed, while keeping track of your position.

TRAINING AND EVALUATION

Training Outline

1. Proper control of a search line is essential to ensure proper coverage of the search area. It is the team leader's responsibility to ensure that all the terrain in the search area is searched to a given degree of thoroughness. The team leader does this by ensuring the team maintains the proper direction, interval and speed. Additionally, the team leader ensures that no terrain is missed between sweeps. Finally, the team leader must also ensure that safety of the team at all times.
2. To control the team:
 - a. Position yourself where you can best control the team. Normally this is centered on and behind the search line. Sometimes you might choose to travel in front of the search line, scouting out possible hazards. Occasionally, the you should travel along the search line to supervise all team members. Only on the smallest teams should the team leader be part of the search line. **THE TEAM LEADER IS NOT A SEARCHER.** While you should keep your eyes open, your primary duty is controlling the team, not scanning.
 - b. Normally uses whistle signals or voice commands ("Forward the Line", "Halt the Line, etc.), although radios can sometimes be used, especially on a long search line.
3. To maintain proper direction:
 - a. When navigating off a terrain feature or marked path. While you should have appointed a base man to follow the terrain feature or marked path, you must double check the base man occasionally with a map and compass. The team leader, not the base man, is ultimately responsible for the direction of the team.
 - c. If you are navigating by azimuth and distance, use your own compass to double check the base man. Periodically ask the pace man for the total distance traveled, and mark it on the map, using terrain association to see if it is correct.
4. To maintain proper interval: You should monitor you team for correct interval and make corrections as needed. As you walk the line, stand by each team member and see if you can see the number of other team members to either side specified by the interval.
5. To maintain proper speed:

- a. You should look for parts of the line that are moving too quickly and slow them down. If the whole line's speed needs adjusting, adjust the speed of the base man accordingly.
 - b. Watch the designated route marker - he is the most likely to fall behind. Slow the team if necessary to ensure a well-marked edge.
 - c. Occasionally stop the team for listening checks or whistle sound sweeps.
6. To ensure no terrain is missed between sweeps:
- a. Make sure the team member marking the edge of the search line is marking at the proper interval (you can see each mark from the last one).
 - b. When you make subsequent sweeps, let the same person who marked a line be the new base man. He will have the easiest time finding the marks since he left them.
 - c. If you have problems finding a mark, stop the line and send out scouts to find it. Once you do, ensure you haven't missed any terrain while looking for the mark. If so, back up and cover it.
 - d. Periodically check your pace man's count and locate your approximate location on the map.
 - e. Periodically check the map, and mark the areas you have covered.

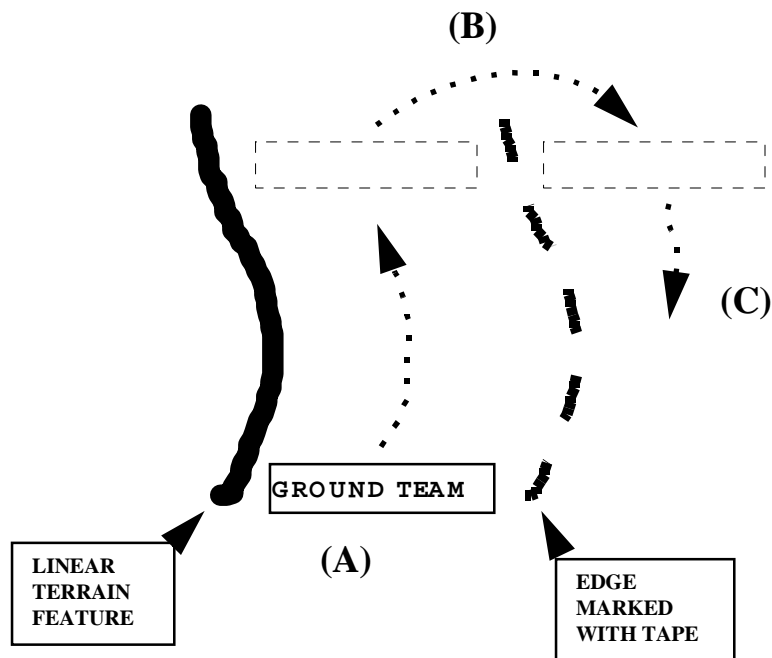

EXAMPLE: Guiding a team with terrain association. (A) On the initial sweep, the base of the team is to the team's left, guiding on the terrain feature. The right hand member of the team marks the edge with tape. (B) When the team reaches the end of the search are it turns around. (C) On second sweep coming back, the base is to the team's right, guiding on the marking tape left from the first sweep.

- 7. To ensure team safety.

- a. Occasionally have the team “Count Off” with their numbers. This ensures you haven’t lost anyone.
- b. Monitor your team for fatigue or dehydration. Take breaks as needed.
- c. If you hit dangerous terrain, stop the team, recon area, and make a safe plan to search or avoid it.
- d. Ensure all team members know they can halt the team for any reason related to the search or safety.

Additional Information

More detailed information on this topic is available in Chapter 7 of the Ground Team Member and Leader Reference Text.

Evaluation Preparation

Setup: Choose a wooded area at least 400 meters long with a linear terrain feature (stream, road, etc.). Line up a search team of at least 5 members. Predesignate a base man, pace man, and an edge marker. Provide a map of the area to the individual to be tested. Choose a magnetic azimuth through a different part of the woods.

Brief Team Leader: Tell the individual to take the team and search the area to one side of the linear terrain feature using a search interval of 2 men visible. Tell him to search a given distance along the feature, then turn around and search coming back one search line width farther from the terrain feature. When he completes that task, tell him to search along the magnetic azimuth for 400 meters. At some point along each search, have him stop the team and determine his position on the map +/- 100 meters.

Evaluation

<u>Performance measures</u>		<u>Results</u>
1. Maintains control of the team at all times.	P	F
2. Uses appropriate voice or whistle signals	P	F
3. Maintains proper direction and control of base and pace men.	P	F
4. Ensures proper interval among team members.	P	F
5. Maintains proper speed.	P	F
6. Ensures edge marking is adequate	P	F
7. When asked, can determine the team’s location +/- 100 meters	P	F
8. Leaves no terrain un-searched between the sweeps	P	F
9. Maintains team safety at all times.	P	F

Student must receive a pass on all performance measures to qualify in this task. If the individual fails any measure, show what was done wrong and how to do it correctly.

O-0419

PLAN AND ORGANIZE A HASTY SEARCH

CONDITIONS

You are leading a team in the field, and are assigned to hasty search trails and linear features in an area.

OBJECTIVES

Within 10 minutes, plan and organize an effective team hasty search of the assigned area.

TRAINING AND EVALUATION

Training Outline

1. Efficiency is important to cover a large search area quickly. It takes many searchers a long time to search one square mile, especially in a line search, and it is not wise to waste resources this way when many survivors are found by searching high probability areas. This could be because the search target is believed to be mobile and looking for help, or because the search target is believed to be located near a road or other terrain feature. The objective of a hasty search is to search areas of high probability in an area quickly to a moderate probability of detection. Areas of high probability include linear features like trails, roads, streams, and drainages, and point features like cliffs, boulder fields, caves, etc.

- a. Team movement during a hasty search is normally on trails and roads. Vehicles may be used on some roads, while team members walk on smaller trails.
- b. In order to cover more area, the team leader often will be required to operate the team in two to three-member sections remotely from your location. This requires additional care to keep all team members safe.
- c. Hasty search usually involves attraction tasks, such as yelling, horn blowing, lights at night, etc. (See the Conduct Attraction Techniques task O-0407.)
- d. Sometimes, the team will be told exactly what terrain features to search. Other times, the team will be given an area to cover, and the team leader chooses where to search.

2. To plan and organize a hasty search:

- a. **Determine what linear and point features to search** (unless this is specified) using a map. Take into account the past history of the area, preliminary information from investigations, and the possibility that you may be looking for someone that isn't lost, but just delayed: a "bastard" search.

- 1) Linear features within a search area include trails, ridge lines, drainages, and roads. These are normally places the search target might be walking (like roads), obstacles a plane might have crashed into (ridge lines), or places that allow visibility of surrounding terrain.

- 2) Point features are specific points of interest. They could also include isolated buildings, bridges, or other places the search target may have taken shelter. They could be high points from which a team can visually scan the area. Or they could be danger areas that might have caused the target to become lost or injured (cliffs and caves for missing persons, towers and mountain tops for airplanes).

3) Remember what your target is. A missing plane search will look at different terrain features than a missing persons search.

b. **Determine the hazards in the area** (see separate task -- Identify Natural Hazards - O-0101), so you can brief your team.

c. **Divide the team into sections** of two to three team members.

1) The ability to divide the team into sections is determined by the number of people and the ability to maintain communications with each section. The buddy system requires that no person be sent out alone, so the maximum number of sections is simply half the number of team members.. The team member may choose to make three person sections based on the assignment and the experience level of the team members.

2) Ideally each section will have radio communications with the team leader, but this is not an absolute requirement. Being in whistle range should be adequate for short periods of time.

3) Determine who will carry what team equipment, including the first aid kit, DF gear, and radios.

d. **Determine the rally point.** Where should sections go when they are done searching. It might be the start point, or it might be some other place in the area.

e. **Determine who searches what features.** Divide the work up evenly. Starting from the team's current location and trace routes for each team to the rally point. Decide if each team travels mounted or dismounted. Remember to allow more time for teams moving through rough terrain (such as "ridge running") than for teams traveling on well kept roads.

e. **Make a communications plan.** How do sections communicate -- radio or whistle? Ensure sections are always in at least whistle range of other sections. Determine check-in times and procedures with the team leader. This can be done with whistle signals.

f. **Determine lost procedures.** If there is a clearly definable terrain feature, such as a tower, that is visible from all directions, you could have lost team members move to that feature. If there is a linear terrain feature at or beyond a boundary of the search area (such as a river or highway), you could determine the azimuth to it, and have lost team members travel to it and then stop. At the very least, you could have lost personnel stationary on the trail they are on. In any case, have a plan.

g. **Brief your sections.** The briefing should include the results of all your planning. . Make each section knows exactly where to search. If maps are not available for all, drawing sketches is desirable. Brief the team on:

- 1) The chain of command for the team (who's in charge if the leader is absent or injured).
- 2) Who is in what section, and who carries what team gear.
- 3) Exactly what routes each section takes, and what they search.
- 4) The communications plan
- 5) Terrain hazards and lost procedures

- 6) Actions on clue find or target find.
- 7) Where the team leader will be located.
- 8) Specific clues to search for (remind the team what the target is).
- 9) Attraction techniques to use.

3. To conduct the hasty search, each section travels along its route, using proper scanning techniques. At point terrain features, the section stops and searches the point and it's surrounding area.

Additional Information

More detailed information on this topic is available in Chapters 7, 18, and 19 of the Ground Team Member and Leader Reference Text.

Evaluation Preparation

Setup: Provide the team leader with a map with an area to search marked on it. The leader may use any item in his field gear, including this checklist. Prepare a list of team equipment.

Brief Team Leader: Tell the team leader that he has an 8 man team (including himself) and must develop a plan for a hasty search of the marked area. Brief the team leader on what the target of the search is. Give him the list of team equipment. Tell him to brief you on his plan in 15 minutes as if you were his team.

Evaluation

Performance measures

Results

The team leader:

- | | | |
|--|---|---|
| 1. Starts the briefing within 15 minutes. | P | F |
| 2. Briefs the team on: | P | F |
| a. The chain of command and duty assignments for the team (Who's in charge in lieu of the team leader? Who is in what section, and who carries what team gear?). | | |
| b. Exactly what routes each section takes, what to search, and attraction techniques to use. | | |
| c. The communications plan | | |
| d. Safety hazards and lost procedures | | |
| e. Actions on clue find or target find. | | |
| f. Where the team leader will be located. | | |
| g. Specific clues to search for (remind the team what the target is). | | |

- | | | |
|--|---|---|
| 3. Correctly identified the terrain features that need searching and safety hazards | P | F |
| 4. Made section assignments that: | P | F |
| a. Let each section cover a logical number of features located along a logical route | | |
| b. Cover all terrain features identified in # 1 above | | |
| c. Make use of vehicles and personnel on foot as appropriate. | | |
| 5. Developed a logical communications plan and lost procedures. | P | F |
| 6. Used all available resources, including team gear and vehicles as appropriate | P | F |

Student must receive a pass on all performance measures to qualify in this task. If the individual fails any measure, show what was done wrong and how to do it correctly.

O-0420
PERFORM AN AIRFIELD SEARCH (RAMP CHECK)

CONDITIONS

You are leading a ground team that has been tasked to search an airfield and have just arrived at the airfield.

OBJECTIVES

Take all steps necessary to determine if the missing aircraft is at this airport.

TRAINING AND EVALUATION

Training Outline

1. During a missing aircraft search, one of the first priorities of the mission is to investigate airfields in the surrounding area. This investigation is to determine if the missing aircraft may have landed, refueled, or stopped over to avoid weather. Missing planes can be found at the wrong airport for many reasons. The pilot might have landed successfully and gone about his business, not realizing that people are looking for him. Sometimes, aircraft crash near an airport they were trying to land at, or just took off from.

2. Your team may be tasked to search one or more airfields, or you may come across an airfield during a search. In either case, you should follow the following steps:

a. **Contact the Owner.** The first priority is to contact the airfield owner/operator or fixed base operator (FBO). This individual will permit you access to controlled airfields and will also be helpful in obtaining any records. If no FBO is present, you may proceed to search the airfield within the limits of safety and trespassing laws.

b. **Brief your people.** Make sure all your team members know what the missing aircraft looks like, and what it's tail number is. Remind them of possible search clues, including

1) The missing plane itself.

2) Any plane that comes close to the description (it's possible your briefing at mission base contained an error)

3) Any clues that a plane might have crashed near the airport, such as bad weather in the vicinity at the time the plane was lost, trees knocked down, people reporting hearing/seeing something strange, etc. See Task O-0408 - Identify Aircraft Search Clues for more details.

c. **Conduct the search.** Have your team conduct the following search actions (you may divide your team up as you see fit, making sure that inexperienced members are teamed with more experienced members):

1) **Check records.** Check any landing/take-off records at the airport for information on the missing aircraft. Also check any fuel purchase logs. Look for the tail number of the plane you are looking for.

2) **Conduct Interviews.** Interview people at the airport (See Task O-1101 - Conduct Witness Interview). Airport workers, maintenance personnel, or perhaps somebody just 'hanging around' may have seen the missing aircraft or know someone who might have seen it. All of these types of leads must be thoroughly

investigated. Continue to conduct interviews over time - people come and go at airfields all the time, and the person who saw the search target might not be there when you arrive.

3) **Check the flight line.** Have personnel walk down the flight line / tarmac and check the registration numbers on all aircraft parked on the airfield. Look into hangars and check numbers. Each of these should be conducted within regulations and local laws. If on a controlled airport, notify ground control and/or operations before entering operational areas like the ramps and hangars. Use good judgment in deciding to enter hangars or aircraft; you are not normally going to find a person in distress within a hangar or parked airplane, so waiting for law enforcement personnel, the aircraft owner, or the FBO to open it is totally reasonable.

e. **Leave a phone number.** If the search results are negative, leave the mission base phone number and a contact name (normally the incident commander) with the FBO. Request that he continue asking about the missing aircraft to people who come into the airport. Any information that he develops can then be forwarded directly to mission base. **Note: Do not leave the airfield until you receive permission from mission base.**

Additional Information

More detailed information on this topic is available in Chapters 7, 18, and 19 of the Ground Team Member and Leader Reference Text.

Evaluation Preparation

Setup: Prepare a diagram of an airfield (or conduct the test at an actual airfield). Prepare a description of a missing aircraft and its pilot as well as the incident commander's name and phone number. The team leader may use any equipment in his field gear (including this guide).

Brief Team Leader: Verbally brief the team leader on the missing aircraft. Tell him that he has a ground team consisting of himself, one other senior (GTM qualified) and 5 cadets (3 GTM, 2 Trainee). Tell the team leader to describe, in sequence how he will search the airport. Tell him that you will play the role of the FBO. After he has described the search, tell him he did not find the plane, and ask him what he would do now.

Evaluation

<u>Performance measures</u>	<u>Results</u>	
The team leader:		
1. Contacts the FBO and identifies himself and mission	P	F
2. Briefs his team on the missing aircraft and personnel, and what to look for.	P	F
3. Describes how he would use his team to:		
a. Check for landing/takeoff/refueling logs.	P	F
b. Conduct interviews of people at the airport.	P	F
c. Search the flight line and hangers	P	F
4. Does not leave inexperienced team members to operate without supervision.	P	F
5. Requests and receives permission to depart from mission base.	P	F
6. Leaves mission base information with the FBO before departing	P	F

Student must receive a pass on all performance measures to qualify in this task. If the individual fails any measure, show what was done wrong and how to do it correctly.

DIRECT TEAM ACTIONS ON LOCATING A CLUE

CONDITIONS

You are leading a search team moving when a team member discovers the possible search clue.

OBJECTIVES

Direct your team through the necessary actions to protect the clue, and search the immediate area for additional clues.

TRAINING AND EVALUATION

Training Outline

1. When a team member discovers a possible clue, the team leader must direct the team actions properly in order to prevent the clue from being disturbed, preventing destruction of other possible clues in the area, find any other clues in the area, and report the information to mission base.
2. When a team member spots a clue, they will halt the team and alert the team leader. The team leader should then:
 - a. Ensure the team is halted.
 - b. Move to the team member who found the clue.
 - c. Survey the immediate area for safety hazards such as falling debris, rotting tree limbs, pits and holes, etc., and for other clues in the immediate area.
 - d. Protect the clue: Have a team member mark off the immediate area with flagging tape. Neither the team leader nor members should actually touch nor disturb the clue. This will allow man-trackers, dog teams, etc. to work with an undisturbed source.
 - e. Search the immediate area. Based on the initial survey, search the area around the clue in order to detect any other possible clues in the area. Search carefully, because the objective is to find other clues without significantly disturbing the area. If necessary, call other team members over to assist. Ensure they know of any safety hazards, and where the clue(s) are (so they do not disturb them). Usually the best plan is to have two or three experienced people sweep the area around the clue location while the rest of the team remains off to the side.
 - f. Report the clue to mission base. Follow any instructions they give you.
 - g. On a high visibility marker by the clue, record the time, date, and clue number (based upon a standard issue log). In the team log, record the time, date, clue number, location, and description of the clue.
 - h. Do not leave the area until directed by mission base.

Additional Information

More detailed information on this topic is available in Chapters 7 and 15 of the Ground Team Member and Leader Reference Text.

Evaluation Preparation

Setup: Pick a piece of terrain and put a clue (article of clothing, piece of aircraft debris, etc.) on the ground. Ensure the team leader has his field gear. Place the team leader at least 20 yards from the clue. Position yourself at the clue. (As an option, you can place another clue nearby to be found in the subsequent search of the area.)

Brief Team Leader: Brief the ground team leader that he is leading a team on a search. Tell him that you will play the role of a team member who has just spotted a clue. Tell him to take all necessary actions. Finally, inform him that that you will also play the roles of all team members and mission base, if he wants to call them on the radio (simulate radio traffic).

Evaluation

<u>Performance measures</u>	<u>Results</u>	
1. Halts the team in place	P	F
2. Performs a survey of the immediate area.	P	F
3. Has a team member mark the clue	P	F
4. Doesn't disturb the clue, or allow anyone else to disturb it	P	F
5. Has team sweep area for additional clues	P	F
6. Reports the clue detection to mission base	P	F
7. Follows instructions for mission base	P	F
8. Does not leave the area until directed	P	F

Student must receive a pass on all performance measures to qualify in this task. If the individual fails any measure, show what was done wrong and how to do it correctly.

O-0422
DIRECT TEAM ACTIONS ON FIND

CONDITIONS

You are leading a ground team when one of your team members discovers the search target.

OBJECTIVES

Direct team actions to identify the target, provide first aid, and protect your team.

TRAINING AND EVALUATION

Training Outline

1. At the point when an individual team member first sights the object of a SAR mission, the search phase ends and the rescue and recovery phase begins. In this process, the safety of the search objective and your team are the primary concern.

2. If a team member discovers the search target, you, the team leader, should:

a. **Halt the Team.** Have everyone remain in place. You should only call personnel in to the scene as they are needed. Be especially sensitive to exposing younger cadets to accident sites.

b. **Assess the Situation.** Move to the search target. As you approach, survey the surrounding area for safety hazards such as falling tree limbs, wreckage, fires, hazardous materials, etc. Do not put your team in danger.

c. **Provide Life Saving first aid.** Direct your medically trained personnel to aid the injured to the extent of your team members' training. Ensure anyone who comes in contact with the victims or the crash site takes appropriate protective measures against blood borne pathogens. Leave obviously deceased personnel alone. Determine if you need outside agency assistance, such as an ambulance, helicopter, or coroner. Whenever practical, use ambulances or helicopters for evacuation of the injured - don't do it yourself.

d. **Positively identify the target.** Make sure you've found what you think you've found. Verify the tail number off the airplane, ask conscious survivors their names, and check physical descriptions against your mission briefing. If you haven't found all the missing persons, organize a hasty search of the surrounding terrain. Ask victims where the others are.

e. **Send a Report to Mission Base.** Advise the mission base of your situation. Once your team medics are at work and you know what you have, send a find report. If you are still searching for some victims, make that a part of your report. If you find them, you can always update your report.

f. **Assist Local Authorities** - Establish a staging area on the nearest road, post a team member there, and let mission base know where it is. If necessary, establish a separate entry-control point. Depending on the location of the staging area, you may not need a separate entry control point from the staging area. Either way, until the scene is turned over to another agency, you are responsible for documenting who or what enters or exits the site. Be prepared to assist the local fire department, medical examiner, FAA or NTSB representatives as required. This includes establishing traffic control points, area security, or assisting in the evacuation of survivors and victims. Any requests for assistance beyond the team leaders instructions from ground operations must be approved by the mission coordinator prior to rendering assistance.

g. **Safeguard the Area.** Assign at least two members of the team to sweep the entire area to determine the extent of the crash site. Use other team members to establish an initial perimeter around the site for security. Don't disturb any wreckage except as required to save lives. See Task O-0802 - Plan and Organize Site Surveillance.

Additional Information

More detailed information on this topic is available in Chapters 7 and 15 of the Ground Team Member and Leader Reference Text.

Evaluation Preparation

Setup: In a wooded area, place a simulated target with at least one simulated victim. Prepare a mission briefing describing the search target. Provide the team leader at least a standard ground team. Place the target along the route of travel of the team.

Brief Team Leader: Brief the ground team leader whether he is on a missing aircraft or missing person search and that one of his members has just spotted the target.

Evaluation

<u>Performance measures</u>	<u>Results</u>	
The team leader:		
1. Halts the Team.	P	F
2. Assess the Situation.	P	F
3. Directs life-saving first aid.	P	F
4. Positively identifies the target.	P	F
5. Sends a Find Report in the appropriate format.	P	F
6. Establishes a link-up point	P	F
7. Safeguards the area.	P	F
8. Takes adequate precautions to safeguard team from hazards, including bloodborne pathogens.	P	F

Student must receive a pass on all performance measures to qualify in this task. If the individual fails any measure, show what was done wrong and how to do it correctly.

O-0502
PARTICIPATE IN A LITTER OR STRETCHER CARRY

CONDITIONS

As part of team you are required to evacuate a patient from a wilderness environment using a litter or stretcher.

OJECTIVES

Participate as part of a litter team to properly evacuate a simulated patient from the wilderness over several obstacles.

TRAINING AND EVALUATION

Training Outline

1. At times the ground search and rescue team will be required to assist in the transportation of a patient from a remote location to medical assistance. This is usually done by placing the patient in a stretcher or litter and having a six to eight person team manually transport them to safety. As part of the team, the individual is responsible for knowing how to lift, carry, pass the litter, and set the patient down properly.

2. Litter lifting. Once the patient is in the litter and secured, the team must bring the litter to waist height to begin transport.

a. To do this four to six individuals line up on alongside the litter (two or three per side), the person at the right front (head position) is in charge of the lift. All individuals get down on one knee facing the litter. Grab the litter rail with both hands.

b. On the command "lift to the knees," straighten your back and lift with both hands, pulling the litter up to knee height.

c. On the command "lift to the waist," use your rear leg to lever yourself to a standing position, with both hands still on the litter.

3. Litter Carry.

a. After the litter is lifted, the team leader commands 'face front.' At this point take your front hand off the litter and rotate your body to face the front (head) of the litter.

b. On the command 'forward', start walking with your inside foot first. Ideally the people on each side of the litter are 'out of step with each other,' to avoid bouncing the litter, but moving the litter should not be stopped to simply stay in step.

c. If you tire and need relief, alert the team leader. A relief bearer will come up directly behind you and grab the litter. When he tells you that he has 'got the litter' you may let go and move off to the side. At this point you join the pool of relief bearers.

4. Pass over obstacles. Fences, rocks, or fallen logs represent obstacles to properly carrying the litter. To overcome these:

a. The team leader brings the litter directly up to the obstacle and halts the team.

b. Two relief bearers cross the obstacle and position themselves at the head. The litter is passed forward to so that the relief bearers take over the front of the litter.

c. The bearers at the rear of the litter who just passed their load forward, then cross the obstacle and position themselves in front of the relief bearers.

d. The litter is again passed forward until the only the rear of the litter is on the obstacle.

e. The process is repeated until the litter and all the bearers are passed the obstacle and normal travel can resume.

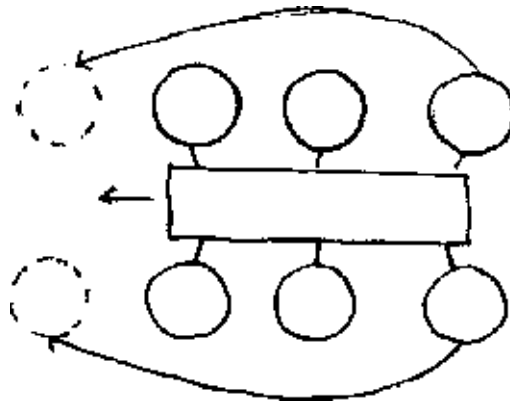

Litter Transfer Uphill or Over an Obstacle

5. This same technique should be used when moving up or down a steep slope (whenever possible, however, avoid such slopes). Ropes can be secured to the litter to allow personnel at the top of the slope to assist in the movement up or downhill.

6. Setting the litter down

a. To set the litter down, the team leader calls a halt and then 'face center.' At this point the bearers rotate their bodies to face into the litter and grab the litter rails with both hands.

b. The team leaders then command 'lower to the knees.' At this point keep your back straight and lower yourself to a kneeling position with the litter in front of you and at knee height.

c. On the command 'lower to the ground,' bend forward slightly until the litter is safely on the ground. At this point move away from the litter to allow the team medic to check out the patient.

6. Lift straps. If you have a length of 1" webbing in your gear, it may be easier on your arms to construct a sling to help carry the litter. Tie a water knot in the webbing to secure the ends together. Girth hitch or snaplink the webbing to the litter rail and place the long loop over your shoulder. Adjust the position of the water knot to set the loop to the proper length. On long evacuations, this will reduce fatigue.

Additional Information

More detailed information on this topic is available in Chapter 8 of the Ground Team Member & Leader Reference Text.

Evaluation Preparation

Setup: Place the student on stretcher team. Provide the team with a litter and a simulated patient secured to the litter. (You can use an actual person in the litter, or something of similar weight.) Prepare a course of at least 300 meters containing at least 3 obstacles that will the team must pass the litter over.

Brief Student: Tell the team that you will call all commands for the team. Show them the course they must carry the stretcher over. Have the students line up on the stretcher, with the relief bearers off to the side. Tell all students that they should request relief at least once during the 300 meter course.

Evaluation

<u>Performance measures</u>	<u>Results</u>	
1. Lifts the litter on command to the knees while keeping his back straight.	P	F
2. Lifts the litter to the waist properly	P	F
3. Relieves another litter bearer properly	P	F
4. Participates in transfer over an obstacle properly	P	F
5. Lowers the litter to his knees and ground on command.	P	F

Student must receive a pass on all performance measures to qualify in this task. If the individual fails any measure, show what was done wrong and how to do it correctly.

O-0601
CONDUCT ACTIONS WHEN LOST

CONDITIONS

You have become separated from your ground team in the wilderness, and do not know where they are or where you are.

OJECTIVES

Take correct actions needed to survive and be found.

TRAINING AND EVALUATION

Training Outline

1. Search and rescue operations are frequently conducted in adverse weather and terrain conditions. The same environment that caused the search objective to be missing could cause the same difficulties for a team member. All ground team members should have a knowledge of basic survival skills. This will decrease the chances of serious injuries and decrease the time before the team member can be found.

2. If you are in a survival situation, remember the acronyms **SURVIVAL** or **STOP**:

a. **SURVIVAL**:

1) **S**ize up the situation. Look at where you are. What resources (water, wood, etc.) are available nearby? What dangers are there? (see task O-0101 - Identify Natural Hazards.) Inventory your equipment to establish what tools you have to handle the situation. Are there people nearby who might be able to help you? For example, if you just became separated from you team, just blowing your whistle might rescue you. (See task O-0406 - Use Whistle Signals)

2) **U**ndue Haste Makes Waste. **STOP**. Walking around aimlessly is a waste of energy. Take your time and think about your decisions. You could easily make the situation worse by moving farther from help, injuring yourself, or losing an important item.

3) **R**emember Where You Are. You may not be as lost as you think, just momentarily disoriented. Think about the last time you knew where you were, and what happened next. Mark your current location, and memorize it. That way, as you look around, you will not become more lost.

4) **V**anquish Fear and Panic. These feelings are natural, but might lead you to do something that you have not thought through clearly. If you are tired, frustrated, or near panic, stop and rest. Provide your body and mind with a few minutes or hours of down time. This will help to calm anxieties and better prepare you to handle the situation. Keep a positive mental attitude -- believe you are going to be all right.

5) **I**mprove Your Situation. Think about how to be found, safe from danger, and more comfortable.

a) Find a clear area. This will facilitate your being spotted from the air.

b) Establish shelter for your body. If you have to spend the night in the wilderness, spend the necessary time to build adequate shelter and a fire. Maintaining body warmth and protection is a high priority.

c) Establish signals. Place orange markers or vests in nearby location. Preferably where they can be seen from the air. Do not forget Ground to Air Signals (task O-0703). Build a large signal fire. Establish a schedule for blowing your whistle to attract anybody in the area. If you are moving at night, stay in the open. Tie your chem-lite to the end of a string and swing it in a circle over your head. This will make you easy to spot from the air, and make it easy for the pilots to tell the difference between you and the lights of the ground searchers looking for you.

d) Find water. If you are in a wilderness area, remember that downhill always leads to water. Do not drink standing water, build a fire and boil it at least one minute to remove bacteria. Rain water, melting snow or ice will provide adequate bacteria-free water.

e) If you have to move, remember that downhill and downstream leads to civilization. Moving uphill will rarely lead you to any help.

6) **V**alue Living. Never stop trying. Giving up is the surest way to ensure failure. No matter how cold, wet, or tired you get, do not forget that positive mental attitude. Never give up!

7) **A**ct Like the Natives. Observe animals in the area. They live here -- they know where the where food and water are, and what the dangers are. (be careful what you eat, though. Some plants are poisonous to people but harmless to animals.)

8) **L**earn Basic Skills. And use them. This book is full of them. Make sure you know how to build a fire, avoid hazards, build a shelter, signal for help, and find water.

b. **STOP:**

1) **S**tay where you are. Rather than wandering aimlessly, don't move unless it is more hazardous to stay where you are than to move.

2) **T**hink before acting rashly. If something does not seem right, it probably isn't. If you take the time to stop and think, you may come up with a better solution.

3) **O**bserve your surrounding and its' inhabitants. Animals survive on natural instinct experience in their surroundings. By observing their habits, and in many cases mimicking them, you will survive.

4) **P**lan for the worst. Most people who do not survive had the tools and the knowledge to survive, but got caught off guard and didn't do anything about it. If you plan for the worst using what you have, you will at least be ready, and kept your mind off of being lost and re-focused your energy on living.

3. If you ever end up in a survival situation, remember that a Positive Mental Attitude will save you. If you don't want to live, then most of what you do will be a waste of time, but if you really do want to live then you have a chance. There are many stories of people that should have died days earlier being rescued and returning to happy and healthy lives long after the normal person dies. And there are obviously many other of people who died that shouldn't have. Stay focused, and tell yourself you want to live!

Additional Information

More detailed information on this topic is available in Chapter 9 of the Ground Team Member & Leader Reference Text.

Evaluation Preparation

Setup: None

Brief Student: Tell the individual that that he has become separated from his team and darkness is 2 hours away. Have him describe his immediate actions and survival steps.

Evaluation

Performance measures

Results

The individual:

- | | | |
|--|---|---|
| 1. Identifies and describes the SURVIVAL or STOP procedure steps. | P | F |
| 2. Defines Positive Mental Attitude and demonstrates understanding the importance of it. | P | F |

Student must receive a pass on all performance measures to qualify in this task. If the individual fails any measure, show what was done wrong and how to do it correctly.

O-0605
EXTINGUISH A SMALL FIRE

CONDITIONS

You have come across a small fire.

OBJECTIVES

Safely extinguish the fire.

TRAINING AND EVALUATION

Training Outline

1. Fire burns in two basic modes: flaming and surface combustion (or smoldering). The surface or smoldering fire is represented by the fire triangle with the three sides representing fuel, heat and oxygen. Flaming combustion is represented by the fire tetrahedron (pyramid) with the four sides representing fuel, heat, oxygen and an uninhibited chemical chain reaction.

Fire Triangle

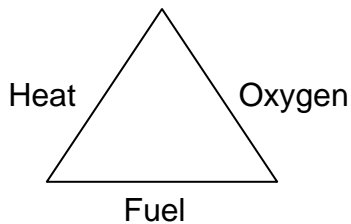

Fire Pyramid (unfolded)

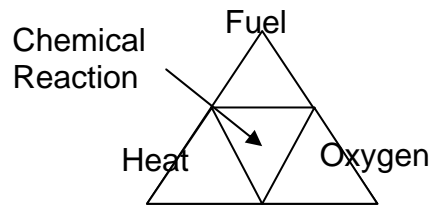

2. The fuel portion of either type of fire may be solid, liquid or gas. Oxygen may be that present in the air or in another solid, liquid or gaseous chemical which contains oxygen (an oxidizer). Combustion (fire) starts when there is the proper mixture of oxidizer, fuel and either heat or a chemical reaction.

3. To extinguish a fire, the triangle or pyramid must be broken by:

- a. removing the fuel or
- b. removing the oxygen or
- c. reducing the heat or
- d. interfering with the chemical reaction.

4. The most common method of extinguishing a fire is by reducing the heat, in other words, cooling the fire, using water. This is most effective on common combustibles such as wood and paper.

5. Cooling will not work on flammable liquids such as gasoline and grease. To extinguish fires such as these, the fuel must be removed (such as closing a valve to stop the flow), displacing the oxygen (with a non-flammable gas for instance), or breaking up the chemical reaction with another chemical.

6. Fires are divided into four classes and fire extinguishers are classified the same to indicate what type of fire they are effective against:

a. Class A - Common combustibles such as wood, paper, cloth and many plastics. Water works well on these by cooling them below their ignition points.

b. Class B - Flammable liquids and gases. These must be extinguished by smothering (removing the oxygen), displacing the oxygen, removing the fuel or breaking up the chemical reaction.

c. Class C - Fires involving energized electrical equipment. Although there are special extinguishing agents for these, it is normally easiest to de-energize the circuit (turn off the power), then put out the resulting Class A or B fire.

d. Class D - Flammable metals. These are rare and require special techniques to extinguish.

7. Fire extinguishers also have a numerical rating which indicates the relative size fire it will extinguish. A 4A extinguisher will put out a Class A fire twice as big as a 2A extinguisher can and 4 times the size that a 1A extinguisher can extinguish.

8. The most common type of extinguisher is an ABC, with the most versatile being a 4A-20B:C (the C has no rating, it just indicates that the extinguishing agent is non-conductive). This type of extinguisher is effective against most small fires in a home or vehicle.

9. To use a fire extinguisher:

a. Make sure it is appropriate to the type of fire: A, B or C.

b. Make sure the fire is small. This means that if the extinguisher fails to put out the fire, you must be able to safely escape. If in doubt, retreat and call 9-1-1.

c. Start on the upwind side of the fire.

d. Follow the letters **PASS**:

P = PULL the pin at the top of the extinguisher that keeps the handle from being pressed. There is usually a wire or plastic tab that keeps the pin from falling out. This can easily be broken just by pulling on the pin. Then check the gauge. If it does not show a full charge, it should not be used because the effectiveness may be greatly degraded.

A = AIM the nozzle towards the fire. If the nozzle is at the end of a hose attached to the body of the extinguisher, detach the hose before aiming the nozzle.

S = SQUEEZE the handle to discharge the extinguishing agent. Use long or short bursts depending on the fire size and location, aiming at the base of the fire. Carefully move closer if the stream does not reach the fire.

S = SWEEP the extinguishing stream along the base of the fire. On liquid or grease fires, sweeping just above the liquid is important, otherwise the burning liquid may be spread around further. Move closer to the fire as it goes out, circling it if necessary.

- 1) The discharge may only last 30 seconds at the most, so have another extinguisher at the ready or plan to abandon the effort if the fire is not out.
- 2) Make sure the fire is out and be prepared for flare-ups.
- 3) If you don't know what is burning, don't attempt to put out the fire.
- 4) Don't attempt to extinguish hazardous material fires.
- 5) Approach burning vehicles from an angle, not head on or in direct line with the tires. When opening the hood of a vehicle with an engine fire, open it slightly, spray some extinguishing agent in, then open the hood the rest of the way. Be prepared for flare ups or a flashover.
- 6) If any doubt exists before or after a fire, notify authorities.

10. To extinguish an outdoor fire such as a campfire or small brushfire:

- a. Keep upwind of the fire
- b. Have all personnel, vehicles and equipment ready to clear out quickly.
Use water if available. Do not use the drinking water supply if it cannot be easily replenished.
- c. Splash, spray or sprinkle water onto the fire, do not pour it on all at once. As the water is put on the fire, break up big pieces of material if possible, spread out any burning or smoldering material, turning it over to ensure that all areas are wetted. Continue to add water while disturbing the material until all signs of flame and glowing embers are extinguished. Dig up or overturn the soil under the burned area to try to mix the ashes into the soil.
- d. Using care, place your hand close to the burned area to ensure that it is cool. If not, add more water and continue disturbing the material until it is cool.
- e. After the fire is out and cool, ensure the burned material is adequately mixed in with the soil.
- f. Be prepared for flare-ups.
- g. If water is not available, or in combination with water if it is, throw soil, sand, etc. onto the fire while breaking up, spreading around and disturbing the burning material, mixing it in with the soil.
- h. Blankets, coats, shelter halves or similar objects of heavy fabric, not plastic or synthetic, can be used to extinguish flames by beating directly on the flames to smother them. This must be done directly on the flames, otherwise this action will fan the flames, causing the fire to grow in intensity. This technique can also be used in combination with water, and the objects should be wetted if it is.
- i. Campfires, signal fires and warming fires must always be completely extinguished and cool to the touch before leaving them.
- j. Efforts to extinguish a brushfire should only be attempted if the fire is very small, there is little or no wind and an escape route is planned. If in doubt, retreat and notify authorities.

Additional Information

More detailed information on this topic is available in Chapter 9 of the Ground Team Member & Leader Reference Text.

Evaluation Preparation

Setup: This exercise should be conducted with a fire protection agency. These agencies will provide instruction and in most cases, will have a safe area and supplies for igniting training fires and have fire extinguishers for students to use.

Establish a safe area away from combustibles with backup or alternate extinguishing methods to the one(s) the students will use. Have a fireproof container in which a small, controlled fire can be ignited, sufficient fuel to ignite a fire for each student to extinguish an ignition source(s).

NOTE: Fire protection personnel should start the fire and have the student extinguish the fire just built, but should also be prepared to put out the fire if necessary.

Brief student: Prior to igniting the test fire, the student is to list the four components necessary for fire, what the basic requirement is to extinguish a fire, the four classes of fire, the types of materials each represents and how to select the correct extinguisher for each, explain PASS, and list two safety considerations before attempting to extinguish a fire. Ignite a fire and have the student extinguish it.

Evaluation

<u>Performance Measures</u>	<u>Results</u>	
1. Lists fuel, oxygen (oxidizer), heat and chemical reaction as the four components necessary for fire.	P	F
2. Explains the basic requirement to extinguish a fire is to remove one of the components necessary for fire.	P	F
3. Lists Class A, B, C, D fires.	P	F
4. Lists the type of material each type of fire represents.	P	F
5. Explains that the fire extinguisher selected must have the same letter type as the class of fire to be extinguished.	P	F
6. Explains each letter in PASS.	P	F
7. Lists two safety precautions prior to extinguishing a fire (stay upwind, fire must be small, be prepared for flare-ups, etc.)	P	F
8. Safely extinguishes a small fire using an extinguisher or technique appropriate to the type of test fire.	P	F

Student must receive a pass on all performance measures to qualify in this task. If the individual fails any measure, show what was done wrong and how to do it correctly.

O-0701
RECOGNIZE AND REACT TO AIR/GROUND SIGNALS

CONDITIONS

You are on a ground team in the field, when a search plane flies overhead and attempts to communicate with your team without a radio.

OJECTIVES

Recognize what signal the aircraft is giving and react appropriately.

TRAINING AND EVALUATION

Training Outline

1. When on a search, it is possible to communicate with and receive direction from an aircraft that does not have two-way radio capability with the ground search team. This is accomplished by recognizing the signals that an aircraft can communicate by using its wings, nose, and engine.

2. The signals are:

a. Flying directly over the vehicle from rear to front (6 o'clock to 12 o'clock) revving the engine to indicate to the team to follow that aircraft.

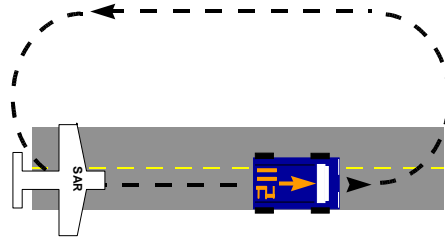

b. Aircraft wags wings back and forth (rocking the wings, rolling the aircraft).

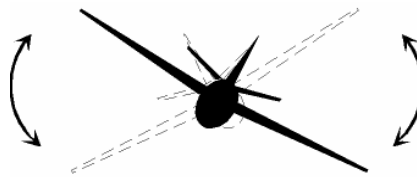

This is a signal that the aircraft receives your message and understands.

c. Aircraft makes wide right hand turn over team

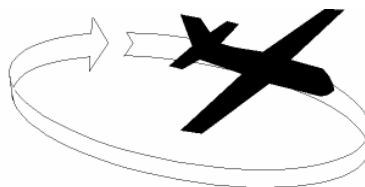

This is a signal that the aircraft has received your message but does not understand it.

d. Aircraft rocks it's nose up and down (pitching)



The aircraft is answering a message as affirmative or 'yes'

e. Aircraft yaws nose back and forth



The aircraft is answering a message as negative or 'no'

f. Aircraft circles the team and then heads away in a straight line while wagging its wings. The aircraft wants the team to head in that direction. After doing so, if the aircraft makes tight left hand turn over area, the aircraft is pointing out a specific target area to be searched.

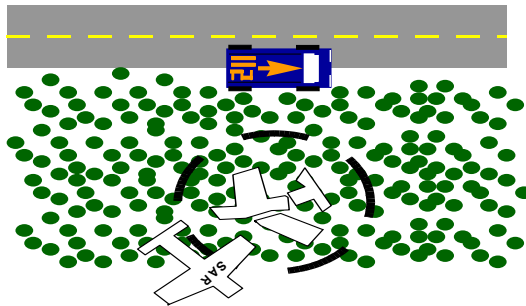

g. Flying directly over team from front to rear. This is a signal for the ground team to stop in place and observe the aircraft for further directions. (12 o'clock position to 6 o'clock positions) to indicate to the ground team to stop.

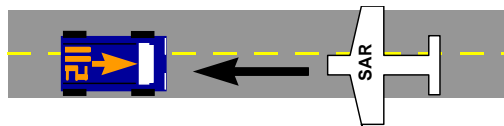

h. The aircraft indicates turns by flying ahead of the team and turning at the appropriate turnoff.

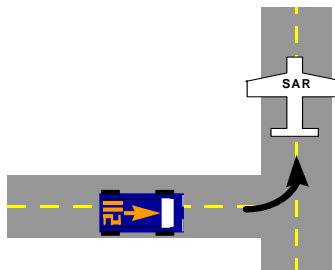

i. The aircraft approaches the vehicle from the rear and then turns sharply right (or left) in front of the vehicle while in motion to indicate to the team to turn around. The aircraft will circle back as necessary, flying against the team's direction of travel, and then take up the initial follow me procedure outlined above.

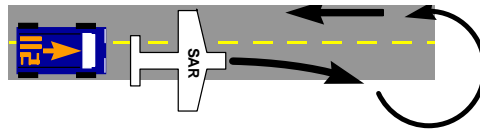

Additional Information

More detailed information on this topic is available in Chapter 10 of the Ground Team Member & Leader Reference Text.

Evaluation Preparation

Setup: None.

Brief Student: Describe each air/ground signal to the student or show a diagram to the student, and ask him what it means.

Evaluation

<u>Performance measures</u>	<u>Results</u>	
The student identifies the meaning of:		
1. Aircraft flying directly over the team (6 o'clock to 12 o'clock), revving the engine.	P	F
2. Aircraft wagging wings back and forth	P	F
3. Aircraft rocking nose up and down.	P	F
4. Aircraft makes tight left hand circle over area.	P	F
5. Aircraft makes wide right hand circle over ground team	P	F
6. Aircraft flying towards the team (12 o'clock to 6 o'clock), possibly revving the engine.	P	F
7. Aircraft circles team and then heads off in a straight line while wagging its wings.	P	F
8. Aircraft approaches the vehicle from the rear and then turns sharply right (or left) in front of the vehicle while in motion	P	F

Student must receive a pass on all performance measures to qualify in this task. If the individual fails any measure, show what was done wrong and how to do it correctly.

O-0702
USE A SIGNAL MIRROR

CONDITIONS

You are in the field, alone or with your team, in daylight, and need to attract the attention of an overflying aircraft

OJECTIVES

With a mirror, correctly signal in the direction of an overflying aircraft.

TRAINING AND EVALUATION

Training Outline

1. At times, you may have radio difficulties and need to attract the attention of an aircraft. Even if you have radio communication with the airplane, the pilot might be having difficulty in spotting you. In daylight, using a signal mirror is an excellent way to attract a pilot's attention, or let him know where you are. Mirror signals can be seen for over 70 miles under normal conditions. Over desert terrain or on the water they can be seen from over 100 miles. A signal mirror can be a high-tech glass mirror (military MK-3 signal mirror) or just a highly polished piece of metal. Mirror signals work well even on hazy or overcast days.

2. To use the MK-3 signal mirror:

- a. Outstretch one hand in the direction of the airplane, leaving the palm facing you.
- b. With the mirror, reflect sunlight into the palm your outstretched hand.
- c. Move your outstretched hand out of the way. Slowly bring the mirror up to eye-level and look through the sighting hole. You will see a bright spot of light. This is the aim indicator.
- d. Hold the mirror near your eye and slowly turn and manipulate it so that the bright spot is on the target aircraft. If having a tough time lining up on the airplane, the individual might try sighting the mirror between two fingers on the outstretched hand.

3. To use a polished metal surface:

- a. Outstretch one hand in the direction of the airplane, leaving the palm facing you.
- b. With the mirror, reflect sunlight into the palm your outstretched hand.
- c. Slowly bring the mirror to chest level while maintaining the reflected light on your hand
- d. Move your outstretched hand out of the way. Maneuver the mirror so that the light reflection is in the direction of the overhead aircraft. Move your hand in and out in front of the beam to create flashes or simply manipulate the mirror.

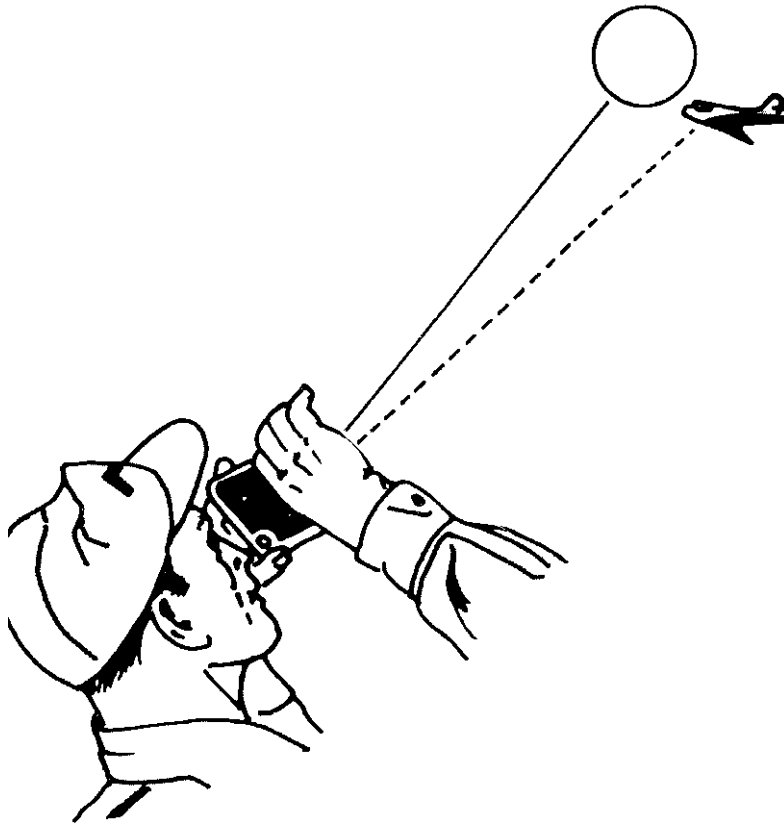

Using an MK-3 mirror

Additional Information

More detailed information on this topic is available in Chapter 10 of the Ground Team Member & Leader Reference Text.

Evaluation Preparation

Setup: Place someone on a distant point (preferably higher ground than where the student is standing). This person will simulate the airplane. Ensure he has communications with you. Ensure the student has signal mirror, preferably the one from that student's own field gear.

Brief Student: Tell the student to use the mirror to signal the person simulating the aircraft.

Evaluation

<u>Performance measures</u>	<u>Results</u>
1. The student produces a reflection on his hand	P F
2. The student successfully directs the flashes toward the target within 15 seconds	P F

Student must receive a pass on all performance measures to qualify in this task. If the individual fails any measure, show what was done wrong and how to do it correctly.

O-0703
EMPLOY GROUND TO AIR SIGNALS

CONDITIONS

You are in the field and must communicate with an airplane without a radio or signal mirror. You have your field gear.

OJECTIVES

Identify the appropriate ground to air signal, correctly construct one signal using your field gear and available materials within 15 minutes, and correctly use body signals

TRAINING AND EVALUATION

Training Outline

1. Ground to air signals can be used by lost personnel and ground teams, whenever a radio is not available. The international ground to air signals are listed below. There are three types of signals. The five distress signals are used primarily by lost persons. The seven search team signals are primarily used by ground search teams. Finally, there are eleven body signals. All team members should memorize the five distress signals, and carry a reference for the others.

2. To use ground to air signals:

- a. Choose an open area visible from the air.
- b. If possible, draw attention to the area with campfires, smoke, etc.
- c. Construct the signals from any suitable materials, including signal panels, colored cloth (such as tarps or ponchos), logs, stones, or by digging trenches. The key is contrasting the signal with the background terrain.
- d. Signals should be at least ten feet tall. Each "leg" of the signal should be at least eighteen inches thick.
- e. The five distress signals are as follows (you can also use the international "S O S"):

 - REQUIRE ASSISTANCE

 - REQUIRE MEDICAL ASSISTANCE

 - NO OR NEGATIVE

 - YES OR AFFIRMATIVE

 - PROCEEDING IN THIS DIRECTION

f. The seven ground search team signals are:

LLL - OPERATION COMPLETED

LL - WE HAVE FOUND ALL PERSONNEL

++ - WE HAVE FOUND ONLY SOME PERSONNEL

XX - WE ARE NOT ABLE TO CONTINUE.
RETURNING TO BASE

 - HAVE DIVIDED INTO TWO GROUPS (EACH
PROCEEDING IN THE DIRECTION INDICATED

 - INFORMATION RECEIVED THAT AIRCRAFT
IS IN THIS DIRECTION

NN - NOTHING FOUND, WILL CONTINUE SEARCH

3. Additionally, there are body signals, used once you are sure the aircraft is looking at you.



Additional Information

More detailed information on this topic is available in Chapter 10 of the Ground Team Member & Leader Reference Text.

Evaluation Preparation

Setup: Pick an area. Ensure there are enough materials readily available to construct signals. Ensure the student has his field gear. For the second and third steps of the tasks (ground search and body signals) below, the student may use any reference material he has in his field gear, including this manual.

Brief Student:

1. Ask the student to draw each of the five distress signals from memory.
2. Then pick one of the ground search team signals and tell him that he has 15 minutes to construct that signal (do not tell him what the signal looks like; make him look that up in his reference material). Tell him that he can use any materials in the area, and any items in he field gear.
3. Finally have the student demonstrate the three body signals of your choice from the above list. Again, tell him that he may use any reference materials in his field gear.

Evaluation

<u>Performance measures</u>	<u>Results</u>	
1. From memory, the individual correctly draws the signal for:		
a. REQUIRE ASSISTANCE	P	F
b. REQUIRE MEDICAL ASSISTANCE	P	F
c. NO OR NEGATIVE	P	F
d. YES OR AFFIRMATIVE	P	F
e. PROCEEDING IN THIS DIRECTION	P	F
2. The individual constructs a specified ground search team signal:		
a. At least 10' high, with each leg at least 18" thick	P	F
b. Providing adequate contrast with the surrounding terrain	P	F
c. Within 15 minutes.	P	F
3. The individual successfully uses three body signals chosen by the evaluator	P	F

Student must receive a pass on all performance measures to qualify in this task. If the individual fails any measure, show what was done wrong and how to do it correctly.

O-0802
PLAN AND ORGANIZE SITE SURVEILLANCE

CONDITIONS

You are leading a team in the field, and are assigned to conduct surveillance of a site. All victims have been evacuated. Your team is the first site surveillance team to guard the site.

OBJECTIVES

Within 30 minutes of arrival (60 at night). Conduct a reconnaissance, establish a hasty perimeter, determine the final placement of all sentries, mark the perimeter, determine the locations of the command post, parking area and bivouac area, and brief the first relief.

TRAINING AND EVALUATION

Training Outline

1. Site surveillance is a critical CAP mission. The intent is to ensure that the wreckage of an airplane, possible crime scenes, or other disaster sites are not disturbed by any intruders until investigators (such as NTSB investigators) arrive or until another agency takes control of the scene. Additionally, site surveillance helps prevent injury caused by people wandering in to a potentially hazardous crash site that could contain jagged metal, highly flammable fuel and/or possible contaminated blood.

a. Conducting site surveillance requires a good deal of planning. The team leader must plan the posting of sentries and the positioning of vehicles, bivouac areas, and his own command post to ensure that the site is secure from all directions, that his operation presents a favorable and professional appearance to observers, and that his own team is safe from any hazards from the crash itself.

b. Site surveillance is a continuous mission; a team may be constantly “on duty” for 24 hours or longer. Because of this, a team leader must ensure his plan allows his team adequate rest time to ensure they can sustain operations until relieved.

b. The team leader must also remember that his primary objective is to ensure that no one, including his team, disturbs the wreckage. The only time a team may disturb the wreckage is if it presents a safety hazard that cannot be avoided any other way or if moving the wreckage would help preserve it (this second situation does not happen often).

2. When you arrive on the scene:

a. Determine if there is any other agency already on site. If so, get a full briefing from them and then relieve them once your sentries are posted.

b. Conduct a reconnaissance. Take all necessary precautions against bloodborne pathogens (BBP). For example, if you are the first agency on the scene, conduct the recon wearing full protective gear, if available. If another agency is on station, determine the BBP threat from them. During the reconnaissance, you are specifically looking for:

1) Any safety hazards, including jagged metal, fuel or blood. Remember to look overhead in the trees for pieces of the wreck that might fall and for any trees that have been dangerously weakened by the crash.

2) The most likely avenues of approach to the crash site that intruders might take, such as trails, roads or open terrain.

3) The outline of the crash, formed by the pieces of wreckage furthest from the center.

4) Places where sentries could have good visibility of the crash site and/or the surrounding terrain, focusing on likely avenues of approach.

c. Establish a hasty perimeter. Put sentries around the crash site, outside of all wreckage, and a safe distance from any hazards found in the reconnaissance.

d. Mark the perimeter. Use engineers or surveyor's tape. Put tape as close to waist level as possible.

e. Determine permanent sentry positions. Sentries can be stationary or roving. In addition to watching the crash site, sentries can also be used to direct traffic around the site, if near a road. Don't have too many sentries at once -- you need multiple shifts. Choose positions that minimize the number of sentries you need.

f. Determine where you will put:

1) Your command post. This should be located where you can best control the crash site and access to it.

2) The bivouac area. This should be far enough away from the wreck to avoid destroying any evidence, out of the view of the public (if possible) and where you can easily call for team members as needed.

3) The parking area. If the crash is near a road, decide where to put your vehicles and where you will try to keep visitor's vehicle. Avoid crowding the crash site.

g. Divide your team into sentry shifts, or "reliefs". You will need at least two reliefs in the daytime, and three at night.

h. Pull your first relief personnel off the perimeter, brief them and post them in the permanent sentry posts (see separate task O-0803 -- Supervise a Site Surveillance Shift).

i. At no time should you disturb any piece of the wreckage unless it poses a safety threat. If you must disturb wreckage, mark its original location and photograph it if possible.

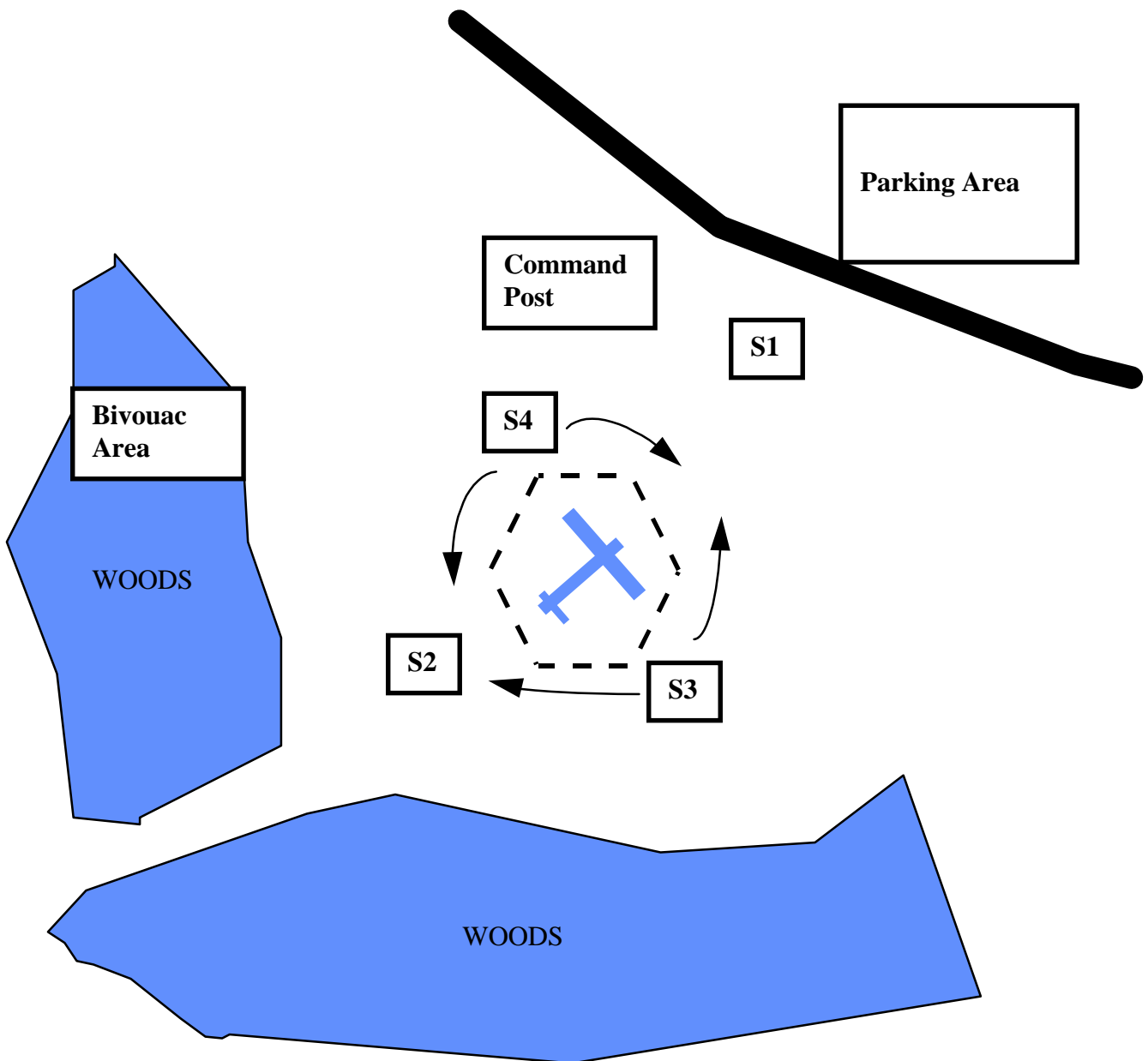

Example of A Site Surveillance Plan - The team leader determined that the two avenues of approach were the road (upper right) and the trail between the two pieces of woods (lower left). He posted four sentries. Sentry S1 faces the road, where he can intercept anyone coming from the road, while Sentry S2 faces the woods trail. Sentries S3 and S4 each rove along half of the marked perimeter. The dotted hexagon represents engineer tape, which circles the outmost pieces of the wreckage. The command post is set up near the road, and where the team leader can see everything that is going on. The bivouac area is in the woods to the left - nearby but out of view from the road. The parking area has been set up across the road, where it will not congest the crash site.

Additional Information

More detailed information on this topic is available in Chapter 15 of the Ground Team Member and Leader Reference Text.

Evaluation Preparation

Setup: Mark a “crash site” or disaster site on a piece of terrain. you can use a signal panel, a car, or anything else you might have available. Use a few signs to mark associated hazards, such a , “Pool of Fuel”, “Unstable Tree”, etc.

Brief Team Leader: Tell the student that he is the team leader and has been assigned to secure this crash site. Tell him that all victims have been evacuated, and there is currently no one on site. Inform him that he may use any checklist, including this book, that he carries in his field gear. Tell him to perform all actions necessary to plan and organize the CSS. Tell him to you will play the role of all team members. Finally tell him that in 30 minutes (60 if a BBP protective suit is available and expected to be used) that he must brief you on his plan.

Evaluation

<u>Performance measures</u>	<u>Results</u>	
The team leader:		
1. Conducts surveillance.	P	F
a. Taking BBP precautions (or simulating)		
b. Determines all safety hazards.		
c. Determines the most likely avenues of approach that bystanders/intruders would use.		
d. Determines the outline of the crash site.		
e. Determines terrain with good visibility of the site and the avenues of approach		
2. Directs part of his team to establish a hasty sentry perimeter safe from all hazards and outside the crash site outline.	P	F
3. Directs the marking of the perimeter with tape, as close to waist level as possible (simulated)	P	F
4. Determines final sentry positions	P	F
5. Determines the location of the command post, bivouac area, and parking area (if needed)	P	F
6. Divides his team into at least 2 shifts (day) or 3 shifts (night)	P	F

Student must receive a pass on all performance measures to qualify in this task. If the individual fails any measure, show what was done wrong and how to do it correctly.

O-0803
SUPERVISE A SITE SURVEILLANCE SHIFT

CONDITIONS

You are leading a team in the field, and are assigned to conduct surveillance of a crashed aircraft, scene of victim location or other disaster site. All victims have been evacuated. You have already planned your site surveillance and organized your shifts (relief).

OBJECTIVES

Correctly, inspect, brief, post, and check your first relief. Politely and correctly deal with potential intruders.

TRAINING AND EVALUATION

Training Outline

1. Site surveillance is a critical CAP mission. The intent is to ensure that the wreckage of an airplane, possible crime scene or other disaster scene is not disturbed by any intruders until investigators (such as NTSB investigators) arrive or until another agency takes control of the scene. Additionally, site surveillance helps prevent injury caused by people wandering in to a potentially hazardous site, which contains jagged metal, highly flammable fuel and/or possible contaminated blood.

a. Performance of this mission is made more difficult by the fact that CAP may not use any force or show of force in the execution of it's duties. Simply put, you cannot keep someone from entering the site if he wants to. You can inform him of the risks, both legal and safety related, of intruding. You can notify law enforcement officials. But you cannot physically threaten or restrain anyone.

b. Another important part of the site surveillance mission is public relations. Site surveillance personnel are in a "high visibility" position. Bystanders may be getting their first look at the Civil Air Patrol in Action. Reporters and photographers covering the crash may choose to cover the CAP ground team as well.

c. In order to accomplish the surveillance mission without the use of force AND present CAP in a positive light, appearance, politeness and professionalism are essential.

d. Once you have completed your surveillance plan, you must post your team members, and begin operations.

2. To post a relief, use the following steps. Each time a new relief comes on duty, go through these steps again. (Note: if you have enough personnel, you may appoint a sergeant of the guard to inspect, post and directly supervise the guard shift. However, you as the team leader are still responsible for the site.)

a. Assemble all members of the relief, preferably at a point where they can observe the site.

b. Inspect the relief for:

1) Proper uniforms, and grooming.

2) Field Gear. Sentries should have all their field gear with them at their posts. At the team leader's discretion, they can ground the pack at their post, but they should have all items. Especially check

water, rain gear, flashlights and batteries (if at night), whistle, and any other items essential to the sentry mission.

3) Knives. No knives should be visible on a sentry's gear or his person. This could constitute a show of force.

4) Knowledge of General Orders.

c. Brief the relief. Describe your plan. Make sure everyone knows what they are guarding, where all the guard posts are, where the command post is, and safety issues.

d. Post the relief. You may take one person at a time to his post, or move the whole relief around the perimeter, dropping off one person at each post. As you put each person on his post, brief him on the following items (Note: If there is already a guard at the post whom the new guard is relieving, let the old guard conduct the briefing.)

1) Exactly what he will be responsible for guarding

2) Where he should stand or walk

3) The guard post number

4) The locations of all other guard posts (by number)

5) The location of the team leader (and sergeant of the guard, if assigned)

6) Any special instructions for this post (for example, "If any cars pull up, tell them the detour is one mile back on the right.")

7) Any activity in the area, such as intruders.

8) Any safety issues, such as sharp objects, holes or spilled fuel in the area.

3. Once the relief is posted:

a. Make periodic inspections of all posts.

b. Maintain communications with the mission coordinator, either by radio or periodic phone checks.

c. If one of your sentries has a potential intruder, you should:

1) Identify yourself as the team leader.

2) Politely inform the intruder that to enter the perimeter could be construed as trespassing (you should explain that this is for their safety and for preserving evidence.).

3) If the intruder persists, let them know you are summoning local law enforcement. Let them pass - do not hinder them in any way.

d. If the press arrives:

1) Escort them to the IO, if present. Otherwise, you, as team leader, act as IO.

2) Give out no information on the accident or the conditions of the passengers without prior approval of the PAO or mission coordinator. If they have questions, give them the mission base phone number.

3) Allow them to take pictures, but only from outside the perimeter. It's fine for the press to take pictures of your team members while they work, but don't pose them for pictures.

e. If official investigators (police, FAA, NTSB, county coroner or medical examiner, etc.) arrive:

1) Determine their name and affiliation. Put it in the log.

2) Once the official's identity is confirmed take the steps outlined in Task O-0804 - Sign Over a Site.

3) If they do not wish to take over the site (Often officials may not take over the site if a higher official is known to be on the way. Some jurisdictions only allow shift supervisors or director level personnel to receive custody from other agencies):

(a) Escort them to the scene, and into it if they desire.

(b) Remind them not to disturb wreckage. If they do, note it in the mission log with before and after diagrams or photographs.

f. **Always, be polite and courteous.**

Additional Information

More detailed information on this topic is available in Chapter 15 of the Ground Team Member and Leader Reference Text.

Evaluation Preparation

Setup: This task is normally tested in conjunction with O-0802 - Plan and Organize Site Surveillance. You let the student use the plan he came up with for that task. If you are testing this task alone, prepare a mock crash site. Mark the wreck, any safety hazards and the perimeter. Prepare a written plan for surveillance, using the task P-0202 as a guide. Provide the team leader with 6-10 personnel with field gear to act as the ground team. Post 2 or 3 of them in a hasty perimeter around the site.

Brief Team Leader: Tell the student that he is the team leader and has been assigned to secure this crash site. Brief him on the plan using the format in Task P-0202 (or to use the plan he developed when being tested on Task P-0202. Tell him that all survivors have been evacuated, and there is currently no one on site. Tell him he has already established a hasty perimeter (the 2 or 3 members you posted), but that they have received no briefing. Inform him that he may use any checklist, including this book, that he carries in his field gear. Tell him to perform all actions necessary to post his rest relief and begin surveillance.. Tell him to you will play the role bystanders, intruders, and mission base. Finally, tell the team leader that the first relief must be in position in 1 hour.

Evaluation

<u>Performance measures</u>	<u>Results</u>	
The team leader:		
1. Assembles the relief.	P	F
2. Inspects the relief for:		
a. Appearance	P	F
b. Essential and Non-Essential (Visible knives) field gear items	P	F
c. Knowledge of General Orders	P	F
3. Briefs the relief on the plan, location of guard posts and command posts, and safety issues.	P	F
4. Posts the relief, conducts briefing at each post on:		
a. What that sentry guards are to do.	P	F
b. Where he should stand or walk.	P	F
c. Locations all guard posts (by number).	P	F
d. Location of team leader and sergeant of the guard.	P	F
e. Any special instructions.	P	F
f. Any recent activity in the area.	P	F
g. Safety issues.	P	F
5. Completes posting of the relief within 1 hour of receiving the briefing.	P	F
6. Periodically inspects all posts.	P	F
7. Maintains communications with mission base.	P	F
8. Handles intruders, press, and investigators according to the checklist above.	P	F
9. Is polite and courteous.	P	F

Student must receive a pass on all performance measures to qualify in this task. If the individual fails any measure, show what was done wrong and how to do it correctly.

O-0804
SIGN OVER A SITE

CONDITIONS

You are leading a team that is conducting site surveillance. An outside agency or another CAP ground team arrives on site to relieve you.

OBJECTIVES

Correctly brief your replacement, assist in posting their sentries (as needed) and sign over control of the site.

TRAINING AND EVALUATION

Training Outline

1. Once you take control of a site, you cannot leave it without formally relinquishing control. Normally, this is done by turning the site over to another CAP Ground Team, or to an outside agency such as the police or the FAA. In either case, you also want to get permission for the relief from the mission coordinator.

a. If you are being relieved by another ground team, you should brief them, help post their first relief, and then sign the site over in both team's mission logs.

b. If you are being relieved by an outside agency, the procedure is similar, except the signing over is more formal. Also, most agencies will not be posting sentries as CAP does.

2. To turn over control to another CAP Ground Team:

a. Get permission from the mission coordinator.

b. Brief the new team leader (and his team, if he desires) on:

1) The aircraft.

2) Any safety hazards in the area.

3) Your plan for surveillance including your communications plan, sentry locations, bivouac area, parking area, and command post.

4) Significant events (from your log).

5) Anything you expect to happen in the future. For example, "The FAA investigator called and said he will be here tomorrow morning at 10:00."

c. Assist the new team leader in posting his first sentry shift (relief). Have your sentries brief his sentries as they take over.

d. Once the new team leader has posted his sentries, he initiates the sign over. Each team leader signs the other team's log entry, stating that you (state your name and rank) briefed him (state his name) and that he assumes control of the crash site at this time. Remember, the new team leader initiates this. Until he says he is assuming control, you cannot leave.

- e. The new team leader notifies mission base that he has assumed control.
2. To turn over control to a representative of an outside agency:
- a. Get the representative's name and agency, and write them in the log.
 - b. Get permission from the mission coordinator.
 - c. Brief the representative new team leader on:
 - 1) The aircraft, victims, or other disaster remnants.
 - 2) Any safety hazards in the area.
 - 3) Significant events (from your log).
 - 4) Anything you expect to happen in the future. For example, "The FAA investigator called and said he will be here tomorrow morning at 10:00."
 - d. Assist the agency representative in setting up any security he desires.
 - e. Write the following or a similar entry in your log:

“ I _____ (representative's name) _____, representing _____ (his organization) _____, hereby accept responsibility for the scene involving (victims' name, aircraft number, make, model, fuselage and trim color, if known) I am releasing _____ (your name) _____ of the Civil Air Patrol from any further requirement to secure the site. I have been completely briefed by - _____ (your name) _____. I acknowledge that the scene appears to be in good order, and any movement of wreckage, fatalities and/or parts thereof have been described to me.
 - f. Have both you and the representative sign and date this log entry.
 - e. Notify mission base that you have turned over control.

Additional Information

More detailed information on this topic is available in Chapter 15 of the Ground Team Member and Leader Reference Text.

Evaluation Preparation

Setup: Set up a simulated crash site or other surveillance site, with a perimeter and sentries (this can be done outdoors, or on a terrain model or sketch). Prepare a simulated log of the key activities since the team took over the site.

Brief Team Leader: Tell the student that he is the team leader and has been assigned to secure this crash site. Brief him on the security plan, including safety and communications plans. Give him the log and tell him that the log represents what has transpired since his team arrives.

Step 1 - Tell him that another ground team has arrived to relieve his team. Have him take the appropriate actions.

Step 2 - Tell him that, instead, the FAA investigator or local Sheriff arrives to relieve him. Have him take the appropriate actions.

Evaluation

Performance measures

Results

Step 1 (sign over to another ground team)

The team leader:

- | | | |
|--|---|----|
| 1. Obtains permission from the mission coordinator. | P | F |
| 2. Brief the new team leader on the status of the victims, aircraft or other items within the perimeter, safety hazards, site surveillance plan, significant events, and expected future events. | P | F |
| 3. Assists the new team leader in posting his first sentry shift (relief). | P | F |
| 4. Once the new team leader is ready, correctly logs the sign over and has the new team leader sign it. | P | F |
| 5. Signs the other team leader's log | P | F. |

Step 2 (sign over to a representative of an outside agency)

The team leader:

- | | | |
|--|---|---|
| 6. Logs the representative's name and agency. | P | F |
| 7. Obtains permission from the mission coordinator. | P | F |
| 8. Brief the representative on the status of the victims, aircraft or other items within the perimeter, safety hazards, site surveillance plan, significant events, and expected future events | P | F |
| 9. Assists the representative in posting his security (if applicable) | P | F |
| 10. Prepares the sign over statement listed above | P | F |

11. Signs and dates it, and has the representative sign and date it. P F

12. Notifies the mission coordinator of sign over P F

Student must receive a pass on all performance measures to qualify in this task. If the individual fails any measure, show what was done wrong and how to do it correctly.

EXERCISE UNIVERSAL PRECAUTIONS

CONDITIONS

In participating as a member of the CAP mission team, you encounter a patient that needs to be assessed and possibly treated.

OJECTIVES

The student will take adequate action to protect himself from bloodborne pathogens utilizing universal precautions while assessing and possibly treating the patient.

TRAINING AND EVALUATION

Training Outline

1. Universal Precautions is the concept that all blood and certain body fluids are to be treated as if contaminated with Human Immunodeficiency Virus (HIV), Hepatitis B Virus (HBV), or other bloodborne pathogens
2. An acceptable alternative to Universal Precautions is Body Substance Isolation (the treating of all fluids and substances as infectious).
3. Materials requiring universal precautions:
 - a. Blood
 - b. Semen
 - c. Vaginal secretions
 - d. Cerebrospinal fluid
 - e. Synovial fluid
 - f. Pleural fluid
 - g. Any body fluid with visible blood
 - h. Any unidentifiable body fluid
 - i. Saliva from dental procedures
4. Materials not requiring universal precautions unless there is visible blood:
 - a. Feces
 - b. Nasal secretions
 - c. Sputum

- d. Sweat
- e. Tears
- f. Urine
- g. Vomitus

NOTE: Though not required, it be difficult for team members to determine if blood is present, and they should exercise universal precautions if unsure to be safe.

5. Personal protective equipment like gloves and a mask must be used whenever you might be exposed to blood or other potentially infectious materials. Rubber gloves and surgical masks create a basic barrier between the provider and the survivor, and protects both from transmitting potentially harmful diseases. There are some basic rules to follow in exercising Universal Precautions.

a. When conducting a hands-on assessment of a patient, always wear rubber gloves, and if the potential exists for airborne transmission or being splashed with blood or other pathogenic fluids, at least wear a surgical mask and goggles or face shield.

b. Change gloves between patients. This avoids the transmission of pathogens between patients.

c. Use well-fitting, disposable, latex or vinyl gloves for any task involving exposure to blood and other body fluids. Make sure extra pairs are available.

d. Before putting on gloves, make sure they have no holes, cracks or tears.

e. Change gloves if they become torn or dirty.

f. Remove gloves by grasping the cuffs and pulling them off inside out.

g. Use work gloves over latex gloves when working around broken glass or sharp surfaces - for instance when removing a person from an auto wreck or crashed aircraft.

h. Dispose of latex gloves in identifiable medical-waste containers.

i. Wash hands following removal of gloves. Handwashing is the best overall protective measure against most communicable diseases. Wash your hands and other skin surfaces thoroughly with soap and running water immediately after contact with blood or other body fluids. When running water is not available, waterless, hand-wash substitutes should be used until a more thorough handwashing can be accomplished.

Additional Information

More detailed information on this topic is available in Chapter 16 of the Ground Team Member & Leader Reference Text.

Evaluation Preparation

Setup: The evaluator will moulage a patient for the student to assess. The patient should have formal signs of trauma, preferably with "bleeding" wounds. If multiple patients are to be examined in a large group exercise, insure that the provider changes gloves between patients. If only one patient is to be assessed, determine

verbally what the student would do if multiple patients needed to be assessed. More than one student can be assessed at the same time, but a one-to-one ratio of evaluators to students is preferable.

Brief Student: The student will be briefed to perform a basic assessment of the patient utilizing training and equipment required of all ground team members.

Evaluation

<u>Performance measures</u>	<u>Results</u>	
1. The student assesses the scene and determines accurately to wear rubber gloves, and face shield and goggles or other eye protection as necessary?	P	F
2. The student properly demonstrates how to remove rubber gloves without exposing himself to potential pathogenic materials.	P	F
3. The student either demonstrates or verbally explains why changing gloves between patients is necessary.	P	F

Student must receive a pass on all performance measures to qualify in this task. If the individual fails any measure, show what was done wrong and how to do it correctly.

O-1001
DIRECT TEAM ACTIONS AT MEETING POINT

CONDITIONS

You are the leader of a GSAR team that has just been alerted for a mission. You have designated a place for team members to meet and assemble for movement to the mission base. Your team members and the team vehicles have just arrived.

OBJECTIVES

Performs necessary inspections and organizes the team within 20 minutes.

TRAINING AND EVALUATION

Training Outline

1. When the team leader arrives at the unit's meeting point prior to departing for mission base, certain actions must be taken prior to departure. These actions will ensure the team readiness to participate on the mission and ensure adequate contact is maintained with the home unit for communicating with family members of mission personnel.
2. To accomplish this the team leader should take the following actions, in any order.
 - a. Complete two copies of the CAPF 109 for the entire team.
 - b. Inspect each person for key equipment items. Before you take someone on a mission, you must ensure that they have the minimum equipment needed to survive and be effective. This is not the same as a full inspection; you're merely checking for the basics. If anyone expected to be a member of the team does not have these basic items, **DON'T BRING THEM TO THE MISSION**. Persons needed at mission base to perform other duties with different equipment requirements may often travel with your team for convenience sake. You'll spend more time caring for their needs than searching for your target. Basic items include:
 - 1) Current CAP ID card and current CAPF 101 certifying the person as a Ground Team Member or Ground Team Member Trainee.
 - 2) Appropriate clothing for the climate, for example proper uniform, orange safety vest, gloves and coat in the winter time, etc.
 - 3) Appropriate food, water, sleeping gear, and shelter.
 - 4) Anything else you think is necessary (such as flashlights for night missions).
 - 5) For all vehicle drivers, (including those just driving to mission base) a valid state driver's license from any state is required. For corporate vehicles that will be used on the mission, the driver must possess a valid CAP Driver's license from any state in addition to a valid state driver's license.
 - c. Ensure drivers complete vehicle safety inspections in accordance with CAPF 73 (Daily CAP Vehicle Inspection Report). Don't use any vehicle that fails the inspection without the permission of the Incident Commander. This includes privately owned vehicles.

- d. Assign personnel to vehicles, and have the driver’s supervise the packing of personal equipment.
- e. Inspect critical team equipment. Check those items critical to the mission, to make sure you have them and that they are functional. For example, maps, radios, distress beacon DF Kit, etc.
- f. Assign jobs to team members as necessary (Assistant Team Leader, team medic, navigator, and log keeper, or radio operator for example).
- g. As time permits, start mission paperwork (CAPF 109, and ICSF 214).
- h. Have the log keeper start the team log.

Additional Information

More detailed information on this topic is available in Chapters 1, 2, and 3 of the Ground Team Member and Leader Reference Text.

Evaluation Preparation

Setup: Provide a ground team of at least four individuals with personal equipment, one ground team vehicle, and copies of CAPF 73, CAPF 109, and ICSF 214. Have a stopwatch or timer. The person being tested may use any part of their equipment, including this book, to perform the task.

Brief Team Leader: Tell the Team leader that his team has just assembled at the meeting point. Tell him what sort of mission the team is going on (choose any that seem appropriate to the team’s equipment), and that he has 20 minutes to perform all necessary actions before moving to mission base.

Evaluation

Performance measures

Results

NOTE: Steps may be performed in any order.

1. Ensures all members sign in (legibly) on an ICSF 214 and leaves a copy with a responsible person who is not going on the mission.	P	F
2. Inspects team members uniforms, equipment and ID cards. Rejects any team member without adequate equipment or certification.	P	F
3. Ensures vehicle safety inspections are complete. Rejects any vehicle failing inspection.	P	F
4. Assigns personnel to vehicles and directs driver’s supervising packing of personal gear.	P	F
5. Inspects critical team equipment for the mission.	P	F
6. Assigns team duties.	P	F
7. Starts mission paperwork.	P	F
8. Starts mission log.	P	F

9. Performs all tasks within 20 minutes

P F

Student must receive a pass on all performance measures to qualify in this task. If the individual fails any measure, show what was done wrong and how to do it correctly.

O-1002
ESTABLISH A HELICOPTER LANDING ZONE

CONDITIONS

You are leading a search team, and have been directed to prepare a helicopter landing zone. (LZ). It can be either day or night.

OBJECTIVES

Select a good site for the (LZ). Take the steps necessary to prepare it, and direct the helicopter in.

TRAINING AND EVALUATION

Training Outline

1. Occasionally, police, military or medevac helicopters may be working with CAP ground teams, especially for search and evacuation. In these situations, ground teams may be called upon to select and prepare a landing zone (LZ) for a helicopter.

2. To establish a helicopter landing zone:

a. Whenever possible, establish radio communication with the pilot, and have him tell you what he wants you to do.

1) Follow his instructions, even if they differ from what is listed below.

2) If you don't have an appropriate radio, attempt to relay through someone who does (policeman, mission base, CAP aircraft, etc.)

b. Prepare the landing zone:

1) The LZ must be large enough to allow for the helicopters approach, landing, and turn around.

2) Attempt to find a large area that will permit a 15 degree approach and takeoff angle.

3) Remember, the higher the barriers, the longer the LZ must be.

4) Attempt to find the landing zone that is oriented with the long axis generally into the wind.

5) Remember that wires are extremely difficult for the pilot to see when approaching the LZ.

6) The touchdown zone must be free of obstacles that might damage the bottom of the helicopter, that is, tree stumps, large rocks, etc.

7) Remove all loose brush from areas that the helicopter may be landing in, hovering around, or taking off from.

8) Mark landing zones, if needed, with a signal panel (stake or weight it down to keep the rotors from blowing it away). Indicate wind direction via streamers, smoke, etc. (don't obscure the LZ with smoke!)

9) Keep unauthorized personnel away!

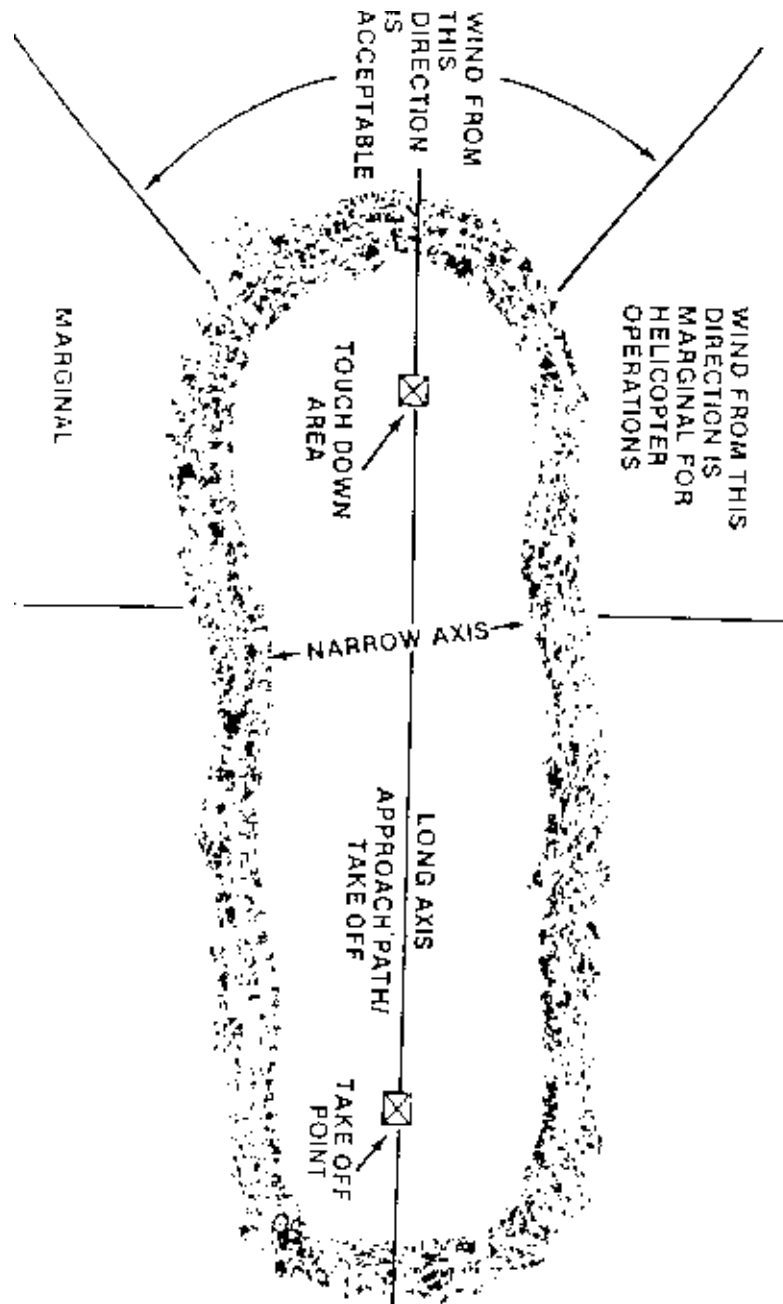

c. At night, do all the above, plus:

- 1) Be especially aware of any hazards such as power lines, fences, trees, etc. that the pilot may not be able to see.
- 2) Park vehicles with low beams on approximately 40 to 50 feet from the helicopter landing area, offset from the helicopter approach route. (see diagram below)
- 3) Never shine lights at helicopter which may blind the pilot.

Helicopter Landing Zone

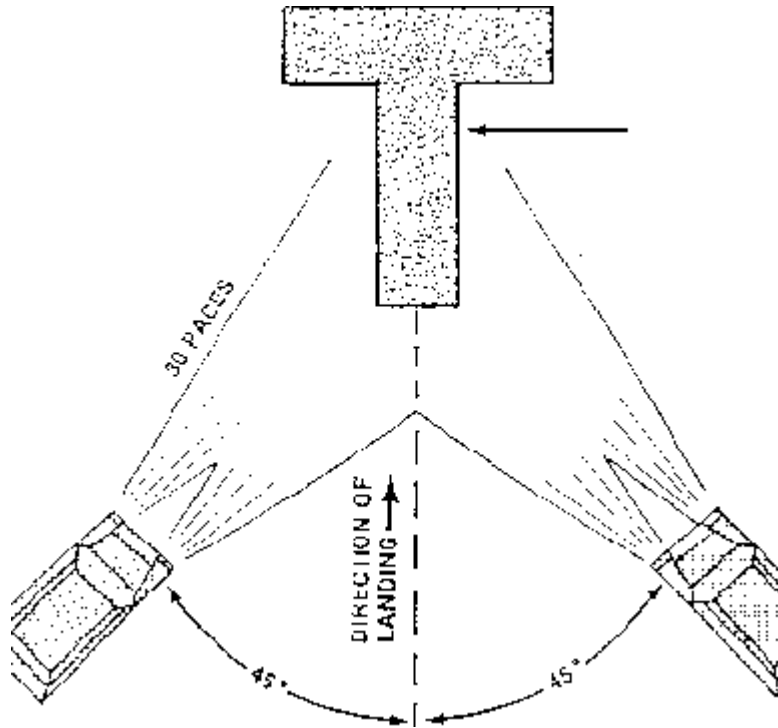

3. To direct the helicopter down.

a. Whenever possible, establish radio communications with the pilot. Describe the landing zone, the wind speed and direction (the direction the wind is coming from), and any obstacles.

b. Get the pilot's attention with signal panels, signal mirrors, waving, etc. Show him where the LZ is.

c. If the pilot wishes, place a signal man at the upwind end of the LZ. The signal man should use the hand signals listed in Attachment B of the Ground Team Member and Leader Reference Text. Only volunteer this service if you have someone fully trained in the signals. Incorrect signals can be more damaging than no signals at all. (The signal man should always wear eye protection).

d. **REMEMBER** - The pilot is in charge. He is responsible for the safe operation of the aircraft. He has a right to ignore anything you tell him, and land wherever he chooses. Your job is to help him according to his wishes. He has landed that helicopter many more times than you have!

4. To approach or exit the helicopter.

a. Wait for permission to board or exit from the pilot.

b. Approach or leave the helicopter from near the front so the pilot can see you at all times. Never approach from the rear 180 degrees.

c. No smoking around the helicopter.

d. Secure hats and other loose items to protect against rotor winds.

e. Keep long-handled tools, litters, antennas and similar items away from rotor blades.

f. Keep you head down at all times. The slower the rotor blades are turning, the lower they will dip towards the ground.

g. Never approach or leave a helicopter from any side where the ground is higher than where the helicopter is standing, or you may walk into a rotor blade.

Additional Information

More detailed information on this topic is available in Chapter 11 and Attachment B of the Ground Team Member and Leader Reference Text.

Evaluation Preparation

Setup: Take the team leader outdoors. He may use any item of field gear he normally carries (including this book).

Brief Team Leader: Tell the team leader to select a landing site for a helicopter. Tell him to describe to you all the actions he would take to prepare the landing site. If he attempts to contact the helicopter, tell him he is unsuccessful. After he is complete, ask him what additional things he would do if the landing was at night.

Evaluation

<u>Performance measures</u>	<u>Results</u>	
The team leader:		
1. Attempts to establish communications with the pilot.	P	F
2. Chooses a suitably large, flat area, oriented into the wind, free of obstacles, with good approach and departure routes.	P	F
3. Describes how he would clear all loose debris.	P	F
4. Describes how he would mark the LZ and indicate wind direction.	P	F
5. Describes lighting of the LZ at night. (and does not shine bright lights at the pilot).	P	F

Student must receive a pass on all performance measures to qualify in this task. If the individual fails any measure, show what was done wrong and how to do it correctly.

O-1101
CONDUCT WITNESS INTERVIEW

CONDITIONS

You have been informed that there is a person who may have knowledge about the location of the search target. You have paper, pen or pencil, and a CAP Form 106.

OBJECTIVE

Politely conduct the interview, via phone or in person, gathering all necessary information without confusing the witness, and prepare a CAP Form 106 with the results of your interview.

TRAINING AND EVALUATION

Training Outline

1. Witness interviews can be the single most important source of information on a mission. Information from witnesses can help the mission coordinator narrow the search area, allocate search resources, and even locate the target.

a. Witness interviews can occur in four different situations:

- 1) A witness comes up to you and volunteers knowledge.
- 2) Your team has been sent to interview a specific person or persons.
- 3) Your team is sent out to question people in an area where the search target (person or plane) might have been.
- 4) You receive a phone call and take the interview.

b. Witnesses may have all kinds of useful information, for example:

- 1) If someone has seen the search target alive and well at a given time, it helps the mission coordinator in determining where search target is not, which means less area to search. They may also have seen where the target was headed, or even talked to the target.
- 2) In the case of a lost plane, someone may have seen the plane in trouble, or seen or heard indications of a crash.
- 3) Witnesses such as hunters may have seen signs of the search target in the woods.

c. When conducting a witness interview, you are gathering information to fill out a CAP Form 106 (Witness Interrogation Form). This form is designed for lost aircraft, but can be used for lost persons as well. There are a variety of lost person forms available, though none are official CAP. Use these only when directed by your team leader.

d. It is extremely important to get only the facts out of the witness. Witnesses might give false information because of faulty memories or a desire to please the interviewer. Do not offer any information about the incident to the witness during the interview, as this might change their recollections.

e. Whenever possible, use two personnel to conduct an interview. One asks questions and one takes notes. More than two is intimidating, and does not help.

2. To conduct an interview:

a. Prepare yourself. Make sure your uniform is worn correctly. Remove excess field gear, especially anything that might bother the witness, such as large knives. "Clean up" before the interview, combing your hair, washing off any dirt from the field. ENSURE YOUR BREATH IS FRESH -- you want your witness to think about the search target, not your breath.

b. Properly identify yourself as a CAP member. Show the witness your ID card, and some photo ID if he asks. Let the witness know exactly what you are here to do.

c. Conduct the interview in a comfortable location for the interviewee, preferably a living room or family room. This area should also be relatively free of distractions.

d. If the interviewee believes that he or she saw the search objective, then try to take them back to that location. If that is not possible, have a map available.

e. Questioning the witness:

1) First, let the witness tell the story without you interrupting. Take notes. Then go back and ask questions to make sure they cover everything. Control your body language while conducting the interview; witnesses may unconsciously or purposefully change their story if the interviewer shows too much.

2) DON'T LEAD THE WITNESS. Do not volunteer information that might alter their recollection. For example, ask them what color the plane was. Do not ask "Was it blue?" They might agree with you even though they do not really remember that detail.

3) Do not hurry the witness, or press them for information they do not have. If they insist that they do not know something, do not insist that they "make a guess."

4) Show acceptance for what they have to say

5) To probe an area of interest, restate their words or summarize what they said.

6) If the witness says something that does not make sense, ask questions to verify what exactly they witnessed.

7) When interviewing children, be very wary of reliability. Question them thoroughly and ask their parents about the child's reliability, but be tactful since many parents would resent questioning their child's honesty. It is often preferable to interview children without their parents present to avoid parental coaching, but remember to get the parent's permission first.

8) Ask questions that will give you confidence in their answers. In determining the time of the event you might need to ask them how they know the time. In judging flight related items, be especially careful

to determine the interviewee's knowledge of the subject. How did the interviewee know how high the plane was flying? Is the interviewee a pilot, or does he or she have aviation experience?

9) In a good interview, the witness does most of the talking.

10) At the end of the interview, review the answers given. This allows you correct any errors made, and the witness could relate new information not previously discussed.

e. Use the CAP Form 106 as a guide. You may want to show the form to the witness so they are not intimidated by it. You can write directly on the form or take notes on paper. Either way, you will need to prepare a legible copy of the 106 after the interview. You probably will not be able to fill in the form from top to bottom -- the witness might. There are advantages and disadvantages to the interviewee filling out the form. It allows them to express what they mean directly, but could hinder the free flow of information encouraged between the interviewer and the interviewee. The 106 is self explanatory for the most part, but a few of the blocks require comment:

1) Block 9 (Telephone). The telephone number of the witness where he can be contacted later. If he has a work and home number, put them both in block 9.

2) Block 10 (Estimated Age). Estimate the age of the person, do not ask them. Some people do not want to state their age.

3) Block 14 (What occurrence fixed time he heard/saw plane?). If the person said he saw the plane at 1400, ask him how he is sure of that. If he looked at his watch, then it probably was 1400. If he looked at his watch at 1300, and about an hour later he saw the plane, then he might be off on his time estimate. This sort of information is very important to know. If the witness was watching television or listening to the radio it may be easier for the witness to relate what was playing, and you can get at least a rough time of airing from the broadcasting station.

4) Block 17 (About how high above the ground was it?) and Block 18 (About how far away was it at the nearest point?) Most people will not be very accurate at this. Ask them how they figured the height and distance, and write that down as well. For example, they might be able to compare the height of the plane to the height of a nearby building.

5) Block 8 (Address) Sometimes the location where the interviewee lives is different than the location where they witnessed the event. Be sure to note such discrepancies.

6) If you have information that will not fit on the form, make a note at the bottom and write the information on the back of the form.

f. At the end of the interview, thank them for their time. Make sure to give them the phone number to mission base, and ask them to call if they remember something else or find someone else who might know something.

g. Above all, be courteous and professional at all times.

Additional Information

More detailed information on this topic is available in Chapter 14 of the Ground Team Member and Leader Reference Text.

Evaluation Preparation

Setup: Prepare a CAP Form 106 with the results of a witness interview. You will use this as a script for the test interview. Ensure the student has paper, pen or pencil, and at least one blank Form 106.

Brief Student: Tell the student that he has been sent to interview a potential witness. Tell him you will play the role of the witness. Have him start the interview by “knocking on the door” and role-playing from there. Do not volunteer all the information on your “script”-- make the student ask questions to get all the details. At the end of the interview, tell the student that he has 15 minutes to prepare a CAP Form 106 to turn in to the Mission Coordinator.

Evaluation

<u>Performance measures</u>	<u>Results</u>	
The student:		
1. Is polite and courteous.	P	F
2. Presents a professional appearance.	P	F
3. Properly identifies himself.	P	F
4. Allows the witness to describe what he saw, and then asks questions.	P	F
5. Doesn't lead the witness	P	F
6. Informs the witness how to get in touch with mission base if they remember anything or meet someone else who may be a witness.	P	F
7. Get all information needed for the CAPF 106.	P	F
8. Within 15 minutes after the interview, Legibly completes the 106 (in a format that a mission coordinator could read and use)	P	F
9. The completed 106 contains 90% of the information on the script.	P	F

Student must receive a pass on all performance measures to qualify in this task. If the individual fails any measure, show what was done wrong and how to do it correctly.

P-0101
KEEP A LOG

CONDITIONS

You have been assigned to keep a log on a mission, and must log the actions of your unit, section or team on the ICS Form 214 for use during debrief after the mission.

OJECTIVES

Correctly maintain a log of actions during an incident.

TRAINING AND EVALUATION

Training Outline

1. When working an incident, staff members are required to maintain a log of all significant actions. This is important for record keeping of the accomplishments and setbacks, determining search effectiveness during debriefing, and as a legal record of CAP actions amongst many other things.
2. The mission log is started once a unit or section is opened and maintained until personnel are called in and at home safely to the incident commander. A separate log should be maintained for each varying unit or section that is assigned to the incident, and subordinate units at varying levels will normally also keep a log. This log is turned in with the debriefing paperwork and becomes part of the official mission record.
3. The following actions are always recorded in the log:

FOR GROUND OPERATIONS

- a. Departure and return times to mission base.
- b. Routes taken to and from the search area.
- c. Times of entering and leaving search areas.
- d. Any time the search line changes direction.
- e. Times/locations of clue detections or witness interviews.
- f. Time/location of find.
- g. Time/Location of communications checks.
- h. Any event or action related to the team's ability to complete the sortie requirements (natural hazards encountered, injuries to team members, etc.).
- i. Encounters or instructions from local authorities.
- j. Encounters with the media.
- k. Mileage/Flight time at key intersections, when leaving pavement, at other key locations, etc.

l. Time of distress beacon or other emergency signal acquisition.

m. Times distress beacon located and silenced. Also, if available, include the name(s) and organization(s) of person(s) involved in silencing the distress beacon, the manufacturer, serial number, dates of manufacture and battery expiration, vehicle information (type, vehicle registry, description), and the name of the owner.

n. Personnel assignments to and from the team/unit.

Note: this log (ICSF 214) may be kept as an attachment to the CAPF 109

FOR AIRCREW OPERATIONS

a. Briefing details.

b. Names of crew members.

c. Engine start time.

d. Take Off time.

e. Communications checks.

f. Time beginning assigned grid or route.

g. Time departing grid or route.

h. Significant weather, turbulence, other.

i. Time of landing.

j. Time of engine shutdown.

k. Crew changes if any.

Note: this log (ICSF 214) may be kept as an attachment to the CAPF 104

FOR MISSION BASE STAFF OPERATIONS

a. Time/date unit or log started or activated.

b. Name of unit, supervisor, and individual keeping the log.

c. Notes from initial briefing.

d. Time and noted from staff meetings.

e. Significant events, actions taken, direction received or provided.

4. For each log entry, the log keeper writes down:

- a. The time.
- b. The event taking place (see list above)
- c. Mileage and/or location as appropriate.
- d. Name of individual annotating the log each time there is a change.

Additional Information

More detailed information on this topic is available in each emergency services reference text.

Evaluation Preparation

Setup: Prepare narrative of 10 events/actions and times. Provide the individual with the list, a pen, and an ICS Form 214.

Brief Student: Tell the student that he is the log keeper for his unit, and that the 10 events listed in the narrative have occurred. Tell him to log the events/actions on the on team log form.

Note: this evaluation can be accomplished during a training exercise by observing the events taking place and checking the log to see that they are properly annotated.

Evaluation

Performance measures

Results

For each of the 10 events/actions, the student:

- | | | |
|----------------------------------|---|---|
| 1. Logs the time and event | P | F |
| 2. Writes legibly and completely | P | F |

Student must receive a pass on all performance measures to qualify in this task. If the individual fails any measure, show what was done wrong and how to do it correctly.

P-0102
CONDUCT PHONE ALERT

CONDITIONS

You are a member of a ground team, and receive a phone call at home alerting you for a mission.

OJECTIVES

Take the steps necessary to alert all the personnel you are responsible for on the alert roster, passing on all the necessary information.

TRAINING AND EVALUATION

Training Outline

1. Alerting the team is the first step to saving a life. Done correctly, the phone alert quickly notifies all members of the team that a mission is in progress, gives them the information they need to prepare for the mission and move to the team meeting place, and informs the team leader of who will be attending the mission.

a. Your squadron should have an alert roster, which graphically designates who calls who in the event of an alert. The roster will look something like this:

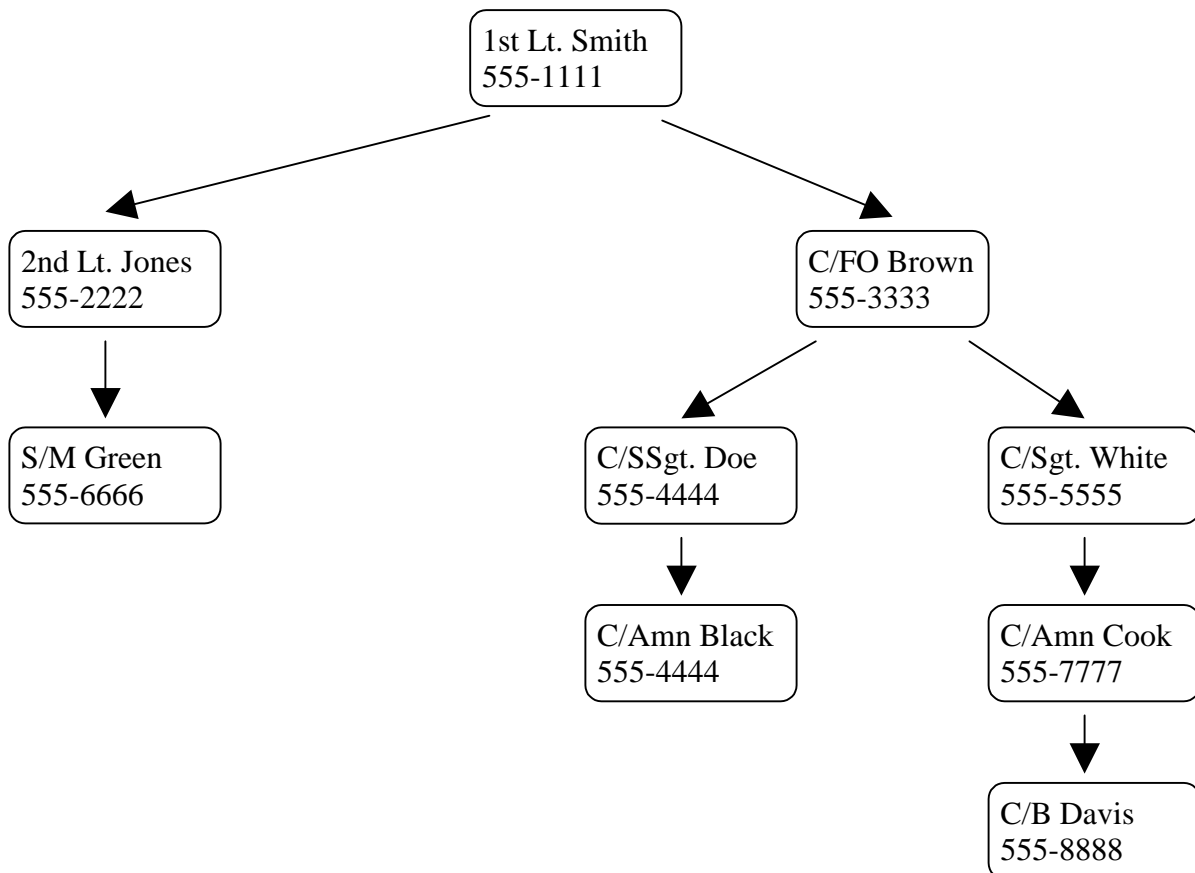

With this diagram, it is easy to see who calls who in an alert. 1st Lt. Smith calls 2nd Lt. Jones and Cadet Brown. 2nd Lt. Jones calls S/M Green. Cadet Brown calls Cadets Doe and White. Cadet Doe calls Cadet

Black. Cadet White calls Cadet Cook, who in turn calls Cadet Davis. This chart also assumes that 1st Lt. Smith is the squadron commander. If for some reason the squadron commander is not the main POC for missions in the unit, then the commander should be notified that the squadron has been alerted.

b. The team leader or designated individual must ensure the alert roster is kept up to date as members leave or join the team.

c. When a team leader starts the alert by "calling down the alert roster," he or she needs feedback. The personnel on the alert roster must confirm that they have passed the information on to those they were supposed to call, report on whom they could not reach, and report who will be attending the mission. This last piece of information can be critically important in determining how much transportation is needed. Accomplishing this can be done one of two ways. First, when the people at the bottom of the roster have been called, the people who called them should call back UP the roster, telling the person who called them, whom they contacted, whom they did not contact, and who will be attending the mission. Second, last member notified in the chain contacts the squadron POC initiating the alert (in this case probably 1st Lt. Smith) before departing for the meeting place with the same information.

d. The biggest problem with alert rosters occurs when you cannot reach someone you are supposed to call. If this happens, you must take responsibility for calling all the personnel that person was supposed to call. If you do not, those personnel will never be alerted.

2. When you receive an alert call:

a. Ensure the person tells you (at a minimum):

1. Type of Mission
2. Expected Duration of Mission
3. Time and Location of Meeting Place
4. Any special instructions.
5. Mission number
6. Their call back number

b. Write down all this information. Do not trust your memory.

c. Call those people directly below you on the alert roster. If one of those people is not available, call all the people that person would call. (if you could not reach them because of a busy signal, make sure to try again later.) Pass on all the information. Find out if they will be able to attend the mission.

d. If the personnel you call are at the bottom of the roster, after you call them, call the person who called you or the alerting officer and report who you reached, who you did not reach, and who will be attending as advised during your alert briefing.

e. If the personnel you call have other people to call, wait until they call you back with their report. Then call and report to the person who called you.

f. Keep conversations short and keep the phone line open as much as possible. Someone may be trying to call you with a report or an update to the information.

Additional Information

More detailed information on this topic is available in Chapter 17 of the Ground Team Member & Leader Reference Text.

Evaluation Preparation

Setup: Prepare an alert roster and give a copy to the student.

Brief Student: Show the student where he is on the roster (it does not have to really be his name. Just ensure that the name you pick is someone in the middle of the roster). Tell the student that you will simulate an alert call, and that the student should take all necessary actions, including simulating the calling of all the personnel that they should call on the list. Tell him that you will play the role of anyone he calls. Then “call” the member and pretend to alert them for the mission. Ensure you leave out one of the required elements of the alert call (listed in paragraph 2 above). When they simulate calling others, have one of those people not be home.

Evaluation

<u>Performance measures</u>	<u>Results</u>	
When alerted, the individual:		
1. Asks questions to ensure he or she knows the Type of Mission, Expected Duration of Mission, Time and Location of Meeting Place, Mission number, any special instructions and call back number.	P	F
2. Writes down all information	P	F
3. Calls all personnel directly below him/her on the alert roster.	P	F
4. Passes on all information, and finds out who will be attending	P	F
5. If someone is not there, call the personnel that person was responsible for calling.	P	F
6. Follows correct procedures to report back up the roster after making the calls.	P	F

Student must receive a pass on all performance measures to qualify in this task. If the individual fails any measure, show what was done wrong and how to do it correctly.

P-0201
SIGN-IN GROUND SEARCH TEAM AT MISSION

CONDITIONS

You are the leader of a ground team that has just arrived at mission base. You have completed a individual and vehicle accountability and safety inspection.

OBJECTIVES

Complete personnel and vehicle sign-in within 15 minutes of arriving at mission base.

TRAINING AND EVALUATION

Training Outline

1. Before a team can depart mission base to perform a sortie, the team leader is responsible for ensuring that all personnel are properly “signed-in” to the mission. This should be done immediately upon arrival at mission base. Signing-in gives the mission staff information on what vehicle and personnel resources are available, and it gives the ground operations staff specific information on team composition and capability. Legally, it also ensures that all personnel and vehicles on the mission are accounted for and are covered by the appropriate insurance regulations.

a. There are three forms used to sign-in a team - team leaders should have copies of these forms on-hand.

1) ICS Form 211, Check-In List - used to record all personnel or teams present at the mission, along with several other critical pieces of information. For this reason, it is essential that everyone writes legibly on the form.

2) ICS Form 218, Support Vehicle Inventory – used by the ground support unit of the logistics section to record all ground support vehicles (corporate and private) participating in the mission. This includes vehicles that only transport people to the mission base and aren’t expected to be used during the mission. This form is used primarily for insurance, reimbursement, and letting the mission staff know what assets are available.

3) CAPF-109, Vehicle Clearance Form - used to plan and brief all ground team sorties assigned during a mission.

b. Teams can actually begin the sign in process before arriving at mission base. A team leader can have his team fill out the paperwork at the meeting point, or while en route.

2. To sign in a team for a mission:

a. Have your team members complete an ICS Form 211. As they do this, ensure that:

1) Each member has on-hand a current CAP ID card and CAPF 101 for the job they will be doing. (normally, inspect this yourself. For large teams, delegate the inspection to your second-in-command.

2) Each member writes legibly, providing his appropriate information (listing Trainee status if applicable).

3) Emergency contact information should be on file, but may need to be provided. Ensure that someone is known who can actually be reached during the mission if something happens to you.

b. Have all drivers complete the ICS Form 218, providing the required information.

c. Fill out a CAPF 109. It is often good to do this as each person is logged onto the 211. This way, you can question them on their qualifications and check any qualification cards at the same time you're checking CAP ID's and 101 cards.

1) Only list personnel who will be part of your ground team. If you transported people to the mission who will be working mission staff, base operations, aircrew, etc., don't list them on the form. Also don't list people who don't have at least a Ground Team Member Trainee Rating - GES personnel cannot be part of a ground team.

2) Fill in all required information on your vehicles, communications resources. For each team member, indicate each person's name, list each member's ground operations specialties, and their personal equipment.

3) List all the items of team equipment your team has, and what vehicle it is located in. Have your drivers fill in the safety checklist for all team vehicles.

4) Turn one copy of the form in to the Ground Branch Director and make one for yourself.

5) During the mission, people will often be added or taken from your team and assignments may change. When this happens, you should immediately update the CAPF 109 with the Ground Branch Director.

Additional Information

More detailed information on this topic is available in Chapter 13 of the Ground Team Member and Leader Reference Text.

Evaluation Preparation

Setup: Ensure you have provided the team leader with an ICS Form 211, ICS form 218, CAPF 109, and a pen. Prepare a sheet containing all necessary information on two ground team vehicles (including equipment in each vehicle) and 6 team members (including name, age, senior/cadet status, what vehicles they are driving/riding in, and the qualifications they have). Ensure there is at least one person on the list with only a GES or other non-ground team rating. Prepare a second sheet describing two other team members from a different squadron.

Brief Team Leader:

1. Give the team leader the CAP Forms listed above, and the information on the vehicles and the six team members. Tell him that he has just arrived at mission base, and has inspected his vehicles and equipment, and that the handouts describe what assets and personnel his team have. Tell him that you will act as a team member just attached to his team. Tell him that he has 15 minutes to correctly:

- a. Have himself and you sign in on the ICS Form 211.
- b. Complete the ICS Form 218 for all vehicles.
- c. Complete the CAPF 109 for all team members.

2. After the team leader has completed this task, tell him that at the end of the day, one member of his team (choose a name), is assigned to work at mission base for the rest of the mission, and that two members from another squadron have been added to the team (give him the sheet describing the two team members). Tell the team leader to update the paperwork as needed.

Evaluation

<u>Performance measures</u>	<u>Results</u>	
The Team Leader:		
1. Has all personnel sign-in on the ICS Form 211		
a. Verifies Current ID Card	P	F
b. Verifies Current 101 Card	P	F
2. Signs all vehicles in correctly on the ICS Form 218	P	F
3. Completely fills out CAPF 109 form (front and back)		
a. Does not list non-ground team personnel	P	F
b. Lists all team members (including the evaluator)	P	F
4. Completely Fills out headers on all forms	P	F
5. Ensures all form entries are legible.	P	F
6. Completes the above steps in 15 minutes.	P	F

7. As team members are added or subtracted from the team, lines them out or adds them to the CAPF 109.

P F

Student must receive a pass on all performance measures to qualify in this task. If the individual fails any measure, show what was done wrong and how to do it correctly.

P-0202
PLAN AND BRIEF SORTIE

CONDITIONS

You are the leader of a ground team that has just been given a sortie briefing.

OBJECTIVES

Within 5 minutes, issue a warning order to your team. Within 20 minutes, correctly issue an operations order.

TRAINING AND EVALUATION

Training Outline

1. The key to a successful mission is a usable plan. The team leader makes this plan for his unit. There are three types of orders. All of these are normally given verbally.

a. **The Warning Order** is designed to save time. It lets your team know what preparations to make while you are preparing your plan. That way, they're not waiting around for you to finish the plan before they do anything. It consists of four items of information:

1. Type of Sortie - what, roughly, is your team about to do (line search, witness interview, etc.)
2. Preparations to begin - for example "pack up the van, check out the distress beacon DF gear."
3. Earliest Time of Movement - when the team will leave. This lets them know how long they have for preparations.
4. Attachments and Detachments - if anyone is joining the team (for example another squadron, a police dog team, etc.) and if anyone is leaving your team.
5. Time and Place of Operations Order - When and where the team should gather for you to brief your operations order.

b. **The Operations Order** tells your team what you're about to do, and how to do it. Normally, it's given orally, and team members copy it down in their notebooks. The operations order uses five paragraphs, which are:

- 1) Paragraph 1 - Situation - information on the search target, other search elements in the area, and terrain and weather.
- 2) Paragraph 2 - Mission - exactly what your team is about to do. Written as a few quick sentences, answering the questions Who, what, where, when and why.
- 3) Paragraph 3 - Execution - exactly how your team will accomplish the mission, in detail.

a) This paragraph starts off with the *Ground Branch Director's Intent*, which is a statement of exactly what the GBD. wants you to accomplish. In a line search, for example, there's a big difference between "This is the best lead we have. I want you to go over that area with a fine tooth comb until

you reach 80% probability” and “The police are about to call off the search. Cover as much ground as you can in the next two hours.” Each of these intents will result in a very different plan.

b) The rest of the paragraph is the *Concept of Execution*, which covers how the team will move, what each person’s job is, what team equipment each should carry, how you will search, what you will do when you find the target, etc. Describe, in sequence, exactly what you plan to do.

4) Paragraph 4 - Service Support - how you will support yourselves in the field. What food you should take, where the nearest medical assistance is, whether you should plan on being in the search area overnight, what equipment checks and maintenance should the team do before it leaves.

5) Paragraph 5 - Command and Signal - everything about the communications plan, including frequencies, radio check-in times, key phone numbers, whistle signals, etc. Also reviews the chain of command for the team and the mission, and states where the team leader will be located during the mission.

c. **A Fragmentary Order** is simply an update to an operations order. For example, once you arrive at the search area, you may change your mind about how you plan to search it. There is no special format. Just use the operations order format, but only brief those items that change.

2. To ensure you come up with a workable plan, follow the Troop Leading Procedure listed below:

a. Receive the Mission. Get the sortie brief from the Ground Branch. Start thinking about what you want to do.

b. Issue a Warning Order - this gets your team started in preparing for the operations.

c. Make a Tentative Plan - sit down with a map, and start your plan.

d. Initiate Movement - if time is of the essence, start driving/walking to the search area.

e. Conduct Reconnaissance - when possible, look at the ground you will be walking. If not, use a map.

f. Complete the Plan

g. Issue the Operations Order

h. Supervise - and revise the plan as necessary with Fragmentary Orders.

3. The Warning Order Format:

WARNING ORDER

- 1. Type of Sortie**
- 2. Preparations to begin**
- 3. Earliest Time of Movement**
- 4. Attachments and Detachments**
- 5. Time and Place of Operations Order**

4. The Operations Order Format: Use the following checklist to make sure you cover everything during your operations order brief. Make sure to use visual aids like maps and diagrams when you brief, if they will help your team to understand. The best place to brief is at the search area, where the team can see what the terrain looks like.

OPERATIONS ORDER

A. Situation:

- 1. Target Information (from the Incident Action Plan)**
 - a. Type, N-number, color, markings**
 - b. Personnel (description, names, ages, habits, probable condition)**
 - c. Current Leads and Information**
- 2. Supporting Agencies/Organizations:**
 - a. CAP teams, aircraft in the area**
 - b. Other agencies**
 - c. Attached or detached personnel**
- 3. Terrain and weather (focus on hazards)**

B. Mission: Who, what, when, where, why

C. Execution:

- 1. Ground Operation Director's Intent**
- 2. Concept of the Operation**
 - a. Execution (schedule of events, including)**
 - 1) Movement to area (primary and alternate routes)**
 - 2) Ground search patterns and techniques of penetration**
 - 3) Probable search area coverage**
 - 4) Actions to take when target is found (aid, evacuation, and notification)**
 - b. Tasks to subordinate units (include team equipment each should carry)**
 - 1) Tasks to sub teams**
 - 2) Medic**
 - 3) Navigator**
 - 4) Log Keeper**
 - 5) Drivers**
 - 6) Distress Beacon - DF specialists**
 - 7) Equipment Assistants**
 - c. Coordinating Instructions**
 - 1) Actions in search area (including what to look for)**
 - 2) Actions on find**
 - 3) Legal procedures for victims**
 - 4) Automatic return time**
 - 5) Departure/meeting points and times**
 - 6) Rally point(s)**

- 7) Required equipment/uniform
- 3. How to deal with press/bystanders
- 4. **Service Support:**
 - a. Concept of support (General re-supply plan, what team must carry with them)
 - b. Supply
 - 1) Food and water
 - 2) Fuel and lubricants
 - 3) Personal items
 - 4) Medical Supplies
 - 5) Spare parts, batteries, etc.
 - c. Services
 - 1) Maintenance (Permission checks, breakdown procedures)
 - 2) Medical Support locations (team and base)
- 5. **Command and Signal:**
 - a. Signal
 - 1) Primary and alternate means of communication.
 - 2) Base call signs, frequencies and phone #
 - 3) Nearby units call signs and frequencies
 - 4) Relay call signs, frequencies, and location
 - 5) Communications schedule and frequencies for check in
 - 6) Air/Ground signals to be used
 - b. Command
 - 1) Chain of command (from Incident Commander down)
 - 2) Location of team leader.

Additional Information

More detailed information on this topic is available throughout the Ground Team Member and Leader Reference Text.

Evaluation Preparation

Setup: Prepare a Mission Brief and a Ground Operations Sortie Brief for a team. Provide the team leader with maps of the sortie area. Have a timer. The leader should have his field gear.

Brief Team Leader: Brief the team leader of the sortie. Then tell him to issue a warning order to you in 5 minutes, and an begin an operations order briefing in 20 minutes. Tell him that he may use any part of his field gear, including this book.

Evaluation

<u>Performance measures</u>	<u>Results</u>	
The Team leader:		
1. Issues a Warning Order containing the 4 critical elements (Sortie Type, Preparations, Earliest Time of Movement, and Place and Time of Operations Order.	P	F
2. Issues Warning Order within 5 minutes of the end of the mission Brief	P	F
3. Issues an Order in the 5 paragraph format, adequately covering:		
a. Situation	P	F
b. Mission - (Who, what, where, when and why).	P	F
c. Execution - (Ground Operation Director's Intent and Concept of Execution)	P	F
d. Service Support	P	F
e. Command and Signal	P	F
4. Starts Operations order within 20 minutes of the end of the mission brief	P	F
5. Uses appropriate visual aids (maps, etc.) during the operations order brief	P	F
6. Asks for questions	P	F
7. Has briefed a workable plan (evaluator's subjective decision)	P	F

Student must receive a pass on all performance measures to qualify in this task. If the individual fails any measure, show what was done wrong and how to do it correctly.

P-0203
CONDUCT REHEARSALS

CONDITIONS

You are the leader of a ground team that has just been given a sortie briefing. You have completed your plan and briefed your team.

OBJECTIVES

Conduct a rehearsal of the key activities you expect to perform on your mission.

TRAINING AND EVALUATION

Training Outline

1. A rehearsal is the act or process of practicing an action in preparation for the actual performance of that action. Often, your team will be given tasks to perform that require rehearsal. For example, you may be ordered to perform a night line search, and your team has some members who have never done it before. So, before you get out in the woods, it's best to rehearse how you will perform that search - how you'll keep interval on the line, how you'll mark your path, how you'll maintain your direction of movement, etc.

a. Rehearsals are much better than just briefing a mission. The rehearsal leaves a lasting mental picture in everyone's mind of what's going to happen, and what part they play in it.

b. Rehearsals are also a great place to practice contingency, or "what if" drills. For instance, during a rehearsal you could ask a team member to demonstrate what he would do if he found a clue, found the victim, or became lost.

c. Team rehearsals take two major forms.

1) In a "full up" rehearsal, the team rehearses exactly what they'll do, using all their equipment, just as if they were actually doing it. So, before starting the night search listed above, the team leader would form his team members in a field or wooded area, and actually practice moving, searching and marking.

2) You can also hold a simulated or "sand table" rehearsal. In this case, you set up a model of the area, either by drawing in the dirt, or using a map or drawing. Then you talk your way through the operation, letting each person describe what actions they will take. You can use rocks or other markers to simulate each team member, and have them move them along the ground.

2. To perform a rehearsal:

a. Decide what to rehearse - this requires determining:

1) How much time you have available. If you must begin the sortie in 5 minutes, you won't have time to rehearse very much. If you have an hour, you can do a much more thorough job.

2) What parts of the operation require rehearsal. You want to rehearse the parts of the sortie that are complicated, or unfamiliar to your team. You especially want to rehearse the key events - the things that would "make or break" the operation. If the sortie is a line search, and your team is very proficient at line

searching, there's no reason to rehearse that. But if your team hasn't practiced what it would do if you found the victim, this would be a good time to go over that.

b. Decide what type of rehearsal - "full up" or simulated. This is mainly based on how much time you have. "Full up" rehearsals are preferable, but often impractical. At the very least, a ground team can conduct a verbal rehearsal of key events while driving to the sortie location (if not required to perform a mounted search en route).

c. Prepare the rehearsal area. For a "full up" rehearsal, this means choosing a place to rehearse. For a simulated, this means preparing the terrain model. As stated above, you can create a miniature version of the terrain on the ground, or use sketches or maps. The bigger the model, the better.

b. Conduct the rehearsal.

1) Overview. Remind the team what the sortie is. Then tell them what you're going to rehearse, and in what sequence.

2) Orientation. Orient the team to the terrain or model being used. For example "The terrain model represents the search area. North is to your right. This line I've drawn represents the highway. The large black rock is the Ranger Station." Always ask for questions, to make sure everyone understands.

3) Walk Through. Walk the team through the operation. Have them demonstrate and describe what actions they will take. Ask "what if" questions, such as "Smith, at this point you come across a 15 foot wide stream blocking your path. What will you do?". These make sure everyone understands the operation.

4) Summary of Changes. Often, you will make changes in your plan during the operation. For example, you might not want Jones to be your compass man, because it was obvious from the rehearsal that he's not proficient enough. If you make changes, make sure everyone understands them.

5) Ask for questions.

Additional Information

More detailed information on this topic is available throughout the Ground Team Member and Leader Reference Text.

Evaluation Preparation

Setup: (This task is normally tested along with P-0202 - Plan and Brief Sortie. If you test it this way, simply have the team leader rehearse his planned sortie. Otherwise, use the following preparation instructions). Choose a type of sortie, such as line search, mounted search, crash site surveillance, ramp check, etc., and prepare an operations order for the sortie (see task P-0202). Choose the part of the task you want the team leader to rehearse, using task name(s) from the ground team member and leaders handbook. Right them down on a sheet of paper. Decide what kind of rehearsal you want the leader to do (full up or sandtable). Provide team members for the rehearsal. Pre brief the team members on the plan.

Brief Team Leader: Tell the team leader that he/she should conduct a rehearsal of the tasks you have chosen. Brief the team leader using the Operations Order Format from task P-0202. Tell him he may use anything he carries in his field gear, including this book. Explain the sortie to the team leader, and give him his team

members. Tell the team leader to complete all planning and preparation and begin the actual rehearsal in 45 minutes.

Evaluation

<u>Performance measures</u>	<u>Results</u>	
During the rehearsal, the team leader:		
1. Provides adequate overview.	P	F
2. Orients the team to the terrain or model.	P	F
3. Walk the team through the operation. Has them demonstrate and describe what actions they will take.	P	F
4. Ask “what if” questions to ensure everyone understands.	P	F
5. Summarizes changes to the plan, that come out the rehearsal (if there are any).	P	F
6. Asks for questions.	P	F
7. Began the rehearsal within 45 minutes.	P	F

Student must receive a pass on all performance measures to qualify in this task. If the individual fails any measure, show what was done wrong and how to do it correctly.

P-0204
CONDUCT AN AFTER ACTION REVIEW

CONDITIONS

You are the leader of a ground team that has just completed a sortie, either actual or training. Debrief and team refit are complete. You now wish to review the team's performance to determine future training requirements.

OBJECTIVE

Successfully conduct a review that fosters individual participation, and determines the team's training strengths and weaknesses with respect to the sortie conducted. Records the results of the review for use in planning future training.

TRAINING AND EVALUATION

Training Outline

1. The After Action Review, or review, is a group activity that allows all members of the group to work together to review a mission sortie or training event. The purpose is to determine those things the team does well (and should *sustain*) and those things the team needs to *improve* in.
2. The review is a group process. If the leader just stands up and tells everyone else what happened, and no one else talks, it is not a review -- it's just a lecture.
3. The review is more than just a group discussion. The leader facilitates the review by leading a discussion of the events and activities that focuses on the training objectives. The discussion should orient on what the team did, what the members did, and what the leaders did, relating these actions to the outcome of the mission and to training objectives (such as the tasks in this book). This discussion should also address the functionality of equipment used by the team. At the close, the review leader summarizes the discussion, covering strengths and weaknesses discussed during the review and what the team needs to do to fix the weaknesses.
4. The leader must make sure the discussion focuses on what the team did, not what higher headquarters or other units did. Remember, the purpose is to help train your unit -- not someone else's.
5. To successfully conduct a review, the leader must:
 - a. PLAN.
 - 1) Establish objectives for the review -- what do you want to accomplish? If your unit just completed a Crash Site Surveillance sortie, then your main objective would be to review the conduct of the surveillance. If you had more time, you might also wish to review how the team alerted and the drive to the site went. You decide on the objectives prior to the review, and keep the discussion within those objectives.
 - 2) Choose the review Site -- pick a place that is comfortable, with adequate light, and protection from the elements if possible. Reviews should not be conducted with the team standing in formation -- it will quickly turn in to a lecture.
 - 3) Select Training Aids -- determine what "props" you need. A map is always handy. A blackboard or white board can be used to draw pictures of how the team moved through an area, or to record the

results of the review. You should always have the appropriate publications on hand (ground team handbook, CAPM 50-15, etc.) that discuss the correct way of doing whatever the team just did.

b. PREPARE

1) Review The Training Objectives And Objectives - Write down what the purpose of the exercise was. (For example "To practice hasty search and first aid"). Then look through your reference publications to make sure you know what the objectives are.

2) Review your notes and the team log- If you took any notes during the exercise or sortie, review them to refresh you memory as to what happened (or at least what you observed -- other team members may add things during the review that you never noticed).

3) Develop an outline -- decide on how you want to lead your team through the discussion. Base your outline on this one:

a) Introduction

b) Present the Mission - What was your team supposed to do. Use the sortie briefing.

c) Summary of Events -- What happened, chronologically, during the sortie?

d) Discussion of Key Issues -- the things that made the mission a success (or failure).

e) Analysis -- in terms of:

- **Command** -- Was direction from upper echelons apparent? Did command staff members assist teams in completing tasks as necessary?

- **Operations** -- Was the appropriate resource used for the task? If combined resources were necessary to complete the tasks assigned, was coordination of those resources effective? Did the mission assignments meet the original intent as briefed?

- **Planning** -- Were all resources assigned prepared for their tasks? Were team assignments made effectively?

- **Finance and Administration** -- Was documentation of team participation readily apparent? Were reimbursement procedures briefed, if applicable?

- **Logistics Support** -- Did the team have all of the necessary equipment to accomplish the missions assigned? Was the communications system utilized effective? If teams were in the field for an extended period, were items needed for refit of the team coordinated effectively?

f) Discussion of the Suggested Training to Sustain or Improve Team Skills.

g) Conclusion

c. EXECUTE.

1. Make sure everyone is comfortable. If people are uncomfortable or distracted, they will not participate.

2. Lead the discussion with questions. For example, if you have noted that had problems maintaining a good search pattern during the sortie, don't just tell the team that. Instead, ask something like "What happened when we started our line search?" or "How well do you think our line search went?". Whenever possible, let the team members tell YOU how things went, not the other way around. The less you talk, the better.

3. Keep the group focused. If team members start talking about things not related to the sortie, or the training objectives, it is your job to bring them back on track.

4. Analyze what the group is saying. If something went wrong (or right) find out why. Discuss how you could have done things better. Determine what training could help your team to improve.

5. Do not embarrass anyone. Make sure everyone feels free to bring up problems without being ridiculed. This is a sensitive issue, since you want team members to discuss their own mistakes. Everyone must understand that the purpose of the review is to make the team better.

6. Ensure performance is graded. By the end of the review, team members must clearly understand what was good, bad and average about their performance. The art of the review is to get the team members to accurately grade their own performance. In some cases, however, you may need to tell the team how they did -- especially with newer members.

7. Record the major points of the review, especially what areas need improvement. Use this information to plan future training.

Additional Information

More detailed information on this topic is available throughout the Ground Team Member and Leader Reference Text.

Evaluation Preparation

Setup: This task is graded by observing a team leader conduct a review after a training exercise or mission sortie. The team leader may use any materials he/she has on hand, including this book.

Brief Team Leader: Tell the team leader that he/she should conduct a review of the exercise or sortie just completed. Tell the team leader to complete all planning and preparation and begin the actual review in 45 minutes.

Evaluation

<u>Performance measures</u>	<u>Results</u>	
During the review, the team leader		
1. Chooses a comfortable review site with adequate light and protection from the elements.	P	F
2. Uses training aids where appropriate.	P	F
2. Introduces him/herself and states the training objectives	P	F

- | | | |
|--|---|---|
| 3. Leads the team through a discussion of: | | |
| a. What the mission was. | P | F |
| b. What happened during the sortie (in chronological order. | P | F |
| c. What were the Key Issue/Events that made the mission a success (or failure). | P | F |
| d. Analysis and Summary of team performance in terms of Command and Control, Intelligence and Search, Movement and Navigation, Recovery and Security, and Logistics and Personnel Support. | P | F |
| e. Suggested Training to Sustain or Improve Team Skills. | P | F |
| 4. Leads the discussion with questions. | P | F |
| 5. Keeps the group focused. | P | F |
| 6. Relates performance to published objectives. | P | F |
| 7. Records the results of the review | P | F |

Student must receive a pass on all performance measures to qualify in this task. If the individual fails any measure, show what was done wrong and how to do it correctly.

L-0001
BASIC COMMUNICATIONS PROCEDURES FOR ES OPERATIONS

CONDITIONS

You are a member of the CAP mission staff performing a task in which the use of a radio is necessary.

OBJECTIVES

Properly operate a CAP radio.

TRAINING AND EVALUATION

Training Information Outline

1. From time to time, duties may require the use of a CAP radio. This is not a difficult task, but does require some knowledge of operating procedures and equipment.
2. You should be able to demonstrate the following skills:
 - a. Demonstrate the proper method to contact another station.
 - b. Demonstrate knowledge of call signs.
 - c. Demonstrate knowledge of basic prowords.
 - d. Demonstrate ability to operate basic radio equipment.
 - e. Demonstrate knowledge of prohibited practices.
 - f. Demonstrate knowledge of National communications policies.
 - g. Demonstrate knowledge of local operating practices.
 - h. Demonstrate knowledge of region, wing, and local policies.

Additional Information

Additional information is available in CAPR 100-1 Vol. 1 and the "Radiotelephone Procedures Guide."

Evaluation Preparation

Setup: The student is provided with a basic radio (volume, squelch, channel controls) and asked to communicate with another station. At least one radio will be needed for this exercise. The pro-words "roger," "over," "out," affirmative," should be used. The exchange should go through several transmissions with questions and answers. Prohibitive practices, such as "chit chat," should be used or discussed.

Brief Student: The student is at mission base and has been assigned the task of reporting when the director of the local office of emergency management arrives for his/her tour of the facility.

Evaluation:

<u>Performance measures</u>	<u>Results</u>	
1. Listen before transmitting	P	F
2. Demonstrate calling procedures including call signs	P	F
3. Demonstrate use/understanding of basic prowords	P	F
4. Demonstrate understanding of radio equipment including finding local repeater/simplex	P	F

Student must receive a pass on all performance measures to qualify in this task. If the individual fails any measure, show what was done wrong and how to do it correctly.

L-0002
PERFORM RADIO OPERATING PROCEDURES

CONDITIONS

You are a mission radio operator at a mission base.

OBJECTIVE

Properly operate a mission base radio system.

TRAINING AND EVALUATION

Training Information Outline

1. A Mission Radio Operator is required to maintain communications with all mission assets (aircraft, ground teams, flight line and forward bases). This allows for sending new instructions, reporting mission information and as a safety measure for keeping track of people in the field.

2. You should be able to demonstrate the following skills:

- a. Demonstrate the proper method to contact another station.
- b. Demonstrate knowledge of the International Phonetic Alphabet.
- c. Demonstrate knowledge of CAP Prowords.
- d. Demonstrate knowledge of international urgency signals.
- e. Demonstrate the ability to maintain a communications status board.
- f. Demonstrate a familiarity with standard equipment and local communications operations.
- g. Demonstrate the proper use of standard radio equipment.
 - 1) Set volume and squelch levels appropriately
 - 2) Demonstrate proper use of microphone

Additional Information

Additional information on this topic can be found in The Radiotelephone Procedures Guide.

Evaluation Preparation

Setup: Provide the student with a message to reassign an aircraft to another grid, a status board, a radio, paper and pencil/pen.

Brief Student: Ask the student how they would contact an aircraft flying a sortie. Tell the student that he needs to transmit the change of grid assignment to the aircraft. Transmit an urgency signal to the student and ask them to identify the meaning of the signal and what action that they should take.

Evaluation:

<u>Performance measures</u>	<u>Results</u>	
1. Demonstrate setting volume and squelch levels for proper function	P	F
2. Demonstrate proper microphone technique	P	F
3. Demonstrate listening before transmitting	P	F
4. Properly call and acknowledge aircraft	P	F
5. Send change of grid assignment, using proper phonetics and prowords	P	F
6. Correctly interpret urgency signal and take appropriate action	P	F
7. Update mission communications status boards	P	F

Student must receive a pass on all performance measures to qualify in this task. If the individual fails any measure, show what was done wrong and how to do it correctly.

EMPLOY APPROPRIATE RADIO FREQUENCIES AND REPEATERS

CONDITIONS

You are the radio operator for a ground team, and have been told by the team leader to contact another station. You must choose what frequency to use.

OBJECTIVE

Within 2 minutes, identify the appropriate frequencies and channels used for ground operations.

TRAINING AND EVALUATION

Training Information Outline

1. Ground Search and Rescue Teams use a number of VHF-FM frequencies to communicate with mission base, other ground teams, and aircraft.
2. Frequency assignments are usually given by the communications unit leader based on the following.
 - a. Simplex Frequencies (VHF-FM): Short range communications where units are operating on the same transmit and receive frequency
 - b. Duplex Frequencies. Longer range communications are accomplished through the use of a repeater. All repeaters are accessed by transmitting a subaudible tone through the radio. The 100.0 Hz tone will activate any CAP repeater, but is used only in emergencies and to request the proper tone frequency for the repeater in use. Other tones are programmed into the radio as required. The communications unit leader will brief teams on what frequency and tones to use to access local repeaters.
 - c. VHF-AM (Airband) SAR Frequencies: These are dedicated frequencies authorized for training and actual missions that can be accessed by any aircraft.
 - d. National HF Frequencies: These are frequencies coordinated by National Headquarters. Some teams may be deployed with HF radios on these frequencies during disasters to serve as relay points out of affected areas.
 - e. Region HF Frequencies: These are frequencies established for HF operations within a region. Teams may also be deployed and operate on these frequencies to transmit greater distances than traditional VHF-FM assets used by ground teams.
 - f. Other frequencies are used to communicate with police, Coast Guard, and other SAR agencies. Again, the communications unit leader will brief on the use of these frequencies.

Additional Information

Additional information on frequencies used in CAP and repeater locations can be found in CAPR 100-1 Vol. 1, chapters 7, 9, & 10, and The Communications Directory. Wing Communications Operations and Training plans will also contain important information for your area.

Evaluation Preparation

Setup: Prepare a list of the five frequency groups listed above for your area of operation with assignments in each group. Give the list to the trainee. The student may use any item from his field gear, including this book or a “cheat sheet”.

Brief Team Leader: Tell the student to identify each frequency and its use, within 2 minutes total time.

Evaluation:

<u>Performance measures</u>	<u>Results</u>	
The individual identifies:		
1. Identifies the primary simplex frequency and its use.	P	F
2. Identifies the alternate simplex frequency and its use.	P	F
3. Identifies the ground to ground frequency and its use.	P	F
4. Identifies the primary duplex frequency pair and its use.	P	F
5. Identifies the alternate duplex frequency pair and its use.	P	F
6. Identifies the primary HF SSB frequency for the region	P	F
7. Identifies the alternate HF-SSB frequency for the region	P	F
8. Completes all steps within 2.5 minutes	P	F

Student must receive a pass on all performance measures to qualify in this task. If the individual fails any measure, show what was done wrong and how to do it correctly.

L-0101
INSPECT A VEHICLE

CONDITIONS

You are part of a ground team preparing to leave on a sortie that you will need to use a vehicle.

OJECTIVES

Demonstrate how to properly inspect the ground team's vehicle.

TRAINING AND EVALUATION

Training Outline

1. Ground teams almost always utilize a vehicle as part of accomplishing their missions. To insure that the team vehicle is safe and ready for the sortie, a vehicle inspection is required prior to every sortie.

2. The following checklist can be used to accomplish these inspections or the current CAP-USAF Evaluation Checklist. Both accomplish the same basic need.

a. Before starting the vehicle

- 1) Check the engine oil level
- 2) Check to make sure that the battery is properly connected and relatively clean
- 3) Check the tires for damage and abnormalities
- 4) Check to make sure that there is a spare tire and a jack
- 5) Check engine coolant level
- 6) Check to make sure that all belts and hoses look normal
- 7) Check to make sure that there are enough safety belts for all passengers
- 8) Check for leaks under the vehicle and in the engine area
- 9) Check to see how clean the vehicle is inside and out
- 10) Check for and damage both internally and externally
- 11) Check to make sure that the inspection sticker (if applicable) and registration is current
- 12) Check Power Steering Fluid, Oil, and Windshield Cleaner levels
- 13) Check to make sure that there is extra fuel and water in labeled containers for emergencies.
- 14) Check to make sure that all necessary team equipment is loaded into the vehicle to include

fire extinguisher and first aid kits.

b. After starting the vehicle

- 1) Check to make sure that all lights work
 - a) High and low beams
 - b) Front and Rear turning signals
 - c) Front and Rear caution lights
 - d) Reverse lights
 - e) Dome lights, and panel lights
- 2) Check to make sure that all instruments, horn, and windshield wipers work
- 3) Check all safety devices again, along with warning lights
- 4) Check the brakes and the steering
- 5) Check for unusual occurrences such as noise, odors, or unusual vibrations
- 6) Check gas level

- a) If there is more than one tank, check both.
- b) Don't just rely on gauges, visually check tanks, and driver records of travel.
- 7) Complete all Mission Paperwork necessary before leaving the mission base.
 - a) Make sure that it is readable.
 - b) Make sure it is signed by the approving officer, normally the Ground Branch Director or his designee.

- c) Make sure to leave a copy with the approving officer and retain a copy for yourself.
- d) If the daily inspection log has not been signed, makes sure the driver completes it before leaving mission base.

Additional Information

More detailed information on this topic is available in Chapter 3 of the Ground Team Member & Leader Reference Text.

Evaluation Preparation

Setup: Ensure that there is a vehicle available for the student to inspect. The evaluator should create a minor problem such as removing the fire extinguisher, first aid kit or tire jack for the student to find. Evaluators will not damage vehicles or make them un-safe for operation or un-roadworthy for the test.

Brief Student: Tell the student to demonstrate a proper vehicle inspection.

Evaluation

<u>Performance measures</u>	<u>Results</u>
1. Demonstrates a proper vehicle inspection noting the evaluator created problem.	P F

Student must receive a pass on all performance measures to qualify in this task. If the individual fails any measure, show what was done wrong and how to do it correctly.

SPECIALTY QUALIFICATION TRAINING RECORDS (SQTR)

On the following pages you will find the specialty qualification training records for the ground and urban direction finding team specialties. These sheets are your record of training accomplished prior to earning any of these emergency services specialty qualifications. We recommend that you keep copies of these records in a safe place just in case you lose this task guide. Electronic records are not required to be updated until all training is accomplished so this may be your only record of training successfully accomplished. Once you have completed a qualification, provide a copy of the appropriate SQTR to your unit commander or other designated officer for processing.

**SPECIALTY QUALIFICATION TRAINING RECORD (SQTR)
Ground Team Member – Level 3**

NAME (Last, First, MI)	CAPID	DATE ISSUED
------------------------	-------	-------------

Prerequisites

Item	Date Completed
Qualified GES	

The above listed member has completed the required prerequisite training for the ground team member – level 3 specialty.

UNIT/WING/REGION COMMANDER OR
AUTHORIZED DESIGNEE'S SIGNATURE

DATE

Familiarization and Preparatory Training

Task	Evaluator's CAPID and Date Completed
Complete Task O-0001 Prepare Individual Equipment	
Complete Task O-0002 Conduct Individual Refit	
Complete Task O-0003 Prevent and Treat Hot Weather Injuries	
Complete Task O-0004 Prevent and Treat Cold Weather Injuries	
Complete Task O-0101 Identify Natural Hazards	
Complete Task O-0102 Prevent and Treat Fatigue	
Complete Task O-0103 Conduct Field Sanitation and Hygiene	
Complete Task O-0201 Use a Compass	
Complete Task O-0601 Conduct actions if Lost	
Complete Task O-0902 Exercise Universal Precautions	
Complete Task P-0102 Conduct a Phone Alert	

The above listed member has completed the required familiarization and preparatory training requirements for the ground team member - level 3 specialty qualification and is authorized to serve in that specialty while supervised on training or actual missions.

UNIT/WING/REGION COMMANDER OR
AUTHORIZED DESIGNEE'S SIGNATURE

DATE

Advanced Training

Evaluator's CAPID and
Date Completed

Task

- Complete Task O-0301 Determine Distress Beacon Bearing
- Complete Task O-0302 Locate a Distress Beacon
- Complete Task O-0403 Employ Search Techniques while on foot
- Complete Task O-0404 Move as Part of a Search Line
- Complete Task O-0405 Communicate to Other Members of a Search Line
- Complete Task O-0406 Use Whistle Signals
- Complete Task O-0407 Conduct Attraction Techniques
- Complete Task O-0408 Identify Aircraft Search Clues
- Complete Task O-0409 Identify Missing Person Search Clues
- Complete Task O-0410 Mark a Route or Search Boundary
- Complete Task O-0411 Conduct individual actions on locating a clue
- Complete Task O-0412 Conduct individual actions on "find"
- Complete Task O-0413 Participate in a hasty search
- Complete Task O-0502 Participate in a litter carry
- Complete Task O-0702 Use a signal mirror
- Complete Task L-0001 Basic Radio Procedures for ES Operators
- Complete Task L-0002 Perform Radio Operations Procedures
- Complete Task L-0003 Employ appropriate radio frequencies and repeaters
- Complete Task P-0101 Keep a Team Log
- Complete Basic First Aid
- Complete Basic Communications User Training
- Complete the appropriate portion of CAPT 117, *Emergency Services Continuing Education examinations*

Exercise Participation

The above listed member satisfactorily participated as a ground team member – level 3 trainee under my direct supervision on mission number _____.

QUALIFIED SUPERVISOR'S SIGNATURE DATE

The above listed member satisfactorily participated as a ground team member – level 3 trainee under my direct supervision on mission number _____.

QUALIFIED SUPERVISOR'S SIGNATURE DATE

Unit Certification and Recommendation

The above listed member has completed the requirements for the ground team member – level 3 specialty qualification and is authorized to serve in that specialty on training or actual missions.

UNIT/WING/REGION COMMANDER OR
AUTHORIZED DESIGNEE'S SIGNATURE DATE

**SPECIALTY QUALIFICATION TRAINING RECORD (SQTR)
Ground Team Member – Level 2**

NAME (Last, First, MI)	CAPID	DATE ISSUED
------------------------	-------	-------------

Prerequisites

Item	Date Completed
Complete requirements for GTM 3	

The above listed member has completed the required prerequisite training for the ground team member – level 2 specialty and is authorized to serve in that specialty while supervised on training or actual missions.

UNIT/WING/REGION COMMANDER OR
AUTHORIZED DESIGNEE'S SIGNATURE

DATE

Familiarization and Preparatory Training
No Additional Training Is Required

Advanced Training

Task	Evaluator's CAPID and Date Completed
Complete Task O-0104 Set up Shelter	
Complete Task O-0202 Measure Distance with Pace Count	
Complete Task O-0203 Navigate past an Obstacle	
Complete Task O-0209 Identify The Major Terrain Features On A Map	
Complete Task O-0210 Identify Topographic Symbols On A Map	
Complete Task O-0211 Determine Elevation On Map	
Complete Task O-0212 Measure Distance On A Map	
Complete Task O-0213 Convert Between Map And Compass Azimuths	
Complete Task O-0215 Determine Azimuths On A Map Using Two Points	
Complete Task O-0216 Orient A Map To The Ground Using Terrain Association	
Complete Task O-0217 Orient A Map To North Using A Compass	
Complete Task O-0420 Perform An Airfield Search (Ramp Check)	
Complete the appropriate portion of CAPT 117, <i>Emergency Services Continuing Education examinations</i>	

Exercise Participation

The above listed member satisfactorily participated as a ground team member – level 2 trainee under my direct supervision on mission number _____.

QUALIFIED SUPERVISOR'S SIGNATURE

DATE

The above listed member satisfactorily participated as a ground team member – level 2 trainee under my direct supervision on mission number _____.

QUALIFIED SUPERVISOR'S SIGNATURE

DATE

Unit Certification and Recommendation

The above listed member has completed the requirements for the ground team member – level 2 specialty qualification and is authorized to serve in that specialty on training or actual missions.

UNIT/WING/REGION COMMANDER OR
AUTHORIZED DESIGNEE'S SIGNATURE

DATE

SPECIALTY QUALIFICATION TRAINING RECORD (SQTR)
Ground Team Member - Level 1

NAME (Last, First, MI)	CAPID	DATE ISSUED
------------------------	-------	-------------

Prerequisites

Item	Date Completed
Complete requirements for GTM 2	

The above listed member has completed the required prerequisite training for the ground team member – level 1 specialty.

UNIT/WING/REGION COMMANDER OR AUTHORIZED DESIGNEE'S SIGNATURE	DATE
--	------

Familiarization and Preparatory Training

Task	Evaluator's CAPID and Date Completed
Complete Task O-0701 Recognize and React to Air to Ground Signals	

The above listed member has completed the required familiarization and preparatory training requirements for the ground team member – level 1 specialty qualification and is authorized to serve in that specialty while supervised on training or actual missions.

UNIT/WING/REGION COMMANDER OR AUTHORIZED DESIGNEE'S SIGNATURE	DATE
--	------

Advanced Training

Task	Evaluator's CAPID and Date Completed
Complete Task O-0401 Work with Canine Search Teams	
Complete Task O-0416 Plan Search Line Operations	
Complete Task O-0417 Organize a Search Line	
Complete Task O-0418 Control a Search Line	
Complete Task O-0419 Plan and Organize a Hasty Search	
Complete Task O-0703 Employ Ground to Air Signals	
Complete Task O-0802 Plan and Organize Site Surveillance	
Complete Task P-0201 Sign-In Team At Mission	
Complete Task P-0202 Plan And Brief Sortie	
Complete Task P-0203 Conduct Rehearsals	
Complete Task P-0204 Conduct After Action Review	
Complete the appropriate portion of CAPT 117, <i>Emergency Services Continuing Education examinations</i>	

Exercise Participation

The above listed member satisfactorily participated as a ground team member – level 1 trainee under my direct supervision on mission number _____.

QUALIFIED SUPERVISOR'S SIGNATURE	DATE
----------------------------------	------

The above listed member satisfactorily participated as a ground team member – level 1 trainee under my direct supervision on mission number _____.

QUALIFIED SUPERVISOR'S SIGNATURE	DATE
----------------------------------	------

Unit Certification and Recommendation

The above listed member has completed the requirements for the ground team member – level 1 specialty qualification and is authorized to serve in that specialty on training or actual missions.

UNIT/WING/REGION COMMANDER OR AUTHORIZED DESIGNEE'S SIGNATURE	DATE
--	------

SPECIALTY QUALIFICATION TRAINING RECORD (SQTR)
Ground Team Leader

NAME (Last, First, MI)	CAPID	DATE ISSUED
------------------------	-------	-------------

Prerequisites

Item	Date Completed
Qualified Ground Team Member (level 3, 2, or 1)	
At least 18 years of age	

The above listed member has completed the required prerequisite training for the ground team leader specialty and is authorized to serve in that specialty while supervised on training or actual missions.

UNIT/WING/REGION COMMANDER OR
AUTHORIZED DESIGNEE'S SIGNATURE

DATE

Familiarization and Preparatory Training
No Additional Training Is Required

Advanced Training

Task	Evaluator's CAPID and Date Completed
Complete Task O-0005 Insect team members	
Complete Task O-0006 Inspect team equipment	
Complete Task O-0007 Direct team refit after sortie	
Complete Task O-0104 Set up Shelter	
Complete Task O-0204 Locate a point on a Map using Latitude and Longitude	
Complete Task O-0205 Locate a point on a map using the CAP Grid System	
Complete Task O-0209 Identify the major terrain features on a map	
Complete Task O-0210 Identify topographic symbols on a map	
Complete Task O-0211 Determine elevation on a map	
Complete Task O-0212 Measure distance on a map	
Complete Task O-0213 Convert between map and compass azimuths	
Complete Task O-0214 Determine and plot an azimuth on a map	
Complete Task O-0215 Determine azimuths on a map using two points	
Complete Task O-0216 Orient a map to the ground using terrain association	
Complete Task O-0217 Orient a map to north using a compass	
Complete Task O-0218 Locate own position on a map using terrain association	
Complete Task O-0220 Move from point to point in a vehicle using a map	
Complete Task O-0301 Determine Distress Beacon Bearing	
Complete Task O-0302 Locate a Distress Beacon	
Complete Task O-0303 Deactivate a distress beacon	
Complete Task O-0304 Triangulate on a distress beacon signal	
Complete Task O-0416 Plan Search Line Operations	
Complete Task O-0417 Organize a Search Line	
Complete Task O-0418 Control a Search Line	
Complete Task O-0419 Plan and Organize a Hasty Search	
Complete Task O-0420 Perform an Airfield Search (Ramp check)	
Complete Task O-0421 Direct team actions on locating a clue	
Complete Task O-0422 Direct team actions on find	
Complete Task O-0605 Extinguish a small Fire	
Complete Task O-0802 Plan and organize site surveillance	
Complete Task O-0803 Supervise a site surveillance shift	
Complete Task O-0804 Sign over a site	
Complete Task O-1001 Direct team actions at meeting point	
Complete Task O-1002 Establish a helicopter landing zone	
Complete Task O-1101 Conduct Witness Interview	
Complete Task P-0201 Sign-in a Team at Mission Base	
Complete Task P-0202 Plan and brief sortie	
Complete Task P-0203 Conduct rehearsals	
Complete Task P-0204 Conduct after action review	
Complete Task L-0101 Inspect a vehicle	
Complete the appropriate portion of CAPT 117, <i>Emergency Services Continuing Education examinations</i>	

Exercise Participation

The above listed member satisfactorily participated as a ground team leader trainee under my direct supervision on mission number _____.

QUALIFIED SUPERVISOR'S SIGNATURE

DATE

The above listed member satisfactorily participated as a ground team leader trainee under my direct supervision on mission number _____.

QUALIFIED SUPERVISOR'S SIGNATURE

DATE

Unit Certification and Recommendation

The above listed member has completed the requirements for the ground team leader specialty qualification and is authorized to serve in that specialty on training or actual missions.

UNIT/WING/REGION COMMANDER OR
AUTHORIZED DESIGNEE'S SIGNATURE

DATE

SPECIALTY QUALIFICATION TRAINING RECORD (SQTR)
Urban Direction Finding Team

NAME (Last, First, MI)	CAPID	DATE ISSUED
------------------------	-------	-------------

Prerequisites

Item	Date Completed
Qualified GES	

The above listed member has completed the required prerequisite training for the urban direction finding team specialty.

UNIT/WING/REGION COMMANDER OR AUTHORIZED DESIGNEE'S SIGNATURE

DATE

Familiarization and Preparatory Training

Task	Evaluator's CAPID and Date Completed
Complete Task O-0010 Prepare UDF Individual Equipment	
Complete Task P-0102 Conduct a Phone Alert	

The above listed member has completed the required familiarization and preparatory training requirements for the urban direction finding team specialty qualification and is authorized to serve in that specialty while supervised on training or actual missions.

UNIT/WING/REGION COMMANDER OR AUTHORIZED DESIGNEE'S SIGNATURE

DATE

Advanced Training

Task	Evaluator's CAPID and Date Completed
Complete Task O-0201 Use a Compass	
Complete Task O-0205 Locate A Point On A Map Using The CAP Grid System	
Complete Task O-0214 Determine And Plot An Azimuth On A Map	
Complete Task O-0218 Locate Own Position On A Map Using Terrain Association	
Complete Task O-0220 Move From Point To Point In A Vehicle Using A Map	
Complete Task O-0301 Determine Distress Beacon Bearing	
Complete Task O-0302 Locate a Distress Beacon	
Complete Task O-0303 Deactivate a Distress Beacon	
Complete Task O-0304 Triangulate on a Distress Beacon Signal	
Complete Task O-0420 Perform an Airfield Search (Ramp check)	
Complete Task L-0001 Basic Radio Procedures for ES Operators	
Complete Task L-0002 Perform Radio Operations Procedures	
Complete Task L-0003 Employ appropriate radio frequencies and repeaters	
Complete Task L-0101 Inspect a vehicle	
Complete Task P-0101 Keep a Log	
Complete Basic Communications User Training	
Complete the appropriate portion of CAPT 117, <i>Emergency Services Continuing Education examinations</i>	

Exercise Participation

The above listed member satisfactorily participated as an urban direction finding team trainee under my direct supervision on mission number _____.

QUALIFIED SUPERVISOR'S SIGNATURE

DATE

The above listed member satisfactorily participated as an urban direction finding team trainee under my direct supervision on mission number _____.

QUALIFIED SUPERVISOR'S SIGNATURE

DATE

Unit Certification and Recommendation

The above listed member has completed the requirements for the urban direction finding team specialty qualification and is authorized to serve in that specialty on training or actual missions.

UNIT/WING/REGION COMMANDER OR
AUTHORIZED DESIGNEE'S SIGNATURE

DATE

COMMENTS AND SUGGESTIONS

Task based training will be new to personnel at all levels. If you have any questions in reference to this task guide please forward them to:

HQ CAP/DOS
105 South Hansell Street, Bldg 714
Maxwell AFB, AL 36112-6332

Fax: (800) 555-7902
E-mail: dos@cap.gov

Operations are continually changing which requires changes to CAP training materials. In accordance with CAPR 60-3, recommended changes to task guides for all specialties will be submitted through the chain of command to the Region Commander. If the Region Commander concurs with the proposed change, he/she will forward the recommendation to NHQ CAP/DO. NHQ will forward the recommendation to all Region Commanders for their consideration. Proposals that are approved by a majority of the Region Commanders will be incorporated into the standardized National task guides.