Piloted Simulation Tests of Propulsion Control as Backup to Loss of Primary Flight Controls for a B747-400 Jet Transport

John Bull, Robert Mah, Gordon Hardy,
Barry Sullivan, Jerry Jones, Diane Williams,
Paul Soukup, Jose Winters

April 1997



National Aeronautics and
Space Administration

Piloted Simulation Tests of Propulsion Control as Backup to Loss of Primary Flight Controls for a B747-400 Jet Transport

John Bull, *CAELUM Research Corporation, Mountain View, California*

Robert Mah, Gordon Hardy, Barry Sullivan, *Ames Research Center, Moffett Field, California*

Jerry Jones, Diane Williams, Paul Soukup, *Man Tech/NSI Technology Services Corporation, Sunnyvale, California*

Jose Winters, *Foothill-DeAnza Intern, Los Altos Hills, California*

April 1997



National Aeronautics and
Space Administration

Ames Research Center
Moffett Field, California 94035-1000

TABLE OF CONTENTS

	<u>Page</u>
TABLE OF CONTENTS	iii
LIST OF TABLES	v
LIST OF FIGURES	vi
SUMMARY	1
1.0 INTRODUCTION	2
1.1 Purpose of B747-400 Piloted Simulation Tests.	
2.0 AIRCRAFT AND FLIGHT SIMULATOR DESCRIPTION.....	4
2.1 B747-400 Aircraft Physical Description.	
2.2 B747-400 Aircraft Flight and Engine Dynamics.	
2.3 B747-400 Normal Landing Configuration and Airspeed.	
2.4 B747-400 Cockpit.	
2.5 B747-400 Emergency Extension of Flaps and Landing Gear.	
2.6 B747-400 Flight Simulator Description.	
2.7 Turbulence Model.	
3.0 PCA CONCEPT	8
3.1 PCA Concept.	
3.2 PCA Control Law Development.	
3.3 PCA Control Law Structure.	
3.4 PCA Engine Control Implementation.	
3.5 PCA Engine Configurations.	
3.6 PCA Industry Benefits.	
4.0 PCA OPERATIONAL MODES	11
5.0 TEST DESCRIPTION	12
5.1 Test Objectives.	
5.2 Test Scope.	
5.3 Baseline Flight Scenario.	
5.4 Emergency Flight Scenario.	
5.5 Approach and Landing Scenarios.	
6.0 RESULTS AND DISCUSSION	16
6.1 Effect of Control Surface Float.	
6.2 Landing Site Selection.	
6.3 Tendency to Float (or Bounce) on Landing.	

6.4 PCA Unusual Attitude Recovery (cruise altitude).	
6.5 PCA Transition to Landing Configuration.	
6.6 PCA Flight Path Angle Step Response (low, mid, cruise altitude).	
6.7 PCA Flight Path Angle Step Response (aft cg).	
6.8 PCA Lateral-Directional Step Responses.	
6.9 PCA Track Angle Step Response (low, mid, cruise altitude).	
6.10 Manual Throttle Approach with Complete Hydraulic Failure.	
6.11 PCA Localizer Only Coupled Approach (no turbulence).	
6.12 PCA Localizer Only Coupled Approach (moderate turbulence).	
6.13 PCA ILS Fully Coupled Approach (aft cg).	
6.14 PCA ILS Fully Coupled Approach (right outboard engine failed).	
6.15 PCA ILS Fully Coupled Approach (out-of-trim yaw moment).	
6.16 PCA Touchdown Footprint.	
6.17 PCA Pilot Ratings.	
6.18 PCA Operational Limitations.	
7.0 CONCLUSIONS	34
APPENDIX A. PCA CONTROL LAW BLOCK DIAGRAM.....	36
APPENDIX B. PCA LONGITUDINAL CONTROL LAWS	37
APPENDIX C. PCA LATERAL-DIRECTIONAL CONTROL LAWS	38
APPENDIX D. PCA ILS COUPLED CONTROL LAWS.....	39
APPENDIX E. PCA ILS AUTOFLARE CONTROL LAWS	41
APPENDIX F. PCA UNUSUAL ATTITUDE CONTROL LAWS	42
APPENDIX G. PCA EPR INITIAL CONDITIONS	44
REFERENCES	45

LIST OF TABLES

	<u>Page</u>
Table 1. B747-400 Aircraft Physical Dimensions	5
Table 2. B747-400 Typical Landing Configuration Open Loop Dynamics	5
Table 3. B747-400 Flight Simulator Description.....	7
Table 4. Light Turbulence Model Amplitude and Bandwidth	7
Table 5. B747 PCA Engine Configurations	10
Table 6. PCA Industry Benefits	10
Table 7. Scope of B747-400 PCA Piloted Simulation Tests	13
Table 8. Pilot Approach and Landing Rating Scale	32
Table 9. Asymmetric epr Required to Balance Rudder Offsets.....	33
Table 10. Asymmetric epr Required to Balance Rudder Offset on Glideslope	33

LIST OF FIGURES

	<u>Page</u>
Figure 1. B747-400 Physical Dimensions.....	4
Figure 2. PCA Concept	9
Figure 3. B747-400 Mode Control Panel.....	11
Figure 4. Sequencing of PCA Modes.....	12
Figure 5. Operational Flight Profile Used as Baseline.....	14
Figure 6. Emergency Flight Profile Used for PCA	14
Figure 7. Simulation Initial Positions for Approach and Landing	15
Figure 8. PCA Unusual Attitude Recovery at Cruise Altitude	17
Figure 9. PCA Transition to Landing Configuration	18
Figure 10. Flight Path Angle Step Response (cruise, medium, low altitude)	19
Figure 11. Flight Path Angle Step Response (22% vs. 40% cg).....	20
Figure 12. PCA Lateral-Directional Responses	21
Figure 13. PCA Track Angle Step Response (cruise, medium, low altitude).....	22
Figure 14. Manual Throttle Approach with Complete Hydraulic Failure	25
Figure 15. PCA Localizer Only Coupled Approach (no turbulence)	26
Figure 16. PCA Localizer Only Coupled Approach (moderate turbulence).....	27
Figure 17. PCA ILS Coupled Approach (aft center of gravity).....	28
Figure 18. PCA ILS Coupled Approach (right outboard engine failure).....	29
Figure 19. PCA ILS Coupled Approach (out-or-trim yaw moment).....	30
Figure 20. PCA Touchdown Footprint	31
Figure 21. PCA Pilot Ratings.....	32
Figure 22. PCA Operational Limitations	34
Figure 23. PCA Control Law Block Diagram	36
Figure 24. PCA Initial epr Trimmings	44

PILOTED SIMULATION TESTS OF PROPULSION CONTROL AS BACKUP TO LOSS OF PRIMARY FLIGHT CONTROLS FOR A B747-400 JET TRANSPORT

John Bull
CAELUM Research Corporation
Mountain View, CA

Robert Mah, Gordon Hardy, Barry Sullivan
Ames Research Center
Moffett Field, CA 94035-1000

Jerry Jones, Diane Williams, Paul Soukup
Man Tech/NSI Technology Services Corporation
Sunnyvale, CA

Jose Winters
Foothill-DeAnza College Intern
Los Altos Hills, CA 94022

SUMMARY

Partial failures of aircraft primary flight control systems and structural damages to aircraft during flight have led to catastrophic accidents with subsequent loss of lives (e.g. DC-10, B-747, C-5, B-52, and others). Following the DC-10 accident at Sioux City, Iowa in 1989, the National Transportation Safety Board recommended "Encourage research and development of backup flight control systems for newly certified wide-body airplanes that utilize an alternate source of motive power separate from that source used for the conventional control system."

NASA Dryden Flight Research Center (DFRC) investigated the use of engine thrust for emergency flight control and has presented results of simulation and flight studies of several airplanes, including the B-720, Lear 24, F-15, B-727, C-402, and B-747. NASA DFRC successfully demonstrated in 1993 in a series of 36 F-15 flights, including actual PCA landings, that throttle control of engines alone can be used to augment or replace the aircraft primary flight control system to safely land the aircraft. NASA DFRC conducted very successful flight tests in August–December 1995 of the MD-11 jet transport utilizing engine thrust for backup flight control. A series of three piloted simulation tests were conducted at NASA Ames Research Center from 1992-1995 to investigate propulsion control for safely landing a medium size jet transport which has experienced a total primary flight control failure.

This report describes the concept of a propulsion controlled aircraft (PCA), discusses pilot controls, displays, and procedures; and presents the results of a PCA piloted simulation test and evaluation of the B747-400 airplane conducted at NASA Ames Research Center in December, 1996. The purpose of the tests was to develop and evaluate propulsion control throughout the full flight envelope of the B747-400 including worse case scenarios of engine failures and out of trim moments.

Pilot ratings of PCA performance ranged from adequate to satisfactory. PCA performed well in unusual attitude recoveries at 35,000 ft altitude, performed well in fully coupled ILS approaches, performed well in single engine failures, and performed well at aft cg. PCA performance was primarily limited by out-of-trim moments.

1.0 INTRODUCTION

Partial failures of aircraft flight control systems and structural damages to aircraft during flight have led to catastrophic accidents with subsequent loss of lives (ref. 1) (e.g., DC-10, B-747, C-5, B-52 and others). These accidents can be prevented if sufficient alternate control authority remains which can be used by the pilot to execute an emergency safe landing.

Following the DC-10 accident at Sioux City, Iowa in 1989, the National Transportation Safety Board recommended "Encourage research and development of backup flight control systems for newly certified wide-body airplanes that utilize an alternate source of motive power separate from that source used for the conventional control system" (ref. 2). The problem in the general case is that currently there is no satisfactory method onboard the aircraft for effectively controlling the aircraft with a disabled primary flight control system. In addition, manual throttle control of engines is extremely difficult because of pilot unfamiliarity with dynamic response of the aircraft in this mode.

NASA Dryden Flight Research Center (DFRC) investigated the use of engine thrust for emergency flight control and has presented results of simulation and flight studies of several airplanes, including the B-720, Lear 24, F-15, B-727, C-402, and B-747 (refs. 3 and 4). Using an F-15 aircraft, NASA DFRC successfully demonstrated in 1993 in a series of 36 flights (ref. 5), including actual PCA landings, that throttle control of engines alone can be used to augment or replace the aircraft primary flight control system to safely land the aircraft (ref. 6). The NASA DFRC concept used specifically developed control laws in the aircraft flight control computer system to drive the engines in response to pilot input commands for bank angle and flight path angle. As a follow-on to the F-15 PCA flight tests, NASA DFRC and MDA developed and implemented PCA control laws for the MD-11 jet transport. Flight tests of MD-11 PCA flight control were very successfully conducted in 1995 (refs. 7 and 8).

NASA Ames Research Center (ARC) conducted three PCA piloted simulation tests for a mid-size jet transport in support of and complementary to the PCA tests conducted by NASA DFRC (ref. 9). NASA ARC conducted a PCA piloted simulation test and evaluation of the B747-400 airplane in December 1996.

This report describes the concept of a propulsion controlled aircraft (PCA), discusses pilot controls, displays, and procedures; and presents the results of a piloted test and evaluation in a B747-400 piloted simulation.

1.1 Purpose of B747-400 Piloted Simulation Tests.

A piloted simulation test and evaluation was conducted at NASA Ames Research Center to investigate propulsion control for safely landing a B747-400 jet transport which has experienced a total primary flight control failure. The test was completed in December 1996 on the Ames B747 Flight Simulator (ref. 10) for the purpose of investigating expanded PCA operational capabilities throughout the full flight envelope and in worst case scenarios including engine failures and out of trim moments.

2.0 AIRCRAFT AND FLIGHT SIMULATOR DESCRIPTION

2.1 B747-400 Aircraft Physical Description.

The B747-400 aircraft physical dimensions are shown in figure 1 and listed in table 1. The B747-400 aircraft has a fuselage length of 225 feet, a wing span of 213 feet, a maximum takeoff weight of 870,000 lb, and a nominal landing weight of 540,000 lb.

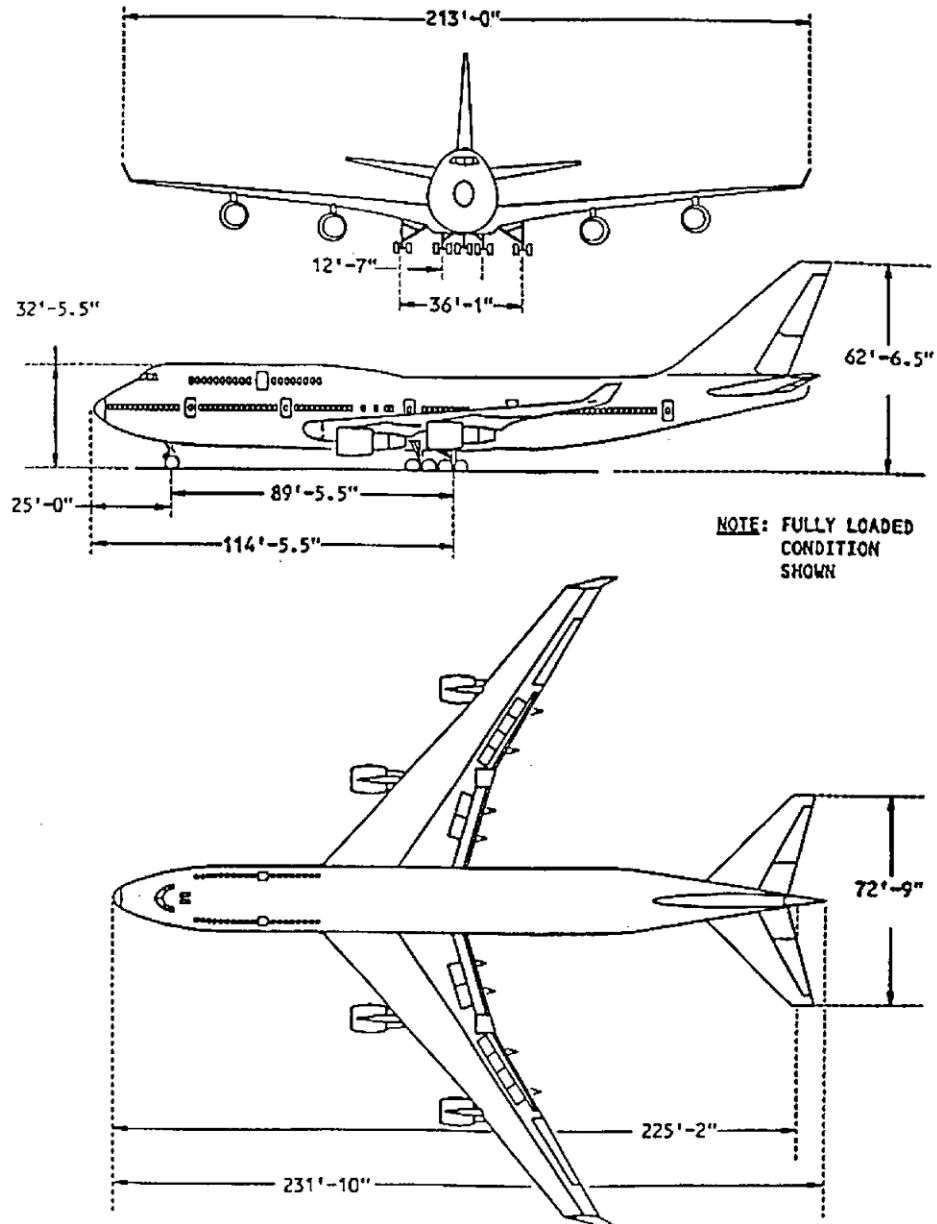

Figure 1. B747-400 Physical Dimensions.

Table 1. B747-400 aircraft physical dimensions.

GROSS WEIGHT.

- Maximum Takeoff: 870,000 lb.
- Maximum Landing: 630,000 lb.
- Typical Landing: 540,000 lb.

DIMENSIONS.

- Wing Area: 5500 sq. ft.
- Wing Span: 196 ft. (winglets extend to 213 ft)
- Mean Chord: 27.3 ft.
- Nominal Landing CG: 22 %

ENGINES.

- Max Thrust: 56,000 lb.
- Inboard eng y dist to cg: 39.6 ft.
- Inboard eng z dist to cg: 7.6 ft. (in flight)
- Outboard eng y dist to cg: 69.4 ft.
- Outboard eng z dist to cg: 2.5 ft. (in flight)

2.2 B747-400 Aircraft Flight and Engine Dynamics.

The B747-400 aircraft flight dynamics characteristics are typical of a large four engine jet transport. The frequency and damping (simulation data) of the open loop dynamics for a typical PCA approach configuration are listed in table 2.

Table 2. Typical landing configuration open loop dynamics.

TRIM CONDITION.

- weight = 540,000 lb., altitude = 2,000 ft.,
- 20 flaps, landing gear down, cg = 22%

LONGITUDINAL SHORT PERIOD.

- freq. = 1.60 rad/sec. period = 3.9 sec. damping ratio = 0.60

PHUGOID.

- freq. = 0.105 rad/sec. period = 60 sec. damping ratio = 0.150

DUTCH ROLL.

- freq. = 1.04 rad/sec. period = 6.0 sec. damping ratio = 0.23

SPIRAL CONVERGENCE.

- tau = 31.0 sec. time to double amplitude = 22.0 sec.

ROLL RATE DAMPING.

- tau = 0.33 sec.

The epr response time constant (63% of commanded value) from simulation data to a step input of the B747-400 PW-5600 engines is about 1.1 seconds at low altitude and approach airspeed; and about 2.5 seconds at 35,000 ft altitude.

2.3 B747-400 Normal Landing Configuration and Airspeed.

The B747-400 aircraft nominal landing weight range is from 520,000 lb to 560,000 lb and with either 25 or 30 degree flaps. Reference landing airspeed at 540,000 lb and 30 degree flaps is 142 kt.

2.4 B747-400 Cockpit.

The B747-400 cockpit has CRTs for pilot and copilot primary flight displays and map displays. A typical Boeing mode control panel (MCP) is located above the instrument panel for selection of various autopilot modes. In the autothrottle mode, the throttles move in unison to a single throttle servo. However, there is a limited amount (approximately 5%) of individual trim capability for each engine.

2.5 B747-400 Emergency Extension of Flaps and Landing Gear.

The B747-400 trailing edge flaps are normally lowered by hydraulics while leading edge flaps are lowered pneumatically. In the event of complete hydraulic failure, the flaps can be lowered by a secondary alternate electrical backup system.

The B747-400 landing gear is normally lowered by hydraulics. In the event of complete hydraulic failure, the landing gear can be unlocked electrically, and extended by gravity.

2.6 B747-400 Flight Simulator Description.

The piloted simulations were conducted in the B747-400 Flight Simulator at NASA Ames Research Center (ref. 10). The B747-400 flight simulator is a very high fidelity motion base simulator with a 180 degree field of view "wrap around" visual scene (table 3). The cab layout of pilot controls and displays is an exact replica of United Airlines aircraft (Tail #RT612) cockpit. All systems within the simulator function and operate just as those in the actual airplane. The simulator has unique research capabilities beyond the normal training simulator used for airline pilots.

The B747-400 Flight Simulator at NASA Ames is certified once each six months by the FAA as a "Level D" simulator, the highest level of fidelity to which a simulator is certified.

Table 3. B747-400 flight simulator description.

COCKPIT.

- Duplicate of B747-400 controls and displays.

MODELS

- High fidelity aerodynamics, controls, and engines.
- High fidelity environmental conditions.
- High fidelity sound.

OUT THE WINDOW SCENE.

- High fidelity 180 degree "wrap around" visual.

CAB MOTION.

- High fidelity cab motion.

DATA COLLECTION.

- Realtime cockpit data time histories.
- Realtime touchdown snapshots.
- Comprehensive set of flight data for post-flight analysis.
- Video and audio tape.

2.7 Turbulence Model.

The turbulence mathematical models provide turbulence rms values and bandwidths (table 4) which are representative of values specified in Military Specifications Mil-Spec 8785 D of April 1989. Both translational turbulence along each stability axis and rotational turbulence about each stability axis is generated.

Table 4. Light turbulence model amplitude and bandwidth.

Altitude=2,000 ft		Airspeed=225 kts.
TRANSLATIONAL GUSTS.		
	rms value (kts)	bandwidth (rad/sec)
u axis:	1.5	1.0
v axis:	1.5	1.0
w axis:	<u>1.3</u>	1.0
Total:	2.6	
ROTATIONAL GUSTS.		
	rms value (deg/sec)	bandwidth (rad/sec)
p gusts:	0.27	1.3
q gusts:	0.25	1.3
r gusts:	<u>0.26</u>	1.3
Total:	0.46	

Note: Gust amplitude and bandwidth depend on airspeed and altitude.

3.0 PCA CONCEPT

3.1 PCA Concept.

PCA control laws provide aircraft longitudinal flight control through parallel engine thrust fore and aft to control climb or descent flight path. PCA lateral-directional flight control is provided through asymmetric thrust to control bank angle. In the PCA mode, commanded engine pressure ratio (epr) is sent directly to each engine control individually, and the throttles do not move. PCA concept implementation is depicted in figure 2. PCA control law diagrams are shown in appendix A, and PCA control law equations are shown in appendices B through F.

3.2 PCA Control Law Development.

An off-line development station was established that utilized aircraft mathematical model software which was an exact duplicate of the B747-400 flight simulator mathematical model software. PCA control law structure and gains were developed using the off-line B747-400 development station. Gains were set for various trim points primarily by analyzing transient response to step inputs of flight path angle command and bank angle command. Gains were tuned until speed of response was satisfactory, response was asymptotic, and steady state values reflected step commands. Software modules from the off-line development station were transported onto the B747-400 Flight Simulator and produced exact duplicate dynamic responses of the full moving base cab simulator.

3.3 PCA Control Law Structure.

The PCA control law initial epr trim point is determined from an epr trimmap rather than simply using the epr values at PCA engage. This initialization method is used because the pilot, in an attempt to fly the aircraft on manual throttles, could possibly have moved the engines far from a desired straight and level trim condition prior to PCA engage. Appendix G shows the epr trimmap for straight and level flight. The PCA control law structure utilizes simple linear feedback control laws which command epr for each engine about the initial epr trim point. Longitudinal control law feedback includes flight path angle and flight path angle rate (derived from vertical speed and ground speed) and pitch rate. Lateral-directional control law feedback includes ground track angle, bank angle, roll rate, and yaw rate.

3.4 PCA Engine Control Implementation.

The conventional B747 autothrottle servos move all throttles simultaneously as one. However, for PCA implementation it is necessary to control all four engines independently. Therefore, it was necessary to develop additional engine control software to provide the capability of commanding each engine pressure ratio independently.

However, there is a limited capability ($\pm 5\%$) for each engine to retrim itself. This capability would provide the possibility of implementing PCA with the current autothrottle controls, thereby minimizing implementation costs.

PCA CONCEPT

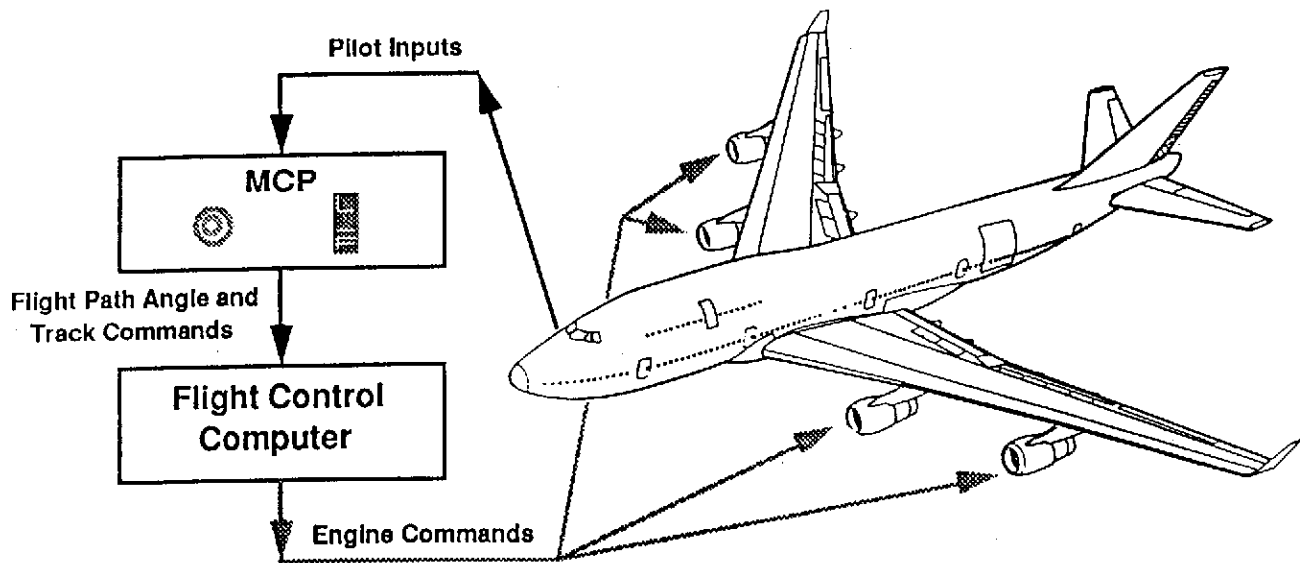

POSSIBLE B747-400 PCA ENGINE CONFIGURATIONS

Pitch Control

1. All four engines.
2. Inboard engines (outboard engines at idle).
3. Outboard engines (inboard engines at idle).

Roll Control

1. Asymmetric Left two engines/Right two engines.
2. Asymmetric Inboard engines (outboard at idle).
3. Asymmetric Outboard engines (inboard at idle).

9 Possible Combinations of Pitch and Roll Control

Figure 2. PCA concept and possible engine configurations.

3.5 PCA Engine Configurations.

Five of the nine possible PCA engine configurations for pitch and roll control were investigated during the control law development phase. The five configurations investigated are shown in table 5. The primary PCA engine configuration mode was use of all four engines for pitch control and use of both engines on each wing to provide the asymmetric thrust for roll control. Engine out modes are provided by using only inboard engines for both pitch and roll control or only outboard engines for both pitch and roll control. Four of the nine possible engine configurations were not investigated as they would not appear to offer any advantages.

Table 5. B747 PCA Engine Configurations.

5 of 9 POSSIBLE CONFIGURATIONS WERE INVESTIGATED

	pitch control	roll control
Primary Mode	Configuration 1: All Four Engines	2 left/2 right Engines
Engine Out Modes	Configuration 2: Outboard Engines	Outboard Engines
	Configuration 3: Inboard Engines	Inboard Engines
	Configuration 4: All four Engines	Inboard Engines
	Configuration 5: All four Engines	Outboard Engines

CONFIGURATIONS NOT INVESTIGATED

	pitch control	roll control
Configuration 6:	Outboard Engines	Inboard Engines
Configuration 7:	Outboard Engines	2 left/2 right Engines
Configuration 8:	Inboard Engines	Outboard Engines
Configuration 9:	Inboard Engines	2 left/2 right Engines

3.6 PCA Industry Benefits.

The results of a study (ref. 11) to identify PCA industry benefits are shown in table 6. The study was conducted for a the 30 year life cycle of a fleet of 300 aircraft in the category of 400,000 lb. takeoff gross weight. It was assumed that PCA allows mechanical backup flight controls to be eliminated, PCA training costs are equal to mechanical backup costs, PCA saves one aircraft over a 30 year period, and insurance is 5% less for a PCA-equipped aircraft.

Table 6. PCA industry benefits.

SAFETY		
• Eliminate Catastrophic Accidents due to Loss Of Primary Flight Control		
ECONOMIC		
• Weight Reduction Saves:	\$295M	
• Insurance Savings:	42M	
• Saved Airplane:	110M	
• PCA Certifications Costs:	<u>-10M</u>	
TOTAL LIFE CYCLE SAVINGS:	\$436M	(1993 dollars)

4.0 PCA Operational Modes.

The B747-400 Mode Control Panel (MCP) is located in the cockpit directly above the pilot's instrument panel. The MCP is used by the pilot for normal autopilot operations and to engage the various autopilot modes that are available, such as airspeed hold, altitude hold, and heading select. The MCP layout is shown in figure 3.

The "left flight computer" button on the B747-400 MCP was used for PCA engage. The pilot then controls the flight path of the aircraft by using the "vertical speed knob" and the ground track by using the "heading select knob." The PCA pilot procedures are basically the same as for normal autopilot operations in the heading select mode and the vertical speed mode.

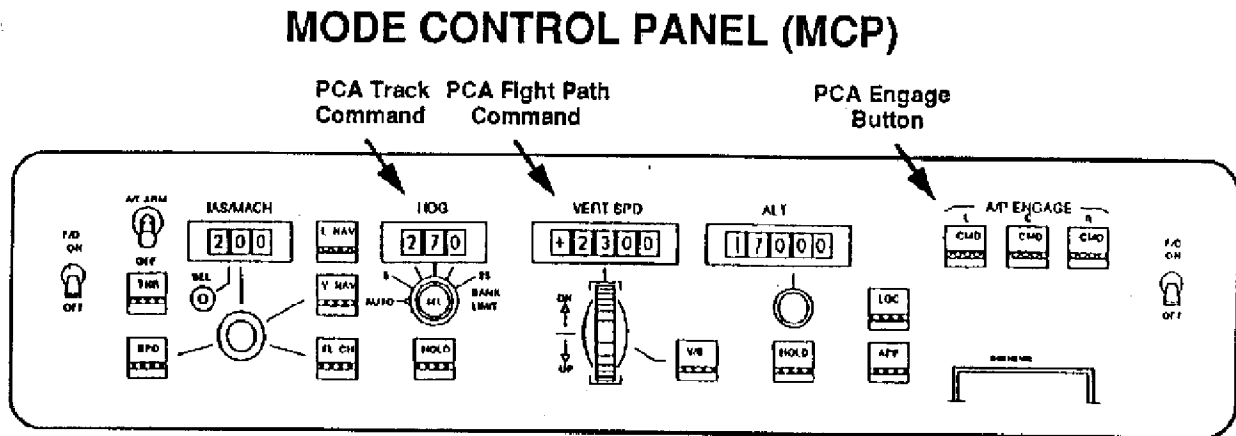

Figure 3. B747-400 Mode Control Panel.

The pilot may also select "localizer only" or "fully coupled" approach modes for performing an approach and landing. In the localizer only mode, PCA automatically tracks the localizer while the pilot controls glidepath angle with the vertical speed knob. In the fully coupled mode, PCA automatically tracks localizer and glideslope, and also initiates autoflare at 150 ft radar altitude.

The sequence of modes at PCA engage is shown in figure 4. Initially, PCA engages in an "ATT HOLD" mode specifically designed to stabilize the aircraft in a wings level attitude at the desired flight path angle. This mode was particularly useful for recovery from unusual attitudes at engagement. After stabilization is achieved the PCA control laws transition to the "HDG HOLD" mode, and then to the "HDG SEL" mode when the pilot desires a new track command.

PCA MCP MODES

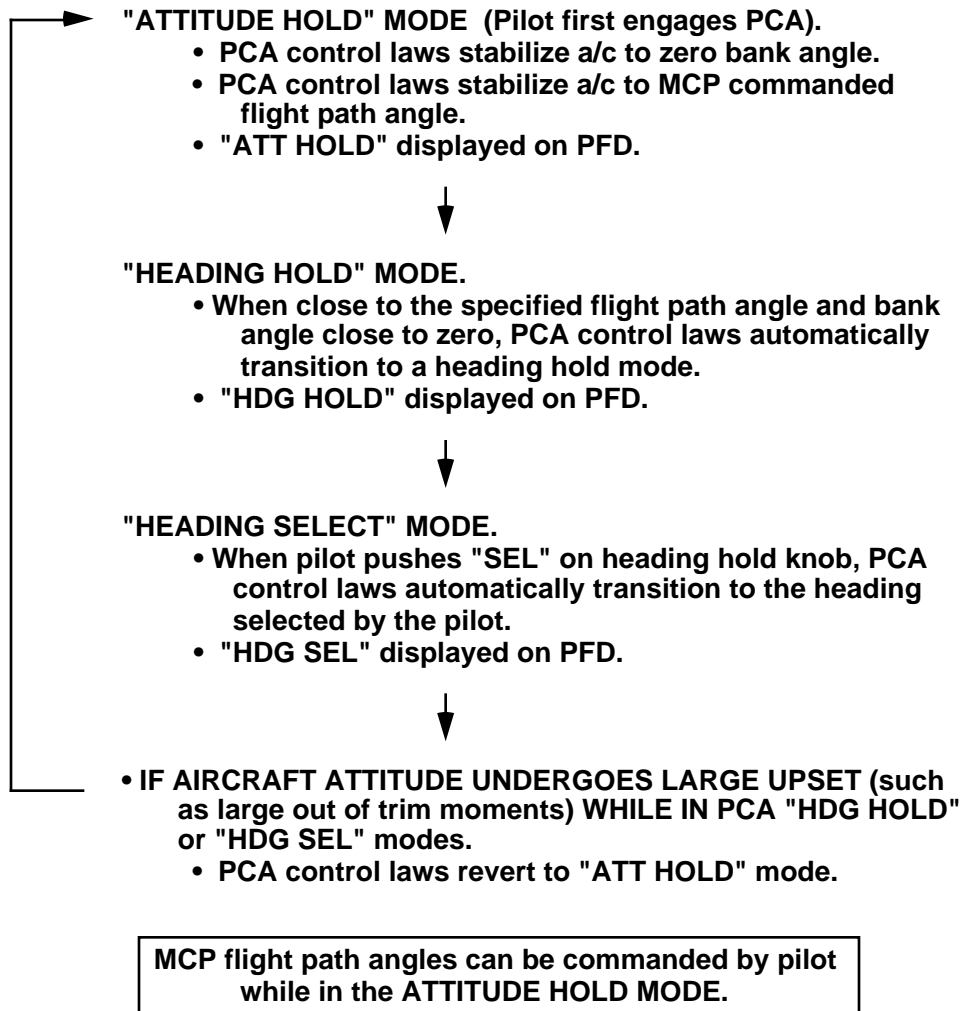

Figure 4. Sequencing of PCA modes.

5.0 TEST DESCRIPTION

5.1 Test Objectives.

Objectives of the simulation test were:

- Develop PCA control laws for the B747-400 full flight operational envelope for loss of primary flight controls including worst case scenarios of engine failure and out of trim moments.
- Test and evaluate PCA performance in piloted simulations.

5.2 Test Scope.

A total of six pilots participated in the tests and conducted approximately 75 simulated approaches and landings to San Francisco runway 28 right. PCA performance was evaluated also at cruise and medium altitudes. Scope of the test is shown in table 7.

Table 7. Scope of the B747-400 PCA piloted simulation tests.

PILOTS

- 3 NASA, 1 Boeing, 1 AirForce, 1 Airline.

EMERGENCY SCENARIOS

- Mechanically jammed controls.
- Complete hydraulic failure.
- Single engine failure.
- Out of trim moments.

ALTITUDES

- Sea level to 35,000 ft altitude (including unusual attitudes).

GROSS WEIGHTS

- 540,000 lb to 620,000 lb.

CENTER OF GRAVITY

- 22% to 40%.

DRAG CONFIGURATIONS

- Clean, 0 flaps & lg down, 20 flaps & lg down.

5.3 Baseline Flight Scenario.

A typical flight from San Francisco to Honolulu was used as the baseline for establishing typical takeoff weights, fuel loads, altitudes, airspeeds, and configurations. The baseline flight profile is shown in figure 5.

5.4 Emergency Flight Scenario.

The worst case emergency for loss of primary flight controls occurs at cruise altitude and with the stabilator is frozen at a cruise airspeed trim setting. This is the worst case because it will end with very high approach airspeeds of over 200 kt. The emergency flight profile is shown in figure 6.

B747 OPERATIONAL SCENARIO USED AS BASIS FOR PCA INVESTIGATIONS

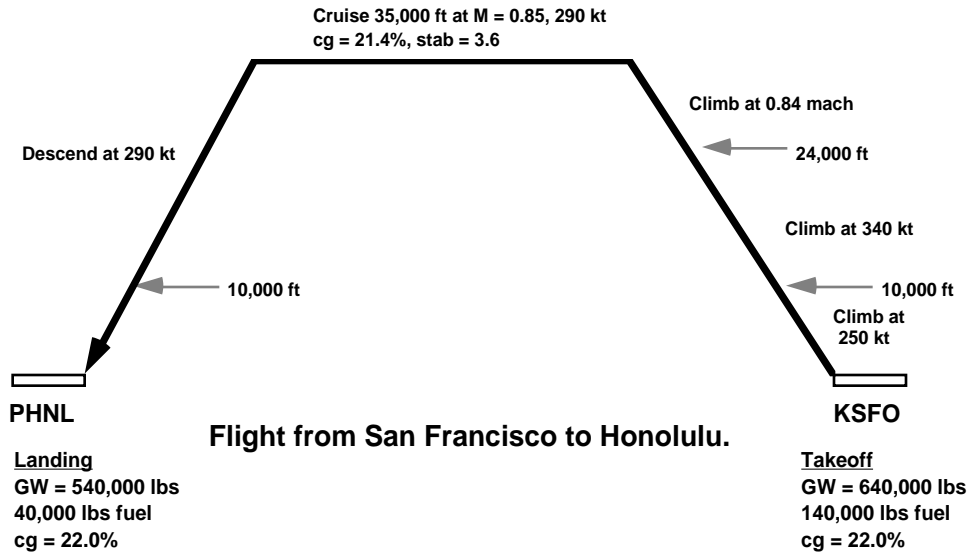

Figure 5. Operational flight profile used as baseline for PCA piloted simulation.

B747 PCA EMERGENCY SCENARIO

An unforeseen explosive event (engine explosion, bulkhead blowout, bomb, etc.) occurs shortly after level off at cruise altitude.

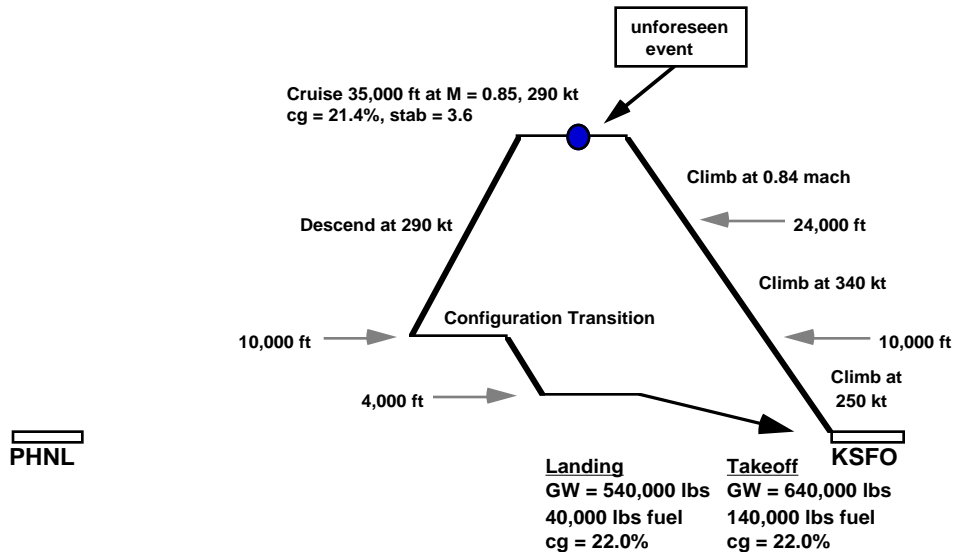

Figure 6. Emergency flight profile use for PCA piloted simulation.

5.5 Approach and Landing Scenarios.

Approaches were conducted under daylight conditions and nominally in light turbulence with a 20 kt. mean wind from 30 degrees off the left of the aircraft nose. Approaches were conducted with complete loss of primary controls simulated as a result of (1) mechanically jammed controls, or (2) complete hydraulic failure. In addition, single engine failures and out-of-trim moments were superimposed on the emergency scenario of loss of primary flight controls. Approaches were begun at 2000 feet altitude, offset to the left of the runway, and on a heading parallel to the runway requiring an "S-turn" to the right for runway line up. Pilots could conduct the approach in either (1) manual throttles-only control, (2) PCA MCP heading and vertical speed knobs, (3) PCA localizer-only coupled, or (4) PCA ILS fully coupled. The initial approach conditions are shown in figure 7. Evaluation criteria included pilot comments, Cooper-Harper ratings, and touchdown performance.

SIMULATION INITIAL POSITIONS FOR APPROACH AND LANDING

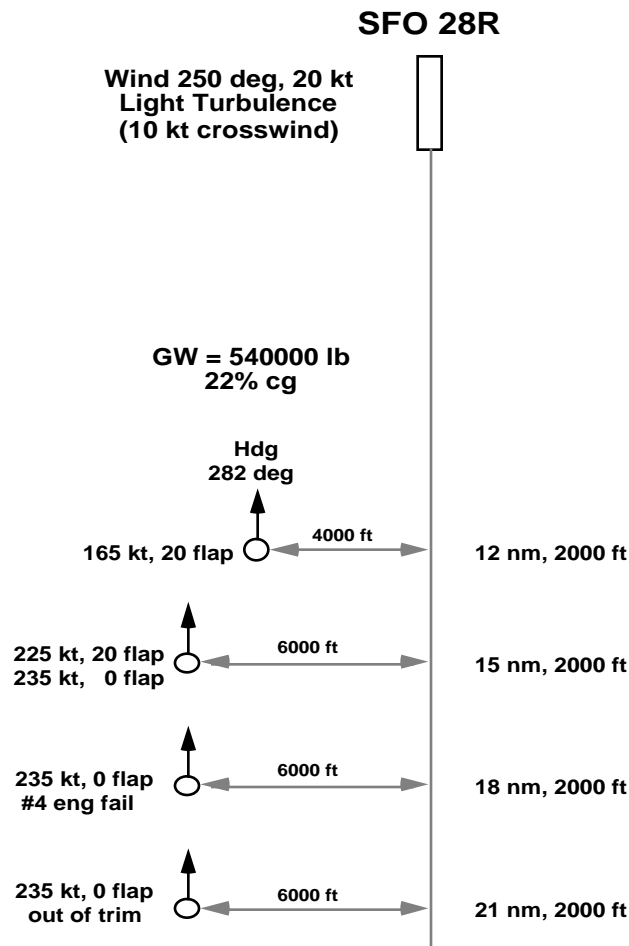

Figure 7. Initial approach conditions for landings at San Francisco runway 28R.

6.0 RESULTS AND DISCUSSION

6.1 Effect of Control Surface Float.

Control surface float during a complete hydraulic failure has a significant effect on aircraft dynamics that needs to be taken into consideration for the best landing configuration. In the clean configuration and with control surfaces floating due to hydraulic failure, the ailerons typically float upward 10-12 deg resulting in a trim airspeed decrease of about 20 kt. This was about the same amount of control surface float experienced in NASA Dryden MD11 flight tests.

In the case of mechanically jammed control surfaces and no control surface float, lowering 20 deg flaps decreased trim airspeed about 30 kt as would be expected. Thus, with mechanically jammed controls, the desirable landing configuration was 20 flaps.

However, in the case of a complete hydraulic failure and with control surfaces floating, lowering any leading edge or trailing edge combination of flaps increased trim airspeed up to 50 kt. Thus, with a complete hydraulic failure, the desirable landing configuration was no flaps.

In summary:

1. Mechanically jammed controls, no control surface float: Land with 20 flaps.
2. Complete hydraulic failure, control surfaces floating: Land with 0 flaps.

It should be noted that these results in simulation for trim airspeeds with flaps lowered and control surfaces floating have not been validated in flight tests.

6.2 Landing Site Selection.

PCA approach airspeeds are high (220–240 kt) when conducting approaches with the stabilator frozen at cruise trim settings. With either mechanically jammed controls or complete hydraulic failure, a landing site with sufficiently long runway should be selected that provides for safe landing and rollout at these high landing airspeeds.

Spoilers, engine thrust reversers, and brakes are not operable in the case of a complete hydraulic failure. Thus, with a complete hydraulic failure, the pilot has no way to slow the aircraft on rollout other than simply shutting down one or more engines.

6.3 Tendency to Float (or Bounce) on Landing.

Sink rate is reduced typically about 6 fps when the aircraft enters ground effect (below about 60 ft altitude). Sink rate is increased typically about 6 fps for a 10 kt wind shear below 100 ft altitude. PCA approaches are typically at high airspeeds (220–240 kt). All of these factors (combined with no elevator control) cause the aircraft to be very susceptible to either float or bounce. Once the aircraft has begun to float, all that can be done is to bring throttles to idle, but the aircraft will continue to float until airspeed bleeds off sufficiently to "settle in."

6.4 PCA Unusual Attitude Recovery.

PCA performance in an unusual attitude recovery is shown in figure 8. PCA was initially engaged at about 36,000 ft altitude, about 10 degrees nose up flight path angle, and about 90 degrees roll angle to the left. The roll angle recovered rapidly with large asymmetric thrust, and then the phugoid was damped in about 2 oscillations. Lowest altitude during the recovery was 30,000 ft.

UNUSUAL ATTITUDE RECOVERY

620,000 lb, 22% cg, Mechanically Jammed Controls, Clean Configuration

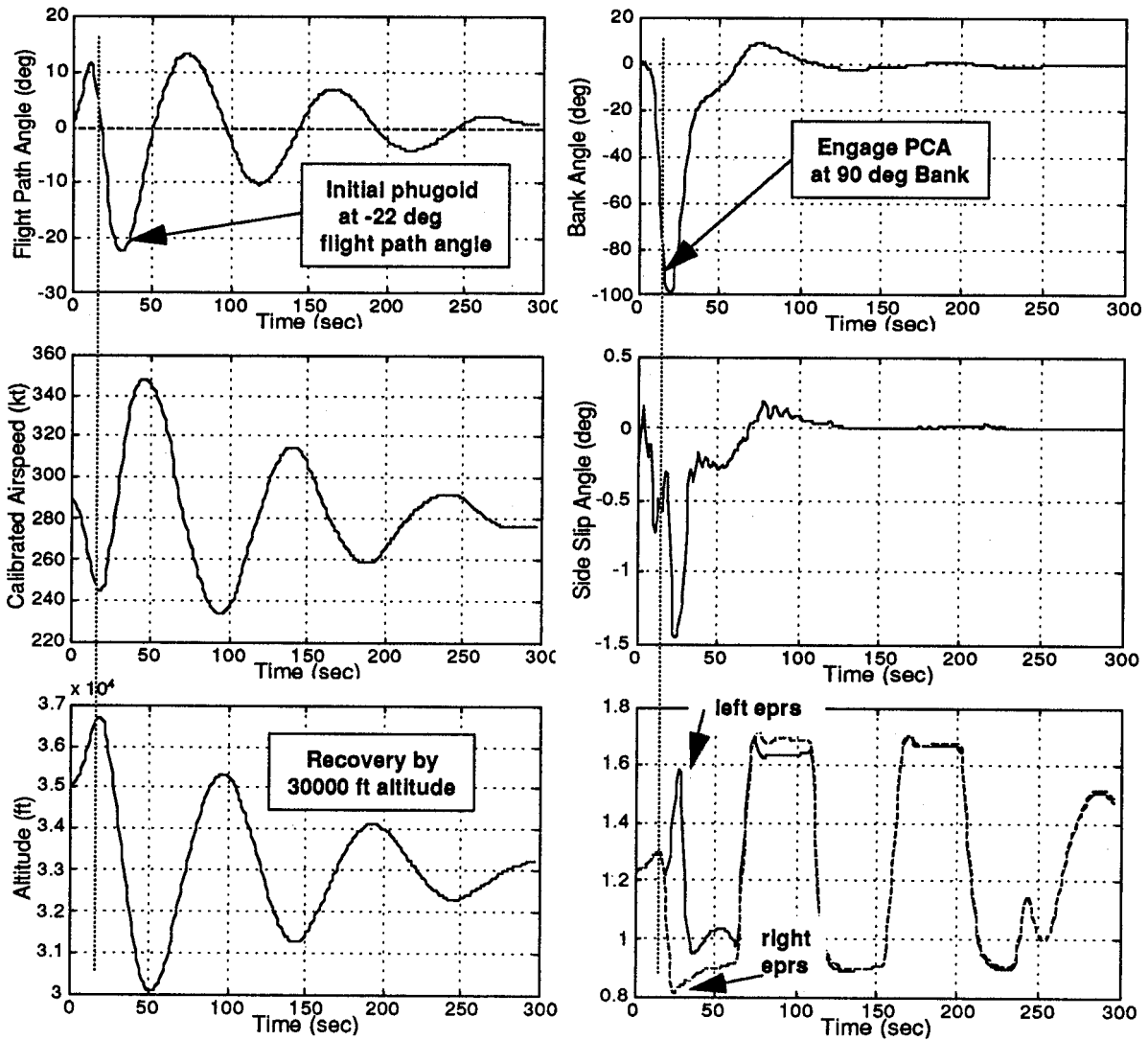

Figure 8. PCA unusual attitude recovery at cruise altitude.

6.5 Transition to Landing Configuration.

PCA performance in a transition to landing configuration at 10,000 ft altitude is shown in figure 9. Trim airspeed decreased 11 kt by dumping 80,000 lb of fuel. Trim airspeed decreased another 20 kt by lowering the landing gear. PCA performed well in minimizing altitude and pitch changes.

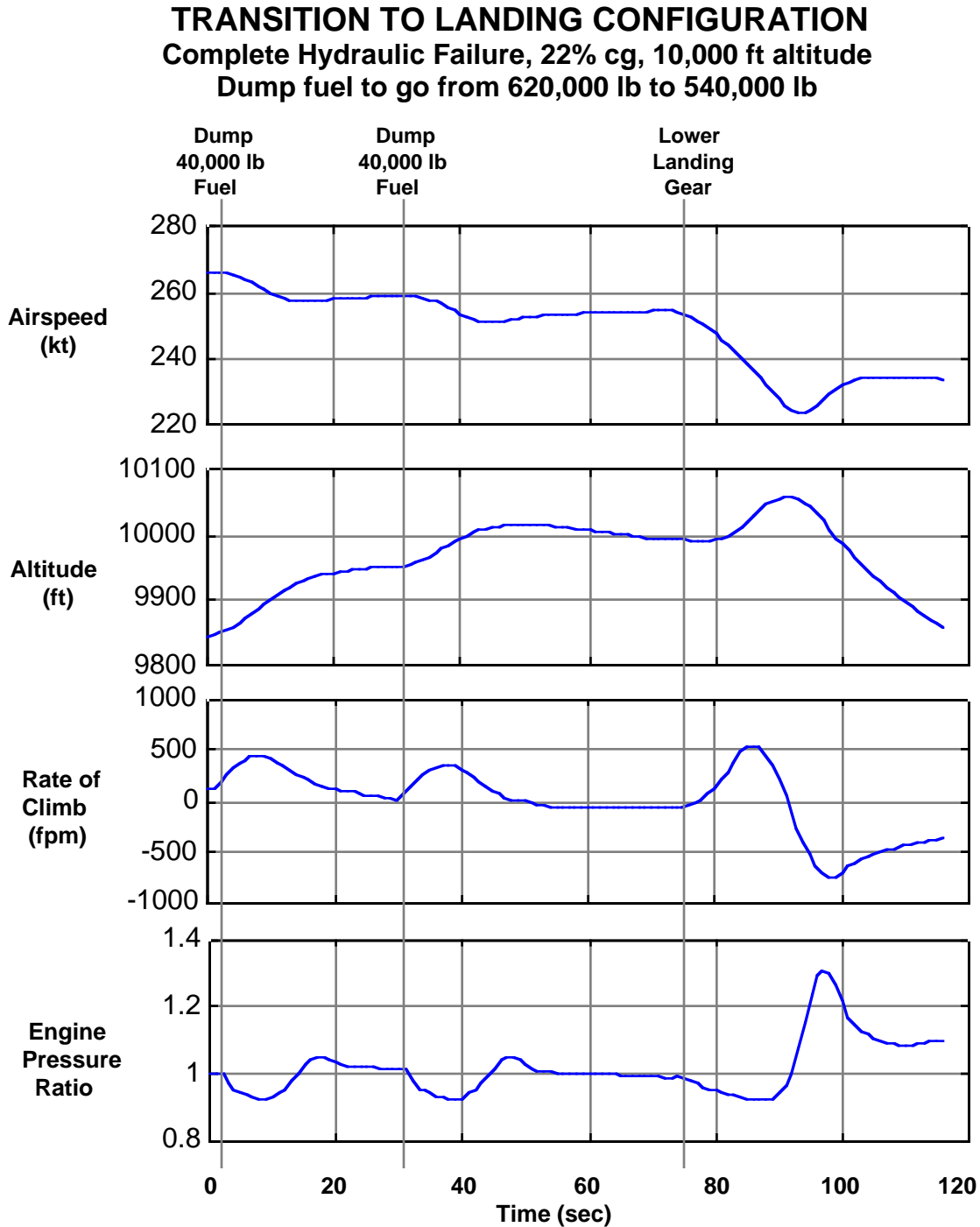

Figure 9. Transition to landing configuration at 10,000 ft altitude.

6.6 PCA Flight Path Angle Step Response (low, medium, cruise altitude).

A comparison of typical PCA longitudinal step responses for cruise, medium, and low altitudes is shown in figure 10. Longitudinal flight path control at low altitudes was precise with good stability and sufficiently fast to provide satisfactory glideslope tracking for landing. Response times (63% of commanded value) decreased with altitude, but were sufficiently fast to satisfy requirements.

FLIGHT PATH ANGLE STEP RESPONSE

Comparison of Cruise, Medium, and Low Altitude Performance Complete Hydraulic Failure, 22% CG

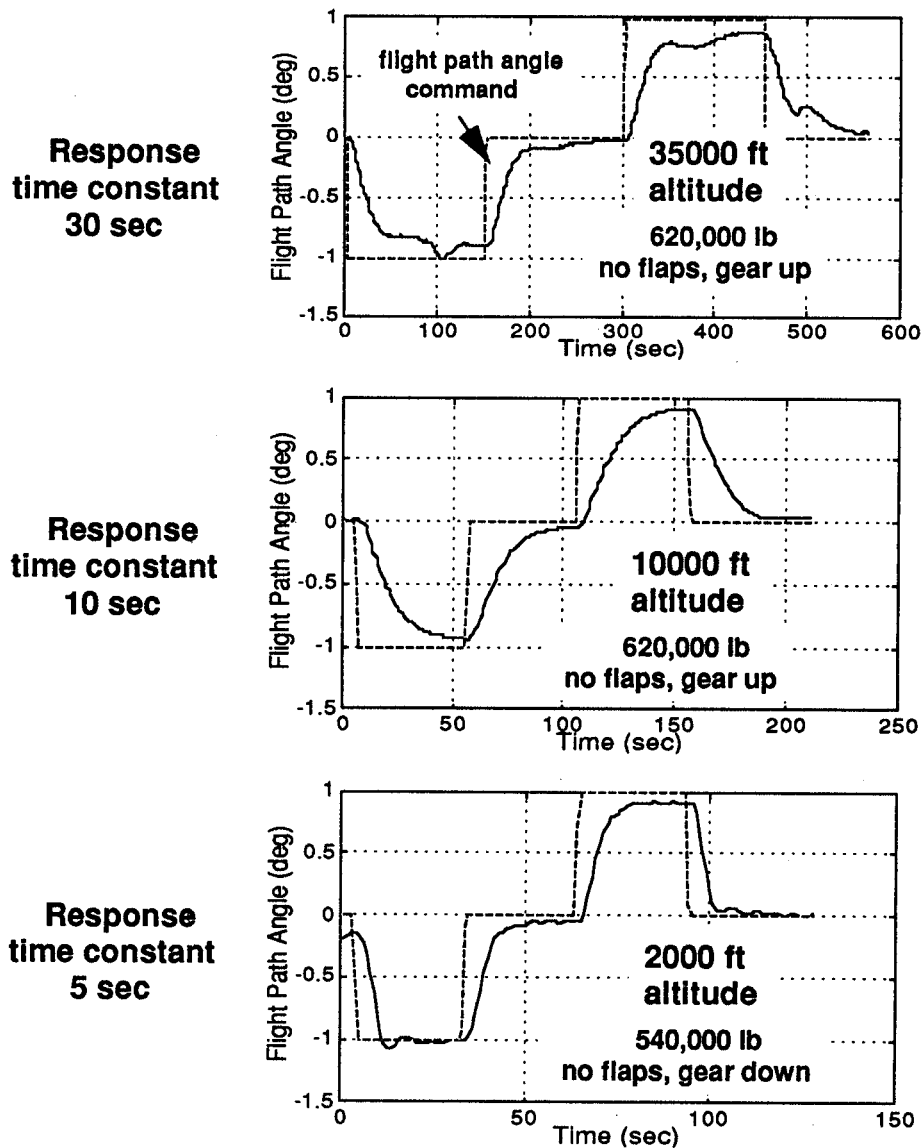

Figure 10. Responses to -1 and +1 degree flight path command at cruise, medium, and low altitudes.

6.7 PCA Flight Path Angle Step Response (aft cg).

A comparison of longitudinal step responses for 22% cg and 40% cg with equal stabilator position is shown in figure 11. The response at 40% cg was as fast and as well damped as the response at 22% cg. However, gain scheduling with cg was necessary to retain the good response at aft cg.

FLIGHT PATH ANGLE STEP RESPONSE

Comparison of 22% and 40% CG Performance 540,000 lb, 20 flaps, lg down, 2000 ft altitude Mechanically Jammed Controls, Hydraulics On

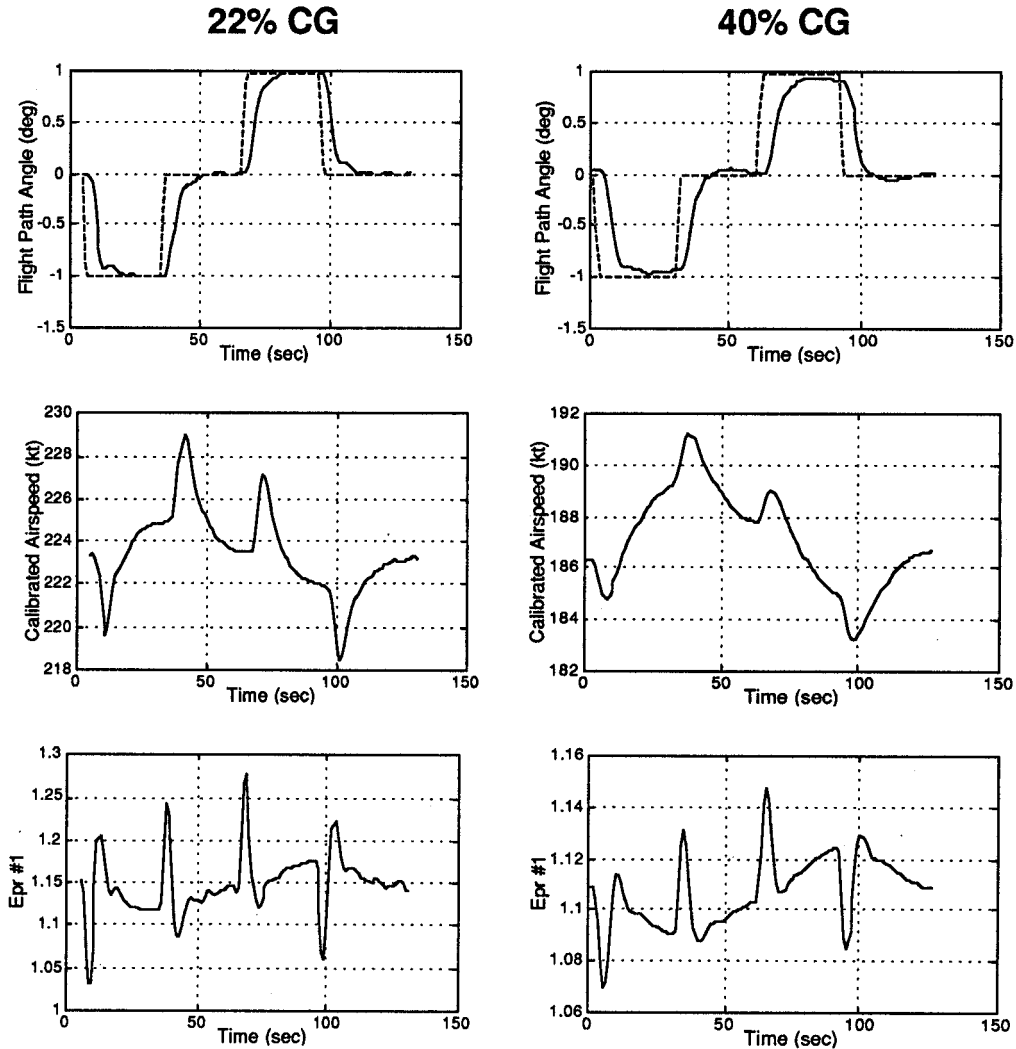

Figure 11. Comparison of longitudinal step response at 22% cg and 40% cg.

6.8 PCA Lateral-Directional Step Responses.

A comparison of typical PCA lateral-directional step responses for track angle commands of 30 degrees and 5 degrees is shown in figure 12. Satisfactory roll rates are achieved with peak sideslip angle of less than 1.5 degrees. Peak asymmetric epr was only 0.08 for 30 deg track change, and only 0.02 for 5 deg track change.

LATERAL-DIRECTIONAL STEP RESPONSES

540,000 lb, 0 flaps, gear down, 22% cg, 2000 ft altitude
Complete Hydraulic Failure

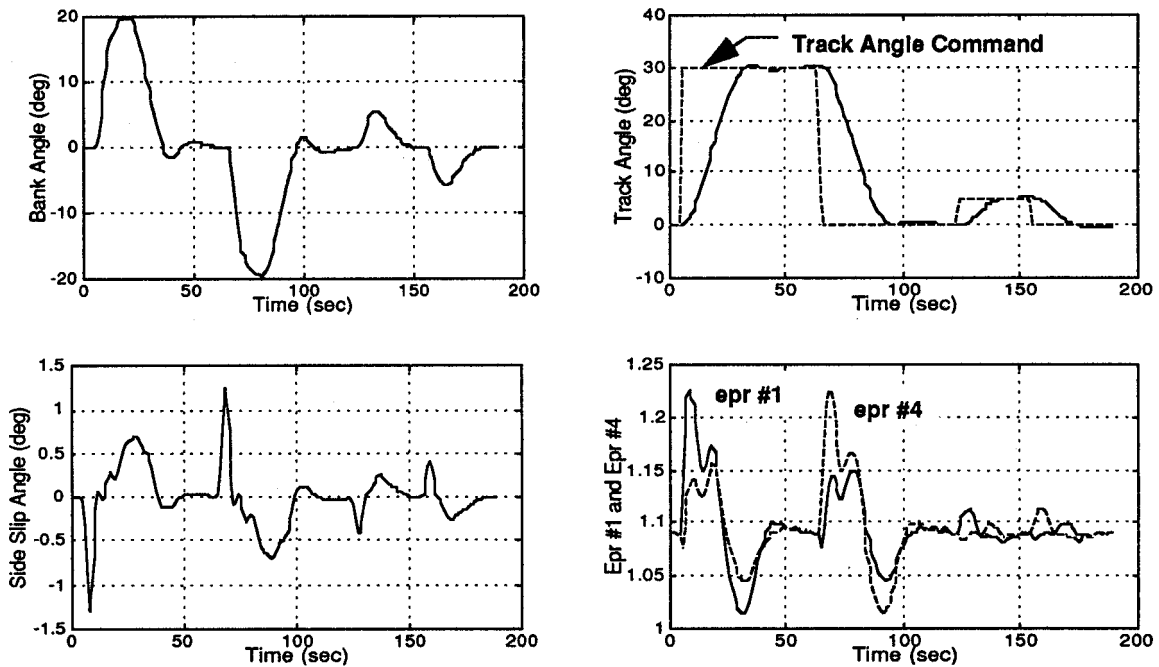

Figure 12. Lateral-Directional step responses at 2,000 ft altitude.

6.9 PCA Track Angle Step Response (low, medium, cruise altitude).

A comparison of typical PCA lateral-directional step responses for cruise, medium, and low altitudes is shown in figure 13. Track angle control at low altitude was precise with good stability, and sufficiently fast to provide satisfactory control for landing. Bank angle response times were slower at altitude, but were sufficiently fast to provide satisfactory track angle performance.

TRACK ANGLE STEP RESPONSE

Comparison of Cruise, Medium, and Low Altitude Performance Complete Hydraulic Failure, 22% CG

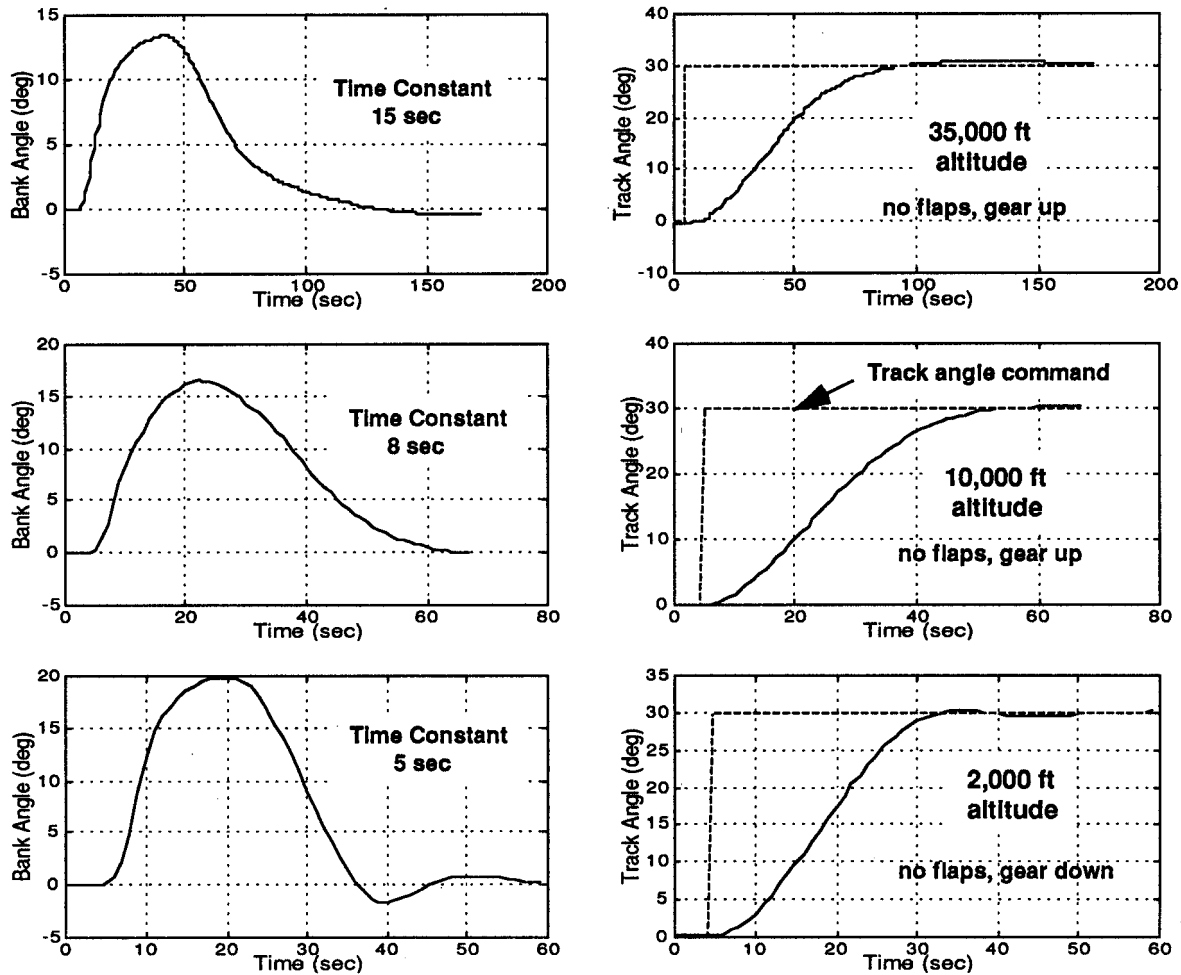

Figure 13. Comparison of lateral-directional step responses at cruise, medium, and low altitude.

6.10 Manual Throttle Approach with Complete Hydraulic Failure.

A typical manual throttle approach following a complete hydraulic failure is shown in figure 14. The approach was conducted in light turbulence with a mean wind from 250 deg at 20 kt (10 kt left crosswind). The aircraft was in a fairly large amplitude phugoid throughout the approach resulting in flying over the airport at about 500 ft altitude. Bank angle varied between -10 to +10 degrees, and the pilot was able to align the aircraft track to runway centerline reasonably well. None of the pilots were able to make a successful manual throttle approach and landing. In each case, the aircraft either landed hard and short of the runway or flew over the airport.

6.11 PCA Localizer Only Coupled Approach (no turbulence).

PCA performance for a localizer only coupled approach is shown in figure 15 for a condition of no turbulence but including a 10 kt crosswind (mean wind from 250 deg at 20 kt). The aircraft was coupled to the localizer for automatic track control, while the pilot commanded flight path angle through the MCP vertical speed knob for controlling glideslope and flare. With mechanically jammed controls, 540,000 lb gross weight, 20 deg flaps, 22% cg, and stabilator at cruise trim setting, the trim airspeed straight and level was 225 kt. Trim airspeed increased about 5 kt on the glideslope.

PCA performed well in providing satisfactorily fast and precise control of flight path angle and track angle. With no turbulence, the aircraft tracking was very smooth and stable, and quickly compensates for crosswind conditions. The aircraft touched down 1,695 ft past the glideslope touchdown point, 16 ft left of centerline, and with a sink rate of 8.2 fps.

6.12 PCA Localizer Only Coupled Approach (moderate turbulence).

PCA performance for a localizer only coupled approach is shown in figure 16 for a condition of moderate turbulence including a 10 kt crosswind (mean wind from 250 deg at 20 kt). The emergency scenario was a complete hydraulic failure. With a complete hydraulic failure at 540,000 lb, 0 deg flaps, 22% cg, and stabilator at cruise trim setting, the trim airspeed straight and level was 235 kt. Trim airspeed increased about 5 kt on the glideslope. The pilot flew the approach about "1-dot-low."

PCA performance was good, considering the condition of moderate turbulence. Peak bank angle excursion on glideslope was about +/-8 deg with an rms of 2 deg. Peak flight path angle excursion on glideslope was about +/-1 deg with an rms of 0.25 deg. The aircraft touched down 2,361 ft past the glideslope touchdown point, 10 ft left of centerline, and with a sink rate of 8.9 fps.

6.13 PCA ILS Fully Coupled Approach (aft cg).

PCA performance for an ILS fully coupled approach with a 40% aft cg is shown in figure 17. Wind conditions were light turbulence including a 10 kt crosswind (mean wind from 250 deg at 20 kt). The emergency scenario was mechanically jammed controls. With mechanically jammed controls at 540,000 lb, 20 deg flaps, 40% cg, and stabilator at cruise trim setting, the trim airspeed straight and level was 185 kt. Trim airspeed increased about 5 kt on the glideslope.

PCA approach and landing performance at 40% was as good as performance at 22% cg (normal cg range at 540,000 lb gross weight is 13% to 31%). The aircraft touched down 2,108 ft past the glideslope touchdown point, 21 ft left of centerline, and with a sink rate of 6.8 fps. In general, PCA ILS fully coupled tracking performance was within 1/4 dot on localizer and glideslope for light turbulence and 10 kt crosswinds.

6.14 PCA ILS Coupled Approach (right outboard engine failure).

PCA performance for an ILS fully coupled approach with the right outboard engine failed is shown in figure 18. Wind conditions were light turbulence including a 10 kt crosswind (mean wind from 250 deg at 20 kt). The emergency scenario was a complete hydraulic failure with superimposed engine failure. In this scenario, PCA identified the engine failure by monitoring engine rpm and fuel flow, and automatically reconfigured control to the PCA "two inboard engine mode," and brought the left outboard engine to idle to reduce yaw moment of the failed engine. With a complete hydraulic failure and the outboard engine failed at 540,000 lb, 0 deg flaps, 22% cg, and stabilator at cruise trim setting, the trim airspeed straight and level was 230 kt. Trim airspeed increased about 5 kt on the glideslope.

PCA approach and landing performance in the "inboard engines mode" was as good as performance with all four engines operating. The good performance is due to the fact that the engines are operating at higher epr than when in the "all four engine mode" which provides faster engine response and also more thrust margin above idle. The aircraft touched down initially slightly hard and bounced slightly, and then settled in 848 ft past the glideslope touchdown point, 32 ft left of centerline, and with a sink rate of 2.1 fps.

6.15 PCA ILS Coupled Approach (out-of-trim yaw moment).

PCA performance for an ILS fully coupled approach with an out-of-trim yaw moment equal to 2 deg of left rudder is shown in figure 19. Wind conditions were light turbulence including a 10 kt crosswind (mean wind from 250 deg at 20 kt). The emergency scenario was a complete hydraulic failure with superimposed out-of-trim yaw moment. In this scenario, PCA automatically retrimmed the aircraft in yaw by compensating the out-of-yaw moment with an asymmetric bias of about 0.03 epr. With a complete hydraulic failure and the 2 deg rudder out-of-trim yaw moment at 540,000 lb, 0 deg flaps, 22% cg, and stabilator at cruise trim setting, the trim airspeed straight and level was 235 kt. Trim airspeed increased about 5 kt on the glideslope.

PCA approach and landing performance was adequate with the 2 deg out-of-trim yaw moment. However, PCA could not have handled much more out-of-trim yaw moment when on the glideslope because the right side engines were operating close to idle. The aircraft touched down 96 ft short of the glideslope touchdown point, 5 ft left of centerline, and with a sink rate of 13.3 fps. After touchdown and with engines at idle, the aircraft veered off to the left on rollout due to the 2 deg of left rudder.

MANUAL THROTTLE APPROACH

Complete Hydraulic Failure, 540,000 lb, 0 flaps, 22% cg

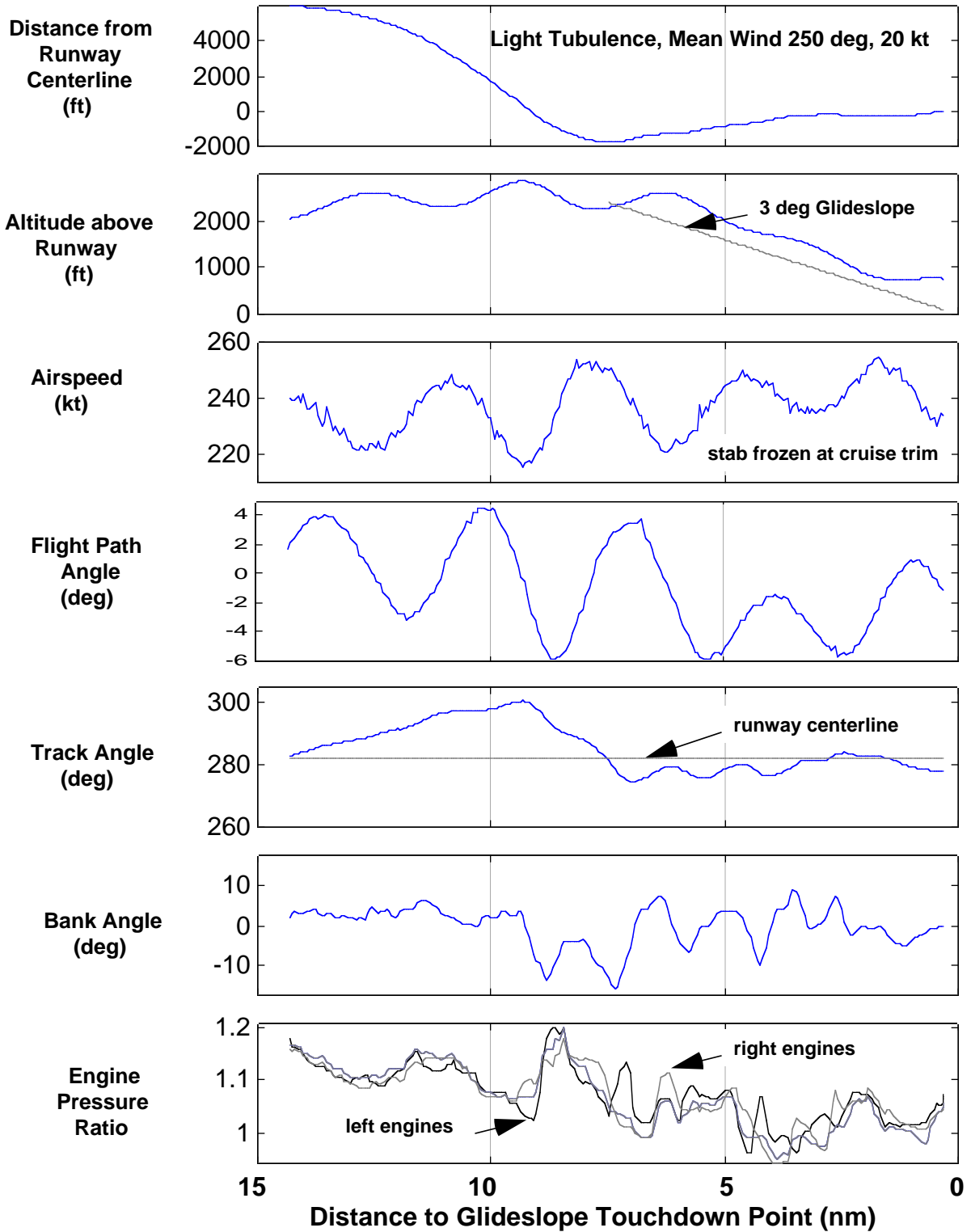

Figure 14. Manual throttle approach with complete hydraulic failure.

PCA LOCALIZER ONLY COUPLED APPROACH

Mechanically Jammed Controls, 540,000 lb, 20 flaps, 22% cg

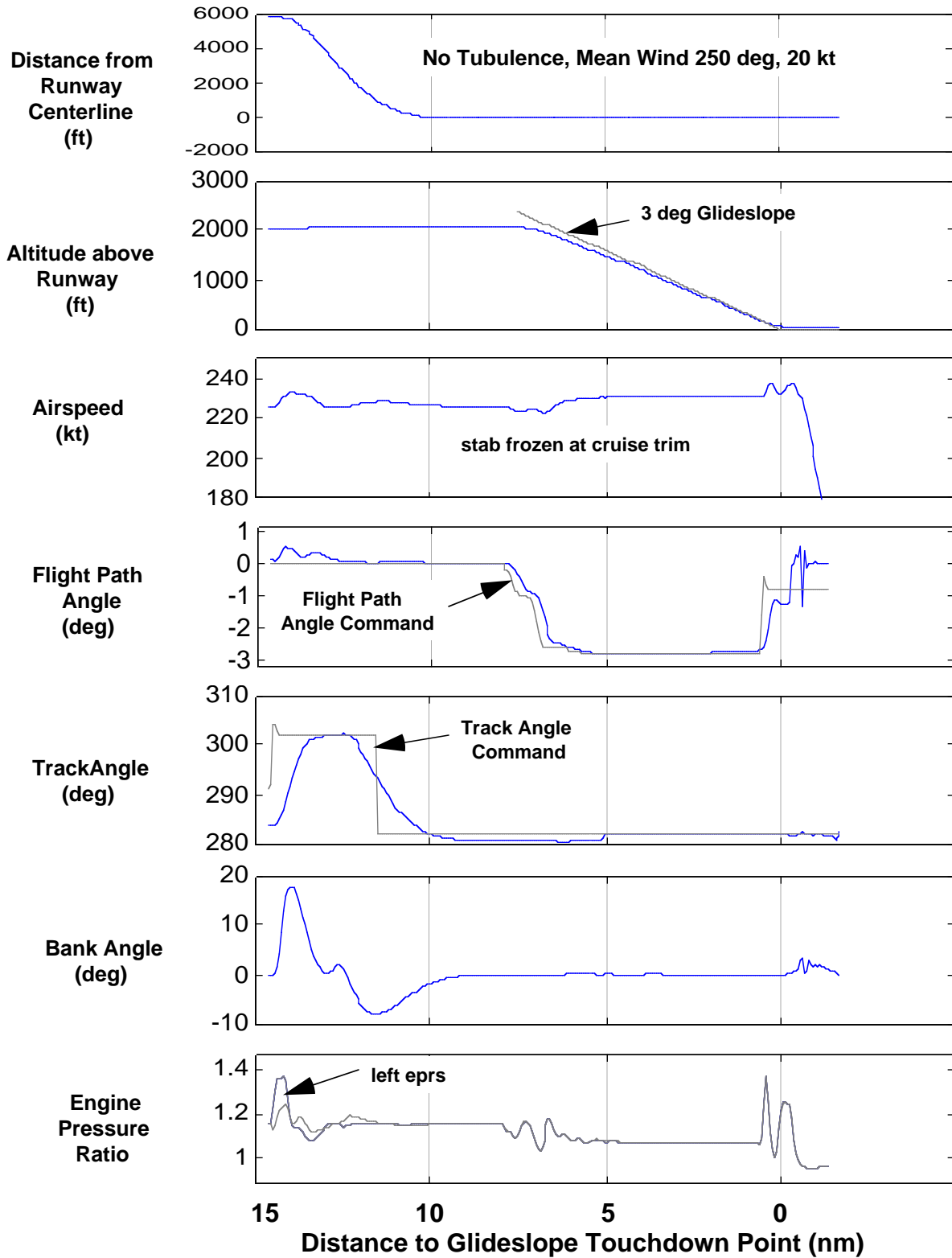

Figure 15. PCA localizer only coupled approach with no turbulence.

PCA LOCALIZER ONLY COUPLED APPROACH (moderate turbulence)
Complete Hydraulic Failure, 540,000 lb, 0 flaps, 22% cg

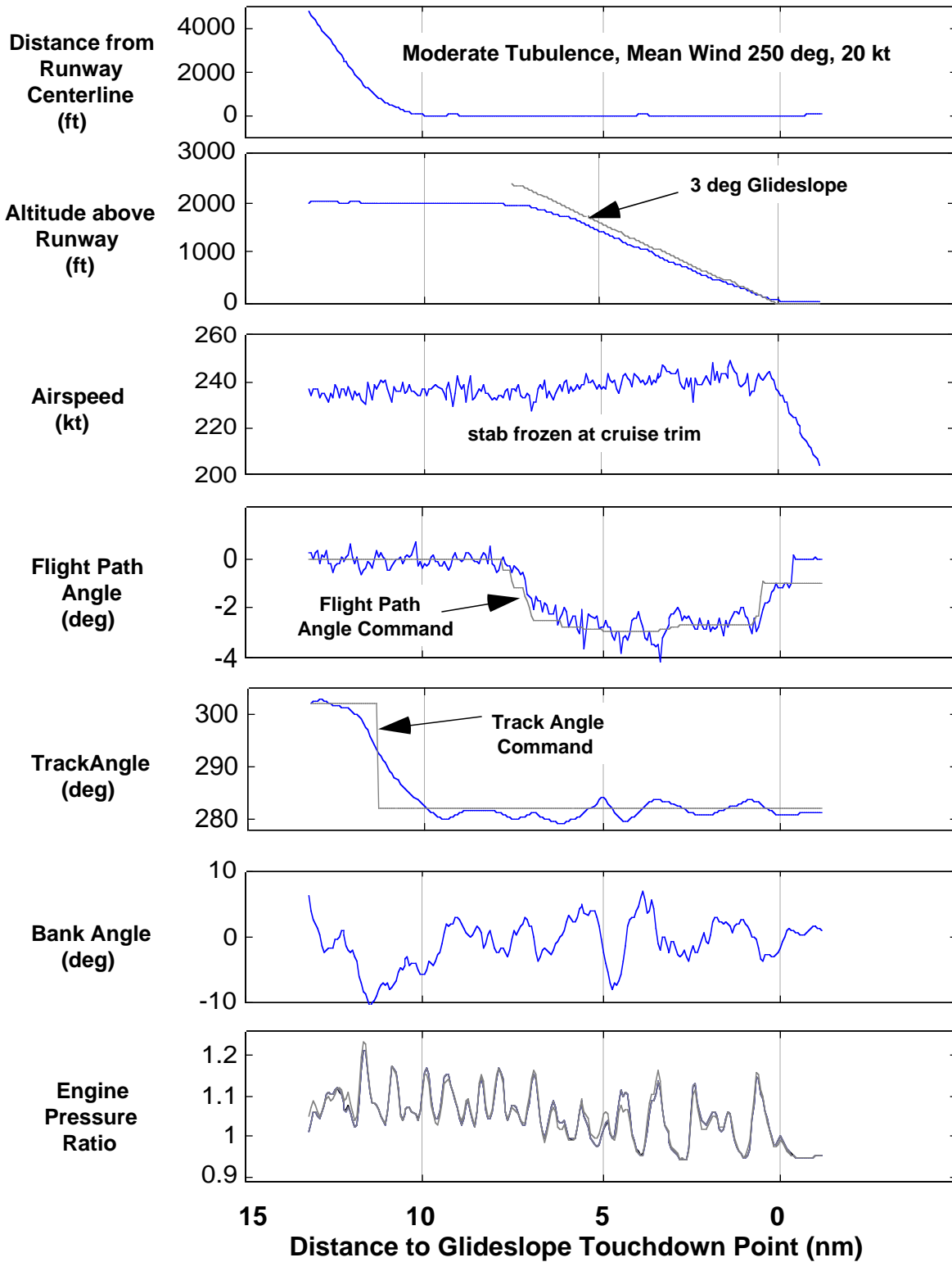

Figure 16. PCA localizer only coupled approach with moderate turbulence.

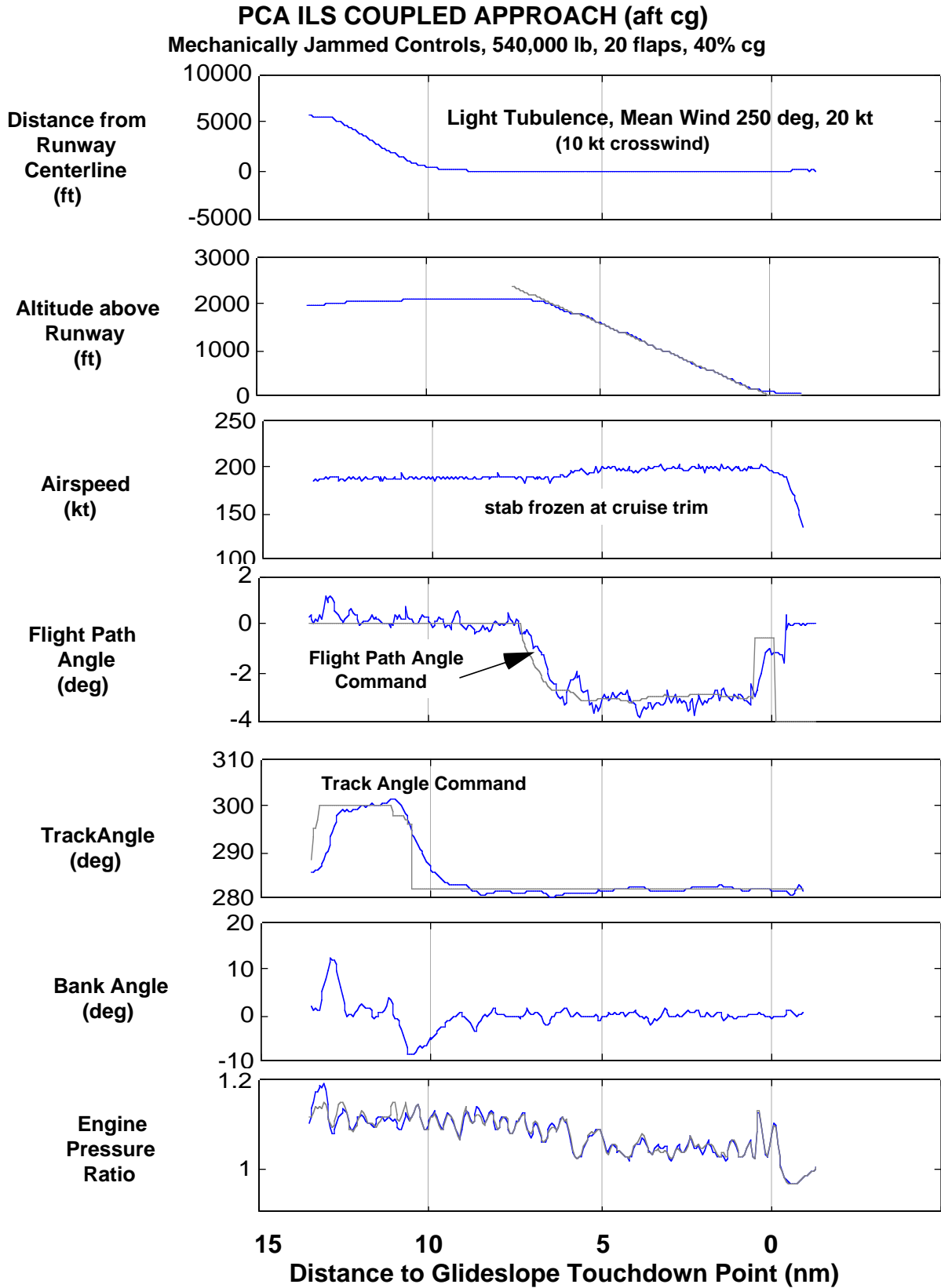

Figure 17. PCA fully coupled approach with aft center of gravity.

PCA ILS COUPLED APPROACH (right outboard engine failure)

Complete Hydraulic Failure, 540,000 lb, 0 flaps, 22% cg

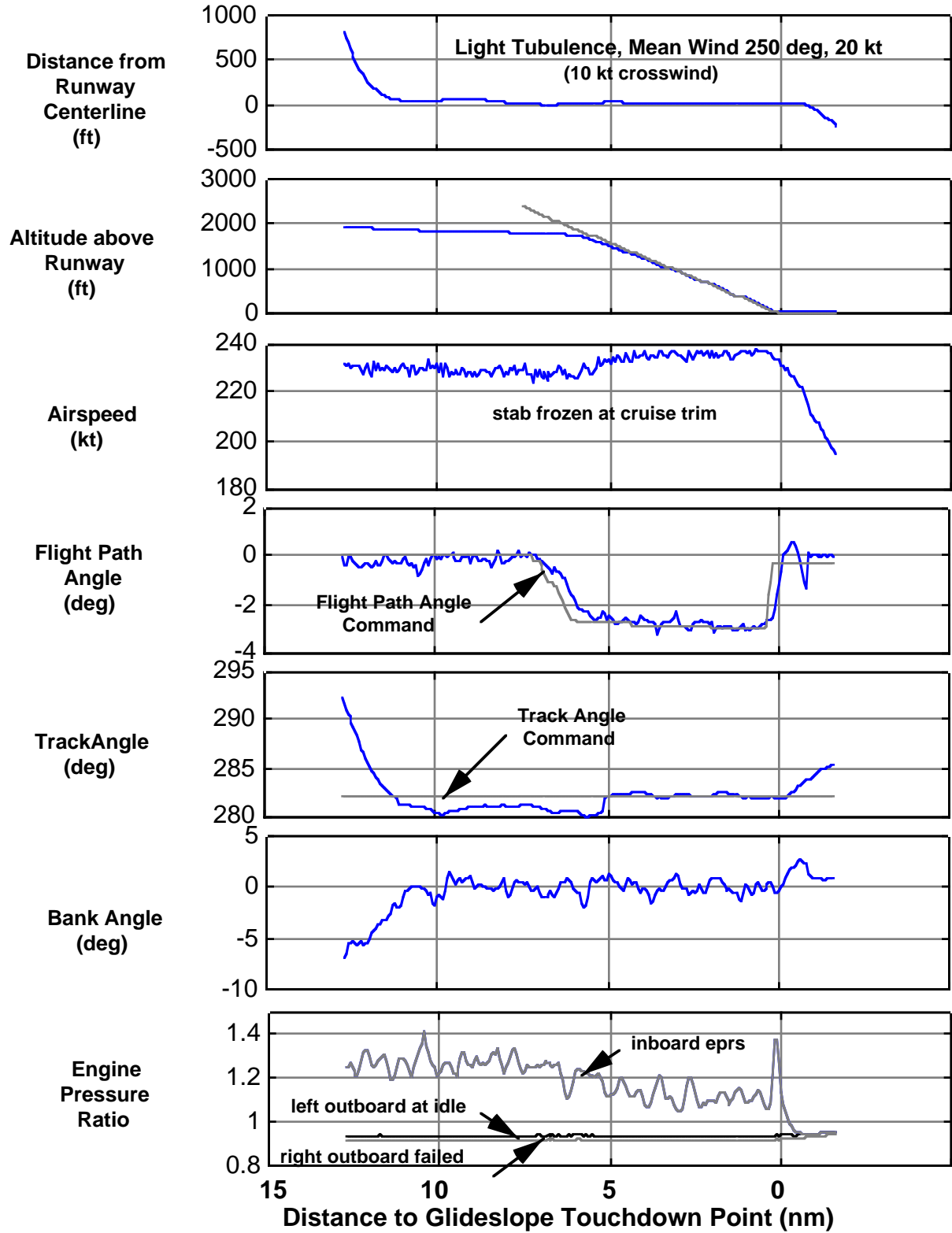

Figure 18. PCA ILS coupled approach with right outboard engine failed.

PCA ILS COUPLED APPROACH (out-of-trim yaw moment)

Complete Hydraulic Failure, 540,000 lb, 0 flaps, 22% cg

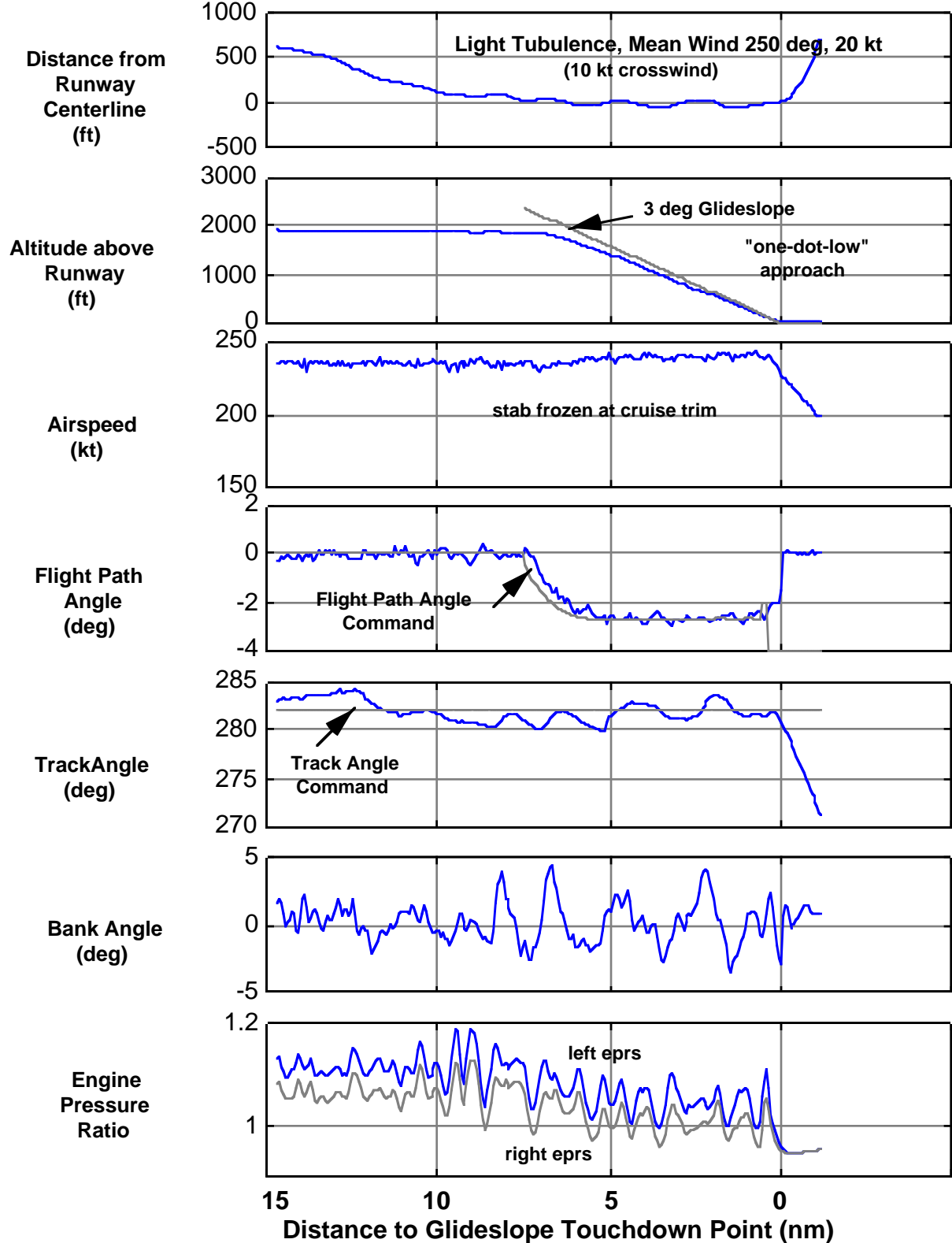

Figure 19. PCA ILS coupled approach with 2 degree rudder out-of-trim yaw moment.

6.16 PCA Touchdown Footprint.

Manual throttle mode touchdown footprint and sink rate were unacceptable. None of the pilots were able to successfully complete a "manual throttle" approach and landing on their first try. The longitudinal "phugoid" mode was particularly difficult for pilots to control with "manual throttles" because of the low natural dynamic damping of this mode. The natural spiral convergence of the B747 helped in maintaining control of bank angles. Typically, aircraft flight path diverged when pilots flew manual throttle approaches due to either over correcting or correcting out of phase with the phugoid mode.

PCA touchdown footprints and sink rates were consistently satisfactory. Touchdown footprint for PCA ILS coupled approaches is shown in figure 20. PCA coupled approach landings had a mean touchdown sink rate of 8 fps with an rms deviation of +/- 3 fps.

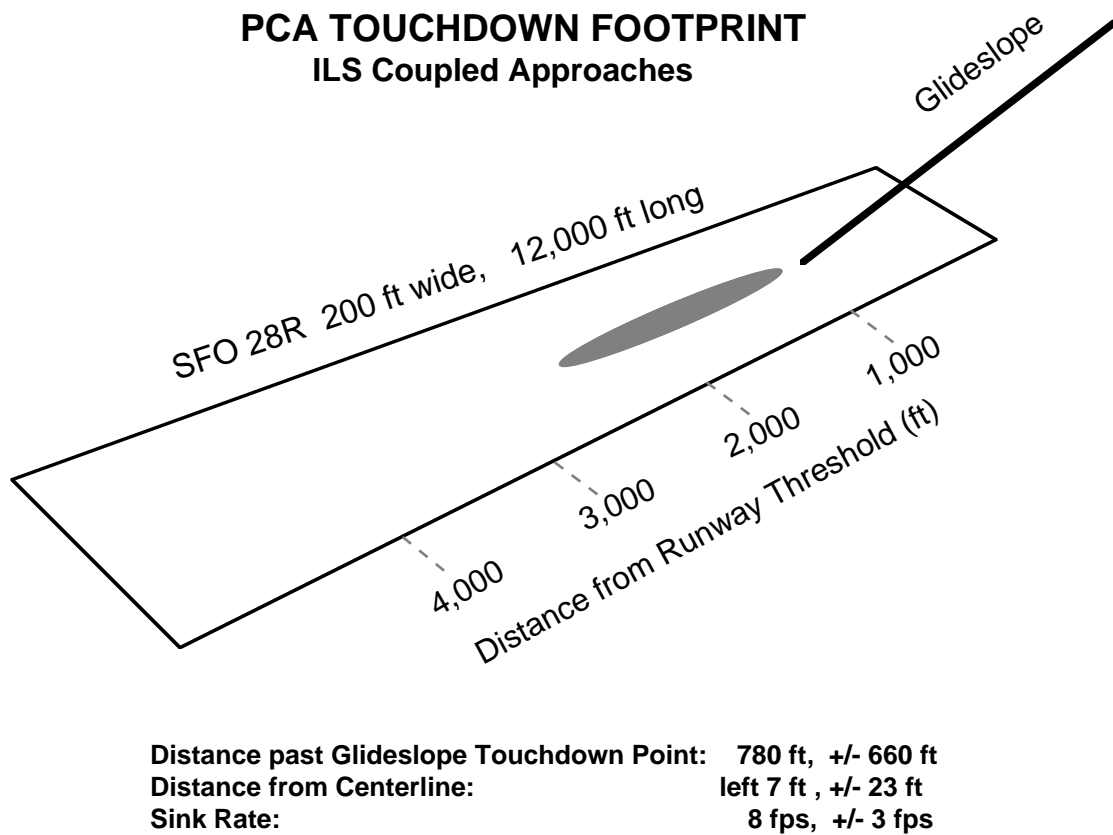

Figure 20. PCA ILS coupled approach footprint.

6.17 Pilot Ratings.

Pilots were asked to rate the various modes in which they conducted approaches and landing. The rating scale is shown in table 8. Mean and standard deviations of the pilot performance ratings are shown in figure 21.

Table 8. Pilot approach and landing rating scale.

- 1 - 3: Satisfactory without improvement, negligible deficiencies.
 4 - 6: Adequate, warrants improvements, moderately objectionable deficiencies.
 7 - 9: Inadequate, requires improvements, major deficiencies.
 10: Unacceptable, improvements mandatory, major deficiencies.
- Satisfactory performance:
 Land on runway, touchdown sink less than 6 fps.
 Touchdown within first 1,500 feet of runway.
- Adequate Performance:
 Land on runway, touchdown sink less than 12 fps.
 Touchdown within first 3,000 feet of runway.

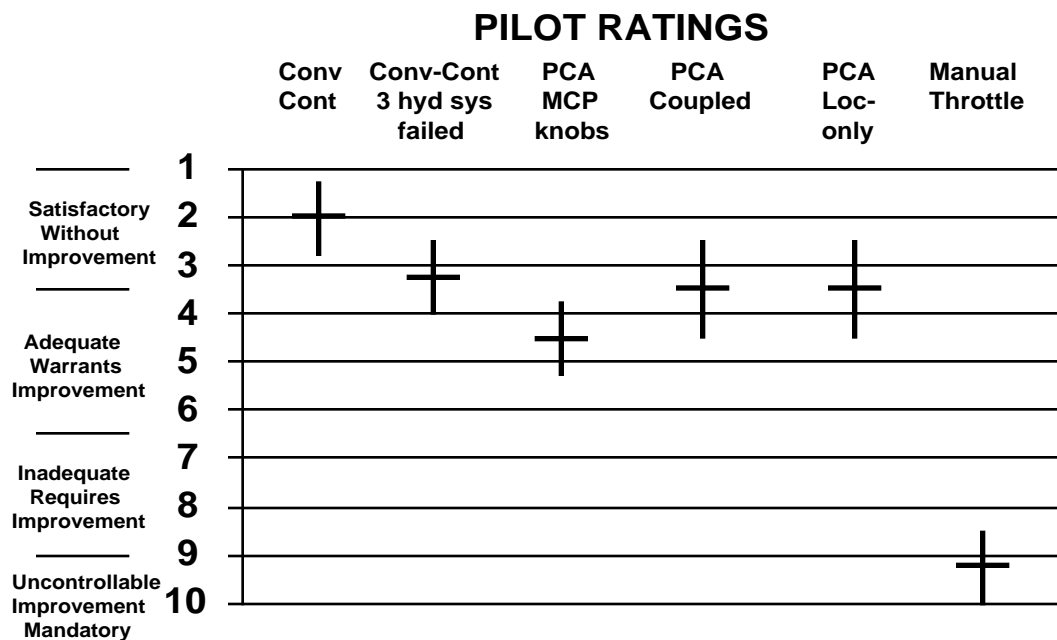

Figure 21. PCA pilot ratings. Conventional controls had a mean rating of 2.0, conventional controls with 3 hydraulic systems failed was rated at 3.2, PCA MCP knobs was rated at 4.5, PCA coupled was rated at 3.5, PCA localizer-only was rated at 3.5, and manual throttle was rated at 9.3.

6.18 Operational Limitations.

The most severe PCA operational limitation is the ability of PCA to control out-of-trim moments. The required asymmetric epr in level flight to offset an equivalent yaw moment due to rudder is shown in table 9. At cruise altitude, over half (0.45) of the available asymmetric epr (0.70) is required in order to balance a 3 deg rudder offset. The low thrust engine epr during an approach on a 3 deg glideslope for various rudder offsets is shown in table 10. When yaw moments equivalent to a 6 deg rudder offset are present, engines on the side opposite the yaw direction are driven to idle thrust. Thus, with 6 deg of rudder offset, there is no margin for lateral-directional maneuvering. An example of a PCA fully coupled approach with 2 deg of rudder offset was discussed and shown in figure 17.

Table 9. Asymmetric epr required to balance a rudder offset in level flight.

	Yaw Moment Equivalent	4 Engine Required Asymmetric EPR
Sea Level	3 deg rudder	0.10
10,000 ft Altitude	3 deg rudder	0.15
35,000 ft Altitude	3 deg rudder	0.45

Table 10. Asymmetric low epr required to balance a rudder offset on a 3 deg glideslope.

Rudder Offset	Low EPR
0	0.99
2	0.97
4	0.95
6	0.93 (idle thrust)

Turbulence amplitude is also a PCA operational limitation during approach and landing. When there were no out-of-trim moments present, PCA was able to perform a satisfactory fully coupled approach in moderate turbulence (see figure 12). However, as rudder offset increases, the level of acceptable turbulence for a safe landing is reduced because of the reduced thrust margins above idle thrust.

The envelope for a safe PCA landing under various conditions of turbulence versus rudder offset is shown in figure 22.

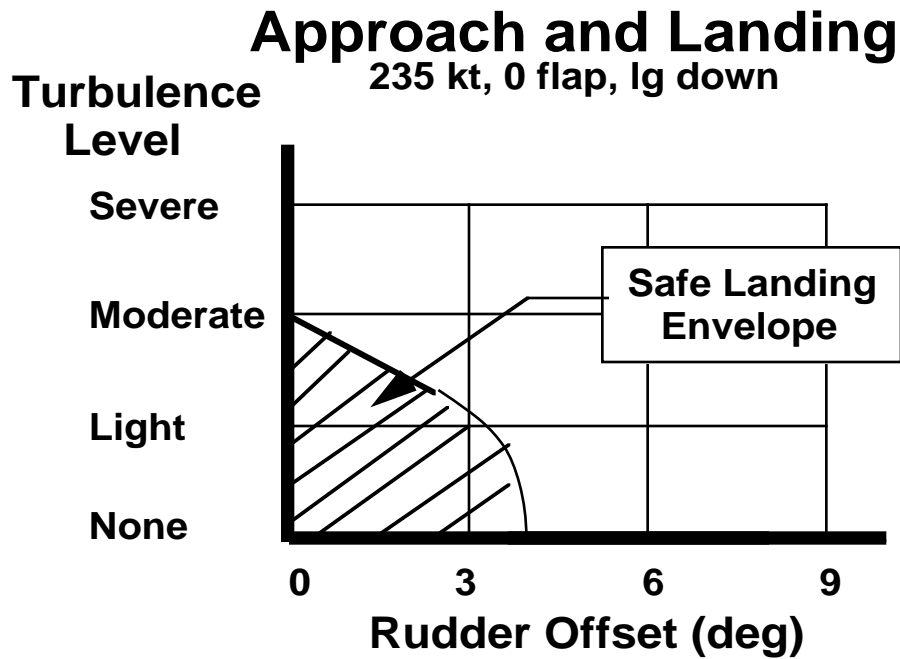

Figure 22. PCA operational limitations in turbulence and with rudder offsets.

7.0 CONCLUSIONS

A PCA system using closed loop linear feedback control laws was developed, tested, and evaluated in piloted simulations on the B747-400 flight simulator at NASA Ames Research Center. The basic PCA design concept was similar to the PCA concept flight tested by NASA Dryden Flight Research Center on the F15 and MD11 aircraft.

STEP RESPONSE

- Aircraft response to PCA flight path angle and track angle commands was precise and generally well damped. Response times were adequate for consistent and safe landings.

ILS TRACKING

- Glideslope and localizer tracking on PCA ILS coupled approaches in light turbulence and 10 kt crosswinds was within 1/4 dot.

TOUCHDOWN FOOTPRINT

- Touchdown footprint was consistent to provide safe landings.
- Touchdown past glideslope touchdown point: 780 ft, +/-660 ft.
- Touchdown from centerline: left 7 ft, +/-23 ft.
- Touchdown sink rate: 8 fps, +/-3 fps.

UNUSUAL ATTITUDE RECOVERY

- PCA performed well in recovering from bank angles of over 90 degrees.
- PCA normally required 2 to 3 oscillations to damp out the phugoid motion at cruise altitude after PCA engage in pitch angles up to 30 degrees.

AFT CG PERFORMANCE

- PCA performance at 40% cg was as good as at 22% cg when control gains were scheduled with cg.

SINGLE ENGINE FAILURE PERFORMANCE

- PCA landing performance with single engine failures was as good as with all 4 engines operating.

PILOT RATINGS

- Pilot mean rating for PCA ILS coupled approaches was satisfactory.
- Pilot mean rating for PCA MCP approaches was adequate.
- Pilots slightly prefer localizer only coupled approaches so that they can select glideslope approach angle.

LANDING SITE SELECTION

- PCA approach airspeeds were high (225 - 240 kt) with cruise stab trim settings and require long runways for safe landing and rollout.

OPERATIONAL LIMITATIONS

- Safe landings were limited to below moderate turbulence (with no rudder offset).
- Safe landings were limited to less than 4 deg rudder offset (with no turbulence).

APPENDIX A - PCA CONTROL LAW BLOCK DIAGRAM

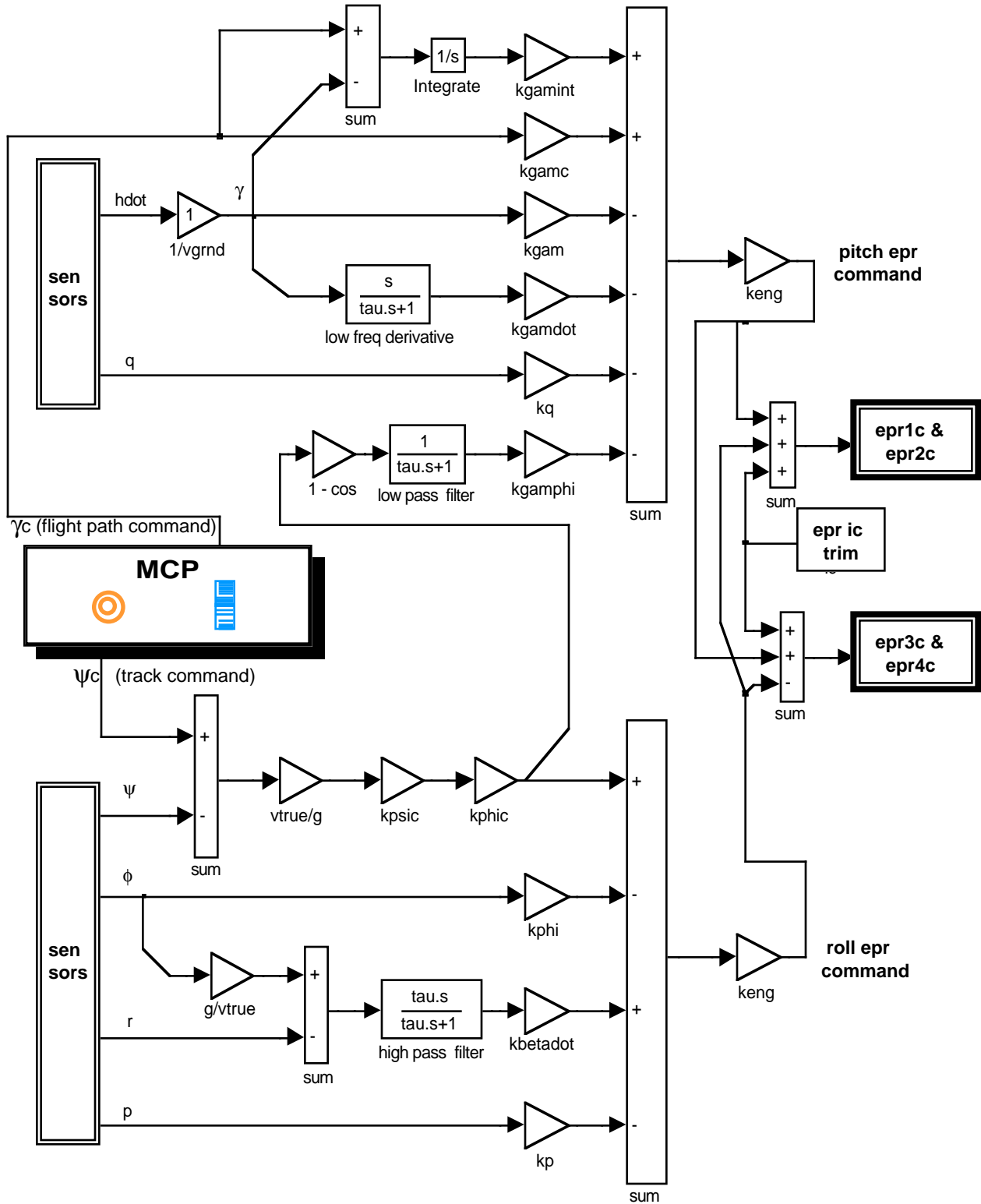

Figure 23. PCA control law block diagram.

APPENDIX B - PCA LONGITUDINAL CONTROL LAWS

tgamc = delta thrust command/engine (lbs/eng) for flight path angle control.

eprgamc = delta epr command/engine for flight path angle control.

γ_c = commanded flight path angle (deg.)

(pilot input from MCP knob in MCP mode, calculated in ILS Coupled mode)

ϕ_c = commanded bank angle (deg.)

(pilot input from MCP knob in Bank mode, calculated in MCP Track mode)

Longitudinal Control Law Structure

tgamc = kgamref*tgain*[(kgamc* γ_c - kgam* γ) +
kgamint* $\dot{\gamma}_{int}$ - kq*qf - kgamdot* $\dot{\gamma}_{dotf}$ + kgamphi* $\dot{\gamma}\phi$]

eprgamc = kpitmode*tgamc*keng keng = 1/56,000

qf = [1/(0.5*s + 1)]*q

$\dot{\gamma}_{int}$ = (γ_c - γ)/s, absolute value $\dot{\gamma}_{int}$ < 40.

$\dot{\gamma}_{dotf}$ = [s/(s + 1/taugamf)]* $\dot{\gamma}$

$\dot{\gamma}\phi$ = 54*[1/(taugamphi*s + 1)][1 - cos(ϕ_c)]

tgain = (sea level pressure)/(ambient pressure)

kpitmode = 1.00 for all four engine configuration.

kpitmode = 2.00 for inboard engine only configuration.

kpitmode = 2.00 for outboard engine only configuration.

Longitudinal Control Law Gains

	Mechanically Jammed			Complete Hydraulic Failure	
	(no controls float)			(controls floating)	
	20 flaps lg down <u>165 kt</u>	20 flaps lg down <u>225 kt</u>	clean <u>285 kt</u>	0 flaps lg down <u>235 kt</u>	clean <u>265 kt</u>
kgamref	0.08	0.08	0.11	0.05	0.11
kgamc	0.80	2.00	2.00	2.00	2.00
kgam	0.80	2.00	2.00	2.00	2.00
kgamdot	1.60	5.20	40.30	7.20	40.30
taugamdot	4.00	4.00	1.00	4.00	1.00
kgamint	0.04	0.07	0.08	0.07	0.08
kq	4.00	5.50	5.50	5.50	5.50
kgamphi	1.25	1.25	1.00	1.25	1.00
taugamphi	3.50	3.50	1.50	3.50	1.50

Gain Scheduling tgain with Altitude

h = altitude (ft.) h1 = h/1000, h2 = h1*h1, h3 = h1*h2

tgain = 1.0000 + 0.43123*h1 - 0.0000525*h2 + 0.0000423*h3

APPENDIX C - PCA LATERAL-DIRECTIONAL CONTROL LAWS

tpsic = delta thrust command/engine (lbs/eng) for psi track angle control.

eprpsic = delta epr command/engine for psi track angle control.

ψ_C = commanded track angle, deg. (pilot input from MCP knob in Track mode).

ϕ_C = computed bank angle, deg. (based on track angle command).

Lateral-Directional Control Law Structure

$$\text{tpsic} = \text{kphiref} * [(\text{kphic} * \phi_C - \text{kgam} * \phi) - \text{kp} * p - \text{betastar}]$$

$$\text{eprpsic} = \text{krollmode} * \text{tpsic} * \text{keng} \quad \text{keng} = 1/56,000$$

$$\text{betastar} = [\text{kbetadot} * s / (s + 1/\text{taubdot})][g * \phi / v_{\text{true}} - r]$$

$$\phi_C = \text{kpsic} * (v_{\text{true}}/g) * [\psi_C - \psi_{\text{trk}}] \text{ when in Track mode.}$$

krollmode = 0.65 for all four engine configuration.

krollmode = 2.20 for inboard engine only configuration.

krollmode = 1.40 for outboard engine only configuration.

Lateral-Directional Control Law Gains

	Mechanically Jammed			Complete Hydraulic Failure	
	(no controls float)			(controls floating)	
	20 flaps lg down 165 kt	20 flaps lg down 225 kt	clean 285 kt	0 flaps lg down 235 kt	clean 265 kt
kphiref	0.0188	0.0188	0.0250	0.0108	0.0250
kphic	0.2500	0.3550	0.3550	0.3550	0.3550
kphi	0.2000	0.3050	0.3050	0.3050	0.3050
kp	0.2000	0.0200	0.2200	0.0200	0.2200
kbetadot	-2.1000	-2.1000	-2.1000	-2.1000	-2.1000
taubdot	0.7000	0.7000	0.7000	0.7000	0.7000
kpsic	0.1200	0.1200	0.0500	0.1200	0.0500

Max bank angle may be selected by the pilot or may operate in an automatically limited mode. The automatic limits for bank angle vary with altitude as follows:

$$\text{Auto bank angle command limit} = 21.8 - 1.7 * \text{tgain} \quad (\text{tgain} = \text{psl/pa})$$

at 2,000 ft altitude, ϕ_{max} command = 20.0 deg.

at 10,000 ft altitude, ϕ_{max} command = 19.3 deg.

at 35,000 ft altitude, ϕ_{max} command = 15.0 deg.

APPENDIX D - PCA ILS COUPLED CONTROL LAWS

Glideslope Capture and Track Mode

gsdev = ILS Glideslope deviation (deg.)

gsref = ILS Glideslope (deg.)

xgs = horizontal distance to glideslope touchdown point.

herr = $xgs * gsdev / 57.3$ (altitude deviation (ft) from glideslope)

hdotf = $[s / (s + 1)] * herr$

vtrue = true airspeed (fps)

- Glideslope Capture

if coupled approach is armed, and if glideslope deviation signal is active:

then gamtest = $gsref + (kh * herr + khdot * hdot) / vtrue$

if gamtest < 0:

then initiate glideslope track mode

- Glideslope Track Mode

tgamc = same as in PCA MCP mode, except that γ_c is now calculated as follows:

$\gamma_c = gsref + (kh * herr + khdot * hdot) / vtrue$

Localizer Capture and Track Mode

locdev = ILS Localizer deviation (deg.)

psiref = Localizer ground track (deg).

locdist = distance to localizer antenna

yerr = $locdist * locdev$ (lateral localizer track error, ft)

ydotf = $[s / (s + 1)] * yerr$

- Localizer Capture

if localizer approach is armed, and if localizer deviation signal is active:

then phitest = $-57.3 * (ky * yerr + kydot * ydotf) / 32.2$

if $sign(y_{nav}) * phitest > 0$: then initiate localizer track mode

- Localizer Track Mode

tpsic = same as in PCA MCP mode, except that ϕ_c is now calculated as follows:

$\phi_c = -ky * yerr - kydot * ydotf - kphiint * phiint$

ILS Coupled Gains

	Mechanically jammed (no controls float)		Complete Hydraulic Failure
	20 flaps, lg down		(controls floating)
	<u>165 kt</u>	<u>225 kt</u>	0 flaps, lg down <u>235 kt</u>
kh	3.60	3.60	3.60
khdot	0.64	0.64	0.64
khint	0.16	0.16	0.16
ky	0.0036	0.0036	0.0036
kydot	0.1050	0.1050	0.1050
kphiint	0.0080	0.0122	0.0122

APPENDIX E - PCA ILS AUTOFLARE CONTROL LAWS

Mechanically Jammed Controls (no control float)

At 150 ft radar altitude: $\dot{h} = -3$ fps.
 $\gamma_c = 57.3 \cdot \dot{h} / v_g$ (v_g = ground speed, fps)

At 60 ft radar altitude: $\phi_c = 0$.

At 40 ft radar altitude: If $\dot{h} < 10$ fps, $e_{prc} = \text{idle}$.

At touchdown: PCA disconnected.

Pilot Procedures:

1. Deploy spoilers and reverse thrust at touchdown.
2. If aircraft is floating, deploy spoilers prior to touchdown.

Complete Hydraulic Failure (controls floating)

At 150 ft radar altitude: $\dot{h} = -13$ fps.
 $\gamma_c = 57.3 \cdot \dot{h} / v_g$ (v_g = ground speed, fps)

At 60 ft radar altitude: $\phi_c = 0$.

At 40 ft radar altitude: If $\dot{h} < 10$ fps, $e_{prc} = \text{idle}$.

At touchdown: PCA disconnected

Pilot Procedures:

1. Choose landing site for no spoilers, no brakes, and no reversers.

APPENDIX F - PCA UNUSUAL ATTITUDE CONTROL LAWS

In the event the PCA is engaged in an unusual attitude, a separate set of control laws is used at PCA engage to initially stabilize the aircraft in a straight and level flight condition. An "unusual attitude" is defined in the controls by the following criteria:

"Unusual Attitude" criteria in control laws:

$$\begin{aligned} & \text{abs}(\gamma_c - \gamma) > 1.0 \text{ deg, and } \text{abs}(\dot{\gamma}) > 0.2 \text{ deg/sec, and} \\ & \text{abs}(\phi) > 2 \text{ deg, and } \text{abs}(p) > 4 \text{ deg/sec.} \end{aligned}$$

Longitudinal Control Law Structure

$$\begin{aligned} \text{tgamc} &= \text{kgamref} * \text{tgain} * [(\text{kgamc} * \gamma_c - \text{kgam} * \gamma) - \text{kq} * \text{qf} - \cos(\phi) * \text{kgamdot} * \dot{\gamma} + \text{ku} * \text{uf}] \\ \text{eprgamc} &= \text{kpitmode} * \text{tgamc} * \text{keng} \quad \text{keng} = 1/56,000 \quad \gamma \text{ limited to } \pm 1.0 \text{ deg.} \end{aligned}$$

Lateral-Directional Control Law Structure

$$\begin{aligned} \text{tpsicc} &= \text{kphiref} * [\text{kphi} * \phi - \text{kp} * p - \text{betastar} - \text{kphiint} * \text{phiint}] - \text{yawtrimepr} + \text{roltirmepr} \\ \text{eprpsicc} &= \text{krollmode} * \text{tpsicc} * \text{keng} \quad \text{keng} = 1/56,000 \quad \text{betastar limited to } \pm 3 \text{ deg/sec.} \end{aligned}$$

Control Law Gains

Mechanically Jammed or Complete Hydraulic Failure
clean and at cruise mach
35,000 ft altitude

kgamref	0.1030	kphiref	0.0250
kgamc	1.9840	kphi	0.3036
kgam	0.3970	kp	0.220
kq	5.4800	kbetadot	-2.1000
kgamdot	40.2800	kphiint	0.0150
ku	7.8000		

Out of Trim Yaw Estimate

$$\begin{aligned} \text{Cnbeta} &= 0.18 + 0.06 * h / 35000 \quad \text{Cybeta} = -0.018 * 57.3 \\ \text{dthr14} &= (\text{epr1} - \text{epr4}) * 56000 / (0.7 * \text{tgain}) \\ \text{dthr23} &= (\text{epr2} - \text{epr3}) * 56000 / (0.7 * \text{tgain}) \\ \text{nthr} &= 69.4 * \text{dthr14} + 39.6 * \text{dthr13} \\ \text{betaest} &= \text{vayb} * (W/g) / (\text{Cybeta} * Q * 5500) \quad \text{rdot} = [1 / (1 + s)] * r \quad \text{pdot} = [1 / (1 + s)] * p \\ \text{naero} &= I_{zz} * \text{rdot} - \text{nthr} + (I_{yy} - I_{xx}) * p * q - I_{xz} * (\text{pdot} - q * r) \\ \text{yawtrimmeas} &= \text{naero} - Q * S * \text{span} * [\text{Cnbeta} * \text{betaest} + \text{Cnrud} * \text{rud} + \text{Cnr} * r * \text{span} / (2 * vt)] \\ \text{yawtrimfil} &= [1 / (1 + 10S)] * \text{yawtrim_meas} \\ \text{yawtrimepr} &= \text{yawtrimfil} * 0.7 * \text{tgain} / (4 * 60 * 56000) \quad (\text{command per engine}) \end{aligned}$$

Out of Trim Roll Estimate

$$Cl_{\beta} = -0.10 \quad Cl_p = -0.25$$

$$l_{aero} = I_{xx} \cdot \dot{p} + (I_{zz} - I_{yy}) \cdot q \cdot r - I_{xz} \cdot (\dot{r} - p \cdot q)$$

$$\text{rolltrimmeas} = l_{aero} - Q \cdot 5500 \cdot 196 \cdot [Cl_{\beta} \cdot \beta_{est} + Cl_a \cdot a_{il} + Cl_p \cdot p \cdot 196 / (2 \cdot v_t)]$$

$$\text{rolltrimfil} = [1 / (1 + 10S)] \cdot \text{rolltrimmeas}$$

$$\text{rolltrimepr} = (C_{n\beta} / Cl_{\beta}) \cdot \text{rolltrimfil} \cdot 0.7 \cdot t_{gain} / (4 \cdot 60 \cdot 56000) \text{ (command per engine)}$$

APPENDIX G - PCA EPR INITIAL CONDITIONS

The PCA control law initial epr trim point is determined from an epr trimmap rather than simply using the epr values at PCA engage (figure 24). This initialization method insures that a close approximation to an initial straight and level epr trim is used by the control laws at time of PCA engage.

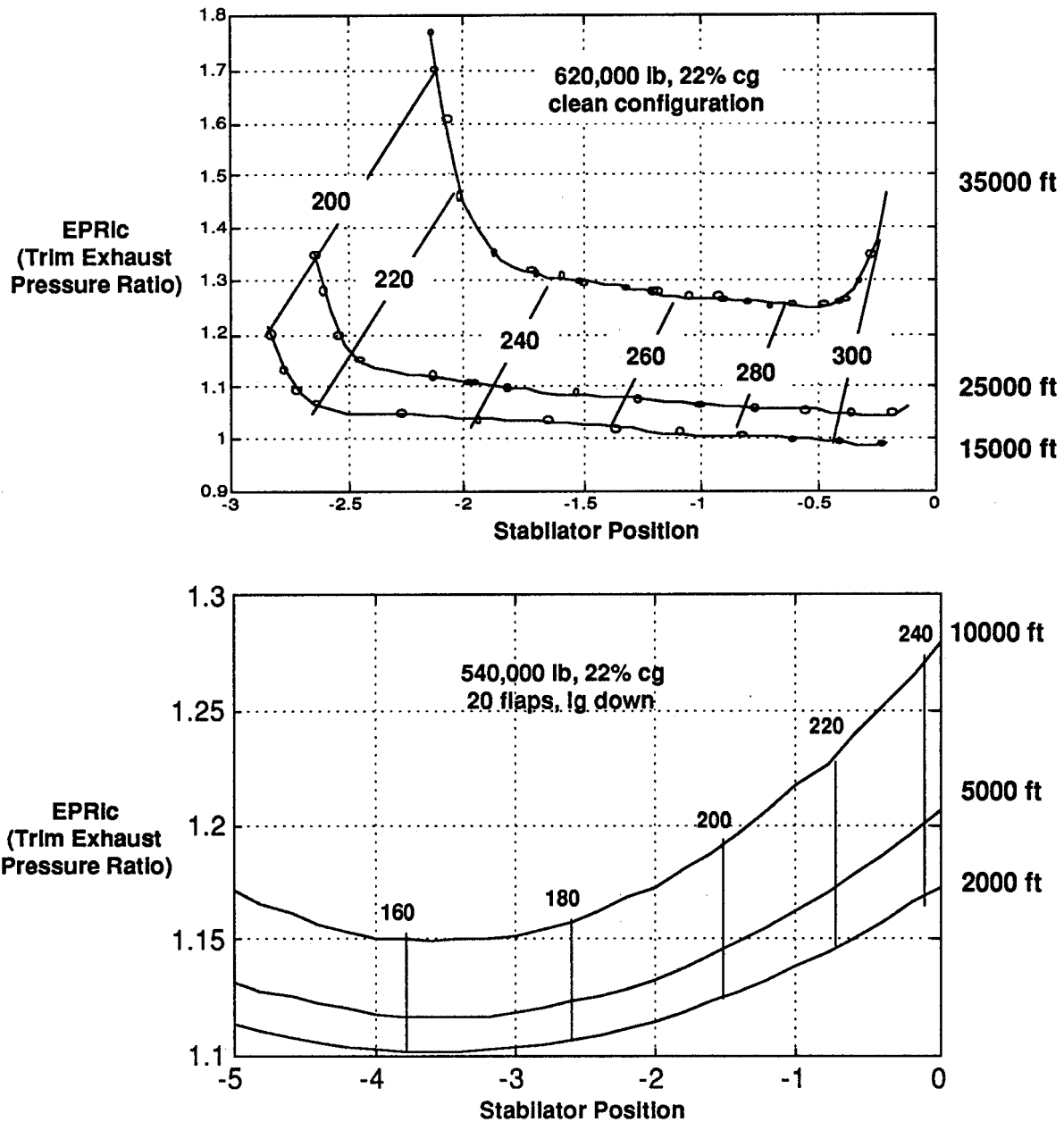

Figure 24. PCA initial epr trimmaps.

REFERENCES

1. Burcham, F. W.; Fullerton, C. G.; Gilyard, G.; Wolf, T.; and Stewart, J.: "A Preliminary Investigation of the Use of Throttles for Emergency Flight Control"; AIAA-91-2222, June 1991.
2. National Transportation Safety Board, Aircraft Accident Report, PB90-910406, NTSB/AAR-90/06, United Airlines Flight 232, McDonnell Douglas DC-10, Sioux Gateway Airport, Sioux City, Iowa, July 1989.
3. Gilyard, F.; Conley, J.; Le, J.; Burcham, F.: "A Simulation Evaluation of a Four-Engine Jet Transport Using Engine Thrust Modulation for Flight Path Control"; AIAA 91-2223, June 1991.
4. Burcham, Frank W. Jr.; and Fullerton, C. Gordon: "Controlling Crippled Aircraft With Throttles"; Flight Safety Foundation Paper and NASA TM 104238, Nov 1991.
5. Burcham, Frank W. Jr.; Maine, Trindel; and Wolf, Thomas: "Flight Testing and Simulation of an F-15 Airplane Using Throttles for Flight Control"; AIAA-92-4109-CP, and NASA TM-104255.
6. Frank W. Burcham, Trindel A. Maine, C. Gordon Fullerton, and Lannie Dean Webb: "Development and Flight Evaluation of an Emergency Digital Flight Control System Using Only Engine Thrust on an F-15 Airplane"; NASA TP 3627, September 1996.
7. Burcham, Frank W. Jr.; Maine, Trindel A.; Burken, John J.; and Pappas, Drew: "Flight Test of an Augmented Thrust-Only Flight Control System on an MD-11 Transport Airplane." NASA TM 4745, July 1996.
8. Burcham, Frank, W.; and Fullerton, G. Gordon: "Propulsion Control Update - MD-11 Flight Results," Society of Experimental Test Pilots 40th Symposium Proceedings, Sept 1996.
9. Bull, John; Mah, Robert; Davis, Gloria; Conley, Joe; Hardy, Gordon; Gibson, Jim; Blake, Matthew; Bryant, Don; and Williams, Diane: "Piloted Simulation Tests of Propulsion Control as Backup to Loss of Primary Flight Controls for a Mid-Size Jet Transport"; NASA TM 110374, December 1995.
10. Sullivan, Barry T. and Soukup, Paul A.: "The NASA 747-400 Flight Simulator: A National Resource for Aviation Safety," AIAA Flight Simulation Technology Conference, San Diego, California, July 1996.
11. Gelhausen, Paul: "PCA Benefits Assessment"; PCA Workshop, NASA Dryden, June 1993.

REPORT DOCUMENTATION PAGE

Form Approved
OMB No. 0704-0188

Public reporting burden for this collection of information is estimated to average 1 hour per response, including the time for reviewing instructions, searching existing data sources, gathering and maintaining the data needed, and completing and reviewing the collection of information. Send comments regarding this burden estimate or any other aspect of this collection of information, including suggestions for reducing this burden, to Washington Headquarters Services, Directorate for Information Operations and Reports, 1215 Jefferson Davis Highway, Suite 1204, Arlington, VA 22202-4302, and to the Office of Management and Budget, Paperwork Reduction Project (0704-0188), Washington, DC 20503.

1. AGENCY USE ONLY (Leave blank)	2. REPORT DATE April 1997	3. REPORT TYPE AND DATES COVERED Technical Memorandum	
4. TITLE AND SUBTITLE Piloted Simulation Tests of Propulsion Control as Backup to Loss of Primary Flight Controls for a B747-400 Jet Transport		5. FUNDING NUMBERS	
6. AUTHOR(S) *John Bull, Robert Mah, Gordon Hardy, Barry Sullivan, **Jerry Jones, **Diane Williams, **Paul Soukup, ***Jose Winters			
7. PERFORMING ORGANIZATION NAME(S) AND ADDRESS(ES) Ames Research Center, Moffett Field, CA 94035-1000 *CAELUM Research Corporation, Mt. View, CA **Man Tech/NSA Technology Services Corporation, Sunnyvale, CA ***Foothill-DeAnza College, Los Altos Hills, CA 94022		8. PERFORMING ORGANIZATION REPORT NUMBER A-976382	
9. SPONSORING/MONITORING AGENCY NAME(S) AND ADDRESS(ES) National Aeronautics and Space Administration Washington, DC 20546-0001		10. SPONSORING/MONITORING AGENCY REPORT NUMBER NASA TM-112191	
11. SUPPLEMENTARY NOTES Point of Contact: Robert Mah, Ames Research Center, MS 269-1, Moffett Field, CA 94035-1000 (415) 604-6044			
12a. DISTRIBUTION/AVAILABILITY STATEMENT Unclassified-Unlimited Subject Category-03, 08		12b. DISTRIBUTION CODE	
13. ABSTRACT (Maximum 200 words) Partial failures of aircraft primary flight control systems and structural damages to aircraft during flight have led to catastrophic accidents with subsequent loss of lives (e.g. DC-10, B-747, C-5, B-52, and others). Following the DC-10 accident at Sioux City, Iowa in 1989, the National Transportation Safety Board recommended "Encourage research and development of backup flight control systems for newly certified wide-body airplanes that utilize an alternate source of motive power separate from that source used for the conventional control system." This report describes the concept of a propulsion controlled aircraft (PCA), discusses pilot controls, displays, and procedures; and presents the results of a PCA piloted simulation test and evaluation of the B747-400 airplane conducted at NASA Ames Research Center in December, 1996. The purpose of the tests was to develop and evaluate propulsion control throughout the full flight envelope of the B747-400 including worse case scenarios of engine failures and out of trim moments. Pilot ratings of PCA performance ranged from adequate to satisfactory. PCA performed well in unusual attitude recoveries at 35,000 ft altitude, performed well in fully coupled ILS approaches, performed well in single engine failures, and performed well at aft cg. PCA performance was primarily limited by out-of-trim moments.			
14. SUBJECT TERMS Propulsion control, Flight control, Piloted simulation test		15. NUMBER OF PAGES 52	
		16. PRICE CODE A04	
17. SECURITY CLASSIFICATION OF REPORT Unclassified	18. SECURITY CLASSIFICATION OF THIS PAGE Unclassified	19. SECURITY CLASSIFICATION OF ABSTRACT	20. LIMITATION OF ABSTRACT