

# Discussion of Burnthrough Test Method for Aircraft Thermal Acoustic Insulation Blankets



Tim Marker

FAA Technical Center

# Flanged vs. Socket Type Housing





# Flanged vs. Socket Type Draft Tube



# Assortment of Draft Tube Types Used on Park Burners



**DRAFT TUBES**

# Socket Burner at FAA Lab

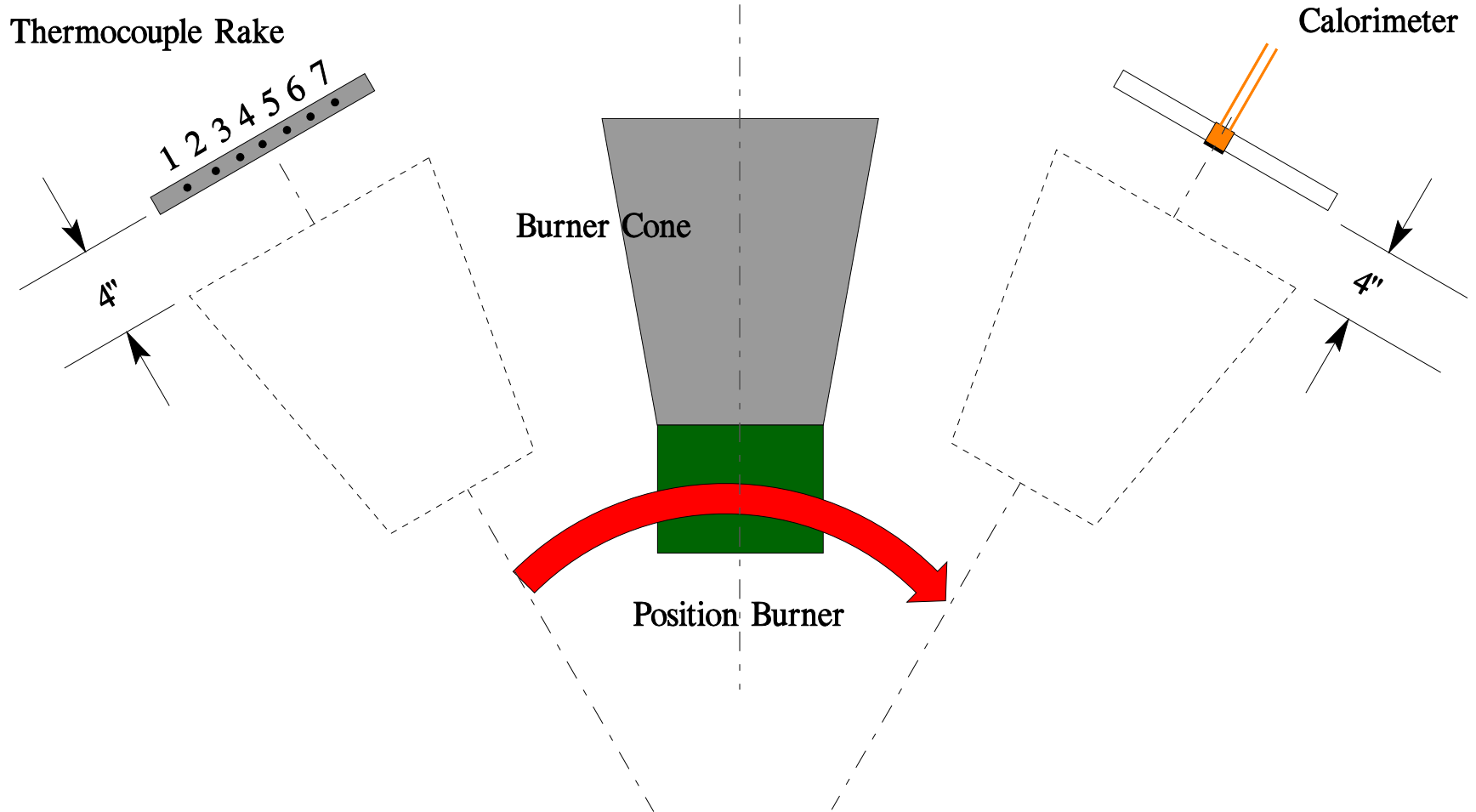

# Socket Burner at FAA Lab

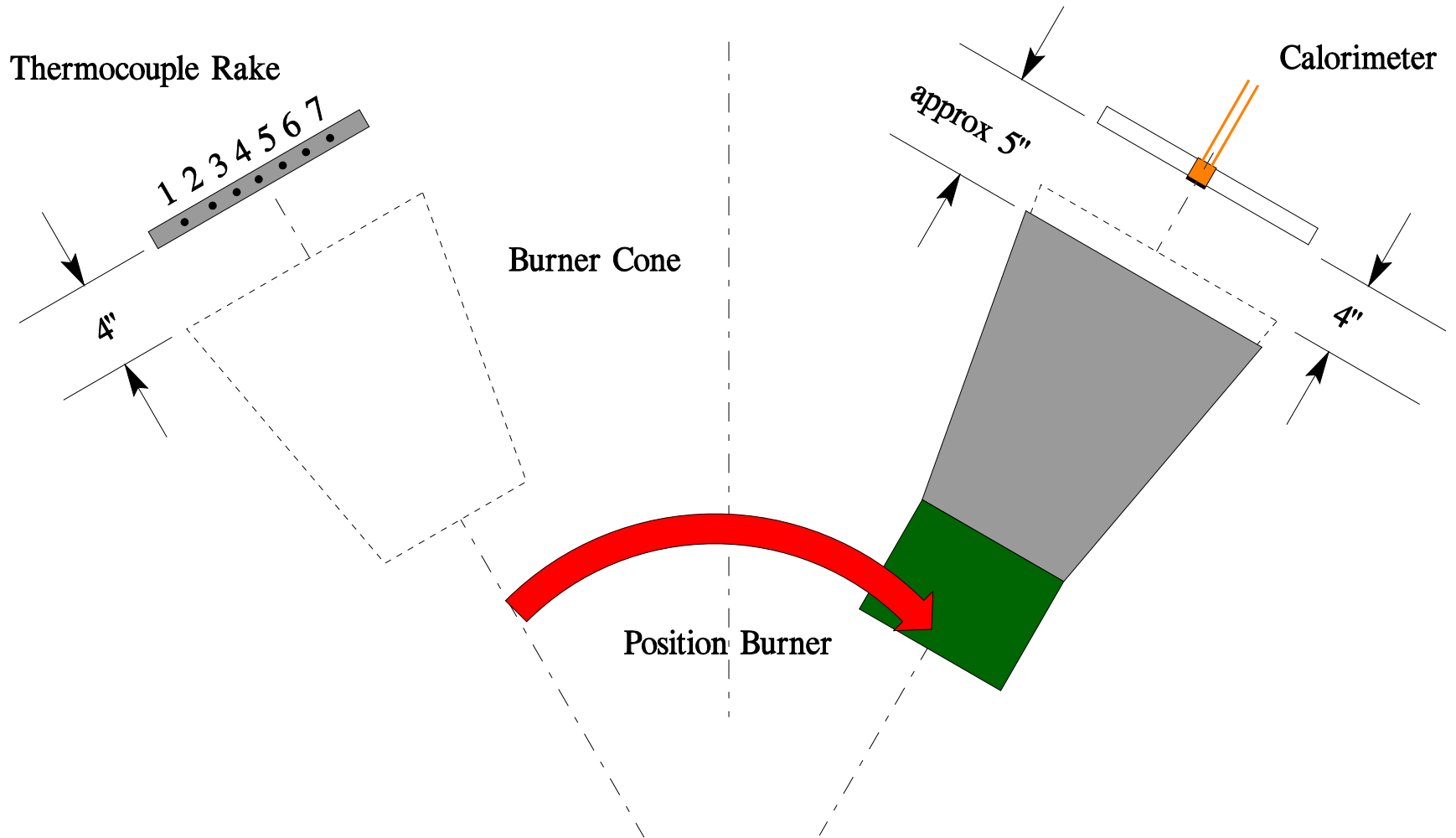

# Flanged Burner

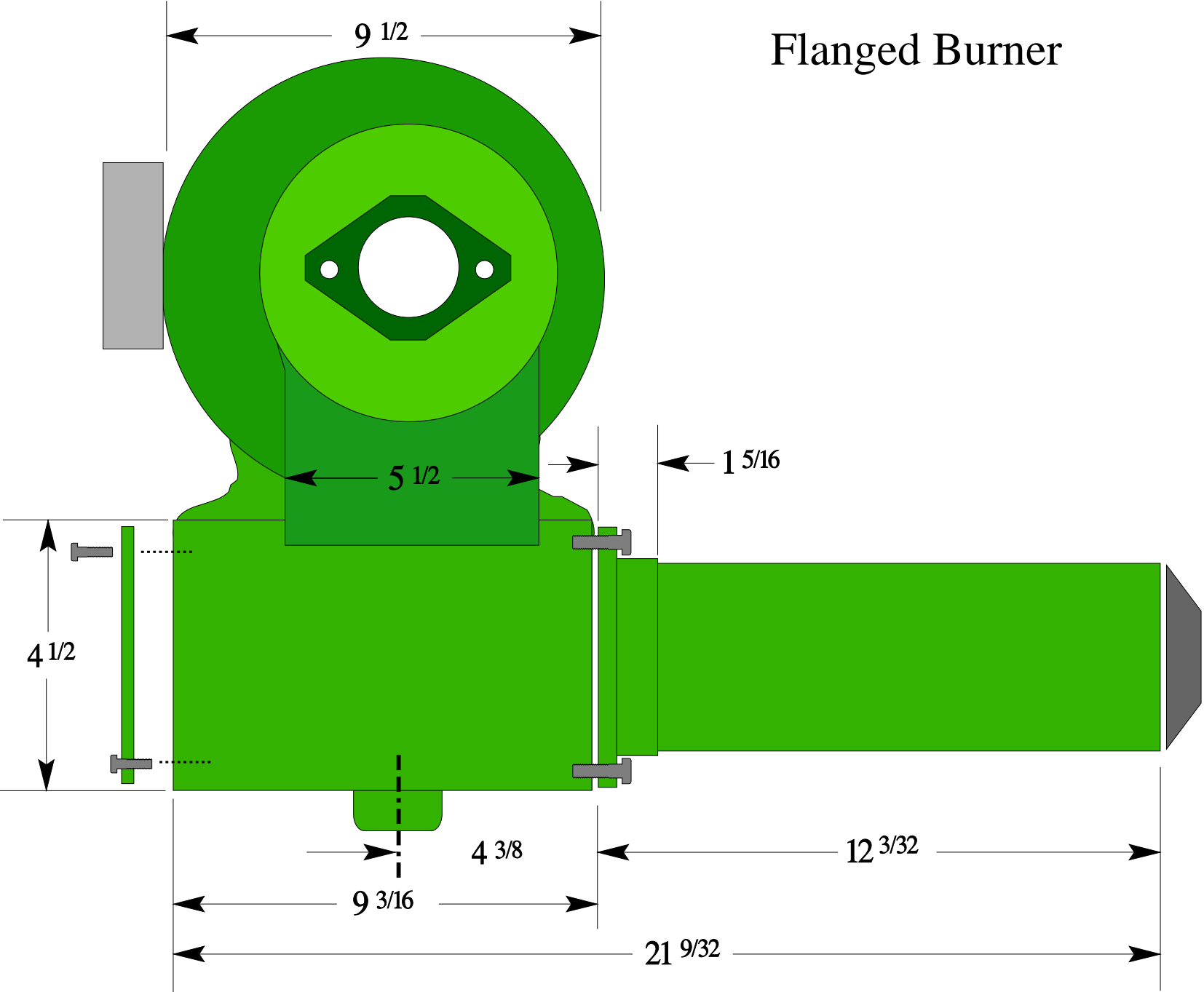

# Socket Burner

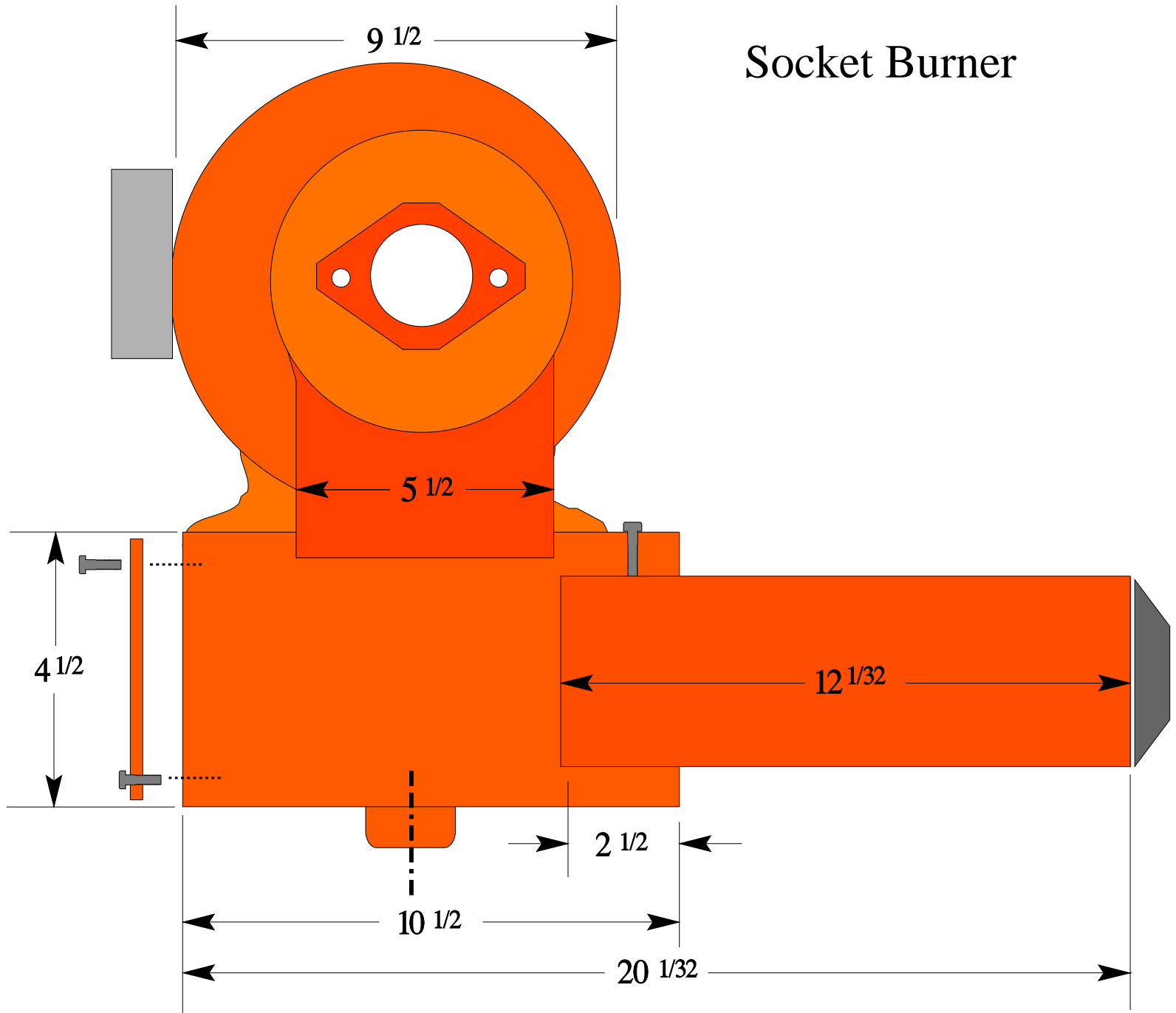



# Length Difference

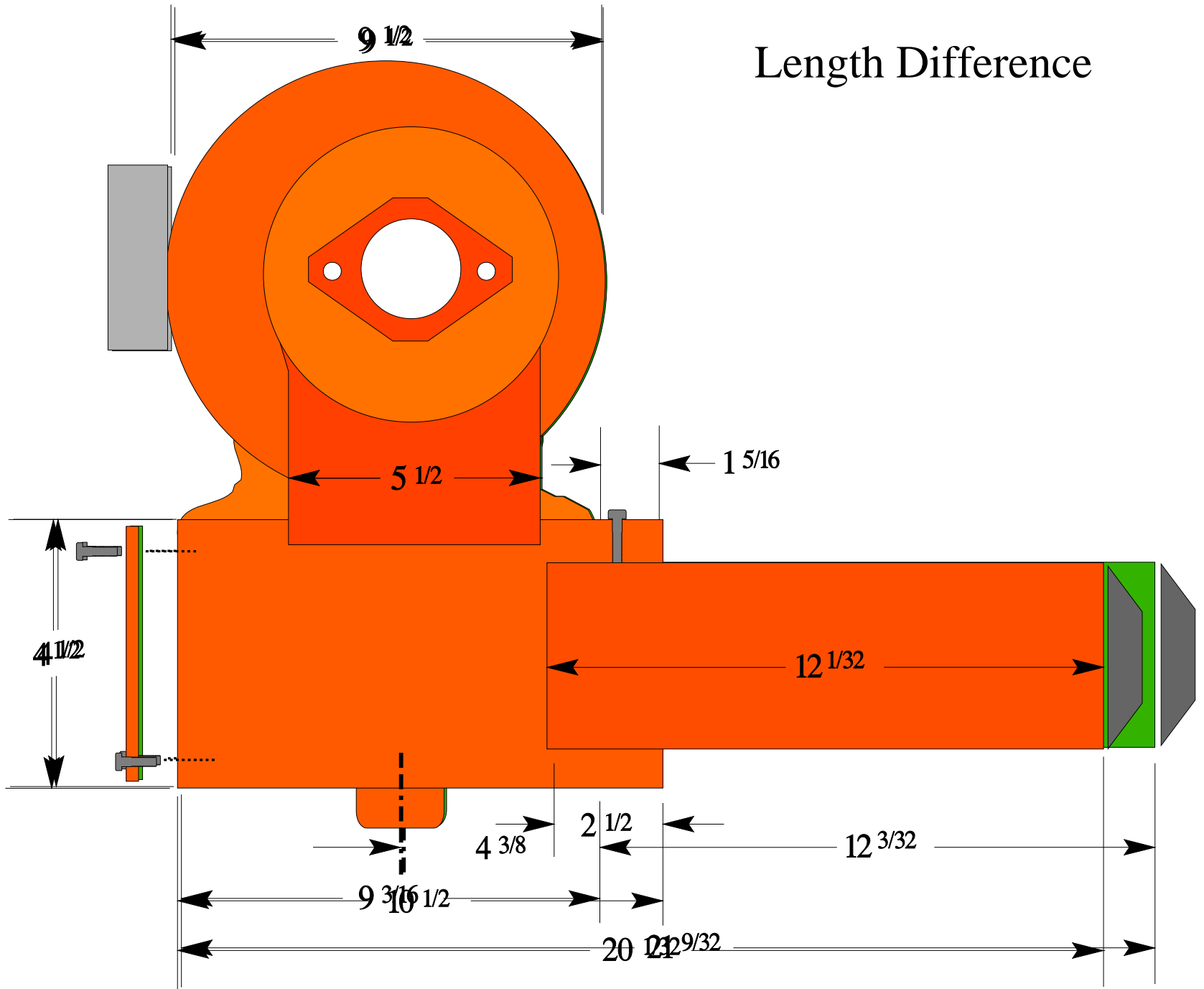

# Extended Draft Tube for Socket Burner

13 3/8 Draft Tube Length



# Test Results, Socket Burner with Extended Draft Tube

**Finding 1:** During calibration, the measured heat flux was still low and not within specification (low 14's)

**Finding 2:** During burnthrough test using TexTech 8 oz/yd<sup>2</sup> felt, the failure time was still early (2 ½ min) when compared to results using FAA flanged burner (typically 3 to 3 ½ minutes).



# Measurement of Exit Air Velocity

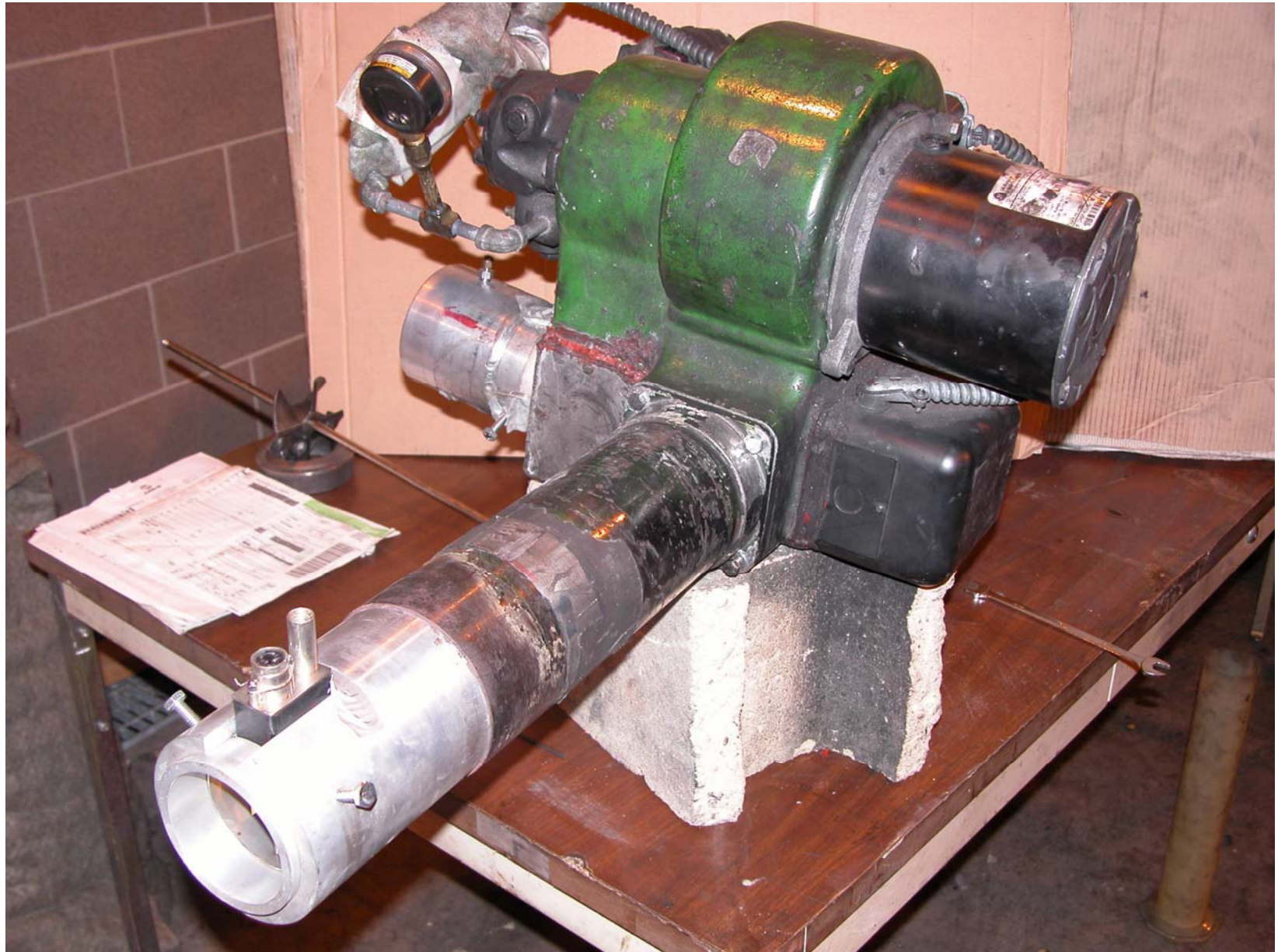



# Measurement of Exit Air Velocity



# Measurement of Intake Velocity Through Straightening Device



## Comparison of Exit Air Velocity, Flanged vs. Socket

	<b>Inlet Velocity Through Stream Straightening Device (ft/min)</b>	<b>Exit Velocity Through Sleeve Containing Annemometer (ft/min)</b>
<b>Flanged Burner</b>	<b>2000</b>	<b>1300</b>
<b>Socket Burner</b>	<b>2000</b>	<b>1350</b>

Results indicate higher exit velocity with socket burner. However, air velocity device could be sensing a higher “stream”, and not necessarily the true average velocity of the exit area.



# Housing Inner Diameter Measurement

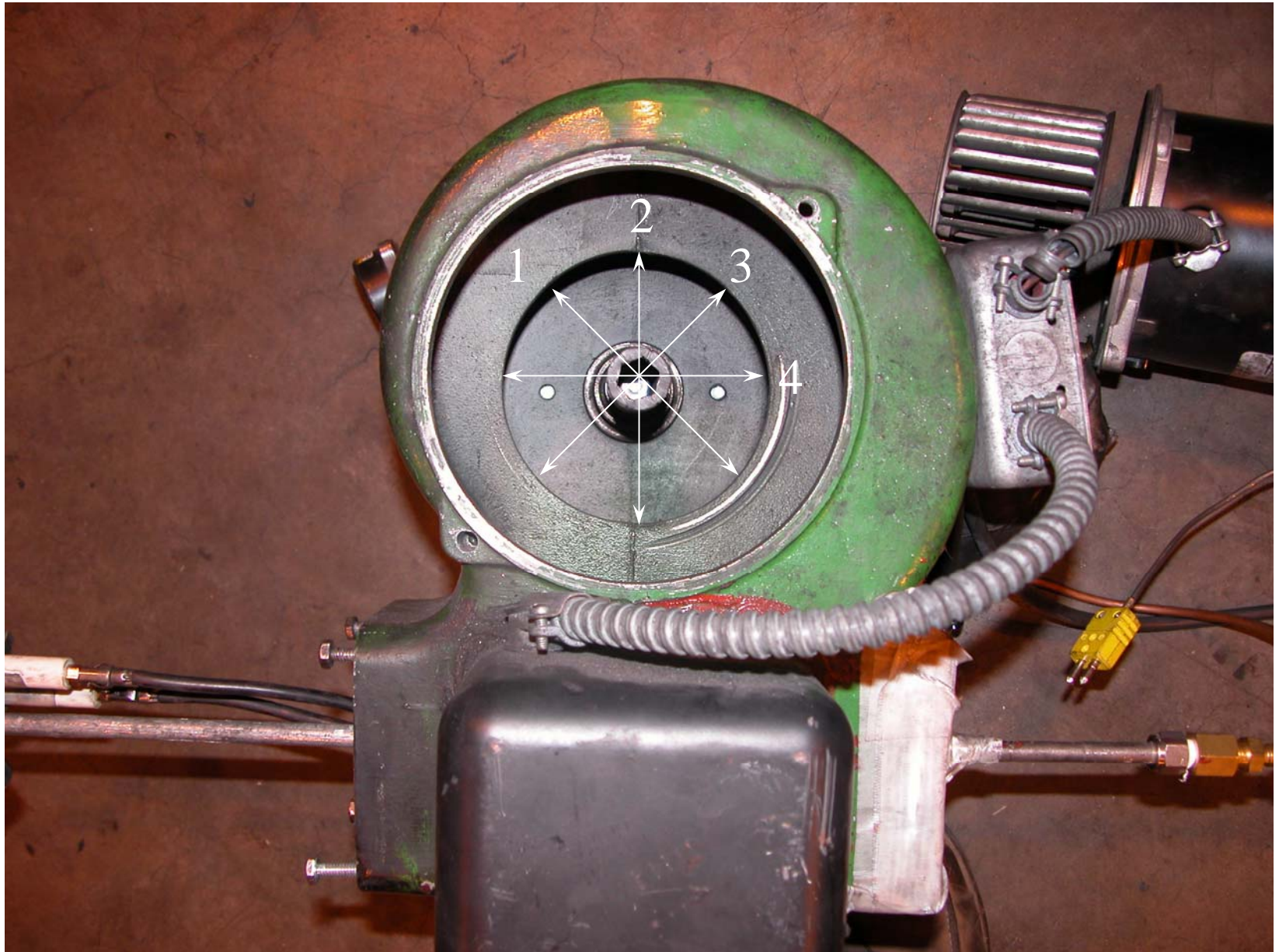



# Housing Inner Diameter Measurement

Flanged

Socket

Diameter 1	4.94	4.84
Diameter 2	5.03	5.01
Diameter 3	4.98	4.93
Diameter 4	4.96	4.88
Diameter Average	4.9775	4.915
Area	19.46	18.97

# Mapping Exit Area Air Velocity

**Objective:** To determine cause of differences in calibration heat flux and test results between flanged style burner and socket style burner when both units are identically-prepared.

**Methodology:** Map exit area air velocity of each burner to determine if there is a correlation between “shape” of exit air and heat flux/test results.

# Mapping Exit Area Air Velocity

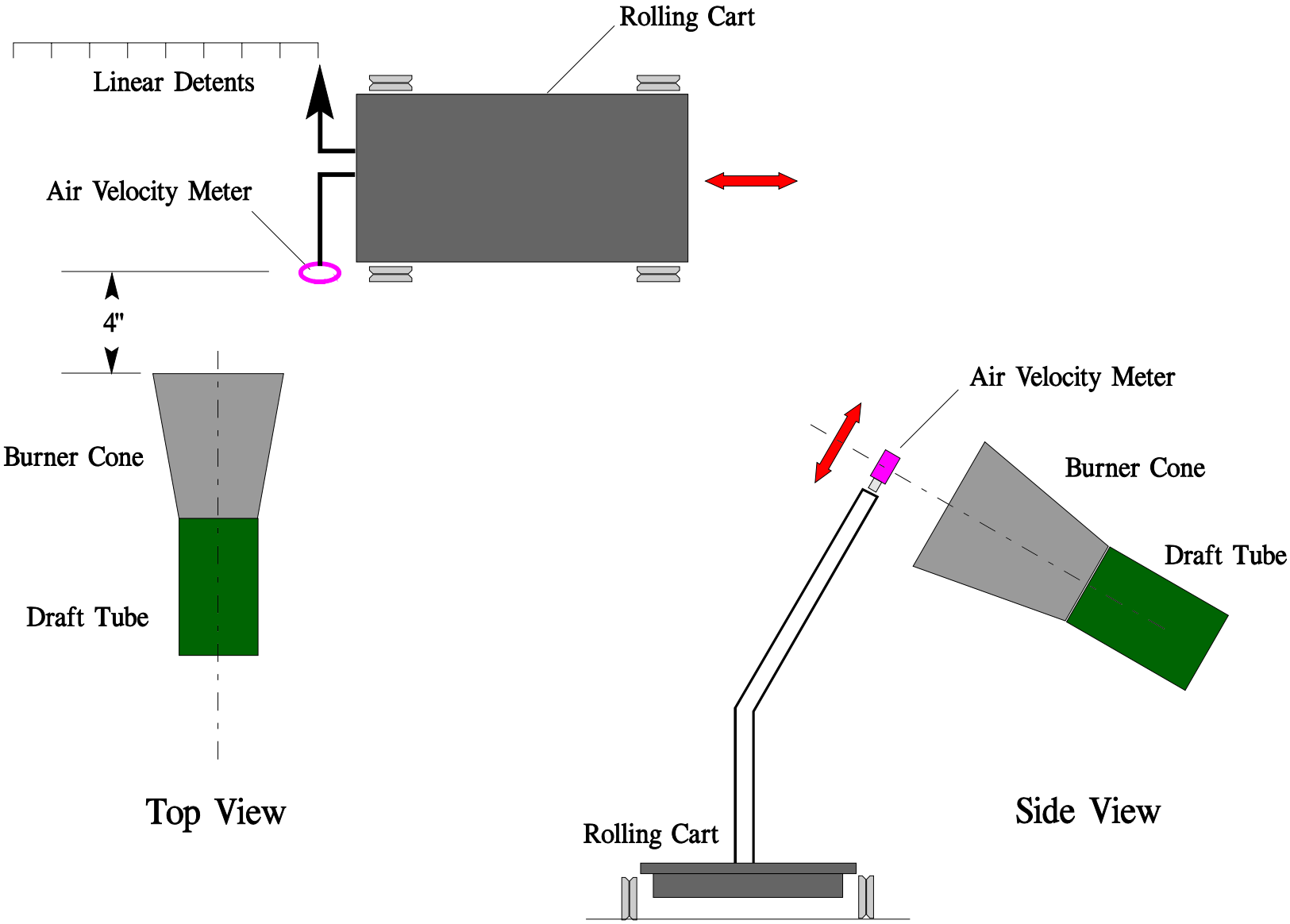

# Exit Area Air Velocity Mapping

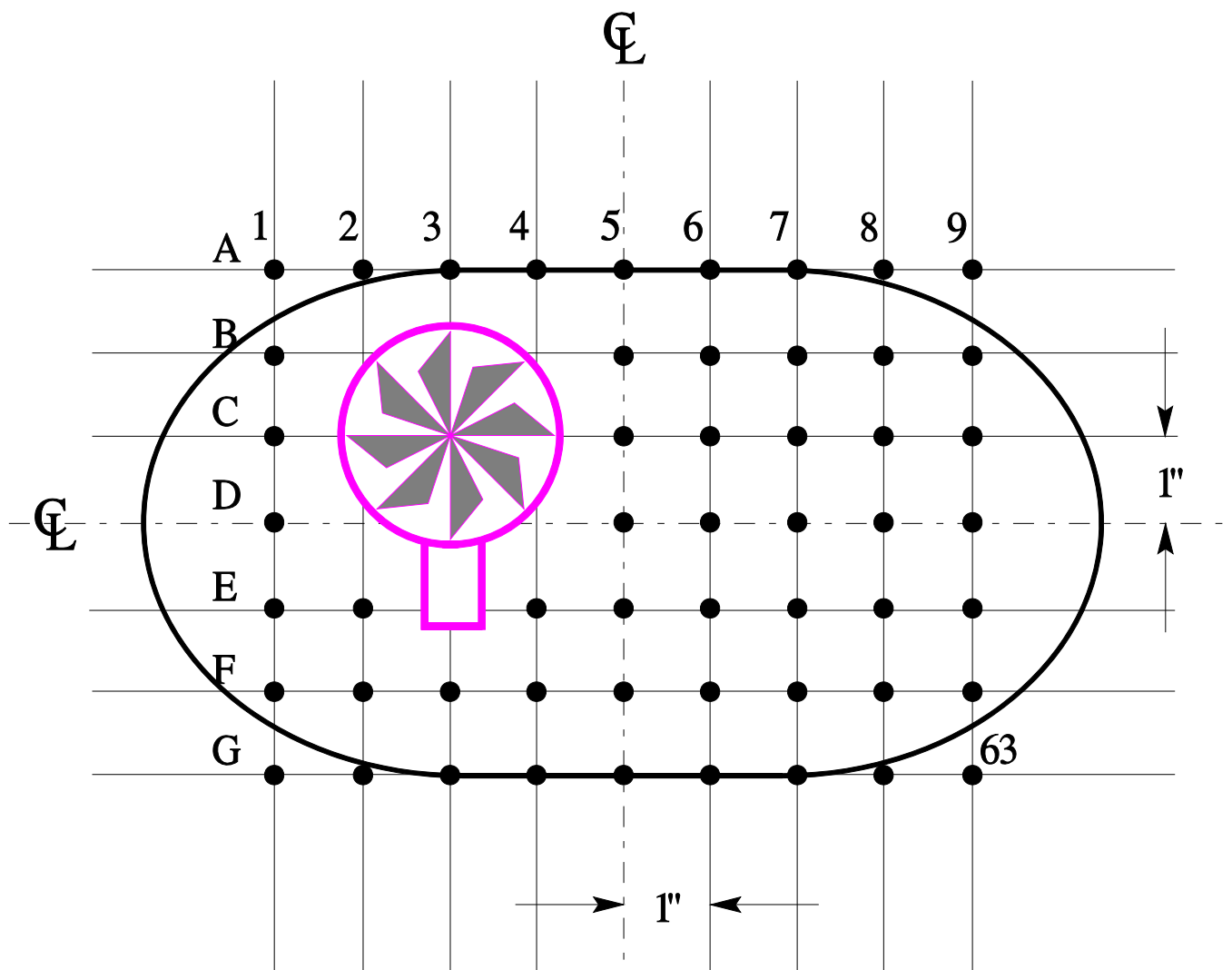



# Exit Velocity Comparison

## FAA Flanged Burner

averaged air velocities

	1	2	3	4	5	6	7	8	9
A	96	118	118	122	134	139	134	125	123
B	168	174	168	170	177	175	165	154	131
C	218	234	225	219	218	219	204	174	151
D	295	318	306	282	275	266	241	208	185
E	328	<b>381</b>	360	348	327	310	283	246	200
F	321	367	365	352	337	315	274	238	201
G	238	281	290	287	280	265	229	187	142

## Socket Burner

averaged air velocities

	1	2	3	4	5	6	7	8	9
A	155	185	214	203	197	173	146	130	113
B	200	220	231	246	224	199	166	140	126
C	232	239	261	241	228	196	163	137	118
D	292	280	274	266	237	192	162	126	110
E	387	366	346	316	284	236	193	146	128
F	<b>437</b>	429	413	368	330	290	242	182	163
G	402	407	404	361	329	279	226	167	124

Air Velocity Map, FAA Burner

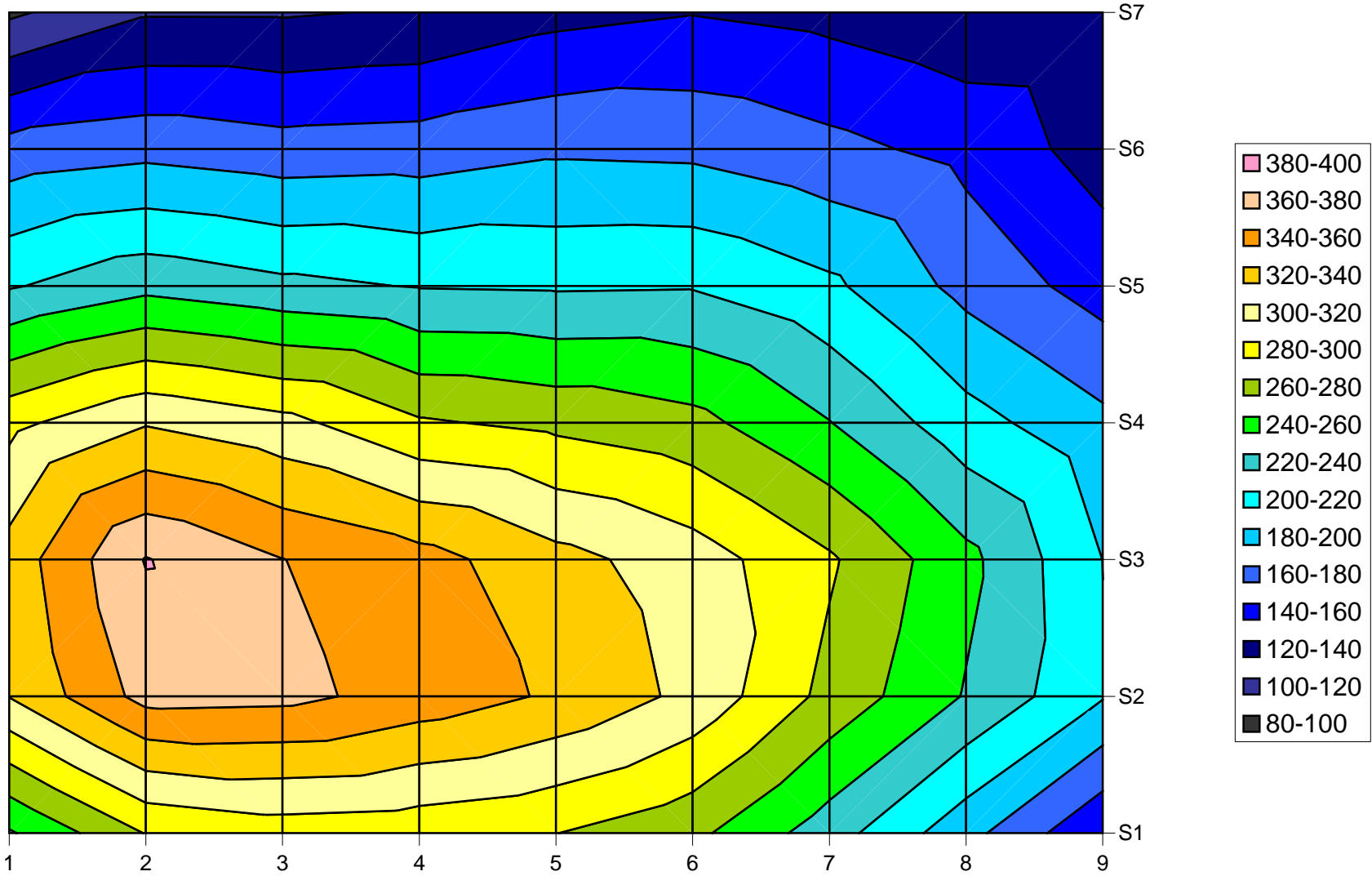

Air Velocity Map, Round Burner A

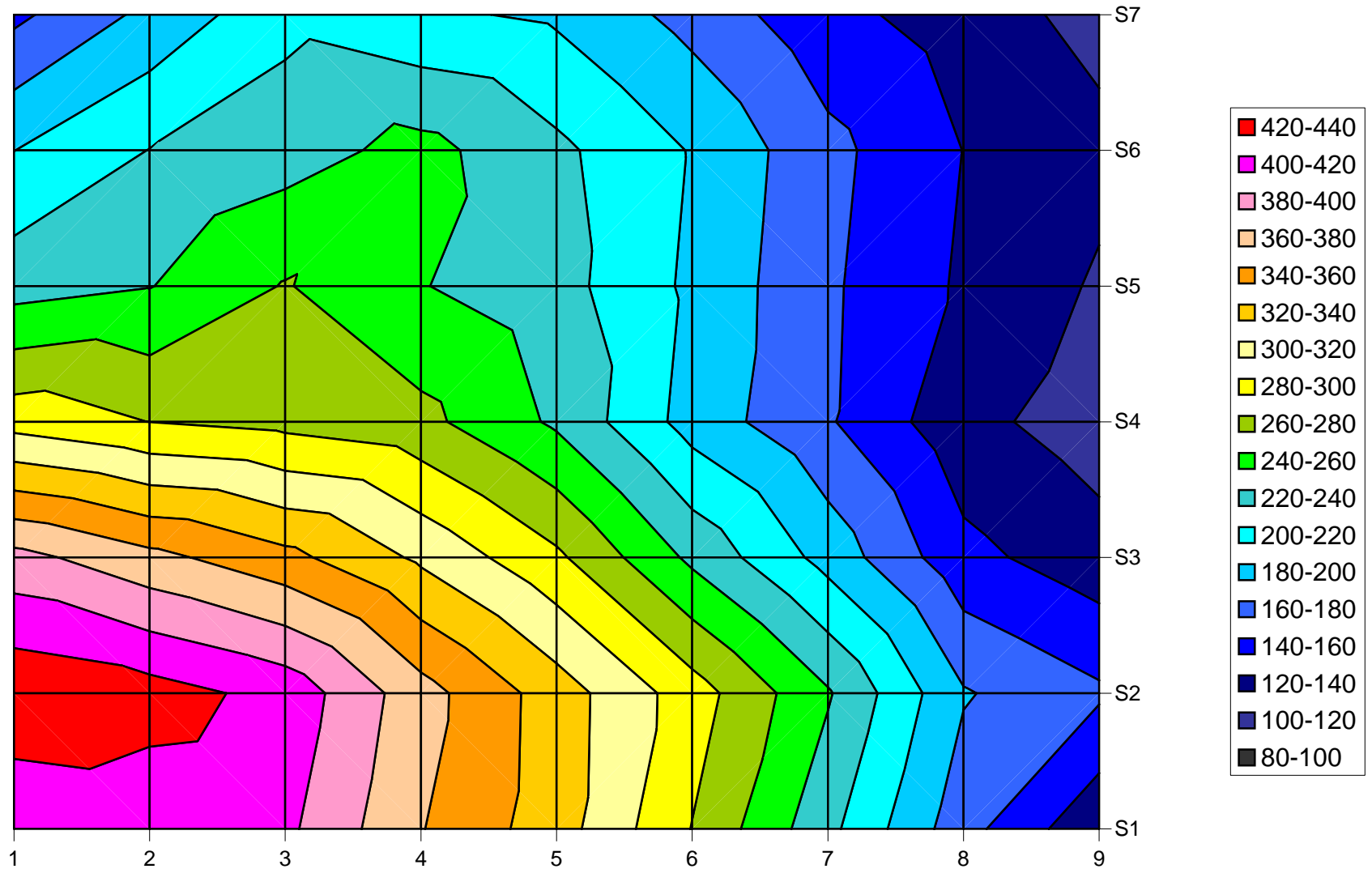

# Analysis of Exit Air Velocity Measurement

averaged air velocities

	1	2	3	4	5	6	7	8	9
A	96	118	118	122	134	139	134	125	123
B	168	174	168	170	177	175	165	154	131
C	218	234	225	219	218	219	204	174	151
D	295	318	306	282	275	266	241	208	185
E	328	<b>381</b>	360	348	327	310	283	246	200
F	321	367	365	352	337	315	274	238	201
G	238	281	290	287	280	265	229	187	142

Flanged Burner Total Average = 231 ft/min

averaged air velocities

	1	2	3	4	5	6	7	8	9
A	155	185	214	203	197	173	146	130	113
B	200	220	231	246	224	199	166	140	126
C	232	239	261	241	228	196	163	137	118
D	292	280	274	266	237	192	162	126	110
E	387	366	346	316	284	236	193	146	128
F	<b>437</b>	429	413	368	330	290	242	182	163
G	402	407	404	361	329	279	226	167	124

Socket Burner Total Average = 238 ft/min

# Analysis of Exit Air Velocity Measurement

Peak Exit Velocity of Flanged Burner = 381 ft/min

Peak Exit Velocity of Socket Burner = 437 ft/min

$$381/437 = 87\% \text{ and } 87\% \text{ of } 2150 = 1874 \text{ ft/min}$$

Adjust intake velocity to approx 1874 ft/min, determine effect

# Socket Burner with Adjusted Intake Velocity of 1900 ft/min

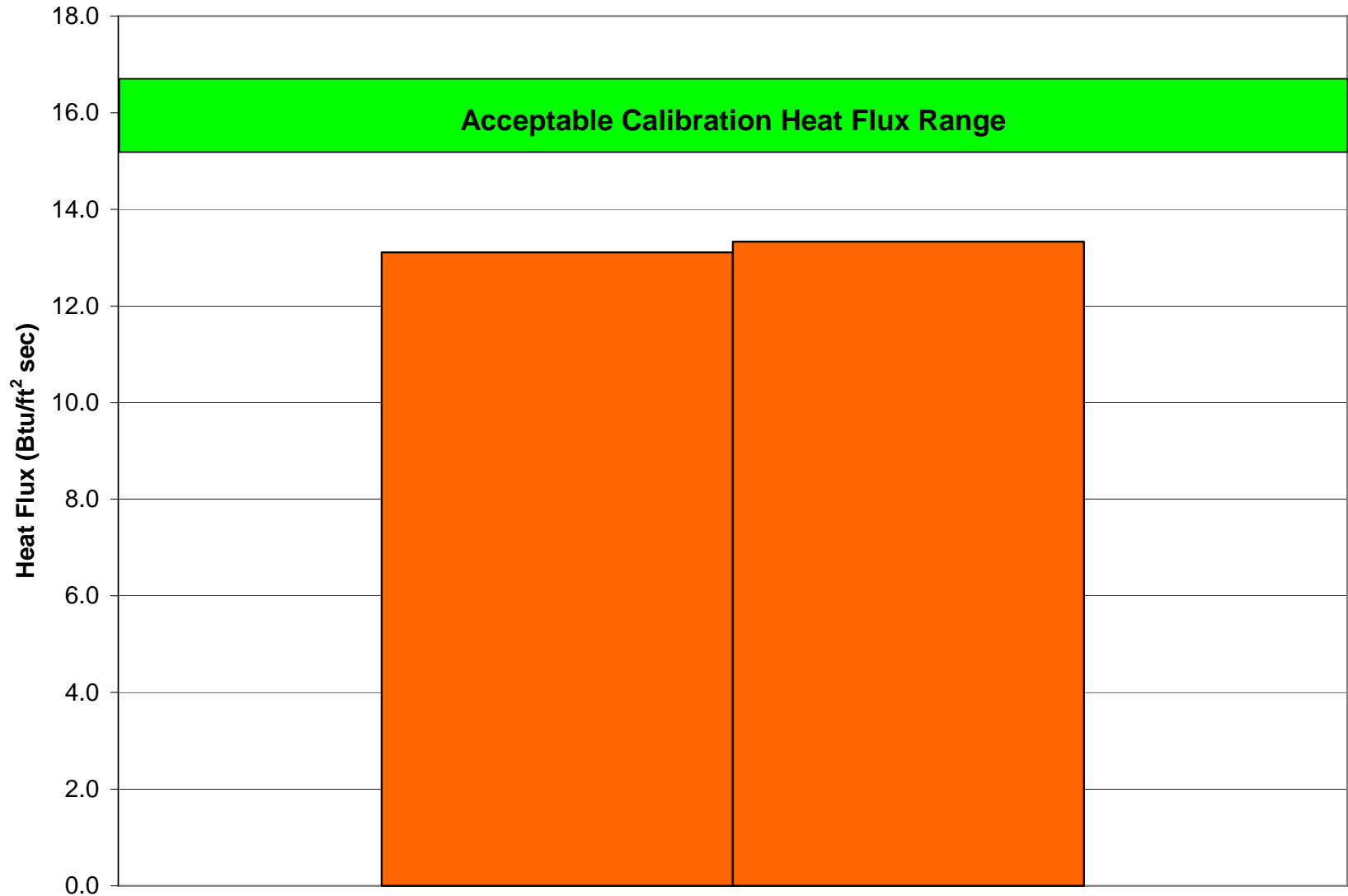



# Socket Burner with Adjusted Intake Velocity of 1900 ft/min

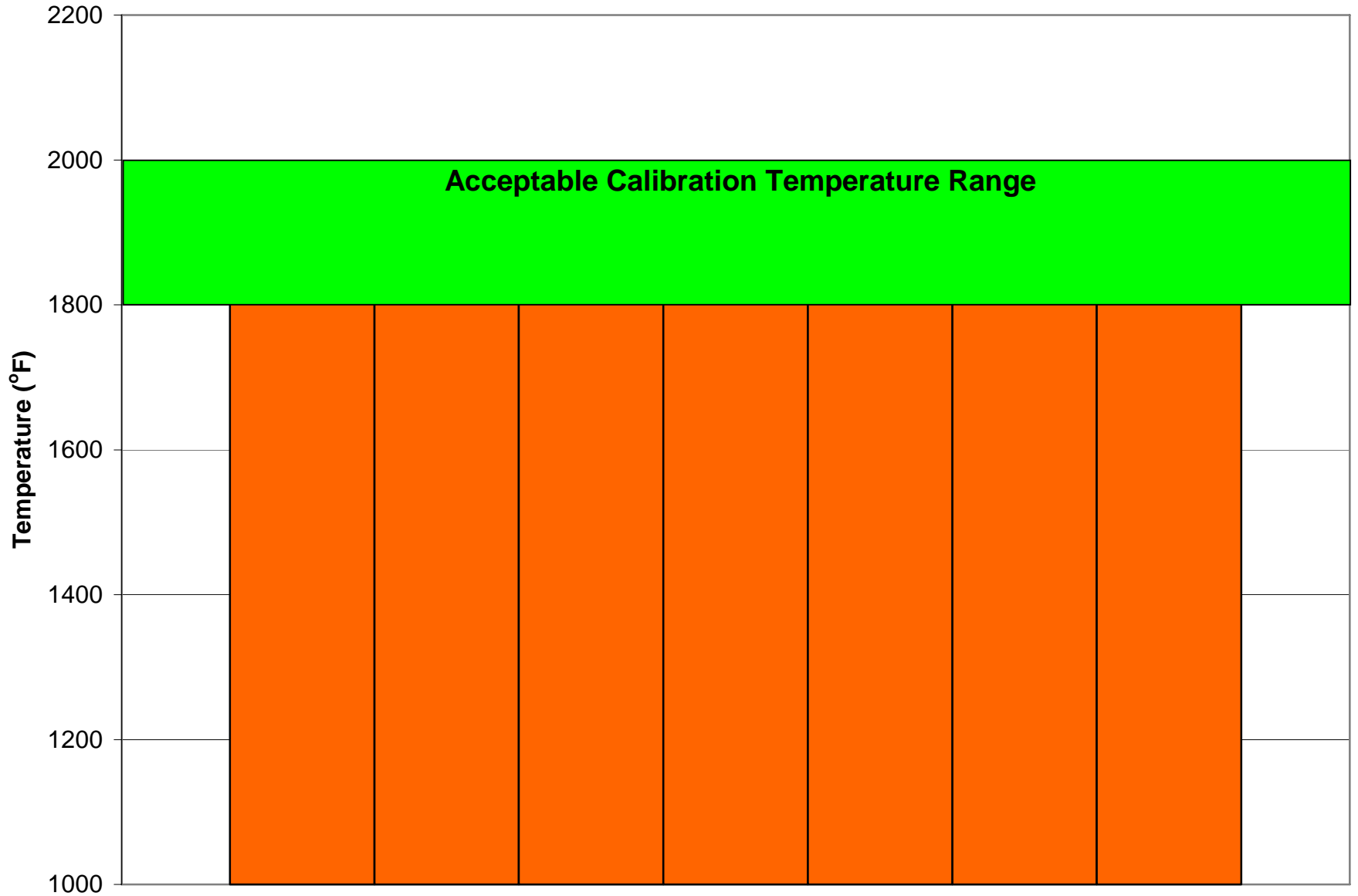

# Socket Burner with Adjusted Intake Velocity of 1900 ft/min

## **Burnthrough of TexTech 8 oz/yd<sup>2</sup> at 3 min 59 sec**

**Interim Conclusion 1:** calibration heat flux and temperature profile not impacted by reduced exit air velocity.

**Interim Conclusion 2:** burnthrough test results are highly dependent on reduced exit air velocity.

# Possible Simple Modifications to Socket Burner

**Objective:** To develop a simple modification to the socket burner that would result in equivalent performance to the flanged burner (i.e., reduced exit air velocity while maintaining specified 2150 ft/min intake velocity).

**Methodology:** Alter the flow of air in the draft tube using various deflectors, discs, and stators in order to reduce the output velocity.

# RTV Sealant Added to Blade Edge

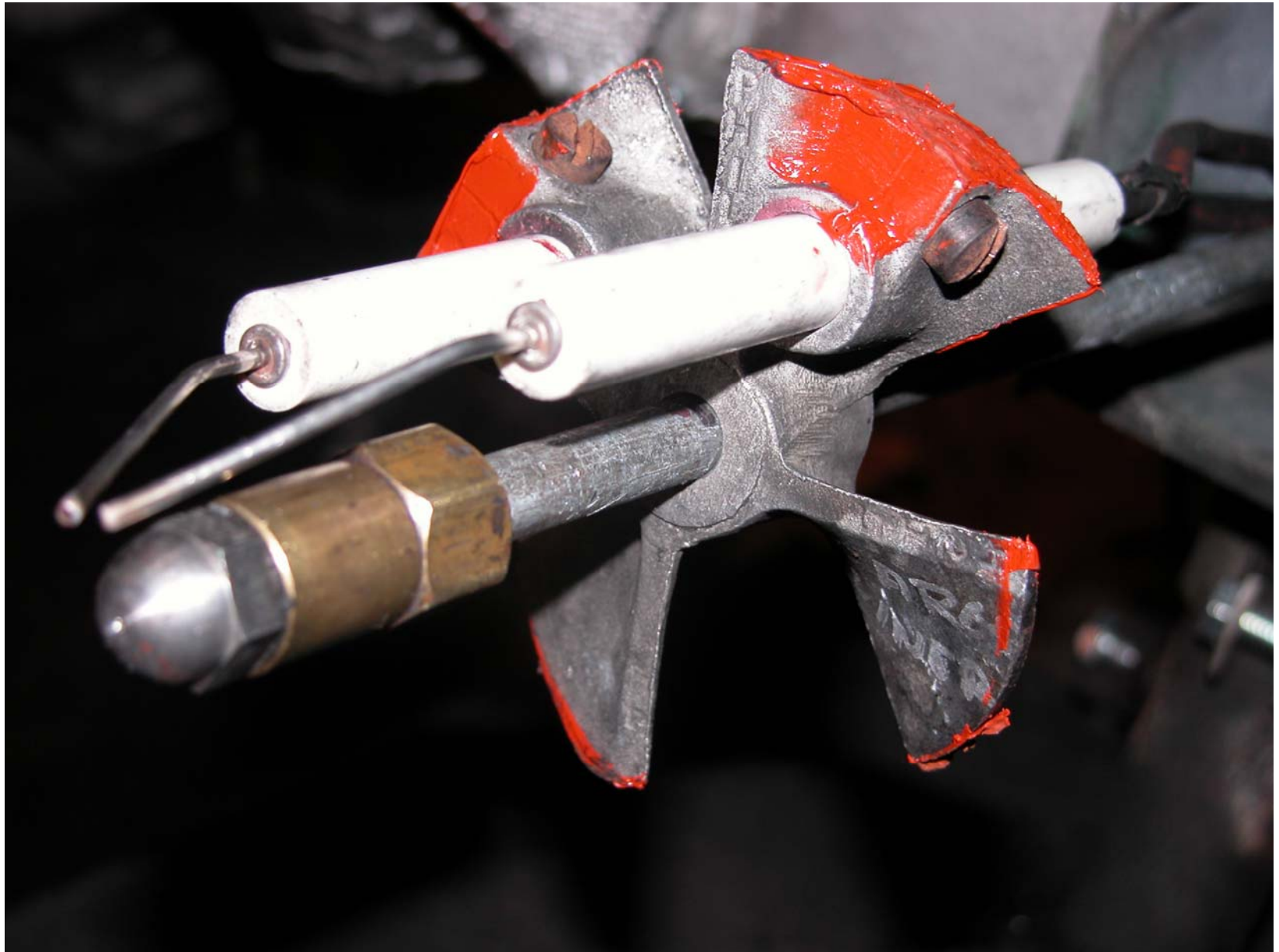

# Possible Simple Modifications to Socket Burner

3 1/8 inch disc behind stator

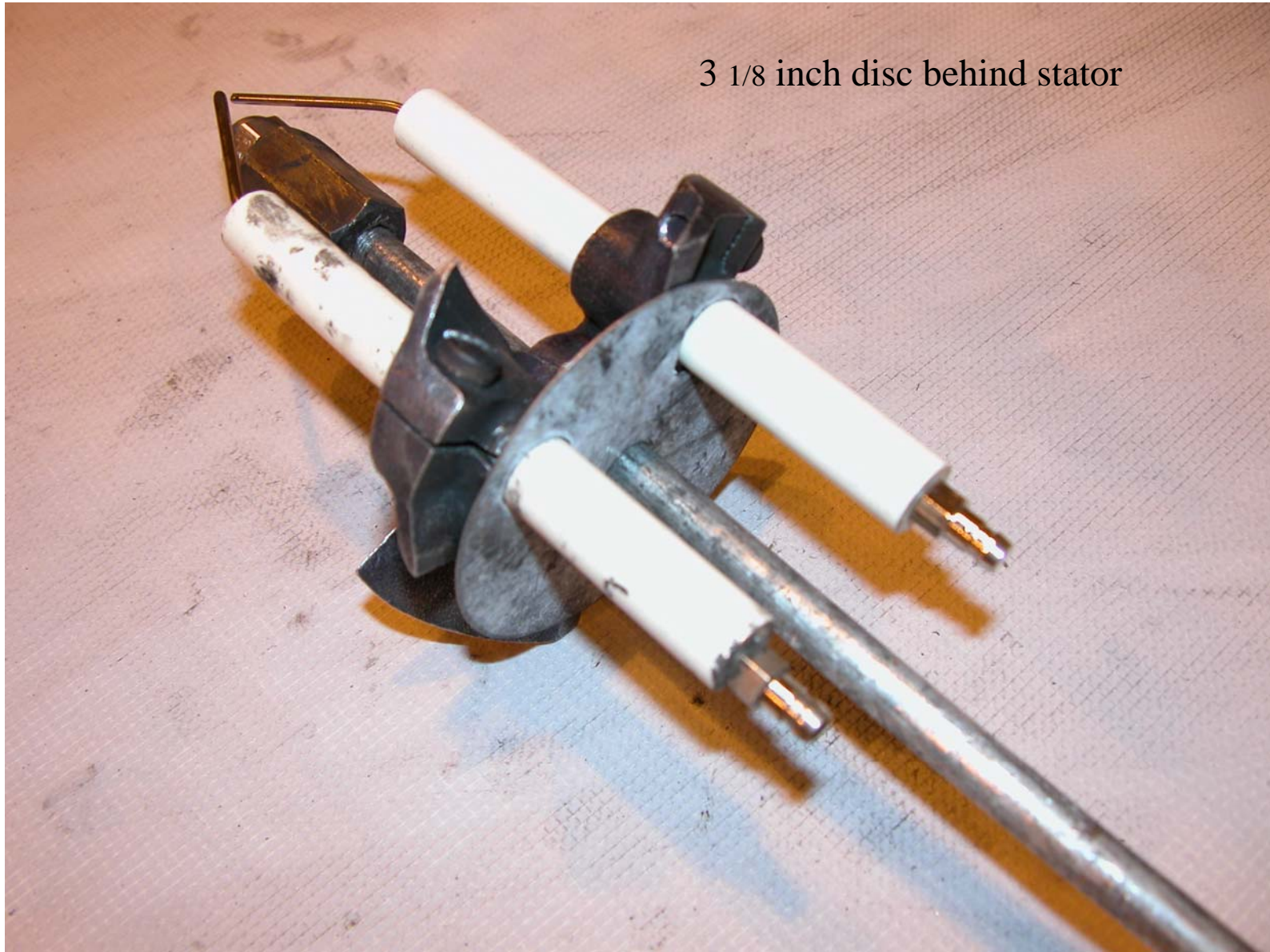



## Possible Simple Modifications to Socket Burner

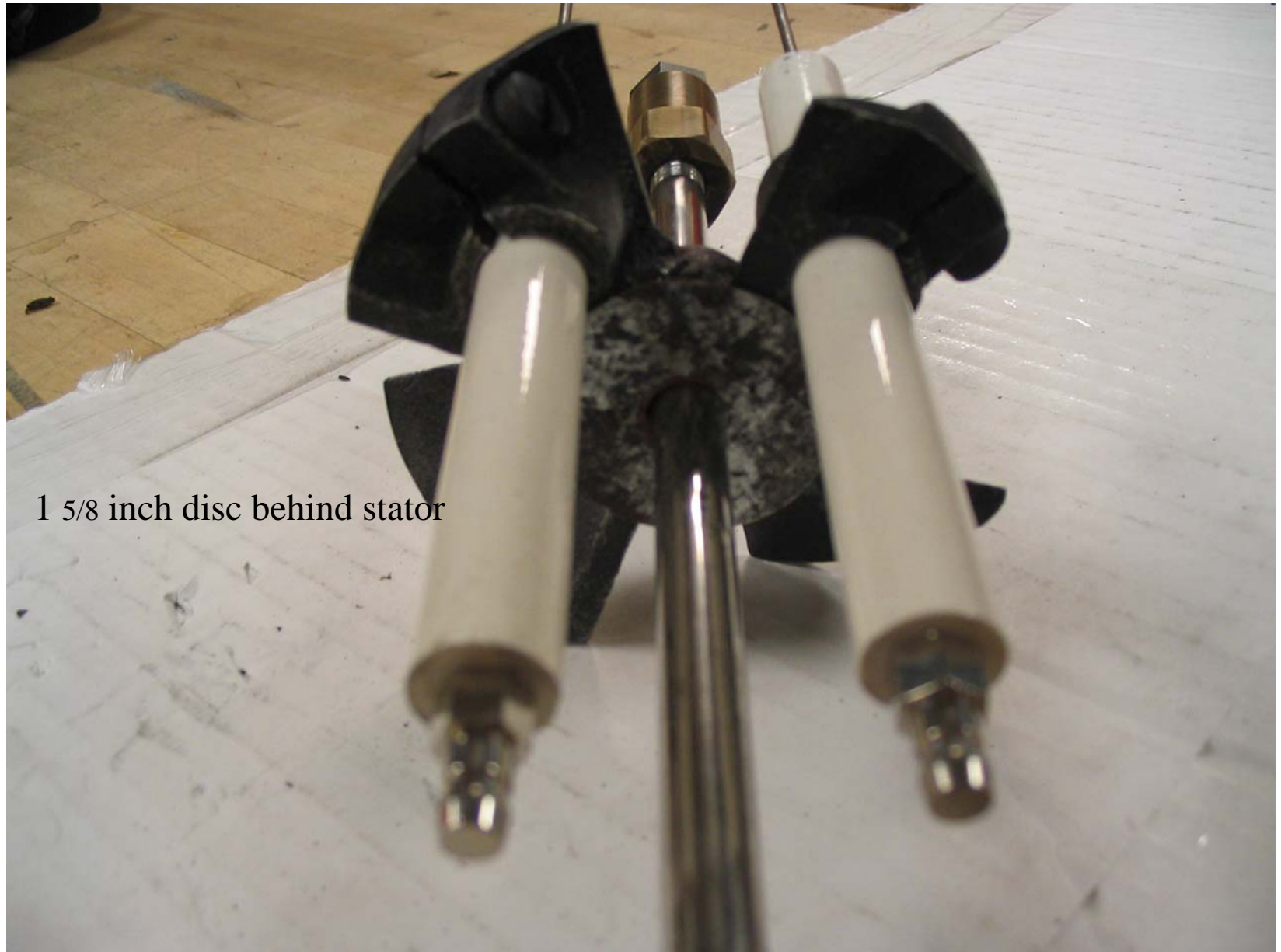

# Possible Simple Modifications to Socket Burner



1 3/8 inch disc behind stator



## Possible Simple Modifications to Socket Burner



## Possible Simple Modifications to Socket Burner



Half moon static disc behind stator

## Possible Simple Modifications to Socket Burner

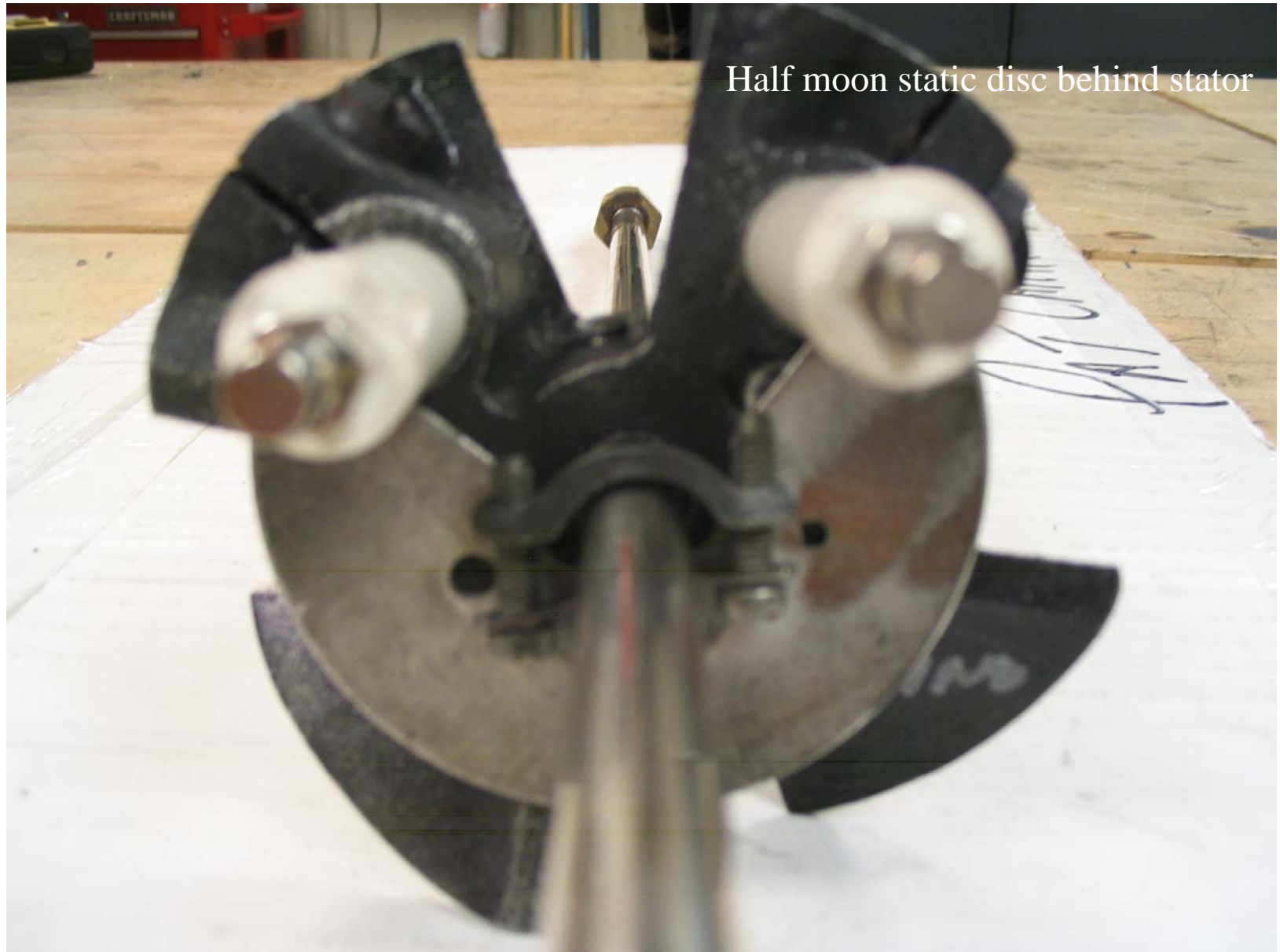



# Possible Simple Modifications to Socket Burner

3 7/8 O.D. by 3 1/2 I.D. Ring



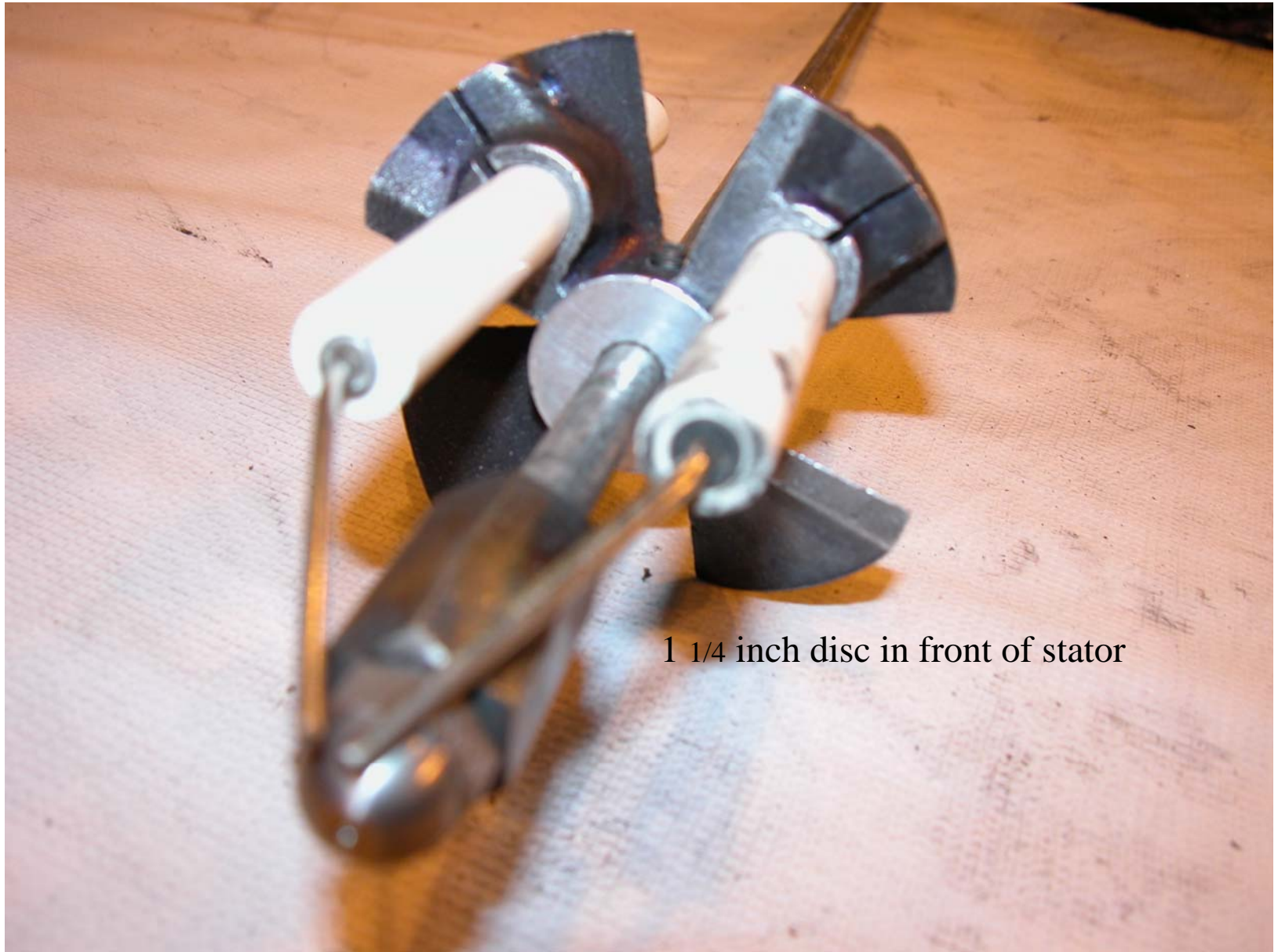

1 1/4 inch disc in front of stator



# Possible Simple Modifications to Socket Burner

3 7/8 O.D. by 3 1/2 I.D. Ring



# Socket Burner Testing

Simple Modifications to Socket Burner  
(Equipped with an Original H215 Stator)

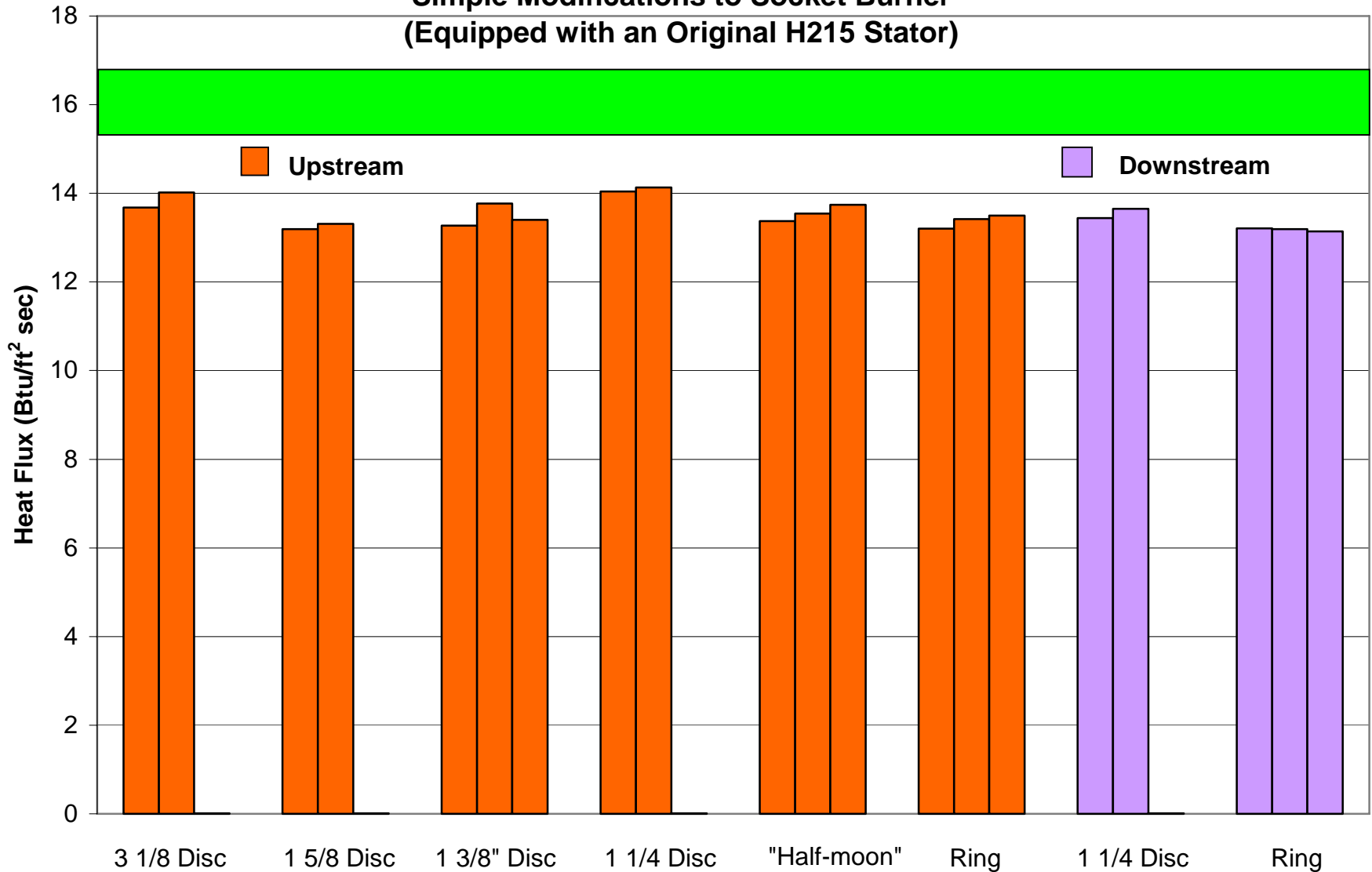

# Possible Simple Modifications to Socket Burner

Thin-blade cross





## Possible Simple Modifications to Socket Burner

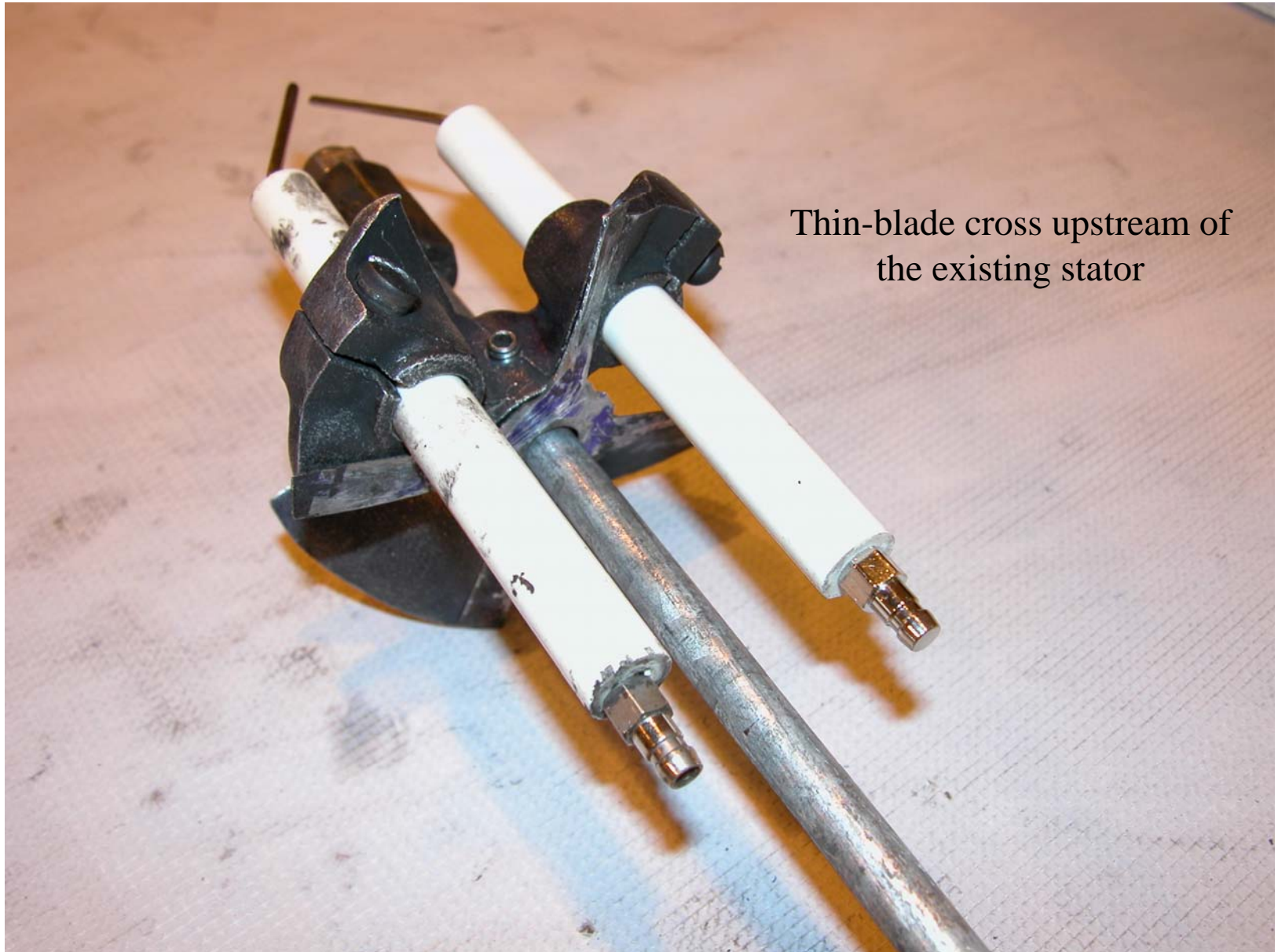

Thin-blade cross upstream of  
the existing stator

# Possible Simple Modifications to Socket Burner

Thin-blade cross upstream of  
the existing stator



## Possible Simple Modifications to Socket Burner





## Possible Simple Modifications to Socket Burner

Thin-blade cross downstream of  
the existing stator



# Socket Burner Testing

**Metal Cross Used in Socket Burner  
(Equipped with an Original H215 Stator)**

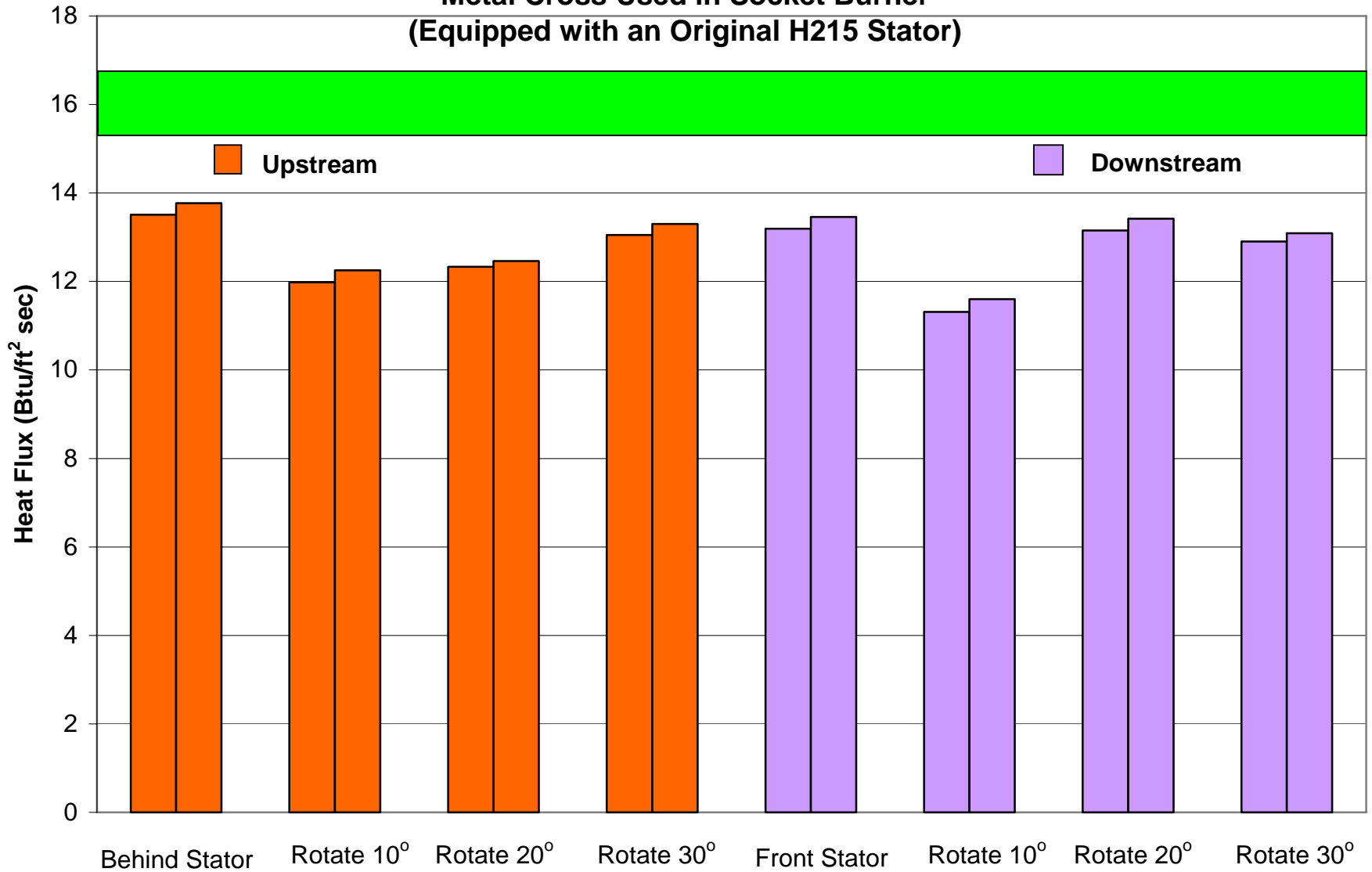



# Assorted Components Used in Socket Burner



## Possible Simple Modifications to Socket Burner

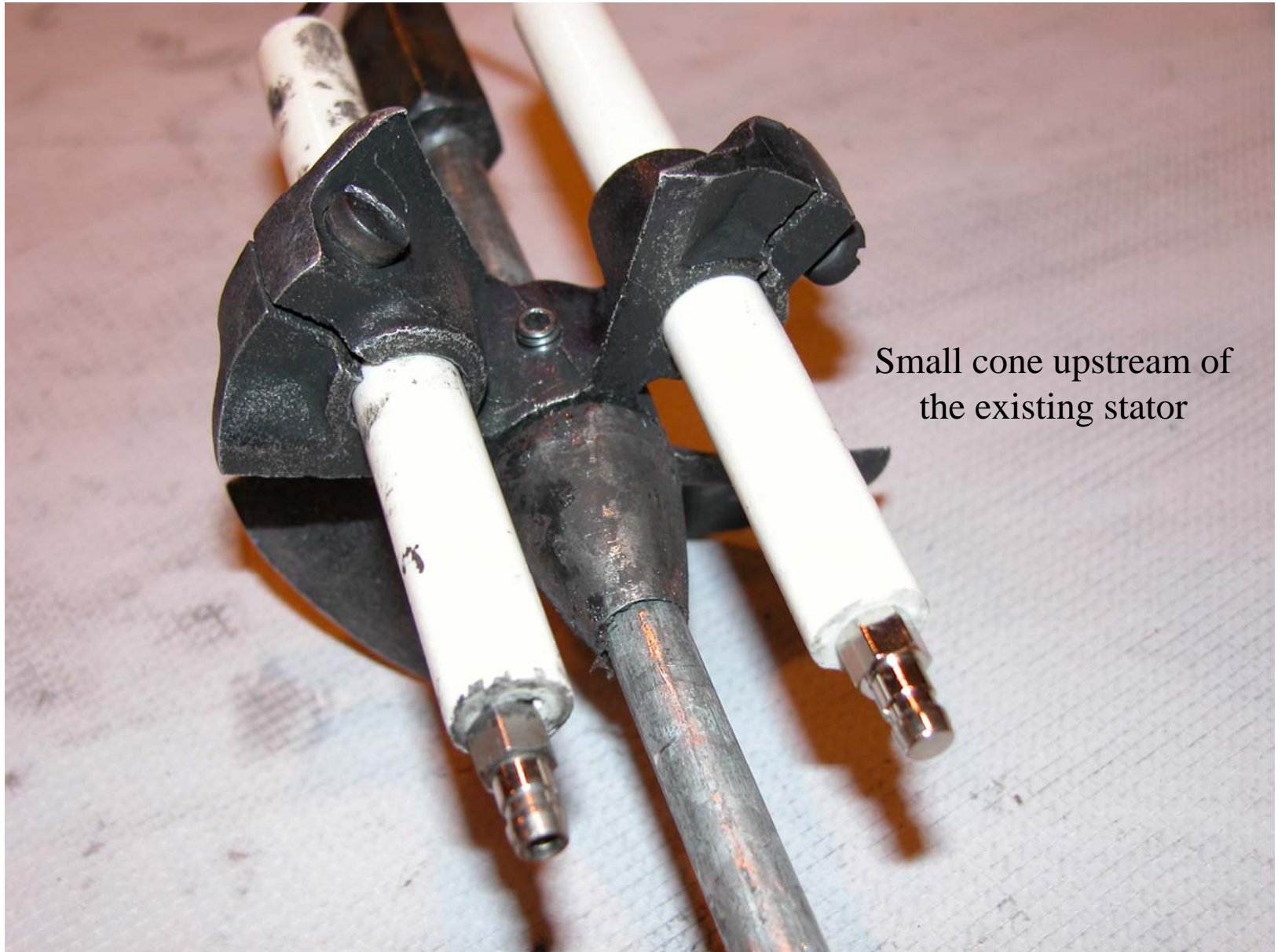

Small cone upstream of  
the existing stator



## Possible Simple Modifications to Socket Burner



Small cone downstream of  
the existing stator

**Small Deflection Cone in Socket Burner  
(Equipped with an Original H215 Stator)**

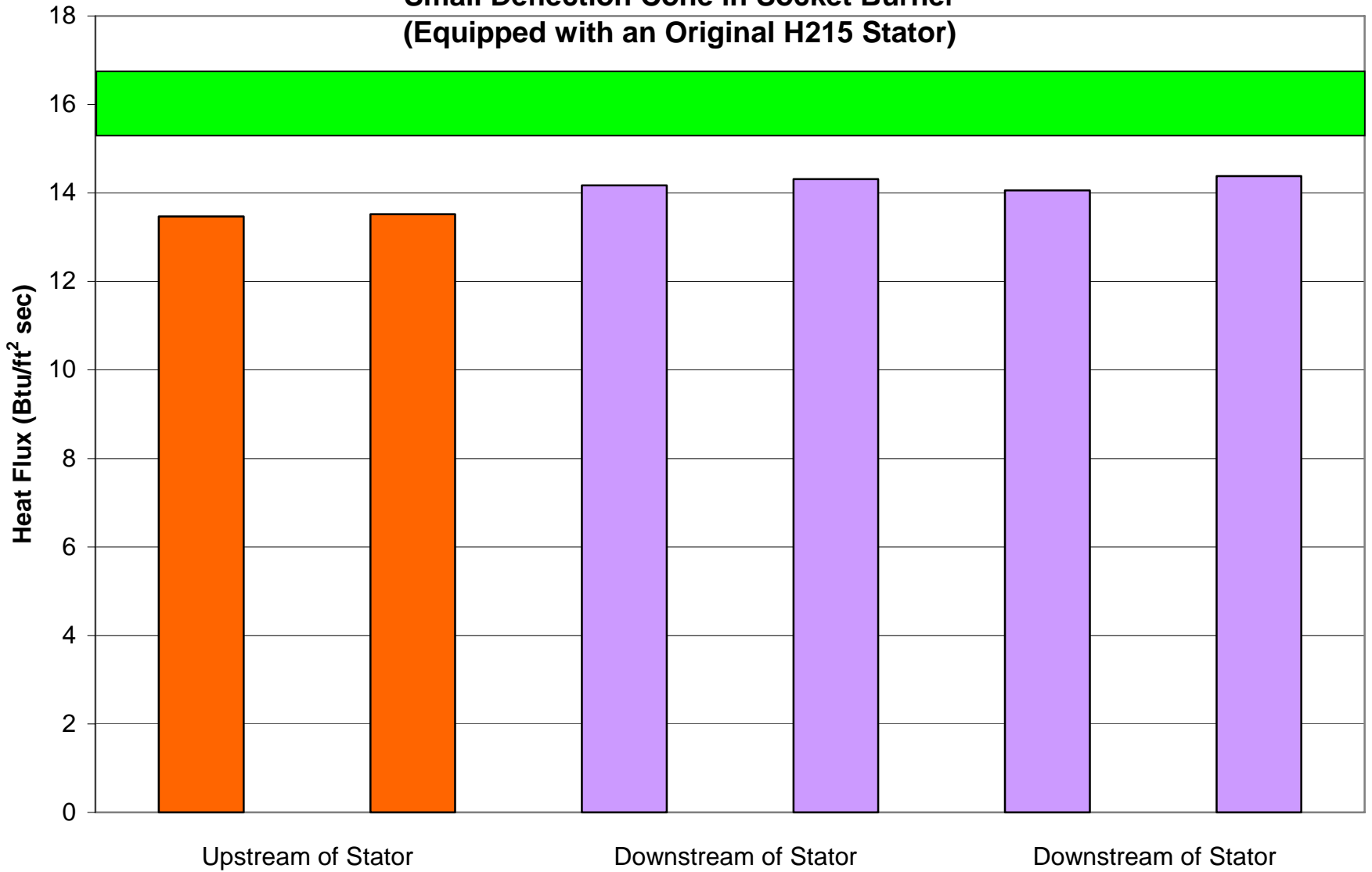

# Current Specification for Stator Position

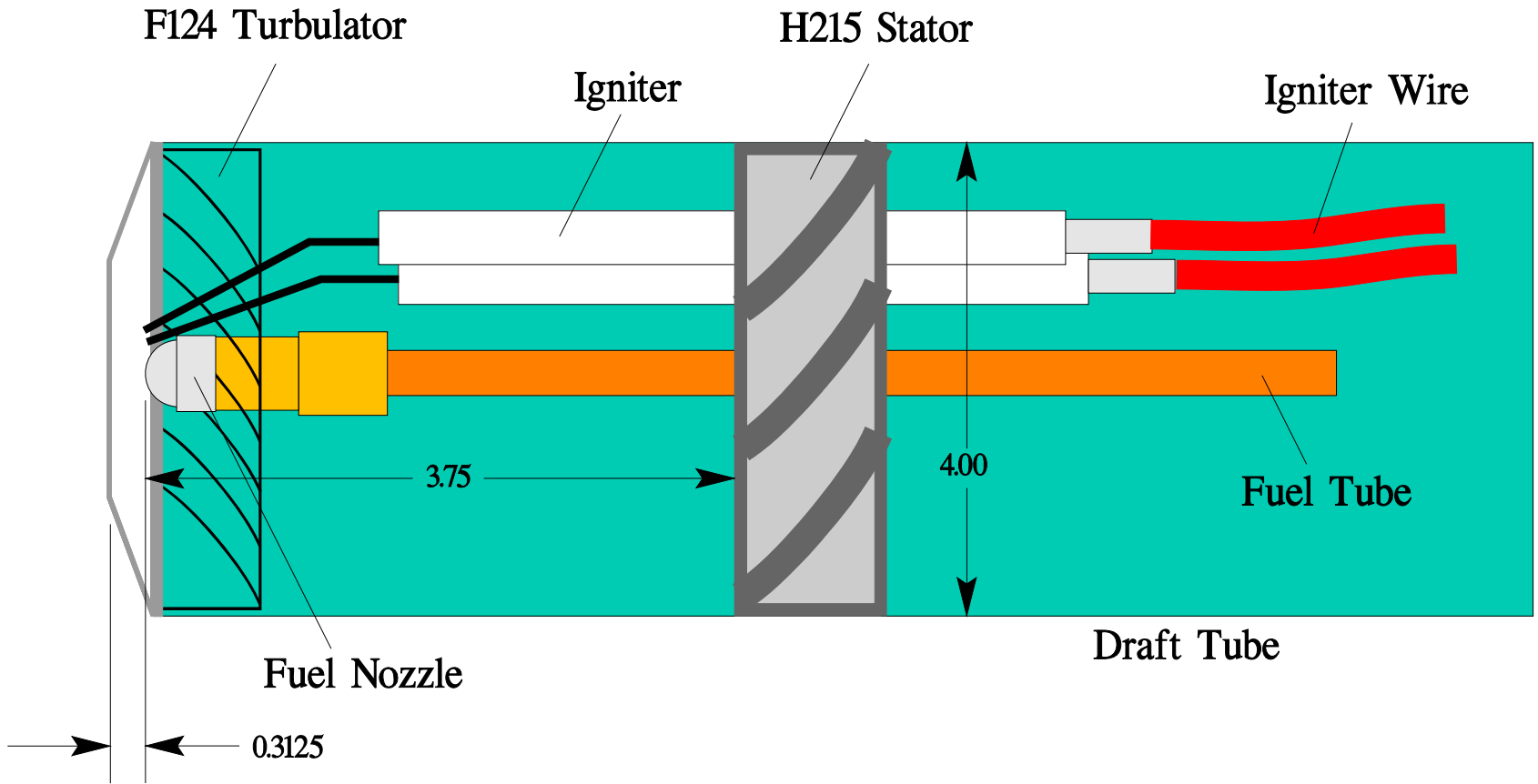



# Socket Burner Testing

Heat Flux as Function of Internal Stator Depth  
Using an Original H215 Stator

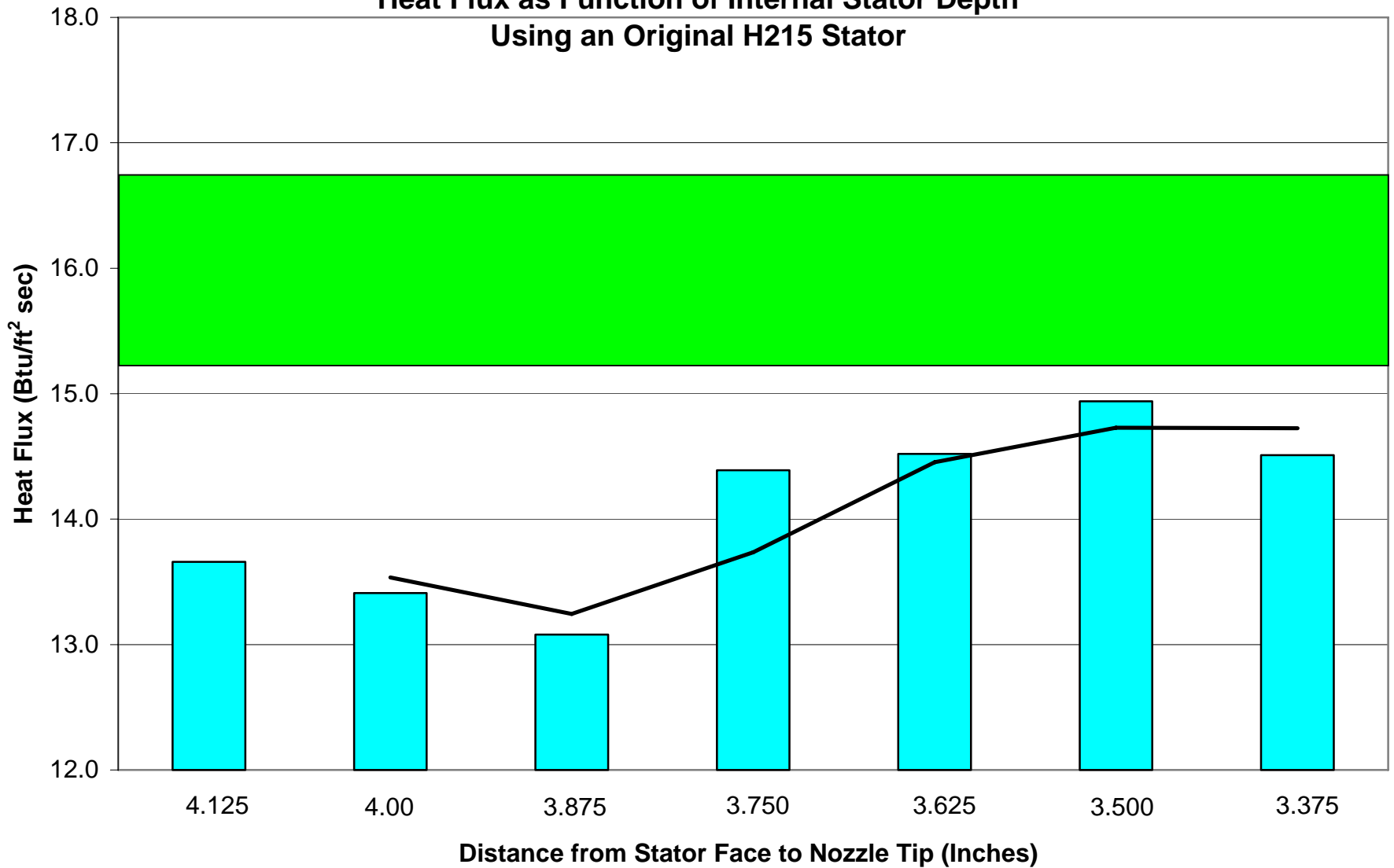

# Reproduction Stator, Modified at Edges of Blades



# Socket Burner Testing

**Reproduction Stator Modified at Edges  
Using Epoxy Filler (Initial Modification)**

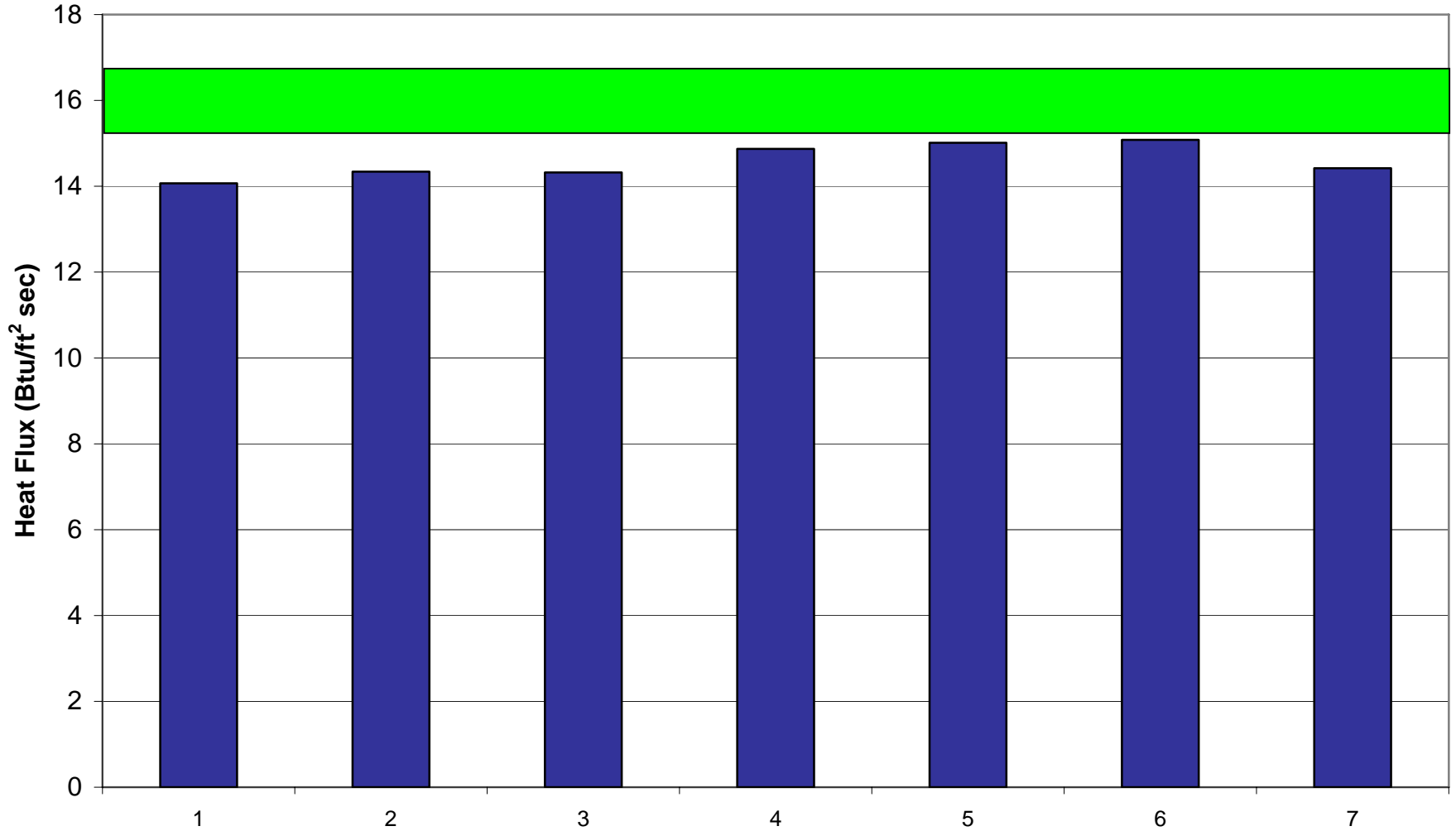

# Reproduction Stator, Modified at Edges of Blades





# Reproduction Stator, Modified at Edges of Blades



# Socket Burner Testing

Heat Flux as a Function of Stator Depth  
Using Modified Reproduction Stator (Final Modification)

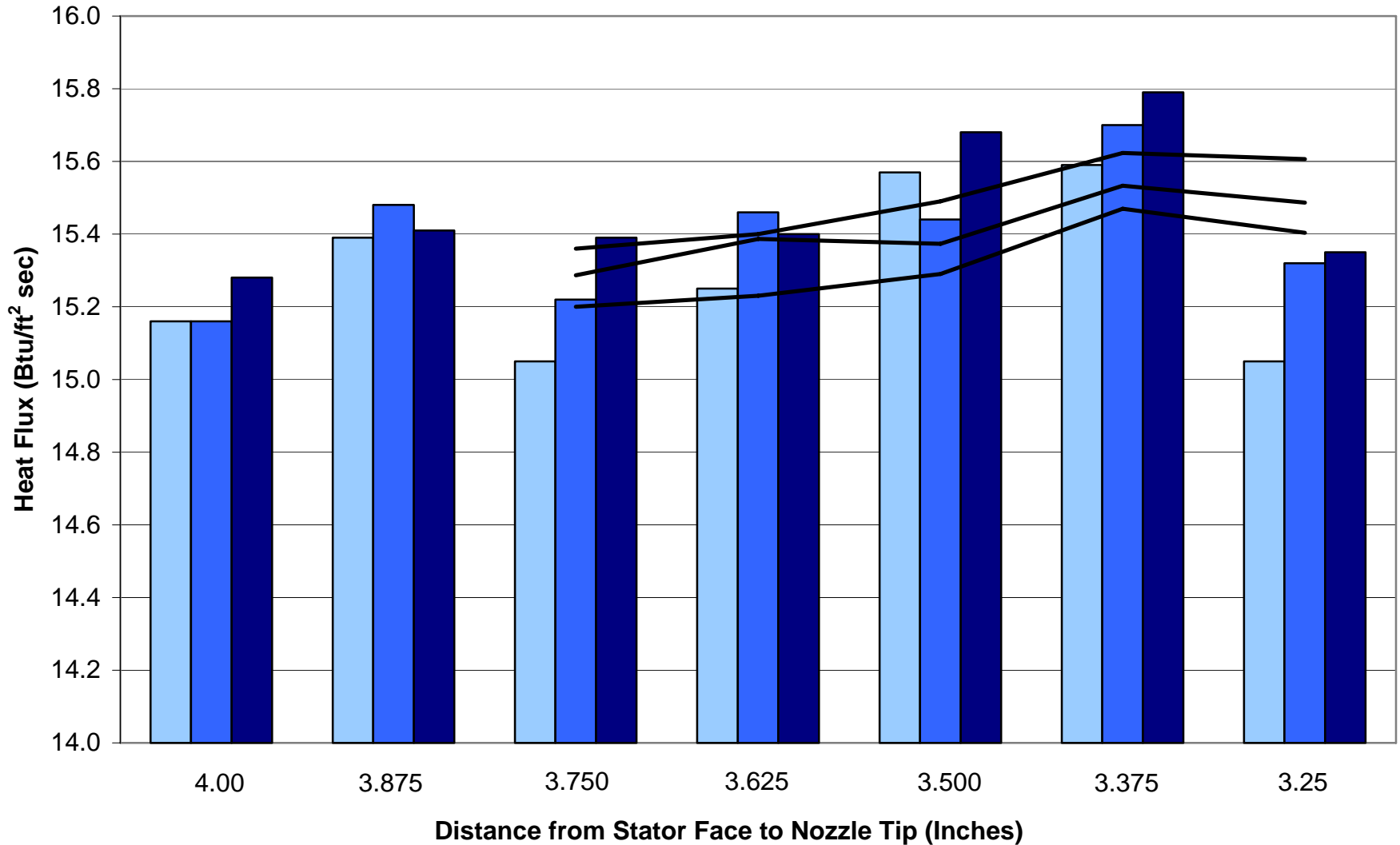

# Socket Burner Testing

**Heat Flux as a Function of Stator Depth  
Using Modified Reproduction Stator (Final Modification)**

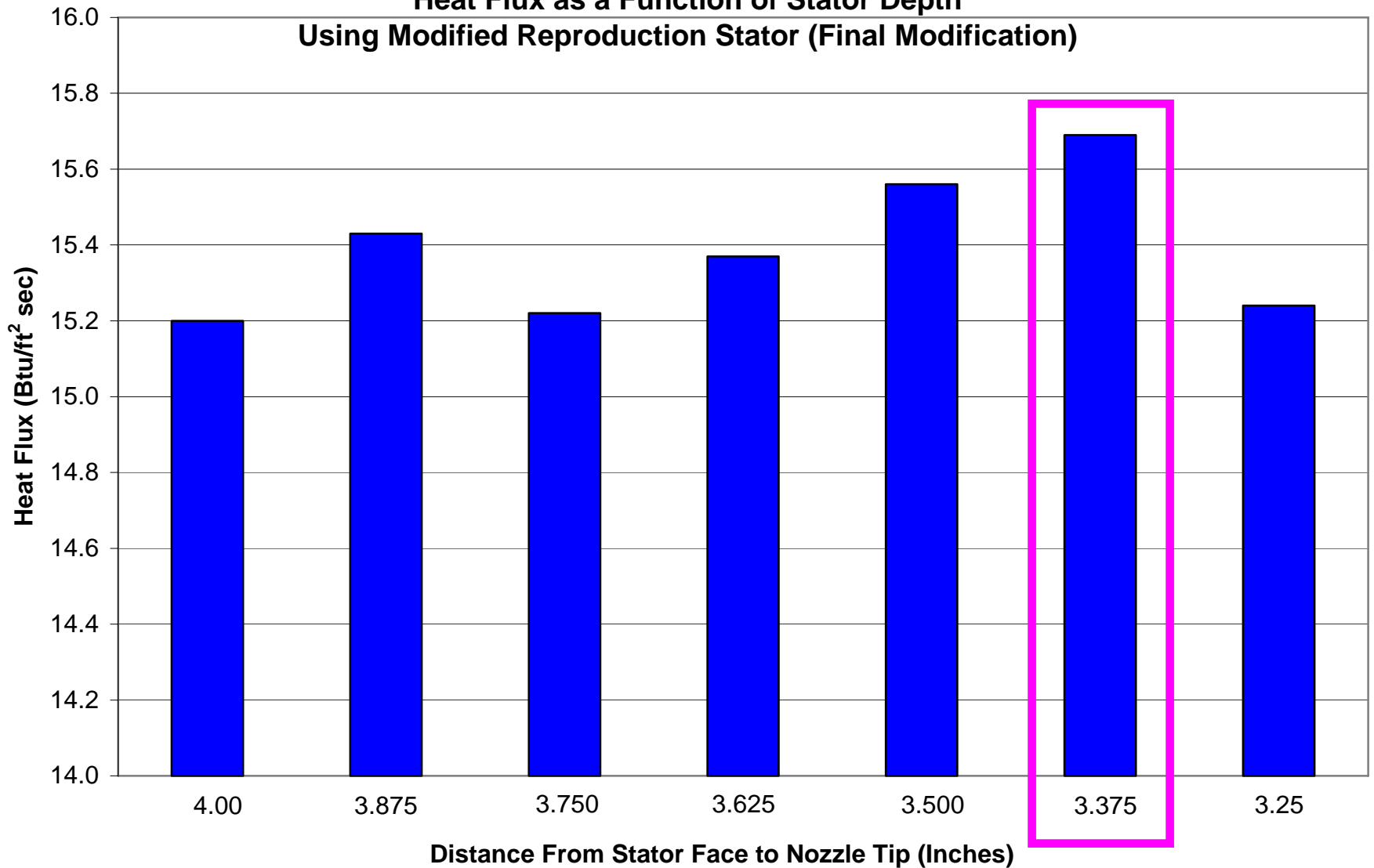

# Test Results of "New" TexTech 8 oz/yd<sup>2</sup> Felt Using Socket Burner w/Modified Reproduction Stator

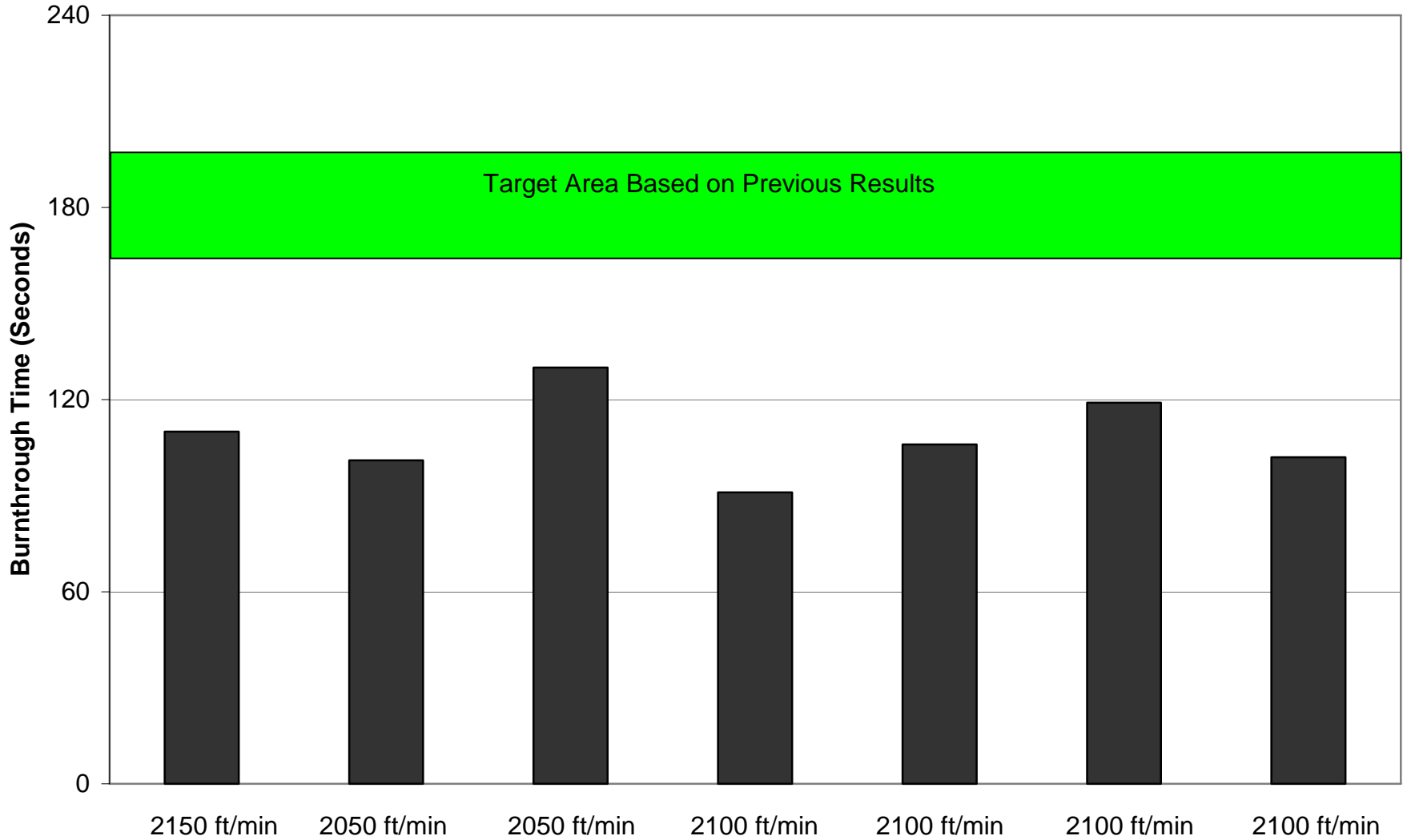



# New TexTech Material Showing Creased Areas



# Burnthrough Location of New TexTech Material

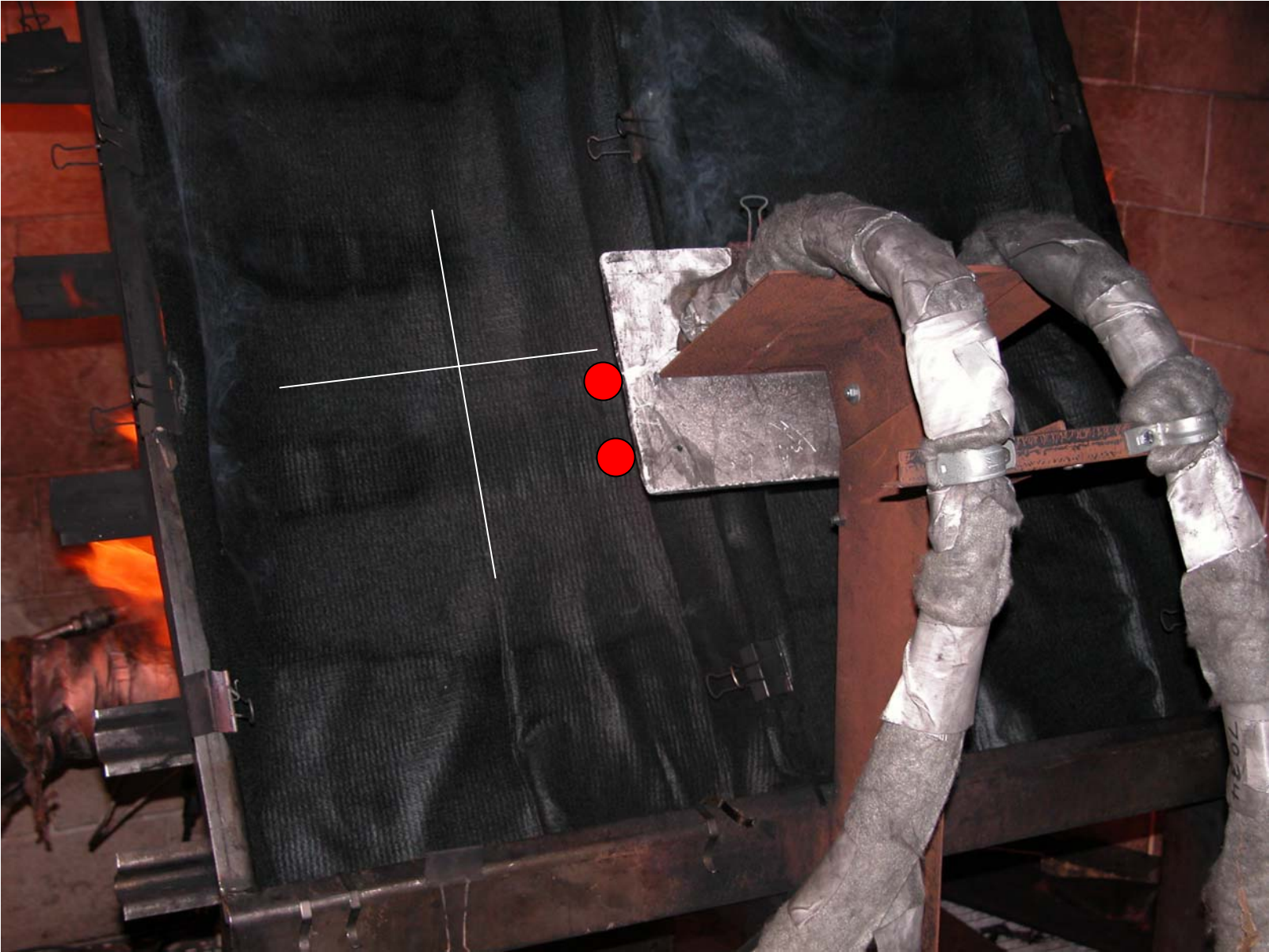

# Comparison of Flanged and Socket Burners

Test Results Using "New" TexTech 8 oz/yd<sup>2</sup> Felt

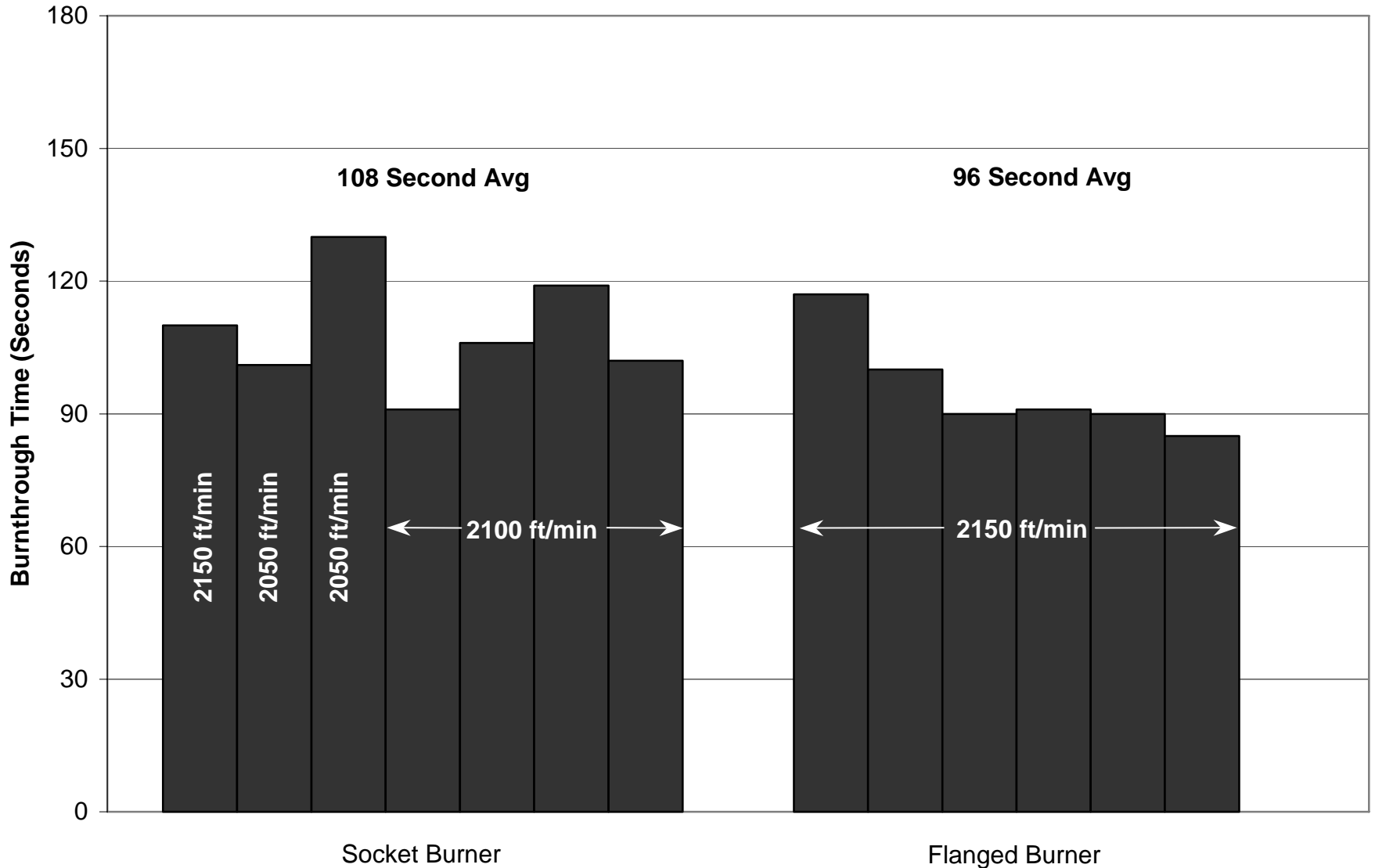

# Comparison of Flanged and Socket Burners

Test Results Using TexTech 14 oz/yd<sup>2</sup> Felt

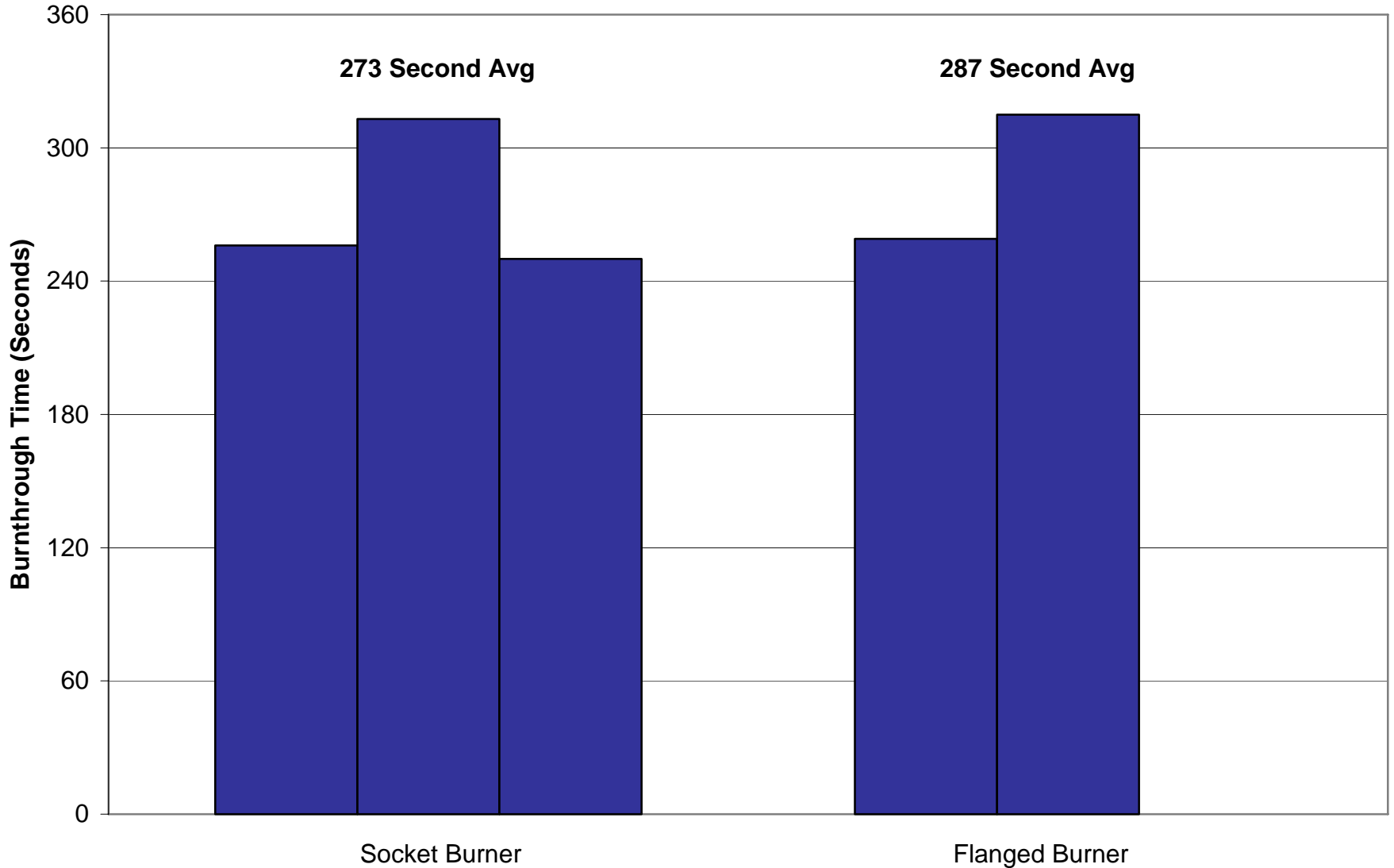



# Summary of Testing

- Slight differences in burner housings/draft tube result in higher exit air velocity when using the socket-style burner.
- Lowering the intake velocity of the socket burner to 1900 ft/min resulted in good correlation to flanged burner, but heat flux still low (when using unmodified stator).
- An assortment of modifications were tested in an attempt to reduce the exit air velocity, and ultimately replicate the flanged burner performance. Modifications placed upstream and downstream of the stator appeared to have very little impact on the measured heat flux.

## Summary of Testing (con't)

- Enlargement of stator diameter, resulting in a tighter fit within the draft tube bore, produced higher heat flux in socket burner.
- Positioning of the stator within the draft tube was critical in maximizing the heat flux for the socket burner.
- Final results using modified stator at maximized depth indicate good correlation between socket and flanged burners.

# Influence of Material on Test Method Results

# Consistency of Test Data Using TexTech Blanket Material





# Consistency of Test Data Using TexTech Blanket Material





# Consistency of Test Data Using TexTech Blanket Material



# Consistency of Test Data Using TexTech Blanket Material

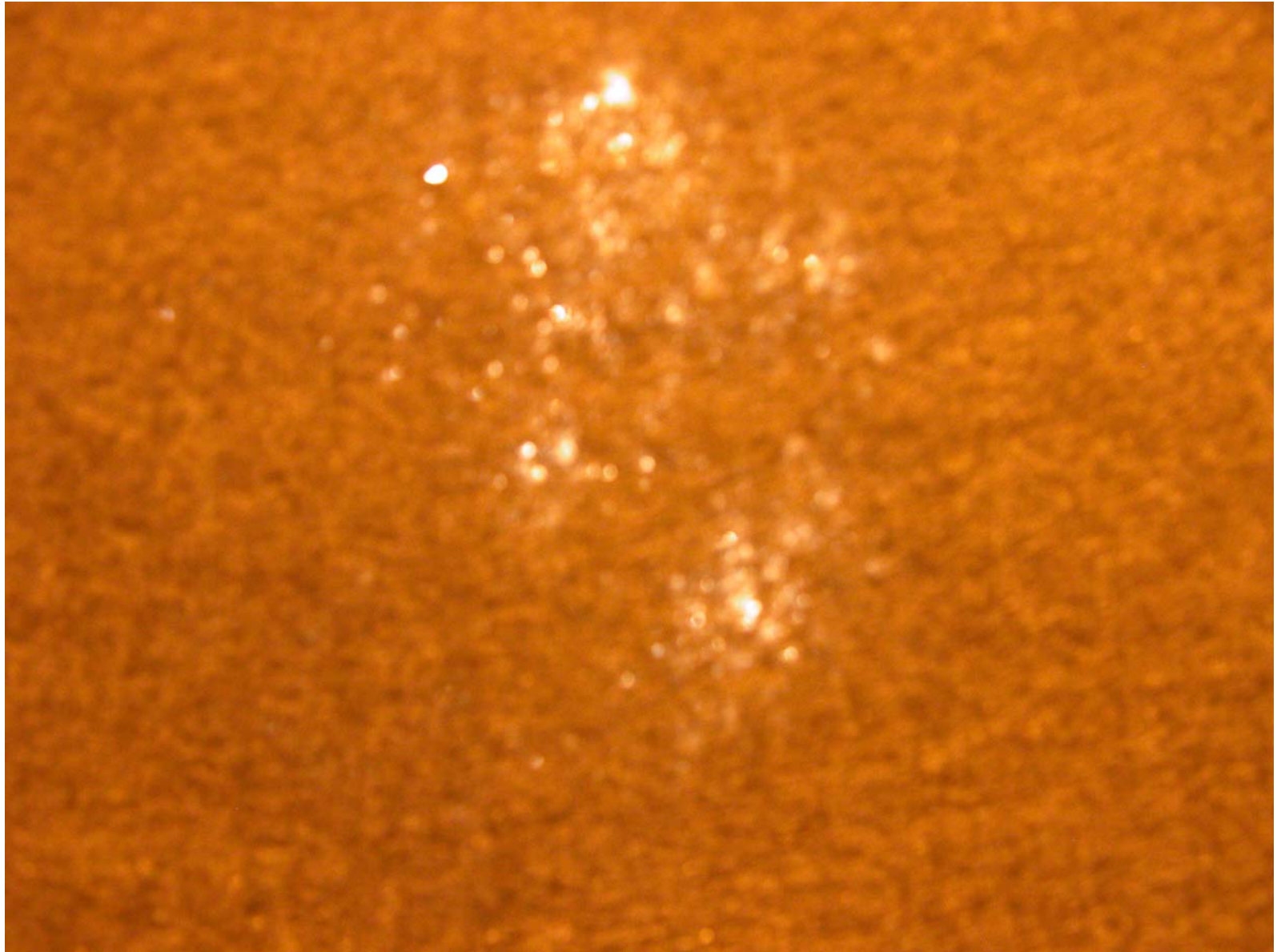



# Consistency of Test Data Using TexTech Blanket Material

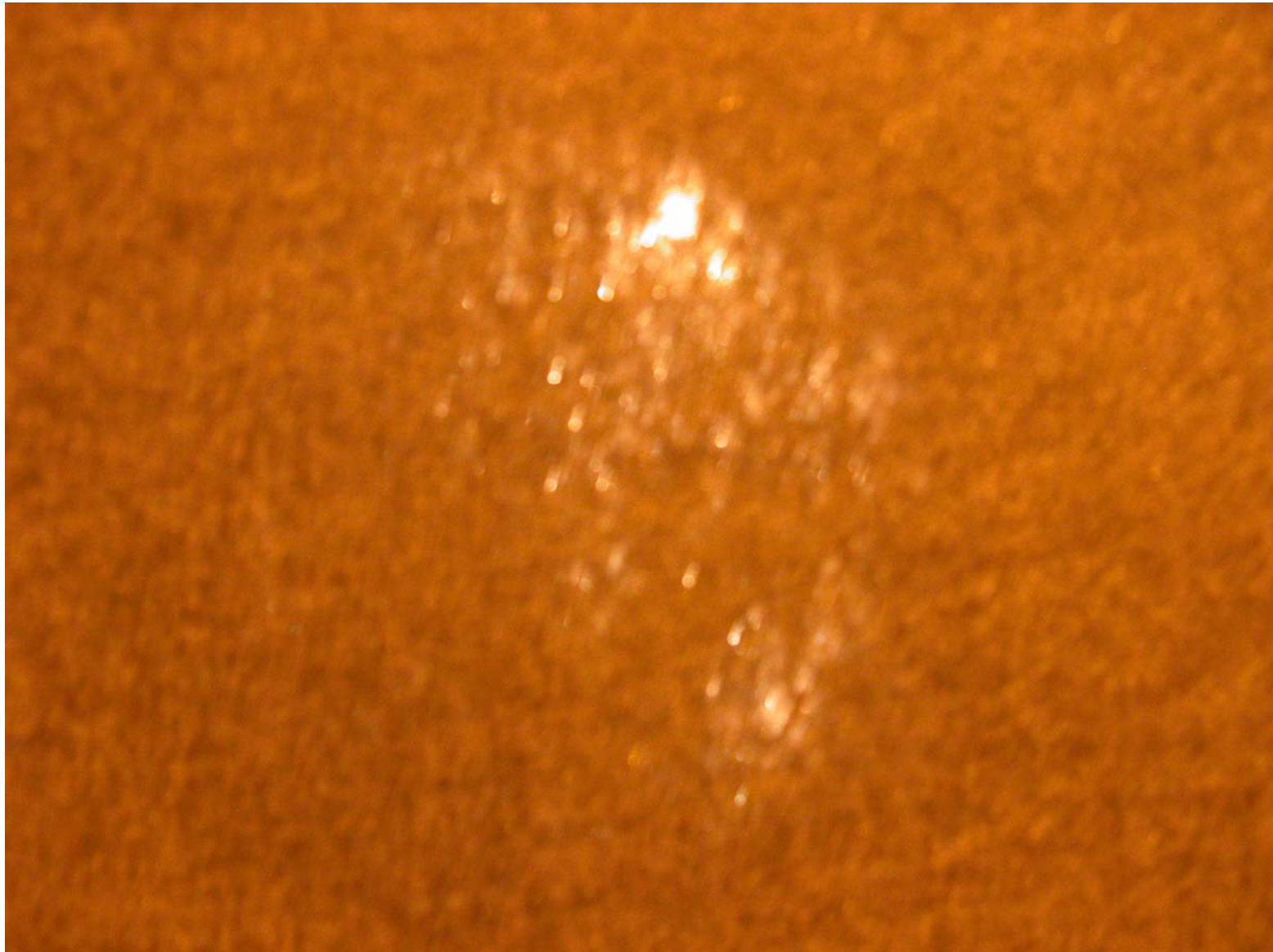



# Tex Tech Style 362 (8.0 Oz/Yd<sup>2</sup> PAN Blanket)

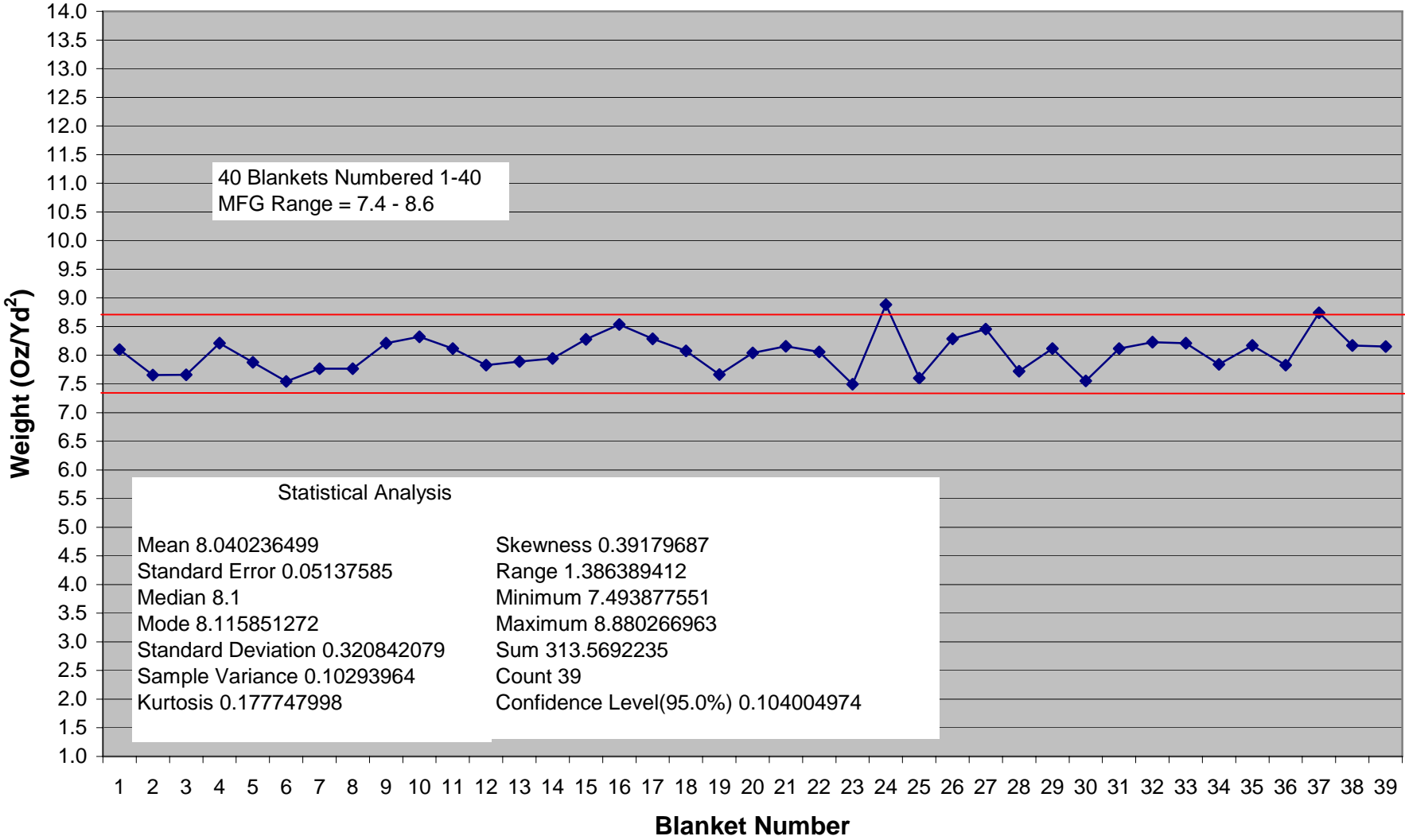

# Planned Activities

Confirm stator modifications are repeatable in socket burner.

Supply modified stators to participating labs that currently use the socket style burner.

Conduct socket-burner round robin, with original FAA burner as a control.

Consider blueprinting optimal stator, reproduce via machining (no casting!).

Develop a new stator for future use, which can be produced via machining.