

APPENDIX A: SAR TEST DATA

PCTEST ENGINEERING LABORATORY, INC.

DUT: CF-T7/W7; Type: Notebook PC with WLAN abg, Bluetooth and EVDO; SN:7HKSA00020

Communication System: IEEE 802.11b; Frequency: 2437 MHz; Duty Cycle: 1:1

Medium: 2450 Muscle ($\sigma = 1.99$ mho/m, $\epsilon_r = 55.12$, $\rho = 1000$ kg/m³)

Phantom section: Flat Section

Test Date: 09-03-2007; Ambient Temp: 23.6°C; Tissue Temp: 21.8°C

Probe: EX3DV4 - SN3589; ConvF(6.37, 6.37, 6.37); Calibrated: 5/28/2007

Sensor-Surface: 3mm (Mechanical Surface Detection)

Electronics: DAE4 Sn704; Calibrated: 5/25/2007

Phantom: SAM Main; Type: SAM 4.0; Serial: TP-1406

Measurement SW: DASY4, V4.7 Build 53; Postprocessing SW: SEMCAD, V1.8 Build 172

Mode: IEEE 802.11b, Laptop position, Ch.06, 1Mbps, Main Antenna

Area Scan (7x17x1): Measurement grid: dx=15mm, dy=15mm

Zoom Scan (5x5x7)/Cube 0: Measurement grid: dx=8mm, dy=8mm, dz=5mm

Reference Value = 13.2 V/m

Peak SAR (extrapolated) = 0.651 W/kg

SAR(1 g) = 0.276 mW/g; SAR(10 g) = 0.126 mW/g

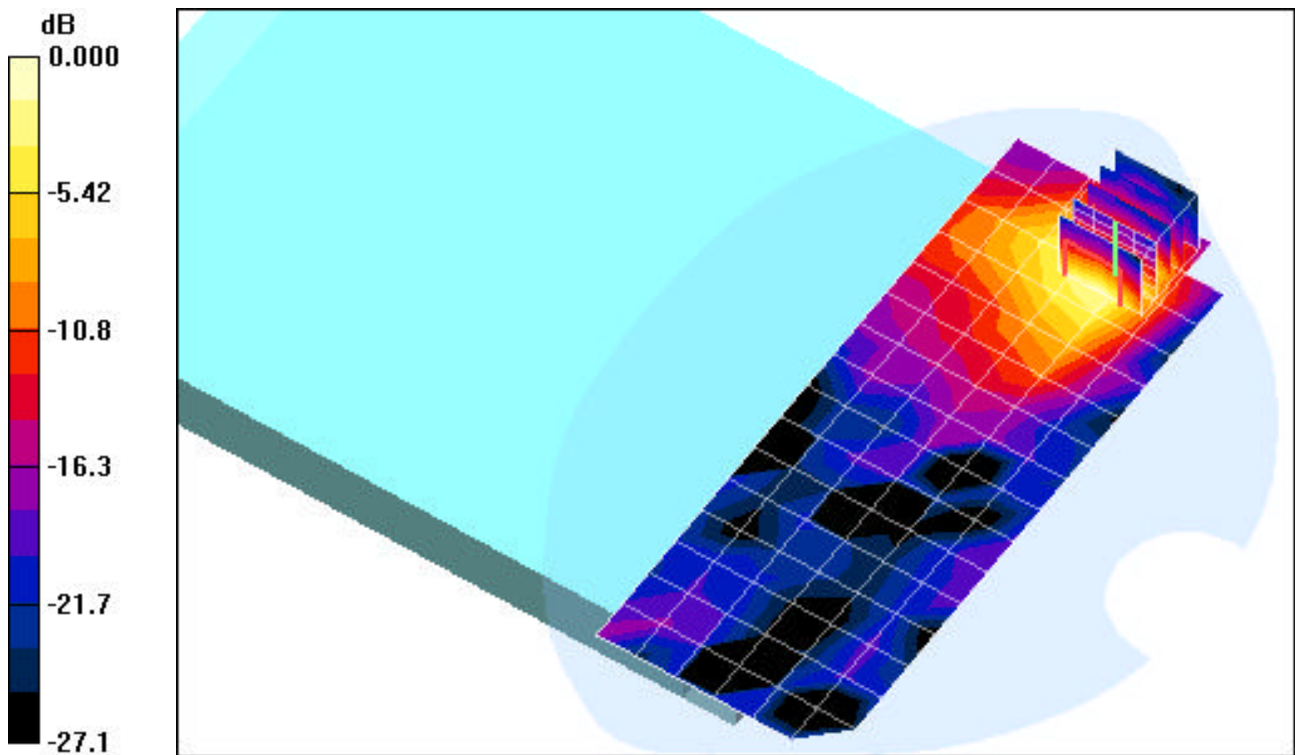

0 dB = 0.359mW/g

PCTEST ENGINEERING LABORATORY, INC.

DUT: CF-T7/W7; Type: Notebook PC with WLAN abg, Bluetooth and EVDO; SN:7HKSA00020

Communication System: IEEE 802.11b; Frequency: 2437 MHz; Duty Cycle: 1:1

Medium: 2450 Muscle ($\sigma = 1.99$ mho/m, $\epsilon_r = 55.12$, $\rho = 1000$ kg/m³)

Phantom section: Flat Section

Test Date: 09-03-2007; Ambient Temp: 23.6°C; Tissue Temp: 21.8°C

Probe: EX3DV4 - SN3589; ConvF(6.37, 6.37, 6.37); Calibrated: 5/28/2007

Sensor-Surface: 3mm (Mechanical Surface Detection)

Electronics: DAE4 Sn704; Calibrated: 5/25/2007

Phantom: SAM Main; Type: SAM 4.0; Serial: TP-1406

Measurement SW: DASY4, V4.7 Build 53; Postprocessing SW: SEMCAD, V1.8 Build 172

Mode: IEEE 802.11b, Laptop position, Ch.06, 1Mbps, Auxillary Antenna

Area Scan (7x17x1): Measurement grid: dx=15mm, dy=15mm

Zoom Scan (5x5x7)/Cube 0: Measurement grid: dx=8mm, dy=8mm, dz=5mm

Reference Value = 15.1 V/m

Peak SAR (extrapolated) = 0.920 W/kg

SAR(1 g) = 0.396 mW/g; SAR(10 g) = 0.186 mW/g

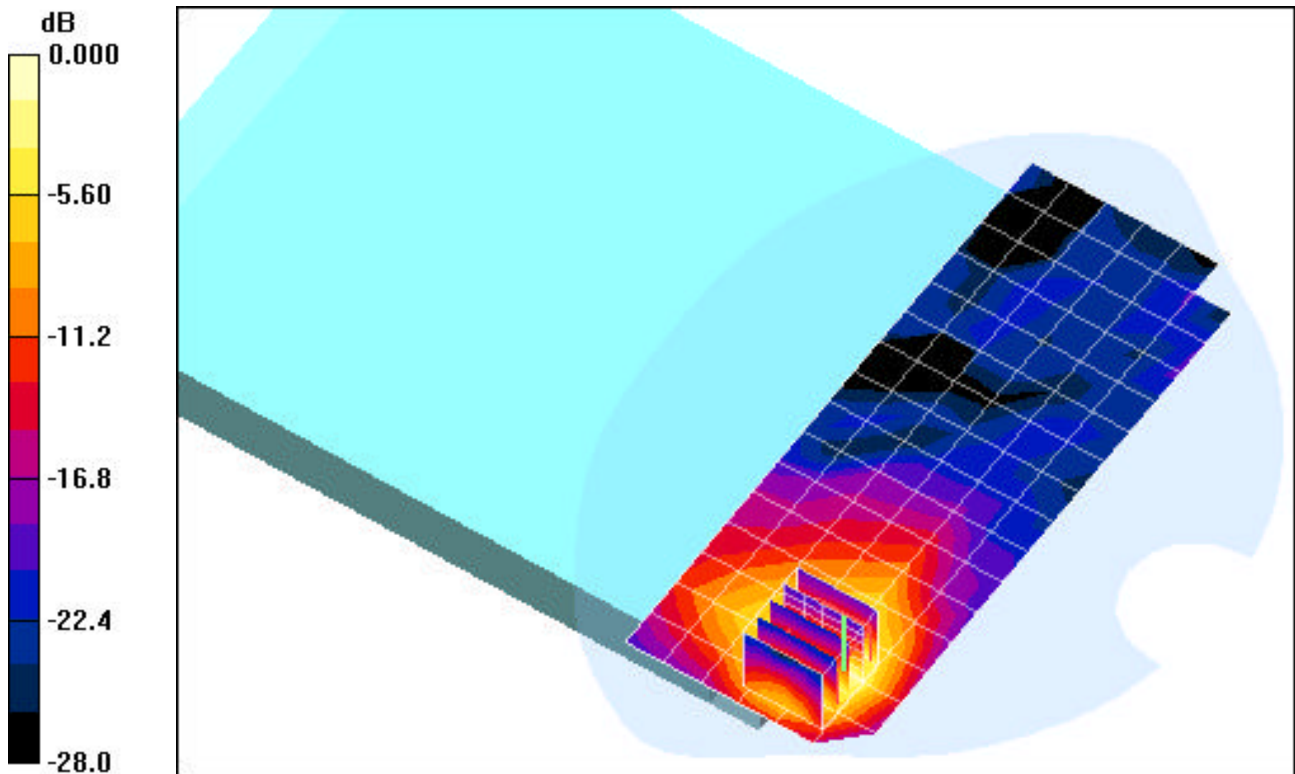

0 dB = 0.489mW/g

PCTEST ENGINEERING LABORATORY, INC.

DUT: CF-T7/W7; Type: Notebook PC with WLAN abg, Bluetooth and EVDO; SN:7HKSA00020

Communication System: Bluetooth; Frequency: 2441 MHz; Duty Cycle: 1:1

Medium: 2450 Muscle ($\sigma = 1.99$ mho/m, $\epsilon_r = 55.12$, $\rho = 1000$ kg/m³)

Phantom section: Flat Section

Test Date: 09-03-2007; Ambient Temp: 23.6°C; Tissue Temp: 21.8°C

Probe: EX3DV4 - SN3589; ConvF(6.37, 6.37, 6.37); Calibrated: 5/28/2007

Sensor-Surface: 3mm (Mechanical Surface Detection)

Electronics: DAE4 Sn704; Calibrated: 5/25/2007

Phantom: SAM Main; Type: SAM 4.0; Serial: TP-1406

Measurement SW: DASY4, V4.7 Build 53; Postprocessing SW: SEMCAD, V1.8 Build 172

Bluetooth, Laptop position, Mid ch, Fixed Antenna

Area Scan (7x17x1): Measurement grid: dx=15mm, dy=15mm

Zoom Scan (5x5x7)/Cube 0: Measurement grid: dx=8mm, dy=8mm, dz=5mm

Reference Value = 6.35 V/m

Peak SAR (extrapolated) = 0.266 W/kg

SAR(1 g) = 0.089 mW/g; SAR(10 g) = 0.074 mW/g

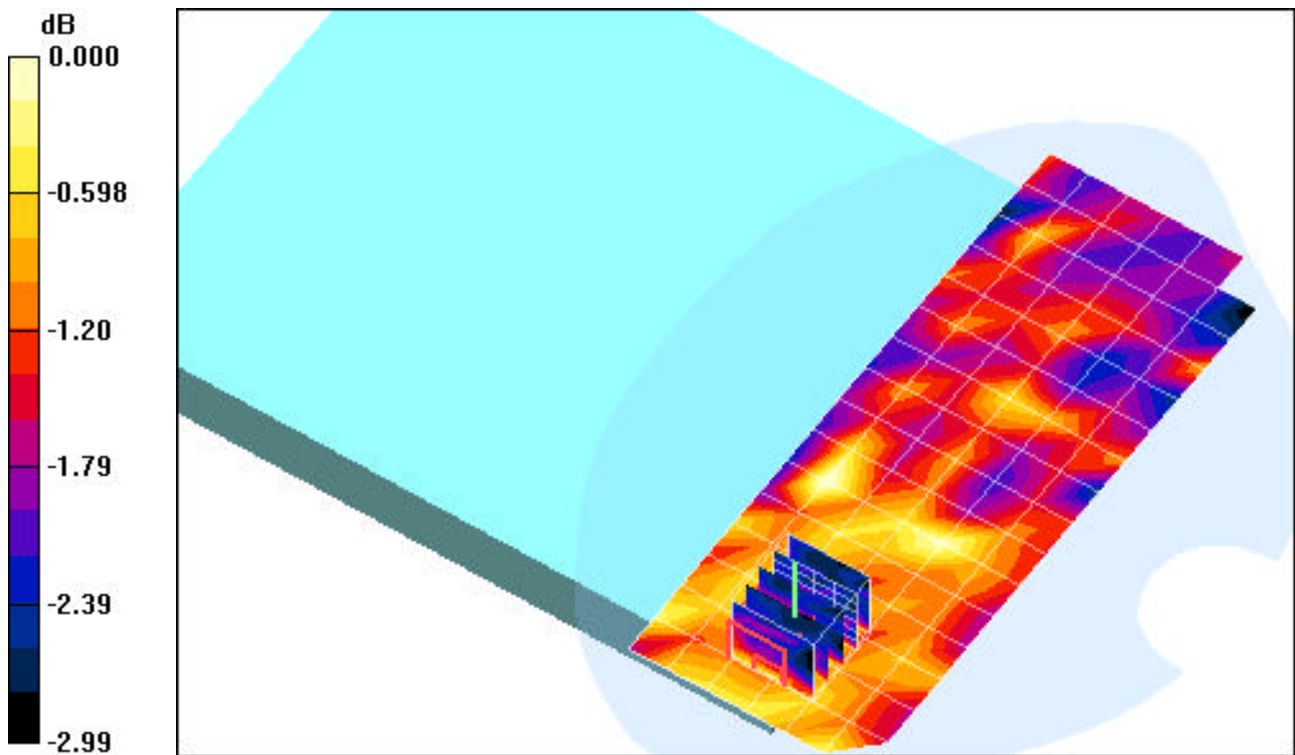

0 dB = 0.102mW/g

PCTEST ENGINEERING LABORATORY, INC.

DUT: CF-T7/W7; Type: Notebook PC with WLAN abg, Bluetooth and EVDO; SN:7HKSA00020

Communication System: IEEE 802.11a; Frequency: 5240 MHz;Duty Cycle: 1:1

Medium: 5300 Muscle ($\sigma = 5.18$ mho/m, $\epsilon_r = 50.9$, $\rho = 1000$ kg/m³)

Phantom section: Flat Section

Test Date: 09-05-2007; Ambient Temp: 23.2°C; Tissue Temp: 21.5°C

Probe: EX3DV4 - SN3589; ConvF(4.12, 4.12, 4.12); Calibrated: 5/28/2007

Sensor-Surface: 3mm (Mechanical Surface Detection)

Electronics: DAE4 Sn704; Calibrated: 5/25/2007

Phantom: SAM Main; Type: SAM 4.0; Serial: TP-1406

Measurement SW: DASY4, V4.7 Build 53; Postprocessing SW: SEMCAD, V1.8 Build 172

Mode: IEEE 802.11a, Laptop position, Ch.48, 6Mbps, Main Antenna

Area Scan/Area Scan (10x25x1): Measurement grid: dx=10mm, dy=10mm

Zoom Scan (8x8x8)/Cube 0: Measurement grid: dx=4.3mm, dy=4.3mm, dz=3mm

Reference Value = 11.9 V/m

Peak SAR (extrapolated) = 3.85 W/kg

SAR(1 g) = 0.728 mW/g; SAR(10 g) = 0.185 mW/g

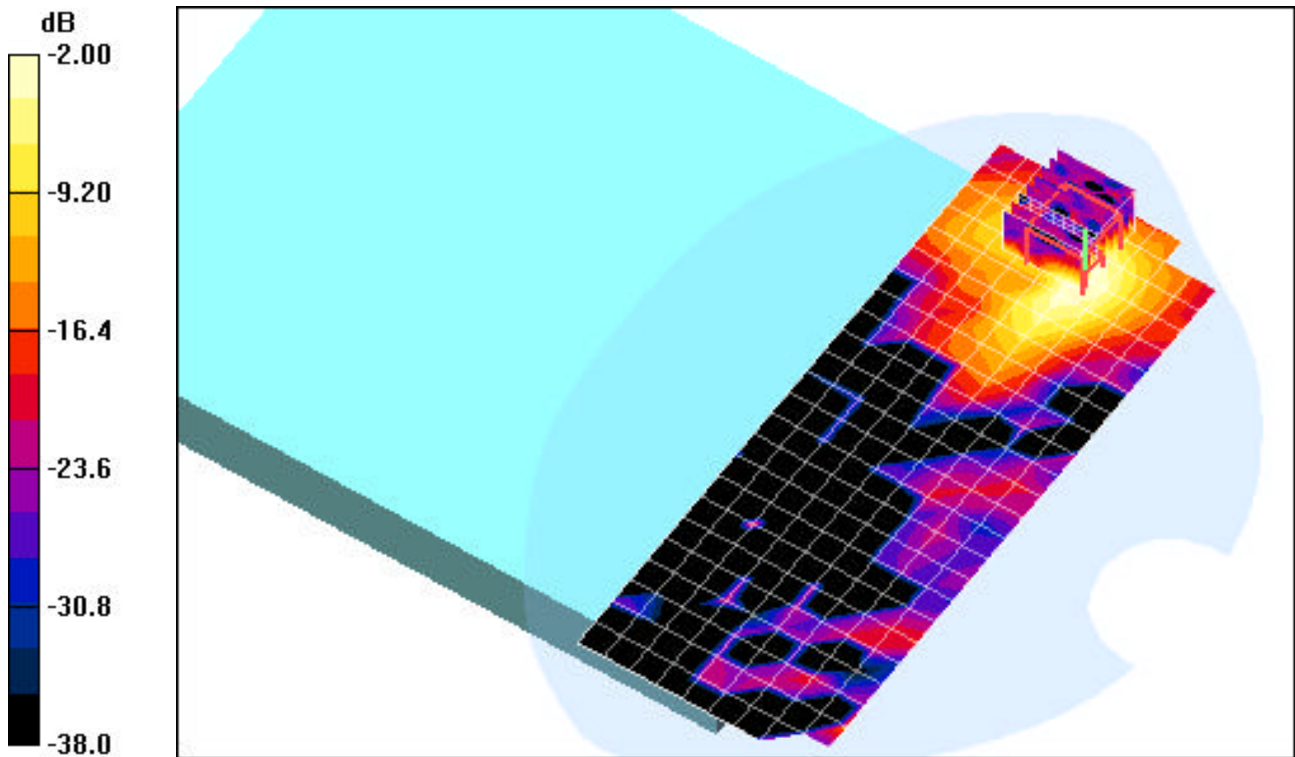

0 dB = 1.11mW/g

PCTEST ENGINEERING LABORATORY, INC.

DUT: CF-T7/W7; Type: Notebook PC with WLAN abg, Bluetooth and EVDO; SN:7HKSA00020

Communication System: IEEE 802.11a; Frequency: 5240 MHz; Duty Cycle: 1:1

Medium: 5300 Muscle ($\sigma = 5.18$ mho/m, $\epsilon_r = 50.9$, $\rho = 1000$ kg/m³)

Phantom section: Flat Section

Test Date: 09-05-2007; Ambient Temp: 23.2°C; Tissue Temp: 21.5°C

Probe: EX3DV4 - SN3589; ConvF(4.12, 4.12, 4.12); Calibrated: 5/28/2007

Sensor-Surface: 3mm (Mechanical Surface Detection)

Electronics: DAE4 Sn704; Calibrated: 5/25/2007

Phantom: SAM Main; Type: SAM 4.0; Serial: TP-1406

Measurement SW: DASY4, V4.7 Build 53; Postprocessing SW: SEMCAD, V1.8 Build 172

Mode: IEEE 802.11a, Laptop position, Ch.48, 6Mbps, Auxillary Antenna

Area Scan (10x25x1): Measurement grid: dx=10mm, dy=10mm

Zoom Scan (8x8x8)/Cube 0: Measurement grid: dx=4.3mm, dy=4.3mm, dz=3mm

Reference Value = 10.1 V/m

Peak SAR (extrapolated) = 3.17 W/kg

SAR(1 g) = 0.742 mW/g; SAR(10 g) = 0.208 mW/g

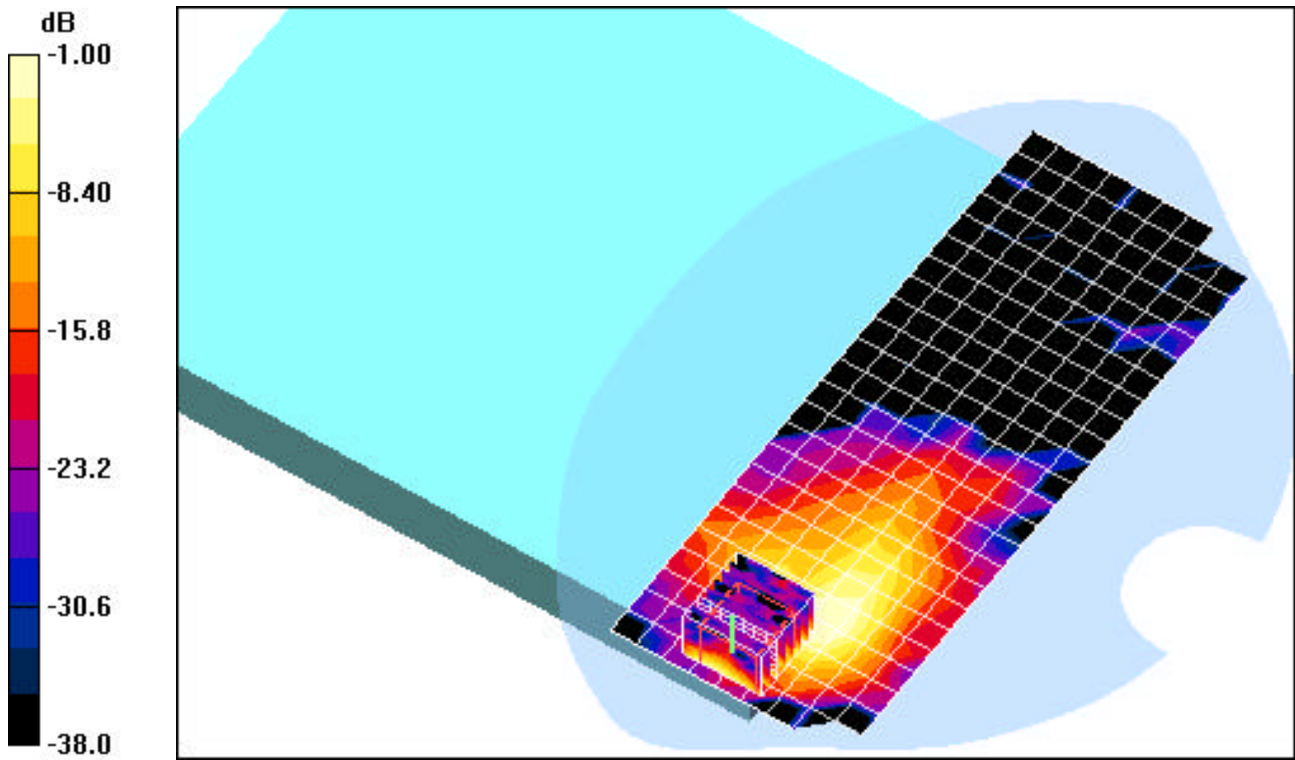

0 dB = 1.04mW/g

PCTEST ENGINEERING LABORATORY, INC.

DUT: CF-T7/W7; Type: Notebook PC with WLAN abg, Bluetooth and EVDO; SN:7HKSA00020

Communication System: IEEE 802.11a; Frequency: 5260; Duty Cycle: 1:1

Medium: 5300 Muscle ($\sigma = 5.18$ mho/m, $\epsilon_r = 50.9$, $\rho = 1000$ kg/m³)

Phantom section: Flat Section

Test Date: 09-05-2007; Ambient Temp: 23.2°C; Tissue Temp: 21.5°C

Probe: EX3DV4 - SN3589; ConvF(3.91, 3.91, 3.91); Calibrated: 5/28/2007

Sensor-Surface: 3mm (Mechanical Surface Detection)

Electronics: DAE4 Sn704; Calibrated: 5/25/2007

Phantom: SAM Main; Type: SAM 4.0; Serial: TP-1406

Measurement SW: DASY4, V4.7 Build 53; Postprocessing SW: SEMCAD, V1.8 Build 172

Mode: IEEE 802.11a, Laptop position, Ch.52, 6Mbps, Main Antenna

Area Scan/Area Scan (10x25x1): Measurement grid: dx=10mm, dy=10mm

Zoom Scan (8x8x8)/Cube 0: Measurement grid: dx=4.3mm, dy=4.3mm, dz=3mm

Reference Value = 11.3 V/m

Peak SAR (extrapolated) = 5.37 W/kg

SAR(1 g) = 0.686 mW/g; SAR(10 g) = 0.175 mW/g

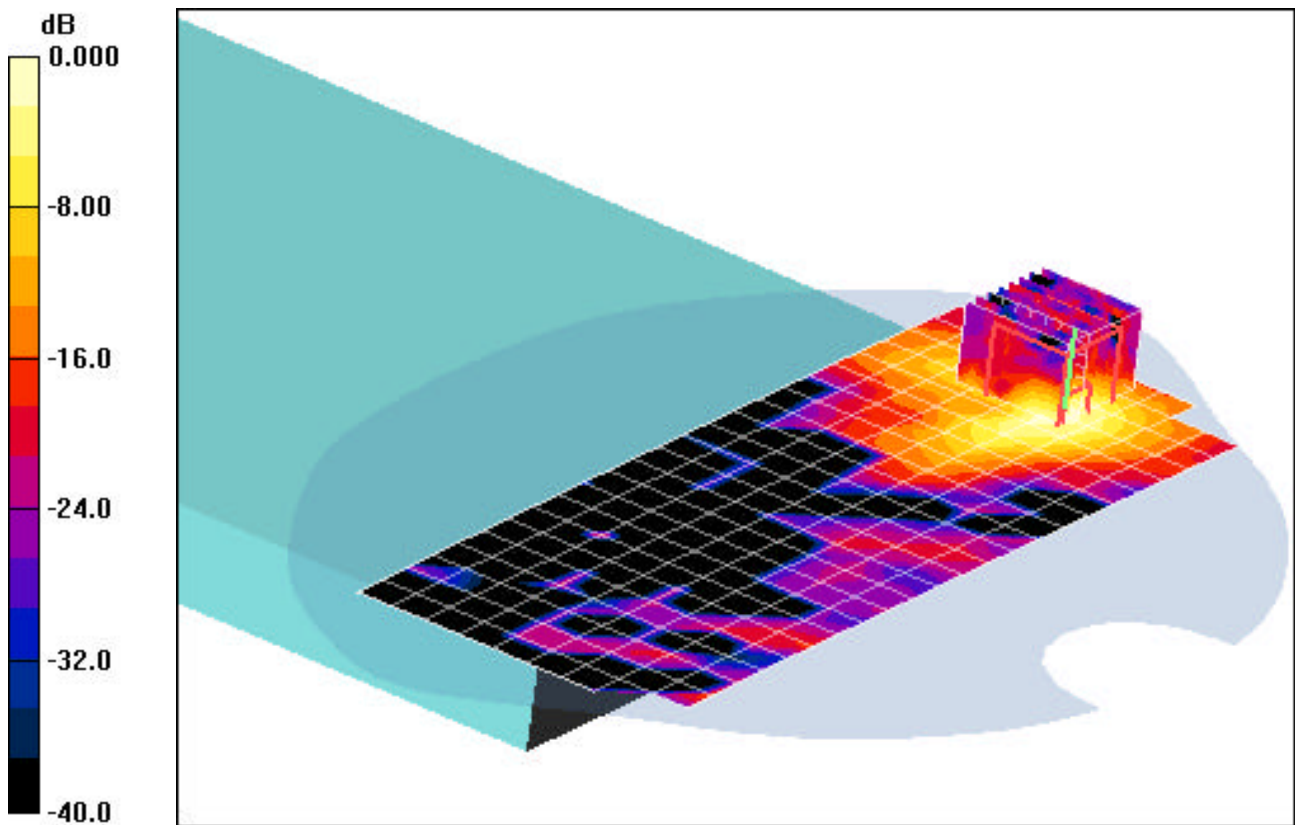

0 dB = 1.01mW/g

PCTEST ENGINEERING LABORATORY, INC.

DUT: CF-T7/W7; Type: Notebook PC with WLAN abg, Bluetooth and EVDO; SN:7HKSA00020

Communication System: IEEE 802.11a; 5320 MHz; Duty Cycle: 1:1
Medium: 5300 Muscle ($\sigma = 5.18$ mho/m, $\epsilon_r = 50.9$, $\rho = 1000$ kg/m³)
Phantom section: Flat Section

Test Date: 09-07-2007; Ambient Temp: 23.2°C; Tissue Temp: 21.5°C

Probe: EX3DV4 - SN3589; ConvF(3.91, 3.91, 3.91); Calibrated: 5/28/2007
Sensor-Surface: 3mm (Mechanical Surface Detection)
Electronics: DAE4 Sn704; Calibrated: 5/25/2007
Phantom: SAM Main; Type: SAM 4.0; Serial: TP-1406
Measurement SW: DASY4, V4.7 Build 53; Postprocessing SW: SEMCAD, V1.8 Build 172

Mode: IEEE 802.11a, Laptop position, Ch.64, 6Mbps, Auxillary Antenna

Area Scan (10x25x1): Measurement grid: dx=10mm, dy=10mm
Zoom Scan (8x8x8)/Cube 0: Measurement grid: dx=4.3mm, dy=4.3mm, dz=3mm
Reference Value = 8.12 V/m
Peak SAR (extrapolated) = 3.63 W/kg
SAR(1 g) = 0.616 mW/g; SAR(10 g) = 0.175 mW/g

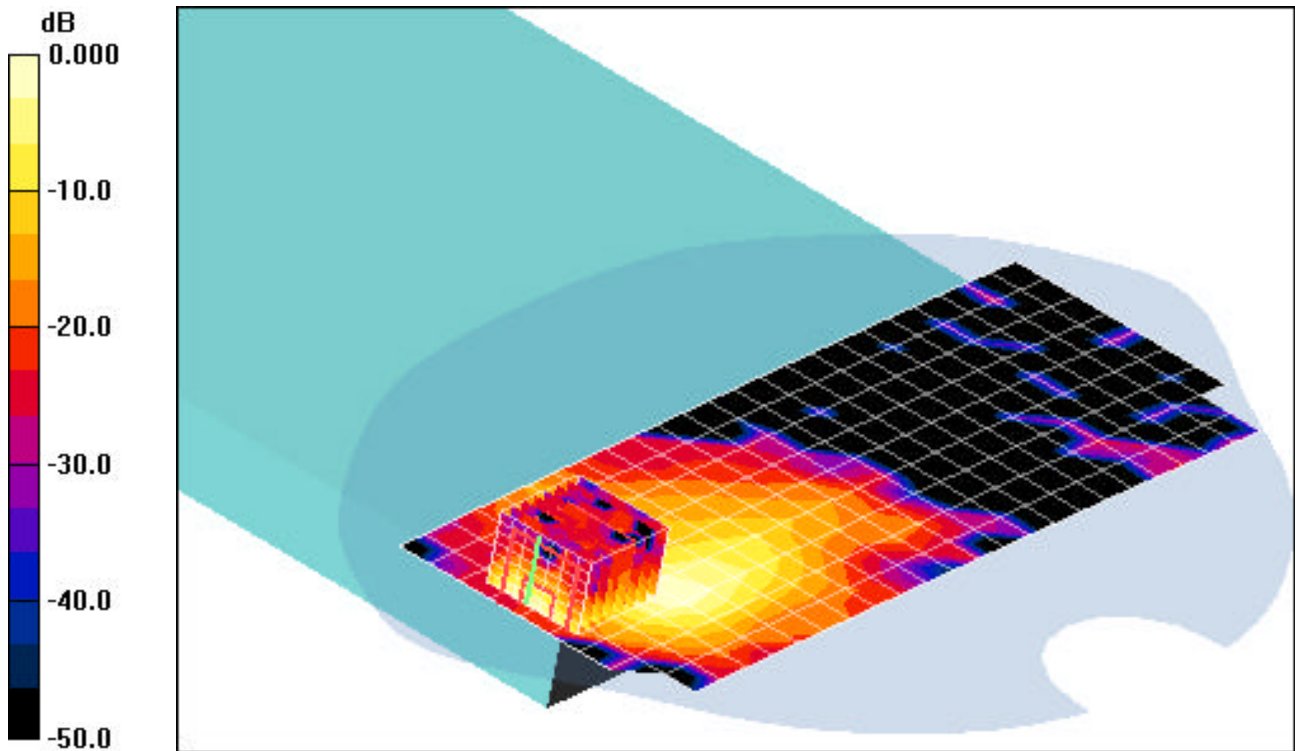

0 dB = 1.23mW/g

PCTEST ENGINEERING LABORATORY, INC.

DUT: CF-T7/W7; Type: Notebook PC with WLAN abg, Bluetooth and EVDO; SN:7HKSA00020

Communication System: IEEE 802.11a; Frequency: 5745 MHz; Duty Cycle: 1:1

Medium: 5800 Muscle ($\sigma = 6.24 \text{ mho/m}$, $\epsilon_r = 49.67$, $\rho = 1000 \text{ kg/m}^3$)

Phantom section: Flat Section

Test Date: 09-10-2007; Ambient Temp: 23.5°C; Tissue Temp: 21.7°C

Probe: EX3DV4 - SN3589; ConvF(3.97, 3.97, 3.97); Calibrated: 5/28/2007

Sensor-Surface: 3mm (Mechanical Surface Detection)

Electronics: DAE4 Sn704; Calibrated: 5/25/2007

Phantom: SAM Main; Type: SAM 4.0; Serial: TP-1406

Measurement SW: DASY4, V4.7 Build 53; Postprocessing SW: SEMCAD, V1.8 Build 172

Mode: IEEE 802.11a, Laptop position, Ch.149, 6Mbps, Main Antenna

Area Scan (10x25x1): Measurement grid: dx=10mm, dy=10mm

Zoom Scan (8x8x8)/Cube 0: Measurement grid: dx=4.3mm, dy=4.3mm, dz=3mm

Reference Value = 8.08 V/m

Peak SAR (extrapolated) = 3.49 W/kg

SAR(1 g) = 0.868 mW/g; SAR(10 g) = 0.235 mW/g

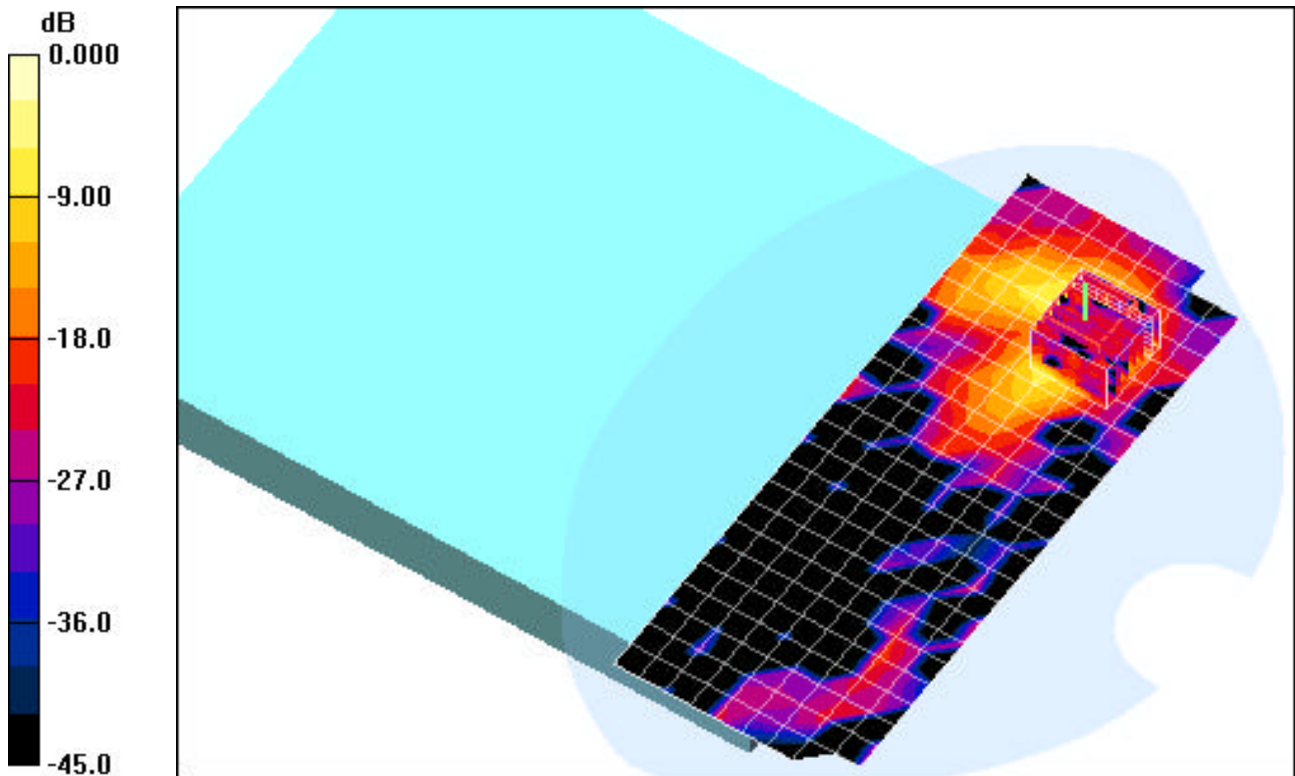

0 dB = 1.30mW/g

PCTEST ENGINEERING LABORATORY, INC.

DUT: CF-T7/W7; Type: Notebook PC with WLAN abg, Bluetooth and EVDO; SN:7HKSA00020

Communication System: IEEE 802.11a; Frequency: 5785 MHz; Duty Cycle: 1:1

Medium: 5800 Muscle ($\sigma = 6.24$ mho/m, $\epsilon_r = 49.67$, $\rho = 1000$ kg/m³)

Phantom section: Flat Section

Test Date: 09-10-2007; Ambient Temp: 23.5°C; Tissue Temp: 21.7°C

Probe: EX3DV4 - SN3589; ConvF(3.97, 3.97, 3.97); Calibrated: 5/28/2007

Sensor-Surface: 3mm (Mechanical Surface Detection)

Electronics: DAE4 Sn704; Calibrated: 5/25/2007

Phantom: SAM Main; Type: SAM 4.0; Serial: TP-1406

Measurement SW: DASY4, V4.7 Build 53; Postprocessing SW: SEMCAD, V1.8 Build 172

Mode: IEEE 802.11a, Laptop position, Ch.157, 6Mbps, Aux Antenna

Area Scan (10x25x1): Measurement grid: dx=10mm, dy=10mm

Zoom Scan (8x8x8)/Cube 0: Measurement grid: dx=4.3mm, dy=4.3mm, dz=3mm

Reference Value = 15.8 V/m

Peak SAR (extrapolated) = 4.81 W/kg

SAR(1 g) = 1.06 mW/g; SAR(10 g) = 0.300 mW/g

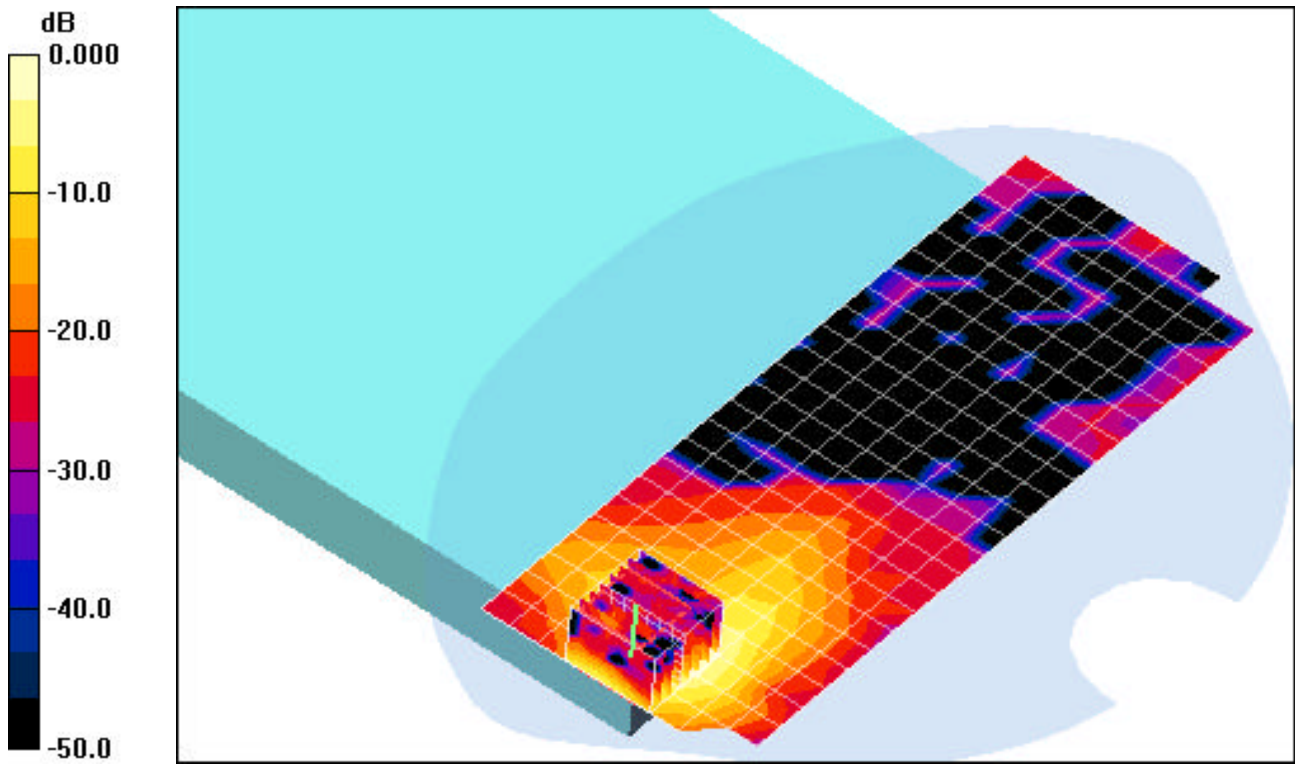

0 dB = 1.58mW/g

PCTEST ENGINEERING LABORATORY, INC.

DUT: CF-T7/W7; Type: Notebook PC with WLAN abg, Bluetooth and EVDO; SN:7HKSA00020

Communication System: IEEE 802.11b; Frequency: 2437 MHz; Duty Cycle: 1:1

Medium: 2450 Muscle ($\sigma = 1.99$ mho/m, $\epsilon_r = 55.12$, $\rho = 1000$ kg/m³)

Phantom section: Flat Section

Test Date: 09-03-2007; Ambient Temp: 23.6°C; Tissue Temp: 21.8°C

Probe: EX3DV4 - SN3589; ConvF(6.37, 6.37, 6.37); Calibrated: 5/28/2007

Sensor-Surface: 3mm (Mechanical Surface Detection)

Electronics: DAE4 Sn704; Calibrated: 5/25/2007

Phantom: SAM Main; Type: SAM 4.0; Serial: TP-1406

Measurement SW: DASY4, V4.7 Build 53; Postprocessing SW: SEMCAD, V1.8 Build 172

Mode: IEEE 802 11b, Laptop position, Ch.06, 1Mbps, Auxillary Antenna

Area Scan (7x17x1): Measurement grid: dx=15mm, dy=15mm

Zoom Scan (5x5x7)/Cube 0: Measurement grid: dx=8mm, dy=8mm, dz=5mm

Reference Value = 15.1 V/m

Peak SAR (extrapolated) = 0.920 W/kg

SAR(1 g) = 0.396 mW/g; SAR(10 g) = 0.186 mW/g

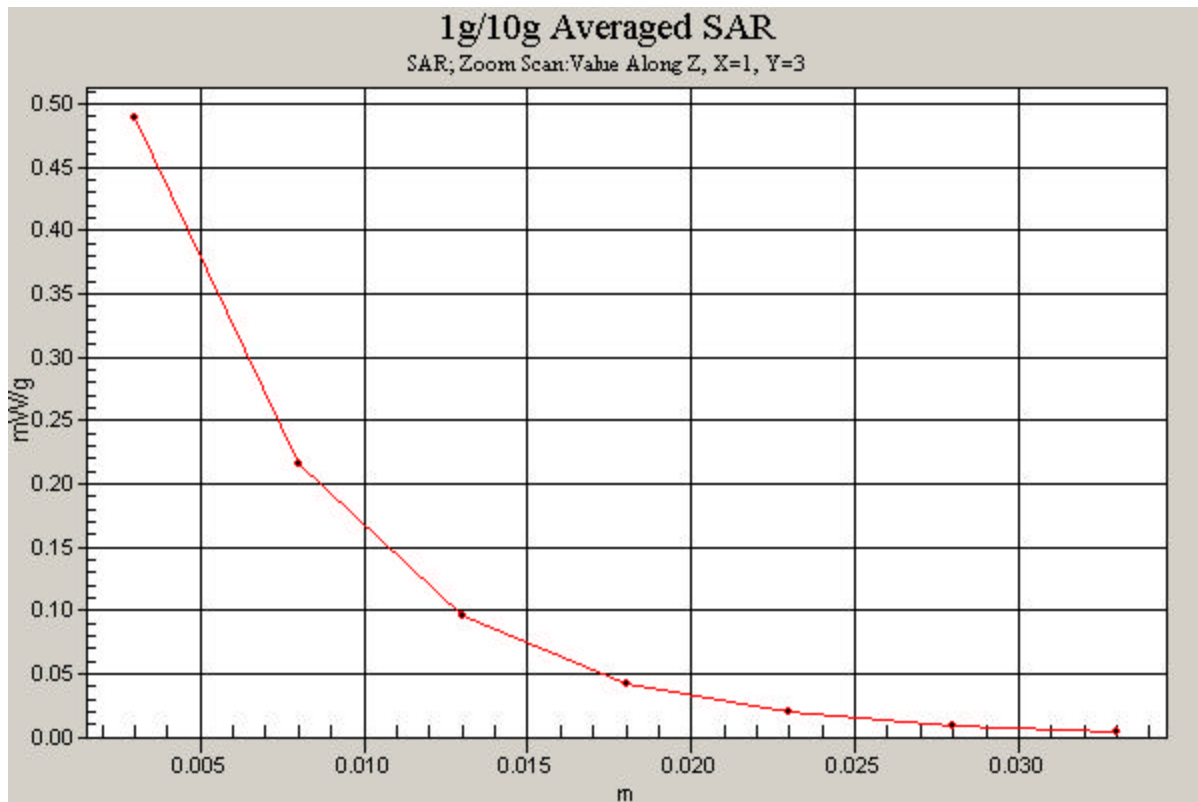

PCTEST ENGINEERING LABORATORY, INC.

DUT: CF-T7/W7; Type: Notebook PC with WLAN abg, Bluetooth and EVDO; SN:7HKSA00020

Communication System: IEEE 802.11a; Frequency: 5240 MHz; Duty Cycle: 1:1

Medium: 5300 Muscle ($\sigma = 5.18$ mho/m, $\epsilon_r = 50.9$, $\rho = 1000$ kg/m³)

Phantom section: Flat Section

Test Date: 09-05-2007; Ambient Temp: 23.2°C; Tissue Temp: 21.5°C

Probe: EX3DV4 - SN3589; ConvF(4.12, 4.12, 4.12); Calibrated: 5/28/2007

Sensor-Surface: 3mm (Mechanical Surface Detection)

Electronics: DAE4 Sn704; Calibrated: 5/25/2007

Phantom: SAM Main; Type: SAM 4.0; Serial: TP-1406

Measurement SW: DASY4, V4.7 Build 53; Postprocessing SW: SEMCAD, V1.8 Build 172

Mode: 802.11a, Laptop position, Ch.48, 6Mbps, Auxillary Antenna

Area Scan (10x25x1): Measurement grid: dx=10mm, dy=10mm

Zoom Scan (8x8x8)/Cube 0: Measurement grid: dx=4.3mm, dy=4.3mm, dz=3mm

Reference Value = 10.1 V/m

Peak SAR (extrapolated) = 3.17 W/kg

SAR(1 g) = 0.742 mW/g; SAR(10 g) = 0.208 mW/g

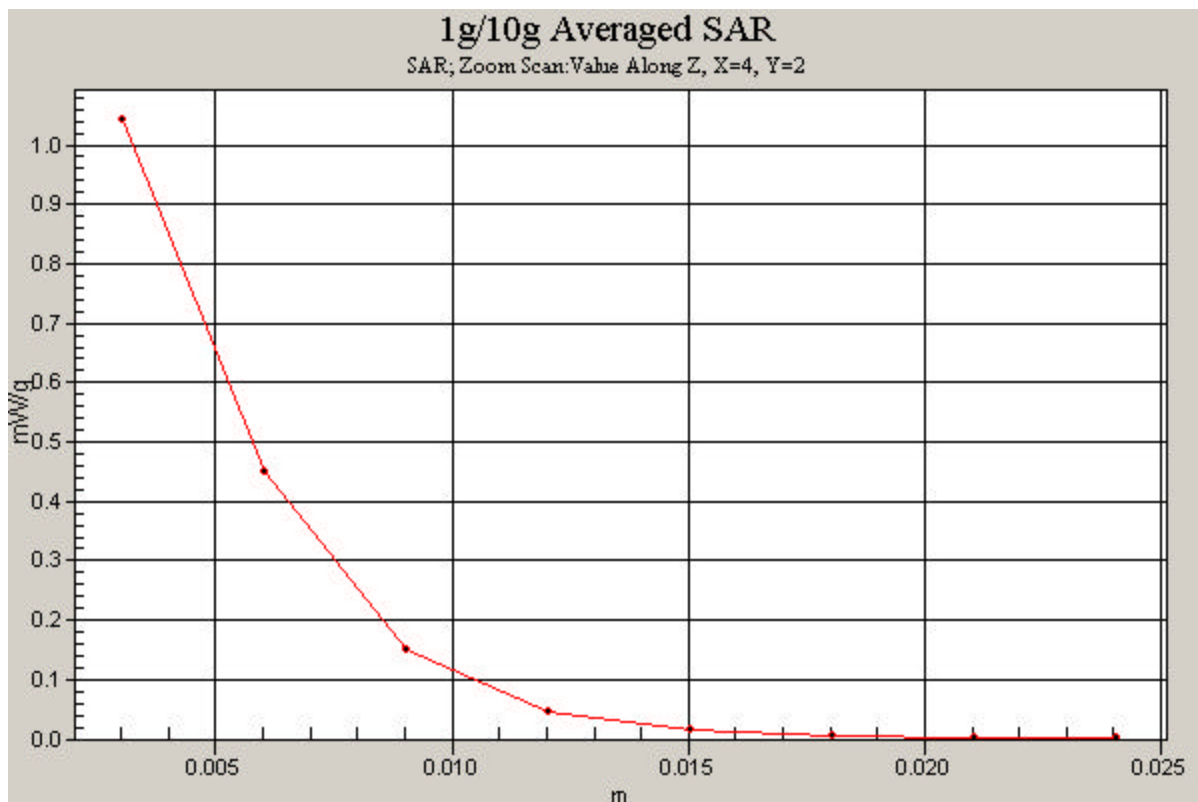

PCTEST ENGINEERING LABORATORY, INC.

DUT: CF-T7/W7; Type: Notebook PC with WLAN abg, Bluetooth and EVDO; SN:7HKSA00020

Communication System: IEEE 802.11a; Frequency: 5745 MHz; Duty Cycle: 1:1

Medium: 5800 Muscle ($\sigma = 6.24 \text{ mho/m}$, $\epsilon_r = 49.67$, $\rho = 1000 \text{ kg/m}^3$)

Phantom section: Flat Section

Test Date: 09-10-2007; Ambient Temp: 23.5°C; Tissue Temp: 21.7°C

Probe: EX3DV4 - SN3589; ConvF(3.97, 3.97, 3.97); Calibrated: 5/28/2007

Sensor-Surface: 3mm (Mechanical Surface Detection)

Electronics: DAE4 Sn704; Calibrated: 5/25/2007

Phantom: SAM Main; Type: SAM 4.0; Serial: TP-1406

Measurement SW: DASY4, V4.7 Build 53; Postprocessing SW: SEMCAD, V1.8 Build 172

Mode: IEEE, 802.11a, Laptop position, Ch.149, 6Mbps, Main Antenna

Area Scan (10x25x1): Measurement grid: dx=10mm, dy=10mm

Zoom Scan (8x8x8)/Cube 0: Measurement grid: dx=4.3mm, dy=4.3mm, dz=3mm

Reference Value = 8.08 V/m

Peak SAR (extrapolated) = 3.49 W/kg

SAR(1 g) = 0.868 mW/g; SAR(10 g) = 0.235 mW/g

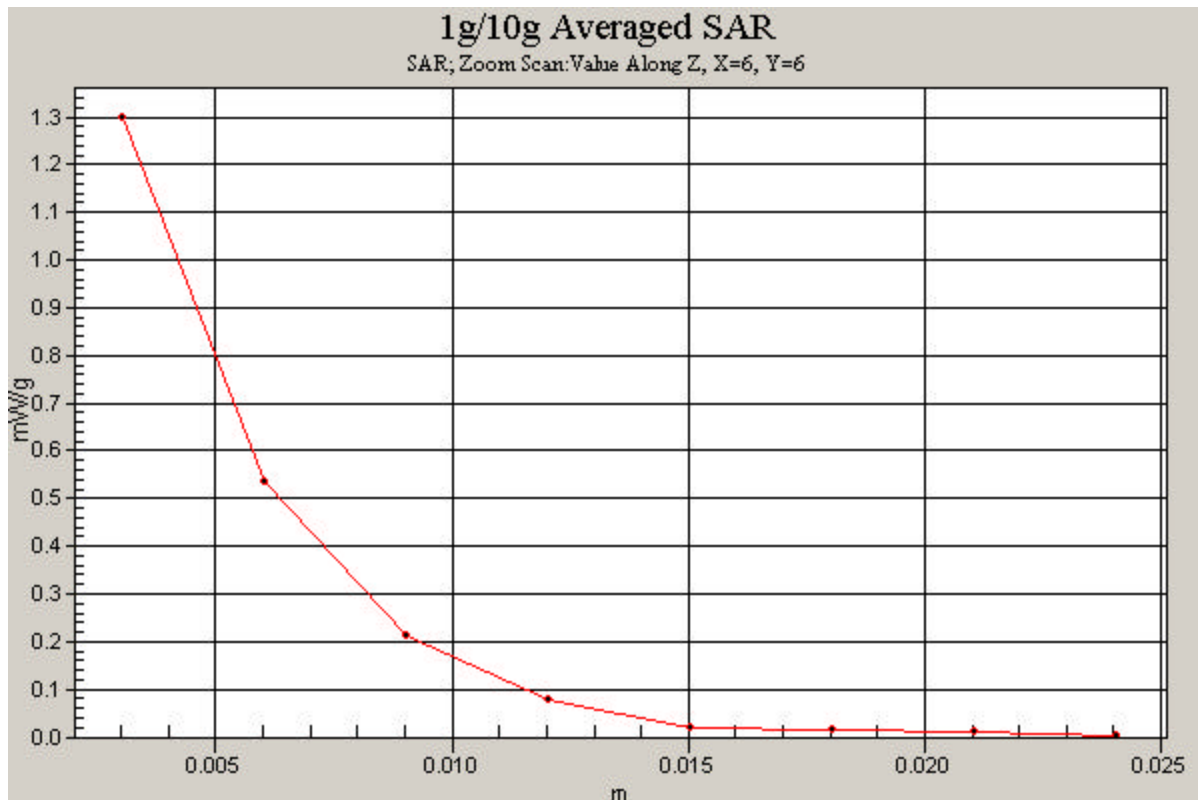

APPENDIX B: DIPOLE VALIDATION

PCTEST ENGINEERING LABORATORY, INC.

DUT: Dipole 2450 MHz; Type: D2450V2; Serial: D2450V2 - SN:719

Communication System: CW; Frequency: 2450 MHz; Duty Cycle: 1:1

Medium: 2450 Brain ($\sigma = 1.89$ mho/m, $\epsilon_r = 40.34$, $\rho = 1000$ kg/m³)

Phantom section: Flat Section; Space: 1.0 cm

Test Date: 09-03-2007; Ambient Temp: 23.6°C; Tissue Temp: 21.5°C

Probe: EX3DV4 - SN3589; ConvF(6.29, 6.29, 6.29); Calibrated: 5/28/2007

Sensor-Surface: 3mm (Mechanical Surface Detection)

Electronics: DAE4 Sn704; Calibrated: 5/25/2007

Phantom: SAM Main; Type: SAM 4.0; Serial: TP-1406

Measurement SW: DASY4, V4.7 Build 53; Postprocessing SW: SEMCAD, V1.8 Build 172

2450MHz Dipole Validation

Area Scan (5x7x1): Measurement grid: dx=15mm, dy=15mm

Zoom Scan (5x5x7)/Cube 0: Measurement grid: dx=8mm, dy=8mm, dz=5mm

Input Power = 20.0 dBm (100 mW)

SAR(1 g) = 5.74 mW/g; SAR(10 g) = 2.76 mW/g

Target SAR(1g) = 5.4 mW/g; Deviation = + 6.30 %

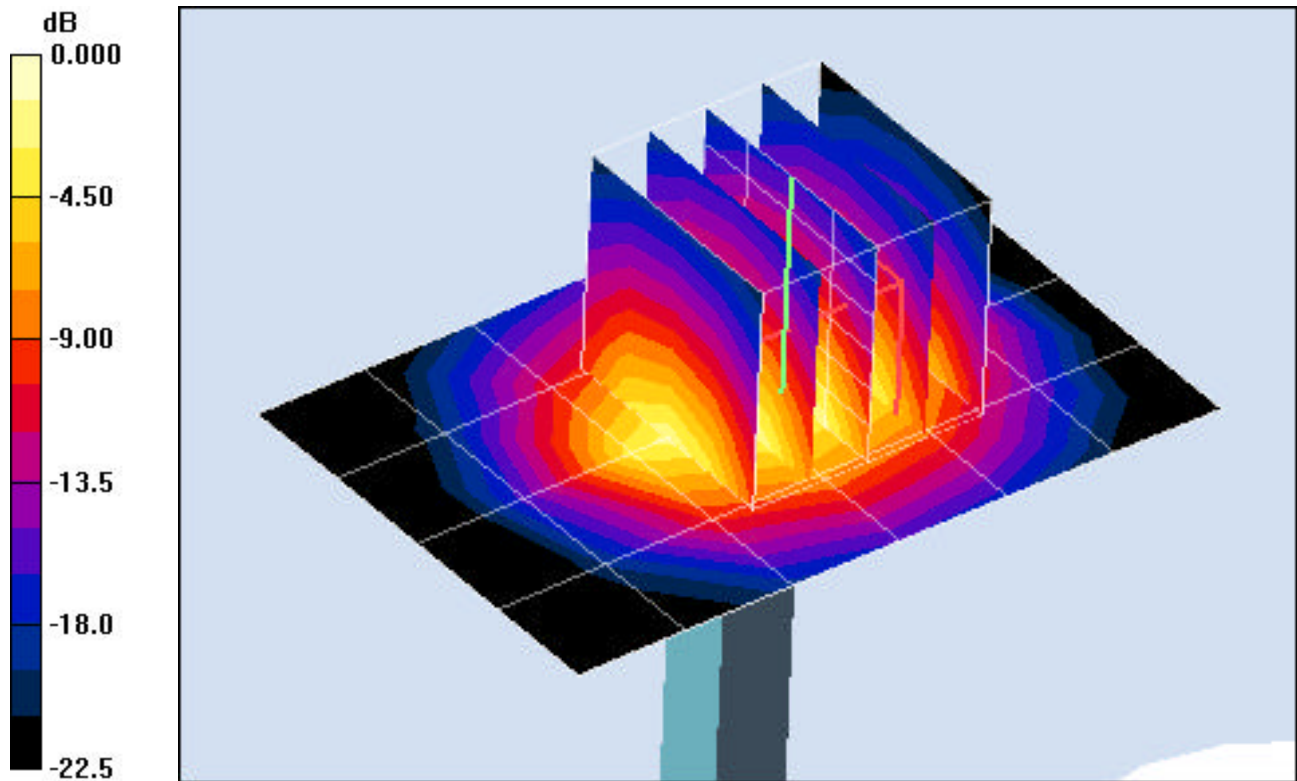

0 dB = 7.63mW/g

PCTEST ENGINEERING LABORATORY, INC.

DUT: Dipole 5200 MHz; Type: D5GHzV2; Serial: 1007

Communication System: CW; Frequency: 5200 MHz; Duty Cycle: 1:1

Medium: 5300 Brain ($\sigma = 4.76$ mho/m, $\epsilon_r = 36.24$, $\rho = 1000$ kg/m³)

Phantom section: Flat Section; Space: 1.0 cm

Test Date: 09-05-2007; Ambient Temp: 23.2°C; Tissue Temp: 21.3°C

Probe: EX3DV4 - SN3589; ConvF(4.6, 4.6, 4.6); Calibrated: 5/28/2007

Sensor-Surface: 3mm (Mechanical Surface Detection)

Electronics: DAE4 Sn704; Calibrated: 5/25/2007

Phantom: SAM Main; Type: SAM 4.0; Serial: TP-1406

Measurement SW: DASY4, V4.7 Build 53; Postprocessing SW: SEMCAD, V1.8 Build 172

5200MHz Dipole Validation, 14.0dBm

Area Scan (7x9x1): Measurement grid: dx=10mm, dy=10mm

Zoom Scan (8x8x8)/Cube 0: Measurement grid: dx=4.3mm, dy=4.3mm, dz=3mm

Input Power = 14.0 dBm (25 mW)

SAR(1 g) = 2.05 mW/g; SAR(10 g) = 0.581 mW/g

Target SAR(1g) = 2.03 mW/g; Deviation = -2.38 %

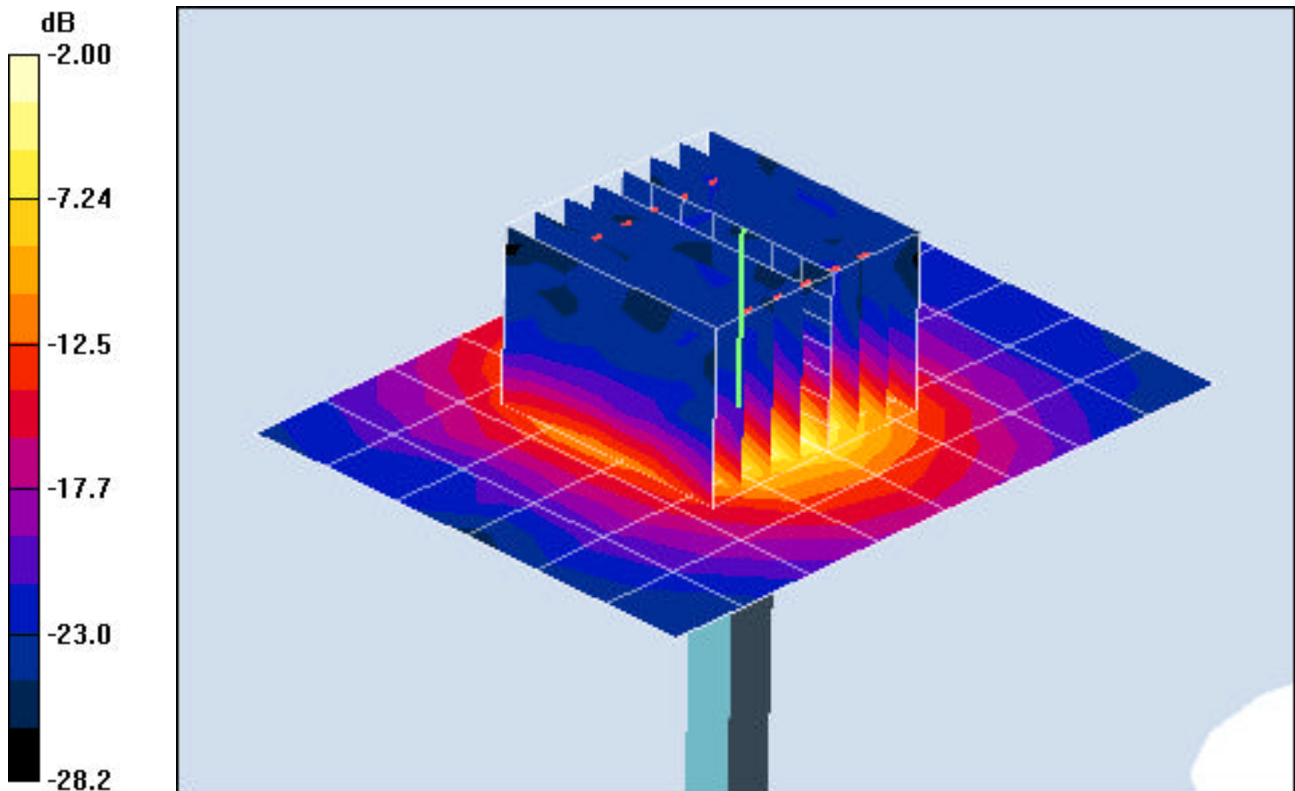

0 dB = 3.03mW/g

PCTEST ENGINEERING LABORATORY, INC.

DUT: Dipole 5800 MHz; Type: D5GHzV2; Serial: 1007

Communication System: CW; Frequency: 5800 MHz; Duty Cycle: 1:1

Medium: 5800 Brain ($\sigma = 5.47$ mho/m, $\epsilon_r = 36.13$, $\rho = 1000$ kg/m³)

Phantom section: Flat Section: Space: 1.0 cm

Test Date: 09-10-2007; Ambient Temp: 23.5°C; Tissue Temp: 21.6°C

Probe: EX3DV4 - SN3589; ConvF(4.16, 4.16, 4.16); Calibrated: 5/28/2007

Sensor-Surface: 3mm (Mechanical Surface Detection)

Electronics: DAE4 Sn704; Calibrated: 5/25/2007

Phantom: SAM Main; Type: SAM 4.0; Serial: TP-1406

Measurement SW: DASY4, V4.7 Build 53; Postprocessing SW: SEMCAD, V1.8 Build 172

5800MHz Dipole Validation

Area Scan (7x9x1): Measurement grid: dx=10mm, dy=10mm

Zoom Scan (8x8x8)/Cube 0: Measurement grid: dx=4.3mm, dy=4.3mm, dz=3mm

Input Power = 14.0 dBm (25 mW)

SAR(1 g) = 2.12 mW/g; SAR(10 g) = 0.747 mW/g

Target SAR(1g) = 2.03 mW/g; Deviation = + 4.43 %

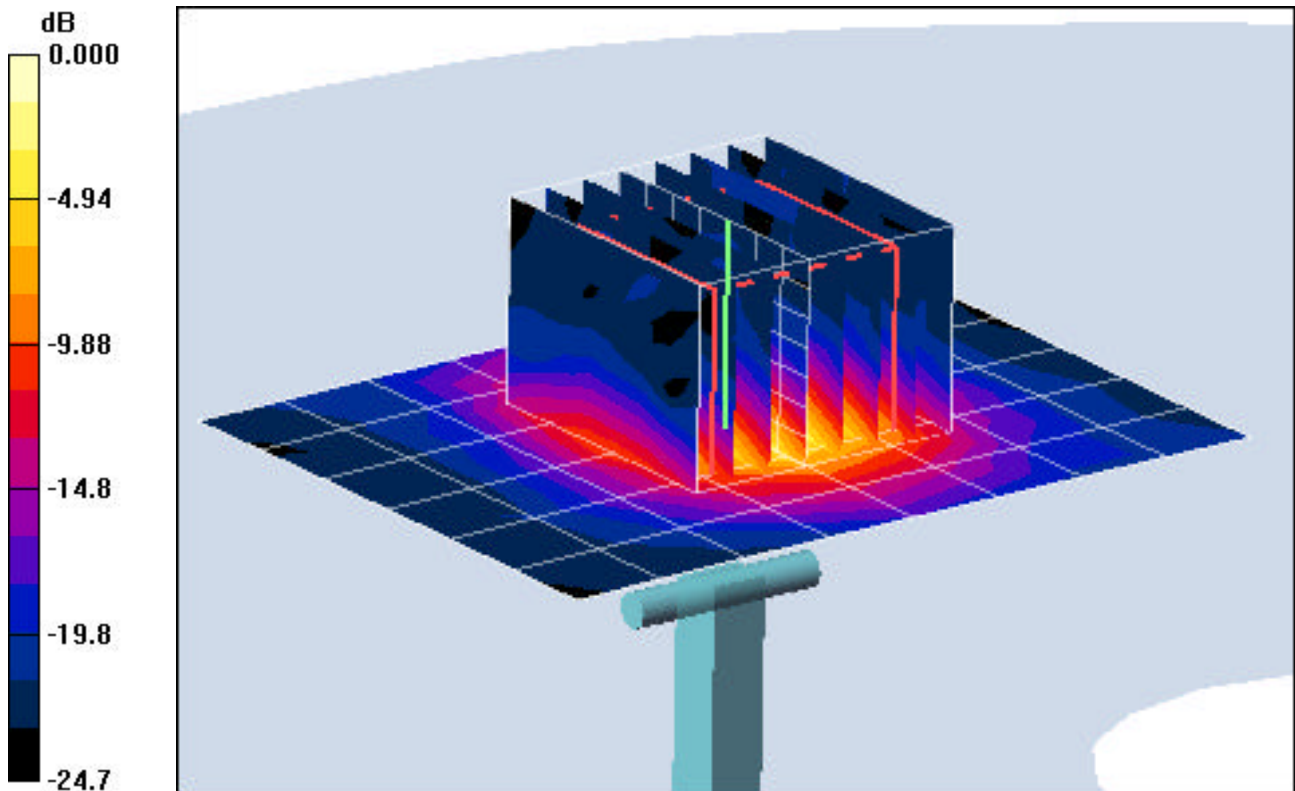

0 dB = 3.83mW/g

APPENDIX C: PROBE CALIBRATION



Accredited by the Swiss Federal Office of Metrology and Accreditation
The Swiss Accreditation Service is one of the signatories to the EA
Multilateral Agreement for the recognition of calibration certificates

Accreditation No.: **SCS 108**

Client **PC Test**

Certificate No: **EX3-3589_May07**

CALIBRATION CERTIFICATE

Object **EX3DV4 - SN:3589**

Calibration procedure(s) **QA CAL-01.v5 and QA CAL-14.v3
Calibration procedure for dosimetric E-field probes**

Calibration date: **May 28, 2007**

Condition of the calibrated item **In Tolerance**

This calibration certificate documents the traceability to national standards, which realize the physical units of measurements (SI).
The measurements and the uncertainties with confidence probability are given on the following pages and are part of the certificate.

All calibrations have been conducted in the closed laboratory facility: environment temperature $(22 \pm 3)^\circ\text{C}$ and humidity $< 70\%$.

Calibration Equipment used (M&TE critical for calibration)

Primary Standards	ID #	Cal Date (Calibrated by, Certificate No.)	Scheduled Calibration
Power meter E4419B	GB41293874	29-Mar-07 (METAS, No. 217-00670)	Mar-08
Power sensor E4412A	MY41495277	29-Mar-07 (METAS, No. 217-00670)	Mar-08
Power sensor E4412A	MY41498087	29-Mar-07 (METAS, No. 217-00670)	Mar-08
Reference 3 dB Attenuator	SN: S5054 (3c)	10-Aug-06 (METAS, No. 217-00592)	Aug-07
Reference 20 dB Attenuator	SN: S5086 (20b)	29-Mar-07 (METAS, No. 217-00671)	Mar-08
Reference 30 dB Attenuator	SN: S5129 (30b)	10-Aug-06 (METAS, No. 217-00593)	Aug-07
Reference Probe ES3DV2	SN: 3013	4-Jan-07 (SPEAG, No. ES3-3013_Jan07)	Jan-08
DAE4	SN: 654	20-Apr-07 (SPEAG, No. DAE4-654_Apr07)	Apr-08

Secondary Standards	ID #	Check Date (in house)	Scheduled Check
RF generator HP 8648C	US3642U01700	4-Aug-99 (SPEAG, in house check Nov-05)	In house check: Nov-07
Network Analyzer HP 8753E	US37390585	18-Oct-01 (SPEAG, in house check Oct-06)	In house check: Oct-07

	Name	Function	Signature
Calibrated by:	Katja Pokovic	Technical Manager	
Approved by:	Fin Bomholt	R&D Director	

Issued: May 29, 2007

This calibration certificate shall not be reproduced except in full without written approval of the laboratory.



Accredited by the Swiss Federal Office of Metrology and Accreditation
The Swiss Accreditation Service is one of the signatories to the EA
Multilateral Agreement for the recognition of calibration certificates

Accreditation No.: **SCS 108**

Glossary:

TSL	tissue simulating liquid
NORM _{x,y,z}	sensitivity in free space
ConvF	sensitivity in TSL / NORM _{x,y,z}
DCP	diode compression point
Polarization φ	φ rotation around probe axis
Polarization ϑ	ϑ rotation around an axis that is in the plane normal to probe axis (at measurement center), i.e., $\vartheta = 0$ is normal to probe axis

Calibration is Performed According to the Following Standards:

- IEEE Std 1528-2003, "IEEE Recommended Practice for Determining the Peak Spatial-Averaged Specific Absorption Rate (SAR) in the Human Head from Wireless Communications Devices: Measurement Techniques", December 2003
- IEC 62209-1, "Procedure to measure the Specific Absorption Rate (SAR) for hand-held devices used in close proximity to the ear (frequency range of 300 MHz to 3 GHz)", February 2005

Methods Applied and Interpretation of Parameters:

- NORM_{x,y,z}**: Assessed for E-field polarization $\vartheta = 0$ ($f \leq 900$ MHz in TEM-cell; $f > 1800$ MHz: R22 waveguide). NORM_{x,y,z} are only intermediate values, i.e., the uncertainties of NORM_{x,y,z} does not effect the E²-field uncertainty inside TSL (see below *ConvF*).
- NORM(f)_{x,y,z} = NORM_{x,y,z} * frequency_response** (see Frequency Response Chart). This linearization is implemented in DASY4 software versions later than 4.2. The uncertainty of the frequency response is included in the stated uncertainty of *ConvF*.
- DCP_{x,y,z}**: DCP are numerical linearization parameters assessed based on the data of power sweep (no uncertainty required). DCP does not depend on frequency nor media.
- ConvF and Boundary Effect Parameters**: Assessed in flat phantom using E-field (or Temperature Transfer Standard for $f \leq 800$ MHz) and inside waveguide using analytical field distributions based on power measurements for $f > 800$ MHz. The same setups are used for assessment of the parameters applied for boundary compensation (alpha, depth) of which typical uncertainty values are given. These parameters are used in DASY4 software to improve probe accuracy close to the boundary. The sensitivity in TSL corresponds to NORM_{x,y,z} * ConvF whereby the uncertainty corresponds to that given for ConvF. A frequency dependent ConvF is used in DASY version 4.4 and higher which allows extending the validity from ± 50 MHz to ± 100 MHz.
- Spherical isotropy (3D deviation from isotropy)**: in a field of low gradients realized using a flat phantom exposed by a patch antenna.
- Sensor Offset**: The sensor offset corresponds to the offset of virtual measurement center from the probe tip (on probe axis). No tolerance required.

Probe EX3DV4

SN:3589

Manufactured:	March 30, 2006
Last calibrated:	July 14, 2006
Recalibrated:	May 28, 2007

Calibrated for DASYS Systems

(Note: non-compatible with DASYS2 system!)

DASY - Parameters of Probe: EX3DV4 SN:3589

Sensitivity in Free Space^A

NormX	0.460 ± 10.1%	$\mu\text{V}/(\text{V}/\text{m})^2$	DCP X	90 mV
NormY	0.400 ± 10.1%	$\mu\text{V}/(\text{V}/\text{m})^2$	DCP Y	91 mV
NormZ	0.370 ± 10.1%	$\mu\text{V}/(\text{V}/\text{m})^2$	DCP Z	92 mV

Diode Compression^B

Sensitivity in Tissue Simulating Liquid (Conversion Factors)

Please see Page 8.

Boundary Effect

TSL **835 MHz** **Typical SAR gradient: 5 % per mm**

Sensor Center to Phantom Surface Distance		2.0 mm	3.0 mm
SAR _{be} [%]	Without Correction Algorithm	3.8	1.3
SAR _{be} [%]	With Correction Algorithm	0.0	0.1

TSL **1900 MHz** **Typical SAR gradient: 10 % per mm**

Sensor Center to Phantom Surface Distance		2.0 mm	3.0 mm
SAR _{be} [%]	Without Correction Algorithm	4.5	1.6
SAR _{be} [%]	With Correction Algorithm	0.3	0.5

Sensor Offset

Probe Tip to Sensor Center **1.0 mm**

The reported uncertainty of measurement is stated as the standard uncertainty of measurement multiplied by the coverage factor k=2, which for a normal distribution corresponds to a coverage probability of approximately 95%.

^A The uncertainties of NormX,Y,Z do not affect the E²-field uncertainty inside TSL (see Page 8).

^B Numerical linearization parameter: uncertainty not required.

Frequency Response of E-Field

(TEM-Cell:ifi110 EXX, Waveguide: R22)

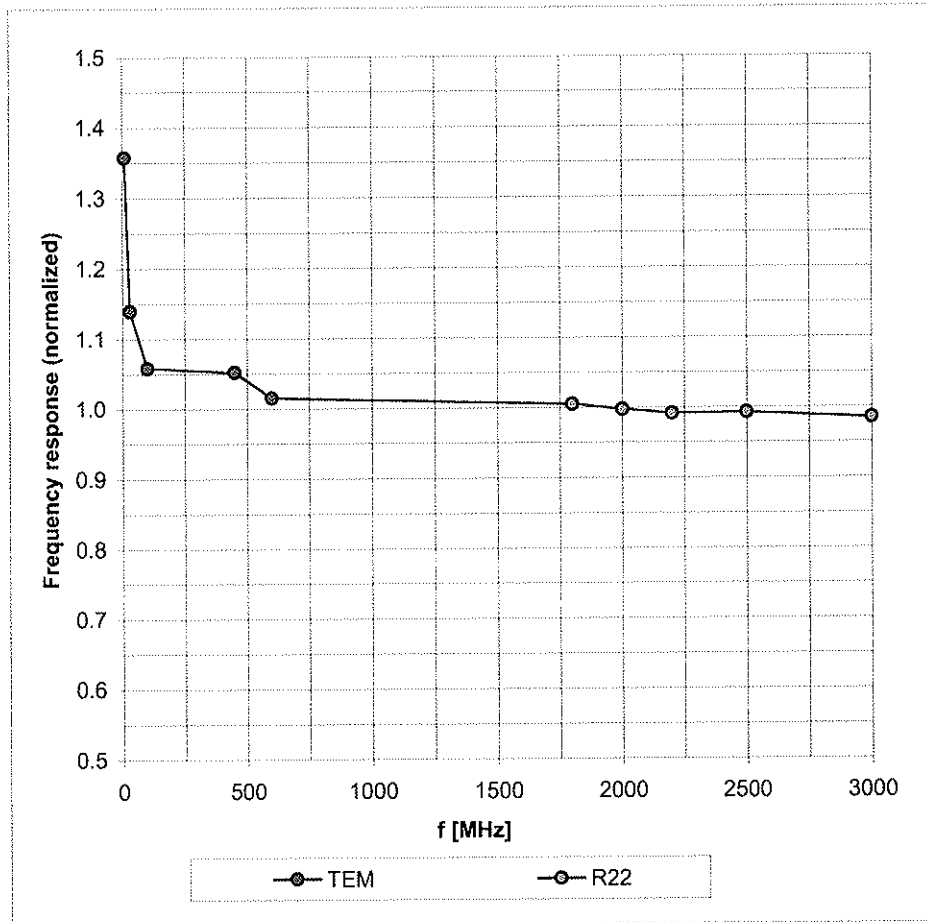

Uncertainty of Frequency Response of E-field: $\pm 6.3\%$ (k=2)

Receiving Pattern (ϕ), $\vartheta = 0^\circ$

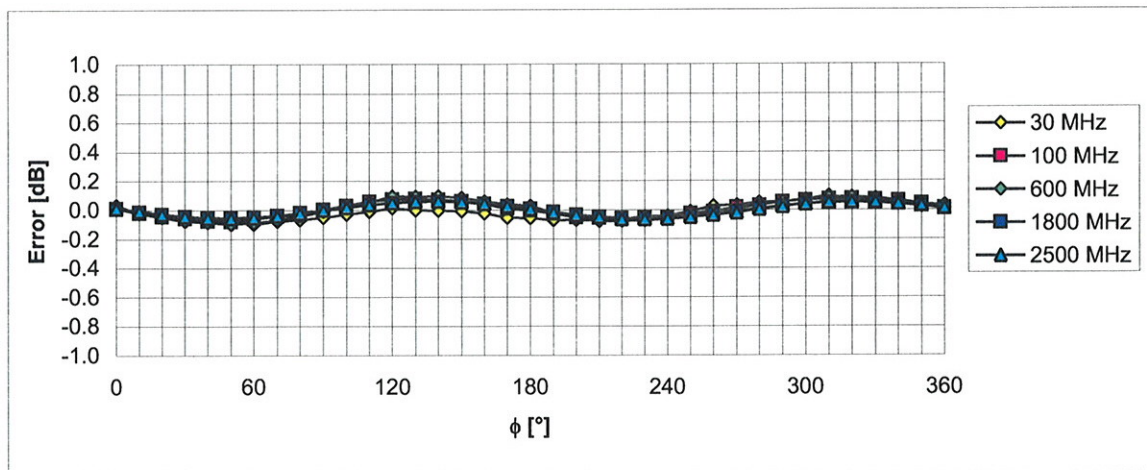
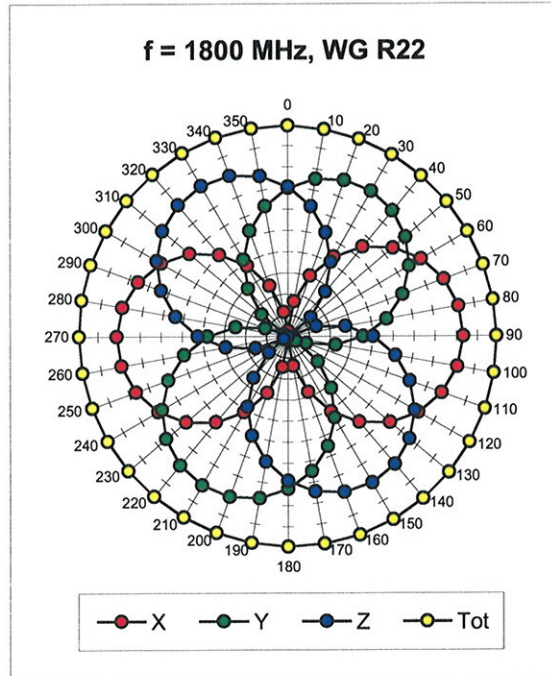
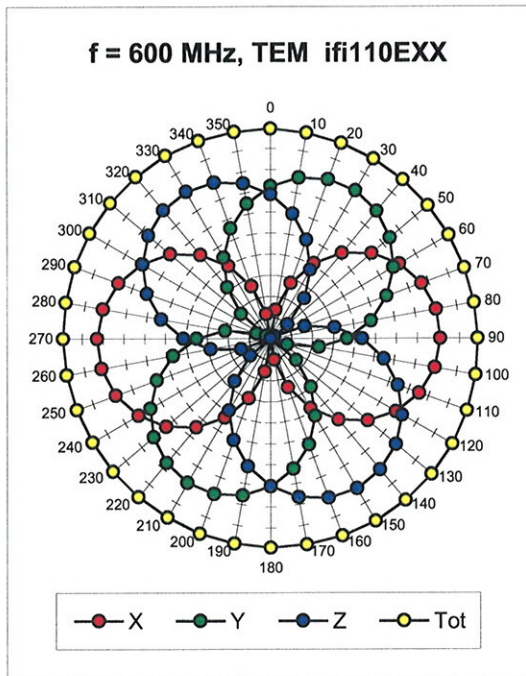

Uncertainty of Axial Isotropy Assessment: $\pm 0.5\%$ ($k=2$)

Dynamic Range $f(SAR_{head})$ (Waveguide R22, $f = 1800$ MHz)

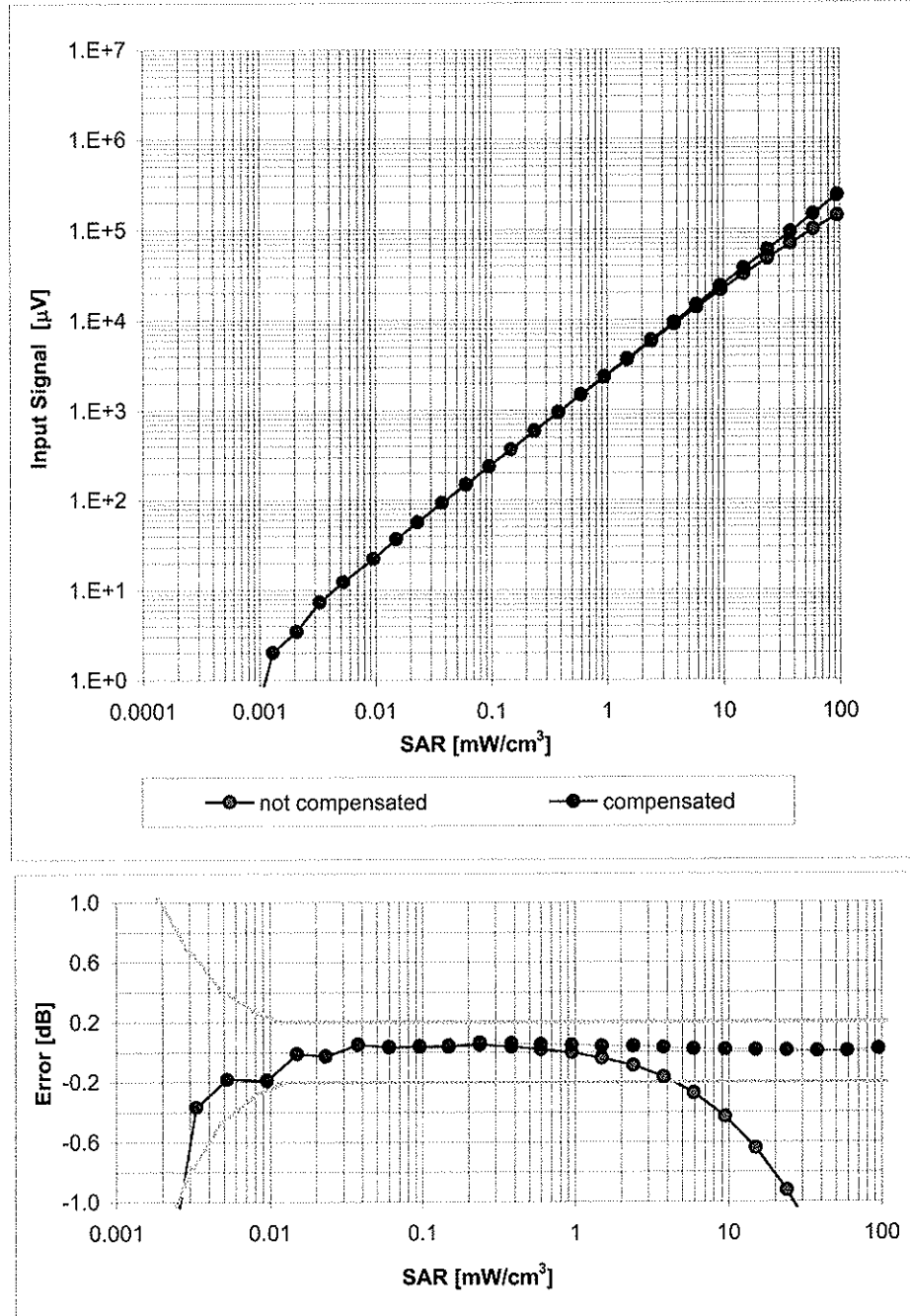

Uncertainty of Linearity Assessment: $\pm 0.6\%$ ($k=2$)

Conversion Factor Assessment

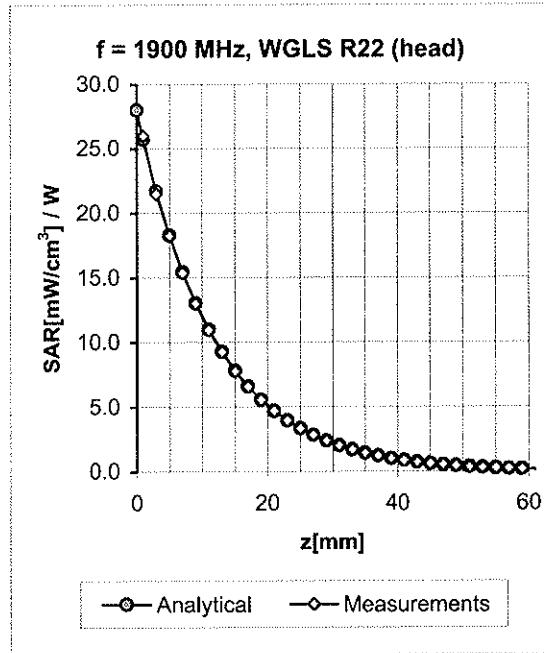
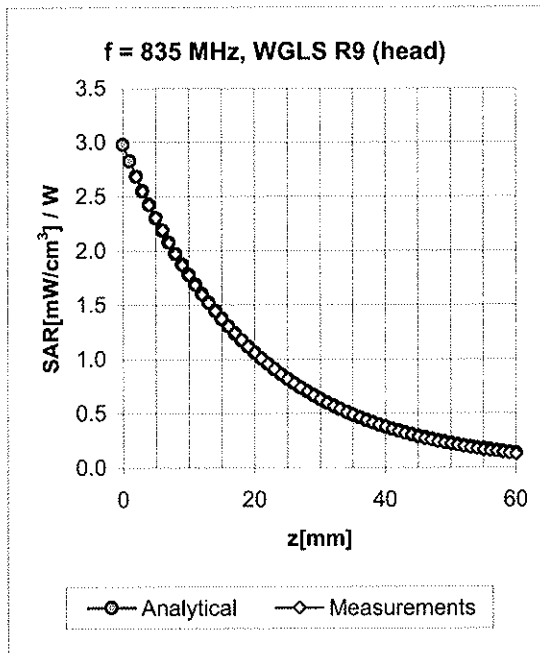

f [MHz]	Validity [MHz] ^c	TSL	Permittivity	Conductivity	Alpha	Depth	ConvF Uncertainty
835	± 50 / ± 100	Head	41.5 ± 5%	0.90 ± 5%	0.27	0.99	8.28 ± 11.0% (k=2)
1900	± 50 / ± 100	Head	40.0 ± 5%	1.40 ± 5%	0.22	1.08	6.71 ± 11.0% (k=2)
2450	± 50 / ± 100	Head	39.2 ± 5%	1.80 ± 5%	0.44	1.00	6.29 ± 11.8% (k=2)
2600	± 50 / ± 100	Head	39.0 ± 5%	1.96 ± 5%	0.50	1.08	6.10 ± 11.8% (k=2)
5200	± 50 / ± 100	Head	36.0 ± 5%	4.66 ± 5%	0.36	1.75	4.60 ± 13.1% (k=2)
5300	± 50 / ± 100	Head	35.9 ± 5%	4.76 ± 5%	0.38	1.75	4.31 ± 13.1% (k=2)
5800	± 50 / ± 100	Head	35.3 ± 5%	5.27 ± 5%	0.35	1.75	4.16 ± 13.1% (k=2)
835	± 50 / ± 100	Body	55.2 ± 5%	0.97 ± 5%	0.33	0.91	8.30 ± 11.0% (k=2)
1900	± 50 / ± 100	Body	53.3 ± 5%	1.52 ± 5%	0.26	1.00	6.79 ± 11.0% (k=2)
2450	± 50 / ± 100	Body	52.7 ± 5%	1.95 ± 5%	0.47	1.00	6.37 ± 11.8% (k=2)
2600	± 50 / ± 100	Body	52.5 ± 5%	2.16 ± 5%	0.52	1.08	6.06 ± 11.8% (k=2)
5200	± 50 / ± 100	Body	49.0 ± 5%	5.30 ± 5%	0.42	1.70	4.12 ± 13.1% (k=2)
5300	± 50 / ± 100	Body	48.5 ± 5%	5.42 ± 5%	0.38	1.70	3.91 ± 13.1% (k=2)
5800	± 50 / ± 100	Body	48.2 ± 5%	6.00 ± 5%	0.35	1.70	3.97 ± 13.1% (k=2)

^c The validity of ± 100 MHz only applies for DASY v4.4 and higher (see Page 2). The uncertainty is the RSS of the ConvF uncertainty at calibration frequency and the uncertainty for the indicated frequency band.

Deviation from Isotropy in HSL

Error (ϕ, ϑ), $f = 900$ MHz

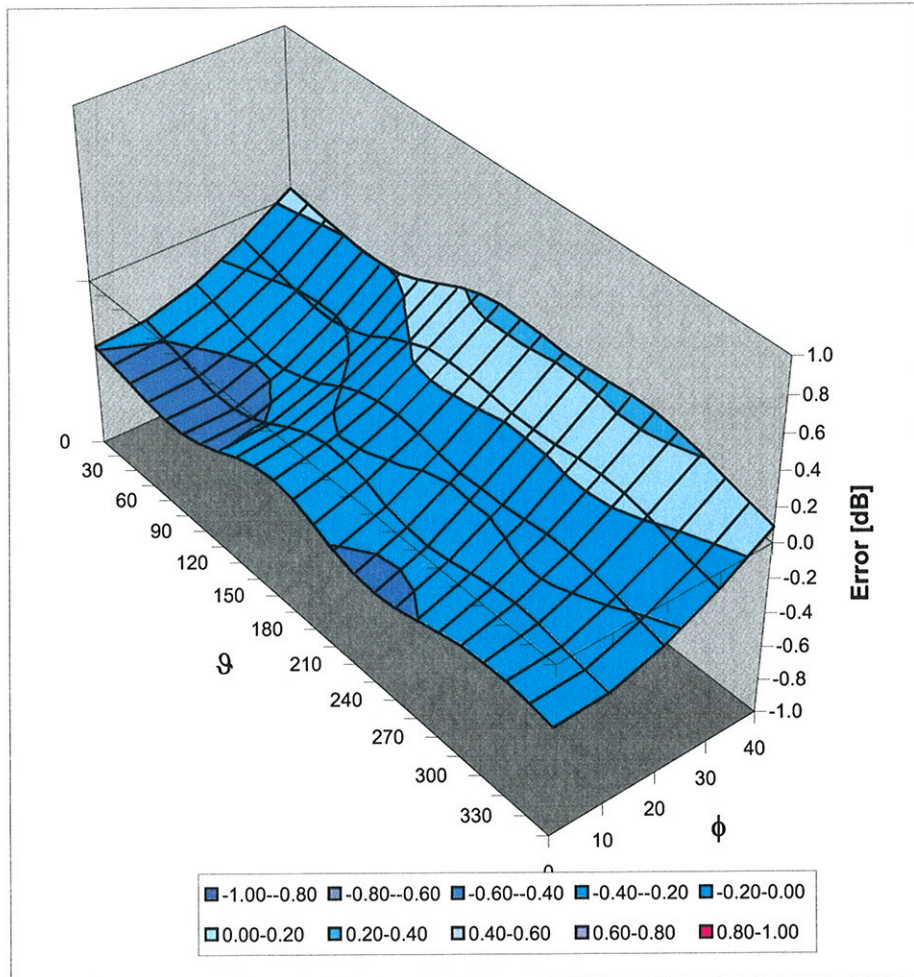

Uncertainty of Spherical Isotropy Assessment: $\pm 2.6\%$ ($k=2$)